

California State University, San Bernardino

CSUSB ScholarWorks

Theses Digitization Project

John M. Pfau Library

1990

A curriculum guide: for the freshman level program at Upland High School

Timothy S. Kistler

Follow this and additional works at: <https://scholarworks.lib.csusb.edu/etd-project>



Part of the [Health and Physical Education Commons](#)

Recommended Citation

Kistler, Timothy S., "A curriculum guide: for the freshman level program at Upland High School" (1990). *Theses Digitization Project*. 765.

<https://scholarworks.lib.csusb.edu/etd-project/765>

This Project is brought to you for free and open access by the John M. Pfau Library at CSUSB ScholarWorks. It has been accepted for inclusion in Theses Digitization Project by an authorized administrator of CSUSB ScholarWorks. For more information, please contact scholarworks@csusb.edu.

California State University
San Bernardino

// A CURRICULUM GUIDE: //
FOR THE FRESHMAN LEVEL PROGRAM
AT UPLAND HIGH SCHOOL

A Project Submitted to
The Faculty of the School of Education
In Partial Fulfillment of the Requirements of the
Degree of

Master of Arts
in
School Administration

By

Timothy S. Kistler, M.A.
San Bernardino, California

1990

APPROVED BY:

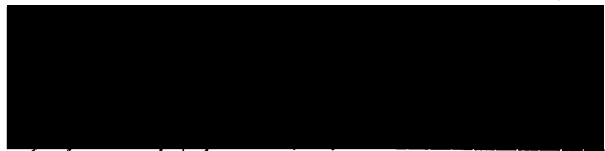

Advisor: Dr. Keith Dolan

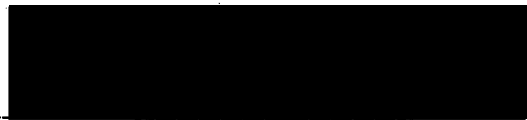

Second Reader: Dr. David O. Stine

ABSTRACT

The primary objective of this project is to develop a physical education curriculum guide for the freshman class of the Upland Unified School District.

The curriculum guide developed for this Master's project is a result of a review of current literature, new state guidelines, school site administrative considerations, fellow educator's suggestions, school district administrative input, and the author's own concern regarding the importance of a physical education program in the school system.

This guide is written so that the physical educators at Upland High School will have a base on which to conduct and evaluate a freshmen core physical education program. It is designed to allow teacher instructional flexibility, a necessity, considering the many different teaching styles, personalities, and class make up.

Although the main objective of this project is to implement a physical education curriculum guide for teachers at Upland High School, a consideration of the administrative functions and developmental process are also discussed in the guide. Both the guide, the administrative functions, and the developmental process are vital to the development and implementation of the curriculum.

DEDICATION PAGE

This project is dedicated to three special people, the first being my wife. Her patience, kindness, love, and support means more to me than anything else in this world.

The second person is my son, Joshua. His boundless energy has shown me that even though I may be on my last wind, I can still dig down deep to find the extra help that is needed to complete this work.

The third person is my precious, newly born daughter, Nichole, who reminds me of how beautiful life can be.

PART I
TABLE OF CONTENTS

Title Page i
Signature Page ii
Abstractiii
Dedication Pageiv

PART I

CHAPTER ONE: Introduction 1
CHAPTER TWO: Review Of Literature 4
CHAPTER THREE: Assessing The Needs 16
CHAPTER FOUR: Evaluation 23
CHAPTER FIVE: Summary And Conclusions 29
TABLE I 30
BIBIOGRAPHY 31

PART II
TABLE OF CONTENTS
A CURRICULUM GUIDE :
FOR THE FRESHMAN LEVEL PROGRAM
AT UPLAND HIGH SCHOOL

Title Page	A1
Statement of Philosophy ...	A2
Pursuit of Physical Activity	A3
Physical Fitness and Wellness	A4
Movement Skills and Knowledge	A6
Social Development and Interaction	A7
Self Image and Self Realization	A8
Pursuit of Individual Excellence	A9

ACTIVITIES

Badminton	A10
Basketball	A28
Dance	A49
Flag Football	A58
Soccer	A76
Softball	A93
Swimming	A112
Tennis	A122
Track and Field	A144
Volleyball	A161

CHAPTER ONE: INTRODUCTION

The main purpose of this project is to provide the Upland Unified School District with a physical education curriculum guide for the freshman class. Neither the high school nor the school district has an appropriate, updated curriculum guide at this time. The last curriculum guide presented to the high school was developed in 1974. This guide was developed during the time that Upland High School was part of the Chaffey Joint Union High School District. This district consisted of five different high schools located in five different socio-economic areas, each having it's own unique needs in a curriculum. No guide existed that was written specifically for the unique needs of the students at Upland High School.

Because there was no specific curriculum guide, if one wanted to teach a particular area of physical education, he or she had several ways in which to do it. The first way, was to draw upon the teacher's past experience in that particular sport. The second way was to obtain the needed information from another teacher or related source. The third way was to team with another teacher who had knowledge in the particular area to be taught. This kind of instruction tends to cause inconsistencies and confusions. Each teacher does his or her "*own thing*."

After realizing that the high school has never had a document written specifically for its needs, the author decided that both the students and teachers would greatly benefit from a comprehensive curriculum guide that would meet the specific needs of the students at Upland High School; one that would provide continuity and consistency to the physical education program. Therefore, the author set out to write an updated, more appropriate handbook that would not only help teachers meet the requirements set forth by the school district, but also be beneficial to the students by adding continuity and consistency to the program.

This project is not designed with stringent boundaries that must be followed to the tee, but rather as a system in which teachers can draw upon suggestions and information in order to teach and meet goals and objectives that have been set by the California State guidelines and fellow educators.

The development of this project has included a review of current literature, a needs assessment process, and formulation of chapters dealing with administration and evaluation as well as the actual curriculum guide. In developing this manual, the author asked each teacher for input in the area of his or her expertise. For example, the swim coach was asked to give input in the area of swimming. The track coach was asked to give input in the area of track.

Drawing upon other's expertise is a good method, for it brings out the strong points in the areas being taught. It also gives credibility to what is being taught in the physical education department.

While writing this curriculum project, the author stayed in close touch with the instructional coordinator and the Assistant Superintendent of Instruction at the school district. Because the author is writing this guide for both Upland High School and the school district itself, the author wanted to make sure that all of the contents were valid and usable.

Once the guide was written, the contents were discussed with the Physical Education Instructional Coordinator. The discussion included how the document would meet with the State Guidelines for physical education. If any segment was in question, the author, along with the instructional coordinator, assessed the problem and worked it out so that it was in compliance with the state.

This report was written to conform with state guidelines. The goals and objectives are consistent with those written by the State of California.

CHAPTER TWO: A REVIEW OF THE LITERATURE

A lack of fitness of epidemic proportions exists in much of our world, including the U.S.A. "... where such maladies as obesity, coronary heart disease, and low back pain have become significant problems." (American Alliance of Health Physical Education Recreation and Dance, 1980)

Rapid technological advances have contributed greatly to this problem. Lifestyles have changed, but the need for physical activity has not changed. Children have become more sedentary. Body tissues, when unused, begin to atrophy, and waste away. Muscle cells weaken and become flabby which makes the heart an insufficient pump. Fat cells plug up the blood vessels and accumulate throughout the body. This produces heart problems.

Scott Goodmen in Current Health (Nov. 1988) reports:

According to a survey released last year by the President's council, out of 19,000 six to seventeen year olds, a third of the boys and fifty percent of the girls cannot run a mile in less than ten minutes. (p. 8).

A recent Louis Harris poll confirms, "Forty percent of boys and seventy percent of girls cannot do more than a single pull up." (Time Magazine Jan. 26, 1987, p. 64).

A. Burfoot in Runner's World (Sept. 1985) continues:

Eighteen million youngsters take the Presidential Fitness Test each year, but in the 1983-1984 school year only two percent received the Presidential Sports Award, which goes to those scoring in the eighty fifth percentile or higher on all six exercises. (Sit ups, pull ups, standing long jump, 50 yard dash, shuttle run, and distance run). (p.36).

When you compare statistics of the children today and the children of 20 years ago, the facts become even more significant that the children of today are not in shape. John Carey says that "in 1954, fifty-eight percent of our children could not pass the physical fitness test. In 1983, over ninety-nine percent of the children could not pass the same test." (Newsweek, Apr. 1,1985, p. 84).

According to Reston (1986), a U.S. Department of Health and Human Services study reveals, "... children today have about twenty percent more body fat than kids of twenty years ago. One out of every three children is overweight; one out of every five is obese." (p. 12).

The fact that children are out of shape and overweight is a strong indicator that something needs to be done in the area of physical education.

"Studies show that most schools do not place a high priority in the area of physical education." (Betty Hennesy. Thrust. Sept.

1988, p. 8). The support for physical education has especially dropped in the last five years.

Physical education has played an important part in school curriculum since World War II, and is now considered expendable under tight budgets. "Unfortunately, physical education is often squeezed to the sidelines." (Francis, 1986, p.64).

At the present time, less than 24 states have mandatory physical education. Only a third of all students take such classes daily. (Votmeir, 1979, p.112).

One of two things is happening: 1) Schools are not putting a priority on physical education, or 2) Schools are not doing an adequate job of teaching the necessary components of physical education.

Physical education should be considered a vital element in any comprehensive, well balanced, educational program for optimum development of an individual physically, mentally, emotionally, and socially. (Beverly Hills High School Curriculum, 1985)

Physical education is very important, and should be dealt with as such. It is an important part of one's life both as a child and as an adult. Lessons learned about physical education will be carved into adulthood. The American Academy of Pediatrics contends that, "Lessons learned in school about exercise and physical fitness are likely to be carried into adulthood." (Koszuta, 1987, p.16).

If these lessons are not being taught, then we as educators are creating an unfit, unhealthy generation. In the National association for Sport and Physical Education, Reston (1986) writes: "In an increasingly complex, technologically advancing society, a most pressing need of students is to develop the skills and attitudes necessary for a productive and healthy quality of life." (p. 54).

Not only does physical education play an important role in one's body development, it also has far reaching, long lasting effects on the mind of an individual. (Pardik, 1984, p. 25).

S. Goodman (Current Health, Sept. 1988) notes:

... an unfit child may develop a low opinion of himself or herself, and an active dislike of physical activity and sports, and an antisocial attitude. Such a child also is likely to become a sedentary, overweight adult with cardiac, respiratory, and other added health risks. (p.8).

A. Burfoot (Sept. 1988) adds:

This spreading fitness failure may be affecting far more than our children's bodies. There is a strong connection between the decline in academic scores and the sorry state of fitness and health among our young people. (p36).

We really have to indicate that physical education is one of our most important studies. If a child is not alert and fit, all

the education in the world won't provide the desired benefits. Sound bodies create sound minds.

Carey (Apr. 1,1985) states:

In one Canadian elementary school, children ran, climbed and otherwise exercised vigorously during time taken away from their basic studies. Not only did their fitness levels rise when compared to those in other schools, but so did their scores on language and math tests. (p. 84).

Physical education is as important as any other area of the general education, and when well taught can contribute more to the goals of general education than any other school subject (Thatcher, 1988, p44).

In order for physical education to be well taught, a well thought out, comprehensive curriculum guide is needed. Before this guide can be developed, one must first understand what is meant when speaking of physical education.

C.E. Wilgoose (1986) defines physical education as, "Education through the physical." (p.37).

T. Wood (1962) defines the word in much more detail:

The term physical education is so misleading, and even misrepresented, that we look for a name which shall represent fairly the real idea of the science. What is physical education? This is one of the unsolved problems. Many people answer; 'the training and development of the physical;' and they consider that the aim and end may be

found in anthropometric apparatus, physical measurements and of averages.

Now these things are very well in their places, but if our science is to be worthy of the best efforts of men and women, and of the respect and recognition of the educational world, physical education must have an aim as human life.

The great thought in physical education is not the education of the physical nature, but the relation of physical training to complete education, and then the effort to make the physical contribute its full share to the life of the individual, in environment, training, and culture. (p. 127).

Physical education is not just the study of the human body but rather the study of life through the body. In order to build a satisfactory curriculum, one must understand that today's children are overweight and underfit, that the physical education program is important in teaching fitness, and that through physical education comes the understanding that a sound body creates a sound mind.

Keeping this information in mind, the goal would be for teachers and administrators to view physical education as part of the whole school curriculum as important as math, science, or any other subject.

In the California State Handbook for Physical Education
(1986) Bill Honig writes:

This handbook is designed to encourage teachers and administrators to view physical education as an integral part of the school's educational program and as a discipline through which students not only learn the skills necessary to perform physical activities successfully but also understand the importance of those skills and transfer them to other areas of instruction. (p.3).

A curriculum guide should be an organized, sequential, orderly set of guidelines that develops knowledge, skills, attitudes, and understandings through the use of the concepts and principles of human movement and through participation.

The scope of the curriculum will vary from school district to school district and the content of the physical education curriculum needs to be organized so that boys and girls will be able to progress toward an increasingly mature utilization of their knowledge and competency. (Handbook for Physical Education 1986) "Physical educators can achieve a balanced and diverse program by (1) identifying appropriate areas of instruction for each grade level; (2) designing physical activities in a sequential manner; and (3) explaining the relationship between the areas of instruction and other subjects." (p. 5).

However, developing a curriculum guide is not as simple as one would like to think. According to Robert Zais (1979): "A

problem of curriculum design is ... the problem of maintaining balance in the curriculum. Balance, of course, means ensuring that appropriate weight be given to each aspect of the design so that distortions due to overemphasis and underemphasis do not occur." (p. 441).

In developing a curriculum one cannot just take a pinch of this and a dab of that. In order for consistency to take place at all, a map must be laid out, which takes away a lot of the "guess work." A curriculum design is a mode or a pattern. It is a generalized framework which exists for teachers individually and collectively.

The quality of the physical education program in an institution is dependent upon the administration more than any other factor. Wilgoose (1979) states, "As might be expected, the support of the school's administrator is crucial to successful curriculum development." (p. 205).

It is the responsibility of the administrator to set guidelines that provide direction for the development of a sound, comprehensive, program of physical education. Wilgoose (1979) adds:

It is true that what can be accomplished is dependant on the facilities, equipment and personnel, and time allotment available; but in any given situation, a good administrator produces a substantially better program than

a poor one.... Physical education will be much better understood when it is correlated as often as possible with other subject matter areas. (p.202).

D. Leieritz (1988) writes that: "Administrators who firmly believe in their teachers and their curriculum, can enhance staff involvement and moral by allowing teachers the autonomy to implement the physical education program utilizing the methods they find most effective for themselves and their students. " (p.12).

The administrator must set goals for the instructional program. The goals of the instructional program are the foundation for a common core of learning experiences for all students. These goals should promote a balance of activities grouped under fitness and wellness, motor performance, cognitive, and effective areas. The goals should include performance objectives, sequential progression of activities, and prescribed evaluation procedures.

These goals should provide students with several different learning activities. First of all, a well managed instructional environment should be provided because of the importance of a physically and emotionally safe place to learn. Secondly, opportunities should be given to develop and improve movement skills in a wide range of activities that go beyond the beginning level. Thirdly, experiences should contribute to the student's own development of personal programs for gaining and maintaining a

high level of physical health and enjoyment of movement activities.

The administrator should provide a curriculum which meets state and school district standards. In providing this curriculum, the administrator must share responsibility with others involved in the curriculum area. Vann (1989) advocates, "Using common sense leadership, administrators can involve teachers in all aspects of management and instructional decision making." (p.17).

The administrator must take several things into consideration when involving teachers in the process. He or she should first consider which of the teachers can handle the extra burden of being on the curriculum committee. The administrator should then arrange for a proper meeting place for the teachers. There should be made available to the committee members resources, release time to participate in conferences, names of consultant services, and materials that would assist in developing a curriculum. The administrator should also be available for help in appraising the curriculum.

The administrator must be able to implement the curriculum once it has been completed. He or she must seek the support of the staff. In the case of this project, the administration and staff were both involved. This raised the level of awareness of the need for a curriculum and its implementation. The staff was able to give their input and

concerns about the physical education program. This way, the teachers have a part in the development of the curriculum.

The teachers, using the evaluation sheet, (table 1) were given an extended opportunity to help in the implementation and the updating of the curriculum. According to Wilgoose (1979) : "When teachers are involved in planning, selecting implementation, evaluating, and revising the curriculum the program is more likely to achieve the needs and interests of the participants." (208).

The administrator should have the curriculum evaluated at least once a year by the teachers. Achievement and program objectives should be measured and decisions should be based on the information gathered. The process of measurement and evaluation should be viewed as a means to improve the students knowledge, learning, and experience in physical education. It should be a means of helping the students to realize their potential and to help administrators redirect programs where necessary.

The administrator must realize that scheduling, time, and class size have a direct bearing on the health, safety, and extent of participation by the students. A daily instructional period of directed physical education should be provided for all students. The instructional program should be structured for maximum participation and for optimal achievement by all students. Class

size in physical education should not exceed those in other areas of education.

The administrator must produce a budget that gives way to quality facilities, equipment, and supplies that will enhance the program. These are of the utmost importance in conducting a comprehensive program of physical education, and should be provided for the instructional program in accordance with the needs of the students. The daily maintenance services of the facilities must also be provided for the health, welfare, safety, and performance of the students.

In conclusion, Leieritz (1988) states: "Administration of any school program requires ongoing attention to detail. Although most programs will not be as closely scrutinized in subsequent years as when they are initially implemented, a good administrator is always aware of strengths and weaknesses as well as possible changes. " (p. 23).

CHAPTER THREE: NEEDS ASSESSEMENT

The development of this guide was initiated as a direct result of teachers, and site and district administrators, who expressed a need for an improved curriculum in the physical education department of the Upland Unified School District. The district needed a guide that could be used as a tool to ensure that the department functioned as a well organized system. Therefore, the author set out to develop a guide that would meet the needs of the physical education department of Upland High School.

The author conducted extensive research in the area of physical fitness and physical education in order to gain the needed information to produce a curriculum that would be appropriate for the needs of Upland High School.

After assessing that there was a need for a new physical education curriculum, the author used the following five-step process to develop the curriculum:

The first step was to decide what was to be accomplished through the use of the guide, and then goals and objectives were set accordingly.

These goals and objectives were taken from the 1986 California State Department of Education Handbook. The handbook lists six program goals.

These goals are:

- A. Physical activity
- B. Physical fitness and wellness
- C. Movement skill and movement knowledge
- D. Social development and interaction
- E. Self image and self realization
- F. Individual excellence

These goals were then modified to meet the particular needs of the Upland High School Physical Education Department.

The author spent time observing various teachers in the physical education department of Upland High School. From these observations the author concluded that the California Education Handbook goals were being only partially met. There was also a lack of consistency in the methods used by the teachers to accomplish these goals.

The second step of the process was to balance out the importance given to each area of physical education. Every area of the physical education curriculum is equally important in the opinion of the author. Therefore, the author set out to give equal consideration to each. Meetings with physical education teachers, the Physical Education Instructional Coordinator, and the Assistant Superintendent of Instruction at the Upland Unified School District, helped to map out how the guide could be set up in such a way as to give equal time and consideration to all areas of the curriculum. These meetings varied in content from what

was to be taught in the curriculum area, to how the teachers could become more aware of the state guidelines, and therefore more closely follow the guidelines.

The third step was to develop learning activities for each curriculum area. Many teachers had concerns about various curriculum areas that were to be taught. For instance, the current curriculum consisted of 12 areas that were required to be taught during the freshman year and the beginning semester of the sophomore year. Teachers did not support this, and felt that the students should have more opportunity to choose elective classes. They felt the students needed more instruction in lifetime activities (golf, bowling, etc.). With the opportunity for more electives the students would get an opportunity to participate in more lifetime activities, ones they would most likely be involved with after high school.

After meeting with the teachers and the Instructional Coordinator, and receiving input about what they felt were the more important activities to be taught during the physical education core program, it was decided that the emphasis should be on meeting the state requirements of aquatics, rhythm, individual sports, team sports, fitness and combatives. A decision was also made to add a quarter of health/fitness, more lifetime activities, and more elective courses in the sophomore, junior, and senior years. The final outcome of this meeting was the decision to condense the core program into only one year, the

freshman year. This meant that four of the original core curriculum areas needed to be dropped or modified.

Following are the twelve areas that were previously being taught:

- a. Rhythm and movement
- b. Wrestling (boys)
- c. Gymnastics (girls)
- d. Flag football
- e. Basketball
- f. Soccer
- g. Badminton
- h. Tennis
- i. Track and field
- j. Conditioning
- k. Softball
- l. Volleyball
- m. Swimming

Some activities were combined and some were dropped altogether. In compliance with the state, and after numerous meetings, it was decided that the new guide would consist of the following activities:

- a. Rhythm and movement (Folk and Square Dance)
- b. Aquatics (Swimming)
- c. Soccer
- d. Flag football

- e. Track and field
- f. Volleyball
- g. Conditioning
- h. Racket sports (Badminton and Tennis)

A symmetry had now been provided to the program. A variety of different activities such as: aquatics, rhythm, individual sports, team sports, fitness, and daily life activities, had been included into the curriculum. These activities were set up not only to intertwine and support one another, but also to provide the balance that is needed to have a well organized physical education program.

The fourth step in the process was to develop evaluation procedures. Some type of an evaluation process is necessary for an effective program of any kind.

Various methods of evaluating physical fitness are suggested in the State mandated Physical Fitness Program Guide. One of the suggestions mentioned is to make an information card for each student that is involved in the freshman program. This procedure is structured so that the teacher who is giving the tests and measurements can write down the results on the card. This insures that the physical development and progress of each student is kept on record.

The following information will be found on the card.

- A. Name, Height and weight of the student
- B. Skin fold measurement, to measure body fat

- C. Shuttle run, to measure agility (timed)
- D. Sit ups, to measure abdominal strength (one minute time limit)
- E. Pull ups, to measure upper body strength (The bent arm hang may be used an alternative).
- F. 12 Minute run for distance, to measure cardiovascular endurance
- G. Sit and reach, to measure flexibility
- H. A comprehensive test on physical fitness, to measure student's knowledge on health and fitness.

The student's progress, listed on the card, will suggest how well the program meets the goals set forth in the guide, and what particular areas of the program need to be revised. Besides being used to keep track of students progress, the data on the card can be sent to the State for the annual fitness testing. This test should be given at least once a semester.

The measurement and evaluation of skill mastery, attitude, and knowledge, will be based on the teachers discretion. This information will not be listed on the card.

Along with the ability to participate skillfully in various physical activities, the author feels that the student should also have a cognitive understanding of the activities in the program. He has therefore included written tests as an important part of the curriculum guide.

The teacher can provide this information to the students in a regular classroom setting, and then reinforce this information during the "physical" part of the class.

The fifth step in the development of this guide was to ensure that it was practical and useful. As stated from the beginning, this project was developed because of a personal concern of a need for a curriculum guide to help the teachers of Upland High School implement a more effective physical education program.

Input from fellow teachers and administrators, extensive research, evaluation of the needs of Upland High School students, and information taken from the California State handbook, have together helped the author put together what the author feels is a useful and practical guide.

The author's hope is that this project will be a guide that will benefit the students by teaching them skills that will enable them to live mentally and physically "fit" lives.

CHAPTER FOUR: EVALUATION

A successful program must have as one of its components, a valid form of evaluation in which sound principles are understood and followed. When this occurs, greater depth and meaning are given to the total physical education program.

Evaluation should be considered as a means to an end and not an end in itself. Testing just for the sake of testing is not only a waste of time, but an actual obstruction to the total educational process. Evaluations should be given with a specific purpose in mind. Evaluation is the means through which we accomplish the task of developing well adjusted and physically educated students. Evaluation can help inform teachers of beneficial changes that occur for each student.

Evaluation should be consistent in what it measures and give meaning to the tests and measurements. One must be aware of the final objectives, know which tools are most effective for the data, and make unbiased judgments concerning educational significance in order to make an intelligent evaluation.

There are many reasons for using tests and measurements. Once the data has been taken, the interpretation and usefulness of the information may have different applications. A test that is given for the purpose of improving the learning process may be put to further use in the area of grading, and or interpreting the program to students, administrators, and teachers.

Test and measurements in the evaluation process should be used to:

1. motivate students.
2. help the teacher assess the students' performances.
3. help students evaluate their own knowledge or skills.
4. assist the teacher in pinpointing the limitations as well as the strong points in a program.
5. aid the teacher in evaluation of different ways of instruction.
6. help establish norms for use in a school district as well as for comparison with national norms.
7. collect data for research.
8. determine the needs of individuals within the program and the extent to which educational objectives have been accomplished.

The most effective evaluation program includes both formative and summative procedures. These will insure that some measurement is used throughout the unit of instruction in order to help the learning process.

Formative evaluation promotes high levels of learning among all the students and pinpoints areas where further development and learning are needed. Summative evaluation is used to determine whether broad objectives have been reached and to determine the extent of achievement.

The administrator should be responsible for the evaluation that takes place in the physical education department. He or she must evaluate the achievements of staff members and department objectives to determine if they have been successful or if improvement is needed. It is the administrator's responsibility to delegate the job of collecting the data, so that they can be evaluated. The administrator must also analyze the way in which data are investigated.

This project will analyze and evaluate the goals and activities of the physical education program in Upland High School. The six components of the State Physical Fitness Test will be used.

Whenever testing occurs, especially in areas where improvement can be monitored, pre and post-testing should be given. This can be accomplished through norm referenced testing. Students are then able to compare their individual efforts with students of their own age, sex, and particular ability level.

In selecting a physical fitness test, specific goals are needed for choosing the test items. First of all, a physical fitness test should measure capacities that can be improved with appropriate physical activity. Secondly, the test should accurately reflect an individual's physical fitness status as well as changes in functional capacity by corresponding test scores. The areas of bodily functions that are related to positive health are: (1) the cardiorespiratory function, (2) the body composition

(skin fold), (3) the abdominal and low back musculoskeletal function and, (4) the agility function.

The test used to evaluate the cardiorespiratory function will be the twelve minute run. This is where the student will try and complete one and one-half miles within a twelve minute frame. The distance the student runs during the twelve minutes will be scored on a card (mentioned in the needs assessment section). The purpose of this test is to measure the cardiovascular fitness.

The test used to evaluate the body composition will be the skin fold test. The child will have the triceps and subscapular skinfold measured by the school nurse. The purpose is to evaluate the level of fat in school aged children.

The test used to evaluate the musculoskeletal function will be the modified sit ups, and the sit and reach. The sit-ups test will measure strength and endurance of the lower abdominals, while the sit and reach will measure lower body flexibility.

The test used to evaluate the agility function will be the shuttle run. The test, as a general motor ability test, is given to measure the students ability to run and change direction.

The criterion referenced testing is used to test the physical activity objectives. This type of testing is used to determine the student's progress as related to a certain learning task. The teacher will determine the criteria that are to be tested.

The criterion reference testing gives the teacher the flexibility needed when working with several different levels of ability in one class. An example of this type of testing would be for ninth grade boys to perform 44 modified sit ups in one minute. This type of testing measures the degree to which a student has a level of competence.

The measurement of knowledge in physical education classes is just as important as knowledge measurement in other subject area. The tools employed in the measurement of knowledge should be so designed that the teacher can easily determine what the students have learned from participation, from facts, and from materials presented within the unit. Specific tests and answer keys are given in the back of each section in the curriculum guide. (See the end of each curriculum area).

Goals dealing with social development, self image, and self realization, are very difficult to measure objectively. It is too often assumed that desirable changes automatically come about through physical education participation. It must be noted though, that games and other physical activities under poor leadership can give way to unwanted social change. Therefore, a systematic, conscientious effort should be made to evaluate this aspect of the student's development. One objective may be to determine the extent to which students get along with themselves and with others. Another objective may be to

determine the ability of students to work as part of a "team." Another is to measure the ability of a student to be able to work under different types of authority.

The final goal, which is the goal of excellence, may be measured by the student's increased skill and knowledge. This type of measurement makes it possible for students with less knowledge and skills to actually receive higher grades.

The administrator is a key figure in the implementation of a new curriculum guide. He or she must be able to evaluate the validity and the reliability of each area being taught. He or she must be able to measure the attitudes of the students, as well as the teachers to determine what parts need to be changed in the curriculum.

The teacher is also a key figure to a successful program. He or she needs to give suggestions for improvement of the guide. Times change and so do needs of the students. If no modifications of the curriculum takes place, the guide becomes stagnant and useless. Teachers must be willing to make changes so as to stay in touch with the ever changing needs of the students.

CHAPTER FIVE: SUMMARY AND CONCLUSIONS

The need for consistency, information, and cooperation are some of the reasons for writing this curriculum guide. The author's hope is that the curriculum will provide the information needed to teach the freshman physical education program at Upland High School.

The desire of the staff of the Upland High School Physical Education Department is to serve the community by providing a program that helps the student learn through the physical. It is also the desire of the department of the department to provide a safe and meaningful learning environment that the students will be able to draw upon in their years to come.

This curriculum guide is more than rules and information. It is an expression of opportunities and advantages offered by Upland High School.

It is the hope of this author that the teachers, and site and district administrators will assist in the implementation and evaluation of this curriculum guide. The support and effort from each administrator will ensure the success of this guide, rather than it being just another guide that was written to fulfill a master's project requirement.

EVALUATION FORM

ACTIVITY BEING EVALUATED

TEACHER'S NAME

1. WAS THIS GUIDE A HELP TO YOU IN YOUR TEACHING OF THE CLASS? (CIRCLE 1) YES NO

A) IF YES, HOW WAS IT A HELP TO YOU.

B) IF NO, HOW COULD THE GUIDE BE CHANGED OR IMPROVED TO MEET YOUR NEEDS ?

2. WHAT COULD BE ADDED OR TAKEN AWAY FROM THIS GUIDE SO THAT IT WOULD BE MORE HELPFUL TO OUR PROGRAM.

(PLEASE FEEL FREE TO USE BOTH SIDES OF THE SHEET)

BIBLIOGRAPHY

- American Alliance of Health, Physical Education, Recreation, and Dance (1980). Fitness and Performance Test manual. Reston: Virginia.
- Beverly Hills School District. (1985). Beverly Hills High School Curriculum. [School Curriculum] Beverly Hills, CA.
- Burfoot, A. (1985, September). Johnny Can't Run. Runner's World, pp. 36-37
- Honig, Bill. (1986). Handbook for physical education: Framework for developing a curriculum for California public schools, kindergarten through grade twelve. California State Department of Education. Sacramento, California: California State Handbook on Physical Education. p. 3-5.
- Carey, John. Joseph, Nadine. (1985, April 1) Failing in fitness Newsweek. pp. 84-85.
- Francis, R. (1986, May). Physical education makes winners. Parents. p. 64.
- Getting an F for flabby (1987, January 26). Time magazine. pp. 64-65.
- Goodman, S. (1988, September) '80's actualities: are we really better off? Current Health, pp. 8-9.
- Koszuta, L.E, (1988, November). Find out how fit you really are. Current health. pp. 15-16.
- Leieritz, D. (1988) An Intermediate school physical education Curriculum: A guide and it's development. (Masters Thesis, California State University at San Bernardino, 1988) pp.12-23
- Hennessy, Betty. (1988, September) Lifetime Fitness starts at school Thrust. pp. 8-9.

- Pardik, I. (1984). Quantum Fitness: Breakthrough to excellence. New York: Pocket Books. Division of Simon and Schuster. p.25.
- Reston, B. (1986). Guidelines for secondary physical education. Virginia: National Association for Sport and Physical Education. p. 12.
- Thatcher, R. (1988). Private School Faculty Handbook. (Masters Thesis, California Polytechnic at Pomona, 1988) p. 44.
- Vann, A. (January 1989) Shared Decision Making For Principals and Teachers. Education Digest. p.17
- Voltmeir, E.F. (1979). The organization and Administration of physical education. New Jersey: Prentice Hall Inc. p.112.
- Willgoose, C. E. (1979) The curriculum in physical education (3rd ed.). New Jersey: Prentice Hall Inc. pp. 202-208.
- Willgoose, C.E. (1986). Evaluation in health education and physical education. New York: Hill Book Co. Inc. p. 37
- Wood, T. (1962) The scientific approach in physical education: the making of American physical education. New York: Meredith Publishing Co. p. 127.
- Zais, R. (1976) Curriculum Principles and Foundations. New York: Thomas Y. Crowell Co. p.441.

APPENDIX A

**CURRICULUM GUIDE:
FOR THE FRESHMAN LEVEL PROGRAM
AT UPLAND HIGH SCHOOL**

Developed by:
Timothy Kistler. M.A.
Upland High School
Summer, 1989

THE AUTHOR'S STATEMENT OF PHILOSOPHY

Physical education should meet the individual needs of each student. Each individual is unique and therefore, the program should be diverse enough to meet these individual needs, interests, and abilities.

Physical education is an integral part of education and contributes to the development of the individual through planned movement, physical activity, exercise, and academic studies.

Physical education includes a body of knowledge that depends on many disciplines including the physical, biological, and behavioral sciences.

The philosophy at Upland High School is that human needs exist throughout a lifetime. Therefore, education, including physical education, must be viewed as a continual process.

The following pages are goals stated in the California State handbook of Physical Education.

PURSUIT OF PHYSICAL ACTIVITY

The object of this goal is to develop interest and proficiency in movement skills that are essential to lifelong participation in physical activity. It includes :

1. Observing and experiencing a wide variety of physical activity and plan the future physical activity based on these experiences.
2. Participating in the full range of physical activity, from forceful, explosive movements to quiet, restful movements.
3. Developing a proficiency in movement skills so that physical activity will be a successful and enjoyable experience.
4. Experiencing the pleasure and exhilaration inherent in physical activity.
5. Appreciating the value of physical activity and choosing active, rather than passive, life styles.
6. Observing safe practices during participation in physical activity and balancing safe practices with a willingness to take risks.
7. Using school and community resources for lifelong participation in physical activity.
8. Learning the principles of movement and the history, rules, and strategies of various activities.

PHYSICAL FITNESS AND WELLNESS

The object of this goal is to develop and maintain the highest profitable level of physical fitness and wellness in order to meet the demands of high level physical performance during work, play, and emergency situations. It includes :

FITNESS

1. Improving and maintaining cardiorespiratory efficiency through regular aerobic activities of sufficient duration and intensity to achieve a training effect.
2. Improving and maintaining the ability to exert force through progressive and gradual resistance activities that overload a muscle group.
3. Improving and maintaining the ability of muscle groups to persist in physical activity.
4. Improving and maintaining the functional capacity of specific muscles and joints.

WELLNESS

1. Understanding the relationship between nutrition and exercise.
2. Identifying personal stress symptoms and cope with stress through relaxation techniques.
3. Understanding the value of adequate and regular sleep and the relationship between rest and vigorous activity.

4. Understanding the principles and practices of proper conditioning, warm-ups, and cool downs as they pertain to the preventions and care of injuries.
5. Observing sound practices relating to bodily health and cleanliness.
6. Learning the principles, mechanics, and concepts of all physical fitness and physical wellness components as they relate to personal health and physical performance.

MOVEMENT SKILLS AND KNOWLEDGE

The object of this goal is to understand the foundations of movement and to develop increasingly effective movement skills through selected daily movement experiences. It includes :

1. Receiving, interpreting, and responding to visual, auditory, tactile, and kinesthetic stimuli.
2. Improving fine and gross motor skills and locomotor and nonlocomotor movement performance and performance involving object manipulation.
3. Being aware of how the body moves and adjusts to flow, weight, time, and space and appreciating the aesthetic and expressive elements of movement.
4. Assessing and identifying functional, static, and dynamic posture problems and improve them through exercise.
5. Transferring learned movement skills and concepts from one activity to another.
6. Learning the foundations and relationships of efficient, effective, and purposeful movement.

SOCIAL DEVELOPMENT AND INTERACTION

The object of this goal is to develop appropriate social behaviors by working independently as well as with others during planned physical activity. It includes :

1. Understanding that getting along with others begins by accepting one's self, including one's physical capabilities.
2. Appreciating the performance of others and understanding the decision of authority figures.
3. Perceiving and appreciating similarities and differences between individuals.
4. Seeking the company of others and develop friendships.
5. Sharing in the development of one's peers by giving and receiving support.
6. Developing the skill needed to control aggression and conflicts while participating in physical activity.
7. Understanding the relationship between effective group living and to cooperate and compete fairly.

SELF IMAGE AND SELF REALIZATION

The object of this goal is to develop and maintain a positive self image and to strive to achieve self realization through planned physical activities. It includes :

SELF IMAGE

1. Developing an accurate concept of one's body.
2. Accepting one's physical capabilities and limitations.
3. Recognizing stressful situations and symptoms and developing the skills and strategies to deal with them.
4. Understanding the relationship between human anatomy and bodily functions as they affect the development of a positive self image.

SELF REALIZATION

1. Being aware of one's feelings and their role in behavior.
2. Developing a personal code of ethics.
3. Taking charge of one's personal well being through self evaluation, critical thinking, and planning for growth.
4. Exploring solutions to movement problems and create new movement forms and patterns.
5. Enjoying and celebrating the struggles and success of participating in physical activity.
6. Understanding the components of self image and self realization and how they contribute to develop one's potential.

PURSUIT OF INDIVIDUAL EXCELLENCE

The object of this goal is to achieve the highest level of physical performance through the application of all available knowledge, movement experiences, and personal resources.

It includes :

1. Evaluating one's capability to establish realistic personal goals.
2. Identifying and assessing the merits of one's motives.
3. Developing the perseverance needed to make the extra effort required for high achievement.
4. Developing the ability to focus on critical elements and ignore distracting elements and ignore distracting elements.
5. Developing the confidence needed to pursue excellence.
6. Seeking to excel in rigorous physical training.
7. Experiencing the sense of satisfaction and exhilaration from high level physical performance.
8. Understanding and applying the knowledge essential for high achievement.

PURSIUT OF INDIVIDUAL EXCELLENCE

The object of this goal is to achieve the highest level of physical performance through the application of all available knowledge, movement experiences, and personal resources.

It includes :

1. Evaluating one's capability to establish realistic personal goals.
2. Identifying and assessing the merits of one's motives.
3. Developing the perseverance needed to make the extra effort required for high achievement.
4. Developing the ability to focus on critical elements and ignore distracting elements and ignore distracting elements.
5. Developing the confidence needed to pursue excellence.
6. Seeking to excel in rigorous physical training.
7. Experiencing the sense of satisfaction and exhilaration from high level physical performance.
8. Understanding and applying the knowledge essential for high achievement.

A

GUIDE

TO

BADMINTON

TEACHING PACKET BADMINTON

COURSE DESCRIPTION

The purpose of this unit is to acquaint students with the basic knowledge needed to actively participate in badminton. It is essential that the students learn the basic skills and game strategy necessary for individual satisfaction.

INTRODUCTION

History
Safety
Rules

BEGINNING

Grip
Strokes
Serve
Terminology

INTERMEDIATE

Overhead strokes
Underhand strokes

ADVANCED

Smash
Dink
Clear
Strategies

EVALUATION PROCESS

Written and or practical evaluation will be used to determine student knowledge and skill development of badminton.

HISTORY

A game with some sort of racquet using a feathered object is found way back in history. A game similar to badminton was played in China some centuries ago, and there is some mention of the game as far back as the twelfth century in the Royal Court records of England. A portrait of "Young Prince Sulkonsik" by Adam Mangoki, who live about 1700, shows young members of the Royal Family of Poland holding a shuttlecock and racquet, with a stance similar to that used by a modern expert preparing to serve. A portrait by Jean Simeon Chardin (1699-1779), which now hangs in the Uffizi Gallery in Florence, depicts a young girl with a racquet and shuttle.

It is generally accepted that the modern game of badminton was named when a group of British army officers home on leave from India played the game at Badminton, the country estate of the Duke of Beaufort in Gloucestershire, England. The date was sometime around 1873. In 1878 the New York Badminton Club was founded. This is said to be the oldest organized club in the world. Original records stored in New York City Museum of History substantiate this claim. The American Badminton Association was founded in 1936. This association changed its name in 1977 to the United States Badminton Association.

SCORING

- a) Only the serving side may win a point.
- b) A player needs to win by only one point.
- c) In doubles and men's singles, a game consists of either 15 or 21 points. (This must be decided at the beginning of the game).
- d) In women's singles a game ends when the first player receives 11 points.
- e) A match generally consists of the best of three games.

DOUBLES PLAY

- a) Service is decided by spinning a racket for the choice of the side or the choice of serving.

- b) At the start of a doubles game the two sides nominate a server and a receiver.
 - 1) The server serves from the right service court.
 - 2) Upon winning the first point, the server then moves to the left service court and serves to the opponent's left service court.
 - 3) The opponent who did not receive on the first point now becomes the receiver.
- c) On the initial service of the game, only one hand is automatically down. (Only one partner is able to serve at the beginning of the match.) When the server loses the serve, side out or service over is declared.
 - 1) When this serve is lost, the serve is now given to the player who is in the right service court. This player serves from alternate courts until the rally is lost.
 - 2) That player's partner then takes over, serving from the court occupied at the beginning of the losing rally. The second partner serves from the alternate court until that rally is lost.
 - 3) The service then passes across the net, and both partners serve. This manner is continued until the the game is ended.

SINGLES PLAY

- a) The serving court is always decided by the server's score. If it is an even score the right hand court is used. If it is an odd score, the left hand court is used.
- b) The shuttle or bird is served into the service court diagonally opposite to the server.

FAULTS

- a) If the server commits a fault, the opponent take over the serve.
- b) If the nonserver or receiver commits a fault, the server wins a point.

SERVICE FAULTS

- a) A fault is considered a service fault if:
 - 1) the shuttle is hit above the waist.
 - 2) the head of the racquet is not below the level of the hand holding the racquet.
 - 3) the server's feet are not in the correct serving court.
 - 4) neither of the server's feet are in contact with the floor.
 - 5) a feinting move is made. (Deceptive move)
 - 6) the bird lands outside the correct service court.
 - 7) the receiver is not standing within the correct service court.
 - 8) a foot which is on or touching a line.
 - 9) the receiver moves before the shuttle is struck.
 - 10) the server serves before the receiver is ready, but the receiver shall be deemed ready if a return is attempted.
- b) If on the serve the bird touches the net, yet still goes into the proper service court, it is legal and play continues. If the server in attempting to serve, misses the bird completely, it is not a fault.

GENERAL FAULTS:

A general fault occurs if:

- a) The bird falls outside the court;
- b) A player is struck by the bird;
- c) A player hits the bird twice in succession or a player and partner hit the bird on successive shots;
- d) The bird is struck before it crosses the net;
- e) A player touches the net while the bird is in play.
- f) A player catches a bird instead of letting it drop.
- g) A player obstructs an opponent.

PLAYER ETIQUETTE

- a) A warm up should always precede the game. Avoid the temptation to "kill" the shot at each opportunity. Begin warming up with clear shots.

- b) When there is no umpire, the server keeps the score. The score should be given clearly before each serve. The server's score should always be given first.
- c) A player should wait until a rally is over before attempting to recover a bird which has fallen on or near an adjacent court.
- d) No one should walk behind the baselines while a rally is underway.
- e) The server should be certain that the opponent is ready for the service before the bird is served. The receiver should prepare as quickly as possible, not taking an undue amount of time before each service.
- f) If a spectator interferes with the progress of a player, the point should be replayed.
- g) If a referee is not present, each player should call his own carries. At no time should an opponent call an illegal hit. A partner may call a carry on his partner.
- h) A player should always let the bird drop to the ground when out of bounds. The bird should not be caught and declared out.
- i) A referee's decision should never be questioned either verbally or non verbally.
- j) The loser of a match should be the first to congratulate the winners.

BADMINTON DEFINITIONS:

Alley: The extension of the court by one and one half feet on both sides for doubles play.

Back alley: The area between the back boundary and the long service lines.

Badminton: The name of the game that came from the village of Badminton in Gloucestershire, England.

Bird: The object (made of feathers, nylon or plastic) which flies through the air over a badminton court in place of a ball. Officially known as a shuttle cock.

Block: Placing the racquet in front of the bird and letting it rebound into the opponent's side of the court. It is not considered a stroke.

Carry: The momentary holding of the bird on the racquet during the execution of a stroke, which is illegal. This is also call a sling or a throw.

Clear: A high, deep shot hit to the back boundary line.

Court: The area bounded by the outer lines of play. For singles it is the long and narrow boundaries. For doubles, it is the entire area.

Crosscourt Shot: A shot hit diagonally from one side of the court to the other side of the court.(Opponent's side).

Deception: The art of deceiving or outwitting one's opponent. This is accomplished in badminton with a deceptive stroke.

Drive: A fast and low shot which makes a horizontal flight pattern over the net.

Driven Serve: A quickly hit serve with a flat trajectory.

Dropshot: A finesse stroke hit with very little speed. This shot falls close to the net on the opponent's side.

Face: The hitting surface of the badminton racquet.

Flight: The path of the bird as it moves through the air.

Flick: To speed up the bird with a quick wrist action. This is useful in stroking from below the level of the net, thereby surprising an opponent by quickly changing a soft shot into a faster passing shot.

Game Bird: The game winning point.

Hairpin Net Shot: The stroke made from below and very close to the net with the bird just clearing the net and then dropping sharply downward.

Halfcourt Shot: A shot placed to the midcourt. This shot is used more in doubles than in singles play, especially against the up and back formation.

Inning: The term of service. The time in which during a player or side holds the service.

In Play: The bird is said to be "in play" from the time it is struck by the server's racquet until it touches the ground.

Kill: The fast downward shot which usually cannot be returned.

Let: The legitimate cessation of play that allows an exchange or rally to be replayed.

Love: No score. English pronunciation of the French word "l'oeuf", meaning goose egg or zero.

Love All: No score. Also used after a game has been set.

Match: The best two out of three games.

Match Point: The match winning point.

Net Shot: A shot hit from the forecourt with the bird just clearing the net cord.

Overhead: A stroke played above the height of the head.

Placement: A shot directed with control into an area where it will be difficult for the opponent to play.

Point: The smallest unit of scoring.

Push Shot: A gentle net shot played by merely pushing the bird.

Ready Position: An alert body position enabling quick movement in any direction.

Round The Head Shot: A stroke peculiar to badminton. An overhead stroke played on the left side of the body. The contact point is above the left shoulder for a right handed hitter.

Rushing The Servē: A quick spurt to the net in an attempt to put away a low serve simply by smashing the bird down into an opponent's court.

Serve or Service: The act of putting the bird into play.

Service Court: The area into which the serve must be delivered. In singles it is determined by the score.

Set Up: A poor shot which makes a "kill" easy for the opponent.

Shuttlecock: The official name for the bird.

Side In: This term refers to the side whose turn it is to serve.

Side Out: This occurs when the side that is serving loses the serve and becomes the receiving side or team.

Smash: The hard hit overhead shot which forces the bird sharply downward. It is the game's chief attacking stroke.

SINGLES STRATEGY

- a) Hit high and deep serves. This will cut down the angle of the opponent's return. Serve the short shot and use a flick serve at times to keep the opponent honest.
- b) Keep the opponent deep, when possible, by using quick deep clear shots.
- c) Keep the opponent away from the center of the court.
- d) As long as you are in good position, hit the shot that is most difficult to return.
- e) Hit the smart, easy shot for you. In singles it is better to play patiently.
- f) Contact the bird as high as possible on all shots.

- g) On overhead strokes, make sure you move to the bird and position your body properly instead of reaching off to the side.
- h) Be patient. Concentrate.
- i) Work on a good defensive high clear shot from the net and from the backcourt.
- j) Make sure you are moving back to the center of the court after all shots.
- k) Try to play your own game.

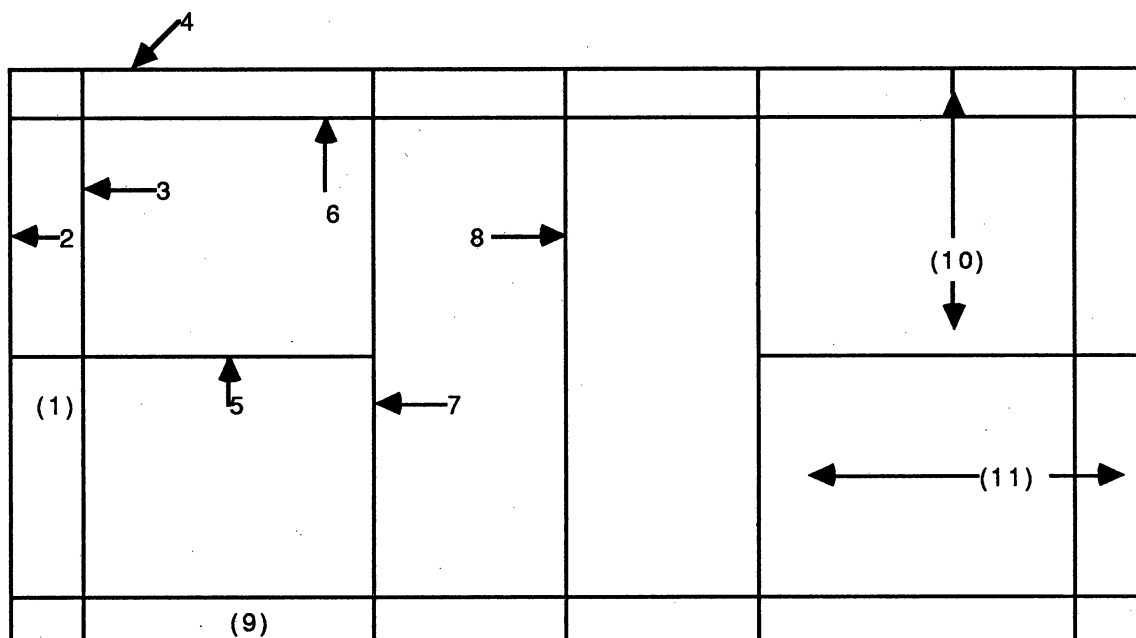

THE COURT.

Areas are marked with () while lines are marked with arrows --> or <--

- | | |
|-------------------------------|---------------------------|
| 1- Back alley | 2- Back boundary line |
| 3- Doubles back boundary line | 4- Doubles sideline |
| 5- Center line | 6- Singles sideline |
| 7- Neutral Zone | 8- Net |
| 9- Alley | 10- Doubles(short & wide) |
| 11- Singles (long & narrow) | |

FACE

HANGE

THROAT

GRIP

BUTT

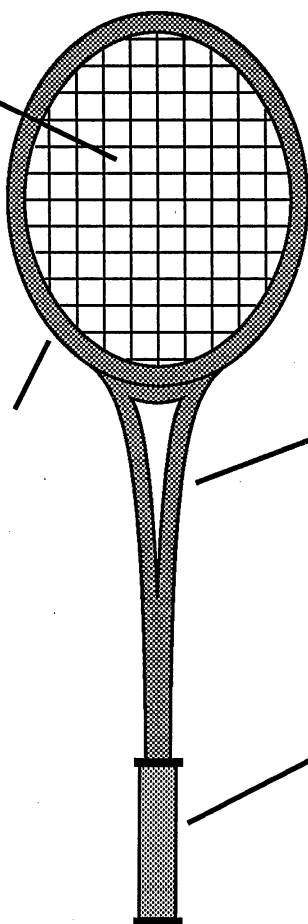

A VIEW OF SHOTS

A- SINGLES DEEP SERVE
B- CLEAR
C- DROP
D- SMASH

E- DOUBLES LOW SERVE
F- NET CLEAR SHOT
G- HAIRPIN DROP
H- DRIVES

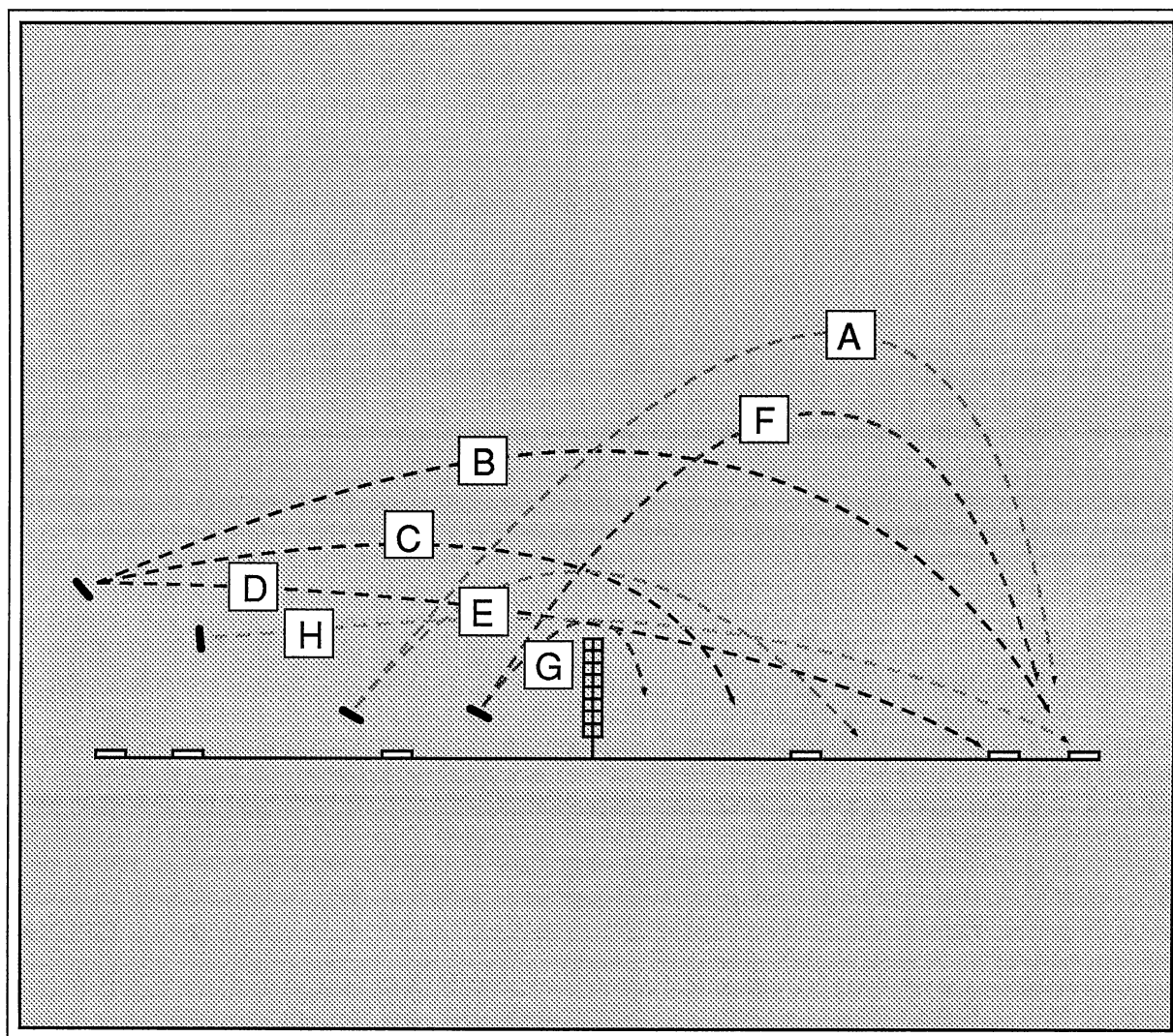

BADMINTON TEST

NAME _____

DATE _____

PERIOD _____

NAME THE LINES AND AREAS OF THE COURT. ON THE LINES PROVIDED PUT THE NAME OF THE LINE OR AREA THAT CORRESPONDS TO THE NUMBER ON THE DIAGRAM. AREAS ARE IN () BRACKETS. LINES HAVE ARROWS.

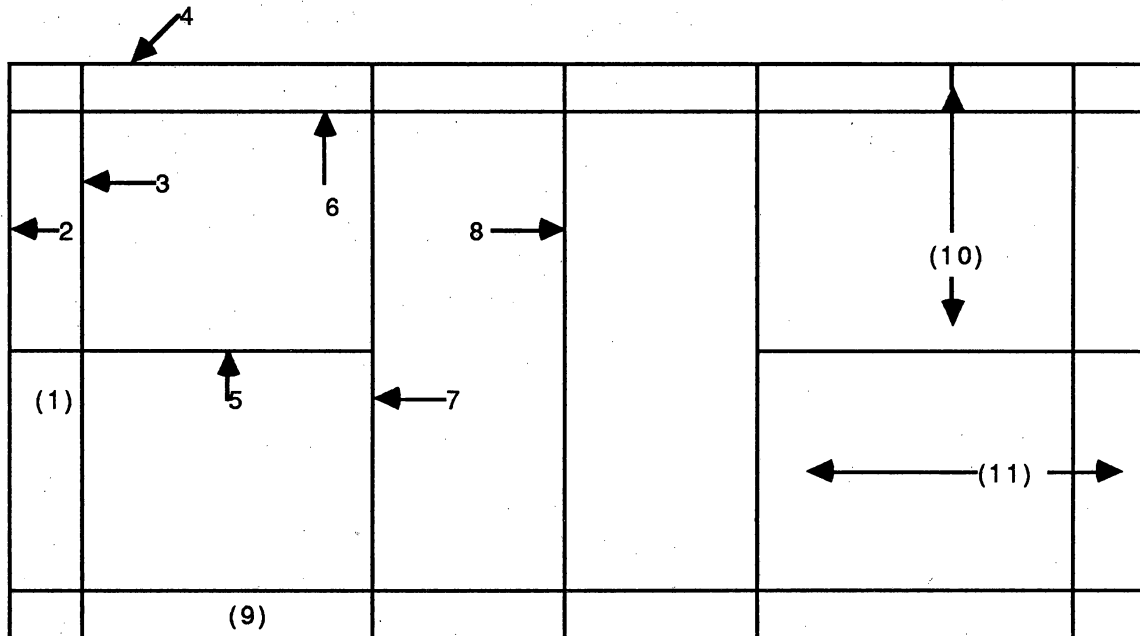

1. _____
2. _____
3. _____
4. _____
5. _____
6. _____
7. _____

8. _____

9. _____

10. _____

11. _____

12. What is the distance between line #7 and line #8 ?

13. Shade the right doubles service court with diagonals (NE to SW)

14. Shade the left singles service court with diagonals (NW to SE)

15. _____ What is the height of the net.

FILL IN: FILL IN THE CORRECT WORD OR WORDS THAT COMPLETE THE STATEMENT.

1. In singles the game goes to _____ points unless agreed upon before the game begins.

2. In doubles the game goes to _____ or 21 points unless set at another score.

3. You must be serving to be able to _____.

4. In singles the court your serve from is determined by the score. If your score is even you serve from the _____ court.

5. When a team has lost their term at service, _____ is called.

6. In doubles, after the first inning, when an error is committed by the receiving side, _____ is called.

7. Two out of three games is call a _____.

8. Shuttles falling on a line are considered _____.

9. To begin the game of badminton, the server always begins from the _____ court.

PARTS OF THE RACQUET

1. _____

2. _____

4. _____

3. _____

5. _____

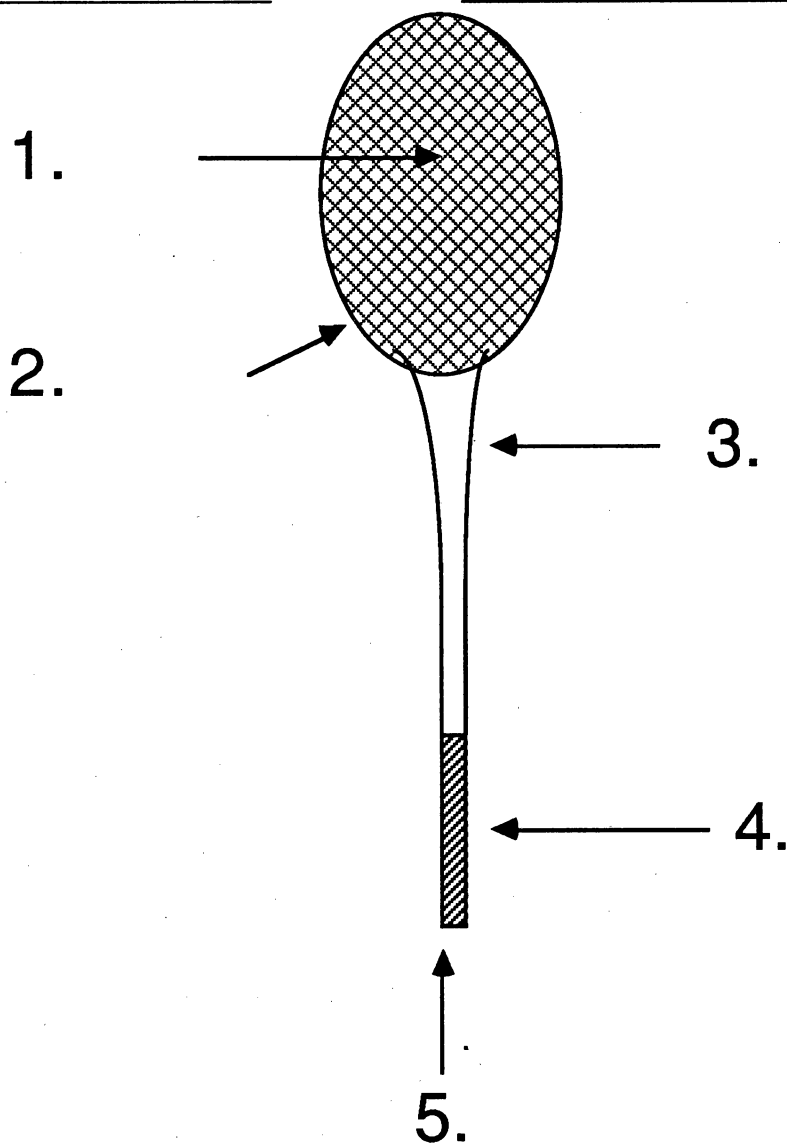

BADMINTON TEST

NAME ANSWER SHEET

DATE _____

PERIOD _____

NAME THE LINES AND AREAS OF THE COURT. ON THE LINES PROVIDED PUT THE NAME OF THE LINE OR AREA THAT CORRESPONDS TO THE NUMBER ON THE DIAGRAM. AREAS ARE IN () BRACKETS. LINES HAVE ARROWS.

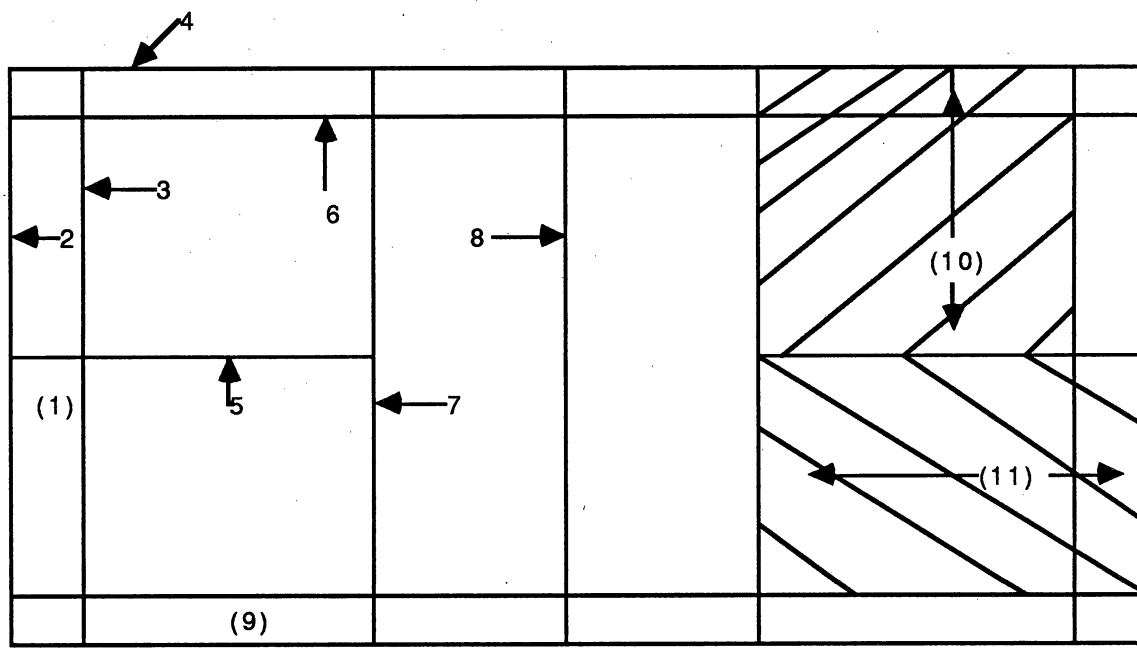

1. BACK ALLEY
2. BACK BOUNDARY LINE
3. DOUBLES LONG SERVICE LINE
4. DOUBLES SIDE LINE
5. CENTER LINE
6. SINGLES SIDE LINE

7. SERVICE LINE (SHORT)

8. NET

9. SIDE ALLEY

10. LEFT SERVICE COURT

11. RIGHT SERVICE COURT

12. 10 FEET

13. Shade the right doubles service court

14. Shade the left singles service court.

15. _____ FIVE FEET _____ What is the height of the net.

FILL IN: FILL IN THE CORRECT WORD OR WORDS THAT COMPLETE THE STATEMENT.

1. In singles the game goes to 11 OR 15 _____ points unless agreed upon before the game begins.

2. In doubles the game goes to 11 _____ or 21 points unless set at another score.

3. You must be serving to be able to SCORE _____.

4. In singles the court your serve from is determined by the score. If your score is even you serve from the RIGHT _____ court.

5. When a team has lost their term at service, SIDE OUT/SERVICE is called.

6. In doubles, after the first inning, when an error is committed by the receiving side, POINT _____ is called.

7. Two out of three games is call a MATCH .
8. Shuttles falling on a line are considered IN OR GOOD .
9. To begin the game of badminton, the server always begins from the RIGHT court.

PARTS OF THE RACQUET

1. FACE
2. HANGE
3. THROAT
4. GRIP
5. BUTT

A

GUIDE

TO

BASKETBALL

TEACHING PACKET BASKETBALL

COURSE DESCRIPTION

The purpose of this unit is to acquaint students with the basic knowledge needed to actively participate in basketball. It is essential that the students learn the basic skills and game strategy necessary for individual satisfaction.

INTRODUCTION

History
Safety
Rules

BEGINNING

Catching
Passing
Dribbling
Shooting
Offense and Defense

INTERMEDIATE

Passing
Shooting

ADVANCED

Advanced Shooting

EVALUATION

Written and or practical evaluation will be used to determine the student's knowledge and skill development of basketball.

HISTORY

Basketball was first introduced in 1891 by Dr. James A. Naismith, who at the time was the physical education director at the Y.M.C.A. College in Springfield, Massachusetts. The first official game was not played until 1892. Basketball was principally designed as a game to create interest in the gymnasium during the winter months.

The first ball used was a volleyball, and a peach basket was used as the hoop. After each score the ball had to be taken out of the basket before play could be resumed.

The game spread rapidly to the nation's playgrounds, community centers, and gymnasiums, until today nearly every boy and girl learns to play basketball.

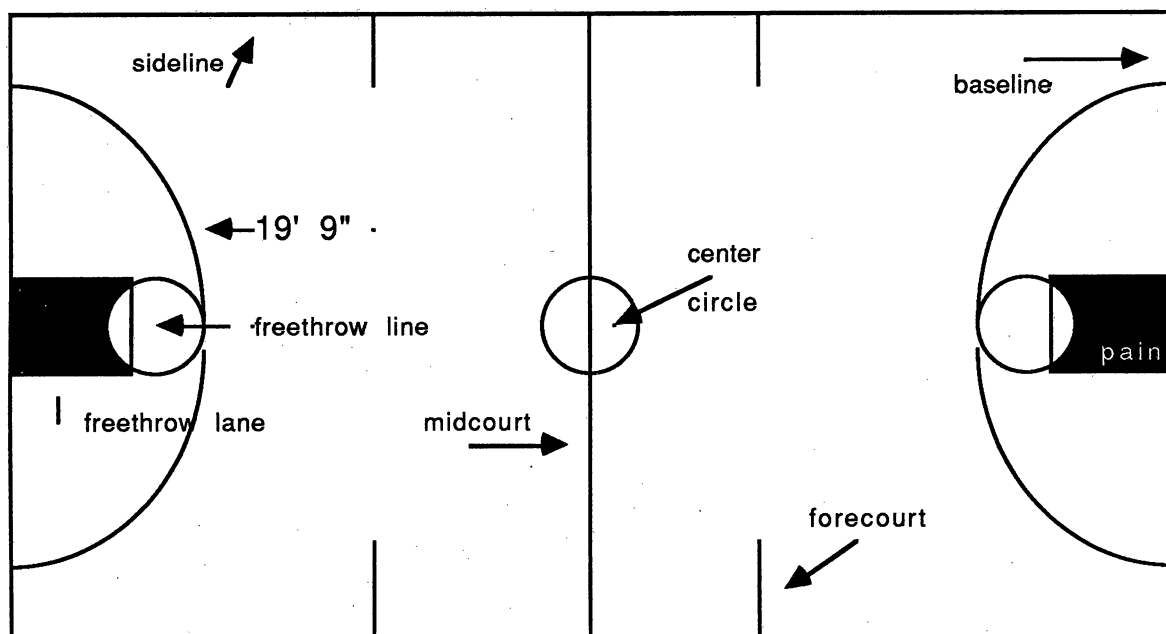

I GAME

Basketball is a game played by two teams of five players each. The ball is passed, thrown, bounced, handed or rolled from one player to another. The purpose of each team is to get the ball into its own basket and prevent the other team from securing possession of the ball or scoring.

For teams of high school age, four quarters of eight (8) minutes each with intermissions of one minute after the first and third quarters, and ten (10) minutes between the half. The object of the game is to score the greatest number of baskets in the aloted time limit.

II SCORING

- 1) **A goal** is made when a live ball enters the basket from above and remains in or passes through. If a player control foul occurs after a goal, the goal is canceled.
- 2) **A successful try** from the field (called a field goal) by a player who is located behind the 19-foot 9 inch line counts as three (3) points.
- 3) **Any other goal** from the field is worth two (2) points for the team into whose basket the ball thrown.
- 4) **A goal from a free throw** is worth one (1) point for the thrower's team and is credited to the thrower.

III THE COURT

The court is a rectangular surface free from obstructions. The dimensions for a high school court should be 50 feet by 84 feet (see diagram)

IV PURPOSE OF THE RULES

The rules place upon the players the responsibility of the balance of play. This provides equal opportunity between the offense and the defense. The rules should provide an equal opportunity to the small and the tall player. The rules must provide reasonable safety and protection. They create an atmosphere of

sportsmanship and fair play. Therefore, the emphasis is put on cleverness and skill and allows both the offense and the defense the freedom of action that basketball has to offer the individual.

V THE RULES OF MOVING THE BALL

(Includes the definitions and terminology!)

- 1) **Act of shooting:** Begins simultaneously with the start of the try and ends when the ball is clearly in flight.
- 2) **A try for field goal:** An attempt by a player to score two or three points by throwing the ball into his or her basket.
- 3) **A tap (tip):** The attempt to lightly touch the ball. (a type of shot usually found to be used under the basket, when unable to grasp the ball)
- 4) **A jump ball:** A method of putting the ball into play. To start the game, the ball is tossed up between two opponents in the center circle.
- 5) **Alternate possession:** Replaces the jump ball. The team that did not win the jump ball at the beginning of the game, will receive the ball on the next jump ball situation. (If no situation happens, then at the beginning of the next quarter that team will receive the ball.)
- 6) **Lack of sufficient action:** The failure of the responsible team to force play. The trail official shall be responsible for the recognizing lack of action., After a warning, the team cited must act within five seconds or a technical foul will be called.
- 7) **A pass:** Movement of the ball caused by a player who throws, bounces, or rolls the ball to another player.
- 8) **A throw in:** A method of putting the ball in play from out of bounds.
- 9) **A dribble:** The movement of the ball caused by a player in control who pushes, or bounces the ball to the floor once or several times. The dribble ends when:
 - a) the dribbler catches the ball with one or both hands;
 - b) the dribbler simultaneously touches the ball with both hands;
 - c) an opponent bats the ball;

- d) the ball becomes dead.
- 10) **Dunking:** The driving, forcing, pushing, or attempting to force a ball through the basket with the hand(s)
 - 11) **Held ball:** Occurs when two opponents have one or both hands firmly on the ball, and neither can gain possession without undue roughness.
 - 12) **Pivot:** This takes place when a player who is holding the ball steps once in any direction with the same foot. The other foot, called the pivot foot, is kept at its point of contact with the floor. "Pivot" is also another name for an inside player.
 - 13) **A live ball:** Is in the frontcourt or backcourt of the team that is in control, as follows:
 - a) A ball which is in contact with a player, or when the ball or the player is touching the backcourt.(either player if the ball is touching more than one). It is in the frontcourt if neither the ball nor the player is touching the backcourt;
 - b) A ball which is not in contact with a player or the court retains the same status as when it was last in contact with a player or the court;
 - c) During a dribble from backcourt to the frontcourt, the ball is in the frontcourt when the ball and both feet of the dribbler touch the court entirely in the frontcourt.
 - 14) **A player in control:** Is closely guarded when an opponent is in a guarding stance at a distance not exceeding six feet from him or her.
 - 15) **A player in control:** is when he or she is holding or dribbling a live ball.
 - 16) **A team in control:** When a player of the team is in control. Also, while a live ball is being passed between teammates. Team control continues until:
 - a) the ball is in flight during a try for goal;
 - b) an opponent secures control;
 - c) the ball becomes dead.
 - 17) **There is no team control:** During a jump ball, a throw in, or the tapping of a rebound. In these situations, team control is reestablished when a player regains control.

- 18) **The possession arrow:** The device at the table which is used to indicate the direction of a team's basket for alternating possession procedure.

VI COURT TERMINOLOGY

(With definitions)

- 1) **Boundary lines of the court:** Consist of end lines and sidelines. The inside edges of these lines define the inbounds and out of bounds areas.
- 2) **Base line:** Another name for end line.
- 3) **A basket:** An 18 inch ring, having a flange, braces, and an appended net through which players attempt to shoot the ball.
- 4) **A team's own basket:** The basket into which its players try to shoot the ball.
- 5) **Team's backcourt:** That part of the court containing the opponent's basket.
- 6) **Team's frontcourt:** That part of the court containing team's own basket.
- 7) **A team's midcourt:** That part of a team's frontcourt between the division line and a parallel, imaginary line. This line is 28 feet from the inside edge of the end boundary to the nearer edge of the midcourt area marker. This imaginary line is from the inside edge of each side line and is drawn at right angles to it.
- 8) **A team's forecourt:** Extends from the nearer edge of the midcourt area marker to the inside edge of the end line.
- 9) **The visiting team shall:** Have the irrevocable choice of baskets at which it may practice before the game and the basket shall be its choice for the first half.
- 10) **The team shall:** Change baskets for the second half.

VII PLAYER TERMINOLOGY

- 1) **An airborne shooter:** A player who has released the ball on a try for goal and has not returned to the floor.
- 2) **Backcourt players (guards):** The players who set up the team's offensive pattern.
- 3) **Inside player(center, post, pivot):** Most often the tallest player on the team. This player is situated near the basket, around the three second lane area, and is responsible for rebounding and close range shooting.
- 4) **Corner players (forwards):** The tall players who are responsible for the rebounding and shooting phases of the team's operation. The forwards make up the sides of the offensive set up.
- 5) **Offense:** The team with the ball.
- 6) **Defense:** The team without the ball.

VIII TIME OUT TERMINOLOGY

- 1) **Time out:** Occurs when a team asks an official to momentarily stop the game. The length of a time out is one minute in length.
- 2) **Five time outs:** May be charged to each team during a regulation game. Any more than that, the team is called for a technical foul.
- 3) **Extra period:** The extension of playing time necessary to break a tie score. (One time out is given to each team for each extra period)

IX SCORING TERMINOLOGY

- 1) **Field goal:** A basket made from the field. Worth two (2) or three (3) points depending from where the shooter shoots the ball.

- 2) **Free throw:** The privilege given a player to score one (1) or two (2) points by unhindered shot for a goal from within the free throw lane and behind the free throw line.
- 3) **A bonus free throw:** A second free throw which is awarded for each common foul (except a player control foul) committed by a player of a team, beginning with the team's fifth personal foul in a half, provided the first free throw for the foul is successful.
- 4) **A multiple throw:** A succession of free throws attempted by the same team.

X FOULS

(Their definitions and terminology)

- 1) **A foul:** An infraction of the rules which is charged to a team or an individual.
- 2) **A personal foul:** A player foul which involves illegal contact with an opponent while the ball is live, or the ball is in possession of a player for a throw in, or illegal contact has been committed by an airborne shooter when the ball is dead.
- 3) **A common foul:** A personal foul, which is neither flagrant nor intentional nor committed against a player trying for a field goal, nor is it part of a double or multiple foul.
- 4) **A double foul:** A situation in which two opponents commit personal fouls against each other at approximately the same time.
- 5) **A flagrant foul:** May be a personal or technical foul of a violent, savage nature, or a technical noncontact foul which displays vulgar, abusive conduct. This foul may or may not be intentional.
- 6) **An intentional foul:** Is a personal or technical foul, which, in the judgment of the official, appears to be designed or predetermined. It is not based on the severity of the act.
- 7) **A multiple foul:** A situation in which two or more teammates commit personal fouls against the same opponent at approximately the same time.

- 8) **A player control foul:** A common foul committed by a player while he or she is in control of the ball, or by an airborne shooter.
- 9) **Technical foul:** A noncontact foul by a player, team, or coach for unsportsmanlike behavior, or failure to abide by rules regarding submission of lineups, uniform numbering, and substitution procedures.
- 10) **An unsportsmanlike foul:** A noncontact technical foul which consists of unfair, unethical or dishonorable conduct.
- 11) **A disqualified player:** One who is barred from further participation in the game because of committing his or her fifth personal foul, committing a flagrant foul, or an infraction of technical fouls.
- 12) **The penalty for a foul:** The charging of the offender with the foul and awarding one or more free throws. The ball is awarded to the opponents for a throw in.

XII VIOLATIONS

(Their definitions and terminology)

- 1) **A violation:** An infraction of the rules resulting in a throw in from out of bounds for the opponents. The following rule infractions are violations:
 - a) violation of the free throw provisions.;
 - b) causing the ball to go out of bounds;
 - c) violation on the throw in rules;
 - d) traveling , kicking , or striking the ball.
 - e) double dribbles;
 - f) violation of the jump ball rules;
 - g) remaining for three (3) seconds under the basket within the free throw lane without the ball under your team's basket;
 - h) being in continuous control of a ball which is in his backcourt for more than ten (10) seconds;

- i) be the first to touch a ball which he or a teammate caused the ball to go from frontcourt to backcourt by being the last to touch the ball while it was in control by his team and before the ball went into the backcourt;
 - j) excessive swinging of the arms or elbows, even though there is no contact with an opponent;
 - k) when closely guarded anywhere in the frontcourt, controlling the ball for five (5) seconds in an area enclosed by screening teammates;
 - l) while closely guarded in the frontcourt, holding or dribbling the ball for five (5) seconds;
 - m) committing basket interference or goaltend.
- 2) **The penalty for a violation:** The awarding of the ball to the opponents for a throw in, the awarding of one or more points(on violation "m"), or the awarding of a substitute free throw(on violation "a").

XII DEFENSIVE AND OFFENSIVE TERMINOLOGY

- 1) **Blocking out:** A term used to designate a defensive player's position under the backboard which prevents an offensive player from achieving good rebounding position.
- 2) **Denial defense:** An aggressive individual defense in which the defensive player works hard to keep the offensive player from receiving a pass.
- 3) **Switching:** A change of defensive guarding assignments.
- 4) **Outlet pass:** Is a term used to designate a direct pass from a rebounder to a teammate, with the main objective being the start of a fast break.
- 5) **A screen:** A legal action by a player who, without causing contact, delays or prevents an opponent from reaching a desired position. It is an offensive maneuver where a player is positioned between the defender and a teammate in order to free the teammate for an uncontested shot.
- 6) **Pick:** A special kind of screen in which a player stands in such a way so the defensive player slides to make contact, freeing an offensive teammate for a shot or drive.

XIII OTHER IMPORTANT TERMINOLOGY

- 1) **Drive:** An aggressive move toward the basket with the ball.
- 2) **Fake:** The act of using a deceptive move with the ball to pull the defensive player out of position.
- 3) **Fast break:** Moving the ball quickly downcourt in order to score before the defense can set up.
- 4) **A fumble:** The accidental loss of player control.

BASKETBALL SKILL AND TECHNIQUES

I PASSING

- 1) **Chest Pass:** The ball is held in both hands about chest high and released by extending the arms fully, snapping the wrists while stepping in the direction of the intended pass.
- 2) **Bounce Pass:** A short distance pass used when the player is closely guarded. The ball should bounce at approximately two thirds of the distance between players, waist high.
- 3) **Overhead Pass:** Used to pass over a defensive player. The ball is held with both hands over the head and as the passer steps forward, transfers his or her body weight the arms are brought forward using the wrist snap throw.
- 4) **One hand overhead pass(baseball throw):** Used to cover long distances. The ball is brought back to the ear, close to the head, with fingers spread wide. The ball is released about a foot in front of the body.

Hints for good passes:

- 1) Passes should be crisp;
- 2) Always fake before each pass;
- 3) Take a step in the direction of the pass;
- 4) Weight should be balanced when passing;
- 5) Do not "telegraph" the pass. Be deceptive with the eyes;

- 6) Aim to hit the receiver between the waist and the shoulder;
- 7) Put little or no spin on the ball;
- 8) Pass to the side away from the defender;
- 9) Always lead a running teammate.

II CATCHING AND HOLDING

Attempt to catch every pass regardless of how it is thrown. Meet the ball with the hands held out in front of you. Catch with the pads of the fingers and bring the ball to the body to protect it before dribbling, passing, or shooting.

HINTS FOR GOOD HANDLING OF THE BALL:

- 1) Provide a target.
- 2) Move the feet to meet the ball.
- 3) Hands should be spread and relaxed.
- 4) Watch the ball all the way into your hands.
- 5) Hold the ball close to the body for protection.

III DRIBBLING

It is slower than passing so it should not be over used.

- 1) **When to use dribbling.**
 - a) To penetrate or drive to the basket;
 - b) To create a better passing lane;
 - c) To get out of a crowd;
 - d) To bring the ball down the court
- 2) **Technique:** With the hand cupped, the pads of the fingers control the direction of the ball, while the wrist and finger flexion provide the force.
- 3) **When to use a high speed dribble:** Used when a player is unguarded and moving quickly:
 - a) Leading a fastbreak;
 - b) Driving to the basket;
 - c) Bringing the ball down with no opposition.
- 4) **Low control dribble:** Used when a player is closely guarded. Keep both ball and body low. The more frequent contact allows for control and change of direction.

- 5) **Crossover dribble:** Used when the person is loosely guarded. Rebounds to the opposite hand, must be done quickly with only one bounce.

HINTS ON DRIBBLING;

- 1) Keep eyes and head up.
- 2) Be able to dribble with either hand;
- 3) Protect the ball with your body from your opponents;
- 4) Control the ball with the fingers;
- 5) Keep your knees bent for balance;
- 6) Dribble with the right hand going to the right, and the left hand, going to the left.

IV SHOOTING

The primary objective in basketball is to make baskets. Know your point of aim. There can be two targets:

- a) The rim;
- b) The square on the back board behind the rim.

- 1) **One handed set shot:** Used for most long shots. With one foot forward and the other foot back, the knees, and hips should be slightly flexed. The ball is held above the forehead (to aim for the basket). The ball should be in the fingers and the shooting hand is behind the ball. The guide hand comes off when the shooting wrist flexes forward. The follow through is very important.
- 2) **Jump shot:** A very effective offensive weapon. The shooter jumps into the air by pushing off with both legs. From this position, the action is the same as the one handed set shot.
- 3) **Lay up:** One of the shots that has the highest percent of making it into the basket. This is due to the closeness of range. Using the backboard to bank the ball in, the shooter comes diagonal to the basket. At the last dribble, the ball is firmly grasped with the fingers of both hands and carried above the head. The shooting arm and fingers then extend upward to "lay" the ball against the backboard.

HINTS ON SHOOTING:

- 1) Knees should be bent for balance and power.
- 2) Focus your eyes on the target before, during, and after the shot.
- 3) Fingertips control every shot.
- 4) Maintain good body balance and control.
- 5) Angle shot should use the backboard.
- 6) Follow through with the shooting hand toward basket.
- 7) Backspin on the ball is desirable.
- 8) A higher arc on the ball generally assures greater accuracy.
- 9) Practice, practice, practice.

V REBOUNDING

Approximately 60 percent of the field goals attempted are missed. Therefore, it is essential to any team to know how to rebound.

HINTS ON REBOUNDING:

- 1) Work hard to get good positioning
- 2) Don't get too far under the basket.
- 3) Be aggressive
- 4) Jump with the arms, bend the knees, and reach with both hands.
- 5) Time the jump in order to grasp the ball at its highest point.
- 6) Go for the ball !
- 7) Keep a firm hold , and keep it away form the opponents.
- 8) Land with the feet comfortable spread and elbows out.

BASKETBALL TESTNAME _____
DATE _____
PERIOD _____

USE THE LETTER "F" FOR FOULS, "V" FOR VIOLATIONS, AND "L" FOR LEGAL PLAY, AS THEY WOULD APPLY IN THE SITUATIONS BELOW.

- ___ 1. Traveling
- ___ 2. 10 second team holding the ball in their backcourt
- ___ 3. Failure to report when substituting
- ___ 4. Dribbling
- ___ 5. Hitting the arm of the shooter.
- ___ 6. Stepping on the side lines with the ball.
- ___ 7. Goaltending
- ___ 8. A forward without the ball in the lane for three seconds.
- ___ 9. Double dribbles.
- ___ 10. Bounce pass.
- ___ 11. Pushing.
- ___ 12. Jump ball.
- ___ 13. Stepping on the boundary line on a throw in.
- ___ 14. Unsportsmanlike behavior.
- ___ 15. Dribbling in on a throw in.
- ___ 16. Catching the ball on the jump ball.

- ___ 17. Rolling the ball.
- ___ 18. Kicking the ball.
- ___ 19. Striking the ball with the fist.
- ___ 20. Blocking out.

MATCHING: PUT THE LETTER CORRESPONDING TO THE WORD THAT ANSWERS THE QUESTION ON THE SPACE IN FRONT OF EACH NUMBER.

- | | |
|---|--------------------|
| ___ 1. How many players on a team ? | <u>CHOICES:</u> |
| ___ 2. A field goal from outside the 19'9" line | a) Five |
| ___ 3. A free throw counts ? | b) Violation |
| ___ 4. A game is started by a ? | c) Foul |
| ___ 5. Moving the pivot foot with the ball in the hands is called | d) Two |
| ___ 6. Putting the ball in play at the side line is called a ? | e) One |
| ___ 7. The area under the basket that includes the free throw line is ? | f) Guarding |
| ___ 8. The breakage of the rule which causes a throw in is called ? | g) Jump ball |
| ___ 9. The breakage of the rule which causes a free throw is called ? | h) Free throw lane |
| ___ 10. Any field goal other than that in #2 is worth ? | i) Center circle |
| | j) Passing |
| | k) Traveling |

_____ 12. A legal method of covering your opponent ?

_____ 11. A play in which a player may move the ball without penalty ?

- i) Throw in
- m) Traveling
- n) Three

BASKETBALL TEST**answer sheet**NAME _____
DATE _____
PERIOD _____

USE THE LETTER "F" FOR FOULS, "V" FOR VIOLATIONS, AND "L" FOR LEGAL PLAY, AS THEY WOULD APPLY IN THE SITUATIONS BELOW.

- V 1. Traveling
- V 2. Ten (10) second team holding the ball in their backcourt
- F 3. Failure to report when substituting
- V 4. Dribbling
- F 5. Hitting the arm of the shooter.
- V 6. Stepping on the side lines with the ball.
- V 7. Goaltending
- V 8. A forward without the ball in the lane for three seconds.
- V 9. Double dribbles.
- L 10. Bounce pass.
- F 11. Pushing.
- L 12. Jump ball.
- L 13. Stepping on the boundary line on a throw in.

- F 14. Unsportsmanlike behavior.
- V 15. Dribbling in on a throw in.
- V 16. Catching the ball on the jump ball.
- L 17. Rolling the ball.
- V 18. Kicking the ball.
- V 19. Striking the ball with the fist.
- L 20. Blocking out.

MATCHING: PUT THE LETTER CORRESPONDING TO THE WORD THAT ANSWERS THE QUESTION ON THE SPACE IN FRONT OF EACH NUMBER.

- | | |
|--|--------------------|
| <u>A</u> 1. How many players on a team ? | <u>CHOICES:</u> |
| <u>N</u> 2. A field goal from outside the 19'9" line | a) Five |
| <u>E</u> 3. A free throw counts ? | b) Violation |
| <u>G</u> 4. A game is started by a ? | c) Foul |
| <u>K</u> 5. Moving the pivot foot with the ball in the hands is called | d) Two |
| <u>L</u> 6. Putting the ball in play at the side line is called a ? | e) One |
| <u>H</u> 7. The area under the basket that includes the free throw line is ? | f) Guarding |
| <u>B</u> 8. The breakage of the rule which causes a throw in is called ? | g) Jump ball |
| | h) Free throw lane |

- ___C___ 9. The breakage of the rule which causes a free throw is called ?
- ___D___ 10. Any field goal other than that in #2 is worth ?
- ___J___ 11. A play in which a player may move the ball without penalty ?
- ___F___ 12. A legal method of covering your opponent ?
- i) Center circle
j) Passing
k) Traveling
l) Throw in
m) Traveling
n) Three

A

GUIDE

TO

DANCE

TEACHING PACKET SQUARE DANCE

COURSE DESCRIPTION

The purpose of this unit is to acquaint students with the basic knowledge of square dancing so they can participate fully. It is essential that the students learn the basic skills necessary for individual satisfaction.

EXPECTED STUDENT PERFORMANCE SKILLS

INTRODUCTION

History
Definition

BEGINNING

Beginning Square figures
Beginning Round Dances
Beginning Contra Dances

INTERMEDIATE

Intermediate Square Figures
Intermediate Square Dances
Intermediate Contra Dances

EVALUATION PROCESS

Written and or practical evaluation will be used to determine the student's knowledge and skill development.

HISTORY

This traditional American dance form involves four couples, called a set, dancing together starting out in a square formation. "Sets in order" and "Square your sets" are calls for dancers to take their position on the floor. During the dance partners and formations are often changed, going smoothly from square to circles, lines, columns, waves, or stars, but always ending back to the square. Dancers all use the basic shuffle step in which the feet glide along the floor, causing the characteristic "shuffling" sound of square dance. (Modern square dancers avoid the hopping, jumping, kicking, skipping motions associated with earlier "barn" dances.

American square dance evolved from European folk dance, the country dances of England and Scotland and quadrilles of the French court. The square formation and many of the movements still used started with these dances of long ago.

The square dance as it developed from the 1940's to the 1970's is vastly different from the square dance of the early twentieth century. From some ten or twelve basics prior the 1940, there are now almost 1500 calls listed in the square dance encyclopedia. A square dancer needs to know seventy five to a hundred of them for ordinary dancing. A year or more of instruction is required for community dancing. Many clubs employ professional callers to conduct classes and workshops on a regular basis.

SQUARE DANCE TERMINOLOGY

1. **Across the set:** Action will occur between two opposite couples
2. **Active couple(s):** Those couples designated by the caller to take action.
3. **Along the line:** Couples will right and left through or ladies will chain within the same line.
4. **Arky style:** Refers to figures that are done with dancers of the same sex working together.
5. **Around one:** Indicates that the working person(s) will move out and around one or more non-active person(s)
6. **Behind you:** Referring to the person directly in back of the one to whom the call is directed.
7. **Break:** To release hands.
8. **Break and trail:** Change the form of a circle with hands joined to a single file promenade.
9. **Bunch the girls:** Girls go to the center, back to back or face toward the center as indicated by the caller.
10. **Circle:** Three or more dancers can circle left (or right if directed) using the same shuffle as they walk.
11. **Circle to a line:** From a circle of any given number, the man or lady indicated by the caller will break from the circle with the left hand, retaining to hold the person on their right with their right hand, and form a line facing the square unless directed to face out. The person who breaks the line will be at the left end of the circle.
12. **Corner:** When in a square formation, the corner is the person to the man's left or the lady's right at the time of the call.
13. **Don't stop/don't slow down:** Directions given to keep promenading even if "home" position is reached.
14. **Eight to the center:** The dancers progress three steps into the center of the set, stopping on the fourth count. If hands are joined, arms should be down to start and then raised into the center on count four.
15. **Face in , face out:** Calls for a 90 degree change of direction. Face the sides, face the heads- Directs person to turn back on partner and face outside couples.
16. **Face those two:** Designated persons will face those with whom they have just been working.

17. **Face to the middle:** A call usually directed to active couples to change their present facing direction to make a 1/4 turn toward the center of the square.
18. **Face your own:** Designates a 1/4 turn to face your partner.
19. **Full turn around:** This movement is basically descriptive of an arm turn or courtesy turn that is greater than halfway and is completely dependent upon a good following descriptive call to direct the dancers' next movement.
20. **Honors:** The men bow and the ladies curtsy.
21. **Line:** The dancers indicated are lined up shoulder to shoulder in the direction given by the caller.
22. **Look her in the eye:** An indication that the same girls get the action. A reminder not to change facings.
23. **Make an arch:** Two people raise their joined hands.
24. **New lines of four:** The dancers working in a line, facing a given direction, execute a movement and upon completing it are in new lines, with other dancers, and facing at right angles to their former partners.
25. **On to the next:** After executing a movement with a couple (or single dancer), the active person or couple will leave that position and move on in the direction they were going.
26. **Opposite:** The lady across the set from the man at the time of a given call.
27. **Pick up a couple, make it six (or eight):** From a circle the active person or the one indicated by the call will release holds with the person on his left and pick up the couple or person, also indicated by the call, who will then become a part of the circle.
28. **Pull by:** Two dancers, each holding the other's hand, pull by each other and move on as directed by the next call.
29. **Reverse:** The call to change a right hand star to a left, or vice versa.
30. **Right hand lady:** One lady ahead or counter clockwise from where the man is at during a given call.
31. **Rim:** The outside persons in a star promenade
32. **Roll promenade:** When a couple promenade is called just before the completion of a Do Paso or any figure ending with a courtesy turn, the dancers will do a wheel around or roll promenade in promenade position rather than awkwardly switching from a courtesy turn position.

33. **Separate:** Two persons working as a couple turn their backs to each other and head in opposite directions as indicated by the call. Sometimes referred to as back to back.
34. **Sides(heads)divide:** The couples designated leave their partner and move to their corner spot. They'll remain there until the next call or unless told to execute some action with their opposite, in which case they move forward and are now in a position in the square 1/4 from their former home.
35. **Square:** Formed by four couples facing in with the back of each couple parallel to a different wall in the hall. Each couple is from 8 to 12 feet from its opposite couple. The lady is to the right of her man. The couples are numbered 1,2,3 and 4 around the square to the right, or counter clockwise, starting with the couple whose backs are closest to the music. The head couples are numbered 1 and 3, and the side couples are numbered 2 & 4.
36. **Swap:** To exchange partners.
37. **Swing the one across the hall:** The call normally goes to the men. If two are involved, they just pass right shoulders in trading places. When four are involved, the men just move into the center and then clockwise across the set, letting the man to the left have the right of way. In some areas, the men make a right hand star while doing this movement.
38. **Three ladies chain:** With the active couple in the center of the square facing either their right hand or left hand couple, the active lady chains with the lady she is facing. The active man in the center joins left hands with this new lady and turns half around as she passes by to chain with the lady of the opposite couple. The center man continues to pass the ladies across the center with his left hand as they chain from one side of the square to the other as long as called, generally until partners are reunited.
39. **Turn alone:** An individual about face
40. **Walk:** A comfortable, effortless shuffle done to the beat of the music.
41. **Wrong way:** The opposite from the normal or accepted direction.
42. **Contra Dance:** The dancers face each other forming two parallel lines.

TEACHING PACKET FOLK DANCE

COURSE DESCRIPTION

The purpose of this unit is to acquaint students with the basic knowledge of folk dancing so they may participate fully. Students will also become acquainted with other cultures and customs through folk dancing. It is essential that the students learn the basic skills necessary for individual satisfaction.

EXPECTED STUDENT PERFORMANCE SKILLS

INTRODUCTION

History
Definition

BEGINNING

Basic circle formations
Counter clockwise and clockwise
Basic steps and rhythmic patterns
Beginning folk dances

INTERMEDIATE

Intermediate step combinations
Steps and rhythmic patterns
Intermediate folk dances

ADVANCED

Formations and couple positions
Advanced step combinations
Beginning to advanced folk dances

EVALUATION PROCESS

Written and or practical evaluation will be used to determine the student's knowledge and skill development.

HISTORY

Folk dances are traditional dances, part of the cultural heritage of a group, nation, or region. They developed as ethnic dances in which ordinary folk participated. In contrast, some ethnic dances evolved as art forms danced by selected, highly skilled performers.

Folk dances are international. Some had their start as a means of celebrating some special occasion such as the harvest, a wedding, or a feast day. Others grew out of work practices, religious ceremonies, or military customs. But most evolved as recreational pastimes, a means of having fun.

Since folk dances are "of the people," they often are changed "by the people." Someone may add a clap here or a turn there to make a dance more enjoyable. Others follow along and the change thus spreads. This continues today. There may be a local variation on almost any dance, but basic styles, steps and formations tend to endure and give each dance its special flavor.

FOLK DANCE TERMINOLOGY

1. **Bleking step:** 2/4 meter. The dancer should hop with his right foot while extending his left foot forward with the heel touching the floor. Hop with the left foot, while extending the right foot forward and the heel touching floor.
2. **Buzz step swing:** Step on right foot, pivoting clockwise on the ball of the foot. The left foot while it is in a short, direct, line to the back of the right foot pushes with in the same direction. The same action needed to move a scooter.
3. **Grapevine:** Moving to the left, the right foot crosses in front then in back of the left foot. The dancer then steps sideward to the left with the left foot. The right foot crosses in back then in front of the left foot. Next, the dancer steps sideward to the left with the left foot. A grapevine to the right starts with the opposite footwork.
4. **Hey:** An English term for a grand right and left which is performed with out joining hands. Dancers weave, passing right and then left shoulders. A straight line hey is known in Scottish dances as a reel.
5. **Meter:** The number of underlying beats in a measure of music. The top number of the meter states the number of beats existing in each measure. The bottom number stipulates the type of note which receives the value of one beat.
6. **Pas De Basque:** The dancer leaps sideways. Then, the dancer steps forward in front of the supporting leg. He or she then, steps in place or in a closed position.
7. **Push step:** A step sideward. The dancer brings his free foot to instep of the supporting foot and then pushes away. This forces the first foot to move sideways again.
- 8.- **Step arch:** This is usually associated with the waltz. The dancer steps sideways, then pulls the free foot to the instep of the supporting leg.
9. **Step draw:** The dancer steps sideways, then drags the free foot to the closing position and then transfers the weight of the body.

A

GUIDE

TO

FLAG
FOOTBALL

TEACHING PACKET
FLAG FOOTBALL

COURSE DESCRIPTION

The purpose of this unit is to acquaint students with the basic knowledge needed to actively participate in flag football. It is essential that the students learn the basic skills and game strategy necessary for individual satisfaction.

INTRODUCTION

History
Safety
Rules

BEGINNING

Passing
Pass Receiving/Patterns
Kicking
Stance/Formations

INTERMEDIATE

Blocking
Plays

ADVANCED

Team Plays
Game Strategies

EVALUATION PROCESS

Written and/or practical evaluation will be used to determine student knowledge and skill development of flag football.

HISTORY

Football as we see it today came to us through soccer and rugby. Harvard, Yale, Princeton, and Rutgers were the schools that made early attempts at playing this game. The early attempts at football were not much more than gang fights over a round ball.

However, through the years since 1869, rules have been formulated, equipment has been adopted and qualified, and coaches and members of the medical profession have worked toward making football a relatively safe game.

From tackle football the game has been modified in such a way that it can be played without pads and still be played safely. Playing the game without the costly equipment has enabled children and young adults to participate. Flag football as it is played today is an interesting and beneficial game for all who desire fun and competition.

In 1932, the intramural Sports Section of the College Physical Education Association drafted and adopted an acceptable set of rules for school and college play. These rules are not as yet standardized as official rules.

FLAG FOOTBALL RULES

Flag football is a game utilizing many of the basic skills of football with a minimum amount of contact. Flag football is valuable in the program in that it involves many new skills, makes the participants better informed spectators, and is safe, fun and vigorous.

THE GAME

The object of the game is to score a touchdown by legally running or passing the ball over the opponent's goal line. The game starts with a kick off from the 40 yard line.

THE PLAYERS

An official team shall be composed of nine players.

- a) The offensive team shall have five line players: two ends, two guards, and a center.
- b) The offensive team shall have four backfield players: the quarterback, two halfbacks, and a fullback.
- c) The defensive team shall line up in any fashion so that they are three yards from the line of scrimmage.

DOWNS

Upon gaining possession of the ball a team shall have four downs in which to advance the ball into the next zone (next dividing line) or score.

- a) If a team crosses into the next quarter zone, a first down is earned and that team will again have four downs in which to advance the ball into the next zone or to score.
- b) If a team fails to move the ball into the next zone within four downs, they lose possession of the ball. The opposing team starts its series of downs from the spot where the ball became dead.
- c) If a team loses yardage, the team still needs to cross the original "next" zone to be able to receive a first down.

SCRIMMAGE KICK (PUNT)

- a) A team may punt on any down (this is usually done on fourth down) but must announce the punt to the referee before the ball is centered.
- b) Any backfield player may punt after receiving the ball from the center.
- c) Neither team may cross the line of scrimmage until the ball has been kicked.
- d) Each team must have at least three players on the line of scrimmage when the ball is kicked.
- e) The receiver may run with the ball, hand off, or throw a lateral pass.

- f) If the ball goes out of bounds at the side line it is considered dead and the next series of downs starts from the "in bound" (see diagram) line opposite the spot where the ball went out of bounds.
- g) The ball is dead on the spot if a member of the kicking team touches the ball before it has been touched by a member of the receiving team.
- h) If the ball is fumbled in or lands in the end zone, it is a touchback, and the receiving team starts its series of downs on their quarter line.
- i) If the ball hits the ground inbounds, the ball is declared dead and it will then be put in play by the receiving team at the spot where it first touched the ground.

OFFENSIVE PLAY

- a) The ball carrier may run in any direction until the ball is declared dead.
- b) The ball carrier may use any number of lateral passes or hand offs anywhere on the field.
- c) A forward pass may be thrown only from behind the line of scrimmage to any player on the offensive team.
- d) Screening:
 - 1) Any player may screen by virtue of body position only. No player may use his arms in screening.
 - 2) Screening for a ball carrier on a running play is legal provided there are no more than two teammates screening at one time.
- e) Fumbles
When a fumbled ball touches the ground, the ball is dead at the spot where the player was at the time of the fumble.

DEFENSIVE PLAY

- a) A defensive player must have one or both feet on the ground when detaching a flag. After a flag is pulled, the ball is dead and the next down starts from that spot.
- b) The flag must be pulled without pushing, holding or hitting the ball carrier.

- c) The ball carrier may not use the hands or arms in any manner to prevent the flag from being pulled (guarding the flags).
- d) After intercepting the ball, a player may run, hand off, or throw a lateral pass to another team member.

DEAD BALL

The ball is dead:

- a) Anytime the ball carrier touches the ground with any part of the body other than the feet or hands.
- b) When the ball carrier has had a flag pulled.
- c) Following a touchdown, conversion, safety or a touchback.
- d) When the ball goes out of bounds or when a player in possession of the ball steps on or over a boundary line.
- e) Whenever the ball touches the ground.
- f) Whenever two opponents catch the ball at the same time.
- g) Whenever a player of the kicking team touches a scrimmage kick(punt) before a member of the receiving team does.

DEAD BALL

- a) When a ball or the ball carrier touches or goes over the side line, the ball is put in play on the in bound line, opposite the spot at which the out of bounds play occurred.
- b) A forward pass that is caught out of bounds or over the end line is incomplete.

SCORING

- a) A touchdown is made when a runner carries the ball across the opposing team's goal line or a pass is completed in the end zone. A touchdown is worth six (6) points.
- b) A conversion is attempted after a touchdown is scored. A team is given one scrimmage play from the conversion line (three yards from the goal line) to complete a pass in the end zone (two points) or carry the ball over the goal line (one point).

- c) A safety is scored when the ball, legally in the possession of a player, becomes dead behind the players goal line. Two points are awarded to the opposing team and the team scored upon restarts play with a kick off from their quarter line.
- d) Following a conversion attempt, the play is restarted with a kickoff by the team who scored.

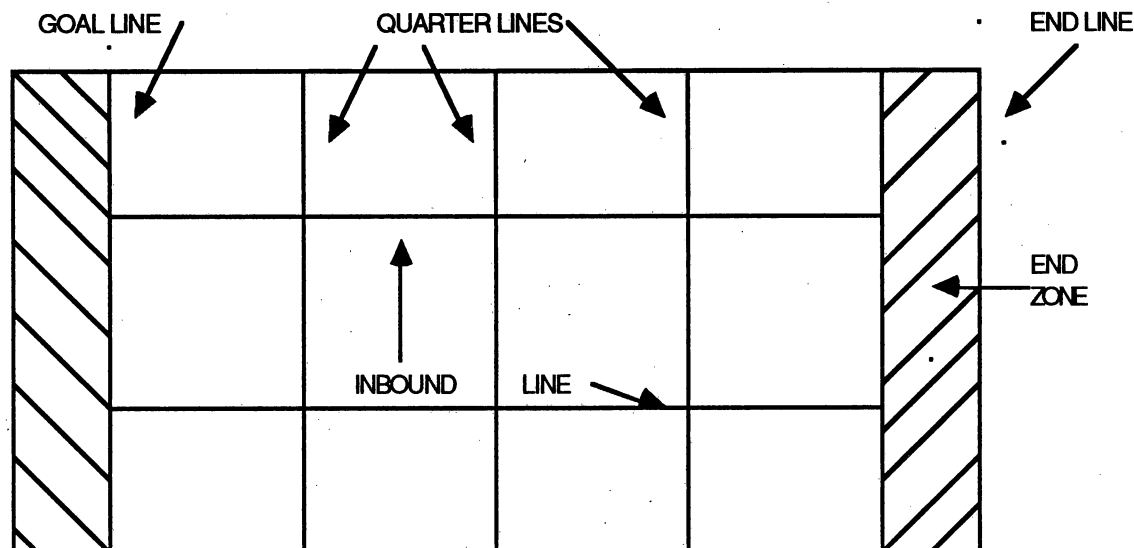

GLOSSARY

- Center snap:** The handing or passing the ball backward from it's position on the ground between the legs of the center. The ball must be on the ground and snapped to any backfield player in one continuous motion.
- Dead Ball:** The ball is dead any time the ball hits the ground, if the ball carrier is downed, a penalty is called, or after scoring.
- Defensive Team:** The team without the ball.
- Down:** A unit of the game which starts with a snap, and ends when the ball becomes dead.
- End Zone:** The area between the goal line and the end line, and bounded at each side by the side lines.
- Flag Guarding:** Any player who uses his hands, arms, clothing or spinning movement to prevent a player from pulling the flag.
- Fumble:** A player loses possession the ball while carrying, handling, passing, catching, or kicking it.
- Hand Off:** Transferring the ball from one teammate to another behind the line of scrimmage without throwing or kicking it.

The ball may be handed in front of the line of scrimmage to a teammate who is either parallel to or behind the person who is handing the ball off. Forward handoffs made behind the scrimmage line may be made only to a backfield player.

Huddle: Two or more players grouped together between downs, prior to the snap of the ball, and before getting into formation for the play. The huddle is used to communicate plays and strategy.

Kick Off: A punt which puts the ball in play at the beginning of the game and after any scoring.

Lateral Pass: A pass that is thrown sideways or back toward the passer's own goal.

Line Of Scrimmage:

Offensive: An imaginary line drawn from the front tip of the ball and parallel to the end line.

Defensive: A line three yards from, and parallel to, the offensive scrimmage line.

Neutral Zone: A three yard area separating the defensive team from the line of scrimmage until the ball is snapped.

Off Side: Any player entering the neutral zone before the ball is snapped.

Offensive Team: The team with the ball.

Own Goal: The goal that the team is defending.

Pass Interference: An act in which a player pushes, blocks, removes a flag or holds an opponent to prevent them from catching or intercepting a pass.

Personal Contact: Any bodily contact between opponents. The use of the hands and arms by pushing, or holding shall be personal contact.

Punt: A kick by a player who drops the ball and kicks it before it has touched the ground .

Ready For Play: The ball is ready for play when, after it has been placed on the ground for a down, the referee begins the thirty second count.

Screening Play: A play when no more than two players run in front or to the side of a teammate who is carrying the ball. Players may screen by virtue of body position only. No player may use the arms in screening.

FLAG FOOTBALL PENALTY CHART

Penalties should be enforced at the Point of Infraction(**POI**), Line Of Scrimmage (**LOS**), or the Point Of Kick (**POK**). The down remains the same unless otherwise indicated.

THE PROCEDURES FOR FOULS ARE:

1. Offended team has option of accepting or declining the penalty.
2. If the foul is declined, the number of the next down is the same as if no foul occurred.
3. When the penalty is greater than the distance to the goal line, one half (1/2) of the distance to the goal line is taken.

KICK OFF (POK): Crossing the line by either team before the ball is kicked results in a five yard penalty and a rekick.

Centering the Ball: (LOS) The following infractions result in a five yard penalty and the down will remain the same:

1. More than a 30 second count by the referee.
2. Offsides by either team.
3. A false start by anyone on the line of scrimmage.
4. An illegal center snap.
5. If more than one backfield player is in motion at the snap of the ball.

SCRIMMAGE KICK

1. **LOS**: Failure to announce the kick. The penalty is five yards, and the kick is repeated or a first down will be given to the opponents at the spot where the ball was called dead. (Depends on the down).
2. **POK**: The kicking team or receiving team enter the neutral zone before the kick. The penalty is five yards from where the ball is called dead after the kick.
3. **POK**: If there are less than three players on the the line of scrimmage. The penalty is five yards from where the ball is called dead after the kick.

FORWARD PASS

1. Interception of an illegal pass:
 - a) The play continues until the ball is called dead.
 - b) The intercepting team has the option of having a first down when and where the ball becomes dead, or accepting the penalty.
2. A forward pass thrown after crossing the line of scrimmage. the penalty is five yards and the loss of that down.
3. **LOS:** The intentional grounding of a pass. The penalty is five yards and the loss of that down.
4. **POI:** A pass thrown after catching a kick. The penalty is five yards.
5. **POI:** A pass is thrown after an interception or the catching of a forward pass. The penalty is five yards.
6. **LOS:** Pass interference by the offense. The penalty is 15 yards and the loss of that down.
7. **POI:** Pass interference by the defense. The penalty is a first down for the offense, and the nearest "next" zone.

DELAYING THE GAME

1. **POI:** The delay of the game. The penalty is five yards.
2. **LOS:** A player falling on the ball. The penalty is 15 yards.

FLAG WEARING AND PULLING

1. **POI:** If flags are worn illegally. The penalty is five yards and the loss of that down.
2. **POI:** The ball carrier uses the hands illegally. The penalty is 15 yards.
3. **POI:** If the ball carrier is pushed, hit, or held. The penalty is 15 yards.
4. **POI:** When the defensive person falls to the knees while pulling the flag. Flag diving is called. The penalty is 15 yards.

HAND OFF

1. **POI:** The ball is handed forward on or beyond the scrimmage line. The penalty is five yards and the loss of that down.
2. **POI:** A backfield player hands the ball forward to a lineman. The penalty is five yards and the loss of that down.

SUBSTITUTION

1. **LOS:** If a player enters a game before the ball is called dead. The penalty is five yards.
2. **LOS:** If more than nine players are on the field. The penalty is five yards.
3. If a disqualified player reenters the game. The penalty is 15 yards.

SCREENING

1. **POI:** if the offense uses the hands to screen. The penalty is five yards and the loss of that down.
2. **POI:** If the defense uses the hands to screen. The penalty is that the down remains the same.
3. **POI:** If more than two players screen. The penalty is five yards and the loss of that down.

PERSONAL CONTACT AND UNSPORTSMANLIKE CONDUCT

1. **POI:** Personal contact, striking, tripping, kicking, using hands, running blocks, clipping, or unnecessary roughness all are penalized. The penalty:
 - a) If it is the offense: 15 yards and the loss of that down.
 - b) If it is the defense: 15 yards and the down remains the same.
2. **POI:** If repeated roughness and unsportsmanlike conduct continue. The penalty is disqualification from the game, plus the yardage penalty.
3. **POI-** Abusive language by a player or a coach. The penalty is 15 yards.

FLAG FOOTBALL TEST

NAME _____
DATE _____
PERIOD _____

MATCHING:

DIRECTIONS: Write the letter of the item that best matches the statement. Use the answer sheet.

- | | | |
|-----------------|----------------------|-------------------|
| a. quarter line | h. punt | o. quarterback |
| b. backfield | i. offside | p. snap |
| c. screening | j. give and go | q. interception |
| d. touchback | k. conversion | r. dead ball |
| e. down | l. line of scrimmage | s. defense |
| f. center line | m. safety | t. offensive line |
| g. touchdown | n. rushers | |

1. Scores six points.
2. The team without the ball.
3. A legal kick by a player who drops the ball and kicks it before it has touched the ground.
4. When the ball is not in play.
5. A unit of the game which starts with a snap of the ball and ends when the ball is dead.
6. A forward pass is caught by a member of the defensive team.
7. Any player who is illegally in advance of the line of scrimmage before the ball is snapped.
8. The center, the guards, the tackles and the ends.
9. A try for extra point(s) following a touchdown.
10. When a kicked ball lands in the end zone.

TRUE OR FALSE:

DIRECTIONS: Use the symbol "T" if the statement is true. Use the symbol "F" if the statement is false or partially false. Circle the correct letter on your answer sheet.

11. The offensive team has four downs in which to advance the ball beyond the next dividing line.

12. A team must always punt on fourth down.
13. The halfbacks and the quarterback are also know as safeties.
14. The touchback scores one point.
15. A forward pass must be thrown from behind the line of scrimmage.
16. It is illegal to hand off the ball to a teammate behind the line of scrimmage.
17. The defensive quarterback calls the down and the play to be run.
18. A huddle is used to decide which team will kick off.
19. When punting, the ball should be tossed upward just before kicking it.
20. When receiving a hand off, it is important to reach out and take the ball from the hands of the giver.
21. When gripping the ball for the forward pass, the fingertips of the middle finger, ring finger and little finger should be on the lacing.
22. On the forward pass, it is desirable to have the ball travel through the air end over end.
23. When punting, the ball should contact the foot on the instep.
24. Unsportsmanlike conduct is a five yard penalty.
25. The kicking team lines up behind the 35 yard line.

MULTIPLE CHOICE:

DIRECTIONS: Circle the correct letter on your answer sheet.

26. Guarding your flags is a ____?____ yard penalty.
a) five b) ten c) 15 d) none of these
27. A ____?____ pass can be thrown at any time by any player.
a) forward b) backward c) lateral d) flip flop
28. A passing conversion is worth ____?____ points
a) one b) two c) three d) none of these
29. A safety occurs when you are downed in your ____?____
a) backfield b) end zone c) huddle

30. It is known as a ____?____ when a player drops the ball while running with it .

- a) touchdown b) pass c) fumble d) lateral

31. The ____?____ is used to decide plays and strategy.

- a) safety b) touchback c) huddle d) end zone

32. After an incomplete forward pass, the ball is returned to the ____?____ .

- a) end zone b) goal line c) LOS. d) inline

33. Following an interception(except on a conversion play) the player may ____?____ .

- a) run with it b) pass c) both d) none of these

ANSWER SHEET

NAME _____
DATE _____
PERIOD _____

MATCHING:

- 1. _____
- 2. _____
- 3. _____
- 4. _____
- 5. _____
- 6. _____
- 7. _____
- 8. _____
- 9. _____
- 10. _____

TRUE AND FALSE

- 11. T
- 12. F
- 13. T
- 14. F
- 15. T
- 16. F
- 17. T
- 18. F
- 19. T
- 20. F
- 21. T

22. T F
23. T F
24. T F
25. T F.
26. A B C D
27. A B C D
28. A B C D
29. A B C D
30. A B C D
31. A B C D
32. A B C D
33. A B C D

ANSWER SHEET

NAME _____ KEY _____

MATCHING:

1. G 2. S 3. H 4. R 5. E 6. Q 7. I 8. T 9. K 10. D

TRUE AND FALSE

11. T F12. T F13. T F14. T F15. T F16. T F17. T F18. T F

19. T F
20. T F
21. T F
22. T F
23. T F
24. T F
25. T F.
26. A B C D
27. A B C D
28. A B C D
29. A B C D
30. A B C D
31. A B C D
32. A B C D
33. A B C D

A

GUIDE

TO

SOCCER

TEACHING PACKET SOCCER

COURSE DESCRIPTION

The purpose of this unit is to acquaint students with the basic knowledge needed to actively participate in soccer. It is essential that the students learn the basic skills and game strategy necessary for individual satisfaction.

INTRODUCTION

History
Rules

BEGINNING

Dribbling
Passing
Trapping
shooting

INTERMEDIATE

Kicks
Body Trapping
Heading
Goalkeeping
Tackling

ADVANCED

Team Plays
Game Strategies

EVALUATION PROCESS

Written and or practical evaluation will be used to determine the student's knowledge and skill development of soccer.

HISTORY OF SOCCER

Some form of soccer was played in American colleges as early as 1830, Rutgers and Princeton drew up a set of rules and played the first intercollegiate soccer game in 1868. All rules were unified in 1904 and, at present, soccer is played throughout the world under the same regulation.

Although football and soccer have been played in this country for a long time, soccer has never achieved the popularity of football. Outside the United States, however, soccer is the most widely played and watched game in the world.

In 1967 the organization of two professional soccer leagues in the United States further increased interest and enthusiasm for the game. Both of these leagues played scheduled league games during 1967. However, dwindling attendance caused financial problems. The two leagues merged to become the North American Soccer League (NASL) in 1968, and the league consisted of five professional teams in 1969. Within the last few years soccer interest in the United States has been increasing.

Soccer is often called the "universal game." What baseball is to the United States, soccer is to the rest of the world. It is difficult to determine how many millions of people play the game, but it is estimated that the number of fans may reach over 600 million. The game is played in more than 130 nations and enjoys a long history. There are over seven hundred college and three thousand secondary school teams playing soccer in the United States.

As in most other sports, the skills of soccer can be practiced in an area of any size and on almost any type surface. To play the game, however, an area the size of a football field or larger is required. Within the boundaries of the official field (110 to 120 by 65 to 75 yards) are goalposts with attached nets and numerous markings.

SOCCER RULES

1. THE PLAYING FIELD

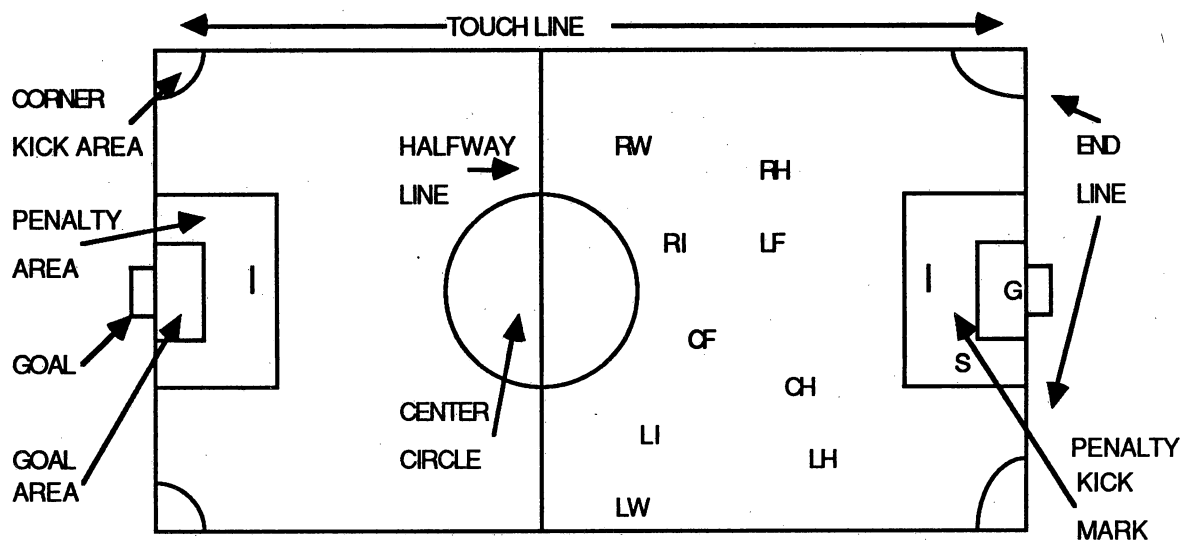

2. THE GAME

The object of the game is to place the ball into the opponent's goal.

A) Scoring : Field Goal 1 point
 Penalty Goal 1 point

B) Length of game
 2 Halves of 30 minutes each.

3. DEFINITION OF TERMS

- A) **Attacking team:** Team which has possession of the ball.
- B) **Blocking:** Intercepting the progress of the ball with some part of the body. (It is legal to block with the arms and hands IF they are in total contact with the body).
- C) **Carrying:** An infringement of the rules by the goalkeeper. Consists of taking more than four steps while holding, bouncing, or throwing the ball.
- D) **Dangerous Kicking:** Raising the leg to shoulder height while an opponent is near by.

- E) **Defending Team:** The team which is attempting to gain possession of the ball while at the same time defending the goal.
- F) **Direct Free Kick:** A free kick from which a goal may be directly scored.
- G) **Double Foul:** An infringement of the rules committed simultaneously by a member of each team, for which a drop ball is awarded.
- H) **Dribbling:** A succession of forward kicks in which the player keeps the ball under control.
- I) **Drop Ball:** One that the official holds waist high and lets drop directly from his hands to the ground between two players.
- J) **Field Goal:** Shall be scored when the ball has been kicked so that it passes wholly between the goal posts and under the crossbar. A field goal may be scored from any spot within the field by any player who is not offside. If such a ball is last touched by a defensive player, a goal shall be scored for the offense.
- K) **Handling:** Contacting the ball intentionally with the hand or any part of the arm. Free kick for opponents.
- L) **Indirect Free Kick:** A free kick from which a goal may not be scored directly.
- M) **Offside:** A player is in an offside position IF he is nearer the opponent's goal line than the ball at the moment when the ball is played by one of their own team, unless (1) the player is in his own half of the field; or at least two of the opponents, one of whom may be the goalkeeper, are nearer their own goal line than the player from the opposing team.
- N) **Own Goal:** The goal the team is defending.
- O) **Own Half Of The Field:** The half of the field in which a particular team's goal is located.
- P) **Passing:** Advancing the ball from one player to another player by means of a kick.
- Q) **Penalty Goal:** Shall be scored when the ball passes wholly between the goal posts and under the crossbar, having been kicked directly from the penalty kick mark (12 yards in front of the goal) by the player taking the penalty kick. Such a kick, deflected into the goal by a

defending player, shall score one point for the attackers (offense).

- R) **Place Kick:** A kick made while the ball is stationary on the ground.
- S) **Punt:** A ball which is dropped and kicked before it strikes the ground. The goalie within the penalty area is the only one permitted to punt.
- T) **Throw in:** The manner of putting the ball in play after it has gone completely over the touch line.
- U) **Trapping:** Stopping the progress of the ball by securing it under the foot, between the feet, or between the front of the leg or legs and the ground.
- V) **Unnecessary Roughness:** Any act which might cause injury to an opponent. This includes dangerous kicking in an attempt to gain possession of the ball or kicking a ball directly into a player standing at close range without regard for the player's safety.
- W) **Unintentional Handling:** When the ball strikes or touches the hands or arms of the player. This action shall not be penalized even though the advantage gained by the unintentional handling may go to the offending team of the player.

4. PLAYER'S PRIVILEGES

- A) Any player may dribble, place kick, or advance the ball with the head or shoulder (heading)
- B) A player in possession of the ball may place himself between the opponent and the ball.
- C) A player may kick the ball while it is trapped by an opponent provided a foul is not committed. (Only the ball may be kicked).
- D) A player may play the ball without waiting for the umpire's whistle except in the case of the kick off, penalty kick, and drop kick.
- E) A player may run forward any number of steps preliminary to a free kick, penalty kick, corner kick, defense kick, or kickoff.
- F) A player shall be penalized if he/she charges the goalkeeper in the penalty area. The umpire will remove without

caution any player who intentionally charges the goalkeeper. Possession of the ball or control of the ball includes; the goalkeeper trapping the ball with either one or two hands, bouncing the ball, and dropping the ball for the kick.

5. GOALKEEPER'S PRIVILEGES

- A) Only the goalkeeper may: pick up the ball, throw the ball, dropkick the ball, or punt. (Each of these actions must take place in the goalkeeper's area)!
- B) Bounce the ball any number of times to the edge of the penalty area. A bounce may be dribbling or a bounce and a catch, as long as no more than four steps are taken.
- C) Combine bounces with a punt, a drop kick or a throw.
- D) Take four steps with the ball. Immediately upon completion the goalkeeper must get rid of the ball within three seconds.
- E) The goalkeeper must not be interfered with or impeded in any manner when in possession of the ball.

6. OUT OF BOUNDS BALL

- A) **Throw in:** Taken when the ball goes out of bounds at the Touch Line.
- B) **Defense kick or goal kick:** When the ball goes over the goal line by the attacking team But does not go inside the goal. The ball is taken by the defense (usually the goalie) within the goal area.
- C) **Drop ball:** When the ball goes out any line off of opponent's feet simultaneously. The umpire drops the ball between the players, five yards inside the touch line or outside the penalty area.
- D) **Corner kick:** When the defense touches the ball last as it goes over the goal line. The ball is taken by the attackers at the corner kick mark.

7. FOULS

- A) Tripping an opponent
- B) Kicking an opponent
- C) Striking an opponent
- D) Jumping at an opponent
- E) Holding an opponent
- F) Pushing an opponent
- G) Intentional handling of the ball
- H) Unnecessary roughness
- I) High kicking
- J) Low heading
- K) Charging the goalkeeper

8. PENALTIES

- A) Outside the Penalty area...Free kick for the opponent.
 - 1. **A direct free kick:** (for the following fouls)
 - a) if either team is fouled outside the penalty area,
 - b) if the attacking team inside the penalty area,
 - c) those plays which result in disqualification of a player or players,
 - d) for dangerous kicking and low heading.
 - 2. **A indirect free kick:** (for the following fouls)
 - a) An improperly taken free kick, corner kick, kickoff, penalty kick, defense kick, or drop kick,
 - b) An infringement of the rule governing the goalkeeper's privileges,
 - c) Offsides.

3. **Penalty kick:** (is awarded)
 - a) for fouls committed by a player of the defending team within the penalty area;
 - b) for a team taking more than two time outs.
 - c) for failure to notify the umpire when the goalie is changed and the new goalie handles the ball;
 - d) for illegal substitution.
4. **Intentional charging of the goalkeeper:** The player is dismissed.
5. **Any foul language will not be tolerated and will warrant removal from the game.**

GLOSSARY OF SOCCER TERMS

1. **Charging:** A method of unbalancing an opponent when he has possession or is attempting to gain possession of the ball.
2. **Clearing:** A throw or kick by the goalkeeper after he has stopped a ball in the vicinity of the goal area.
3. **Corner Kick:** A kick made by the attacking team from a corner arc. A corner kick is awarded when the ball is last touched by a defensive player and passes over the goal line without resulting in a goal.
4. **Direct Free Kick:** A free kick from which a goal can be scored directly. It is awarded for personal fouls and major infractions of the rules.
5. **Drop Ball:** A ball held by the referee and allowed to fall directly to the ground between two opponents. The ball is in play when it touches the ground. A goal may be scored directly from a drop ball.
6. **Goal:** A one point score occurring when the ball passes wholly over the goal line, between the goalposts, and under the crossbar.
7. **Goal Kick:** An indirect free kick made by any defending player from the goal box. A goal kick is awarded when the ball is last

- touched by an offensive player and passes over the goal line without resulting in a goal.
8. **Handling:** The act of carrying, striking, or propelling the ball with the hand or arm.
 9. **Immunity:** The goalkeeper may not be charged in the penalty area. While he has possession of the ball, an opponent may not interfere in any manner.
 10. **Indirect Free Kick:** A free kick from which a goal cannot be scored until the ball is touched by another player. It is awarded for technical and minor infractions of the rules.
 11. **Marking:** Guarding or covering the player with the ball when he moves into your area of play.
 12. **Penalty Box:** That area directly in front of the mouth of the goal (eighteen by forty five yards). The goal keeper may use his hands in this area only.
 13. **Penalty Kick:** A direct free kick from spot (penalty mark) twelve yards from the goal line. It is awarded to the offended team for fouls committed by the defensive team in its own penalty area.
 14. **Tackling:** A method of gaining possession of the ball by use of the feet. Unnecessary roughness and use of the hands are not permitted.
 15. **Throw In:** A two handed, over the head throw that puts the ball into play after it has gone out of play over a touchline.
 16. **Touchline:** The boundary lines on each side of the field. (Ball is "in" as long as the ball stays "on" or within the boundaries)
 17. **Unintentional Handling:** The ball touches the hands or arms of a player.

SOCCER SUGGESTED ACTIVITIES AND SKILLS

1. DRIBBLING

A) **Weave:** The students will dribble in and out of cones for control, down and back.

0 * * * * * *

B) **Sprint:** Repeat drill "A" and have students return to the end of the line using the sprint dribble.

0 * * * * * *

|-----

2. PASSING/TRAPPING

A) **Stationary:** Partners are five (5) to ten (10) yards apart. Use inside part of the foot, pass the ball to the partner, trap the ball, then pass the ball back.

B) **Moving:** Partners will start side by side approximately five (5) to ten(10) yards apart. "A" dribbles ball. "A" then executes a lead pass to "B". "B" accelerates to the ball, bringing the ball under control. "B" will then reverses drill.

A|

A

A

B|

B

B

B

3. TRAPPING

(Getting the ball under control and or stopping ball).
For stationary passing drill - "stopping" the ball.

Stop ball:

1. Use the sole of the foot. Give with the ball at point of contact.

2. The inside of the foot is perpendicular to the ball.
Contact with the ball is at it's midpoint, using the inside of the foot.

4. KICKING/TRAPPING

1. **Stationary:Instep (shoe laces):** Partners are approximately 15-25 yards apart. Partner "A" kicks the ball to Partner "B" using the instep drive kick. Partner "B" then traps the ball and executes same kick back to "A".
2. **Running:** Use the instep and toe of the foot to kick. partners "A" and "B" are 20 yards apart. "A" passes to "B" who then brings the ball under control. "B" then makes an attempt to shoot at the goal.

SOCCER WRITTEN TESTNAME _____
DATE _____
PERIOD _____**MULTIPLE CHOICE**

Circle the correct answer on the answer sheet.

1. The game of soccer is played in more than ____?____ nations.
A) 80 B) 100 C) 110 D) 130
2. Within recent years the popularity of soccer in the United States has ...
A) increased tremendously B) decreased slowly
C) remained the same D) decreased rapidly
3. In 1968 two soccer leagues merged to form ...
A) USFL B) NASL C) USSA D) WSAF
4. Soccer is often called ...
A) a foot game B) a commie game
C) universal game D) no hands ma
5. A volley kick is executed when the ball is
A) rolling on the ground B) stationary on the ground
C) at least as high as the head D) in the air, either before or after it bounces
6. The process of bringing the ball under your control is called ...
A) charging B) dribbling C) passing D) trapping

7. A good method of gaining control of a ball in low flight is the ...

- | | |
|---------------------|-----------------------------|
| A) half volley kick | B) chest trap |
| C) stomach trap | D) inside of the thigh trap |

8. A tackle is considered successful if you ...

- A) physically drag your opponent to the ground
- B) knock your opponent off balance
- C) take the ball from your opponent by use of the feet
- D) tag your opponent with one hand between the shoulder and knees

9. When a fullback covers the goal for the goalie, he ...

- A) has the same privileges as the goalie
- B) must remain in the goal box in order to handle the ball
- C) cannot touch the ball with his hands
- D) may catch the ball, but he cannot run with it.

10. Because of his position of play, the ____?____ has the best opportunity for directing the team's defense.

- | | |
|-------------------|--------------------|
| A) right fullback | B) left fullback |
| C) goalie | D) center halfback |

TRUE AND FALSE

Circle the correct answer (T) or (F) on the answer sheet.

- 11. To perform the push pass, place the inside of the foot slightly under the ball and lift as you kick.
- 12. The sole of the foot trap can be used to trap a rolling or bouncing ball.
- 13. A simple rule to follow is dribble the ball whenever possible rather than pass.

14. When executing the throw in, you may use one hand to throw the ball so long as the ball is delivered from over the head.
15. In order to head the ball effectively, it is important to wait for the ball with both feet firmly placed on the ground.
16. The center forward is primarily an offensive player.
17. The attacking team can score a goal by using any portion of the arms from the elbow to the shoulder.
18. Basically, the offside rule eliminates the possibility of a player remaining close to the goal area where he can score a goal from short range.
19. When a penalty kick has been awarded, the goalkeeper must stand stationary on the goal line until the ball is kicked.
20. The touch line is the line which divides the field into two equal halves.

FILL IN THE BLANKS

Fill in the blank with the correct answer. Write the answer on your answer sheet.

21. The only player who would not use the side of the foot trap is the ____?____.
22. The type of dribble which gives best ball control is the ____?____ of the foot dribble.
23. To head the ball forward, the ball should make contact with the ____?____.
24. The primary position of play for the goalie is the ____?____
25. The most successful way for the goal keeper to clear the ball is to ____?____.

SOCCER TEST

NAME _____
DATE _____
PERIOD _____

MULTIPLE CHOICE (Circle the correct answer)

- | | | | | | | | | | |
|----|---|---|---|---|-----|---|---|---|---|
| 1. | A | B | C | D | 6. | A | B | C | D |
| 2. | A | B | C | D | 7. | A | B | C | D |
| 3. | A | B | C | D | 8. | A | B | C | D |
| 4. | A | B | C | D | 9. | A | B | C | D |
| 5. | A | B | C | D | 10. | A | B | C | D |

TRUE AND FALSE (Circle the correct answer)

- | | | | | | |
|-----|---|---|-----|---|---|
| 11. | T | F | 16. | T | F |
| 12. | T | F | 17. | T | F |
| 13. | T | F | 18. | T | F |
| 14. | T | F | 19. | T | F |
| 15. | T | F | 20. | T | F |

FILL IN THE BLANK

21. _____
22. _____
23. _____
24. _____
25. _____

**SOCCER TEST
KEY**

- | | | | | | | | | | |
|----|------------------------------------|------------------------------------|------------------------------------|------------------------------------|-----|---|------------------------------------|------------------------------------|------------------------------------|
| 1. | A | B | C | <input checked="" type="radio"/> D | 6. | A | B | C | <input checked="" type="radio"/> D |
| 2. | <input checked="" type="radio"/> A | B | C | D | 7. | A | B | C | <input checked="" type="radio"/> D |
| 3. | A | <input checked="" type="radio"/> B | C | D | 8. | A | B | <input checked="" type="radio"/> C | D |
| 4. | A | B | <input checked="" type="radio"/> C | D | 9. | A | B | <input checked="" type="radio"/> C | D |
| 5. | A | B | C | <input checked="" type="radio"/> D | 10. | A | <input checked="" type="radio"/> B | C | D |

TRUE AND FALSE

- | | | | | | |
|-----|------------------------------------|------------------------------------|-----|------------------------------------|------------------------------------|
| 11. | T | <input checked="" type="radio"/> F | 16. | <input checked="" type="radio"/> T | F |
| 12. | <input checked="" type="radio"/> T | F | 17. | T | <input checked="" type="radio"/> F |
| 13. | T | <input checked="" type="radio"/> F | 18. | <input checked="" type="radio"/> T | F |
| 14. | T | <input checked="" type="radio"/> F | 19. | <input checked="" type="radio"/> T | F |
| 15. | T | <input checked="" type="radio"/> F | 20. | T | <input checked="" type="radio"/> F |

FILL IN THE BLANK

21. GOALIE

22. INSIDE

23. TOP OF FOREHEAD

24. ANGLE BETWEEN THE BALL AND GOAL

25. PUNT

A

GUIDE

TO

SOFTBALL

TEACHING PACKET SOFTBALL

Course Description

The purpose of this unit is to acquaint students with the basic knowledge needed to actively participate in softball. It is essential that the students learn the basic skills and game strategy necessary for individual satisfaction.

INTRODUCTION

History
Equipment
Safety
Rules

BEGINNING

Throwing
Catching
Fielding
Hitting
Pitching

INTERMEDIATE

Base Running
Place hitting
Defensive and Offensive strategies

EVALUATION PROCESS

Written and or practical evaluation will be used to determine the student's knowledge and skill development.

HISTORY

Softball is an adaptation of baseball. Because of the lack of indoor space and the hardness of the ball, directors made the ball softer , the bat smaller, and the base lines, and pitching distances, shorter.

Prior to World War II, public interest in softball grew so much that teams were organized into leagues all over the country, and it was estimated that over five million people engaged in this genuinely popular American game. Because of its great appeal to Americans of all ages, and because only a small amount of equipment is needed (any ordinary playground is adequate),this game has become the first choice of many recreational playgrounds.

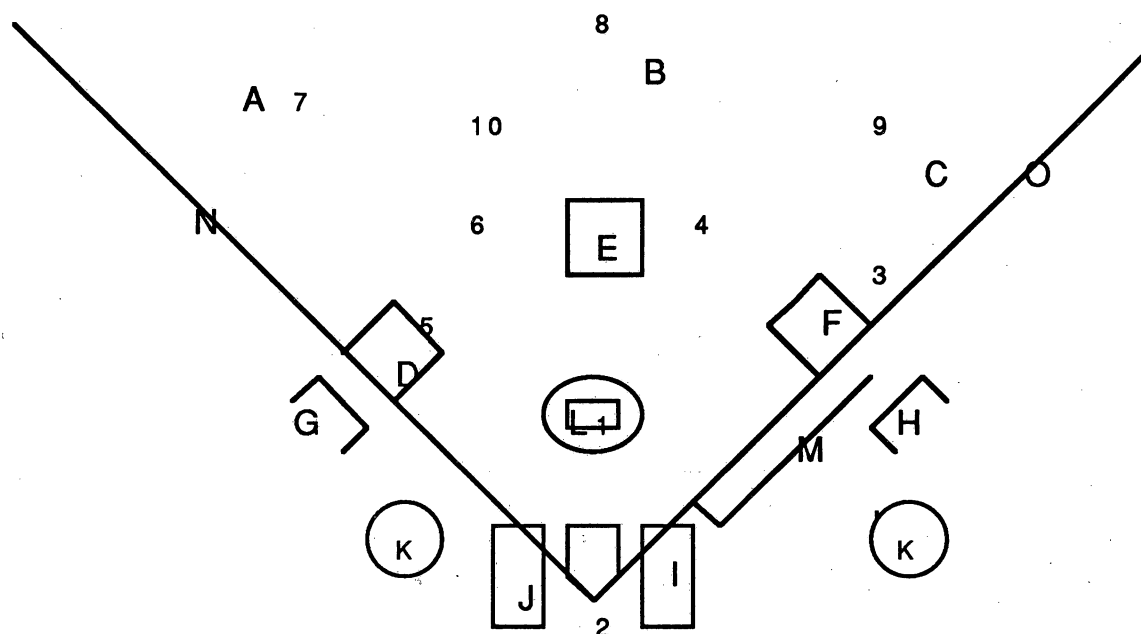

I Players and their position numbers

- | | | |
|-----------------|------------------|----------------|
| 1 - Pitcher | 2 - Catcher | 3 - First Base |
| 4 - Second Base | 5 - Third Base | 6 - Short Stop |
| 7 - Left Field | 8 - Center Field | 9 - Left Field |
| 10 - Rover | | |

II Parts of the Softball Diamond

- | | | |
|-----------------------------|-----------------------------|-----------------|
| A - Left Field | B - Center Field | C - Right Field |
| D - Third Base | E - Second Base | F - First Base |
| G - Third Base Coaching Box | H - First Base Coaching Box | |
| I - Right Hand Batters Box | J - Left Hand Batters Box | |
| K - On Deck Circle(s) | L - Pitcher's Plate | |
| M - Base extension | N - Third Base Foul Line | |
| O - First Base Foul Line | | |

III The Game

An official game is seven (7) innings. (An inning consists of both teams having had their turn at bat).

IV Pitching

- 1) The pitcher must have both feet on the pitcher's plate and only take one step forward while pitching.
- 2) The ball must be thrown underhand.
- 3) The ball must be thrown, not rolled during a pitch.
- 4) Both hands must be on the ball at the start of the pitch.
(One hand is in the mitt).
- 5) If these rules are broken an illegal pitch will be called.
- 6) Penalty for an illegal pitch :
 - a) A ball is called on the batter.
 - b) Base runners may take one base.
- 7) Any pitch must have a maximum arc of 12 feet and a minimum arc of six(6) feet.

V Batting

- 1) Batters must follow the same order throughout the entire game. If an incorrect batter finishes a turn at bat, the batter whose turn it was is out. If the error is caught before the at bat is finished, the correct batter may finish the turn, but will receive the called ball and strikes.
- 2) The batter is out if and when :
 - a) three strikes have been called;
 - b) a fly ball is caught;
 - c) a foul ball is caught;
 - d) the batter is hit by the batted ball in fair territory;
 - e) the batter interferes with the catcher's fielding or throwing.

VI Base Running

- 1) The batter becomes a base runner when:
 - a) He makes a fair hit.
 - b) Four balls have been called. (This is called a walk)
- 2) The base runner must touch each base in order.
- 3) The base runner may overrun first base only.
- 4) The runner may not leave the base until the ball has left the pitcher's hand. (He cannot lead off base)

- 5) After a fly ball is caught, the base runner must tag the occupied base before running to the next base (Runner may leave when the ball has been touched by the opposing player).
 - 6) One base runner cannot pass another base runner who is ahead of him. (Runner who has been passed up is considered out).
- 7) The base runner is Out :
- a) upon being tagged with the ball before reaching the base.
 - b) if the ball gets to first base before the runner.
 - c) upon running more than three (3) feet off the baseline to avoid being tagged.
 - d) if hit by a batted ball before a fielder has played the batted ball.
 - e) if the runner does not touch each base. (No appeal is necessary).
 - f) if the runner does not tag the base after a fly ball is caught.
 - g) if the runner passes a preceding base runner.
 - h) upon interfering with a fielder who is attempting to get the ball.
 - i) if the ball reaches the base ahead of the player who is forced to run. This is called a Forced out.
 - j) if there should happen to be two (2) runners on a base, the first runner being rundown between bases and returning to the base just vacated; or the second runner player who is out if touched by the ball.
 - k) if the runner leads off before the ball leaves the pitcher's hand.
8. A fielder shall not block the baseline unless actually fielding the ball. If the fielder does so (in not attempting to field the ball) the runner shall be safe. (Hindrance will be called)

VII Definitions

- 1) **Ball:** A legally pitched ball that does not enter the strike zone. If four balls are called the batter walks to first base without being thrown out.
- 2) **Base:** Part of the equipment that designates a position on the field.
- 3) **Ball in play :**
 - a) A ball that finally settles in the infield. (Or touches an infielder).
 - b) A ball that first lands in the outfield in fair ground.
- 4) **Complete Inning :** Both teams have been up to bat and have each had three outs.
- 5) **Force Out:** When a base runner has to go to the next base to make room for a following base runner. (Defensive players do not have to tag the runner for an out on a force run, but must tag the base while holding the ball.)
- 6) **Foul Ball:** A batted ball that settles on foul territory in the infield or lands on foul territory in the outfield.(If ball is caught in the foul territory it is still considered an out).
- 7) **Infield Fly:** A fly ball that remains in the area of the infield that can be caught by the infielder with reasonable effort.
- 8) **Infield Fly Rule :** If there are runners on first and second, or first, second, and third and less than two outs, the batter shall be out upon hitting an infield fly. Runners will hold their bases.
- 9) **Overthrown Ball:**
 - a) A ball that is thrown to a player who does not catch it.
 - b) If the ball goes into fair territory a base runner may take as many bases as desired.
 - c) If the overthrown ball goes into dead ball territory, a baserunner may take only one base.
- 10) **Strike Out:** The batter is out if he takes, or is called for three strikes. (Three outs retires the side).
- 11) **Strike:** Term used for a ball struck at and missed, or a ball that hits either home plate or the extension.

- 12) **Strike zone:** That area over home plate that strikes either home plate or the extension behind. (Ball may not have an arc of higher than 12 feet or lower than six feet).
- 13) **Third Strike Rule :** The batter is considered out, when after the second strike, the batter then fouls two more balls in the same at bat.
- 14) **Walk :** Batter receives four called balls. The batter may walk to first base without being called out.

VIII Other Important Terminology

- 1) **Double :** Another name for a two (2) base hit. Which is hitting the ball hard enough that the runner reaches second base without being called out.
- 2) **Error:** - When a fielder is unable to field or catch a ball. An error is called only if the ball could have been fielded or caught with reasonable effort.
- 3) **Grounder:** A ball hitting the ground .
- 4) **Home Run:** Hitting the ball hard enough so that the runner is able to round all the bases.
- 5) **In The Hole:** The batter who hits after the on deck batter.
- 6) **Run:** Coming safely into home plate after running all bases. Counted as the score in softball and baseball. The team with the most runs at the completion of seven innings wins the game.
- 7) **Single:** Another name for a one base hit.
- 8) **Triple:** Another name for a three base hit.
- 9) **Ups:** The batter or team that is at bat.

IV Scoresheet

Every team member should be able to keep score on the score sheet.

Here is an example of a score sheet.

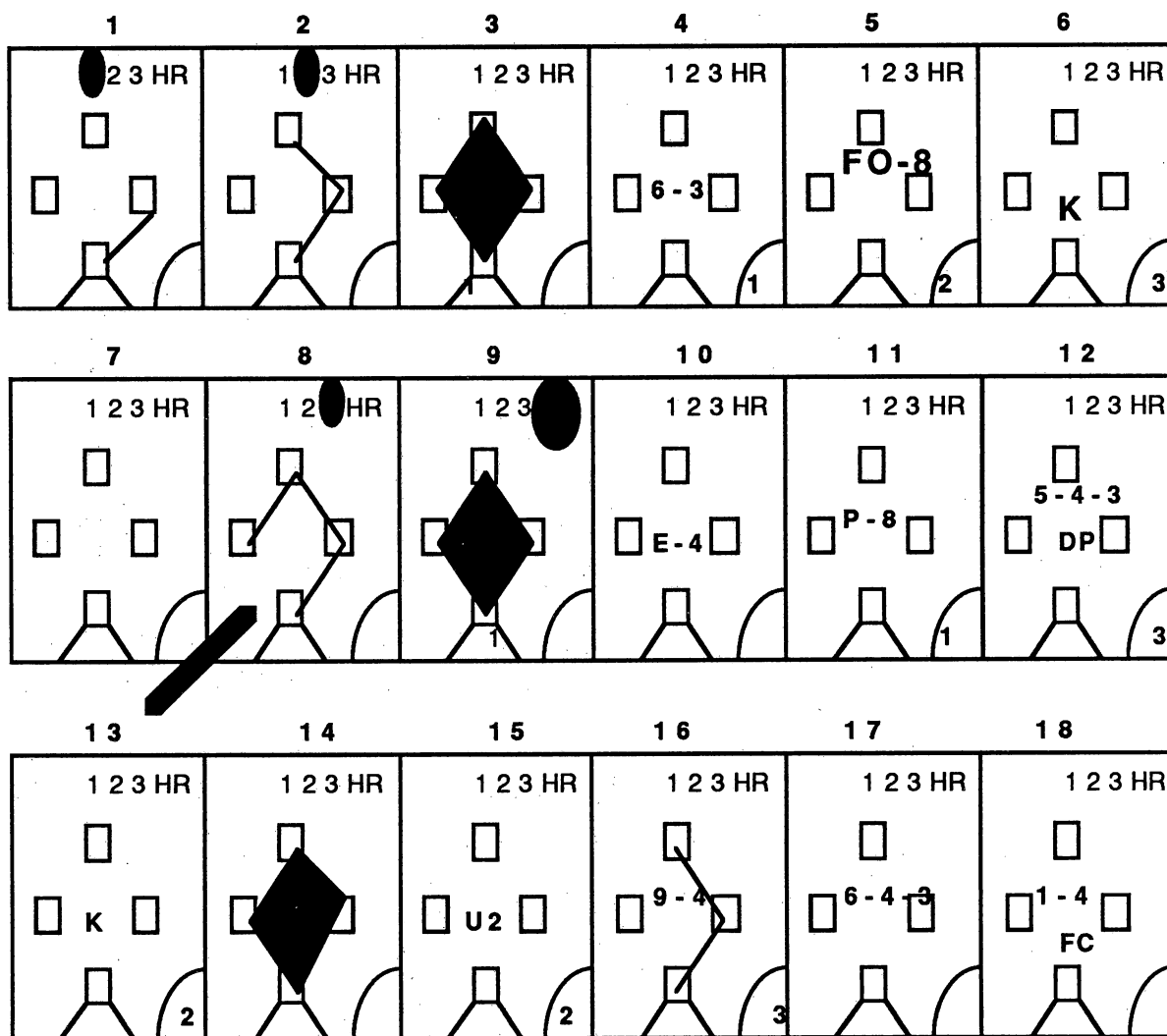

- 1- single
- 2- two base hit
- 3 -run
- 4 - SS to 1st baseman
- 5- fly out
- 6- strike out
- 7- last up
- 8- three base hit
- 9- home run
- 10- error on 2nd baseman
- 11- popfly to center
- 12- double play 3rd to 2nd to 1st
- 13- strikeout
- 14- runner scored
- 15- unassisted by catcher
- 16- right fielder throws to third baseman to force the third out.
- 17- shortstop to second baseman to first baseman.(Double Play)
- 18- fielder's Choice (pitcher to 2nd baseman)

SUGGESTED ACTIVITIES**THROWING, CATCHING AND FIELDING DRILLS****DRILL # 1****THROWING**

1. Line students up with a partner approximately 20 feet apart. (See diagram below). Each partner will throw the ball (overhand) to his partner. Emphasize the proper throwing techniques. (Step with opposite foot, lead with elbow, follow through with back foot, hips and shoulders).

CATCHING

2. While in line formation work on catching ball properly. Students will use two hands to catch. Emphasize to the students to catch the ball in front of their body, chest level, step and throw the ball back to their partner. Have each partner throw ten times and then switch (both throwing and catching).

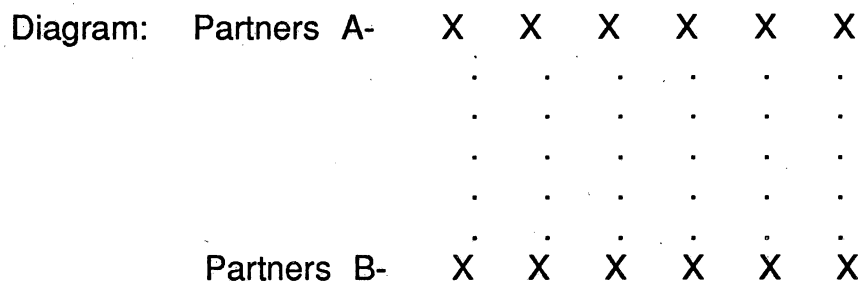

DRILL # 2

FIELDING

Line up students approximately 20 feet from each other. One student rolls the ball on the ground to partner, who fields it and tosses it back to partner. Emphasize proper fielding technique: Stay low, bend at hips, not waist, have feet in straddle position (one foot slightly ahead of other), field ball in front of body, keep eyes on ball, chin tucked down to chest and keep weight on balls of feet, shift weight from forward foot to back foot and then throw back to partner.

DRILL # 3

FIELDING: TWO LINE FIELDING REACTION DRILL

The instructor will give verbal directions (read, set, throw) to fielders. Partner will then roll the ball hard in the direction to where the instructor points. The partner who is fielding, then fields the ball and throws it back to partner.

DRILL # 4**CATCHING FLY BALLS**

Have partners line up across from each other approximately 60 feet apart. Have one partner throw high fly balls to the other partner. Emphasize to fielders to catch fly ball on throwing side shoulder level; Emphasize catching ball at highest point and to set up throw (move under ball and throw while on the move).

HITTING DRILLSDRILL # 1

TEE BALL HITTING

Set up groups of 8 - 10 students, each having a tee. One student places ball on tee, another student hits ball off tee and all others shag ball hit. Emphasize proper batting techniques; step into pitch, wrist snap, back elbow up, hip rotation, eye on ball, follow through , bat position, balance.

DRILL # 2

PEPPER DRILL

Set up students in groups of 6-8. One will be the hitter. The others will be in a semicircle approximately 20-30 feet away. (See diagram below). Student with the ball will toss under hand to hitter. Hitter uses a half swing and attempts to hit ball to fielders.

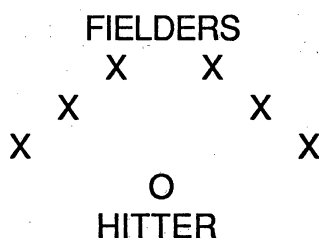
DRILL # 3

HITTING

There is one hitter, and eight to ten fielders. One person pitches the ball underhand. Fielders who field the ball, will roll the ball back to the pitcher. Each hitter gets 10 pitches and then rotates to field.

Softball Test

NAME _____
 DATE _____
 PERIOD _____

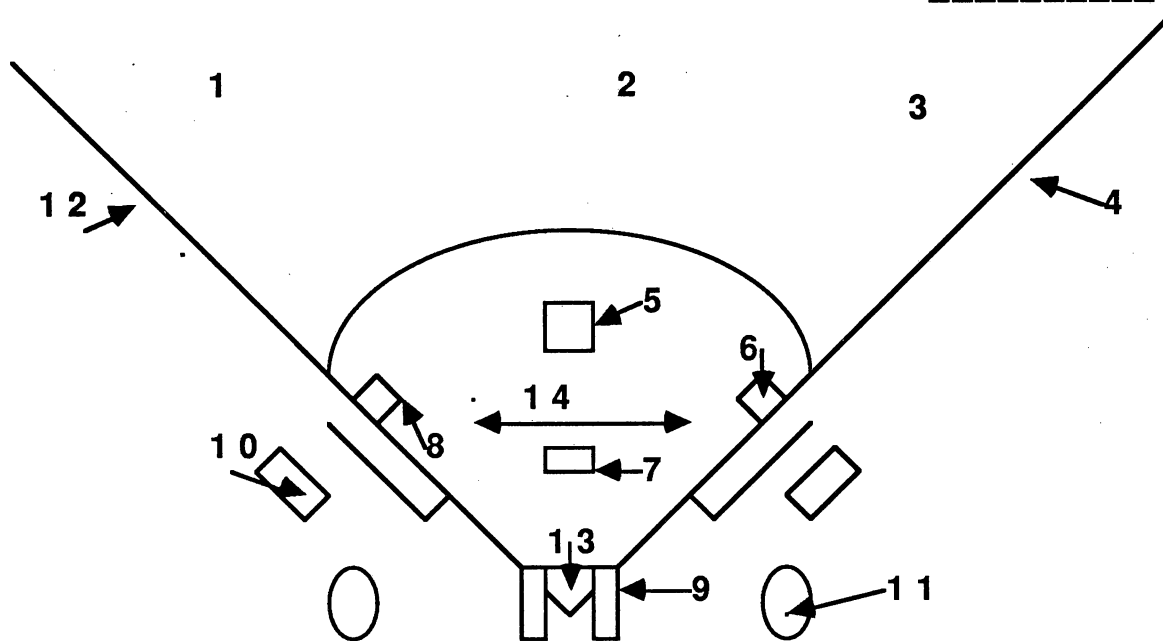

I Diagram

The words below correspond to a number on the diagram. Place the correct number on the line provided.

- | | | |
|----------------------------|----------------------------|------------------|
| _____ Right Field | _____ On Deck Circle | _____ Infield |
| _____ First Base | _____ Pitcher's Plate | _____ Third Base |
| _____ Center Field | _____ Home Plate | _____ Left Field |
| _____ Coach's Box | _____ Second Base | |
| _____ Third Base Foul Line | _____ First Base Foul Line | |
| _____ Batter's Box | | |

II Matching

Put the correct number of the word that best fits the definition on the space provided.

- | | | | |
|----------|---|-----|------------------|
| _____ A) | The area that is beyond the infield but between the baselines. | 1) | Walk |
| _____ B) | When both teams have had their turn at bat. | 2) | Diamond |
| _____ C) | The nickname for the entire ball field | 3) | Double |
| _____ D) | Four _____ allows runner to go to first | 4) | Forced Run |
| _____ E) | Anyone forced to cross home base | 5) | Foul Ball |
| _____ F) | Batter or team at bat | 6) | Infield |
| _____ H) | Term used for a ball struck at and missed | 7) | Infield Fly Rule |
| _____ I) | A three base hit | 8) | Inning |
| _____ J) | Batter gets four balls called. | 9) | Outfield |
| _____ K) | If there are runners on first and second and less than two outs, the batter hits an infield fly. | 10) | Strikes |
| _____ I) | A batted ball that settles on foul territory in the infield or lands on foul territory in the outfield. | 11) | Overthrown ball |
| | | 12) | Home Run |
| | | 13) | 3RD Strike Rule |
| | | 14) | Triple |
| | | 15) | 2 Base Hit |

III Fill in

Fill in the correct word or words that correctly completes the statement. Place the word or words on the spaces to the left of the statement.

- _____ 1. The most ___?___ in seven innings wins the game.
- _____ 2. "In the Hole" signifies the next batter after the ___?___ Batter.
- _____ 3. A fielder shall not ___?___ the baseline unless they are fielding the ball.

- _____ 4. A ___?___ is any ball that goes outside the first or third Base lines
- _____ 5. The left, center and right fielders play in the ___?___.
- _____ 6. A baserunner may ___?___ first base only.
- _____ 7. If the ball reaches the base ahead of the runner who is forced to run, it is called a ___?___.
- _____ 8. A base runner is out if they do not ___?___ the base after a fly ball is caught.

IV Softball Scoring Test

Score each person as if they are the only person playing
(One persons actions does not determine what the next will do)

Team "A"

1. Sue hits a single
2. Bob Flew out to LF
3. Jennifer struck out
4. Dave hit a triple
5. Tim hit a single
6. Mark is thrown out (shortstop to first)

Team "B"

7. Ed Hit a single
8. Jim hit a double
9. Antoine flew out to right field
10. Debbie out at first (3rd to 1st)
11. Lisa hit a home run
12. Larry hit into a 6-4-3 double play

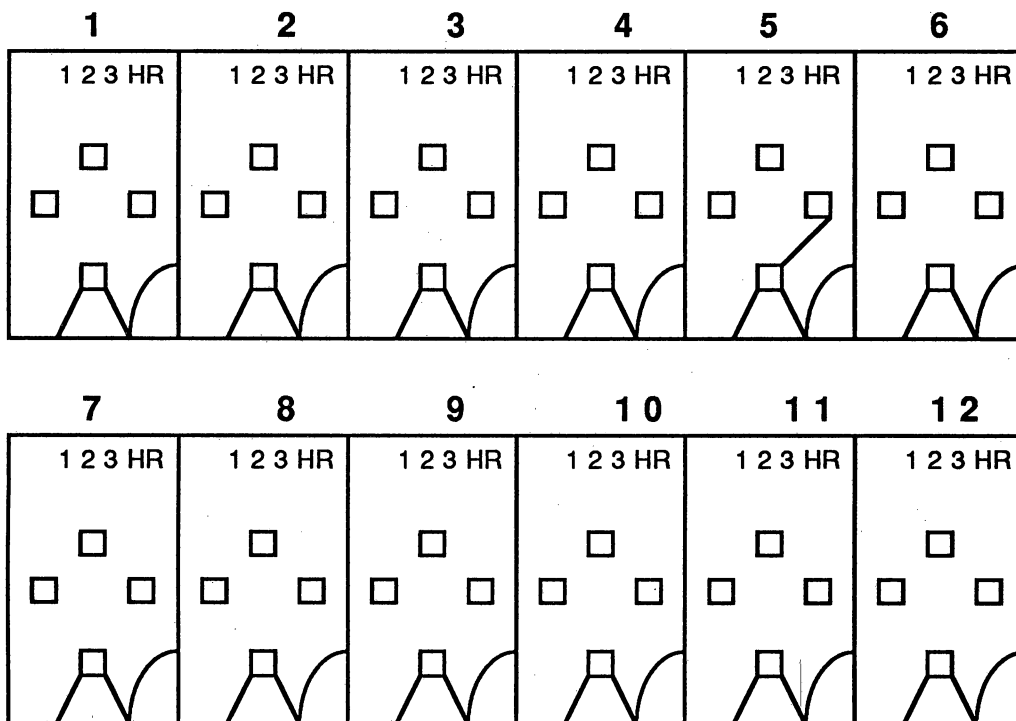

Softball Test

KEY

I Diagram

Put in the correct number from the diagram that fits the words given on the test.

__3__ Right Field __11__ On Deck Circle __14__ Infield

__6__ First Base __7__ Pitcher's Plate __8__ Third Base

__2__ Center Field __13__ Home Plate __1__ Left Field

__10__ Coach's Box __5__ Second Base

__12__ Third Base Foul Line __4__ First Base Foul Line

__9__ Batter's Box

II Matching

Put the correct number of the word that best fits the definition on the space provided.

- | | | | |
|----|--|-----|------------------|
| 9 | A) The area that is beyond the infield but between the foul lines. | 1) | Walk |
| 8 | B) When both teams have had their turn at bat. | 2) | Diamond |
| 2 | C) The nickname for the entire ball field | 3) | Up |
| 10 | D) Three _____ retires the batter | 4) | Forced Run |
| 4 | E) Anyone forced to cross home plate | 5) | Foul Ball |
| 3 | F) Batter or team at bat | 6) | Infield |
| 12 | G) Term used for a ball struck at and missed | 7) | Infield Fly Rule |
| 14 | H) A three base hit | 8) | Inning |
| 1 | I) Batter gets four balls called. | 9) | Outfield |
| 7 | J) If there are runners on first and second and less than two outs, the batter hits an infield fly. | 10) | Strikes |
| 5 | K) A batted ball that settles in foul territory in the infield or lands on foul territory in the outfield. | 11) | Overthrown ball |
| | | 12) | Home Run |
| | | 13) | 3RD Strike |
| | | 14) | Triple |
| | | 15) | 2 Base Hit |

III Fill in

Fill in the correct word or words that correctly completes the statement. Put the word or words on the spaces to the left of the statement.

- ___RUNS___ 1. The most ___?___ in seven innings wins the game.
- ___ON DECK___ 2. "In the Hole" signifies the next batter after the ___?___ Batter.
- ___HINDER___ 3. A fielder shall not ___?___ the baseline unless they are fielding the ball.
- ___FOUL___ 4. A ___?___ is any ball that goes outside the first or third Base lines
- ___OUTFIELD___ 5. The left, center and right fielders play in the ___?___.
- ___OVERRUN___ 6. A baserunner may ___?___ first base only.
- ___OUT___ 7. If the ball reaches the base ahead of the runner who is forced to run, it is called an ___?___.
- ___TAG___ 8. A base runner is out if they do not ___?___ the base after a fly ball is caught.

IV Softball Scoring Test

Score each person as if they are the only person playing
(One persons actions does not determine what the next will do)

Team "A"

1. Sue hits a single
2. Bob Flew out to LF
3. Jennifer struck out
4. Dave hit a triple
5. Tim hit a single
6. Mark is thrown out.
shortstop to 1st base.

Team "B"

7. Ed Hit a single
8. Jim hit a double
9. Antoine flew out to right field
10. Debbie out at first
(3rd to 1st)
11. Lisa hit a home run
12. Larry hit into a 6-4-3
double play

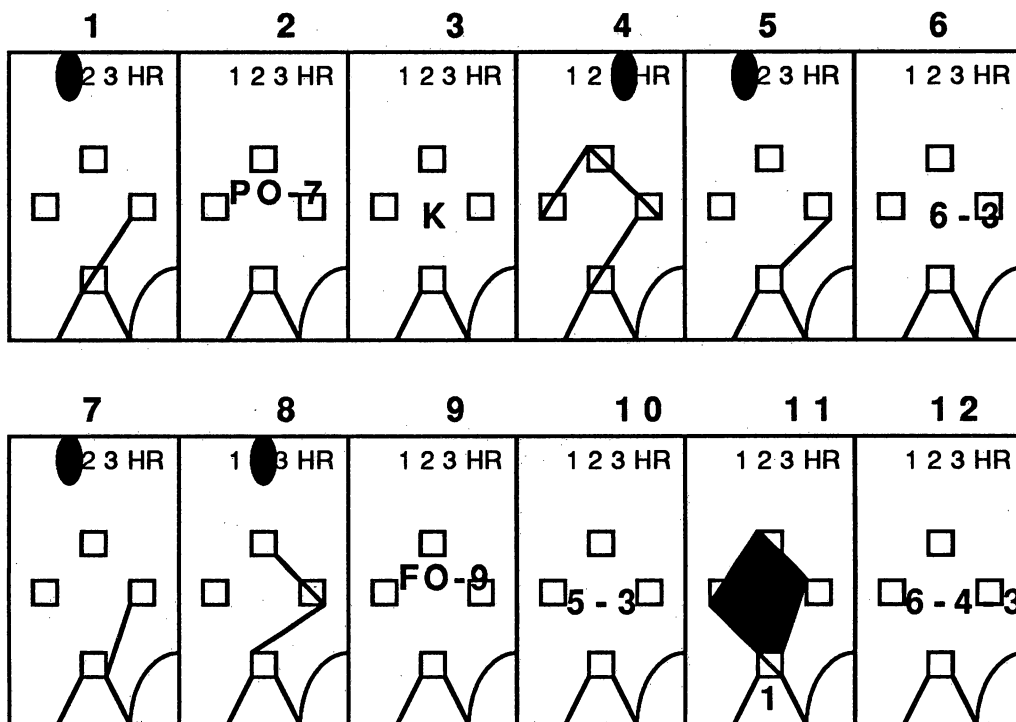

A

GUIDE

TO

SWIMMING

TEACHING PACKET SWIMMING

COURSE DESCRIPTION

The purpose of this unit is to acquaint students with the basic knowledge needed to actively participate in aquatics. It is essential that the students learn the basic strokes and fundamentals of water safety necessary for individual enjoyment and survival.

INTRODUCTION

History
Equipment
Safety
Rules

INTERMEDIATE

Sidestroke
Breaststroke
Underwater Swim
Rescue Skills

BEGINNER

Hold Breath
Floats and Glides
Crawl Stroke
Combined Stroke (back)
Change Direction/Turn Over
Safety Skills

ADVANCED

Inverted Backstroke
Overarm Sidestroke
Trudgen Crawl
Back Crawl
Safety and Rescue
Dolphin Kick
Butterfly Stroke

ADVANCED BEGINNER

Rhythmic Breath
Survival Float
Tread Water
Elementary Back stroke
Front Dive
Safety and Rescue

SURIVAL SKILLS

Breath Control
Survival Float
Surface Dive
Lifesaving Skills
Artificial Respiration
Stroke Modification

EVALUATION PROCESS

Written and or practical evaluation will be used to determine student knowledge and skill development of aquatics and water survival.

HISTORY

Swimming was undoubtedly learned by observing animals that usually set up a running motion to move about on or in the water. Water is an unnatural medium for humans because it interferes with our breathing mechanism. The animal is better equipped anatomically for swimming simply because it holds its nose higher. The human being cannot easily do this successfully and remain in the horizontal position.

Carvings showing swimming have been found dating as early as 9000 B.C. In the middle Ages, accounts in the Greek, Roman, Anglo Saxon, and Scandinavian classics dealt often with great feats of swimming prowess of the heroes of their day.

In 1538, Nicolaus Wynman, a German professor of languages, wrote the first book about swimming. In 1696, M. Thevenot, a Frenchman, wrote a more scientific treatise.

SAFETY AND SWIMMING REGULATIONS:

- 1) Any money or valuables should be checked in with the teacher or aid before entering the pool area.
- 2) Students must stay with the class until the teacher gives the signal to leave.
- 3) Students should shower before and after they swim.
- 4) Students should dress warmly when leaving the locker room.
- 5) Hair should be dry and students should avoid drafts when leaving the swimming area.

- 6) If unable to dress, the student should always bring something to study. Bring a notepad, and writing utensil to jot down notes if you are not swimming that day.
- 7) There should be no running anywhere in the pool area.
- 8) There should be no gum, candy, or food in the pool area.
- 9) Students should familiarize themselves with the pool depths and the contour of the bottom.
- 10) There should be no hanging, sitting, or playing on safety lines.
- 11) Teacher should be present and give permission before the students enter.
- 12) Students should not go in the deep water without teacher's permission.
- 13) Students should not push off from the side, unless they are sure they have room to swim.
- 14) If a student should bump into another swimmer, be sure the other swimmer is all right before continuing to swim.
- 15) A student should never jump into the pool with the intention of jumping close to someone.
- 16) A student should not yell "help" except when really necessary.
- 17) Do not push or pull anyone into the water, or duck another swimmer even in fun.
- 18) A student should not help anyone out of the pool by pulling them over the side in play.
- 19) Any accident, however slight, should be reported immediately to the teacher.
- 20) A student should not dive until the person ahead has come up and is out of the way.
- 21) A student should not attempt difficult dives until they are ready for them.
- 22) A student should never do a standing dive in shallow water.
- 23) When the signal to leave the pool is given, the students should swim to the nearest exit and leave promptly.
- 24) When it is time to go in, if the students are out of the water, they may not reenter again.
- 25) The noise level should be kept to a minimum so instructions can be heard by everyone.

- 26) This is a learning experience. Students should take full advantage of every minute.
- 27) Students should relieve themselves before entering the pool.
- 28) All rules and regulations should be obeyed for the safety of everyone.
- 29) The student is responsible for every day's lesson.

CHECK OFF LIST

Check off the items, as they have been mastered.

- Entering the water/ wading and submerging
- Breath holding beneath the surface.
- Opening eyes under water.
- Crawl Float
- Back Glide
- Elementary Backstroke
- Change Direction/ Turn over
- Safety Skills
 - Release of Cramp
 - Reaching and extension assists
 - Treading Water

- Rhythmic Breath
- Survival Float
- Front Dive
- Safety and Rescue
- Introduce C.P.R.

- Sidestroke
- Breast stroke
- Underwater Swim
- Rescue Skills
- More emphasis on C.P.R.

- Trudgen Crawl
- Back Crawl
- Safety and Rescue
- Running Front Dive
- Butterfly Stroke

- Flutter Kick
- Scissors Kick
- Breaststroke Kick

SAFETY AND SWIMMING EXAM

FILL IN THE BLANKS

Fill in the blank with the correct answer. Write the answer on your answer sheet.

1. Never swim ____?____, for it is not safe.
2. Stay out of water during ____?____ . ____?____.
3. Do not hang on the ____?____ lines
4. Dive only into known waters of ____?____ depth.
5. When an accident occurs ____?____ it immediately to the teacher.
6. Do not yell "____?____" except when really necessary.
7. List the 5 steps necessary for the artificial respiration.
7. ____?____
8. ____?____
9. ____?____
10. ____?____
11. ____?____
12. The emergency number is ____?____.
13. An efficient swimmer maintains a body position in the water assimilating
____(13)____ ____ (14)____/____(15)____
16. The crawl stroke arm pulls the ____?____ of the body.

17. The ____?____ recovers first in the crawl stroke.
18. The flutter kick is the kick used for which strokes ?
18. ____?____
19. ____?____
20. The stroke that uses the frog kick is the ____?____.
21. The stroke that is the most efficient to propel one through the water is the ____?____.
22. The stroke that uses the scissor kick is the ____?____.
23. Most arm strokes require that the majority of force should be applied in a ____?____ direction.
24. Treading water combines the two skills of the ____?____ and ____?____.

SWIMMING TEST ANSWER SHEET

NAME _____
DATE _____
PERIOD _____

1. _____

2. _____

3. _____

4. _____

5. _____

6. _____

7. _____

8. _____

9. _____

10. _____

11. _____

12. _____

13. _____

14. _____

15. _____

16. _____

17. _____

18. _____

19. _____

20. _____

21. _____

22. _____

23. _____

24. _____

**SWIMMING TEST
KEY**

- | | |
|------------------------------------|---------------------------|
| 1. ALONE | 13. SWIMMING |
| 2. ELECTRIC STORM | 14. DOWNHILL |
| 3. SAFETY | 15. HORIZONTAL |
| 4. KNOWN | 16. MID LINE |
| 5. TELL | 17. ELBOW |
| 6. HELP | 18. CRAWL |
| 7. CHECK FOR FOREIGN MATTER | 19. BACK STROKE |
| 8. OPEN AIR PASSAGE | 20. BREAST STROKE |
| 9. PINCH NOSTRILS | 21. FREE STYLE |
| 10. SEAL MOUTH | 22. SIDE STROKE |
| 11. TURN HEAD, & LISTEN FOR EXHALE | 23. BACKWARDS |
| 12. 911 | 24. EGG
BEATER/FINNING |

A

GUIDE

TO

TENNIS

TEACHING PACKET TENNIS

COURSE DESCRIPTION

The purpose of this unit is to acquaint students with the basic knowledge needed to actively participate in tennis. It is essential that the students learn the basic skills and game strategy necessary for individual satisfaction.

INTRODUCTION

History
Rules

BEGINNING

Grip
Footwork
Forehand/Backhand
Serve
Terminology/Scoring
Serving rotation (doubles)

INTERMEDIATE

Lob/Volley
Drives
Game Strategies (doubles)

ADVANCED

Smash
Net shots
Offensive and Defensive coverages (singles and doubles)

EVALUATION PROCESS

Written and or practical evaluation will be used to determine student knowledge and skill development of tennis.

HISTORY

There are some historians who trace the game of tennis to the ancient Greeks. Others consider it an outgrowth of the game of handball, which was first played in Ireland and Scotland as early as the tenth century. However, most authorities trace its origin to "le paume" (game of the hand), which was first played in France as early as 1300 A.D. The game at this early time was played either indoors or outdoors. A cork ball or a ball of hair covered with leather was batted with the hand back and forth over a mound of earth on blocks of wood about three high. Gloves were used to protect the hands. Soon, however, a paddle was used, which later was replaced by a racquet with tightly drawn strings. The cork ball was replaced by an inflated ball, and a net replaced the mound of earth. Undoubtedly, the original game of batting the ball with the hand has continued to the present day and is known as handball.

The game received its present day name when English visitors heard French officials call "tenez," which meant to resume play, an expression similar to "play ball" used by baseball umpires. The English thought "tenez" was the correct name for "la paume." In time the English word tennis was substituted.

TENNIS STUDY GUIDE/RULES

CHOICE OF SERVICE OR SIDE.

The choice of sides and the right to be server or receiver in the first game is decided by the spinning of the racquet. Generally, one player spins the racquet and the other player calls one of the options presented by the markings on the racquet. The player winning the toss may choose, or require the opponent to choose:

1. the right to serve;
2. the right to receive;
3. the side of the court.

FAULTS

The serve is a fault if:

1. the server fails to hit the ball into the proper court;
2. the server misses the ball in an attempt to strike it;
3. the ball served touches a permanent fixture (other than the net);
4. the server's partner hits the ball before it hits the ground;
5. a foot fault is committed.

A foot fault is called:

1. if the server changes her/his position by walking or running before the student hits the ball;
2. if the server touches the baseline or the court area within the baseline before the student hits the ball;
3. if the server serves the ball from outside the area between the side line and the other center line.

LETS

A "let" is a served ball which touches the net, strap, or band and is otherwise good. A let is called when play is interrupted or if the serve is delivered before the receiver is ready.

When a let occurs on a service, the serve is then replayed. When a let occurs during a play other than a serve, the play continues uninterrupted.

WHEN A PLAYER LOSES A POINT

A player loses a point if:

1. the student serves a double fault;
2. the student fails to return the ball before it bounces twice, or if the student doesn't return the ball into the opponent's court;

3. the student returns the ball so that it hits the ground, a permanent fixture, or other objects outside any of the lines which bound the opponent's court;
4. the student volleys the ball and fails to make a good return even when standing outside the court;
5. the student touches the ball in play with the student's racquet more than once when making a stroke;
6. the student or racquet or anything the student wears or carries touches the net or the ground within the opponent's court;
7. the student volleys the ball before it has passed the net;
8. the ball in play touches the student or anything the student wears or carries except the racquet;
9. the student throws the racquet and hits the ball;
10. the student deliberately commits an act which hinders the opponent in making a stroke.

GOOD RETURN

It is a good return if:

1. the ball lands on the line;
2. the ball touches the net, provided it passes over it and lands in the proper court;
3. the player reaches over the net to hit a ball that has blown or rebounded back to the other side on its own accord. Providing, the player does not touch the net with the racquet, body, or clothing;
5. the player's racquet passes over the net after the ball has been returned, provided the net is not touched;
6. the player returns a ball which has hit a ball lying in the court;
7. the ball is returned outside the post, either above or below the level of the net, provided the ball lands in the proper court, even though it touches the post.

ORDER OF SERVICE IN DOUBLES

The order of serving is decided at the beginning of each set. The pair who serves in the first game of each set decide which partner shall do so. The other partner serves the third game. The opposing pair decide who shall serve the second game of the set. The partner then serves the fourth game.

ORDER OF RECEIVING

The order of receiving is determined at the beginning of each set. The pair who receives decides who will receive the first point, and that player continues to receive the serves directed to that particular service court throughout the set. The other partner does the same to the serves directed to the other service court.

If a player receives out of turn, the student remains in that position until the game in which it occurred is completed. The partners then resume their original position.

VIII THE SCORING OF THE GAME

Points are called as follows, with the server's score always called first:

0 points	=	love
First point	=	15
Second point	=	30
Third point	=	40
Fourth point	=	game

"Deuce" means that each side has won three points. One side must now win two consecutive points to win the game. The first point after deuce is call "advantage." If the server wins the first point after deuce, the score is then called "advantage (ad) in." If the server loses, the first point after deuce, the score is called "advantage (ad) out."

IX THE SCORING OF THE SET

The first side to win six games wins the set, provided they are ahead by at least two games.

X LABELING THE COURT

- | | |
|------------------------|-----------------------|
| 1. Left Service court | 6. Single's Side Line |
| 2. Right Service court | 7. Double's Side line |
| 3. Alley | 8. Center Mark |
| 4. Center Line | 9. No Man's Land |
| 5. Net | 10. Service Line |

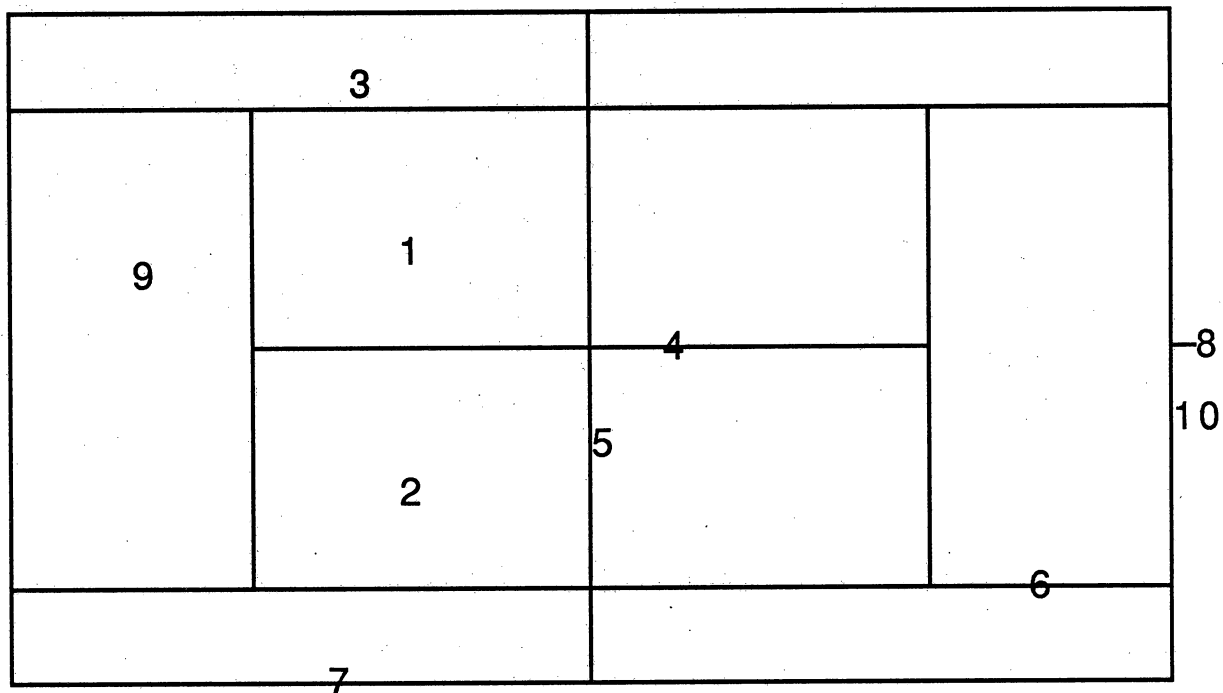

XI LABELING THE RACQUET

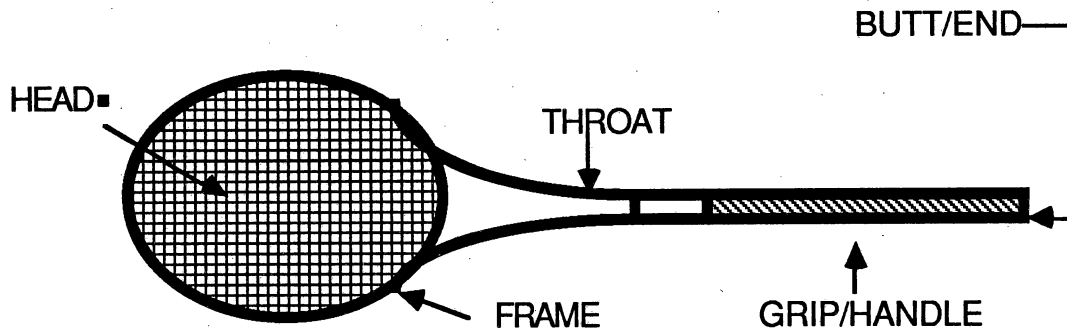

XII TENNIS TERMINOLOGY

1. TERMS PERTAINING TO THE BALL:

- a) **Back spin:** The rotation of the ball in which the top of the ball spins backward away from the direction of flight.
- b) **Ball flight:** The direction of the ball goes through the air after being hit.
- c) **Side Spin:** The rotation of the ball from right to left or left to right around the vertical axis.
- d) **Top Spin:** The rotation of the ball in which the top of the ball spins forward in the direction of flight.

2. TERMS PERTAINING TO STROKE:

- a) **Backhand:** The Stroke used when the ball is hit on the left side of a right handed player and the stroke used when the ball is on the right side of a left handed player.
- b) **Chop:** The stroke in which the racquet is drawn sharply down under the back of the ball to give it backspin.
- c) **Courtesy stroke:** The start of a rally by hitting the ball with a forehand stroke without letting it bounce.
- d) **Drive:** A shot hit hard and close to the net so that the ball lands deep near the baseline.
- e) **Forehand:** The Stroke used to hit balls on the right side of a right handed player and a stroke used to hit balls on the left side of a left handed player.
- f) **Ground stroke:** Any stroke taken after the ball has bounced.
- g) **Half volley:** A stroke in which the ball is hit immediately after it has hit the ground.
- h) **Lob:** A high arching shot that lands near the baseline.
- i) **Serve:** The stroke used to put the ball into play at the beginning of each point.

- j) **Slice:** A stroke in which the racquet is drawn sharply down across the ball with a wrist action to give it side spin which crosses the hitters body.
- k) **Smash:** A hard and fast downward shot made with an overhead stroke.
- l) **Volley:** The stroke used to hit the ball in the air before it has bounced.

3. TERMS PERTAINING TO SCORING

- a) **Advantage:** The Point following deuce.
- b) **Advantage in: (Ad in)** Indicates that the server has won the first point after deuce.
- c) **Advantage out: (Ad out)** Indicates that the receiver has won the first point after deuce.
- d) **Deuce:** The term used to indicate an even score. When each side has won three (3) points. (40-40)
- e) **Double fault:** The failure to make a good serve on two (2) consecutive serves.
- f) **Fault:** The failure to make a good serve.
- g) **Fifteen: (15)** The first point of the game.
- h) **Foot fault:** The illegal movement of the feet during service, including stepping on or over the baseline before hitting the ball.
- i) **Forty: (40)** The third point of the game.
- j) **Game:** The winning of four points before the opponent reaches three or by winning two consecutive points after deuce.
- k) **Let:** The service or point that is replayed.
- l) **Love:** Zero or nothing.
- m) **Match:** The winning of two out of three sets, or the winning of three out of five sets in some men's tournaments.
- n) **Match Point:** The point, if won, that allows a player to win the match.
- o) **Set:** The winning of six games or the winning of two consecutive games after each team has won five games.
- p) **Set point:** The point that, if won, allows a player to win the set.

q) **Thirty:** (30) The second point

4. TERMS PERTAINING TO THE GAME:

- a) **Ace:** A good serve that is not touched by the opponent's racquet.
- b) **Baseline game:** A player that stays on or near the baseline when playing, seldom coming to the net.
- c) **Break Service:** A phrase indicating that the receiver has won a game that the opponent has served.
- d) **Change of pace:** The changing or mixing up the speed of the hits.
- e) **Deep:** A shot that lands near or on the baseline.
- f) **Cross court:** A ball hit diagonally from one corner across the net to the other corner of the opponents court.
- g) **Doubles:** The game played with two people on each side of the net.
- h) **Down the line shot:** A ball which is driven parallel and close to the sideline.
- i) **Forcing shot:** A deep, hard shot designed to maneuver an opponent out of position.
- j) **Hold service:** When the person who is serving wins the game.
- k) **Long:** Shot that lands beyond the baseline outside the court.
- l) **Love Game:** A game in which the loser has not won a single point.
- m) **Mixed doubles:** A game in which a man and a woman play as partners on each side.
- n) **Net game:** The type of play in which a player gets to the net as soon as possible to volley.
- o) **Pass:** A shot going to either side of an opponent near the net and out of his reach.
- p) **Placement:** A shot placed accurately out of reach of the opponent.
- q) **Poaching:** This usually applies to the play at the net in doubles in which one player plays a ball that should have been played by their partner.
- r) **Rally:** The continued play between the serve and the winning of a point.

- s) **Singles:** The game played with one person on each side of the net.
- t) **Toss:** The spinning of the racquet at the beginning of a match to determine choice of serving first, receiving first, or choice of the side of court.
- u) **Wide:** A shot that lands beyond the sideline outside the court.

SUGGESTED ACTIVITIES

MAJOR SKILLS

1. FOREHAND DRILL

The tosser stands just in front of the net. The hitter is on the same side of the court but on the end line. The retrievers are on the opposite end line.

The tosser throws an underhand toss to the hitter. The hitter pivots on the right foot, steps out diagonally with the left foot. The racquet then swings back, and makes contact with the ball when it is in front of the front foot. (Make sure the student follows through).

2. BACKHAND DRILL

Use the same drill as in #1, but change the body position and the grip.

Turn the racquet grip 1/4 turns to the right. Pivot on the left foot, step out diagonally on the right foot, with the back to the net. Swing the racquet back. From here begin the motion forward, contact of the ball should be made off the front foot.

3. FOREHAND AND BACKHAND DRILL

- a) Eight players line up behind the end line on each side of the court. The instructor stands at the right net post and tosses the ball to the line using only the forehand. When a player completes that line, the player goes to the other net post and tosses to the forehand of the other group. The remaining students at the post now tosses the ball to the opposite line which is using their backhand.
- b) Place one single file line at the end of each end line with eight players in each line. The first player hits a forehand (from self toss) shot over the net and runs to the end of the line. The first player on the other side returns the ball and goes to the end of the line. If the ball is not kept in play, start the drill over again. As skill increases, this drill may be used as an elimination contest. If a player makes a fault, the player sits down on the side line.

4. SERVING DRILLS

- a) This is a beginning lead up game for the serve. Player A,B, and C oppose players X,Y, and Z. Player A serves from the center of the court to any part of the opposite courts. Player X,Y, and Z return the serve and play continues until an error occurs. Each player serves ten (10) balls. The score for each player is kept and the team score is the total of the three players. It is suggested that the server serves from the middle of the court so that the widest range possible is permitted for directional inaccuracy.
- b) This is an accuracy lead up game for the serve. This is the same as drill "A", except that the service is taken from the right and left courts alternately while the service must go into the correct service box.

TENNIS WRITTEN TEST**MULTIPLE CHOICE****DIRECTIONS**

Circle the correct letter on your answer sheet.

1. What is the ready position in which a player should wait for the opponent to return the ball ?
 - a) Weight well back on the heels and knees straight.
 - b) Weight forward on the balls of the feet, the feet are slightly apart and the knees are bent.
 - c) Weight forward on the balls of the feet, the feet are close together and the knees are straight.

2. In hitting a backhand drive, what is the most desirable spot to contact the ball ?
 - a) The opposite side of the rear foot
 - b) Just ahead of the rear foot.
 - c) Opposite the center of the body.
 - d) Opposite the forward foot.
 - e) Just ahead of the forward foot.

3. In hitting a ground stroke, where should the weight of the player be at the moment of impact ?
 - a) On the rear foot.
 - b) Evenly distributed on both feet.
 - c) On the forward foot.
 - d) In front of the forward foot.

TRUE OR FALSE**DIRECTIONS**

Circle to correct letter (T) or (F) on your answer sheet.

4. When using the forehand grip, the thumb extends up the top plate of the handle of the racquet.
5. In the forehand grip, the fore finger is extended directly up the handle of the racquet.

6. When the player grips the racquet, the racquet face should be at right angles to the ground.
7. In the execution of a forehand or backhand drive, the follow through should be in the direction of the intended ball flight.
8. In hitting a forehand drive, the ball should be contacted when it is opposite the right foot.
9. A beginner should attempt to play the ball when it is approximately hip high (after the bounce).
10. In hitting a backhand drive, the player should look over the right shoulder at the on coming ball.
11. When hitting a backhand drive, the elbow should lead the racquet head through the forward swing.
12. In executing a ground stroke, you should swing the racquet head forward rapidly (you should hear a "swish") through the point of contact.
13. The same racquet face should contact the ball on both the forehand and the backhand drives.
14. In executing a backhand drive, the player should use the forehand grip.
15. The server's left side should point toward the intended direction of the serve.
16. In tossing the ball for the serve, the ball should be released from the tossing hand as the racquet begins to swing down.
17. The recommended point of contact for the basic flat serve is above and in front of the right shoulder.
18. When serving, the ball should be hit with the racquet arm fully extended.

MULTIPLE CHOICE

DIRECTIONS

Darken the correct letter on your answer sheet.

19. What choice is given the winner of the toss ?
 - a) Sides of the court.
 - b) Serving or receiving
 - c) Serving, receiving, or sides of the court.
 - d) Serve and side, or receiving.

20. What is the decision when the server tosses the ball up and catches it instead of striking it
- A fault should be called.
 - A let should be called.
 - The server may try again without penalty.
 - The server may try again, but if the same action is repeated, a fault occurs.
21. Which of the following is a foot fault ?
- The server steps over the baseline before the served ball crosses the net.
 - The server steps over the baseline before the racquet strikes the ball.
 - The server's feet are both off the ground when the ball is struck.
22. On the second serve, the server serves underhand into the proper service court, and the receiver makes no effort to return it, claiming that the serve was delivered incorrectly. What is the ruling ?
- The server wins the point.
 - The receiver wins the point.
 - Let is called and the ball is reserved.
 - The point is replayed.
23. During the serve, where must the receiver stand ?
- Anywhere on the receiver's side of the net.
 - Anywhere except within the service court.
 - Anywhere within the court boundaries.
 - Anywhere outside the court boundaries.
24. When is a ball considered out ? When it hits...
- Completely behind the line.
 - Just on the back edge of the baseline
 - More off than on a boundary line.
 - Any part of the boundary line.
25. In the match between Jane and Sue, there is a long rally. During the rally Jane swung at the ball and missed it; the ball landed outside the baseline. What is the ruling ?
- Point for Jane.
 - Point for Sue.
 - Let.
 - Fault.

26. Where should the service be made when the score is 40-love?
- On the right side of the court.
 - On the left side of the court.
 - On either side, depending on the side of the court the game started.
27. What is the score when the server wins the next point after deuce ?
- 40-30
 - 30-40
 - Ad out
 - Ad in
28. Using the traditional scoring system, when is a game completed?
- When one side has won four points and the opponents have not more than two points
 - When one side has won four points and the opponents have won three.
 - When a total of four points have been scored.
 - When either side wins five points.
29. Which of the following scores is a completed set?
- 4-2
 - 6-5
 - 5-1
 - 6-4
30. When should players change ends of the court ? When the score is:
- 6-0
 - 6-3, 3-5
 - 5-7,6-4,1-3
 - 3-6,6-1
31. When may a doubles team change its order of serving ?
- At the beginning of any game in a set.
 - At any time during the match.
 - At the beginning of any set.
 - The serving order may not be changed.
32. In doubles, when may the order of receiving be altered (changed)?
- Any time during the match.
 - When the service changes.
 - When the team changes sides of the court.
 - When the next set starts.

LABELING THE COURT

DIRECTIONS

Identify each numbered area on the tennis court. Write your answer on the answer sheet.

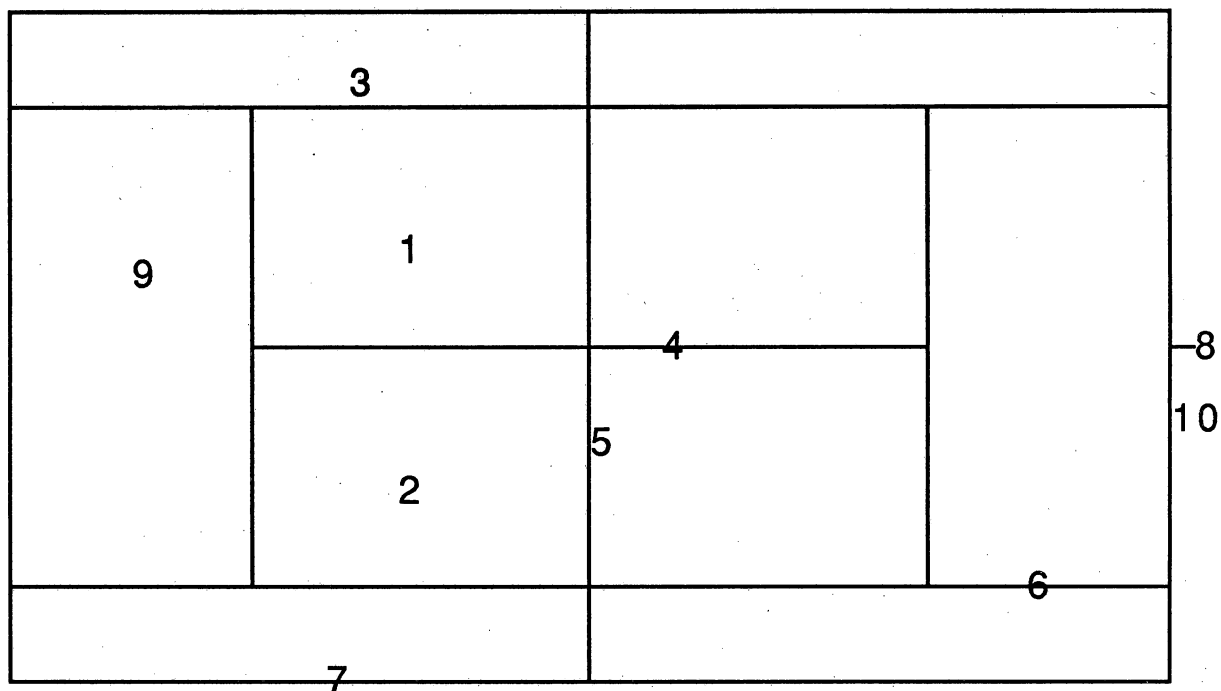

LABELING THE RACQUET

DIRECTIONS

Identify each numbered area on the tennis racquet. Write your answer on the answer sheet.

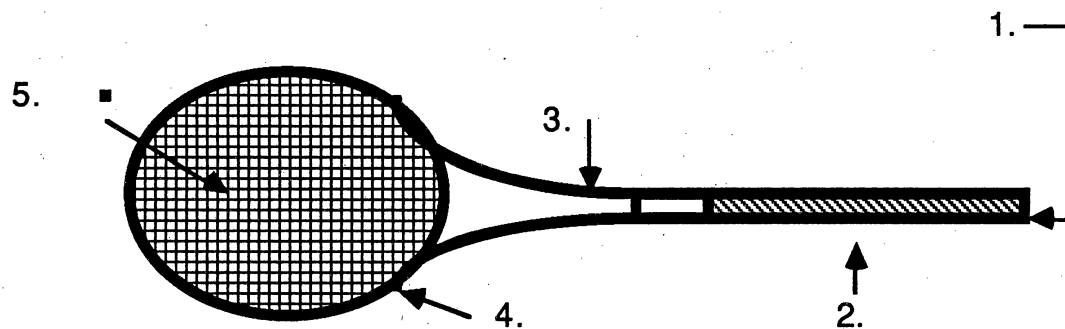

TENNIS ANSWER SHEET

NAME _____
 DATE _____
 PERIOD _____

MULTIPLE CHOICE

1. A B C D E
 2. A B C D E
 3. A B C D E

TRUE AND FALSE

- | | | |
|--------|---------|---------|
| 4. T F | 9. T F | 14. T F |
| 5. T F | 10. T F | 15. T F |
| 6. T F | 11. T F | 16. T F |
| 7. T F | 12. T F | 17. T F |
| 8. T F | 13. T F | 18. T F |

MULTIPLE CHOICE

- | | |
|-------------|-------------|
| 19. A B C D | 26. A B C D |
| 20. A B C D | 27. A B C D |
| 21. A B C D | 28. A B C D |
| 22. A B C D | 29. A B C D |
| 23. A B C D | 30. A B C D |
| 24. A B C D | 31. A B C D |
| 24. A B C D | 32. A B C D |

LABEL THE COURT

- | | |
|----------|----------|
| 1. _____ | 6. _____ |
| 2. _____ | 7. _____ |
| 3. _____ | 8. _____ |

4. _____

9. _____

5. _____

10. _____

LABEL THE RACQUET

1. _____

4. _____

2. _____

5. _____

3. _____

TENNIS ANSWER SHEET

NAME _____ KEY _____

MULTIPLE CHOICE

- 1. A B C D E
- 2. A B C D E
- 3. A B C D E

TRUE AND FALSE

- 4. T F
- 5. T F
- 6. T F
- 7. T F
- 8. T F
- 9. T F
- 10. T F
- 11. T F
- 12. T F
- 13. T F
- 14. T F
- 15. T F
- 16. T F
- 17. T F
- 18. T F

MULTIPLE CHOICE

- 19. A B C D
- 20. A B C D
- 21. A B C D
- 22. A B C D
- 23. A B C D
- 24. A B C D
- 25. A B C D
- 26. A B C D
- 27. A B C D
- 28. A B C D
- 29. A B C D
- 30. A B C D
- 31. A B C D
- 32. A B C D

LABEL THE COURT

- 1. LEFT SERVICE COURT
- 2. RIGHT SERVICE CT.
- 3. ALLEY
- 4. ALLEY
- 5. ALLEY
- 6. SINGLES SIDE LINE
- 7. DOUBLE'S SIDE LINE
- 8. CENTER MARK

4. CENTER LINE

9. NO MAN'S LAND

5. NET

10. SERVICE LINE

LABEL THE RACQUET

1. BUTT/END

4. FRAME

2. GRIP/HANDLE

5. HEAD

3. THROAT

A

GUIDE

TO

TRACK

&

FIELD

TEACHING PACKET TRACK AND FIELD

COURSE DESCRIPTION

The purpose of this unit is to acquaint students with the basic knowledge needed to actively participate in Track and Field activities. It is essential that the students learn the basic skills necessary for individual satisfaction.

INTRODUCTION

History

Equipment

Safety

Rules

BEGINNING

Starting

Running form: Sprints, middle distance, distance

Relay races/Baton passes

Shot Put

Long Jump/High Jump

Triple jump

INTERMEDIATE

Running forms- start and finish

Hurdles

Blind Baton pass

Shot put

Long jump

Intermediate high jump techniques

Running triple jump

ADVANCED

Starting blocks

Competitive strategies

EVALUATION PROCESS

Written and or practical evaluation will be used to determine student knowledge and skill development of track and field.

HISTORY

The equivalent of track and field events originated almost with the beginning of humanity. In order to survive, humans had to be both gymnast and sprinters. Survival depended on the ability to outperform the challenger, human or animal. When not in search of sustenance or being pursued, early humans kept physically fit by engaging in running, jumping, or throwing activities with immediate family.

Games involving the fundamentals of track and field were first formulated by the Greeks during their Golden or Homeric Age. The most famous of these games were the Olympics, which began in 776 B.C. and continued to be held every five and then four years until 392 A.D., at which time they were abolished by the Romans. In 1896 they were reorganized again by Baron Pierre de Coubertin of France, and since that time they have been conducted as international festival. One of the strong motivations behind the American national sports program is the meeting together every four years of the many champions of the various countries of the world.

RULES TO FOLLOW FOR TRACK AND FIELD

1. SAFETY

- A) Stretch well before beginning any activity.
- B) Make sure the legs and ankles are ready to run.
- C) Prepare by practice.
- D) The person raking the jumping pit should stand on the rake while someone is jumping.
- E) Make sure the field is clear when putting the shot.
- F) Don't step out of your lane when you pass off the baton during the relays until everyone has gone past you.
- G) Stay clear of the track while a race is in progress.

II. RUNNING EVENTS

A) Sprints (50, 100, 200 meters)

- 1) Begin at the starting line.
- 2) The crouch start gives you more drive and explosive power.
 - a) Be sure the elbows are firm and the arms are directly below the shoulders behind the starting line.
 - b) The chin should be up and eyes should look slightly down the track.
 - c) The back and head should form a straight line parallel to the ground.
 - d) Stay low coming out of the blocks. Concentrate on stepping out at a 40 degree angle then rising slowly to about 70 degrees after five or six strides.
- 3) One false start and you are out of the race.
- 4) You have assigned lanes.
- 5) Stay in your lane throughout the entire race.
- 6) Do not interfere with anyone in another lane.
- 7) Rules on sprinting form:
 - a) Run relaxed;
 - b) Use the balls of your feet with long strides. Concentrate on hitting with the ball of the foot and "pawing" the ground;
 - c) Maintain a good body lean.
 - d) Arms should be at a 90 degree angle at the elbow and swinging in opposition to legs to help pull the body;
 - e) Run through the finish line rather than to it.
- 8) To begin the race the commands are:
 - a) "Runners take your mark".
 - b) "Set"
 - c) "Bang" or "Go"

B) Relay

- 1) The baton passes are exchanged in the designated zones only.

- 2) Carry the baton in the hand.
- 3) If the baton is dropped, always pick it up and finish the race.
- 4) A runner may only run one leg of the relay.
- 5) All rules of the sprints apply.

C) Hurdles

- 1) Emphasize that hurdling is not jumping. It is the running over the barrier by extending the take off leg and pushing forward off of the lead off leg.
- 2) The faster the run, the farther from the hurdle the runner's take off leg will be.
- 3) Knocking over a hurdle does not disqualify a runner.
- 4) In a hurdle race, a runner must stay in his/her own lane.
- 5) Use the arms for balance and pulling power when crossing over the hurdle. The shoulders should be square to the front. The arm, working in opposition, moves forward and down as if trying to grasp a bar to help pull the body over.
- 6) Forcing the jaw forward also aids in driving over the hurdle.
- 7) As the body runs over the barrier, the knee and toe of the trailing leg are pointed toward the side, being pulled close to the body with the toe parallel to the ground.

III FIELD EVENTS

A) Putting the shot

- 1) The action cannot be a throw.
- 2) The shot put may not pass behind the shoulder
- 3) The body may not pass the toe board.
- 4) The shot putter must enter and leave the shot put ring from the rear half of the circle.
- 5) The best of three trials is recorded.

- 6) Measurement is from inside edge of ring to the nearest mark of the shot.
- 7) The shot put is held by the first three fingers with the thumb and little finger curled under and around the sides.
- 8) Utilize the entire body by being in a balanced stance.
- 9) Avoid throwing, by tucking the shot against the neck and pushing it from this point(not from behind the shoulder).

B) Long jump

- 1) Only a one foot take off from the board may be used.
- 2) A jumper may not step over the take off board.
- 3) The best of three jumps is recorded.
- 4) Measure from the nearest right angle from the edge of the board to nearest mark made by the jumper.
- 5) Emphasize the take off with a heel to toe roll from the board. Try to concentrate on getting an upward lift of the body.
- 6) Stress getting height on take off by the use of the arms in a upward motion.
- 7) The take off leg is fully extended and the opposite knee drawn up in line with the waist.
- 8) Avoid landing or falling backwards by stressing a landing in an extended sitting position with feet up. Remember to thrust arms forward when the heels touch the pit, pulling downward and forward with head and shoulders to raise hips forward.
- 9) While you practice your run, mark off your stride from the center of the board to where your fastest sprint stride would take you.

C) High jump

- 1) A jumper has three consecutive misses before he/she is disqualified.
- 2) Only a one foot take off from the ground is allowed.
- 3) Rules on jumping form:

- a) Drive upward and parallel to the bar with the non jumping leg.
- b) Lift the shoulders upward and lift the arms.
- c) In a straddle roll, stress that the knees and toes are up and out.
- d) Stress the natural motion. Do not try to stop the momentum.

Things to look for:

Running:

- 1) The arms move in opposition to leg.
- 2) The arms move forward from the shoulders.
- 3) The head should remain still.
- 4) "Pace" during the long races.
- 5) Lean forward at finish line.
- 6) Run the "sprints" on toes.
- 7) Run the "distance" runs, landing on heel and rolling up to toe.
- 8) The runner is disqualified with one false start.

Relays:

- 1) Put the fastest runners at lead and trail leg positions.
- 2) At the hand off both runners should be at full speed.

Shot put:

- 1) Keep the shot in next to neck.
- 2) Keep the elbow up and away from the body.
- 3) The knees are bent low.
- 4) Get the entire body momentum behind shot.

Long Jump

- 1) Get a fast run for forward momentum.
- 2) Take off as close to the front edge of the board as possible.
- 3) Drive the knee up.
- 4) Lift chest, head and arms up.
- 5) Land rotating forward . (Don't fall back).

- 6) Measure the jump from the part of the body that touches the furthest back.

Triple Jump

- 1) The steps are the hop, skip, and jump.
- 2) Stay balanced and not overextended.
- 3) Follow the basic long jump hints.

SUGGESTED ACTIVITIES AND/OR SKILL TESTS

I USING THE STARTING BLOCK

- A) Explain the purpose of the starting blocks, and how to come out of them.
- B) Show where to place the blocks on the track, and how to adjust them for a particular setting.
- C) Determine the power foot by standing with the weight distributed equally on both feet, then go through the motions of kicking a ball out of the hands. The foot remaining on the ground is the power foot and will be the forward foot in the starting block.
- D) Assign one starting block to each team. Teams will put the starting blocks on the track and students will assist each other in finding the correct setting. They will have their choice of using the bunch start or the medium start.
- E) As soon as a setting is established for each student, it is to be recorded by reporting it to the instructor.

II SPRINTS

- A) Explain the basic components of a sprint.
- B) Assemble the class on the track in squads. At the sound of the whistle the first person in each squad will sprint 50 yards.
- C) The class will then set up the starting blocks and sprint 50 yards from the starting blocks using the standard signal (take your mark, set, go). Explain what each of the signals mean.

III HURDLES

- A) Explain and demonstrate the hurdle position.
- B) With squads assembled on the grass, two people from each squad will hold a jump rope approximately 10 inches off the ground while the rest of the squad run toward it and try to clear it without breaking their running stride. (Students will trade off holding the rope so everyone gets an opportunity to practice.) After everyone in the squad has, the rope should be raised 2-3 inches until the students need to begin really lifting their lead leg and knee high. The trail leg then begins assuming the hurdle position.
- C) Substitute a standard low hurdle and have students walk through the motions of going over the hurdle.
- D) Students should practice running and jumping over one hurdle on the grass.
- E) Set up four stations on the grass, one with one(1) hurdle, a station with two (2) hurdles, etc., up to four hurdles. Let students go to whatever station they feel their level is and let them practice.
- F) Assemble the hurdles on the track for the 50 yard hurdles. Have students run through once without the use of the starting blocks, and then have them use the starting blocks for the rest of the time allowed.

IV LONG JUMP

- A) Briefly explain and demonstrate the sail.
- B) Have students line up on runway with the first person about seven (7) strides back from take off board. To determine the take off foot, have the students run about seven strides, and then take off on one foot. Have them swing the free leg upward and forward and then land on both feet. Run the class through twice so students can check to see if the same foot was used both times.
- C) Have students take a short run, then have them take off near the pit. Next have them then spring up into the air as high as possible attempting to jump into the sand pit. Don't worry about distance.

- D) Have two students hold a jump rope about two feet in the air and a foot back from the sand pit. Having the students try for distance, also make sure the students clear the height of the rope.
- E) Teach students to measure off their stride and find the correct starting point on the runway.
- F) Have students take a full run and jump for distance. Make sure someone is watching for foot faults.
- G) Any of the students who are interested and seem skilled can also be taught the hitch kick or the hang.

V HIGH JUMP

- A) Briefly explain and demonstrate the straddle roll
- B) Determine the take off foot by running three strides, then jumping into the air off one foot. The foot left on the ground is the take off foot.
- C) Have students line up on either side of take off area depending on their take off foot. With the bar place at a very low level have students run through several times, working on body positioning and being aware of where all body parts are in relation to the bar.
- D) Gradually raise the bar until it reaches a height of three feet. Place a towel in the pit about one foot from the bar. Have each student make a jump, and at the height of the jump, reach into the pit to grab the towel. This aids in teaching them to drop the head and shoulders as soon as they have cleared.
- E) Continue practicing and raising the bar for as long as time allows.

VI SHOT PUT

- A) Explain and demonstrate the stance, grip, glide, and release.
- B) The students will choose partners and help each other practice the foot movements on the grass. A sheet will be passed out with a diagram of things to look for and feet moving through the glide.

- C) The grip and release can be practiced on the grass with softballs. Depending on the number of softballs, the class can remain in partners or work in small groups.
- D) As the students feel they are ready they can move to the shot put circle and practice the glide then release the softball.
- E) The student can now practice with a shot.

VII RELAYS

- A) Explain and demonstrate how to pass and carry the baton (underhand exchange).
- B) The students will choose partners and practice passing the baton to each other.
- C) After practicing for about five (5) minutes, have two groups join together so that two students can be passing off while the other two are observing their partners.
- D) Explain how to receive the baton properly and the signal used for passing during a race.
- E) Divide the class into five groups of ten each and spread each group all around one lane of the track. Have each student sprint to the student ahead of him on the track and pass the baton. After the students have practiced a couple of times, it can be made into a relay race to see which group can return the baton to its starting place the fastest.

VIII DISTANCE RUNNING

- A) Explain pacing, and the basic principle behind distance running.
- B) Lead the group slowly around the track once, making sure they keep an even, smooth pace all the way around.
- C) Explain what a "kick" is.
- D) After pacing the class about halfway around the track, give them a signal and let them "kick" to a finish line about 20 yards away.

TRACK AND FIELD WRITTEN TEST

NAME _____
DATE _____
PERIOD _____

TRUE OR FALSE

Use the word True if the statement is true. Use the word False if the statement is false or partially false. (Write the entire word)

1. While running, when your right foot is forward your left arm should be forward.
2. A participant receives 3 attempts in the field events.
3. When measuring long or triple jump, you always measure from where the right foot lands.
4. A runner is allowed 2 false starts before disqualification.
5. The javelin and hammer are not high school field events.
6. The action of putting the shot is identical to that of throwing a baseball.
7. The 100 meter sprint is run around one curve of the track.
8. There are always 4 people on a relay team.
9. 800 Meters is considered a distance run.
10. The points awarded for a relay race are the same as for all other events.

FILL IN THE BALNKS

Fill in the blank with the correct answer, Write the answer on your answer sheet.

The runner's starting commands are as follows (in sequence):

1. _____
2. _____
3. _____
4. One mile is ____?____ laps around the track.
- 5, 6, 7, Name the three steps of a triple jump (in sequence)
____?____, ____?____, ____?____.
8. The term used for one complete lap around the track is called a
____?____.
9. To help prevent injuries ____?____ is very important before
track and field competition.
10. Half way around the track is ____?____ meters.
11. The tube like plastic object which is passed from one runner to
the next in a relay is called a ____?____.
12. The term used for a short distance race run at top speed is call
a ____?____.
13. Your lead and trail leg play a very important role in the
____?____ race.
14. A crow hop would be called if you stepped over the ____?____,
in the long and triple jump.
15. The word "____?____" is another way to explain how to run in
the sprints.

MATCHING

Match the correct letter of the word that best fits the definition. Use the answer sheet.

1. 15-20 feet

A. Triple Jump

2. 100 meters

3. 200 meters

4. 25-35 feet

5. 400 meters

6. 800 meters

7. 1600 meters

8. 4-5 feet

B. 1/2 lap

C. 2 laps

D. High Jump

E. Straight a way

F. 4 laps

G. 1 lap

H. Long jump

NAME ALL THE FIELD EVENTS IN TRACK

1. _____

2. _____

3. _____

4. _____

5. _____

6. _____

7. _____

8. _____

Name three important thing to look for when you are competing or participating in:

Long Jump

1. _____

2. _____

3. _____

Shot put

1. _____

2. _____

3. _____

Running (sprint or distance) specify which ones you are talking about.

1. _____

2. _____

3. _____

**TRACK TEST
KEY**

1. FALSE
2. FALSE
3. FALSE
4. FALSE
5. TRUE
6. FALSE
7. FALSE
8. TRUE
9. FALSE
10. FALSE

FILL IN THE BLANK

1. "ON YOUR MARKS"
2. "SET" OR "GET SET"
3. "GO" OR "BANG"
4. 4 FOUR
5. HOP
6. SKIP
7. JUMP
8. LAP
9. STRETCHING
10. 200
11. BATON
12. SPRINT

13. HURDLE

14. BOARD

15. PAW OR PAWING

MATCHING

1. H

5. G

2. E

6. C

3. B

7. F

4. A

8. D

NAME ALL THE FIELD EVENTS

1. HIGH JUMP

5. LONG JUMP

2. TRIPLE JUMP

6. SHOT PUT

3. DISCUS

7. JAVELIN

4. POLE VAULT

8. HAMMER

LONG JUMP

1. LIFT KNEE

2. LAND MOVING FORWARD

3. LIFT WITH ARMS

SHOT PUT

1. SHOT SHOULD BE PRESSED INTO THE NECK

2. THROW BY PUSHING THE PUT

3. USE THE LEGS FOR POWER

RUNNING

1. PAW AT THE GROUND (S)

2. BE AT A GOOD ANGLE (S)

3. ROLL ON THE FOOT (D)

A

GUIDE

TO

VOLLEYBALL

TEACHING PACKET VOLLEYBALL

COURSE DESCRIPTION

The purpose of this unit is to acquaint students with the basic knowledge needed to actively participate in volleyball. It is essential that the students learn the basic skills and game strategy necessary for individual satisfaction.

INTRODUCTION

History
Safety
Rules

BEGINNING

Underhand Serve
Pass/Set
Offensive Position and Defensive Position

INTERMEDIATE

Overhead Serve
Spike
Dink
Blocking
Net Recovery
Basic Offensive Patterns

ADVANCED

Floater and Roundhouse Serve
Two man Block
Dive and Roll
Advance Offensive Patterns

EVALUATION PROCESS

Written and or practical evaluation will be used to determine the student's knowledge and skill development in volleyball.

HISTORY

Volleyball was developed in 1895 by William J. Morgan, who at the time was the physical education director of the Y.M.C.A. in Holyoke, Massachusetts. He invented the game to provide an indoor game for the winter months in which relatively large groups of men could participate in a small gymnasium. The principal features of tennis were employed, but the net was raised and the players struck a basketball with their hands instead of racquets.

The adoption of volleyball as an Olympic sport in 1964 has produced major changes. The initial recreational game requiring limited skills, organization, and conditioning has progressed to "power" volleyball. Today the game of power volleyball requires team strategies involving offensive and defensive plays and highly refined individual skills.

I COURT AND ROTATION

- 1) Number of players on a team is six (6).
- 2) Substitutes will enter at the LF position.
- 3) A team must be serving to score.
- 4) A team must rotate in a clockwise circle.
- 5) The length of the end Line is 30 feet.
- 6) The RB is the server.
- 7) The server must call the score. The serving team calls their score first.
- 8) The serving area is 10 feet wide.

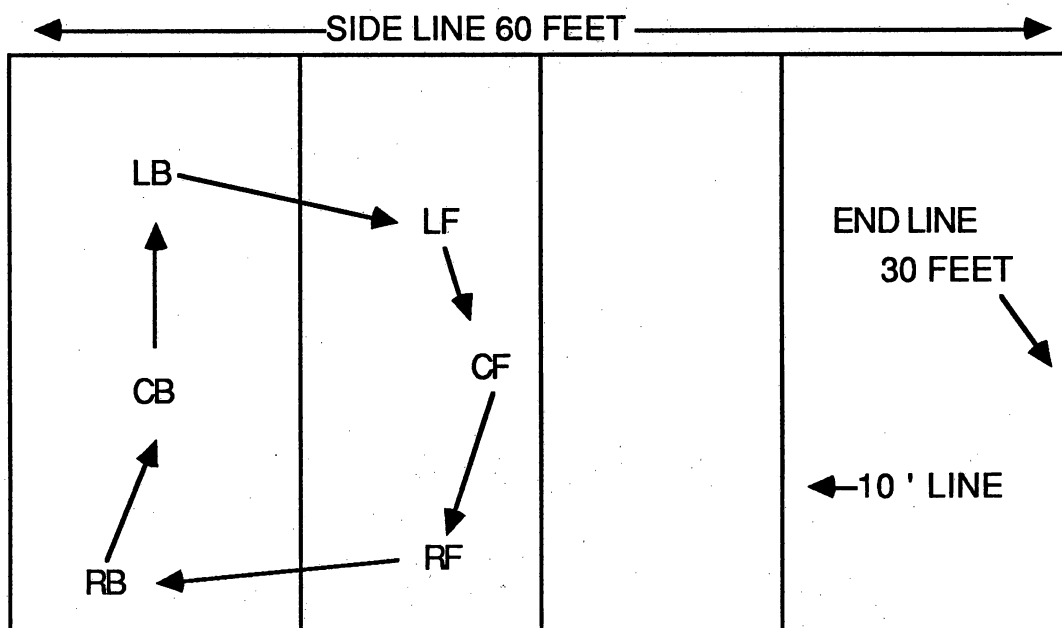

II THE GAME

The game is played with two teams of six players each. The object of the game is to hit the ball back and forth across the net, trying to prevent it from becoming dead on one's own half of the court. Also trying to cause the opponent to miss the ball. The perfect play in volleyball: **Bump, Set, Spike !**

III SCORING

The score of the game goes to fifteen (15) . A team must win by two points.

III DEFINITION OF TERMS

1. **Block:** A defensive play in which players at the net attempt to block or interfere with the flight of the ball which is being returned by the opponents.

2. **Bump Pass.** The ball is bumped off the forearms with the hands clasped together and the forearms side by side. (It helps to hyperextend the elbows and be bent at the knees).
3. **Body Foul:** A ball that touches any part of the player below the waist.
4. **Dead Ball:** A ball that is temporarily out of play.
5. **Double Foul:** Faults committed simultaneously or on the same play by opponents.
6. **Foot Fault:** The server steps on or over the end line at the moment of serving the ball.
7. **Foul:** A fault for which a point or side out is awarded.
8. **Game:** Fifteen points. Must be at least two points ahead.
9. **Holding:** Allowing the ball to visibly come to rest even momentarily in the hands.
10. **Illegal Hit:** Hitting the ball with both hands below the waist.
11. **Legal Hit:** A ball that is given immediate impetus with any part of the body above and including the waist.
12. **Legal Serve:** Putting the ball into play over the net into the opponent's court without the ball touching the net.
13. **Net Ball:** A ball may not touch the net on the serve. However, during play the ball may be played off the net if the person playing the ball does not touch the net.
14. **Opponent's Court:** The playing area occupied by a team's opponents.
15. **Out of Bounds:** Any surface or object outside the court except a player in the act of playing the ball.
16. **Own Court:** The playing area occupied by one's own team.
17. **Perfect play: BUMP, SET, SPIKE.**
18. **Point:** The scoring unit awarded to the serving team for an infringement of the rules by the opponent.
19. **Replay:** Called when fouls are committed by the players on opposite teams simultaneously or on the same play.
20. **Rotation:** The act of shifting positions in a clockwise direction when the team is awarded the serve on a side out.
21. **Server:** The player in the Right Back position who begins play by hitting the ball over the net.
22. **Service:** The act of serving.

23. **Serving order:** The sequence of service of a team's players. The team must stay in correct rotation or lose the serve.
24. **Set:** A Ball (other than a serve) which is hit (volleyed) higher and closer to the net so that it can be spiked or dinked.
25. **Side out:** The decision following the infringement of a rule by the serving team at which time service is awarded to the opposing team.
26. **Spike:** A ball (other than a serve) which is hit forcibly from a height greater than the top of the net.
27. **Team:** The six players who work together to defend their area and try to defeat their opponents.
28. **Term of Service:** The server continues to serve until side out is called.
29. **Volley:** The hitting of the ball before it bounces on the ground.

V FOULS AND PENALTIES

1. Illegal Serves

- a) Failing to give immediate impetus upon contact.
- b) Causing the ball to contact the net.
- c) Failing to cause some part of the ball to pass over either one of the markers on the net or within the two markers.
- d) Causing the ball to strike an object or land outside the playing area (Hitting the line is legal).
- e) Causing ball to strike an object directly over the court unless local ground rules alter this rule.
- f) Failing to be within own serving area. (Area 10' wide and behind the end line.)
- g) Committing a foot fault. (Touching the end line with the foot in the act of serving.)

2. Illegal Play

- a) Failing to return the ball within the opponent's court.
- b) Failing to cause some part of the ball to pass over either one of the markers on the net or within the two markers.
- c) Hitting the ball illegally.
- d) Playing the ball more than once in succession.

- e) Becoming the fourth player on the team to contact the ball (only three hits per side).
- f) Committing a body foul.
- g) Catching or touching the ball, either on or off the court, and call it out.
- h) Playing the ball while supported by any player or object.

3. Illegal plays at the net.

- a) Holding or pushing the ball against the net.
- b) Touching the net with any part of the body while the ball is in play.
- c) Reaching over the net.
- d) Leaving the floor from a position which is not clearly behind the 10' line when executing a spike from a back line position.
- e) Reaching under the net.
- f) Touching the floor on the opposite side of the center line.
- g) Touching the opponent's court in completing a play.

4. Plays in an illegal position.

- a) Failing to be in the correct serving order when the ball is served.
- b) Blocking or spiking from a position not behind the 10' line.

VI PENALTIES

1. Point: The serving team scores if the receiving team fouls.
2. Side out: The receivers now serve, if the service team fouls.
3. Replay: If fouls are committed by players on opposite teams either simultaneously or on the same play, the ball shall be replayed. (Any ball that is questioned shall be a replay).

VII CLASS CONDUCT

1. Teach the students to be as fair as they can be in their calls. You would like someone to be fair in their calls for you.
2. Return any ball to the server by rolling the ball under the net directly to him.

3. Replay any point when there is interference.
4. Foul Language will not be tolerated.
5. Do not kick a volley ball.

VIII STRATEGY REMARKS

1. To play good volleyball, a player must move the feet and get behind the ball to play it well.
2. Call your balls and communicate with your teammates.

CIRCLE DRILL FOREARM PASS/SET

PROCEDURE

This drill consists of the following steps:

1. Forearm pass the ball across the circle. Forearm pass the ball on the rebound from the floor to work on form. Everyone in the circle must make a successful pass.
2. Forearm pass the ball across the circle without letting the ball hit the floor. Every member in circle must complete this drill successfully.
3. Forearm pass the ball up into the center and call for someone to go in and forearm pass it to someone in the circle. Every member of the circle must be called to the center for a forearm pass in order to complete the task.
4. The leader in the middle of the circle forearm passes to someone outside of the circle and they forearm pass it back to the leader.

WALL DRILL -FOREARM PASS

PROCEDURE

Two forearm passers stand about 15-20 feet from the wall. The third player stands 30 feet away and overhead serves to a line 7' 4" high on the wall. As the serve is rebounded, the forearm passer attempt to pass it to his partner.

LINE DRILL- FOREARM PASS**PROCEDURE**

The leader (X) throws a bounced ball to (A) who returns the ball with a forearm pass to the leader. Then on to (B), (C), etc.

Suggested Task each group must complete ten successful forearm passes.

LINE DRILL -"SET"**PROCEDURE**

1. Same as diagram in the line drill forearm pass
2. This drill to be used after introduction of the set.

SERVE- FOREARM PASS- SET**PROCEDURE**

1. The ball is served to a five player team who forearm passes the ball to setter. The setter will set the ball to the right or left front position.
2. Players will rotate positions after five successful sets.

SERVE -PASS -SET -OFFENSIVE HIT**PROCEDURE**

Same drill as the serve forearm pass set except the retriever becomes an offensive hitter.

SHUTTLE TEAM SET DRILL

PROCEDURE

Set the ball to a player on the other side of net and then go to the end of the line to which the ball was set.

Suggested Task: This drill must complete ten successful sets without the ball touching ground.

SERVE

TEACHING HINTS

1. Concentrate.
2. Watch the ball.
3. Hold the ball high.
4. Keep the toss low.
5. Be aware of valve placement.
6. "Punch" the ball for better floating action.
7. Practice for a variety of placements, speeds, and spins.

COMMON ERRORS

1. Having no "action" on a floater serve. This is caused by too much follow through or too much contact area on the ball.
2. The ball going out of bounds. This is caused by contacting ball on an improper area.
3. Not watching the ball get hit.

STRATEGY

1. Keep all serves "IN" Assume you will lose a point for every missed serve.
2. Serve so that the ball is tough to return.
3. Serve "the seams" between the opposing players.
4. Serve the ball to the weak passers.
5. Server crosscourt to the off hand hitting side of the opponents.
6. Serve away from the best hitters.

7. Serve to the Right Back, if the setter is running from the right .
8. Serve to the back row.

DRILLS - SERVE/SERVE RECEIVE

1. **Serving:** Practice serving to all areas, down the line, cross court, short, and deep.

2. **Serving and passing:**

Players should rotate and alternate positions

They may play out a rally. The passers should go to the end of the serving or passing line.

The teacher can add running to wall etc.

3. **Rapid serve/receive drill:**

The teacher should do the serving (five (5) in a row). There will need to be receivers and shaggers.

4. **Shuttle Drill**

A player serves and runs to end of receiving line (conditioning). As the drill progresses a setter is added as in a hitting drill.

5. **Concentration drill**

The teacher serves to the first player, while the second player runs in front of the first player to pass, or fake a pass.

6. **Team Serve Receive**

The teacher (or player) serves to the entire team which may play out a rally . Remind players to rotate.

VOLLEYBALL WRITTEN TEST

THE COURT AND THE PLAYERS

Fill in the correct names of lines, dimensions, and team positions that correspond to the numbers on the diagram.

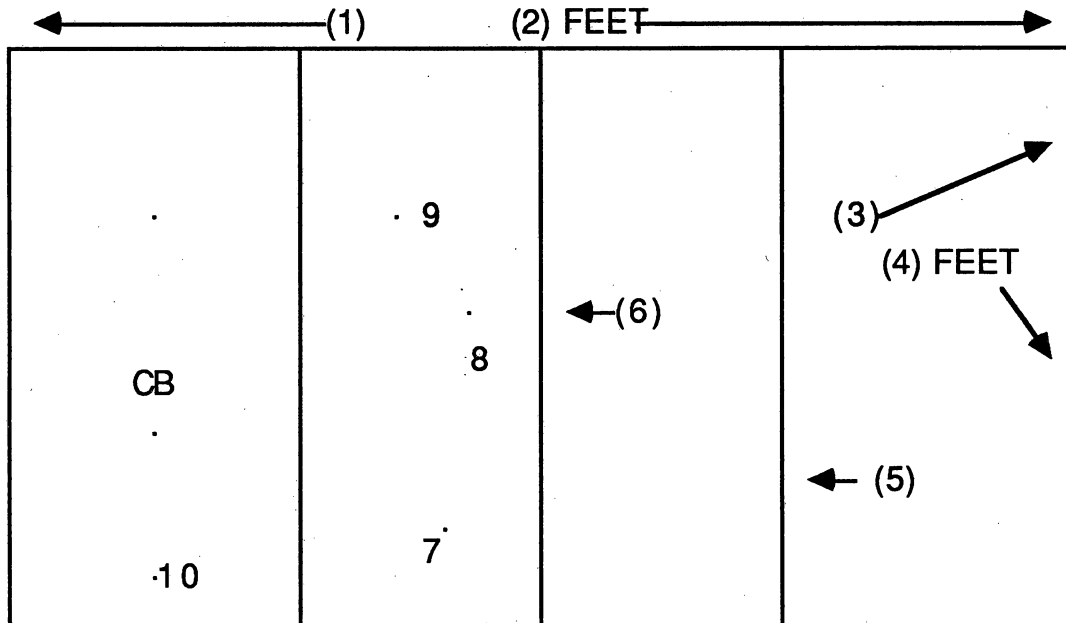

1. _____
2. _____
3. _____
4. _____
5. _____
6. _____
7. _____
8. _____
9. _____
10. _____

FILL IN THE BLANKS

Fill in the correct word or words that correctly completes the statement. Write the word or words on your answer sheet.

1. Each team is allowed a maximum of ___?___ hits to return the ball.
2. A ball which lands on a boundary line is considered ___?___.
3. When players from opposite teams touch the net at the same time ___?___ is called.
4. Only the ___?___ team may score.
5. If a player steps out of bounds to volley the ball, it is considered ___?___.
6. If the server steps on the end line during the act of serving, it is called a ___?___.
7. If #6 occurs, ___?___ is called.
8. The ___?___ position is the server.
9. Substitutes should enter at the ___?___ position,
10. Rotation is always moved in a ___?___ movement.

MULTIPLE CHOICE

Choose the best answer and darken in the letter on your answer sheet.

1. Team "A" commits an illegal serve.
 - a) Point is awarded to Team "B".
 - b) Point for Team "A".
 - c) Point is taken off of Team's "A" score.
 - d) Side out

2. Team "A" serves the ball. A player on Team "A" touched the net when returning it.
 - a) Point is called
 - b) Side out is called.
3. After the third hit the ball bounces on the court and then is hit across the net.
 - a) Legal.
 - b) Illegal.
4. A back row player should ...
 - a) Hit the ball directly over the net.
 - b) Bump the ball to the setter.
 - c) Set the ball to the front row.
 - d) Spike the ball
5. At which of the following scores could an official game end
 - a) 15-14
 - b) 17-15
 - c) 21-18
6. The perfect play is ...
 - a) Bump, Block, Set.
 - b) Bump, Volley, Spike
 - c) Bump, Set , Spike
7. Defensive play is the ...
 - a) Bump
 - b) Block
 - c) Set
 - d) Spike
8. Volleyball is a fast game of ...
 - a) Skill
 - b) Coordination
 - c) Agility
 - d) All of these
9. The server steps on the back line as he/she serves.
 - a) Point
 - b) Side out
 - c) Reserve
10. The receiver hits the ball below the waist with both hands apart.
 - a) Point
 - b) Side out
 - c) Reserve

MATCHING**DIRECTIONS**

Match the correct number of the word that best fits the definition on the space provided. Use the answer sheet.

- | | | |
|--------------|----------------|-------------------|
| 1. Block | 8. Net ball | 15. Side out |
| 2. Bump | 9. Point | 16. Spike |
| 3. Dead ball | 10. Right back | 17. Team |
| 4. Foul | 11. Rotation | 18. Volley |
| 5. Game | 12. Server | 19. Volley ball |
| 6. Holding | 13. Service | 20. None of these |
| 7. Let ball | 14. Set | |

- 15 points, provided one team has a two point lead.
- Called when the serving team commits a foul.
- Called when the receiving team commits a foul.
- Method of putting the ball into play.
- The moving of the players into serving position.
- Hitting the ball with the hand or forearm.
- The ball touches the net on the serve.
- The ball momentarily come to rest in the hands of the player.
- Called when the ball is temporarily out of play
- The ball touches the net during play.
- Name of the game.
- Player juggled the ball.
- Player puts both arms up in a defensive move.

14. Player puts both hands together below the waist to rebound the ball.
15. Player jumps up and hits the ball down into opponent's court.
16. A ball that hits the net on a serve.
17. The person who serves.
18. Bump, _____?_____, Spike.
19. Consists of 6 players.
20. RB

VOLLEY BALL

NAME _____
DATE _____
PERIOD _____

1. _____
2. _____
3. _____
4. _____
5. _____
6. _____
7. _____
8. _____
9. _____
10. _____

FILL IN THE BLANKS

1. _____
2. _____
3. _____
4. _____

- 5. _____
- 6. _____
- 7. _____
- 8. _____
- 9. _____
- 10. _____

MULTIPLE CHOICE

- 1. A B C D
- 2. A B C D
- 3. A B C D
- 4. A B C D
- 5. A B C D
- 6. A B C D
- 7. A B C D
- 8. A B C D
- 9. A B C D
- 10. A B C D

MATCHING

- 1. _____
- 2. _____
- 3. _____
- 4. _____
- 5. _____
- 6. _____
- 7. _____

8. _____

9. _____

10. _____

11. _____

12. _____

13. _____

14. _____

15. _____

16. _____

17. _____

18. _____

19. _____

20. _____

VOLLEY BALL

1. _____ **SIDE LINE** _____

2. _____ **60 FEET** _____

3. _____ **END LINE** _____

4. _____ **30 FEET** _____

5. _____ **TEN FOOT LINE** _____

6. _____ NET OR CENTER LINE _____
7. _____ RF OR RIGHT FRONT _____
8. _____ CF OR CENTER FRONT _____
9. _____ LF OR LEFT FRONT _____
10. _____ RB OR RIGHT BACK _____

FILL IN THE BLANKS

1. _____ THREE _____
2. _____ IN OR GOOD _____
3. _____ RESERVE _____
4. _____ SERVING _____
5. _____ LEGAL _____
6. _____ FOOT FAULT _____
7. _____ SIDE OUT _____
8. _____ RB OR RIGHT BACK _____
9. _____ LF OR LEFT FRONT _____
10. _____ CLOCK WISE _____

MULTIPLE CHOICE

1. A B C D
2. A B C D
3. A B C D

- 4. A B C D
- 5. A B C D
- 6. A B C D
- 7. A B C D
- 8. A B C D
- 9. A B C D
- 10. A B C D

MATCHING

- 1. ___ 5 ___
- 2. ___ 15 ___
- 3. ___ 9 ___
- 4. ___ 13 ___
- 5. ___ 11 ___
- 6. ___ 18 ___
- 7. ___ 8/15 ___
- 8. ___ 6 ___
- 9. ___ 3 ___
- 10. ___ 8 ___
- 11. ___ 19 ___
- 12. ___ 20 ___
- 13. ___ 1 ___

FIBER...
 SOLUTION CO. U.S.A.
 25% COTTON FIBER

14. 2 15. 16 16. 7 17. 12 18. 14 19. 17 20. 10