

# **STUDY, DESIGN AND FABRICATION OF A 3D PRINTER**

**A THESIS SUBMITTED IN PARTIAL FULFILLMENT OF THE  
REQUIREMENTS FOR THE DEGREE OF**

**BACHELOR OF TECHNOLOGY  
IN  
MECHANICAL ENGINEERING**

**BY**

**DEBASISH NAYAK**

**ROLL NO: 111ME0320**



**Department of Mechanical Engineering  
National Institute of Technology  
Rourkela -769008**

# **STUDY, DESIGN AND FABRICATION OF A 3D PRINTER**

**A THESIS SUBMITTED IN PARTIAL FULFILLMENT OF THE  
REQUIREMENTS FOR THE DEGREE OF**

**BACHELOR OF TECHNOLOGY  
IN  
MECHANICAL ENGINEERING**

**BY**

**DEBASISH NAYAK**

**ROLL NO: 111ME0320**

**UNDER THE GUIDANCE OF  
Dr. D.R.K PARHI**



**Department of Mechanical Engineering  
National Institute of Technology  
Rourkela -769008**



## **CERTIFICATE**

This is to certify that the thesis entitled, “**STUDY, DESIGN AND FABRICATION OF A 3D PRINTER**” submitted by DEBASISH NAYAK (111ME0320) in partial fulfilment of the requirements for the award of Bachelor of Technology degree in Mechanical Engineering at National Institute of Technology, Rourkela (Deemed University) and is an authentic study and design work carried out by him under my supervision. To the best of my knowledge, the matter embodied in the thesis has not been submitted to any other university/institute for the award of any Degree or Diploma.

**Dr. D.R.K. PARHI**

Professor

Department of Mechanical Engineering

National Institute of Technology

Rourkela, Odisha-769008, India

# ACKNOWLEDGEMENT

This is a note of my deepest appreciation to my family for motivating me throughout the project, which is a brilliant addition to my career objectives and helping me to accomplish it successfully. It would have been impossible go long way without their persistent inspiration.

I am thankful to Dr D.R.K PARHI Professor in the Department of Mechanical Engineering, NIT Rourkela who has the attitude and substance of a genius and a true guide. Having the fine opportunity to work under him and getting his support at all stages of my project is truly a reward in itself. I am genuinely indebted for the kind of values he bestowed upon me, providing his esteemed guidance and being an epitome of encouragement throughout the journey in bringing up my thesis. Without his valuable conviction and assistance towards me and my work, this piece of work would not have achieved its true potency. I am overwhelmed to express my gratitude towards him for guiding my decisions and being benignly present through all odd and even.

Now I take the opportunity to extend my gratitude to Mr. Naveen Kumar, who is pursuing M.tech dual degree in mechanical engineering department who has been a pillar of support in sustaining and bringing out the best in me. He continually and convincingly conveyed a spirit of inspiration in regard to my thesis work. The kind of support from him has helped a lot to transcend all limitations. I put forth a sincere expression of gratitude for providing wings to my quests. It would have been a tedious and mundane journey without your kind and cogent support.

Last but not the least, I want to extend my regards to all the teachers of Department of Mechanical Engineering for providing a consolidated backup in this field. I am also very glad to thank all my classmates and friends who were always the patrons of encouragement to me and accompanied me in the successful completion of my thesis work.

DEBASISH NAYAK  
ROLL No-111ME0320

# ABSTRACT

3D printing is called as desktop fabrication. It is a process of prototyping where by a structure is synthesized from a 3d model. The 3d model is stored in as a STL format and after that forwarded to a 3D printer. It can use a wide range of materials such as ABS, PLA, and composites as well.3D printing is a rapidly developing and cost optimized form of rapid prototyping. The 3D printer prints the CAD design layer by layer forming a real object. 3D printing process is derived from inkjet desktop printers in which multiple deposit jets and the printing material, layer by layer derived from the CAD 3D data.

3D printing significantly challenges mass production processes in the future. This type of printing is predicted to influence industries, like automotive, medical, education, equipment, consumer products industries and various businesses.

**KEYWORDS:** 3d printing, Rapid Prototyping, ABS, PLA

# ACRONYMS

**CAD**-Computer Added Graphics

**AM**-Additive manufacturing

**DARPA**- Defense Advanced Research Projects Agency

**SLS**- Selective Laser Sintering

**ABS**-Acrylonitrilebutadienestyrene

**PLA**- Polylactic Acid

**FDM**-FuseddepositionModelling

**SHS**-Selective Heat Sintering

**SLM**- SelectiveLaser Melting

**EBM**-Electron Beam Melting

**SLA**-Stereo Lithography Apparatus

**DLP**- Digital Light Processing

**LOM**-Laminated Object Manufacturing

**RAMPS**- Reprap Arduino Mega PoluloShield

**SMPS**- Switched Mode Power Supply

# CONTENTS

Sl. No.	Title	Page No.
	Acknowledgement	i
	Abstract	ii
	Acronyms	iii
	List of Figures	vi
<b>MODULE-1</b>	<b>INTRODUCTION</b>	
	1.1. INTRODUCTION	2
	1.2. MOTIVATION FOR THE PRESENT RESEARCH WORK	2
	1.3. OBJECTIVES OF THE PROJECT	3
	1.4 APPLICATION OF 3D PRINTER	3
	1.5 PROCESS OF 3D PRINTING	4
	1.6 LAYOUT OF THE THESIS	4
<b>MODULE-2</b>	<b>LITERATURE REVIEW</b>	
	2.1. INTRODUCTION	7
	2.2. PRINTING METHODS	7
	2.3. PREVIOUS RESEARCH	19
	2.4. HISTORY OF 3-D PRINTING	21
<b>MODULE-3</b>	<b>DESIGN,SPECIFICATIONAND FABRICATION OF 3D PRINTER</b>	
	3.1. EXPERIMENT AND METHODOLOGY	22
	3.2. DIFFERENT PARTS OF A 3D PRINTER	23
	3.3. WORK DONE	33
<b>MODULE-4</b>	<b>4.1. CAD MODELS OF DIFFERENT PARTS OF A 3D PRINTER</b>	<b>37</b>
	4.2 SPECIFICATION OF DIFFERENT PARTS	42
<b>MODULE-5</b>	<b>RESULTS OBTAINED</b>	<b>44</b>
<b>MODULE-6</b>	<b>FUTURE PERSPECTIVE</b>	<b>46</b>
<b>MODULE-7</b>	<b>CONCLUSIONAND RECOMMENDATION</b>	
	7.1. CONCLUSION	48

	7.2. RECOMMENDATION	48
MODULE-8	REFERENCES	50



# LIST OF FIGURES

SL NO	FIGURE NO	DESCRIPTION
1	1	Basic method of FDM technology
2	2	Thermoplastic
3	3	Granular material binding 3d printer
4	4	Selective Laser Sintering Citation Process
5	5	Blue Printer Citation
6	6	Model created by Blue Print Citation
7	7	Illustration of selective laser sintering method
8	8	Selective laser sintering in action
9	9	Illustration of EBM process citation
10	10	Illustration of granular material
11	11	SLA Platform
12	12	Illustration of SLA process
13	13	Illustration of DLP Projection
14	14	Illustration of material jetting process citation
15	15	Depiction of Laminated Object Manufacturing process
16	16	Example of final LOM printed model citation
17	17(A)	fully assembled working 3D printer
18	17(B)	CAD model of 3D printer
19	18	Empty 3D printer Frame
20	19	3D printer frame with y-axis installed
21	20	Brass Bushing inserted in printed parts
22	21	Printed Linear Bearing
23	22	3D printer frame 3 axis installed
24	23	X-end idler part on LHS and X-end motor part on RHS
25	24	Assembled X-end idler
26	25	Wade's geared extruder
27	26	heater block with a resistor installed
28	27	Heater barrel wrapped with nichrome wire

29	28	Heater Barrel
30	29	X-axis is assembled with two rods, the X-end motor and idler the printed X-carriage and printed parts
31	30	Assembled Wade's geared extruder mounted on the X-carriage
32	31	Top print plate stack on bottom print plate
33	32	Warping of bottom section
34	33	Heat bed mounted on top print plate
35	34	Wade's geared wheel (Extruder Assembly)
36	35	X-end motor & belt drive, bushing
37	36	Assembled Microcontroller
38	37	Cooling fan connected to the microcontroller
39	38	Voltage converter (SMPS)
40	39	Ball Bearing 624_2z
41	40	Axial
42	41	Ball Bearing608_2z
43	42	Axle holder
44	43	X- Carriage
45	44	Extruder Idler
46	45	Head Nozzle
47	46	Body Extruder Wade
48	47	X-Idler
49	48	Bearing LM8UU
50	49	X End Motor
51	50	Struts
52	51	Bolt
53	52	Nut
54	53	X End Idler
55	54	Wade Big Gear
56	55	Wade Small Gear
57	56	Bracket
58	57	Y- Axle holder
59	58	End Stop Holder

**MODULE#01**  
**INTRODUCTION**

## **1.1. INTRODUCTION:**

3D printing called as desktop fabrication. It is a rapid prototyping process whereby a real object can be created from a 3D design. A 3D printer machine uses a CAD model for rapid prototyping process. [1]

3D printing is called as desktop fabrication which is a process of prototyping where by a structure is synthesized from its 3d model. The 3d design is stored in as a STL format And after that forwarded to the 3D printer. It can use a wide range of materials such as ABS,PLA, and composites as well.3D printing is one kind of rapidly developing and cost optimized form which is used for rapid prototyping.The 3D printer prints the CAD design layer by layer forming a real object. 3D printing process is derived from inkjet desktop printers in which multiple deposit jets and the printing material, layer by layer derived from the CAD 3D data.3D printing is diversifying and accelerating our life, letting various qualities of products to be synthesised easier and faster [2].Three dimensional (3D) printing has the ability to impact the transmission of information in ways similar to the influence of such earlier technologies as photocopying. This identifies sources of information on 3D printing, its technology, required software and applications. Along 3D printing, companies are able to extract and innovate new ideologies and various design replications with no time or tool expense. 3D printing possibly challenges mass production processes in future. 3D printing influences many industries, such as automotive, architecture, education, medical, business and consumer industries [3].

## **1.1.MOTIVATION FOR THE PRESENT RESEARCH WORK:**

Since over a century the visual world of printed scriptures has been dominated by the 2-D printing methods. Be that easy to read or comprehend but when it comes to imaging of definite and real life models it is sorely outsourced. Any 3-D model cannot be represented and displayed easily in a 2-D workplace. The only thing worth mentioning for likable perception is the rendering of the image. This ushered in the era of the much needed idea of “3-D” printing.

Basically the singular purpose for the division of 3-D printer was to prepare 3-D samples directly on the bed of the printer. It has been an effective way of manufacturing since many companies are now opting for this type of method for their production operations.

### **1.3. OBJECTIVE:**

1. To study different methods of 3d printing and their applications.
2. To study the working procedure of each component of a 3d printer and the evolution of 3d printer.
3. To design and fabricate a 3d printer using tool kit.

### **1.4. APPLICATION OF 3D PRINTER:**

3-D printing was originally developed for rapid prototyping purposes, making less complicated physical samples. It allowed designers to identify and rectify design flaws quickly and cheaply, thereby speeding up the product development process and minimizing commercial risks. Here are some applications of a 3D printer described below:

#### **Aerospace and Automotive sector**

With the help of 3-D-printed components which are used for aircrafts and parts are 70% less weighing but identically tough as conventional parts, indicating cost reduction and carbon reduction and emissions of unwanted particle. It uses less raw constituents and manufactures parts which are less weight, complicated but possess more strength [4].

#### **Medicine**

Medical sector is one of the most promising areas of usage. It is being applied to face many medical situations, and develop medical research, also combining the field of “regenerative medicine”. In 2012, using a 3-D printer, engineers and doctors at Hasselt successfully experimented the very first patient-specific instrument of prosthetic jaw transplant [4].

#### **Rapid manufacturing:**

Advancements in Rapid Prototyping have presented materials those are necessary for final manufacturing, leading to the possibility of manufactured finished components and parts [5].

**Mass customization:**

Many industries have provided services where people can recreate their desirables implementing simple web-based customizing software. This now enables customers to replicate cases of their mobiles. Nokia has displayed the 3D designs of their mobiles so that owners will be able to recreate their own phone case [5].

**1.5. PROCESS OF 3D PRINTING:**

3D printing process can be described and defined in the following steps:

**CAD Model Creation:** Initially, the item to be 3D printed is designed utilizing Computer-Aided Design (CAD) software. Solid modelers, for example, CATIA, and SOLID WORKS have a tendency to represent 3-D objects more precisely than wire-frame modelers, for example, AutoCAD. This procedure is comparative for the majority of the Rapid Prototyping building methods [6].

**Conversion to STL Format:** The different CAD models use different methods to present solid parts. To have consistency, the stereo lithography format has been followed as the standard of the 3D printing industry.

**Slice the STL File:** A preprocessing computer program is done which readies the STL format going to be built. Numerous programs are there, which permit the user to tweak the model. The preprocessing program cuts the Stereo lithography model into numerous layers from 0.01 mm to 0.7 mm thickness, in view of the building method. The program likewise makes an auxiliary structure to help the model amidst of building. Sophisticated structures are bound to use auxiliary support [7].

**Layer by Layer Construction:** The fourth step is the actual construction of the part. Using one of various techniques RP machines build one layer at a time from polymers, or powdered metal [7].

**1.5. LAYOUT OF THESIS:**

<b>Chapter 1</b>	Introduction to the research work, its Motivation, objectives of the project, Application of 3d printer, Process of 3d printing and Layout of the Thesis.
<b>Chapter 2</b>	Literature Review, Methods of printing, History of 3d printer, Overview of Past

	Research
<b>Chapter 3</b>	Design, specification and fabrication methodology of 3d printer
<b>Chapter 4</b>	Presents the result obtained
<b>Chapter 5</b>	CAD models of different parts of a 3D printer
<b>Chapter 6</b>	Brief Discussion on Future Perspective
<b>Chapter 7</b>	Conclusion and Recommendation
<b>Chapter 8</b>	References

**MODULE#02**  
**LITERATURE**  
**REVIEW**



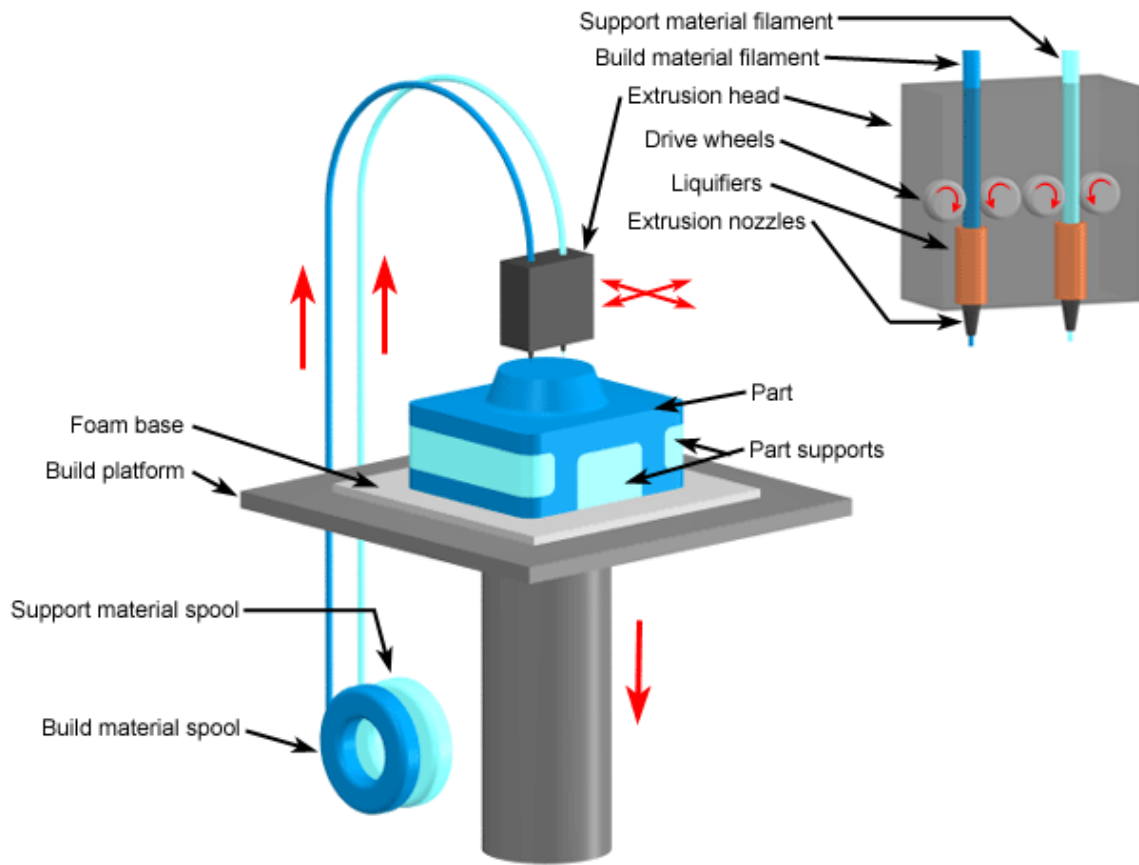
## **2.1. INTRODUCTION:**

The beginning of 3D printing is related to studies of photography, sculpting, and Landscape design, which took place in America. Much of the technology was not being developed until the mid-1980s. During this period, 3D printing was known as “RAPIDPROTOTYPING”. Chuck Hull, of 3D Systems Corporation, manufactured the first usable 3D printer. Later in the 80’s, Selective Laser Sintering (SLS) technology was synthesized by Dr. Deckard at the University of Texas during the commencement of project being done by Defence Advanced Research Projects Agency. In the 1990s, the technology was further improvised with the advancement of a method that uses UV light to solidify photopolymer, a highly viscous liquid material [8]. In the 20th century, 3D printers were very expensive and were used to print a few number of products. Most of the printers were owned by scientists and electronics groupies for research and display. However advancements in the area of 3D printing have allowed for the design of products to no longer be limited by complex shapes or colours [9].

## **2.2. PRINTING METHODS:**

### **2.2.1. FUSED DEPOSITION MODELLING:**

In this process the thermoplastics; which constitute ABS (Acrylonitrile butadiene styrene), wax and nylon were utilized. The introductory venture of the FDM procedure were to warmth up the thermoplastic constituent until it is at an intertwined state . The printers join a much weaker bolster composite. The bolster material goes about as framework to the test item. This is valuable amid the building procedure when parts have overhangs that could not bolster it. There are numerous benefits of FDM innovation; it is anything but difficult to control, use, and fix. The expense of the machine and material are generally low.



**Fig-1: BASIC METHOD OF FDM TECHNOLOGY**



**Fig-2: Thermoplastic**

### **2.2.2. GRANULAR MATERIAL BINDING (USING HEAT/ ENERGY):**

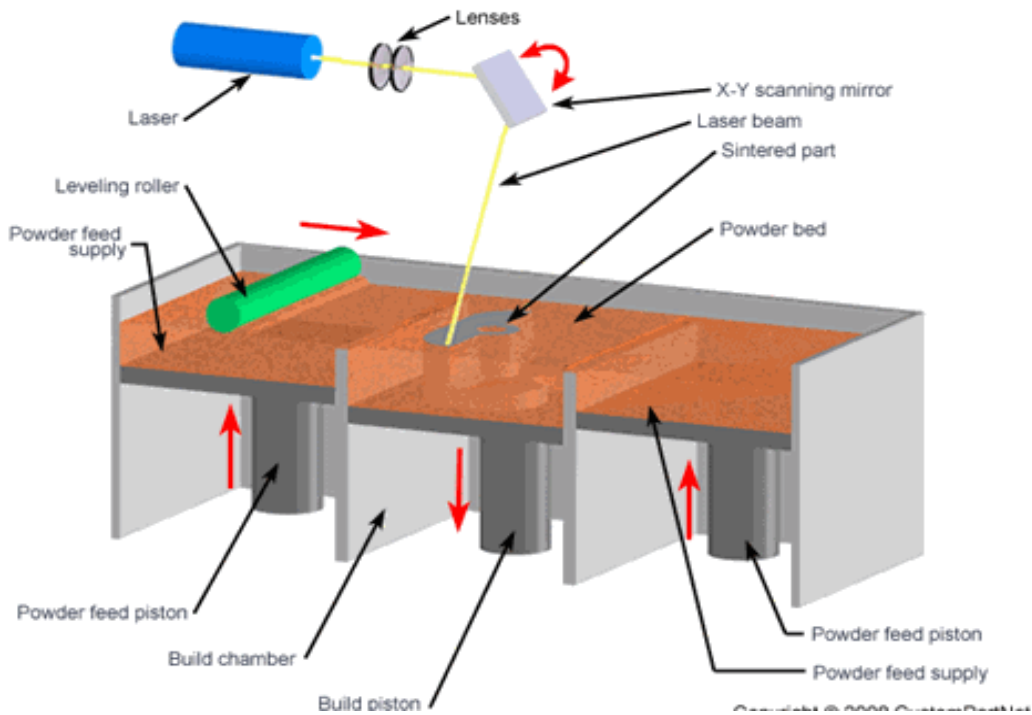
The joining of granular materials involves specifically fusing powder, layer by layer. The elemental constitution of the powder and binding process relies on the machine.



**Fig-3:** Granular material binding

### **2.2.3. SELECTIVE LASER SINTERING (SLS):**

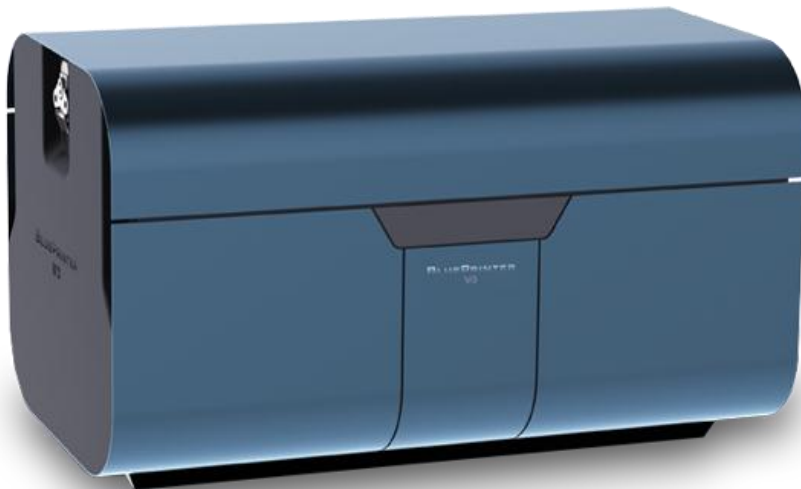
In this method once the first layer is made, the whole granular plate, in which the powder (and the "print") is found, is cut down. From Figure 6, this procedure is performed by using a vertical cylinder. Moreover, cylinders are additionally utilized as a part of a few printers to send the coupling powder up so that the moving instrument would continue working adequately and the sintering process will proceed. When a greater part of the layers is appropriately sintered, the item is removed from the build chamber.



**Fig-4:** Selective Laser Sintering Citation Process [27]

#### 2.2.4. SELECTIVE HEAT SINTERING:

SHS is indistinguishable to SLS. Selective Heat Sintering utilized a thermal print head. This new strategy uses concentrated heat to fuse the binding powder.



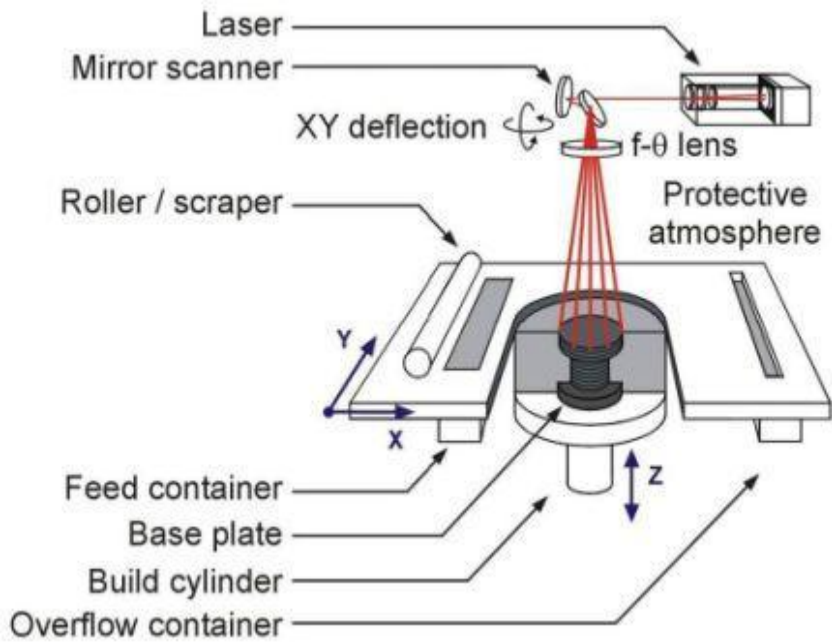
**Fig-5:** Illustration of a Blue Printer Citation [28]



**Fig-6:** A model created by Blue Print Citation [29]

#### **2.2.5. SELECTIVE LASER MELTING (SLM):**

SLM can generally be compared to SLS. A laser of higher intensity is generally used. It required more energy for the metal to be melted.



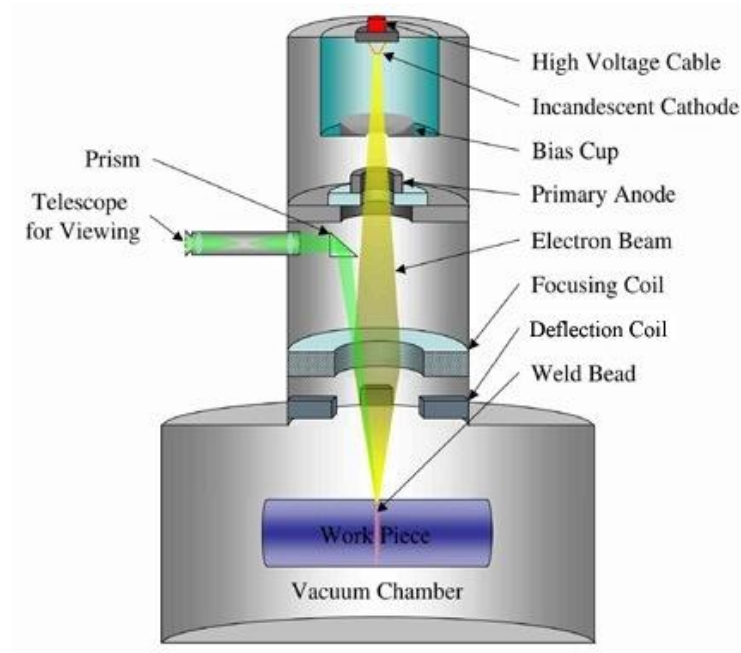
**Fig-7:** Illustration of selective laser sintering method



**Fig-8:** Selective laser sintering in action

### 2.2.6. Electron Beam Melting (EBM):

Electron Beam Melting is in some cases similar to SLM; an electron beam was used to melt the powder. Unlike models produced by SLM, EBM models are fully accurate, void-less, and extremely powerful.



**Fig-9:** Illustration of an EBM process citation [30]

### **2.2.7. GRANULAR MATERIAL BINDING (USING BINDING AGENT):**

This methodology utilized fluid material for the binding procedure of the powder together, instead of a laser. Zcorp, has a copyright of this innovation around the world. 3D printing is also called fundamental inkjet printing procedures. As opposed to utilizing paper like as a part of the instance of a 2D printer, a 3D printer moves the print heads over a bed of powder whereupon it printed information sent from the product. The fluid binding materials here utilized is much the same as super glue. Composite material or mortar is utilized as powder here.



**Fig-10:** Illustration of granular material

#### **2.2.8. Photo Polymerization:**

This is an additive manufacturing process. This methodology utilizes UV light for the hardening of the photopolymer. There are diverse sorts of photopolymers which are accessible today. Fundamental contrasts are materials sand system utilized for the printing process.

#### **2.2.9. Stereo Lithography:**

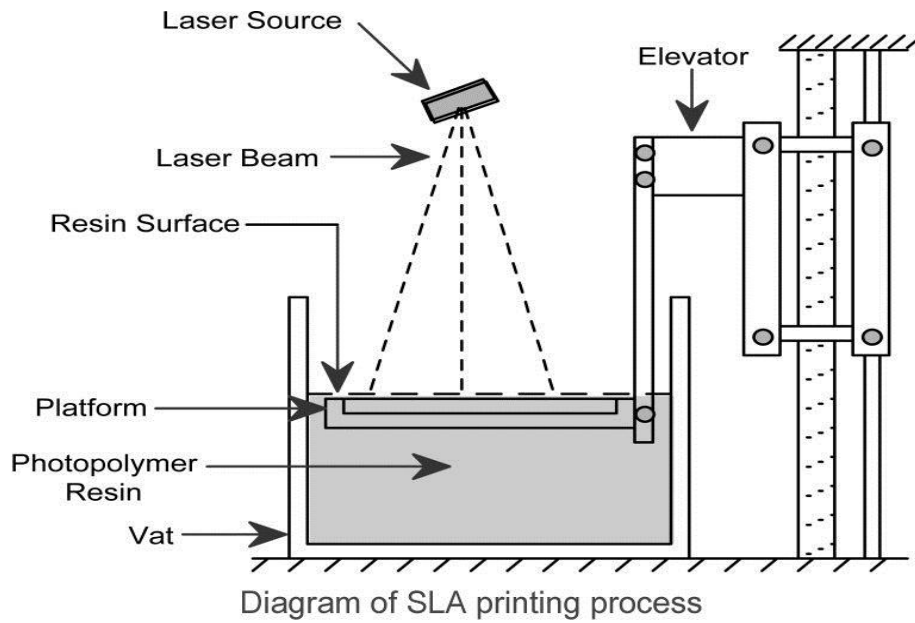
A stereo lithographic printer is regularly known as a SLA. A perforated platform was put just beneath the surface of a carriage of fluid polymer.





**Fig- 11:** Illustration of SLA Platform [31]

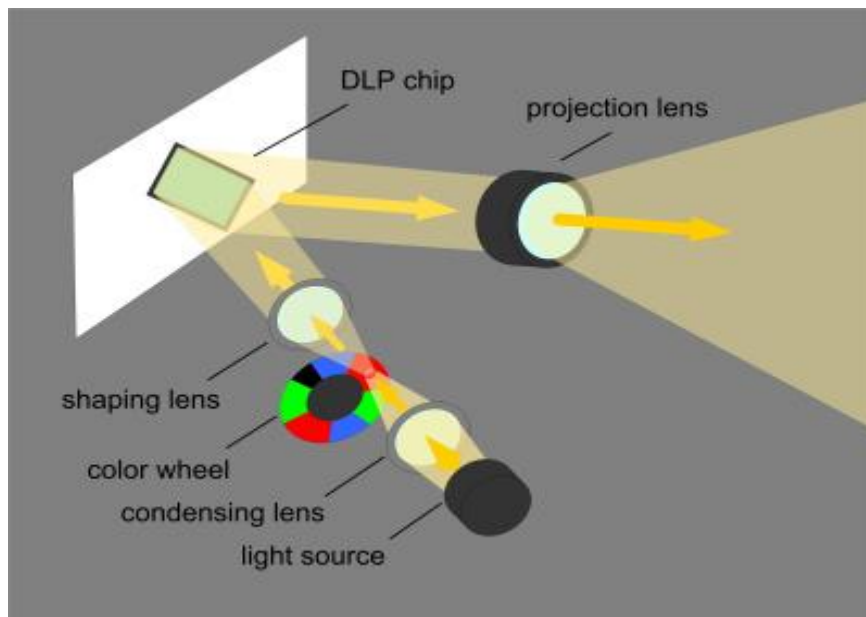
The UV-treatable fluid solidifies quick, shaping the essential layer of the 3D-printed item. Next, the stage was brought down, uncovering another surface layer of the fluid substance. This procedure is rehashed more till the whole question is framed and is completely submerged in the tank [10].



**Fig- 12:** Illustration of SLA process

**2.2.10. DLP Projecting:**

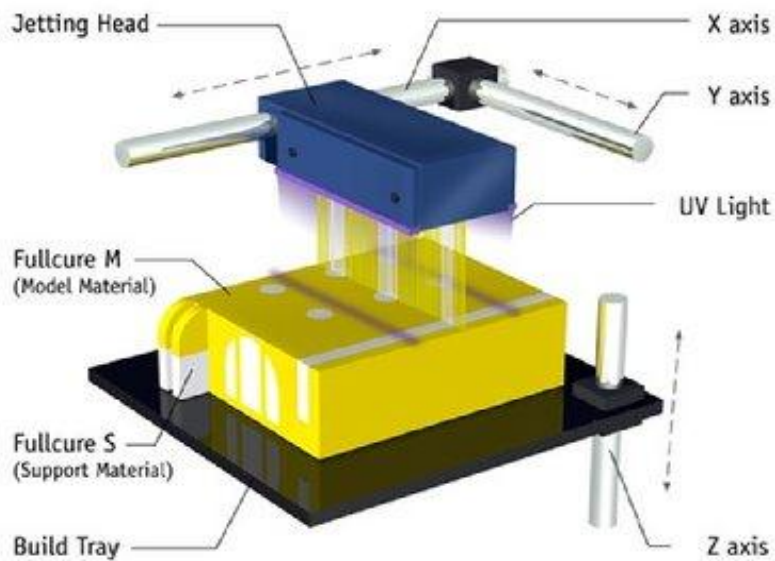
DLP (Digital Light Processing) is one kind of stereo lithographic procedure. It utilizes a projector to solidify a layer of photopolymer at once, as opposed to utilizing a laser for the following of distinctive layers. A mirror was most normally used to position and size the replication precisely onto layer of photopolymer.



**Fig- 13:** Illustration of DLP Projection

### 2.2.11. Material Jetting:

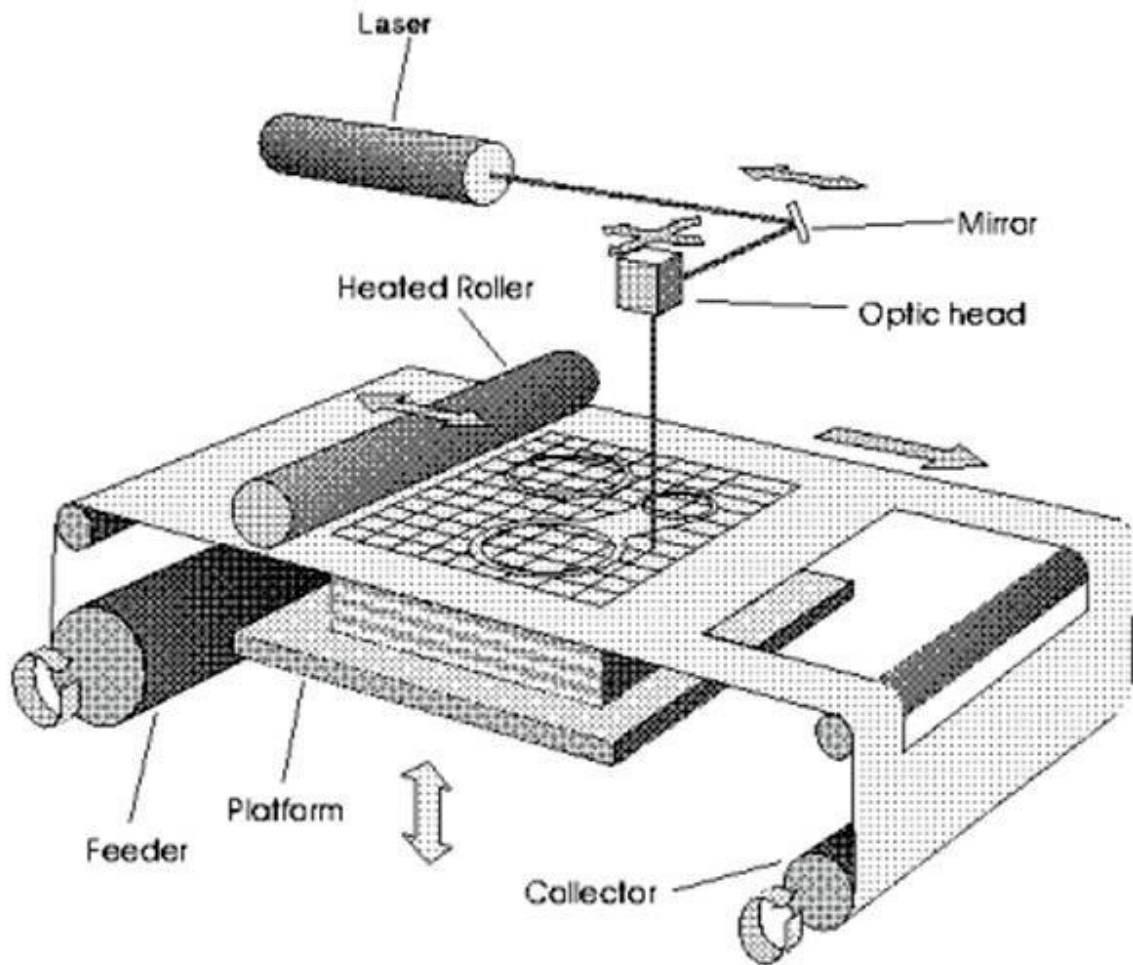
Material Jetting is much the same as the FDM process, yet it works absolutely in an alternate manner than the basic plastic extrusion system. Layers were made by emanating fluid photopolymer into a specific example. These sorts of printers utilize a bolster material alongside the model material. When every layer is shaped, an UV laser is utilized for the solidification of the photopolymer.



**Fig- 14:** Illustration of material jetting process citation [32]

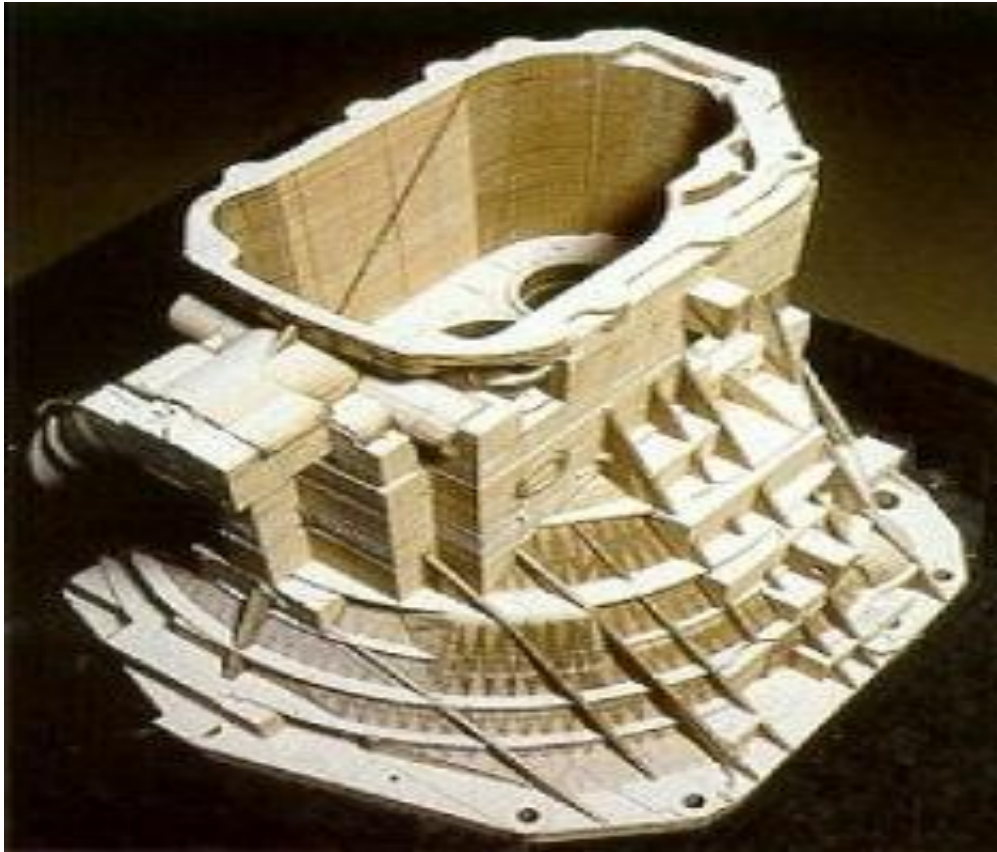
### 2.2.12. Laminated Object Manufacturing (LOM):

Covered article assembling can give great results. To follow the pattern of the material laser has been used. It is a less prevalent rapid prototyping process yet looks into are continuing for its future actualizes.



**Fig- 15:** Depiction of Laminated Object Manufacturing process

In this technique the chose printing material is initially covered with a sticky material. The material supply roll turns simply enough with the goal that there is another layer of substance which is prepared to be cut with the assistance of the laser. The warmth and weight from the roller join so that the following layer is safely stuck to the past layer. The laser is being customized in a manner that it cuts the material so that the abundance material is effortlessly expelled from the setup. After the "print" is expelled from the stage, the abundance material and backings are to be uprooted. In this technique at last, regularly there is requirement for devices, for example, etches, to pry the additional parts far from the set up.



**Fig- 16:** Example of final LOM printed model citation [33]

### **2.3. PREVIOUS RESEARCH:**

A three phase search for relevant articles was conducted to assess the prevalence of articles on 3D printing in the information science literature. The first phase consulted three information science databases: *Library and Information Science Abstracts*; *Library, Information Science and Technology Abstracts*; and *Library Literature & Information Science Full Text*. The search terms employed were '3D print\*', 'three-dimens\* print\*', 'three dimens\* print\*' and 'tridimens\*print\*'.

This involved a wide range of fields and variety of sources, including reports and conference proceedings, newspapers, industry publications and online information, and articles in engineering database systems. Various synonyms for the term '3D printing' were found in this literature were carefully specified.

Results of the three literature searches depict that most of the relevant material on including many sources less than two to three years old. As a technology, however, 3D printing has been around for some time, and commercial printers “have existed for years” [17] [19] [20].

Bradshaw et al. [10] confirm that the first patent was deposited in 1977. One reason for the recent nature of most of the literature is that prices for 3D printers have dropped sufficiently that individuals can now afford to purchase their own equipment [8] [11] [13] [20].

This search concluded only four additional results. Two of these articles [21] [22] were by the same author, giving a brief assessment of one commercial 3D printer and of a particular piece of modelling software which was being used at that time for rapid prototyping. Another [23] explained combining two databases to give a 3D printable file of the outline of buildings in Norway. The three articles were very focused on their specific topics from which none of them clearly mentioned about the usefulness of the 3D printing systems.

Although also narrowly focused, the fourth article [24] discusses the use of 3D scanners and a 3D printer to create replicas of wooden stamps and replicas. The article concludes by explaining that the stamps were now easier to share with other libraries and museums.

Articles relevant to the information implications of 3D printing technology were also discovered in the more general, were conducted in the second phase of the literature review. A kinematic library was identified which has made 3D printable files of kinetic models available online [25].

The metadata for reflecting on the classification and cataloguing of 3D printable files, it did not appear to be systematically maintained, and many of the supplied links are broken [26].

Ingole et al. [27] make some valuable observations about the need for more formalized standards for 3D printing and explains some of the difficulties associated with the different standards associated with commercial machineries.

The second engineering article, by Mortara et al. [28] reveals an awareness of such important classification concepts as a classification, but the proposed classification scheme was clearly aimed at engineers, and it would not be easy to use for publicly accessible firms.

## **2.4. HISTORY OF 3-D PRINTING:**

The very first patent application for RP technology was filed by a Dr Kodama in 1985. Hull became the co-founder of the 3D corporations which is one of the largest and most major companies in the field of 3D printing and rapid prototyping.

The primary business Rapid prototyping framework, the SLA-1, was presented in 1987 the patent in regards to the FDM innovation was at initially issued to Stratasys in 1992. After a wasting with the stereo lithography process, EOS' R&D center was chiefly on the laser sintering (LS) process, which got reinforced step by step. Today, the EOS frameworks are all around perceived the world over for their gainful and subjective yield for mechanical prototyping and enthusiastic applications in the 3D printing part. The organization's metal laser sintering (MLS) procedure came about because of an undertaking with a bureau of Electrolux Finland, which was later obtained by the organization EOS in the year 1993.

## **MODULE#03**

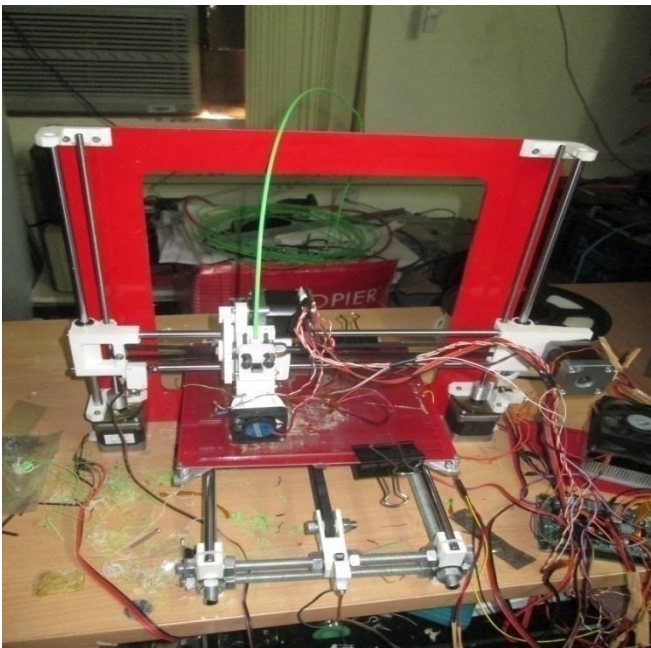
# **DESIGN, SPECIFICATION AND FABRICATION OF 3D PRINTER**



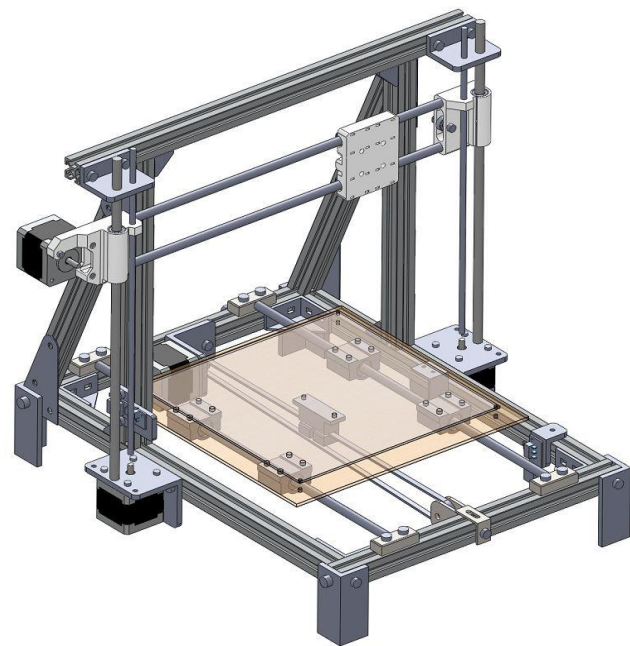
### 3.1. EXPERIMENT AND METHODOLOGY:

Our objective was to study, design and fabrication of a 3d printer. We studied the history, different printing methods and overview of the past research in the previous chapter. This chapter includes design and fabrication of the same mentioned earlier. First we ordered the whole tool-kit including all the parts and components those are used to manufacture a 3d printer. It took a while to procure the whole kit. In the meanwhile a CAD model of a 3d printer has been created using solidworks. First we designed all the parts required for the assembly and dimensions were strictly taken from internet as we didn't have the kit or manual to find out the original dimensions. Then all the parts are assembled in the solidworks workbench to create the 3d printer assembly. Here are the real life pictures, designed model of individual parts and their working process.

#### Assembled 3d printer:



**FIG.17 (A)** fully assembled working 3D printer



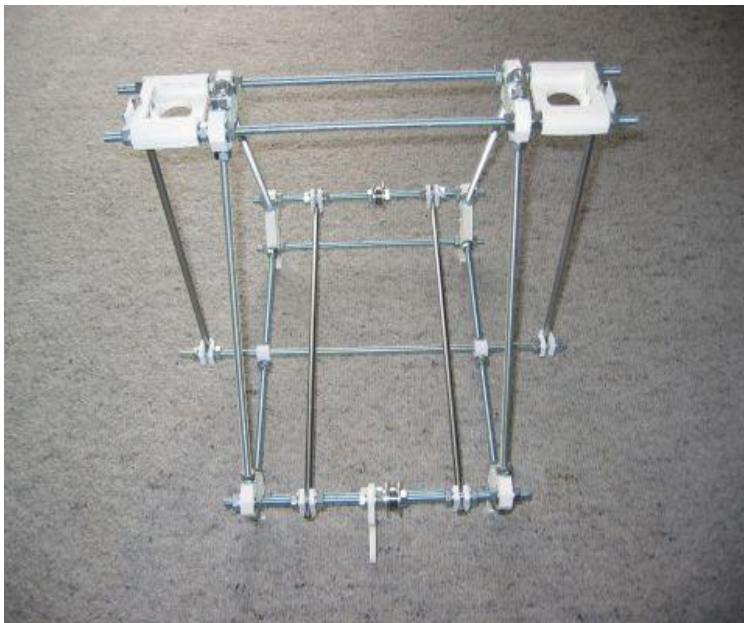
**FIG.17 (B)** CAD model of 3D printer

### 3.2. Different parts of a 3d printer:

Various components of 3D printers are: Frame, Y-axis and bushing, Extruder, print plate, stepper motors, Z-axis and Y- axis, X-carriage, Electronics parts, stepper motor controllers and end-stops [42].

#### Description of a 3d printer parts:

**Frame:** The frame provides the printer its property regarding stiffness. The three axes of the printer are added to frame. The frame consists of threaded rods combined together with printed parts. Aside from the vertex the edge likewise comprises of printed parts to hold and recreate the Y-axis and Z-axis. On the upper left and upper right we observe the printed parts that hold the stepper motors of the Z-axis.

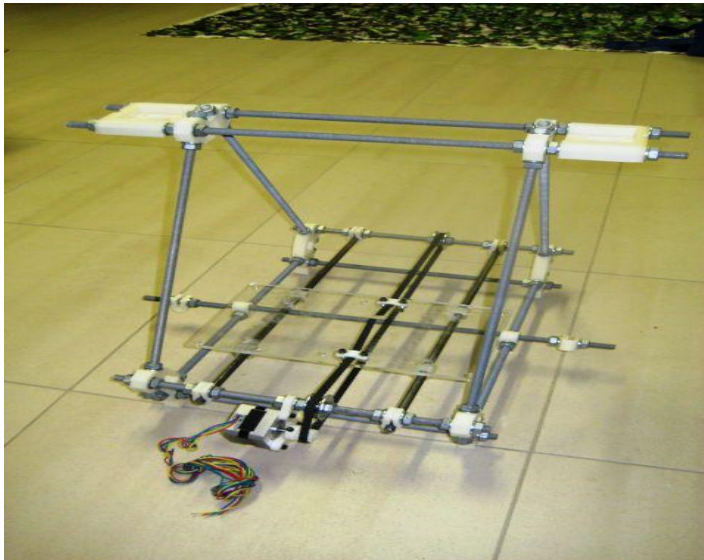


**FIG.18** Empty 3d printer Frame

#### Y-axis and Bushing:

From picture 19 we can see the print base plate is collected on the Y-axis smooth poles. The Y-axis has one degree of freedom i.e. it can move between the front and back of the casing. The Y-axis is controlled by a belt drive appended to a stepper motor with pulley. The print base plate has four bushings joined to it. Bushings are only plain bearing. They slide over smooth bars and give right around zero rubbing when going here and there the poles. On the 3d printer, the bushings climb and down the smooth poles taking after a virtual line on the bars. Linear Bearing has little balls inside and gives free and smooth movement in one course

just. Metal bushings are by and large comprised of metal which have low erosion and is self-lubricating up too. 3D printer outline utilizing direct course by and large favor LM8UU metal orientation. The standard 3D printer utilizes bushings [42].



**Fig-19:** 3D printer frame with y-axis installed



**Fig-20:** Brass Bushing inserted in printed parts



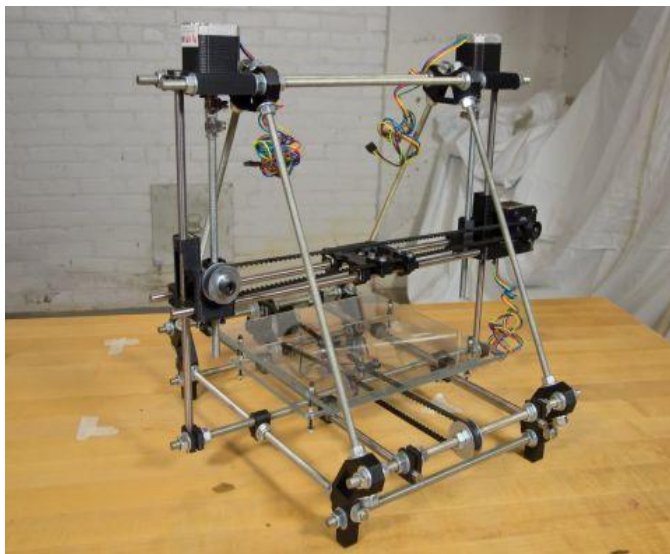
**Fig-21:** Printed Linear Bearing

### **Z-axis and Y-axis:**

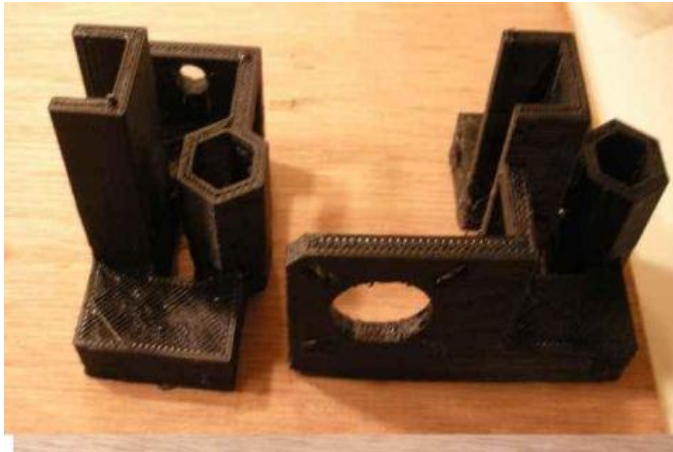
From figure 22 we can see 3D printer frame with X-, Y- and Z-axis assembled and installed. The Z-axis and Y-axis follow the identical construction process. The Z-axis moves the X-axis up and down the frame. The X-axis traverses the extruder left and right within the frame.

The Z-and-X axis development utilizes two printed parts called the X-end idler and X-end engine as indicated in the figure. The stepper motor will turn the strung pole around its own particular pivot which thus will permit the X-end idler climb and down. Collected X-end idler is indicated in figure 23:

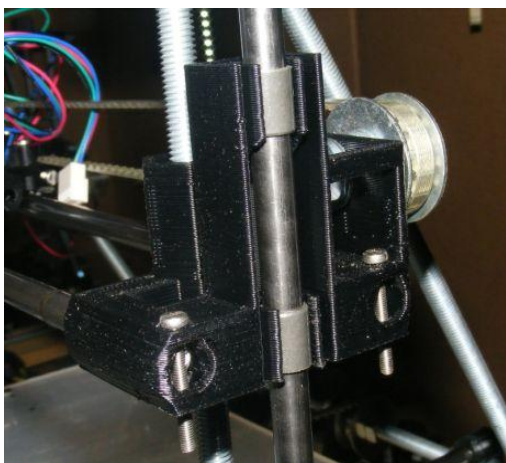
The X-end motor is assembled of the comparable two areas and is assembled in a comparative manner. As we can see from the figures, Z-axis is controlled by 2 stepper motors. It results out to be less expensive and improvement of precision to have 2 stepper motors on the Z-axis rather than one motor and a belt, on the grounds that the later one requests an extremely complex development and an extravagant belt too. The Y- and X-hub are commonly controlled by one motor and a belt drive [42].



**Fig-22:** 3D printer frame with X-axis, Y-axis and Z-axis installed



**Fig-23:** X-end idler part on LHS and X-end motor part on RHS



**Fig-24:** Assembled X-end idler

### **EXTRUDER:**



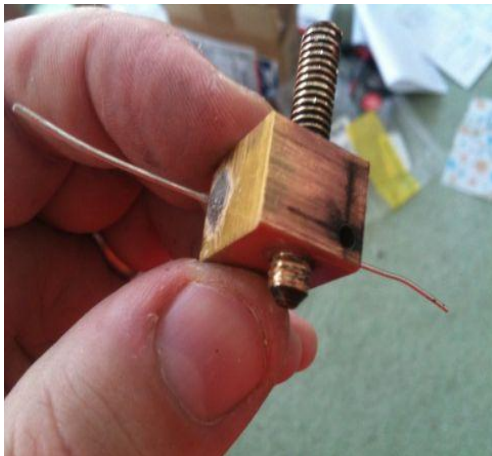
**Fig-25:** Wade's geared extruder

The 3D printer is generally assembled with a Wade's geared extruder. This extruder contains two parts: a cold top part which feeds or provides the plastic filament and a hot bottom part which helps in melting and in turn the plastic gets extruded. These two parts, usually known as the Wade extruder (the cold part) and the hot-end (the hot part).

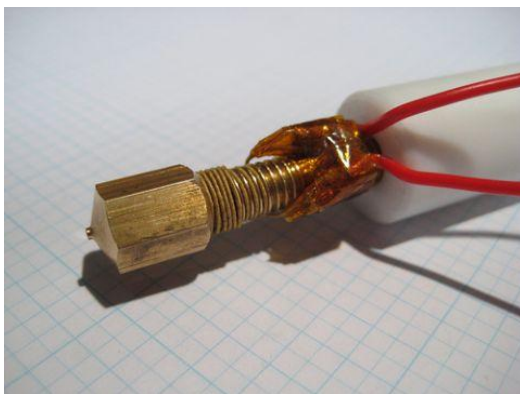
The Wade extruder holds of a large gear which is driven by a stepper motor. This large gear drives a bolt, which extracts the plastic filament and pushes it into the hot-end where the plastic starts melting.

The hot-end is generally a bolt made up of metal with a gap penetrated down the vertical pivot. This screw, otherwise called a heater barrel. At the tip of the heated barrel, the way out opening diminishes down to under 1mm from 3mm.

Two techniques are utilized to warmth the hot-end: utilizing resistor or NiChrome wire. A NiChrome wire is far too simple .A resistor needs a heater block which will be turned onto the heater barrel.



**Fig-26:** shows a heater block with a resistor installed.



**Fig-27:** Heater barrel wrapped with nichrome wire

A hot-end have three basic parts: Thermistor, to discover the temperature, a heat barrier to keep the hot-end far from the cool end, the chilly end will dissolve without heat barrier and a spout which permits the dissolved plastic to be flown out of the heater barrel.

A connection has been made in the middle of thermistor and the gadgets board - only like the resistor or NiChrome wire – and this helps the hardware to quantify and choose the temperature of the warmer barrel. The radiator barrel meets expectations at a temperature configurationally, and that temperature could be come to utilizing a thermistor Figure 28 shows a heater barrel with nozzle:



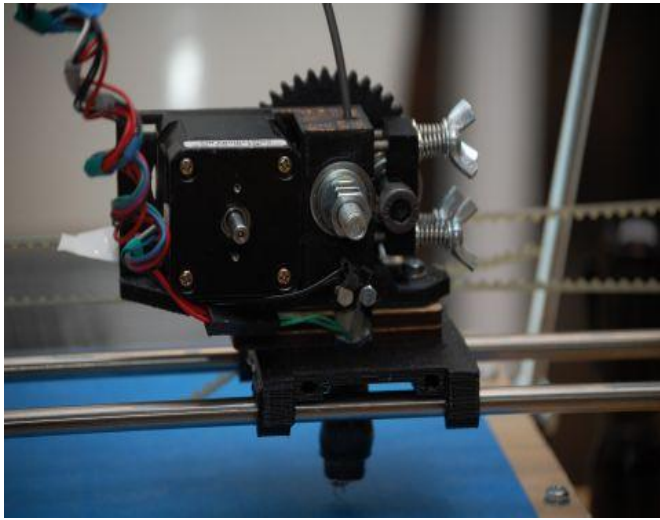
**Fig-28:** Heater Barrel

**X-CARRIAGE:** The amassed extruder alongside cold end, heat barrier and hot-end is fitted on the X-axis carriage. Figure 29 beneath demonstrates an amassed X-axis with two smooth poles, an X-end idler and a X-end motor parts and the printed X-carriage:



**Fig-29:** Assembled X-axis with two smooth rods, the X-end idler and X-end motor printed parts and the printed X-carriage:

The movement of the X-carriage is taken care by one stepper motor and a belt.



**Fig-30:** Assembled Wade's geared extruder mounted on the X-carriage

**PRINT PLATE:**

Printed parts are intended to be imprinted on the print plate. The three axes move with respect to one another so that the nozzle can be set simply over the print plate for the printing reason in a range given by the particular of the print plate.

The print plate for the most part constitutes two plates: the print base plate which is fitted and mounted on the X-pivot smooth poles by utilizing a bushing or a direct bearing and the print top plate which is mounted on the base plate and in this way, shapes the print surface.

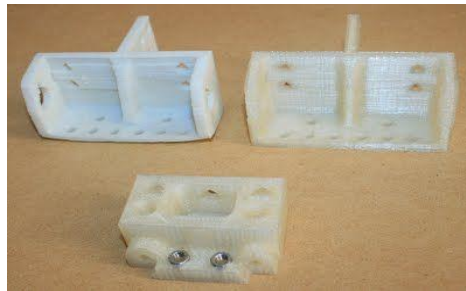


**Fig-31:** Top print plate stack on bottom print plate

Another vital part of a 3D printer is the heated bed. These altogether cutoff the measure of twisting on the printed parts, particularly on the lower layers. Distorting is brought on

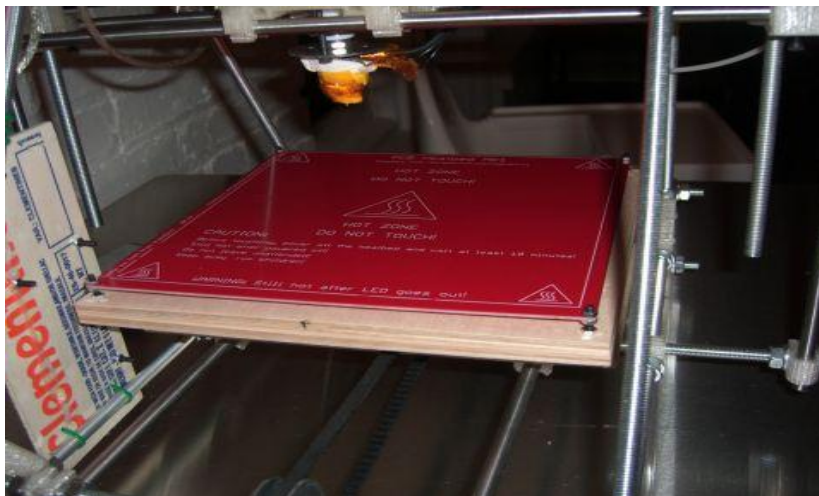


because of the uneven and undistributed cooling of both external and inward segments of a printed part. This will make the cooler material to get twisted or bowed while the hot material will never. This uneven contracting will twist the straight edges and can bring about changeless disappointment in parts. Twisting is basically a significant issue for the lower layers of a part as the print plate will cool those layers at a rate much speedier than higher layers.



**Fig-32:** Left hand part clearly shows warping of bottom section

So we have to keep the entire lower section of a part at the same temperature. A heat bed heats up the top print plate up to 100C.



**Fig-33:** heat bed mounted on top print plate

## **ELECTRONICS:**

The electronics board known as microcontroller controls the entire printing process. Several electronics options do available for 3D printers which are all open-source. Presently the most popular are:

- RAMPS, a DIY shield board for Arduino MEGA
- Sanguinololu, a DIY board with microprocessor on board

Functions of a 3d printer electronics board:

- Processes G-code instructions.
- Controls and regulates the four stepper motor controllers where both Z-axis motors are essentially connected to the same stepper motor controller.
- Monitors the end-stops
- Controls the temperature of the heated bed

The electronics board is connected to the PC using a USB-to-serial converter.

### **STEPPER MOTOR:**

There are five stepper motors used in the 3D printer are One to control the Y-axis, One to control the X-axis, Two to control the Z-axis, One to control the extruder.

### **STEPPER MOTOR CONTROLLER:**

Controlling a bipolar stepper motor is truly muddled, particularly in the matter of smaller scale venturing mode. Unipolar stepper motors are much simpler to control however they give lesser torque given the motor size is same. Exceptionally outlined stepper motor controllers are being utilized to assume control over the troubles of directing a stepper motor. With the assistance of such controller stand out small scale step can be made. Consequently controlling of a stepper motor has been rearranged.

### **END STOPS:**

While printing an object, all three axes need to be altered the initial position to their starting one. This is known as the zero position of any Cartesian robot. The axes can't move any further than zero.

To acquire this, three end stops are to be installed one for each axis. An end stop needs to be mounted at such a position where the axis shouldn't go beyond:

For the X-axis, this ought to be the position where the nozzle achieves the left-hand side of the print plate, For the Y-axis this ought to be on the posterior of the pivot such that the print plate is permitted to move to the back sufficiently far so that the nozzle winds up on the forward of the print plate, For the Z-axis position ought to be the place the nozzle scarcely touches the print plate.

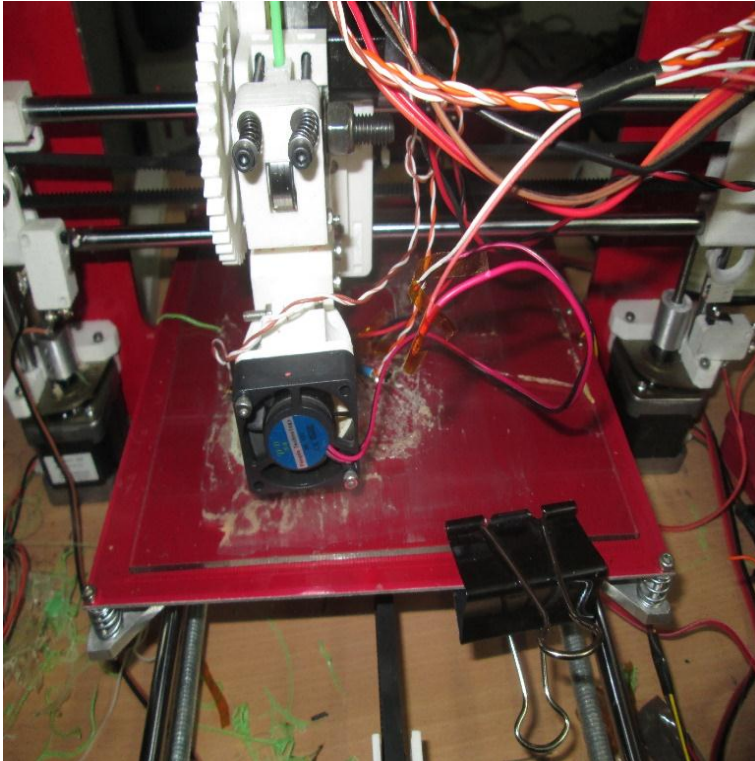
In a 3d printer 2 SMPS ,1 voltage converter,1 micro cotroller,5 stepper motors and 2 belt drives are considered as important components. After all the connection is made, AC power supply is given to the SMPS. Later this voltage is supplied to the voltage converter which is basically a step down transformer which reduces the voltage up to a noticeable level. This reduced voltage is just high enough to propel a 3d printer and this voltage is supplied to the micro controller. All the motors are connected to the micro controller which sends appropriate signal to each component for it to work.

Some of the parameters those need to be valued before printing a product using 3d printer are:

Bed Temperature, Extruder Temperature, Feed Rate, Flow Rate .Bed Temperature shouldn't exceed the melting temperature of the filaments used. A number of fans are required for the cooling purpose of the bed and for all the metallic parts of the printer.

### 3.3.WORK DONE:

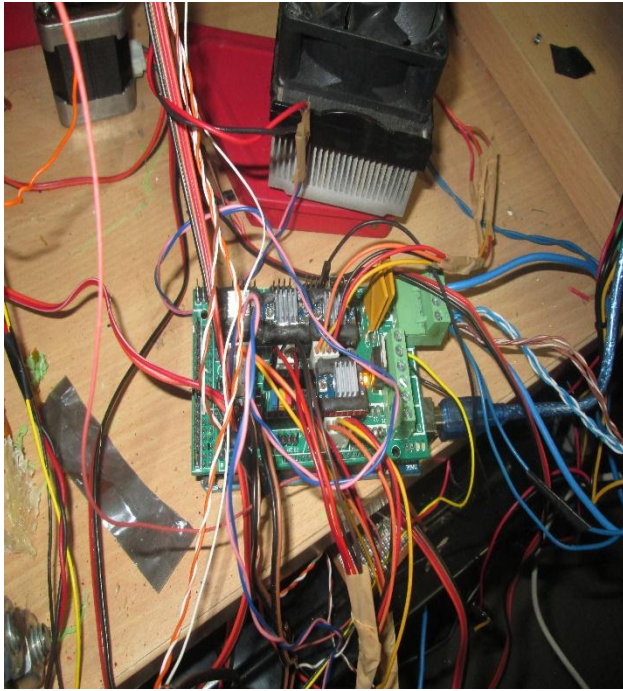
Here are some images of a working home-built 3D printer and its components:



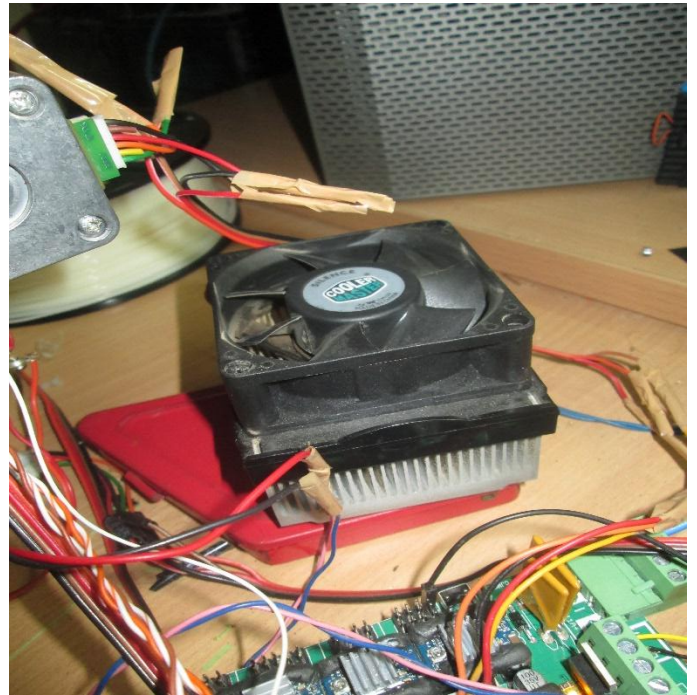
**Fig-34:** Wade's geared wheel  
(Extruder Assembly)



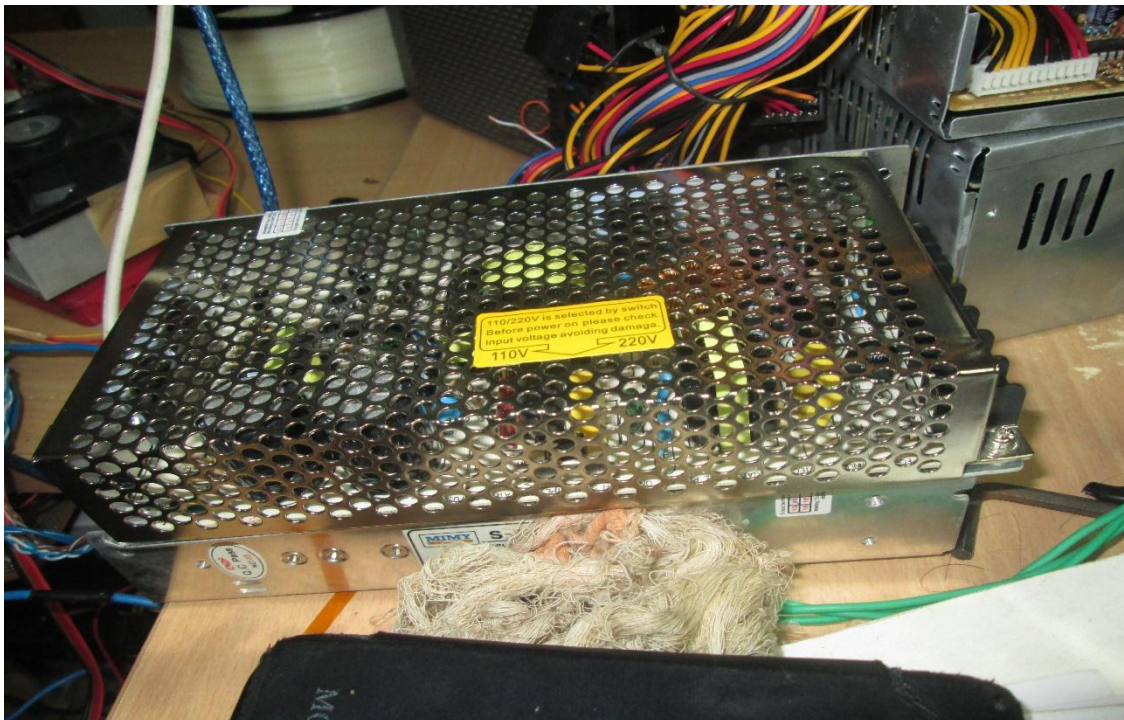
**Fig-35:** X-end motor & belt drive, bushing,



**Fig-36:** Assembled Microcontroller



**Fig-37:** Cooling fan connected to the microcontroller



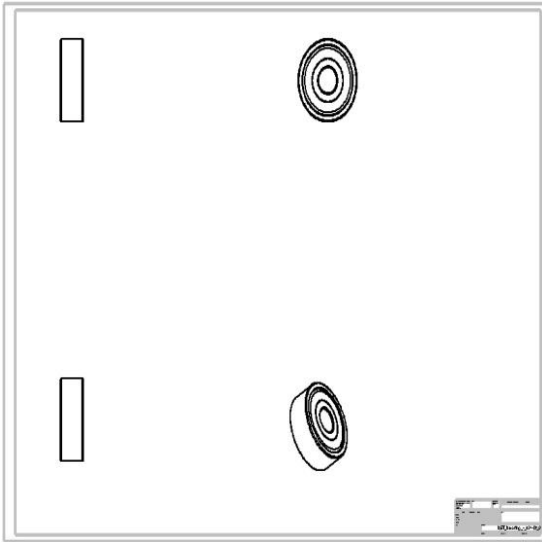
**Fig-38:** Voltage converter (SMPS)

**MODULE#04**

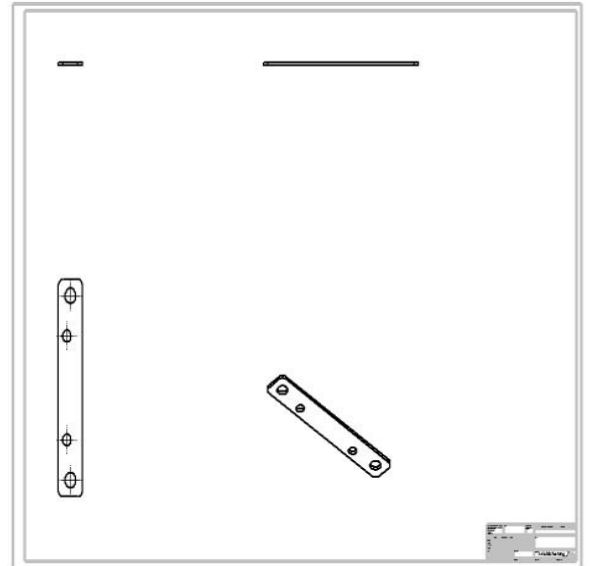
**CAD MODELS OF  
DIFFERENT PARTS OF A  
3D PRINTER**

#### 4.1. DIFFERENT VIEWS OF THE COMPONENTS:

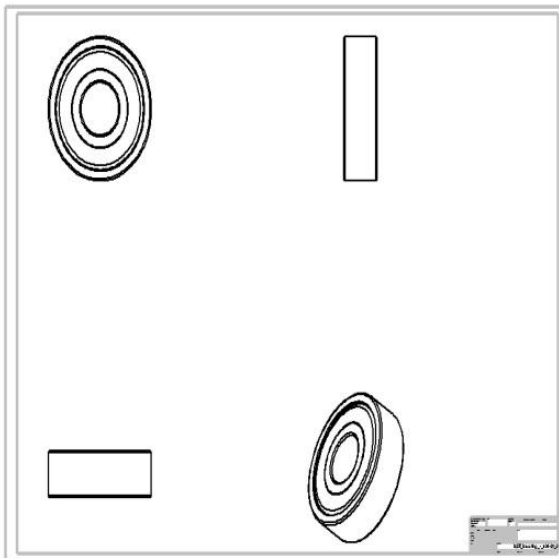
Here are some images representing the Left side view, Right side view, Top view and Isometric view of some essential components of a 3D printer.



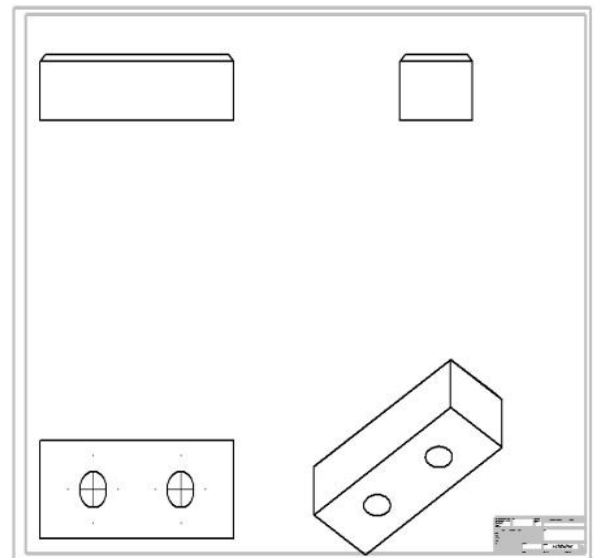
**Fig-39: Ball Bearing 624\_2z**



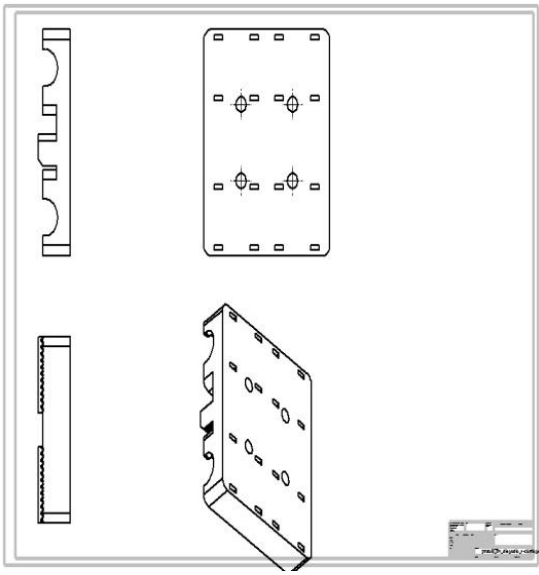
**Fig-40: Axial**



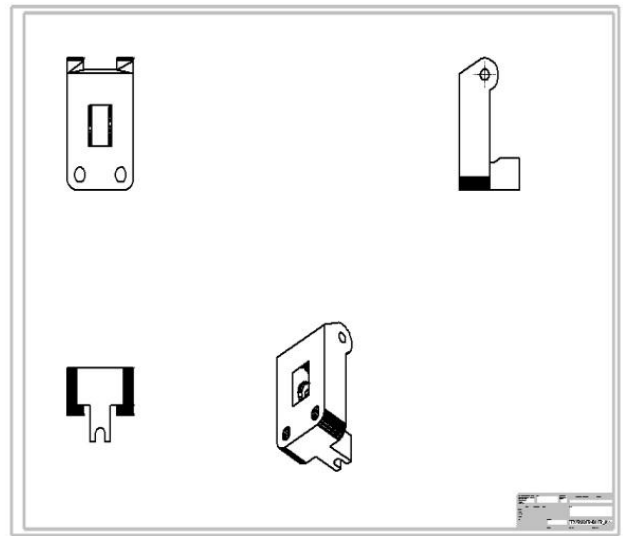
**Fig-41: Ball Bearing 608\_2z**



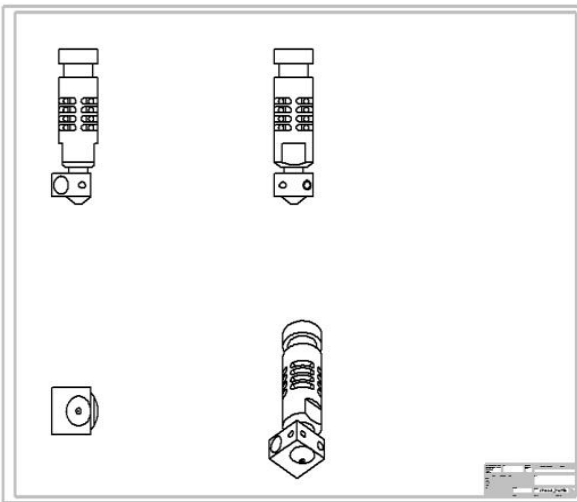
**Fig-42: Axle holder**



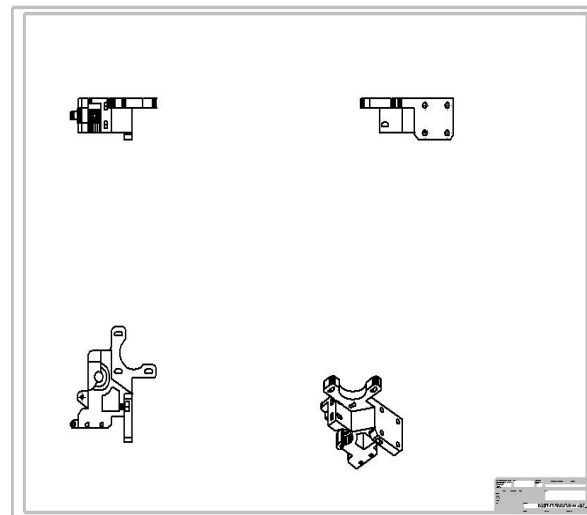
**Fig-43: X- Carriage**



**Fig-44: Extruder Idler**

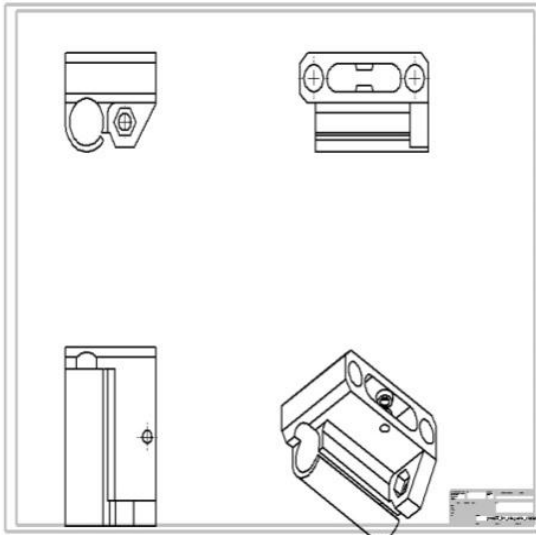


**Fig-45: Head Nozzle**

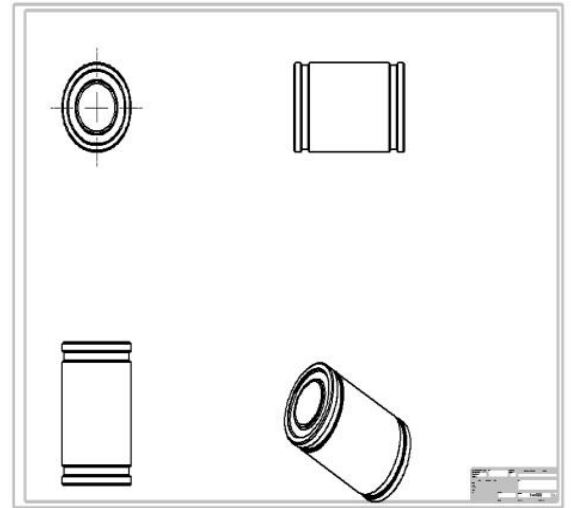


**Fig-46: Body Extruder Wade**

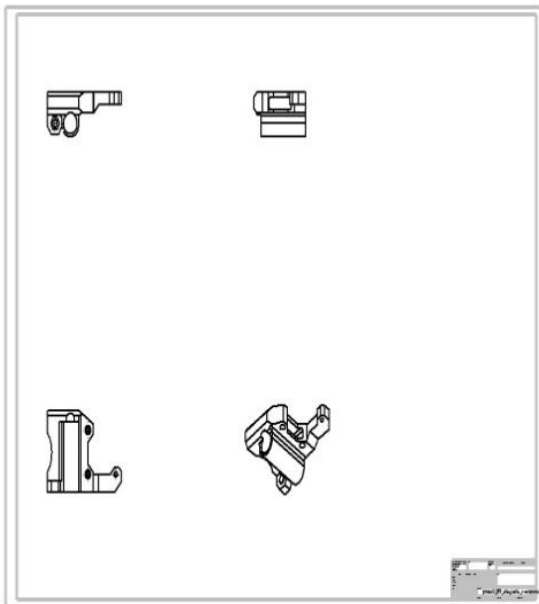




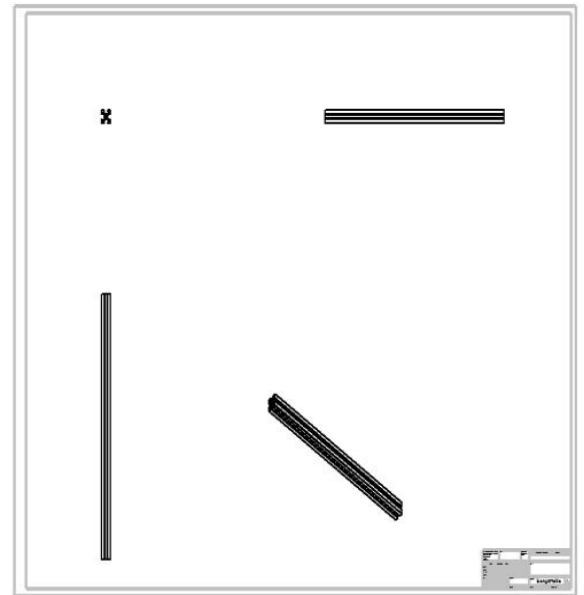
**Fig-47: X-Idler**



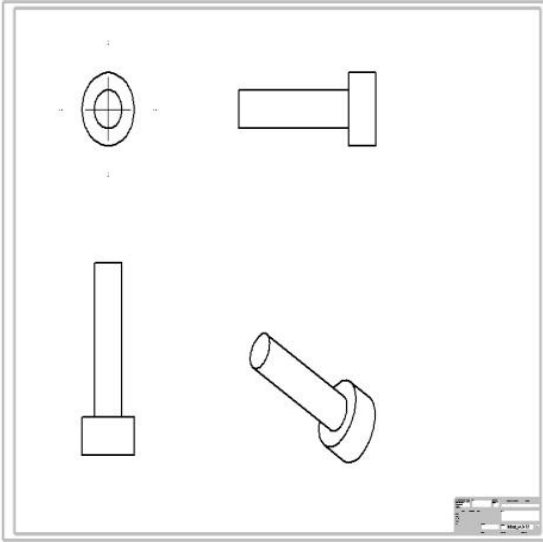
**Fig-48: Bearing LM8UU**



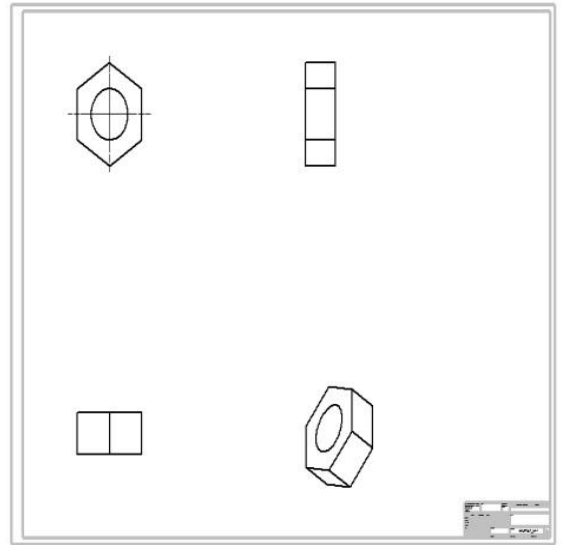
**Fig-49: X End Motor**



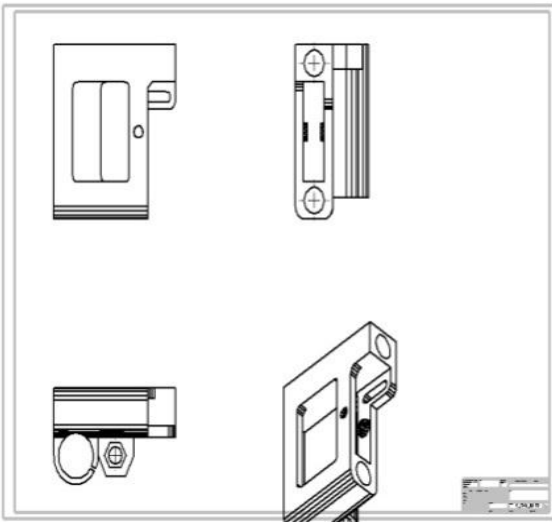
**Fig-50: Struts**



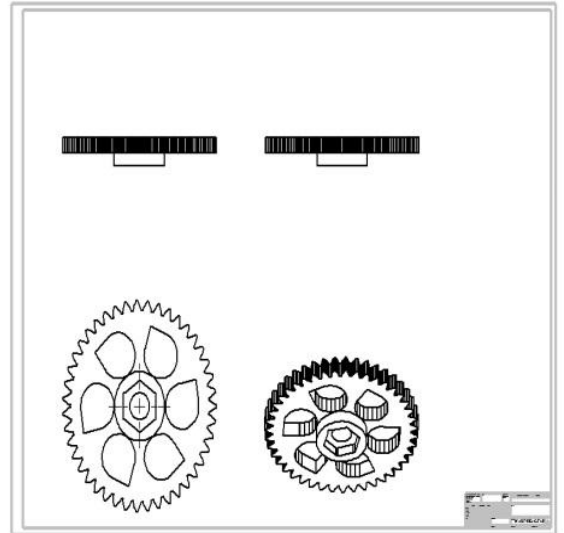
**Fig-51: Bolt M3x12**



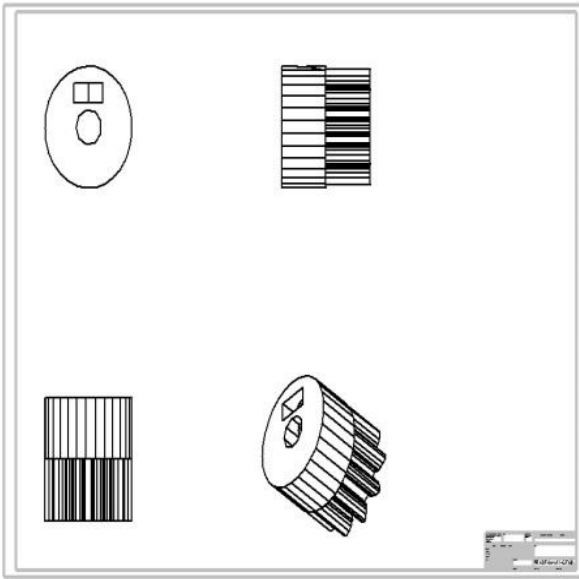
**Fig-52: Nut\_M4**



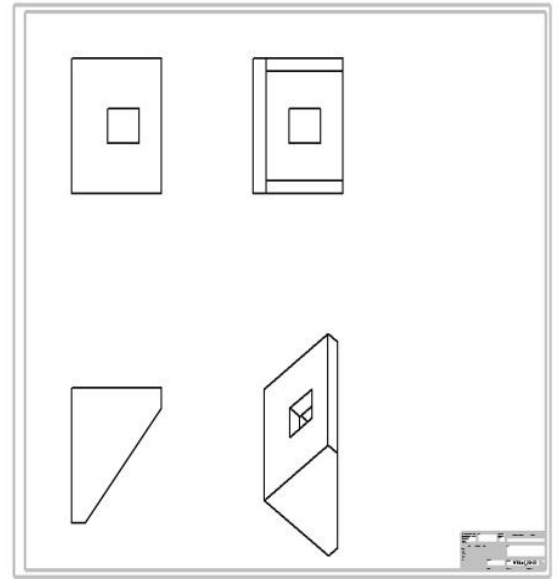
**Fig-53: X End Idler**



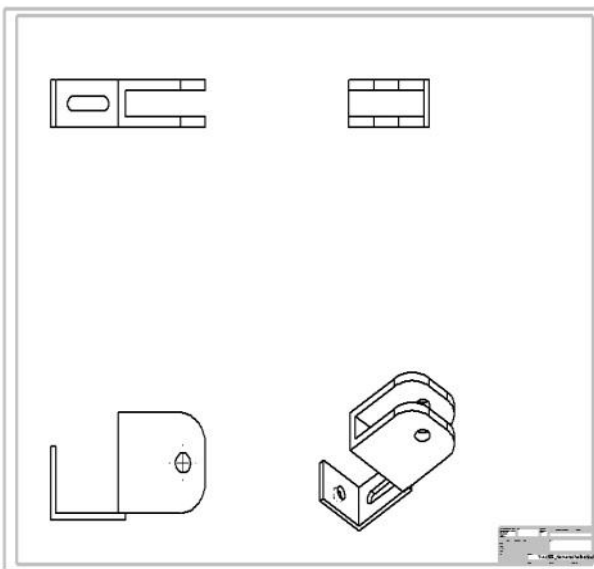
**Fig-54: Wade Big Gear**



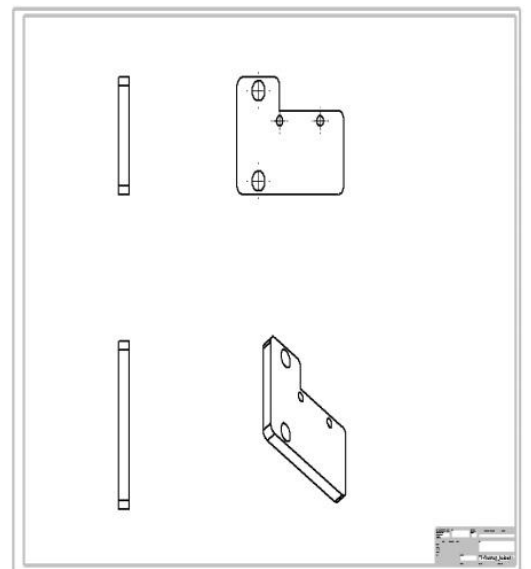
**Fig-55: Wade Small Gear**



**Fig-56: Bracket 20x20**



**Fig-57: Y- Axle holder**



**Fig-58: End Stop Holder**

## **4.2. SPECIFICATION OF DIFFERENT COMPONENTS:**

### **ELECTRONICS:**

- 1 x Ramps board (RAMPS +Mega 2560+ A4988 Polulu stepper Drivers quantity 4 nos.)
- 3 x End stops including connecting cables
- 1 x Heat Bed
- 5 x NEMA 17 Stepper motor ( 5.5 Kg-cm)
- 1 X Power Supply ( 220 Volt, assured 12 Volt ; 29 Ampere supply)

### **HARDWARE:**

- Smooth and threaded rods
- Linear bearing , ball bearing , coupling , belt , GT pulley , GT 2 belt
- Screw Nut, washers,
- Metal Frame.

### **PLASTIC PARTS:**

Printed Plastic parts to build PRUSA i3.

### **HOT END:**

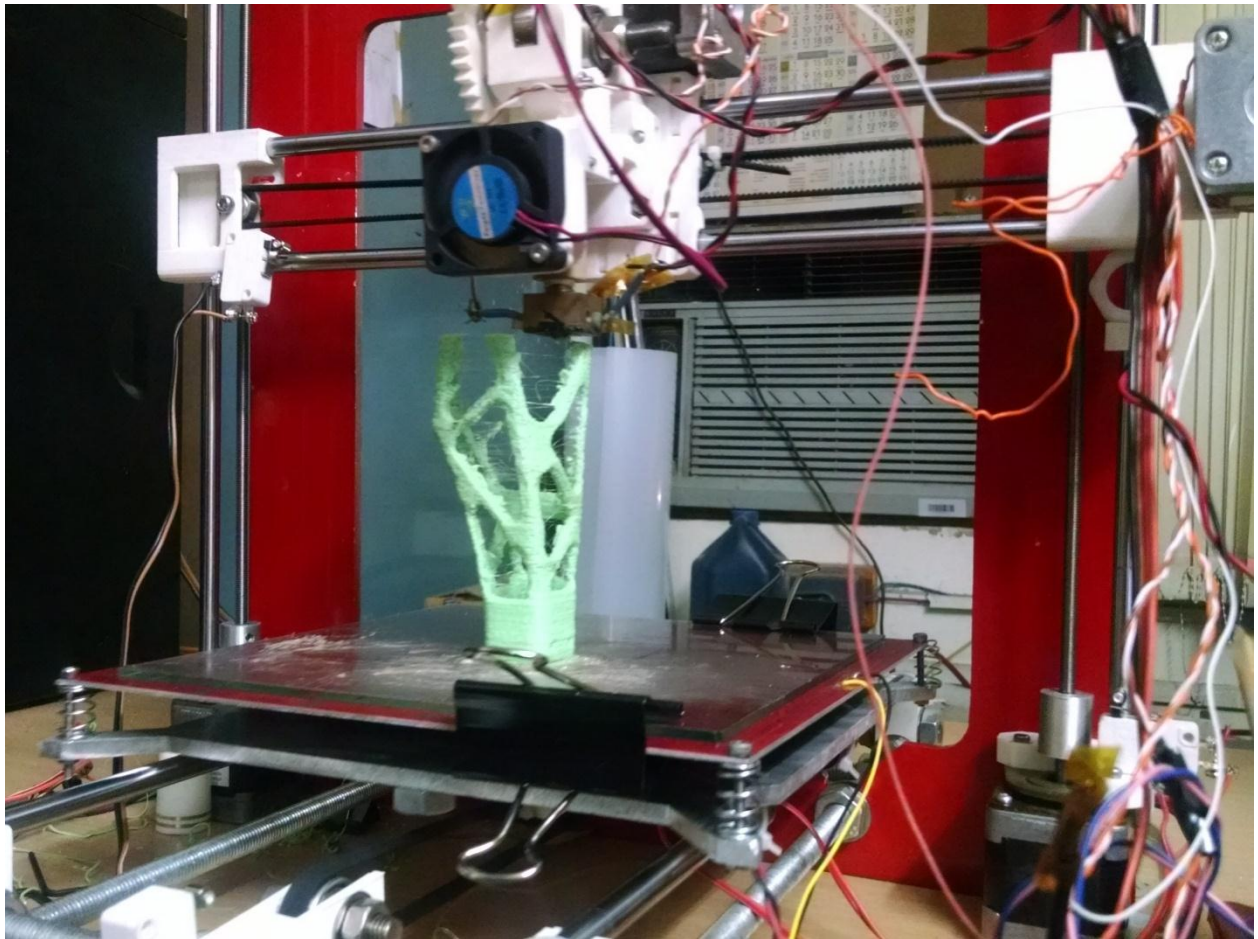
- Magma Hot end kit (Thermister& resistor included)
- 40 mm Fan & its Holder.

### **SOFTWARE:**

- Repetitor (open source)
- V-rep ( Open source)

**MODULE#05**  
**RESULTS**  
**OBTAINED**

After the procurement of the whole tool kit, a detailed study of all the components is made so as to gain knowledge about the working procedure and connection of each part. Then the 3d printer is structured using manual, with the help of internet and some research students. Electronics parts are connected very carefully so as to avoid any kind of accidents. After building the 3d printer it is put into working condition and some products are manufactured. Here is an image of a working 3-D printer manufacturing a product sample:



**Fig-64:** WORKING OF 3D PRINTER

# **MODULE#06**

## **FUTURE PERSPECTIVE**

3D printing is a new and promising technology, and as with all developing fields the scope for improvement and advancement are definitely infinite.

## **NASA**

Nothing incorporates innovation and advancement like our space program. In July 2013, NASA designed, printed, and tested rocket engine injectors by subjecting them to challenging pressures and temperatures of over 6,000 degrees F. In fall 2014, NASA has devised to launch and deliver a 3-D printer to the International Space Station, which will help astronauts to print replacement tools in space [34].

## **BIOTECHNOLOGY**

In 2012, an elderly woman in Belgium proclaimed a 3-D printed jawbone, transplanted and specially tailored to her facial structure [35]. This year, engineers at Princeton were able to produce an ear imprint, applying a culture of animal cells and silver nanoparticles; the experimental version was able to read audio beyond the limit of human levels, making this a “bionic” ear [36]. Using this method, leather could be manufactured and even meat [37]. Engineers are working on producing non-perishable foods from powder (liquid-free) cartridges; imagine the effect that developments like these could have on global sustainability process in the future [38].

## **REPLICATION**

A key idea in the flourishing field of 3-D printing is the ability for printers to reproduce themselves, or to manufacture as many essential components as possible that are required to build a machine. Many consumer 3-D printers now come assembled with components that were themselves manufactured in 3-D. This year, a functioning pistol was designed and printed, with the computer automated drawing schematics made readily available online [39].



**MODULE#07**  
**CONCLUSION**  
**AND**  
**RECOMMENDATION**

## **6.1. CONCLUSION:**

Not all technical information about 3D printing could be shared in this introduction of the subject. Documenting the technology, very much a work-in-progress, must also recognize that not all authors agree on the likelihood of 3D printing gaining wider dissemination into the homes of individuals [41]. Also, as a still emerging technology, 3D printing is not without its problems, such as slow printing speeds [40]. Nevertheless, as prices are decreasing, the number of 3D printers sold worldwide has been growing steadily.

## **6.2. RECOMMENDATION:**

The following recommendations can be considered for the improvement in the field of 3D printing.

- Desktop 3D printing assembling innovation could be possible at home; the workplace, a healing facility or a school, conveying assembling to non-producers the way PCs conveyed processing to non-customary situations.
- Later on, it might be workable for the military to print new parts right on the war zone as opposed to needing to depend on constrained extras and supply chain management.

# **MODULE#08**

# **REFERENCES**

- [1] "3D Printing," Wikipedia, Available: [http://en.wikipedia.org/wiki/3D\\_printing](http://en.wikipedia.org/wiki/3D_printing).
- [2] "Introduction to 3D Printing," Intractable,  
Available: <http://www.instructables.com/id/3D-Printing-1/>.
- [3] <http://www.industryweek.com/emergingtechnologies/history-3-d-printing-slide-show>
- [4] [http://www.wipo.int/wipo\\_magazine/en/2013/0](http://www.wipo.int/wipo_magazine/en/2013/0)
- [5] [http://iysn.org/2011/09/17/pushing-boundaries-3-d-printing/2/article\\_0004.htm](http://iysn.org/2011/09/17/pushing-boundaries-3-d-printing/2/article_0004.htm)
- [6] <http://www.arctron.de/uploads/media/3DPrinting-Info.pdf>
- [7] <http://www.arctron.de/uploads/media/3DPrinting-Info.pdf>
- [8] American Public Media, "Brave new world of 3D printing," [Podcast], Marketplace Tech Report, November 29, 2010. Retrieved from  
<http://marketplace.publicradio.org/display/web/2010/11/24/tech-report-the-brave-new-world-of-3d-printing/> 25.11.2011
- [9] A. Anderson. "A Whole New Dimension: Rich Homes Can Afford 3D Printers," The Economist, 15<sup>th</sup> November 2007 Retrieved from  
[http://www.economist.com/node/10105016?story\\_id=10105016](http://www.economist.com/node/10105016?story_id=10105016) 25.11.2011
- [10] S. Bradshaw, A. Bower, and P. Haufe. "The Intellectual Property Implications of Low-cost 3D printing," *SCRIPTeD*, vol. 7, (1), 2010, pp. 5-31, doi: 10.2966/scrip.070110.5.
- [11] C. Inacu, D. Inancu, and A. Stanciou, "From CAD Model to 3D Print via 'STL' File Format," *FiabilitesiDurabilite = Fiability& Durability*, vol.1, 2010, pp. 73-80.
- [12] H. Lipson and M. Kurman, *Factory at Home: The Emerging Economy of Personal Manufacturing*. Washington: U.S. Office of Science and Technology, 2010, n.p.

[13] E. Malone and H. Lipson, "The Factory in Your Kitchen," 2007 WorldConference on Mass Customization & Personalization (MCPC), Cambridge, MA: MCPC 2007. Retrieved from

[http://ccsl.mae.cornell.edu/papers/MCPC07\\_Malone.pdf](http://ccsl.mae.cornell.edu/papers/MCPC07_Malone.pdf) 24.11.2011

[14] D. Smock, "Lower Prices Drive 3-D Printer Market", Design News, May, 2010, n.p.

[15] M. Weinberg, "It Will Be Awesome if They Don't Screw It Up: 3D Printing, Intellectual Property, and the Fight Over the Next Great Disruptive Technology," Public Knowledge, November, 2010, pp. 1-15. Retrieved from

<http://www.publicknowledge.org/files/docs/3DPrintingPaperPublicKnowledge.pdf>  
24.11.2011

[16] L. Wiegler, "Jumping Off the Page," Engineering & Technology, vol. 3, 2008, no. (1), pp. 24-26.

[17] C. Major and A. Vance, Desktop manufacturing [Video file]. The New York Times, 2010. Retrieved from

<http://video.nytimes.com/video/2010/09/13/technology/1248068999175> desktop  
manufacturing.html 24.11.2011

[18] D. L. Bourrel, M. C. Leu, and D. W. Rosen, Roadmap for Additive Manufacturing: Identifying the Future of Freeform Processing. Austin, TX: University of Texas, Laboratory for Freeform Fabrication, 2010.

[19] G. Stemp-Morlock, "Personal Fabrication: Open Source 3D Printers Could Herald the Start of a New Industrial Revolution," Communications of the ACM, vol. 53, 2010, no. 10, pp. 14-15, doi:10.1145/1831407.1831414.

[20] S. Ellerin, "The Art and Science of 3D Printing," Emedia, vol. 17, 2004, no. (5), pp. 14-15.

- [21] S. Ellerin, "Strata 3D Pro," EMedia, vol. 17, 2004, no. 6, pp. 28-29.
- [22] J. O. Nygaard, "Semiautomatic Reconstruction of 3D Buildings from Map Data and Aerial Laser Scans," Journal of Digital Information Management, vol. 2, 2004, no.4, pp. 164-170.
- [23] R. Seulin, C. Stolz, D. Fofi, G. Million, and F. Nicolier, "Three Dimensional Tools for Analysis and Conservation of Ancient Wooden Stamps," Imaging Science Journal, vol. 54, 2006, pp. 111-121, doi: 10.1179/174313106X98755.I.
- [24] K. Walker and J. M.Saylor, "Kinematic Models for Design Digital Library," D-Lib Magazine, vol.11,2005,no.7.retrieved from <http://www.dlib.org/dlib/july05/07featuredcollection.html> 24.11.2011
- [25] CTS Metadata Services, KMODDL application profile, 2004. Retrieved from <http://kmoddl.library.cornell.edu/aboutmeta2.php> 24.11.2011
- [26] D. Ingole, A. Kuthe, T. Deshmukh, and S. Bansod, "Coding System for Rapid Prototyping Industry," Rapid Prototyping Journal, vol. 14, 2008, no. (4), pp. 221-233.
- [27] "Selective Laser Sintering," CustomPartNet, 2013. Available: <http://www.custompartnet.com/wu/selective-laser-sintering>. [Accessed 29 September 2013].
- [28] T. Grimm, "BlueprinterApS Introduces New 3D Printer," 29th November 2011. Available: <http://www.engineering.com/3DPrinting/3DPrintingArticles/ArticleID/4034/Blueprinter-ApS-Introduces-New-3D-Printer.aspx>. [Accessed 30th September 2013].
- [29] "Blue Printer," Blue Printer, 2013. Available: <http://www.blueprinter.dk/>. [Accessed 30th September 2013].
- [30] "Electron Beam Melting (EBM)," Popular 3D Printers, 2013. Available: <http://www.popular3dprinters.com/electron-beam-melting-ebm/>. [Accessed 29th September 2013].

- [31] "How Photopolymers Work," Castle Island Co., 9th June 2009. Available: <http://www.additive3d.com/photo.htm>. [Accessed 29th September 2013].
- [32] "Objet 3D Printing Technology," engatech, inc, 2008. Available: <http://www.engatech.com/objet-3d-printing-technology.asp>. [Accessed 29th September 2013].
- [33] "Laminated objects manufacturing," Alex Den Ouden, Available: <http://www.alexdenouden.nl/08/rapprod5.htm>. [Accessed 30th September 2013].
- [34] M. Wall, "3D-Printed Rocket Parts Excel in NASA Tests," Space.com, 26 July 2013.
- [35] M. Smith, "83-year Old Woman Gets Replacement 3D Printed Titanium Jaw, Makes Her the Coolest Member of the Bridge Club Alt," End gadget, 13 June 2013.
- [36] J. Fingas, "83-year Old Woman Gets Replacement 3D Printed Titanium Jaw, Makes Her the Coolest Member of the Bridge Club Alt," End gadget, 6 February 2013.
- [37] K. Torgovnick, "TED Blog How to Print Meat and Leather AndrasForgacs at TEDGlobal2013," TED Global, 13 June 2013.
- [38] M. Peckham, "News Feed NASA Funded 3D Food Printer Could It End World Hunger Comments," Time Magazine, 24 May 2013.
- [39] A. Greenberg, "Meet the 'Liberator': Test-Firing The World's First Fully 3D-Printed Gun," Forbes Magazine, 4 October 2013.
- [40] H. Lipson and M. Kurman, Factory at Home: The Emerging Economy of Personal Manufacturing. Washington: U.S. Office of Science and Technology, 2010, n.p.
- [41] L. Wiegler, "Jumping Off the Page," Engineering & Technology, vol. 3, 2008, no. (1), pp. 24-26.
- [42] Reprap 3D printer kits "<https://reprappro.com/product-category/reprap-kits/>"