

Hydrostatic Vibratory Drive of the Test Stand for Excitation of the Amplitude-Modulated Vibrations

A I Nizhegorodov^{1,4}, A N Gavrilin^{2,5}, B B Moyzes^{3,6}

¹ Professor, Irkutsk national research technical university, Irkutsk, Russia

² Associate professor, Tomsk Polytechnic University, Tomsk, Russia

³ Associate professor, Tomsk Polytechnic University, Tomsk, Russia

E-mail: ⁴nastromo_irkutsk@mail.ru, ⁵tom-gawral@list.ru, ⁶mbb@tpu.ru

Abstract. The article reviews the problems arising during the development of the test stand hydrostatic vibratory drive, which synthesize controlled amplitude-modulated vibrations required testing of vibration strength and vibrostability of technological devices. The newly developed modification can adequately simulate the transport vibration and vibration of the operating power-supply units of technological machinery vibration by means of implementing of a continuous frequency spectrum of the vibration exposure in the desired frequency range.

1. Introduction

It was found that polyharmonic vibrations superposition [1, 2] is one of the effective methods for vibration strength and vibrostability testing of technological devices.

It provides the simulation of hard harmonic vibrational impacts which the most frequently occurred during operation. The method can be implemented by the set of the driving oscillator for sinusoidal signals [2] of the technological devices, synthesizing frequency-modulated and spectrally rich vibrations [3] or by controlled amplitude-modulated vibrations (AM-oscillations) [4].

The spectrum of the AM-oscillations can be represented as a wide line spectrum [4, 5], which is quite satisfactory oscillatory process that simulates the transport vibration and vibration of the operating power-supply units of technological machinery. AM-vibrations envelopes can be defined by different functions, prompting to modify their spectral composition [4–9].

The mechanism of impact on any technical devices or machinery (hydraulics and pneumatics, electronic and radio-relay devices, board computers and other mechanical and electrical devices) is due to the occurrence of resonance elements of these products and the corresponding dynamic load, leading to failure, failure of normal functioning (vibrostability) and even mechanical failure of structural components of such devices (vibration strength) [2, 10, 11].

Regardless of the dynamic structure of the vibratory system, the amplitude modulation of harmonic vibrations is made up of the deformation of the envelope amplitude (modulating function), and can be illustrated by a block diagram of an amplitude modulation channel (figure 1a) [4]. The spectrum of the AM-oscillations can be represented as a wide line spectrum [4], which is quite satisfactory oscillatory process that simulates the transport vibration and vibration of the operating power-supply units of technological machinery. AM-vibrations envelopes can be defined by different functions, prompting to modify their spectral composition [4].

The input signal (modulating function) specified in the operator form $x_0(p)$, after passing through a variable coefficient block $\sin(\omega t)$, will have the following form:



$$x(p) = 0,5[x_0(p + j\omega) + x_0(p - j\omega)], \quad (1)$$

where ω – carrier frequency of AM vibrations, $p = \frac{d}{dt}$ – differentiation operator.

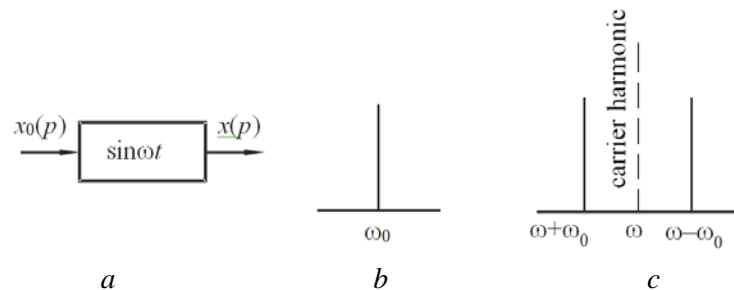

Figure 1. Block diagrams: *a* – amplitude modulation channel; *b* – input vibration spectrum; *c* – output vibration spectrum.

The output vibrations spectrum becomes evident when substituted $p=j\omega_0$:

$$x(j\omega) = 0,5[x_0(\omega_0 + \omega)j + x_0(\omega_0 - \omega j)]. \quad (2)$$

Therefore, the spectrum of the AM-oscillations is equal to half-sum of the spectra of the modulating function when shifted to the frequency rate of the variable coefficient $\sin(\omega t)$, i.e. at the carrier vibrations frequency. If the modulating function comprises only one harmonic (figure 1b) $x_0(t) = \sin\omega_0 t$, then the AM vibrations consist of two harmonics (figure 1c) – the cumulative and differential:

$$x(t) = 0.5[\sin(\omega + \omega_0)t - \sin(\omega - \omega_0)t]. \quad (3)$$

The spectrum of the modulating function when the amplitude varies with frequency ω_0 harmonically and the spectrum of the AM-oscillations contains only $\omega \pm \omega_0$ (figure 1c) frequency side. It is obvious that the carrier harmonic divides the modulating spectrum which set of harmonics varies infinitely. Therefore spectrally saturated oscillatory processes can be carried out by means of the amplitude modulation in the vibration test stands.

Consider the content of the AM frequency vibrations (figure 2).

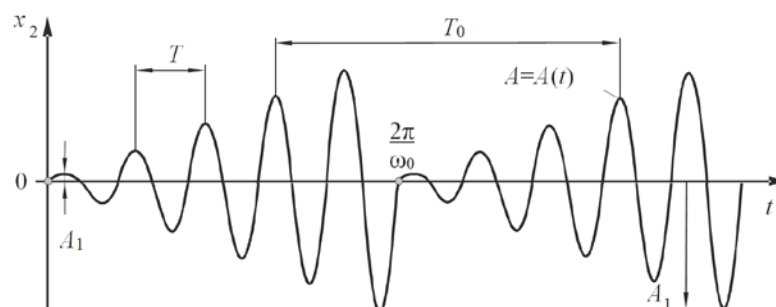

Figure 2. Amplitude modulation with a linear law of the amplitude change: T and T_0 – periods of the carrier and modulating functions, accordingly.

When changing the modulating function according to linear law:

$$x = kt \text{ at } 0 < t < \frac{2\pi}{\omega_0},$$

where k – the rate of increase of the modulating function, A – the amplitude of the first harmonic, the frequency spectrum of AM-vibrations will have the form shown in figure 3.

The spectrum shown in figure 3 is full of side harmonics, the level of harmonics vary slightly with decrease, this indicates the harmonics high energy [4].

The interval covering the spectrum in the range of from $\omega - 4\omega_0$ to $\omega + 4\omega_0$ at the carrier frequency, e.g., 50 Hz (314 rad / s) and a ratio $\omega_0/\omega=5$, is almost a decade (the ratio of the frequency of extreme harmonics differs by 10 times).

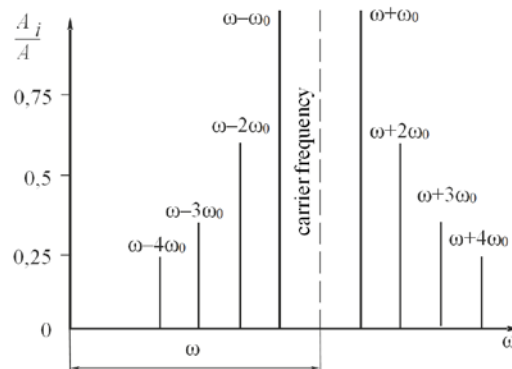

Figure 3. The range of the AM vibrations in the linear modulating function.

2. Hydrostatic vibratory drive of the test stand for excitation of the amplitude-modulated oscillations

To implement this method the hydrostatic vibratory drive of the test stand was developed. The hydraulic of the test stand (figure 4) incorporates a plunger generator I with a drive hydraulic motor 2 and the load hydraulic cylinder 3 .

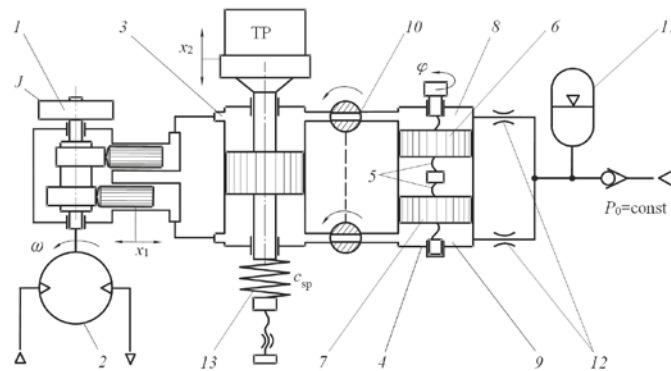

Figure 4. Hydrostatic vibratory drive of the test stand scheme.

The additional double-piston hydraulic cylinder design incorporates the follows: a crossed-axis helical gear 5 and the pistons 6 and 7 on the threaded multidirectional screw. When the screw rotates the pistons either come closer together increasing the volume of the chamber 8 and 9 , or move apart reducing the given volumes.

The load hydraulic cylinder 3 and 4 additional hydraulic cylinders are connected through the rotary valve 10 , which can be moved to one of two positions – «open» or «closed» by means of a rotary cylinder (not shown in figure 4). The hydraulic fluid leakage is made up by the boost pump (figure 4 not shown). The average initial pressure in the system $P_0=\text{const}$ is maintained by the pneumatic pressure tank 11 and throttles 12 . There is a spring 13 with the adjusting screw to compensate the weight of the test product. When the directional valve 10 is closed, the generator I creates alternating fluid flow in the hydraulic lines which are connected with the hydraulic cylinder 3 with the angular frequency ω and oscillates the vibrating table x_2 with test product (TP) with a small amplitude of a below resonance mode $A_1 \sim 0.15 \dots 0.3$ mm (figures 2 and 5).

The rigidity of the vibratory system determined mainly by «hydraulic spring» (deformable liquid volume contained in the cavities 8 and 9 of the hydraulic cylinder 4), is calculated according to the formula

$$c_1 = c_{sp} + 2F_2^2 \frac{E}{W_0}, \quad (4)$$

where c_{sp} – spring rigidity, F_2 – the effective area of the load hydraulic cylinder piston, E – modulus of fluid elasticity, W_0 – liquid volume in the hydraulic cylinder chambers and connecting hydraulic lines.

However natural (resonance) frequency of the vibrating system is determined by the expression:

$$\omega_{p1} = \sqrt{\frac{c_{sp} + \frac{2F_2^2 E}{W_0}}{m_{mp} + m_{tp}}}, \quad (5)$$

where m_{mp} – the mass of the table with moving parts of the hydraulic cylinder, m_{tp} – the mass of the test product, it is in the a -point of the frequency characteristic 1 (AFC 1, figure 5), and it is much more excitation frequency ω .

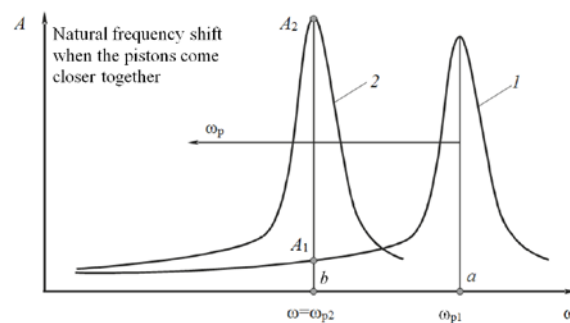

Figure 5. Changing of the frequency characteristic of the resistance system when the distributor is switching.

This below resonance mode is the initial point of the transient amplitude-modulating process corresponding to the switching of the distributor 10 in the «open» position.

At that moment, the rigidity (4) and the natural (resonance) frequency of the system (5) is instantly reduced by the adding extra liquid volume contained in the cavities 8 and 9 of the additional hydraulic cylinder 4 to the values evaluated by:

$$c_2 = c_{sp} + 2F_2^2 \frac{E}{W_{\Sigma}}, \quad (6)$$

$$\omega_{p2} = \sqrt{\frac{c_{sp} + \frac{2F_2^2 E}{W_{\Sigma}}}{m_{mp} + m_{tp}}}, \quad (7)$$

where W_{Σ} – total liquid volume in the chambers of load and additional hydraulic cylinders and connecting hydraulic lines.

Now the natural frequency of the oscillating system is shifted to the point b (AFC 2, figure 5) and becomes equal to the excitation frequency ω . The transient process begins (amplitude modulation) which is accompanied by an increase of the amplitude from A_1 to A_2 (figures 2 and 5), with the period of the modulating function, equal to T_0 .

Let's consider the block-diagram of the oscillating system (figure 6).

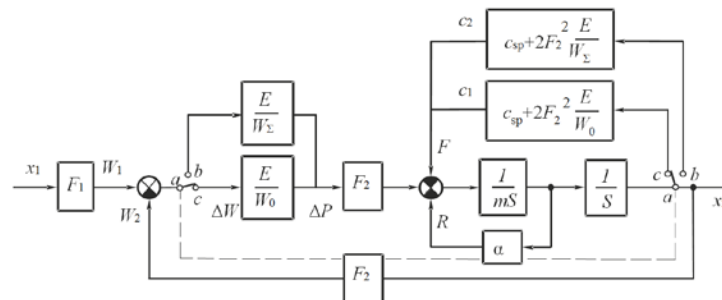

Figure 6. The block-diagram of the oscillating system.

There is linear system in each of the modes (below resonance and resonance), if we neglect the change of the modulus of elasticity and liquid volume ΔW . The Non-linear element is a valve 10 (figure 4) and it's imitator marked as abc (figure 6).

The switches connection $a-c$ corresponds to below resonance mode, when the fluid volume determines the system rigidity c_1 equals W_0 . Other switches position $a-b$ corresponds to the resonant mode when the amount of liquid which determines the system rigidity is equal to $c_2 W_\Sigma$.

The important factor is the duration of the transient process t_{pt} . The transient process time which equals to the period T_0 will depend on the quality factor of the system.

Unlike the technological vibration machinery, for test stands, the quality factor estimated by dynamic factor k_d [12, 13] is very high – $k_d = 10\dots 12$ as the resistance to vibrations (the dissipative force R , figure 6 reduced to the rod of the load hydraulic cylinder) have only friction in the liquid in the movable joints of the load hydraulic cylinder and air friction.

Control for the transient process duration and the period of the modulating function can be carried out only by controlling the valve switching duration from closed position to open. The liquid throttling in the valve at the initial stage of its opening will lead to the increase of transient process time t_{pt} .

The amplitude modulation mode creates a line spectrum with a very high level of energy of the fundamental (carrier) and side harmonics but the resonant frequencies of the test product elements may occur in the range between neighboring harmonics. To implement the most effective test conditions, it is necessary to set the shutting motion (fluctuation) to the carrier frequency ω , simultaneously changing the resonant frequency of the oscillating system (7), while maintaining the equality $\omega = \omega_p$ by drawing the pistons 6 and 7 of the auxiliary cylinder 4 (figure 4) together and apart when changing a parameter at a specific algorithm. So it is possible to implement a wide continuous spectrum of a decade or more, scanning the test product in the required test mode frequency range. This process can be regarded as the identical to amplitude frequency modulation of oscillations [14].

Figure 7 shows the spectrum of an AM-oscillations with fluctuating carrier frequency for the case corresponding to the linear spectrum shown in figure 3 in the coordinates $S(\omega) - \omega$, where $S(\omega)$ – the process spectrum density. It also consists of a carrier and multiple side harmonics symmetrically arranged relative to the carrier frequency ω . The usual AM oscillation spectrum structure persists but now it is continuous.

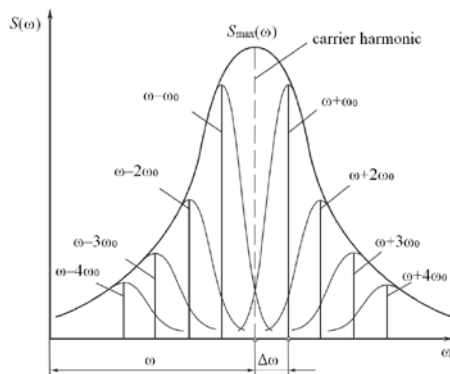

Figure 7. The spectrum of the AM-oscillations with the swinging (fluctuating) carrier frequency.

3. Conclusion

Further development of the concept of hydrostatic drive for the vibrational test stands requires creation of the dynamic excitation systems of random narrow-band vibration with the high level of harmonics spectrum density. This type of testing machines are capable to synthesize the random oscillations, simulating as much as possible the transport vibration and the vibration of the operating power technological machinery at high lifting capacity due to the energy and control possibilities of the volume hydraulic drive.

4. Acknowledgment

The research work was supported by Grant for Research of BP exploration operating company limited) and performed by research team of Department of Automation and Robotics in Mechanical Engineering of National Research Tomsk Polytechnic University and Department of Road Construction Machinery and Hydraulic Systems of Irkutsk National Research Technical University.

References

- [1] Kljuev V V 2010 *Devices and systems for measuring vibration, noise and shock* (Moscow, Mashinostroeniye)
- [2] Kljuev V V 1982 *Test engineering* (Moscow, Mashinostroeniye)
- [3] Nizhegorodov A I (2014) Hydraulic drive testing stand with commutating device *Stroitel'nye i dorozhnye mashyny* **4** 31–34
- [4] Shatalov A S 1977 *Automatic Control Theory* (Moscow, Vysshaya shkola)
- [5] Goinaraghi F, Kuo B C 2010 *Automatic Control Systems* (Wiley Online Library)
- [6] Groves R L, Piphio G A 1983 *Test stand for testing hydraulic devices* United States Patent 4368638
- [7] Nizhegorodov A I, Gavrilin A N, Moyzes B B Hydraulic Power of Vibration Test Stand with Vibration Generator Based on Switching Device *Key Engineering Materials* Article in Press
- [8] Gavrilin A N, Moyzes B B, Zharkevich O M Design and technological methods to reduce vibration activity of elements in technological systems *Journal of Vibroengineering* Article in Press
- [9] Gavrilin A N, Chuprin A E, Moyzes B B, Halabuzar E A (2014) Land-based sources of seismic signals *Proceedings of 2014 International Conference on Mechanical Engineering, Automation and Control Systems, MEACS 2014* Article number 6986947
- [10] Tjablikov Ju E, Karamyshkin V V 1979 *Features of interaction of the vibrating system of a given structure with an energy source: in Elastic and hydroelastic vibrations of machines and structures* (Moscow, Nauka)
- [11] Grudin V G (2011) Study of the effect of additional bonds in mechanical oscillating systems *Vestnik of Irkutsk National Research Technical University* **2** 34–40
- [12] Shkalikov V S 1980 *Vibration and shock measurement* (Moscow, Standards publishing)
- [13] Halit E 2000 *Acceleration, Vibration, and Shock Measurement* (Abingdon, Taylor & Francis Group, CRC Press LLC)
- [14] Solodovnikov V V 1967 *Technique cybernetics. Automatic control theory* (Moscow, Mashinostroeniye)