

# Reducing Current Spread by Use of a Novel Pulse Shape for Electrical Stimulation of the Auditory Nerve

Trends in Hearing  
2015, Vol. 19: 1–12  
© The Author(s) 2015  
Reprints and permissions:  
[sagepub.co.uk/journalsPermissions.nav](http://sagepub.co.uk/journalsPermissions.nav)  
DOI: 10.1177/2331216515619763  
[tia.sagepub.com](http://tia.sagepub.com)



Jimena Ballester<sup>1,\*</sup>, Matthieu Recugnat<sup>1,\*</sup>, Jonathan Laudanski<sup>2</sup>,  
Katie E. Smith<sup>1</sup>, Daniel J. Jagger<sup>1</sup>, Daniel Gnansia<sup>2</sup>, and  
David McAlpine<sup>1</sup>

## Abstract

Improving the electrode-neuron interface to reduce current spread between individual electrodes has been identified as one of the main objectives in the search for future improvements in cochlear-implant performance. Here, we address this problem by presenting a novel stimulation strategy that takes account of the biophysical properties of the auditory neurons (spiral ganglion neurons, SGNs) stimulated in electrical hearing. This new strategy employs a ramped pulse shape, where the maximum amplitude is achieved through a linear slope in the injected current. We present the theoretical framework that supports this new strategy and that suggests it will improve the modulation of SGNs' activity by exploiting their sensitivity to the rising slope of current pulses. The theoretical consequence of this sensitivity to the slope is a reduction in the spread of excitation within the cochlea and, consequently, an increase in the neural dynamic range. To explore the impact of the novel stimulation method on neural activity, we performed *in vitro* recordings of SGNs in culture. We show that the stimulus efficacy required to evoke action potentials in SGNs falls as the stimulus slope decreases. This work lays the foundation for a novel, and more biomimetic, stimulation strategy with considerable potential for implementation in cochlear-implant technology.

## Keywords

cochlear implant, spiral ganglion neurons, potassium channels, electric stimulation, auditory nerve

## Introduction

Cochlear implants (CIs) remain the most successful sensory implantable device, judged by their ability to restore or provide hearing function and normal patterns of speech in the profoundly deaf. Nevertheless, significant improvements in implant technology are required if implant users are to perform in even moderately challenging listening environments, where individual talkers, for example, must be heard out against a background of competing talkers, reflections, and other sources of sound. Compared with normal-hearing listeners, CI users are considerably disadvantaged in such circumstances, usually requiring attended speech signals to be louder than the interfering sources or background noise. At least some of the limitations in CI performance come about because of the design of the devices themselves. CIs work by electrically stimulating the primary auditory neurons (spiral ganglion neurons, SGNs) through an

electrode array inserted into scala vestibuli of the cochlea. Employed in pathological situations where the sensory hair cells are damaged, or absent altogether, CIs bypass the mechano-electrical and electrochemical transduction processes normally undertaken by the hair cells and evoke action potentials (APs) in the SGNs through direct electrical stimulation. A major factor limiting improved performance in CIs is the uncontrolled spread of electrical current within the cochlea (Middlebrooks, 2004). Current spread is an intrinsic consequence of implant design; the size of the electrodes,

<sup>1</sup>Ear Institute, University College London, London, UK

<sup>2</sup>Oticon Medical, Vallauris, France

\*These authors contributed equally to this work.

## Corresponding author:

David McAlpine, Macquarie University, Australian Hearing Hub, 16 University Avenue, Sydney, New South Wales 2109, Australia.  
Email: [david.mcalpine@mq.edu.au](mailto:david.mcalpine@mq.edu.au)



their distance from SGNs, and the fact that they are immersed in a highly conductive fluid environment lead to a wide population of SGNs being activated by each electrode. The wide field of electrical activation combined with the short distance between electrodes results in overlapping populations of neurons being activated by neighboring electrodes (Cohen, Saunders, Knight, & Cowan, 2006; Hughes & Stille, 2008; O'Leary, Black, & Clark, 1985; Shannon, 1983b). This severely limits the number of independent channels of acoustic information that can be represented. This is in contrast to acoustic hearing, where each SGN receives information from a single hair cell, and the sharp tuning of the basilar membrane results in a relatively small population of hair cells responding to each frequency, controlling the spread of activity (Robles & Ruggero, 2001). Thus, although insertion of the electrode array along the length of the cochlea, from base to apex, theoretically takes into account the cochlea's tonotopic organization, in practice, controlling the spread of excitation in situ remains problematic and renders the frequency resolution of CI listeners extremely poor.

Numerous strategies have been developed to try to limit the area of the stimulated field, and thus limit the number of stimulated SGNs (Bierer & Faulkner, 2010). These include employing so-called bipolar, tripolar, and pseudotripolar patterns of stimulation, which aim to focus the electric field through current *steering* and current focusing (Firszt, Koch, Downing, & Litvak, 2007). These, and similar, strategies are now slowly being integrated into clinical devices as alternatives to the more common square-pulse biphasic, monopolar stimulation (Litvak, Spahr, & Emadi, 2007; Macherey, Deeks, & Carlyon, 2011), although there are limitations to this, as not all manufacturers' devices allow for multipolar stimulation. In addition, the proposed methods for steering electrical current toward specific neural populations involve multiple current sources and usually consume more power compared with monopolar stimulation. Indeed, for a fixed temporal stimulation pulse, a tripolar stimulation strategy can consume at least twice as much power as monopolar stimulation and can often reach the device power limits (Litvak et al., 2007). Although the efficacy of current-steering techniques in reducing the spread of neural excitation has been demonstrated in animal models (Snyder, Bierer, & Middlebrooks, 2004) and some human subjects (Landsberger, Padilla, & Srinivasan, 2012), these techniques are also highly power-consumptive, and, to date, demonstrate relatively small performance gains (Bonham & Litvak, 2008; Marozeau, McDermott, Swanson, & McKay, 2015). An alternative strategy is the use of multiphasic pulses. Typically, electrical stimulation in CI consists of biphasic pulses, with each phase typically of equal amplitude and duration to provide for equalized membrane

depolarization properties. By employing triphasic pulses, the amplitude ratio between excitatory and discharge phases can be changed to control their depolarization properties, thus enabling the membrane to be brought more quickly to its resting potential. This reduction of a neuron's membrane depolarization theoretically should reduce channel interactions. Nevertheless, triphasic pulses are still limited in their use and appear to be less efficient than biphasic pulses in activating auditory neurons (Bahmer & Baumann, 2012).

Besides its remarkable frequency selectivity, physiological activation of SGNs allows for fine coding of sound intensity. In acoustic hearing, an increase in the intensity of a sound wave is coded as a change (increase) in the firing rate of individual nerve fibers synapsing at the base of the hair cell. In addition, individual fibers show different activation thresholds such that the number of fibers recruited increases with sound intensity (Liberman & Kiang, 1978). Conversely, when SGNs are stimulated through CI electrodes, their responses largely take the form of an all-or-nothing response, reducing the coding capacity at the level of individual, and populations of, neurons. Combined with the wide spread of activation in electrical hearing, this limits the dynamic ranges of individual CI listeners (often less than 10 dB), compared with the 120-dB dynamic range observed in normal-hearing listeners (Shannon, 1983a; Zeng, 2004).

Signal-processing techniques have driven the most effective improvements in CI performances (Macherey & Carlyon, 2014; Rubinstein & Miller, 1999). However, improving CI performance from a more biological perspective at the level of the cochlea could achieve similar increases in performance and possibly outperform the advances already achieved through signal-processing techniques if electrical stimulation strategies were more suited to the biological properties of auditory neurons. Here, we address this engineering-to-biology mismatch with an innovative stimulation strategy using novel pulse shapes based both on biophysical principles of SGNs and on the interaction of the electrical stimulus with the cochlear environment. The main novelty in the proposed stimulus shape is the addition of a rising slope to the electrical pulses. The theoretical benefit of this strategy is to limit the deleterious effects of the spread of excitation within the implanted cochlea. For many neurons in the auditory brain, generation of APs is controlled by the rate of change, as well as the amplitude, of synaptic input currents. This behavior is dependent, in part, on the expression of low-threshold potassium channels activated during slow depolarization (Golding & Oertel, 2012). Because SGNs express these type of channels (Mo, Adamson, & Davis, 2002; Smith, Browne, Selwood, McAlpine, & Jagger, 2015), their firing patterns are likely to depend on the rate at which they are depolarized. We hypothesize that this sensitivity

to the slope of the input current can be exploited by use of our novel ramped stimulus to reduce the excitation spread. Here, we first present the theoretical framework behind this novel approach, and then demonstrate, from the responses of SGNs recorded in vitro, that altering the slope of current pulses that could be employed in CI stimulation alters firing probability in a manner consistent with the theoretical predictions.

## Methods

### SGN Cultures

Cell cultures were prepared from P12-15 C57BL/6 mouse cochleae as described in Smith et al. (2015). The animals were sacrificed in accordance with the United Kingdom Animals (Scientific Procedures) Act of 1986. Mice were decapitated and both inner ears removed from the base of the cranium. Cochleae were extracted from the outer bony labyrinth, the bone and *stria vascularis* were removed, and the modiolus isolated and divided into three sections (apical, medial, and basal). Each section was digested in 0.25% trypsin at 37°C for 30 min. Growth medium (Dulbecco's modified Eagle medium containing 10% fetal calf serum, 10 mM 4-(2-hydroxyethyl)-1-piperazineethanesulfonic acid (HEPES), and 1% penicillin/streptomycin) was added, and the tissue was gently triturated. Cells were pelleted, resuspended in growth medium, and plated onto poly-L-lysine-coated glass coverslips. Plated cultures were incubated at 37°C, 5% CO<sub>2</sub> in growth medium containing 10 ng/ml brain-derived neurotrophic factor. All reagents were obtained from Sigma Aldrich (St Louis, Missouri, USA).

### Electrophysiology

The whole-cell configuration of the patch-clamp technique was employed to obtain intracellular recordings from SGNs. Current-clamp responses of SGNs were recorded using a Multiclamp 700B amplifier in bridge balance mode, low-pass filtered at 10 kHz, digitized at 10 to 50 kHz with a Digidata 1440A board, and acquired using pClamp 10 (Molecular Devices, Sunnyvale, California, USA). Glass recording pipettes of 1.5-mm external diameter (World Precision Instruments, Sarasota, Florida, USA) were pulled using a two-stage pipette puller (Narishige group, Tokyo, Japan, PC-10 puller), generating electrode resistances in the range 3 to 4 MΩ. Micropipettes were filled with a K-gluconate solution containing the following (in mM): 130 Kglu, 5 KCl, 1 ethylene glycol tetraacetic acid (EGTA), 2 MgATP, 2 Na<sub>2</sub>ATP, 0.3 Na<sub>3</sub>GTP, 10 (4-(2-hydroxyethyl)-1-piperazineethanesulfonic acid) (HEPES), and 10 Na<sub>2</sub>Phosphocreatine. During the recordings, the cells were superfused with artificial perilymph composed of

the following (in mM): 145 NaCl, 4 KCl, 1 MgCl<sub>2</sub>, 1.3 CaCl<sub>2</sub>, 10 HEPES, and 5 glucose, pH 7.3. The pipette position was controlled using a Luigs and Neumann SM-5 micromanipulator. After establishing the whole-cell configuration, resting membrane potential was noted for each SGN, and the firing properties of neurons were evaluated by applying a series of depolarizing current steps. The liquid junction potential was not accounted for. For the pulse stimulation protocol, membrane voltages of neurons were set to -60 mV.

SGNs from cochlear cultures were recorded following 2 to 3 days in vitro. Neurons in culture were identified by the presence of APs generated in response to depolarizing current steps. Two types of neurons are present in the cochlea: Type I SGNs, which convey auditory information from the inner hair cells (IHCs) to the brain, and Type II SGNs that arise from outer hair cells (OHCs) and participate in the control of cochlear gain (Froud et al., 2015). To corroborate the identity of recorded neurons, we applied a series of 200-ms depolarizing and hyperpolarizing current steps to characterize firing properties and the activation of voltage-dependent currents. We recorded from 37 SGNs (26 basal, 9 medial, and 2 midapical). Thirty of these responded with only one or a few APs to a current step (i.e., they were *fast adapting*; Figure 1(a)). In addition, these SGNs showed a fast sag in the response to hyperpolarizing steps. These features are characteristic of Type I neurons (Rusznak & Szucs, 2009). The remaining seven neurons fired multiple APs in response to depolarizing steps, characterized by an increased delay in the first AP, a slow depolarizing response, and a slower sag in the response to negative steps compared with Type I neurons (Figure 1(b)), response properties that may be linked to Type II neurons in vitro (Reid, Flores-Otero, & Davis, 2004). Therefore, these seven neurons were excluded from further analyses.

## Results

### Theoretical Considerations for Employing Ramped Pulses in CIs

The most common coding strategies in CIs employ square biphasic, or pseudobiphasic, pulse shapes modulated in terms of their amplitude or duration with the anodic phase presented first for excitation (Carlyon, Deeks, & Macherey, 2013). Phase polarity has been shown to be a major factor in the efficacy of electrical stimulation (Bahmer & Baumann, 2013; Macherey, van Wieringen, Carlyon, Deeks, & Wouters, 2006). Here, we consider the biphasic anodic-leading phase as the reference gold standard for electrical stimulation in human subjects. In the majority of cases, stimulation is monopolar, that is, referenced to an extracochlear return electrode (Macherey & Carlyon, 2014; Macherey et al.,

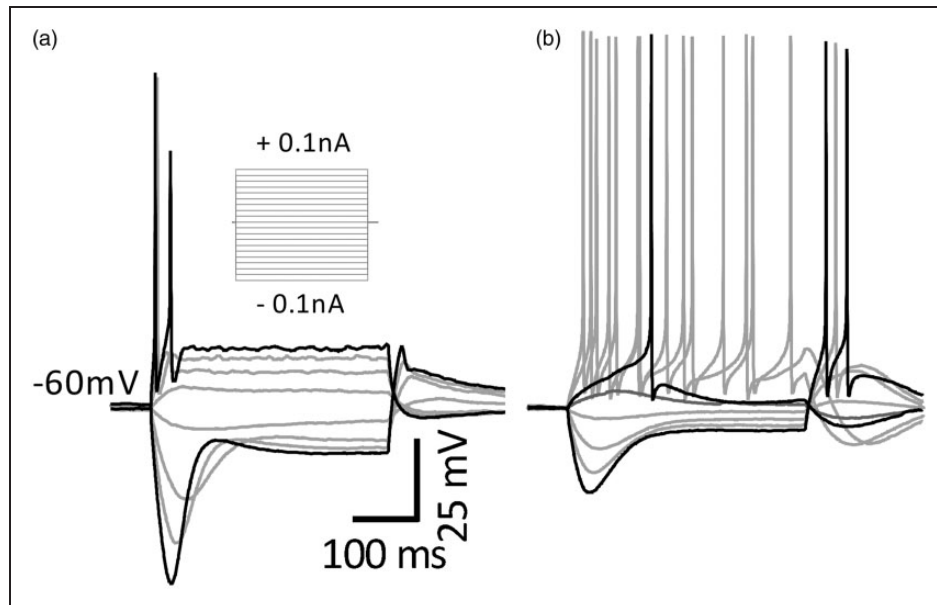

**Figure 1.** Biophysical properties of cultured SGNs. (a) Representative response of a neuron classified as Type I to a series of depolarizing and hyperpolarizing steps (inset shows the stimulus waveform). The dark traces depict the responses to  $+0.1$  and  $-0.1$  nA. (b) Same for a neuron classified as Type II. In this case, the dark traces correspond to responses to  $+0.02$  and  $-0.1$  nA. In darker gray, the response to  $0.01$  nA is shown to highlight the slow depolarizing response. SGNs = spiral ganglion neurons.

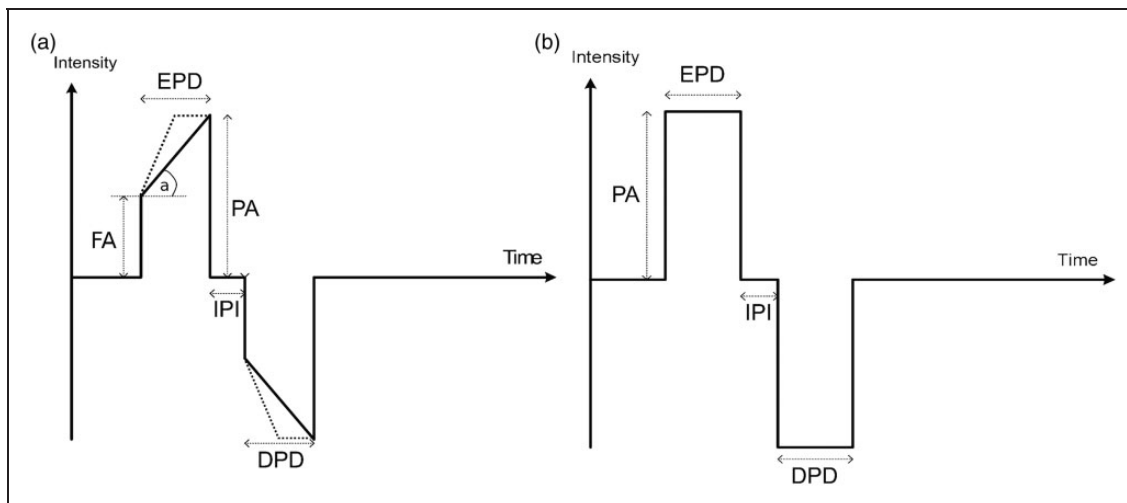

**Figure 2.** Parametrized temporal representation of (a) a current ramp pulse shape and (b) a current square pulse shape. The parameters used to define the pulse shapes are foot amplitude (FA), peak amplitude (PA), the slope rate (a), the excitatory phase duration (EPD), the discharge phase duration (DPD), and the interphase interval (IPI). Current ramp pulses include pure ramps and truncated ramps. All the parameters insure that the pulse will be described in the most accurate fashion.

2006). This results in a predefined range of possible stimulation intensities, the precision of which is mainly limited by the technology. Square pulses (Figure 2(b)) are the most commonly employed pulse shapes in current CI technologies and, to date, the development of

new stimulation strategies relies on the efficacy of electrical stimulation using square pulse shapes. Here, we lay the foundations for a new stimulation strategy based on the use of ramped pulse shapes (Figure 2(a)). The rationale behind this new stimulus shape relies on



two important features of auditory neurons and the cochlea itself.

The first feature involves the biophysical properties of the SGNs and is predicated on the generation of APs in SGNs being dependent on the slope of the electrical stimulation. Sensitivity to the rate at which the input changes (the slope) is a general phenomenon of many neurons and is related to the dynamics of the ion channels underlying a neuron's spiking behavior. Initiation of APs relies on the activation of sodium channels, whilst their termination depends on negative feedback mechanisms, including inactivation of sodium channels and activation of potassium conductances. Typically, sodium activation is faster than activation for potassium, and spiking occurs. However, if, for some reason, the dynamics of the negative feedback compete with sodium activation (e.g., during slow rising of the membrane potential), spiking is prevented. This behavior has been observed in different neuronal types, including cortical neurons (Azouz & Gray, 2000), octopus and bushy cells in the cochlear nucleus (Ferragamo & Oertel, 2002; McGinley & Oertel, 2006), and principal neurons of the medial superior olive (Golding & Oertel, 2012). Moreover, recordings from the dendrites of SGNs have shown the same type of behavior (Rutherford, Chapochnikov, & Moser, 2012). In neurons of the cochlear nucleus, it was found that the negative feedback mechanism relies on the activation of low-threshold activated potassium channels sensitive to dendrotoxin (i.e., containing Kv1.1/2/6 subunits). Kv1.1 and Kv1.2 subunits are strongly expressed in SGNs, where they are determinant in regulating firing patterns (Smith et al., 2015). This supports the notion that SGNs should also be sensitive to the input slope and that this feature can be exploited during electrical activation by shaping the stimulus waveform.

The second feature relates to the principle that stimulation in aqueous media results in diffusion of the electrical current (Figure 3(c); Rattay, Leao, & Felix, 2001). For the case of a square stimulus, the peak value attenuates with increasing distance, but the square shape (and, hence, infinite slope) is maintained (Figure 3(a)). However, if the stimulation is performed using a ramped pulse, both the slope and the peak value are attenuated with increasing distance from the point of stimulation (Figure 3(b)).

The theoretical outcome of the combination of these two elements (i.e., the reduction of the stimulus slope over space and a concomitant reduction in neural response as the slope becomes shallower) will be a reduction in the spread of neural excitation without the requirement for the spatial spread of the current to be reduced. The main principle of the theory we report is evident by comparing the illustrations in Figure 3. For two current pulses with equal peak value, one square

(Figure 3(a)) and the other with a ramp of defined slope (Figure 3(b)), the SGN at the focus of the stimulation will show a higher firing threshold for the ramped pulse. However, moving further from the stimulation point, the combination of the reduction in amplitude and in slope will result in a more rapid reduction in firing probability for the ramped stimulus compared with the square one, therefore effectively reducing the spread of excitation. Figure 3(d) illustrates the theoretical reduction of the spread of excitation between a square, and a ramped, pulse shape.

In the following, we characterize the features of this pulse shape in a manner that makes it easy to parameterize, and we lay out the theoretical principles and potential benefits of this new coding strategy for electrical hearing. Briefly, the presumed benefits will be realized in terms of reduced spread of excitation, an increase in perceptual dynamic range, reduced perceptual thresholds, and benefits associated with these improvements.

### *Characterization of Ramped Pulses*

Even though the biphasic aspect of the pulses is not under investigation here, the features of these symmetric pulses should be considered when defining or discussing any novel, pulse-based stimulation strategy. The stimulation strategy proposed here does not assess the effect of the second phase of the pulse but focuses entirely on the anodic, excitatory first phase. This theory assumes that the symmetric characteristics of the pulses, as shown in Figure 2, will behave similarly to those of the square pulses assessed in earlier studies (Macherey et al., 2006).

For purposes of standardization, the slopes of the ramped pulses need to be parameterized. In current devices, sound-coding strategies modulate pulse amplitude or pulse duration to recruit the neural population according to the intensity of the acoustic input signal (Macherey & Carlyon, 2014; Rubinstein & Miller, 1999). Here, we introduce a new parameter—the ramp—which we suggest provides for a more biomimetic stimulation. Ramped current pulses can be defined according to their slope, specifically the rate at which the current increases. Considering the dynamics of ion channels in SGNs, the rate of change of current will result in increased or decreased excitation of the neural population proportional to the slope. This introduces a new dimension to coding strategies currently instantiated in CIs and represents the novel foundation of the ramped pulse coding strategy.

The new ramp pulse shape is composed of various defining parameters (see Figure 2(a)). In terms of amplitude, the pulse can be defined by two parameters: The foot amplitude (FA) is the amplitude at the start of the slope, and the peak amplitude (PA) is the maximum amplitude at the end of the slope. One set of amplitude

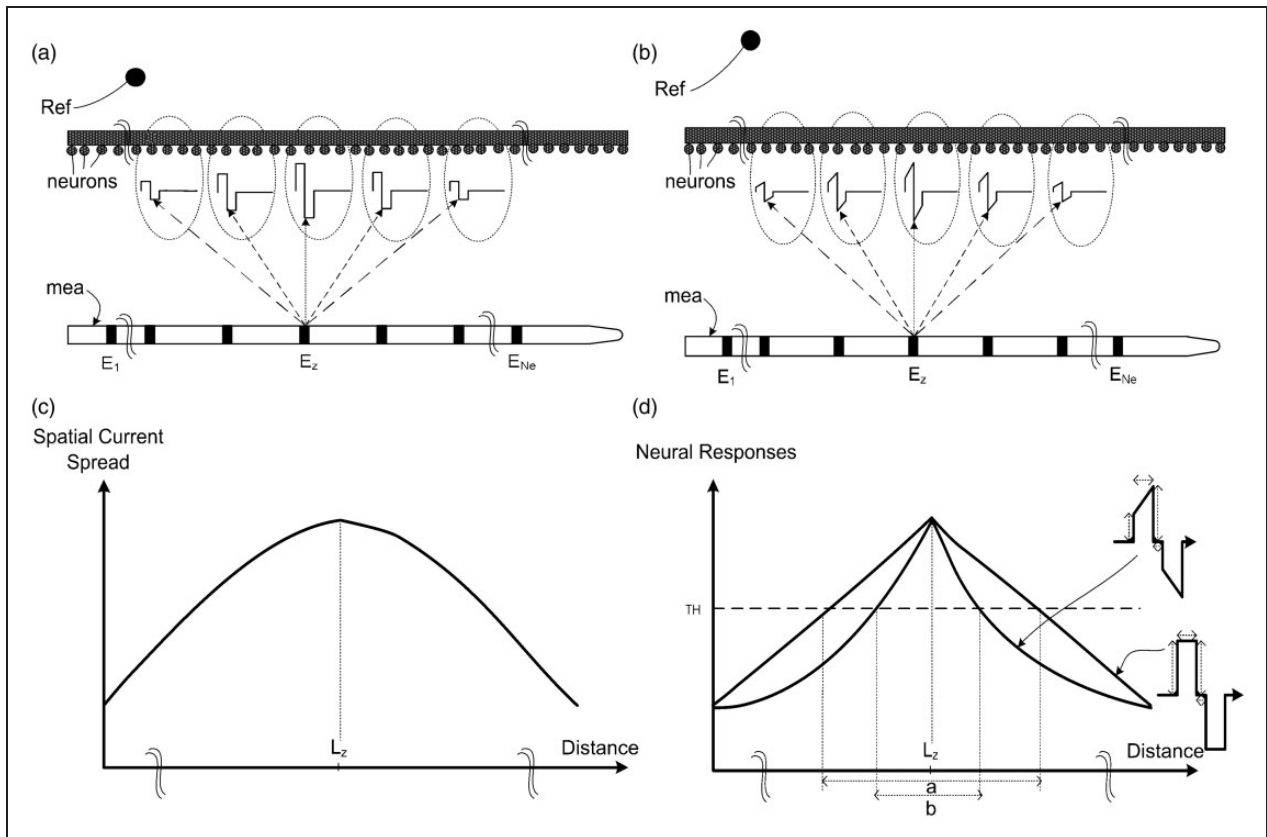

**Figure 3.** Reduction in spread of excitation. (a) Schematic representation of diffusion of a square pulse stimulated at electrode  $E_z$  of a multiple electrode array (mea) and perception by neuron populations. Ref is the reference electrode a. (b) Schematic representation of diffusion of a current ramp pulse stimulated at electrode  $E_z$  of mea and perception by neuron populations. (c) Theoretical spatial spread of current in the cochlea. (d) Theoretical representation of decrease in spread of excitation. The current ramp temporal waveform will induce less over threshold (TH) neural responses away from the stimulating point  $L_z$  compared with a square pulse. This will cause the spread of excitation to reduce from theoretical length width  $a$  to theoretical width  $b$ .

parameters will have to be defined for the excitatory phase and another set for the discharge phase (if the latter is different from the excitatory parameters). Similarly, the slope parameter  $a$  can be defined in two sets, one for the excitatory phase and one for the discharge phase. In addition to these, the ramp pulse should also be defined in duration of phase. Again, there will be excitatory phase duration and a discharge phase duration. Finally, the interphase time duration will have to be defined.

### Theoretical Benefits of Ramped Pulses

Theoretically, the use of ramped pulses will enable better control of the stimulation of specific neuron populations. Benefits of the ramped pulse include greater control over thresholds and dynamic ranges both locally to, and with increasing distance from, the stimulating electrode. The reduction in the spread of excitation should lead to a reduction in electrode-channel interactions providing reduced recovery times, with

a concomitant reduction in firing latency in populations of neurons closer to neighboring electrodes. This has the potential to enable electrical stimulation to transmit more information in either simultaneous or asynchronous stimulation modes. Reduction of channel interaction represents, in itself, a major benefit to electrical hearing. In addition, ramped pulse shapes can potentially (re)introduce some elements of stochasticity to neural firing across the population of SGNs. Variability in the expression of ion channels can potentially lead to different sensitivity to ramp pulses across different neuronal types (McGinley & Oertel, 2006). This could lead to a more graded recruitment of SGNs as signal level is increased, improving the dynamic range of sound intensity coding. In this manner, the use of ramped stimulation would more closely resemble the combination of fine frequency coding and wide dynamic range accomplished by the auditory system. Finally, a recent study by Lotfi Navaii, Sadjedi, and Jalali (2013) employed a model demonstrating quantitatively that triangular pulses are more power

efficient than square pulses. This means that, from an engineering perspective, even if similar in terms of overall energy, transmitting instantaneous power with triangular, compared with square, pulse shapes is efficient.

### Modulation of SGN's Firing by Ramped Electrical Pulses

As a first stage in evaluating the feasibility of ramped electrical pulses generating benefits for users of CIs, we assessed whether ramped pulses are more efficient than square pulses for modulating the firing patterns of SGNs. To this end, we recorded responses of Type I SGNs using patch clamp in whole-cell configuration in cochlear cultures from P12–15 mice (see Methods section for details).

We first assessed the sensitivity of each SGN to square pulses by applying a series of stimuli of increasing amplitude. Sensitivity to the different pulse shapes was measured by injecting current pulses of different amplitude through the recording electrode. Ten repeats of each current amplitude were presented (one every 3 s), and the firing probability was defined as the proportion of trials in which an AP was evoked. Representative traces of responses of SGNs to square pulses are shown in Figure 4(a) and (b). Note, from Figure 4(a), the delay for the membrane current (*I<sub>m</sub>*, green) to reach the maximum amplitude compared with the stimulus (red). This is due to the current required to charge the neuron's membrane at the beginning of the stimulus, and its time course is proportional to the neuron's capacitance and the number of activated ion channels (i.e., the membrane conductance). Figure 4(c) plots the firing probability as a function of pulse amplitude (i.e., the rate function) for the population of SGNs, with that of the SGN for which responses are shown in (a) and (b) highlighted in black. In general, SGNs showed relatively steep response functions, rising from zero probability of firing to maximum probability (i.e., one AP per stimulus) within 1.0 to 1.5 nA of threshold. Nevertheless, neurons showed a relatively wide range of sensitivities to current injection with square pulses.

We next assessed the response of the same population of SGNs to the ramped current pulses previously described (see also inset to Figure 5). A key outcome of this study is to characterize the effect of the different stimulus parameters on SGN firing to better predict the effect of this new stimulation paradigm in the context of electrical hearing. As outlined, the stimulus will be characterized by three parameters, the PA, the FA, and the slope *a*, all of which are differentially affected by current diffusion in the cochlear fluids. Thus, we focused on how changing these three parameters might influence the efficacy with which current pulses evoke APs in SGNs. Figure 5 plots responses of an SGN to injected current

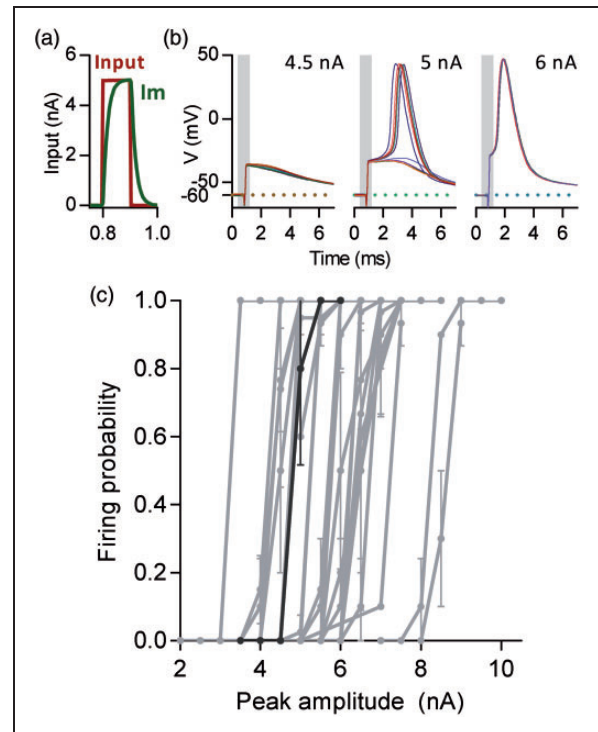

**Figure 4.** SGN population rate functions. Square pulses of variable amplitude were applied to SGNs. In the top panels, representative traces of the SGN responses are shown. (a) Stimulus input current (red) and current cell response (*I<sub>m</sub>*, green). (b) Voltage response of the same cell. In each panel, the stimulus amplitude is indicated. Action potentials are evoked in response to the 5 and 6 nA stimulus. The gray bar indicates the duration of the stimulus. (c) Rate functions for all the SGNs recorded. The black trace highlights the neuron corresponding to the responses shown in (a) and (b). SGN = spiral ganglion neuron.

conveyed by different pulse shapes that vary in the rising slope (a), for different PAs of the injected current and with a constant 50% FA. Note how decreasing the slope of the stimulus increases the PA necessary to evoke APs reliably.

To better characterize the effect of each parameter in SGN firing modulation, we constructed for each SGN, functions describing the firing rate versus input current varying only the slope (at constant FA) or the FA (at constant slope). Figure 6(a) illustrates how the rate functions change for an SGN that was stimulated using square pulses (gray trace), or ramped pulses with slopes of 100 nA/ms (blue) or 50 nA/ms (red; see schema above each panel for details of the stimulus shape). Note that, as the slope of the stimulus decreases, the rate functions curves are shifted to higher amplitudes, that is, current amplitude required to evoke firing increases. To quantify this shift in the response of the population of recorded SGNs, we calculated, for each function, the current amplitude yielding a .5 probability of firing (*AP*<sub>50</sub>), as an indication of

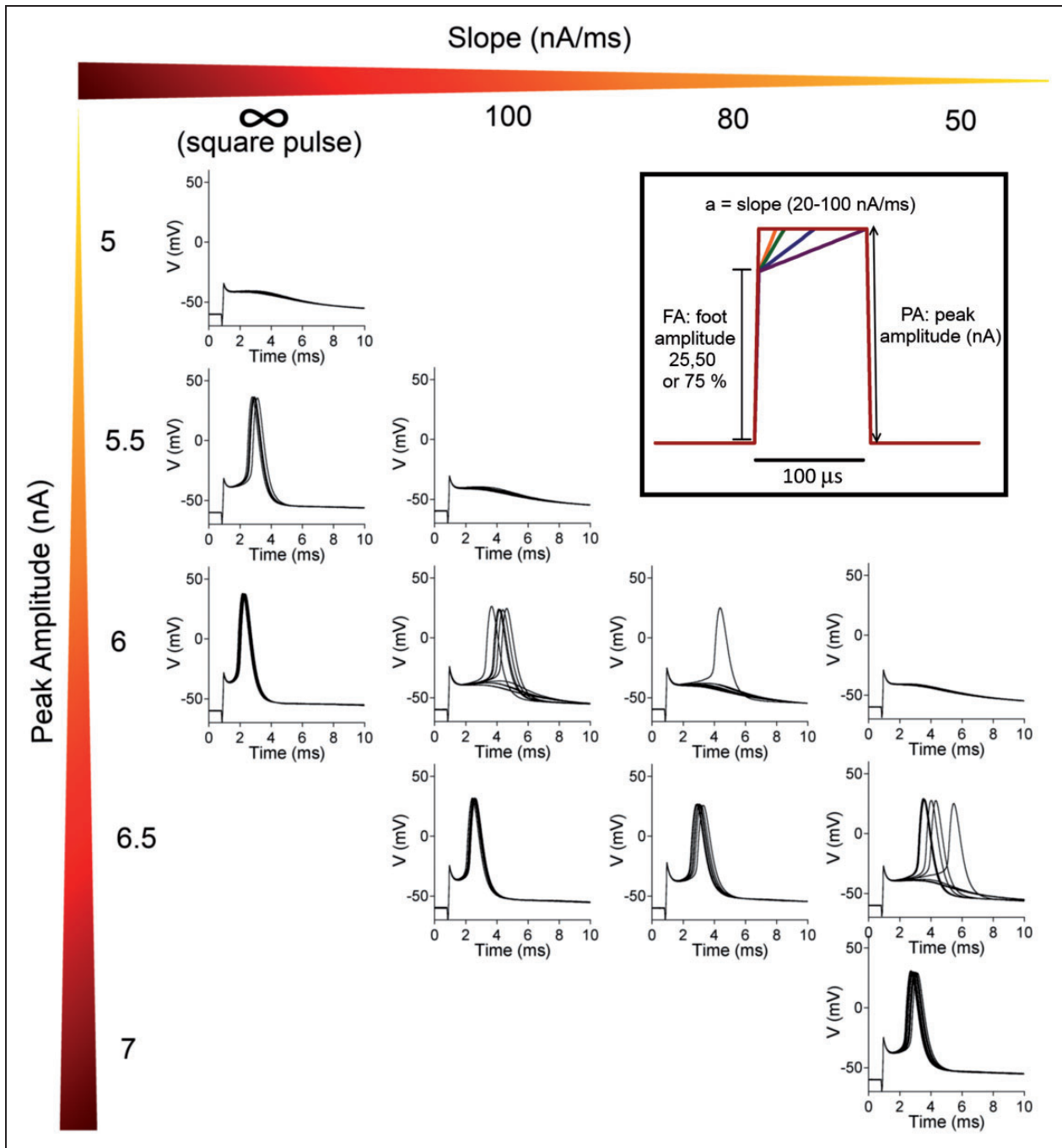
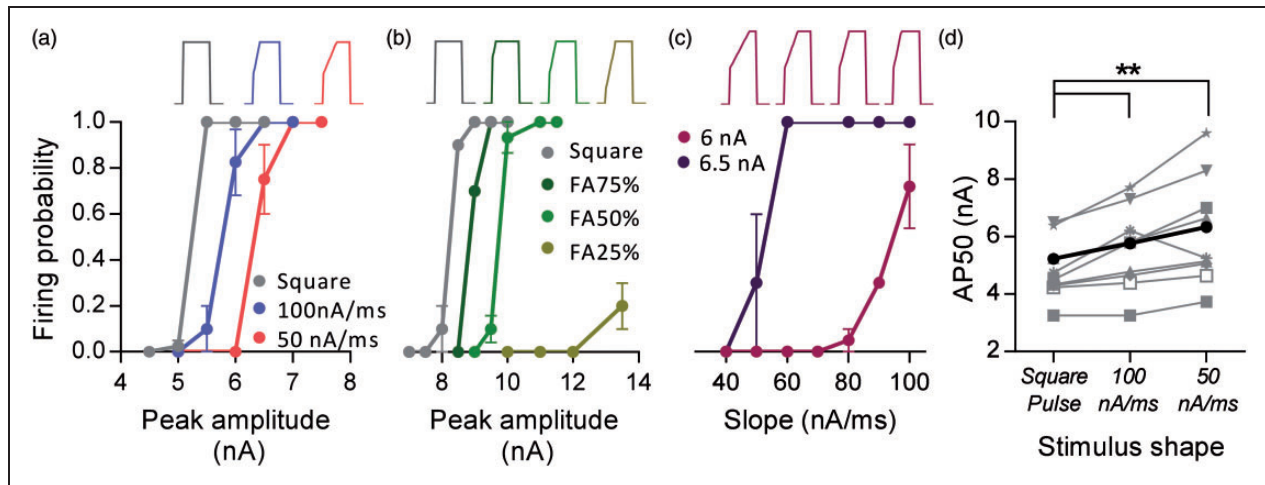

**Figure 5.** Representative traces showing the change in SGN firing as the stimulus peak amplitude and slope are changed. The inset shows the stimulus shape and the parameters that were varied. Foot amplitude is expressed as a percentage of the peak amplitude. In all the recordings shown, the FA was 50%. SGN = spiral ganglion neuron.

the neuron's threshold. Figure 6(d) plots AP50s for each of the neurons assessed with pulses comprising slopes of 50 and 100 nA/ms (Figure 6(d)). Note that, for the population of SGNs recorded ( $n=10$ ), the minimum AP50s observed were generated by rate curves obtained in response to square pulses. The addition of either a 50 or

100 nA/ms slope in the stimulus significantly increased the AP50 values (paired analysis of variance,  $p < .01$ ) with a trend for higher values of AP50 as the slope decreases. Moreover, responses to a change in the slope of the ramped portion of the current pulses was variable among the SGN population tested, yielding AP50





**Figure 6.** Effect of different stimulus parameters on SGN firing. (a) Representative rate functions of an SGN that was stimulated with square pulses (gray) and ramped pulses of 50 (red) and 100 (blue) nA.ms slopes. (b) Representative rate functions of an SGN that was stimulated with square pulses (gray) and ramped pulses with different foot amplitude (green traces) at a constant slope (100 nA/ms). In (a) and (b), the shape of the stimulus used for each curve is shown (color coded on top). (c) Change in firing probability for an SGN where the slope of the stimulus was changed maintaining the peak and foot amplitude constant. On top of the panel, representative traces of the stimulus presented are shown. (d) Change in AP50 in response to a change in stimulus slope for all the SGN tested. Each symbol represents a single SGN. The black trace highlights the points corresponding to the data plotted in panel (a). Comparison of AP50 values under the different stimulation conditions was done by performing a paired ANOVA ( $p < .01$ ). In a, c, and d, the foot amplitude was 50%. SGN = spiral ganglion neuron; ANOVA = analysis of variance; FA = foot amplitude.

increments that range from 0.4 to 2 nA. The black symbols and trace in Figure 6(d) indicate the data correspondent to the rate functions showed in panel 6A.

A similar outcome is observed when rate functions are constructed with stimulus of different FAs. Figure 6(b) plots rate functions for a neuron stimulated with different waveforms in which the slope was constant (100 nA/ms) but the FA was changed (see schema above the panel). As the size of the FA decreases, more current is required to evoke firing. Finally, Figure 6(c) highlights the effect of changing only the stimulus slope while leaving the FA and PA constant. As expected, at constant peak and FAs, the steeper the slope, the higher the firing probability. The sequence of stimulus shapes used to construct the response to pulses with 6-nA PAs is shown for reference. Together, the data indicate that, in principle, all the parameters proposed for the ramped pulses do indeed influence firing probabilities of SGNs and potentially can contribute to their modulation in the context of electrical stimulation in cochlear implantation.

## Discussion

We propose a novel approach to cochlear-implant stimulation in which the shape of individual electrical pulses is modified to take account of the biophysical properties of SGNs, with the aim of reducing the spread of excitation within the cochlea in electrical hearing. The two key

features of this new strategy are (a) the introduction of a slope in the stimulation pulse and the consequent effect this will have on current spread within the cochlea and (b) the sensitivity of auditory neurons to the rate at which the magnitude of current pulses is increased. We demonstrate the theoretical considerations contributing to this new stimulus design, highlighting the predicted benefits for sound coding, and provide experimental evidence supporting the view that SGN neurons can be modulated by the new stimulus design in a manner consistent with the theoretical considerations.

### Sensitivity of SGNs to Ramped Electrical Pulses

The first working hypothesis presented by this new stimulation paradigm relies on the sensitivity of SGNs to ramped electrical pulses and the principle that this feature could be exploited during electrical activation by shaping the stimulus waveform. A key issue to support this hypothesis was to examine not only whether SGNs show such sensitivity but also whether this sensitivity could be triggered by stimulus over the time course relevant to CI stimulation. When slope sensitivity is tested experimentally in neurons, stimuli are typically ramps at near-threshold amplitudes, the durations of which are in the order of milliseconds (Ferragamo & Oertel, 2002; McGinley & Oertel, 2006). Current pulses employed in CIs, on the other hand, are in the order of 0.1-ms duration. This limitation in the duration of the

stimulus also has an impact on the range of slopes that could be assessed in the stimulus design. Even with the addition of the FA, the range of input slopes tested is between one and two orders of magnitude higher (steeper) than those previously tested. Despite these differences, however, we find that cultured SGNs are capable of modulating their firing rates in response to this short ramped stimulus. Moreover, we also observed some variability in their sensitivity to slopes: Heterogeneity in the biophysical properties of SGNs has been linked to variations in the expression of Kv1 channels (Liu, Lee, & Davis, 2014) and can also explain the variation in responses to slopes we report here. Such heterogeneity in the sensitivity to the slope of the ramp has the potential to increase the range of thresholds for electrical activation across the population of SGNs and could have utility in broadening the neural dynamic range in vivo.

It should be noted, however, that it remains unclear whether the short stimuli we employed are actually activating Kv1 channels in such a way that they impact on initiation of APs. Activation times of homomeric Kv1.1 and 1.2 channels in expression systems, such as cell lines or *Xenopus laevis* oocytes, are reported to be in the order of a few milliseconds (Gutman et al., 2005). However, when tested in neurons in brain slices, Kv1.1/2 channels do affect firing in response to stimuli as short as 0.5 ms (Gittelman & Tempel, 2006), suggesting that information drawn from expression systems might not represent the channel behavior in neurons and that CI stimulus duration can be effective in recruiting Kv channel activation. Nevertheless, further research is necessary to test explicitly whether Kv1.1/2 channels are indeed responsible for the sensitivity of SGN neurons to ramped stimulation.

### Applicability of Ramped Stimulation in CI Technology

The new stimulus pulse shape was designed primarily to reduce the spread of excitation within the cochlea, based on the sensitivity of SGNs to ramped stimuli. We have demonstrated experimentally that SGN's biophysical properties would indeed enable them to respond differentially to ramped stimuli. Further, we assessed how the variation of individual stimulus parameters affects SGN firing. We did not observe differences in the slope of the rate function curves for square versus ramped stimuli. This observation should be taken with caution because in the interest of testing a wide variety of stimulus parameters, the PA was varied in 0.5 nA steps. Constructing such curves with smaller differences between PAs could generate modifications in the shape of functions. Nevertheless, it is worth noting that, according to the theoretical considerations we posit, both PA and slope should change concomitantly at greater distances from the point of stimulation in situ (Figure 3). Therefore,

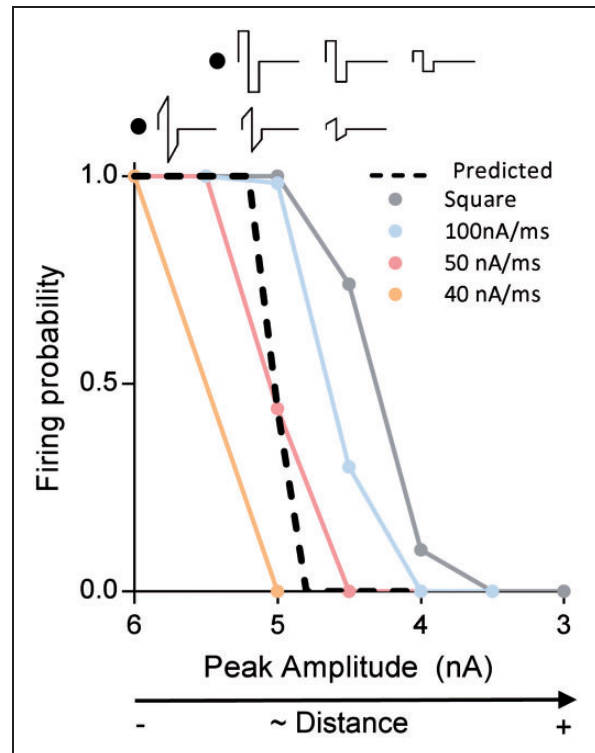

**Figure 7.** Prediction of the effect of the ramped stimulus in the spread of excitation. The drawings on the top represent the change in the shape of the stimulus as its position moves further from the electrode (represented with a dark circle) for either a square or a ramped pulse. Experimentally determined rate functions are shown for an SGN stimulated with square (gray line) and ramped stimulus (color lines). The dashed line represents the predicted change in firing rates as a function of the position for a ramped stimulus applied in an aqueous environment. SGN = spiral ganglion neuron.

rather than a single rate function being altered, a population of rate functions constructed with stimuli of different slopes might be employed to predict the effect of the new stimulation on neural firing in situ. Figure 7 plots recorded rate functions for an SGN stimulated with square and ramped stimuli. If the change in PA (abscissa) is considered to represent the change in the stimulus amplitude moving further from the stimulation point, it can be reinterpreted as distance from the stimulating electrode. The cartoons above Figure 7 represent the change in the shape of the stimulus received by SGNs positioned further from the electrode (represented by a filled circle) for either a square or a ramped pulse. The change in firing rates for SGNs at different positions for a square pulses should be predicted by the gray curve (rate function to square pulses). For ramped stimuli, as both the amplitude and shape of the stimulus vary, the change in firing rates as a function of the position will span rate function curves for different slopes (dashed line), resulting in a greater reduction in firing rate with

increasing distance from the center (i.e., less excitation spread). Therefore, the differences in firing probability should be steeper for the ramped, than for the square, pulse shapes, (Figure 7) consistent qualitatively with our predictions (Figure 3(d)).

The current study constitutes a proof-of-concept for a new stimulation strategy for cochlear implantation. It will be necessary to assess the validity of the theoretical consideration if it is to be brought into the design and implementation of electrical implants. As a first step in this process, we demonstrate that the theoretical framework upon which it rests—that the slopes of ramped pulses are suited to modulating the firing pattern of individual SGNs—appears to hold. The next issue that should be addressed, then, is to understand better how the pulse shape will be affected by diffusion within the cochlea in a quantitative manner, and a modeling approach could make predictions for further in vitro stimulus parameters that will closely resemble the shape of the stimulus as it moves further from the stimulation point.

As we report, our in vitro data suggest that the ion channels present in SGNs might be important in modulating their response to ramped stimuli. However, this was examined in cultured SGNs, and so the actual variation in the cellular localization of ion channels is unknown, compared with the normal or pathological situation in vivo. It is therefore important to assess whether the predictions derived from the in vitro studies are supported in an in vivo experimental paradigm.

### Improving Frequency Resolution in Electrical Hearing

As well as adding a new dimension to stimulus coding, reducing the spread of excitation could potentially aid the transmission of extra frequency information currently not possible in either synchronous or asynchronous stimulation modes. This provides the possibility of increasing the precision by which the frequency range is covered by electrode channels. Also, quantitatively, the potential reduction in channel interactions could provide a means of increasing the rate at which different channels are stimulated, if neural activity is reduced in channels distant from the stimulation site. This could improve the possibility of conveying information about the temporal fine structure of sounds in addition to information conveyed in the modulated stimulus envelope, a feature of most current CI stimulation strategies.

### Beyond Cochlear Implantation

The theoretical benefits of coding with ramped pulses could also be applied to other sensory systems and, depending on ion-channel characteristics, motor neurons. The rehabilitation of vision in visually impaired people is currently under intense investigation, including

through the use of electrode matrices implanted to lie on the retina, stimulating the optic nerve. This could be one of the potential beneficiaries of the ramped stimulus, allowing better control of the spread of excitation (Jepson et al., 2014). Finally, a similar extrapolation could be made for the functional electrical stimulation of motor neurons, studied for the restitution of limb control for patients with paralysis, providing stimulating implants and devices with a finer and broader span of stimulation to better reproduce the natural changes in spiking rate believed to code for intensity of movement (Quandt & Hummel, 2014).

### Declaration of Conflicting Interests

The authors declared no potential conflicts of interest with respect to the research, authorship, and/or publication of this article.

### Funding

The authors received no financial support for the research, authorship, and/or publication of this article.

### References

- Azouz, R., & Gray, C. M. (2000). Dynamic spike threshold reveals a mechanism for synaptic coincidence detection in cortical neurons in vivo. *Proceedings of the National Academy of Sciences*, *97*(14), 8110–8115.
- Bahmer, A., & Baumann, U. (2012). Application of triphasic pulses with adjustable phase amplitude ratio (PAR) for cochlear ECAP recording: I. Amplitude growth functions. *Journal of Neuroscience Methods*, *205*(1), 202–211.
- Bahmer, A., & Baumann, U. (2013). Effects of electrical pulse polarity shape on intra cochlear neural responses in humans: Triphasic pulses with cathodic second phase. *Hearing Research*, *306*, 123–130.
- Bierer, J. A., & Faulkner, K. F. (2010). Identifying cochlear implant channels with poor electrode-neuron interface: Partial tripolar, single-channel thresholds and psychophysical tuning curves. *Ear and Hearing*, *31*(2), 247–258.
- Bonham, B. H., & Litvak, L. M. (2008). Current focusing and steering: Modeling, physiology, and psychophysics (Research support, N.I.H., Extramural research support, Non-U.S. Gov't. *Hearing Research*, *242*(1–2), 141–153.
- Carlyon, R. P., Deeks, J. M., & Macherey, O. (2013). Polarity effects on place pitch and loudness for three cochlear-implant designs and at different cochlear sites. *Journal of the Acoustical Society of America*, *134*(1), 503–509.
- Cohen, L. T., Saunders, E., Knight, M. R., & Cowan, R. S. (2006). Psychophysical measures in patients fitted with contour and straight nucleus electrode arrays. *Hearing Research*, *212*(1–2), 160–175.
- Ferragamo, M. J., & Oertel, D. (2002). Octopus cells of the mammalian ventral cochlear nucleus sense the rate of depolarization. *Journal of Neurophysiology*, *87*(5), 2262–2270.
- Firszt, J. B., Koch, D. B., Downing, M., & Litvak, L. (2007). Current steering creates additional pitch percepts in adult



- cochlear implant recipients. *Otology & Neurotology*, 28(5), 629–636.
- Froud, K. E., Wong, A. C., Cederholm, J. M., Klugmann, M., Sandow, S. L., Julien, J. P., . . . Housley, G. D. (2015). Type II spiral ganglion afferent neurons drive medial olivocochlear reflex suppression of the cochlear amplifier. *Nature Communications*, 6, 7115.
- Gittelmann, J. X., & Tempel, B. L. (2006). Kv1.1-containing channels are critical for temporal precision during spike initiation. *Journal of Neurophysiology*, 96(3), 1203–1214.
- Golding, N. L., & Oertel, D. (2012). Synaptic integration in dendrites: Exceptional need for speed. *The Journal of Physiology*, 590(Pt 22), 5563–5569.
- Gutman, G. A., Chandy, K. G., Grissmer, S., Lazdunski, M., McKinnon, D., Pardo, L. A., . . . Wang, X. (2005). International union of pharmacology. LIII. Nomenclature and molecular relationships of voltage-gated potassium channels. *Pharmacological Reviews*, 57(4), 473–508.
- Hughes, M. L., & Stille, L. J. (2008). Psychophysical versus physiological spatial forward masking and the relation to speech perception in cochlear implants. *Ear and Hearing*, 29(3), 435–452.
- Jepson, L. H., Hottowy, P., Mathieson, K., Gunning, D. E., Dabrowski, W., Litke, A. M., . . . Chichilnisky, E. J. (2014). Spatially patterned electrical stimulation to enhance resolution of retinal prostheses. *Journal of Neuroscience*, 34(14), 4871–4881.
- Landsberger, D. M., Padilla, M., & Srinivasan, A. G. (2012). Reducing current spread using current focusing in cochlear implant users. *Hearing Research*, 284(1–2), 16–24.
- Lieberman, M. C., & Kiang, N. Y. (1978). Acoustic trauma in cats. Cochlear pathology and auditory-nerve activity. *ACTA Oto-laryngologica. Supplementum*, 358, 1–63.
- Litvak, L. M., Spahr, A. J., & Emadi, G. (2007). Loudness growth observed under partially tripolar stimulation: Model and data from cochlear implant listeners. *Journal of the Acoustical Society of America*, 122(2), 967–981.
- Liu, Q., Lee, E., & Davis, R. L. (2014). Heterogeneous intrinsic excitability of murine spiral ganglion neurons is determined by Kv1 and HCN channels. *Neuroscience*, 257, 96–110.
- Lotfi Navaii, M., Sadjedi, H., & Jalali, M. (2013). Waveform efficiency analysis of auditory nerve fiber stimulation for cochlear implants. *Australasian Physical and Engineering Sciences in Medicine*, 36(3), 289–300.
- Macherey, O., & Carlyon, R. P. (2014). Cochlear implants. *Current Biology*, 24(18), R878–R884.
- Macherey, O., Deeks, J. M., & Carlyon, R. P. (2011). Extending the limits of place and temporal pitch perception in cochlear implant users. *Journal of the Association for Research in Otolaryngology*, 12(2), 233–251.
- Macherey, O., van Wieringen, A., Carlyon, R. P., Deeks, J. M., & Wouters, J. (2006). Asymmetric pulses in cochlear implants: Effects of pulse shape, polarity, and rate. *Journal of the Association for Research in Otolaryngology*, 7(3), 253–266.
- Marozeau, J., McDermott, H. J., Swanson, B. A., & McKay, C. M. (2015). Perceptual interactions between electrodes using focused and monopolar cochlear stimulation (Research support, Non-U.S. Gov't). *Journal of the Association for Research in Otolaryngology*, 16(3), 401–412.
- McGinley, M. J., & Oertel, D. (2006). Rate thresholds determine the precision of temporal integration in principal cells of the ventral cochlear nucleus. *Hearing Research*, 216–217, 52–63.
- Middlebrooks, J. C. (2004). Effects of cochlear-implant pulse rate and inter-channel timing on channel interactions and thresholds. *Journal of the Acoustical Society of America*, 116(1), 452–468.
- Mo, Z. L., Adamson, C. L., & Davis, R. L. (2002). Dendrotoxin-sensitive K(+) currents contribute to accommodation in murine spiral ganglion neurons. *The Journal of Physiology*, 542(Pt 3), 763–778.
- O'Leary, S. J., Black, R. C., & Clark, G. M. (1985). Current distributions in the cat cochlea: A modelling and electrophysiological study. *Hearing Research*, 18(3), 273–281.
- Quandt, F., & Hummel, F. C. (2014). The influence of functional electrical stimulation on hand motor recovery in stroke patients: A review. *Experimental & Translational Stroke Medicine*, 6, 9. doi:10.1186/2040-7378-6-9.
- Rattay, F., Leao, R. N., & Felix, H. (2001). A model of the electrically excited human cochlear neuron. II. Influence of the three-dimensional cochlear structure on neural excitability. *Hearing Research*, 153(1–2), 64–79.
- Reid, M. A., Flores-Otero, J., & Davis, R. L. (2004). Firing patterns of type II spiral ganglion neurons in vitro. *Journal of Neuroscience*, 24(3), 733–742.
- Robles, L., & Ruggero, M. A. (2001). Mechanics of the mammalian cochlea. *Physiological Reviews*, 81(3), 1305–1352.
- Rubinstein, J. T., & Miller, C. A. (1999). How do cochlear prostheses work? *Current Opinion in Neurobiology*, 9(4), 399–404.
- Rusznak, Z., & Szucs, G. (2009). Spiral ganglion neurones: An overview of morphology, firing behaviour, ionic channels and function. *Pflugers Archiv*, 457(6), 1303–1325.
- Rutherford, M. A., Chapochnikov, N. M., & Moser, T. (2012). Spike encoding of neurotransmitter release timing by spiral ganglion neurons of the cochlea (Comparative study research support, Non-U.S. Gov't). *Journal of Neuroscience*, 32(14), 4773–4789.
- Shannon, R. V. (1983a). Multichannel electrical stimulation of the auditory nerve in man. I. Basic psychophysics. *Hearing Research*, 11(2), 157–189.
- Shannon, R. V. (1983b). Multichannel electrical stimulation of the auditory nerve in man. II. Channel interaction. *Hearing Research*, 12(1), 1–16.
- Smith, K. E., Browne, L., Selwood, D. L., McAlpine, D., & Jagger, D. J. (2015). Phosphoinositide modulation of heteromeric Kv1 channels adjusts output of spiral ganglion neurons from hearing mice. *Journal of Neuroscience*, 35(32), 11221–11232.
- Snyder, R. L., Bierer, J. A., & Middlebrooks, J. C. (2004). Topographic spread of inferior colliculus activation in response to acoustic and intracochlear electric stimulation (Research support, U.S. Gov't, P.H.S.). *Journal of the Association for Research in Otolaryngology*, 5(3), 305–322.
- Zeng, F. G. (2004). Trends in cochlear implants. *Trends in Amplification*, 8(1), 1–34.