

Some pages of this thesis may have been removed for copyright restrictions.

If you have discovered material in Aston Research Explorer which is unlawful e.g. breaches copyright, (either yours or that of a third party) or any other law, including but not limited to those relating to patent, trademark, confidentiality, data protection, obscenity, defamation, libel, then please read our [Takedown policy](#) and contact the service immediately (openaccess@aston.ac.uk)

**THE DEVELOPMENT, EVALUATION AND USE OF FRESHLY
ISOLATED RENAL PROXIMAL TUBULE SYSTEMS IN THE
FISCHER RAT**

Caroline Elizabeth Mary Jones

Doctor of Philosophy

THE UNIVERSITY OF ASTON IN BIRMINGHAM

March 1990

This copy of the thesis has been supplied on condition that anyone who consults it is understood to recognise that *sole* copyright rests with its author and that no quotation from the thesis and no information derived from it may be published without the author's prior, written consent.

The University of Aston in Birmingham

**THE DEVELOPMENT, EVALUATION AND USE OF FRESHLY ISOLATED
RENAL TUBULE SYSTEMS FROM THE FISCHER RAT.**

Caroline Elizabeth Mary Jones

Submitted for the degree of Doctor of Philosophy 1990.

SUMMARY

The investigation of renal pathophysiology and toxicology has traditionally been advanced by the development of increasingly defined and refined *in vitro* preparations. This study has sought to develop and evaluate various methods of producing pure samples of renal proximal tubules (PTs) from the Fischer rat.

The introduction summarised the most common *in vitro* preparations together with the parameters used to monitor viability — particularly with regard to toxic events. The most prevalent isolation methods have involved the use of collagenase to produce dissociation of the cortex. However, the present study has shown that even the mildest collagenase treatment caused significant structural damage which resulted in a longevity of only 3hr in suspension. An alternative mechanical isolation technique has been developed in this study that consists of perfusion loading the renal glomeruli with Fe_3O_4 followed by disruption of the cortex by homogenisation and sequential sieving. The glomeruli are removed magnetically and the PTs then harvested by a $64\mu\text{M}$ sieve. PTs isolated in this way showed a vastly superior structural preservation over their collagenase isolated counterparts; also oxygen consumption and enzyme leakage measurements showed a longevity in excess of 6hr when incubated in a very basic medium. Attempts were then made to measure the cytosolic calcium levels in both mechanical and collagenase isolated PTs using the fluorescent calcium indicator Fura. However results were inconclusive due to significant binding of the Fura to the external PT surfaces.

In conclusion, PTs prepared by the present mechanical isolation technique exhibit superior preservation and longevity compared with even the mildest collagenase isolation technique and hence appear to offer potential advantages over collagenase isolation as an *in vitro* renal system.

Key words: Renal proximal tubules, Collagenase isolation, Mechanical isolation, Fura.

ACKNOWLEDGMENTS

Thanks are extended to the UK Science and Engineering Research Council for my research studentship, to Ms L. Tomkins (University of Birmingham) for invaluable histological advice and assistance together with R Holt, to Jackie Archibald, Irene Woon and Graham Smith for their patient computer coaching and also to the gentlemen of the animal house for their unstinting bravery in the face of some highly malevolent Fischer rats. In addition I wish to express my gratitude and appreciation to Dr P.H. Bach (Robens Institute, Guildford) whose encouragement and patronage enabled me to attend the two International Nephrotoxicity Conferences at which I learnt so *very* much and also to my parents for the support and sacrifice that gave me the opportunity to extend my education — with my apologies to all three, if I didn't always appear to live up to expectations.

Finally my most profound thanks go to Prof C.B. Ferry and Dr P.J. Nicholls (Welsh School of Pharmacy, Cardiff) who very kindly agreed to become my 'adoptive' tutors. They evaluated my thesis with integrity and treated me with a refreshing professionalism that was very much appreciated. Their advice and philosophical encouragement were instrumental in the completion of this thesis and I am deeply grateful to them both.

'Honi soi qui mal y pense'

INDEX

TITLE PAGE.....	1
SUMMARY	2
ACKNOWLEDGMENTS	3
INDEX.....	4
LIST OF TABLES.....	9
LIST OF FIGURES	12

CHAPTER 1

INTRODUCTION

1.1 In vitro renal systems.....	21
1.1.1 Isolated Perfused Kidney	21
1.1.2 Renal Slices.....	23
1.1.3 Single Nephron Studies	25
1.1.4 Cultured Renal Cells.....	30
1.1.5 Renal Tubule Suspensions.....	32
1.2 Choice and validation of in vitro methods.....	33
1.3 Factors thought to control cytosolic calcium in renal epithelium.....	33
1.4 The role of calcium in toxic cell injury.....	37
1.5 The effects of aminoglycosides on $[Ca^{2+}]_i$	38
1.6 Measurement of cytosolic calcium in epithelial cells	41
1.7 The tetracarboxylate fluorescent calcium indicators	44
1.8 Aims and objectives of the project	46

CHAPTER 2

EVOLUTION OF THE MECHANICAL TECHNIQUE FOR ISOLATING RAT PROXIMAL TUBULES

2.1 General materials and methods	49
2.1.1 Animals and materials	49
2.1.2 Perfusion Apparatus	49
2.1.3 Dissection procedure for renal perfusion.....	50
2.1.4 Trypan Blue exclusion viability test	53
2.1.5 Periodic Acid Schiff (PAS) differential staining protocol	53
2.2 Isolation of PTs by the whole cortex digestion technique	55

2.2.1 Tubule Isolation Protocol	55
2.2.2 Morphological Examination	57
2.2.3 Results	58
2.3 Isolation of PTs by the enzyme perfusion technique.....	61
2.3.1 Tubule isolation protocol.....	61
2.3.2 PAS differential staining	63
2.3.3 Rationale for the choice of separating mesh	63
2.3.4 Trypan Blue Exclusion	65
2.4 Isolation of PTs by the mechanical isolation technique.....	65
2.4.1 Tubule isolation protocol.....	66
2.5 Development of the technique for cortical disruption	68
2.5.1 'Straightforward' Homogenisation	68
2.5.2 Sonication.....	72
2.5.3 'Modified' Homogenisation	74
2.6 Refinement of the technique for the magnetic removal of the Glomeruli	75
2.7 Discussion.....	78
2.7.1 The whole cortex digestion technique	78
2.7.2 The collagenase perfusion technique	82
2.7.3 The mechanical isolation technique	85

CHAPTER 3

MORPHOLOGICAL EVALUATION OF PROXIMAL TUBULES ISOLATED BY MECHANICAL AND COLLAGENASE PERFUSION TECHNIQUES

3.1 Light microscopy.....	91
3.1.1 Examination of fixed PT samples	92
3.1.2 Examination of fresh PT samples.....	94
3.1.3 Results	94
3.2 Electron Microscopy	102
3.2.1 Scanning Electron Microscopy	102
3.2.2 Results	104
3.2.3 Transmission Electron Microscope	107
3.2.4 Results	108
3.3 Evaluation of Glomeruli	110
3.4 Discussion	114
3.4.1 General Discussion	114
3.4.2 Light Microscope Evaluation	115

3.4.3 Evaluation of the SEM examination	117
3.4.4 Evaluation of the TEM examination	119
3.4.5 Evaluation of the structural integrity of mechanically isolated glomeruli	121

CHAPTER 4

BIOCHEMICAL EVALUATION OF PROXIMAL TUBULES ISOLATED BY MECHANICAL AND COLLAGENASE PERFUSION TECHNIQUES

4.1 Evaluation of the purity of the PT samples.....	124
4.1.1 Measurement of the Enrichment Factor	125
4.1.2 Statistical Analysis of Data.....	128
4.1.3 Results	128
4.1.4 Coomassie Protein Assay.....	129
4.1.5 Hexokinase Determination.....	130
4.1.6 Results	133
4.2 Evaluation of the structural integrity of the PT samples	133
4.2.1 Measurement of the percentage enzyme retention.....	133
4.2.2 Results	136
4.3 Measurement of the long - term viability of the PT samples	137
4.4 Preliminary investigation into the stability of AAP and LDH to prolonged incubation at 37°C.....	138
4.4.1 Results	139
4.5 Preliminary investigation into the effect of incubation media on PT viability.....	139
4.5.1 Preliminary measurement of leakage of LDH from PT samples incubated in various media	141
4.5.2 Preliminary measurement of Oxygen Consumption by PT samples incubated in various media.....	142
4.5.3 Results	145
4.6 Comparison of the long-term viability of mechanical and perfused collagenase isolated PT samples incubated in defined medium.....	147
4.6.1 Evaluation of long-term PT viability through the measurement of LDH leakage	147
4.6.2 Evaluation of the long-term PT viability through the measurement of oxygen consumption	148
4.6.3 Results.....	150

4.7	Discussion.....	157
4.7.1	Evaluation of the purity of the PT samples	157
4.7.2	Enrichment of proximal marker enzymes	157
4.7.3	Measurement of distal contamination	160
4.7.4	Evaluation of the initial structural integrity of the PT samples.....	161
4.7.5	Evaluation of the longevity of the PT samples	162
4.7.6	Effect of incubation medium on PT longevity	163
4.7.7	Evaluation of the viability produced with the chosen incubation medium	164

CHAPTER 5

USE OF THE FLUORESCENT CALCIUM INDICATOR FURA IN FRESHLY ISOLATED RENAL TUBULE SYSTEMS

5.1	Preliminary technical problems and verifications.....	173
5.1.1	Preparation of the tubule samples used in $[Ca^{2+}]_i$ measurements	173
5.1.2	Preliminary check to ensure that whole PTs from Fischer rat converted FURA 2-AM to FURA	174
5.1.3	Development of the FURA loading protocol	177
5.2	Final protocol for the measurement of $[Ca^{2+}]_i$ in whole rat PT's using FURA	184
5.3	Potential factors affecting the FURA signal.....	185
5.3.1	Examination of the potential quenching effect of the Fe^+ loading on the FURA signal.....	185
5.3.2	Measurement of FURA leakage from PT samples	188
5.4	Potential factors affecting $[Ca^{2+}]_i$ levels	192
5.4.1	Effect of FURA on the viability of mechanically isolated PTs	192
5.4.2	Effect of alterations in the medium on basal $[Ca^{2+}]_i$ levels.....	195
5.4.3	Use of Pluronic F-127 during FURA loading in mechanical and collagenase isolated PTs	198
5.5	Effect of agonists on $[Ca^{2+}]_i$ levels.....	203
5.5.1	Effect of the addition of parathyroid hormone to mechanical and collagenase isolated PTs	204
5.5.2	Effect of addition of Noradrenaline to mechanical and collagenase isolated PTs	206

5.5.3 Effect of the addition of Ionomycin to mechanical and collagenase isolated PTs	209
5.6 Measurement of the degree of external binding of FURA to mechanical and collagenase isolated PTs.....	212
5.7 Discussion.....	219
5.7.1 General Discussion	219
5.7.2 Quenching of the FURA signal by heavy metals.....	221
5.7.3. Leakage of FURA from the PT cells	221
5.7.4 Toxic effects of FURA ?	223
5.7.5 The effect of Pluronic® on FURA loading.....	224
5.7.6 The response of the two PT systems to agonists.....	225
5.7.7 Binding of FURA to external surfaces of mechanical and collagenase isolated PTs and dual wavelength calibrations	226

CHAPTER 6

EVALUATION AND DISCUSSION OF MECHANICAL ISOLATION

6.1 General Evaluation	230
6.2 Disadvantages of a Mechanical Isolation	236
6.2.1 Choice of starting material.....	236
6.2.2 Variations in PT dimensions.....	237
6.3 Toxic effects of Fe ₃ O ₄ ?	238
6.4 Future uses and developments of mechanical tubule isolations.....	240
6.4.1 Tubule suspensions	240
6.4.2 Renal Culture	242
6.5 Imminent novel renal systems	243
6.5.1 Proximal Cell Elution.....	243
6.5.2 Isolation of Distal Tubules	244
REFERENCES	246
APPENDIX 1	260

LIST OF TABLES

Table 1a. Comparison of the salient features of the different types of cell culture	27
Table 1b. Comparison of cytosolic calcium probes.....	43
Table 2a. Evaluation of the effect of clearance (distance between the pestle and the homogeniser tube) and the number of vertical strokes on the mechanical dispersion of rat renal cortex by various cylinder homogenisers. N = no mechanical dispersion. D = tubules destroyed rather than dispersed.	69
Table 2b. Evaluation of the number of vertical strokes on the mechanical dispersion of rat renal cortex by an homogeniser with a tear shaped pestle and a 2mm clearance (distance between the pestle and the homogeniser tube). N = no mechanical disruption. D = tubules destroyed rather than dispersed.	72
Table 2c. Evaluation of the dispersive effect of a sonic probe on rat renal cortex applied at various tunings for either 2 or 4 sec. N = no mechanical disruption. D = Tubules destroyed rather than disrupted.....	73
Table 2d. Evaluation of the dispersive effect of the application of a sonic bath to rat renal cortex for various times. N = no mechanical disruption. D = Tubules destroyed rather than disrupted.	73
Table 4a. Measurement of the enrichment ratio (EF) of the proximal marker enzyme alanine aminopeptidase in PT samples over that found in the original renal cortex. The results are related to the weight of the rats used and have been analysed statistically through the use of standard deviation (SD) and the coefficient of variation (CV)	129
Table 4b. Measurement of the percentage of alanine aminopeptidase (AAP) and lactate dehydrogenase (LDH) retained in mechanically isolated PTs. The results have been analysed statistically through the use of standard deviation (SD) and coefficient of variation (CV)	136

Table 4c. Measurement of the percentage of alanine aminopeptidase (AAP) and lactate dehydrogenase (LDH) retained in PTs isolated by collagenase perfusion. The results have been analysed statistically through the use of standard deviation (SD) and coefficient of variation (CV).	137
Table 4d. Measurements of the percentage of LDH leaked with time from mechanically isolated PTs incubated in KHS/3% Dextran/10mM Lactate at 37 °C. The results are the mean of 5 separate isolations ± standard deviation (SD) and the coefficient of variation (CV) is also shown	150
Table 4e. Measurement of oxygen consumption with time for mechanically isolated PTs incubated in KHS/ 3% Dextran/10mM Pyruvate at 37 °C. The results are the mean of 5 separate isolations ± standard deviation (SD) and the coefficient of variation (CV) is also shown.	151
Table 4f. Measurement of the percentage of LDH leaked with time from PTs isolated by collagenase perfusion incubated in KHS/ 3%Dextran/ 10mM Lactate at 37°C. The results are the mean of 5 separate isolations ± standard deviation (SD) and the coefficient of variation (CV) is also shown.	153
Table 4g. Measurement of oxygen consumption with time for PTs isolated by collagenase perfusion incubated in KHS/3% Dextran/10mM Pyruvate at 37 °C. The results are the mean of 5 separate isolations ± standard deviation (SD) and the coefficient of variation (CV) is also shown.	154
Table 5a. Measurement of the percentage of FURA leaked from mechanical and collagenase isolated rat PTs incubated at 25°C. The results are the average of three separate isolations (n=3) and are expressed ± the standard deviation.....	190
Table 5b. Measurement of the percentage of FURA leaked from mechanical and collagenase isolated rat PTs incubated at 37°C. The results are the average of three separate isolations (n=3) and are expressed ± the standard deviation.....	190

Table 5c. Measurement of oxygen consumption (R_Q) and LDH leakage from mechanically isolated PTs incubated at 37°C with 0.5µM FURA 2-AM in DMSO. The results are from two separate experiments.....	193
Table 5d. Measurement of oxygen consumption (R_Q) and LDH leakage from mechanically isolated PTs incubated at 37°C with DMSO vehicle (final concentration 0.1%). The results are from two separate experiments.	193
Table 5e. Basal $[Ca^{2+}]_i$ values in mechanically isolated PTs incubated at 25°C with 0.5µM FURA 2-AM in a medium containing 3% Dextran, 10mM pyruvate, 5mM HEPES and KHS (containing different levels of calcium chloride). The results are the average of n separate measurements from 2 different experiments.	197
Table 5f. Measurement of basal $[Ca^{2+}]_i$ levels in mechanical and collagenase isolated PTs loaded with FURA 2-AM with and without the presence of the surfactant pluronic.....	201
Table 5g. Measurements of viability after loading and FURA leakage after 15min of incubation at 25°C in mechanical and collagenase isolated PTs incubated with FURA 2-AM in the presence and absence of the surfactant pluronic. The results are the average of three separate experiments and are expressed \pm the standard deviation.	201
Table 5h. Results of the degree of external signal present in mechanical and collagenase isolated PTs measured by the invasive technique of modified calibration [section 5.13.1]. The results are the average of four separate experiments (n=4) and are expressed \pm SD.....	214
Table 5i. Results of the degree of external signal present in mechanical and collagenase isolated PTs measured by the non-invasive use of nickel chloride and the chelator diethyltriaminepentaacetic acid (DTPA) [section 5.13.1].The results are the average of four separate experiments (n=4) and are expressed \pm SD.	217

LIST OF FIGURES

Fig 1a Structure of QUIN-2.....	45
Fig 1b Structure of FURA-2.....	45
Fig 2a. Diagrammatic representation of the surgical procedure required for renal perfusion; see text for details.....	52
Fig 2b. PAS staining protocol.....	54
Fig 2c. PAS stained wax section of a PT sample isolated by the whole cortex digestion technique described in section 2.2.1. The PAS stain fails to produce characteristic differential staining of the brush border membrane of the PT and thus it is not possible to distinguish between proximal and distal elements.....	60
Fig 2d. Schematic representation of the stages involved in the mechanical technique for the isolation of rat PTs.	67
Fig 2e. Diagrammatic comparison of the shearing lengths of the two homogeniser pestles used in the mechanical dispersion of rat renal cortex. The length of pestle in contact with the homogeniser tube (shearing length) is greater with the cylindrical pestle (i) than the tear-shaped pestle (ii).	70
Fig 2f. The homogeniser used in the present study for the mechanical isolation of rat PTs. The homogeniser has a specially constructed round-headed pestle which produces a clearance between the pestle and the tube of 2mm.	71
Fig 2g. Diagrammatic representation of the system for the magnetic removal of Fe ₃ O ₄ loaded glomeruli	76
Fig 3a. Vial pelleting technique used for the preparation of wax sections of renal PTs.....	94
Fig 3b. LM of a typical freshly isolated PT sample obtained by mechanical separation (see section 2.4 for details). The only distal tubule found in the micrograph is arrowed. No collecting ducts or glomeruli are shown, but fragments of connective tissue are present (C).	96

Fig 3c. LM of a fresh, mechanically isolated PT exhibiting total luminal patency along its length.....	97
Fig 3d. LM of typical mechanically isolated whole PTs fixed and stained with PAS (see section 2.1.5 for protocol). The PTs exhibit the distinguishing features of dark mauve colouration and dense nucleation (N).....	99
Fig 3e. LM of a typical mechanically isolated whole distal tubule fixed and stained with PAS (see section 2.1.5 for protocol). The distal tubule exhibits the distinguishing features of light mauve colouration and sparse nucleation (N).	100
Fig 3f. LM of typical PAS stained wax section from mechanically isolated PTs. Samples show characteristic staining of intact and well defined brush border membranes. Connective tissue is also present (C).....	101
Fig 3g. LM of typical PAS stained wax section from PTs isolated by the collagenase perfusion technique described in section 2.3. Although the samples show characteristic staining of the brush border membrane, the membranes have reduced definition and exhibit areas where BBM staining is totally absent (arrowed).	101
Fig 3h. SEM of the basolateral surface from a representative mechanically isolated PT. The membrane exhibits a smooth, uniform surface with fragments of connective tissue seen to be still attached to the membrane surface in places (arrowed).	105
Fig 3i. (Inset) SEM of the cut end of a typical mechanically isolated PT. The tubule exhibits an open lumen and minimal deformation to the cut edges of the basolateral and brush border membranes.....	105
Fig 3j. SEM of the basolateral surface and cut ends of a typical PT isolated by collagenase perfusion. No connective tissue residues are seen and the basolateral membrane exhibits a highly irregular and corrugated surface with the general shape of the tubule appearing contorted. The cut ends show gross distortion with severe damage to the basolateral and luminal membrane with poor luminal access.	106

Fig 3k. TEM of the ultrastructure from a typical PT isolated by collagenase perfusion. There is a loss of definition in both the basolateral membrane and the basal infoldings. A slight unevenness can also be seen in the structure of the basolateral surface.....	109
Fig 3l. TEM of the ultrastructure from a typical mechanically isolated PT. Basolateral and luminal membranes appear intact and the internal organelles are well preserved.	109
Fig 3m. Diagrammatic representation of the salient anatomical features of the various S portions of the proximal tubule.....	111
Fig 3n. (Inset) PAS stained wax section of a mechanically isolated glomerulus showing loading of the glomerular vasculature with iron oxide (arrowed).....	113
Fig 3o. SEM of a typical mechanically isolated glomerulus. Despite iron loading, the filtering membrane shows intact podocytes (P) and trabeculae (T) and no damage to the pedicels (PE)	113
Fig 4a. Assay protocol for Alanine Aminopeptidase.....	127
Fig 4b. Assay protocol for Hexokinase	132
Fig 4c. Assay protocol for Lactate Dehydrogenase	135
Fig 4d. Graph of the stability of the brush border enzyme alanine aminopeptidase (AAP) to incubation at 37°C. The results plotted were the mean of 3 separate experiments \pm the standard deviation.....	140
Fig 4e. Graph of the stability of the cytosolic enzyme lactate dehydrogenase (LDH) to incubation at 37°C. The results plotted were the mean of 3 separate experiments \pm the standard deviation.....	140
Fig 4f. Schematic representation of the principles of the Clark Oxygen Electrode	143
Fig 4g. Leakage of LDH from mechanically isolated PTs incubated at 37°C in various media. The results plotted are the mean of two separate experiments	146

Fig 4h. Oxygen consumption in mechanically isolated PTs incubated at 37°C in various media. The results plotted are the mean of 2 separate experiments.....	146
Fig 4i. Measurement of oxygen consumption and leakage of LDH from mechanically isolated rat proximal tubules incubated at 37°C in KHS/3% Dextran/10mM Pyruvate or Lactate. The results plotted were the mean of 5 separate isolations ± standard deviation.....	152
Fig 4j. Measurement of oxygen consumption and leakage of LDH from collagenase isolated rat proximal tubules incubated at 37°C in KHS/3% Dextran/10mM Pyruvate or Lactate. The results plotted are the mean of 5 separate isolations ± standard deviation.....	156
Fig 5a. Emission scans of a mechanically isolated rat PT suspension, incubated at 37°C, following the addition of FURA 2-AM. (1): Emission scan at time 0; trace exhibits a peak at 380nM indicative of the presence of FURA 2-AM only. (2): Emission scan at 3min; trace exhibits a broader peak which suggests that the hydrolysis of FURA 2-AM is underway. (3): Emission scan at 5min; trace exhibits a main peak at 340nM with a slight shoulder at 380nM suggesting that only a little of the FURA 2-AM is left in the cuvette. (4): Emission scan at 10min; trace exhibits a peak at 340nM only suggesting that the conversion of FURA 2-AM to free FURA is complete.	176
Fig 5b. Representative traces of mechanically isolated PTs loaded with FURA 2-AM and calibrated either by the addition of 0.05% Triton and alkaline EGTA (1) or by 100µM digitonin and alkaline EGTA (2). The traces show lower F _{max} values following the addition of digitonin compared with the addition of Triton which suggests that better lysis of the PTs is achieved with Triton rather than digitonin.	180
Fig 5c. Representative emission scans of the uptake of FURA in mechanically isolated PTs incubated for 15 min (1) and 30min (2) at 37°C. The traces show little increase in uptake after 15min incubation and suggests that incubations of longer than 15min serves little purpose with this system.	181

Fig 5d. Representative calibrations of mechanically isolated PTs loaded with 0.1 μ M (1), 0.5 μ M (2), 1 μ M (3) and 3 μ M (4) FURA 2-AM for 15min at 37°C. The traces show similar distances between F_{min} and F_{max} for FURA concentration 0.5 - 3 μ M, but a shorter distance and a 'noisier' trace at the 0.1 μ M FURA concentration. The calibration suggests that the optimal FURA incubation concentration for this system is 0.5 μ M. 182

Fig 5e. Representative trace of the effect of the addition of the membrane impermeable heavy metal chelator diethylenetriaminepentaacetic acid (DTPA) on the calibration of the fluorescent trace produced by mechanically isolated rat PTs loaded with FURA 2-AM. Trace shows no alteration in the signal following the addition of 200 μ M DTPA suggesting that no extracellular heavy metal quenching was present in this system. 187

Fig 5f. Representative trace of the effect of the addition of the membrane permeable heavy metal chelator N,N,N',N'-tetrakis(2-pyridylmethyl)ethylenediamine (TPEN) on the basal intracellular fluorescent signal produced by mechanically isolates PTs loaded with FURA 2-AM. Trace shows no alteration of the signal following the addition of 20 μ M TPEN suggesting that no intracellular heavy metal quenching was present in this system. 187

Fig 5g. Graphs showing the oxygen consumption and LDH leakage from mechanically isolated PTs incubated at 37°C with either [1] 0.5 μ M FURA 2-AM in DMSO or [2] DMSO vehicle (final concentration 0.1%). Each point is the average of two separate experiments. 194

Fig 5h. Representative emission scans of mechanically isolated PTs loaded at 37°C with either (1) 0.5 μ M FURA 2-AM with 0.01% Pluronic *amplitude* 1 or (2) 0.5 μ M FURA 2-AM *amplitude* 1.5. The traces show greater uptake of FURA when the surfactant Pluronic is incorporated. 200

Fig 5i. Representative traces of mechanically isolated PTs incubated with 0.5 μ M FURA in the absence (1) and presence (2) of the surfactant pluronic and run at 25°C. Trace shows a smooth, level baseline in the absence of pluronic, but a steadily *rising* baseline in the presence of pluronic. 202

Fig 5j. Representative traces of the type of response sometimes seen on the addition of 10^{-5} parathyroid hormone (PTH) to mechanically isolated [1] and collagenase isolated [2] PTs loaded with FURA 2-AM and run at 25°C. Both traces show an elevation in the basal $[Ca^{2+}]_i$ level immediately after the addition of PTH but neither response shows a distinct plateau. 205

Fig 5k. Representative traces of the type of response sometimes seen on the addition of 50µM noradrenaline (NOR) to mechanically isolated [1] and collagenase isolated [2] PTs loaded with FURA 2-AM and run at 25°C. The traces show an elevation in the basal $[Ca^{2+}]_i$ level immediately after the addition of NOR and a more distinct plateau in both systems. 207

Fig 5l. Representative trace of the effect of the addition of ionomycin on the basal $[Ca^{2+}]_i$ level of mechanically isolated rat PTs loaded with FURA 2-AM. The trace shows that 2µM ionomycin produced virtually no effect on the fluorescent signal..... 211

Fig 5m. Representative trace of the effect of the addition of ionomycin on the basal $[Ca^{2+}]_i$ level of collagenase isolated rat PTs loaded with FURA 2-AM. The trace showed that 2µM ionomycin produced a definite and immediate signal which reached a plateau within 2min of addition. 211

Fig 5n. Representative trace of the degree external FURA signal present in mechanical [1] and collagenase [2] isolated rat PTs. Quenching of the external signal is produced by EGTA then, following lysis of the cells with 0.05% Triton to give F_{min} , the F_{max} value was obtained by the addition of $CaCl_2$. The traces show a greater degree of external signal in mechanically isolated PTs compared with their collagenase isolated counterparts..... 215

Fig 5o. Representative trace of the degree external FURA signal present in mechanical [1] and collagenase [2] isolated rat PTs. Quenching of the external signal is produced by nickel chloride (Ni) and restoration of the signal is obtained with the chelator diethylenetriaminepentaacetic acid (DTPA). The traces show a greater degree of external signal in mechanically isolated PTs compared with their mechanically isolated counterparts. 216

~~~ CHAPTER 1 ~~~

## INTRODUCTION

Historically, the study of renal pathophysiology has been advanced by the development of increasingly defined and refined *in vitro* preparations. With current, justifiable, pressures to reduce the number of animals used in experimentation it is to be expected that this trend will continue and very probably accelerate — especially in the field of toxicology.

The kidneys are particularly susceptible to toxic injury, primarily due to their unique structure and highly dynamic functions. Factors which predispose the kidney to damage by toxins include;

1. High rate of renal blood flow which exposes the kidney to blood borne toxins.
2. The presence of mechanisms for concentrating toxins within tubular fluids.
3. Transport systems capable of concentrating toxins within cells
4. A substantial capacity for xenobiotic biotransformation.

The nephron is the functional unit of the kidney and toxicity evaluations are further complicated by the nephron being made up of different segments composed of varying cell types which, although functionally related, may differ in their susceptibility to toxic injury [Smith *et al* 1987a]. Over the years, however, it is the proximal tubule (PT) segment of the nephron that has proved to be the site of action of many nephrotoxins. This is probably a reflection of the significant concentrating and transporting capacities of this nephronal region and further emphasises the significance of the above factors on PT nephrotoxicity ie.

1. The renal cortex (containing 90% PT tissue) receives over 85% of the renal blood flow which may preferentially expose the PT to blood-borne toxins.
2. PTs contain several active transport systems for the secretion and reabsorption of xenobiotics and toxins may achieve high intracellular levels if they are the substrates for one or more of the PT transporters.

3. The cortex contains cytochrome dependent P-450 mixed function oxidases which are capable of activating compounds to toxic intermediates [Lote 1987, Sheikh & Møller 1987, Smith *et al* 1987a].

In fact these features have already been discerned as being important in several nephropathies eg cephalosporin toxicity is related to intracellular accumulation probably due to transport by the organic anion (hippurate) system across the basolateral membrane [Sheikh & Møller 1987], lead accumulation occurs partly via active transport processes, and pinocytosis is thought to be important for gentamicin accumulation [Porter & Bennett 1981]. Whilst other areas of the nephron can also incur toxic injury [Toubeau *et al* 1986], the particular susceptibility of the proximal tubule to toxic insult is undoubtedly the reason why, in recent years, much effort has been expended to produce *in vitro* systems that focus on the proximal region.

*In vitro* renal preparations encompass methods as diverse as whole kidney perfusion down to membrane vesicle systems. Yet, at present, it is difficult to see any of the current *in vitro* techniques replacing whole animal studies as general, primary toxicological screens; though with continual technical improvements, together with stringent validation [Balls & Clothier 1987], it may eventually be possible to compile a *battery of in vitro* tests that will.

Method development is often a painfully slow, tortuous process with much effort expended for a low volume of data — that concession tending to go to subsequent workers who capitalise on the horizons opened up by the new methodologies. Nevertheless, method development can be very rewarding and where *in vitro* renal preparations have already proved effective are as valuable tools in proximate evaluations of the disposition and mechanisms involved in injuries by known toxicants [Berndt 1984, Smith *et al* 1987a, Bach 1989]. It is the aim of the initial part of this introduction to give a brief synopsis of the main *in vitro* renal systems in current use together with their fortes and inadequacies.

## 1.1 IN VITRO RENAL SYSTEMS

As stated earlier, the main utilisation of *in vitro* renal systems has been directed at studying the mechanisms of action of known nephrotoxins and here these preparations can offer several advantages over whole animal work. For example, specific transport studies can be made without undue influence by alterations in glomerular filtration or renal blood flow, either of which can affect the availability of metabolites, substrates etc to the nephron. Having said this, however, it should be borne in mind that a toxin may exert its adverse effects through the renal vasculature; though equally, toxic changes in systemic circulation may also produce changes in renal blood flow which merely elicit indirect effects on renal function. Varying degrees of control may be maintained over the preparation's experimental conditions and so noxious agents may be applied to an *in vitro* system without unwanted outside physiological influences. Large numbers of different measurements can be made on the renal tissue from a single animal. The exact location of a toxic insult can be pinpointed within the kidney and analysed. In fact advantages increase with the development of new techniques. Nevertheless, the *in vitro* systems each also have inherent difficulties peculiar to their methodologies — though perhaps the one drawback they all share is effective correlation of the results obtained with these *in vitro* preparations to *in vivo* situations.

The *in vitro* renal systems can conveniently be divided into systems that utilise the whole kidney or unpurified sections of it and those preparations that focus on a particular nephronal area or element. The first two systems described belong to the former category, and the remainder to the latter:

### 1.1.1 Isolated Perfused Kidney

The isolated perfused kidney is the only *in vitro* method where renal function is measured in the presence of intact vasculature and 'normal' anatomical relationships between nephrons. It is also the only *in vitro* system where the intrarenal haemodynamic effects of a toxin can be observed. One of the earliest whole kidney perfusion experiments

was performed by Hemingway 1931; since then, a number of different perfusion methodologies have been devised [Nizet 1975, Newton & Hook 1981, Mehendale 1984, Berndt 1984].

The kidney may be perfused via the aorta or renal artery using either pulsatile or nonpulsatile perfusion flows, however, the most important experimental variable appears to be the perfusion medium [Berndt 1984]. A whole blood perfusate caused vasoconstriction and deterioration of the kidney and even diluted blood generated embolization of fat droplets, blood clots etc [Nizet 1975] — quite apart from the large number of blood donors required to perfuse a single kidney. Most investigators now use a modified Krebs-Ringer buffer containing albumin and glucose [Newton & Hook 1981]; though supplementation with amino acids is also thought to increase the longevity of the preparation.

Glomerular filtration rate, fractional sodium excretion, water reabsorption, perfusate flow rate and perfusion pressure are used as indices of organ function and as viability criteria for this kidney system. Alterations in these indices have been used to evaluate the direct nephrotoxic potential of various chemicals [Newton *et al* 1982]. The technical considerations for this preparation are reviewed comprehensively and in detail by Mehendale 1984.

Most workers agree that retention of anatomical relationships is important to the evaluation of renal function and whole organ perfusion is the only *in vitro* renal technique that achieves this. Consequently, the perfused kidney is a very useful tool for examining the effects of filtration, secretion, reabsorption and metabolism on toxins without the complication of systemic influences eg liver metabolites. The experimenter can also maintain control over perfusion pressure and blood flow — unlike the *in vivo* situation where these parameters often change during the course of an experiment. In addition, the perfused kidney retains the membrane barriers, not only between vascular and parenchymal cells but also between individual cells; hence the natural constraints of the intact organ are maintained.

Nevertheless, despite this, the perfused kidney has not been widely used in toxicology; perhaps because the skill, time and expense involved in the preparation is preclusive for routine toxicological evaluations. However, other drawbacks to the system may be motives also. For example, the perfused kidney yields *whole* organ information and this does not allow the experimenter to reliably discern the specific cellular location of the toxic events. Mechanistic experiments are also not usually suitable with this preparation for that reason. In addition, there are technical drawbacks ie. the useful functioning time of the preparation appears to be between only 90min to 3hr and also the perfused kidney does not concentrate the urine well due to a reabsorptive defect in the distal tubule not yet fully characterised [Maack 1980]. Mitochondrial swelling and cellular disruption also occurs in the cells of the thick ascending limb and may be related to the above concentrating defect. As a consequence, the intrarenal disposition and potential toxicity of certain compounds may be altered in this preparation thus compromising toxicological evaluations.

### **1.1.2 Renal Slices**

Renal slices have been used since the 1940's to examine the transport of organic ions and the effects of nephrotoxins. Several procedures are available for the preparation of renal slices from free hand dissection to microtomes and tissue slicers [Berndt 1987]. The slices prepared are usually between 0.2-0.5mm thick and may be cut, not only from whole kidney, but from specific regions also eg. cortical or medullary slices. Approximately 100mg of tissue slices are then transferred to flasks containing oxygenated physiological buffers and incubated in temperature controlled, shaking water baths. Viability of the slices is usually monitored by measuring oxygen consumption and this is an important assessment to make as the experimenter may then distinguish between the effect of nephrotoxins on transport and general tissue metabolism. Following an initial equilibration period, the transport substance/toxin is added to the incubation medium and then, after the appropriate experimental period, the slices are removed, blotted and weighed. The slices, together with an aliquot of incubation medium, are subsequently



processed to determine the effect of the nephrotoxin on renal transport/metabolism etc. The methodology for this technique is described in detail by Berndt 1984.

Renal slices have been widely used in toxicology [Cruz *et al* 1988, Wolfgang *et al* 1989]. Nephrotoxins may be applied directly to slices or slices may be taken from pretreated animals. Parameters such as para aminohippurate (PAH) accumulation, gluconeogenesis, ammoniogenesis can then be measured to evaluate toxic cell injury eg gluconeogenesis has been shown to be altered by gentamicin [Kluwe & Hook 1978].

Ease of preparation and manipulation are the major advantages of renal slices. They can be obtained from most species at any age and thus are useful in the evaluation of species and age-related toxicity differences. However, the specific advantage of this technique relates to its utility in the study of organic ion accumulation and/or efflux and several studies have shown PAH accumulation to be amongst the most sensitive and versatile indicators of PT injury [Smith *et al* 1987a]. Disadvantages again come from the heterogeneous nature of the preparation and the lack of appropriate methodologies for the location of renal toxic injury. Slice viability is limited to 4-6hr and there is evidence that access of exogenous agents to the lumen may be limited by the collapse of the lumen within the first hour of incubation [Smith *et al* 1987a]. There is also concern that regions of hypoxia may develop in the central portion of the slice.

### 1.1.3 Single Nephron Studies

Single nephron studies are an attempt to develop an *in vitro* system approximating very closely to renal tubular function in the intact animal. It is used mainly for the analysis of precise mechanisms of transport, particularly transepithelial and as such is an advantage over slice preparations. *In vivo* single nephron studies are performed by micropuncture and *in vitro*, the isolated perfused tubule is used [Diezi & Roch-Ramel 1987].

With the *in vitro* perfusion, the tubule segments are dissociated from the kidney and then studied under conditions where both the luminal and contra-luminal fluids may be precisely controlled. Preparation of the tubules is the most difficult part of

the procedure. Early attempts used collagenase isolated nephrons, but these proved unsatisfactory due to basement membrane damage and now microdissection is the prevalent method. One of the drawbacks to microdissection, however, is that only certain species are successful (mainly rabbit) and some portions of the nephron can be difficult to obtain. Minipipettes are used for the perfusion procedure and fluid transport out of the tubule is monitored by the incorporation of a non-permeable marker eg.  $^{14}\text{C}$ -inulin in the perfusion fluid. The methodology for this technique is described in detail by Diezi & Roch-Ramel 1987.

The isolated perfused tubule is thought to produce data highly representative of the *in vivo* situation. Most nephronal regions can be examined and perfusion conditions can be tightly controlled — both improvements over micropuncture. Very sophisticated measurements can be made using probes such as ion-selective electrodes, patch-clamping, intracellular electrical measurements, radiolabelled compounds etc. Indeed much useful physiological and pathophysiological data has already been obtained with this method [Greger 1985]. Yet, despite this, microperfusion has rarely been utilised in toxicological evaluations and the reason for this is unclear. Admittedly, the system is technically very demanding, potentially costly and time consuming for routine toxicological studies. The method is also difficult to use in chronic studies as the tubule dissection is often hampered by the extreme fragility of the injured tissue [Diezi & Roch-Ramel 1987]. However, perhaps the most significant problem is the severe functional alterations that can be produced by some toxic agents and which can seriously compromise the reliability of the technique [Berndt 1984, Diezi & Roch-Ramel 1987].

#### **1.1.4 Cultured Renal Cells**

The development of epithelial cell culture is probably the most significant advance in renal *in vitro* methodology in the last 20 years — it is certainly the technique for which the greatest claims have been made. Metabolic and functional aspects of renal cellular function have been studied using continuous cell lines [Holohan *et al* 1987, Inui *et al* 1988], primary culture [Josepovitz *et al* 1987, Kaloyanides & Ramsammy 1989] and

very occasionally explant culture [Horster 1979, 1980a]. The properties of these types of culture are summarised in table 1a.

The main renal continuous cell lines used are the proximal 'like' LLC-PK pig line [Hull *et al* 1976] and the distal 'like' MDCK dog line [Rindler *et al* 1979], although other renal cell lines are available [Sakhrani & Fine 1983]. Both cell strains have been well characterised biochemically, and appear to possess many of the transport functions of renal cells *in vivo* [Handler *et al* 1980, Horster 1980b, Sakhrani & Fine 1983, Lever 1986]. Primary cell lines have been developed firstly from mixed populations of cortical cells [Jones *et al* 1986] and then, as better techniques became available for the separation of various tubular elements, specific regions of the nephron [Fine & Sakhrani 1986]. Where primary culture has been exploited to best effect, however, is in the development of renal culture of *human* origin [Williams *et al* 1987, Sens *et al* 1988] — the ultimate in *in vitro* methodology.

The use of renal explant culture is, by comparison, more rare. The reason for this is unclear, but it may be due to difficulty in finding expedient methods of obtaining specific nephronal elements suitable for explantation ie successful explantation cultures have previously used microdissected nephronal elements; which is both expensive and time consuming. Collagenase isolated tubules (described in section 1.1.5) tend not to grow as explants [Horster 1979, 1980a, Valentich 1986], and have to be broken down into cells or tubule fragments before seeding — the possible reasons for this are discussed in section 6.4.2. The development of a technique for the isolation of specific nephronal elements quickly, in comparatively large amounts and without the use of proteolytic enzymes might prove beneficial to the development of explant renal cultures.

The potential for developing human culture, together with the unmatched longevity of culture preparations, is undoubtedly the reason why so much work has been expended in this field — perhaps at the expense of other *in vitro* developments? Indeed it is evident that epithelial cell culture in general demonstrates considerable potential as an *in vitro* technique, for example:

Table 1a Comparison of the salient features of the different types of renal cell culture

| PRIMARY CELL CULTURE                                                                  | EXPLANT CULTURE                                                                                 | CONTINUOUS CELL LINE                                        |
|---------------------------------------------------------------------------------------|-------------------------------------------------------------------------------------------------|-------------------------------------------------------------|
| <b>Advantages</b>                                                                     |                                                                                                 |                                                             |
| Characterisable into defined cell population and propagates into identical replicates | Longest retention of histological and biochemical differentiation                               | Greatest growth rates                                       |
| Incurs less de-differentiation than cell lines                                        | Can remain in non growing steady state for several days                                         | Higher cell density and higher yields                       |
| Genotypic and phenotypic purification                                                 | Preserved cell interactions and cloning possible                                                | Ease of maintenance in simple media                         |
| Cloning possible                                                                      | Tendency to retain hormonal responsiveness                                                      | More experimental data available                            |
| <b>Disadvantages</b>                                                                  |                                                                                                 |                                                             |
| Loss of biochemical responsiveness                                                    | Cannot be propagated                                                                            | Gross de-differentiation                                    |
| Loss of histotypic architecture                                                       | Colonies may form rather than monolayers                                                        | Loss of tissue-specific markers                             |
| Devoid of structural organisation                                                     | Greater experimental variation between replicates                                               | Increase in tumorigenicity                                  |
| Do not achieve steady state unless special conditions are employed                    | Quantitative determinations more difficult due to minor variations in geometry and constitution | Chromosomal instability and divergence from donor phenotype |

1. Growth of replicate populations of cells from specific nephronal regions and maintenance in highly controllable environments.
2. Large amounts of cells may be grown to facilitate subfractionation and biochemical assays.
3. The ready access to cells and their growth medium, facilitated by culture, allows materials to be conveniently added and withdrawn.
4. Small quantities of test substances may be used and, in appropriate systems, may be added to either the apical or basolateral tubule surfaces.
5. The longevity of the preparations allows chronic studies and even recovery with cellular regeneration to be observed.
6. Relative ease of manipulation; though this is a moot point, as it is debatable whether the technique would still be considered easy if the use of antibiotics and serum were restricted.
7. Cells may be stored frozen and returned to culture at a later date; thus enabling re-examination of the same experimental material.
8. Culture can be very economical with regard to the use of animals and very many results can be obtained for the expenditure of one animal.

Yet the use of cell culture has major drawbacks which appear to focus principally around the alteration in cellular environment and the loss of differential cellular characteristics that occur during proliferation.

As cells undergo sequential passaging in culture, they lose some of their morphological and functional characteristics and are said to become de-differentiated [Freshney 1983]. The system most affected by de-differentiation is the continuous cell line, for example: The MDCK cell line exhibits collecting duct as well as distal properties and are tumorigenic when implanted into nude mice [Wilson 1986]. Likewise, the LLC-PK line possesses a glucose transport system similar to the proximal tubule and yet also has an adenylate cyclase activity sensitive to calcitonin and vasopressin similar to the medullary thick ascending limb together with a high transepithelial resistance like the

collecting ducts [Handler *et al* 1980, Sakhrani & Fine 1983]. De-Differentiation in continuous cell lines is compounded still further by the existence of different *strains* within these lines exhibiting varying properties [Handler *et al* 1980]. Indeed it may be argued that the immortality acquired by continuous cell lines is in itself indicative of neoplastic transformation; as normal epithelial cells have finite division potentials both *in vivo* and *in vitro* [Wilson 1986].

Primary cell cultures are not exempt from the problem of de-differentiation, although to a lesser extent than continuous cell lines. They have been known to exhibit:

1. Altered hormonal responses and nutritional requirements.
2. Loss of morphological features eg. brush border and basolateral membranes.
3. Loss of ability to perform metabolic activation and detoxification
4. Reduced enzyme and organelle levels eg. mitochondria.

Little data is available on explanted renal cells, but they are thought to undergo less de-differentiation than primary culture [Valentich 1986].

Admittedly, the development of serum-free media for renal culture [Taub *et al* 1979, Taub & Sato 1980, Taub & Livingston 1981, Chuman *et al* 1982, Chung *et al* 1982] and the potential for using collagen raft substrates [Michalopoulos & Pitot 1975] has reduced the problem slightly; but de-differentiation, with its attendant alterations in cell functions, are significant impediments in the use of culture systems.

In the face of its undoubted potential, it is all too easy to become insensitive to the drawbacks of cell culture and to advocate its use as a primary toxicological screening replacement for animals. Yet in light of the above drawbacks, it is important to be highly circumspect when extrapolating data from cultured systems to the *in vivo* situation and to appreciate the artificiality of this *in vitro* milieu and the contribution it may have on the behaviour of the culture preparation under study. Indeed, until comprehensive validation of renal culture systems is carried out [Balls & Clothier 1987], it is probably prudent to validate all cell culture findings against other *in vitro* systems and whole animal models.

### 1.1.5 Renal Tubule Suspensions

As whole kidney perfusion and renal slices failed to address the problem of tubular heterogeneity, efforts were made to produce *in vitro* methods that focused on specific nephronal regions. Microdissection might have seemed the obvious choice however, as stated earlier, this technique had drawbacks in that it was expensive in terms of equipment, time and skills and at the end produced only low levels of experimental tissue. What was needed was a method of producing fairly large amounts of tissue, derived from a specific nephronal region, quickly and economically. To this end, renal tubule suspensions were developed.

Although precise technical details may vary, the methods employed in extracting nephronal material from the renal matrix resolves into two categories; enzyme dispersion and mechanical disruption. Enzyme dispersion is by far the most popular method and involves perfusing [Green *et al* 1987] or soaking [Scholer & Edelman 1979, Vinay *et al* 1981, Schnellman & Mandel 1986, Schnellman 1988] the cortex with proteolytic enzymes (usually collagenase) in order to digest the connective tissue matrix and thereby release the nephronal elements. Mechanical disruption, by comparison, is much less common and involves mechanical disruption of the connective tissue architecture (usually by passing the tissue through needles [Phillips 1967] or graded sieves [Brendel & Meezan 1975, Hjelle *et al* 1981 & 1983]) to produce dispersed nephronal tissue.

Initially the mixed populations of tubular fragments obtained by these techniques were used without further attempts to purify specific nephronal regions [Burg & Orloff 1962, Thimmappayya *et al* 1970, Dawson 1972, Helwig *et al* 1974, Chahwala & Harpur 1986, Green *et al* 1987]. Naturally these preparations offered few advantages over slices except as starting points for tissue culture [Jones *et al* 1986]. Then, gradually, highly diverse techniques began to appear which extracted specific nephronal elements from the heterogeneous tubular soup. Initial attempts, using differential sedimentation, only produced PT enrichment [Scholer & Edelman 1979, Balaban *et al* 1980, Kumar *et al* 1986]. However, as more sophisticated systems were devised, sample purities began to

exceed 90%. Differential centrifugation, following collagenase digestion, has become the most widespread method of obtaining virtually pure proximal and distal samples [Vinay *et al* 1981, Schnellman & Mandel 1986, Gesek *et al* 1987]. However, other novel systems available include; Iron loading of renal vasculature to obtain glomeruli [Cook & Pickering 1958, Meezan *et al* 1973], sieving through graded sieves following mechanical separation [Brendel & Meezan 1975, Hjelle *et al* 1981 & 1983, Jones 1990], osmotic lysis to obtain collecting ducts [Cuthbert *et al* 1985] and immunodissection [Garcia-Perez & Smith 1983, Smith & Garcia-Perez 1985, Smith & Spielman 1989].

These purified samples have been used not only in suspension studies [Schnellman 1988, Jones 1990] but also as the starting point for cell cultures [Chung *et al* 1982]. This system allows the effects of toxins on specific nephronal regions to be observed and can be more economical in terms of animal usage than slices or whole kidney perfusion. It also has the advantage over cultured cells that cellular structures and connections are, for the most part, preserved.

The main drawback to this preparation, however, is their brief longevity of between 1-4hr [Scholer & Edelman 1979, Green *et al* 1987], though this is gradually being improved (see section 6.4.1). There are also problems associated with their method of preparation i.e. the proteolytic enzymes, unfortunately, fail to stop after digesting the connective tissue matrix and go on to attack the tubules [Smith *et al* 1987a]. This has been manifest in the loss of basement membrane [Balaban *et al* 1980, Chahwala 1981, Chahwala & Harpur 1986] and brush border membrane [Vinay *et al* 1981] leading to an overall weakening of the general tubular structure. Indeed collagenase isolated PTs disintegrate on prolonged incubation and burst if attempts are made to microperfuse them. This type of membrane damage might also result in altered handling of xenobiotics by the tubules and hence affect toxicities [Smith *et al* 1987a]. Tubules isolated by current mechanical methods might also be expected to incur traumatic damage during their isolation, but this has not previously been fully characterised [Brendel & Meezan 1975].



## 1.2 CHOICE AND VALIDATION OF IN VITRO METHODS

It is generally recognised that all new *in vitro* methods should be properly validated before being accepted for general use [Balls & Clothier 1987]. In this way the most appropriate *in vitro* method may be selected for the problem under study, as along with the advantages come the inevitable inherent limitations of each system which must be evaluated before the decision as to which preparation to use is made.

Yet thorough, comparative validation data are all too rare and are undoubtedly the reason why current legislative authorities are cautious about accepting the new methodologies. Indeed until comprehensive validation of *in vitro* methods and assays is undertaken, their relevance to any testing strategy will, quite rightly, remain speculative. Some of the problem may lie in uncertainty about what is required for validation and how it should be performed [Balls & Clothier 1987]. Even after obtaining a new system, the selection of *quantifiable* endpoints indicative of reversible/irreversible events leading to toxicity is highly problematic. Indeed, at the end of the day, what does a morphological or biochemical change in an *in vitro* animal system predict about likely symptoms *in vivo*. What seems clear, however, is that a few studies in one or two laboratories are inadequate and stringent, multi-centre, blind trials are necessary — though this is often beyond the means of most experimenters attempting new methodologies (present study included).

In terms of *in vitro* renal methodology it is probably fair to say that, since the advent of cell culture, the development of other *in vitro* renal systems has been in the doldrums. Yet the problem of de-differentiation is such that there is still room for other *in vitro* techniques. The single most advantageous feature of culture over other *in vitro* renal systems is its longevity. In fact it is tempting to speculate that its longevity has blinded many to its poor representative qualities. Nevertheless, it has long been a source of concern that interpretation of results from even short-term, non-cultured experiments may be compromised by the fact that they are taken against a background of deteriorating function. Hence it would seem reasonable to suggest that a non-culture technique with improved longevity could have significant uses.

The original brief of this project was the examination of the effects of aminoglycosides on epithelial transport using renal cell culture. However it was soon realised that the continuous cell line LLC-PK, initially advocated, was unsuitable for this study due to the extent of its de-differentiation. It was felt, therefore, that a better system would be a primary explant culture of proximal origin grown on collagen rafts in serum free medium. To achieve this, a method of obtaining large amounts of well preserved PTs had to be found — microdissection being too expensive to initiate.

Previous work in this laboratory suggested that a method of preparing pure, intact PTs was available [Chahwala & Harpur 1986]. However, close scrutiny of the original data [Chahwala 1981] showed that these claims were unwarranted as the preparation produced by this collagenase technique was highly impure and grossly damaged. Other, milder, collagenase isolation techniques were attempted [Vinay *et al* 1981] but, due to enzyme induced damage, were still felt to be unsatisfactory. The development of a *mechanical* isolation technique, based on the work of Meezan *et al* 1973 and Brendel & Meezan 1975, was then attempted as an alternative to collagenase isolation. Preliminary validation of these mechanically isolated PTs showed better preservation of morphological and biochemical parameters and also superior longevity over their collagenase isolated counterparts. In addition these PTs were found to grow as explants in serum supplemented medium. Unfortunately, due to lack of facilities and technical support, this part of the project was unable to be pursued any further than this and PT suspension studies to measure cytosolic calcium levels as indicators of toxicity were pressingly advocated instead.

### **1.3 FACTORS THOUGHT TO CONTROL CYTOSOLIC CALCIUM IN RENAL EPITHELIUM**

Calcium is the fifth most abundant element in the body [Willets 1982]. Although most of this is in skeletal bones and teeth, calcium also has important extraskelatal functions [Lote 1987]. Calcium in extracellular fluid (including plasma)

affects the excitability of nerve and muscle cell membranes, blood coagulation, endocrine/exocrine secretions etc [Bowman & Rand 1980] and intracellular calcium has a number of important regulatory and messenger functions [Goligorsky & Hruska 1988]. However, for reasons described later, it was the free *cytosolic*  $[Ca^{2+}]_i$  level and its importance in the regulation of many renal cell functions [Borle 1981, Murphy & Mandel 1982, Mandel & Murphy 1984, Snowdowne *et al* 1985, Tang & Weinberg 1986, Smith *et al* 1987a, Stassen *et al* 1988, Phelps *et al* 1989] that were of immediate interest. The latter part of the present study sought to develop the methodology to examine  $[Ca^{2+}]_i$  in whole PT isolates. The present observations on  $[Ca^{2+}]_i$  apply to renal tubule cells and, due to differences in total calcium levels and patterns of intracellular calcium distribution, are not necessarily applicable to other cell types.

Although *total* intracellular and extracellular calcium concentrations are of a similar magnitude ( $10^{-3}M$ ), there is a large difference in the concentrations of free ionised  $[Ca^{2+}]_i$  ( $10^{-7}M$ ) between the cytoplasmic organelles and extracellular fluid. Consequently, a steep electrochemical gradient of around -70 to -80mV is formed which favours the passive entry of  $Ca^{2+}$  into the cell [Frindt *et al* 1988]. Since renal cell membranes are known to be permeable to calcium [Borle 1981] it, therefore, follows that there must also be one or more active transport systems that remove  $Ca^{2+}$  from the cytosol to maintain  $[Ca^{2+}]_i$  levels at around  $10^{-7}M$ .

Cellular calcium can be considered to distribute within epithelial cells into four major pools or compartments [Weinberg 1984];

1. Calcium bound to the outer surfaces of the cell membranes and in equilibrium with free calcium in the extracellular fluid.
2. 'Free' cytosolic calcium  $[Ca^{2+}]_i$  that, in most healthy cells, appears to be maintained at concentrations well under  $0.5\mu mol l^{-1}$ .
3. Calcium bound to sites on membrane surfaces facing the cytosol, as well as soluble components and macromolecules of the cytosol (eg the specific calcium binding protein calmodulin [Lote 1987], acidic phospholipids) and in equilibrium with free  $[Ca^{2+}]_i$ .

4. Calcium actively sequestered within intracellular membrane-bound organelles eg mitochondria and smooth endoplasmic reticulum.

At present, much current thinking suggests that, at steady state  $[Ca^{2+}]_i$  appears to be determined by the balance between  $Ca^{2+}$  influx across both the brush border [Gmaj *et al* 1979] and basolateral membranes and  $Ca^{2+}$  extrusion through the basolateral membrane catalysed predominantly by a calmodulin-activated  $Ca^{2+}$ -ATPase [Gmaj & Murer 1988]. There is also a  $Na^+/Ca^{2+}$  exchange system present in the basolateral membrane, but it is not thought to be important quantitatively in  $Ca^{2+}$  extrusion but may act as a  $Ca^{2+}$  'valve' by allowing limited increases in  $Ca^{2+}$  influx in response to an increase in cell  $Na^+$  or cell depolarisation. In such a way, the  $Na^+/Ca^{2+}$  exchanger system may act as a device for coupling luminal entry and basolateral exit of  $Na^+$  — mediated by *limited* changes in intracellular  $Ca^{2+}$  concentration [Gmaj & Murer 1988]. However, these conclusions about the importance of the  $Na^+/Ca^{2+}$  exchange system compared to the  $Ca^{2+}$ -ATPase tend to be based on electrical/kinetic calculations in *in vitro* systems and are highly sensitive to the magnitude of the basolateral cell membrane potential — which are generally higher in *in vivo* than in *in vitro* preparations [Frindt *et al* 1988]. In fact, the work of Ullrich *et al* 1976 showed that a reduction of the electrochemical potential gradient for sodium across the basolateral membrane diminished the rate of active transepithelial calcium reabsorption indicating, therefore, that active transepithelial calcium reabsorption was dependent on sodium transport and the activity of the  $Na^+/Ca^{2+}$  exchange system. When the sodium gradient was no longer sufficient to drive the  $Na^+/Ca^{2+}$  exchange, calcium transport diminished; indicating that the ATP-driven calcium pump was unable to compensate.

The  $Ca^{2+}$  transport systems of the endomembranes eg endoplasmic reticulum are thought to be mainly activated during stimulation of the cell and resultant  $Ca^{2+}$  transients. Hormonal stimulation of the cell results in the formation of the hydrolysis product of phosphatidylinositol (4,5)-bisphosphate ( $PIP_2$ ), inositol 1,4,5-trisphosphate ( $IP_3$ ).  $IP_3$  is a key metabolite that directly mobilises  $Ca^{2+}$  from the endoplasmic reticulum

which results in transient increases in  $[Ca^{2+}]_i$  and stimulation of calmodulin dependent enzymes [Thevenod *et al* 1986, Gmaj & Murer 1988, Goligorsky & Hruska 1988]. Agonists and hormones that have been shown to produce increases in PT  $[Ca^{2+}]_i$ , possibly through the above ( $IP_3$ ) mechanism, include phenylephrine [Goligorsky *et al* 1986a], bradykinin [Aboolian & Nord 1988], oxytocin [Stassen *et al* 1987], calcitonin [Murphy *et al* 1986], parathyroid hormone [Hruska *et al* 1986, Goligorsky & Hruska 1988] and vasopressin [Burnatowska-Hledin & Spielman 1987].

The involvement of mitochondria in the regulation of  $[Ca^{2+}]_i$  is rather contentious. Accumulation of  $Ca^{2+}$  in mitochondria is driven by an electrical potential, generated across the inner mitochondrial membrane by respiration or ATP hydrolysis, and is catalysed by a specific glycoprotein [Carafoli & Lehninger 1971]. In nonexcitable tissues,  $Ca^{2+}$  is released from mitochondria via a separate pathway involving an electroneutral ion exchange and controlled by the redox state of intramitochondrial pyridine nucleotides [Gmaj & Murer 1988]. In isolated renal mitochondria, electroneutral  $Ca^{2+}$  efflux is catalysed by endogenous unsaturated fatty acids and inhibited by  $Na^+$  ions [Roman *et al* 1979]. Mitochondria are capable of uptake and retention of calcium without any sustained deleterious effects up to certain levels (which differ between tissues). However, above this there is spontaneous release of a large fraction of the mitochondrial calcium that was previously taken up [Weinberg 1984].

Borle 1981 (in his kinetic analysis of  $Ca^{2+}$  fluxes in cultured kidney cells) and Murphy & Mandel 1982 (in their work on whole PTs) have suggested that mitochondria might provide the largest intracellular pool of exchangeable calcium controlling  $[Ca^{2+}]_i$  and reactions to different exogenous stimuli. However, their analysis may have been compromised by membrane damage incurred by the *in vitro* isolation resulting in massive accumulation of  $Ca^{2+}$  in the mitochondria [Somylo *et al* 1981]. In contrast, Thevenod *et al* 1986, working on permeabilised rat cortical cells, found that  $[Ca^{2+}]_i$  levels (plasma membrane functionally excluded) were dependent upon a vanadate-inhibitable nonmitochondrial pool — vanadate inhibits the ATP-driven Ca pump of the endoplasmic

reticulum [Ortiz *et al* 1984]. Only when cells were loaded with unphysiologically high amounts of calcium, that exceeded the uptake capacity of the endoplasmic reticulum, did mitochondrial uptake assume the dominant role in buffering  $[Ca^{2+}]_i$  [Thevenod *et al* 1986]. Other workers, using other tissues, also feel that little mitochondrial  $Ca^{2+}$  uptake should occur at normal  $[Ca^{2+}]_i$  levels ie Somlyo *et al* 1981 have shown that the mitochondria in undamaged muscle cells contain little  $Ca^{2+}$  even after prolonged contraction. Indeed, many feel that where mitochondrial involvement in  $[Ca^{2+}]_i$  is important is in toxic situations within the cell [Weinberg 1984, Trump & Berezesky 1985, Carafoli 1987, Trump & Berezesky 1989].

#### **1.4 THE ROLE OF CALCIUM IN TOXIC CELL INJURY**

Although calcium appears to have important roles in 'normal' cell functions such as mitosis [Petzelt *et al* 1987], fertilization [Hafner *et al* 1988], muscle contraction [Bowman & Rand 1980], hormone and agonist responses [Tang & Weinberg 1986, Burnatowska-Hledin & Spielman 1987, Goligorsky & Hruska 1988] etc where fluctuations in  $[Ca^{2+}]_i$  are physiologically regulated by the cell; calcium is also thought to be involved in toxic cell injuries caused by insults as diverse as anoxia [Mandel *et al* 1987], antibiotics [Holohan *et al* 1988, Inui *et al* 1988] and chemical toxins [Smith *et al* 1987b, Ambudkar *et al* 1988, Skeer & Lindup 1989]. One of the reasons for the latter theory appears to be the observation that, in many tissues, dead and dying cells accumulate large amounts of calcium (dystrophic calcification) [Trump & Berezesky 1985]. In addition, with the advent of more sophisticated  $[Ca^{2+}]_i$  indicators, it has been seen that many toxic insults produce early elevations in  $[Ca^{2+}]_i$  and in a dose dependent manner [Smith *et al* 1987b, Holohan *et al* 1988, Trump & Berezesky 1989] — in fact some studies have shown that a reduction in extracellular calcium can be protective [Ambudkar *et al* 1988]. Nevertheless, despite this, some work with hepatocytes suggests that toxic injury is not caused by an increase in total cellular calcium resulting from the influx of extracellular calcium [Smith *et al* 1981, Fariss & Reed 1985]. It is difficult to know how

this relates to events in renal epithelium but, interestingly, a high calcium diet has been shown to ameliorate gentamicin nephrotoxicity [Bennett et al 1982, Humes et al 1984] — though this is probably due to extracellular effects eg competitive binding, suppression of PTH, phosphate depletion rather than direct effects on  $[Ca^{2+}]_i$ .

The precise mechanism(s) by which alterations in cellular calcium critically influence cell viability remain to be authenticated, and difficulties in elucidating the role of calcium in cell injury stem from the probability that different toxins will effect different aberrant mechanisms and will act in conjunction with non-calcium mediated injurious processes. Whilst the calcification and events of cell death, that occur once renal cells have been injured past 'the point of no return' may be slightly more established [Trump & Berezsky 1989], it is still unclear whether calcium deregulation is generally important in the early stages of cell injury. A growing body of data, however, suggests that changes in  $[Ca^{2+}]_i$  homeostasis are an important event in the pathogenesis of certain types of renal injury and a number of potential intracellular sites and mechanisms have been identified. Unfortunately, it is beyond the scope of this chapter to examine these theories in detail, but good reviews are available [Trump *et al* 1984, Weinberg 1984, Trump & Berezsky 1985, Mandel *et al* 1987, Phelps *et al* 1989, Trump & Berezsky 1989].

## 1.5 THE EFFECTS OF AMINOGLYCOSIDES ON $[Ca^{2+}]_i$

This laboratory has had a long-standing interest in the mechanisms underlying the nephrotoxicity of aminoglycosides — particularly with regard to electrolyte disturbances. As stated earlier, a high calcium diet has been shown to be protective against gentamicin nephrotoxicity [Bennett *et al* 1982, Humes *et al* 1984]. The most obvious explanation of this event would appear to be competitive displacement of gentamicin by the calcium with a corresponding reduction in gentamicin uptake [Humes *et al* 1984] but, paradoxically, no increase in serum calcium (and hence filtered load) is found in this situation. An alternative explanation has been suggested, however, namely that dietary calcium supplementation induces a secondary hypoparathyroidism.

It has been observed in rabbit renal cortex that parathyroid hormone (PTH) affects kidney phospholipid metabolism and increases the content of acidic polyphosphoinositides [Farese *et al* 1980] — implicated as being the renal binding sites for aminoglycosides. In light of this, it was theorised that PTH suppression might reduce phospholipid metabolism and hence decrease the number and/or affinity of the aminoglycoside receptors. This in turn would reduce the cellular uptake and, hence, the nephrotoxicity of the drug [Holohan *et al* 1987].

Further evidence that suppression of PTH was important in ameliorating gentamicin nephrotoxicity was given by Bennett *et al* 1985 and Elliott *et al* 1987 who showed that parathyroidectomy afforded protection against gentamicin nephrotoxicity; which was removed by administration of exogenous PTH. Although Elliott *et al* 1985 found that renal accumulation was reduced by suppression of PTH in this situation, conversely the results of Bennett *et al* 1985 found that PTH had no effect on uptake. Interestingly Holohan *et al* 1987, using membrane binding studies, showed that PTH suppression did decrease gentamicin uptake though *not* through alteration in the binding parameters of gentamicin to brush border and basolateral membranes. From this data, Holohan *et al* 1987 concluded that the difference in gentamicin uptake following PTH suppression reflected some event(s) *distal* to the binding site.

In recent years, the effect of gentamicin on phospholipids and  $[Ca^{2+}]_i$  has been examined with very interesting results. Inui *et al* 1988 and Holohan *et al* 1988, using LLC-PK renal cell lines, have shown that gentamicin increases the  $[Ca^{2+}]_i$  levels in these cell lines in a dose dependent manner and that changes in  $[Ca^{2+}]_i$  are seen *before* characteristic adverse morphological changes — although, as yet, it is uncertain whether the increased  $[Ca^{2+}]_i$  comes from intra or extracellular pools. Since perturbation of  $[Ca^{2+}]_i$  levels is seen as an early feature of some nephrotoxic insults, the above findings are interpreted to mean that gentamicin pathogenesis is *initiated* by elevated  $[Ca^{2+}]_i$  levels. Whilst prolonged elevation of  $[Ca^{2+}]_i$  is very probably injurious to the cell, it is probably premature to claim that  $[Ca^{2+}]_i$  initiates pathogenesis as it is difficult to see how gentamicin



would act on  $[Ca^{2+}]_i$  directly. It might be more reasonable to imagine gentamicin disrupting a preceding homeostatic mechanism which then initiates deregulation of  $[Ca^{2+}]_i$  levels and thereby *promotes* toxic events.

A potential candidate for gentamicin inhibition leading to disruption of  $[Ca^{2+}]_i$  homeostasis is the phosphatidylinositol (PI) cascade. Much work has shown that the aminoglycosides interact with phosphoinositides [Feldman *et al* 1982, Schwertz *et al* 1984, Josepovitz *et al* 1987] and it is postulated that, through inhibition of the PI cascade, aminoglycosides might cause profound derangement in the regulation of a number of intracellular processes thereby contributing to the toxicity of these antibiotics. Kaloyanides & Ramsammy 1989 have shown gentamicin capable of inhibiting the generation of  $IP_3$  by PTH, bradykinin, phenylephrine and other agonists. They also found that gentamicin inhibited the redistribution of PI-specific protein kinase C which suggested that gentamicin may be acting through inhibition of  $PIP_2$  hydrolysis. The mechanism by which disruption of the PI cascade contributes to aminoglycoside toxicity can only be speculated upon at present. However one possibility is suggested by the excellent review of Berridge 1987 in which it is stated that protein kinase C has a pivotal role in cellular function in that, among other things, it can either enhance or inhibit calcium signalling and so control  $[Ca^{2+}]_i$  homeostasis.

The activity of protein kinase C is enhanced by calcium and it appears to stimulate not only the kinases involved in the formation of  $PIP_2$ , but also has a negative feedback system to inhibit calcium signaling which is thought to involve either inhibition of  $PIP_2$  hydrolysis or activation of calcium pumps. It is therefore tempting to speculate that although gentamicin might prevent release of  $Ca^{2+}$  from endoplasmic reticulum by its inhibition of  $IP_3$ , its simultaneous inhibition of protein kinase C means that regulation of  $Ca^{2+}$  released into the cytosol by other sources might be compromised. This could result in elevated  $[Ca^{2+}]_i$  levels with corresponding toxic effects; particularly since the 'protective' cellular response of mitochondrial  $Ca^{2+}$  uptake leading to the formation of the

storage Ca-phosphate deposits [Carafoli 1987] is also inhibited by gentamicin [Sastrasinh *et al* 1982].

In light of this, the alleged beneficial effects of PTH suppression are difficult to account for unless PTH permeabilises the membrane to either  $\text{Ca}^{2+}$  or gentamicin through its adenylate cyclase effects which are not inhibited by gentamicin [Kaloyanides & Ramsammy 1989]. It was hoped to examine the interactions of gentamicin, PTH, PI cascade and  $[\text{Ca}^{2+}]_i$  in PT cells in the hopes of further elucidating the mechanisms underlying gentamicin nephrotoxicity — provided a suitable *in vitro* system could be developed.

## 1.6 MEASUREMENT OF CYTOSOLIC CALCIUM IN EPITHELIAL CELLS

The first estimates of  $[\text{Ca}^{2+}]_i$  values were made over 15 years ago through indirect means on giant muscle fibres by Portzehl *et al* 1964. Since then, several methods of measuring  $[\text{Ca}^{2+}]_i$  have been developed.

The properties desirable in a probe will vary with the type of cells used and the experimental question under study. Nevertheless, ideally, a  $[\text{Ca}^{2+}]_i$  indicator should exhibit certain general features such as; maximal sensitivity to small changes in the physiological range of most cells ie  $10^{-8}$  to  $10^{-6}\text{M}$ . A low affinity for  $\text{Ca}^{2+}$  (ie high  $K_d$ ) in order to minimise buffering effects which can blunt calcium transients and expand the exchangeable  $[\text{Ca}^{2+}]_i$  pool. The response time of the probe should be at least one order of magnitude faster than the physiological event to be recorded in order to avoid blurred/masked transients and the probe should be highly selective against other cations — particularly  $\text{Mg}^{2+}$ . The signal from the indicator should be strong enough not to be distorted by noise, autofluorescence or spontaneous signal emissions from the cell. Calibration should be straightforward and the instrumentation needed for analysis should not be prohibitively costly. Incorporation of the probe into the cells should ideally be rapid, technically easy and harmless to the cell. Once incorporated, the indicator should

distribute uniformly through the cytosol without compartmentalisation into other organelles, decay or leakage from the cells. Finally, and perhaps most importantly, the probe should be *inert* and not influence  $\text{Ca}^{2+}$  metabolism or cellular functions; and above all should not be toxic or release toxic catabolites.

Leaving aside indirect methods of measurement, the 5 main direct measuring techniques that fulfil many of the above criteria are:

1. The bisazometallochromic indicators eg Arsenazo III
2. Bioluminescent protein indicators eg Aequorin
3.  $\text{Ca}^{2+}$  selective microelectrodes [Lee 1988]
4. NMR probes [Rink 1983]
5. The tetracarboxylate fluorescent indicators eg QUIN-2, FURA-2.

The salient advantages and disadvantages for these probes are provisionally summarised in table 1b and it is beyond the scope of this introduction to appraise these techniques further — though good reviews are available [Rink 1983, Tsien *et al* 1984, Cheung 1987, Rink 1988]. It is impossible to say which is the best probe as they each have different properties which may be beneficial to various systems and it is most important to consider the technical requirement for each new cell system.

Although  $[\text{Ca}^{2+}]_i$  measurements using the null point method and arsenazo have previously been used in renal epithelium [Murphy & Mandel 1982, Mandel & Murphy 1984], it was decided to use one of the tetracarboxylate fluorescent indicators; namely FURA-2, to measure  $[\text{Ca}^{2+}]_i$  in the present whole renal PTs. The main criteria for this decision was the ease with which the indicators could be incorporated into the whole PT and the availability to the project of a comparatively cheap fluorimeter.

**Table 1b Comparison of Cytosolic Calcium Probes**

| <u>Bisazometallochromic</u><br>eg Arsenazo III                | <u>Bioluminescent</u><br>eg Aequorin                                                 | <u>Microelectrodes</u>                                  | <u>NMR probes</u>                                           | <u>Tetracarboxylates</u><br>eg Quin & Fura                                       |
|---------------------------------------------------------------|--------------------------------------------------------------------------------------|---------------------------------------------------------|-------------------------------------------------------------|----------------------------------------------------------------------------------|
| <b>Advantages:</b>                                            |                                                                                      |                                                         |                                                             |                                                                                  |
| Will detect $\text{Ca}^{2+}$ concentrations above $10^{-6}$ M | Best signal to noise ratio                                                           | Can sample discrete areas of the cell                   | High selectivity for $\text{Ca}^{2+}$ over $\text{Mg}^{2+}$ | Incorporated into cells by simple incubation                                     |
| Very sensitive to fast, high calcium transients               | No reported side effects on cell function                                            | Highly selective for $\text{Ca}^{2+}$                   | Show large chemical shift on binding $\text{Ca}^{2+}$       | Most sensitive probes below $\text{Ca}^{2+}$ concentrations of $10^{-7}\text{M}$ |
| Linear response in the cytoplasmic calcium range              | Very sensitive to fast calcium transients                                            | Causes no buffering artifacts                           | Can quantify extent of interfering metals                   | Lower intracellular concentration needed with newer probes                       |
| *****                                                         | Little compartmentalisation into organelles                                          | *****                                                   | Incorporated into cells by simple incubation                | Comparatively low cost of detection equipment                                    |
| *****                                                         |                                                                                      |                                                         |                                                             |                                                                                  |
| <b>Disadvantages:</b>                                         |                                                                                      |                                                         |                                                             |                                                                                  |
| Forms toxic artifacts which can damage cells                  | Relatively insensitive at resting $\text{Ca}^{2+}$ ranges                            | Risk of impalement damage on insertion of electrode tip | High intracellular concentration needed for detection       | Forms toxic artifacts which can damage cells                                     |
| Poor selectivity for $\text{Ca}^{2+}$ over $\text{Mg}^{2+}$   | Rapidly and irreversibly consumed at $\text{Ca}^{2+}$ levels above $10^{-5}\text{M}$ | Localised $\text{Ca}^{2+}$ transients may be missed     | Cells need to be maintained in much denser suspensions      | Fura partitions into organelles and binds to cell membranes                      |
| Least favourable signal to noise ratio                        | Loading of cells can be problematic                                                  | Unsuitable for measuring fast high transients           | Prohibitively expensive detection equipment                 | Leakage and photobleaching can affect calibrations                               |
| Has to be micro-injected into cells                           | *****                                                                                | Technically very demanding                              | *****                                                       | Sensitivity declines above $5 \times 10^{-7}\text{M}$                            |

## 1.7 THE TETRACARBOXYLATE FLUORESCENT CALCIUM INDICATORS

These fluorescent calcium indicators are tetracarboxylic acid derivatives of the calcium chelator ethylene glycol bis( $\beta$ -aminoethyl ether)-N,N'-tetraacetic acid (EGTA). They were first synthesized by Dr Roger Tsien and colleagues in the early 1980's and their development has since revolutionised  $[Ca^{2+}]_i$  measurements in individual cells and tissues [Tsien 1980, Tsien 1981, Tsien *et al* 1982, Rink 1983, Grynkiewicz *et al* 1985, Rink & Pozzan 1985, Tsien *et al* 1985, Rink 1988].

The tetracarboxylate fluorescent indicators are polyanionic and hence, for the most part membrane impermeable. Whilst, as such, they may be injected into the cytoplasm of large cells, the unique feature of Tsien's work was to mask the carboxylate groups with acetoxymethyl (AM) ester groups. The resulting derivatives were uncharged and hence penetrated plasma membranes, usually, without difficulty to accumulate in the cytosol. Once inside the cell, the AM esters were hydrolysed back to the impermeable parent compound by cytoplasmic esterases present in most, *but not all*, cells — thereby trapping the indicator inside the cell. The ability to incorporate these indicators by simple incubation of cells in indicator solutions is probably a major reason why this range of probes has become so popular. Once the indicator is hydrolysed, it then binds  $Ca^{2+}$  which causes a shift in the probe's excitation spectrum and an increase in the intensity of the fluorescent signal.

The original probe designed by Tsien's laboratory was QUIN-2AM (fig 1a) [Tsien 1980, Tsien 1981, Tsien *et al* 1982]. However their probe had certain drawbacks namely;

1. Low selectivity for  $Ca^{2+}$  over  $Mg^{2+}$ .
2. QUIN exhibited low fluorescence and produced little spectral shift on the addition of  $Ca^{2+}$ .
3. As a consequence of 2, large amounts of the probe had to be incorporated into the cell which resulted in an often significant buffering effect.

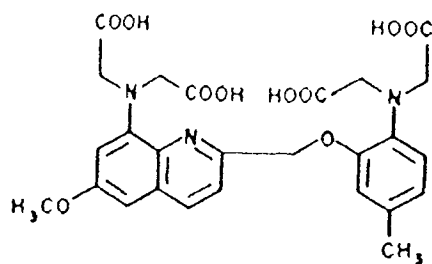

Fig 1a Structure of QUIN-2

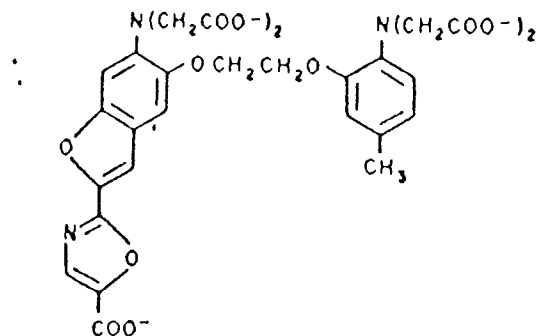

Fig 1b Structure of FURA-2

However, another fluorescent probe was subsequently developed by Tsien's laboratory called FURA-2AM (fig 1b) [Grynkiewicz *et al* 1985, Tsien *et al* 1985] which had certain distinct advantages over QUIN-2AM.

1. On binding  $\text{Ca}^{2+}$ , the peak of its excitation spectrum shifted from 360 to 340nm. This enabled differential recordings to be made (with the appropriate equipment) which increased the sensitivity of the detection system.
2. The fluorescent intensity of FURA was 30 times greater than that of QUIN [Cheung 1987] which meant that less indicator had to be incorporated into the cells to give a good signal to noise ratio — thereby reducing buffering effects. However, FURA unfortunately has a tendency to compartmentalise into organelles more than QUIN.

Other fluorescent indicators are now also commercially available which each have slightly different advantages and disadvantages eg INDO-1, FLUO-3 and RHOD-2 (Molecular Probes). However, at the time the present study commenced only QUIN and FURA were the main fluorescent probes available and about which there was the most technical information.

Although QUIN has been used by other workers to measure  $[\text{Ca}^{2+}]_i$  in renal epithelium [Sakhrani *et al* 1985, Goligorsky *et al* 1986a, Hruska *et al* 1986, Murphy *et al*

1986, Tang & Weinberg 1986, Fujii *et al* 1988], it was decided to use FURA in the present study in order to overcome the noise produced by extracellular components (appendix 1) and at the same time alleviate any potential buffering effects. FURA has also been used to measure  $[Ca^{2+}]_i$  in renal epithelium [Goligorsky *et al* 1986b, Smith *et al* 1987b, Stassen *et al* 1987, Aboolian & Nord 1987, Nord 1987, Batlle *et al* 1988, Holohan *et al* 1988, Inui *et al* 1988, Trump & Berezesky 1989]. However, most of this work has been in cultured renal epithelium with very little work in whole PTs [Llibre *et al* 1988] — and the majority of that in *abstract* form only [Jacobs *et al* 1987, Llibre *et al* 1987, Yanagawa 1987].

In authoritative reviews of the fluorescent indicators by Rink & Pozzan 1985 and Rink 1988, it was emphasized that each cell system is different and that the conditions of use for the fluorescent indicators (together with appropriate controls) *must* vary accordingly. As a consequence it was felt unwise to simply adopt FURA loading conditions etc from previous work using other renal systems and to develop the necessary experimental protocols *de novo*. In addition, certain facets of the PT systems developed meant that some esoteric controls also had to be made (Chapter 6).

Considering that laboratory experience in the use of these indicators was virtually non-existent and that information regarding use of the fluorescent indicators in whole PT systems was so scant, these experiments were undoubtedly a highly ambitious undertaking. Yet it was felt at the time that the potential advantages of measuring  $[Ca^{2+}]_i$  levels in a PT system that had undergone no de-differentiation, was apparently very well preserved structurally and that still maintained its inter-cellular connections was worth the 'risk'. Even if unsuccessful, knowledge of the faults and capabilities of the new PT system would certainly be increased.

## 1.8 AIMS AND OBJECTIVES OF THE PROJECT

The aim of the project was to find a way of isolating PTs from the Fischer rat which were sufficiently intact to be suitable for both *in vitro* suspension studies and as explants for tissue culture. Various collagenase isolation techniques were attempted

initially but, because of the extent of damage produced by even the mildest collagenase dispersion, a non-enzymatic mechanical method of PT isolation was developed. A preliminary comparative study was then conducted of the morphological and biochemical integrity of PTs isolated by the new mechanical technique against those isolated by collagenase perfusion. Finally attempts were made to develop protocols for the use of FURA in mechanical and collagenase isolates in order to employ cytosolic calcium measurements as indicators of toxic insult.



~~~ CHAPTER 2 ~~~

EVOLUTION OF THE MECHANICAL TECHNIQUE FOR ISOLATING RAT PROXIMAL TUBULES

The initial aim of the project was to find a way of isolating rat proximal tubules which were sufficiently intact to be suitable for both *in vitro* suspension studies and explant-type culture. Examination of the literature generated many different techniques for the isolation of PTs. However, after eliminating microdissection because of the low yield and need for expensive specialised equipment, the remaining techniques resolved into three basic categories;

1. Whole cortex digestion and centrifugation.
2. Enzyme perfusion and centrifugation or graded sieving.
3. Mechanical separation and purification.

Whole cortex digestion was tackled firstly then, based on the results obtained, the remaining two methods were attempted in the hope of assuaging some of the problems of whole cortex digestion.

2.1 GENERAL MATERIALS AND METHODS

2.1.1 Animals and materials

All experiments in this study used male Fischer F344 rats supplied by Charles Rivers UK Ltd. They were kept in standard animal house conditions of 12 hours light at 20-25°C and allowed free access to tap water and Heygates modified rat and mouse breeding diet, type 422. All chemicals and materials in this study were of analytical grade and obtained from the Sigma Chemical Company, unless otherwise stated.

2.1.2 Perfusion Apparatus

The initial perfusion apparatus was a gravity flow reservoir system — akin to a hospital drip. For various reasons, however, this proved to be unsatisfactory and an

alternative system was sought. The final perfusion apparatus consisted very simply of a 50ml plastic syringe with a 19G luer gauge needle (Terumo) over the end of which was attached 150mm of plastic 1.27mm OD cannula tubing (Portex). A mechanical injection system would undoubtedly have been better, but one was not available to the project.

The perfusate required was drawn into the syringe and then flushed out through the system to remove any dust or previous perfusates. The perfusion line was primed by drawing perfusate *slowly* into the syringe, so as to avoid forming air bubbles, and attaching the needle with the cannula to the syringe. Perfusate was then injected into the cannula tubing, ensuring that all air bubbles were removed from the line. It was important that the perfusate loaded right to the tip of the cannula tubing so that no air bubbles entered the aorta when the cannula was inserted; it was also important to ensure that no air was introduced to the system when syringes were changed over for the addition of fresh/new perfusate. With the use of a clock, the perfusion pressure was adjusted to maintain a flow of about 10-15ml min⁻¹ and throughout the perfusion procedures, all perfusion fluids were gassed whenever possible.

2.1.3 Dissection procedure for renal perfusion

Both the enzyme perfusion and the mechanical separation utilized the technique of renal perfusion and the following section describes the surgical procedures that were common to both methods.

Surgical procedures

i. Each Fischer rat was anaesthetised with fentanyl citrate and fluanisone (Hypnorm®, Janssen) 0.3mgkg⁻¹ subcutaneously and given the muscle relaxant Diazepam (Dialar) 2.5mgkg⁻¹ intraperitoneally. When fully anaesthetised, the abdominal cavity was opened up and the intestines were displaced to expose the kidneys and vessels beneath.

- ii. The dissection diagram is summarised in Fig 2a. Keeping the abdominal cavity well irrigated with normal saline (NS) at 37°C, the aorta and vena cava were separated approximately 1cm above the bladder (A) and two threads (Silko) were placed around the aorta, but were not tied off yet.
- iii. To prevent perfusion of the intestinal vasculature, the two mesenteric vessels (found in the connective tissue surrounding the loop of intestine nearest the aorta) were tied off firmly (B&C).
- iv. A portion of the aorta, just above the superior renal artery was cleared (D) and a thread was placed around the aorta but was not tied off yet.
- v. A portion of the vena cava, just above the superior renal vein (E) was cleared in preparation for being cut quickly at the start of perfusion.
- vi. The rat was heparinised with a single dose of heparin (Evans) 25,000U intravenously to facilitate perfusion and 5mins were allowed for the heparin to take effect.
- vii. The perfusion line was primed (described in section 2.1.2) and the threads on the upper and lower aorta (A&D) were tied off firmly. A small incision was made into the aorta, approximately 0.5cm above the lower tie (F), and the cannula was inserted into the aorta as quickly as possible.
- viii. The perfusion of NS at 37°C was started and the vena cava was rapidly slit (E) to release the perfusate. The cannula was tied firmly in place with the second thread placed at A.
- ix. If the rat had not died by the end of the perfusion period, it was killed by puncturing the diaphragm and inducing a pneumothorax.

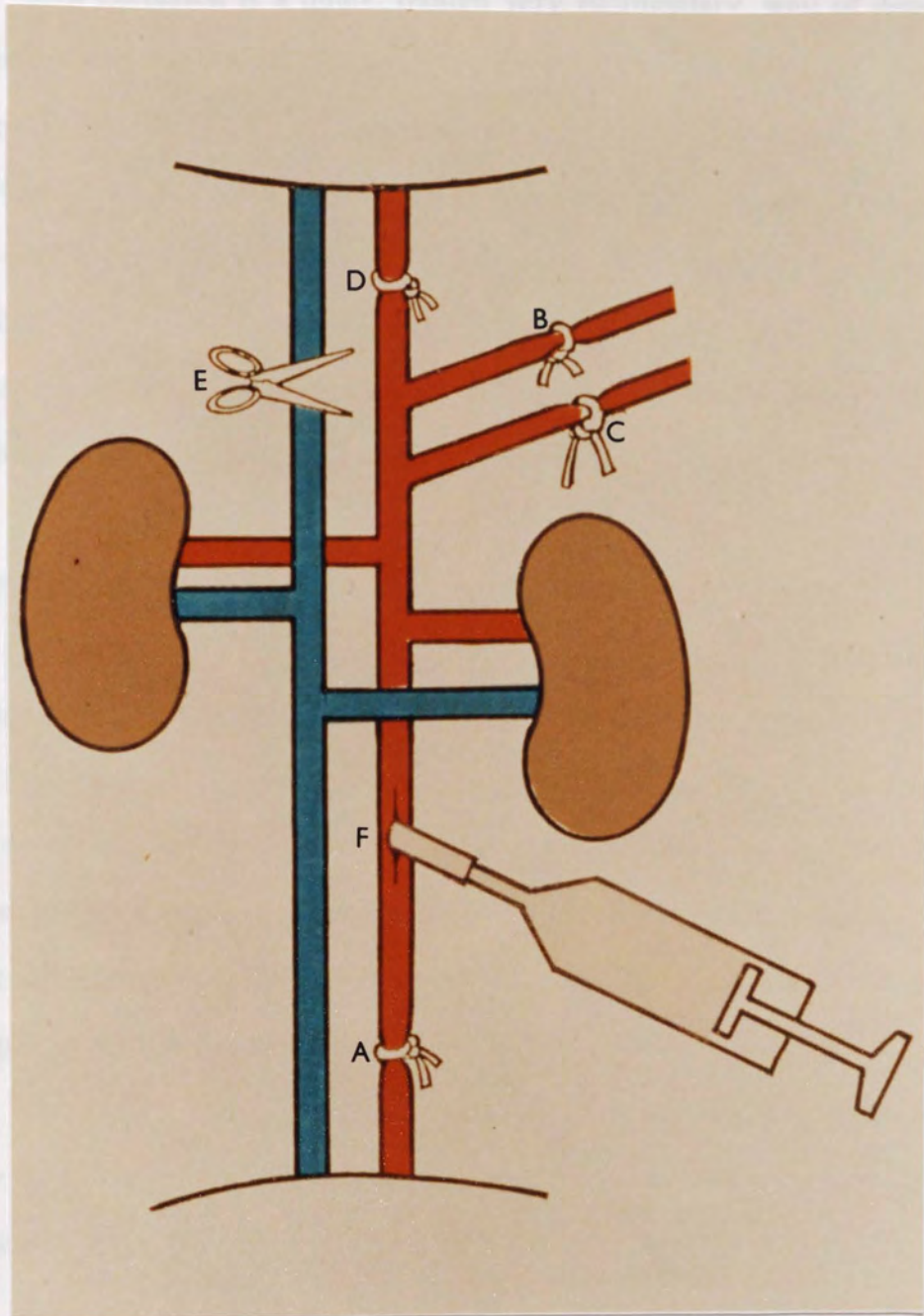

Fig 2a Diagrammatic representation of the surgical procedure required for renal perfusion; see text for details.

2.1.4 Trypan Blue exclusion viability test

Dye exclusion is a quick, though very rudimentary, way of determining cellular viability. A 0.5% (w/v) solution of the dyestuff Trypan Blue was made up in water. Equal volumes of PT suspension in Krebs-Henseleit (KHS) and Trypan Blue solution were mixed on a glass cavity slide and viewed under a microscope within 1-5min. Non-viable tubules appeared blue, with the nuclei staining particularly darkly, whilst viable tubules showed little or no blue staining whatsoever. The number of viable tubules was expressed as a percentage of the total number of tubules counted. The assay was repeated three times in total and an average was taken.

2.1.5 Periodic Acid Schiff (PAS) differential staining protocol

The PAS reaction is used for staining carbohydrates, polysaccharides and mucosubstances. It involves using periodic acid to hydrolyse carbon bonds (C-C), presented in the form of adjacent 1:2 glycol groups (CHOH-CHOH) and subsequently oxidising them to aldehydes (CHO). These aldehydes recolour the colourless Schiff's reagent and so PAS reactive groupings therefore develop a crimson colouration. Periodic acid is the preferred agent as it does not continue to oxidise the aldehydes to carboxyl (COOH) groups once they have been formed.

The PAS reaction is capable of distinguishing between proximal and distal tubules by highlighting the brush border membrane which is present in proximal tubules though absent in the distal.

Staining protocol.

On examining the literature it was found that PAS staining protocols varied widely. The reason for this was unclear but one reason might be that Schiff's reagent is prone to significant batch variations and protocols may have to be adapted accordingly. Even once a protocol is established, it is advisable to do control sections with each new solution batch. The staining protocol used in this study is shown in fig 2b.

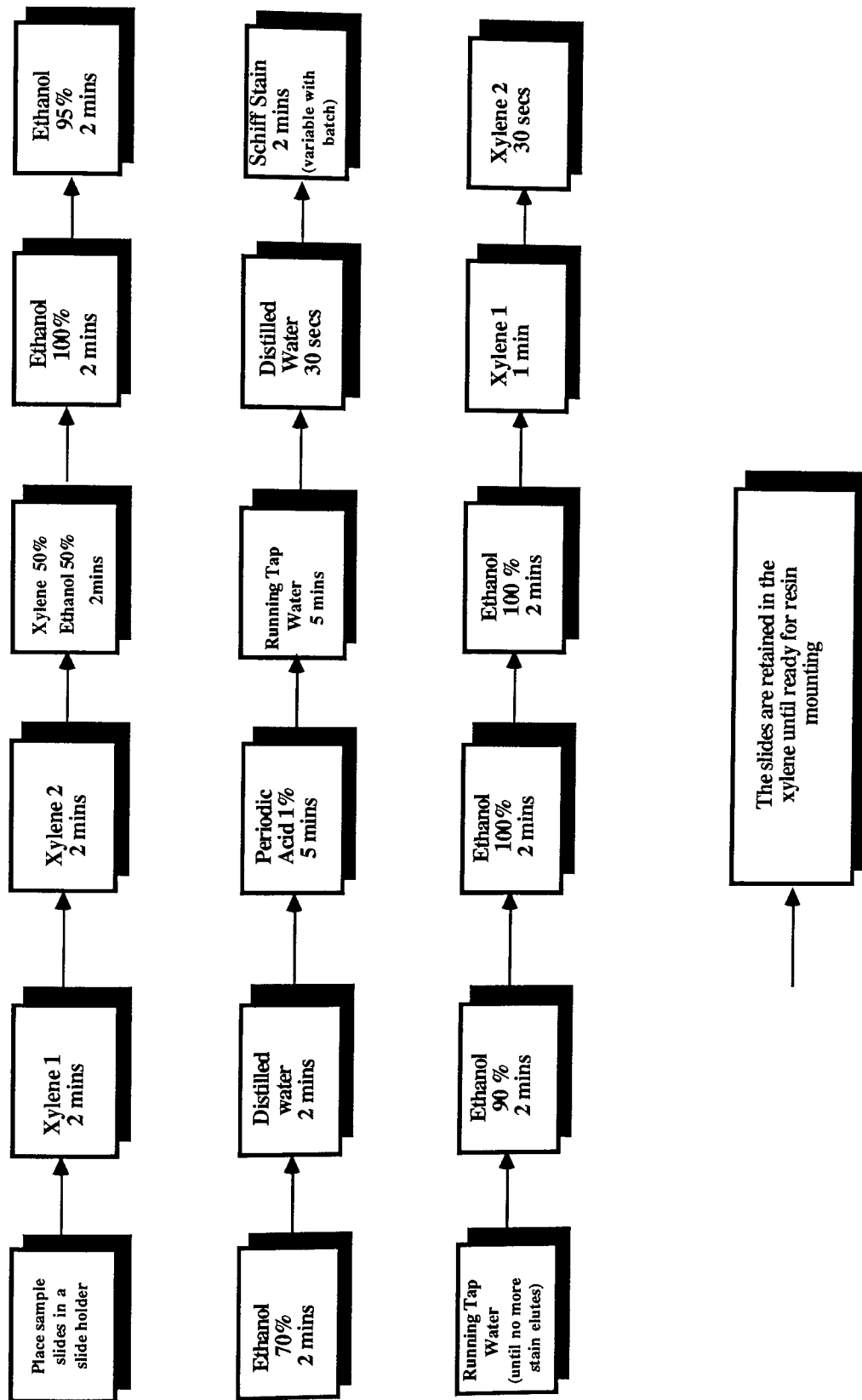

Fig 2b PAS Staining Protocol

The prepared slides were placed in slide holders and immersed successively in the various chemicals for the times stated. If the slides were prepared by air-dry mounting, the initial xylene and xylene:ethanol stages were omitted and the slides started the protocol at the 100% ethanol stage. Slides from wax sections however had to go through the xylene stages to remove the wax and render them hydrophilic for staining.

The colourless Schiff's reagent (BDH chemicals) remains active for approximately three months if stored in a light occlusive bottle in the refrigerator and should be discarded if a pink colouration develops. However it was found that to obtain reproducible results, the reagents should be brought to room temperature before use.

Once the treated slides were completely dry, they were examined by LM for purity and structural integrity.

2.2 ISOLATION OF PTs BY THE WHOLE CORTEX DIGESTION TECHNIQUE

This is the most popular form of tubule isolation and there are many variations of this technique [Scholer & Edelman 1979, Vinay *et al* 1981, Gesek *et al* 1987, Schnellman 1988]. The version adopted in this study was loosely based on the method of Vinay *et al* 1981.

2.2.1 Tubule Isolation Protocol

Cortex Digestion

i. Two 300-400g Fischer rats were killed by cervical dislocation and their kidneys were removed, decapsulated and placed in iced (KHS) buffer gassed with 95%O₂/5%CO₂ (British Oxygen Company). Unless otherwise stated, all subsequent gassing was with 95%O₂/5%CO₂.

- ii. The cortex was carefully removed, cut into small pieces, washed three times with iced gassed KHS and placed in a 250ml flask that had been siliconised with Sigmacote® to prevent tissue adhesion.
- iii. 100ml of 0.05%(w/v) collagenase solution (Type IV Sigma) in KHS, which had been gassed continuously and incubated at 37°C, was then added to the flask.
- iv. This whole cortex suspension was incubated in a shaking water bath at 37°C for 20min, with continuous gassing, and then filtered through a 140µm nylon mesh (Henry Simons Ltd, PO Box 31, Stockport, Cheshire). The mesh was rinsed with iced KHS and the filtrate collected was stored on ice to stop the digestion process.
- v. Retained, undigested cortex was returned to the flask and 50ml of fresh collagenase solution was added. Step iv was repeated using 10 min incubation periods until all the tissue was digested ie. approximately 2-3 times.
- vi. The digested cortex suspension was washed free of the collagenase by centrifuging (Beckman) at 60 x g (500rpm) for 30 sec, discarding the supernatant and resuspending the pellet rapidly with iced, gassed KHS. This procedure was repeated three times in total.

Separation by centrifugation

- vii. Following the final washing stage, the pellet was resuspended in 120ml of iced centrifugation medium that had previously been gassed for 30min at 20°C. The composition of the medium was Percoll® based and had the formula;

| | |
|--------------------|-------|
| Percoll® | 75mls |
| NaCl | 983mg |
| CaCl ₂ | 44mg |
| NaHCO ₃ | 325mg |
| KCL | 11mg |

| | |
|---------------------------------|-----------|
| KH ₂ PO ₄ | 32mg |
| H ₂ O | to 150mls |

NaCl was used to adjust the medium to 300mOsm kg⁻¹.

viii. The 120ml of Percoll medium, containing digested cortical sample, was divided into 4x30ml aliquots, placed in 4x50ml centrifuge tubes and centrifuged (Beckman) at 12,000 rpm for 30min at 4°C.

ix. This separated the sample into four distinct bands. The band nearest the bottom of the centrifuge tube was claimed by Vinay *et al* 1981 to contain the enriched proximal sample and this was removed with a pasteur pipette.

x. The Percoll was removed from the proximal fraction by diluting the freshly removed sample with 30ml of iced, gassed KHS, centrifuging at 60 x g (500 rpm) for 30sec, removing the supernatant and resuspending the fraction in KHS. This was repeated three times in total.

The fraction isolated by this method has been claimed by Vinay *et al* 1981 to be a relatively pure sample of proximal tubules and these could now be subjected to identification and validation.

2.2.2 Morphological Examination

The aim of this examination was to discriminate between proximal and distal tubules and thus enable the purity of the PT samples to be evaluated.

METHODS

Differential Periodic Acid Schiff staining

The protocol for PAS staining is given in detail in section 2.1.5. PAS staining was performed on fixed whole tubules and fixed sectioned tubules.

i. Fixed whole tubules — Freshly isolated tubule samples were fixed in 2.5% (v/v) glutaraldehyde (BDH) for 1hr at 4°C. Small aliquots were then placed onto chrome alum slides [Carleton 1980] and allowed to air-dry.

ii Sectioned tubules — Freshly isolated tubule samples were pelleted from iced KHS at 3,000 rpm for 5min. The KHS was then removed and replaced with 2.5% (v/v) glutaraldehyde. The pellet was allowed to fix overnight at 4°C and was then mounted in wax by standard techniques [Carleton 1980] for sectioning onto chrome-alum slides.

PAS staining was then performed on both preparations which were then viewed by light microscopy (Zeiss).

Histological Vital Staining

An alternative method of tubule differentiation was suggested by Jacobsen *et al* 1967 and consisted of injecting the rats intraperitoneally with 200mgkg⁻¹ Trypan Blue solution 48 hours before they were killed for the isolation procedure. The tubules obtained from these pre-treated kidneys were then prepared as whole tubule and wax section preparations as described above for viewing by light microscopy.

2.2.3 Results

According to Vinay *et al* 1981, the PT sample produced by their technique had a purity of approximately 98%. It was necessary, therefore, to verify this value in the analogous preparation produced in this study. Freshly isolated PT samples, viewed in KHS on a cavity slide by light microscopy, consisted mainly of short intact tubular structures together with a moderate population of tubule fragments and cellular debris. At this stage of the project, however, there was insufficient experience with tubule systems to enable percentage purity to be assessed by direct visual inspection of fresh isolates and so various staining techniques were employed to facilitate differentiation.

The first of these was vital staining with Trypan Blue. This has been used as a vital and post-mortem stain [Linshaw *et al* 1986] as it is sequestered by proximal but not distal tubules. Despite the fact, however, that after two days of vital staining every conceivable piece of living tissue possessed by the rat had stained some shade of blue, when the isolated whole PT samples were viewed under light microscopy only a generalised faint blue colouration was seen in all tubules. The same generalised staining also appeared in the sectioned PT samples as well. Examination of unpurified tubule samples (known to contain distal elements) showed that the blue colouration was so faint that it was not really possible to make definitive identifications of proximal and distal elements. As the results of Trypan Blue vital staining were inconclusive, the PT sample was then subjected to PAS differential staining.

PAS stains whole PTs dark mauve and whole distal tubules a lighter mauve whilst in cross-section, the brush border membranes (BBMs) of the PTs stain dark pink thus distinguishing them from the distal tubules which have no brush border. When PAS staining was performed on whole fixed PT samples, however, all the tubules stained dark mauve and no colour distinction was observed. Although this might have initially seemed to imply 100% purity, this would in fact have been an erroneous assessment as an unpurified tubule sample (known to contain distal elements) also failed to generate differential staining patterns. Staining controls on cortical slices produced the classic differential staining patterns expected — suggesting that the fault lay in the tissue rather than the staining technique.

When the sectioned PT samples were stained with PAS little or no distinct BBM staining was detected and the PAS was seen to have entered the cytoplasm (fig 2c). This suggested that the BBMs were either totally destroyed or sufficiently damaged so as to preclude selective staining. This aberrant staining meant that it was not possible to conclusively evaluate PT sample purity at his stage. However when more experience was acquired, purity was again evaluated by direct visual inspection on unstained fixed whole

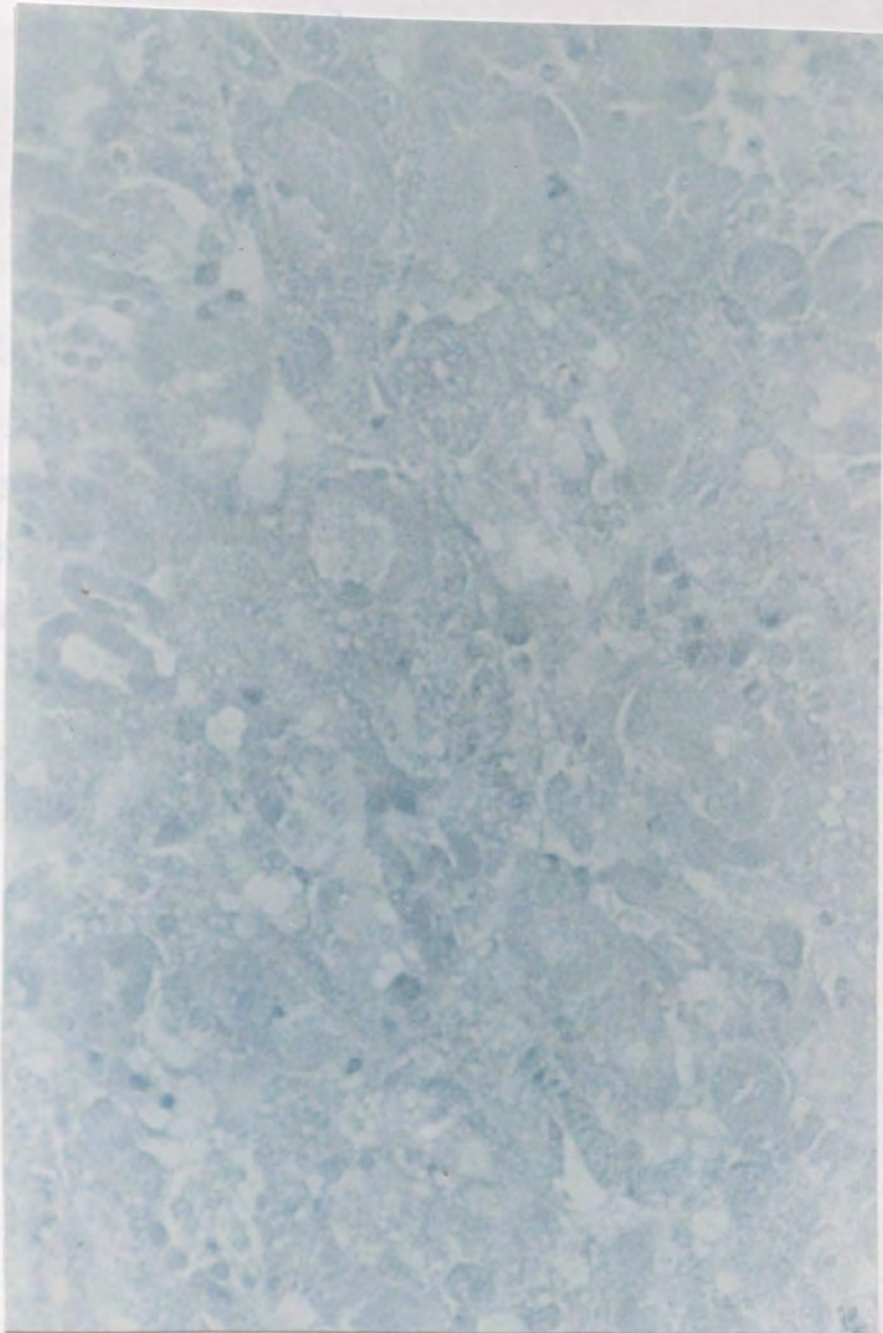

Fig 2c PAS stained wax section of a PT sample isolated by the whole cortex digestion technique described in section 2.2.1.

The PAS stain fails to produce characteristic differential staining of the brush border membrane of the PT and thus it is not possible to distinguish between proximal and distal elements.

PT samples and found to be > 95%. Due to their aberrant staining patterns, no further validation was carried out on these PT samples.

2.3 ISOLATION OF PTs BY THE ENZYME PERFUSION TECHNIQUE

Due to its intricate nature, collagenase perfusion is probably the least popular of the enzyme isolation techniques. Yet its use has often been adopted by experimenters keen to increase tubule longevity [Green *et al* 1987]. Collagenase perfusion was attempted in this study to try and assuage some of the damage seen in the whole cortex digestion technique and also because of difficulties experienced in the initial experiments on mechanical cortex disruption (described in section 2.5). The procedure is described for one rat, but may be repeated as required.

2.3.1 Tubule isolation protocol

- i. One Fischer rat was anaesthetised and dissected for renal perfusion according to the procedures described earlier. The kidneys were perfused firstly with NS at 37°C until all renal blood was removed and the kidneys were a pale greyish pink colour.
- ii. The perfusate was changed to a solution of 0.05% (w/v) collagenase in KHS at 37°C and perfused for 3-5min. During this time it was important to flush the abdominal cavity with warm NS to remove the spent collagenase as, if left, it tended to digest the renal vasculature causing bursting during subsequent perfusions.
- iii. The collagenase was removed by flushing the kidneys through with gassed KHS at 25°C for approximately 3-4min.

iv. Finally, the kidneys were perfused with a suspension of 0.5%w/v Fe_3O_4 (magnetic iron oxide BDH) in KHS at 25°C until the cortex turned a *uniform* grey-black colour — indicative of a good perfusion.

v. The kidneys were removed, decapsulated and the outer cortex was dissected off in thin slices with a scalpel. The cortex slices were chopped into 1mm² pieces and suspended in approximately 5ml of iced gassed KHS.

vi. A 15cm² piece of 140µm mesh was stretched over a siliconised beaker and secured in place with an elastic band. The cortex suspension was poured onto the mesh and washed through with a spray (Boots) of iced gassed KHS. From this point onwards all glasswear was siliconised with Sigmacote® and all tissue suspensions were kept on ice and gassed whenever possible with 95%O₂/5%CO₂.

vii. Glomeruli and vasculature, loaded with Fe_3O_4 , were removed by dipping a strong horseshoe magnet into the tubule suspension whilst the mixture was agitated by the gassing line. At intervals the magnet was removed, cleaned and replaced until no further magnetic material was attracted.

viii. PTs were separated from the resultant tubule suspension through retention on a 64µm nylon mesh (Henry Simon Ltd). The suspension was poured onto a 15cm² piece of the mesh stretched over a beaker and *gently* spray washed with an iced KHS spray to ensure that all tissue <64µm in diameter passed through the mesh.

viii. The tissue retained by the mesh at this stage was the final sample enriched in PTs. This could then be spray-washed off the mesh into an appropriate vehicle/medium for further use.

There were, however, several difficulties which had to be overcome during the development of this technique

2.3.2 PAS differential staining

Tubules isolated by whole cortex digestion failed to exhibit characteristic PAS staining, which made it difficult to discriminate between proximal and distal elements. It was hoped that collagenase perfusion would cause fewer structural alterations and facilitate differential staining. This was important, not only for evaluation of the purity of the PT sample, but also in the decision regarding the choice of size of the final separating mesh (described in section 2.3.3).

Samples of unpurified, fixed whole tubules (collected after magnetic removal of the iron loaded glomeruli) were stained with PAS. The proximal and distal elements in the unpurified sample showed the differential patterns characteristic of PAS staining — suggesting a potential improvement in structural preservation over PTs isolated by whole cortex digestion. This result meant that PTs could now be distinguished following this form of collagenase separation and that there was, therefore, merit in developing it as an enzymatic method of isolating PTs.

2.3.3 Rationale for the choice of separating mesh

Once the renal cortex was dispersed and the glomeruli removed, the PTs had to be separated from the resultant tubule mixture. This was done by sieving the tubule mixture on nylon mesh. To ensure that only *PTs* were harvested, the correct mesh size had to be calculated and this was done by measuring the diameters of *freshly* isolated proximal and distal elements. Measurement of fixed tubules was futile as during the fixation process the tubules were dehydrated and therefore shrank considerably.

After studying several slides of PAS stained tubule mixtures, it eventually became possible to distinguish between freshly isolated, unfixed proximal and distal elements placed on a cavity slide with KHS. In fact three distinct tubular structures were seen in the unpurified tubule sample namely proximal and distal tubules together with collecting ducts and the salient discriminatory features of these three elements are described in detail in Chapter 3.

An eyepiece graticule was attached to the microscope (Zeiss) and calibrated for each optical power. A sample of freshly isolated tubule suspension was then examined under the microscope and the diameters of the various tubule elements were measured. The diameters of ten examples of each element was measured and multiplied by the appropriate calibration factor to give a size-range for each nephronal element. The values obtained for a 250-350g Fischer rat are summarised below:

| <u>Nephronal Element</u> | <u>Diameter (μm)</u> |
|--------------------------|--|
| Proximal Tubule | 62-66 |
| Distal Tubule | 54-58 |
| Collecting Duct | 46-50 |

Based on these values, a 60 μm nylon mesh would have been the optimal choice, however, only 53 and 64 μm meshes were available commercially. Metal meshes were available in a 60 μm gradation, but it was felt that these were possibly too harsh for separating tubules. The only viable option, therefore, was to use a 64 μm mesh for separation — with the consequent loss of yield having to be accepted.

After the choice of a 64 μm separating mesh, PTs could then be isolated from the suspension of mixed nephronal elements. When the freshly isolated tubules were viewed in KHS on a cavity slide by light microscopy, a much 'cleaner' PT specimen was observed. The sample consisted mainly of short, intact tubular structures with very few PT fragments and virtually no cellular debris. Purity of the PT samples was evaluated initially with the aid of PAS differential staining and later, as more experience was acquired, by direct visual inspection of fresh, unstained isolates. In the early stages of development, the PT samples obtained by enzyme perfusion had an unacceptable level of glomerular contamination of around 12% (± 1.45) with distal contamination rarely exceeding 2%. However, through procedural modifications of their magnetic removal

(described in section 2.4), this was largely overcome and the eventual purity of the final PT sample was consistently assessed to be > 95%.

2.3.4 Trypan Blue Exclusion

Exclusion of Trypan Blue (described in section 1.1.4) in these PTs was difficult to interpret due to the fact that the cut ends of the tubules took up the dye to varying degrees. Also if the tubules were left in the dye for longer than approximately 15min, they started to *transport* the dye into the cytosol. Nevertheless, if a tubule had over half its central length unstained it was considered viable. Even then, in the initial experiments, viability was poor at approximately 65-75% but again, with procedural modifications (described later), this value was improved until eventually the percentage viability was found consistently to be > 80%. Vital staining with Trypan Blue was no longer attempted because the deep navy blue colouration it produced in the kidneys made it difficult to visually discriminate between cortical and medullary tissue — also PAS staining was now producing useful results which obviated the need for vital staining.

2.4 ISOLATION OF PTs BY THE MECHANICAL ISOLATION TECHNIQUE.

Mechanical isolation is the least popular method for isolating renal tubules and, in the past, has usually consisted of forcing tissue through a series of metal meshes [Phillips 1968] or needles [Zaroff *et al* 1961]. The technique described here evolved from the work of Meezan *et al* 1975, Brendel & Meezan 1975 and Chung *et al* 1982. The procedure detailed below is the full and final method developed for the mechanical isolation of rat proximal tubules.

2.4.1 Tubule isolation protocol

- i. One Fischer rat was anaesthetised and dissected for renal perfusion according to the procedures described earlier. The kidneys were perfused firstly with NS at 37°C until all renal blood was removed and the kidneys were a pale greyish pink colour
- ii. The perfusate was changed to a suspension of 0.5%w/v Fe₃O₄ in KHS at 25°C and perfused until the cortex turned a *uniform* grey-black colour — indicative of a good perfusion.
- iii. The kidneys were removed, decapsulated and the outer cortex was dissected off in thin slices with a scalpel. The cortex slices were chopped into 1mm² pieces and suspended in approximately 5ml of iced gassed KHS.
- iv. The cortex suspension was poured into a specially constructed hand homogeniser with a loose fitting, tear shaped pestle (described later) and homogenised with 2-4 spiralling *not vertical* strokes of the pestle — thereby ensuring no 'drag' on the pestle's movements at any time.
- v. The homogenised tissue was poured into a tea strainer (Tesco) and washed through into a siliconised beaker with a spray of iced gassed KHS.
- vi. The cortical tissue was spray-washed through a 140µm nylon mesh, stretched over a siliconised beaker, until only fluffy white connective tissue and iron loaded vasculature remained. This mesh had the function of not only disrupting the tissue still further, but also removing much of the extraneous tissue and vasculature present. From this point onwards all glassware was siliconised with Sigmacote® and all tissue suspensions were kept on ice and gassed whenever possible with 95%O₂/5%CO₂.
- vii. Glomeruli and vasculature, loaded with Fe₃O₄, were removed by dipping a strong horseshoe magnet into the tubule suspension whilst the mixture was agitated by the

gassing line. At intervals the magnet was removed, cleaned and replaced until no further magnetic material was attracted.

viii. PTs were separated from the resultant tubule suspension through retention on a 64 μ m nylon mesh (Henry Simon Ltd). The suspension was poured onto a 15cm² piece of the mesh stretched over a beaker and *gently* spray-washed with an iced KHS spray to ensure that all tissue <64 μ m in diameter passed through the mesh.

ix. The tissue retained by the mesh at this stage was the final mechanically isolated sample enriched in PTs. This could then be spray-washed off the mesh into an appropriate vehicle/medium for further use. The technique is summarised in fig 2d.

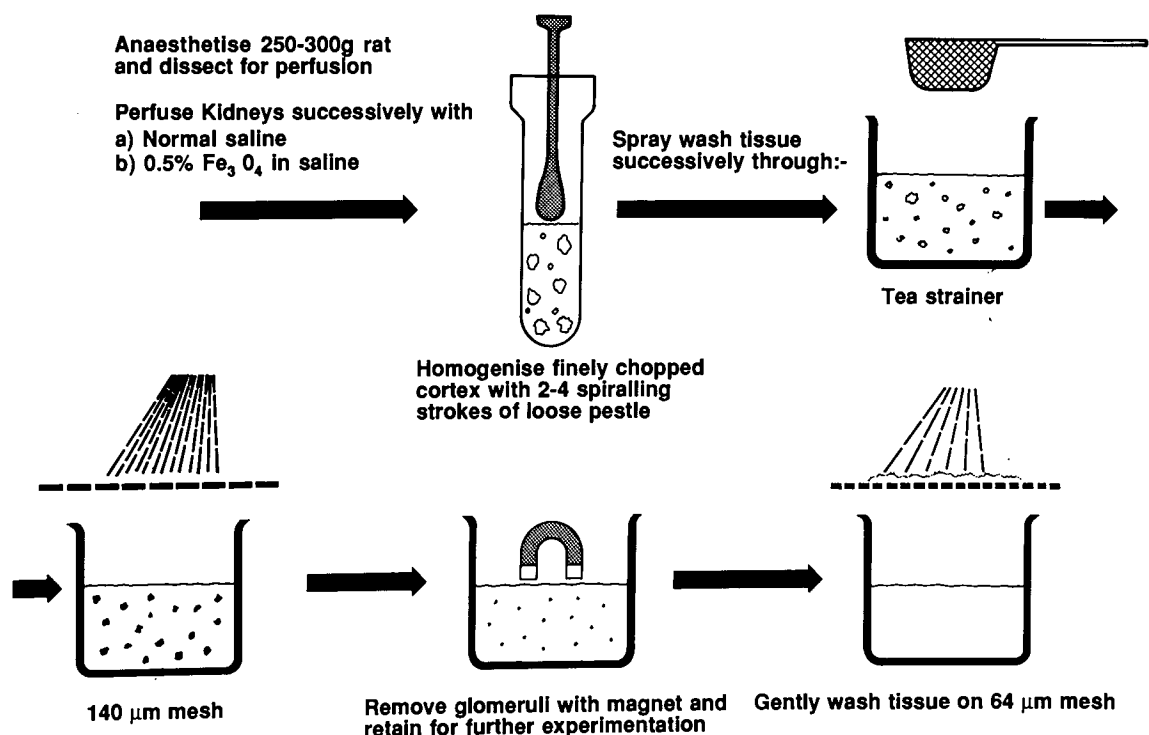

Fig 2d Schematic representation of the stages involved in the mechanical technique for the isolation of rat PTs.

The above procedure has been refined and standardised to produce maximum yield and viability with minimal contamination. However, two main areas of difficulty were encountered during the development of the method namely magnetic removal of glomeruli and cortical disruption. The following sections relate the technical problems incurred and how they were overcome.

2.5 DEVELOPMENT OF THE TECHNIQUE FOR CORTICAL DISRUPTION

Following the removal of the perfused kidneys and sectioning of the cortex it was seen that, in a good perfusion, the Fe_3O_4 had distributed itself evenly through the cortical area. A dissection microscope showed that the iron was confined mainly to the glomeruli and cortical vasculature although some medullary vessels (mainly in the collagenase perfusion preparations) did contain some Fe_3O_4 . Once the cortical tissue had been removed and chopped, the next stage of the procedure was to disperse the cortical tissue in order to release *intact* tubules and glomeruli from their connective tissue matrix. This exercise proved highly problematic and a number of different approaches to this problem were tried.

2.5.1 'Straightforward' Homogenisation

Brendel & Meezan 1975 described a mechanical dispersion consisting of six vertical strokes of a hand homogeniser with a 'loose' pestle — no indications of dimensions were given. By combining various pestles and homogeniser tubes found in the laboratory, three different 'loose pestle' homogenisers were obtained which gave varied clearances (distance between pestle and homogeniser tube) of 1mm, 2.5mm and 3mm. Each homogeniser was used in turn on samples of chopped cortex which were given either 2, 4 or 6 vertical strokes in each homogeniser and then spray-washed through

a 140 μ m nylon mesh with a spray of iced gassed KHS. Samples from the results of each disruption were placed in a cavity slide with some KHS and examined under light microscopy.

The results of this initial set of homogenisation experiments (table 2a) were disappointing

| No of strokes | Approximate clearances | | |
|---------------|------------------------|-------|-----|
| | 1mm | 2.5mm | 3mm |
| 2 | D | N | N |
| 4 | D | N | N |
| 6 | D | D | N |

Table 2a Evaluation of the effect of clearance (distance between the pestle and the homogeniser tube) and the number of vertical strokes on the mechanical dispersion of rat renal cortex by various cylinder homogenisers. N = no mechanical dispersion. D = tubules destroyed rather than dispersed.

The symbol D did not mean total tissue destruction but rather that, of the tissue dispersed, the glomeruli were largely intact but the tubules released were badly fragmented and/or reduced to its cellular components. The results indicated that the shearing distance of 1mm was too close and that of 3mm too far. The distance of 2.5mm appeared promising, but when an intermediate 5 strokes was used, the dispersed tissue was still damaged — suggesting that perhaps shearing distance and the number of strokes were not the only factors.

It was thought that the shearing length (ie the 'length' of pestle in contact with the homogeniser tube) might be a factor in that with standard cylindrical homogeniser pestles the area of pestle in contact with the tube was quite long (fig 2ei) and so a tissue might be subjected to a fairly prolonged and potentially damaging shearing stress.

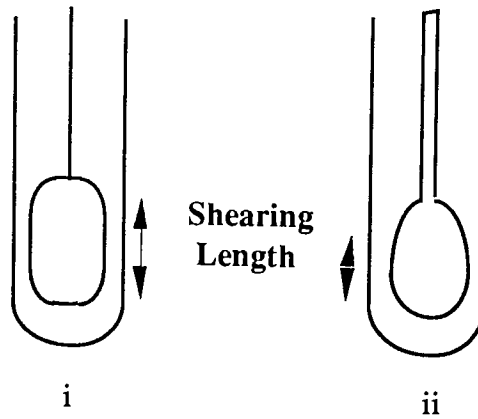

Fig 2e Diagrammatic comparison of the shearing lengths of the two homogeniser pestles used in the mechanical dispersion of rat renal cortex. The length of pestle in contact with the homogeniser tube (shearing length) is greater with the cylindrical pestle (i) than the tear-shaped pestle (ii).

On the other hand, a round or tear shaped pestle (fig 2eii) has a much shorter shearing length and therefore might possibly be less damaging.

From the adaptations made by Hjelle *et al* 1981 and Chung *et al* 1982 on the method of Brendel & Meezan 1975, it was decided to construct a different type of homogeniser. Hjelle *et al* 1981 described the dispersion of rabbit cortex by the use of four vertical strokes of an homogeniser with a tear-shaped loose pestle. As no dimensions were given and, from the results of the above homogenisation, it was arbitrarily decided to construct a pestle with a round or tear-shaped head which gave a clearance of approximately 2mm. The homogeniser used in this study was constructed by the University glassblower (fig 2f), but round headed pestles may be obtained commercially (Gallenkamp). The homogeniser was used on samples of chopped cortex which were given either 2, 4 or 6 vertical strokes in the homogeniser and then spray washed through a 140 μ m nylon mesh with a spray of iced gassed KHS. Samples from the results of each dispersion were placed in a cavity slide with some KHS and examined under light microscopy.

However the results obtained with the new homogeniser were only partially improved;



Fig 2f The homogeniser used in the present study for the mechanical isolation of rat PTs. The homogeniser has a specially constructed round-headed pestle which produces a clearance between the pestle and the tube of 2mm.

| No of strokes | 2 | 4 | 6 |
|---------------|---|---|-------------------------------|
| Effect | N | N | Mostly D but
some survived |

Table 2b Evaluation of the number of vertical strokes on the mechanical dispersion of rat renal cortex by an homogeniser with a tear shaped pestle and a 2mm clearance (distance between the pestle and the homogeniser tube). N = no mechanical disruption. D = tubules destroyed rather than dispersed.

The results in table 2b showed that after six strokes most of the disrupted tubules were fragmented but *not* reduced to cellular debris and, promisingly, approximately 20-30% of the released tubules were intact. So it seemed that the new pestle shape was an improvement but that some other factor would also have to be found that increased the tubule yield and this will be discussed later.

2.5.2 Sonication

Following the results of 'straightforward' homogenisation, sonication was attempted as another method of cortical dispersion. The first type of sonication used was a sonic probe (M S E). A sample of chopped cortex was placed with 10ml of iced gassed KHS in a bijou bottle which was then embedded in a beaker of ice in order to keep the sample cool during sonication. The sonicator probe was positioned just under the surface of the cortex suspension and the beaker of ice was clamped around the bijou bottle to hold it in place. Various samples of chopped cortex were sonicated at tunings of 14, 16, 18 and 22 for 2 or 4 sec bursts. Samples from the results of each dispersion were placed in a cavity slide and examined under light microscopy.

The other form of sonication attempted was a sonic bath (Gallenkamp). Chopped cortex, suspended in 20ml of iced gassed KHS, was placed in a siliconised

50ml glass beaker and placed in the sonic bath. The sample was gently sonicated for 5, 10 or 15min. Samples from the results of each dispersion were placed in a cavity slide and examined under light microscopy.

The results of the tissue disruption by the sonication probe are summarised in table 2c;

| Time (sec) | Sonicator Tuning | | | |
|------------|------------------|----|----|----|
| | 14 | 16 | 18 | 22 |
| 2 | N | N | D | D |
| 4 | N | N | D | D |

Table 2c Evaluation of the dispersive effect of a sonic probe on rat renal cortex applied at various tunings for either 2 or 4 sec. N = no mechanical disruption. D = Tubules destroyed rather than disrupted.

In this case the symbol D really did mean total tissue destruction. The sonicator probe disintegrated the cortical tissue into cellular debris and proved too harsh for the disruption of the cortex. It was decided not to persevere with finding a disruptive tuning between 16 and 18 because there were no gradations between these values on the dial of the sonicator and setting the probe consistently to the correct tuning (should it have been found) would have been virtually impossible. It was thought that a sonic bath might provide a gentler, more controllable form of sonication. The results of the tissue disruption by sonic bath are summarised in table 2d;

| Time (mins) | 5 | 10 | 15 |
|-------------|---|----|----|
| Effect | N | D | D |

Table 2d Evaluation of the dispersive effect of the application of a sonic bath to rat renal cortex for various times. N = no mechanical disruption. D = Tubules destroyed rather than disrupted.

When the tissue from the 10 and 15min sonication treatments were examined, curious lattice-like structures were the only visible tissues left and at first they were not readily identifiable. It was only when they were viewed at high power that it was realised that the lattices were actually sheets of connective tissue matrix with holes where the tubules used to be — the sonic bath had left behind the matrix and sonicated the tubules. On the basis of this result, it was decided to abandon sonication as a practical way of releasing intact tubules from the renal cortex.

2.5.3 'Modified' Homogenisation

Because the above initial attempts at mechanical dispersion were unsuccessful, collagenase perfusion (described in section 2.3.1) was brought in at this stage to alleviate some of the problems of mechanical dispersion. However the idea of a non-enzyme method of isolation had not been abandoned and a 'modified' style of homogenisation was subsequently developed.

The earlier results in section 2.5.1, on the use of the tear-shaped homogeniser pestle, seemed to offer promise in that at least a proportion of the tubules isolated remained intact and the aim was then to find a way to increase this value. After several different attempts, the method found to be most successful was a combination of homogenisation and sieving. The key to successful homogenisation appeared to be the use of *spiralling* rather than vertical strokes of the tear-shaped pestle. This style of homogenisation eliminated any 'drag' on the pestles movements which, it was felt, was the cause of the tubular damage. The tissue obtained by this method was not so much dissociated as 'teased out' and this weakened tissue could then be totally dispersed by spray washing it firstly through a tea strainer and then through the 140µm nylon mesh. This procedure produced complete dispersion of the renal cortex and yielded a population of virtually completely intact tubules.

Although the tubules were dissociated from their matrix intact, it was found that by the end of the total isolation procedure there was a reduction of viability to approximately 65-75% and an unacceptable level of glomerular contamination of around 12% (± 1.45). By taking tubule samples from various stages of the isolation procedure and subjecting them to Trypan Blue exclusion viability tests the problem area was found to be the method of magnetically removing the glomeruli. Attempts were, therefore, made to refine and standardise this stage in order to improve both purity and viability.

2.6 REFINEMENT OF THE TECHNIQUE FOR THE MAGNETIC REMOVAL OF THE GLOMERULI

The initial method used was that suggested by Hjelle *et al* 1981 and Chung *et al* 1982. It consisted of putting a magnetic stirring bar into a beaker containing the suspension of mixed nephronal elements and then placing the beaker on a magnetic stirrer — set to allow the bar to spin at a slow to moderate rate. At intervals the bar was withdrawn, cleaned and replaced in the suspension until no further magnetic material attached to the bar. This technique, however, had two drawbacks; Firstly, the bar's magnetic power was too weak to remove glomeruli which were only lightly loaded with Fe_3O_4 — which were seen to fall back into solution as the bar was removed thus increasing contamination levels. Secondly it was observed that as the bar turned on the bottom of the beaker, it exerted a damaging shearing effect on the tubule elements in suspension and significantly reduced their viability. Hjelle *et al* 1981 and Chung *et al* 1982 may not have observed this effect on viability as they cultured their tubular products which may have allowed the remaining or even slightly damaged tubules to regenerate. Placing a beaker of mixed nephronal elements over a strong magnet and decanting off the non-magnetic material, as described by Brendel & Meezan 1975, was useful for isolating

glomeruli (and was used later for collecting glomeruli for morphological examination) but proved too inefficient and time consuming for the isolation of the tubular elements.

An alternative method involved the use of an electromagnet obtained from the Physics department. This technique involved passing plastic tubing down between the poles of the electromagnet and then pouring the suspension of mixed nephronal elements through the tubing into another receptacle. The theory was that the magnet would abstract the glomeruli from the moving suspension leaving the tubules to carry on down the tubing [Cook & Pickering 1958]. Unfortunately the magnet was 'over zealous' in its action in that the glomeruli moved towards the magnet at such a speed that the tubules became caught in the rush and because the magnet was so powerful, the tubules remained trapped — pinned to the tubing by the glomeruli. This rendered the tubule yield unacceptably low and even when the trapped material was resuspended and passed down the tubing again the released tubules were too battered and dented to be used. Despite many adjustments to the system, a suitable result was not obtained and the technique was abandoned.

The use of a powerful horseshoe magnet eventually proved to be the most effective answer. Here a strong horseshoe magnet was dipped into the suspension of mixed nephronal elements whilst the suspension was agitated by the gassing line of 95%O₂/5%CO₂ (fig 2g). At intervals the magnet was removed, cleaned and replaced until no further magnetic material was attracted.

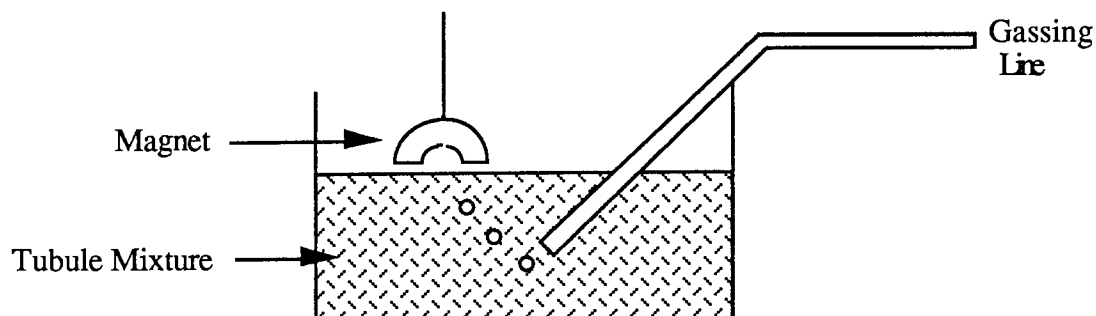

Fig 2g Diagrammatic representation of the system for the magnetic removal of Fe₃O₄ loaded glomeruli

This system afforded optimal removal of glomeruli with minimal tubule trauma. This system also had the advantage that, as well as being very gentle, the tubules could be iced and gassed the whole time — undoubtedly aiding viability.

With the above procedural refinements, the final method for the mechanical isolation of rat proximal tubules was derived. When PT samples, freshly isolated by this final method, were viewed in KHS on a cavity slide by light microscopy, the sample was seen to consist of short intact tubular structures and connective tissue residues with no PT fragments or cellular debris. In addition the PTs isolated had a much more robust structure than their collagenase isolated counterparts. The purity of the sample was assessed by direct visual inspection and PAS staining and consistently found to be > 95%.

Exclusion of Trypan Blue in these samples was much easier to interpret as the tubules only took up the dye on the very edges of the cut tubule ends with the vast majority of the tubule length remaining free of dye. Again, however, if the tubules remained in contact with the dye for more than approximately 15 mins they started to transport dye into the cytosol. With all the procedural modifications, the final percentage viability was consistently found to be > 90%.

2.7 DISCUSSION

Renal tubule systems were developed to overcome the manipulative disadvantages of whole organs and the diffusion limitations of kidney slices [Dawson 1972]. Many different isolation techniques have been adopted [Brendel & Meezan 1975, Scholer & Edelman 1979, Balaban *et al* 1980, Vinay *et al* 1981, Green *et al* 1987] yet comparative studies of these various tubule isolation techniques do not appear to have been made. As a result it was difficult in the initial stages of the study to judge which isolation technique could be exploited to the best effect as an *in vitro* renal system.

The most popular tubule isolation technique was undoubtedly digestion of whole renal cortex by enzymes (usually collagenase) followed by purification through gradient centrifugation. This technique was typified in the work of Helwig *et al* 1974, Scholer & Edelman 1979, Vinay *et al* 1981 and was the first tubule isolation technique attempted.

2.7.1 The whole cortex digestion technique

The procedure used in this study followed the methodology of Vinay *et al* 1981 closely except that 0.05% collagenase was used compared with the 0.15% collagenase concentration advocated by Vinay *et al* 1981 and also the bovine albumin used by Vinay *et al* 1981 was omitted from the incubation medium. According to Vinay *et al* 1981 the sample partitioned into the lowest band of the centrifuge tube, following their method of Percoll centrifugation, should contain a virtually pure sample of PTs with less than 2% contamination by distal tubules and glomeruli. One of the earliest problems encountered with this technique, however, was differentiating between the various nephronal elements so that this value could be verified in this slightly altered preparation.

The first technique employed to facilitate this was vital staining with Trypan Blue. When injected into living animals, Trypan Blue enters the cells of the proximal tubule by endocytosis across the BBM and is sequestered into the lysosomes whilst the distal portion of the nephron remains uncoloured [Jacobsen *et al* 1967, Linshaw *et al*

1986]. In fact it has been claimed that Trypan Blue vital staining is particularly heavy in the early S₁ segment of the PT and so can be used as a morphological marker for this area [Linshaw *et al* 1986]. Unfortunately when applied to the PT sample isolated by the whole cortex digestion technique used in this study, distinctive differential staining was not seen. Freshly isolated cortex from treated rats was navy blue in colour, however, the depth of staining became progressively lighter as the cortex went through the various isolation stages to the final PT sample. They also lost further colour during their morphological preparation so that when the tubule samples were viewed under light microscopy, little definitive differential staining was apparent — even in cross section. Trypan Blue was undoubtedly sequestered into the kidney so, in theory, differential staining should have occurred and been maintained. The fact that the staining was not maintained indicated that the dye had been progressively leached out of the cell and suggested that the structural integrity of the PTs had been damaged significantly.

PAS staining was the second discriminatory stain applied and, like Trypan Blue, it also showed an aberrant staining pattern with the tissue samples isolated by whole cortex digestion. PAS stained whole tubules showed none of the differential light mauve staining of distal tubules and dark mauve staining of proximal tubules. The reason for this was indicated by the PAS stained wax sections which showed very sparse differential staining of the BBM (fig 2c). At this stage much time was spent altering the PAS staining conditions eg pH, sulphurous acid rinses etc to ensure that the technique was not at fault, but differential PAS staining obtained with control renal sections suggested that the technique was operating correctly and that some other factor was responsible for the aberrant staining patterns — namely structural damage to the tubule BBM. This damage was incurred following the collagenase treatment rather than the Percoll centrifugation as PT samples taken after collagenase digestion but *before* centrifugation showed the same irregular staining patterns. In fact, centrifugation did not appear to increase the aberrant staining and therefore, by implication, structural damage. This feature was felt to be very encouraging suggesting that separation of nephronal elements by gradient centrifugation

was potentially very useful — though the possible development of anoxia during prolonged centrifugation might be a major drawback. The use of centrifugation as a way of isolating distal elements is discussed in more detail in section 6.5.2.

Vinay *et al* 1981 alluded to some loss of PAS staining due to BBM damage but gave no indication of to what extent. Thus it was difficult to assess whether the lower collagenase concentration used in the whole cortex digestion technique described here caused less damage than the procedure of Vinay *et al* 1981. Also the inclusion of bovine albumin in the incubation medium of Vinay *et al* 1981, may have afforded some protection against enzyme damage as it usually contains inhibitors of the collagenase contaminant trypsin — used in cell culture to produce cell dissociation [Chung *et al* 1982]. However, as discussed later in Chapter 4, Vinay *et al* 1981 also failed to achieve any significant enrichment of two brush border marker enzymes which suggested that BBM damage was considerable. Damage to the basolateral membrane (BLM) of tubules isolated by whole cortex digestion and even collagenase perfusion has been seen in other studies [Helwig *et al* 1974, Balaban *et al* 1980, Linshaw & Grantham 1980, Chahwala 1981, Chahwala & Harpur 1986], but damage to the apical membranes is not well documented.

As stated earlier, the failure to obtain discriminatory staining meant that it was difficult to assess the level of purity of the PT sample produced by this technique. However, with more experience, purity was able to be evaluated by direct visual inspection and found to be consistently >95% suggesting that gradient centrifugation produced a highly acceptable level of PT purification. Purity in this situation, however, could only really be measured in terms of the type of *whole* tubule present. This is noteworthy as tubule separations performed by gradient centrifugation tend to produce 'dirty' samples in that they contain tubule fragments and individual cells which are often difficult to quantify and identify — even with discriminatory staining techniques. The sample produced in this study was no exception in that it contained a moderate level of unidentifiable tubule fragments and cellular debris.

Balaban *et al* 1980 attempted to address this problem by spinning their tubule sample on a Ficoll® cushion following cortical disruption by a 0.5% collagenase perfusion. This technique was partially successful in that it significantly 'cleaned up' the final tubule sample (no actual percentages were given) but it did not, however, purify the PT sample to the extent of the Vinay *et al* 1981 technique — glomerular contamination being up to 10% of the cell volume. Mandel & Murphy 1984, using the same technique, gave the vague evaluation that their final PT sample contained 'mostly proximal tubules'. It is difficult, however, to see how this could be very high in percentage terms as the theory behind the Ficoll cushion is that lysed cells and debris, together with the denser glomeruli, pass through the cushion leaving the osmotically active vital cells on top. To produce a highly purified PT sample by this technique, *all* the collecting ducts and distal elements would have to be lysed or dead to sink through the cushion and leave behind vital PTs. Whilst collecting ducts and distal tubules are decidedly more fragile than their proximal compatriots it is unlikely that all, or even the majority, would die following the collagenase perfusion hence it is difficult to see how this technique could produce a highly pure PT sample — especially since Balaban *et al* 1980 laud their enzyme perfusion technique as being *less* damaging by virtue of the shorter enzyme contact times it facilitates.

Scholer & Edelman 1979 also used Ficoll in the form of a discontinuous gradient. With this technique nephronal elements, isolated by whole cortex digestion, were layered on top of the Ficoll and then allowed to sediment naturally down the gradient. Because the various tubule elements have different dimensions, they sediment at different rates and the discontinuous Ficoll probably has the effect of enhancing this separation. The system was effective at cleaning up the sample by removing cellular debris, but it was only partially successful at separating the various nephronal elements. The two final samples were only classified as being proximal and distal enriched with the proximal sample attaining approximately 75% purity and the distal sample only 64%. The

distal sample also had the problem that it collected at the top of the gradient together with the cellular debris so, in addition to being impure, it was also a rather 'dirty' sample.

Kumar *et al* 1986 also used sedimentation as a form of PT purification. They sedimented several times through Ringer's solution and claimed a purity of around 93% for the final PT sample. When the technique was attempted in this study on PTs prepared by mechanical isolation, approximately 60% PT enrichment was obtained — the 93% enrichment claimed by Kumar *et al* 1986 was found to be impossible to procure. It may be that the best way to achieve a pure 'clean' sample of PTs by gradient centrifugation might be to put the sample through a Ficoll cushion first, to remove the majority of the debris, and then subject the sample to Percoll centrifugation to isolate the PTs.

However, purification by this type of procedure does not obviate the problem of collagenase induced damage inherent in this technique for cortex dispersion. Helwig *et al* 1974 and Vinay *et al* 1981 in their studies described structural damage to both the basolateral and apical membranes respectively following whole cortex digestion by collagenase. For this reason, the collagenase concentration used in this study was reduced to 0.05% and the incubation time curtailed from 45 to 20min in the hope of assuaging some of the potential damage. However the aberrant staining patterns obtained with both Trypan Blue and PAS indicated that, despite the use of milder conditions, severe structural damage was still incurred. Whilst these tubules might be suitable for renal culture (where cellular regeneration could occur), it was felt that their quality was inadequate for in vitro suspension studies and so no further work was done with this isolation technique.

2.7.2 The collagenase perfusion technique

Following the structural damage seen with whole cortex digestion it was decided to aim for a mechanical method of PT isolation that involved no kind of enzyme treatment whatsoever. Unfortunately, as described earlier, the initial attempts to mechanically disrupt the rat renal cortex by straightforward homogenisation and

sonication were unsuccessful. Therefore, as a temporary 'fallback' position, it was decided to resort to a modified use of collagenase namely collagenase perfusion. This technique had the advantage of producing an ubiquitous distribution of collagenase within the renal cortex thereby facilitating the use of lower concentrations and shorter exposure times to the enzyme.

Collagenase perfusion has a reputation for being a tricky and expensive procedure. However, in this study, each rat required only 50mls of a 0.05% collagenase solution to produce the desired effect which compared favourably with the 200mls of 0.05% collagenase required for the whole cortex digestion technique (and, with longer perfusions, recycling of the enzyme is possible). Although a perfusion pump would have undoubtedly been helpful to the project, the perfusion apparatus used in this study (whilst amateurish in appearance) performed its function adequately and provided a cheap way of perfusing the renal vasculature. The aim of the perfusion by collagenase was not to digest the cortex into tubules but rather to weaken the cortical matrix prior to gentle dispersion through a 140 μ m nylon mesh — thus obviating the need for, what was at the time, a more traumatic mechanical dispersion.

Following the modifications described earlier to the magnetic method of glomerular removal, the perfusion technique used in this study produced a PT sample with a purity of consistently >95%. The tubules appeared essentially intact, although the cut tubule' ends did have a slightly 'frayed' aspect (the implications of this are discussed in detail in Chapter 3). The most noticeable feature, however, between this sample and that produced by whole cortex digestion was its 'cleanliness'. Although some tubule fragments were present, the sample was virtually free of cellular debris — presumably eliminated by eluting through the 64 μ m nylon mesh during the final stage of this PT isolation procedure.

Apart from producing a cleaner sample, it was hoped that the low collagenase concentrations and very short exposure times used in this study would diminish the basolateral and apical damage seen with other workers [Balaban *et al* 1980, Vinay *et al*

1981, Chahwala & Harpur 1986] and in the earlier work with PTs isolated by whole cortex digestion. These milder conditions did appear to alleviate the damage to the extent that the tubules formed were capable of producing differential staining with PAS. However, later work was to show (Chapters 3 & 4) that, even with these milder conditions, structural damage was still incurred and was significant enough to influence tubule longevity.

Nevertheless, structural preservation was sufficient to allow the dimensions of the various nephronal elements to be measured in order for a final separating mesh size to be chosen. The use of a 64 μ m nylon mesh instead of the required 60 μ m size was necessitated by the failure to obtain a 60 μ m nylon mesh commercially. This deficiency posed a problem as it meant that that proportion of the PT population measuring <64 μ m was inevitably lost through the mesh which thus reduced the yield of the final PT sample. A combination of Ficoll and Percoll separation on the tubule sample eluted through the 64 μ m mesh was attempted as a way of recovering the 'lost' PT population, but it was found to be costly and time consuming and it was felt that time would be better spent in validating the PTs obtained. No attempt was made to quantify the amount of PTs lost in this way and it may be that the loss was significant in terms of the final PT yield (discussed in detail in section 6.2.2).

The ability of cells to exclude dyes like Trypan Blue has long been known to be a measure of their viability [Black & Berenbaum 1964, Freshney 1986, Linshaw *et al* 1986, Benford & Hubbard 1987]. Although Trypan Blue exclusion is probably the most widely used indicator of viability, there are many factors which can affect its accuracy [Black & Berenbaum 1964] and many feel that it should only be regarded as a rudimentary test of viability [Williams & Wilson 1981, Benford & Hubbard 1987] to be used in conjunction with other tests such as respiration — as in this study.

Nevertheless Trypan Blue exclusion is a quick and easy method of evaluating initial viability. When the PTs isolated by collagenase perfusion were challenged with Trypan Blue they were found to take up dye at the cut ends of the PT while the central

portion of the PT remained unstained. If over 50% of the total tubule length was free of dye, then it was considered to be viable. Uptake of the dye at the tubule ends supplemented the earlier observation that the cut ends of these fresh PT isolates had a frayed and fragile appearance. These two features suggested that the deformation in this region was in fact serious structural damage which had resulted in cell death and therefore uptake of the dye. This is evaluated more fully in Chapter 3.

Renal epithelium is very much a transporting tissue and it is acknowledged that Trypan Blue will enter the renal cytosol by endocytosis across the BBM if given time [Linshaw *et al* 1986] and is the principle behind vital staining. It was not surprising, therefore, that if the PT samples were left in contact with Trypan Blue for extended periods (in excess of 15min) they gradually transported the dye into the cytosol. Trypan Blue is not thought to be transported across the BLM [Linshaw *et al* 1986] therefore, in order to enter the PT cytosol, the dye must have had access to the BBM which must also have been sufficiently intact for endocytosis to occur. This result would suggest, therefore, that the PTs obtained with this method not only had lumens that were initially open, but also a fairly well preserved BBM. In fact it might be prudent, when using Trypan Blue with this sort of preparation, to test for this 'latent' uptake of dye to ensure that the central portion of the tubule is truly viable and that rapid uptake of the dye through damaged apical membranes was not being physically prevented by occlusion through luminal collapse. Nevertheless, this example serves to highlight the importance of using other viability tests in conjunction with Trypan Blue exclusion.

So it would seem that collagenase perfusion produced PT samples which, initial inspection suggested, were of high purity and viability with improved structural preservation over PTs isolated by whole cortex digestion.

2.7.3 The mechanical isolation technique

Despite the earlier difficulties, the idea of a collagenase free technique for the isolation of rat proximal tubules had not been totally abandoned and a mechanical method

was evolved from the technique of Meezan *et al* 1973 developed for the isolation of rat renal glomeruli. Brendel & Meezan 1975 and Chung *et al* 1982 also exploited this technique to develop a method of mechanically isolating rabbit PTs but there did not seem to have been a consistently successful method of isolating *rat* PTs mechanically — indeed other workers that tried, produced fragmented products that were only suitable for sub-fractionation eg basement membrane studies [Carlson *et al* 1978]. Since most *in vitro* data derive from rodent experimentation, it was felt to be worthwhile persevering at finding a method of mechanically isolating rat PTs.

The final, fully developed technique consisted of loading the glomeruli with Fe_3O_4 by renal perfusion, disruption of the cortex by homogenisation and sieving, removal of the glomeruli with a magnet and final extraction of the PT population by sieving through a graded mesh. The use of Fe_3O_4 in the isolation of glomeruli was first suggested by Cook & Pickering in 1958. The vasculature of the kidney is particularly suited for this kind of treatment as the unusually wide afferent renal arterioles narrow into smaller glomerular capillaries. This means that when Fe_3O_4 suspension is perfused through the kidney the iron lodges preferentially in the glomerular capillaries and serving arteries whilst only small amounts pass into the efferent renal vasculature. Indeed when the Fe_3O_4 treated kidney was viewed under a dissecting microscope it was clearly seen that the iron loading was confined solely to the cortical area. Paradoxically, the distribution of the iron following pre-treatment by collagenase perfusion was different with the Fe_3O_4 being seen as far down as the inner regions of the renal medulla. The reason for this is not known. Despite this difference, at no time was Fe_3O_4 ever seen in the tubule' lumens of either preparation — suggesting that the variation in distribution was not a result of collagenase induced damage to the filtering membranes of the glomerulus.

The biggest obstacle to the development of this mechanical isolation technique was undoubtedly finding an effective method of cortical disruption. Homogenisation has long been an important feature in the disruption of tissue from many organs, not only

kidney [Lloyd & Coakley 1979, Cain & Skilleter 1987, Sheikh & Møller 1987] and the dimensions of the homogeniser are often crucial [Lloyd & Coakley 1979].

Straightforward homogenisation of the renal cortex by vertical strokes of a cylindrical pestle was found to damage the tissue rather than disperse it. It was felt that the reason for this were the prolonged shearing stresses inflicted on the cortex by the elongated shape of the pestle and the vertical strokes used in the homogenisation. In order to try and alleviate this, and so release intact tubules, the shape of the pestle was changed to a loose tear shaped pestle with a clearance of approximately 2mm. The method of homogenisation was also changed in that spiralling homogeniser strokes now replaced the earlier vertical ones. Spiralling the strokes eliminated the damaging 'drag' on the tissue inherent in the vertical style of homogenisation and this, together with the reduced shearing length of the pestle, had the effect of *teasing out* the cortical tissue thus weakening the matrix prior to the main dispersion through the various meshes. In fact, the teasing out of the tissue by this modified form of homogenisation could be regarded as being analogous to the weakening effect on the matrix produced by the earlier collagenase perfusion. Although the development and emphasis on cortical disruption might appear callow, the homogenisation procedure was actually a crucial part of the methodology for mechanical isolation and, together with the procedural refinements for the magnetic removal of the glomeruli, contributed significantly to the viability and integrity of the final sample. Sonication did not prove to be a useful method of dissociation in this type of tissue, despite having been used to disperse tissue clusters by other workers [Lloyd & Coakley 1979], but it would probably be of great benefit in the disruption of cells for biochemical assays etc.

The PT sample produced by this mechanical technique had a purity of consistently >95% and appeared intact with a more robust configuration compared to the PTs isolated by collagenase perfusion. At this stage the most noticeable difference was at the cut ends of the PTs which had none of the frayed, fragile aspects seen earlier in the collagenase isolates. This difference was further emphasized in the results of the Trypan

Blue exclusion tests. In mechanically isolated PTs Trypan Blue uptake was only seen at the very edges of the cut tubule ends with the rest of the tubule structure remaining free of dye. This contrasted notably with the PTs obtained with collagenase perfusion where Trypan Blue uptake at the cut ends extended further into the main body of the tubule. Because the tubule ends had been cut, and therefore by implication damaged, some uptake of the dye would be expected in the immediate vicinity of that cut. The fact that the Trypan Blue uptake was localised to the cut edge in the mechanical isolates but was more diffuse in the collagenase isolates added to the earlier suggestion that additional, significant damage had been incurred by the latter sample and was probably a result of the collagenase treatment. This is discussed in more detail in Chapter 3. Like the PTs isolated by collagenase perfusion, the mechanically isolated PTs also began to transport Trypan Blue into the cytosol if left in contact with the dye for periods in excess of 15min — suggesting that their lumens also were initially open and that the BBM was essentially intact.

The structural integrity of these mechanical isolates was further emphasized by the discriminatory PAS staining obtained with these PTs. This indicated that the PT sample produced by this technique was, initially at least, as structurally intact as those produced by collagenase perfusion and better than PTs produced by whole cortex digestion (Chapter 3 examines this area in more detail).

The mechanically isolated PT sample was also found to be cleaner, in terms of cellular debris, than the PT sample isolated by *either* collagenase method. The reason for this was felt to be that with PTs isolated by collagenase, cells and tubule fragments sloughed off from the frayed and potentially damaged cut ends. With the mechanical isolates, the cut ends were more robust and so structural disintegration was not such a problem. Disintegration of collagenase isolates has also been found to be a problem by other workers (see section 6.4). Nevertheless, mechanical isolates did have a contaminant not found with collagenase isolates namely connective tissue and this, together with its problems, are discussed in Chapters 3, 5 and 6.

So it would seem that a method of mechanically isolating rat PTs had been found which initial examination promisingly suggested had a purity, integrity and viability comparable with PTs isolated by collagenase perfusion and superior to PTs isolated by whole cortex digestion. However, this initial inspection was rudimentary and it was felt that a more stringent morphological and biochemical comparison between the PTs isolated by mechanical and collagenase perfusion techniques should be performed before any further evaluations were made.

~~~ CHAPTER 3 ~~~

# MORPHOLOGICAL EVALUATION OF PROXIMAL TUBULES ISOLATED BY MECHANICAL AND COLLAGENASE PERFUSION TECHNIQUES

Nephronal cells are polarised along the length of the tubule and also across their axis from lumen to basement membrane. Within the nephron cytological structure and function are undoubtedly linked [Welling & Welling 1988], not only at tissue but subcellular levels as well, and morphological evaluation has become an important if not obligatory component of renal pathophysiology studies. It was decided, therefore, to subject the various PT and glomerular samples obtained to a morphological examination. The aim of this inspection was to evaluate and compare the level of damage incurred by PTs during a) Mechanical separation and b) Perfused enzyme separation.

No single histological staining or microscope technique can display all the components of a cell equally well. Consequently many different techniques have been developed for the examination of tissues and any comprehensive histological study should be prepared to utilize more than one method. The two main microscopical techniques employed in this study were:

1. Light Microscopy (LM)
2. Electron Microscopy (EM)

The histological profiles produced by these techniques were then compared for the PTs isolated by the two methods.

## 3.1 LIGHT MICROSCOPY

This technique took two forms

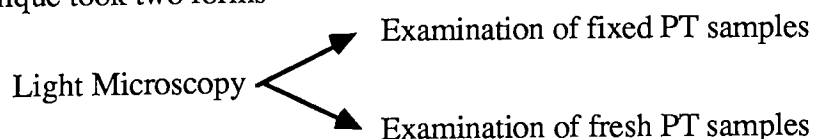

### 3.1.1 Examination of fixed PT samples

Untreated tissues are extremely labile so fixation is used to stabilize the cellular components thus rendering them suitable for sectioning and staining. It is generally true that a fixative protocol is unlikely to yield optimal results in all parts of a complex tissue nor sometimes even within a cell [Williams 1987, Williams & Lowrie 1987] so the composition of the fixative can profoundly affect the structural appearance of the kidney. It was necessary, therefore, to decide which vital cells or components had to be conserved for the study and which fixative best achieved this.

The objective of using LM on fixed specimens was to assess the purity and gross structural integrity of the various PT samples using the discriminating staining technique Periodic Acid Schiff (PAS) described in section 2.1.5. Therefore preservation of luminal and basement membrane components was essential. Literature suggested that glutaraldehyde and formaldehyde based fixatives were suitable for this type of preservation and staining technique.

#### Fixation Protocols

The protocol used was the same for all PT samples regardless of their method of preparation.

Freshly isolated PT samples were transferred from the final 64  $\mu\text{m}$  separating mesh into a fixative solution of 2.5% glutaraldehyde (BDH) in KHS. They remained in this solution for 1 hr at 2-4 °C to complete fixation.

Glomeruli were prepared by placing a beaker over a strong magnet and pouring into it a suspension of the mixed nephronal elements i.e. before the glomeruli were magnetically removed. The iron loaded glomeruli were attracted out of suspension to the bottom of the beaker and the remaining cellular suspension was then decanted off. The glomeruli retained in the beaker were then quickly resuspended in the 2.5% glutaraldehyde solution (BDH) and allowed to fix for 1hr at 2-4°C.

After fixing, aliquots from the various samples underwent further processing procedures to enable the tissues to be stained and/or sectioned for visual inspection.

i . Air-dried mounting.

Specimen aliquots from the fixed samples were pipetted onto chrome alum coated glass slides [Carleton 1980] — plain glass slides were insufficient to sustain tissue adherence during the subsequent staining procedures. The slides were then allowed to air dry naturally at room temperature (approximately 4-5 hr). No heat was applied to accelerate evaporation of the fixative and the slides were protected from dust whilst drying. When completely dry, the slides underwent PAS staining (described in section 2.1.5) and the samples were then inspected for purity.

ii. Pelleted wax mounting.

To enable the PTs and glomeruli to be viewed in cross-section, the samples had to be mounted in wax for sectioning. Wax mounting requires that loose cells or tissue fragments be pelleted before processing. It was found that fixative penetration was improved if the tissue was fixed first and then pelleted rather than attempting to fix pelleted tissue — although pelleting fixed tissue did require more force.

Traditionally the tissue is usually spun down in a centrifuge tube and the resulting pellet is scraped off the bottom of the tube for further processing. However this method was found to be unsuitable as the PTs had to be spun down quite forcefully to produce a pellet cohesive enough to survive being scraped off the bottom of the centrifuge tube. Therefore another method was developed involving disposable centrifuge vials.

Specimen aliquots were pipetted into small plastic disposable centrifuge vials. The vials were spun in a fixed speed bench centrifuge (Beckman) for 3-4 mins and then sliced open transversely with a blade to release pellets of tissue (fig 3a).

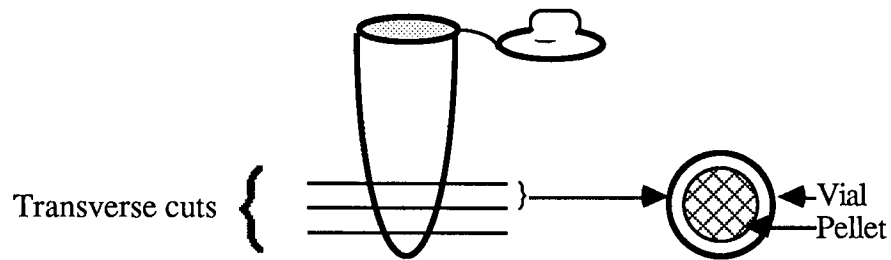

**Fig 3a** Vial pelleting technique used for the preparation of wax sections of renal PTs.

The pellets were embedded in wax by standard techniques and subsequently sectioned and then mounted onto chrome alum coated glass slides. The sections were stained with PAS (described in section 2.1.5) and then inspected for purity and gross structural integrity. Glomeruli were also sectioned to ensure that the iron oxide penetrated their vasculature.

### 3.1.2 Examination of fresh PT samples.

The necessity to pellet the PTs before wax mounting made it difficult to conclusively evaluate luminal patency as the PTs tended to be compressed during the pelleting procedure. An alternative method of assessing luminal patency using LM was exemplified in the work of Pirie and Potts 1986.

Freshly isolated PT samples were suspended in iced, gassed KHS and aliquots placed on cavity slides for LM inspection. The samples were initially examined for purity, but by adjusting the phase contrast and light intensity controls on the microscope it was possible to view the PT lumens and any occlusion therein. The patency of the PT lumens was then assessed using this technique.

### 3.1.3 Results

Under LM the various freshly isolated nephronal elements were able to be distinguished by their appearance. Of the three tubular elements, the collecting duct was the most readily identifiable due to its narrow (approx 46-50  $\mu\text{m}$ ) almost thread-like

dimensions. Distinguishing between the proximal and distal elements proved more difficult, but careful examination showed that PTs had an opaque, yellowish appearance which distinguished them from the more translucent, slightly narrower distal elements (fig 3b). Unfortunately, it was not possible to discriminate between the various segments of the PT using these basic LM techniques. Finally the glomerulus was easily identified by its size (diam > 90µm) and well defined globular configuration. These visual differences enabled the fresh PT samples initially to be assessed for purity.

Several aliquots were examined for purity from numerous mechanical and enzymatic isolations. In both cases, purity was consistently assessed to be > 95%. The main contaminant was found to be glomeruli — usually having taken up little or no iron oxide. Then came distal contamination with collecting ducts very rarely being found. In mechanically isolated PT samples, pieces of connective tissue matrix were also found. The amount of matrix present appeared to increase with the age/weight of the rat. Unfortunately, due to the fragmented nature of the tissue it was not possible to accurately measure its occurrence in terms of a percentage. No such connective tissue pieces were found in enzymatically isolated PT samples.

Examination of the PT lumens, by the LM technique exemplified in the work of Pirie and Potts 1986, showed that in excess of 90% of the fresh mechanical isolates had total luminal patency along their length (fig 3c). PTs isolated by enzyme perfusion showed a similar degree of patency in the main body of the tubules. However, as stated in Chapter 2, LM showed that the cut tubule ends of the collagenase isolates appeared frayed and damaged which suggested that the patency of the tubule ends might in fact be compromised. This was later investigated further using SEM.

Further evidence of percentage purity was given through differential PAS staining on fixed unsectioned samples from both mechanical and enzymatic isolations. In contrast to the aberrant PAS staining exhibited by the whole cortex digestion method, the



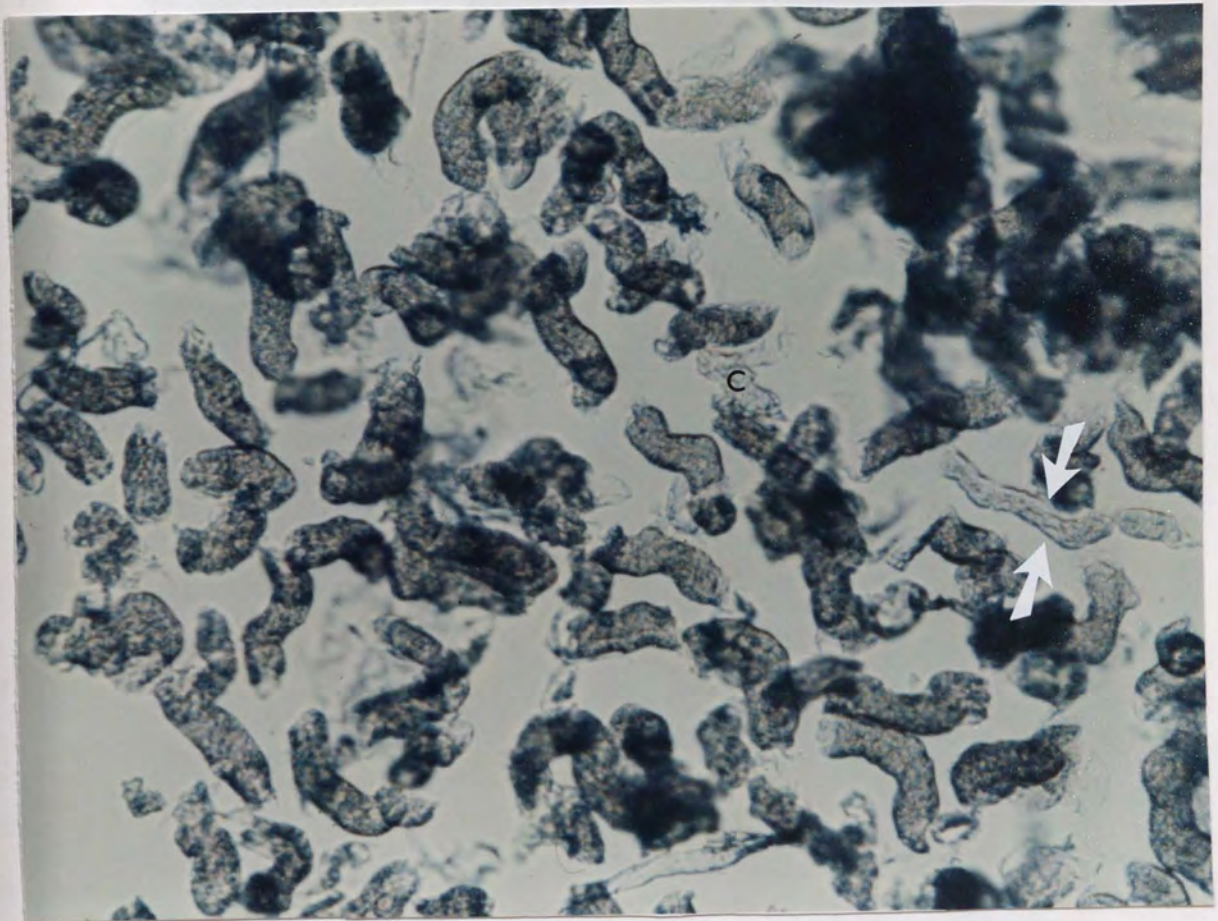

**Fig 3b LM of a typical freshly isolated PT sample obtained by mechanical separation (see section 2.4 for details). The only distal tubule found in the micrograph is arrowed. No collecting ducts or glomeruli are shown, but fragments of connective tissue are present (C).**

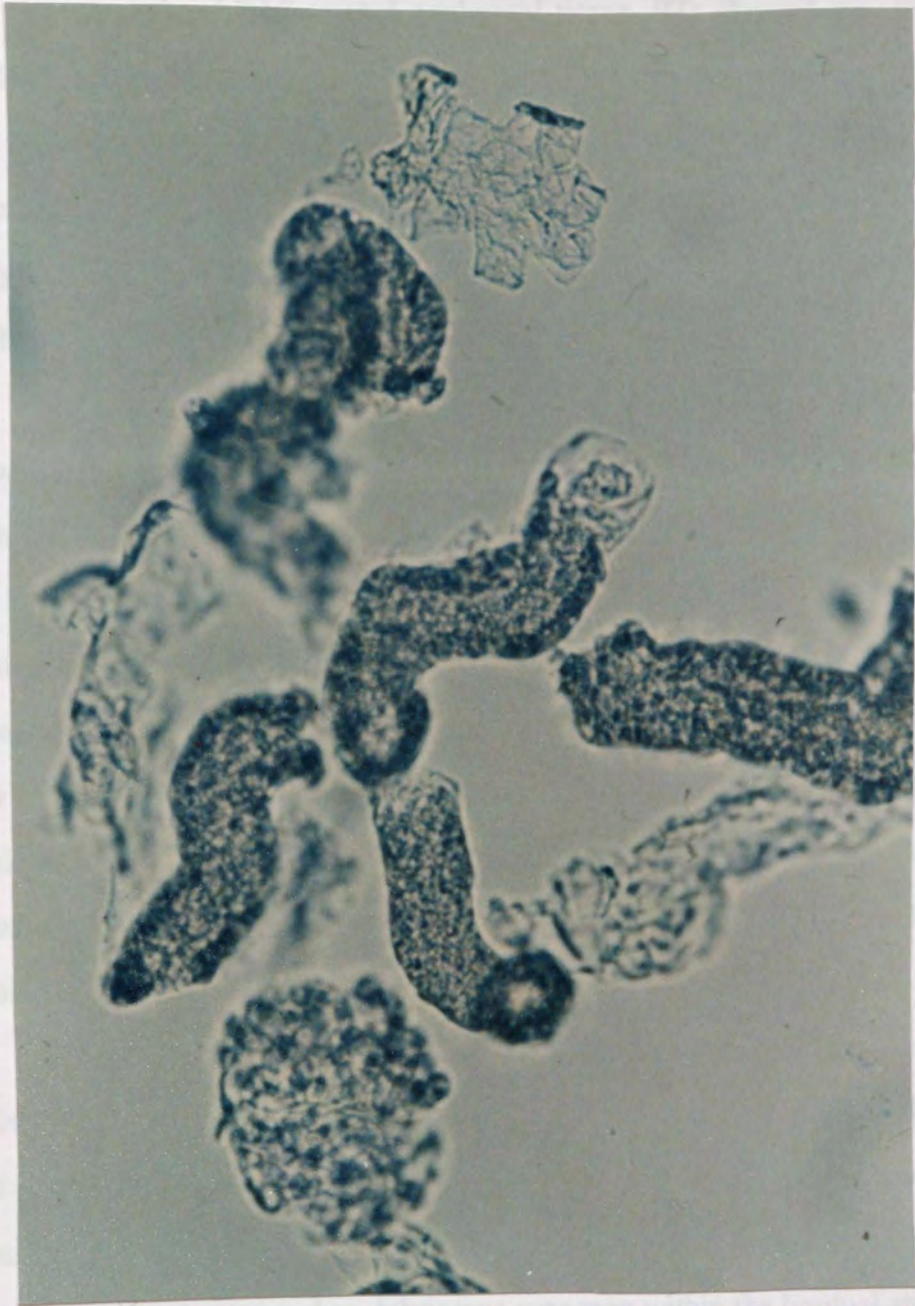

**Fig 3c LM of a fresh, mechanically isolated PT exhibiting total luminal patency along its length**

fixed whole tubule samples from both techniques produced the differential staining patterns characteristic of PAS treated nephronal tissue. PTs showed the classic dark mauve, densely nucleated appearance with PAS (fig 3d) which distinguished them from the light mauve, sparsely nucleated features of the distal tubules (fig 3e). PAS staining therefore facilitated the differentiation between proximal and distal elements and so enabled purity to be more conclusively assessed — it was found to be unchanged at > 95% in both cases.

Differentiation was also seen with PAS staining of the wax cross-sections. PAS characteristically stains the brush border membranes (BBM) of PTs dark mauve which thus distinguishes them from distal tubules which have no BBM. Unlike the sections from PTs isolated by whole cortex digestion (fig 2c), differential staining was seen with cross-sections from both mechanical and enzyme perfused preparations and indicated improved structural preservation. Closer examination of the gross structural integrity of the BBMs showed that mechanically isolated preparations had BBMs that were well defined and appeared essentially intact (fig 3f). In contrast, however, sections from enzyme perfused preparations showed BBMs that were less well defined and often had missing or damaged regions (fig 3g).

Although the micrographs showed patent lumens, it was difficult to be conclusive about general patency in any of the sections. This was because the luminal shape of the tubules, particularly in the collagenase isolates, were squashed and distorted which made decisive evaluation difficult. Nevertheless, despite the distortion the lumens were, for the most part, open and no debris was ever seen within the luminal area.



**Fig 3d LM of typical mechanically isolated whole PTs fixed and stained with PAS (see section 2.1.5 for protocol). The PTs exhibit the distinguishing features of dark mauve colouration and dense nucleation (N).**

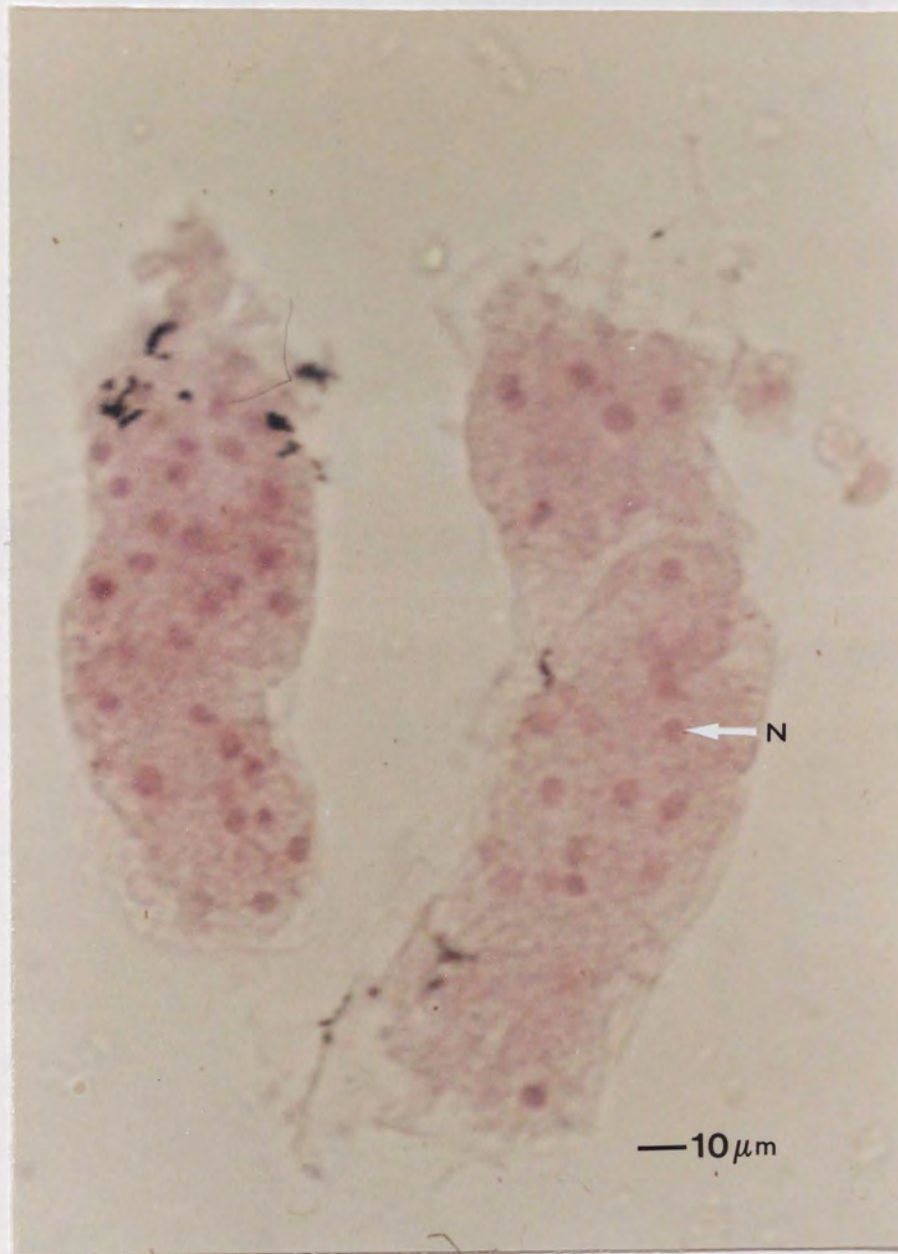

**Fig 3e LM of a typical mechanically isolated whole distal tubule fixed and stained with PAS (see section 2.1.5 for protocol). The distal tubule exhibits the distinguishing features of light mauve colouration and sparse nucleation (N).**

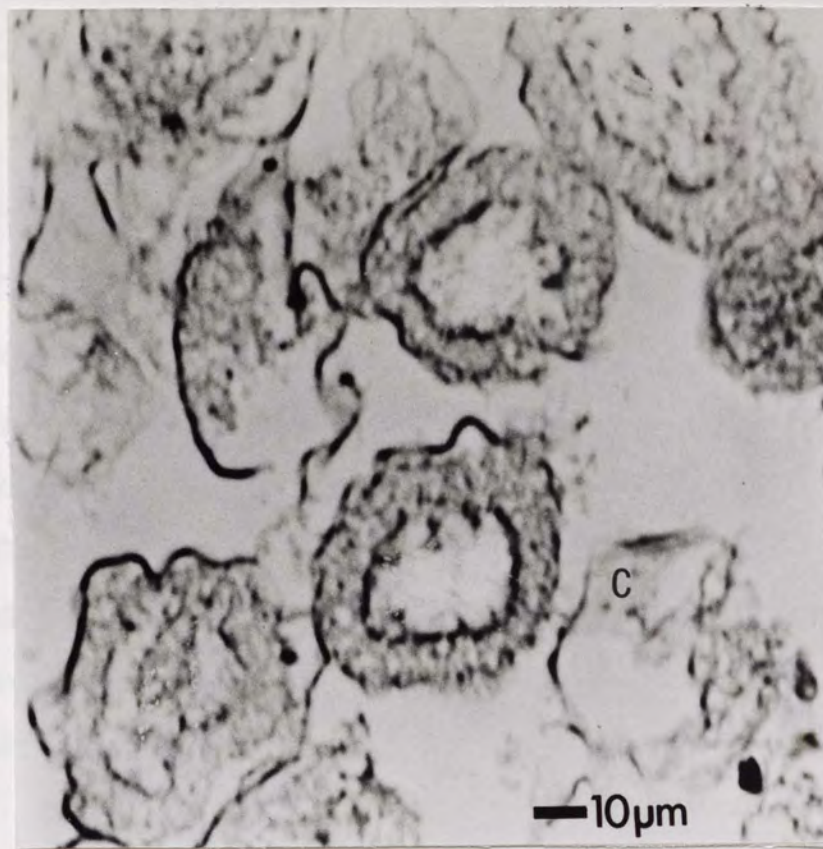

Fig 3f LM of typical PAS stained wax section from mechanically isolated PTs. Samples show characteristic staining of intact and well defined brush border membranes. Connective tissue is also present (C).

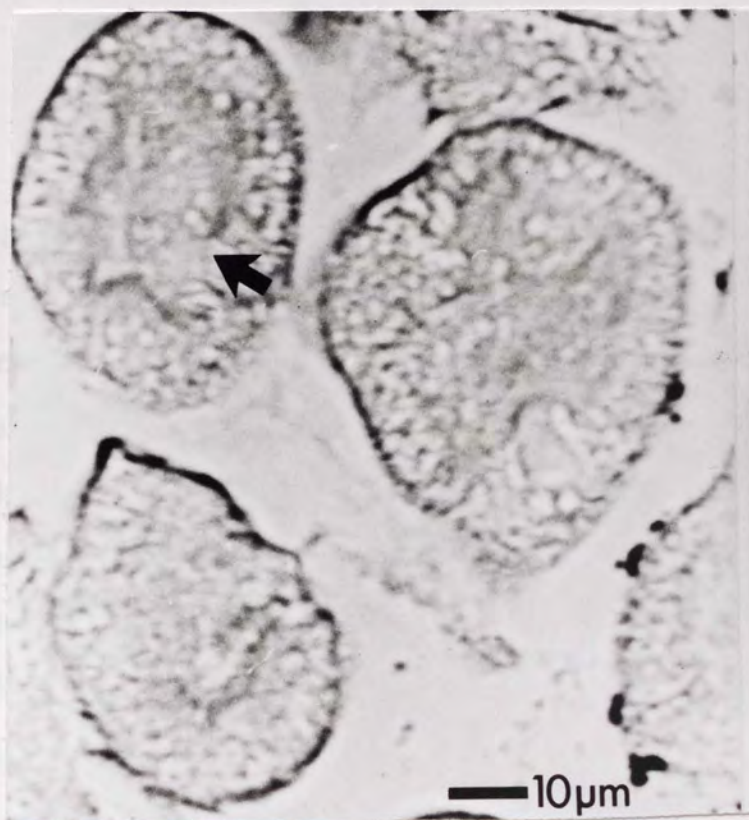
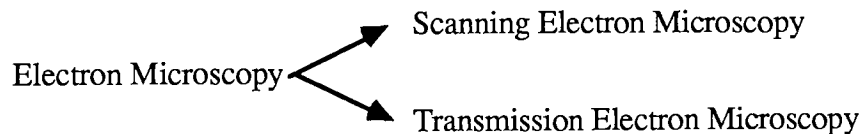

Fig 3g LM of typical PAS stained wax section from PTs isolated by the collagenase perfusion technique described in section 2.3. Although the samples show characteristic staining of the brush border membrane, the membranes have reduced definition and exhibit areas where the brush border membrane is totally absent (arrowed).

### 3.2 ELECTRON MICROSCOPY

The wavelength of visible light limits the resolving power of the light microscope to 0.2  $\mu\text{m}$  under optimal conditions. In EM electrons are accelerated through an electrical potential difference producing a short wavelength illumination which vastly increases resolving power down to 0.5nm.

The increased resolution produced by EM techniques was used to evaluate the surface and ultrastructural integrity of both the mechanical and enzymatically isolated PT samples. This was to see whether the PTs incurred any *insidious* damage during their isolation. Two types of EM technique were employed in this study:



#### 3.2.1 Scanning Electron Microscopy

EM uses transmitted light to examine specimens in the same way as LM. In Scanning Electron Microscopy (SEM) a narrow beam of electrons scan the *surface* of the tissue. Electrons are reflected back by the specimen and are collected to produce a 3-D topographical view of the surface contours of that specimen. No staining is required, but samples are coated in gold to protect them from charging during bombardment by the scanning electron beam. However, prior to being coated with gold, the PT samples had to be fixed and dehydrated. The fixing requirements for EM were found to be significantly different to those for LM.

##### Fixing protocol

Although LM studies indicated that 2.5% glutaraldehyde gave adequate preservation of gross tubular structure, EM disclosed that this fixing protocol was

insufficient to preserve the ultrastructural features of the rat PT. The literature generated a number of different fixing protocols, but the one that was found to be the most suitable was a Karnovsky-type formula [Carleton 1980] in a hypo-osmotic buffer developed by McDowell and Trump 1978.

There was also an additional problem in that, due to the dismembered nature of the tissue samples being dealt with, it was necessary to find a method of manipulating the tubules through the subsequent dehydration and drying stages of the protocol.

The problem was solved by containing the fixed samples in specially constructed pouches made out of nylon mesh of the type used in the isolation procedure. Small circles of approximately 1-1.5 cm diameter were cut from 53 $\mu$ m nylon mesh. Two of these circles were placed on top of each other and the edges were heat sealed together all the way round — except for a 5-6 mm opening on one side. The pouches thus formed were small enough to fit inside the baskets used in the critical point drying apparatus.

With these difficulties overcome, the final fixing protocol was as follows and was the same for PTs isolated either mechanically or by enzymatic means. The protocol was also used to examine glomeruli.

- i Freshly isolated PT samples were transferred from the final 64 $\mu$ m separating mesh into a fixative solution containing 4% formaldehyde and 1% glutaraldehyde in a 200 mOsm phosphate buffer. The sample was allowed to fix in this formula for 1hr at 4°C.
- ii After fixing, aliquots from the tissue samples were pipetted into separate mesh pouches through their small opening. The gap was then heat sealed shut to retain the aliquot inside the pouch.
- iii In order to dehydrate the tissue sample, the pouches were placed sequentially in 50%, 75%, 90% and (2x100%) baths of acetone or ethanol for 15min periods. Then the samples were fully dried in a critical point drier.



iv Whilst the tissue was drying, SEM stubs were prepared by covering their surface with double sided sellotape. When dry, the pouches were cut open and the tissue inside was transferred to the SEM stubs for sputter coating with gold. It was important to carry out these procedures in a clean, dry environment and the stubs were protected from dust and moisture at all times.

v Finally the surfaces of the PT samples were viewed with a Jeol electron microscope.

### 3.2.2 Results

SEM examination of mechanically isolated PT samples showed a large collection of well defined tubular structures. Closer examination of the tubules' surface showed that the basolateral membrane was intact and had a smooth uniform appearance (fig 3h). In addition connective tissue was seen to be still attached in places to the membrane surface. The tubules appeared to have incurred little obvious trauma from their mechanical isolation. The cut ends of the PTs were also examined by SEM (fig 3i) and the micrographs disclosed minimal damage with no distortion of the basolateral membrane edges nor luminal collapse.

Comparative SEM examination of PTs isolated by enzyme perfusion showed a collection of distorted tubular structures. As can be seen from the micrograph (fig 3j) the overall shape of the PTs appeared convoluted and indented in comparison to their mechanically isolated counterparts. SEM also showed significant alteration to the structure of the basolateral surface with a loss of the membrane uniformity seen in fig 3h. The basolateral membrane now had developed a highly wrinkled and corrugated surface although there appeared to be no actual holes or tears in the membrane. Little or no connective tissue residues were seen.

In addition, SEM confirmed the tubular end damage suggested by the LM inspection. Micrographs showed that the cut luminal ends had suffered gross deformation and damage. The basolateral membrane edges no longer exhibited an obvious tubular

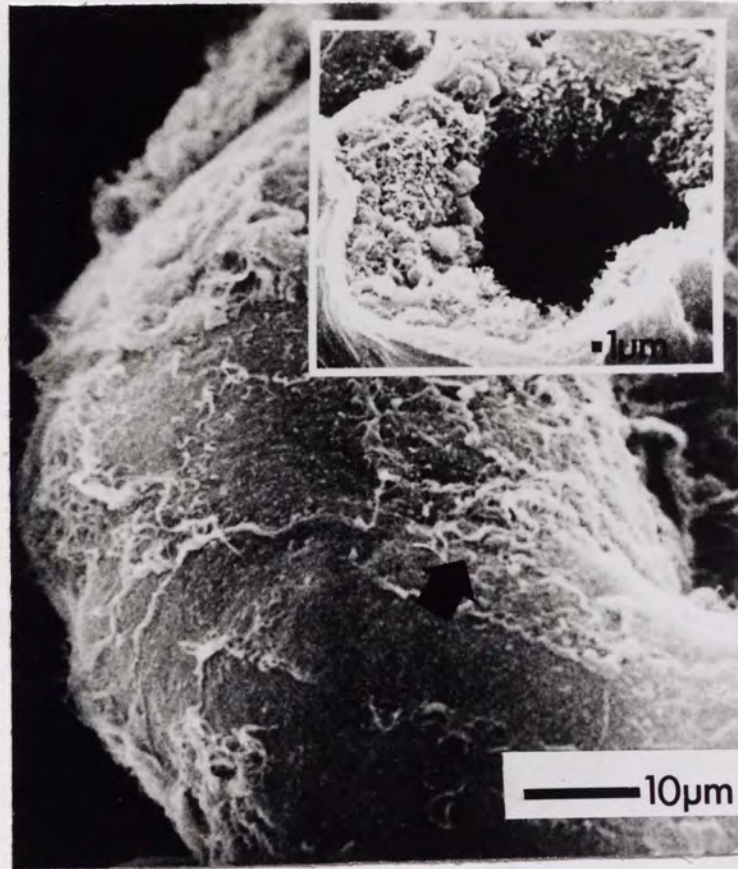

**Fig 3h SEM of the basolateral surface from a representative mechanically isolated PT. The membrane exhibits a smooth, uniform surface with fragments of connective tissue seen to be still attached to the membrane surface in places (arrowed).**

**Fig 3i (Inset) SEM of the cut end of a typical mechanically isolated PT. The tubule exhibits an open lumen and minimal deformation to the cut edges of the basolateral and brush border membranes.**



**Fig 3j SEM of the basolateral surface and cut ends of a typical PT isolated by collagenase perfusion. No connective tissue residues are seen and the basolateral membrane exhibits a highly irregular and corrugated surface with the general shape of the tubule appearing contorted. The cut ends show gross distortion with severe damage to the basolateral and luminal membrane with poor luminal access.**

structure and in many cases the tubular ends appeared to have partially or completely collapsed — thus compromising luminal patency.

### 3.2.3 Transmission Electron Microscope

In general the microscope principles of Transmission Electron Microscopy (TEM) are similar to SEM. However, the method of preparing the specimen for examination is significantly different. In TEM the test specimen has to be fixed and then embedded in epoxy resin. This enables the tissue to be sectioned very thinly (approximately 60nm), so that the samples can be *penetrated* by the instrument's electron beam. Thus although TEM produces a two dimensional image of this thin section, the resolution is so great that it enables the subcellular and suborganellar structure of the PT to be seen. Colours have no real place in TEM but contrast may be increased by staining the sections with heavy metal salts and/or uranyl acetate. In addition tissues for TEM are generally post fixed with osmium tetroxide — which not only stabilises lipids but also serves as an electron stain. Membranes that are not fixed appear light in electron micrographs.

#### Fixation protocol

The fixative formula was essentially the same as for SEM except that a sodium cacodylate buffer was substituted for the phosphate one to aid staining. The fixation procedure was as follows and again was the same for PTs isolated either mechanically or by enzymatic means.

i Freshly isolated PT samples were transferred from the final 64µm separating mesh into a fixative solution containing 4% formaldehyde and 1% glutaraldehyde in 0.1M sodium cacodylate buffer (pH 7.2). The sample was allowed to fix in this formula for 1hr at 4°C.

- ii After fixing, aliquots from the samples were pelleted in small plastic disposable centrifuge vials using the procedure described earlier under LM.
- iii The pellets released after sectioning the vials were post fixed in 1% osmium tetroxide, dehydrated with alcohols and then embedded in Epon araldite using standard techniques [Carleton 1980].
- iv Thin sections were cut using an ultramicrotome and then mounted on copper grids covered by a thin plastic film. Contrast was enhanced by staining with uranyl acetate and lead citrate. The ultrastructural integrity of the PT samples was then examined using a Jeol electron microscope.

#### **3.2.4 Results**

TEM examination provided corroborative evidence of damage to PTs isolated by enzyme perfusion. The micrographs showed significant changes in the definition of both the basement membrane and basal infoldings (fig 3k). Some PTs showed crenation of the nucleus, but the most prevalent structural alteration was increased formation of vacuoles.

In contrast TEM micrographs of mechanically isolated PTs showed intact basolateral infoldings and membrane structures (fig 3l). The internal organelles of the PT also appeared to be well preserved. The ultrastructural features revealed by TEM also enabled the PTs to be examined to see which segment(s) of the PT had been isolated by the mechanical technique.

The salient features of the three segments of the PT are shown in fig 3m. Close study of many micrographs showed the following general features to be present in the majority of the PTs viewed:

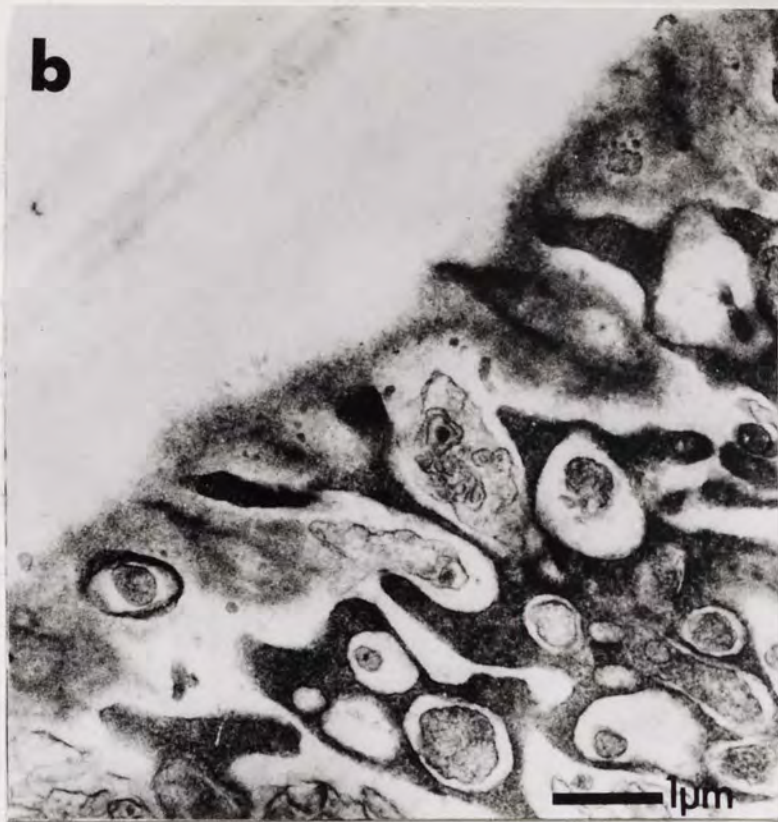

**Fig 3k** TEM of the ultrastructure from a typical PT isolated by collagenase perfusion. There is a loss of definition in both the basolateral membrane and the basal infoldings. A slight unevenness can also be seen in the structure of the basolateral surface.

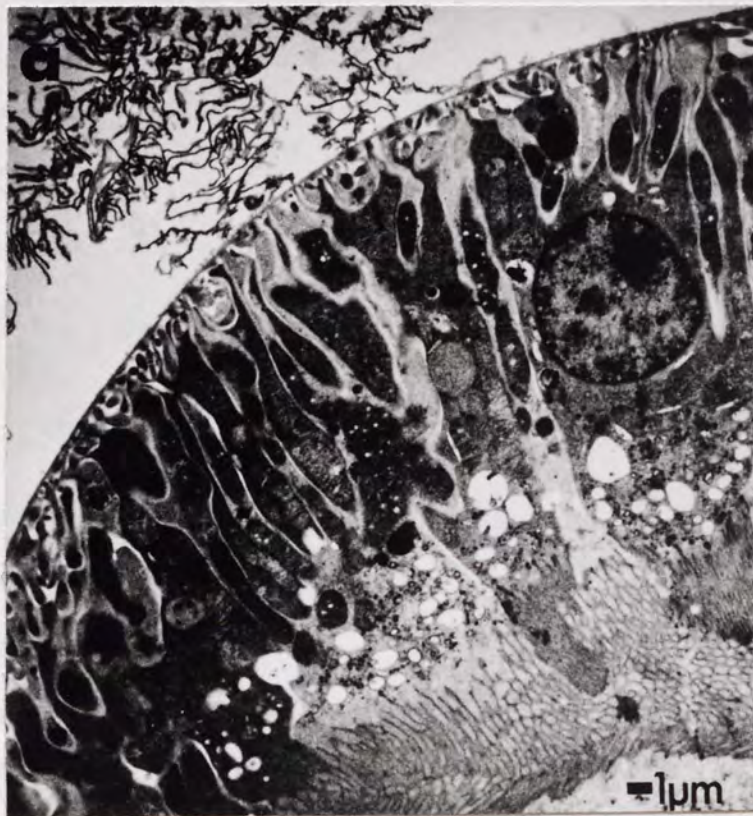

**Fig 3l** TEM of the ultrastructure from a typical mechanically isolated PT. Basolateral and luminal membranes appear intact and the internal organelles are well preserved.

- i Short to moderate length microvilli.
- ii Large lysosomes.
- iii Numerous, elongated mitochondria with distinct orientations.
- iv Extensive basal infoldings.

These observations suggested that the PTs were of predominantly S<sub>1</sub> and S<sub>2</sub> origin rather than S<sub>3</sub> as the S<sub>3</sub> portion has:

- i Long, densely packed microvilli.
- ii Small lysosomes.
- iii Few basolateral infoldings.
- iv Smaller, less numerous mitochondria with much less orientation.

Distinguishing between S<sub>1</sub> and S<sub>2</sub> portions is generally a difficult process. Pfaller *et al* 1982 utilized the presence or absence of basement ridges in the S<sub>1</sub> and S<sub>2</sub> segments respectively as a way of distinguishing between these two regions and this criteria was applied to the TEM micrographs obtained. The presence of these basement membrane ridges in some tubules but not in others led to the tentative conclusion that both S<sub>1</sub> and S<sub>2</sub> segments had been isolated.

### 3.3 EVALUATION OF GLOMERULI.

Mechanically isolated glomeruli were examined by LM and SEM. Wax cross-sections, viewed under LM, of isolated glomeruli showed penetration of the iron oxide into the glomerular vasculature (fig 3n). However, despite the iron loading, SEM examination of the surface of the filtering membrane showed that the podocytes and trabeculae were intact and that the interdigitation of the pedicels was uninterrupted

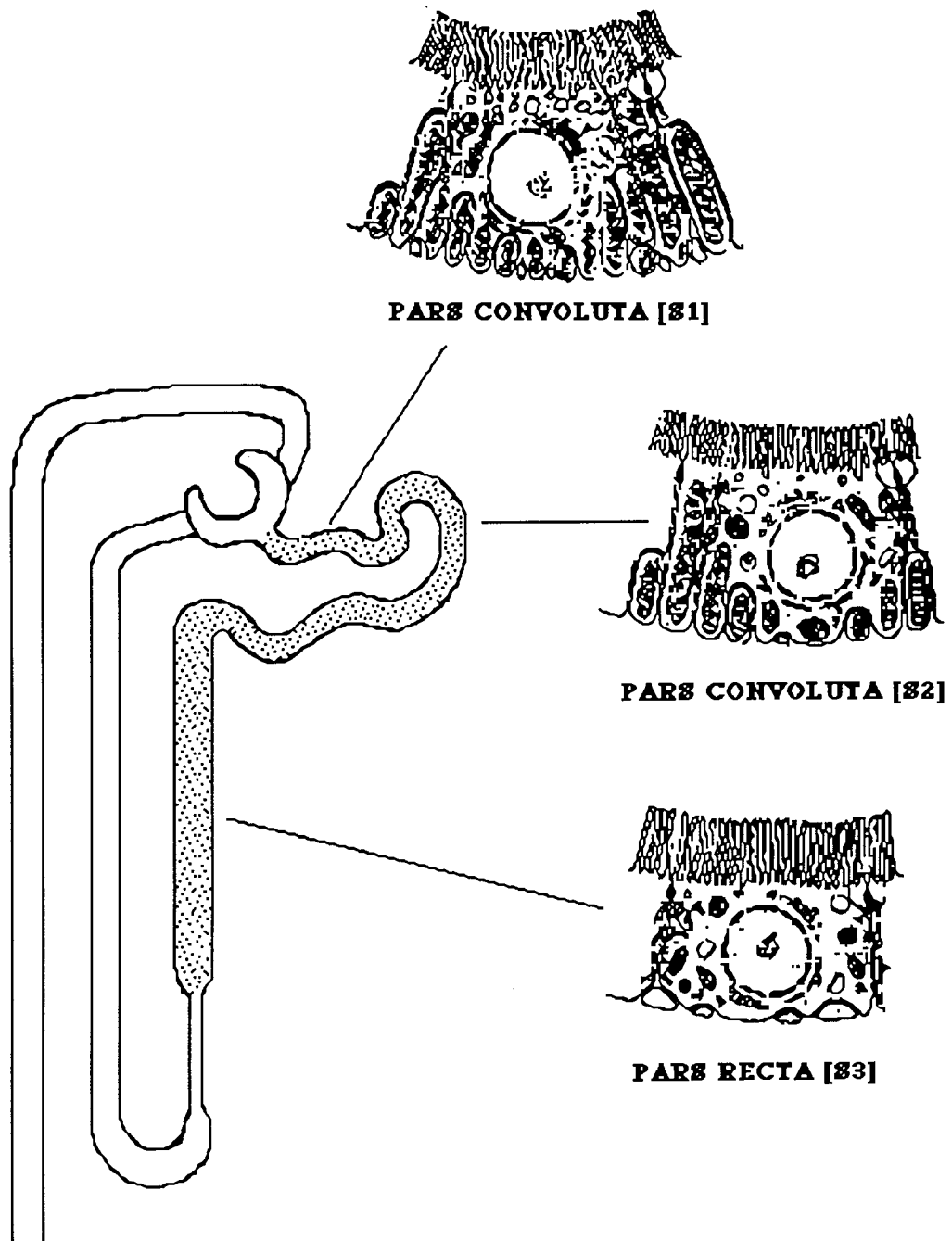

**Fig 3 m** Diagrammatic representation of the salient anatomical features of the various S portions of the proximal tubule



(fig 3o). The glomeruli, therefore, appeared to have suffered minimal trauma during their loading and isolation.

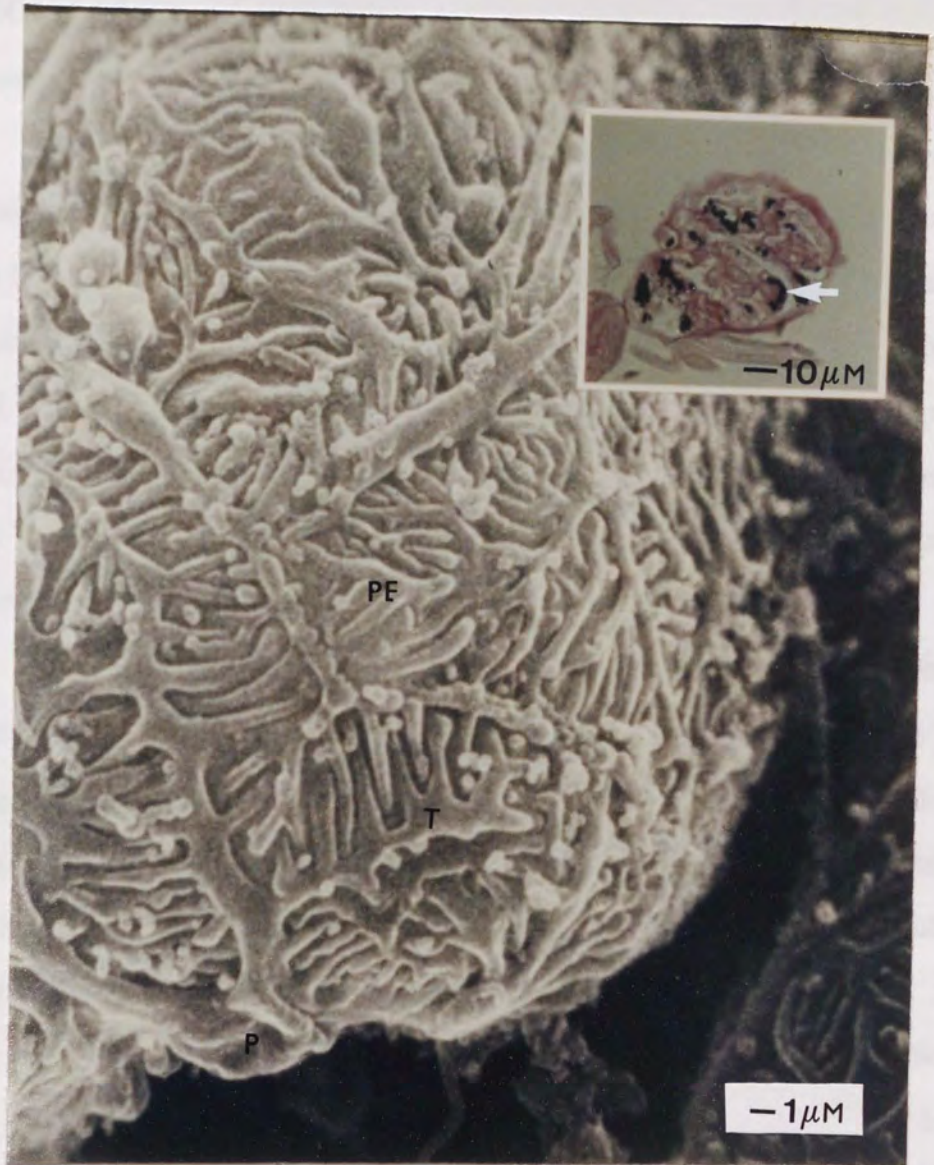

**Fig 3n (Inset) PAS stained wax section of a mechanically isolated glomerulus showing loading of the glomerular vasculature with iron oxide (arrowed)**

**Fig 3o SEM of a typical mechanically isolated glomerulus. Despite iron loading, the filtering membrane shows intact podocytes (P) and trabeculae (T) and no damage to the pedicels (PE)**

## 3.4 DISCUSSION

### 3.4.1 General Discussion

Morphological evaluation is extensively used as a starting point in pathological and toxicological studies [Mandal 1979, Bach *et al* 1987]. Yet curiously, relatively little histology has been applied to *in vitro* tubule samples and where it has, results have tended to be exemplary rather than analytical [Carlsson *et al* 1978, Chahwala & Harpur 1986, Hjelle *et al* 1986, Kumar *et al* 1986]. Indeed there does not appear to have been any attempt to compare the histology of tubule samples variously isolated for *in vitro* use. This short, preliminary study sought to evaluate and compare the structural integrity of PT samples isolated by mechanical and enzymatic means.

Fixation is a complex process and less predictable than would be desired with histological preparations sometimes developing certain changes or artifacts during processing [Olsen *et al* 1988]. It was, therefore, important to be aware of potential artifact and examine several tissue samples. Fixation of renal tissue is notoriously problematic [Mandal 1979, Williams 1987, Williams & Lowrie 1987] so it was felt advisable to be particularly circumspect in drawing conclusions.

Any technique for isolating tubular elements would be expected to inflict some alteration on the final product. In a mechanical separation, direct trauma might be incurred as the PTs were physically released from their connective tissue matrix. This could manifest as tears or splits in the basolateral membrane, crushed or broken BBM and injury to the tubule organelles. Potential damage from an enzymatic isolation, however, was more difficult to predict. This was partly due to the unpredictability of the enzyme's interaction with renal cortex complicated by variations in the activity and levels of contamination between different batches of collagenase. So it was not only the interaction of collagenase that had to be considered but those of trypsinase, clostripain and caseinase as well (Sigma data sheet on collagenase). In fact throughout the study it was not possible to distinguish which component of 'collagenase enzyme' was responsible for any enzyme induced damage seen.

### 3.4.2 Light Microscope Evaluation

The evaluation began with LM examination. This technique had the advantage of a broad field of view which enabled a large tubule sample to be assessed. By direct visual inspection of freshly isolated PT samples, it was found that both isolation techniques produced samples with a purity of consistently >95%. This value compared favourably with other workers using mechanical [Brendel & Meezan 1975] and collagenase isolation [Vinay *et al* 1981] and indicated that the different methods of cortical disruption did not affect the final sample purity. The presence of cellular debris inherent in collagenase isolated samples and connective tissue residues inherent to mechanical isolation has been discussed in Chapter 2. It is difficult to evaluate whether the cellular debris in collagenase isolates is a problem as it was often impossible to identify the origin of the debris. If the cells came from areas of the nephron other than the proximal region then they might pose a contamination problem — particularly if the sample was used in culture where they might generate an aberrant sub-population within the colony. However, the level of debris was so low in this type of collagenase separation, that it was not felt that they would be a problem in *in vitro* suspension studies. The presence of connective tissue residues in mechanical isolates also posed a potential problem in that it was felt that binding of exogenous agents to collagen was a real possibility and the effect of this will be discussed more fully in section 5.6. It was also thought that those residues would affect protein determinations. However, this did not materialise and it was felt that the reason for this lay in the fact that protein assays normally measure *soluble* protein and the majority of connective tissue protein is insoluble [Bowman & Rand 1980]. The problem of connective tissue residues was obviated in enzyme isolated samples as collagenase digested away the majority of the connective tissue.

A total luminal patency of > 90% was achieved with both techniques and was particularly encouraging. Except for renal slices and microperfused tubules, luminal patency in *in vitro* tubules is rarely described [Chahwala & Harpur 1986, Green *et al* 1987]. Yet luminal patency is essential for exogenous agents to gain access to the binding

areas and transport systems of the BBM, though admittedly some capillary uptake might occur in collapsed lumens. Open lumens were also seen in the PAS stained wax cross sections obtained from both techniques (fig 3 f&g), but, some structural distortion of the luminal shape was observed with these cross sections — particularly in the collagenase isolated tubules. It was felt, however, that this distortion might be an artifact of the histological processing.

During the processing both samples were spun into pellets in bench centrifuge vials and, as a result, compression may well have distorted the luminal structure. Why the collagenase isolated PTs suffered greater distortion is unclear, but the damage seen with EM to the basolateral surface of the preparation might be a factor. The basolateral region forms the 'backbone' of the tubule, so any damage to it might weaken the general tubule architecture thus rendering them less resistant to physical trauma. An alternative sectioning technique, that obviates the need for pelleting, involves the use of Nobel agar instead of wax [Carleton 1980] and would have proved useful in elucidating whether the compression was actual or artifactual.

The results of PAS treatment on both preparations showed that differential staining was obtained with fixed whole tubules (figs 3 d&e) and with fixed sectioned tubules (figs 3 f&g). This indicated adequate structural preservation by both techniques and was an improvement over PTs prepared by whole cortex digestion whose aberrant staining patterns produced with PAS were attributed to enzyme induced structural damage. The ubiquitous enzyme distribution produced by the collagenase perfusion was undoubtedly a significant factor in this difference, in that it enabled lower concentrations and shorter, less damaging enzyme contact times to be used thereby contrasting with the protracted enzyme exposure of whole cortex digestion.

For mechanically isolated PTs the differential staining produced with whole fixed tubules suggested that the tubules had incurred little structural damage during their isolation — or at least not enough to affect their ability to produce differential staining. The degree of structural integrity of mechanical isolates was further indicated by the PAS

staining of their wax cross sections. PAS staining of the poly bis glycol groups (present in renal BBM) showed that the BBM was well defined and essentially uniformly present around the luminal margin (fig 3f). In PTs isolated by collagenase perfusion, however, PAS staining showed that the BBM was more diffuse with areas of the luminal margin where staining was totally absent — presumably due to missing or excessively damaged regions of BBM. So although enzyme perfusion was an improvement over whole cortex digestion techniques, it still appeared to cause more damage to the BBM than mechanical isolation.

The damage seen to the BBM of collagenase perfused PTs raises the interesting question of whether collagenase or one of its contaminants was filtered by the glomerulus. It was unlikely that collagenase caused gross damage to the glomerular filtering membrane and reached the tubule' lumens that way as no iron oxide was ever found in the isolated tubules and yet it is difficult to see how else the BBM could have been damaged.

EM examination comprised the remainder of the study and this scrutinised the surface of the PTs and then evaluated their ultrastructural integrity.

### **3.4.3 Evaluation of the SEM examination**

As stated earlier, choice of fixative for EM proved problematic. The 2.5% glutaraldehyde solution used initially for LM preparations was adequate for LM and also for SEM, but when applied to TEM alterations were seen in the tubule ultrastructure — with mitochondria proving particularly sensitive. Many fixative formulae were tried and important factors in preservation appeared to be osmotic pressure and use of formaldehyde — a rapidly penetrating fixative. The final Karnovsky type formula [Carleton 1980] combined formaldehyde for rapid initial fixation with glutaraldehyde for slower, more stable preservation. A final osmotic pressure of between 280-300 mOsm was found to give the best mitochondrial preservation.

SEM micrographs of the surface of mechanically isolated PTs were examined very carefully for any predicted splits or tears. Despite examining several mechanically isolated samples, no such damage was ever seen. In fact the presence of connective tissue residues attached to the tubule' surface suggested that if they were still there then the membrane underneath should be essentially intact. The condition of the mechanically isolated rat PTs were very similar to Hjelle *et al's* 1983 SEM of mechanically isolated rabbit PTs. The sound appearance of the basolateral surface indicated that the mechanical procedure for dispersion of rat renal cortex had been highly successful in that intact PTs had been released from the matrix (fig 3h). It also showed that it was just the matrix itself that had been torn apart rather than the basement membrane having given way also.

The SEM examination of PTs isolated by collagenase perfusion, however, showed startling differences. Loss of BLM following collagenase digestion of whole renal cortex has been described [Helwig *et al* 1974] and shown in the work of other experimenters [Chahwala 1981, Chahwala & Harpur 1986] — though in the latter two studies, despite the fact that the basement membrane was seen to have been totally digested, the tubules were described as being well preserved. In fact collagenase has been used by some workers specifically to remove renal basement membrane and so facilitate morphological examination of the basal infoldings [Welling & Welling 1988]. Even workers that have used collagenase perfusion in order to reduce digestive damage found that the basement membrane of their product was still totally removed [Balaban *et al* 1980]. For this reason the conditions employed for the collagenase perfusion used in this study was as mild as practicably possible. Yet despite this, startling structural changes were still observed.

As expected, no connective tissue residues were visible and the basement membrane was undoubtedly seen to be present, but unexpected was the corrugated appearance of that membrane (fig 3j). There did not seem to be any actual splits or lesions in the basement membranes but this wrinkling of the surface was interpreted as damage (probably enzyme induced, as this wrinkling was not seen with the mechanical isolates

and was, therefore unlikely to be an effect of the sieving). So it would seem that the very mild enzyme conditions used in the perfusion technique had been successful compared with the techniques of other workers [Balaban *et al* 1980, Chahwala 1981, Vinay *et al* 1981, Chahwala & Harpur 1986] in that the basement membrane was at least present but, nevertheless, its structure still appeared to have been grossly distorted by the enzymatic treatment. It is difficult to gauge what effect this structural alteration would have on tubular function — if any.

As suggested earlier the basolateral surface is potentially the 'backbone' of the tubule and it was interesting to see that with the damage incurred by the basolateral membrane came a distortion of the general tubule shape. This was particularly evident at the cut tubule end which was severely damaged and had virtually collapsed (fig 3j) — confirming the earlier LM indication of structural damage to the cut tubule ends of collagenase isolates. In comparison, the mechanically isolated PTs, which had apparently sustained little basolateral damage, maintained a good tubular structure and had remarkably well preserved cut ends (fig 3i). The healthy appearance of these cut ends might have distinct advantages for the use of mechanically isolated PTs in the development of renal organ culture — where cell proliferation occurs mainly from the cut ends [Horster 1979, 1980a]. It is reasonable to assume that the healthier the tissue at the cut end, the greater the likelihood of obtaining cellular outgrowth. In fact the gross tissue damage seen in the SEMs of collagenase isolated PTs might be one reason why enzyme isolates tend to be less successful in organ culture.

#### **3.4.4 Evaluation of the TEM examination**

TEM provided probably the most stringent test of structural integrity. In PTs isolated by collagenase perfusion TEM examination showed a loss of definition in the basolateral region (fig 3k), although the rest of the tubule appeared in sharp focus. Fuzziness of this kind in a region usually happens when some of the electrons



bombarding the section pass *through* the sample and tends to occur in areas that are, or have become, less dense. Assuming that the sections cut were uniform (a reasonable assumption as in all the samples examined, fuzzy areas occurred only in the basolateral regions whilst the rest of the tubule appeared in sharp focus) and since no loss of definition was seen with mechanically isolated PTs, the tentative conclusion drawn was that the basolateral regions had *become* less dense during the isolation procedure. Implicit in the loss of density has to be an alteration in the structure of the basolateral region again probably as a result of enzyme damage. So it would appear that the basolateral damage seen with SEM was confirmed by TEM and that TEM showed that the damage extended into the basal infoldings as well — though neither SEM or TEM examination showed any actual lesions in the basolateral membrane. TEM examination of mechanically isolated PTs, however, showed a well preserved ultrastructure with no 'fuzzy' regions (fig 31). Therefore, even after TEM examination, mechanical isolation appeared to cause virtually no structural damage to its final product and would seem to have produced much 'gentler' separation of renal cortex than collagenase perfusion.

It must be emphasised that distinguishing between the various segments of the proximal tubule is difficult and requires a great deal of experience as although the change from S<sub>2</sub> to S<sub>3</sub> is abrupt, the change from S<sub>1</sub> to S<sub>2</sub> is very gradual [Weiss 1984]. Therefore, the conclusion that the sample contained predominantly S<sub>1</sub> and S<sub>2</sub> is tentative rather than definitive. It was felt that the segments isolated were not dependent on the sieving process of the isolation technique, but rather a result of the portion of cortex used for mechanical separation. In an attempt to exclude medullary tissue, only the very outer cortex was excised and consequently some of the inner (S<sub>3</sub> rich) cortex was sacrificed.

So in summary, it would seem that the potential physical trauma anticipated in mechanical isolation was not realised. Indeed the morphological evidence suggested that their structural preservation was superior to PTs isolated by collagenase perfusion. No attempt was made to evaluate the EM morphology of PTs isolated by whole cortex digestion as enzyme perfusion was felt to be the more stringent test for general enzyme

isolation techniques. Also EM examples of tubules isolated by one of the whole cortex techniques were given by Chahwala 1981 and Chahwala & Harpur 1986. In fact, the enzyme perfusion results shown in this study indicated that significantly less damage was incurred with the perfusion technique compared with whole cortex digestion methods.

### **3.4.5 Evaluation of the structural integrity of glomeruli produced by mechanical isolation**

Since the original use of iron oxide perfusion by Meezan *et al* 1973 was for the isolation of glomeruli, it was felt necessary to ensure that intact glomeruli could still be obtained despite the methodological modifications employed. High power SEMs of the filtering membrane showed that the glomeruli were essentially intact (fig 3o) — despite being loaded with iron oxide (fig 3n). Data on the metabolic characteristics of glomeruli isolated in a similar fashion is given by Meezan & Brendel 1973 and suggested that, even with iron loading, the glomeruli were still functionally useful.

Some would argue that variations in the biological activity of collagenase might limit comparisons between different enzyme techniques and therefore ultimately with mechanical isolations. Product information from Sigma chemicals indicated that collagenase activity of their product varied between 380 and 680 U/mg dry weight ie 1:1.79. Collagenase concentrations in whole cortex digestion techniques varied between 0.15 and 0.375% [Burg & Orloff 1962, Helwig *et al* 1974, Scholer & Edelman 1979, Vinay *et al* 1981] for contact times usually in excess of 20min. The collagenase perfusion technique employed in this study however, used an enzyme concentration of 0.05% for 3-5 min — an enzyme concentration three times less than the lowest whole cortex digestion method and for only a fraction of the contact time. Whilst agreeing that variation in enzyme activity is a factor that cannot be ignored, it was felt that the perfusion protocol used in

this study was not only comparable with other whole cortex digestion results, but was actually a more rigorous comparison. After all any damage sustained during this enzyme perfusion technique could only be escalated with the higher concentrations and longer contact times of whole cortex digestion.

Histology has often been regarded as an art rather than a technical science. However, the tendency today is for histology results to be evaluated quantitatively rather than just qualitatively [Carlton 1980, Kinne 1985]. Unfortunately quantification requires specialised equipment and also considerable experience. For this reason quantification was not attempted in this study — though admittedly the results could prove useful.

Whilst this basic morphology study does not claim to be definitive, it does raise interesting questions about the effect renal tubule isolation techniques have on their final product. Dawson 1972 and Chahwala 1981 have claimed that collagenase separation was the 'gentlest' form of tissue dispersion. This study suggests that this may be erroneous as the results of the morphological comparison between PTs isolated by the enzyme perfusion technique and the mechanical method appear to be at variance with this unqualified submission and indeed seem to show that mechanical isolation may in fact be the less structurally injurious technique of the two.

~~~ CHAPTER 4 ~~~

BIOCHEMICAL EVALUATION OF PROXIMAL TUBULES ISOLATED BY MECHANICAL AND COLLAGENASE PERFUSION TECHNIQUES

Biochemical assessments have been widely used as diagnostic aids [Stonard 1987] and as valuable tools in the elucidation of pathophysiological renal mechanisms in both *in vivo* and *in vitro* systems [Chonka & Grantham 1976, Sheikh & Møller 1987]. In order to extend the characterisation profile, various biochemical determinations were undertaken on both the mechanical and perfused enzyme isolated PTs. The aim of this evaluation was to verify the general findings of the morphological examination in Chapter 3, and to see whether the structural disparities seen in this chapter between the two isolation methods extended into functional anomalies.

The choice of which biochemical parameters to measure was immense. However, based on previous studies [Scholer & Edelman 1979, Vinay *et al* 1981, Kumar *et al* 1986] and personal observations, the evaluation parameters chosen derived from three broad areas namely;

1. Purity
2. Structural Integrity
3. Long-term Viability

The biochemical profiles produced by the tests were then compared for the PT samples isolated by the two techniques.

4.1 EVALUATION OF THE PURITY OF THE PT SAMPLES

The purpose of these tests was not only to provide a more stringent appraisal of sample purity but also, and perhaps more importantly, to give an indication of its reproducibility.

4.1.1 Measurement of the Enrichment Factor

Measurement of enzyme enrichment, or as it is sometimes known Relative Specific Activity [Dobrota 1987], has often been used as a rudimentary indicator of purity [Scholer & Edelman 1979, Vinay *et al* 1981, Hjelle *et al* 1981].

It involves measuring the activity in the final sample of an enzyme specific to, or a *marker* of, the proximal tubule and dividing that value by the specific activity of that same marker enzyme in the starting cortical material. The quotient obtained gives the Enrichment Factor (EF) for the preparation.

$$\text{Enrichment Factor} = \frac{\text{Specific activity of marker enzyme in final sample}}{\text{Specific activity of marker enzyme in starting tissue}}$$

The marker enzyme chosen for this study was alanine aminopeptidase (AAP) which has been accepted as being relatively specific for the renal proximal tubule [Hjelle *et al* 1981].

- i The kidneys of two rats were perfused, dissected and processed according to the mechanical isolation procedure described in section 2.4.
- ii Five to six 1mm² pieces of renal cortex were removed during the whole cortex chopping procedure and placed in 2mls of iced gassed KHS until required for use.
- iii The remaining cortex then completed the procedure and the PT sample obtained was suspended in 10ml of iced gassed KHS. A 2ml aliquot of this final suspension was withdrawn and retained on ice until required for use.
- iv Both the whole cortex and PT samples were sonicated separately with 0.05% Triton to disrupt the tissue and release the AAP.

v The samples were spun down for 5min at 5,000 rpm to remove the sonicated tissue debris and iron oxide. The supernatants from the two samples were removed and stored on ice until required for assay.

vi The whole cortex and PT samples were assayed for both AAP and protein content.

Assay protocol for Alanine Aminopeptidase

In neutral or slightly alkaline media, the splitting of an amino p-nitroanilide effects an increase in absorption. The simplest method of assaying AAP utilises this effect and involves measuring the hydrolysis rates of the p-nitroanilide of the amino acid alanine [Mondorf *et al* 1972]

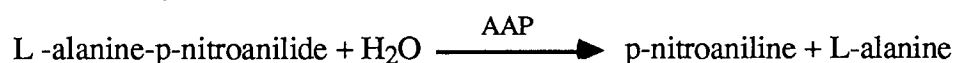

The p-nitroanilide was determined directly in the cuvette by measurement of the increase in extinction at 405nm using a spectrophotometer (Beckman)

Reagents required:

i. Phosphate Buffer

0.1M Na_2HPO_4

0.1M KH_2PO_4

Mixed in approximate ratios of 9:1 to give pH 7.4

Tris buffers are unsuitable as they act as competitive inhibitors.

ii. Substrate

L-alanine-p-nitroanilide HCl 5mg ml^{-1} in dist H_2O .

The assay protocol and correction process are summarised in fig 4a. Each of the two samples were assayed in triplicate and an average of the three readings was taken. To compensate for absorbance due to any colour in the sample, cuvettes containing unreacted sample were measured against blanks of buffer to give a correction value. This value was subtracted from its respective test value to give the corrected absorbance value. The activity was expressed in units of AAP activity [Bergmeyer 1974] calculated from

| | | | | | | |
|-------|-----------------------------|------------------------|-------------------------------|-----------------|-------------------------------|-------------------|
| BLANK | 0.2ml Dist H ₂ O | 1.6ml Phosphate Buffer | Mix and equilibriate to 37° c | 0.2ml Substrate | Incubate for 20 min precisely | Read Test V Blank |
| | 0.2ml Sample | | | | | |

| | | | | | |
|---------------|----------------------|------------------------|-------------------------------|------------------------------|-------------------------|
| OPTICAL BLANK | 2ml Phosphate Buffer | | Mix and equilibriate to 37° c | Incubate for 20min precisely | Read Correction V Blank |
| | 0.2ml Sample | 1.6ml Phosphate Buffer | | | |

Fig 4 a Assay Protocol for Alanine Aminopeptidase

$$\text{Units of AAP in 1ml sample} = 1.04 \times \frac{\text{Corrected Absorbance}}{\text{Time}} \times \text{Factor to give 1ml}$$

To calculate enrichment, variations in the amount of sample had to taken into account so the results were expressed in relation to their protein content. The Coomassie protein determination method of Bradford 1976 as modified by Gadd 1981 was used and is described in section 4.1.4.

4.1.2 Statistical Analysis of Data

All data presented in the graphs were plotted as the mean \pm standard deviation (SD).

Data was further analysed for significance by the Mann Whitney test for non-parametric data [Meddis 1975]. Any values of $p \leq 0.05$ (2-tailed test) were considered significant enough for the rejection of the null hypothesis that the groups were not significantly different.

Variability between means was assessed by the coefficient of variation (CV) where

$$CV = \frac{SD}{\text{Mean}} \times 100$$

4.1.3 Results

Enrichment factors for AAP were measured in six separate mechanical tubule isolations (n=6 and each isolation utilised two Fischer rats) and then averaged. Of the rat pairs used in the six isolations, three pairs (n=3) fell in the weight range 150-250g with the remainder in the range 250-350g and EF values were also calculated for these subdivisions. The results are summarised in table 4a;

| Weights | EF | SD | CV |
|------------------------|-----|-----|----|
| Rats 150-350g
(n=6) | 2.1 | 0.4 | 18 |
| Rats 150-250g
(n=3) | 1.8 | 0.1 | 5 |
| Rats 250-350g
(n=3) | 2.4 | 0.2 | 10 |

Table 4a Measurement of the enrichment ratio (EF) of the proximal marker enzyme alanine aminopeptidase in PT samples over that found in the original renal cortex. The results are related to the weight of the rats used and have been analysed statistically through the use of standard deviation (SD) and coefficient of variation (CV).

There was just over a 2-fold enrichment of AAP in the overall weight range 150-350g. However, this broke down unevenly when the weight ranges were subdivided with a 2.4 fold enrichment in the weight range 250-350g and a 1.8-fold enrichment in the 150-250g weight range. However, the variation within the 250-350g range was twice that of the 150-250g group. These results confirmed the morphological evidence that the final sample was enriched with proximal tubules and gave a preliminary indication of a link between enrichment levels and rat weight.

4.1.4 Coomassie Protein Assay

The assay is based on the observation that in acid solution in the absence of protein the dyestuff Coomassie Brilliant Blue G-250 (CBB) has a reddish-brown colouration with an absorbance peak in the region of 470nm. Addition of protein yields a blue complex absorbing at 600nm, with a corresponding decrease in the absorption peak at 470nm. The CBB reagent may be bought (Calbiochem) or made [Gadd 1981].

The method involved plotting a calibration graph with known concentrations of protein and then using this to estimate unknown protein levels. Test tubes were set up in duplicate containing the following;

- a). BLANK : 1.9ml CBB reagent + 0.1ml of test sample diluent.
- b). CALIBRATION : 1.9ml CBB reagent + 0.1ml of calibration soln(s) of known protein concentration.
- c). TEST : 1.9ml CBB reagent + 0.1ml of unknown test sample(s).

A 1ml aliquot of PT suspension was removed and placed in a bijou bottle embedded in ice. The tissues were disrupted by sonication using a sonic probe applied for 10 sec at tuning 25 to release the cellular contents. The cellular debris was removed by centrifuging for 5min at 5,000 rpm and the supernatant was removed and stored on ice until required for assay. The samples for assay were then set up in assay tubes as described above. The contents of the tubes were mixed thoroughly and allowed to stand at room temperature for at least 5min and no longer than 1hr. The spectrophotometer was set to 600nm with the zero obtained using a double blank. Calibration and test solutions were then measured against the blank. Averages were taken of the duplicate values obtained and the results were plotted to give a linear calibration graph from which the level of protein in the test sample was calculated.

4.1.5 Hexokinase Determination.

Hexokinase is an enzyme confined to the distal portion of the nephron [Schmidt & Guder 1976]. Determination of its concentration in the final PT sample would therefore give an indication of the extent of distal contamination.

PTs isolated by both the mechanical and collagenase perfusion isolation procedures, described in sections 2.4 and 2.3, respectively were suspended in 10ml of iced gassed KHS. A 3ml aliquot of each PT suspension was withdrawn and sonicated to

disrupt the tissue and release the cellular contents. To remove the cellular debris, the sample was spun down for 5min at 5,000 rpm. The supernatant was removed and stored on ice until required for assay.

The hexokinase content of each sample was determined according to the method of Mira & Jagannathan 1966. The following processes were involved

Primary system

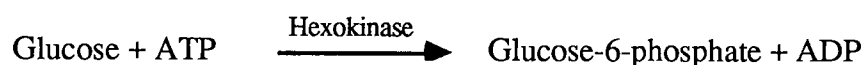

Indicator system

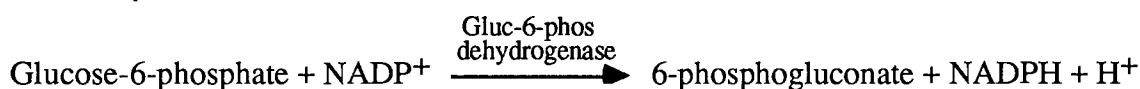

Reagents required:

i. Basic Reaction Mixture.

Quantity required for each cuvette

| <u>Substance</u> | <u>Conc (mM/ml)</u> | <u>Vol (ml)</u> |
|--------------------------------------|----------------------|-----------------|
| Glucose | 0.15 | 0.3 |
| MgCl ₂ .6H ₂ O | 0.20 | 0.3 |
| NADP | 0.0013 | 0.3 |
| EDTA | 0.0001 | 0.3 |
| Dist H ₂ O | — | 1.0 |
| Gluc-6-phos dehydrogenase | 2 U ml ⁻¹ | variable |
| Test Sample | — | 0.1 |

The assay protocol is summarised in fig 4b and each sample was assayed in duplicate. On addition of the reaction initiator (ATP) to the cuvette, the rate of change in absorbance due to the formation of NADPH was recorded against the blank for at least 5min. By calculating the slope produced by any hexokinase present the level of distal contamination could be assessed.

| | | | | | | |
|--------------|---------------------------------------|--|---|---|---|---|
| BLANK | Basic
Reaction
Mixture | Incubate
at 0-4° c
for 20 min | Warm to
20° c in spec
set at
340mM | Record 3 min
baseline
for
Test V Blank | 0.1ml Tris HCL
0.2mMml⁻¹ pH 7.6
0.1ml ATP (Na)
0.3mMml⁻¹ | Record
Extinction
Test V Blank |
| | | | | | | |

Fig 4b Assay Protocol for Hexokinase

4.1.6 Results

A slight downward drift in absorption was found in virtually all the baseline measurements of the hexokinase assay and this drift increased marginally on the addition of plain KHS buffer without sample. However, the same increase in drift occurred with the addition of distilled water so the drift was not felt to be an artifact of the buffer; the exact reason for the drift was unclear. A sample of cortical homogenate in KHS (known to contain hexokinase) was used to validate the assay and a rapid increase in absorption, due to the formation of NADPH₂ was seen.

Hexokinase measurements were then made in six separate mechanical and collagenase tubule isolations (and each isolation utilised two Fischer rats). In all samples no increase in absorption was seen over and above the basic drift produced by the KHS alone. This suggested that no hexokinase was present in the PT samples assayed.

4.2 EVALUATION OF THE STRUCTURAL INTEGRITY OF THE PT SAMPLES

Morphological examination suggested good structural preservation of PT samples isolated mechanically. Measurement of the amount of enzyme leakage from these tubules aimed to substantiate this [Benford & Hubbard 1987]

4.2.1 Measurement of the percentage enzyme retention

AAP and the cytosolic enzyme Lactate Dehydrogenase (LDH) were the two enzymes chosen for this study. The intention of the experiment was to measure the percentage of these enzymes retained in the tubules, isolated by both the mechanical and the enzyme perfusion techniques, immediately after isolation.

i Kidneys from two rats were perfused, dissected and processed according to either the mechanical isolation procedure or the collagenase perfusion procedure described in sections 2.4 and 2.3 respectively. The PT sample obtained was suspended in 10ml of iced gassed KHS.

ii A 2ml aliquot of PT suspension was then withdrawn and pipetted through 53 μ M nylon mesh into a bijou bottle. This removed any tubular tissue leaving only suspension vehicle containing any leaked enzyme in the bottle. The resultant aliquot of suspension vehicle was kept on ice until required for assay.

iii Another 2ml aliquot of PT suspension was then withdrawn and pipetted directly into a bijou bottle. This sample was sonicated with 0.05% Triton to release tubular AAP and LDH. The sample was spun down for 5min at 5,000 rpm to remove the sonicated tissue debris and the supernatant was withdrawn and stored on ice until required for assay.

iv The samples of PT suspension vehicle and of sonicated whole PT suspension were assayed for both AAP (described in section 4.1.1) and LDH.

v The amount of each enzyme present in the suspension vehicle was subtracted from its total value — obtained from the whole PT suspension. This enabled the percentage of total enzyme still retained within the PT structures to be calculated.

Assay protocol for Lactate Dehydrogenase

LDH was assayed according to the method of Bergmeyer 1974. LDH catalyses the final step of glycolysis and the assay utilised the principle of Hydrogen Transfer Enzymes [Warburg & Christian 1936] to follow the process.

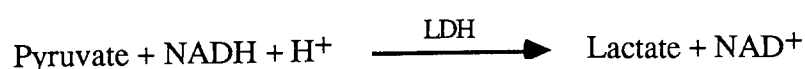

The assay measured the extinction of NADH₂ at 340nm and the protocol is summarised in fig 4c.

| | | | | | | | |
|--------------|---|--|-------------------------------|---|--|--|---|
| BLANK | 1.2ml
Phosphate
Buffer | 0.05ml
NADH
(3.5mM) | 0.2ml
Sample | Incubate
at 37° c
for 5min | Record 1min
baseline
Test V Blank | 0.05ml
Phosphate Buffer | Record
Extinction
Test V Blank |
| | | | | | | | |
| TEST | | | | | | | |

Fig 4c Assay Protocol for LDH

Reagents required:

i. Phosphate Buffer

As for AAP assay.

ii Substrate

Sodium Pyruvate 3.25 mgml⁻¹ in dist H₂O.

Each sample was assayed in duplicate. By using the molar extinction coefficient for NADH₂ of 6.3 x 10³ and measuring the slope produced by any enzyme present, the LDH activity was calculated.

4.2.2 Results

Measurements were made on tubules freshly isolated by both the mechanical and the enzyme perfusion techniques. Two Fischer rats were used in each separate isolation experiment (n=1) and the results are summarised below:

i Mechanically Isolated PTs.

| | % enzyme retained | SD | CV |
|-----------|-------------------|-----|----|
| AAP (n=6) | 86 | 3.4 | 4 |
| LDH (n=4) | 82 | 2.6 | 3 |

Table 4b Measurement of the percentage of alanine aminopeptidase (AAP) and lactate dehydrogenase (LDH) retained in mechanically isolated PTs. The results have been analysed statistically through the use of standard deviation (SD) and coefficient of variation (CV).

ii Collagenase Isolated PTs.

| | % enzyme retained | SD | CV |
|-----------|-------------------|-----|----|
| AAP (n=5) | 79 | 4.2 | 5 |
| LDH (n=5) | 82 | 3.4 | 4 |

Table 4c Measurement of the percentage of alanine aminopeptidase (AAP) and lactate dehydrogenase (LDH) retained in PTs isolated by collagenase perfusion. The results have been analysed statistically through the use of standard deviation (SD) and coefficient of variation (CV).

The percentage of LDH initially retained in both tubule samples showed no statistical difference at over 80% but the variability in these values (judged by SD and CV) was found to be slightly greater for the collagenase compared with the mechanically isolated PTs. In contrast, the 86% retention of AAP in the mechanical isolates was found to be significantly higher than the 79% AAP retention in the PTs isolated by collagenase perfusion — again there was also a slightly greater statistical variability in the latter value. Neither iron oxide nor triton had any affect on the enzyme assays.

4.3 MEASUREMENT OF THE LONG - TERM VIABILITY OF THE PT SAMPLES

With purity and initial structural integrity of the PT samples having been assessed, an examination of their viability during prolonged *in vitro* incubation was performed to see whether the different isolation processes had insidious effects on PT longevity.

Various indicators of viability are available for *in vitro* application [Freshney 1983, Wilson 1986, Benford & Hubbard 1987]. The two techniques employed in this

study were enzyme leakage; which can be used to assess viability as well as structural integrity [Benford & Hubbard 1987], and Oxygen Consumption. However before final viability measurements could be made, certain initial features pertaining to the two methods had to be ratified i.e.

- i Stability of AAP and LDH to prolonged incubation.
- ii Effect of incubation media on PT viability.

4.4 PRELIMINARY INVESTIGATION INTO THE STABILITY OF AAP AND LDH TO PROLONGED INCUBATION AT 37°C

In previous measurements of enzyme leakage, the two enzymes used were AAP and LDH. This choice posed no problems for that experiment as the measurements were made very soon after isolation. However, it was uncertain whether both these enzymes were stable to prolonged incubation at 37°C and therefore suitable for use as indicators of long term PT viability. Consequently it was decided to perform stability studies on both AAP and LDH.

i Kidneys from one rat were perfused, dissected and processed according to the mechanical isolation procedure described in section 2.4. The PT sample obtained was suspended in 20ml of iced gassed KHS.

ii The 20ml suspension was sonicated to disrupt the PTs and release the cellular enzymes. The sonicated suspension was spun down for 5min at 5,000 rpm to remove the tissue debris and the supernatant was removed and stored on ice until required for use.

iii The resultant sample was placed in a stoppered, gassed flask and incubated at 37°C in an oscillating water bath.

iv One ml aliquots were withdrawn from the incubating mixture at specified time intervals

| | | | | | | | | |
|-----------|---|-----|----|----|----|-----|-----|-----|
| AAP (min) | 0 | 15 | 30 | 60 | 90 | 120 | 150 | 180 |
| LDH (hr) | 0 | 0.5 | 1 | 2 | 3 | 4 | 5 | 6 |

and placed in separate plastic vials. The sample were kept on ice until required for assay.

v The appropriate vials were assayed for either AAP (described in section 4.1.1) or LDH (described in section 4.2.1) and, from these respective results, enzyme stability at 37°C was evaluated as a percentage of the initial value.

4.4.1 Results

Stability measurements for AAP and LDH were made in three separate experiments (n=3 with one Fischer rat used per experiment). The value of AAP and LDH obtained at the start of each experiment (ie time 0) was designated the initial or 100% value. All subsequent values were then expressed as a percentage of their initial value. The values obtained over the three experiments were averaged and then plotted against time. The stability plots obtained are shown in fig 4d for AAP and fig 4e for LDH \pm SD.

The plots showed that less than 40% of the initial AAP value remained after 3hr of incubation at 37°C whilst, with LDH, nearly 80% of the original value was still retained after 6 hr of incubation at 37°C.

4.5 PRELIMINARY INVESTIGATION INTO THE EFFECT OF INCUBATION MEDIA ON PT VIABILITY

After obtaining healthy tissue isolates, perhaps media composition is the next important key to the development of a successful *in vitro* system. It was felt that KHS alone was insufficient to support PT function and that other additives should be

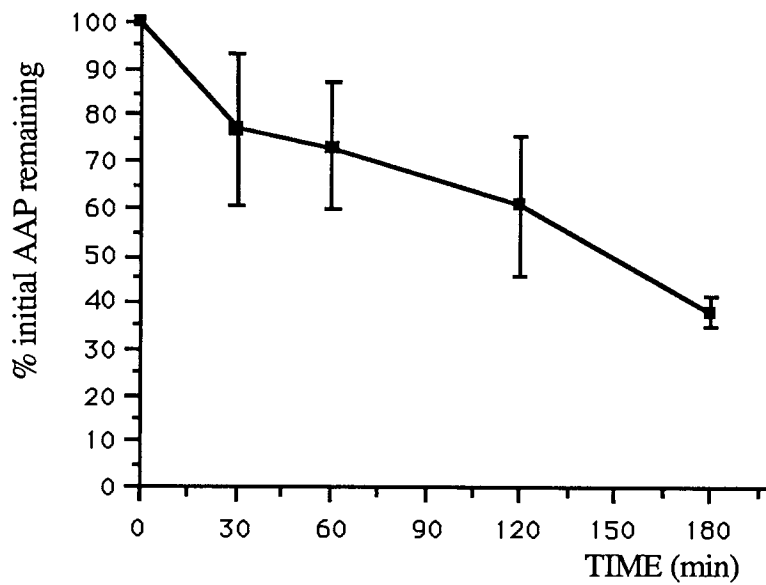

Fig 4d Graph of the stability of the brush border enzyme alanine aminopeptidase (AAP) to incubation at 37°C. The results plotted were the mean of 3 separate experiments \pm the standard deviation

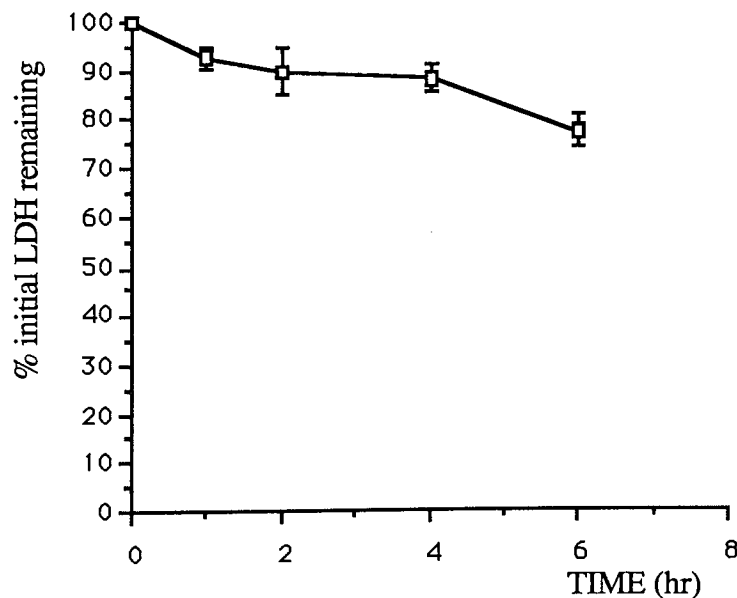

Fig 4e Graph of the stability of the cytosolic enzyme lactate dehydrogenase (LDH) to incubation at 37°C. The results plotted were the mean of 3 separate experiments \pm the standard deviation

incorporated to see whether they increased tubule longevity *in vitro*. Four experimental media were tested with the following compositions:

- i. KHS.
- ii KHS + 6% Bovine Serum Albumin (BSA) + 5mM Pyruvate or Lactate.
- iii KHS + 3% Dextran (mol wt 40,000) + 5mM Pyruvate or Lactate.
- iv Hams/F12 culture media + 10% Fetal Calf Serum (FCS).

The viability of the PTs in each medium was evaluated by either measuring leakage of LDH or oxygen consumption.

i PTs were isolated according to the mechanical isolation method described in section 2.4.

Samples pooled from 2 rats were used for each experimental medium.

ii The freshly isolated PT sample was suspended in 20ml of one of the four media.

iii The suspension was placed in a siliconised, stoppered flask gassed with humidified 95% O₂/5% CO₂ and then incubated in an oscillating water bath at 37°C.

4.5.1 Preliminary measurement of leakage of LDH from PT samples incubated in various media

This was used to assess media i, ii and iii but not iv as it was not possible to obtain this media without the additive Phenol Red — whose red colouration rendered spectrophotometry impossible.

A. A 2ml aliquot was withdrawn from each suspension at the start of the incubation time course. This sample was sonicated with 0.05% Triton to release all the tubular LDH and the tissue debris was removed by spinning down the sample at 5,000 rpm for 5min.

B. The supernatant was withdrawn and stored on ice until required. The sample was assayed for total LDH content

C. At specified time intervals, 1ml aliquots were withdrawn from the remaining incubating suspension and pipetted through 53 μ m mesh into plastic vials.

| | | | | | | |
|----------------------|----|----|----|-----|-----|-----|
| Time Intervals (min) | 30 | 60 | 90 | 120 | 150 | 180 |
|----------------------|----|----|----|-----|-----|-----|

The vials were stored on ice until required for assay. These samples were assayed for leaked LDH and corrected for enzyme degradation incurred over the time course.

D. The amount of LDH leakage with time for each medium was expressed as a percentage of the total LDH content and from this the effect of medium composition on long term viability was assessed.

4.5.2 Preliminary measurement of Oxygen Consumption by PT samples incubated in various media

Oxygen consumption has been widely used as an indicator of viability in *in vitro* renal systems [Dawson 1972, Balaban *et al* 1980, Gullans *et al* 1982, Kumar *et al* 1986]. Two quantitative methods have been prevalent in these studies; Manometry [Burg & Orloff 1962] and the Oxygen Electrode [Scholer & Edelman 1979]. This study utilised the Clark Type Oxygen Electrode on media iii and iv. The principles of this type of electrode are summarised in fig 4f.

Pre-Experiment Preparation

A. A Clark Type Oxygen Electrode (Rank Brothers, Cambridge) was set up with a teflon membrane and 3M KCL salt bridge as directed by the manufacturer. The temperature jacket was set to 37°C as measured in the incubation chamber.

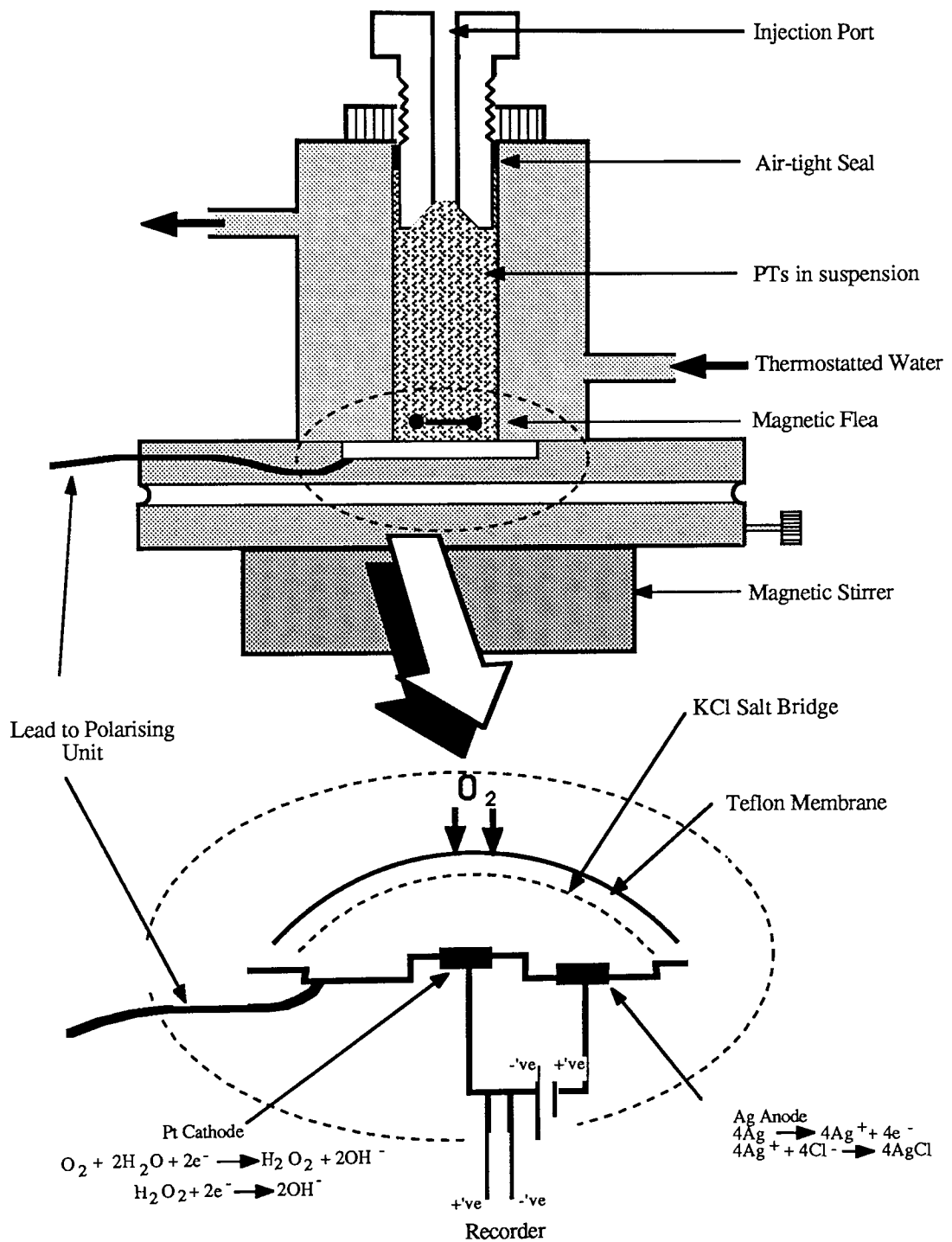

Fig 4d Schematic Drawing of Clark Oxygen Electrode

B. A 1ml aliquot of media (equilibrated to 37°C and fully saturated with 95% O₂/5% CO₂) was pipetted into the incubation chamber. After allowing 1-2min for the system to stabilise, the recorder was adjusted to the 95% position and then run for approximately 5min. This represented the saturation point for the medium. There was a very slight downward drift in this reading, due to oxygen consumption by the machine, and this 'background' effect was deducted from any subsequent readings made.

C. The anaerobic point was then calculated by adding a few crystals of sodium dithionite through the injection port. A dramatic drop in the chart recorder pen was seen and the new resting position was known as the anaerobic point.

D. The difference between the saturation and anaerobic points represented the oxygen concentration in the medium. Using this measurement of full scale deflection and concentration of dissolved oxygen at 37°C [Weast 1979] the concentration of oxygen represented by each recorder division was calculated.

E. Following this calibration procedure, the incubation chamber was thoroughly washed with distilled H₂O.

Oxygen Measurement

F. A 2ml aliquot was withdrawn from each medium suspension at the start of the time course. This sample was sonicated to disrupt the tissue and the resulting debris was removed by spinning down the sample at 5,000 rpm for 5min.

G. The supernatant was removed and stored on ice until assayed for total protein content by the CBB methods described earlier.

H. At specified time intervals 2ml aliquots were withdrawn from the remaining incubating suspension and pipetted carefully into the incubation chamber of the oxygen electrode.

Time Intervals (min) 30 60 90 120 150 180

It was important to ensure no air bubbles were introduced into the chamber — particularly when the sealing nut was replaced in the chamber.

I. The height of the sealing nut was adjusted until the medium rose to approximately 1cm up the injection port. At this point the chamber was now sealed and the only source of oxygen for the PTs was that dissolved in the medium.

J. After allowing 1-2 min for the system to stabilise, the rate of oxygen consumption was followed on a chart recorder for approximately 5-10 min.

K. The rate of oxygen consumption was expressed in terms of a Respiratory Quotient R_Q .

$$R_Q = \text{Slope} \times O_2 \text{ conc per recorder division}$$

The R_Q was calculated per mg of protein which compensated for any variations in tissue content of the samples.

With the questions on media and enzyme stability ratified, the final viability study was conducted in medium iii with LDH Leakage and Oxygen Consumption used to monitor viability. These studies were performed on PTs isolated by both the mechanical technique and also the enzyme perfusion technique so that comparative viabilities could be evaluated.

4.5.3 Results

The results of the affect of media composition on LDH leakage are shown in fig 4g. The values plotted were the mean of two separate experiments and were corrected for LDH degradation incurred over the time course and initial enzyme loss (obtained from the enzyme retention value for LDH in mechanically isolated PTs). Lactate was chosen in preference to pyruvate for this part of the study as pyruvate affected the LDH assay

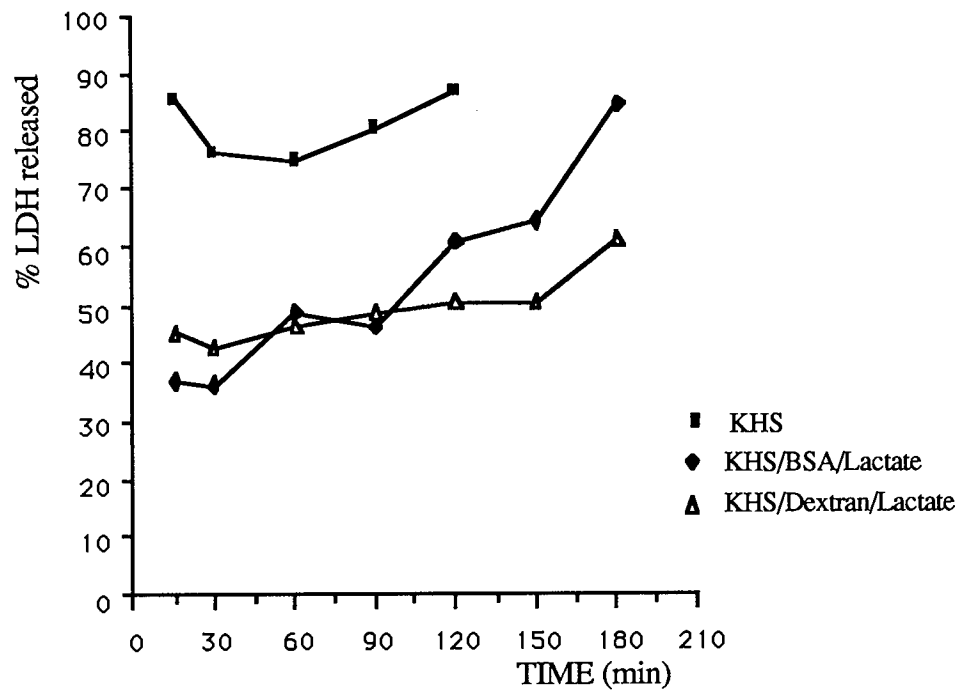

Fig 4g Leakage of LDH from mechanically isolated PTs incubated at 37°C in various media. The results plotted are the mean of two separate experiments

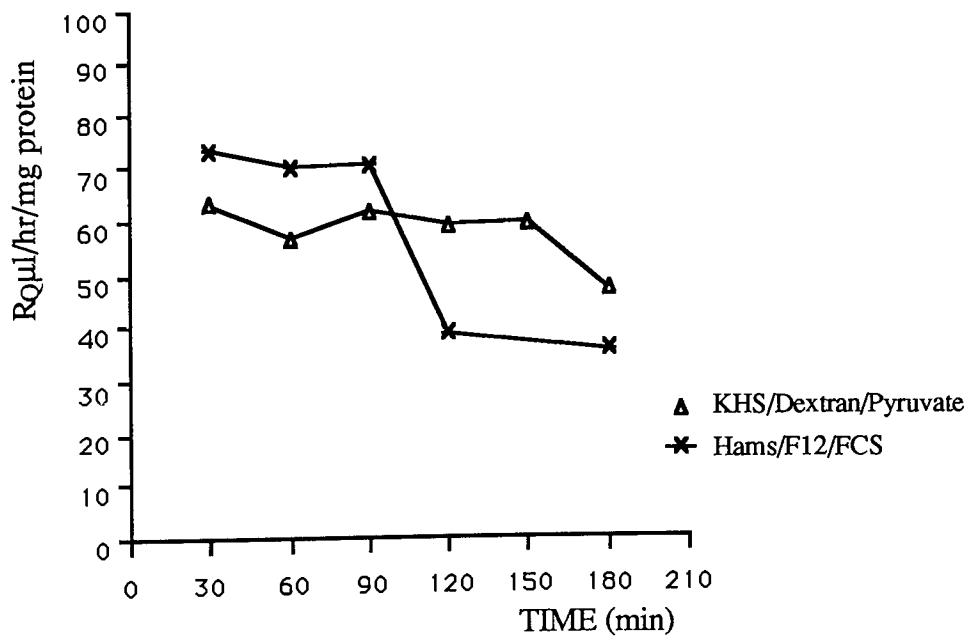

Fig 4h Oxygen consumption in mechanically isolated PTs incubated at 37°C in various media. The results plotted are the mean of 2 separate experiments.

procedure. The plot showed that KHS alone was the least adequate medium for the support of tubule function as LDH leakage became unacceptably high after approximately 1hr of incubation. Supplementing the KHS with 6% BSA and 5mM lactate extended the viability to about 2hr. Oxygen consumption values (fig 4h) showed that the use of Hams/F12 culture medium supplemented with 10% FCS did not improve on this 2hr value with the R_Q falling consistently after 90 min of incubation — suggesting a progressive loss of viability after that time point.

The addition of 3% dextran and 5mM lactate or pyruvate, however, appeared to produce the most optimal conditions with both LDH leakage and oxygen consumption being maintained at acceptable levels for in excess of 3hr.

4.6 COMPARISON OF THE LONG-TERM VIABILITY OF MECHANICAL AND PERFUSED COLLAGENASE ISOLATED PT SAMPLES INCUBATED IN DEFINED MEDIUM

4.6.1 Evaluation of long-term PT viability through the measurement of LDH leakage

METHOD

i Kidneys from two rats were perfused, dissected and processed according to *either* the mechanical or the enzyme perfusion techniques described in sections 2.4 and 2.3 respectively.

From this point onwards, the PTs followed the same experimental protocol regardless of the original isolation technique.

ii The PT sample obtained was suspended in 20ml of iced medium containing KHS, 3% Dextran (mol wt 40,000) and 10mM Lactate.

iii The incubation suspension was placed in a siliconised, stoppered flask, gassed with humidified 95% O₂/ 5% CO₂ and then incubated at 37°C in an oscillating water bath.

iv A 2ml aliquot was withdrawn from the incubation suspension at the start of the experiment. This sample was sonicated with 0.05% Triton to release all the tubular LDH and the tissue debris was removed by spinning down the sample at 5,000 rpm for 5min. The supernatant was withdrawn and stored on ice until assayed for total LDH content.

v. At specified time intervals, 1ml aliquots were withdrawn from the remaining incubating suspension and pipetted through 53µm mesh into plastic vials.

| | | | | | | | |
|---------------------|-----|---|---|---|---|---|---|
| Time Intervals (hr) | 0.5 | 1 | 2 | 3 | 4 | 5 | 6 |
|---------------------|-----|---|---|---|---|---|---|

The vials were quickly spun down for 3min in a bench centrifuge to remove any remaining extraneous tissue. The supernatant was withdrawn and stored on ice until assayed for leaked LDH. These values were corrected for enzyme degradation incurred over the time course.

vi The amount of LDH leakage with time was expressed as a percentage of the total LDH content. The effect of isolation technique on longevity was then evaluated.

4.6.2 Evaluation of the long-term PT viability through the measurement of Oxygen Consumption

i Kidneys from two rats were perfused, dissected and processed according to *either* the mechanical or the enzyme perfusion techniques described in sections 2.4 and 2.3 respectively.

From this point onwards, the PTs followed the same experimental protocol regardless of the original isolation technique.

ii The PT sample obtained was suspended in 20ml of iced medium containing KHS, 3% Dextran (mol wt 40,000) and 10mM Pyruvate.

iii The incubation suspension was placed in a siliconised, stoppered flask, gassed with humidified 95% O₂/ 5% CO₂ and then incubated at 37°C in an oscillating water bath.

iv A 2ml aliquot was withdrawn from the incubation suspension at the start of the experiment. This sample was sonicated to disrupt the tissue and the resulting debris was removed by spinning down the sample at 5,000 rpm for 5min. The supernatant was removed and stored on ice until assayed for total protein content by the CBB method described earlier.

v. At specified time intervals 2ml aliquots were withdrawn from the remaining incubating suspension and pipetted carefully into the incubation chamber of the oxygen electrode,

| | | | | | | | |
|---------------------|-----|---|---|---|---|---|---|
| Time Intervals (hr) | 0.5 | 1 | 2 | 3 | 4 | 5 | 6 |
|---------------------|-----|---|---|---|---|---|---|

ensuring that no air bubbles were introduced into the chamber. The sealing nut was replaced and lowered into the chamber until the medium rose to 1cm up the injection port.

vi After allowing 1-2 min for the system to stabilise, the rate of oxygen consumption was followed on a chart recorder for approximately 5-10 min.

vii Sodium succinate solution (final concentration in incubation chamber 5mM) was then added to the incubation chamber through the injection port. The effect of this on the rate of oxygen consumption was recorded for a further 4-5 min.

viii The R_Q for each time interval was calculated — together with the effect of succinate on the system, and the effect of isolation technique on *in vitro* PT longevity was assessed.

4.6.3 Results

Extended viability measurements were performed on both mechanically and enzyme isolated PTs in medium iii containing KHS, 3% dextran and 10mM of either pyruvate or lactate. Pyruvate and lactate levels were increased to ensure that substrate levels did not become a limiting factor in PT viability.

i Mechanically Isolated PTs

The results of the LDH leakage measurements for these PTs in the chosen medium are shown in table 4d below;

| Time(Hr) | n | Mean % \pm SD | CV |
|----------|---|-------------------|----|
| 1 | 5 | \$ 34.7 \pm 3.2 | 9 |
| 2 | 5 | 43.2 \pm 6.5 | 15 |
| 3 | 5 | 41.7 \pm 4.1 | 10 |
| 4 | 5 | 41.5 \pm 4.3 | 10 |
| 5 | 5 | 43.5 \pm 4.2 | 10 |
| 6 | 5 | 47.4 \pm 3.7 | 8 |
| 7 | 5 | #56.2 \pm 7.2 | 13 |

1. Unless otherwise marked, all data points were not significantly different from every other data point.
2. Data points marked \$ were significantly different from all other data points *except* the 2hr time point.
3. Data points marked # were significantly different from all other data points.

Table 4d Measurements of the percentage of LDH leaked with time from mechanically isolated PTs incubated in KHS/3% Dextran/10mM Lactate at 37 °C. The results are the mean of 5 separate isolations \pm standard deviation (SD) and the coefficient of variation (CV) is also shown.

The results were averaged from 5 separate mechanical isolations (n=5) and each experiment utilised two Fischer rats. The data showed that following a release of approximately 35% during the initial hour of equilibration, there was a statistically significant increase in LDH leakage which continued up to three hours into the incubation — but which had virtually peaked at around the 2hr time point. From the 2hr time point onward there was no statistically significant rise in LDH leakage until the 7hr time point.

In fact between 1 and 6hr, less than 15% of the total enzyme activity was released with over 50% of the total enzyme activity still retained within the tubules at the end of 6hr incubation in the chosen medium. After 6hr, however, the rise in LDH leakage became significant.

The results of oxygen consumption experiments in the mechanically isolated PTs incubated in the chosen medium are shown in table 4e below;

| Time(Hr) | n | Mean $R_Q \pm SD$ | CV |
|----------|---|-------------------|----|
| 1 | 5 | 49.9 \pm 2.8 | 6 |
| 3 | 5 | 48.7 \pm 8.7 | 18 |
| 4 | 5 | 45.7 \pm 7.9 | 17 |
| 5 | 5 | 53.1 \pm 11.7 | 22 |
| 6 | 5 | 43.8 \pm 5.8 | 13 |
| 7 | 5 | #23.5 \pm 7.5 | 32 |

1. Unless otherwise marked, all data points were not significantly different from every other data point.
2. Data points marked # were significantly different from all other data points.

Table 4e Measurement of oxygen consumption with time for mechanically isolated PTs incubated in KHS/3% Dextran/10mM Pyruvate at 37 °C. The results are the mean of 5 separate isolations \pm standard deviation (SD) and the coefficient of variation (CV) is also shown.

The results were averaged from 5 separate mechanical isolations (n=5) and each experiment utilised two Fischer rats. Maintenance of oxygen consumption levels followed a very similar time course to that of LDH leakage. After the 1hr equilibration period, R_Q was maintained with no statistically significant deviations up to and including the 6hr time point; thereafter the R_Q fell sharply and significantly. On addition of succinate, the R_Q rose 3-fold at each time point, up to and including the 6hr measurement. After 7hr, however, the stimulant effects of the succinate either ceased or were significantly attenuated.

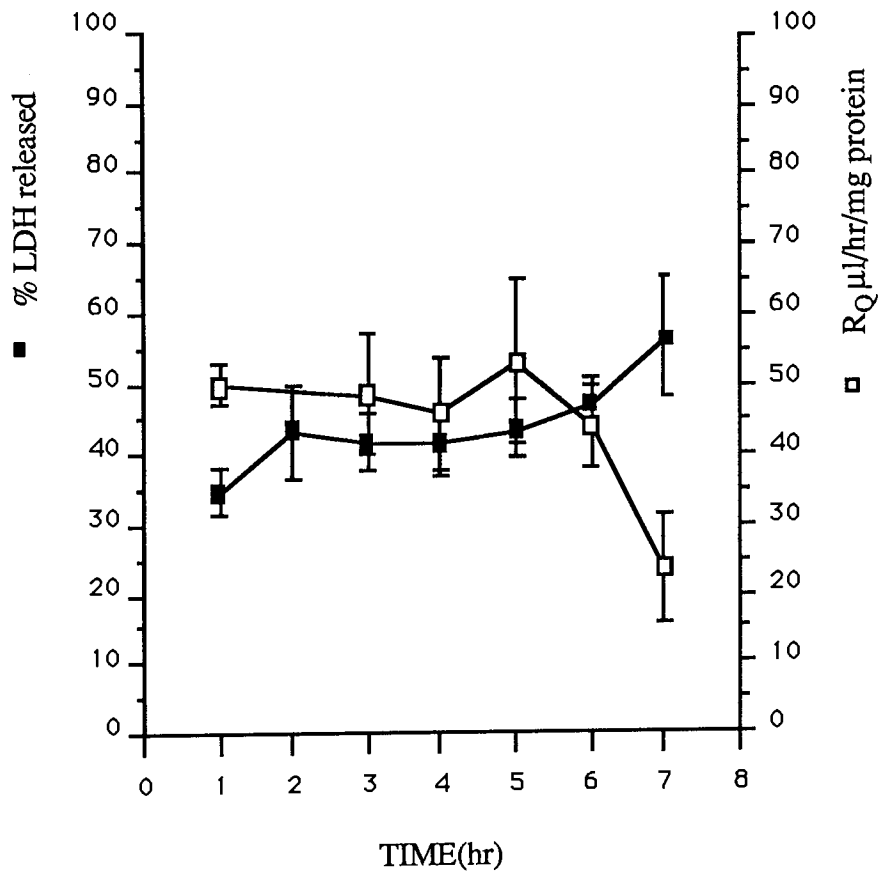

Fig 4i Measurement of oxygen consumption and leakage of LDH from mechanically isolated rat proximal tubules incubated at 37°C in KHS/3% Dextran/10mM Pyruvate or Lactate. The results plotted were the mean of 5 separate isolations \pm standard deviation

The results of LDH leakage and oxygen consumption measurements in mechanically isolated PTs are summarised in fig 4i. Each value plotted is the mean of 5 separate isolations \pm SD. The graph clearly showed that both parameters of viability were maintained over a similar time course and therefore corroborated each other in suggesting a viability in the chosen medium of approximately 6hr at 37°C for mechanically isolated PTs.

ii Collagenase Isolated PTs

The results of the measurement of LDH leakage from PTs isolated by collagenase perfusion incubated in the chosen medium are shown in table 4f below;

| Time(Hr) | n | Mean% \pm SD | CV |
|----------|---|---------------------|-----|
| 1 | 5 | 27.4 \pm 3.6
* | 13 |
| 3 | 5 | 45.4 \pm 5.8 | 13 |
| 4 | 5 | 53.5 \pm 6.8 | 3.1 |
| 5 | 5 | 74.7 \pm 6.8 | 9 |

1. Unless otherwise marked, all data points were significantly different from every other data point.
2. The annotation * means that the groups on either side were not statistically different from each other.

Table 4f Measurement of the percentage of LDH leaked with time from PTs isolated by collagenase perfusion incubated in KHS/3%Dextran/10mM Lactate at 37°C. The results are the mean of 5 separate isolations \pm standard deviation (SD) and the coefficient of variation (CV) is also shown.

The results were averaged from 5 separate mechanical isolations (n=5) and each experiment utilised two Fischer rats. During the initial 1hr equilibration period the collagenase isolated PTs had released significantly less LDH, at around 25%, than the mechanical isolates. Unfortunately, instead of stabilising like the mechanical isolates, the collagenase isolated PTs continued to leak LDH steadily such that at the end of 5hr incubation, only 25% of the total LDH activity was still retained within the tubules —

though interestingly the value of 3hr time point of the collagenase isolated PTs was not statistically different from that of the mechanically isolated PTs.

The results of the measurement of oxygen consumption in PTs isolated by collagenase perfusion incubated in the chosen medium are summarised in table 4g;

| Time(Hr) | n | Mean $R_Q \pm SD$ | CV |
|----------|---|-------------------|----|
| 1 | 5 | 38.1 \pm 7.6 | 20 |
| 3 | 5 | 24.4 \pm 4.8 | 20 |
| 4 | 5 | 13.4 \pm 3.9 | 29 |
| 5 | 5 | 7.7 \pm 3.4 | 44 |

1. Unless otherwise marked all data points were significantly different from every other data point.
2. The annotation * means that the groups on either side were not statistically different from each other.

Table 4g Measurement of oxygen consumption with time for PTs isolated by collagenase perfusion incubated in KHS/3% Dextran/10mM Pyruvate at 37 °C. The results are the mean of 5 separate isolations \pm standard deviation (SD) and the coefficient of variation (CV) is also shown.

The results were averaged from 5 separate mechanical isolations (n=5) and each experiment utilised two Fischer rats. After the initial 1hr equilibration period the collagenase isolated PTs had achieved a significantly lower R_Q than that of the mechanically isolated PTs. Instead of stabilising, the R_Q then continued to fall significantly up to the 4hr time point thereafter; the decline in R_Q was no longer significant — the R_Q was so low by this stage that this was indicative of gross functional deterioration rather than stability. At all time points the R_Q for the collagenase isolated PTs was significantly lower than that obtained with the mechanical isolates. Succinate produced a 5-fold increase in R_Q up to and including the 3hr measurement thereafter; succinate stimulation either ceased or was attenuated. In both mechanical and enzyme isolated PTs, the addition of Drabkin's reagent abolished the basal R_Q rates and succinate responses and neither the succinate nor the Drabkin's reagent had any effect on the background electrode readings.

The results of LDH leakage and oxygen consumption in PTs isolated by collagenase perfusion are summarised in fig 4j. The graph showed a much shorter maintenance of the two viability parameters in these PT s compared with the mechanical isolates with the collagenase isolated PTs exhibiting a reduced viability of barely 3hr at 37°C in the chosen medium.

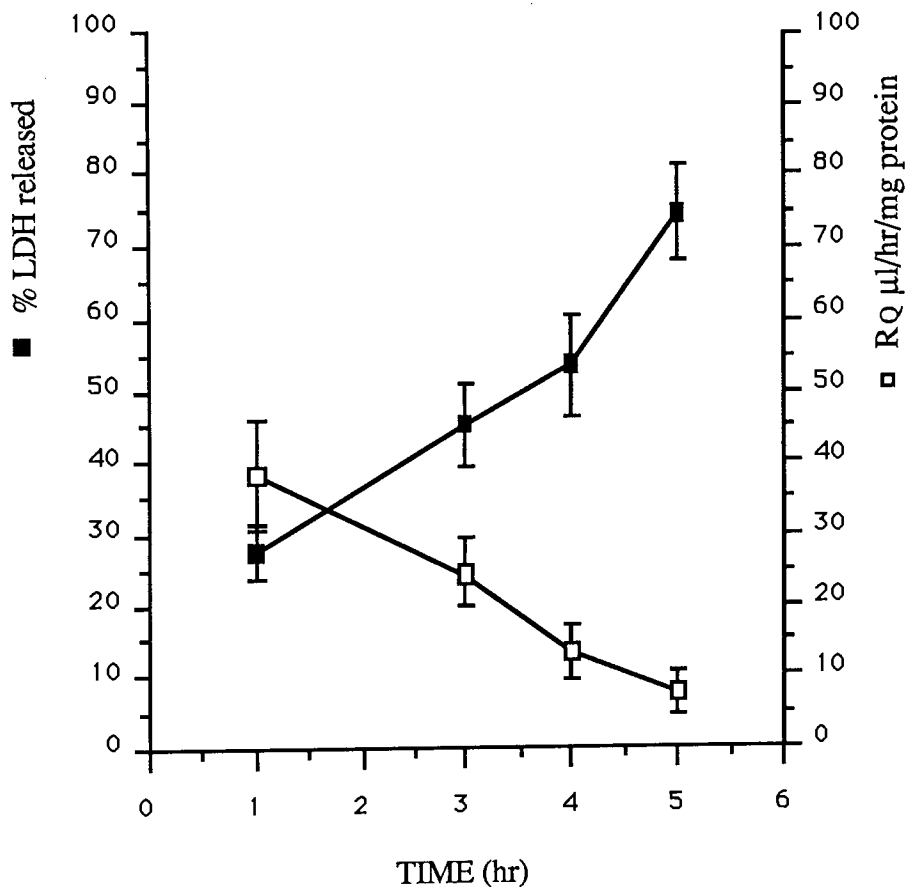

Fig 4j Measurement of oxygen consumption and leakage of LDH from collagenase isolated rat proximal tubules incubated at 37°C in KHS/3% Dextran/10mM Pyruvate or Lactate. The results plotted are the mean of 5 separate isolations \pm standard deviation

4.7 DISCUSSION

The morphological evaluation in Chapter 3 gave data evidential of major structural differences between PT samples produced by the mechanical and enzymatic techniques. Despite this, however, it was unclear whether these structural disparities were sufficiently injurious as to induce detrimental effects on PT function. After all, collagenase isolated tubules, even ones showing serious structural damage [Chahwala & Harpur 1986], have been widely used for mechanistic studies [Vinay *et al* 1979, Balaban *et al* 1980, Schnellman 1988]. It was decided, therefore, to compare various biochemical functions in PT samples from the two isolation techniques to see whether the structural damage incurred further manifested itself as functional aberrations or whether the injuries sustained were too superficial to impair performance. Indeed, it may also be that, although the mechanically isolated PTs showed better structural preservation, they might have sustained insidious effects not immediately obvious to visual inspection. In addition, other biochemical parameters, not directly associated with function, were measured to corroborate the morphological findings on sample purity and integrity.

4.7.1 Evaluation of the purity of the PT samples

Purity was assessed by the use of enrichment factors and the absence of the distal marker enzyme hexokinase. The worth of EF in assessing purity lay not so much in its absolute value, although this can be useful when comparing isolation techniques, but rather in its *variation* which indicated the reproducibility of samples produced by the technique.

4.7.2 Enrichment of proximal marker enzymes

The enrichment value for AAP of 2.1 obtained in this study for the mechanically isolated rat PTs compared very favourably with the AAP enrichment of 0.97

obtained with an analogous mechanical preparation by Hjelle *et al* 1981. Although the experiments of Hjelle *et al* 1981 were performed in rabbits rather than rats, and species difference may have been a factor, their level of enrichment was still surprisingly low for a 99% pure preparation of rabbit PTs. Hjelle *et al* 1981 stated that the BBM of the rabbit could only be preserved by the mildest of cortical disruption conditions. This was corroborated by their finding that, following the sub-fractionation of their rabbit PTs by homogenisation and isopycnic centrifugation, the BBMs were proved to be extensively damaged with microvilli, containing AAP, having partitioned into the microsomal fraction. Unfortunately, it was never made clear in their study whether all the BBM damage was incurred during sub-fractionation or whether some occurred during the PT isolation.

As the EF value for the BBM marker AAP was so low, compared with that obtained in this study, it may well be that the homogenisation technique used in their isolation procedure initiated some BBM damage which caused the AAP to leak out. If true, this would account for the low EF obtained — particularly since other enzymes located more deeply within the cell eg Na-K-ATPase, glucose-6-phosphatase were enriched approximately two fold.

Hjelle *et al* 1981 used an homogenisation technique in their isolation procedure which consisted of 8 vertical strokes by a tear shaped pestle (no clearance dimensions were given) and it may be that this style of homogenisation was more stressful to the BBM than the 2-4 spiralling strokes of a loose tear shaped pestle used in the present study. Their PTs also underwent an unnecessary double sieving on an 86 μ m mesh and a prolonged removal of the iron loaded glomeruli by decanting over a magnet — both procedures which could have put extra stress on the fragile BBMs of the rabbit PTs.

A latter study by Hjelle *et al* 1982, using an identical preparation, showed TEM micrographs of the mechanically isolated rabbit PTs that exhibited an apparently well preserved morphological structure. The problem, however, of using TEM alone to evaluate the structural integrity of the BBM is that the villi are so luxuriant that damage

has to be quite significant before it becomes visible by this technique with insidious damage being more difficult to detect. For this reason perhaps leakage and enzyme enrichment of BBM markers are more sensitive guides to the structural integrity of this membrane than morphology alone.

The CV values for the specific activities of AAP in the proximal and cortical samples of Hjelle *et al* 1981 were found to be very similar to that obtained in this study. This indicated that the reproducibility of the mechanical technique developed in this study was at least comparable to the mechanical technique of Hjelle *et al* 1981.

Scholer & Edelman 1979 used the BBM marker enzyme alkaline phosphatase on their PTs produced by collagenase digestion. Therefore, it was not really possible to compare their value of 1.15 with the AAP value obtained in the present mechanical isolates. It was the collagenase isolation of rat proximal tubules by Vinay *et al* 1981, however, that perhaps provided the most interesting comparison. They obtained two-fold enrichment of proximal cytosolic enzymes but failed to obtain any significant enrichment of *two* brush border enzymes. The cytosolic EF suggested good PT enrichment with this rat sample and so, in theory, the BBM enzymes should have been enriched. The fact that they were not, indicated loss of the enzymes during preparation — similar to the findings of Hjelle *et al* 1981. Similarly, Vinay *et al* 1981 also alluded to BBM damage but gave no indication of its extent. The fact that no BBM enrichment was obtained suggested that the damage was considerable and confirmed the aberrant BBM staining shown in section 2.2.3 of this study with a similar PT preparation isolated by whole cortex digestion. No statistical treatment of the enrichment values was shown by Vinay *et al* 1981 and so no comparison of the reproducibility of sieving and centrifuge separation techniques was possible.

So it would seem from the EF values derived in this study that the final tubule samples were enriched in proximal elements — thus confirming the earlier morphological findings in Chapter 3. The values also showed that the *degree* of enrichment obtained with these PTs was greater than that measured by other workers [Scholer & Edelman 1979, Hjelle *et al* 1981, Vinay *et al* 1981] in both mechanical and enzyme isolated PT

preparations. This suggested that the BBM integrity in the mechanical PT preparation was superior, not only to collagenase isolates, but also probably to other similar mechanical techniques as well. In addition, the reproducibility of the mechanical technique used in this study was comparable to that of other mechanical techniques [Hjelle *et al* 1981].

The variation of the EF values with the weight/age of the rat was difficult to explain. It is unlikely that the contamination of mechanical samples by connective tissue was the reason for this difference as the degree of contamination in these samples increased with the weight of the rat and so EF would have, therefore, been expected to *decrease* with a rise in weight — whereas in fact the reverse occurred. However this finding did tend to confirm the theory that connective tissue did not contribute significantly to protein determinations.

It may be that the BBM was more fragile in the younger animals and, as a result, suffered slightly more damage than the older rats during the isolation procedure with a consequent reduction in the EF values. However, at the end of the day, this observation derived from a very small sample of rats and possibly this apparent variation in EF with weight might 'even out' if a larger sample were to be studied.

4.7.3 Measurement of distal contamination

Expressing purity in terms of EF only indicated the degree of enrichment over the original homogenate; it did not indicate what proportion of the final sample was attributable to other contaminants. For this reason, the amount of hexokinase present was measured to obtain an idea of the amount of distal contamination in the final PT sample. The total absence of hexokinase with both PT preparations over six isolations was very reassuring and confirmed the morphological findings that glomeruli and connective tissue, rather than distal tubules, which were the major contaminants and that collagenase did not affect the purity of the final sample. The results also suggested that the sieving technique used in the mechanical isolation was an improvement over the percoll purification

techniques of Scholer & Edelman 1979 and Vinay *et al* 1981 who both detected hexokinase in their final PT samples.

4.7.4 Evaluation of the initial structural integrity of the PT samples

Structural integrity was examined by the measurement of the percentage of various enzymes retained within the tubule structure. It was felt that this parameter gave a more sensitive evaluation of any structural impairment and was likely to detect insidious damage more readily than morphology alone. The two enzymes used for these measurements were LDH and AAP which evaluated the main cellular structure and the more fragile brush border regions respectively. In this way, an indication of the percentage of PTs with good initial structure was obtained for each isolation technique.

The percentage of LDH retained showed no statistical difference at around 82% for both mechanical and perfused enzyme isolated PTs. This high value confirmed the earlier morphological finding that mechanical isolation had caused no significant damage to the main tubule structure. A similar percentage retention with collagenase isolated PTs indicated that, although their morphological examination had shown gross basolateral distortion, it appeared not to have extended sufficiently deeply into the tubule structure to induce LDH leakage. This basolateral distortion might, however, have contributed to the slightly greater variation in their percentage of LDH retention compared with that of mechanical isolates.

In contrast, the percentage of AAP retained was found to be statistically greater at 87% in mechanical isolates compared with the 79% AAP retention obtained in the collagenase isolated PTs. This result confirmed earlier morphological findings that collagenase perfusion had caused significant damage to the BBM region of its isolates — although the retention of 79% of the AAP activity suggested that the degree of damage incurred with this form of collagenase isolation was very probably less than that inflicted by the whole cortex collagenase digestion described in section 2.2. In fact, in all likelihood, significant enrichment of BBM enzymes might well have been obtained with

the PTs produced by this collagenase perfusion technique. The significantly higher value of 87% AAP retention obtained with the mechanical isolated PTs suggested that the homogenisation and sieving procedures used in this method had caused minimal BBM damage — indicating a potential improvement with this technique over the mechanical isolations of Hjelle *et al* 1981.

Although enzyme leakage is felt by some to be an indicator of initial viability [Benford & Hubbard 1979], the importance of its use in this study was to give a more sensitive indication of the extent of damage each isolation technique imposed. This could have value in any future experiments conducted on these PTs where it might become essential to know what proportion of total damage was caused by various factors eg isolation, prolonged incubation, exogenous toxins etc.

The EF values obtained in this study for AAP and LDH suggested that, despite the morphological indications, the two isolation techniques produced samples that appeared initially to have similar basic overall integrity but that the more fragile regions (like the BBM) suffered more damage under the collagenase perfusion technique.

4.7.5 Evaluation of the longevity of the PT samples

The two PT samples were now examined to see whether their method of isolation affected their final longevity. It was hoped to have used both AAP and LDH in the viability measurements but stability studies showed that over 60% of the AAP had degraded within the first three hours of incubation at 37°C (fig 4d), so it was not felt that AAP was a suitable indicator of viability. LDH on the other hand still retained over 80% of its activity after six hours of incubation (fig 4e) and the variability in LDH measurements between assays was lower than those found for AAP. LDH was, therefore, deemed suitable for use in viability studies although all the subsequent long term LDH measurements made in this study were corrected for this enzyme degradation — a feature often ignored by other workers [Green *et al* 1987, Schnellman 1988].

4.7.6 Effect of incubation medium on PT longevity

Not surprisingly, medium composition significantly influenced viability. Many different media formulae exist in the literature [Scholer & Edelman 1979, Mandel & Murphy 1984, Green *et al* 1987, Schnellman 1988] but the ingredients appeared to have been based on trial and error rather than definite evidence. Nevertheless, most media seemed to contain three basic elements;

1. Physiological electrolyte solutions.
2. Substrate.
3. Oncotic agent.

The viability results obtained in this study showed that the physiological solution KHS alone was totally inadequate to support PT viability with most of the PTs having died within the first 30min of incubation at 37°C (fig 4g). Hams/F12 medium is a rich cell culture medium widely used in the maintenance of renal cell lines and primary culture [Taub & Livingston 1981, Hori *et al* 1984]. It was felt that the rich combination of cellular 'fuels' in this medium [Freshney 1983] together with the oncotic properties of the additional 10% FCS might prolong PT viability. Oxygen consumption results (fig 4h) showed that it did so, but for only a rather disappointing 90min. Although surprising, this result was perhaps fortuitous as the presence of phenol red in the medium would have undoubtedly reduced its utility.

Although the simple medium containing just the three basic elements namely KHS, lactate and BSA extended viability to approximately 2hr (fig 4g), it was the substitution of the oncotic agent dextran for BSA that appeared to have the most beneficial effect — extending viability to >3hr. The substitution of dextran for serum albumin also had other significant advantages which, it was felt, ultimately increased the flexibility of the system [Gullans *et al* 1982];

1. Dextran does not fluoresce in the same way as albumin which makes the system suitable for fluorimetric assays.

2. Dextran binds exogenous agents to a much lesser extent than albumin which is important when using xenobiotics etc in this system.

One of the drawbacks of using dextran, however, is in its potential to induce artifact during the histological preparation for EM [Bjugn & Flood 1988]. For this reason, dextran was not present in the medium during any of the histological preparations seen in Chapter 3. Because of the increased viability facilitated by dextran, and with the morphological problems in mind, it was decided to adopt this simplified medium and measure its ability to preserve, over a period of time, the viability of PTs produced by the two isolation techniques.

4.7.7 Evaluation of the viability produced with the chosen incubation medium

LDH leakage showed, and oxygen consumption confirmed, a difference of 3hr between the viability of the two PT samples with mechanical isolates remaining viable for at least 6hr (fig 4i) whilst collagenase isolates maintained viability for barely 3hr (fig 4j). For the mechanically isolated PTs fig 4i showed a loss of approximately 35% during the initial hour of incubation and a further significant rise up to the 3hr time point — but which had virtually peaked by the 2hr time point. Then from the 2-6hr time points there was no significant increase in LDH leakage until the 7hr time point when the rate of leakage again became significant.

The loss of enzyme during the equilibration phase could be accounted for, to a significant extent, by leakage of LDH from cells that had been damaged during the cutting of the tubule ends and also by release of trapped enzyme (leaked by other tubule elements during isolation) retained in the lumens — which dilated as the PTs were raised from 2-4°C to 37 °C. The further loss of LDH between 1-3hr is more difficult to explain. It is unlikely that this loss was heralding the death of more cells as the R_Q oxygen consumption values for the same preparation showed no significant difference over the same period — and indeed showed no significant change in R_Q until the 7hr time point.

During cell death, the attenuation of respiration would be expected to occur *before* the release of LDH and it may be that the rise in LDH leakage between 1 and 3hr was a 'latent' manifestation of the cell death that occurred during the equilibration phase i.e. although the majority of the initially damaged cells probably ceased to respire and contribute to R_Q during the equilibration phase, they might well have released their LDH over a more prolonged period.

LDH leakage is a parameter widely used to assess cellular damage and toxicity [Schnellman & Mandel 1986, Schnellman 1988]. Whilst it is probably acceptable to use LDH in this way to evaluate *direct* structural damage (as in this case, although not alone due to its potentially insensitivity compared with other viability parameters such as oxygen consumption), a growing body of opinion feels that it is possibly not sufficiently sensitive to monitor toxic events. Other enzymes such as the mesenchymal marker Vimentin [Hatzinger *et al* 1988] have been suggested and if these PT samples were to be used in future toxicological studies, it would perhaps be prudent to employ some of these new markers in addition to LDH.

The oxygen consumption profile for the mechanical isolates closely paralleled that of LDH leakage. After the initial equilibration period, the R_Q levels were maintained until the 6hr time point — after which time the R_Q fell significantly. The R_Q values obtained with this preparation of on average $48\mu\text{l/hr/mg}$ protein or 31nmol/min/mg protein fell within the ranges quoted by other workers for collagenase isolated tubule preparations eg 33nmol/min/mg protein in rats [Dawson 1972], 35nmol/min/mg protein in rabbits [Balaban *et al* 1980] and $25\text{-}34\mu\text{l/hr/mg}$ protein in rats [Scholer & Edelman 1979] although in the latter study, the PTs were incubated at 28°C rather than the 37°C of the other studies — which may account in part for their lower R_Q values.

The similarity of the R_Q value in this study with that of Balaban *et al* 1980 is particularly interesting as their tubule preparations had open lumens and Balaban *et al* 1980 stated that tubules with closed lumens exhibit lower R_Q values due to a reduction in transport processes. The parity of the R_Q levels in this study would therefore suggest that the lumens of the present mechanical isolates were also open — thus confirming the

earlier morphological findings on luminal patency [Chapter 3]. In fact further morphological examination of the mechanically isolated PTs showed that not only were their lumens open initially, but that they maintained a luminal patency of approximately 60-70% after 6hr of incubation, which may have been a significant factor in their maintenance of R_Q over the 6hr incubation period.

Maintenance of luminal patency in the mechanical isolated PTs was felt to be a potential advantage over cortical slice or collagenase isolated PTs which tended to collapse after approximately 1hr of incubation. Indeed the lumens of the perfused collagenase samples tested here collapsed within 90 min of incubation. Whether this feature was due to a weakening effect by collagenase digestion on the BLM was unclear.

Respiration in isolated tubules has already been shown by other workers to be higher than in renal slices [Burg & Orloff 1962, Thimmappayya *et al* 1970]. Some feel that the higher R_Q generally found in isolated tubules compared with slices is indicative of 'a loss of respiratory control' [Thimmappayya *et al* 1970]. Others suggest that this is not the reason and that improved oxygenation and access of substrate in the isolated tubules are more likely causes of the raised R_Q [Burg & Orloff 1962, Balaban *et al* 1980]. The fact that the lumens of cortical slices close within 1hr of incubation may also be a contributing factor in their lower R_Q values [Gandolfi personal communication] and Dawson 1972 in his work on collagenase isolated tubule fragments showed that the raised R_Q was unlikely to be due to a loss of respiratory control. Indeed if the raised R_Q in this study was a result of respiratory distress, then it is difficult to see how this was maintained over the 6hr incubation and also how they showed a 3-fold stimulation in R_Q on the addition of succinate.

Comparable viability measurements do not appear to have been performed with other mechanical isolations [Brendel & Meezan 1975, Carlsson *et al* 1978, Hjelle *et al* 1981] therefore it was not possible to relate the performance of this mechanical sample to similarly isolated tissues. Nevertheless, the viability of this mechanical preparation was a considerable improvement on the usual 3-4hr viability of collagenase isolated preparations [Scholer & Edelman 1979, Green *et al* 1987].

The 6hr viability obtained with mechanical isolates was also a considerable improvement on the 3hr viability obtained with the PTs isolated in this study by collagenase perfusion. Although the viability of the collagenase isolates was less than their mechanical counterparts, their viability nevertheless compared favourably with the 3-4hrs exhibited by other collagenase preparations [Scholer & Edelman 1979, Green *et al* 1987].

Fig 4j showed that after the initial equilibration period, the collagenase isolated PTs had released approximately 25% of their LDH content. Thereafter, the percentage of released LDH continued to rise but did not become statistically significant until after the 3hr time point. By the end of the 5hr time point, only about 25% of the total LDH content was still retained within the tubules.

The amount of LDH lost by the collagenase isolates during the incubation period was significantly less than that from the mechanical isolates. It is difficult to know why this should be, but one reason might be due to the quality of the cut ends of both PT preparations. Fig 3j showed that the cut ends of the collagenase isolates were grossly damaged and distorted whereas the cut ends of the mechanical isolates were remarkably well preserved (fig 3i). It may be that because the ends of the collagenase isolates were so heavily damaged they released their LDH content more readily and probably lost a great deal of it during the isolation procedure so that, by the time they started the incubation, there was comparatively less residual LDH left for leakage. In comparison, the ends of the mechanical isolates were less damaged and so may have released LDH at a much slower rate — thereby having more residual LDH present when they started their incubation. In addition, the patency of the lumens at the cut ends of the collagenase isolates was also compromised and in fact the majority of the lumens had closed within the first 90min of incubation — both factors which may well have affected the release of any LDH trapped in the lumens of the collagenase isolated PTs. After 3hr of incubation at 37°C, however, the rise in LDH released became significant and suggested a progressive loss of viability after that time point.

Interestingly, the oxygen consumption values of the collagenase isolated did not parallel their LDH viability profile as closely as their mechanical counterparts. After the equilibration period, their R_Q was significantly lower at $38\mu\text{l/hr/mg}$ protein or 25nmol/min/mg protein than the mechanically isolated PTs. Although their value is lower than that obtained by Dawson 1972 and Balaban *et al* 1980, the value is still higher than the R_Q obtained in rats by Kumar *et al* 1986 of $0.42\mu\text{l/min/mg}$ protein and in the range quoted for rats by Scholer & Edelman 1979. In fact the higher R_Q levels obtained by Balaban *et al* 1980 may in part be due to species differences between rabbits and rats. Also the higher R_Q in Dawson's 1972 work may be an artifact of the fragmented nature of his tubule preparation which could have allowed even greater access of oxygen and substrates than even whole tubules.

After the 1hr time point the R_Q fell significantly up to the 4hr time point and thereafter, the R_Q values were so low that further decreases were no longer significant. It is likely that the loss of luminal patency over the first 90min of incubation may have contributed significantly to the fall in R_Q between the 1 and 3hr time points — although after 3hr the low value of R_Q together with the rise in LDH leakage was probably indicative of cell death. So it would seem that collagenase treatment did attenuate the viability of the PTs compared with the mechanical separation.

In conclusion, the mechanical isolation technique described herein produced PTs of consistently high purity and structural integrity. Despite the formidable morphological changes seen in the PTs produced by collagenase perfusion [Chapter 3], the parity of the LDH levels retained in the two tubule preparations suggested that the *initial* integrity of the main tubule structure of the collagenase isolates was comparable with that of mechanical isolates. However, significantly more BBMs damage was incurred with the collagenase perfusion technique. Nevertheless, it later became apparent that the exposure to collagenase had in fact inflicted insidious damage on the PTs isolated

in this way which, although not affecting initial structure greatly, did initiate changes which compromised the *longevity* of the final product.

So in the final analysis collagenase did affect the performance of the tubules and the reduced level of structural damage found in the mechanically isolated PTs was probably a very significant factor in their superior longevity.

~~~ CHAPTER 5 ~~~

## USE OF THE FLUORESCENT CALCIUM INDICATOR FURA IN FRESHLY ISOLATED RENAL TUBULE SYSTEMS

It was the ultimate intention of this study to use the mechanically isolated PT samples, described earlier, to investigate toxic renal mechanisms — particularly those pertaining to aminoglycoside nephrotoxicity. As stated in section 1.4, alterations in cellular cytosolic calcium  $[Ca^{2+}]_i$  levels have been implicated in many stages of various renal cell injuries [Weinberg 1984, Trump & Berezsky 1985, Smith *et al* 1987b, Phelps *et al* 1989, Skeer & Lindup 1989, Trump & Berezsky 1989], including aminoglycoside insults [Holohan *et al* 1988, Inui *et al* 1988]. It therefore seemed a worthwhile, if ambitious, aim to try and develop a method of measuring changes in  $[Ca^{2+}]_i$  in fresh, mechanically isolated PT samples.

There are several methods for measuring  $[Ca^{2+}]_i$  in cellular systems including bis-azo dyes eg arsenazo III [Murphy & Mandel 1982], calcium-sensitive photoproteins eg aequorin and obelin [Cheung 1987], calcium-sensitive microelectrodes [Lee 1988] and fluorine-labeled NMR probes [Rink 1983]. The properties of some of these alternative probes have already been outlined in table 1b. Each has specific advantages for certain tasks, however each also, in their different ways, is technically demanding in terms of both equipment costs and skills. As a consequence, their use was felt to be inherently unsuitable in this part of the study where the measurement of  $[Ca^{2+}]_i$  was intended to be part of an investigation of toxicological processes rather than a major aim — neither was the potential expense of equipment outlay in a rather *ambitious* system lost on the experimenter.

The fluorescent tetracarboxylates, QUIN 2, FURA 2 and INDO 1, have gained enormous popularity due to the general availability of basic fluorimetric apparatus (although much more sophisticated fluorescence systems are now increasingly used) [Phelps *et al* 1989] and the relative ease with which these indicators are incorporated into cells — thus obviating the need for the skills and equipment necessary for micro-

injection. As FURA had many desirable experimental properties as a  $[Ca^{2+}]_i$  indicator and had already been successfully used in renal cell culture systems [Goligorsky *et al* 1986 a&b, Jones *et al* 1986, Nord 1987, Smith *et al* 1987b, Goligorsky & Hruska 1988], it was decided to try FURA in the measurement of  $[Ca^{2+}]_i$  in freshly isolated whole rat PTs.

At the time this part of the study commenced, the use of FURA for the measurement of  $[Ca^{2+}]_i$  in renal epithelia seemed confined mainly to cultured renal cells [Goligorsky *et al* 1986a&b, Jones *et al* 1986, Nord 1987, Smith *et al* 1987b] rather than whole tubule systems. Apart from the work of Murphy *et al* 1986 and Llibre *et al* 1988, most of the fluorescent indicator work in *whole* PT systems has been published in abstract form [Jacobs *et al* 1987, Llibre *et al* 1987, Yanagawa 1987]. Rink, in his 1988 review of the use of fluorescent calcium indicators, emphasized that when using QUIN and FURA in various systems;

*'Care and skill are needed in designing, conducting and interpreting the experiments and certain key controls are needed. It is seldom good enough to simply 'follow the recipe'. A reasonable understanding of the method and its application to the particular experimental system is important.'*

Each tissue system is different and errors can result from generalizations regarding technical considerations. Rink's statement was considered to be particularly pertinent to the present study where fresh tissue isolates were employed over the more common cultured renal cell systems. It was felt that the whole PT isolates might well have unique properties and problems associated with the use of FURA not seen in cultured systems and that it would be unwise to simply adopt the technical protocols used in other renal culture systems. For this reason, nothing was taken for granted and the loading and operating conditions for the use of FURA in whole PT systems was developed *de novo*. In addition, various checks were made on as many aspects of the experimental procedures as possible eg. FURA leakage, signal quenching by heavy metals etc.

## 5.1 PRELIMINARY TECHNICAL PROBLEMS AND VERIFICATIONS

### 5.1.1 Preparation of the tubule samples used in $[Ca^{2+}]_i$ measurements

PTs isolated by both mechanical and collagenase perfusion techniques (described in sections 2.4 and 2.3 respectively) were used in this part of the study. During the biochemical measurements in Chapter 4, both PT samples were incubated in a medium consisting of KHS, 3% Dextran with 10mM Pyruvate or Lactate. The pH was maintained in this medium by continuous gassing with 95% O<sub>2</sub>/5% CO<sub>2</sub>. In the measurements of  $[Ca^{2+}]_i$  by FURA, however, it was not always possible to maintain gassing and so in these studies 5mM HEPES was added to the KHS (during both the PT isolation and the subsequent incubations) to maintain pH at 7.4. Notwithstanding, PTs suspended in the modified medium were still gassed with 95% O<sub>2</sub>/5% CO<sub>2</sub> whenever possible to ensure that they did not become hypoxic.

PT samples, freshly isolated by either technique from 250-350g Fischer rats, were suspended in approximately 20ml of the modified incubation medium. Mechanically isolated PTs *only* were then pre-plated to remove extraneous tissue according to the method described in appendix 1. Following the pre-plating, the protein content of each PT sample (isolated either mechanically or enzymatically) was determined by the Coomassie protein assay (described in section 4.1.4) and then diluted with the appropriate amount of medium to produce PT suspensions with a protein concentration of approximately 1mg protein ml<sup>-1</sup>. Each diluted PT suspension was then placed on ice in a siliconised flask and gassed with 95% O<sub>2</sub>/5% CO<sub>2</sub> until required for use. Trypan Blue viability assessments (described in section 2.1.4) were also performed on the PT suspensions at this stage. Unless otherwise stated all mechanical and collagenase isolated PT samples were prepared in this way prior to FURA loading.

### 5.1.2 Preliminary check to ensure that whole PTs from the Fischer rat converted FURA 2-AM to FURA

Verification of the method of incorporation of the FURA 2-AM ester into PT cells, with the subsequent intracellular hydrolysis of the ester into the free tetracarboxylate, was the initial starting point in the development of the loading protocol. Not all cell systems are suitable for FURA loading by straightforward incubation; for instance smooth muscle cells from guinea-pig *Taenia coli* lack the appropriate intracellular esterases — yet uterine smooth muscle from the same animal loads well [Rink & Pozzan 1985]. Although FURA had been used successfully in renal cell culture and whole rabbit PTs, no data was found on the use of FURA in *Fischer rat*. It was, therefore, felt prudent at the outset of these experiments to check whether the PTs isolated from the Fischer rat contained the appropriate esterases for the conversion of the FURA 2-AM ester to free FURA.

In addition, according to Rink & Pozzan 1985, the rate limiting step for the accumulation of QUIN into cells is not uptake but rather hydrolysis of the dye — which is made more effective at 37°C than at room temperature. Cells from cold-blooded animals load poorly (due to the low ambient temperatures which have to be used) and Rink & Pozzan 1985 have observed that loading mammalian cells at temperatures below 37°C can lead to the intracellular accumulation of unhydrolysed QUIN 2-AM which cannot be rescued by subsequent re-exposure of the cells to 37°C. Whether the same phenomenon occurs with FURA is not known. Since some experimenters have found that the degree of FURA leakage is reduced by loading and operating cell systems at lower temperatures (which indeed proved the case in this study) it was also necessary, therefore, to examine whether reduced operating temperatures significantly affected FURA uptake.

### METHODS

A 2ml aliquot of mechanically isolated PT suspension (prepared as described in section 5.1.1) was inoculated into a fluorimeter cuvette so that the cuvette contained approximately 2mg protein. The cuvette was then placed into the stirring cuvette chamber

of a Perkin Elmer LS-5 fluorimeter and incubated to 37°C with constant stirring. The cuvette was monitored at 510nM emission and excited over a 250-450nM scan to obtain the autofluorescence scan for the system. At time 0, 3µM (final concentration) of FURA 2-AM (Calbiochem) in DMSO (BDH) was inoculated into the PT suspension. Starting at time 0, the cuvette was scanned at

0 1 2 3 4 5 10 min

intervals as described above. At the end of the 10min time course, the scans were then examined to see whether there was a shift in the excitation spectrum to 340nM which indicated the formation of free FURA in the cuvette — and therefore the presence of the appropriate esterases.

## RESULTS

Samples of the scans obtained at 37°C over the experimental time course are shown in fig 5a. As expected, at time 0 (fig 5a 1) the emission scan peaked at 380nM indicating that the cuvette contained only FURA-2AM. After 3min of incubation (fig 5a 2) the trace had flattened and broadened to give an excitation peak that extended over a 350-380nM wavelength suggesting that the cuvette contained a mixture of the ester and free hydrolysed FURA. Following 5min of incubation (fig 5a 3) the trace had again sharpened with the main emission peak now appearing at 340nM, but with a slight residual 'shoulder' still on the trace at around 380nM. By 10min incubation, however, the shoulder on the trace had disappeared (fig 5a 4) leaving a sharp emission peak at 340nM only — suggesting that the FURA 2-AM ester had been completely hydrolysed to free FURA and that the appropriate esterases were therefore present in the Fischer rat PTs. A similar conversion was also seen when the PTs were incubated at 25°C. However, at this lower temperature, the process was slightly slower with the complete conversion accomplished in 12 rather than 10 min.



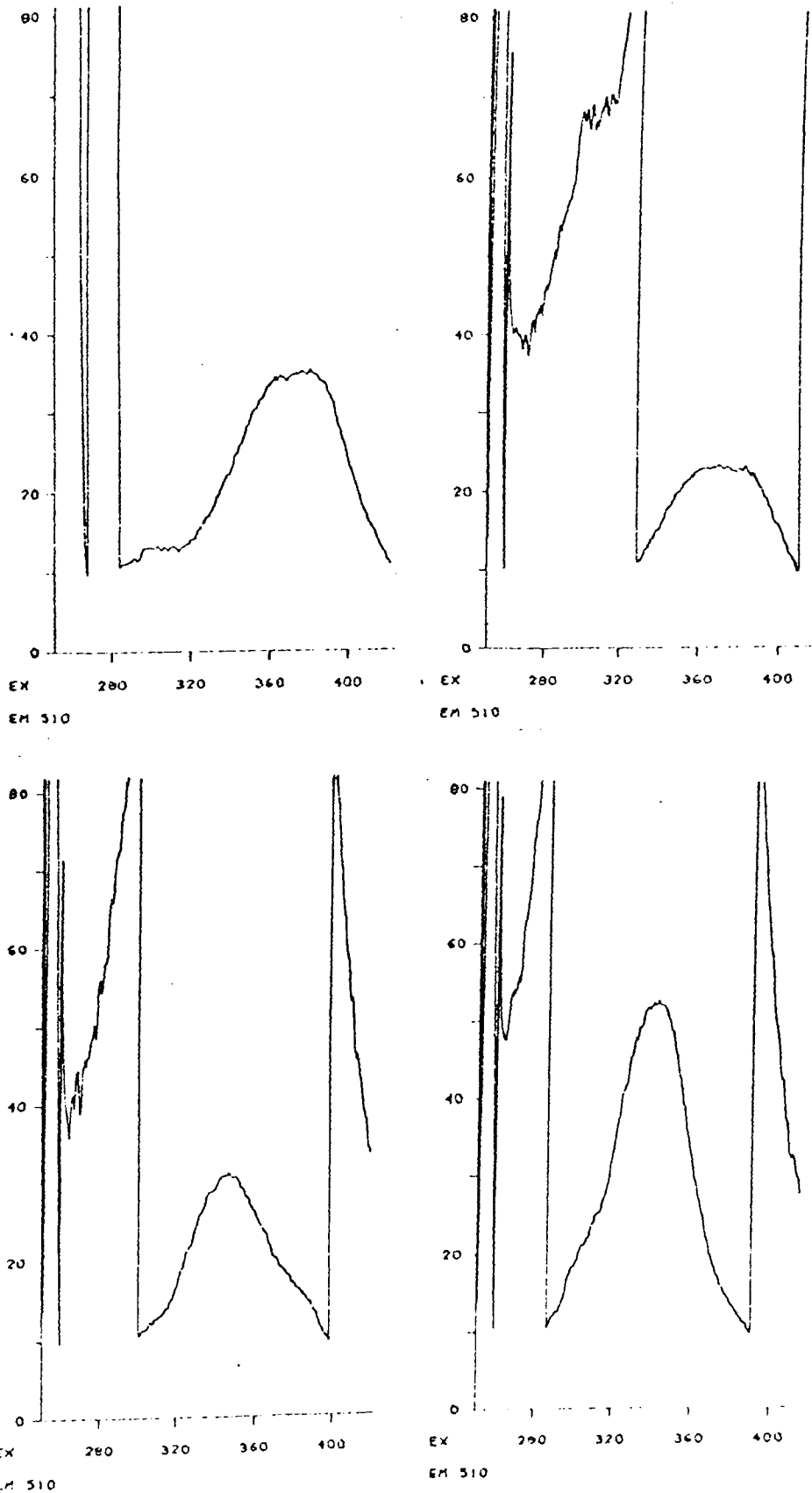

**Fig 5a** Emission scans of a mechanically isolated rat PT suspension, incubated at 37°C, following the addition of FURA 2-AM. (1): Emission scan at time 0; trace exhibits a peak at 380nM indicative of the presence of FURA 2-AM only. (2): Emission scan at 3min; trace exhibits a broader peak which suggests that the hydrolysis of FURA 2-AM is underway. (3): Emission scan at 5min; trace exhibits a main peak at 340nM with a slight shoulder at 380nM suggesting that only a little of the FURA 2-AM is left in the cuvette. (4): Emission scan at 10min; trace exhibits a peak at 340nM only suggesting that the conversion of FURA 2-AM to free FURA is complete.

## DISCUSSION

The results in fig 5a of the emission scans of mechanically isolated Fischer rat PTs PTs loaded with FURA showed clearly that hydrolysis of the FURA 2-AM had occurred and that the appropriate esterases were, therefore, present in this tissue system. It also appeared that temperature did have an effect on uptake but only to the extent that the time taken to achieve maximal uptake in this system was slightly delayed at 25°C; other than that, the traces at both temperatures were identical.

So it would seem that, provided the tubules were incubated for a minimum of 15min, reduced temperature apparently had little effect on the final uptake levels or the degree of FURA 2-AM conversion. However, without corroborative microscopy, it is difficult to be totally certain that no unhydrolysed FURA 2-AM was taken up by the PT cells at the lower temperature.

### **5.1.3 Development of the FURA loading protocol**

Examination of the literature elicited several different protocols for the loading of FURA into cultured renal epithelial systems [Goligorsky *et al* 1986a, Smith *et al* 1987b, Aboolian & Nord 1988, Stassen *et al* 1988, Holohan *et al* 1988, Inui *et al* 1988] with the variable parameters being FURA concentration, incubation time and temperature. As it was not possible to accurately gauge how many *cells* were present in each PT sample, it was difficult to relate the FURA loading concentration used by other workers in individual cell suspensions [Smith *et al* 1987b, Holohan *et al* 1988, Inui *et al* 1988] to that required by whole PTs.

To ensure that the whole PT system used in this study was loaded correctly, the above parameters were variously combined to produce different loading protocols which were then tested on mechanically isolated PTs to see which conditions produced optimal results. FURA loading concentration in renal cell culture ranged from 2µM [Stassen *et al* 1988] to 20µM [Goligorsky *et al* 1986a]. However an abstract by Yanagawa

1987, using isolated perfused rabbit PTs, quoted a FURA loading concentration of  $3\mu\text{M}$  — but gave no incubation times or temperature values. It was therefore decided to start by studying FURA concentrations around the  $2\mu\text{M}$  range.

## METHODS

Fresh, mechanically isolated PT suspension (prepared as described in section 5.1.1) was inoculated into foil covered, siliconised flasks at a protein concentration of  $4\text{mg}$  per flask (ie  $4\text{ml}$  of the  $1\text{mg protein ml}^{-1}$  PT suspension). Aliquots of a stock solution of FURA 2-AM in DMSO were added to the flask with gentle swirling to produce *final* FURA concentrations of:

0.1 $\mu\text{M}$     0.5 $\mu\text{M}$     1 $\mu\text{M}$     2 $\mu\text{M}$     3 $\mu\text{M}$

Each flask was gassed with humidified 95%  $\text{O}_2$ /5%  $\text{CO}_2$  and then incubated for 15 and 30min periods in a shaking water baths set at either  $25^\circ\text{C}$  or  $37^\circ\text{C}$ . After each incubation period, to avoid several potentially damaging centrifuge stages, the PTs were allowed to sediment in their flasks and the excess FURA was removed with a pipette. Fresh medium (kept at the same temperature as each sample's incubation temperature) was added and the PTs were then spun down at  $5,000 \times g$  for 2min. The supernatant was again drawn off and  $4\text{ml}$  of fresh medium was added.

$2\text{ml}$  of the sample was placed in the fluorimeter (whose cuvette holder was kept at the same temperature as each sample's incubation temperature) with slit widths set at 2.5 and 20 and was monitored at  $510\text{nM}$  emission with continuous  $340\text{nM}$  excitation for approximately 10-15min. At the end of the run, the samples were calibrated by the addition of 0.05% Triton X-100 (final concentration) to make the PTs permeable and then by the addition of alkaline EGTA to chelate the  $\text{Ca}^{2+}$ . Each incubation protocol was run in duplicate. The general condition of the traces and the distance between  $F_{\text{min}}$  and  $F_{\text{max}}$  for each FURA incubation protocol was compared and the efficiency of each loading was evaluated.

## RESULTS

Examples of some of the emission scans and calibration traces produced by the various FURA loading protocols are shown in figs 5b, c and d. Examination of the traces showed the following general features;

1. PT cell lysis was best accomplished by 0.05% Triton rather than, the often used, digitonin [Llibre *et al* 1988]. Fig 5b shows the calibration traces obtained from two identical mechanically isolated PT samples loaded with FURA 2-AM. As can be seen in fig 5b1, Triton produced greater lysis of the cells than digitonin (fig 5b2) which resulted in higher  $F_{max}$  values being achieved and hence more accurate calibrations.

2. Emission scans showed that maximal uptake of FURA occurred within 15min (fig 5c1) and extended incubations of 30min (fig 5c2) failed to produce any significant increase in the height of the emission scan and, therefore, served no useful purpose.

3. Provided the PTs were incubated for a minimum of 15min, then the uptake at 25°C was not significantly different from that at 37°C.

4. Calibration traces showed that the optimal FURA incubation concentration was 0.5 $\mu$ M for 15min (fig 5d2). FURA concentrations above 0.5 $\mu$ M produced no increase in the distance between  $F_{min}$  and  $F_{max}$  (fig 5d 3&4). A FURA concentration of 0.1 $\mu$ M (fig 5d1) not only curtailed the distance between  $F_{min}$  and  $F_{max}$ , but the quality of the trace was seen to deteriorate also.

From these results, a FURA concentration of 0.5 $\mu$ M, an incubation time of 15min and a temperature of 25°C were adopted. With this protocol, there was found to be approximately a 5% loss in viability during the loading stage and the basal  $[Ca^{2+}]_i$  values were  $821 \pm 60$  nM (n=8).

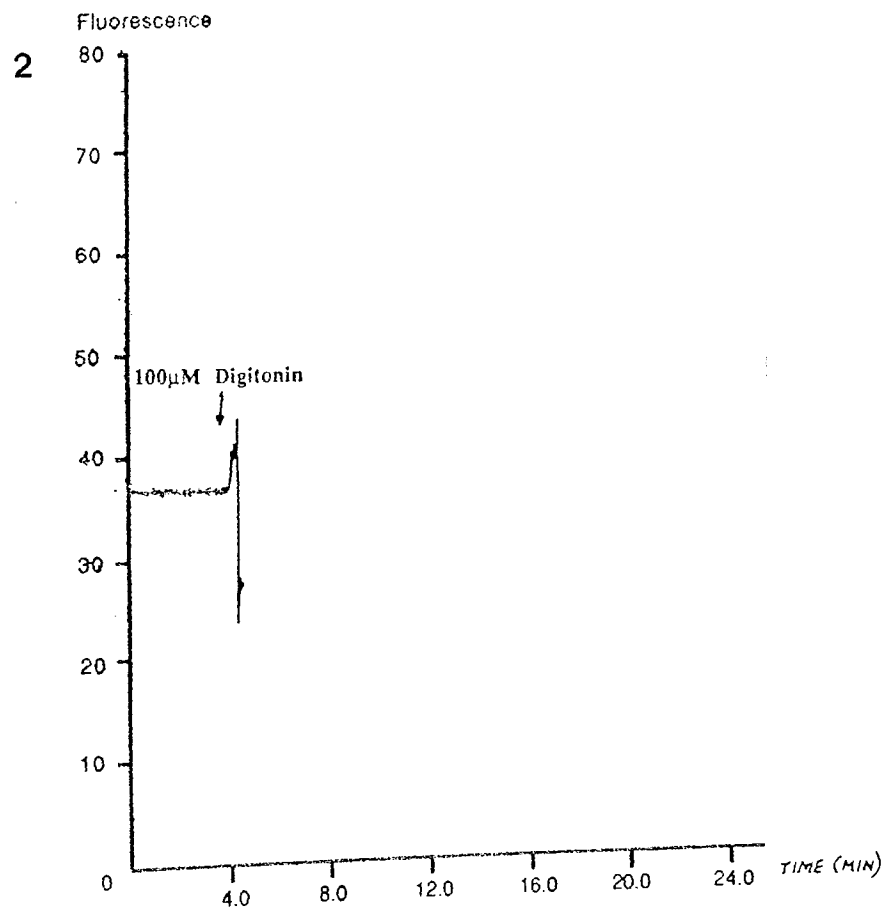
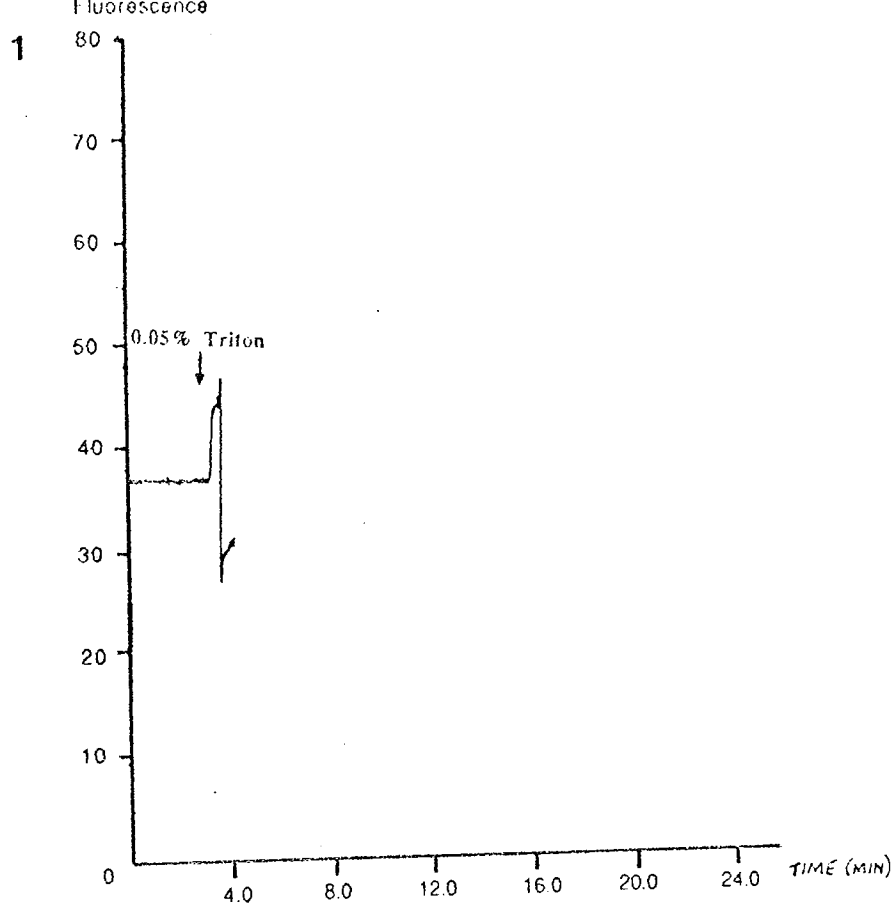

Fig 5b Representative traces of mechanically isolated PTs loaded with FURA 2-AM and calibrated either by the addition of 0.05% Triton and alkaline EGTA (1) or by 100 $\mu$ M digitonin and alkaline EGTA (2). The traces show lower  $F_{max}$  values following the addition of digitonin compared with the addition of Triton which suggests that better lysis of the PTs is achieved with Triton rather than digitonin.

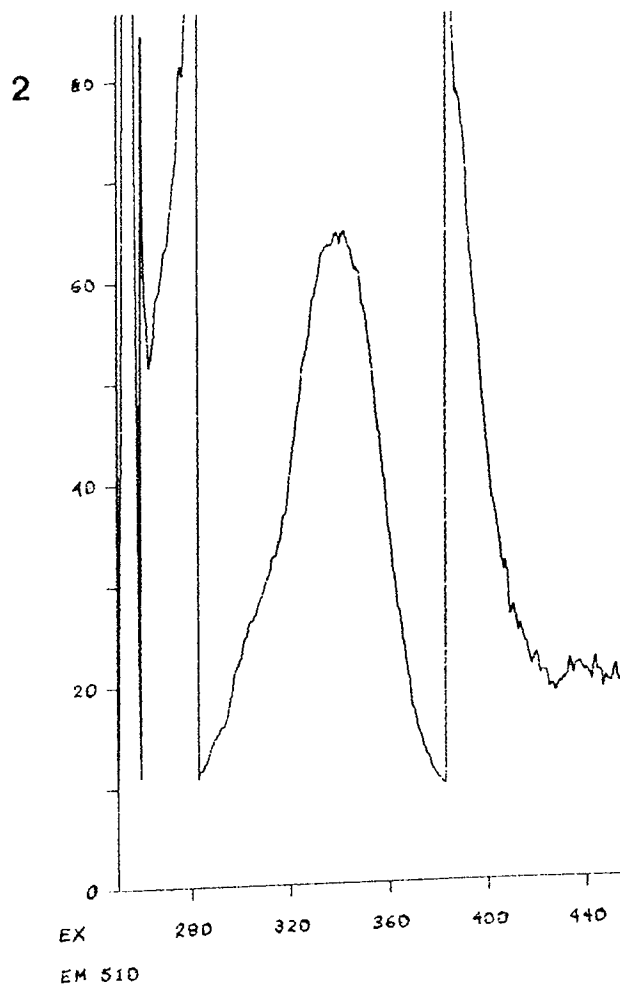
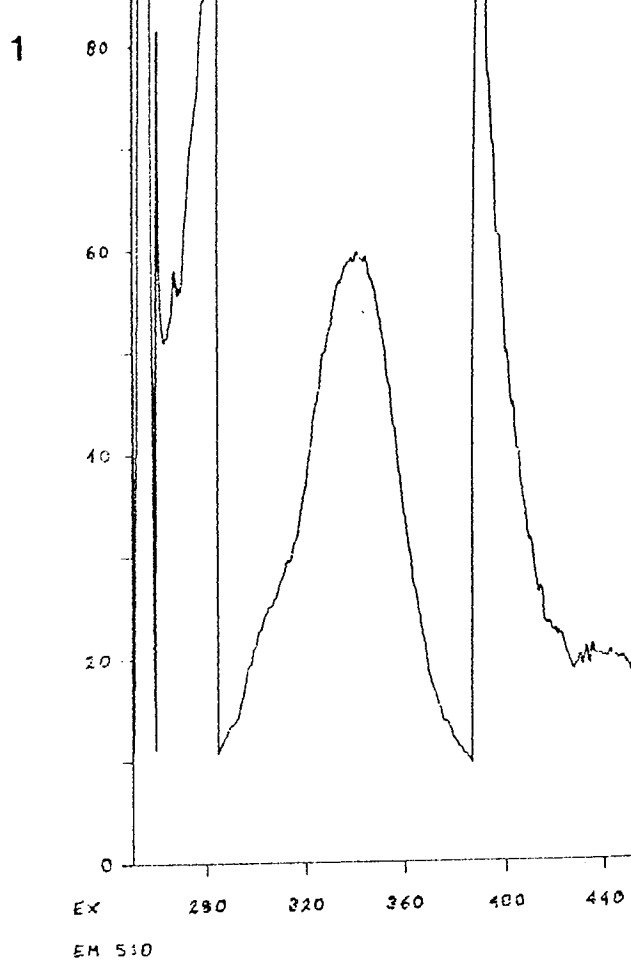

Fig 5c Representative emission scans of the uptake of FURA in mechanically isolated PTs incubated for 15 mins (1) and 30mins (2) at 37°C. The traces show little increase in uptake after 15mins incubation and suggests that incubations of longer than 15mins serves little purpose with this system.

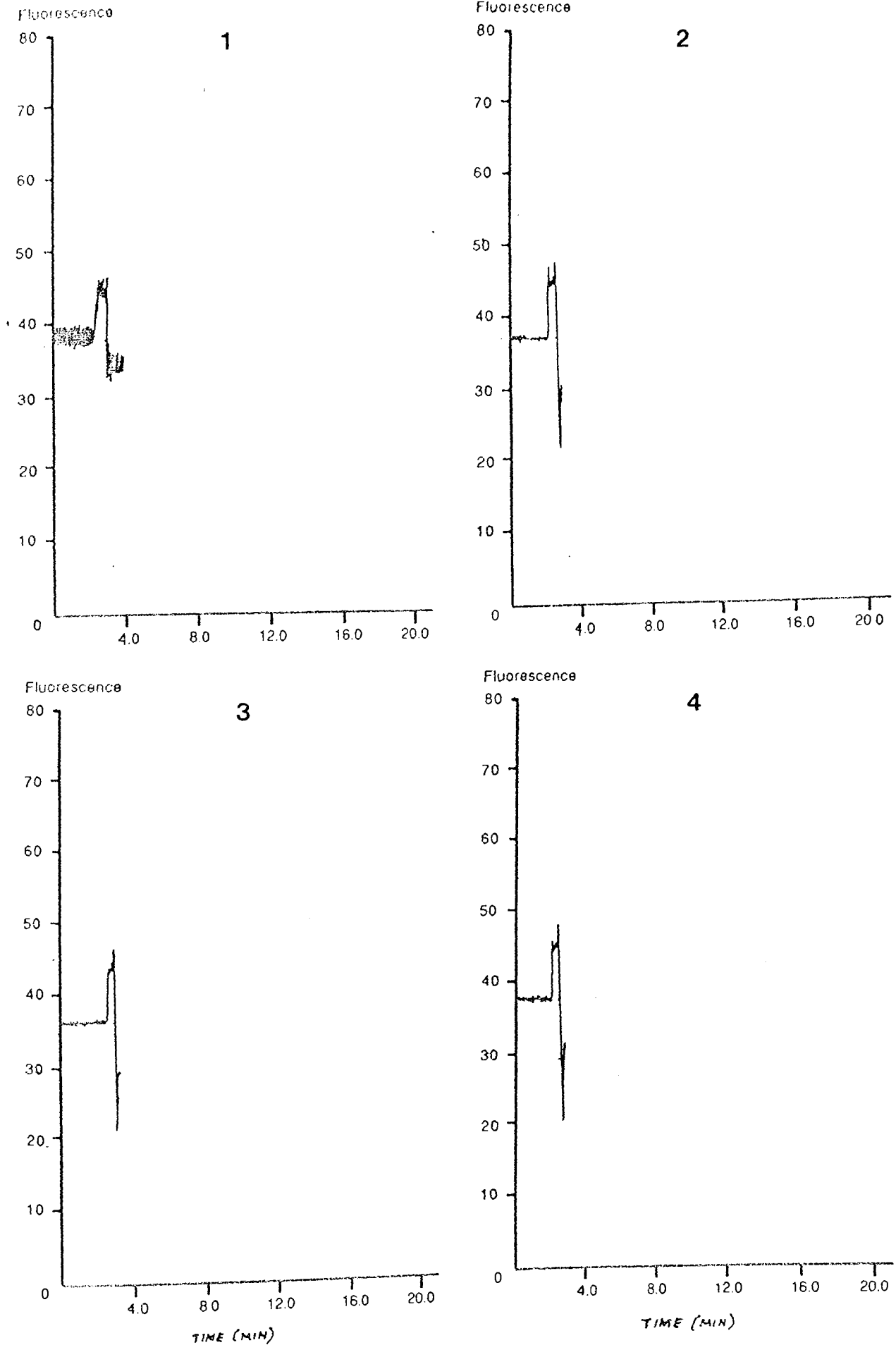

Fig 5d Representative calibrations of mechanically isolated PTs loaded with 0.1 $\mu$ M (1), 0.5 $\mu$ M (2), 1 $\mu$ M (3) and 3 $\mu$ M (4) FURA 2-AM for 15mins at 37°C. The traces show similar distances between  $F_{min}$  and  $F_{max}$  for FURA concentration 0.5 - 3 $\mu$ M, but a shorter distance and a 'noisier' trace at the 0.1 $\mu$ M FURA concentration. The calibrations suggest that the optimal FURA incubation concentration for this system is 0.5 $\mu$ M.

## DISCUSSION

The most effective way of evaluating an adequate loading concentration is through the examination of calibration traces. Following release of the dye by Triton (digitonin having proved inefficient in this system; see fig 5b) to give  $F_{\max}$ , the fluorescent signal was quenched by the addition of alkaline EGTA to give  $F_{\min}$ . With an adequate loading concentration, the  $F_{\min}$  value should leave only the signal from the cells themselves ie autofluorescence [Rink 1983, Rink *et al* 1983] which indicates that the signal is in excess of the background autofluorescence. If insufficient dye has been incorporated, then the signal becomes 'noisier' as the weak signal is broken up by the tissue particles and the  $F_{\min}$  value occurs above the autofluorescence signal [Hallam personal communication]. In calibrations involving these indicators, a general assumption tends to be made that the autofluorescence of each system is unaffected by cell lysis. This assumption was verified in the present whole PT system through the addition of Triton to unloaded PTs which produced no alteration in their intrinsic fluorescent signal.

The PT samples were incubated in various concentrations of FURA and then calibrated to give the traces shown in fig 5d. Loading concentrations of 0.5 - 3 $\mu$ M gave quiet traces whose  $F_{\min}$  values consistently fell to autofluorescence levels. Loading concentrations of 0.1 $\mu$ M, however, gave noisier traces and  $F_{\min}$  values consistently above the intrinsic autofluorescence. In addition, the emission scans (fig 5c) showed that incubations in excess of 15min did not improve uptake levels. On the basis of these results, a loading concentration of 0.5 $\mu$ M for 15min was adopted to give a signal both substantially in excess of the autofluorescence and also as low as practicable to minimise any potential buffering effects.



## 5.2 FINAL PROTOCOL FOR THE MEASUREMENT OF $[Ca^{2+}]_i$ IN WHOLE RAT PT'S USING FURA

Fresh, mechanically isolated PT suspension (prepared as described in section 5.1.1) was inoculated into siliconised, foil covered flasks at a protein concentration of 4mg per flask. Each flask was gassed with humidified 95%  $O_2$ /5%  $CO_2$  and incubated to 25°C in a shaking water bath. Aliquots of stock solution of FURA in DMSO were added with gentle swirling to produce a final concentration of 0.5 $\mu$ M (final DMSO concentration < 0.1%) and the flask was incubated for a further 15min at 25°C. At the end of the incubation period the PTs were allowed to sediment in the flask, the excess FURA was drawn off with a pipette and fresh medium was added. The PT suspension was then spun down at 5,000 x g for 2min, the supernatant was withdrawn and 4ml of fresh medium (kept at 25°C) was added.

Each sample was run at 25°C in a fluorimeter with slit widths set at 2.5 and 20 and was monitored at 510nm emission with continuous 340nm excitation for the required time interval. At the end of the run, the samples were calibrated by the addition of 0.05% Triton X-100 (final concentration) to lyse the PTs and then by the addition of alkaline EGTA to chelate the  $Ca^{2+}$ . Estimation of  $[Ca^{2+}]_i$  was based on the formula by Tsien *et al* 1982:

$$[Ca^{2+}]_i = \frac{(F - F_{min})}{(F_{max} - F)} Kd$$

where;

F = the intracellular FURA fluorescence.

$F_{min}$  = the fluorescence of FURA in the absence of  $Ca^{2+}$  ie in the presence of EGTA.

$F_{max}$  = the fluorescence of  $Ca^{2+}$  saturated FURA ie in the presence of Triton.

Kd = the  $Ca^{2+}$  dissociation constant for FURA.

A value of 224 was assumed for the  $K_d$  of FURA based on the work of Grynkiewicz *et al* 1985. Unless otherwise stated all PT samples, isolated both mechanically and by collagenase perfusion, were treated in this way.

### 5.3 POTENTIAL FACTORS AFFECTING THE FURA SIGNAL

#### 5.3.1 Examination of the potential quenching effect of the $Fe^+$ loading on the FURA signal

It has been found that heavy metals have the potential to quench the signals of the fluorescent calcium indicators [Tsien *et al* 1982, Weinberg 1984, Arslan *et al* 1985, Grynkiewicz *et al* 1985, Cheung 1987]. There was concern, therefore, that the  $Fe_3O_4$  used in both tubule isolation procedures might exert residual quenching effects on the FURA signal leading to an *underestimation* of  $[Ca^{2+}]_i$  levels [Tsien *et al* 1982, Arslan *et al* 1985, Grynkiewicz *et al* 1985]. This possibility was explored using the membrane impermeant heavy metal chelator diethylenetriaminepentaacetic acid (DTPA) and the membrane permeable chelator N, N, N', N'- tetrakis(2-pyridylmethyl)ethylenediamine (TPEN).

### METHODS

#### Measurement of effect of residual external $Fe_3O_4$ by DTPA

Mechanically isolated PT samples were prepared and loaded as described in section 5.2. The PT sample was run for approximately 5min to produce a baseline then 0.05% Triton X-100 was added and the trace was run for 30sec. 200 $\mu$ M DTPA (final concentration) was added and the trace was run for a further 2min to see whether the DTPA produced an increase in  $F_{max}$ . Finally alkaline EGTA was added to complete the calibration. Each experiment was performed in duplicate.

### Measurement of effect of potential internal Fe<sub>3</sub>O<sub>4</sub> by TPEN

Mechanically isolated PT samples were prepared and loaded as described in section 5.2. The PT sample was run for approximately 4min to produce a baseline then 20μM TPEN (final concentration) was added and the trace was run for a further 10min to see whether any rise in the trace was produced by the TPEN. At the end of the run the sample was calibrated as described in section 5.2. Each experiment was performed in duplicate.

## RESULTS

### The potential effect of extracellular Fe<sup>+</sup> ions on calibration signals

An example of the traces obtained is shown in fig 5e. The trace showed a smooth level baseline until the addition of 0.05% Triton when, due to cellular lysis, the trace rose *ostensibly* to F<sub>max</sub>. If external Fe<sup>+</sup> ions were present, and were quenching the signal, then the true F<sub>max</sub> would not be reached in this system and falsely low calibrations would result. In that event, the addition of 200μM DTPA would chelate the Fe<sup>+</sup> ions, release the FURA and consequently increase the fluorescent signal [Arslan *et al* 1985]. However as shown in fig 5e, the addition of 200μM DTPA in two separate experiments produced no rise in the F<sub>max</sub> signal. To ensure that sufficient DTPA was present to chelate all potential Fe<sup>+</sup> ions present more DTPA was added, in 200μM aliquots up to a total concentration of 800μM, but no increase in the FURA signal was seen. It appeared, therefore, that no extracellular heavy metal quenching had occurred in this system.

### The potential effect of intracellular Fe<sup>+</sup> ions on basal [Ca<sup>2+</sup>]<sub>i</sub> signals

An example of the traces obtained is shown in Fig 5f. The trace showed a smooth and steady baseline up to the addition of 20μM TPEN at 4min. If during the isolation procedure significant amounts of Fe<sup>+</sup> ions had been ingested by the PT cells, with consequent quenching

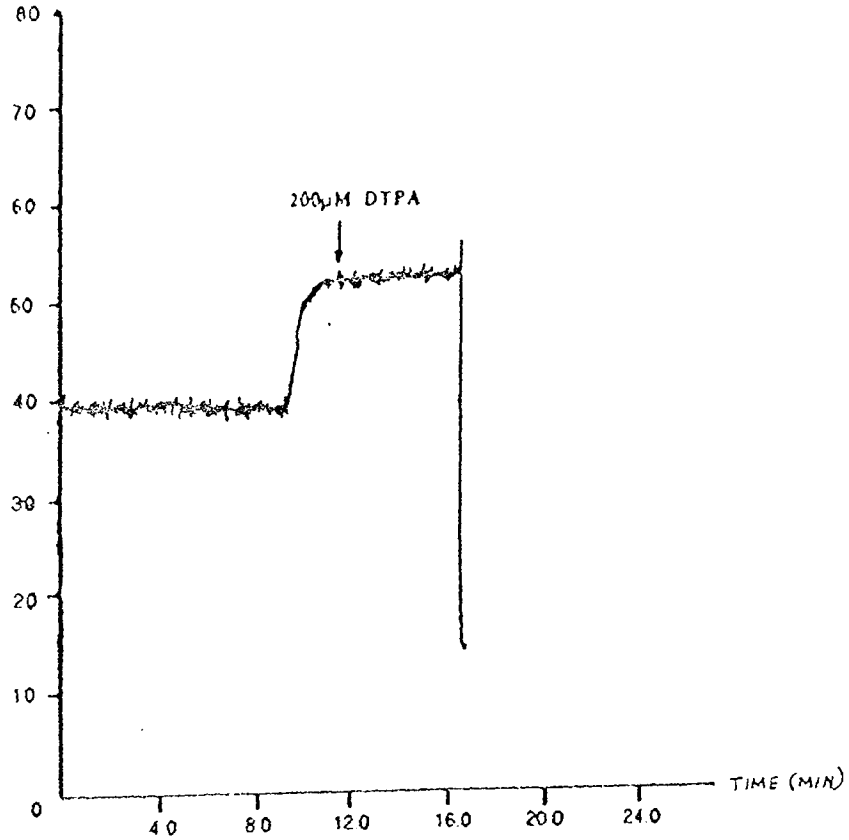

**Fig 5e** Representative trace of the effect of the addition of the membrane impermeable heavy metal chelator diethylenetriaminepentaacetic acid (DTPA) on the calibration of the fluorescent trace produced by mechanically isolated rat PTs loaded with FURA 2-AM. Trace shows no alteration in the signal following the addition of 200 $\mu$ M DTPA suggesting that no extracellular heavy metal quenching was present in this system.

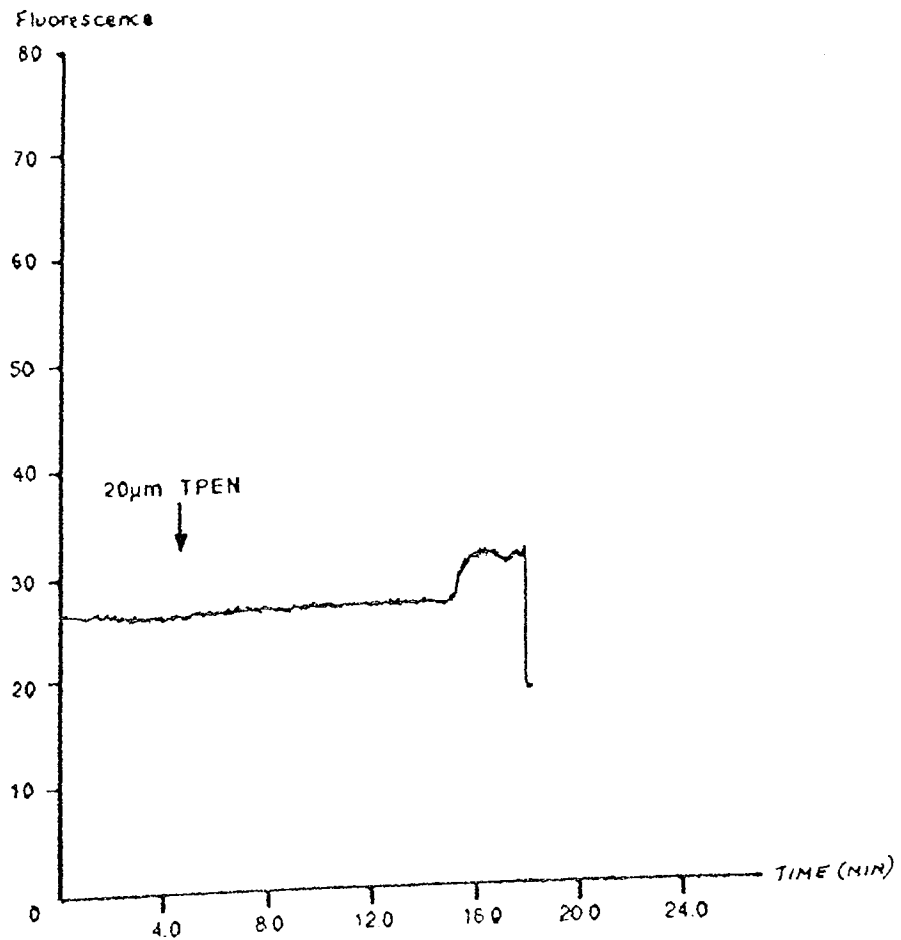

**Fig 5f** Representative trace of the effect of the addition of the membrane permeable heavy metal chelator N,N,N',N'-tetrakis(2-pyridylmethyl)ethylenediamine (TPEN) on the basal intracellular fluorescent signal produced by mechanically isolates PTs loaded with FURA 2-AM. Trace shows no alteration of the signal following the addition of 20 $\mu$ M TPEN suggesting that no intracellular heavy metal quenching was present in this system.

of the internal FURA signal, then this would cause a falsely low F value. In theory, the addition of the membrane permeable TPEN would chelate any internal Fe<sup>+</sup> and so increase the fluorescent signal [Arslan *et al* 1985]. In two separate experiments, however, the addition of 20µM TPEN caused no increase in the basal fluorescent signal. To ensure that sufficient TPEN was present to chelate all the internal Fe<sup>+</sup> more TPEN was added, in 20µM increments up to a final concentration of 80µM, but no increase in FURA signal was seen. It appeared, therefore, that no intracellular heavy metal quenching had occurred in this system.

## DISCUSSION

Despite the use of Fe<sub>3</sub>O<sub>4</sub> during the PT isolation procedure, the use of the heavy metal chelators DTPA (fig 5e) and TPEN (fig 5f) showed that the Fe<sub>3</sub>O<sub>4</sub> had virtually no effect on either the internal signal nor the calibration values. This indicated that the Fe<sub>3</sub>O<sub>4</sub> had not entered the PT cells to any significant extent which tended to corroborate the findings of Schnellman (personal communication) and this is discussed further in section 6.3. The fact that no quenching of the internal FURA signal was shown by the addition of TPEN also suggested that the intracellular FURA had not chelated any endogenous cellular metals eg Mn, Cu, Zn and so did not interfere with the natural biological activities dependent on these metals [Rink 1983].

### **5.3.2 Measurement of FURA leakage from PT samples**

Theoretically, the hydrolysed tetracarboxylic indicators cannot permeate the plasmalemma due to their polyanionic charges [Rink 1983, Tsien *et al* 1984]. However, several workers have reported leakage of the nonesterified indicators from various cell systems [Tsien *et al* 1982, Rorsman *et al* 1983, Nachsen 1985], including renal cell systems [Smith *et al* 1987b, Holohan *et al* 1988]. It is also known that dying cells release their fluorescent indicator thus making cell viability and length of incubation important

factors in cell leakage. The method chosen to evaluate leakage of FURA from both mechanical and collagenase isolated PTs was that used by Holohan *et al* 1988.

## METHODS

A sample from a fresh, mechanically isolated PT suspension (prepared as described in section 5.1.1, but using 0.5mM CaCl<sub>2</sub>) was loaded with FURA as described in section 5.2. The sample was run for approximately 15sec at 25°C and then calibrated immediately with triton and EGTA to obtain a maximal fluorescence value. Four fresh samples of the same PT suspension were then loaded with FURA as described in section 5.2. Each sample was poured into a separate cuvette, placed into the four chambered cuvette holder of the fluorimeter and incubated, with constant stirring, at 25°C. At the following time intervals;

0min      5min      10min      15min

one of the cuvettes was withdrawn and the contents spun down at 5,000 x g for 2min to remove the cellular material. The supernatant was withdrawn and its fluorescence level was measured. This value was expressed as a percentage of the F<sub>max</sub> obtained from the calibration of the first sample. This experiment was repeated three times in total at 25°C and again at 37°C. Analogous measurements were also made in PTs isolated by collagenase perfusion.

## RESULTS

The results of experiments to determine the percentage of FURA which leaked from mechanical and collagenase isolated PTs are summarised in table 5a for incubations at 25°C and table 5b for incubations at 37°C. The results are expressed as a percentage of their respective F<sub>max</sub> values and are the average of three separate isolations.

From the results in tables 5a and b, it was seen that leakage of FURA occurred with each PT sample at both 25°C and 37°C.

| TIME                 | 5min     | 10min     | 15min     |
|----------------------|----------|-----------|-----------|
| Mechanical Isolates  | 5% ± 1.5 | 8% ± 1.0  | 10% ± 2.1 |
| Collagenase Isolates | 9% ± 2.6 | 13% ± 3.1 | 15% ± 3.2 |

**Table 5a** Measurement of the percentage of FURA leaked from mechanical and collagenase isolated rat PTs incubated at 25°C. The results are the average of three separate isolations (n=3) and are expressed ± the standard deviation.

| TIME                 | 5min      | 10min     | 15min     |
|----------------------|-----------|-----------|-----------|
| Mechanical Isolates  | 7% ± 2.1  | 11% ± 2.5 | 14% ± 2.1 |
| Collagenase Isolates | 11% ± 2.1 | 15% ± 3.8 | 18% ± 2.5 |

**Table 5b** Measurement of the percentage of FURA leaked from mechanical and collagenase isolated rat PTs incubated at 37°C. The results are the average of three separate isolations (n=3) and are expressed ± the standard deviation.

Within each separate incubation group, the rate and amount of leakage of FURA was found to be greater in the collagenase isolates compared with similarly incubated mechanical isolates. The rate of leakage appeared to be fairly steady within each incubation group — but the time-course over which the measurements were made was fairly short and it would be unwise to extrapolate this to longer incubations. More interestingly, however, was the observation that in both mechanical and collagenase isolated PTs the rate and amount of FURA leakage increased with the temperature of incubation and again the rate of leakage appeared fairly steady.

From these experiments it was not possible to tell whether the FURA was being transported from the cells or was merely being extruded by dead or dying PT cells. However routine Trypan Blue viability tests on these samples showed that a loss in viability of less than 3% in mechanical isolates and 5% with collagenase isolates occurred at both temperatures over the 15min incubation period.

So it would seem that FURA leakage did occur from both the freshly isolated rat PT systems and that each PT sample would benefit, in terms of reduced leakage, if

they were run at the lower temperature of 25°C rather than at the optimal temperature of 37°C.

## DISCUSSION

Loss of intracellular dye through leakage is important for two reasons;

1. It can give a spurious high reading of  $[Ca^{2+}]_i$  when the dye interacts with extracellular  $Ca^{2+}$ .
2. It can distort the calibration of the intracellular dye concentration used to calculate  $[Ca^{2+}]_i$ .

In respect of leakage, FURA has an advantage over QUIN in that when free FURA binds calcium ions the peak excitation spectrum shifts from 360-340nm. This means that dual wavelength fluorimetry may be used [Tsien *et al* 1985, Grynkiewicz *et al* 1985] and any loss in dye concentration is automatically corrected for by the differential readings [Cheung 1987, Rink 1988]. Unfortunately, dual wavelength facilities were not available to the project and so leakage from the present systems had to be assessed.

The results of the above leakage measurements showed clearly that fairly steady leakage did occur from both mechanical and collagenase isolated PTs at 25°C and 37°C. The results at both temperatures also showed that the collagenase isolates suffered a slight, though consistently, greater amount of leakage than their mechanically isolated counterparts. The reason for this difference is probably due to the slightly higher loss in viability of 5% sustained by the collagenase isolates during the 15min incubation compared with the 3% loss exhibited by the mechanical isolates. Thus, since dying cells release their intracellular indicator, it would therefore be expected that collagenase isolates would show a marginally higher degree of FURA leakage.

Of perhaps more interest, however, was the finding that the amount of FURA leakage from both collagenase and mechanically isolated PTs increased with temperature. It would be easy to account for this by saying that more cells die at the higher temperature and so release more FURA. However, trypan blue viability studies showed no increase in dye uptake at the higher temperature. It may of course be that the increased leakage at the



higher temperature was still due to deterioration in the health of the cells, but not made apparent by the trypan blue; latter work will show a reduction in viability in the presence of FURA in DMSO. As a result, the general health of the cells may possibly have been affected quite early in the incubation leading to increased leakage — but not to the extent that exclusion of trypan blue by the PTs was prevented.

#### **5.4 POTENTIAL FACTORS AFFECTING $[Ca^{2+}]_i$ LEVELS**

In initial experiments, the basal  $[Ca^{2+}]_i$  level found in mechanical isolates of 821nm was considerably higher than that obtained in cultured renal cells [Smith *et al* 1987b, Holohan *et al* 1988] and whole PTs [Batlle *et al* 1988, Libre *et al* 1988] of around 100nm. It was uncertain whether this high value represented the true  $[Ca^{2+}]_i$  of the whole PTs or whether it was, to any extent, artifactual. Attempts were, therefore, made to see whether the  $[Ca^{2+}]_i$  level was being altered by external factors.

##### **5.4.1 Effect of FURA on the viability of mechanically isolated PTs**

In section 4.6, the long term viability of mechanically isolated PTs was evaluated using the parameters of oxygen consumption and LDH leakage. It was hoped to use the FURA loaded PTs in long term measurements and, therefore, it was necessary to investigate whether FURA loading had any adverse effects on PT viability.

#### **METHODS**

Freshly isolated PT samples were loaded with FURA as described in section 5.2. The samples were then incubated in foil covered, siliconised flasks in a shaking water bath at 37°C with continuous gassing. At hourly intervals aliquots were withdrawn and oxygen consumption and LDH leakage measurements were made as described in section 4.6.

## RESULTS

The results of oxygen consumption and LDH leakage measurements are shown in table 5c and fig 5g 1 for PTs incubated with 0.5 $\mu$ M FURA 2-AM in DMSO (final concentration 0.1%) and in table 5d and fig 5g 2 for PTs incubated in the equivalent amount of DMSO vehicle alone.

| Time (Hr) | % LDH Leakage |     | $R_O$ |     |
|-----------|---------------|-----|-------|-----|
|           | [1]           | [2] | [1]   | [2] |
| 1         | 32            | 28  | 53    | 56  |
| 2         | 35            | 33  | 59    | 61  |
| 3         | 39            | 37  | 61    | 65  |
| 4         | 50            | 46  | 41    | 44  |

**Table 5c** Measurement of oxygen consumption ( $R_O$ ) and LDH leakage from mechanically isolated PTs incubated at 37°C with 0.5 $\mu$ M FURA 2-AM in DMSO. The results are from two separate experiments.

| Time (Hr) | % LDH leakage |     | $R_O$ |     |
|-----------|---------------|-----|-------|-----|
|           | [1]           | [2] | [1]   | [2] |
| 1         | 33            | 32  | 60    | 52  |
| 2         | 37            | 35  | 61    | 56  |
| 3         | 44            | 40  | 55    | 46  |
| 4         | 58            | 55  | 44    | 36  |

**Table 5d** Measurement of oxygen consumption ( $R_O$ ) and LDH leakage from mechanically isolated PTs incubated at 37°C with DMSO vehicle (final concentration 0.1%). The results are from two separate experiments.

Fig 5g 1 showed that the viability of mechanically isolated PTs was reduced from the 6hr value, obtained in section 4.6, to barely 4hr following incubation with 0.5 $\mu$ M FURA in DMSO. However, the same length of viability was also seen in fig 5g 2 when the PTs were incubated with an equivalent concentration of DMSO vehicle. By the end of the 4hr incubation each sample had also lost 80% of its viability, according to the Trypan Blue exclusion test.

So it would appear that, although Trypan Blue exclusion suggested an initial loss in viability of only 5% immediately after FURA loading, prolonged incubation

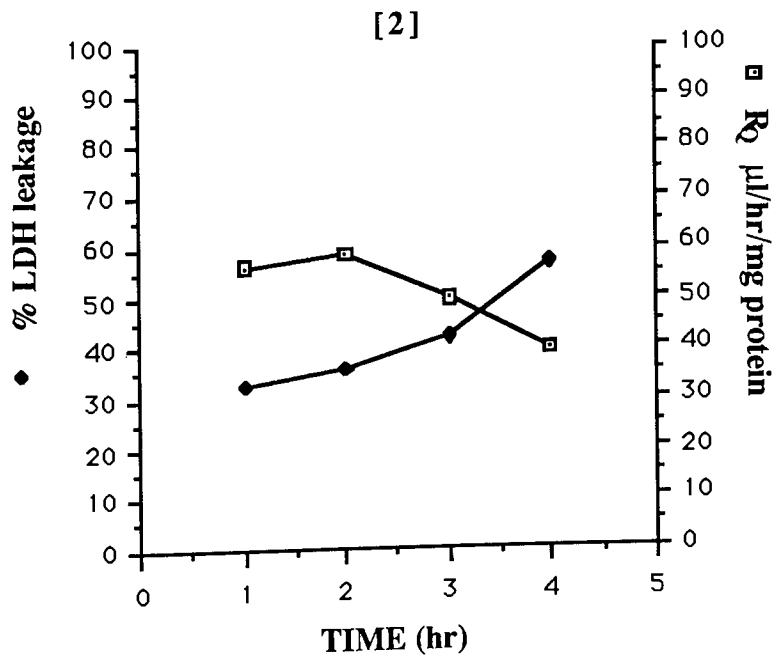
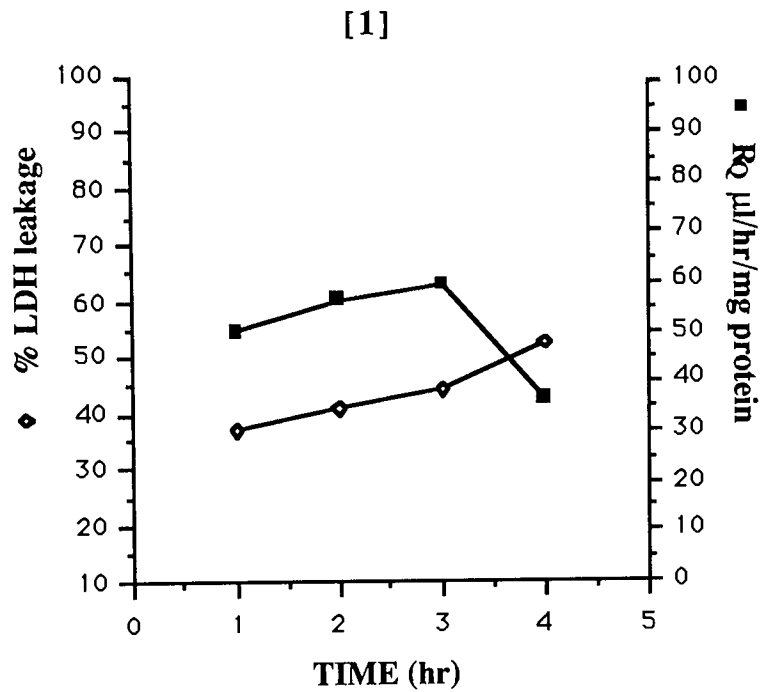

**Fig 5g** Graphs showing the oxygen consumption and LDH leakage from mechanically isolated PTs incubated at 37°C with either [1] 0.5 $\mu\text{M}$  FURA 2-AM in DMSO or [2] DMSO vehicle (final concentration 0.1%). Each point is the average of two separate experiments.

showed that the long term viability of these FURA loaded PTs was curtailed to less than two thirds of their original value. However the loss of viability is probably mostly due to the toxic nature of the DMSO vehicle as the inclusion of FURA 2-AM produced no significant decrease in viability over and above that caused by DMSO alone

## DISCUSSION

According to trypan blue exclusion tests, FURA loading appeared to have little effect on PT viability. Nevertheless, it was felt that trypan blue might not be a sufficiently sensitive parameter; and so oxygen consumption and LDH leakage measurements were made on mechanically isolated PTs loaded with FURA. The above results clearly show that, following FURA loading, the viability of the PTs was curtailed from 6hr to barely 4hr (fig 5g). However, the results of the control experiments, using DMSO vehicle only, showed virtually identical results to the FURA loaded PTs. Since there appeared to be no indication of any cumulative toxic effects between the FURA and the DMSO, the reduced viability was felt to be due to the DMSO vehicle rather than the FURA itself.

Although the viability of the PTs was reduced by the FURA/DMSO loading, the  $R_Q$  levels in the first 1-3hr of incubation were comparable with the values obtained for the unloaded mechanically isolated PTs in section 4.6. It is, therefore, difficult to know if the health of the PTs was significantly affected during the initial hours of incubation and whether this had any effect on the basal  $[Ca^{2+}]_i$  levels of the PTs — but there is undoubtedly a possibility.

### **5.4.2 Effect of alterations in the medium on basal $[Ca^{2+}]_i$ levels**

It was found that the basal  $[Ca^{2+}]_i$  levels for the mechanically isolated PTs in section 5.1.3 were far higher than those found in cultured renal systems of around 100nM [Smith *et al* 1987b, Holohan *et al* 1988, Inui *et al* 1988]. It was decided, therefore, to alter

pH and  $\text{Ca}^{2+}$  concentration in the external medium to see whether they would have any effect on basal  $[\text{Ca}^{2+}]_i$  levels.

## METHODS

### Effect of lowered pH on basal $[\text{Ca}^{2+}]_i$ levels in mechanically isolated PTs

A sample of mechanically isolated PTs was prepared as described in section 5.1.1 with the exception that the pH of the KHS was lowered from 7.4 to 6.5 and this medium was used throughout the PT isolation and the experiment. Three samples of this PT suspension were loaded with FURA as described in section 5.2 and then placed separately in the fluorimeter. Each sample was run for 2-3min, calibrated with Triton and EGTA and their basal  $[\text{Ca}^{2+}]_i$  levels then calculated as described in section 5.2. The experiment was repeated twice in total.

### Effect of lowered external $\text{Ca}^{2+}$ on basal $[\text{Ca}^{2+}]_i$ levels in mechanically isolated PTs

A sample of mechanically isolated PTs was prepared as described in section 5.1.1 with the exception that the concentration of  $\text{CaCl}_2$  in the KHS was lowered from 2.5mM to 0.5mM and this was used throughout the PT isolation and the experiment. Three samples of this PT suspension were loaded with FURA as described in section 5.2 and then placed separately in the fluorimeter. Each sample was run for 2-3min, calibrated with Triton and EGTA and their basal  $[\text{Ca}^{2+}]_i$  levels then calculated as described in section 5.2. The experiment was repeated twice in total. The above experiments were repeated on mechanically isolated PTs in a medium to which no  $\text{CaCl}_2$  had been added. Basal  $[\text{Ca}^{2+}]_i$  levels in the three media were then compared.

## RESULTS

The values for  $[\text{Ca}^{2+}]_i$ , obtained in section 5.1.3 were higher than those obtained by other workers. Alteration of external pH from 7.4 to 6.5 had no effect on basal  $[\text{Ca}^{2+}]_i$  levels, however, lowered external  $\text{Ca}^{2+}$  levels did decrease  $[\text{Ca}^{2+}]_i$  values.

The results are summarised below:

| External CaCl <sub>2</sub> conc | [Ca <sup>2+</sup> ] <sub>i</sub> value (nM) |
|---------------------------------|---------------------------------------------|
| 2.5mM                           | 821 ± 60 (n=8)                              |
| 0.5mM                           | 523 ± 55 (n=6)                              |
| no added Ca <sup>2+</sup>       | 452* ± 54 (n=5)                             |

Unless otherwise stated all values were significantly different from each other ( $p \leq 0.05$ ). The annotation \* means that this value was not statistically different from the previous value.

**Table 5e** Basal [Ca<sup>2+</sup>]<sub>i</sub> values in mechanically isolated PTs incubated at 25°C with 0.5µM FURA 2-AM in a medium containing 3% Dextran, 10mM pyruvate, 5mM HEPES and KHS (containing different levels of calcium chloride). The results are the average of n separate measurements from 2 different experiments.

As shown in table 5e, basal [Ca<sup>2+</sup>]<sub>i</sub> was lowered when Ca<sup>2+</sup> levels in the external medium were reduced. This did not appear to be due to improved PT viability, however, as Trypan Blue values were unchanged by the various external Ca<sup>2+</sup> levels. It was decided to use 0.5mM calcium chloride in the external medium in future experiments, rather than to exclude Ca<sup>2+</sup> from the external medium altogether, as no significant difference was found in [Ca<sup>2+</sup>]<sub>i</sub> values between the exclusion and 0.5mM calcium chloride levels. Also it was felt that some external Ca<sup>2+</sup> should be present to allow for the fact that certain responses require the presence of external Ca<sup>2+</sup> in order to occur. With this reduced calcium medium the basal [Ca<sup>2+</sup>]<sub>i</sub> levels for mechanical and collagenase isolated PTs were;

Mechanical isolates    523 ± 55nM (n=6)  
Collagenase isolates    182 ± 14nM (n=6)

## DISCUSSION

There was concern that, despite copious gassing, anoxia might have developed in the PTs and that this might be the cause of the raised [Ca<sup>2+</sup>]<sub>i</sub> levels. It has been suggested that low pH is protective against this rise [Snowdowne *et al* 1985]. Since FURA, unlike QUIN, is not sensitive to pH changes [Cheung 1987]; the pH of the PT incubation medium was lowered to 6.5. However, no alteration in [Ca<sup>2+</sup>]<sub>i</sub> was produced by the lowered pH.

Not surprisingly, altered external  $\text{Ca}^{2+}$  levels have been observed to affect  $[\text{Ca}^{2+}]_i$  [Tsien *et al* 1984]. When external  $\text{Ca}^{2+}$  levels in the present system were reduced from 2.5mM to 0.5mM a reduction in  $[\text{Ca}^{2+}]_i$  levels of around 35% was obtained. Goligorsky & Hruska 1988 also observed a similar event in cultured renal epithelial cells with a rise in  $[\text{Ca}^{2+}]_i$  being seen when external  $\text{Ca}^{2+}$  concentrations exceeded 1.5mM. There was concern that the high basal  $[\text{Ca}^{2+}]_i$  levels seen in the mechanical isolates might obscure calcium responses or transients. As 0.5mM external  $\text{Ca}^{2+}$  was within physiological ranges [Goligorsky & Hruska 1988], and since it was felt that 0.5mM external  $\text{Ca}^{2+}$  was sufficient not to affect agonist responses, it was decided to use this reduced calcium medium in future experiments. This meant that the basal  $[\text{Ca}^{2+}]_i$  level in mechanical isolates was now approximately 523nM.

#### **5.4.3 Use of Pluronic F-127® during the FURA loading procedure in mechanical and collagenase isolated PTs.**

It has been found that, due to the poor solubility of FURA 2-AM/DMSO mixtures in physiological solutions, FURA 2-AM precipitates may form which may be taken up into cells to give aberrant basal  $[\text{Ca}^{2+}]_i$  levels [Goligorsky *et al* 1986a, Poenie *et al* 1986, Malgaroli *et al* 1987, Himpens & Somlyo 1988]. Addition of the surfactant Pluronic F-127® reduces the degree of precipitation and it was felt that its incorporation into the loading protocol might improve basal  $[\text{Ca}^{2+}]_i$  levels in the two isolated PT samples.

#### **METHODS**

Fresh, mechanical or collagenase isolated PT suspension (prepared as described in section 5.1.1, but using 0.5mM  $\text{CaCl}_2$  in the KHS) was inoculated into foil covered, siliconised flasks at a protein concentration of 4mg per flask. Each flask was then gassed with humidified 95%  $\text{O}_2$ /5%  $\text{CO}_2$  and incubated to 25°C in a shaking water bath. Aliquots of stock solutions of FURA in DMSO and Pluronic F-127 (gift from Dr M

Hafner, but also obtainable from Molecular Probes Inc) in DMSO were mixed together and then added to each flask to produce final concentrations of; FURA 0.5 $\mu$ M, Pluronic 0.01%, DMSO 0.3%. The flask was incubated for a further 15min at 25°C, then the sample was washed and loaded into the fluorimeter as described in section 5.2.

i. Scans, as described in section 5.1.2, were performed on PTs loaded by the pluronic protocol and compared with scans from PTs loaded without pluronic to see whether the degree of FURA uptake was altered.

ii PTs loaded by the pluronic protocol were run for approximately 15min, calibrated with Triton and EGTA and their basal  $[Ca^{2+}]_i$  levels then calculated by the method described in section 5.2. These values were compared with those obtained in PTs loaded in the absence of Pluronic.

iii Viability of the PTs, following a Pluronic loading, was assessed by Trypan Blue exclusion (section 2.1.4) and compared with the values obtained in PTs loaded in the absence of Pluronic. The effect of 0.3% DMSO alone on viability was also assessed.

iv Leakage of FURA from PTs, loaded by the Pluronic protocol, was measured as described in section 5.3.2 and compared with values obtained in PTs loaded in the absence of Pluronic.

All the above experiments on PTs loaded by the Pluronic protocol were repeated three times in total.

## RESULTS

Emission scans on the FURA uptake of mechanically isolated PTs in the presence (fig 5h 1) and absence (fig 5h 2) of pluronic showed that FURA uptake was increased significantly by the addition of pluronic. However table 5f showed that, despite the higher uptake, the basal  $[Ca^{2+}]_i$  levels in both PT samples were, on average, higher in PTs loaded with the aid of pluronic than those without.



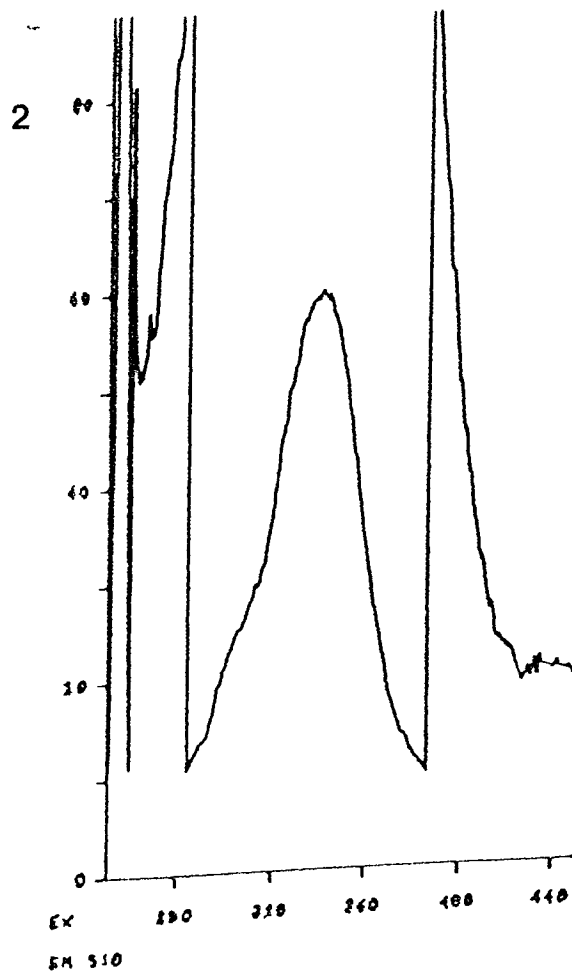
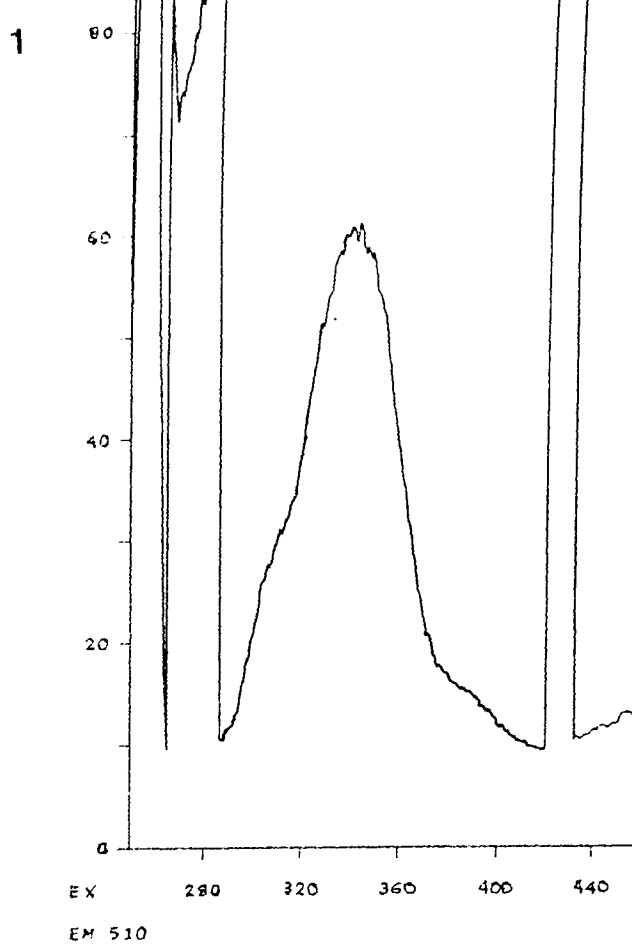

Fig 5h Representative emission scans of mechanically isolated PTs loaded at 37°C with either (1) 0.5 $\mu$ M FURA 2-AM with 0.01% Pluronic *amplitude 1* or (2) 0.5 $\mu$ M FURA 2-AM *amplitude 1.5*. The traces show greater uptake of FURA when the surfactant Pluronic is incorporated.

|                      | Basal $[Ca^{2+}]_i$<br>without pluronic<br>(n=6) | Basal $[Ca^{2+}]_i$<br>with pluronic<br>(n=3) |
|----------------------|--------------------------------------------------|-----------------------------------------------|
| Mechanical isolates  | 523nM                                            | 630nM                                         |
| Collagenase isolates | 182nM                                            | 220nM                                         |

**Table 5f** Measurement of basal  $[Ca^{2+}]_i$  levels in mechanical and collagenase isolated PTs loaded with FURA 2-AM with and without the presence of the surfactant pluronic.

An additional feature of the traces produced in the presence of pluronic is shown in fig 5i. Fig 5i 1 is a representative trace of mechanically isolated PTs incubated with 0.5 $\mu$ M FURA in the absence of pluronic. The trace appeared smooth and level with no obvious rise in the baseline. The representative trace of PTs incubated with FURA in the presence of pluronic (fig 5i 2), on the other hand, consistently showed a steadily *rising* baseline and the same features were also seen in PTs isolated by collagenase perfusion. The reason for this may be accounted for in table 5g;

|                      | Viability<br>without<br>pluronic | Leakage<br>without<br>pluronic | Viability<br>with<br>pluronic | Leakage<br>with<br>pluronic |
|----------------------|----------------------------------|--------------------------------|-------------------------------|-----------------------------|
| Mechanical Isolates  | 97% $\pm$ 1.0                    | 10% $\pm$ 2.1                  | 79% $\pm$ 7.1                 | 19% $\pm$ 3.1               |
| Collagenase Isolates | 95% $\pm$ 2.1                    | 15% $\pm$ 3.2                  | 71% $\pm$ 7.1                 | 24% $\pm$ 3.5               |

**Table 5g** Measurements of viability after loading and FURA leakage after 15min of incubation at 25°C in mechanical and collagenase isolated PTs incubated with FURA 2-AM in the presence and absence of the surfactant pluronic. The results are the average of three separate isolations and are expressed  $\pm$  the standard deviation.

The values in this table clearly showed that pluronic had a detrimental effect on the viability and FURA leakage from both PT samples and that the rising baseline seen in fig 5i 2 was probably a consequence of the increased rate of leakage. It was thought unlikely that the deterioration was due solely to the higher concentration of DMSO present in this experiment as similar DMSO concentrations were achieved by the high

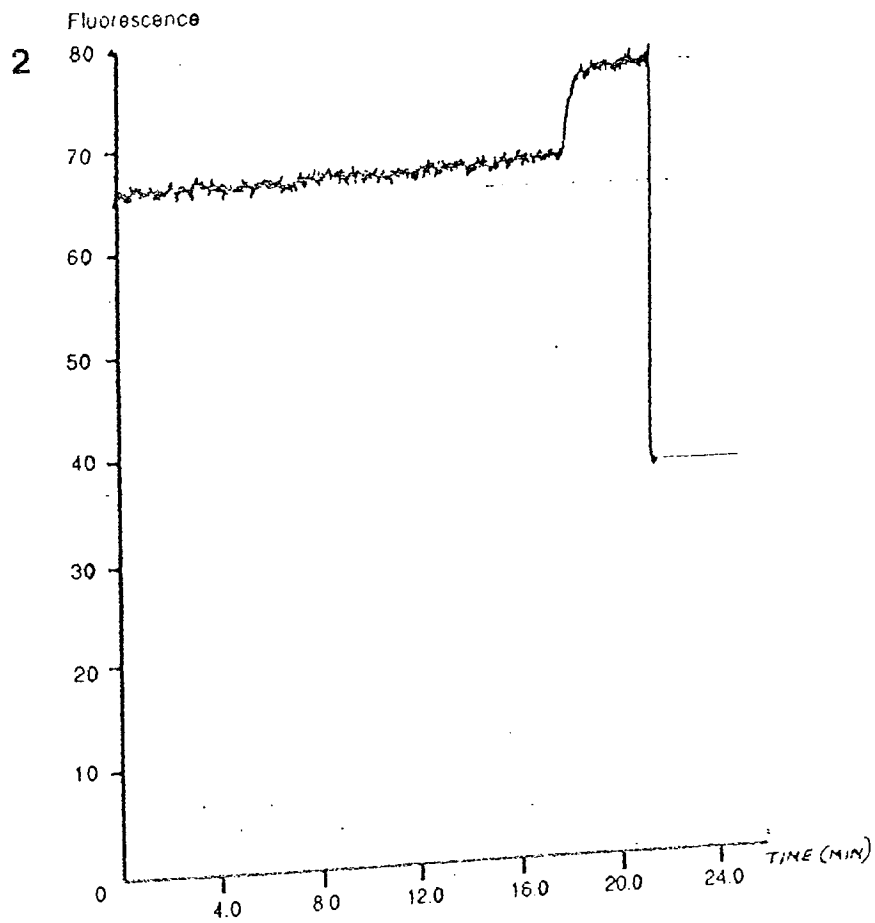
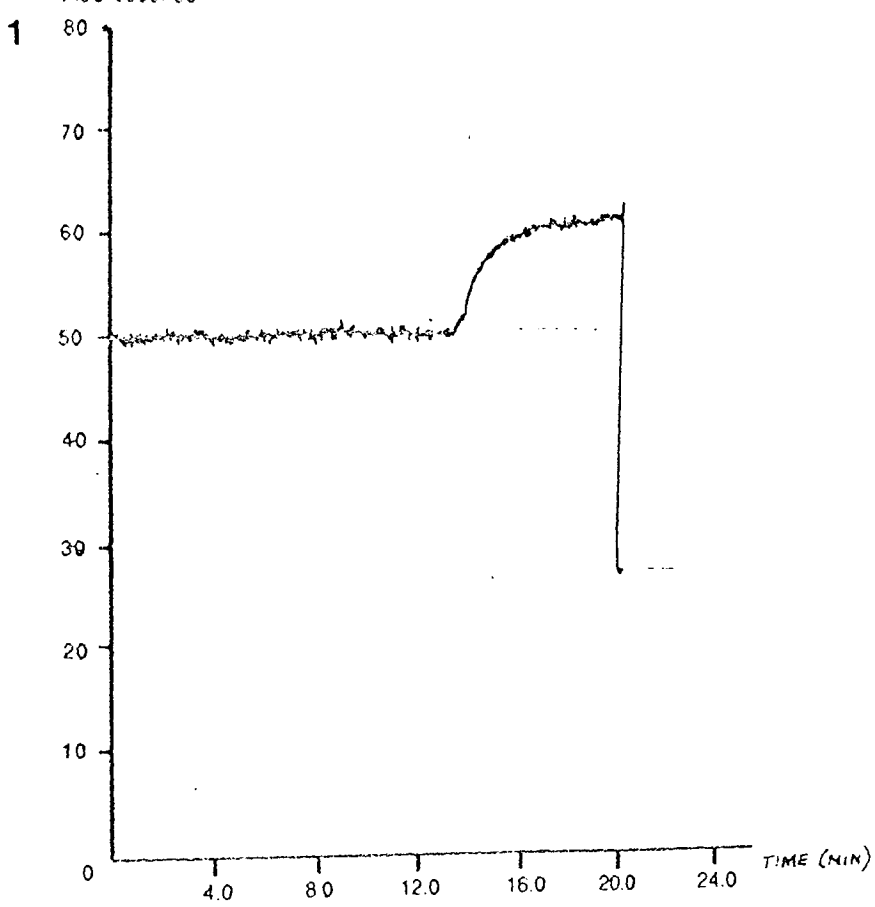

**Fig 5i** Representative traces of mechanically isolated PTs incubated with  $0.5\mu\text{M}$  FURA in the absence (1) and presence (2) of the surfactant pluronic and run at  $25^\circ\text{C}$ . Trace shows a smooth, level baseline in the absence of pluronic, but a steadily *rising* baseline in the presence of pluronic.

concentrations of FURA 2-AM used during the development of the loading protocol and no such rise in the baseline traces was ever seen in those experiments.

## DISCUSSION

The above results showed that the addition of pluronic increased the uptake of FURA into both mechanical and collagenase isolates (fig 5h). This was probably simply a consequence of the pluronic increasing the fraction of solvated FURA available for uptake. Unfortunately, despite the use of only 0.01% pluronic (which is lower than the 0.02-0.2% range usually found) its presence clearly had toxic effects on both PT samples. The PT samples incubated with pluronic showed higher basal  $[Ca^{2+}]_i$  levels, greater losses in viability and increased amounts of leakage — with collagenase isolates slightly more affected than the mechanically isolated PTs. The control experiments indicated that these effects were due to the pluronic rather than the increased levels of DMSO. It is difficult to interpret these results; on the one hand, FURA uptake was increased by the addition of pluronic which suggested that precipitation may have reduced the amount of available FURA. On the other hand, however, its presence induced significant toxicity in the present system which meant that it was impossible to judge whether any precipitate uptake had occurred in the whole PTs. In fact, it is not inconceivable that the increased uptake was not an artifact of the pluronic toxicity. Therefore, from these results, it was unfortunately not possible to judge whether precipitated FURA had been taken up by the PTs and if it had any affect on the high basal  $[Ca^{2+}]_i$  levels. This question can only really be answered conclusively by the appropriate microscopic evaluation.

### **5.5 EFFECT OF AGONISTS ON $[Ca^{2+}]_i$ LEVELS**

In order to ascertain whether the two PT samples still functioned efficiently in the presence of high basal  $Ca^{2+}$  levels, the effect of external stimuli on  $[Ca^{2+}]_i$  was

examined. The stimuli used were PTH and NOR which act on surface receptors and the ionophore ionomycin which by-passes such specific mechanisms. Due to the shortage of experimental time at this stage in the study, the results of these agonist responses are not claimed to be comprehensive but rather qualitative indicators of the responsiveness of the two PT systems.

### **5.5.1 Effect of the addition of parathyroid hormone to mechanical and collagenase isolated PTs**

Parathyroid hormone (PTH) has been shown to produce a rise in  $[Ca^{2+}]_i$  in renal cell culture systems loaded with fluorescent  $Ca^{2+}$  indicators [Hruska *et al* 1986, Yanagawa 1987]. PTH was added to both mechanical and collagenase isolated PTs to see whether each system was capable of responding to an external stimulus.

### **METHODS**

Fresh, mechanical and collagenase isolated PTs were prepared as described in section 5.1.1 (except that 0.5mM  $CaCl_2$  was used in the KHS) and loaded with FURA as described in section 5.2. The samples were run at 25°C for approximately 3-5min to produce a baseline then various concentrations of PTH substance, ranging from  $10^{-7}M$  to  $10^{-5}M$ , were added and the traces were run for a further 5-10min. Finally, the traces were calibrated and  $[Ca^{2+}]_i$  levels calculated according to the method described in section 5.2.

### **RESULTS**

The responses of both mechanical (fig 5j 1) and collagenase (fig 5j 2) isolated PTs to the addition of PTH substance were decidedly inconsistent. Despite the fact that viability, basal  $[Ca^{2+}]_i$  levels, leakage values etc, were the same between samples, PTH produced elevations in basal  $[Ca^{2+}]_i$  only occasionally. Even when responses did occur they did not appear to plateau distinctly. Neither the presence of pluronic, 2.5mM external

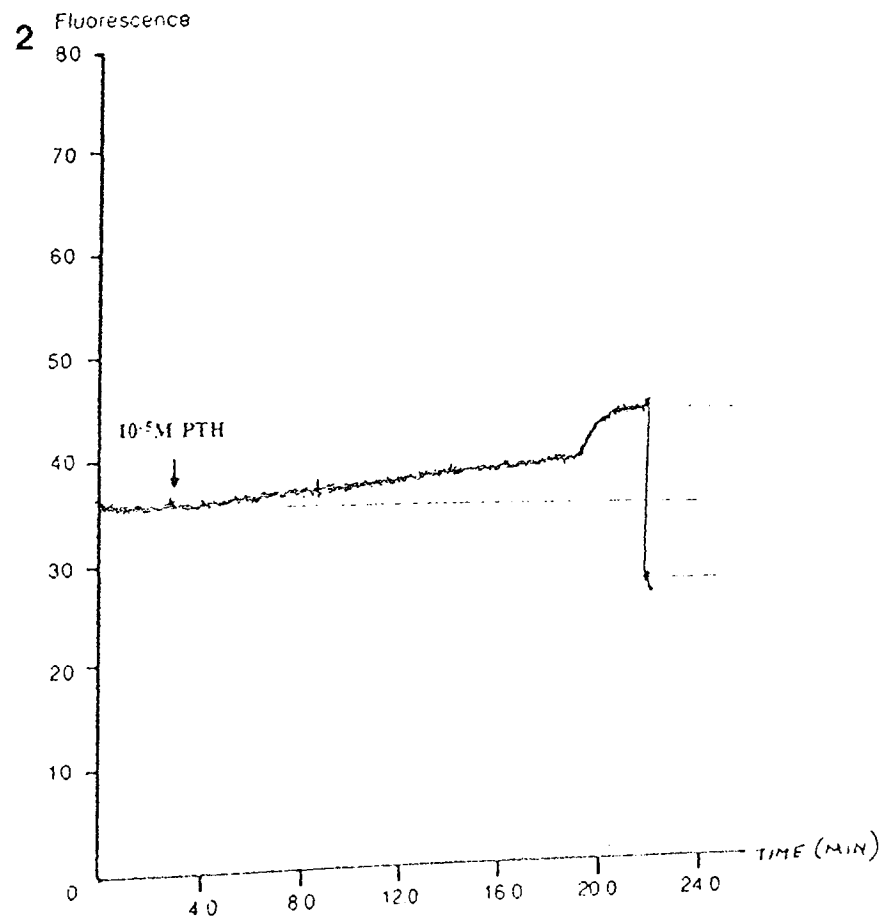
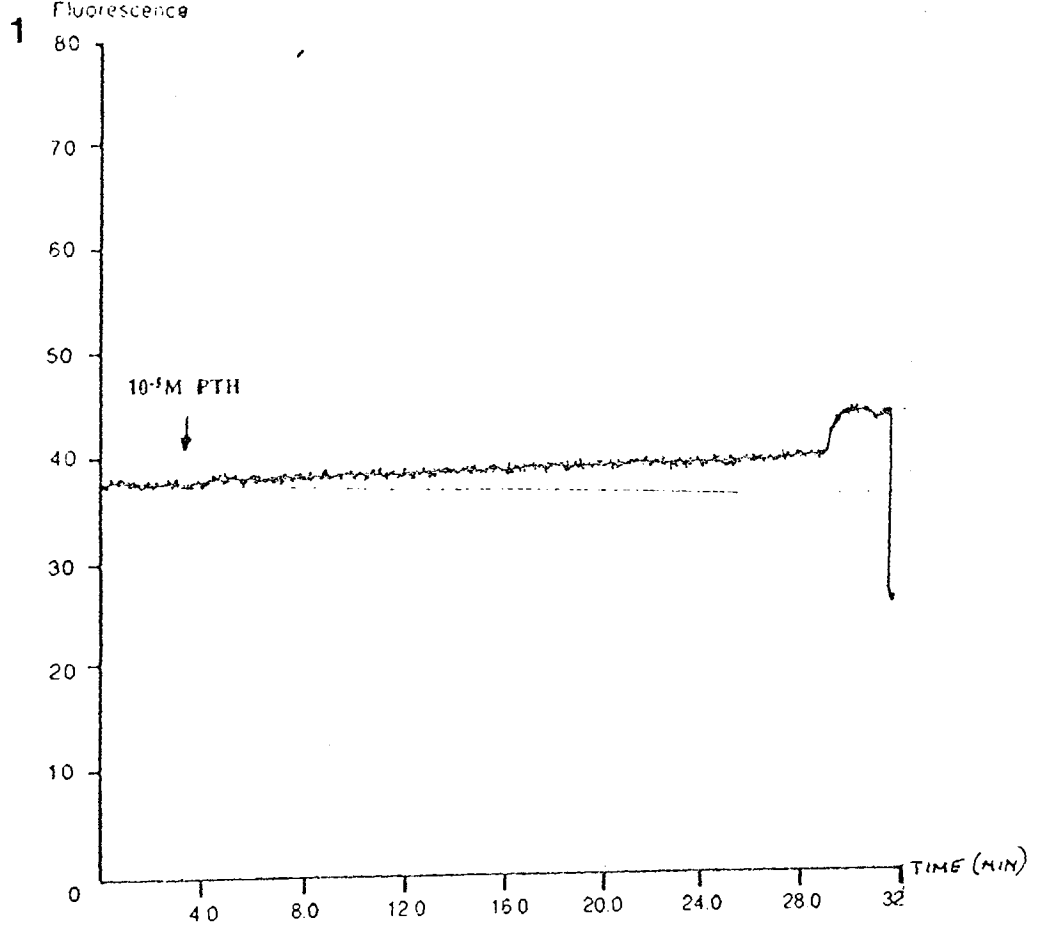

Fig 5j Representative traces of the type of response sometimes seen on the addition of  $10^{-5}$  parathyroid hormone (PTH) to mechanically isolated [1] and collagenase isolated [2] PTs loaded with FURA 2-AM and run at  $25^{\circ}\text{C}$ . Both traces show an elevation in the basal  $[\text{Ca}^{2+}]_i$  level immediately after the addition of PTH but neither response shows a distinct plateau.

CaCl<sub>2</sub> nor incubation at 37°C produced any improvement on these results. Because the responses were so inconsistent it was not possible to make reliable comparisons of the quality of response produced by mechanical and collagenase isolated PTs.

### **5.5.2 Effect of the addition of Noradrenaline to mechanical and collagenase isolated PTs**

Noradrenaline (NOR) is also known to produce elevations in [Ca<sup>2+</sup>]<sub>i</sub> in renal culture systems (Scoble personal communication) loaded with fluorescent calcium indicators. Due to the inconsistency of the PTH response, NOR was added to both mechanical and collagenase isolated PTs to see whether it produced a more consistent response (if any) within the systems.

#### **METHODS**

Fresh, mechanical and collagenase isolated PTs were prepared as described in section 5.1.1 (except that 0.5mM CaCl<sub>2</sub> was used in the KHS) and loaded with FURA as described in section 5.2. The samples were run at 25°C for approximately 3-5min to produce a baseline. A freshly prepared stock solution of NOR was made (with 0.5% ascorbic acid added to improve stability) and stored in a foil covered flask to prevent photodegradation. Aliquots of the stock solution of NOR were added to the flasks to produce final concentrations ranging between 5 to 50µM and the traces were run for a further 5-10min. Finally, the traces were calibrated and [Ca<sup>2+</sup>]<sub>i</sub> levels calculated according to the method described in section 5.2.

#### **RESULTS**

Unlike the PTH responses, the NOR responses in both mechanical (fig 5k 1) and collagenase (fig 5k 2) isolated PTs were more consistent but again there were still occasions when, for no apparent reason, NOR failed to produce any effect on basal [Ca<sup>2+</sup>]<sub>i</sub>. Responses below 20µM were not seen but above that (when they did occur) the

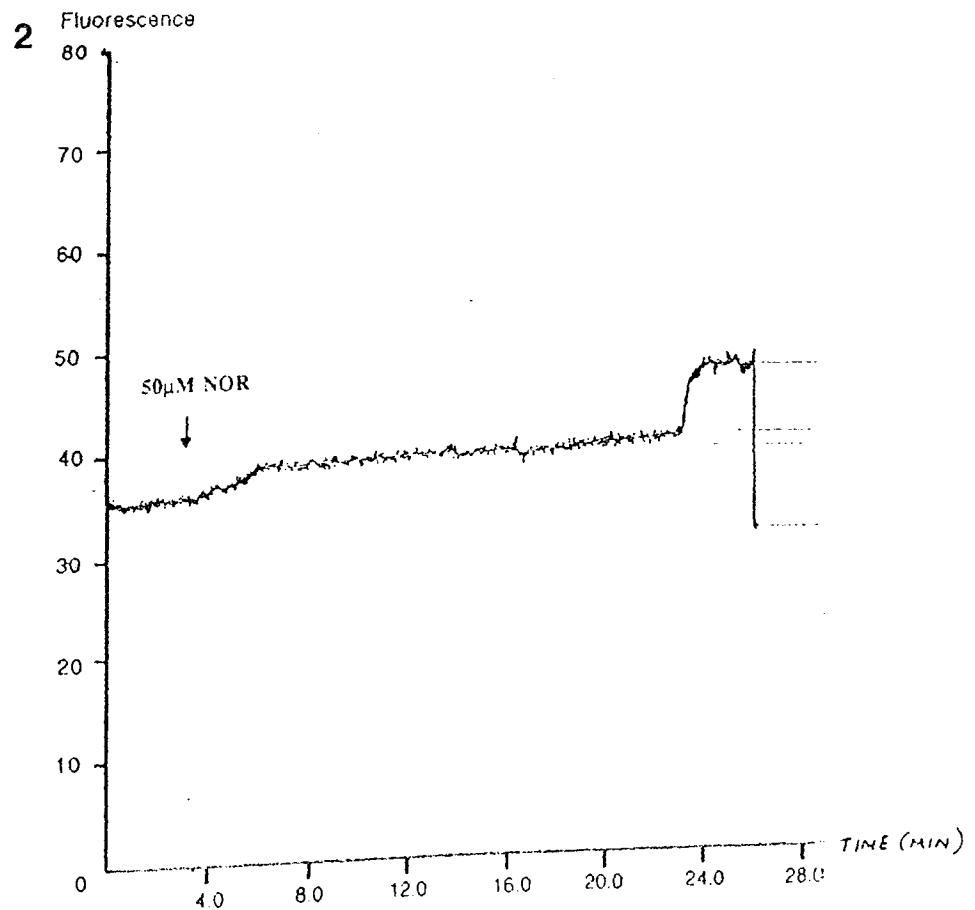
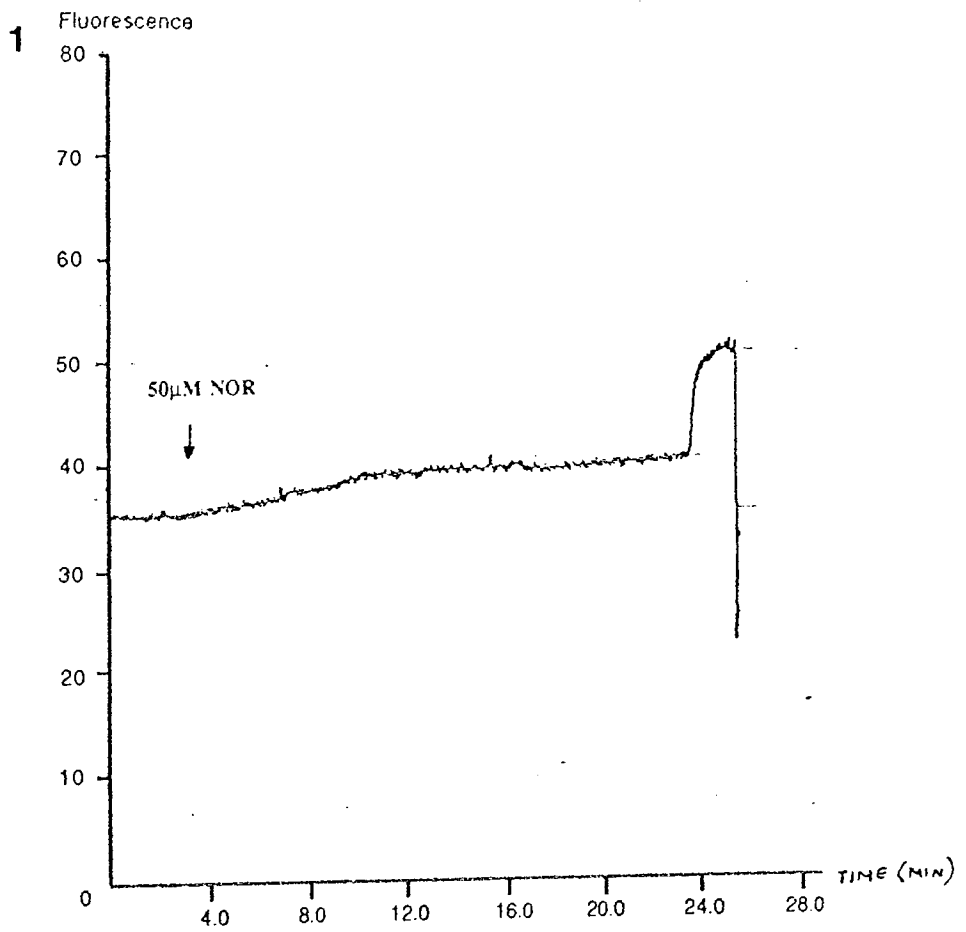

Fig 5k Representative traces of the type of response sometimes seen on the addition of 50  $\mu$ M noradrenaline (NOR) to mechanically isolated [1] and collagenase isolated [2] PTs loaded with FURA 2-AM and run at 25°C. The traces show an elevation in the basal  $[Ca^{2+}]_i$  level immediately after the addition of NOR and a more distinct plateau in both systems.





fraction was not available to the project) and the vague nature of the composition of this preparation meant that it was not possible to accurately calculate the exact amount of the active PTH 1-34 fraction that was being added to the system — nor was there any information about possible impurities in the product. Also, since the PTH was of bovine origin, it may not have been as active in rat PTs. It would be interesting to repeat the results with purified PTH 1-34 fraction, preferably of rat origin.

Noradrenaline produced responses that were more consistent and had a more definite plateau (fig 5k). Nevertheless, for some unknown reasons, there were still some occasions in both PT systems when NOR failed to produce a response — even though the basal  $[Ca^{2+}]_i$  levels and viability of the PTs appeared unaltered. As a consequence it was not possible (in the time left) to produce an accurate dose response curve in either PT system; although the level of the  $[Ca^{2+}]_i$  responses did appear to increase with NOR concentration. The reason why the collagenase isolates produced slightly more consistent and defined responses compared with the mechanical isolates may lie in the fact that NOR binds to collagen [Bowman & Rand 1980] and so some of the NOR dose may have been taken up by the connective tissue residues left on the surface of the mechanical isolates. To ensure that the NOR response was not an artifact of an increase in autofluorescence through redox changes and stimulation of NADH production, NOR was added to unloaded PTs. It was found that NOR produced only a very slight increase in the PT autofluorescence and, therefore, the majority of the response was probably due to raised  $[Ca^{2+}]_i$  levels.

### **5.5.3 Effect of the addition of Ionomycin to mechanical and collagenase isolated PTs**

The non-fluorescent calcium ionophore Ionomycin has been used by many workers in various systems to elicit rises in  $[Ca^{2+}]_i$  [Cheung 1987, Malgaroli et al 1987, Yanagawa 1987, Aboolian & Nord 1988]. Both PTH and NOR had produced

inconsistent responses in each PT system and so Ionomycin was added to see what effect, if any, an ionophore produced.

## METHODS

Fresh, mechanical and collagenase isolated PTs were prepared as described in section 5.1.1 (except that 0.5mM CaCl<sub>2</sub> was used in the KHS) and loaded with FURA as described in section 5.2. The samples were run at 25°C for approximately 3-5min to produce a baseline then an aliquot of a stock solution of Ionomycin was added, to give a final concentration of 2µM, and the traces were run for a further 5-10min. Finally, the traces were calibrated and [Ca<sup>2+</sup>]<sub>i</sub> levels calculated according to the method described in section 5.2.

## RESULTS

The results of the effect of the ionophore Ionomycin on basal [Ca<sup>2+</sup>]<sub>i</sub> levels are shown in fig 5l for mechanical isolates and fig 5m for collagenase isolates. Over 3 separate experiments, 2µM ionomycin consistently produced around a 4 fold rise in the basal [Ca<sup>2+</sup>]<sub>i</sub> levels of collagenase isolated PTs which reached a plateau within 2-3mins. In mechanical isolates no response was produced at 2µM doses and increments thereof up to a 10µM final concentration. However, a bolus dose of 15µM did produce a rise in the basal [Ca<sup>2+</sup>]<sub>i</sub> level of the mechanical isolates which reached a plateau within 1min very close to the F<sub>max</sub> value.

## DISCUSSION

Ionomycin raises [Ca<sup>2+</sup>]<sub>i</sub> levels in cells by making mitochondrial and plasma membranes permeable to Ca<sup>2+</sup> [Solez & Whelton 1984] rather than via the action of receptors. The choice of ionomycin over the other popular ionophore A23187 was based on information that only ionomycin was non-fluorescent [Rink & Pozzan 1985]; whereas A23187 was intensely fluorescent [Inui *et al* 1988].

As shown above, in 3 separate experiments, 2µM ionomycin consistently produced around a 4.5-fold rise in the [Ca<sup>2+</sup>]<sub>i</sub> of collagenase isolated PTs followed by an

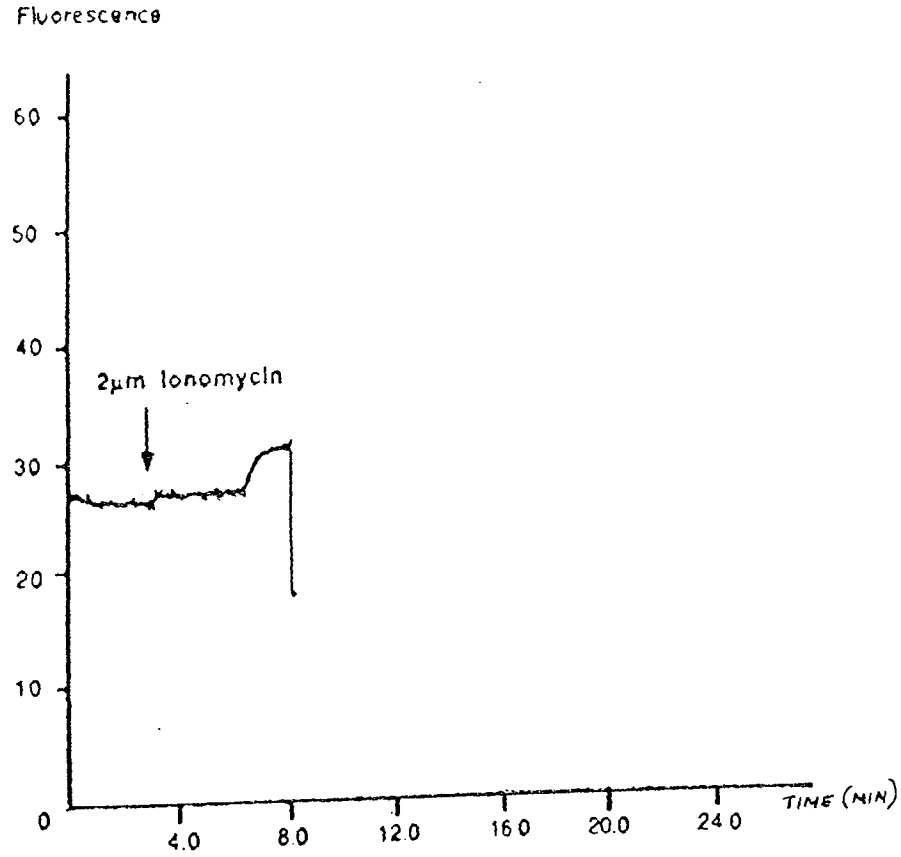

**Fig 5l** Representative trace of the effect of the addition of ionomycin on the basal  $[Ca^{2+}]_i$  level of mechanically isolated rat PTs loaded with FURA 2-AM. The trace shows that  $2\mu M$  ionomycin produced virtually no effect on the fluorescent signal.

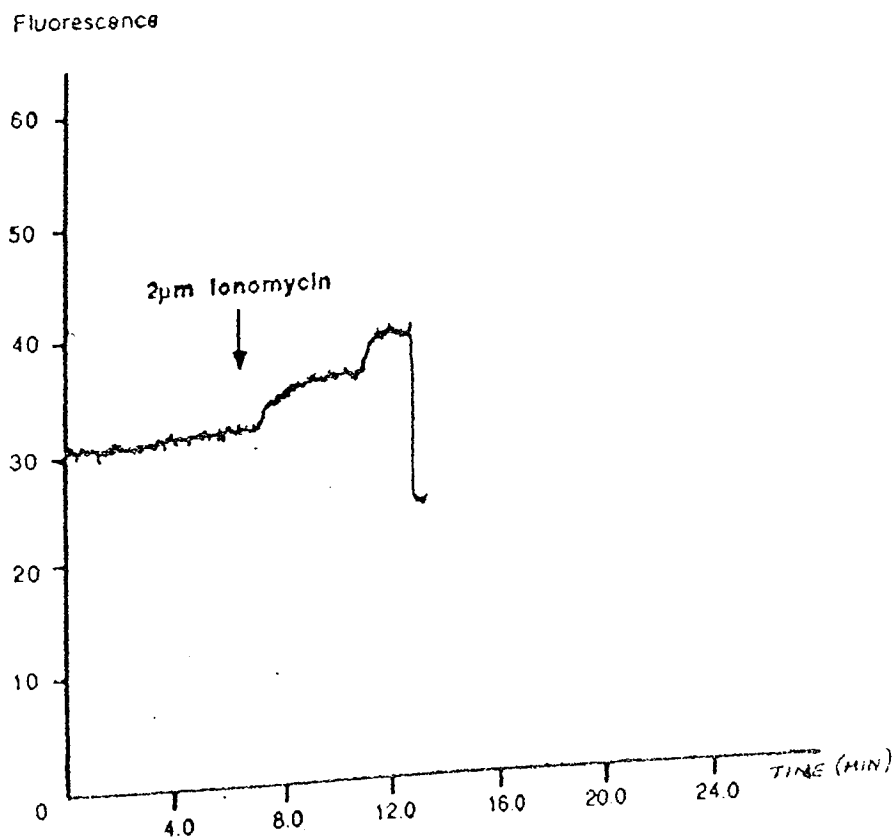

**Fig 5m** Representative trace of the effect of the addition of ionomycin on the basal  $[Ca^{2+}]_i$  level of collagenase isolated rat PTs loaded with FURA 2-AM. The trace showed that  $2\mu M$  ionomycin produced a definite and immediate signal which reached a plateau within 2min of addition.

incomplete recovery after 10-15min (probably contributed to by leakage). In mechanical isolates, on the other hand, 2 $\mu$ M ionomycin produced little effect on  $[Ca^{2+}]_i$ ; but a 15 $\mu$ M bolus dose of ionomycin produced a large rise in their  $[Ca^{2+}]_i$  levels; yet, curiously, 2 $\mu$ M increments of ionomycin up to a final concentration of 10 $\mu$ M had had little effect on  $[Ca^{2+}]_i$ . Unfortunately, due to shortage of time and ionomycin, it was not possible to pursue these experiments further and examine the effects on mechanical isolates of intermediate ionomycin concentrations and whether bolus administrations were more effective at raising  $[Ca^{2+}]_i$  levels than small increment dosing.

It is difficult to explain the discrepancy in the responses between mechanical and collagenase isolates, but external binding or even physical antagonism of the ionomycin by the connective tissue residues may have been factors. Alternatively, the mechanical isolates may, for some reason, have been unresponsive to ionomycin and the rise in  $[Ca^{2+}]_i$  seen at the 20 $\mu$ M bolus dose may have been due to cell damage rather than selective permeabilisation.

## **5.6 MEASUREMENT OF THE DEGREE OF EXTERNAL BINDING OF FURA TO MECHANICAL AND COLLAGENASE ISOLATED PTS**

Binding of FURA to external cellular surfaces is a problem in different cell systems [Batlle *et al* 1988, Hallam personal communication]. As stated in Chapters 3 and 4, mechanically isolated PTs have varying levels of connective tissue matrix attached to their surface which raised concerns regarding possible binding to these residues by exogenous agents. Preliminary leakage experiments had suggested the presence of a significant initial external signal and, following the incongruous agonist responses, it was decided to examine the possibility of extensive FURA binding to the external surfaces of the PTs using two different methods.

## METHODS

### Invasive Modified Calibrations

This was taken from the methods of Smith *et al* 1987b and Batlle *et al* 1988. Fresh, mechanical and collagenase isolated PTs were prepared as described in section 5.1.1 (except that 0.5mM CaCl<sub>2</sub> was used in the KHS) and loaded with FURA as described in section 5.2. Each sample was run at 25°C for 15-30sec to give the value F. Alkaline EGTA (final concentration 1mM) was added to quench any external signal and give a value F', this was then followed by the addition of 0.05% Triton to give the value F<sub>min</sub>. Finally, 2mM CaCl<sub>2</sub> was added to give the value of F<sub>max</sub>. The value for basal [Ca<sup>2+</sup>]<sub>i</sub>, corrected for external signal was calculated from;

$$[\text{Ca}^{2+}]_i \text{ corrected} = \frac{F' - F_{\text{min}}}{F_{\text{max}} - F} \times 224$$

From this value, the degree of external binding was estimated for both mechanical and collagenase isolated PTs.

### Non-invasive estimation of external signal

The problem with the modified calibration as a way of estimating the degree of external signal was that the cells were destroyed during the process. Hallam (personal communication) suggested a way of estimating external signal using nickel chloride and the chelator DTPA (used in section 5.3.1).

Fresh, mechanical and collagenase isolated PTs were prepared as described in section 5.1.1 (except that 0.5mM CaCl<sub>2</sub> was used in the KHS) and loaded with FURA as described in section 5.2. Each sample was run at 25°C for 15-30sec to give the value F. Nickel chloride solution (final concentration 100µM) was added to quench the external signal and give the value F'. DTPA (final concentration 100µM) was then added which chelated the nickel and restored the signal to the original baseline value. Finally the cells were calibrated with Triton and EGTA to give the F<sub>max</sub> and F<sub>min</sub> values respectively, as

described in section 5.2. These values were then used in the modified calibration equation shown above to obtain the corrected basal  $[Ca^{2+}]_i$ . The value obtained with this technique was compared with that obtained in 5.6.1 by the modified calibration method.

## RESULTS

Both the invasive modified calibrations (fig 5n) and the non-invasive (Fig 5o) methods of measuring external fluorescence clearly showed that an external FURA signal was present in each of the tubule systems immediately after loading — with the mechanical isolates particularly affected. The measurements were made approximately 30 sec after the start of the trace recording and so it was felt reasonable to assume that any external signal measured was due mainly to external FURA binding rather than FURA leakage.

The traces obtained with the invasive method of modified calibration showed that the degree of external binding in mechanical isolates (fig 5n 1) was much higher than that seen with collagenase isolates (fig 5n 2). Comparison of the corrected basal  $[Ca^{2+}]_i$  levels produced by this technique (table 5h) showed that the difference was statistically significant ( $p \leq 0.05$ )

|                      | Uncorrected<br>$[Ca^{2+}]_i$ | Corrected<br>$[Ca^{2+}]_i$ | % external<br>binding |
|----------------------|------------------------------|----------------------------|-----------------------|
| Mechanical Isolates  | $507 \pm 50$                 | $231 \pm 32$               | 54%                   |
| Collagenase Isolates | $183 \pm 6$                  | $162 \pm 8$                | 11%                   |

Unless otherwise stated, all values were statistically different from each other ( $p \leq 0.05$ )

**Table 5h** Results of the degree of external signal present in mechanical and collagenase isolated PTs measured by the invasive technique of modified calibration [section 5.13.1]. The results are the average of four separate experiments ( $n=4$ ) and are expressed  $\pm$  SD.

The traces obtained by the non-invasive method showed a similar discrepancy of approximately 4-fold in external binding between mechanical (fig 5o 1) and collagenase isolated

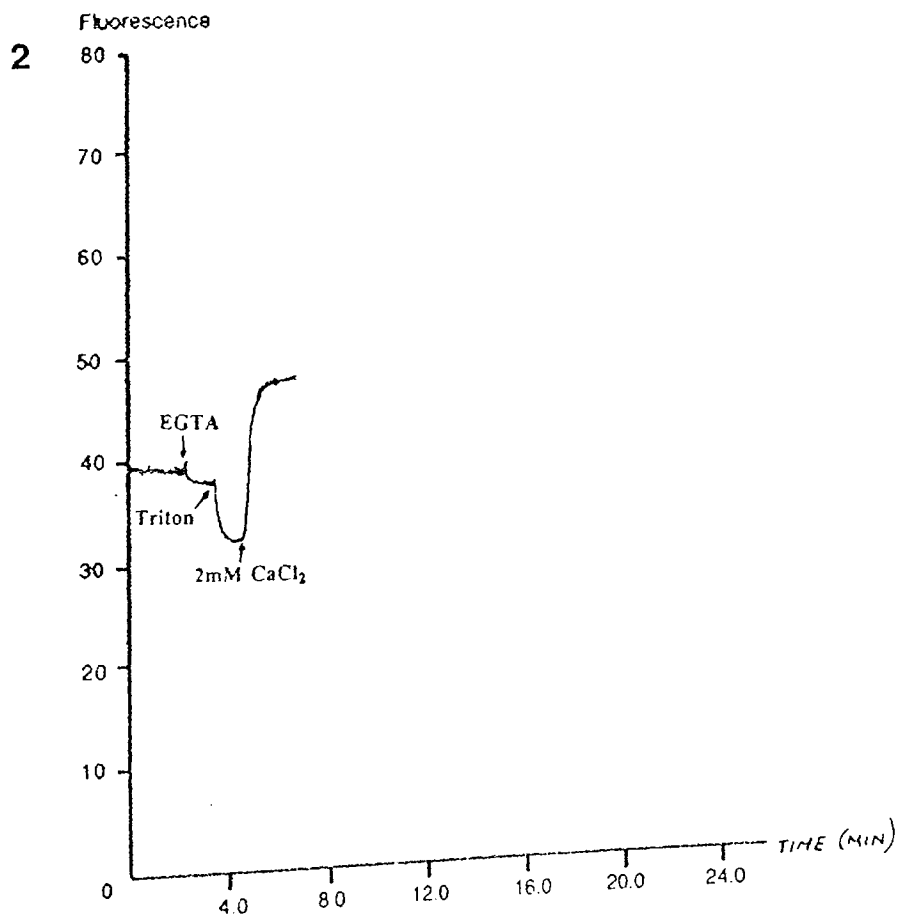
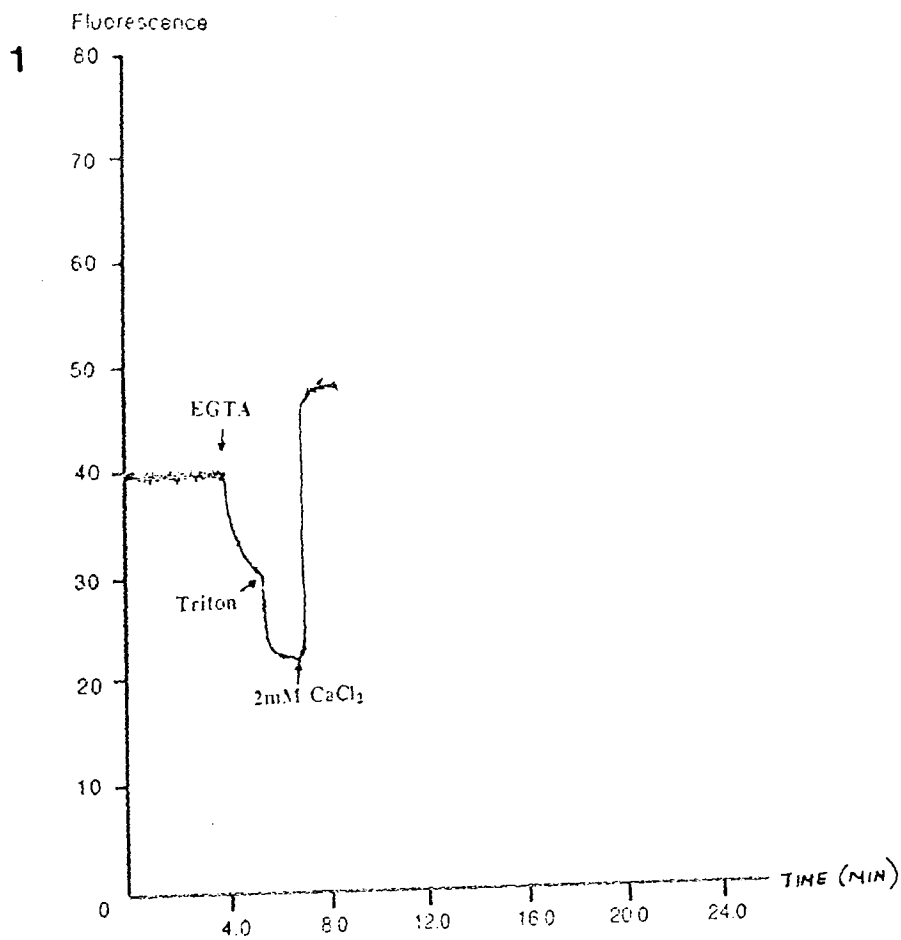

**Fig 5n** Representative trace of the degree external FURA signal present in mechanical [1] and collagenase [2] isolated rat PTs. Quenching of the external signal is produced by EGTA then, following lysis of the cells with 0.05% Triton to give  $F_{min}$ , the  $F_{max}$  value was obtained by the addition of  $CaCl_2$ . The traces show a greater degree of external signal in mechanically isolated PTs compared with their collagenase isolated counterparts.



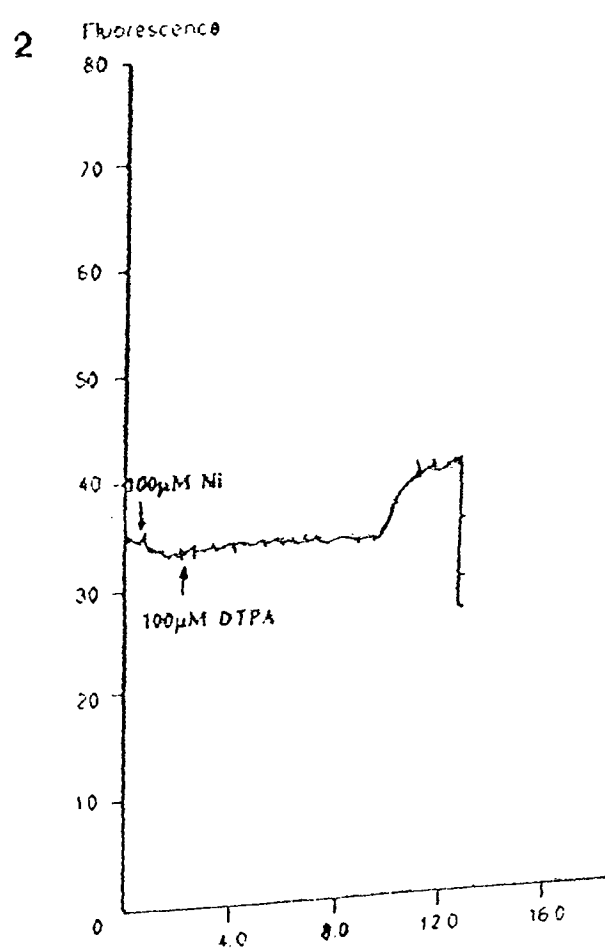
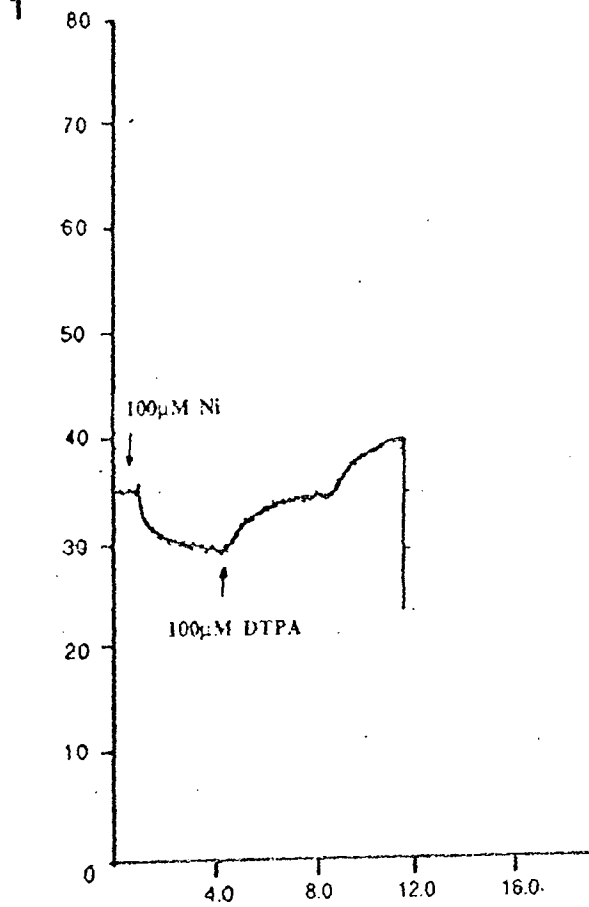

**Fig 5o** Representative trace of the degree external FURA signal present in mechanical [1] and collagenase [2] isolated rat PTs. Quenching of the external signal is produced by nickel chloride (Ni) and restoration of the signal is obtained with the chelator diethylenetriaminepentaacetic acid (DTPA). The traces show a greater degree of external signal in mechanically isolated PTs compared with their collagenase isolated counterparts.

PTs (fig 5o 2) and again comparison of the basal  $[Ca^{2+}]_i$  levels (table 5i) showed that the difference was statistically significant ( $p \leq 0.05$ ).

|                      | Uncorrected<br>$[Ca^{2+}]_i$ | Corrected<br>$[Ca^{2+}]_i$ | % external<br>binding |
|----------------------|------------------------------|----------------------------|-----------------------|
| Mechanical Isolates  | $480 \pm 73$                 | $256 \pm 48$               | 47%                   |
| Collagenase Isolates | $179 \pm 10$                 | $157 \pm 6$                | 12%                   |

Unless otherwise stated, all values were statistically different from each other ( $p \leq 0.05$ )

**Table 5i** Results of the degree of external signal present in mechanical and collagenase isolated PTs measured by the non-invasive use of nickel chloride and the chelator diethylenetriaminepentaacetic acid (DTPA) [section 5.3.1]. The results are the average of four separate experiments ( $n=4$ ) and are expressed  $\pm$  SD.

There was, however, no statistical difference between the values obtained by the invasive and non-invasive methods for the measurement of external FURA binding. So it appears that approximately 50% of the total fluorescent signal in mechanical isolates is located outside the cytosol whereas only about 11% of the total signal is extracellular in collagenase isolates. In addition, both the invasive and non-invasive methods appear equally suitable for the measurement of external signal in these PT systems.

## DISCUSSION

The two methods described in section 5.6 for estimating external fluorescence both showed that approximately 50% of the FURA signal was external in mechanical isolates compared with around 12% in collagenase isolates. The emission scans in fig 5a showed that, following incubation with the mechanical isolates, very little FURA 2-AM remained which suggested that the external signal came mainly from hydrolysed FURA. On the basis of this, one possible scenario might be that during the loading protocol esterases from damaged PTs leaked into the incubation medium and

hydrolysed the FURA 2-AM to the polyanionic free FURA which then bound to the PT surface.

Following corrections for external FURA, the basal  $[Ca^{2+}]_i$  levels became more respectable values of around 240nM for mechanical isolates and 150nM for collagenase isolates. Although these values are higher than those obtained in *cultured* renal cells of between 70-100nM [Smith *et al* 1987b, Goligorsky & Hruska 1988, Holohan *et al* 1988, Inui *et al* 1988], and the possible reasons for this are discussed in Chapter 6, these values are comparable with the  $[Ca^{2+}]_i$  levels found in collagenase isolated *whole* PTs of between 86-280nM [Yanagawa 1987, Batlle *et al* 1988, Libre *et al* 1988, Schnellman personal communication]. Why the basal  $[Ca^{2+}]_i$  levels were still higher in the mechanical isolates over the collagenase isolates is unknown, but light scattering by the collagen might be one reason [Nakano *et al* 1987].



1mgml<sup>-1</sup> an acceptable quality of signal was obtained. The PT concentration was expressed in terms of milligrams of protein, rather than cell density, as attempts to estimate the number of individual cells present in the whole PTs was neither fruitful nor feasible.

Next came the preliminary checks to verify that the PTs isolated from the Fischer rat contained the appropriate esterases for the hydrolysis of FURA 2-AM to free FURA and also to establish a suitable loading protocol. The scans from Fig 5a showed clearly that hydrolysis had occurred and that the appropriate esterases were, therefore, present. Also a reduced incubation temperature of 25°C had little effect on the hydrolysis.

The aim of any protocol for the incorporation or 'loading' of the fluorescent indicators into cells is to strike a compromise between a) the desire for the minimum amount of probe introduced into the cell to give the least possible increase in calcium buffering in the cytosol and b), the requirement to get a signal substantially in excess of the background fluorescence [Tsien *et al* 1984, Rink & Pozzan 1985]. Indeed one of the main reasons that FURA was chosen in preference to QUIN was the fact that FURA is 30 times brighter than QUIN [Grynkiewicz *et al* 1985, Cheung 1987] which means that less dye has to be incorporated into cells to overcome autofluorescence.

The loading concentration of 0.5µM for 15 min was lower than the 2-20µM FURA range used by other workers in cell culture [Burnatowska-Hledin & Spielman 1987, Aboolian & Nord 1988, Goligorsky & Hruska 1988, Holohan *et al* 1988, Inui *et al* 1988 Stassen *et al* 1988] and in isolated rat PTs [Llibre *et al* 1988]. It is difficult to know why this is but cellular density may be a factor; in cell culture studies, the cell density used is usually in the order of 10<sup>6</sup> cells per ml. With the whole PTs used in this study, calculation of an accurate cell density was not possible and it may be that the number of cells present in the whole PT system was considerably less than 10<sup>6</sup>. It was not possible to relate the FURA loading concentration used in the present study with that used in the whole PT system of Llibre *et al* 1988 as their PT concentrations were expressed in terms of wet weight per ml only.

### 5.7.2 Quenching of the FURA signal by heavy metals

One of the possible factors interfering with the FURA signal in the present isolation systems was felt to be the known quenching effect of heavy metals leading to the subsequent underestimation of  $[Ca^{2+}]_i$  levels [Tsien *et al* 1982, Arslan *et al* 1985, Grynkiewicz *et al* 1985]. The present isolation systems are probably fairly unique in that a heavy metal oxide,  $Fe_3O_4$ , was used in the tissue isolation procedure and so the systems had the double problem of both intrinsic and extrinsic heavy metal levels. Nevertheless, other systems can also, unwittingly contain significant levels of quenching metals which are rarely measured — let alone corrected for. For example zinc ions are often present in cell culture media such as the much used, F12 and it is felt by some that representative cell samples should regularly be treated with DTPA and TPEN to evaluate their effect on the fluorescent indicators [Goligorsky & Hruska 1988]. It is also interesting to speculate that the presence of heavy metals in some culture media may account, in part, for the tendency for basal  $[Ca^{2+}]_i$  levels to be lower in cultured renal cells than in fresh isolates [Goligorsky & Hruska 1988].

Fortunately, however, the traces seen in figs 5e and 5f showed that the  $Fe_3O_4$  had little effect on the FURA signal. Nevertheless, despite this, it would probably be unwise to be complacent about the apparent inertia of the compound (see section 6.3).

### 5.7.3. Leakage of FURA from the PT cells

The results in section 5.3.2 showed that FURA did leak steadily from both mechanical and collagenase isolated PTs (though slightly more from the latter) and that the rate of leakage increased with temperature.

Leakage is an emotive term and tends to imply breaches in the cell membrane. Although FURA is extruded by dying cells, this may not be the only reason for the event known as 'leakage'. Some workers have found that dye leakage from cells may be stopped or attenuated by the anion transport inhibitor probenecid [DiVirgilio *et al* 1987,

McDonough & Button 1989]. This would seem to imply that some form of transport process may be involved in leakage, in addition to FURA loss through breaches in the plasmalemma, with FURA acting as a substrate for an organic anionic exchange mechanism [McDonough & Button 1989] — especially since nonesterified FURA has a tetra-anionic charge [Cheung 1987]. In fact the transport system involved may be similar to that already demonstrated in kidney epithelial cells [Møller & Sheikh 1983]. Consequently, a stimulation in this anionic transport system through increased temperature might well be the reason for the greater degree of leakage seen in both PT samples at 37°C. It was decided, however, not to use probenecid to routinely try and attenuate leakage in the present systems as it was felt that it might well interfere with other essential transport processes [McDonough & Button 1989]. However, in order to keep leakage to a minimum, the PTs were incubated and run at 25°C (especially since earlier work had already shown that incubation at 25°C did not significantly affect FURA uptake nor conversion) also any agonists etc were added to the system as soon as possible after loading into the fluorimeter.

Although the effects of probenecid were not examined in this system, anecdotal evidence from Schnellman (personal communication) suggested that there was a significant transport component to leakage from whole PTs. Schnellman, in preliminary studies, examined the use of FURA in collagenase isolated *rabbit* PTs. His isolation technique has been described previously [Schnellman & Mandel 1986, Schnellman 1988] and consisted of whole cortex collagenase digestion followed by differential centrifugation. He found that his initial leakage of approximately 20-25% at 26°C over 15-20mins (which increased with temperature) was significantly attenuated by probenecid — although he currently uses sulfapyrazone instead of probenecid as it is felt that this interferes with other transport processes to a lesser extent than probenecid. Although Schnellman's results are in rabbits, and species differences might occur, it is interesting to speculate that rat PTs may also have the same transport component to FURA leakage. If so, this would probably provide a more likely explanation for the finding of leakage

(when it does occur) often being temperature dependent rather than solely a function of cellular deterioration. Presence or absence of this transport system might also explain why only some cell systems exhibit leakage — whereas all cell systems deteriorate with time

Although the leakage obtained by Schnellman in rabbit PTs was greater than that measured by the present study in collagenase isolated rat PTs, both values appear to be greater than that obtained in primary rabbit culture [Smith *et al* 1987b] — although the way the data is expressed makes it difficult to be totally conclusive about this. However, Trump & Berezesky 1987 stated that FURA loaded rabbit kidney cells examined by fluorescent microscopy did not appear to lose FURA. It is difficult to account for this difference, but one explanation might be that the cultured cells may have lost certain vital transport processes during differentiation.

#### 5.7.4 Toxic effects of FURA ?

There were concerns that the high  $[Ca^{2+}]_i$  levels seen in the mechanically isolated PTs might be due to toxic effects resulting from the intracellular incorporation of FURA. Apart from possible buffering effects, the fluorescent indicators rarely appear to produce toxic effects in cells — although there are some exceptions [Rink & Pozzan 1985]. Nevertheless, there is a toxic potential to these indicators due to the generation of formaldehyde during the hydrolysis of the acetoxymethyl esters which reduces NAD thereby causing accumulation of NADH [Tsien 1981, Rink & Pozzan 1985, Cheung 1987]. In cells with mitochondria, this effect is probably not serious as NADH is readily converted to NAD and the incorporation of pyruvate in the incubation medium (as in the present study) generally overcomes this effect [Rink & Pozzan 1985]. Indeed most cell systems seem able to handle the formaldehyde produced provided that the indicator is not used in high concentration [Tsien 1981] — thus emphasizing the importance of good loading protocols.

Despite a comparatively low FURA concentration and a short loading time, the mechanically isolated PTs still showed a reduction in their basic viability from 6hr to



barely 4hr. It would seem however that it was the DMSO vehicle, rather than the FURA, which was to blame — though the final DMSO concentration used in the present study was still lower than that use by other experimenters. Whether this had any effect on the early basal  $[Ca^{2+}]_i$  levels can only be speculated upon as, unfortunately, little data is available on the possible toxic effects of FURA/DMSO in kidney cells. However, a toxic response may be present in the work of Holohan *et al* 1988 who found great difficulty in maintaining a stable basal  $[Ca^{2+}]_i$  level in their attempts to measure  $[Ca^{2+}]_i$  in LLC-PK cells using FURA. Even over short time courses, startling rises in basal  $[Ca^{2+}]_i$  were seen eg. approximately 100nM in 6.5min. Their trypan blue measurements showed no significant increase in cell death over this period but no more sophisticated tests on cell health were performed. Whilst calcium buffering may be a causal factor in their rising baseline (though unlikely due to the occurrence of sharp calcium responses on the addition of gentamicin) it is also tempting to speculate that the rise might also be due to the deteriorating health of the cells.

#### **5.7.5 The effect of Pluronic® on FURA loading**

Despite the reduction in the basal  $[Ca^{2+}]_i$  level of mechanical isolated PTs to around 523nM, there was concern that this value was still too high compared with other workers. The fluorescent indicators are known to be sparingly soluble in water and consequently have to be dissolved in DMSO. However, when the solvated FURA is added to physiological systems (made up of mainly water), approximately 80% of it can precipitate. Anecdotal evidence has suggested that some cells may incorporate these crystals which can give spurious high  $[Ca^{2+}]_i$  levels. In fact, pockets of unhydrolysed QUIN and FURA have been found in cultured renal epithelia [Goligorsky *et al* 1986a, Goligorsky & Hruska 1988]; no data was given on the effects of these areas on basal  $[Ca^{2+}]_i$  levels and the areas were found to disappear on prolonged incubation. Unfortunately no microscope facilities were available to examine whether the same finding occurred in the present system. Some workers prevent the dye precipitation

through the addition of the detergent pluronic [Malgaroli et al 1987, Himpens & Somylo 1988]. In order to see what effect, if any, precipitation had in the present system; and to see if uptake was improved, the detergent pluronic was included in the FURA loading protocol.

The results in section 5.4.3 showed that the addition of pluronic did increase the uptake of FURA into the cells but, due to detrimental effects on PT viability, it was difficult to judge whether this was due to reduced precipitation of FURA or its concomitant toxic effects. This experiment further emphasizes the need for fluorescent microscopical examination of the FURA loaded PTs.

#### **5.7.6 The response of the two PT systems to agonists**

It is difficult to interpret how the responses to PTH substance, NOR and ionomycin reflect the general functioning ability of the two whole PT systems. The variability of the responses, not only between systems but also within each system, may be artifacts of non-specific binding of agonists to external tissue surfaces or physical antagonism by the external FURA coating (see section 5.7.7). Moreover, FURA might be exerting buffering effects (in addition to the toxic effects of DMSO which might itself affect responses) which result in damped calcium transients. The high basal  $[Ca^{2+}]_i$  levels, real or artifactual, also could possibly mask small responses to agonists. It would be nice to repeat these experiments with better quality agonist samples.

Notwithstanding, the inconsistent agonist responses may reflect genuine variation in the quality of the two preparations. If this is true, it is difficult to reconcile with the oxygen consumption and LDH leakage results obtained in section 4.6 — although  $[Ca^{2+}]_i$  levels and responses, in an efficient system, are probably more sensitive parameters.

### 5.7.7 Binding of FURA to the external surfaces of mechanical and collagenase isolated PTs and dual wavelength calibrations

The abstruse results of some of the previous experiments led to the tentative idea that significant amounts of FURA were binding to the external surfaces of the PTs (particularly the mechanical isolates). This possibility was examined by the two techniques described in section 5.6 and showed that external binding did indeed occur at levels of approximately 50% in mechanical isolates and around 12% for collagenase isolated PTs. Indeed once the basal  $[Ca^{2+}]_i$  values obtained in the two PT systems were corrected for their respective binding levels, the basal values fell within respectable ranges for other whole PT systems. Possible reasons why basal  $[Ca^{2+}]_i$  levels in whole PTs tend to be higher than in cultured renal systems are discussed in section 6.1.

It is difficult to know exactly to which surface component the FURA is bound. Due to the anionic glycoprotein coat containing sialic acid present on the PT basement membrane [Moffat 1979, Asscher & Moffat 1983, Kinne 1985], it would seem unlikely that the polyanionic FURA would be attracted here. This is further suggested by the low level of external binding in collagenase isolated PTs where most of the connective tissue has been enzymatically removed to leave virtually only basement membrane, however, this assumes that collagenase treatment had no effect on the surface charge of the PTs. Nevertheless, despite this, the FURA probably binds to the calcium associated with certain proteins within the basement membrane itself [Timpl & Aumailley 1989]. Damage to these basement membrane proteins through collagenase treatment might also explain the lower external binding seen with collagenase isolates. Another possible binding site might be the extracellular matrix or perhaps, more specifically, the  $Ca^{2+}$  ions contained in this region and which form the '3rd compartment' involved in renal  $Ca^{2+}$  kinetics [Uchikawa & Borle 1978].

In addition to possible binding of the exogenous agents, the external coating of FURA (particularly in the mechanical isolates) might cause physical antagonism of agonists to their receptor sites and so interfere with the responses. It is unlikely that nickel

would affect FURA binding, but it would be interesting to see whether responses were improved if the external signal were quenched prior to the addition of the agonist.

As stated earlier, one of the advantages of FURA is its shift in excitation spectrum on binding calcium from 360 to 340 nm which enables differential wavelength recordings to be made. This facility overcomes many technical drawbacks associated with the single wavelength calibration used in the present study. For example, dye concentrations vary somewhat from cell to cell and decrease continuously due to photobleaching and leakage — even with suitable precautions. Differential recordings mean that intracellular dye concentrations are unimportant and if dye is lost from the cell, both signals fall proportionately and so the ratio is automatically corrected [Tsien *et al* 1985, Rink 1988]. In addition the effects of instrument drift are reduced by differential recording.

The optical thickness of *single* cells can vary between and also within cells — with motility increasing this variegation. It follows, therefore, that the problem of optical thickness would be compounded in the present study where *whole* PTs are used. Ratio measurements largely cancel this effect out and give more accurate results. Unfortunately, dual wavelength measuring facilities were not available to the project and only single wavelength measurements were possible. Out of interest, however, attempts were made to *estimate* basal  $[Ca^{2+}]_i$  levels by differential ratio calculations using measurements from excitation scans according to the formulae of Grynkiewicz *et al* 1985.

The calculations gave a basal  $[Ca^{2+}]_i$  level of approximately 222nM for mechanical isolates which resolved to a value of 111nM when the value was corrected for an external signal of around 50%. So it would seem that a dual wavelength facility might well prove useful in  $[Ca^{2+}]_i$  measurements in whole PT systems. It must be emphasised, however, that these calculations can only be considered a rough estimate.

So, after correction for external FURA binding, both the mechanical and collagenase isolated PT systems exhibited basal  $[Ca^{2+}]_i$  levels at least comparable to other workers using whole PT isolates and dual wavelength calculations suggested that the  $[Ca^{2+}]_i$  levels might even be akin to those obtained with dispersed cells. In addition, the presence of the magnetic iron oxide during the PT isolation did not appear to affect the FURA signal unduly and leakage was controlled by taking certain precautions. Despite this, however, it was not possible to account for the incongruous responses of the PT systems to agonists. In conclusion, it is felt that further investigation of these systems is required before rational decisions can be made regarding their suitability as models for studying the effects of drugs on  $[Ca^{2+}]_i$  levels in the kidney.

~~~ CHAPTER 6 ~~~

EVALUATION AND DISCUSSION OF MECHANICAL ISOLATION

6.1 GENERAL EVALUATION

There are many different *in vitro* renal systems ranging from cortex slices [Wolfgang *et al* 1989] to the recent and exciting development of kidney cell elution [Toutain & Morin 1989], yet comparative studies between different *in vitro* renal systems are still all too rare [Cruz *et al* 1988]. Inevitably when evaluating an isolation method, its capacity to produce tubular injury has to be a major consideration. With this in mind, the present preliminary study has sought to evaluate and compare the structural and functional characteristics of PT samples isolated by mechanical and enzymatic means.

Various forms of collagenase isolation have been developed over the last ten years [Burg *et al* 1966, Mandel *et al* 1973, Helwig *et al* 1974, Scholer & Edelman 1979, Vinay *et al* 1981] mainly because this method was felt to be the 'gentlest' form of cortex dispersion [Dawson 1972, Chahwala 1981] — although no evidence has ever been produced to support the validity of this claim. Indeed as far back as 1966, there were suggestions of collagenase's adverse effects on tubule structure when Burg *et al* 1966 found that collagenase isolated PTs consistently burst when they were subsequently microperfused. Also, being a proteolytic enzyme, collagenase has long been known to have the potential to interfere with assays [Morel *et al* 1976]. In fact in the final analysis, the widespread preference for enzyme separations seems to have been based on doctrine rather than factual comparisons — though perhaps the paucity of non-enzymatic techniques mitigates this. This study chose collagenase perfusion as the enzyme method of choice because its rapid and ubiquitous enzyme distribution throughout the cortex enabled lower collagenase concentrations and shorter contact times to be used. This, it was felt, made it the least deleterious enzyme technique and therefore, potentially, a more stringent 'challenger' to mechanical isolation procedures.

The mechanical method developed was based on the technique of graded sieving. Use of iron loaded glomeruli with subsequent disruption and purification through

sieving was not a new method for isolating tubules [Brendel & Meezan 1975, Carlsson *et al* 1978, Hjelle *et al* 1981/83] but in all previous cases, animals no smaller than rabbits had been used. To date no other work has been found which produced a purified PT sample from a *rat* solely by mechanical means. Since most *in vivo* data derive from experimentation with rats, the successful development of a mechanical technique in this species is considered to be a significant advance.

It is difficult to know why mechanical isolation is less popular than collagenase isolation but misgivings about the putative harshness of the physical separation might well be the constraining factor. It was concern about physical trauma that prompted the initial morphological examination of the mechanically isolated PTs and later the biochemical evaluation.

The degree of difference found between the morphological and biochemical profiles of the mechanical and collagenase perfusion techniques was striking. None of the prospective mechanically induced physical types of damage, such as torn basement membrane or crushed brush border, were seen. Indeed, the mechanically isolated PTs had a robust, intact architecture which undoubtedly contributed significantly to their remarkable maintenance of luminal patency and also longevity. In contrast, collagenase isolates showed gross deformation of the basolateral surface and damage to the BBM significant enough to cause aberrant PAS staining patterns and significantly reduced levels of the brush border marker enzyme AAP.

Some alteration in structure after collagenase treatment had been anticipated, following the basolateral and apical damage described [Helwig *et al* 1974, Balaban *et al* 1980, Vinay *et al* 1981] and seen [Chahwala 1981, Chahwala & Harpur 1986] by other workers using various collagenase separations. In fact, the comparatively milder conditions of collagenase perfusion used in this study were chosen in the hope of reducing some of the detrimental changes seen in these earlier studies. Nevertheless, the SEM results in section 3.2.2 showed clearly that the extent of structural alteration seen with this mild collagenase perfusion, albeit less than that seen in the Chahwala 1981 and

Chahwala & Harpur 1986 studies, was still conspicuous — with basolateral and brush border membranes again bearing the brunt of the damage.

However, despite the deterioration of the basolateral surface compared with mechanical isolates, TEM inspection of these collagenase isolates (section 3.2.4) showed that the basement membrane was still 'fundamentally' present and was thus a significant improvement over other collagenase isolated tubule preparations where the basolateral membrane was 'absent' [Helwig *et al* 1974, Balaban *et al* 1980, Chahwala 1981, Chahwala & Harpur 1986]. Also the initial levels of LDH retained within the collagenase isolates was comparable to that found in mechanical isolates which suggested that the exterior damage produced by the collagenase treatment had not penetrated the PT cells to the extent that more initial cytosolic content was being lost.

Notwithstanding, the result of oxygen consumption and *long-term* LDH leakage measurements in the two PT preparations (section 4.6) showed clearly that the use of collagenase did compromise the performance of the PT cell and halved its basic viability over a non-enzymatic isolation. It is difficult to know precisely how the collagenase treatment impaired the viability of its isolates, but damage to apical and basement membranes, with consequent effects on the more sophisticated transport systems located in these external membrane regions, would seem to be logical factors.

The elastic constraining properties of the basolateral membrane are thought to make a significant hydraulic contribution to intratubular pressures and volume regulation [Solez & Whelton 1984] — particularly when the sodium pump is impaired [Linshaw & Grantham 1980]. Indeed thickening of the basement membrane (eg during cystic disease in rats) is felt to decrease hydraulic permeability and increase intratubular pressure [Solez & Whelton 1984]. It is therefore tempting to speculate that the reverse would be true if the basement membrane were destroyed or weakened — as after collagenase treatment. Yet the work of Linshaw & Grantham 1980 on isolated rabbit PTs, whose basement membranes had been deliberately removed by collagenase treatment, showed that it was the sodium pump in peritubular membranes that had the major control of volume

regulation in hypotonic media and that the hydraulic effect of the basement membrane only became significant when this transport system was impaired.

This finding then begs the question of whether these transport systems might also be affected by collagenase treatment and thereby curtail longevity. Doucet *et al* 1979 showed that the proteolytic action of collagenase had no significant effect on Na-K ATPase activity in rabbit PTs and Linshaw & Grantham 1980 took great pains to ensure that only the basement membrane was removed in their collagenase treated rabbit preparation. In analogous experiments using rat tubules, however, caution would seem particularly appropriate since their basement membranes are known to be significantly less dense than those of the rabbit [Welling & Welling 1975, Kinne 1985]. Nevertheless, Chahwala & Harpur 1982 produced a 60% inhibition of ATPase activity with ouabain in a collagenase isolated rat tubule preparation (seen in TEM to have lost its basement membrane) which suggested that, despite being less dense, the peritubular membrane and its transport systems were unaffected by the collagenase treatment. Whether more rubidium indicator would have been extruded had the hydraulic forces of the basement membrane been present can only be speculated upon.

Curiously though, the sensitivity of Chahwala & Harpur's 1982 preparation to the inhibition of ATPase by gentamicin was 100 times *less* than that produced by Williams *et al* 1984 using a filtering kidney preparation. Williams *et al* 1984 suggested that brush border entry of gentamicin played a significant role in Na-K-ATPase inhibition. Yet Chahwala & Harpur 1986 claimed luminal patency for their preparation, so luminal access should not have been a limiting factor in their measurements of Na-K-ATPase inhibition — provided their luminal transport systems were not compromised by any collagenase induced BBM damage. In fact Chahwala & Harpur 1982 accounted for the relative insensitivity of their system by the occurrence of inert binding to the basement membrane. Yet the TEM micrographs of their preparation clearly showed that the basement membrane was absent [Chahwala 1981] so this suggestion is therefore unlikely to be the reason. However, *reduced* external binding may have occurred generally as a

result of an altered surface charge on the tubules following collagenase treatment [Seaman 1965, Yamada & Ambrose 1966] and this is discussed more fully in section 6.5.1.

It would be interesting to repeat these studies with mechanically isolated PTs to see whether an increased sensitivity is obtained. In fact, until analogous transport studies are performed on mechanically isolated PTs it is difficult to know to what extent damage to the basement and brush border membranes affects cell regulation — and ultimately viability.

Unfortunately, the facilities required for transport studies were not made available and instead, measurement of tubular $[Ca^{2+}]_i$ levels were importuned. The use of FURA in whole PT systems was undoubtedly an ambitious undertaking and produced some abstruse results but, nevertheless, the experiments did expand the understanding of the two PT systems to an extent. It was found that connective tissue fragments could be removed (when necessary) through pre-plating, that Fe ions apparently did not enter the PT cells to any significant extent (discussed further in section 6.3), and that $[Ca^{2+}]_i$ levels in both PT systems were at least comparable to the levels obtained by other workers in whole PT systems [Yanagawa 1987, Batlle *et al* 1988, Llibre *et al* 1988]. The two PT systems also, however, showed inconsistent and incongruous responses to agonists, higher $[Ca^{2+}]_i$ levels than those found in renal cell culture systems [Smith *et al* 1987b, Holohan *et al* 1988, Inui *et al* 1988], and in particular, mechanical isolates showed extensive external binding of FURA.

It is difficult to account for the higher basal $[Ca^{2+}]_i$ levels found in fresh isolates over cultured PT cells. It may be merely an artifact of the FURA itself in that fluorescent FURA intermediates may have formed in the whole PT systems [Highsmith *et al* 1986, Malgaroli *et al* 1987] or the FURA may have sequestered into various intracellular organelles to a greater extent than cultured cells — a problem to which FURA is particularly prone [Rink 1988]. The best way to examine these possibilities is through focal convex microscopy. Indeed fluorescent microscopy should be the next logical step in any further studies with this system; to ensure that no dye sequestration had occurred and that all the cells loaded evenly along the tubule.

Alternatively, the higher $[Ca^{2+}]_i$ levels might reflect genuine differences between the two *in vitro* systems ie cultured cells undergo considerable de-differentiation during their development and renal cells not only lose their basement and brush border membranes [Taub & Livingston 1981] but organelles such as mitochondria are attenuated as well [Weinberg 1984]. It may be that along with the de-differentiation also comes a general 'down-regulation' in the cellular chemistry which manifests, in part, as a lowered $[Ca^{2+}]_i$ level. If that is the case, then it is interesting to speculate that it may be the fresh isolates which reflect the true *in vivo* levels more accurately than cultured renal systems.

Unfortunately, the degree of external FURA binding in the mechanical isolates, although not entirely unexpected, was nevertheless a disappointment. It may be that the FURA binding was unique in this instance in that, instead of just attaching indiscriminately to connective tissue, the calcium indicator may have merely fulfilled its function and highlighted the calcium present in the basement membrane and extracellular matrix [Timpl & Aumailley 1989]. This external FURA coating may then have formed a physical barrier which effectively antagonised the actions of exogenous agents. Cultured cell systems and most collagenase isolated PTs would not be expected to have this problem as the basolateral membranes, that contain the calcium, are invariably absent or significantly attenuated in these *in vitro* systems. Notwithstanding, the possibility that the connective tissue residues affected general binding of the FURA and some of the exogenous agents sadly cannot be discounted at this stage and further work should be done to ascertain whether this is a major drawback to the mechanical isolation system.

Nevertheless, despite the above reservations, the mechanical isolation method presented in this study not only produced PT samples of improved integrity and longevity, but also proved to be quicker and less costly than most other collagenase isolations. The facility of being able to oxygenate the PTs during virtually the whole of the mechanical sieving process was felt to be a distinct advantage over earlier Percoll centrifugation techniques [Scholer & Edelman 1979, Vinay *et al* 1981] — where PTs

could easily become hypoxic during a 20-30 min partitioning period. But perhaps the most beneficial aspect of the mechanical technique was the ease of adaptation to different species. The dimensions of nephronal elements vary between species. To convert a Percoll-type separation to another species would require protracted calculation of a new centrifugation gradient whereas all that a mechanical separation would require is measurement of the new PT dimensions and an appropriate sieving mesh.

6.2 DISADVANTAGES OF A MECHANICAL ISOLATION

Despite the advantages of the present mechanical isolation method there are also the inevitable disadvantages which need to be considered. Probably the biggest of these is the low PT yield obtained with this method compared with collagenase isolations. The average yield for a collagenase isolation in a 250-300g rat is approximately 70-90 mg of protein [Green *et al* 1987 Schnellman personal communication] whereas the yield from a mechanical isolation on a 250-300g rat is approximately 40-50 mg — although this value does vary in direct proportion with rat size. It was felt that there were, potentially, a number of factors involved to account for this difference;

6.2.1 Choice of starting material.

The mammalian kidney contains two types of nephron [Lote 1987, Pfaller 1982] ;

i Cortical Nephrons - consisting of a short loop of Henle with a proximal area confined mainly to the cortex.

ii Juxtamedullary Nephrons - with long loops of Henle and a proximal area that extends well into the outer stripe of the medulla.

In the rat the ratio of cortical to juxtamedullary nephrons is 70:30, although this varies between species [Lote 1987].

In this study only the outer cortex down to, *but not including*, the outer stripe of the medulla was removed for use. This meant that a proportion of the PT population ,

mainly the S₃ segment, was lost and this inevitably reduced the final PT yield. The proclivity of the starting material was probably also the reason why the final PT sample consisted mainly of S₁ and S₂ segments rather than S₃.

In mechanical isolations, dissecting the cortex from the outer medulla was fairly easy to achieve as the tissue was comparatively firm. However, once the kidney was treated with collagenase, the tissue became pulpy and difficult to manipulate with the result that a large amount of outer medulla was included in the initial cortical sample. Although this did not affect final purity, the incorporation of medulla meant that a larger proportion of the PT population was harvested which probably contributed to the increased final yield produced by this technique. In addition, anecdotal evidence indicates that outer medulla tends to be included in the cortical slices used in whole cortex digestion techniques — which again would promote higher yields over mechanical isolations.

Collagenase also facilitated improved dispersion of cortical material compared with mechanical separation which meant that less cortex was wasted during this stage. However, the degree of wastage in a mechanical isolation was not excessive and probably contributed only slightly to the difference in yield. Lastly it was found that the volume of cortical material obtained increased considerably with the weight of the rat. This undoubtedly was a significant factor in the improved absolute yields obtained with larger rats ie >250g in both mechanical and enzyme isolations.

In light of these observations, it was felt that PT yields from a mechanical isolation might increase considerably if larger rats were consistently used and if the outer stripe of the medulla was dissected off in addition to the cortex.

6.2.2 Variations in PT dimensions.

One of the early problems in developing the mechanical sieving technique was the choice of the final purifying mesh and the protocol behind this decision was described in detail in section 2.3.3. The optimal mesh size would have been 60µm, but only 64 and 53 µm nylon meshes were available commercially. A 64 µm mesh was chosen and the problem of the inevitable loss of yield had to be accepted; no attempt was made to

quantify the amount of PTs lost at this final stage. However, losses by this route may in fact have been considerable, particularly in younger/smaller rats ie <250g where a greater proportion of the PT length may be less than 64µm in diameter compared with older/larger animals.

Electron microscope examination of developing rat proximal tubules [Larsson 1975] has shown that as the kidney matures, it is the *volume* of each nephron that increases rather than the total number of nephrons. Consequently an increase in the overall dimensions of the nephron occurs as the rat kidney matures. Because of the fixed mesh size, this would result in a higher percentage of the proximal elements being lost in smaller rats at the purification stage with a consequent reduction in the final tubule yield.

As a consequence, the use of a 60µm mesh in place of the current 64µm one could well have a very beneficial effect on PT yield — particularly in smaller animals. Alteration of nephronal dimensions during development also occurs with humans [Moffat 1979] and rabbits [Larsson & Horster 1976] and it is important to bear this in mind when adapting the mechanical technique to other species.

6.3 TOXIC EFFECTS OF Fe₃O₄ ?

Magnetic iron oxide was used in the mechanical isolation technique for purely physical reasons in that it enabled the glomeruli to be loaded and then efficiently removed with the aid of a magnet. It may be, however, that the iron oxide is not entirely inert and might in fact exert adverse effects on tubule functions and mechanisms. Work by Meezan & Brendel 1973 and Meezan *et al* 1973 on Fe₃O₄ loaded glomeruli suggested that the iron loading did not seem to adversely affect glomerular function but no studies appear to have been done with PTs isolated after iron loading.

It is difficult to know exactly what toxic effects the iron oxide would induce but it is reasonable to assume that toxicity would depend to a great extent on the Fe ions entering the PT cell. Provided the glomeruli were functioning properly (the SEM evidence in section 3.3 indicated that their filtering membranes were structurally intact), one would

not have expected the iron particles to reach the tubules' lumens as the filtering membrane of the glomeruli should have acted as a barrier. Indeed, in the present study, no iron particles were *ever* observed in the lumens of the PTs isolated either mechanically or by enzyme perfusion. Nevertheless, it is difficult to know whether any solvated Fe ions would pass into the lumens. Earlier work in section 5.7, examined the potential quenching effects of heavy metals on the signal from mechanically isolated PTs loaded with the fluorescent calcium indicator Fura. A lipid soluble chelator was used and showed that no quenching of the Fura signal occurred which indicated that no Fe ions had entered the tubule cytosol.

It has been suggested that the presence of Fe ions might induce lipid peroxidation in the PTs with potentially toxic effects [Schnellman 1988]. Peroxidation of unsaturated fatty acids, found particularly in phospholipid membranes, is usually initiated by free radicals formed through the intervention of catalytic metals such as iron, copper or metal complexes such as haemoglobin [Wills 1987]. Recent experiments, however, on PTs isolated by the mechanical method described herein, indicated that no lipid peroxidation was induced in these PTs [Schnellman personal communication].

The reason for this may lie in the fortuitous use of Fe_3O_4 . This particular oxide was chosen in preference to the other two because of its greater magnetic properties — hence its common name of magnetite. Fe^{2+} ions are needed to generate free radicals and the enhancement, by ascorbic acid, of iron catalysed lipid peroxidation is thought to lie in the ability of the ascorbate to reduce Fe^{3+} to Fe^{2+} [Wills 1987]. The Fe_3O_4 used in this mechanical isolation is a mixed oxide and contains both Fe^{2+} and Fe^{3+} ions, however Fe^{2+} are easily oxidised to Fe^{3+} ions by the presence of oxygen. It may be that the copious gassing of the Fe_3O_4 suspension with 95% O_2 / 5% CO_2 before its use might have had the effect of oxidising a large proportion of the Fe^{2+} to Fe^{3+} thus possibly 'protecting' the PTs from lipidosis. In any event, although substitution of Fe_2O_3 for Fe_3O_4 during glomerular loading would be acceptable, the substitution of FeO would probably be inadvisable under the circumstances.

Despite this, perhaps the most perturbing feature in the use of iron oxide lay not so much in the iron itself but rather in the contaminants incidental to the compound. Although only present in trace amounts in high quality Fe_3O_4 , it is nevertheless difficult to gauge the effects these elements might have on PT function. Therefore, although the iron oxide does not in itself appear to be overtly toxic in this situation, it is perhaps unwise to be complacent about its apparent inertness.

6.4 FUTURE USES AND DEVELOPMENTS OF MECHANICAL TUBULE ISOLATIONS

6.4.1 Tubule suspensions

One of the most popular *in vitro* uses for isolated PTs is in straightforward suspension in a chosen medium [Vinay *et al* 1981, Hjelle *et al* 1983, Schnellman & Mandel 1986, Chahwala & Harpur 1982/86, Cruz *et al* 1988, Schnellman 1988]. Various agonists and/or toxins may then be added and their effects monitored using a variety of parameters eg enzyme leakage [Schnellman & Mandel 1986, Schnellman 1988], oxygen consumption [Dawson 1972, Gullans *et al* 1982, Schnellman 1988], inhibition of cellular processes and pathways [Chahwala & Harpur 1982, Cruz *et al* 1988] etc. Other novel uses for *in vitro* PT suspensions have included the measurement of sodium concentrations by NMR spectroscopy [Kumar *et al* 1986] and Chapter 5 of this study showed attempts to measure cytosolic Ca^{2+} levels in isolated PTs using the fluorescent calcium indicator FURA.

The greatest drawback to the use of PTs in *in vitro* suspension, however, has been their relatively short life-span in incubation. Indeed one of the reasons renal cell culture has proved so popular is its vastly improved longevity which facilitates extended *in vitro* studies. The average life-span for collagenase isolates in suspension is 3-4 hours. Claims have been made by some workers of 6 hour [Scholer & Edelman 1979] and 8 hour [Tyson *et al* 1989] life-spans, but when their data is closely scrutinized and corrected for such things as enzyme degradation, subtraction of isolation time from the life-span

and allowance for low temperature incubations then their longevity reduces to 3-4 hours. In light of this, the 6 hour incubations achieved with mechanical isolates in a very basic medium was a definite advance. However, there would be great merit in experimenting with richer media in order to extend viability still further — thereby undoubtedly increasing the usefulness of PT suspensions as an *in vitro* system.

Work of this kind is being done and has already produced interesting results [Schnellman personal communication]. PTs isolated by collagenase perfusion and percoll centrifugation when placed in a rich and highly defined medium attained a longevity, judged by LDH leakage and oxygen consumption, of up to 24 hours. The problem was that by the end of the time course the tubular structure had disintegrated and regressed to cells and tubular fragments — which although viable, had lost the orientation and cellular connections that the isolation technique had sought to maintain. Interestingly, when PTs isolated by the mechanical technique described herein were incubated in the new medium, they also achieved 24 hour viability but at the end of that time-course their tubular structure was *still remarkably intact* — further evidence of the potential of this technique over similar collagenase systems. The preparation used by Schnellman in these studies is the same as that developed by Balaban *et al* 1980. These PTs are known to have lost their basement membrane and, like Linshaw & Grantham 1980, the removal of the basement membrane by collagenase was undoubtedly the reason why the PTs disintegrated during the incubation. This further emphasizes the importance of the basement membrane in the maintenance of luminal patency and tubular architecture. It might even be possible to successfully microperfuse mechanically isolates — a facility not found with collagenase isolates [Burg *et al* 1966].

If it does become possible to maintain these suspension systems for 24 hours, or ultimately even longer, then they could conceivably supplant renal cell culture in certain situations and might even overcome some of the shortcomings of culture. Whole PTs would have none of the de-differentiation and loss of structure associated with culture systems — particularly at the brush border and basolateral membranes. Intercellular connections and orientations would be maintained so transport processes might be better

preserved. In addition, if it were possible to maintain whole PT suspensions for extended periods without the use of antibiotics then this would be a very significant advantage over culture. Virtually all cell cultures in use today have antibiotics added to their media to combat opportunist infections and it would be naive to assume that these xenobiotics have no effect on the cultures and the results they produce. Many renal culture systems are used as nephrotoxic screens [Smith *et al* 1986] — particularly for antibiotics [Sens *et al* 1988]. If antibiotics are already in the medium, they may antagonise or synergise the effects of the test substance thus giving misleading results. Therefore an *in vitro* system that can operate without the need for antibiotics has definite potential.

6.4.2 Renal Culture

There are many different types of renal cell culture ranging from established cell lines [Hori *et al* 1984] to primary culture [Taub & Livingston 1981] and the salient features and uses of these systems have already been described in table 1a. The initial aim of the project was to develop a primary culture of proximal cells for use in transport studies. It was hoped to culture whole PTs on floating collagen gels in a serum free medium as it was considered that this system would produce the least de-differentiation and the greatest sensitivity. Collagenase isolates would have been adequate for a cell-type culture — where any damage incurred during isolation might repair during regeneration and outgrowth. However, whole collagenase isolates have not proved successful in explant-type cultures [Horster 1979, 1980a] and usually have to be digested down to PT fragments before being 'seeded-out' as a cell culture. The reason for this is unclear but may have something to do with the poor condition of the tubule ends of the collagenase isolated PTs. Horster 1979, 1980a showed, with cultured microdissected PTs, that the growth from these explants proliferated almost entirely from the cut tubule ends. Earlier SEM examination in this study (fig3j) showed that the tubule ends of the collagenase isolates were grossly distorted and it may be that the damage was too great to allow cellular outgrowth.

The cut ends of the mechanical isolates, however, were remarkably well preserved and it was felt that they might well have the potential to form an organ-type culture in the same way as micro dissected PTs. Attempts were made to grow mechanically isolated PTs and cultures were obtained when the PTs were grown on Primaria plates (Falcon) in Hams/F12 medium supplemented with 5% FCS and *no antibiotics*. Proliferation occurred mainly from the cut ends and confluency was reached within 5 days — unfortunately lack of facilities and assistance meant that this part of the project could be pursued no further. However, this preliminary finding served to show that mechanically isolated PTs were capable of being developed into culture systems without having to be broken down to fragments before seeding [Taub & Livingston 1981]. A proximal culture system on a gel or membrane would be useful because it would enable xenobiotics to be applied solely to luminal or contraluminal membranes — a facility not available to whole PT suspension systems.

6.5 IMMINENT NOVEL RENAL SYSTEMS

6.5.1 Proximal Cell Elution

As stated in section 3.2.4, the proximal tubule is divided into three sections arbitrarily denoted as S₁, S₂ and S₃ (fig 3m). Although some *in vitro* techniques for isolating PT segments attempt to distinguish the sections obtained, no isolation technique has yet managed to selectively isolate specific S sections. Recent work, however, suggests that cell elution techniques may be about to change this [Toutain & Morin 1989]. Cell elution utilises the fact that cells from different S sections carry different charges and may also have slightly different weights and dimensions. When free flow electrophoresis is applied to these cells they move at varying speeds and therefore elute at different intervals — thus enabling them to be separated. Toutain & Morin 1989 isolated PTs by a mechanical technique very similar to the one described herein and then broke up the tubules into cells by acetate separation — no enzymes were used whatsoever. The reason why mechanically isolated PTs are more successful than collagenase isolates in this type

of separation may be two-fold. Firstly, the digestive effects of the collagenase may alter the surface charge on the isolated cells thus compromising the success of the elution procedure. Seaman 1965 showed that treatment of cells with proteolytic enzymes, mainly trypsin, altered the surface charges of cell membranes. Yamada & Ambrose 1966 showed that treatment of Ehrlich ascites carcinoma with collagenase and hyaluronidase also reduced the electrical mobility of these cells at concentrations of greater than 0.5mgml^{-1} . This was attributed to the contaminants of collagenase rather than collagenase itself. The kidney cell has an anionic coat [Asscher & Moffat 1982] and it is difficult to know what effect collagenase treatment would have on the surface charge of the PT cell. It would depend on what components of the external membrane contributed to surface charge and which regions, if any, the collagenase affected. Nevertheless the potential for collagenase treatment to alter renal cell surface charge is a very real possibility. Secondly, free flow electrophoresis tends to traumatise the cells; even when cells were eluted from a mechanical isolation there was a 22% loss of viability. Therefore the use of cells potentially already weakened by collagenase digestion might prove unwise. As the system currently stands, the differentiated S cells would probably be too traumatised for use in *in vitro* suspension studies but cultures of the three various S cell populations would in all likelihood be possible — allowing cellular repair to occur during proliferation.

6.5.2 Isolation of Distal Tubules

Alterations to the distal portion of the nephron also occur with various pathological states and nephrotoxins [Toubeau *et al* 1986]. Much work has been done to isolate proximal tubules yet comparatively little effort has been expended on the isolation of distal tubules. Attempts were made in this study to isolate distal tubules from the residue left after the removal of the proximal tubules by the $64\mu\text{m}$ mesh.

The residual suspension was washed on a $53\mu\text{m}$ mesh which allowed collecting ducts and various cellular debris through, but retained any distal tubules present. This technique was partially successful, but the distal tubules obtained were of low yield, very poor quality and also contaminated with PTs too small to be retained by

the 64 μ m mesh. It was felt that the poor yield and quality was because the distal tubules were less robust than PTs and, unable to tolerate the extensive sieving, simply disintegrated. An alternative approach might be to separate the tubules using the mechanical procedure up until after the 140 μ m mesh stage (when the distals were known to be still intact) and then use a percoll type centrifugation method to separate off the distal tubules. A suitable centrifugation protocol is shown in the work of Gesek *et al* 1987 on collagenase isolated tubules.

In the past, the idea of producing intact PTs by tearing tubules apart mechanically would, not unreasonably, raise misgivings in an experienced experimenter. To suggest that this might actually be less traumatic than a traditional enzyme separation would cause great consternation — and yet this is what this preliminary evidence would seem to suggest. Nevertheless, further quantitative morphology and biochemical study needs to be done to validate these initial findings; in particular, the potential problem of external binding should be investigated. More sophisticated biochemical measurements should be made on mechanically isolated PTs and compared with the performance of collagenase isolates eg glucose transport and receptor type reactions. Also a quantitative morphological examination could be done as a prelude to future potential toxicity studies — in fact the list of possible experiments and uses for the mechanical isolates is endless.

In conclusion it would seem that proximal tubules isolated by the mechanical technique described in this study have great potential for the future. Nevertheless, mechanical separation has its drawbacks and is certainly not claimed to be the quintessential method for tubule isolation. It is, however, felt meritorious of further study and one day may even confound previous experimenters by *proving* to be the 'gentlest' form of PT isolation.

REFERENCES

- Aboolian A, Nord EP: Bradykinin increases cytosolic free $[Ca^{2+}]$ in proximal tubule cells. *Am J Physiol*: **255** F486-493 (1988).
- Ambudkar IS, Smith MW, Phelps PC, Regec AL, Trump BF: Extracellular Ca^{2+} -dependent elevation in cytosolic Ca^{2+} potentiates $HgCl_2$ -induced renal proximal tubular cell damage. *Toxicol Indust Health*: **4** (1) 107-123 (1988).
- Arslan P, DiVirgilio F, Beltrame M, Tsien RY, Pozzan T: Cytosolic Ca^{2+} homeostasis in Ehrlich and Yoshida carcinomas, *J Cell Biol*: **260** (5) 2719-2727 (1985).
- Asscher AW, Moffat DB: *Nephro-Urology*. William Heinemann Medical Books Ltd 1983.
- Bach PH: Detection of chemically induced renal injury: the cascade of degenerative morphological and functional changes that follow the primary nephrotoxic insult and evaluation of these changes by in-vitro methods. *Toxicol Lett*: **46** (1-3) 237-249 (1989).
- Bach PH, Gregg NJ, Wachsmutt ED: The application of histochemistry at the light microscope level to the study of nephrotoxicity. *Nephrotoxicity in the experimental and clinical situation Part I*. Ed P.H.Bach & E.A. Lock. Martinus Nijhoff Publishers 1987.
- Balaban RS, Soltoff SP, Storey JM, Mandel LJ: Improved renal cortical tubule suspension. *Am J Physiol*: **238** F50-59 (1980).
- Balls M, Clothier R: Validation of alternative toxicity test systems. *Mol Toxicol*: **1** 547-559 (1987).
- Battle DC, LaPointe M, Llibre J, Janns G, Gutterman C: FURA-2 measurements of free cytosolic calcium in various cell suspensions using a method for correction for external dye. *Fed Amer Soc Exp Biol: Part 2* A531 (1988).
- Benford DJ, Hubbard SA: Preparation and culture of mammalian cells. *Biochemical Toxicology*. Ed K. Snell & B. Mullock. IRL Press 1987.
- Bennett WM, Elliott WC, Houghton DC, Gilbert DN, De Fehr J, McCarron DA: Reduction of experimental gentamicin nephrotoxicity in rats by dietary calcium loading. *Antimicrob Agents Chemother*: **22** 508-512 (1982).
- Bennett WM, Pulliam JP, Porter GA, Houghton DC: Modification of experimental gentamicin nephrotoxicity by selective parathyroidectomy. *Am J Physiol*: **249** F832-835 (1985).
- Bergmeyer HU: *Methods of Enzymatic Analysis* 2nd ed. Academic Press Inc 1974.
- Berndt WO: Renal methods in toxicology. *Principles and methods in toxicology*. Student edition. Ed A.W. Hayes. Raven Press 1984.

- Berridge MJ: Inositol trisphosphate and diacyl glycerol: two interacting second messengers.
Ann Rev Biochem: **56** 159-193 (1987).
- Bjugn R, Flood PR: Effects of dextran containing perfusion fixatives on intraluminal compounds in rat kidney tubules.
J Ultrastruct Mol Struct Res: **98** (2) 222-228 (1988).
- Black L, Berenbaum MC: Factors affecting the dye exclusion test for cell viability.
Exp Cell Res: **35** 9-13 (1964).
- Borle AB: Control, modulation and regulation of cell calcium.
Rev Phys Biochem Pharmacol: **90** 13-153 (1981).
- Bowman WC, Rand MJ: Textbook of Pharmacology 2nd Ed. Blackwell Scientific Publications 1980.
- Bradford MM: A rapid and sensitive method for the quantitation of microgram quantities of protein using the principle of protein dye binding.
Analyst Biochem: **72** 248-254 (1976).
- Brendel K, Meezan E: Isolation and properties of a pure preparation of proximal kidney tubules obtained without collagenase treatment.
Fed Proc: **34** 803 (1975).
- Burg MB, Orloff J: Oxygen consumption and active transport in separated renal tubules.
Am J Physiol: **203** 327-330 (1962).
- Burg MB, Grantham J, Abramow M, Orloff J: Preparation and study of single rabbit nephrons.
Am J Physiol: **210** 1293-1296 (1966).
- Burnatowska-Hledin MA, Spielman WS: Vasopressin increases cytosolic free calcium in LLC-PK₁ cells through a V₁-receptor.
Am J Physiol: **253** F328-332 (1987).
- Cain K, Skilleter DN: Preparation and use of mitochondria in toxicological research.
Biochemical Toxicology. Ed K. Snell & B. Mullock. IRL Press 1987.
- Carafoli E: Intracellular calcium homeostasis.
Ann Rev Biochem: **56** 395-433 (1987).
- Carafoli E, Lehninger AL: A survey of the interaction of calcium ions with mitochondria from different tissues and species.
Biochem J: **122** 681-690 (1971).
- Carlson EC, Brendel K, Hjelle JT, Meezan E: Ultrastructural and biochemical analyses of isolated basement membranes from kidney glomeruli and tubules and brain and retinal microvessels.
J Ultrastruct Res: **62** 26-53 (1978).
- Carleton's Histological Technique 5th ed. Ed R.A.B. Drury & E.A. Wallington. Oxford University Press 1980.
- Chahwala SB: An investigation of possible mechanisms of toxicity of the aminoglycoside antibiotics.
PhD Thesis, Aston University, 1981.

Chahwala SB, Harpur ES: An investigation of the effects of aminoglycoside antibiotics on Na⁺-K⁺ ATPase as a possible mechanism of toxicity.
Res Commun Chem Path Pharmacol: **35** (1) 63-78 (1982).

Chahwala SB, Harpur ES: The use of renal tubule fragments isolated from the rat to investigate aspects of gentamicin nephrotoxicity.
J Pharmacol Methods: **15** 21-34 (1986).

Cheung WY: Calcium and cell function Vol VII. Academic Press Inc 1987.

Chonko AM, Grantham JJ: The use of the isolated tubule preparation for the investigation of diuretics.
Methods in Pharmacology Vol 4A. M.Martinez-Maldonado. Plenum Press 1976.

Chuman L, Fine LG, Cohen AH, Saier MH: Continuous growth of proximal tubular kidney epithelial cells in hormone-supplemented, serum-free medium.
J Cell Biol: **94** 506-510 (1982).

Chung SD, Alavi N, Livingston D, Hiller S, Taub M: Characterisation of primary rabbit kidney cultures that express proximal tubule functions in a hormonally defined medium.
J Cell Biol: **95** 118-126 (1982).

Cook WF, Pickering GW: A rapid method for separating glomeruli from rabbit kidney.
Nature: **182** 1103-1104 (1958).

Cruz RH, Gumbleton M, Nicholls PJ: In vitro assessment of cephaloridine nephrotoxicity: comparison of renal cortical slice and tubule fragment techniques.
J Pharmacol Methods: **19** 185-192 (1988).

Cuthbert AW, George AM, MacVinish L: Kinin effects on electrogenic ion transport in primary cultures of pig renal papillary collecting tubule cells.
Am J Physiol: **249** F439-447 (1985).

Dawson AG: Preparation and some properties of a suspension of fragmented tubules from rat kidney.
Biochem J: **130** 525-532 (1972).

Diezi J, Roch-Ramel F: The use of single nephron techniques in renal toxicity studies. Nephrotoxicity in the experimental and clinical situation Part I. Ed P.H.Bach & E.A. Lock. Martinus Nijhoff Publishers 1987.

DiVirgilio F, Steinberg TH, Swanson JA, Silverstein SC: Probenicid inhibits FURA-2 sequestration in the mouse macrophage cell line J774.
Clin Res: **35** 619A (1987).

Dobrota M: Preparation and use of lysosomes and peroxisomes in toxicological research. Biochemical Toxicology. Ed K. Snell & B. Mullock. IRL Press 1987.

Dolson GM, Hise MK, Weinman EJ: Relationship among parathyroid hormone, cAMP, and calcium on proximal tubule sodium transport.
Am J Physiol: **249** F409-416 (1985).

Elliott WC, Patchin DS, Jones DB: Effect of parathyroid hormone activity on gentamicin nephrotoxicity.
J Lab Clin Med: **109** 48-54 (1987).

Farese RV, Bidot-Lopez P, Sabbir MA, Smith JS: Parathyroid hormone acutely increases polyphosphoinositides of the rabbit kidney cortex by a cycloheximide-sensitive process. *J Clin Invest*: **65** 1523-1526 (1980).

Fariss MW, Reed DJ: Mechanism of chemical-induced toxicity. II Role of extracellular calcium. *Toxicol Appl Pharmacol*: **79** 296-306 (1985).

Feldman S, Wang M Kaloyanides GJ: Aminoglycosides induce a phospholipidosis in the renal cortex of the rat: An early manifestation of nephrotoxicity. *J Pharmacol Exp Ther*: **220** 514-520 (1982).

Fine LG, Sakhrani LM: Proximal tubular cells in primary culture. *Mineral Electrolyte Metab*: **12** 51-57 (1986).

Freshney RI: *Culture of Animal Cells* 2nd ed. Alan R Liss Inc, New York 1983.

Frindt G, Lee CO, Yang JM, Windhager EE: Potential role of cytoplasmic calcium ions in the regulation of sodium transport in renal tubules. *Mineral Electrolyte Metab*: **14** 40-47 (1988).

Fujii Y, Fukase M, Tsutsumi M, Miyauchi A, Tsunenari T, Fujita T: Parathyroid hormone control of free cytosolic Ca^{2+} in the kidney. *J Bone Min Res*: **3** (5) 525-531 (1988).

Gadd KG: Protein estimation in spinal fluid using Coomassie Blue reagent. *Med Lab Sci*: **38** 61-63 (1981).

Garcia-Perez A, Smith WL: Use of monoclonal antibodies to isoaltes cortical collecting tubule cells: AVP induces PGE release. *Am J Physiol*: **244** C211-220 (1983).

Gesek FA, Wolff DW, Strandhoy JW: Improved separation method for rat proximal and distal renal tubules. *Am J Physiol*: **253** F358-356 (1987).

Gmaj P, Murer H, Kinne R: Calcium ion transport across plasma membranes isolated from rat kidney cortex. *Biochem J*: **178** 594-557 (1979).

Gmaj P, Murer H: Calcium transport in epithelial cell membranes. *Mineral Electrolyte Metab*: **14** 22-30 (1988).

Goligorsky MS, Hruska KA, Loftus DJ, Elson EL: α_1 - adrenergic stimulation and cytoplasmic free calcium concentration in cultured renal proximal tubular cells: Evidence for compartmentalization of Quin-2 and Fura-2. *J Cell Physiol*: **128** 466-474 (1986) [A].

Goligorsky MS, Loftus DJ, Hruska KA: Cytoplasmic calcium in individual proximal tubule cells in culture. *Am J Physiol*: **251** F938-944 (1986) [B].

Goligorsky MS, Hruska KA: Hormonal modulation of cytoplasmic calcium concentration in renal tubule epithelium. *Mineral Electrolyte Metab*: **14** 58-70 (1988).

- Green CE, Dabbs JE, Tyson CA, Rauckman EJ: Development of an improved in vitro system for prolonged incubation of isolated renal tubules.
Toxicologist: **7** 88 (1987).
- Greger R: Application of electrical measurements in the isolated in vitro perfused tubule.
Molec Physiol: **8** 11-20 (1985).
- Gryniewicz G, Poenie M, Tsien RY: A new generation of Ca²⁺ indicators with greatly improved fluorescent properties.
J Biol Chem: **260** (6) 3440-3450 (1985).
- Gullans SR, Brazy PC, Soltoff SP, Dennis VW, Mandel LJ: Metabolic inhibitors: Effects on metabolism and transport in the proximal tubule.
Am J Physiol: **243** F133-140 (1982).
- Hafner M, Petzelt C, Nobiling R, Pawley JB, Kramp D, Schalten G: Wave of free calcium at fertilization in the sea urchin egg visualised with FURA-2.
Cell Motility and the Cytoskeleton: **9** 271-277 (1988).
- Handler JS, Perkins FM, Johnson JP: Studies of renal cell function using cell culture techniques.
Am J Physiol: **7** F1-9 (1980).
- Hatzinger PB, Chen Q, Dong LQ, Stevens JL: Alterations in intermediate filament proteins in rat kidney proximal tubule epithelial cells.
Biochem Biophys Res Comm: **157** 1316-1322 (1988).
- Helwig JJ, Zachary D, Bollack C: Isolation of glomeruli and tubular fragments from rabbit kidney.
Urol Res: **2** 55-59 (1974).
- Hemingway A: Some observations on the perfusion of the isolated kidney by a pump.
J Physiol: **71** 201-213 (1931).
- Highsmith S, Bloebaum P, Snowdowne KW: Sarcoplasmic reticulum interacts with the Ca(2+) indicator precursor FURA-2-AM.
Biochem Biophys Res Comm: **138** (3) 1153-1162 (1986).
- Himpens B, Somylo AP: Free calcium and force transients during depolarisation and pharmacomechanical coupling in guinea-pig smooth muscle.
J Physiol: **359** 507-530 (1988).
- Hjelle JT, Morin JP, Trouet A: Analytical cell fractionation of isolated rabbit renal proximal tubules.
Kid Int: **20** 71-77 (1981).
- Hjelle JT, Petersen DR, Hjelle JJ: Drug metabolism in isolated proximal tubule cells: Aldehyde Dehydrogenase.
J Pharmacol Exp Ther: **224** 699-706 (1983).
- Holohan PD, Elliott WC, Grace E, Ross CR: Effect of parathyroid hormone on gentamicin plasma membrane binding and tissue accumulation.
J Pharmacol Exp Ther: **243** 893-896 (1987).
- Holohan PD, Sokol PP, Ross CR, Coulson R, Trimble ME, Laska DA, Williams PD: Gentamicin-induced increases in cytosolic calcium in pig kidney cells (LLC-PK₁).
J Pharmacol Exp Ther: **247** (1) 349-354 (1988).

Hori R, Yamamoto K, Saito H, Kohno M, Inui KI: Effects of aminoglycoside antibiotics on cellular functions of kidney epithelial cell lines LLC-PK.
J Pharmacol Exp Ther: **230** 742-748 (1984).

Horster M: Primary culture of mammalian nephron epithelia.
Pflugers Arch: **382** 209-215 (1979).

Horster M: Hormonal stimulation and differential growth response of renal epithelial cells cultivated in vitro from individual nephron segments.
Int J Biochem: **12** 29-35 (1980) [A].

Horster M: Tissue culture in nephrology: Potential and limits for the study of renal disease.
Klin Wschr: **58** 965-973 (1980) [B].

Hruska KA, Goligorsky M, Scoble J, Tsutsumi M, Westbrook S, Moskowitz D: Effects of parathyroid hormone on cytosolic calcium in renal proximal tubular primary cultures.
Am J Physiol: **251** F188-198 (1986).

Humes HD, Sastrasinh M, Weinberg JM: Calcium is a competitive inhibitor of gentamicin renal membrane binding interactions and dietary calcium supplementation protects against gentamicin nephrotoxicity.
J Clin Invest: **73** 134-147 (1984).

Inui K, Saito H, Iwata T, Hori R: Aminoglycoside induced alterations in apical membranes of kidney epithelial cell line (LLC-PK₁).
Am J Physiol: **254** (2) C251-257 (1988).

Jacobs WR, Brazy PC, Mandel LJ: FURA 2 measurements of intracellular free calcium in renal cortical tubules from SHR and WKY rats.
Kid Int: **31** A350 (1987).

Jacobsen NO, Jorgensen F, Thomsen AC: On the localisation of some phosphatases in three different segments of the proximal tubules in the rat kidney.
J Histochem Cytochem: **15** 456-468 (1967).

Jones CEM: Problems with the use of FURA in freshly isolated rat proximal tubules.
Renal Failure: **11** (4) abstract 1989.

Jones TW, Wallin A, Thor H, Gerdes RG, Ormstat K, Orrenius S: The mechanism of pentachlorobutadienyl-glutathione nephrotoxicity studies with isolated rat renal epithelial cells.
Arch Biochem Biophys: **251** (2) 504-513 (1986).

Josepovitz C, Ramsammy L, Lane B, Kaloyanides GJ: Gentamicin inhibits degradation and stimulates synthesis of phosphatidylinositol in primary culture of rabbit proximal tubular cells.
Kid Int: **31** A369 (1987).

Kaloyanides GJ, Ramsammy LS: Aminoglycoside antibiotics inhibit the phosphatidylinositol cascade in renal proximal tubular cells.
Nephrotoxicity, in vitro to in vivo, animals to man. Ed P.H. Bach & E.A. Lock. Plenum Press 1989.

Kinne RKH: *Renal Biochemistry Cells, Membranes, Molecules*. Elsevier 1985.

Kluwe WM, Hook JB: Functional nephrotoxicity of gentamicin in the rat.
Toxicol Appl Pharmacol: **45** 163-170 (1978).

- Kreisberg JI, Wilson PD: Renal cell culture.
J Electron Microsc Tech: **9** (3) 235-263 (1988).
- Kumar AM, Spitzer A, Gupta RK: ^{23}Na NMR spectroscopy of proximal tubule suspensions.
Kid Int: **29** 747-751 (1986).
- Lang MA, Muller J, Preston AS, Handler JS: Complete response to vasopressin requires epithelial organization in A6 cells in culture.
Am J Physiol : **250** C138-145 (1986).
- Larsson L: The ultrastructure of the developing proximal tubule in the rat kidney.
J Ultrastruct Res: **51** 119-139 (1975).
- Larsson L, Horster M: Ultrastructure and net fluid transport in isolated perfused developing proximal tubules.
J Ultrastruct Res: **54** 276-285 (1976).
- Lee CO: Measurement of cytosolic calcium: Ion selective microelectrodes.
Mineral Electrolyte Metab: **14** 15-21 (1988).
- Lever JE: Expression of differentiated functions in kidney epithelial cell lines.
Mineral Electrolyte Metab: **12** 14-19 (1986).
- Linshaw MA, Bauman CA, Welling LW: Use of trypan blue for identifying early proximal convoluted tubules.
Am J Physiol: **251** 214-219 (1986).
- Linshaw MA, Grantham JJ: Effect of collagenase and ouabain on renal cell volume in hypotonic media.
Am J Physiol: **238** F491-498 (1980).
- Llibre J, LaPointe M, Battle DC: FURA-2 measurements of cytosolic cell Ca^{2+} in renal proximal tubules and circulating lymphocytes of rats with genetic hypertension.
Kid Int: **31** A302 (1987).
- Llibre J, LaPointe MS, Battle DC: Free cytosolic calcium in renal proximal tubules from the spontaneously hypertensive rat.
Hypertension: **12** (4) 399-404 (1988).
- Lloyd D, Coakley WT: Techniques for the breakage of cells and tissues.
Techniques in the life sciences. Biochemistry Vol B2/1. Techniques in metabolic research Part 1 B201. Elsevier/North Holland Biomedical Press 1979.
- Lote CJ: Principles of Renal Physiology 2nd Ed. Croom Helm Ltd 1987.
- Maack T: Physiological evaluation of the isolated perfused rat kidney.
Am J Physiol: **238** F71-78 (1980).
- Malgaroli A, Milani D, Meldolesi J, Pozzan T: Fura-2 measurement of cytosolic Ca^{2+} in monolayers and suspensions of various types of animal cells.
J Cell Biol: **105** 2145-2155 (1987).
- Mandal AK: Electron microscopy of the kidney in renal disease and hypertension. Plenum Publishing Co 1979.

- Mandel LJ, Murphy E: Regulation of cytosolic free calcium in rabbit proximal renal tubules.
J Biol Chem: **259** 11188-11196 (1984).
- Mandel LJ, Takano T, Soltoff SP, Jacobs WR, LeFurgey A, Ingram P: Multiple roles of calcium in anoxic-induced injury in renal proximal tubules.
Society of General Physiologists Series: **42** 277-285 (1987).
- Mandel P, Helwig JJ, Bollack C: Rapid preparation of pure glomeruli and tubular fragments from rabbit kidney.
Exptl Cell Res: **83** 414-417 (1973).
- Matlin KS, Valentich JD: Functional epithelial cells in culture. Alan R Liss Inc 1989.
- McDonough PM, Button DC: Measurement of cytoplasmic calcium concentration in cell suspensions: correction for extracellular Fura-2 through use of Mn^{2+} and probenecid.
Cell Calcium: **10** 171-180 (1989).
- McDowell EM, Trump BF: Histological fixatives suitable for routine diagnostic light and electron microscopy.
Arch Pathol Lab Med: **100** (8) 405-414 (1976).
- Meddis R: Statistical handbook for non-statisticians. McGraw Hill Book Company Ltd 1975.
- Meezan E, Brendel K: Effects of ethacrynic acid on oxidative metabolism in isolated glomeruli.
J Pharmacol Exp Ther: **187** 352-364 (1973).
- Meezan E, Brendel K, Ulreich J, Carlson EC: Properties of a pure metabolically active glomerular preparation from rat kidney I. isolation.
J Pharmacol Exp Ther: **187** 332-341 (1973).
- Mehendale HM: Application of isolated organ techniques in toxicology.
Principles and methods of toxicology. Ed A.W.Hayes. Raven Press 1984.
- Michalopoulos G, Pitot HC: Primary culture of parenchymal liver cells on collagen membranes.
Exp Cell Res: **94** 70-78 (1975).
- Moffat DB: Renal Disease 4th Ed. Editors D.Black and NF Jones. Blackwell Scientific Publications 1979.
- Møller JV, Sheikh ML: Renal organic anion transport system: pharmacological, physiological and biochemical aspects.
Pharmacol Rev: **34** 315-358 (1983).
- Morel F, Chambardes D, Teboul MI: Methodology for enzymatic studies of isolated tubule segments.
Methods in Pharmacology 4B. Ed M. Martinez-Maldonado. Plenum Press 1976.
- Mondorf AW, Kinne R, Scherberich JE, Falkenberg F: Isolierung, Enzymatische und immunologische charakterisierung einer plasmamembranfraktion vom proximalen tubulus der menschliche niere.
Clin Chim Acta: **37** 25-32 (1972).
- Mira DJ, Jagannathan V: Hexokinase Assay.
Methods Enzymol: **9** 371-375 (1966).

- Murphy E, Mandel LJ: Cytosolic free calcium levels in rabbit proximal kidney tubules.
Am J Physiol: **242** C124-128 (1982).
- Murphy E, Chamberlin ME, Mandel LJ: Effects of calcitonin on cytosolic Ca in a suspension of rabbit medullary thick ascending limb tubules.
Am J Physiol: **251** C491-495 (1986).
- Nachsen DA: Regulation of cytosolic calcium concentration in presynaptic nerve endings isolated from rat brain.
J Physiol: **363** 87-102 (1985).
- Nakano T, Hanasaki K, Arita H: Involvement of the Na⁺/H⁺ antiporter in activation of rat platelets by collagen.
J Biochem: **102** 677-680 (1987).
- Newton JF, Braselton WE, Kuo CH, Kluwe WM, Gemborys MW, Mudge GH, Hook JB: Metabolism of acetaminophen by the isolated perfused kidney.
J Pharmacol Exp Ther: **221** 76-79 (1982).
- Newton JF, Hook JB: The isolated perfused kidney.
Meth Enz: **77** 94-105 (1981).
- Nizet A: The isolated perfused kidney: possibilities, limitations and results.
Kid Int: **7** 1-7 (1975).
- Nord EP: Bradykinin mobilizes calcium from intracellular stores in rabbit proximal tubule cells.
Kid Int: **31** A282 (1987).
- Olsen TS, Racusen LC, Solez K: Ultrastructural investigation of renal biopsies: a discussion of artifacts and special methodology.
J Electron Microsc Tech: **9** (3) 283-291 (1988).
- Ortiz A, Garcia-Carmona F, Garcia-Canovas F, Gomez-Fernandez JC: A kinetic study of the interaction of vanadate with the Ca²⁺ and Mg²⁺-dependent ATPase from sarcoplasmic reticulum.
Biochem J: **221** 213-222 (1984).
- Petzelt C, Hafner M, Mazia D, Sawin KW: Microtubules and Ca²⁺-sequestering membranes in the mitotic apparatus, isolated by a new method.
Eur J Cell Biol: **45** 268-273 (1987).
- Pfaller W: Structure and function correlations on rat kidney. Advances in anatomy embryology and cell biology. Springer-Verlag 1982.
- Phelps PC, Smith MW, Trump BF: Cytosolic ionized calcium and bleb formation after acute cell injury of cultured rabbit renal tubule cells.
Lab Invest: **60** (5) 630-642 (1989).
- Phillips HJ: Some metabolic changes resulting from treating kidney tissue with trypsin.
Can J Biochem: **45** 1495-1504 (1967).
- Phillips HJ: An initial depression of a cell suspension by L-thyroxine.
Life Sci: **7** 245-250 (1968).

- Pirie SC, Potts DJ: A comparison of the relative effectiveness of three transplant preservation fluids upon the integrity and function of rabbit proximal convoluted tubules perfused in vitro.
Clin Sci: **70** 443-452 (1986).
- Poenie M, Alderton J, Steinhardt R, Tsien R: Calcium rises abruptly and briefly throughout the cell at the onset of anaphase.
Science: **233** 886-889 (1986).
- Portzehl H, Caldwell PC, Ruegg JC: The dependence of contraction and relaxation of muscle fibres from the crab *Maia squinado* on the internal concentration of free calcium ions.
Biochem Biophys Acta: **79** 581-591 (1964).
- Rindler M, Chuman L, Shaffer L, Saier M: Retention of differentiated properties in an established dog kidney epithelial cell line (MDCK).
J Cell Biol: **81** 635-648 (1979).
- Rink TJ: Measurement of free calcium concentration in living cells.
Pure and Appl Chem: **55** 1977-1988 (1983).
- Rink TJ, Sanchez A, Grinstein S, Rothstein A: Volume restoration in osmotically swollen lymphocytes does not involve changes in free Ca^{2+} concentration.
Biochimica et Biophysica Acta: **762** 593-596 (1983).
- Rink TJ, Pozzan T: Using Quin 2 in cell suspensions.
Cell Calcium: **6** 133-144 (1985).
- Rink TJ: Measurement of cytosolic calcium : fluorescent calcium indicators.
Mineral Electrolyte Metab: **14** 7-14 (1988).
- Roman I, Gmaj P, Nowicka C, Angielski S: Regulation of Ca^{2+} efflux from kidney and liver mitochondria by unsaturated fatty acids and Na^{+} ions.
Eur J Biochem: **102** 707-713 (1979).
- Rorsman P, Berggren PO, Gylfe E, Hellman BO: Reduction of the cytosolic calcium activity in clonal insulin-releasing cells exposed to glucose.
Biosci Rep: **3** 937-946 (1983).
- Sakhrani LM, Fine LG: Renal tubular cells in culture.
Mineral Electrolyte Metab: **9** 276-281 (1983).
- Sakhrani LM, Tessitore N, Massry SG: Effects of calcium on transport characteristics of cultured proximal renal cells.
Am J Physiol: **249** F346-355 (1985).
- Sastrasinh M, Weinberg JM, Humes HD: The effect of gentamicin on calcium uptake by renal mitochondria.
Life Sci: **30** 2309-2315 (1982).
- Schmidt U, Guder WG: Sites of enzyme activity along the nephron.
Kid Int: **9** 233-242 (1976).
- Schnellman RG, Mandel LJ: Cellular toxicity of bromobenzene and bromobenzene metabolites to rabbit proximal tubules.
J Pharmacol Exp Ther: **237** 456-461 (1986).

- Schnellmann RG: Mechanisms of t-butyl hydroperoxide-induced toxicity of rabbit renal proximal tubules.
Am J Physiol: **255** C28-33 (1988).
- Scholer DW, Edelman IS: Isolation of rat kidney cortical tubules enriched in proximal and distal segments.
Am J Physiol: **237** F350-359 (1979).
- Schwartz DW, Erisberg JI, Ventkatachalam MA: Effects of aminoglycosides on proximal tubule brush border membrane phosphatidylinositol-specific phospholipase-C.
J Pharmacol Exp Ther: **231** 48-55 (1984).
- Seaman GVF: Cell electrophoresis. Ed EJ Ambrose, Churchill Press London, 1965.
- Sens MA, Hennigar GR, Hazen-Martin DJ, Blackburn JG, Sens DA: Cultured human proximal tubule cells as a model for aminoglycoside nephrotoxicity.
Ann Clin Lab Sci: **18** (3) 204-214 (1988).
- Sheikh MI, Møller JV: Preparation and use of renal and intestinal plasma membrane vesicles for toxicological studies.
Biochemical Toxicology. Ed K. Snell & B. Mullock. IRL Press 1987.
- Skeer BAS, Lindup WE: Chloroform nephrotoxicity and renal uptake of calcium.
Nephrotoxicity, In vitro to in vivo, animals to man. Ed P.H. Bach & E.A. Lock. Plenum Press 1989.
- Smith MA, Acosta D, Bruckner JV: Development of a primary culture system of rat kidney cortical cells to evaluate the nephrotoxicity of xenobiotics.
Fd Chem Toxic: **24** 551-556 (1986).
- Smith MA, Hewitt WR, Hook JB: In vitro methods in renal toxicology.
In vitro methods in toxicology. Ed C.K. Atterwill & C.E. Steele. Cambridge University Press 1987 [A].
- Smith MT, Thor H, Orrenius S: Toxic injury to isolated hepatocytes is not dependent on extracellular calcium.
Science: **213** 1257-1259 (1981).
- Smith MW, Ambudkar IS, Phelps PC, Regec AL, Trump BF: HgCl₂- induced changes in cytosolic Ca²⁺ of cultured rabbit renal tubular cells.
Biochimica et Biophysica Acta: **931** 130-142 1987 [B].
- Smith WL, Garcia-Perez: Immunodissection: use of monoclonal antibodies to isolate specific types of renal cells.
Am J Physiol: **248** F1-7 (1985).
- Smith WL, Spielman WS: Hormonal and antigenic properties of renal cell populations isolated by immunodissection and grown in cell culture.
Functional epithelial cells in culture. Ed K.S. Matlin & J.D. Valentich. Alan R Liss Inc 1989.
- Snowdowne KW, Freudenrich CC, Borle AB: The effects of anoxia on cytosolic free calcium, calcium fluxes and cellular ATP levels in cultured kidney cells.
J Biol Chem: **260** 11619-11626 (1985).
- Solez K, Whelton A: Acute renal failure: correlations between morphology and function.
Kidney Disease Vol 4 Marcel Dekker Inc 1984.

Somlyo AP, Somlyo AV, Schuman H, Scarpa A, Endo M, Inesi G: Mitochondria do not accumulate significant Ca concentrations in normal cells.
Calcium and phosphate transport across biomembranes. Ed A Bronner and D Peterlik. Academic Press 1981.

Stassen FL, Heckman G, Schmidt D, Papadopoulos MT, Nambi P, Sarau H, Aiyar N, Gellai M, Kinter L: Oxytocin induces a transient increase in cytosolic free $[Ca^{2+}]$ in renal tubular epithelial cells: Evidence for oxytocin receptors on LLC-PK₁ cells.
Mol Pharmacol: **33** 218-224 (1988).

Stonard MD: Proteins, enzymes and cells in urine as indicators of the site of renal damage.

Nephrotoxicity in the experimental and clinical situation Part I. Ed P.H. Bach & E.A. Lock. Martinus Nijhoff Publishers 1987.

Tang MJ, Weinberg JM: Vasopressin-induced increases of cytosolic calcium in LLC-PK₁ cells.
Am J Physiol: **251** F1090-1095 (1986).

Taub M, Chuman L, Saier MH, Sato G: Growth of Madin-Darby canine kidney epithelial cell (MDCK) line in hormone-supplemented, serum-free medium.
Proc Natl Acad Sci: **76** (7) 3338-3342 (1979).

Taub M, Livingston D: The development of serum-free hormone-supplemented media for primary kidney cultures and their use in examining renal functions.
Ann NY Acad Sci: **372** 406-421 (1981).

Taub M, Sato G: Growth of functional primary cultures of kidney epithelial cells in defined medium.
J Cellular Physiol: **105** 369-378 (1980).

Thevenod F, Streb H, Ullrich KJ, Schulz I: Inositol-1,4,5-trisphosphate releases Ca^{2+} from a nonmitochondrial store site in permeabilized rat cortical kidney cells.
Kid Int: **29** 695-702 (1986).

Thimmappayya B, Ramachandra Reddy R, Bhargava PM: Preparation of kidney cell suspension and respiration of kidney and liver cell suspensions.
Exp Cell Res: **63** 333-340 (1970).

Timpl R, Aumailley M: Biochemistry of basement membranes.
Adv Neph: **18** 59-76 (1989).

Toubeau G, Malgague P, Laurent G, Vaamonde CA, Tulkens PM, Heuson-Stiennon JA: Morphological alterations in distal and collecting tubules of the rat cortex after aminoglycoside administration at low doses.
Virchows Arch [Cell Pathol]: **51** 475-485 (1986).

Toutain H, Fillastre JP, Morin JP: Preparative free flow electrophoresis for the isolation of two populations of proximal cells from the rabbit kidney.
Eur J Cell Biol: **49** (2) 274-280 (1989).

Trump BF, Berezesky IK: The role of calcium in cell injury and repair: an hypothesis.
Surv Synth Path Res: **4** 248-256 (1985).

Trump BF, Berezesky IK: Ion deregulation in injured proximal tubule epithelial cells. Nephrotoxicity, In vitro to in vivo, animals to man. Ed P.H. Bach & E.A. Lock. Plenum Press 1989.

Trump BF, Berezesky IK, Sato T, Laiho KU, Phelps PC, DeClaris N: Cell calcium, cell injury and cell death.

Environmental Health Perspectives: **57** 281-287 (1984).

Tsien RY: New calcium indicators and buffers with selectivity against magnesium and protons: Design, synthesis and properties of prototype structures.

Biochemistry: **19** 2396-2404 (1980).

Tsien RY: A non-disruptive technique for loading calcium buffers and indicators into cells.

Nature: **290** 527-528 (1981).

Tsien RY, Pozzan T, Rink TJ: Calcium homeostasis in intact lymphocytes: cytoplasmic free calcium monitored with a new, intracellularly trapped fluorescent indicator.

J Cell Biol: **94** 325-334 (1982).

Tsien RY, Pozzan T, Rink TJ: Measuring and manipulating cytosolic Ca^{2+} with trapped indicators.

Trends in Biochem Sci: **9** 263-266 (1984).

Tsien RY, Rink TJ, Poenie M: Measurement of cytosolic free Ca^{2+} in individual small cells using fluorescence microscopy with dual excitation wavelengths.

Cell Calcium: **6** 145-157 (1985).

Tyson CA, Dabbs JE, Cohen PM, Green CE, Melnick RL: Response of a new renal proximal tubule system to nephrotoxic agents.

Renal Failure: **11** (4) abstract 1989.

Uchikawa T, Borle AB: Studies of calcium-45 saturation from kidney slices in flow-through chambers.

Am J Physiol: **234** R34-38 (1978).

Ullrich KL, Rumrich G, Kloss S: Active Ca^{2+} reabsorption in the proximal tubule of the kidney.

Pflugers Arch: **364** 223-228 (1976).

Valentich JD: Innovative approaches for the study of cultured renal epithelia

Mineral Electrolyte Metab: **12** 6-13 (1986).

Vinay P, Gougoux A, Lemieux G: Isolation of a pure suspension of rat proximal tubules.

Am J Physiol: **241** F403-411 (1981).

Warburg O, Christian W: Pyridin, der Wasserstoff-ubertragende Bestandteil von Gärungsfermenten (Pyridin-Nukleotiden).

Biochem Z: **287** 291-298 (1936).

Weast RC: Handbook of Chemistry and Physics 60th ed. The Chemical Rubber Co. Cleveland, Ohio 1979.

Weinberg JM: Calcium as a mediator of renal tubule cell injury.

Seminars in nephrology: **4** (2) 174-191 (1984).

Weiss L: Histology, Cell and Tissue Biology 5th Ed. Macmillan Press 1984.

Welling LW, Welling DJ: Surface areas of brush border and lateral cell walls in the rabbit proximal nephron.

Kid Int: **8** 343-348 (1975).

Welling LW, Welling DJ: Relationship between structure and function in renal proximal tubule.

J Electron Microsc Tech: **9** 171-185 (1988).

Willatts SM: Lecture notes on fluid and electrolyte balance. Blackwell Scientific Publications 1982.

William BL, Wilson K: A Biologist's guide to principles and techniques of practical biochemistry 2nd Edition. Edward Arnold Publishers Ltd 1981.

Williams MA: Fixation of renal tissue for cytochemical evaluation. Nephrotoxicity in the experimental and clinical situation Part I. Ed P.H.Bach & E.A. Lock. Martinus Nijhoff Publishers 1987.

Williams MA, Lowrie JJ: Fixation of kidney tissue for morphimetric study. Nephrotoxicity in the experimental and clinical situation Part I. Ed P.H.Bach & E.A. Lock. Martinus Nijhoff Publishers 1987.

Williams PD, Laska DA, Hottendorf GH: Comparative toxicity of aminoglycoside antibiotics in cell cultures derived from human and pig kidney. In Vitro Toxicol: **1** (1) 23-32 1986/87.

Williams PD, Trimble ME, Crespo L, Holohan PD, Freedman JC, Ross CR: Inhibition of renal Na⁺, K-Adenosine Triphosphatase by gentamicin. J Pharmacol Exp Ther: **231** (2) 248-253 (1984).

Wills ED: Evaluation of lipid peroxidation in lipids and biological membranes. Biochemical Toxicology. Ed K. Snell & B. Mullock. IRL Press 1987.

Wilson AP: Cytotoxicity and viability assays. Animal Cell Culture — a practical approach. Ed R.I. Freshney. IRL Press 1986.

Wilson PD: Use of cultured renal tubular cells in the study of cell injury. Mineral Electrolyte Metab: **12** 71-84 (1986).

Wolfgang GHI, Gandolfi AJ, Brendel K: Regioselective toxicity by dichlorovinyl cysteine in rabbit renal cortical slices. Nephrotoxicity, In vitro to in vivo, animals to man. Ed P.H. Bach & E.A. Lock. Plenum Press 1989.

Yamada T, Ambrose EJ: Preparation of cell suspensions from tissues using collagenase and hyaluronidase, especially for measuring the electrical charges of surface membranes of mammalian cells. Exp Cell Res: **44** 634-636 (1966).

Yanagawa N: Cytosolic free calcium in isolated perfused rabbit proximal tubules : effect of parathyroid hormone. Kid Int: **31** A361 (1987).

Zaroff L, Sato G, Mills SE: Single-cell platings from freshly isolated mammalian tissue. Exp Cell Res: **23** 565-575 (1961).

APPENDIX 1

Removal of connective tissue residues present in mechanically isolated proximal tubule samples

The presence of connective tissue residues in mechanically isolated PT samples, but *not* those isolated by collagenase digestion, has been described in several earlier chapters. For the most part these residues did not appear to cause problems; however, during the attempts to measure $[Ca^{2+}]_i$ in Chapter 5 their presence proved to be a significant handicap.

The initial attempts to measure $[Ca^{2+}]_i$ in whole PTs was made with QUIN rather than FURA. Unfortunately, meaningful results were not obtained at this stage due to the very high degree of vacillation or 'noise' on the trace (fig A1). A reduction in the final amount of tubular material in the cuvette from 10mg protein to 2mg of protein improved the noise level considerably. Nevertheless, at comparable protein concentrations of 2mg, mechanically isolated PTs still continued to produce significantly noisier traces than PTs isolated by collagenase perfusion. It was felt that the reason for this lay with the presence of connective tissue residues in the mechanically isolated samples and that the traces might become 'quieter' if the level of these residues was reduced. Various approaches to this problem were attempted:

i Sedimentation

A freshly isolated PT sample was suspended in 30mls of iced KHS, placed in a measuring cylinder and allowed to sediment. At 2min intervals samples were withdrawn from the top and bottom of the cylinder and examined by light microscopy to see whether significant separation had occurred.

Result

No significant separation occurred until 6mins had elapsed thereafter; connective tissue residues started to accumulate at the bottom of the cylinder with samples from the top of the cylinder showing appreciably less connective tissue contamination — this differentiation continued up until the 10mins time point. Unfortunately a significant number of the PTs also sedimented with the connective tissue so that although the PT sample at the top of the cylinder contained very few residues it did not contain sufficient numbers of PTs for further use either. The inclusion of 3% dextran in the medium did not improve the degree of separation and so this method was abandoned.

ii. Filtering

A freshly isolated PT sample was suspended in 10mls of KHS and then poured onto a 53 μ m nylon mesh. The sample was washed fairly strongly with an iced spray of KHS in the hope that the fluffier and more flexible connective tissue would pass through the mesh and leave the PTs behind.

Result

The connective tissue, instead of passing through the mesh, spread out and clogged up the mesh during the washing. Attempts to elute the residues with more rigorous spraying served only to fragment the PTs which then passed through the mesh. Although this technique might be of use in obtaining PT fragment for tissue culture it was not successful at removing connective tissue residues.

iii Pre-plating

This is predominantly a cell culture technique used to remove fibroblasts and sometimes extraneous tissue from freshly isolated tissues before seeding into growth

medium [Freshney 1983, Smith *et al* 1986]. It consists of plating out the tissue samples onto cell culture plates and leaving them to incubate. The theory is that fibroblasts etc attach to a substrate more quickly than an ordinary cell so that, after an appropriate time, the cell suspension may be poured out into fresh plates leaving the fibroblasts etc behind — still attached to the plates. The problem was to find optimal pre-plating conditions that would allow the removal of the connective tissue residues whilst not losing significant amounts of the PT sample. A number of different protocols were tried;

a) PRE-PLATING ON PRIMARIA® PLATES AT DIFFERENT TEMPERATURES.

Primaria® plates (Falcon) are tissue culture plates made from a specially formulated plastic that carries a residual positive charge designed to facilitate tissue attachment. They had been used earlier in this study during the culture of mechanically isolated PTs and it was felt that these plates would encourage the attachment of connective tissue.

Three cm plates were inoculated with freshly isolated PT samples suspended in KHS, supplemented with 3% Dextran and 5mM pyruvate, and incubated in a gassing incubator at either 0°C, 20°C or 37°C for 30 or 60 mins. At the end of each incubation, the contents of each plate was poured onto a large cavity slide and examined by light microscopy. The residues attached to each plate were also examined using a dissecting microscope.

Results

The primaria plates were *very* successful at removing extraneous tissue, in fact no connective tissue residues were seen in the final sample. Unfortunately, the number of PTs that attached to the plates, even after only 30mins of incubation, was unacceptably high and increased with the length of incubation. Temperature had little affect on the pre-plating efficiency of this system and, because of the high level of PTs lost, this protocol was therefore abandoned.

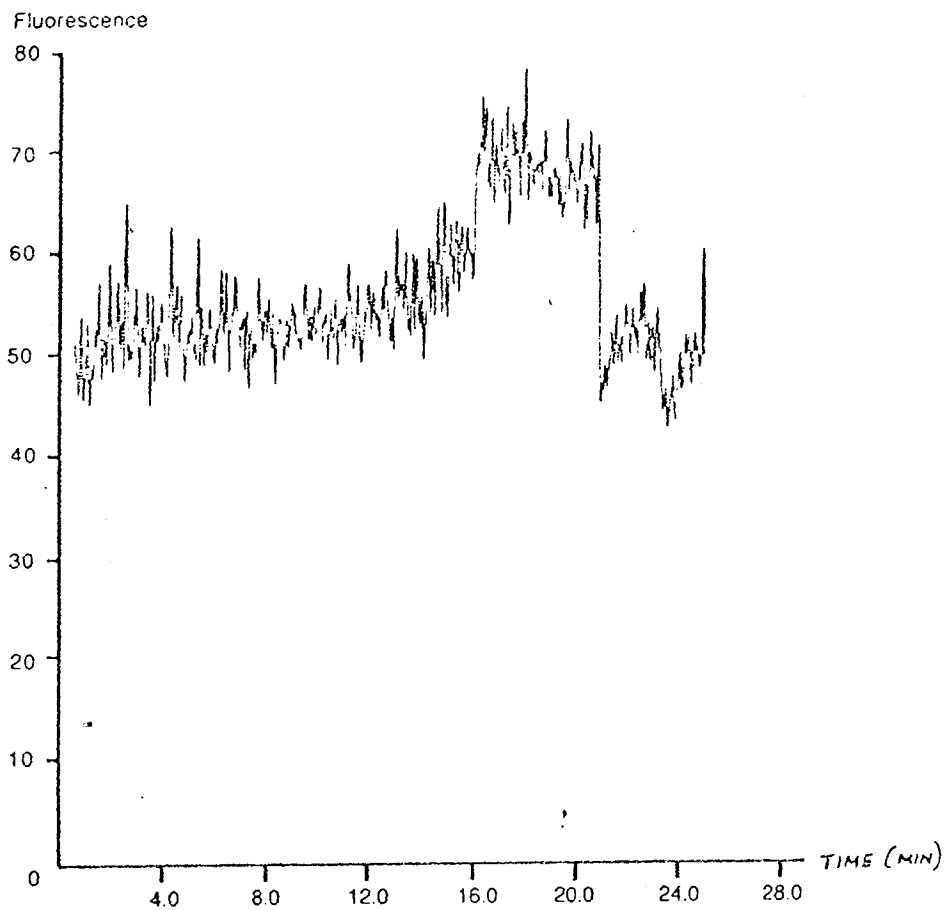

Fig A1 Representative trace of the quality of signal obtained from mechanically isolated PTs, loaded with FURA 2-AM, *before* pre-plating. The trace can be seen to be very 'noisy' in appearance.

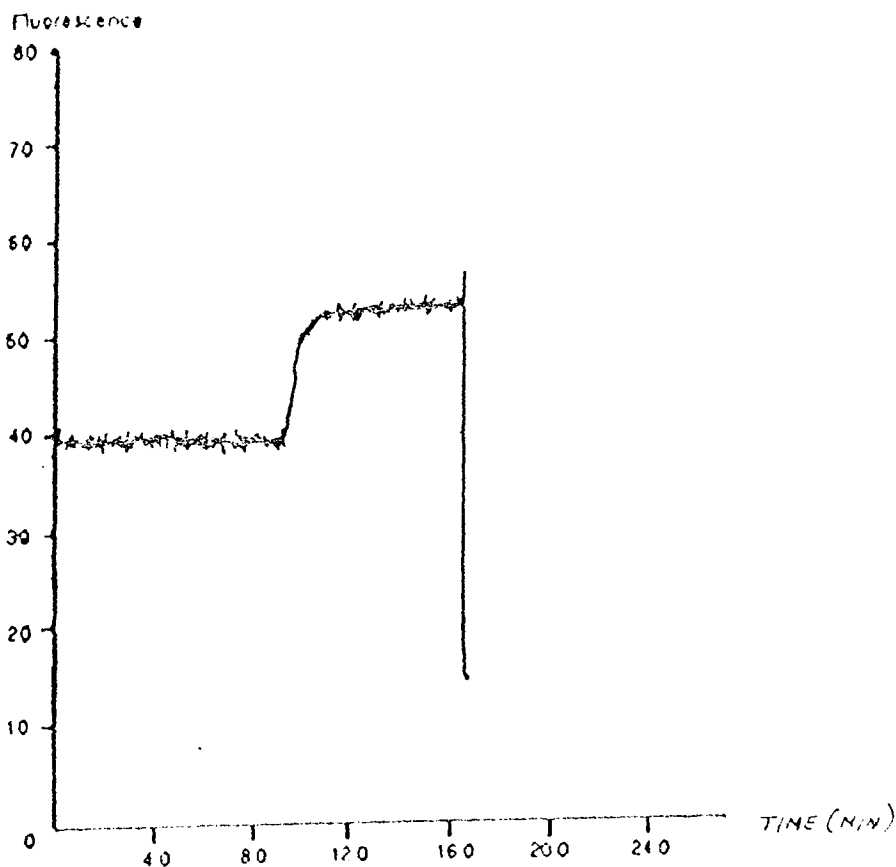

Fig A2 Representative trace of the quality of signal obtained from mechanically isolated PTs, loaded with FURA 2-AM, *after* pre-plating for 30mins at 25°C on plain cell culture plates. The trace is now much 'quieter' in appearance.

b) PRE-PLATING ON STERILLIN PLATES AT VARIOUS TEMPERATURES.

Sterillin cell culture plates (Sterillin) are standard cell culture plates made from neutral plastic. These plates were inoculated and incubated using the same protocol as for the Primaria plates.

Results

Sterillin plates incubated at 37°C achieved good connective tissue attachment but the level of PT attachment, although less than that seen with the Primaria Plates, was still unacceptably high and again increased with incubation time. Plates incubated at 0°C exhibited much lower PT attachment, unfortunately they had less connective tissue attachment also. However plates incubated at 20°C exhibited satisfactory connective tissue attachment (although less than that achieved at 37°C) and the amount of PTs lost was less than that at 37°C. PT loss was found to be less at 30mins rather than 60mins.

None of the above protocols produced a perfect system for the removal of connective tissue. However as a compromise between connective tissue contamination and PT loss, it was decided to try a trial run with FURA and use the pre-plating protocol that involved incubating mechanically isolated PT samples on Sterillin plates for 30 mins at 20°C. The traces obtained with this protocol were much quieter than previous traces run without pre-plating (fig A2) and indeed were almost comparable to those obtained with collagenase isolated PTs (fig 5m). It was decided, therefore to adopt this protocol for the removal of connective tissue residues from mechanically isolated PT samples used in $[Ca^{2+}]_i$ measurements by FURA.