

Some pages of this thesis may have been removed for copyright restrictions.

If you have discovered material in AURA which is unlawful e.g. breaches copyright, (either yours or that of a third party) or any other law, including but not limited to those relating to patent, trademark, confidentiality, data protection, obscenity, defamation, libel, then please read our [Takedown Policy](#) and [contact the service](#) immediately

University of Aston in Birmingham
School of Chemistry
Department of Medicinal Chemistry
CCK-1 Antagonists

**Combinatorial Approach
to Multi-substituted 1,4-Benzodiazepines as
Novel Non-Peptide CCK-Antagonists**

Michael Offel
Doctor of Philosophy

Aston University
2001

This copy of the thesis has been supplied on condition that anyone who consults it is understood to recognise that its copyright rests with its author and that no quotation from the thesis and no information derived from it may be published without proper acknowledgement.

The University of Aston in Birmingham
Combinatorial Approach to Multi-substituted 1,4-Benzodiazepines as
Novel Non-Peptide CCK-Antagonists

A thesis submitted by Michael Offel MSc for the degree of Doctor of
Philosophy
July 2001

Abstract: For the drug discovery process, a library of 168 multisubstituted 1,4-benzodiazepines were prepared by a 5-step solid phase combinatorial approach. Substituents were varied in the 3, 5, 7 and 8-position on the benzodiazepine scaffold. The combinatorial library was evaluated in a CCK radiolabelled binding assay and CCK_A (alimentary) and CCK_B (brain) selective lead structures were discovered. The template of CCK_A selective 1,4-benzodiazepin-2-ones bearing the tryptophan moiety was chemically modified by selective alkylation and acylation reactions. These studies provided a series of Asperlicin naturally analogues. The fully optimised Asperlicin related compound possessed a similar CCK_A activity as the natural occurring compound. 3-Alkylated 1,4-benzodiazepines with selectivity towards the CCK_B receptor subtype were optimised on A) the lipophilic side chain and B) the 2-aminophenyl-ketone moiety, together with some stereochemical changes. A C3 unit in the 3-position of 1,4-benzodiazepines possessed a CCK_B activity within the nanomolar range. Further SAR optimisation on the N₁-position by selective alkylation resulted in an improved CCK_B binding with potentially decreased activity on the GABA_A/benzodiazepine receptor complex. The *in vivo studies* revealed two N₁-alkylated compounds containing unsaturated alkyl groups with anxiolytic properties. Alternative chemical approaches have been developed, including a route that is suitable for scale up of the desired target molecule in order to provide sufficient quantities for further *in vivo* evaluation.

Keywords: Cholecystokinin, non-peptide Cholecystokinin-antagonists,
1,4-Benzodiazepine template, Multisubstitution, Lead structure, N-alkylation.

Acknowledgements

I would like to thank Dr. E. Lattmann for support and guidance throughout the course of work.

Many thanks to Dr. D. Poyner for providing the biological CCK screening results. Thanks to Prof. D.C. Billington for his general help and advice.

I would like to express my gratitude for the help and technical assistance given to me by Mike Davis and Karen Farrow.

Many thanks to Panos Therapeutics, which have helped make this work possible financially, and in particular Dr. L.L. Iversen. I am also grateful to the University of Aston, Department of Pharmaceutical and Biological Sciences, for providing the research facilities.

Thanks are also due to everybody in the chemistry laboratories who kept me motivated, Harjit Singh, Fiona Salvage, Katy Timms, Mike Davis and Dan Rathbone to name but a few.

Contents

Title	1
Abstract	2
Acknowledgements	3
Contents	4
Abbreviations	9

Introduction

Chapter 1

Drug Discovery	10
1.1. The drug discovery process	10
1.1.1. Changes in strategies for drug discovery	11
1.2. Combinatorial chemistry	12
1.2.1. Management of libraries	14
1.2.1.1. Random primary libraries	16
1.2.1.2. Focussed/directed libraries	16
1.2.1.3. Mixtures	17
1.2.1.4. Single compounds/parallel synthesis	18
1.3. Solid phase or solution synthesis	19
1.4. Current directions	21

Chapter 2

Central nervous system disorders	23
2.1. The biological target (Cholecystokinin) for the drug discovery process	24
2.2. Cholecystokinin	24

2.3. Peptide and non-peptide cholecystkinin receptor antagonists	27
2.3.1. Amino acid derivatives	28
2.3.2. Cyclic nucleotide derivatives	30
2.3.3. Tryptophan dipeptoid derivatives	30
2.3.4. Peptides	31
2.3.5. Pyrazolidinones	32
2.3.6. Ureidoacetamides	32
2.3.7. Ureidophenoxyacetanilides	33
2.3.8. Ureidomethylcarbamoylphenylketones	33
2.3.9. Dibenzobicyclo [2.2.2] octane and bicyclic heteroaromatic derivatives	34
2.3.10. Benzodiazepine derivatives	35
2.3.11. Ureidobenzodiazepine derivatives	39
2.4. Summary	45
2.5. Aims and Objectives	47

Results and Discussion

Chapter 3

Synthesis of 2-Aminophenylcyclohexylketones	49
3.1. Planing of the synthesis strategy (Retrosynthesis of 2-aminophenylcyclohexylketone derivatives)	51
3.2. Synthesis of 2-aminophenylcyclohexylketone derivatives	53
3.2.1. Grignard reactions	53
3.2.2. Friedel-Crafts reactions	56

Chapter 4

Solid Phase Synthesis of Multi-Substituted-1,4-Benzodiazepines and their Evaluation as Non-peptidal Cholecystkinin Antagonists	60
4.1. Considerations for the generation of the benzodiazepine library	60
4.1.1. Published solid phase methodologies	61
4.2. Generation of the 1,4-benzodiazepine library	65
4.3. Pharmacology of multi-substituted 3-alkylated-1,4-benzodiazepines	76

Chapter 5	
Synthesis and Evaluation of Asperlicin Analogues as Non-peptidal Cholecystkinin-Antagonists	83
5.1. Synthesis of multi-substituted 1,4 -benzodiazepine-2-ones (Asperlicin analogues)	84
5.2. Pharmacology of alkylated 3-(indolylmethyl)-1,4-benzodiazepines	93
Chapter 6	
Synthesis and Biological Evaluation of 4H-[1,2,4]triazolo[4,3-a][1,4]Benzodiazepines as Cholecystkinin-Antagonists	102
6.1. Synthesis of triazolo-1,4-benzodiazepines and their chemical precursors	103
6.2. Pharmacology of triazolo-1,4-benzodiazepines and their precursors	105
Chapter 7	
Synthesis and Biological Evaluation of 3-Functionalised 1,4-Benzodiazepines	109
7.1. Bioisoteric modifications	110
7.1.1. Synthesis of 3-(alkylamino/anilino)-1,4-benzodiazepines	111
7.1.2. Pharmacology of 3-(alkylamino/anilino)-1,4-benzodiazepines	116
7.2. 3-substituted-1,4-benzodiazepines with C-terminal functional groups	118
7.2.1. Solution phase synthesis of 3-functionalised-1,4-benzodiazepines	118
7.2.2. Pharmacology of 3-functionalised-1,4-benzodiazepines	122
Chapter 8	
Synthesis and Biological Evaluation N₁-C₃-Dialkylated 1,4-Benzodiazepines	125
8.1. Synthesis of 5, 7, 8 substituted 3-n-propyl-1,4-benzodiazepines (ketone optimisation)	127
8.1.1. Pharmacology of 5, 7, 8 substituted 3-n-propyl-1,4-benzodiazepines	131
8.2. C3-Alkylation of 7-chloro-N1-methyl-1,4-benzodiazepine (Diazepam®)	134
8.2.1. Synthesis of Diazepam®	136
8.2.2. C3-Alkylation of Diazepam®	137
8.2.3. Pharmacology 3-substituted-N1-methyl-1,4-benzodiazepines	141

8.3. N1-Alkylation of 7-chloro-3-propyl-1,4-benzodiazepines	144
8.3.1. Development route 1: From 5-nitrobenzophenone to the 7-chloro-3-propyl-1,4-benzodiazepine template as building block for N1-alkylation	146
8.3.2. N1-Alkylation of 7-chloro-3-propyl-1,4-benzodiazepine	149
8.3.3. Pharmacology of N1-alkylated 7-chloro-3-propyl-1,4-benzodiazepines (Route1)	152
8.3.4. Development route 2: Large scale solution phase synthesis of the 7-chloro-3-propyl-1,4-benzodiazepine template as building block for N1-alkylation	156
8.3.4.1. Mechanism for the formation of the building block	158
8.3.5. N1-Alkylation of 7-chloro-3-propyl-1,4-benzodiazepine	160
8.3.6. Pharmacology of N1-alkylated 7-chloro-3-propyl-1,4-benzodiazepines (Route 2)	163

Summary and Conclusion

Chapter 9	168
------------------	-----

Experimental

Chapter 10	
General methods	171
Experiments to Chapter 3	173
Experiments to Chapter 4	177
Experiments to Chapter 5	191
Experiments to Chapter 6	207
Experiments to Chapter 7	215
Experiments to Chapter 8	226
References	260
Publications	287

Abbreviations

Boc	tert-Butoxycarbonyl
BuLi	n-Butyl lithium
BuOH	n-Butanol
BZD	Benzodiazepine
Cbz	Benzyloxycarbonyl
CCK	Cholecystokinin
CDCl ₃	Deuterated chloroform
(CD ₃) ₂ SO	Deuterated dimethylsulphoxide
CHCl ₃	Chloroform
CNS	Central Nervous System
COS	Combinatorial Organic Synthesis
DCE	1,2-Dichloroethane
DCM	Dichloromethane
DIC	Dicyclohexylcarbodiimide
DICDI	Diisopropylcarbodiimide
DMAP	4-Dimethylaminopyridine
DMF	N,N-Dimethylformamide
DMSO	Dimethylsulfoxide
EtOAc	Ethylacetate
Et ₂ O	Diethylether
Eq	Equivalent
FC	Flash chromatography
Fmoc	9-Fluorenylmethoxycarbonyl
GABA	Gamma aminobutyric acid
GAD	Generalised panic disorder
GAS	Gastric acid secretion
HCL	Hydrochloric acid
(i-Pr) ₂ NH	Diisopropylamine
IC ₅₀	Inhibitory concentration, 50 %
LDA	Lithium diisopropylamide

NaH	Sodium hydride
NaOH	Sodium hydroxide
PD	Panic disorder
PTSD	Post-traumatic stress disorder
i-PrOH	iso-Propanol
SAR	Structure-activity-relationship
SP	Social phobia
SPOC	Solid Phase Organic Chemistry
TEA	Triethylamine
TFA	Trifluoroacetic acid
THF	Tetrahydrofuran
TLC	Thin-layer-chromatography

Introduction

Chapter 1

Drug Discovery

Pharmaceutical companies are always searching for new methods to reduce the time spent on the drug discovery processes. There has never been a more exciting and productive time to be involved in drug discovery¹. The pharmaceutical industry has made great contributions to the treatment of human disease, and recent examples of this success include the discovery and introduction of the first effective drugs for treatment of HIV infection² and Alzheimer's disease. During the 1960s the drug discovery process averaged 8 years and doubled in the 1990s. An increased development time leads to increases in development costs and decreases profits that can be made from a successful drug candidate. The cost of the discovery of a single new drug has been estimated to escalate from 100 million dollars in the 1960s to 650 million dollars in the late 1990s³.

1.1. The drug discovery process

The starting point is the identification of the biological target and the study of interaction with the target may lead to therapy in a given area. A wise choice has to be made about which target to pursue because the number of new drug targets in this area, which may emerge, range as high as 3,000.

Compounds were screened against biological targets and active compounds also called "hits" were subjected for further optimisation in order to identify "lead" compounds as potential drug candidates. Lead compounds were subjected to extensive studies in a development phase before entry in clinical trials. The development studies include toxicology, distribution, metabolism and excretion from the body. For every drug approved in the US, in the mid-1990s, an average of 21 compounds of 6,200 were put into the development phase. On average 6.5 of these were tested in humans and only 2.5 made it to the phase III clinical trials. Up to this point the process cost an average of 350 million dollars and took an average of 12.8 years³. The following are some of the reasons for the failures of new compounds in the development phase:

- Poor pharmaceutical properties;
- Lack of efficiency;
- Toxicity and
- other market reasons, e.g. no marketable or no competitive new drugs.

To decrease these possible failures and the resulting enormous costs in development, pharmaceutical companies have had to re-evaluate the drug discovery process and a discussion has now commenced on how to accelerate the drug discovery process, in order to increase the chance of finding a lead compound. Hence, the term combinatorial chemistry was born. Alternatively, combinatorial chemistry in solution or on solid support is being developed to increase the efficiency of organic syntheses. Furthermore, successful applications of such methods leading to the discovery of therapeutic candidates have been reported⁴. Figure 1.1 outlines the key steps for the drug discovery process.

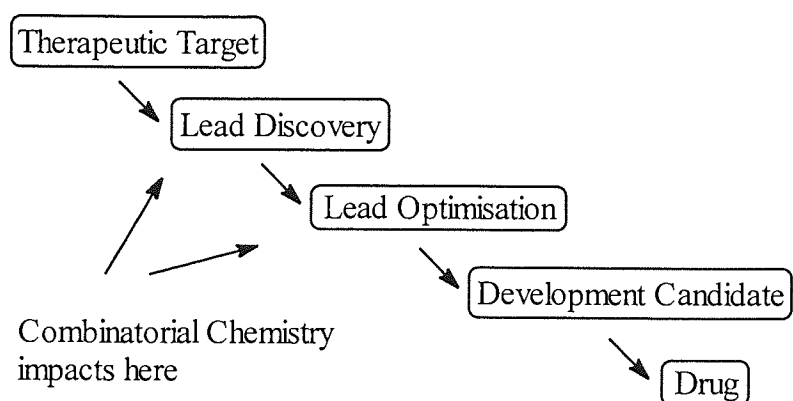

Figure 1.1: The key steps in the drug discovery process and the steps that can be influenced by the application of combinatorial chemistry.

1.1.1. Changes in strategies for drug discovery

New approaches lead to accelerating of the drug discovery process. In the past, most drug leads have come from screening collections consisting of natural products or compounds prepared by "traditional synthesis". The traditional conventional synthesis of compounds and their multi step synthesis by orthodox analogue synthesis is restricted, e.g. one medicinal chemist is able to synthesis between 30 and 100 compounds per year for biological screening⁵.

The enormous number of drug targets lead to a change in medicinal chemistry. All these methods followed a trend; a particular molecule was synthesised and tested for biological activity. If the synthesised molecule showed activity, the structure was modified to give optimum activity. This new, higher activity was often found by trial and error. This process was expensive and thus in the early 1990s, chemists began to synthesise large collection of compounds the so-called “libraries”. These libraries were made by making all possible combinations of a series of reactants and lead to the term “combinatorial chemistry” used nowadays.

1.2. Combinatorial chemistry

A few pioneer companies and academic research groups first practised combinatorial chemistry. With the decreasing cost of the technology a combinatorial chemistry project is becoming much more cheaper. This methodology has found wide acceptance in the pharmaceutical, agrochemical, and biotechnology industries. Simply put, scientists use combinatorial chemistry to create large populations of molecules, or libraries, that can be screened efficiently. Its application can take a variety of forms, each requiring a complex interplay of classical organic synthesis techniques, rational drug design strategies, robotics, and scientific information management.

The combinatorial organic synthesis (COS) is not random, but systematic, using sets of “building blocks” to generate compounds with a high diversity, i.e. with many different molecular shapes and sizes. The ultimate goal of combinatorial chemistry involve three main steps:

1. Preparation of the library;
2. Screening of the library components, and
3. Determination of the chemical structures of active compounds or lead structures from a vast number of structurally similar compounds.

To speed up this process of drug discovery combinatorial chemistry has been developed to prepare combinatorial libraries, which enables the generation of compounds simultaneously, whereas previously the aim was to produce the compounds one at a time. By producing larger, more diverse compound libraries, companies increase the probability that they will find novel compounds of significant therapeutic and commercial value.

Combinatorial chemistry, although new in its introduction to the field of organic synthesis it is strongly correlated with nature. Nature has used basic building blocks (such as the twenty different amino acids) to produce many structurally distinct compounds with a wide magnitude of functions (the peptides) using combinatorial chemistry principles.

In contrast to conventional organic synthesis, combinatorial chemistry (Figure 1.2) is simple in theory, yet effective in its application and relies on producing all possible combinations of a basic set of molecular components or "building blocks". The number of compounds obtainable from a given set of building blocks increases exponentially, while the number of building blocks increases only arithmetically. For example, the building block of type A (A_1 - A_{10}) is reacted with each of the building block of type B (B_1 - B_{10}) according to combinatorial chemistry principles, yielding one hundred different structures (two-dimensional library). Further reaction of the above series with a third building block C (C_1 - C_{10}) yield to 1000 structurally different compounds (three-dimensional library). The process of adding a set of new components at each step in the synthesis is known as "multiple-step combinatorial synthesis". This is the method that is the most prevalent in the search for new drugs.

Ten thousand different chemical structures can be produced in a combinatorial synthesis with three steps using ten building blocks each of type **A**, **B**, **C** and **D**.

The set of all formed compounds is known as a library. Different vessels can either segregate the different molecules produced by combinatorial chemistry in the library or they can all be present in a mixture of a defined composition.

The process of combinatorial chemistry may be automated, increasing the speed in drug discovery process for the generation of more potential novel leads. Once these leads are generated combinatorial chemistry may be used to optimise the activity of initial lead structures.

Conventional synthesis



Combinatorial synthesis

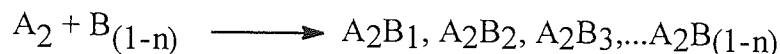
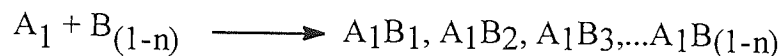

...

...

...

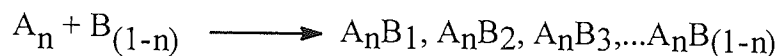

Figure 1.2: Combinatorial chemistry synthesis methodologies

Initial attempts in combinatorial chemistry focussed on the synthesis of peptide libraries⁶, because the chemistry involved was high yielding and reproducible. Solid Phase synthesis was used to prepare mixtures of peptides. Unfortunately, peptides often have a number of disadvantages as therapeutic agents due to poor bioavailability *in vivo* and their rapid enzymatic degradation. Another problem is that the conversion of a peptide lead structure into a non-peptide can be a lengthy process and is often complicated. As a direct result of difficulties experienced with peptides, research has in the last five years been directed towards the formation of libraries of "small organic molecules"⁷.

1.2.1 Management of libraries

The library design is crucial for the combinatorial approach based on the biological target and the following key decisions had to be made before starting library synthesis:

- Which library to make?

The design of a particular library is driven by the nature of the biological target of interest. The following types of information should be considered, if available:

- the biology of the target enzyme or receptor;
- the nature of substrate;
- the mechanism of target-substrate interaction;
- literature information and
- 3-D structural information.

The progress in library design is to date the generation of “universal” libraries” based on the restricted availability of information of the biological target. An alternate approach is the design of sets of compounds, which contain specific pharmacophores, which might be important for activity such as size or shape. Other research groups have maximised the diversity around the framework known to be prevalent in therapeutic agents (Figure 1.3).

- How to make the library? This includes the subsections

Mixtures or single compounds

Solid phase or solution synthesis

The compound libraries are further classified into two types in terms of their diversity, random primary libraries and focussed libraries. The diversity is measured by a variety of parameters, including pharmacophores, molecular volume, molecular weight, polarity, charge, solubility and membrane permeability.

Finally a choice must be made on which of the main strategies to employ to ensure efficient synthesis of the library. In peptide synthesis, doubly functionalised monomer units are linked together by bonds. However, for the generation of a library of small organic molecules, different strategies would need to be considered. The first step in the reaction sequence could involve a compound that has several different functional groups. The subsequent reactions could then be carried out step-by-step, or all at once. Another strategy is to use reactions that change the functionality of the template prior to the addition of the next building block in the synthesis.

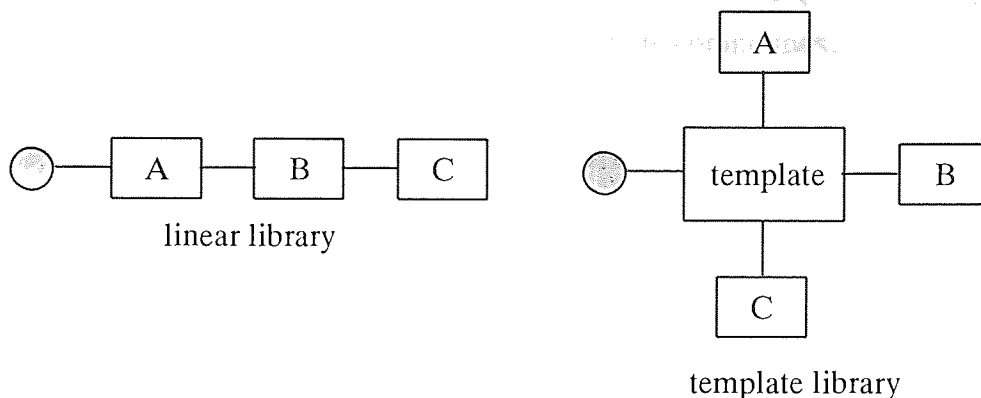

Figure 1.3: The constituent compounds in combinatorial libraries can either be linear or derivatisation of a template.

1.2.1.1. Random primary libraries

Random primary libraries are prepared when no information is available about the target, such as receptor or enzyme structure^{3,8}. With no information about the target the chance of finding active compounds in a library increases with increasing diversity, or as many different molecular shapes and sizes as possible tend to find the maximum number of active compounds⁹. Primary random libraries tend to be large and contain many different types of compounds.

1.2.1.2. Focussed/directed libraries

In another example the focussed or directed libraries are prepared when some information is available about the kind of molecule which might interact with the target, such as structural information about the substrate, ligand or inhibitor¹⁰. Any information about the structure activity relationship changes the requirements for library diversity, directing the process to produce analogues around the active structure or to link substrates in a linear pattern to optimise the original lead^{8,11}. Such compound libraries are smaller than random libraries. Often the members of such libraries will contain a specific pharmacophore, which might be important such as size or shape. Beyond these shared pharmacophore, maximum chemical diversity may be generated³.

Combinatorial libraries are created by one of these methods, split and mix synthesis to create mixtures or parallel synthesis to give discrete compounds:

1.2.1.3. Mixtures

Screening of mixtures was previously used for finding lead compounds from natural product mixtures from microorganisms and plant extracts, which often contained many hundreds of compounds.

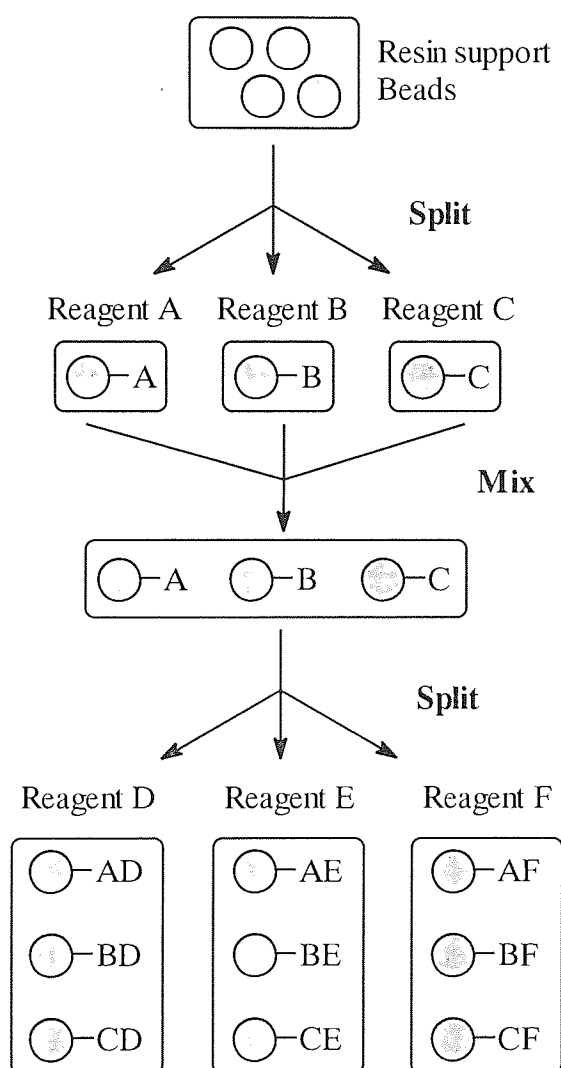

The split and mix technique was first used for peptide synthesis^{3,9,12}. In split and mix combinatorial synthesis, the compounds are linked on the surface of a resin support such as microparticles or beads and then divided into several groups. A different building block is added to each group, the different groups are combined, and then the reassembled mix is again split to form new groups. Another building block is added to each group, the groups are again combined and divided, and the process continues. This mix and split process (Figure 1.4) gives for a simple example of a 3 x 3 x 3 library 27 possible combinations of trimeric products. The reagents A, B and C are bound to a polymer and after 10 steps, nearly 60,000 (3^{10}) compounds can be prepared.

Figure 1.4: Split and Mix combinatorial chemistry

Of course, with so many different products mixed together, the problem is to identify them and in relation to the question: can a single active component be consistently identified from a mixture?

This method allows the screening of an enormous amount of compounds in a given time, however it must deliver all compounds in the mixture in approximately equimolar amounts. The detection of an active compound is not reliable any more, if the mixture contains more than 20 compounds⁹. Thus the screening of single, structurally defined molecules has a proven track record in the industry.

1.2.1.4. Single compounds/parallel synthesis

When a lead structure is identified, the time saved by working with mixtures can be wasted by the effort required to produce less complex sublibraries related to the lead compound. This process is known as "deconvolution".

Generally, the more recent method in combinatorial chemistry has been to move away from making complex mixtures. The second main approach of combinatorial chemistry is the parallel synthesis (Figure 1.5) in which each compound is prepared independently. In the parallel synthesis, the generation of compounds simultaneously results in greater quantities with relatively high purity. The testing of individual compounds from parallel synthesis may be slower than testing a mixture. This method is widely used for the analysis of active compounds and does not have the problems of positive false or negative false in the biological evaluation of compounds. From biological evaluation, the active compound can give an initial SAR (structure activity relationship).

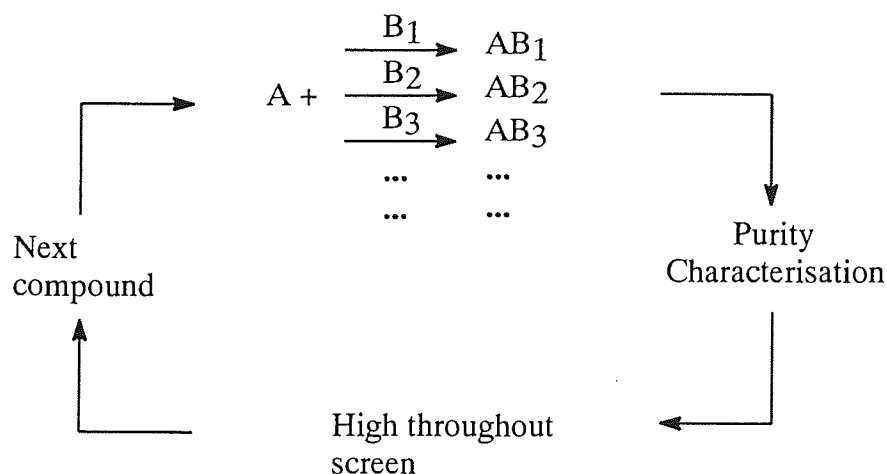

Figure 1.5: Parallel analogue synthesis

It can therefore be seen that the choice of format, i.e. whether to produce compounds within the library separately or in mixtures of a predetermined complexity, depends mainly on the type of problem faced by the operator of the experiment.

1.3. Solid phase or solution synthesis

When performing a synthesis using combinatorial chemistry methods, a choice must be made whether to perform the synthesis in solution or on solid phase. In principle, both methods can be used but the synthesis of small organic molecules on supports is not as well optimised as the synthesis of peptides.

Several key questions are important in choosing the adequate methods such as:

How many and how soon are the compounds required and on what scale and purity should the compounds have?

Since the pioneering work of Merrifield in 1963¹³ the synthesis of peptides on polymer-support (Figure 1.6) methodology was adapted by scientists to generate large numbers of compounds^{14,15} for biological screening. During organic solid phase synthesis, the molecules to be synthesised are bound to a polymeric support using a linker. The linkers can be unstable and place restrictions on the conditions under which the reactions may be carried out.

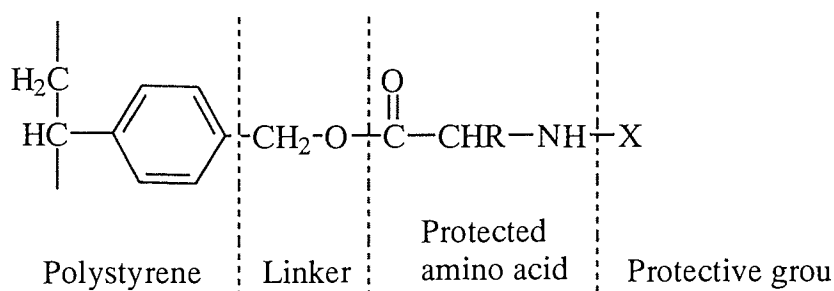

Figure 1.6: Principle of Synthesis on Solid support

For the solid phase of a library of small organic molecules, the most widely used support is the low weight polystyrene, cross-linked with 1-2% divinylbenzene.

The amino group of the initial amino acid is protected, and the carboxylate group reacts with the linker to form an ester bond, which ties the amino acid to the support.

After removal of the protective group X (e.g. Cbz, BOC or Fmoc) the second substrate is joined on by the carbodiimide method, often using dicyclohexylcarbodiimide (DIC) or diisopropylcarbodiimide (DICDI). Acidic conditions are usually required to cleave the molecule from the support and should strongly acidic conditions be used, the linker could become unstable under certain conditions. Furthermore, the solid phase chemistry is not without its problems such as low loading capacities of many resins. Reactions frequently proceed slower on solid phase, and heterogeneous reagents cannot be employed. Many resins display significant swelling and shrinking properties, which can severely affect reaction rates and site accessibility. In addition, it is generally quite labour intensive to adapt solution chemistry to the solid support and furthermore the linkers are expensive. As the result of the development of such synthesis these aspects have to be considered.

However, solid phase synthesis has many advantages over solution-based methodologies¹⁶. These include the ability to force reactions to completion using large excesses of reagents and simple purification through washing of excess reagents and impurities away from the solid support and the resulting preparation of compounds up to 10 synthetic steps. This enables automation for the whole reaction scheme, including multiple step syntheses. However, time saved from the purification process can be lost in carrying out the additional work required to attach to and cleave molecules from the support.

Synthesis in solution has also many advantages, which solid phase combinatorial chemistry does not offer. Solution-generated libraries do not require support beads and therefore reducing the cost of performing the experiment. Also the additional steps required for attachment and cleavages of the polymeric supports become obsolete. In principle, all organic reactions are possible, as the stability and reactivity of the supports and linkers do not need to be taken into account with the biggest advantage that the reaction conditions do not have to be adjusted. Solution techniques clearly have their place in combinatorial chemistry. However, lacking the advantages of rapid purification offered by solid phase chemistry and the ability to drive the reactions to completion by adding large excesses of reagents, solution-phase synthesis is usually only applied when the synthetic steps is likely to be reliable and high yielding,

The solution synthesis is applied primarily to the synthesis of single compounds in parallel synthesis¹⁷ which include not more than 1-3 synthesis steps

Recently, the use of resin bound reagents¹⁸ (scavenger resins), as well as soluble resins, which can be made insoluble for washing steps have been reported¹⁹.

These techniques will certainly add to the scope of reactions that can be employed for solution based library synthesis.

In conclusion, both solid phase and solution techniques have been shown to be useful for library generation. To give the scientist the broadest selection of available chemistries it is advisable to have the ability to carry out both types of syntheses.

1.4. Current directions

15 years ago the market for pharmaceuticals was growing between 5 and 10% per annum but recently the rate of market growth has declined. At the same time, the increased costs of pharmaceutical research have forced the investigation of methods, which offer higher productivity at lower expense.

In the early 1990s scientist and research groups started-up new biotechnology companies. Huge numbers of compounds with disregarding purity were produced. In contrast the pharmaceutical companies produce smaller libraries, which are more carefully chosen. Consequently, the medicinal chemists in industry produce more appropriate compounds rather than more compounds, but recently, the pharmaceutical companies adopted combinatorial chemistry more often in collaboration with the new biotechnology companies.

Combinatorial chemistry, automated analysis (NMR and mass spectrometers) and the biological evaluation of thousands of compounds per month, lead to the challenge of information management. The enormous rate of testing is accomplished by using robotics, bar coding, and other automation strategies at every opportunity. In coping with this enormous amount of information, the pharmaceutical companies have adopted artificial intelligence, which involves testing of "similar" commercially available compounds (and thus eliminating one traditional objective of 3D database searching)²⁰ or designing individual compounds or combinatorial libraries that capitalize on the information found in the initial screening.

Virtual compound libraries (those not physically prepared but stored in the computer) or actual compound libraries (physically prepared) were created in order to generate the chemical and biological properties of the entire library. The diversity analysis of actual compound libraries minimised the number of compounds for the screening process and thus decreased the costs.

This computational approach decreased the number of compounds to achieve the required profile for a potential drug candidate of a given biological target. Conversely the use of computed molecular descriptors, as opposed to measured physicochemical properties, often provides little insight into the actual mechanisms of interactions occurring between the ligand and the biological target. Furthermore, the knowledge of the 3-D structure of the given biological target can have a major impact in the areas of the drug discovery process for the rational design of compound libraries and the optimisation of lead compounds. However, obtaining 3-dimensional structural information of the biological target is a complex and time-consuming task. This involves growing crystals of the protein in question, and then using the "X-ray crystallography" technique to look at how the atoms are arranged within the crystal. The raw X-ray data requires a great deal of mathematical interpretation in order to solve the crystal structure. Thus, crystal structures are not available for all biological targets and restrict the application on the drug discovery process.

Other approaches include computational chemistry, such as Quantitative Structure Activity Relationship (QSAR) in finding a correlation of biological activity against a series of parameters that described the structure of a molecule²¹. The most well known and most used of these descriptors in QSAR for example has been the LOG (Octanol/Water) partition coefficient (usually referred to as LOG P). LOG P has been very useful in correlating a wide range of activities of lipophilic drugs, which have the ability to bridge the blood/brain barrier²². The sets of computed properties have been quite useful in setting up measures of molecular diversity and in designing screening libraries.

In general, artificial intelligence and the automation process is continually improved and increases the effectiveness in the drug discovery process. New applications find their place in science and often a compromise is made between traditionally and new developed methodologies.

Central nervous system disorders

The pace of life in the highly developed industrial nations leads many to become anxious and depressed in view of the high demands placed on them by their peers and society at large. The success ethic and the high price of failure contribute in no small way to this malaise. More than 20% of alcoholics and 10% of the general population suffer significantly from anxiety²³. Panic disorder occurs in about 2% of the population and is punctuated by such attacks, often following a chronic course. The phenomenon of panic, of extreme fear accompanied by physical symptoms, has had numerous descriptions and different names in the psychiatric literature.

First, Klein²⁴ proposed that “anxiety neurosis” should differentiate panic disorder (PD) from other forms of anxiety. Since then, other categories have been defined, such as generalised panic disorder (GAD, phobias (P), and post-traumatic stress disorder (PTSD). Anxiety in general is the emotional condition that is experienced by all humans. It is characterised by the unpleasant and diffuse sense of apprehension, accompanied by symptoms such as headache palpitations, restlessness, muscle pain, respiratory distress just to name a few. It is important to distinguish between fear and anxiety. Fear is considered to be the response of a threat, which is known, whereas anxiety relates to the threat, which is unknown²⁵. The common somatic symptoms of panic attacks tend to consist of palpitations, dizziness, nausea and choking.

Results of studies would seem to suggest a genetic link to the disorder and, due to the significant impairment of social functioning associated with the disorder, has caused much interest within medical research.

For determination and, for a better understanding of the emotional condition anxiety and panic researchers use substrates such as *Carbon Dioxide* inhalation²⁶ and *Sodium Lactate* infusions²⁷ or Flumazenil²⁸, a benzodiazepine derivative, which can produce anxiety or panic attacks in humans.

However, studies have led to the realisation that the underlying biochemical and pathophysiological mechanisms are more complex than was originally thought.

This thesis addresses the development of potential drug compounds relevant for the treatment of central nervous system (CNS) disorders such as anxiety, fear, analgesia or schizophrenia.

2.1. The biological target (Cholecystokinin) for the drug discovery process

A promising new approach has been suggested by the findings that fragments of the amino acid peptide cholecystokinin (CCK₄) provokes panic attacks in healthy volunteers^{29,30,31} shortly after the injection. Bradwejn et al.³² (1991) has also found that, compared to normal volunteers, patients with panic disorder had increased sensitivity to its administration.

These results have led to the conclusion that one type of CCK receptors, which occurs mainly in the brain (CCK_B receptors) are involved in regulation of anxiety and experimental results³³, with new and selective CCK_B antagonists suggests the possibility that CCK antagonists might have a role in the treatment of CNS disorders. CCK is thus widely used as biological target in order to develop new and highly selective CCK antagonists to explore the functional role of CCK.

2.2. Cholecystokinin

Cholecystokinin (CCK) is a major intestinal hormone with a key role in regulating the control of pancreatic secretion and bile release. Ivy and Oldberg³⁴ (1928) were the first to describe, “a substance released from the upper intestine and produced gallbladder contractions”.

There is considerable evidence³⁵ for a physiological role in the regulation of motor function, at various levels in the gastro-intestinal/alimentary tract. Recent advances in peptide chemistry have resulted in a greater understanding of the physiological role of these gastrointestinal hormones. An important step was the development of potent and specific receptor antagonists. Of these gastrointestinal hormones, only the gastrin and Cholecystokinin (CCK) antagonists have been tested in humans

Gastrin was the first gastrointestinal peptide that had its structure determined. It is produced by G cells, which are located in the gastric mucosa and upper small intestine. Gastrin mainly stimulates gastric acid secretion (GAS) for parietal cells and promotes the growth of gastric mucosa³⁶.

Many different structural forms of gastrin have since been discovered³⁷ and they all share the five-amino acid C-terminal that is responsible for the biological activity of gastrin (Table: 2.1). The five-amino acid C-terminal of gastrin is also common to Cholecystokinin (CCK), a structurally related gastrointestinal peptide, which, despite being similar to the C-terminal pentapeptide sequence exhibits different biological effects^{38, 39}.

Cholecystokinin (CCK) is produced by I cells of the duodenal and jejunal mucosa and exists most prominently as an eight amino-acid hormone (CCK-8). CCK has been long been recognised as having an effect on the regulation of pancreatic secretion⁴⁰ and of gall bladder contraction³⁴. Cholecystokinin has also been found in the brain, where it is widely distributed and may therefore have an effect as a neuromodulator or perhaps as a neurotransmitter.

CCK is characterised by the α -aminated terminus Trp-Met-Asp-Phe-NH₂ aminated sequence. It was initially identified as a 33 amino acid chain⁴¹ and was later synthesised⁴². Subsequent studies have revealed the existence of multiple forms^{43,44}. CCK is derived from a primary prepro-CCK polypeptide of 115 residues. After transcription, enzymatic cleavage results in the formation of many different fractions.

CCK₅₈, CCK₃₉, CCK₃₃, CCK₂₂, CCK_{8s} (sulphated), CCK_{8ns} (non-sulphated), CCK₇, CCK₅, CCK₄ all of them demonstrate biochemical activity⁴⁵. The predominant circulating form is a sulphated tyrosine residue at position 7.

CCK 8s	Asp-Tyr-[SO ₃ H]-Met-Gly-Trp-Met-Asp-Phe-NH ₂
CCK 8	Asp-Tyr-Met-Gly-Trp-Met-Asp-Phe-NH ₂
CCK 4	H-Trp-Met-Asp-Phe-NH ₂
Pentagastrin	Gly-Trp-Met-Asp-Phe-NH ₂

Table 2.1: Amino acid sequence of CCK and Pentagastrin fragments.

It is important to distinguish between the CCK tetrapeptide⁴⁶ and octapeptide (Sinvalide)⁴⁷ as shown in table 2.1. Both of them have been extensively studied, particularly in relation to food intake regulation, and have brought a great deal of confusion when it came to anxiety and panic. They have differential affinity for CCK receptors^{48,49} different distribution in both the periphery and the brain^{50,51} and have various effects on behaviour.

CCK and its receptors⁵² are also widely distributed in the central nervous system (CNS) and contribute to the regulation of satiety, anxiety, analgesia, and dopamine-mediated behaviour. Its presence in the brain was first conclusively demonstrated in 1976⁵³. Gastrin and CCK-8 have identical -COOH terminal penta-peptide sequences. Most gastrin-like activity in the brain is present as CCK-8, which exists in sulphated (CCK-S) and desulphated forms. CCK-containing neurones are widely distributed in brain. In some neurones CCK-8 coexists with other neurotransmitters.

This role of CCK in the CNS has been an area of immense investigation over the past 20 years. As a result of this hard investigation CCK has been implicated in e.g. feeding and satiety⁵⁴, pain perception⁵⁵, psychiatric diseases⁵⁶, and anxiety disorders⁵⁷. This suggests an interaction with other neurotransmitter systems. Evidence has been found for interaction of CCK with multiple receptors⁵⁸ such as dopamine (DA)⁵⁹, gamma-aminobutyric acid (GABA)^{60,61}, serotonin (5-hydroxytryptamine, HT), noradrenaline (NA) and opioid peptides^{62,63,64}. Thus, it is expected that its actions and effects are various and complex.

High affinity CCK binding sites were initially demonstrated in rat pancreatic acini⁶⁵ and the cerebral cortex⁶⁶. Derivatives of cyclic nucleotides were shown to antagonize the actions of CCK in the guinea pig pancreatic acini and ileum⁶⁵. Although, an important physiological role was recognized for CCK receptors in the periphery, the function of CCK in the brain was not well understood.

Given the location of CCK receptors, they were classified according to their position. Type *A* (alimentary) and type *B*⁶⁷ (brain). The existence of these receptors was confirmed by cloning by De Weeth et al.⁶⁸. The various CCK fragments showed different affinity for each of the binding sites, periphery and the brain. Peripheral type CCK_A receptors show the greatest affinity for sulphated CCK₈⁶⁹ and have a 100-fold lower affinity for

desulphated CCK₈ and CCK₄⁷⁰. CCK_B receptors show the same affinity for sulphated CCK₈, desulphated CCK₈⁷¹ and CCK₄ (Lee et al.⁷²).

In humans the distribution of CCK_A receptors has been found in the alimentary tract and certain regions in the brain e.g. area postrema, nucleus solitarius, hypothalamus and the vagus nerve complex. CCK_A receptors occur predominantly at the peripheral level where they are responsible for the digestive effects of CCK: intestinal and biliary smooth muscle contraction, pancreatic enzyme secretion, trophic effects on gastric and intestinal mucosa and regulation of feeding. CCK_B receptors are much more widely distributed in the CNS and high densities are present in cortical and limbic areas such as the amygdala, hippocampus and the hypothalamus. However, some brain CCK-receptors belong to the A-type, but the majority of them are CCK_B receptors. Furthermore, extensive studies⁷³ have shown the original classification was oversimplified. B type receptors have also been isolated in the periphery of rat lung cells. At the peripheral level, CCK_B receptor antagonists are active on gastrin receptors; these two receptors are similar, and to date, no compounds have been developed that will clearly distinguish between these two receptors. Experimental evidence suggests involvement of brain CCK processes in 4 domains: modulation of dopaminergic function, control of pain sensation, anxiety and memory formation. Thus, CCK_B antagonists may be useful to treat certain neuropathological conditions associated with CCK dysfunction.

In recent years specific and highly potent CCK antagonists have been developed including some that are highly selective for CCK receptor subtypes. The availability of these compounds has prompted investigations into the functional role of CCK in the brain. This has opened up new possibilities for the treatment of central nervous system disorders.

2.3. Peptide and non-peptide cholecystokinin receptor antagonists

Many scientists have discovered specific peptide and non-peptide antagonists of CCK_B/gastrin receptors. As a result, a number of new chemical entities appeared, exhibiting high selectivity for specific population of CCK_B/gastrin receptors. The various compounds under development belong to the following main chemical classes:

- Amino acid derivatives;
- Cyclic nucleotide derivatives;
- Tryptophan dipeptoid derivatives;
- Peptides;
- Pyrazolidinones;
- Ureidoacetamides;
- Ureidophenoxyacetanilides;
- Ureidomethylcarbamoylphenylketones;
- Dibenzobicyclo[2.2.2] octane and bicyclic hetroaromatic derivatives;
- Benzodiazepine derivatives and
- Ureidobenzodiazepine derivatives.

2.3.1. Amino acid derivatives

During the 1970's amino acid derivatives were found (Figure 2.1) to contain antigestrin activity⁷⁴. The chemical similarities of gastrin and CCK made it possible for such derivatives to demonstrate CCK antagonist activity. Proglumide, the first putative gastrin antagonist clinically available, has long been used in the treatment of peptic ulcers, because of its antisecretory and gastroprotective activities.

Several studies have subsequently demonstrated that proglumide is also a weak CCK_A receptor antagonist⁷⁵ and despite its low potency, it has been the reference CCK and gastrin antagonist for several years.

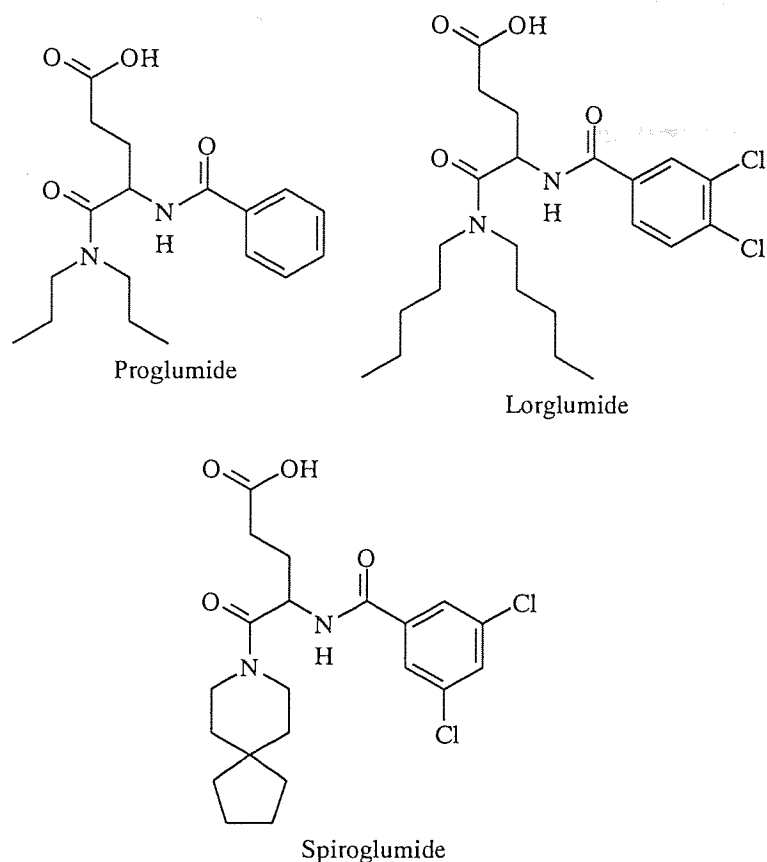

Figure 2.1: Structures of early amino acid derivatives as CCK antagonist

Rotta research group produced analogues of proglumide, which showed varying degrees of selectivity for CCK_A receptors and even suggested possible sub-types of the peripheral receptors. Some derivatives had a higher affinity for pancreatic CCK receptors mediating gallbladder contraction. Lorglumide showed up to a 26-fold increase in potency for blocking CCK-stimulated gallbladder contraction but only a two-fold increase for blocking CCK-stimulated pancreatic amylase secretion^{76,77}. Intravenous administration of lorglumide⁷⁸ antagonized the CCK-induced reduction of gastric emptying in rats, acceleration of intestinal transport in mice, increase in ileal motility in rabbits, gallbladder contraction in guinea pigs and acceleration of gallbladder emptying in mice but showed reduced activity when orally administered⁷⁸. Further structural modifications to lorglumide resulted in CR2194 (spiroglumide). Spiroglumide exhibited CCK_B/gastrin antagonist in the micromolar range, with excellent oral bioavailability.

However, it has poor selectivity for CCK_B/gastrin receptor, which raises doubts of its potential therapeutic usefulness.

2.3.2. Cyclic nucleotide derivatives

Dibutyryl cyclic guanosine monophosphate (Bt₂cGMP) was the first competitive antagonist of CCK-mediated action to be discovered⁷⁹.

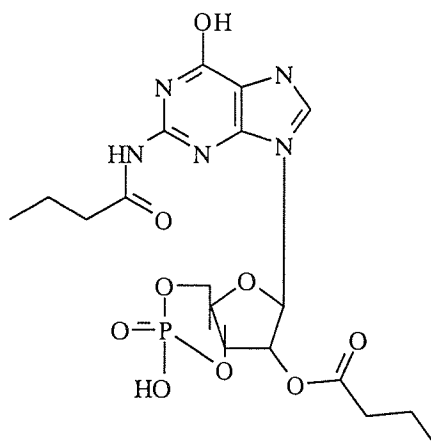

Figure 2.2: Structure of (Bt₂cGMP)

It was found to cause both reversible and selective inhibition of CCK-stimulated amylase secretion from rat pancreatic cells. Subsequently it was found to block the effects of CCK at many peripheral sites. However, Bt₂cGMP failed to inhibit CCK binding in mouse cerebral cortex⁵¹.

2.3.3. Tryptophan dipeptoid derivatives

A research group at Parke-Davis^{80,81} examined the activity of CCK-30-33 fragments in binding experiments on CCK_B/gastrin receptors. This led to the development of C1988 (Figure 2.3), which exhibited 1600-fold selectivity for CCK_B over CCK_A receptors. Structural C-terminal modifications led to alternative compounds, which demonstrated sub-nanomolar affinity for CCK_B/gastrin receptors. Compound (1) displays high affinity (IC₅₀ = 0.3 nM). Further structural modifications, to optimise the substitution on the phenyl ring of (1) led to the analogue (2). This showed exceptionally high affinity for CCK_B/gastrin receptors, (IC₅₀ = 0.08 nM) and was 940 times more selective over the CCK_A receptor.

However, due to the high molecular weight and the dipeptoid structure these derivatives have low bioavailability, and therefore, are not suitable drugs for oral therapy.

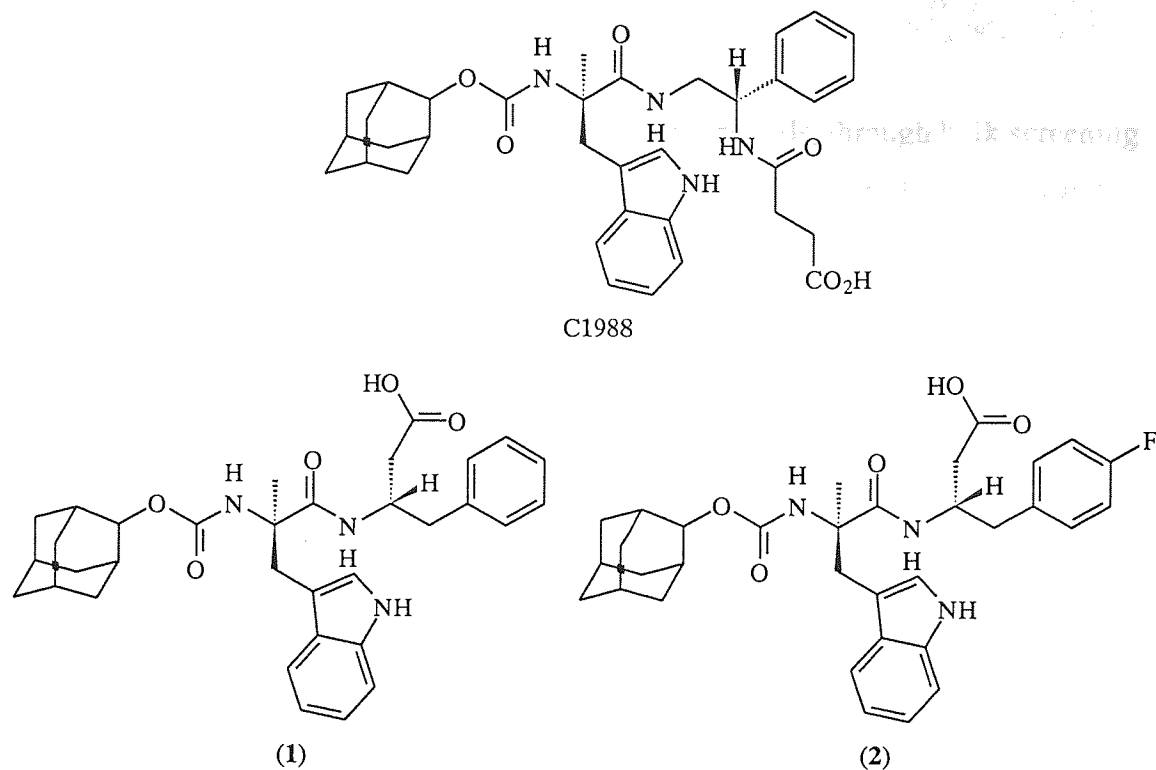

Figure 2.3: Tryptophan dipeptoid CCK_B antagonists

2.3.4. Peptides

The first CCK related peptide found to demonstrate CCK receptor agonist was CCK-27-32-NH₂. This inhibited CCK-induced pancreatic enzyme secretion. Clark et al.⁸² claimed the C-terminal phenylalanine is essential for intrinsic activity but not for binding. The L-tryptophan residue is important also for binding to both central and peripheral CCK receptors.

In another study⁸³, a synthetic peptide derivative of CCK-7, t-butyloxycarbonyl-Tyr-(SO₃)-Met-Gly-D-Try-Nle-Asp2-phenylethyl ester inhibited binding of labelled CCK-9 to both pancreatic acini and cerebral cortical membranes, in addition to blocking agonist-stimulated amylase secretion. The lack of oral bioavailability of these peptide CCK antagonists severely restricts their potential therapeutic use.

2.3.5. Pyrazolidinones

Lilly's approach of designing and optimising lead compounds, through bulk screening resulted in the novel discovery of diphenyl-pyrazolidinones. LY2888513 is a very potent CCK_B receptor antagonist, showing more than 350-fold selectivity for CCK_B receptors^{84, 85}.

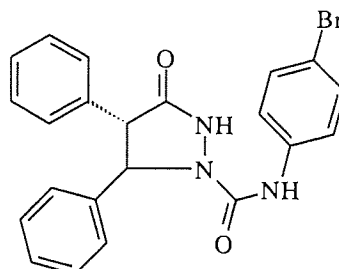

Figure 2.4: Pyrazolidinone derivative LY288513

Further development of LY288513 has been discontinued due to adverse effects in preclinical toxicological studies⁸⁶.

2.3.6. Ureidoacetamides

Developed by Rhone-Poulenc, these nonpeptide ureidoacetamides are potent and selective ligands for CCK_B /gastrin receptors. Compound RP69758 demonstrated nanomolar activity for CCK_B /gastrin receptors, whilst exhibiting 100-1000 fold selectivity for CCK_B /gastrin receptors over CCK_A receptors⁸⁷.

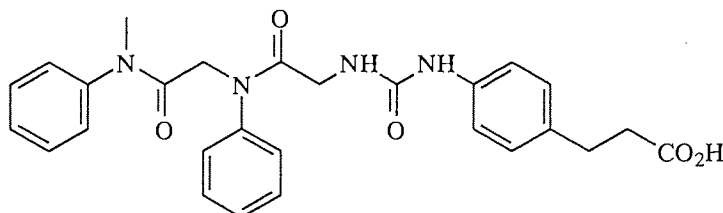

Figure 2.5: Ureidoacetamide derivative RP69758

2.3.7. Ureidophenoxyacetanilides

In order to avoid adverse effects derived from CCK_A receptor antagonist activity with gastrin/CCK_B receptor antagonists (exemplified for Proglumide, Figure: 2.1) Scientists from Japan⁸⁸ have developed a series of phenoxyacetanilide derivatives, which were linked with the ureido-phenyl moiety. The most active compound of this series is DZ-3514, which demonstrated nanomolar activity for CCK_B/gastrin receptors (0.8 nm) with 250-500 fold selectivity over CCK_A receptors.

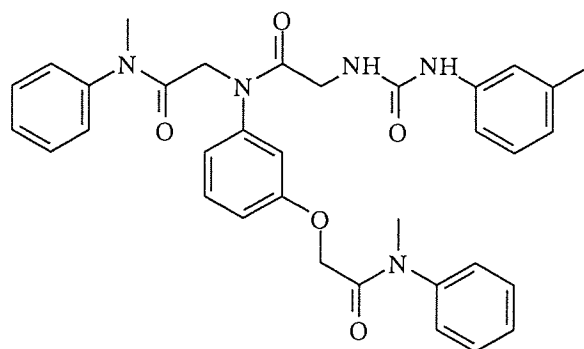

Figure 2.6: Ureidophenoxyacetanilide derivative DZ-3514

2.3.8. Ureidomethylcarbamoylphenylketones

Shiogoni has developed a series of ureidomethylcarbamoylphenylketones⁸⁹ as selective CCK_B receptor antagonists. This series of compounds exemplified by the urea, was derived by cleavage of the C-3/N-4 bond of the 1,4-benzodiazepine L-365.260 (3). The highlight of this series was S-0509 (4), which had 120-fold selectivity for CCK_B receptors over CCK_A.

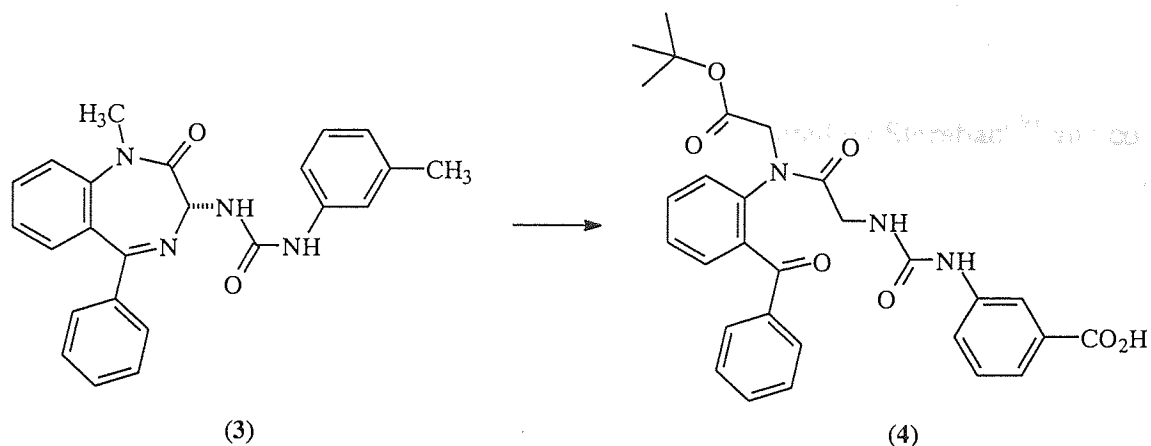

Figure 2.7: Structures of 3-ureido-1,4-benzodiazepine derivative L-365,260 (3) and ureidomethylcarbamoylphenylketone derivative S-0509 (4)

2.3.9. Dibenzobicyclo [2.2.2] octane and bicyclic heteroaromatic derivatives

Based on the dibenzobicyclo [2.2.2] octane skeleton (Figure 2.8), the James Black foundation⁹⁰ synthesised potent and selective CCK_B/gastrin antagonist. The most potent compound was (5). Given intravenously at the dose of 0.025 $\mu\text{m}/\text{kg}$ it gave a peak inhibition of 79% of GAS observed for a submaximal infusion of pentagastrin (i.e. it was at least 40 times more potent than L-365.260). Compound (6), a 5,6-disubstituted-indole derivative was the optimal compound of this new series. It totally inhibited (97%) pentagastrin-stimulated GAS in the rat, when administered intravenously at the dose of 0.025 $\mu\text{m}/\text{kg}$ and exhibited a comparable activity in the dog assay.

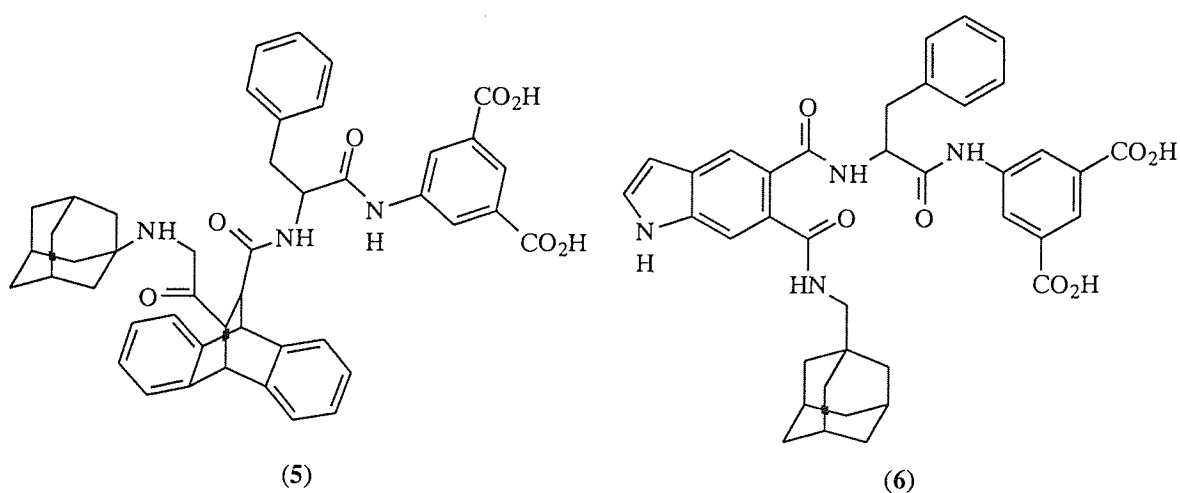

Figure 2.8: Structures of selected dibenzobicyclo [2.2.2] octane (5) and bicyclic heteroaromatic (6) CCK_B antagonists

2.3.10. Benzodiazepine derivatives

Chlordiazepoxide (INN: LIBRIUM[®], Figure 2.9) was discovered by Sternbach⁹¹ and co-workers in the mid 1950s and introduced in 1960 as the first benzodiazepine drug⁹². In the thirty years that followed the discovery of this compound an intense investigation by medicinal chemists⁹³ in search of compounds with useful anxiolytic activity has started.

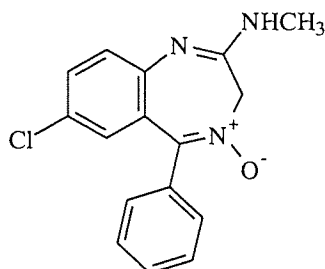
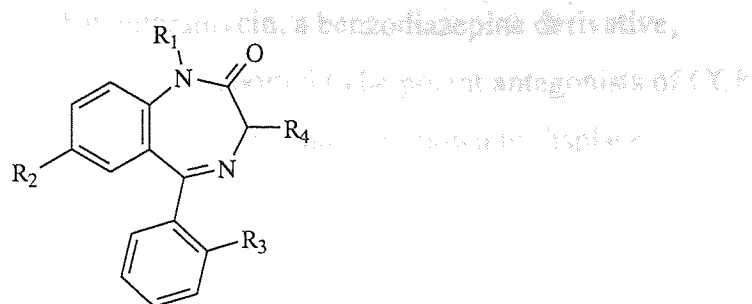

Figure 2.9: Structure of the first 1,4-benzodiazepine, LIBRIUM[®]

Benzodiazepines (BZD) are the primary agents used to treat anxiety and they are one of the most successful compound classes worldwide. Around 50 benzodiazepine derivatives have been on the market worldwide. They are all classed as anxiolytics, anticonvulsants, sedatives and muscle relaxants. They mainly act by binding to a specific regulatory site on the GABA_A (γ -amino butyric acid) receptor, thus increasing the inhibitory effect of GABA⁹⁴.

Many schemes have been proposed to classify the various benzodiazepines (Table 2.2). In pharmacokinetics, a useful framework is the categorization according to the range of elimination half-life (ultrashort, short, intermediate or long). Some authors classify the benzodiazepines as chloro- and nitrobenzodiazepines. It is also possible to classify the benzodiazepines to their pharmacological activity. It is remarkable that a “small” change of a functional group leads to different pharmaceutical categories and some agents exhibiting marked hypnotic activity. This observation stimulated a systematic study⁹⁴ of other derivatives of benzodiazepines, from which a number of these compounds have had effects on the central nervous system. The toxicity is generally very low⁹⁵, so low that the LD₅₀'s has often been difficult to determine and have not been an important factor in the pharmacological evaluation of individual compounds.



1,4-Benzodiazepine template

Compound	R ₁	R ₂	R ₃	R ₄	Therapeutic Category
Diazepam	Methyl	Cl	H	-	anxiolytic, muscle relaxant (skeletal)
Nitrazepam	H	Nitro	H	-	anticonvulsant, hypnotic
Oxazepam	H	Cl	H	OH	anxiolytic
Temazepam	Methyl	Cl	H	OH	sedative, hypnotic
Lorazepam	H	Cl	Cl	OH	anxiolytic

Table 2.2: Selected 1,4-benzodiazepines

Four main substituents groups can be modified without significant loss of activity.

The seven-membered hetero ring system is bent⁹⁶ and is essential for activity⁹⁷.

In a quantitative study on peripheral CCK receptors, chlordiazepoxide, medazepam and diazepam were shown to antagonise the contractile response to CCK in isolated guinea pig gallbladder strips^{98,99}. Although the potency of these compounds was not high, lorazepam and chlordiazepoxide also inhibited nerve mediated responses of ileal longitudinal muscle. However, benzodiazepines were very weak in displacing CCK in mouse brain (IC₅₀ = 10 μm)¹⁰⁰.

In a study¹⁰¹ from Japan it was noted that anthramycin, a benzodiazepine derivative, produced by streptomyces microorganisms were reported to be potent antagonists of CCK in mice. Anthramycin reversed CCK-8 induced satiety and was shown to displace [¹²⁵I] CCK-8 binding in different brain regions, especially in the cortex. Further investigations are underway to elucidate the pharmacological potential of this compound.

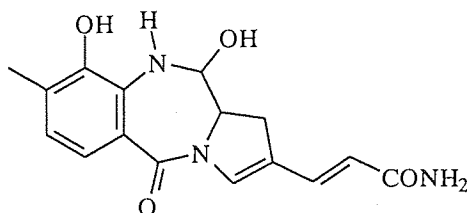

Figure 2.10: Structure of the natural 1,4-benzodiazepine derivative, Anthramycin

The discovery of Asperlicin, as already stated, was important because it led to new potent and specific CCK_A and CCK_B receptor antagonists. This new and naturally occurring benzodiazepine was isolated from the fungus *Aspergillus alliaceus*. It was discovered using an alternative approach, searching through microbial broths, using an assay technique with radioreceptors¹⁰². Asperlicin showed selectivity for CCK_A receptors and at the time of its discovery was the most potent nonpeptide CCK antagonist known (IC₅₀ = 1.4 μM pancreas binding).

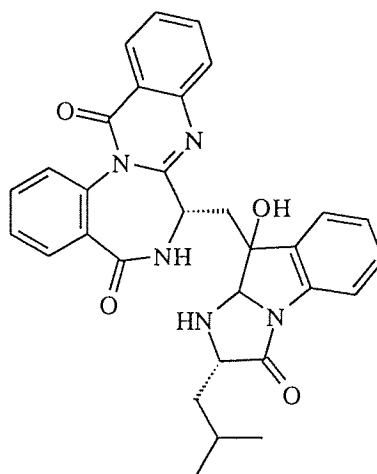

Figure 2.11: Structure of the natural 1,4-benzodiazepine derivative Asperlicin

Asperlicin represented a major advance in the development of CCK receptor antagonists. It demonstrated 300-400 times more affinity for pancreatic and gallbladder CCK receptors than proglumide. Asperlicin is therefore selective for CCK_A receptor as opposed to CCK_B or gastrin receptors. However, this compound demonstrated scarce stability and poor oral bioavailability. Many efforts to prepare Asperlicin modifications devoid of disadvantages of the parent compound were unsuccessful¹⁰³, due both to lack of oral activity and low compound potency.

By combining the elements of Asperlicin, L-364, 286 was the first successful synthetic analogue, in which the diazepam-like structure is linked with a 3-amido group.

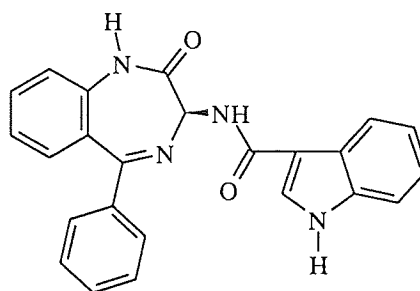

Figure 2.12: 3-amido-1,4-benzodiazepine derivative L-364, 286

New efforts to optimise the CCK_A antagonist activity of these benzodiazepine derivatives were very successful and led to devazepide (MK-329, formerly L-364,718, Figure 2.13) an extremely potent and orally active CCK_A antagonist (IC₅₀ = 0.1 nM inhibition of ¹²⁵I-CCK-8 rat pancreas binding).

This compound with longer lasting efficacy in vitro and in vivo has more than 1000-fold selectivity for the CCK_A receptor with respect to the CCK_B receptor.

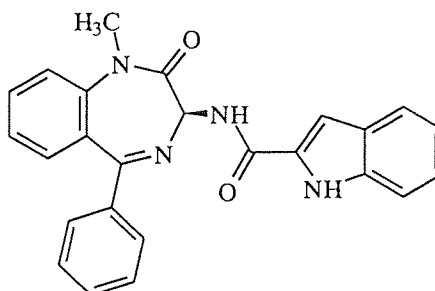

Figure 2.13: 3-amido-1,4-benzodiazepine derivative L-364, 718, MK-329/devazepide

Devazepide possess potent CCK_A blocking activity in different tissues^{104,105} pancreatic amylase secretion is antagonised with a potency of 2,000,000 times more than proglumide (Figure: 2.1). Devazepide has been claimed¹⁰⁶ to be a selective antagonist of the effects of CCK-8 (Sinicalide) on food intake. In contrast, when CCK-8, present in the intestine and brain, secreted from the gastric mucosa, it stimulates the release of both bile from the gallbladder, and the release of digestive enzymes from the pancreas¹⁰⁷. Although devazepide shows selectivity for CCK_A over CCK_B receptors it is nevertheless a potent CCK_B antagonist. Devazepide was a key tool in the autoradiographical demonstration of the presence of CCK_A receptors in the various regions of the brain¹⁰⁸. During the extensive development of L-364, 718 it was noted that some analogues lost their selectivity for CCK_A.

2.3.11. Ureidobenzodiazepine derivatives

When the 3-amido linkages were replaced with a benzamido urea, the CCK_A affinity decreased and the CCK_B affinity increased substantially. The most interesting compound developed by Merck scientists in these studies was L-365,260¹⁰⁹. L-365, 260¹⁰⁷ showed high affinity for CCK_B receptors in rats, mice and in humans. L-364, 718 was reported¹¹⁰ to have a 125 fold greater affinity for pancreatic CCK_A receptors, than for gastrin receptors. L-365,260 shows only an 80 fold greater affinity for gastrin/CCK receptors than for pancreatic CCK_A.

Both L-364,718 and L-365, 260 (Figure 2.14) were investigated¹¹¹ whether the satiety response to CCK is mediated by CCK_A or CCK_B receptors. L-365, 260 was reported to be 100 times more potent than devazepide in increasing feeding frequency and preventing satiated rats. The conclusion from the study was that endogenous CCK causes satiety by interaction with CCK_B receptors in the brain.

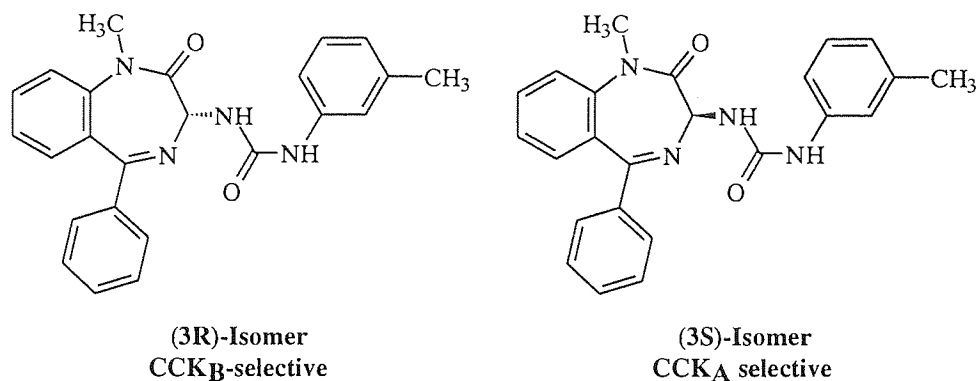

Figure 2.14: Isomers of 3-ureido-1,4-benzodiazepine derivative L-365, 260

The high affinity CCK_B-selective urea L-365,260 and related analogues is dependent upon the stereochemistry at C-3 of the benzodiazepine ring, the (3S)-enantiomer generally being CCK_A selective and the (3R)-isomer CCK_B selective¹¹². L-365, 260 shows high affinity for CCK_B receptors in rats, mice and in humans¹¹¹. Although L-365,260 is a benzodiazepine in structure, it has no affinity for GABA receptors and does not reduce tolerance and withdrawal in animal models. However, during phase 1 clinical trials it was found that L-365,260 had a limited oral bioavailability due to its low aqueous solubility and biodistribution studies in mice¹¹³ showed very low brain uptakes (<0.8% dose/gram) after intravenous injections.

One of the most potent and selective CCK_B receptor ligand is L-708,474¹¹⁴. L-708,474 (Figure 2.15) is about thirty-fold higher in affinity than the L-365,260 enantiomer (IC₅₀ = 8.5nM) at the CCK_B receptor and is markedly more selective for CCK_B receptors over CCK_A (6,500-fold v. 87-fold). The binding affinities of the cyclohexyl benzodiazepines demonstrate the importance of the size of the lipophilic substituent at C-5 of the benzodiazepine, and point to an advantage of cyclohexyl over phenyl for effective binding at the CCK_B receptor. L-708,474 (IC₅₀ = 0.28nM) was an exceptionally high affinity ligand at the CCK_B receptor. L-708,474 is considerably more potent than either the cyclopentyl (IC₅₀ = 16nM) or cyclobutyl (IC₅₀ = 29.9nM) analogues. This compound showed by increasing lipophilicity in comparison to L-365,260 an increase in potency and selectivity for CCK_B receptor but the bioavailability was reduced.

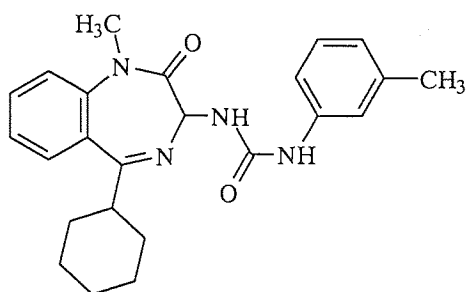

Figure 2.15: 3-ureido-1,4-benzodiazepine derivative L-708,474

Results from the phase 1 clinical trials with L-365,260 prompted Merck chemists to develop a second generation of CCK_B/gastrin receptor antagonists. By increasing a group with high water-solubility properties, the chemists at Merck hoped to increase the oral bioavailability of the new compounds, which were synthesised.

One of the compounds with increased bioavailability, synthesised by Merck^{115,116} was named L-740,093, an amidine derivative with basic character, that was found to be extremely potent. L-740,093 (Figure 2.16) showed an aqueous solubility around one hundred times greater (as HCl salt) than that displayed by the parent compound L-365,260. L-740,093 showed high CCK_B/gastrin affinity (IC₅₀ = 0.1 nM) whilst displaying excellent selectivity for the receptor subtypes, it had a CCK_A/CCK_B ratio of approximately 16000. Thus L-740,093 seems to be suitable for oral treatment in humans.

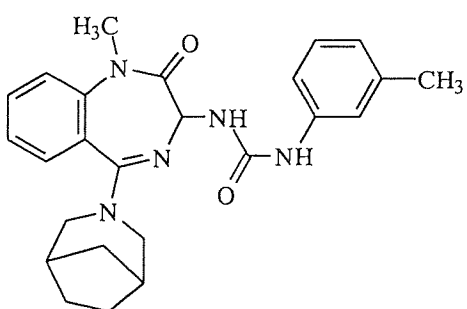

Figure 2.16: 3-ureido-1,4-benzodiazepine derivative L-740,093

Another approach to increase the water solubility of L-365,260 in order to achieve good levels of oral bioavailability, was successfully performed by incorporating acidic solubilising groups into the phenyl ring of the acylurea moiety of the parent compound¹¹⁷.

The C5-cyclohexyl derivatives incorporating aminotetrazole group (L-737,425) was the most potent and selective ($CCK_A/CCK_B = 37000$) antagonists so far reported for CCK_B /gastrin receptors (Figure 2.16). However, the preparation of this compound includes a synthetic complexity.

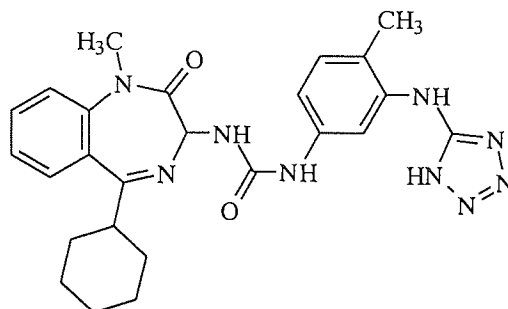

Figure 2.17: 3-ureido-1,4-benzodiazepine derivative L-737,425

A novel series of 1-arylmethyl analogues of L-365,260 was prepared and evaluated for activity as CCK_B /gastrin receptor antagonist by the Yamanouchi group¹¹⁸.

YM022^{119,120,121} has shown to be significantly more potent antagonists of pentagastrin than L-365,260. YM022 (Figure 2.18) was the optimal compound of this series, exhibiting very high CCK_B /gastrin receptor affinity ($IC_{50} = 0.11$ nM) and very good receptor subtype selectivity, the CCK_A/CCK_B ratio being about 1300. YM022 showed, compared to L-365,260, a better bioavailability and is a compromise between the lipophilicity and selectivity for CCK_B receptor. However, the improvement in potency obtained did not compensate for the increase in synthetic complexity in this series.

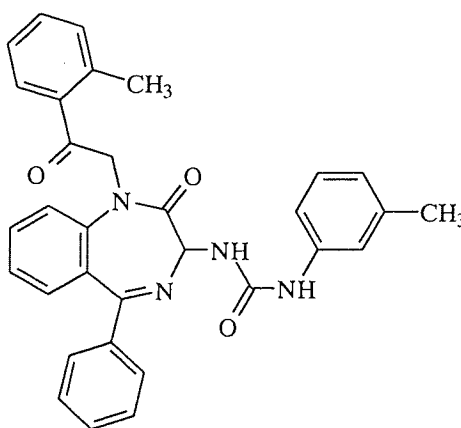
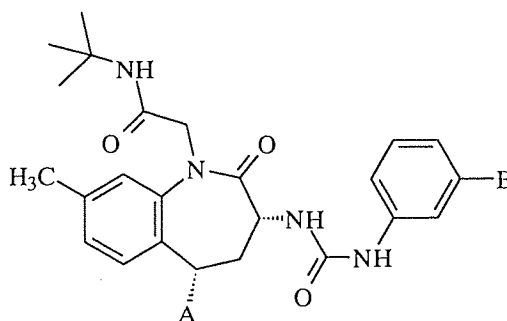

Figure 2.18: 1-benzoylmethyl 3-ureido-1,4-benzodiazepine derivative YM022

Scientists from Pfizer¹²² modified the benzodiazepine nucleus of L-365, 260 to a benzazepin-2-one moiety. These compounds demonstrate typical subnanomolar CCK_B/gastrin receptors affinity (IC₅₀ = 0.48 nM) and have a CCK_A/CCK_B ratio of 350 (Table 2.3). Compound 7 (CP212452) potently inhibited pentagastrin induced GAS, with an ED₅₀ of 0.8 mg/kg compared with 1.5 mg/kg subcutaneously for L-365, 260. Despite its potent and selective CCK_B/gastrin receptor affinity, it has poor oral bioavailability, resulting from its low water solubility. The focus of the program turned to identifying a more water-soluble derivative, and the potassium salt of the carboxylic acid derivative CP-310,713 (**8**) has improved aqueous solubility and in vivo efficacy (ED₅₀ = 0.03 mg/kg s.c in the pentagastrin induced GAS model). The discrepancy between the concentration of drug required for efficacy in the animal models was attributed to low CNS penetration of CP-310,713. In view of the efficacy and bioavailability problems Pfizer have reportedly terminated the project.

In addition Merck scientists synthesised novel ureidobenzazepines containing a basic cationic substituent at the 5-position. Compound (**9**) was the optimal molecule of the series, exhibiting relatively high affinity at the CCK_B receptor (IC₅₀ = 15.7 nM) but with low selectivity.



Compound	A	B
7	Phenyl	Cl
8	Cyclohexyl	CO ₂ H
9		Methyl

Table 2.3: Structures of selected 3-ureido-1,4-benzazepine CCK_B/gastrin receptor antagonists

A series of potent CCK_B antagonists based on the 1,5-benzodiazepin-2,4-dione skeleton possessing a C-3 ureido have been reported by Glaxo Wellcome scientist^{123,124,125} (Figure 2.19). Sterically large groups at N-1 are important for achieving high CCK_B receptor affinity and good selectivity over the CCK_A receptor, and 1-adamantylmethyl was found to be optimal.

The best compound from this series GV150013X showed affinity to CCK_B in 7.5 nm. However, based on the bulky substituent, the bioavailability was reduced but nevertheless GV150013X was selected for exploratory development in the treatment of panic attacks and anxiety.

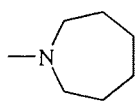
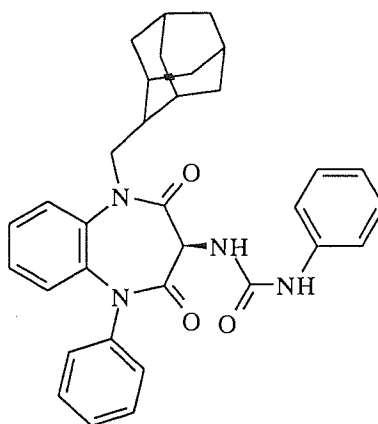
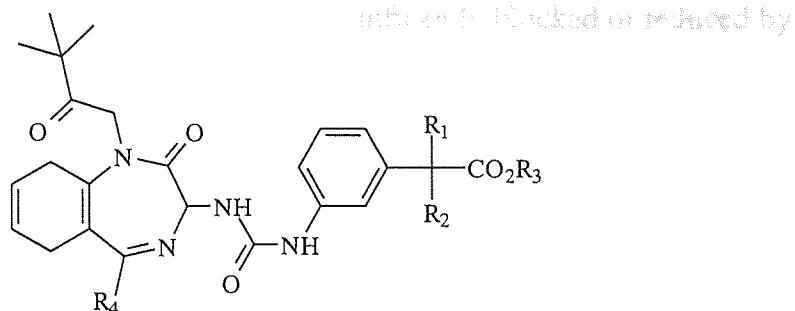

Figure 2.19: 1-adamantylmethyl-3-ureido-1,5-benzodiazepine derivative GV150013X

Recently, the company Zeria Pharma Co. Ltd claimed a patent¹²⁶ on 3-phenylureido-1,4-benzodiazepine derivatives (Table 2.4), which contains a cyclohexenyl ring, annulated to the heterocyclic seven membered ring. Information of the biological potential of the series of these compounds has not been published.



R ₁	Lower alkyl
R ₂ , R ₃	H or lower alkyl
R ₄	Cyclohexyl or phenyl

Table 2.4: Structures of recently developed 3-ureido-1,4-benzodiazepine derivatives

2.4. Summary

Cholecystokinin¹²⁷ (CCK) a 33 amino acid peptide and its various circulating forms act both as a central neurotransmitter/neuromodulator and as a gut hormone¹²⁸. Its peripheral effects are mediated mainly through the A receptor subtype, while the central effects are correlated with the B receptor subtype¹²⁹.

The CCK receptors are involved in many pathological situations, and their antagonists may possess great therapeutic potential in humans. The improvement in potency, specificity, oral-bioavailability and low toxicity of new CCK antagonists has increased hopes of producing therapeutically useful compounds.

Agents which possess CCK_A blocking activity shows effects on food intake; they stimulate the release of both bile from the gallbladder, and the release of digestive enzymes from the pancreas¹⁰⁶. These inhibitors might have a therapeutic use for the treatment of diabetes melitus and chronic pancreatitis.

The CCK_B receptor is involved in many pathological situations as well, and amongst these, anxiety and panic are particularly relevant targets for therapeutic interventions.

The best evidence that CCK is strongly related to panic attacks is based on experiments in which CCK₄ was administered to healthy volunteers who panicked shortly after the

injection¹³⁰. Those physiological reactions were significantly blocked or reduced by administration of selective CCK_B antagonists¹³¹.

Peptides and non-peptides as CCK_B antagonist has been developed by research groups and pharmaceutical companies. However, peptides as CCK antagonists have their own particular difficulties. This include metabolic lability and poor oral absorption and would seem to be far from perfect therapy and further work is needed to eliminate these complications.

Non-peptidal analogues might circumvent these liabilities and academic research groups as well as pharmaceutical companies have synthesised numerous different compound classes. Most of these compounds contain the phenylurealyl moiety, which might be responsible for CCK activity¹³².

Merck scientists have chemically modified the low-toxic benzodiazepine template. The 3-amido and 3-ureido benzodiazepines are the most outstanding non-peptidal CCK antagonists. These compounds have changed successfully a GABA_A/benzodiazepine receptor-selective benzodiazepine, such as Diazepam into a CCK_A and CCK_B/gastrin selective antagonists. MK-329 or Devazepide (Figure 2.13) was the first purely synthetic 3-amido-benzodiazepine which is a CCK_A antagonist. The change from an amido to the urea linkage resulted in the CCK_B selective antagonist L-365.260 (Figure 2.14). Although this potent and selective compound had shown limited oral bioavailability due to its low aqueous solubility it served as a lead structure¹³¹ and was excessively modified to enhance its bioavailability¹¹⁹ and cationic amidines¹¹⁷ have been introduced at the 5-position of the benzodiazepine template (Figure 2.16). Yamanoushi¹¹⁸ developed 1,4-benzodiazepines further by various alkylation reactions¹²⁰ (Figure 2.18) and other major pharmaceutical companies claimed patents on compounds, which are ureas but contain a 1,5-benzodiazepine¹³³ (Figure 2.19) or an azazepine¹³⁴ scaffold (Table 2.3).

2.5. Aims and Objectives

This thesis addresses the development of multi-substituted 1,4-benzodiazepines as potent and selective cholecystokinin antagonists and seeks to establish if these compounds might show CCK binding such as 3-amido or 3-ureido-1,4-benzodiazepines.

While the preparation of 3-amido or 3-ureido-1,4-benzodiazepines includes the synthetic complexity^{120,135,136}, the easy chemical accessibility of substituted 1,4-benzodiazepines was an important task.

This class of 1,4-benzodiazepines has a privileged template, because of their low toxicity rate and are thus ideal for the drug discovery process. However, the classical 1,4-benzodiazepines bind with high affinity to the GABA_A/benzodiazepine receptor complex^{64,137,138}. In order to avoid the resulting side effects such as sedation and tolerance, common with GABA_A/benzodiazepine binding, the drug discovery process is focused on the development as CCK_B antagonist for the possible treatment of anxiety and panic. As reported these side effects were absent for CCK_B antagonists even at high doses of the drugs¹³⁹. However CCK receptors are localised with other multiple receptors⁵⁸ and the known interaction of CCK with GABA^{64,140} has to be taken into account.

For the drug discovery and lead optimisation process the essential parts for enhanced bioactivity of CCK_B selective 3-ureido-benzodiazepines as well as the essential parts of the 1,4-benzodiazepine family, which binds to the GABA_A/benzodiazepine receptor complex were considered. In accordance with biological results the CCK antagonist potencies of benzodiazepines depend critically on the 3-position of the benzodiazepine skeleton¹¹⁰. Furthermore, as reported a cyclohexyl group, instead of a phenyl group on the 5 position of 3-ureido-benzodiazepines has shown a much higher activity. The N₁ alkylation with esters and ketones, especially with the t-butyl ketone¹⁴¹ has enhanced bioactivity of 3-ureido-benzodiazepines, whereas a substituent on the N1 position block GABA_A binding¹⁴². Finally, the 1,4-benzodiazepine family (Table 2.2) shows enhanced binding to the GABA_A/benzodiazepine receptor complex by an electron-withdrawing group at position 7. Based on all these information multi-substituted 1,4-benzodiazepines were generated, which contain specific pharmacophores on the relevant 1, 3, 5 and 7-position.

These pharmacophores might be important to exhibit bioactivity, such as size, shape, hydrogen bond donors, hydrogen bond acceptors, positive charge centres, aromatic ring centres or hydrophobic centres as illustrated in figure 2.20.

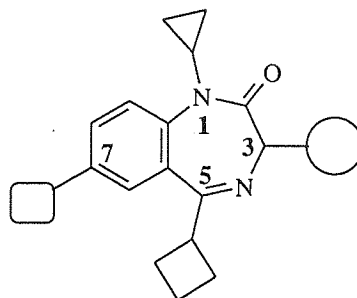

Figure 2.20: Design of 1,4-benzodiazepine derivatives on the basis of pharmacophores

In order to accelerate the drug discovery process in finding the optimal lead structures as potent and selective CCK antagonist, the solid phase organic chemistry (SPOC) will be used, to generate systematically a library of numerous structural different derivatives by using sets of “building blocks”. The combinatorial library will be then evaluated in a CCK radiolabelled binding assay in finding the optimal lead structures for CCK_B (brain) and also CCK_A (alimentary) as well from the series of structural different analogues. The biological evaluation on both CCK receptor subtypes might lead to a better understanding for the essential structural parts of multiplied and substituted 1,4-benzodiazepines as selective CCK antagonists.

For the lead optimisation process the classical synthesis in solution is a useful tool for the preparation of the 1,4-benzodiazepine template of CCK selective compounds, which will be further chemically, modified by alkylation reactions on the N-1 position. The combination of both methodologies, the solid and solution phase syntheses might led to successful and biological identification of the lead structure as a CCK antagonist.

Finally, a suitable chemical route should be developed in order to provide sufficient quantities of selective CCK lead structures for further *in vivo* evaluation.

Results and Discussion

Chapter 3

Synthesis of 2-Aminophenylcyclohexylketones

Certain structures might have the capacity to interact effectively with multiple receptors¹⁴³. The classical 1,4-benzodiazepines, which are known as effective tranquillisers, muscle relaxants, anticonvulsants and hypnotics¹⁴⁴, binds with high affinity to the GABA_A/benzodiazepine receptor complex⁶¹. For the drug discovery and lead optimisation process the known interaction of CCK and GABA^{61,140} was considered, in order to distinguish the affinity of specific multi-substituted 1,4-benzodiazepines between the receptors.

According to the literature¹¹⁴ the C5-cyclohexyl 3-ureido benzodiazepine (**10**) as presented in figure 3.1, has a thirty-fold higher activity to the CCK_B receptor than its parent compound the C5-phenyl analogue L-365,260 and was markedly more selective for CCK_B receptors over CCK_A. This data suggests that the cyclohexyl ring provides a more complementary fit at the CCK_B receptor than the phenyl ring and also that the saturated ring is more discriminating against the CCK_A receptor.

Furthermore, the tranquillising effects on the GABA receptors^{142,145} of the 1,4-benzodiazepine (**11**) family are generally increased through an electron-withdrawing group (nitro, chloro) at position 7, and through an o-fluoro/chloro substituted phenyl rings on the 5-position of the 1,4-benzodiazepine skeleton (Figure 3.1).

In order to furnish 1,4-benzodiazepine derivatives with the desired substituents on the 5 and 7-position of the heterocyclic seven-membered ring system, 3 aromatic 2-aminophenylcyclohexylketone derivatives (**14**, **15**, **16**), as presented in figure 3.2, were prepared either by Grignard or Friedel-Crafts reaction sequence, as they were not readily available. Compound **14** was used for the drug discovery process and the lead optimisation process (Chapters 4 and 8.1), whilst the compounds **15** and **16** were used for the lead optimisation process (Chapter 8.1).

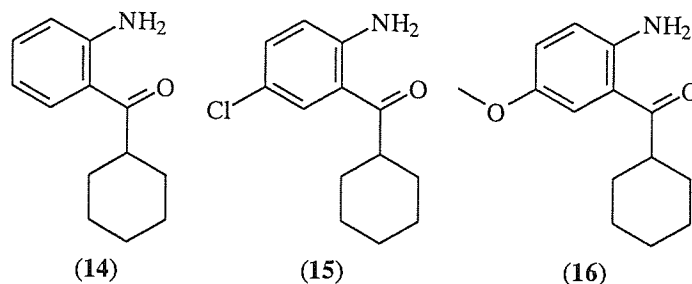

Figure 3.2: 2-Aminophenylcyclohexylketone derivatives (synthetic targets) used as starting materials for substituted 1,4-benzodiazepines

3.1. Planing of the synthesis strategy

(Retrosynthesis of 2-aminophenylcyclohexylketone derivatives)

In contrast to the synthesis of 2-aminophenylketones with the cyclohexyl ring, numerous preparations are described in the literature¹⁴⁸ for 2-aminobenzophenone derivatives. In designing a synthesis of the desired target compounds, based on commercially available aromatic starting materials, two different disconnecting approaches were devised, which are briefly summarised in figure 3.3.

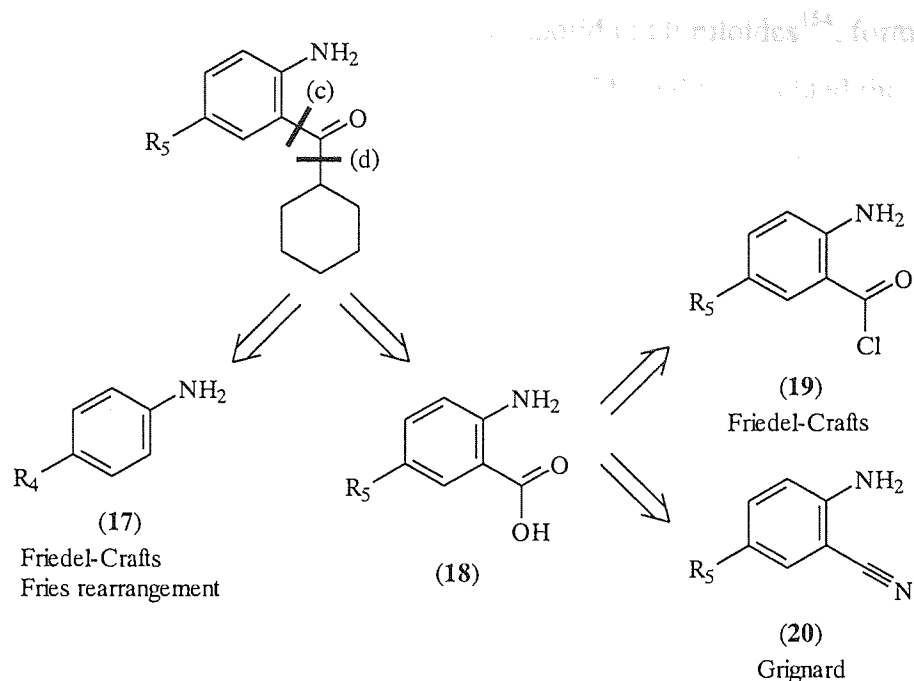

Figure 3.3: Disconnection approach for 2-aminophenylcyclohexylketone derivatives

One useful disconnection approach of the target compounds is between the ketone carbonyl group and the aromatic ring system (c), which corresponds to the Friedel-Crafts Acylation¹⁴⁹. As reported Friedel-Crafts acylation of anilines gives 4-substituted acylanilides almost exclusively¹⁵⁰, thus the Friedel-Crafts reaction is the applicable, regio-specific method, when p-substituted starting materials (17) are used. This approach might furnish the desired orthoacylated products by intramolecular “Fries rearrangement”¹⁵¹ at high temperatures, using 4-substituted anilines and cyclohexanecarboxylic acid chloride.

Another disconnection approach is between the ketone carbonyl-group and the cyclohexyl ring system (d), which corresponds to another Friedel-Crafts reaction for the preparation of 2-aminobenzophenone derivatives using 1,2-disubstituted benzene derivatives such as benzoyl chloride derivatives¹⁵² or 2-aminobenzoic acid chloride¹⁵³ (19) and benzene derivatives. However, this preparation method is not applicable for the preparation of 2-aminophenylcyclohexylketone derivatives by using cyclohexane. Another approach is the Grignard reaction, if 1,2-disubstituted benzene derivatives, for example, anthranilic nitrile (20) or protected anthranilic acid (18), are used.

It is noteworthy, that for the adequate preparation of nitro group containing starting materials instead of the presented aromatic amino starting materials may be used, in order to avoid the use of protecting groups of the aromatic amines.

However, it was reported that even yeasts, *Rhodospiridium toruloides*¹⁵⁴, formed 2-aminobenzhydrol (**22**) from 2-aminobenzophenone (**21**) and highlighted the sensitivity of the ketone group as shown in figure 3.4. Furthermore, the ketone group of the aromatic 2-aminophenylketone derivatives is an essential part for the successful condensation with α -amino acid esters to generate 1,4-benzodiazepines¹⁵⁵ via the imine formation.

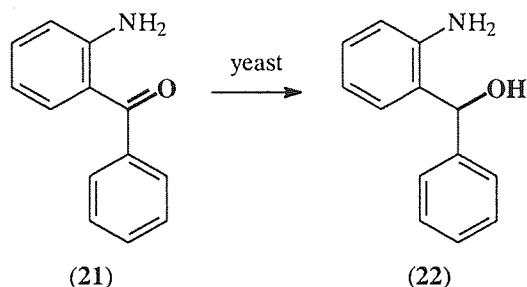

Figure 3.4: Reduction of 2-aminobenzophenone to 2-aminobenzhydrol by yeast

Analogous results have been obtained in an initial attempt, in which the nitro group of 2-amino-5-nitrobenzophenone has only been reduced successfully by hydrogen in the presence of Raney nickel, in contrast to the catalysts platinum or palladium, which afforded the analogue, 2,5-diaminobenzhydrol. According to these results, the syntheses of the desired 2-aminophenylcyclohexylketone derivatives were carried out with starting materials bearing the aromatic amino group.

3.2. Synthesis of 2-aminophenylcyclohexylketone derivatives

3.2.1. Grignard reactions

The preparation of the desired 2-aminophenylcyclohexylketones by Grignard reaction sequences resulted from comprehensive studies in which protected anthranilic acid and anthranilic nitrile derivatives were used as aromatic starting materials.

According to a published method by Lothrop and Goodwin¹⁵⁶, the Grignard reaction sequence (Scheme 3.1) was carried out by using anthranilic acid (**23**) for the preparation of the target compound (**14**).

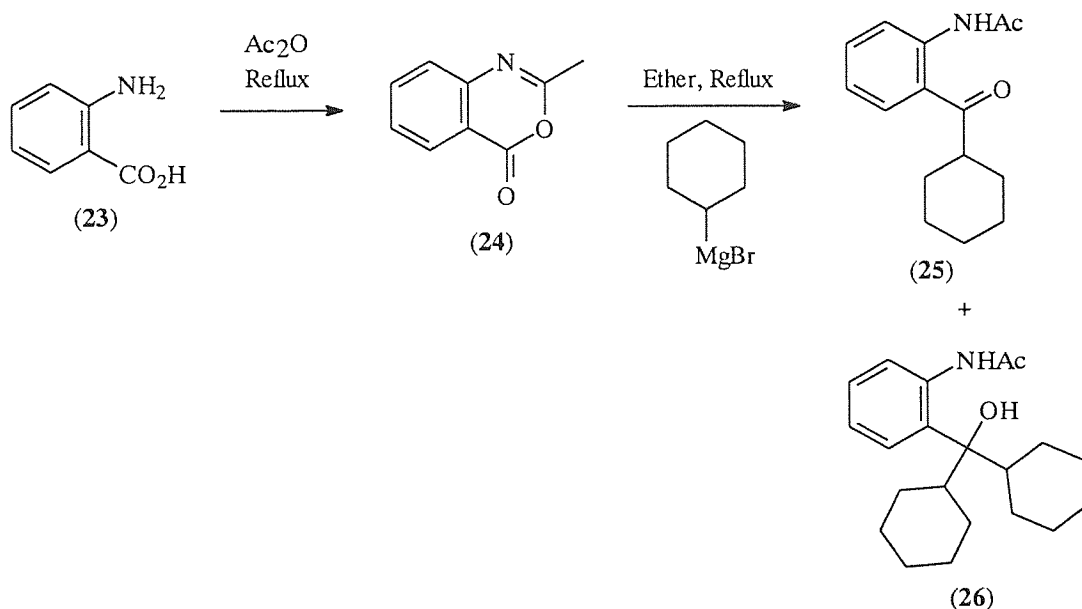

Scheme 3.1: Failed Grignard reaction sequence for the preparation of 2-aminophenylcyclohexylketone

Anthranilic acid (**23**) was converted to 2-methyl-4H-3,1-benzoxazin-4-one (**24**) with 10 eq. of acetic anhydride under reflux for 4 hours in almost quantitative yield. However this starting material (**24**) formed with 3 eq. of cyclohexylmagnesiumbromide the desired acetamido ketone (**25**) in only moderate yields and the main products formed were probably carbinol derivatives (**26**). The formation of these by-products is described widely in the literature^{155,156,157}. The variation of this preparation method by using 1.1 eq. of cyclohexylmagnesiumbromide reduced the formation of these by-products, but unfortunately the yields of the desired acetamido ketone (**25**).

The second approach (Scheme 3.2) involved the successful preparation of 2-aminophenylcyclohexylketone (**14**) in two steps by using the starting material 2-aminobenzonitrile (**27**).

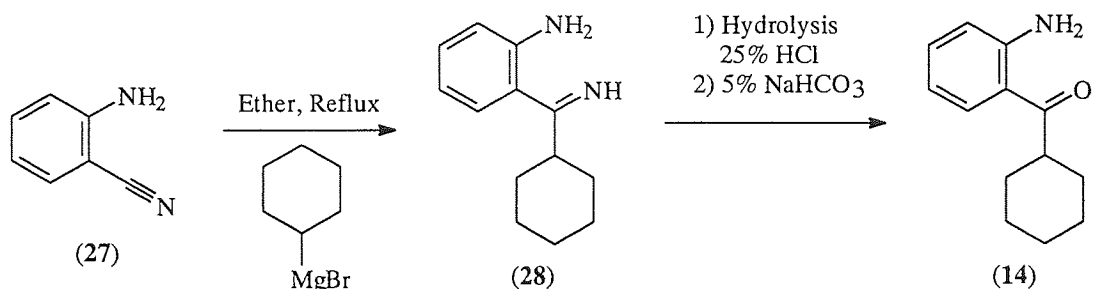

Scheme 3.2: Synthesis of 2-aminophenylcyclohexylketone via Grignard synthesis sequence

2-aminobenzonitrile (**27**) was reacted with 3 eq. of cyclohexylmagnesiumbromide in anhydrous ether under reflux and furnished 2-aminophenylcyclohexylketimine (**28**) in 38% yield. For workup, (**28**) was hydrolysed by warming overnight with a mixture of toluene and 25 % HCl (1:1). The desired product (**14**) was obtained as a free base by addition of 5% sodium bicarbonate solution in almost quantitative yield based on (**28**). The variation of the reaction, e.g. the change of the solvent (THF) did not effect the yields.

The Grignard reaction using 2-aminobenzonitrile led to the desired product in 38% yield without any formation of the carbinols and showed the high chemo-selectivity of this synthesis sequence using nitrile-bearing reagents.

Based on these results 5-chloro-2-aminophenylcyclohexylketone (**15**) was prepared in 32% yield according to this approach of the Grignard reaction sequence by using the readily available 2-amino-5-chlorobenzonitrile as summarised in scheme 3.3.

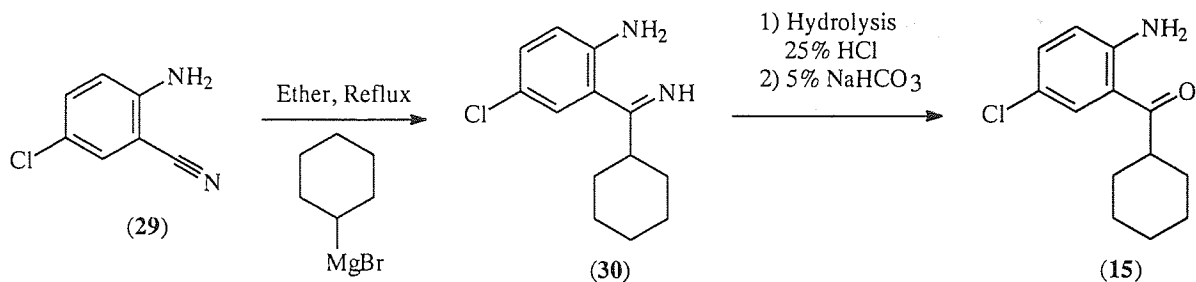

Scheme 3.3: Synthesis of 5-chloro-2-aminophenylcyclohexylketone via Grignard synthesis sequence

2-amino-5-chlorobenzonitrile (**29**) formed an analogue with cyclohexylmagnesiumbromide in anhydrous ether under reflux via the ketimine (**30**), which was hydrolysed to give the desired product (**15**) as a free base by addition of 5% sodium bicarbonate solution.

Unfortunately for the preparation of the desired 5-methoxy-2-aminophenylcyclohexylketone (**16**), the starting material 2-amino-5-methoxybenzonitrile was not commercially available.

3.2.2. Friedel-Crafts reactions

For the preparation of the desired 2-amino-5-methoxyphenylcyclohexylketone (**16**) the Friedel-Crafts reaction sequences was used because the starting material p-anisidine was commercially available.

The preparation of this compound via the Friedel-Crafts reaction sequence, according to the ‘‘Fries rearrangement’’¹⁵⁸ (Scheme 3.4) has been initially investigated. However, this published preparation method¹⁵⁹ was less convenient and has shown limited success.

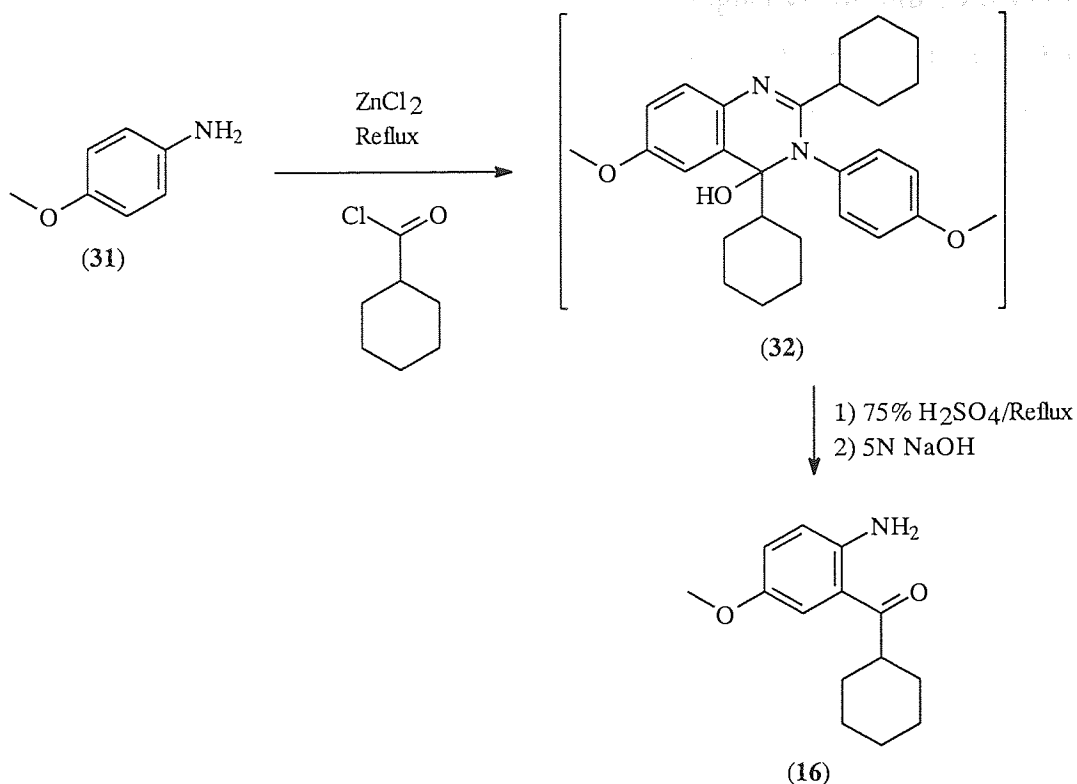

Scheme 3.4: Friedel-Crafts reaction according to “Fries rearrangement”

The reaction conditions were very drastic, namely, heating of p-anisidine (**31**) with 2 eq. of cyclohexanecarboxylic acid chloride, prepared by cyclohexanecarboxylic acid and thionyl chloride under reflux, in the presence of 2.5 eq. of ZnCl_2 at 200 to 230°C for 2–3 hours. This reaction afforded the dimer¹⁵⁹ (**32**) of the orthoacylated product. This intermediate reaction product was not isolated and has shown to split by energetic acid hydrolysis¹⁵⁹ under reflux for 18 hours using a mixture of 75% conc. sulphuric acid in ethanol. However, the desired product (**16**) was obtained in only 7-10% yields. Variations of this preparation method, e.g. the use of equivalent amount of both substrates in order to avoid the formation of the “stable” dimer or the use of different Lewis acids, such as AlCl_3 or BiCl_3 ¹⁶⁰ did not increase the yields.

In order to furnish the desired target compound (**16**) in higher yields, other Friedel-Crafts reaction methods^{161,162} were adopted and further developed. This preparation method, which is outlined in scheme 3.5, led to the target compound in almost 30% yield and involved the protection of the starting material anisidine (**31**) by acylation with 10 eq. of acetic anhydride under reflux to N-acetanisidine (**33**).

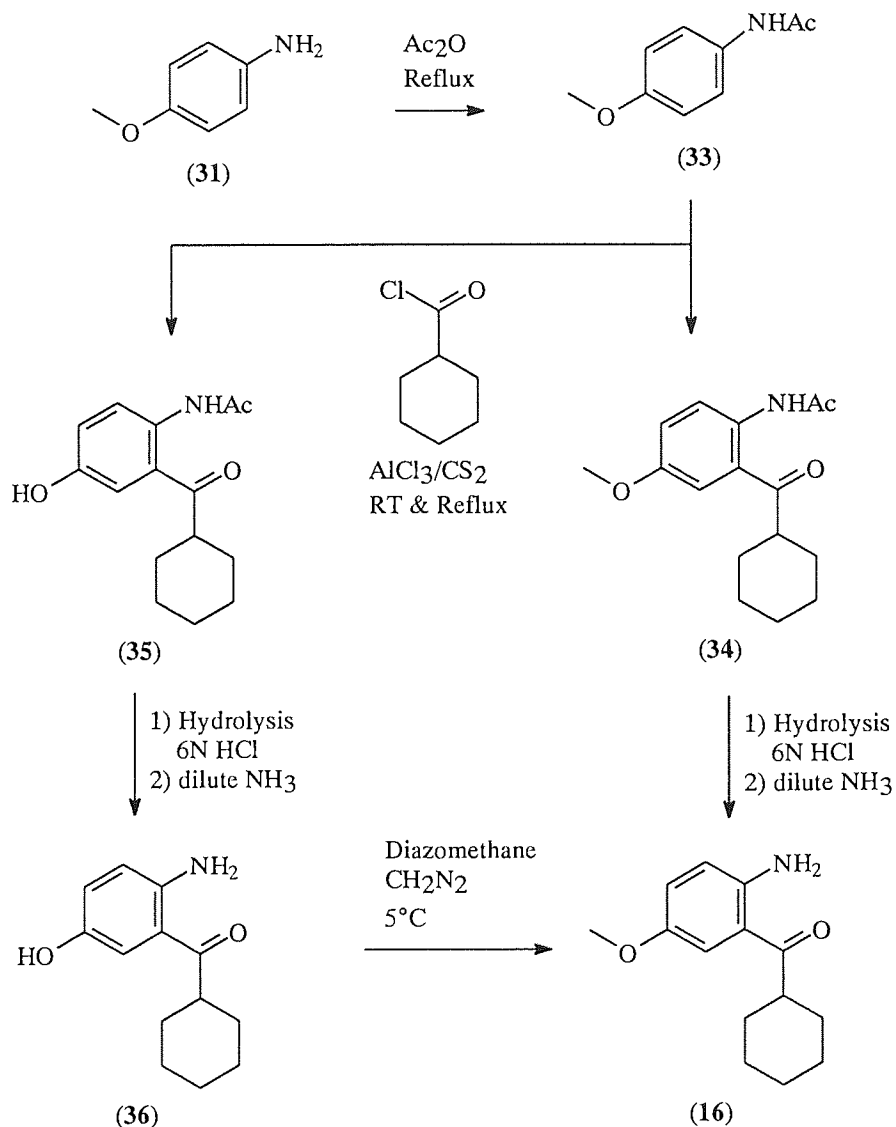

Scheme 3.5: Preparation of 5-methoxy substituted 2-aminophenylketones via Friedel-Crafts reaction sequence

The condensation of N-acetanisidine (**33**) with 1.25 eq. of cyclohexanecarboxylic acid chloride in carbon disulfide under reflux using 1.75 eq. of aluminium chloride as a catalyst afforded (**34**). However, the simultaneous formation of the 7-hydroxyl-2-acetamido compound (**35**) was observed. The demethylating effect by using aluminium chloride has been reported by Sternbach and co-workers^{161,162}. The protecting groups of both products were split completely by acidic hydrolysis under reflux yielding the desired product (**16**) in approximately 25% yield and in 5% yield of the identified demethylated 2-amino-5-hydroxyphenylcyclohexylketone (**36**). In order to increase the yield of the desired product (**16**) a mixture containing both products in ether was treated with an excess of diazomethane at 5°C, which yielded on methylation of compound (**36**) to (**16**). ¹H-NMR studies showed the characteristic signal for the methoxy group at $\delta = 3.8$ ppm.

Several variations of the reaction conditions such as solvents (1,2-dichloroethane, THF) and the use of different Lewis acids (BF₃, FeCl₃), in order to avoid the demethylating effect caused by aluminium chloride, led significantly to decreased yields. Furthermore the presented preparation method, which involved the protection of anisidine by acylation with acetic anhydride to N-acetanisidine (**33**), avoided the necessity of using p-toluenesulfonyl chloride as a protecting group as reported in the literature¹⁶¹. Difficulties in removing this large and relatively inert group by hydrolysis afterwards have been observed in an initial attempt and moderate yields of the target compound (**15**) were obtained, which might be caused by this bulky protecting group.

The Grignard and Friedel-Crafts reactions were presented for the preparation of the desired 2-aminophenylcyclohexylketone derivatives (**14**, **15**, **16**), which were dependent on the commercial available starting materials. The furnished target compounds will furnish novel 1,4-benzodiazepines with specific substituents on the 5 and 7-position. These substituents might play a role in the bioactivity of substituted 1,4-benzodiazepines as CCK antagonists with decreased activity on the GABA_A/benzodiazepine receptor complex.

Chapter 4

Solid Phase Synthesis of Multi-Substituted-1,4-Benzodiazepines and their Evaluation as Non-peptidal Cholecystokinin Antagonists

The combinatorial approach was pursued, which is the recognised methodology in finding the optimal compound from a series of structural different analogues for the specific biological target. This chapter describes the lead discovery process for CCK_A and CCK_B antagonists.

Without having the resources of a major pharmaceutical company, it was considered that the most efficient way to fully explore the SAR of the benzodiazepine template, a solid phase combinatorial approach¹² may be useful in the search for a lead structure. For the generation of a combinatorial library, the synthesis sequences should furnish the desired compounds in high yields, allow the high diversity of benzodiazepine derivatives preferably without formation of the by-products. The synthesis on solid support offers the ability to force the reaction to completion by the addition of excess reagents, and is able to remove all the unwanted materials by the simple Solid Phase extraction¹⁶³.

4.1. Considerations for the generation of the benzodiazepine library

The metabolic lability as well as the poor oral absorption of peptide lead to the investigation of non-peptidal benzodiazepines which might circumvent these liabilities.

The low-toxic 1,4-benzodiazepines are an important class of privileged templates, and numerous derivatives have been identified that have selective activities against a diverse range of biological targets. Here, multi-substituted benzodiazepines were generated combinatorially^{7,164} and biologically evaluated as CCK_A and CCK_B antagonists under the aspect of chemical stability, diversity and selectivity of the biological target. In order to achieve the high diversity, the library was built-up by using the substrates 2-aminobenzophenone or 2-aminoacetophenone and the protected amino acids.

It was known, that the highest affinity to CCK_B receptors had shown 3-ureidobenzodiazepine, which includes unsaturated aryl rests on the position 5 such as L-740,093. Thus, the previously synthesised 2-aminophenylcyclohexylketone was used. Furthermore, typical benzodiazepines, such as Diazepam, are known to undergo a number of biotransformations⁹⁵ on which N1 demethylation and C3 oxidations are characteristic. Benzodiazepines are mainly excreted as their polar and inactive 3-glucuronide derivatives. In order to achieve the combinatorial approach for stable 1,4-benzodiazepines, a hydrocarbon residue on C-3 was considered for chemical stability. The 3-phenylureido-benzodiazepines may lack this stability and in the example of Merck's L-365,260, which shows respective CCK_B activity *in vitro* but no potency *in vivo* indicates a probable metabolism by the enzyme *urease* with the loss of the tolyl-urea moiety to a 3-unsubstituted benzodiazepine.

4.1.1. Published solid phase methodologies

As known solid phase synthesis is not without its difficulties, thus several published approaches have been considered. According to the disconnection of 1,4-benzodiazepines (Figure 4.1) two different strategies for the combinatorial approach on solid support have been originally invented by Ellman¹⁶⁵ and Champs¹⁶⁶/Hobbs de Witt¹⁶⁷.

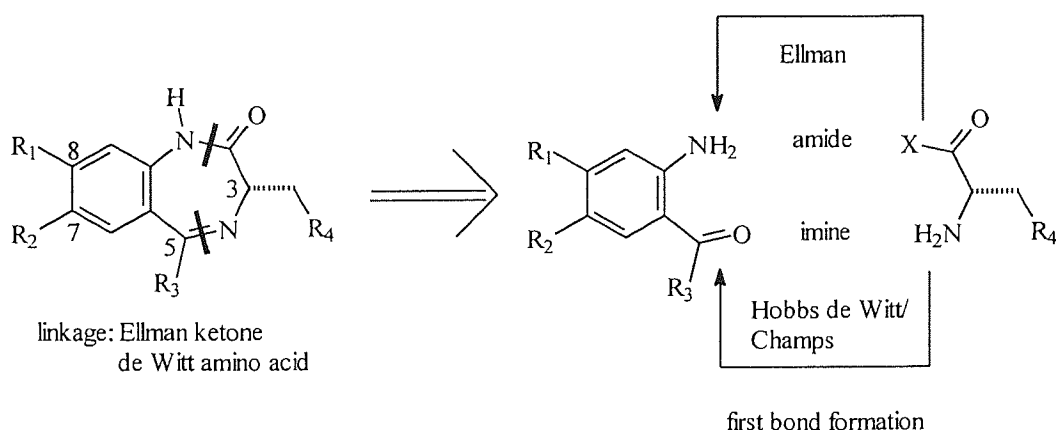

Figure 4.1: Retrosynthesis of 1,4-benzodiazepines

The used abbreviations for the variety of 1,4-benzodiazepines, demonstrate the substituents in the specific positions (3, 5, 7, 8) around the benzodiazepine skeleton.

In 1974, F. Camps et al.¹⁶⁶ reported the first application of the solid phase method for 1,4-benzodiazepines (Figure 4.2).

In this limited study Boc-glycin was linked in the first step to the hydroxyl moiety of the polymer support 2-poly-stryryl-ethanol or poly-p-vinylphenol by using N,N' -carbonyl diimidazole (Im_2CO). Subsequent reaction with excess of 2-aminobenzophenones in refluxing pyridine yielded the corresponding 1,4-benzodiazepines via the imine intermediates.

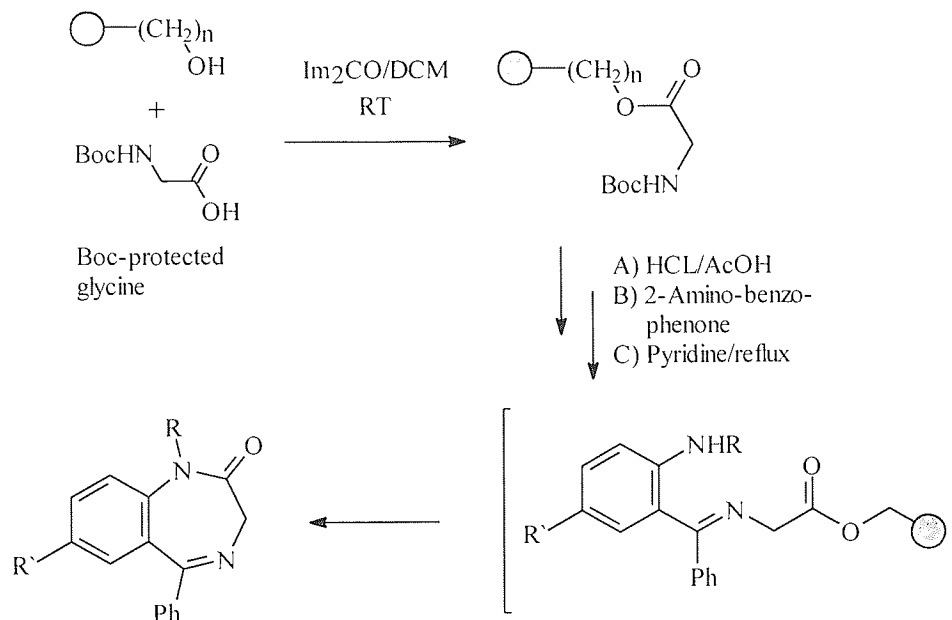

Figure 4.2: Champs solid phase synthesis of 1,4-benzodiazepinones

Hobbs de Witt¹⁶⁷ generated a 1,4-benzodiazepine library (Figure 4.3) analogue to the Champs approach using Boc-protected amino acid Merrifield resin. Subsequent reaction with excess (3-6 eq) of 2-aminobenzophenone imines lead via imine formation and acid triggered cyclisation to the 1,4-benzodiazepinones by using TFA.

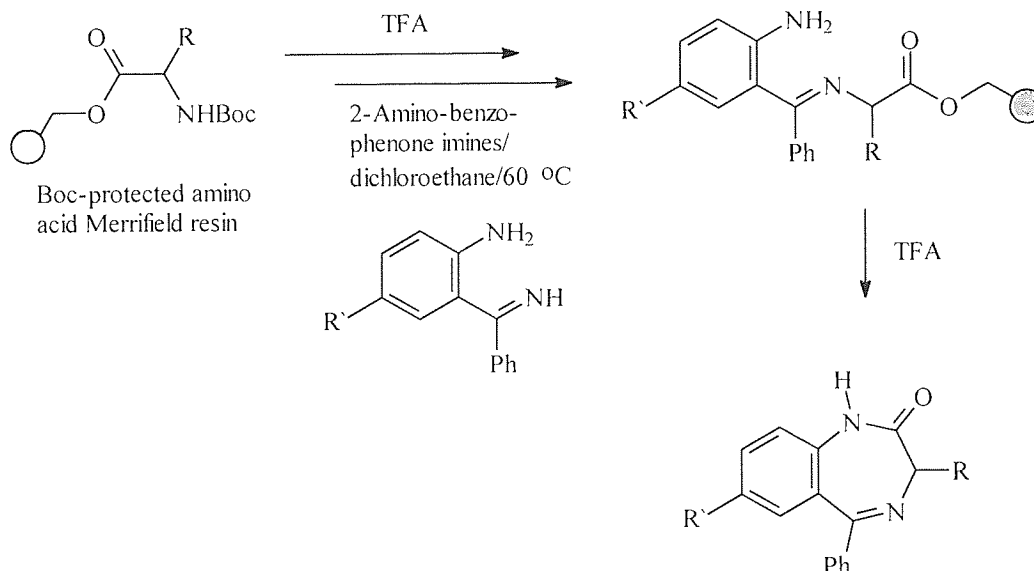

Figure 4.3: De Witt's solid phase synthesis of 1,4-benzodiazepinones

Bunin and Ellman^{15,165,168} generated the 1,4-benzodiazepines combinatorially by solid-phase synthesis (Figure 4.4), in which the target compounds were immobilized via a hydroxyl or carboxyl functionality to polystyrene resin via the acid labile linker, [4-(hydroxymethyl)phenoxy]acetic acid. Key steps in the benzodiazepine synthesis include the acylation of a relative unreactive support-bound aminobenzophenone system with Fmoc protected amino acid fluorides, followed by acid triggered cyclisation yielding 1,4-benzodiazepines. Furthermore, Ellman alkylated the formed benzodiazepines under strongly basic conditions by using lithium 5-phenylmethyl-2-oxazolidione and generated a three dimensional library after cleavage from the solid support by using TFA.

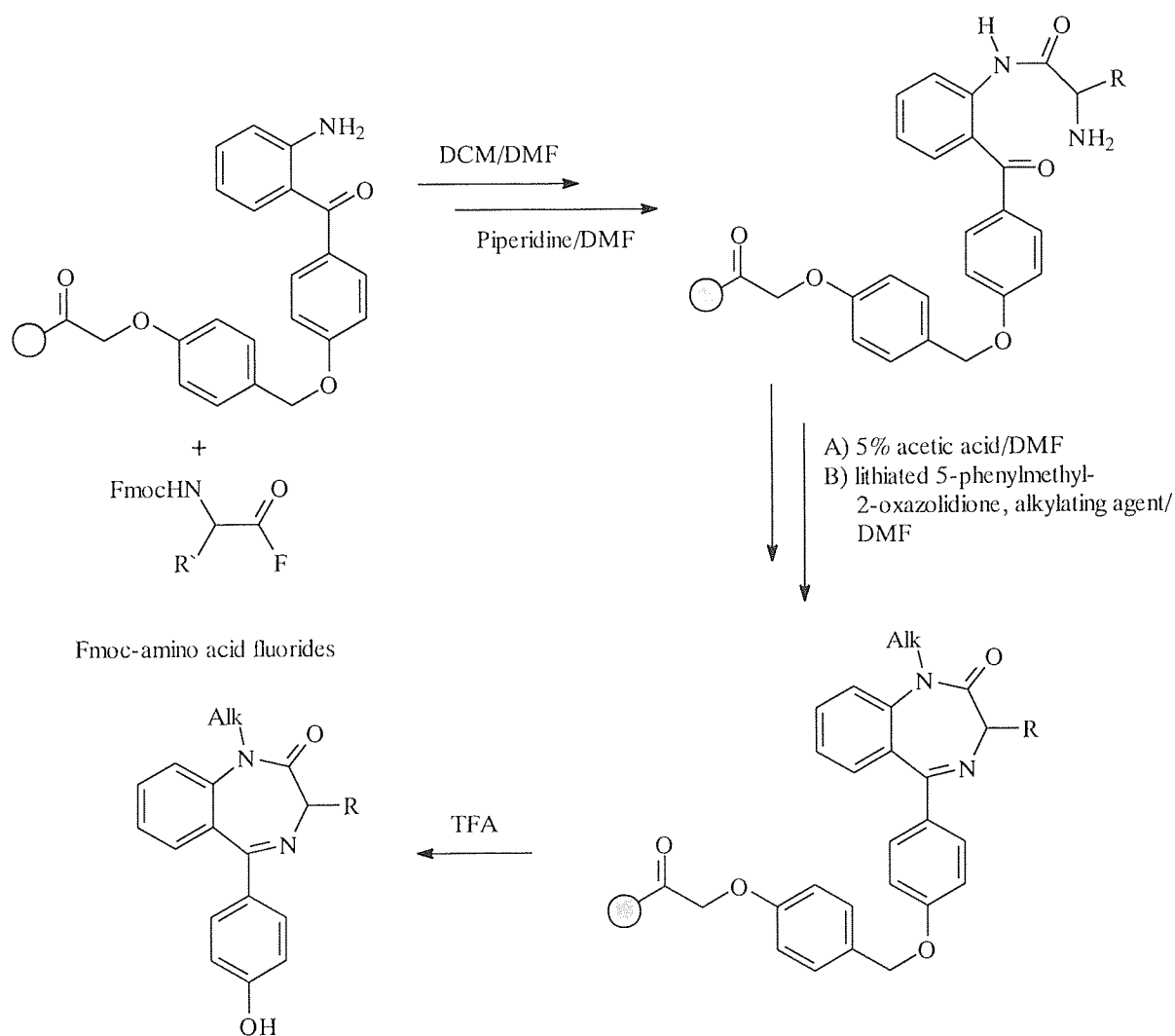

Figure 4.4: Ellman's solid phase synthesis of 1,4-benzodiazepinones

In conclusion, Ellman¹⁶⁹ favoured the solid phase pathway in which the ketone was attached to the resin via an ester linkage. The first bond formed in the solid phase synthesis was the amide¹⁷⁰ by using Fmoc amino acid fluorides, followed by the imine formation of the benzodiazepine template¹⁷¹. The method of Bunin and Ellman¹⁶⁸ for the solid phase synthesis of 1,4-benzodiazepine derivatives is limited by introduction of auxiliary functionality (e.g. hydroxyl or carboxylic acid) in the target molecule to facilitate attachment to the solid support. Furthermore, it should be noted that additional hydrophilic functional groups can result in unfavourable interaction with the CCK receptor as it was reported¹⁶⁷ and this method restrict the preparation of 1,4-benzodiazepines which includes unsaturated aryl rests on position 5 such as the high CCK_B potent antagonist L-740,093. Ellman used for the amide bond formation Fmoc amino acid fluorides, which might be problematic for acid sensitive amino acids such as Trp, Tyr and Asp. In contrast to Ellman, the alternative approach by Champs/Hobbs de Witt were reported, in which the amino acid was fixed to the resin and formed the imine in the first step.

This method seemed to be more applicable for most of the amino acids including their acid sensitive analogues Trp, Tyr, Asp.

It was also noted that the early synthesis of 1,4-benzodiazepines by Champs et al.¹⁶⁶, which studied these compounds¹⁷² as GABA_A ligands, ketones and resin bound amino acids were directly converted into benzodiazepines with pyridine in 40% yield by using Boc-glycine and 2-amino-5-chlorobenzophenone.

This finding is in contrast to a classical solution phase synthesis, which gave the desired compounds depending on their substituent positions on carbon-3 only in very low yields.

The Fmoc protecting group is the routine group used for peptide syntheses because it is very stable to acidic reagents, but is cleaved swiftly under certain basic conditions. Piperidine (20% in DMF) is the routine reagent, and deprotection with piperidine takes only a matter of minutes¹⁷³ at room temperature. Based on these features of the Fmoc group, a combined modified approach, based on the early work of Hobbs de Witt's benzodiazepine synthesis in which the imine CN bond was formed before the formation of the amide, was the strategy of choice using recent SynPhase crowns technology¹⁷⁴.

4.2. Generation of the 1,4-benzodiazepine library Solid phase approach

This solid phase approach was developed using SynPhase crowns with a Wang linker. In order to speed up the drug discovery process, novel crown technology was selected. The classical solid phase Wang resin has to be handled in special peptide flasks and therefore was considered not suitable for libraries constructed of this size. Other recently developed resins are easier to handle but have a very low loading¹⁷⁵. SynPhase crowns offered an ideal solid support, which is available in small, medium and large sizes. The small crowns are only suitable for established peptide synthesis. Medium I-size crowns were used for the construction of this library. In order to increase yields of “bad” reactions for selected compounds (with functionalised side chains) larger crowns may be used. It was found that 3 or 5 crowns of medium size were more convenient and economically cheaper than one large crown due to a higher overall loading. The crowns containing a polystyrene resin on a PE carrier are available with various linkers as well as free protonated or Fmoc protected amines. A polystyrene resin with a p-hydroxymethyl phenoxy acetamido linkage gave the best results for this solid phase synthesis.

11 readily available ketones and **ketone I** which was synthesised from 2-aminobenzonitrile and cyclohexylmagnesium bromide (Chapter 3) were selected using ISIS BASE, based on price and chemical diversity, which are outlined in table 4.1. The price varied from 16 pounds for 500g (**ketone A**) to 18 pounds per 5g (**ketone H**). 14 racemic Fmoc-protected amino acids containing alkyl, aryl and other functionalised side chains were selected to provide a high chemical diversity of the combinatorial library of 3-substituted 1,4-benzodiazepines.

Table 4.1: 12 Ketone building blocks applied to the solid phase approach

<p>A) 2-Amino-5-chloro-benzophenone</p> 	<p>B) 2-Amino-benzophenone</p> 	<p>C) 2-Amino-2',5-dichloro-benzophenone</p> 	<p>D) 2-Amino-5-chloro-2'-fluoro-benzophenone</p> 
<p>E) 2-Amino-5-nitro-benzophenone</p> 	<p>F) 2-Amino-4-methyl-benzophenone</p> 	<p>G) 2-Amino-2'-carboxyl-benzophenone</p> 	<p>H) 1-Amino-9-fluorenone</p> 
<p>I) 2-Amino-phenyl-cyclohexylketone</p> 	<p>J) 2-Amino-acetophenone</p> 	<p>K) 2-Amino-4,5-dimethoxy-acetophenone</p> 	<p>L) 2-Amino-4,5-methylenedioxy-acetophenone</p> 

Table 4.2: α -Amino acid building blocks used.

<p>Amino-butyric acid</p>  <p>Abu</p>	<p>Amino-capric acid</p>  <p>AC (αAhx)</p>	<p>Alanine</p>  <p>Ala</p>	<p>Aspartic acid</p>  <p>Asp</p>	<p>Glycine</p>  <p>Gly</p>
<p>Iso-leucine</p>  <p>Ile</p>	<p>Leucine</p>  <p>Leu</p>	<p>Nor-leucine</p>  <p>Nle</p>	<p>Nor-valine</p>  <p>Nva</p>	<p>Methionine</p>  <p>Met</p>
<p>Phenylalanine</p>  <p>Phe</p>	<p>Tryptophan</p>  <p>Trp</p>	<p>Tyrosine</p>  <p>Tyr</p>	<p>Valine</p>  <p>Val</p>	<p>Overview</p> <p>Fmoc-Aminoacids</p> <p>Fmoc-AA</p>

Remark: pPhe = p-Hydroxyphenyl-

The N-protected amino acids were activated with an 1.2 equivalent of diisopropylcarbodiimide [DIC] and coupled with a catalytic amount of DMAP in DMF/DCM 1:4 to the Wang resin at room temperature. The coupling process was allowed to run to completion over night and may be repeated if required. The Fmoc-protecting group was cleaved off with an excess of a 20% solution of piperidine in DMF and after each reaction step the resin was washed 3 times with DMF, DMF/DCM and DCM, respectively.

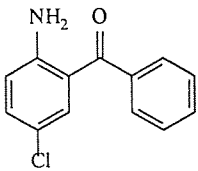
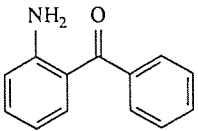
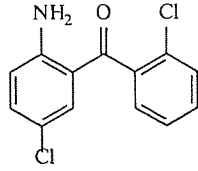
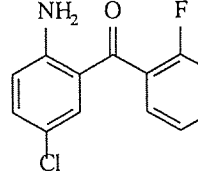
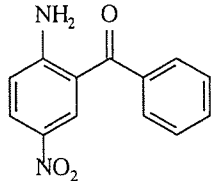
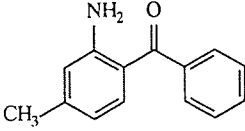
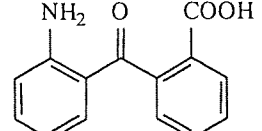
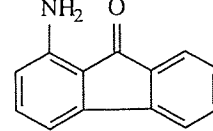
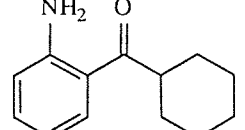
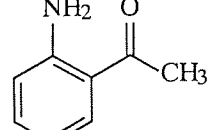
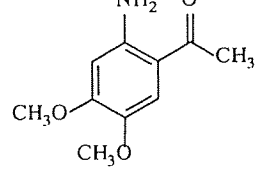
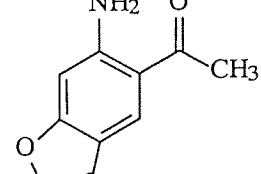
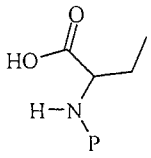
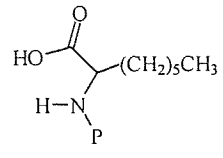
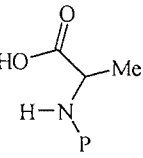
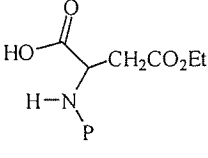
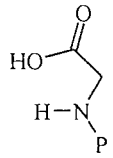
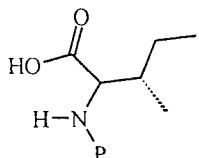
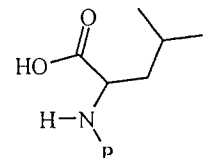
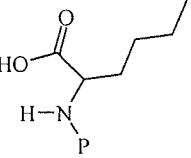
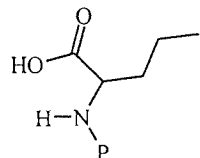
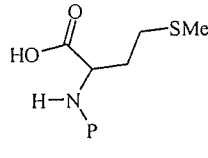
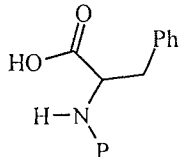
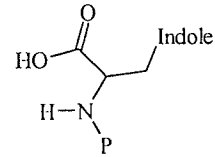
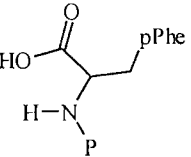
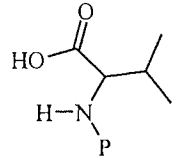
168 crowns containing 14 different amino acids linked to the resin were reacted with 12 solutions of the ketone **A-L** in dichloroethane at 65°C over a period of 2 days. The 168 1,4-benzodiazepines prepared are outlined in Table 4.3.

The purity of the benzodiazepines depends directly on the quality of the washing cycles after the imine formation, as any remaining ketone will contaminate the desired benzodiazepines. Two methods for the cleavage have been applied.

According to general *Method A* the 1,4-benzodiazepines were formed by cleaving the imines with TFA from the resin and subsequent in situ 7-exo-trig formation of the 7 membered ring system (Scheme 4.1). This method does not work with sensitive amino acids like **Trp**, **Tyr** and **Asp** and low yields were obtained with 2-amino-acetophenone (ketone **J**), whereas the electron rich analogues (**K** and **L**) formed the desired BZD's in good yields. Preferably, *Method B* was used for the ketone **J** as well as for **Trp**, **Thy** and **Asp**, in which the formation of the benzodiazepine scaffold was possessed with pyridine and a catalytic amount of DMAP at similar temperature. It is noteworthy that the best method to synthesize the 1,4-benzodiazepines containing simple lipophilic side chains in high yields was *Method A* in which the compounds were cleaved and cyclised in TFA.

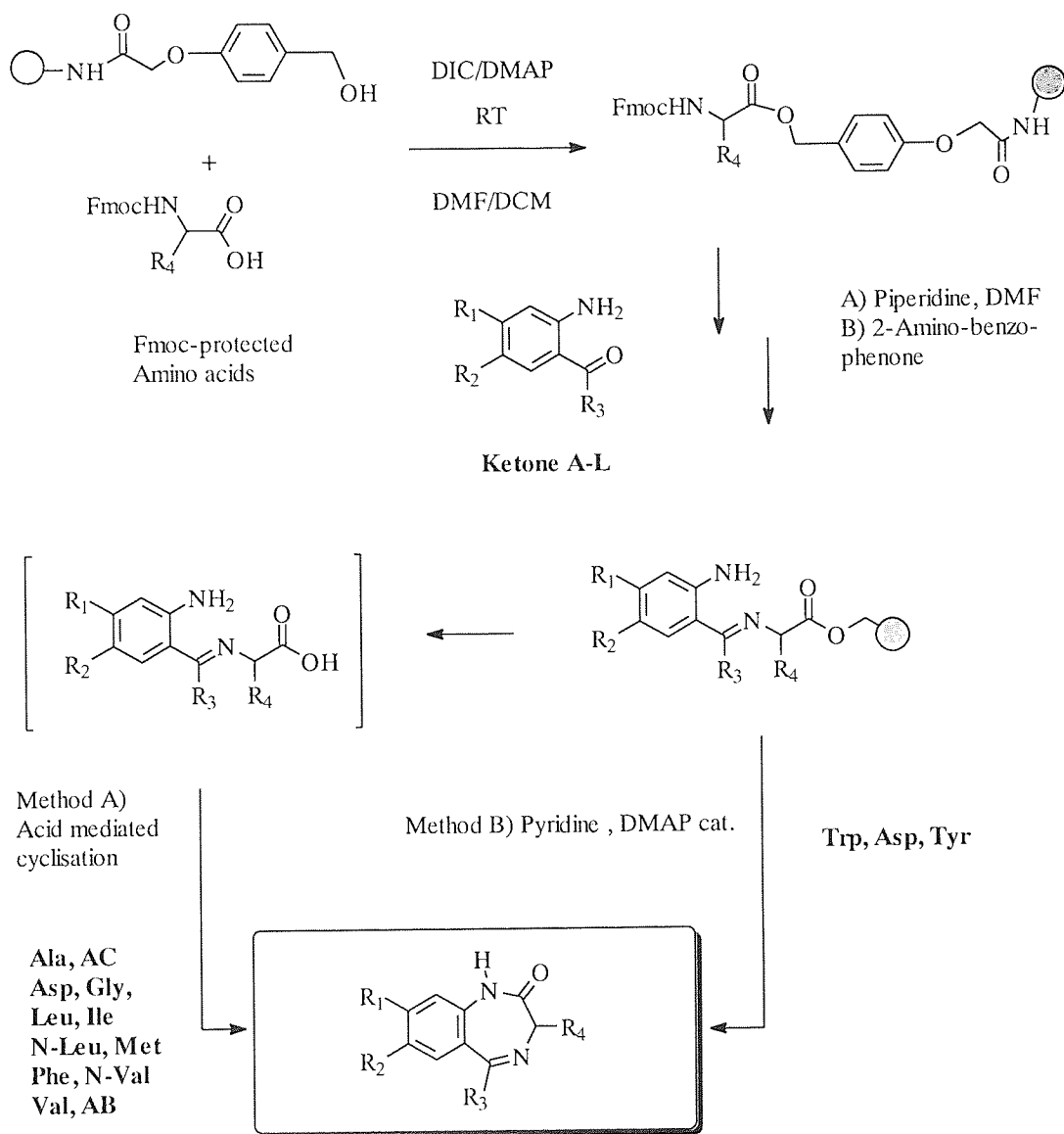

Scheme 4.1: A Combinatorial Solid Phase Approach to Multiple-substituted 1,4-Benzodiazepines

In this 5 step solid phase approach the linkage to the resin, deprotection, imine formation and cleavage/benzodiazepine formation was carried out simultaneously in groups.

Hobbs de Witt prepared 40 benzodiazepines as GABA_A ligands using the Boc-protected amino acids on the Merrifield resin¹³. This library of multiple-substituted 1,4-benzodiazepines were prepared using the medium I-size SynPhase crowns. The subsequently cleaved benzodiazepines were analysed by APCI mass spectroscopy.

In these directly screened samples no HPLC analysis was carried out, but the concentration of the benzodiazepine was estimated correctly, using calibration with internal standards, based on the abundance of the parent compound in the mass spectra.

Selected compounds were isolated by preparative TLC and subsequently screened as pure materials, which is depicted in Table 4.3 and marked as grey fields. As indicated by)¹ 26 compounds were isolated and fully characterized by TLC, APCI-MS, FT-IR, ¹H- and ¹³C resonance spectroscopy. An overview of this effective drug purification/isolation process is summarised in Table 4.3.

Ketone	A	B	C*	D*	E	F	G	H	I	J*	K	L
Amino-butyric acid	299)	264	331	317	309	278	336	262	270	202	262	246
Amino-capric acid	355)	321	390	373	366	355	365	319	327	259	319	303
Alanine	285)	251	320	303	296	265	295	249	257	189	249	233
Aspartic acid *	374)	340	409	392	385	354	384	338	346	278	338	322
Glycine	271)	237	306	289	282	251	281	235	243	175	235	219
Isoleucine	327)	293	362	345	338	307	365	291	299	231	291	275
Leucine	327)	293)	362)	345)	338)	307)	365)	291)	299)	231)	291)	275)
Nor-leucine	327)	293	362	345	338	307	365	291	299	231	291	275
Nor-valine	313)	279	348	331	324	293	323	277	285	217	277	261
Methionine	345)	311	380	363	330	325	355	309	317	249	309	293
Phenylalanine	361)	327	395	379	372	341	399	325	333	265	325	309
Tryptophan	400)	366	435	418	411	380	438	364	372	304	348	348
Tyrosine *	361)	327	396	379	372	341	371	325	333	265	325	309
Valine	313)	279	348	331	324	293	323	277	285	217	277	261

Table 4.3: 168 benzodiazepines prepared by SPCS and screened without purification

)¹ isolated, fully characterized by ¹H-NMR, ¹³C-NMR, IR and APCI-MS

) grey: isolated by preparative TLC, screened as pure compound and characterized by APCI-MS and TLC; white scattered: confirmed by APCI-MS and screened without purification

*: compounds obtained in lower yields (generally)

The compounds depicted in Table 4.3 were each re-synthesised later on 2 large L-SynPhase crowns or 5 medium size crowns in order to carry out a full characterisation by APCI-MS, IR, ^1H and ^{13}C - spectroscopy. The amount of compound required for full characterisation is about 50 times higher than the quantity for primary screening. Based on the price of the crows, the very costly solid phase “large scale synthesis” of compounds was reduced to a minimum. The selection of these compounds, one row and one column of the whole combinatorial library, was based on the most promising biological results. The spectroscopic data of one column and one row of that combinatorial library are given in the experimental section. From 168 compounds, based on the free combination of 12 ketones and 14 amino acids, only $12+14 = 26$ compounds were isolated and fully characterised by this way. **Entry 37-50** represent ketone **A** combined with the chosen set of amino acids, while **entry 51-62** shows the Leucine series with all possible ketone combinations (Ketone A-L).

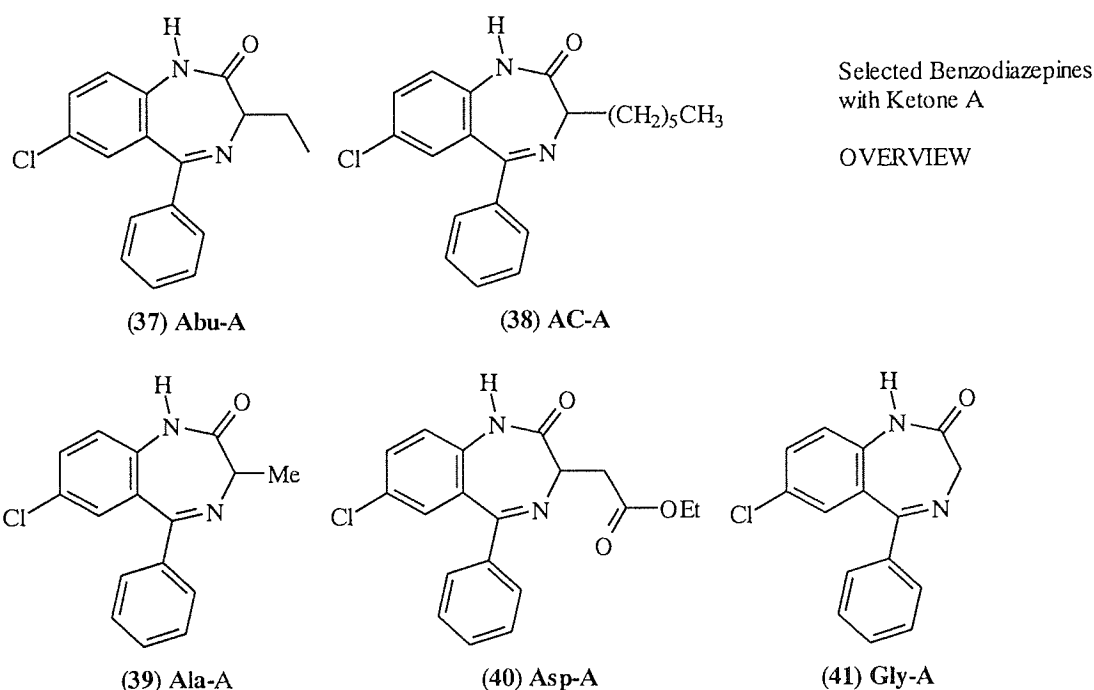

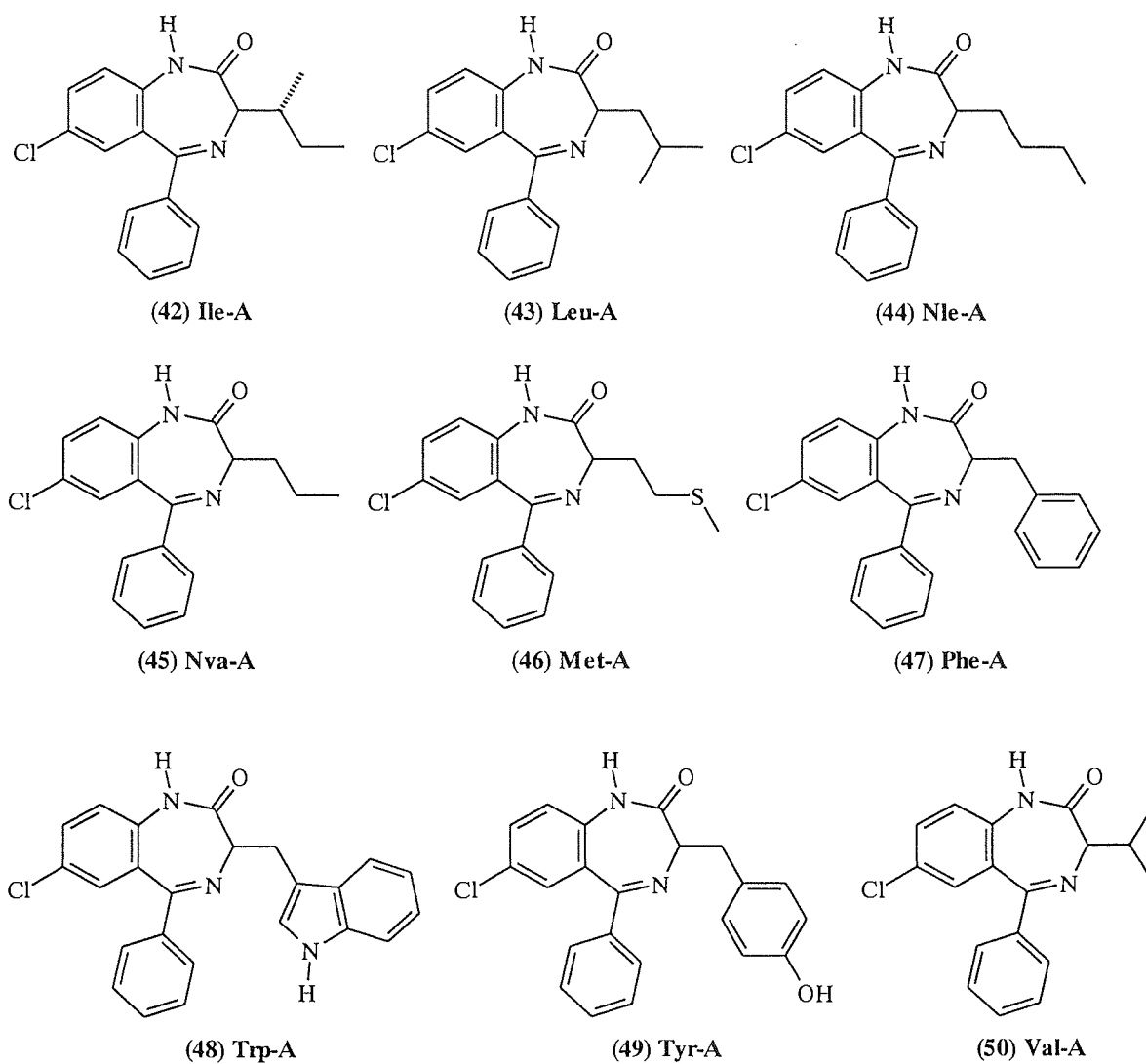

Figure 4.5: Substituted 1,4-benzodiazepines containing the 5-chloro-2-amino-benzophenone substructure (*Ketone A*).

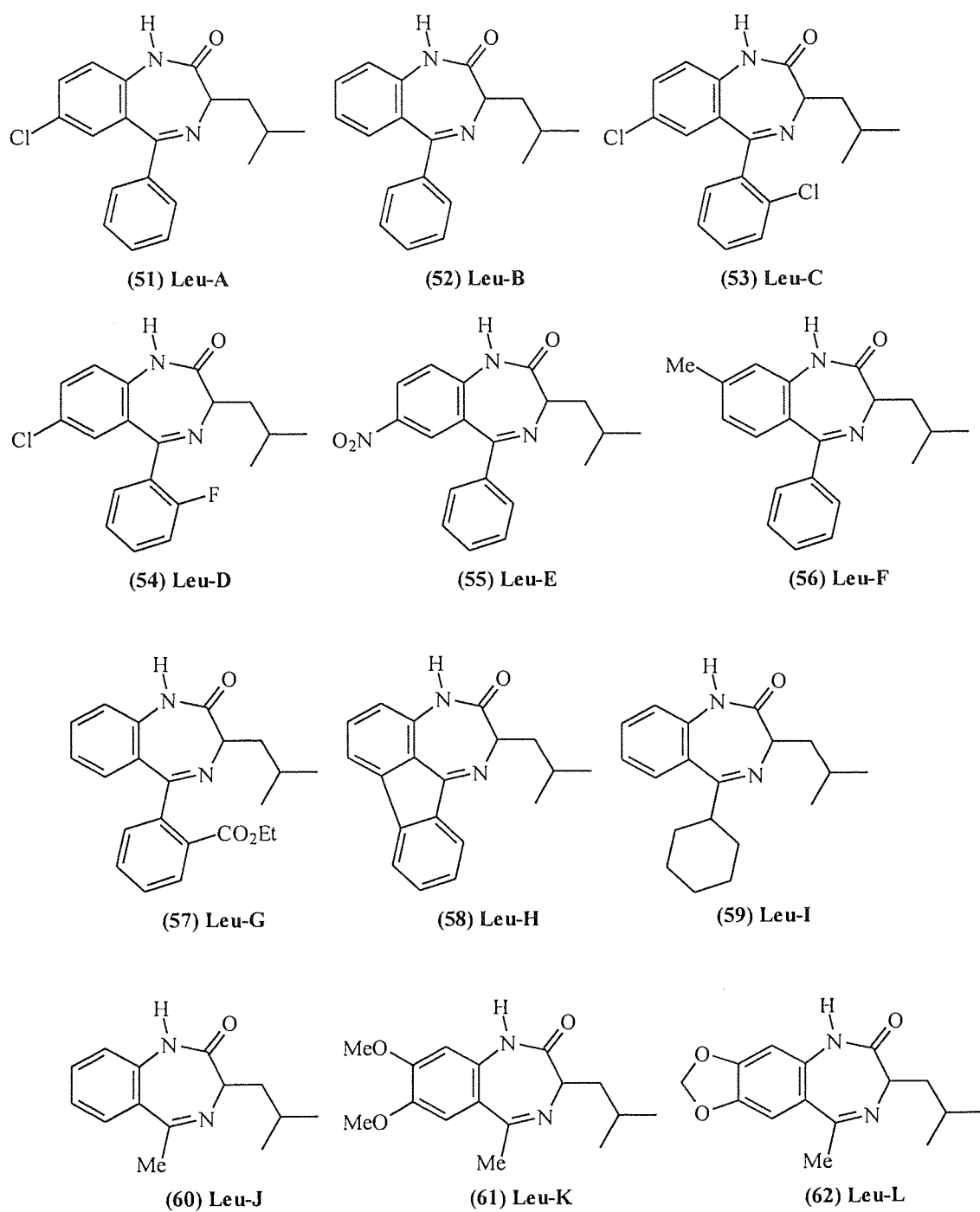













Figure 4.6: 5, 7, 8 substituted 3-isopropyl-1,4-benzodiazepines (Leu-Series) based on the ketone moiety

Table 4.4: Fully characterized 1,4-benzodiazepines by TLC, APCI-mass spectroscopy, IR, ¹H, ¹³C-NMR-spectroscopy

Entry	Code	R ₁	R ₂	R ₃	R ₄	Yield
37	Abu-A	H	Cl	Phenyl	-CH ₂ CH ₃	80
38	AC-A	H	Cl	Phenyl	-(CH ₂) ₆	70
39	Ala-A	H	Cl	Phenyl	-CH ₃	80
40	Asp-A	H	Cl	Phenyl		30
41	Gly-A	H	Cl	Phenyl	H	65
42	Ile-A	H	Cl	Phenyl		85
43	Leu-A	H	Cl	Phenyl		90
44	Nle-A	H	Cl	Phenyl	-(CH ₂) ₄	85
45	Nva-A	H	Cl	Phenyl	-(CH ₂) ₃	90
46	Met-A	H	Cl	Phenyl		70
47	Phe-A	H	Cl	Phenyl	Bz	90
48	Trp-A	H	Cl	Phenyl		60
49	Tyr-A	H	Cl	Phenyl	p-OH-Bz	20
50	Val-A	H	Cl	Phenyl		60
51	Leu-A	H	Cl	Phenyl	i-Propyl	90
52	Leu-B	H	H	Phenyl	i-Propyl	90
53	Leu-C	H	Cl		i-Propyl	30
54	Leu-D	H	Cl		i-Propyl	40
55	Leu-E	H	NO ₂	Phenyl	i-Propyl	70
56	Leu-F	-CH ₃	H	Phenyl	i-Propyl	80
57	Leu-G	H	H		i-Pr	50
58	Leu-H	H	H	o-Toluol-	i-Propyl	90
59	Leu-I	H	H		i-Propyl	80
60	Leu-J	H	H	-CH ₃	i-Propyl	30
61	Leu-K	-OCH ₃	-OCH ₃	-CH ₃	i-Propyl	70
62	Leu-L			-CH ₃	i-Propyl	70

2-dimensional library: 12 x 14 = 168 compounds; 12 + 14 = 26 cps fully characterised

4.3. Pharmacology of multi-substituted 3-alkylated-1,4-benzodiazepines

CCK_A and CCK_B receptor binding assays were performed by using guinea pig and rat pancreas or guinea pig cerebral cortex, respectively. Membranes from male guinea pig brain tissues were prepared according to the modification described by Saita et al.¹⁷⁶ (1994). Cerebral cortex was homogenised in sucrose, centrifuged and stored at -80°C until use. Pancreatic membranes were obtained similarly as described by Charpentier et al.¹⁷⁷ (1988). After the incubation procedure the radioactivity retained on the filter was counted by liquid scintillation spectroscopy. All binding essays were carried out with L-365,260 as internal standard in triplicate.

For an initial screening the compounds were prepared on the medium size crowns and the crude material was analysed based on APCI mass spectroscopy data. The M⁺ peak is shown in table 4.3. There were 3 stages in the drug discovery programme of biological evaluation to optimise time efficiency.

1) Screening of the crude material. 2a) Screening of isolated compounds to recheck SAR on 3 selected ketones. 2b) Chemical characterisation of ketone A and all amino acids, leucine and all ketones A-L. 3) Re-synthesis of compounds around the lead structure and optimisation. Full characterisation and determination of second set of IC₅₀.

SAR-studies

The solid phase combinatorial synthesis^{9,178} on SynPhase crowns with a Wang linker was used providing multiple substituted 1,4-benzodiazepines most of which are novel.

From the combinatorial library of 168 compounds, 58 were isolated by preparative TLC and 26 were fully characterised.

The biological evaluation was carried out using a radiolabelled receptor binding assay.

Table 4.5: Overview of selected active 1,4-benzodiazepines. IC₅₀ in micromolar concentration in water/DMSO

Code	Inhibition IC ₅₀ (μM) CCK _B	Code	Inhibition IC ₅₀ [μM] CCK _B
Gly-A	> 50	Leu-A	1.1 [20]
Ala-A	25	Leu-B	4
Leu-A	1.1 [14]	Leu-C	6
Val-A	1.6 [20]	Leu-D	6.4
Met-A	22	Leu-E	12.1
Asp(OEt)-A	>50	Leu-F	17
Ile-A	1.6 [20]	Leu-G	23
AB-A	1.8 [13]	Leu-H	1.4
NV-A	0.6 [13]	Leu-I	1.5 [23]
NL-A	1.3 [15]	Leu-J	>50
AC-A	2.5 [12]	Leu-K	>50
Phe-A	2.5 [7]	Leu-L	>50
Trp-A	5 [3]	NV-A	0.6 [13]
Tyr-A	19 [0.65]	NV-B	2.3
Tyr-B	26 [2.0]	NV-C	3.5
NV-D	4.0	NV-E	5.5
NV-H	2.5	NV-I	1.8 [21]
NV-J	>50		

Remark: if IC₅₀ for CCK_B < 1^μM, IC₅₀ for CCK_A is given in brackets.

The preliminary screen with unpurified compounds have shown generally that benzodiazepine derivatives incorporated either the **Phe** and the **Leu** moiety bound more tightly than compounds that incorporated other amino acids.

Furthermore, most of these compounds that inhibit binding incorporate ketone **A**, (5-chloro-2-aminobenzophenone), indicating that this particular aminobenzophenone may take important contacts with cholecystokinin in contrast to ketone **B** (2-aminobenzophenone). These results showed the importance of a substituent on the 7 position of the benzodiazepine scaffold. However, it was observed at the beginning a fluctuation of screening results within the **Phe** and **Leu** series. As known, solid phase synthesis does not fulfil the regulation methods, e.g. Current Good Manufacturing Practice regulations¹⁷⁹, for accuracy and reliability, which have been also considered by Glaxo Wellcome Research Scientist¹⁸⁰ for COS. According to these results selected compounds were later re-synthesised on 2 large L-SynPhase crowns or 5 medium size crowns and the second screening with purified compounds delivered reliable results and the following results were reached.

Benzodiazepines based on the **Gly**, **Ala**, **Asp** and **Met** substructure did not show any bioactivity. The **Leu** based series, as well as the **Phe** and **Trp** series were initially active and served as a starting point of an enlarged library. The benzodiazepines containing **Trp** have been considered as Asperlicin analogues and have been modified further by selective mono- and dialkylation. The results of these studies will be presented separately (Chapter 5). 3-Arylated benzodiazepines showed selectivity towards the CCK_A receptor. The benzyl derivatives (**Phe**-series) possessed activity in the low micromolar range and are non-selective, while indolyl-derivatives (**Trp**-series) showed a higher potency with a moderate CCK_A selectivity. The p-hydroxybenzyl derivatives, based on a **Tyr** moiety, have shown an interesting CCK_A potency and also selectivity.

Unfortunately the chemical yield of the functionalised p-hydroxybenzyl-1,4-benzodiazepines was low (**Tyr** series) but this structure served as a lead for further bioisosteric modifications to 3-alkylamino-/anilino-1,4-benzodiazepines (Chapter 7.1).

The 3-isopropyl-1,4-BDZ's (**Leu-series**) was the first CCK_B selective active group of compounds. Further optimisation lead to the discovery of potent and CCK_B selective 3-n-propyl-1,4 benzodiazepines (**Nor-valine**). If a methyl group is attached to this privileged structure in the 1, 2 or 3 position of the n-propyl group (C₃ side chain) the activity decreased significantly (**Ile, Nor-Leucine, Leu-series**). With the loss of a methyl group on the n-propyl side chain, the activity was reduced by the factor 3 (C₂ side chain, **Abu-series**). A C₁ side chain was totally inactive (**Ala**). These important biological results have been verified, in which compounds were prepared by classical solution phase chemistry. The verification of bioactivity has been carried out, was based on the assumption that the bioactivity of those BZD's was caused particularly high yielding compounds in contrast to compounds bearing functional groups. The following diagram gives an overview of bioactivity of those compounds, which incorporate the ketone **A** moiety (5-chloro-2-amino-benzophenone).

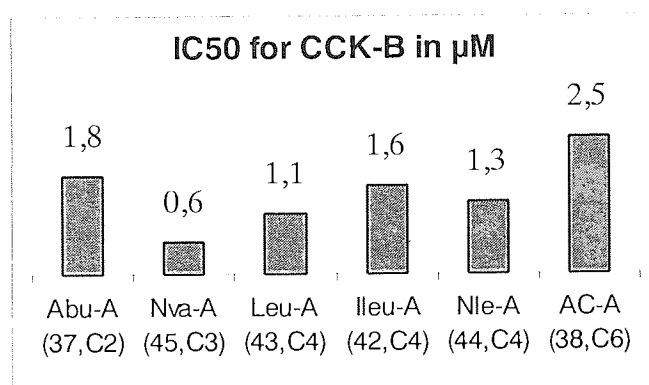

Diagram 4.1: Comparison of biological activity of selected 3-alkylated 1,4-benzodiazepines

The SAR study of the combinatorial library have shown initially an optimum bioactivity with the isopropyl group on the 3-position (**Leu-Series**). The variation of ring A and ring C, based on the ketone moiety, is outlined in the following diagram.

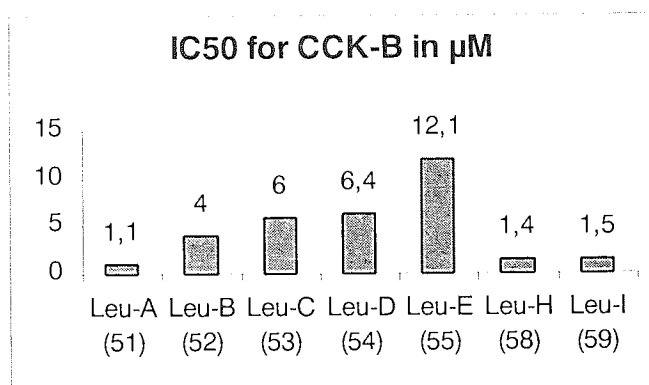

Diagram 4.2: Comparison of biological activity of selected 3-isopropyl-1,4-benzodiazepines with various substituents in position 5, 7, 8.

Additional halogen substituents in the 5-phenyl ring system (o-position) seemed to decrease activity of the BDZ's on the CCK receptor, opposite to SAR on the GABA_A receptor¹⁴⁰ (**Ketone C, D**). These results have been confirmed by classical solution phase chemistry and will be presented separately for the most biologically active compound (**Nva-A**, Chapter 8.1). The biological activity is lost if the phenyl ring is replaced by a methyl group in the 5-position (**Ketone J, K, L**) or the activity is significantly decreased by replacement of the chloride (**Ketone A**) by a nitro group in the 7-position (**Ketone E**). A ring closure between the phenyl groups was tolerated (**Ketone H**). The replacement of the 5-phenyl group by a 5-cyclohexyl ring in the 3-isopropyl-BDZ template (**Ketone I**) does not result in the expected increase of activity, as is observed for the same structure refinement in Merck's 3-ureido-1,4-benzodiazepines¹¹².

The racemic 3-propyl-1,4-benzodiazepine **NV-A** was the most active compound in this library showing an IC_{50} of 600 nM on the B receptor subtype.

In general, the SAR study (Figure 4.7) of the combinatorial library in the 3-position have shown an optimum bioactivity at the C₃ side chain and the variation of ring A and ring C is presented below.

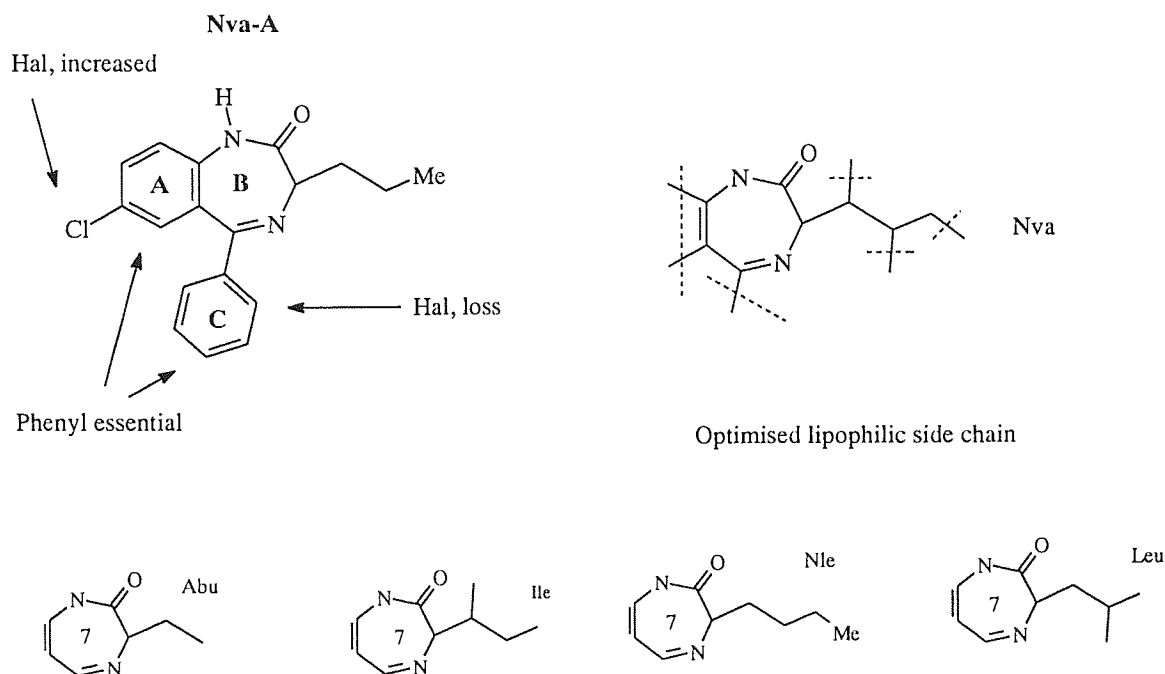

Figure 4.7: SAR essentials for 3-alkylated-1,4-benzodiazepines as CCK_B antagonists

In this topic the combinatorial solid phase synthesis was presented, using a Wang resin on a recently available SynPhase crowns, in which the substituents around the 1,4-benzodiazepine scaffold R₁, R₂, R₃ and R₄ have been varied independently. The biological evaluation of this combinatorial library first emerged with 3-indolyl-benzodiazepine (**Trp**-series) and secondly 3-(p-hydroxy)-benzodiazepine (**Tyr**-series), which possessed a remarkable CCK_A activity.

The novel CCK_B selective lead with the propyl side chain (**Nva-A**) has been discovered in this library displaying a binding activity at the nanomolar range at the B-receptor subtype.

The 3, 5, 7, 8-positions and the stereochemistry of this privileged structure has been optimised by solution phase combinatorial approach so far adopted (Chapter 8.1).

The outstanding SAR studies for the optimisation of the N₁ alkylation¹⁸¹ have been investigated by a classical chemical approach suitable for scale up of the most promising compounds and will be presented separately.

Synthesis and Evaluation of Asperlicin Analogues as Non-peptidal Cholecystokinin-Antagonists

Traditionally, natural products are a good source for new medicines and in this case a microbial fermentation product served as a lead structure. The discovery of a novel cholecystokinin-antagonist from *Aspergillus Alliaceus* called Asperlicin (Figure 5.1) was the starting point for scientists at Merck¹⁸² to develop specific and potent CCK antagonists.

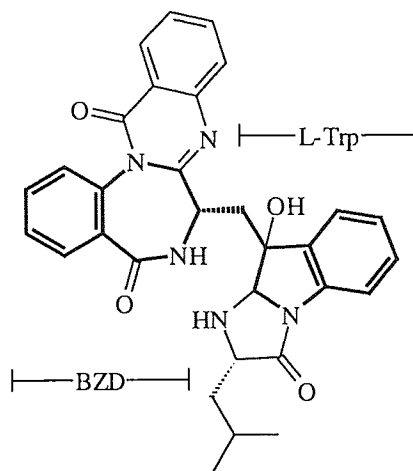

Figure 5.1: (S)-Asperlicin, the fermentation product of *Aspergillus alliaceus*

Asperlicin contains these elements of the 1,4-benzodiazepine (BZD) ring system, which are also found in anti-anxiety agents like diazepam. The 5-phenyl substituent in benzodiazepines especially is absent in Asperlicin, which contains instead a quinazoline ring fused to the opposite side of the 1,4-benzodiazepine ring at the positions 1 and 2.

The concept that Asperlicin can serve as a lead compound for the search of a better antagonist without the tool of combinatorial chemistry was used for the optimisation process of 3-indolylmethyl-1,4-benzodiazepines in the construction of natural product like products for CCK receptors with the ease of chemical accessibility.

The Asperlicin substructure was prepared in a one step synthesis. This template, containing the 1,4-benzodiazepine moiety with the 3-indolylmethyl side chain was subsequently modified by selective alkylation at the amide (R_2) and by acylation at the indole nitrogen (R_3) as shown in figure 5.2. This provides a series of Asperlicin analogues with the aim of finding a new potent CCK antagonist. Although Asperlicin is known as a CCK_A antagonist, the exploration of the structure-activity relationship (SAR) might lead to a better understanding for the further optimisation process of selective CCK_A and CCK_B ligands. The alkylation reactions of the 1,4-benzodiazepine template was supported by the reported enhanced bioactivity of CCK_B alkylated 3-ureido-1,4-benzodiazepines on the amide nitrogen to their t-butyl ketone¹⁴¹ analogues. Furthermore it was interesting to investigate the biological effect of the stereochemistry at C-3 of the benzodiazepine ring, as it was reported that this has a pronounced effect on bioactivity and CCK selectivity for 3-ureido benzodiazepines¹⁸³.

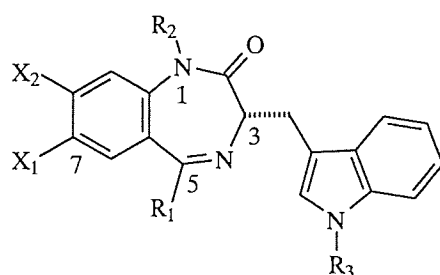
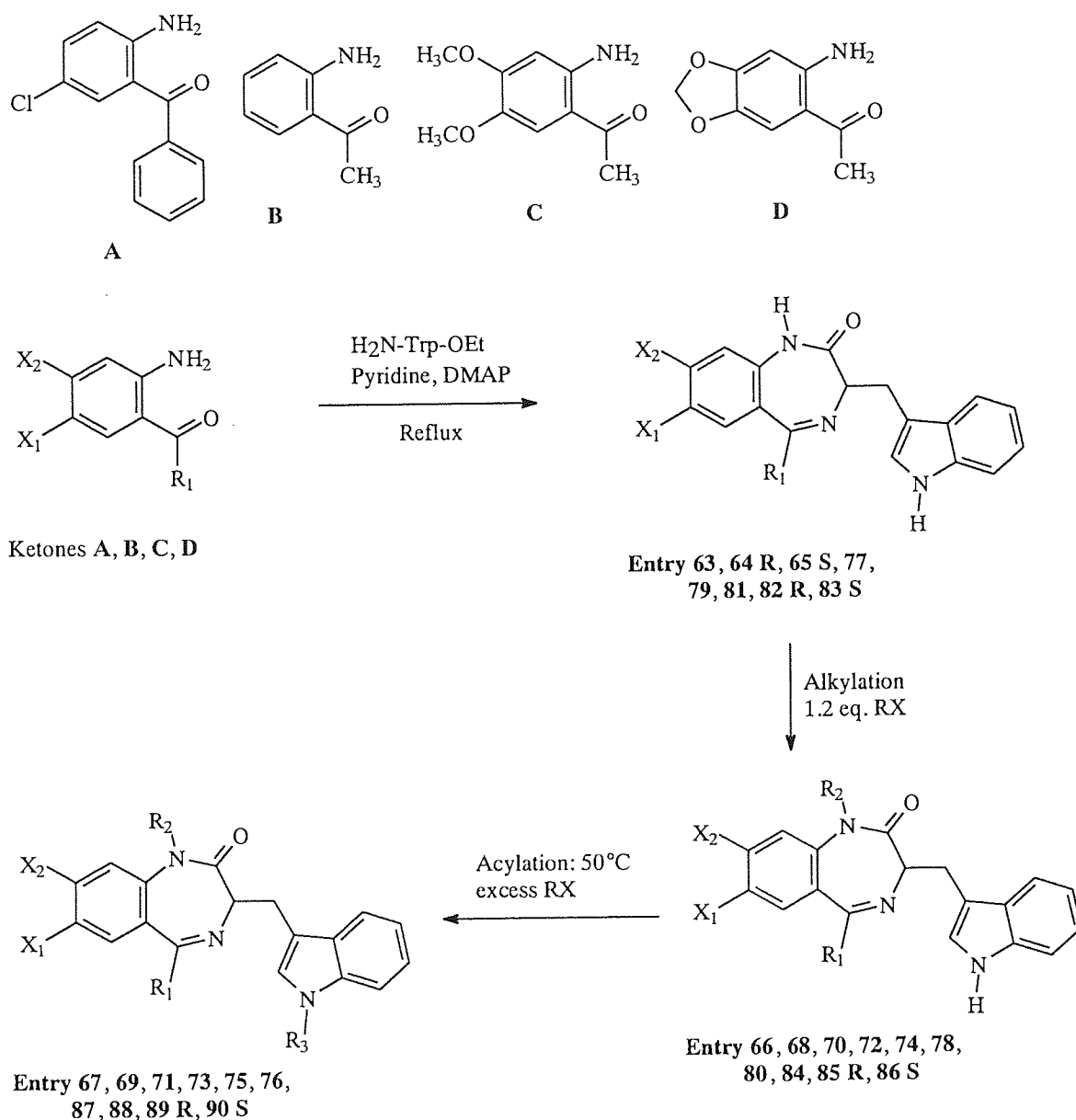

Figure 5.2: Privileged benzodiazepine-indole natural product like sub-structure

5.1. Synthesis of multi-substituted 1,4-benzodiazepine-2-ones (Asperlicin analogues)

Scheme 5.1 summarises the synthesis of Asperlicin analogues in which 2-aminophenyl-ketone building blocks **A** (2-amino-5-chlorobenzophenone), **B** (2-aminoacetophenone), **C** (2-amino-4,5-dimethoxyacetophenone) and **D** (2-amino-4,5-methylenedioxyacetophenone) were reacted by using 2 eq. of racemic (D,L)-tryptophan ethyl ester HCl in boiling pyridine for 48 hours with a catalytic amount of DMAP¹⁸⁴ to build up the desired templates, according to published methods^{185,186,187,188}. These ketone building blocks generated the Asperlicin sub-structure with different substituents on 5-, 7- and 8-position, which might be important for bioactivity.

5-Chloro-2-aminobenzophenone (ketone **A**) was selected and was the starting point for this investigation as it has shown that benzodiazepines incorporating this ketone showed bioactivity across the CCK receptor subtypes, which was discovered by our previous combinatorial solid phase organic chemistry approach (SPOC). These 1,4-benzodiazepine templates were then used for specific alkylation/acylation reactions on the amide (R_2) and indole nitrogen (R_3) to Asperlicin analogues.



Scheme 5.1: Synthesis of multiple-substituted 1,4-benzodiazepines (Asperlicin analogues)

Various other synthetic approaches to build up the templates were investigated. In the first approach according to a published method¹⁸⁹ in which the desired 1,4-benzodiazepines should be formed via the target amide in the first synthesis step by using DIC and Fmoc- or Z-protected tryptophan followed by cleavage of the protecting groups and acid or basic triggered cyclisation. However, DIC activated tryptophan (2 eq.) formed the target amide with ketone **A** in only poor yields, in contrast to the solid phase approach, which yielded the desired 1,4-benzodiazepines by using large excess of the substrates. Another route using tryptophan chloride hydrochloride¹⁹⁰, which was successfully prepared by phosphorus pentachloride in acetyl chloride (even though that tryptophan is an acid sensitive α -amino acid¹⁹¹) did not form the target amide with ketone **A**. This was caused by solubility problems of the strong polar tryptophan chloride present as a hydrochloride and the nonpolar ketones in different anhydrous solvents, such as in THF, dioxane or DMSO.

The direct fusion of the ketone building blocks with tryptophan ethyl ester HCl in boiling pyridine to the desired 1,4-benzodiazepine templates as presented in scheme 5.1 was the method of choice. The yield of this direct conversion of ketones into benzodiazepines depends on the amino acid and the ketones, which were used in the formation. While glycine, exemplified for 3-unsubstituted-1,4-benzodiazepines, formed the seven-membered ring structure in poor yields, tryptophan reacted in 28-42% yields with the ketones **A**, **C** and **D**, which have been enhanced further (44-58%) by using DMAP as a catalyst. Unfortunately low yields were obtained with 2-aminoacetophenone (ketone **B**, entry 77, Figure 5.3), while the electron rich 2-amino-acetophenone derivatives (**C** & **D**) furnished the desired 1,4-benzodiazepine templates (entries 79, 81) in good yields. The following figure represents these racemic 1,4-benzodiazepine templates. The numbering of those compounds is based on their entries in table 5.2.

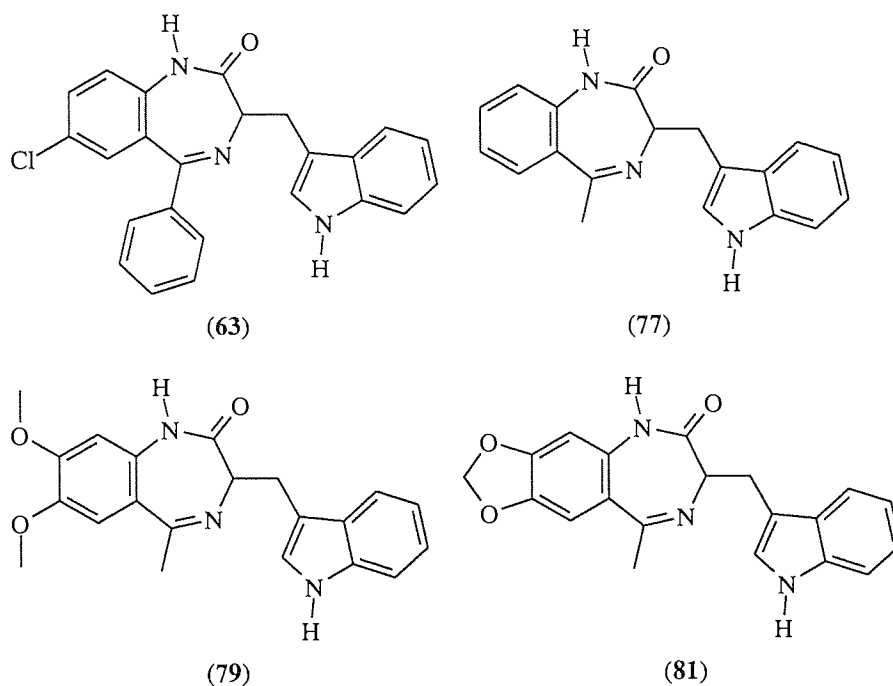

Figure 5.3: Structures of racemic multiple substituted 3-indolylmethyl-1,4-benzodiazepine templates

In order to investigate the stereochemistry, which was based on the most promising biological results of Asperlicin analogues, the ketone building blocks **A** and **D** were reacted with D- and L-tryptophan ethyl ester HCl in boiling pyridine for only 8 hours. The severity of the reaction conditions led to doubts concerning the chiral purity of the purified products for the biological investigation of the enantiomers of the most promising compounds. However the observed optical rotation $[\alpha]_{546}^{25} = -45.2^\circ$ of the R-form of the light yellow coloured compound (**64 R**, Figure 5.4) was almost identical with the reported synthesized enantiomer¹⁹² ($[\alpha]_{546}^{25} = -48.3^\circ$). Unfortunately, the optical rotation of the dark brown 1,4-benzodiazepine isomers bearing the ketone **D** moiety (**82 R**, **83 S**) could not be determined. The ratios of the R- and S-benzodiazepine isomers were determined by using Eu shift reagent¹ in ¹H-NMR experiments. For this studies the solutions containing the racemic compounds in deuterated chloroform containing 5, 10, 15 and 20 mol% of Eu shift reagent based on (**63** and **81**, Figure 5.3) were investigated.

¹ Europium tris[3-(heptafluoropropylhydroxymethylen)-(+)-camphorate

The mixtures with 15 mol% of Eu shift has split successfully the signal of the C-3 hydrogen, characteristically for 3-substituted-1,4-benzodiazepines, of these racemic compounds at $\delta = 4.1$ ppm in two signals at $\delta = 4.3$ and 4.65 ppm. No overlapping by the Eu shift reagent was observed at this range, and the signal for example at $\delta = 4.3$ ppm was identified for the S-isomer. This was achieved by adding the S-isomer to the mixture containing racemic compounds. According to these studies it was established that the desired 1,4-benzodiazepines were formed with the same configuration as the parent amino acid with little racemisation of 5-15%. Freidinger and co-workers¹⁹³ have also reported the preparation of chiral 1,4-benzodiazepines by this method. It is noteworthy that longer reaction times lead to an increased racemisation. The isomers of the 1,4-benzodiazepine templates are outlined in figure 5.4.

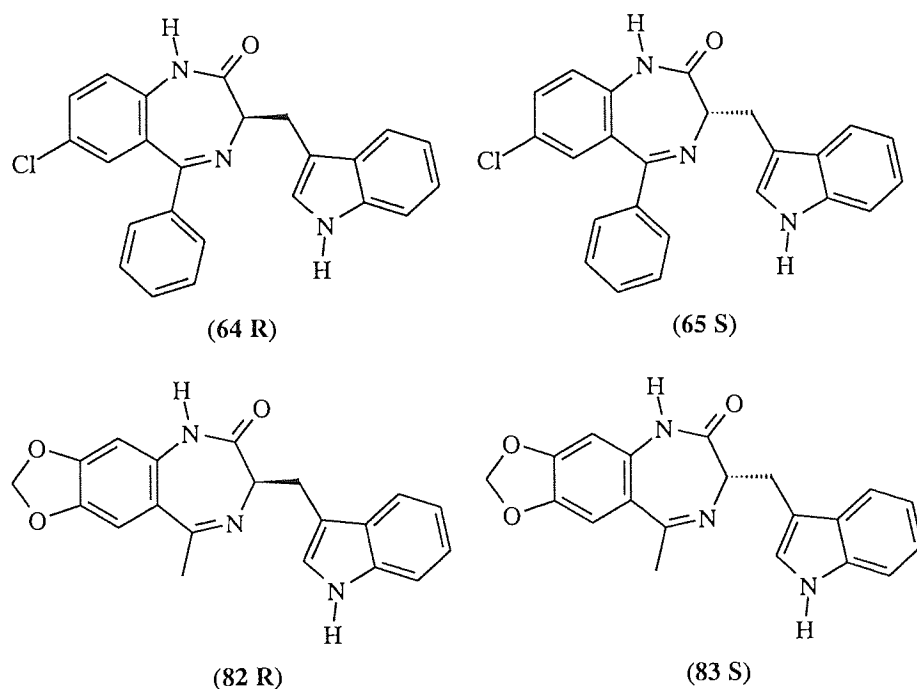
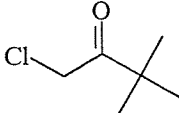
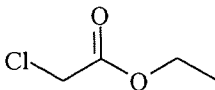
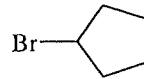
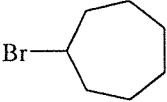
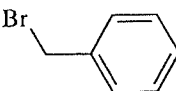
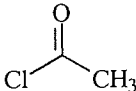
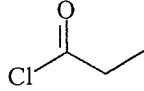

Figure 5.4: Structures of chiral multiple substituted 3-indolylmethyl-1,4-benzodiazepine templates

These multiple substituted 3-indolylmethyl-1,4-benzodiazepine templates were used for the specific alkylation/acylation reactions on the amide and indole nitrogen as already presented in scheme 5.1. In order to provide a high diversity eight readily available alkylating agents were selected. Furthermore, for this approach several aspects were considered. As reported¹⁹⁴ binding was enhanced by N₁ alkylation with esters and ketones, especially with the t-butyl ketone¹⁴¹ for 3-ureido-1,4-benzodiazepines, thus 1-chloro-pinacolone was selected. Furthermore, according to the literature paper¹¹⁴ in which the C5-cyclohexyl 3-ureido benzodiazepine has a higher activity to the CCK_B receptor than its parent compound the C5-phenyl analogue L-365,260 a cyclohexyl ring was desirable. However, the reaction with this substrate did not form the desired mono- or dialkylated products surprisingly and instead cyclopentyl- and cycloheptyl bromide were selected.

Table 5.1: Alkylating Agents used for the synthesis of Asperlicin analogues

Methyl bromide H ₃ C-Br	1-Chloro-pinacolone 	Ethyl-chloro acetate 	Cyclopentyl bromide 
Cycloheptyl bromide 	Benzyl bromide 	Acetyl chloride 	Propionyl chloride 

The alkylation¹⁹⁴ on the N₁ position of the templates furnished the mono-alkylated benzodiazepines **66**, **68**, **70**, **72**, **74**, **78**, **80**, **84**, **85 R** and **86 S** (Figure 5.5) in particular high yields. The reactions have been carried out with sodium hydride¹⁹⁵, under very mild conditions at ambient temperature, with only 1.2 equivalent of the alkylating agent, while the methylation on the amide nitrogen with methyl bromide was carried out at 0-5°C. Generally, dialkylated benzodiazepines were obtained as minor by-products and were separated by column chromatography. However, although 1.2 eq. of the less reactive methyl bromide instead of methyl iodide was used, the reaction furnished higher amounts of the dimethylated product (**67**). An excess of the alkylating agents furnished the dialkylated benzodiazepines **67**, **69**, **71**, **73** and **75** (Figure 5.6). Finally, the N₁-methylated 1,4-benzodiazepine **66** and the isomers of the N₁-benzylated 1,4-benzodiazepines **84**, **85 R** and **86 S** were converted into N acetylated indols by using an excess of the electrophile at higher temperatures (**76**, **87**, **88**, **89 R**, **90 S**). The overall yields were all good and chemical diversity was attached to the benzodiazepine scaffold in each synthetic step of this short reaction sequence.

The assignment of the positions of N-1 and indole N-hydrogen and methyl group in **66**, **67** were made by the H-NMR studies. While the 1,4-benzodiazepine template **63** showed two singlets at $\delta = 8.1$ and $\delta = 8.7$ ppm, the mono-methylated compound **66** indicated the indole N hydrogen at $\delta = 8.2$ ppm. The previous ¹H-NMR studies of 1,4-benzodiazepine derivatives incorporating other than the Trp moiety showed the signal of the N-1 hydrogen at around $\delta = 8.9$ – 9.5 ppm. The assignment of the Asperlicin analogues was based on these studies.

The figure 5.5 represents the racemic mono-alkylated 3-(indolylmethyl)-1,4-benzodiazepines at the amide nitrogen, while figure 5.6 shows the alkylated and acylated products at the amide and indole nitrogen to natural-like Asperlicin analogues.

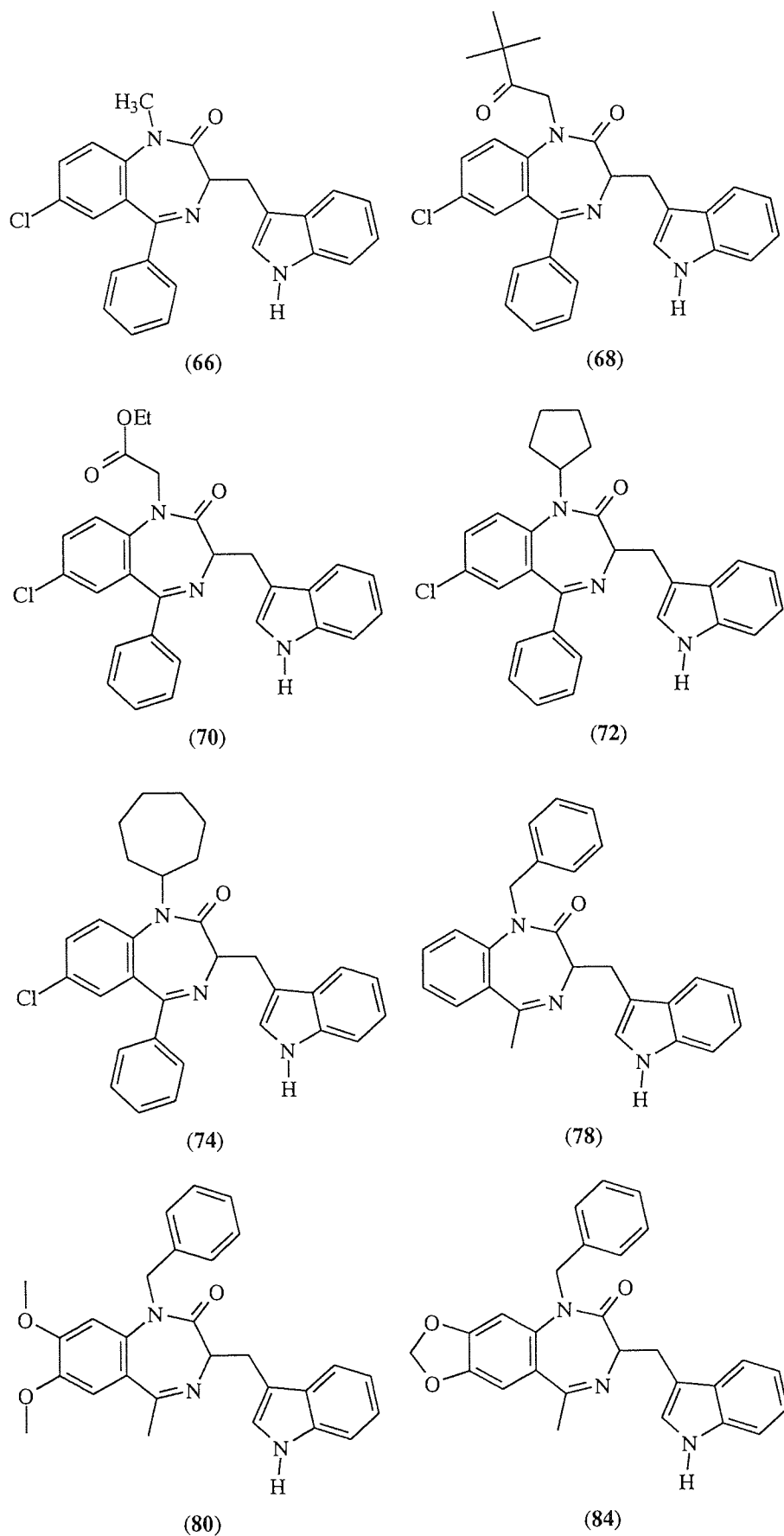
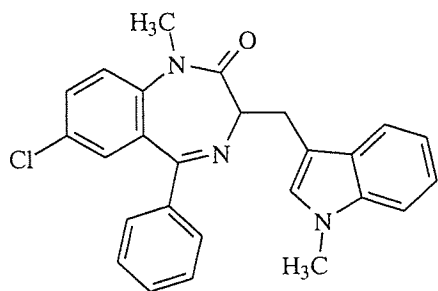
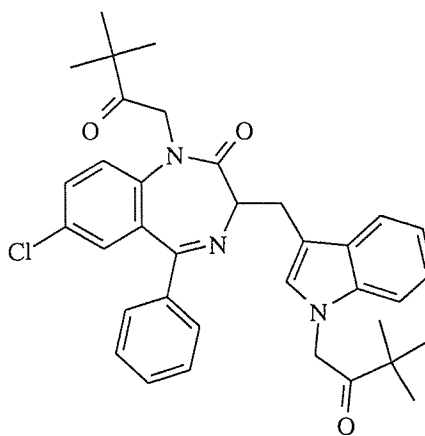

Figure 5.5: Structures of racemic monoalkylated 3-(indolylmethyl)-1,4-benzodiazepines



(67)



(69)

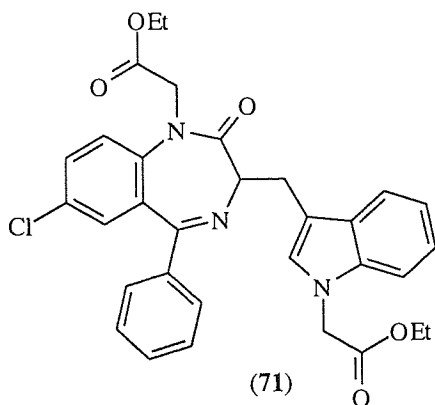

(71)

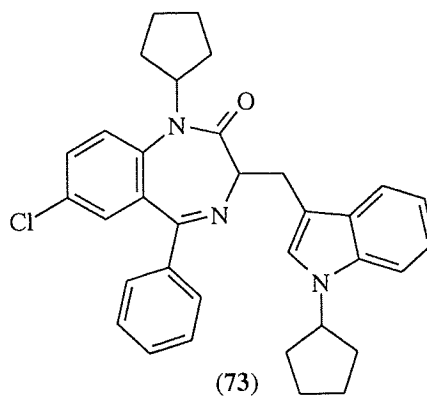

(73)

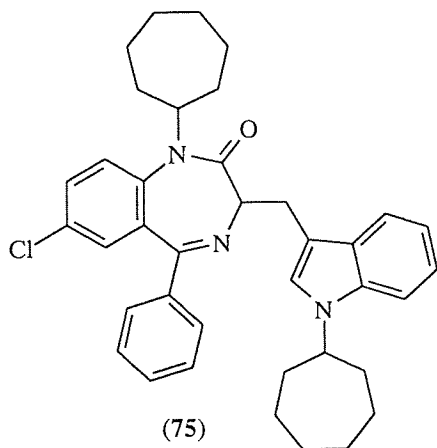

(75)

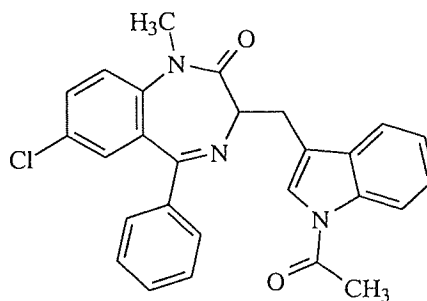

(76)

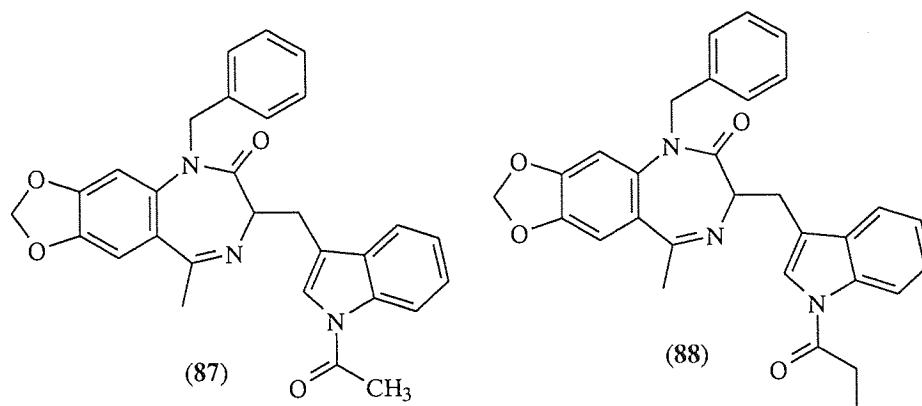
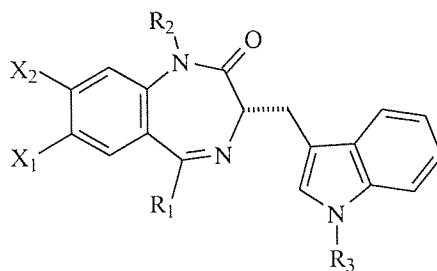

Figure 5.6: Structures of racemic alkylated and acylated 3-(indolylmethyl)-1,4-BZD's at the amide and indole nitrogen to natural-like Asperlicin analogues

5.2. Pharmacology of alkylated 3-(indolylmethyl)-1,4-benzodiazepines

All CCK_B binding assays were carried out with L-365,260 or with MK 329 for the CCK_A receptor subtype as internal standards in triplicate. The prepared compounds were characterised and no binding was observed for concentrations >20 micromolar. Detailed results are reported in table 5.2.

Table 5.2: Biological evaluation of alkylated 3-(indolylmethyl)-1,4-benzodiazepines and their precursors; IC₅₀ [μ M] - binding on CCK_A and CCK_B receptor













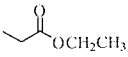
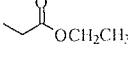
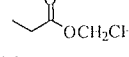

Entry	X ₁	X ₂	R ₁	R ₂	R ₃	Yield	CCK _A	CCK _B
63	Cl	H	Phenyl	H	H	58	5	6
64 R	Cl	H	Phenyl	H	H	45	3	9
65 S	Cl	H	Phenyl	H	H	36	11	3
66	Cl	H	Phenyl	-CH ₃	H	28	7	7
67	Cl	H	Phenyl	-CH ₃	-CH ₃	50	> 20	> 20
68	Cl	H	Phenyl		H	50	> 20	8
69	Cl	H	Phenyl			43	> 20	> 20
70	Cl	H	Phenyl		H	48	> 20	9
71	Cl	H	Phenyl			41	> 20	> 20
72	Cl	H	Phenyl		H	52	> 20	> 20
73	Cl	H	Phenyl			46	> 20	> 20
74	Cl	H	Phenyl		H	49	> 20	> 20
75	Cl	H	Phenyl			42	> 20	> 20
76	Cl	H	Phenyl	-CH ₃	Acetyl	34	3	> 20
77	H	H	-CH ₃	H	H	44	> 20	> 20
78	H	H	-CH ₃	Benzyl	H	44	8	> 20
79	-OCH ₃	-OCH ₃	-CH ₃	H	H	44	> 20	> 20
80	-OCH ₃	-OCH ₃	-CH ₃	Benzyl	H	38	5	> 20
81			-CH ₃	H	H	48	> 20	> 20
82 R			-CH ₃	H	H	38	> 20	> 20
83 S			-CH ₃	H	H	38	> 20	> 20

Table 5.2: Biological evaluation of alkylated 3-(indolylmethyl)-1,4-benzodiazepines and their precursors (**Continued**)



Entry	X ₁	X ₂	R ₁	R ₂	R ₃	Yield	CCK _A	CCK _B
84			-CH ₃	Benzyl	H	42	4	> 20
85 R			-CH ₃	Benzyl	H	34	8	> 20
86 S			-CH ₃	Benzyl	H	34	3	> 20
87			-CH ₃	Benzyl	Acetyl	27	3	> 20
88			-CH ₃	Benzyl	Propionyl	22	4	> 20
89 R			-CH ₃	Benzyl	Acetyl	22	4.5	> 20
90 S			-CH ₃	Benzyl	Acetyl	22	2	> 20

SAR-studies

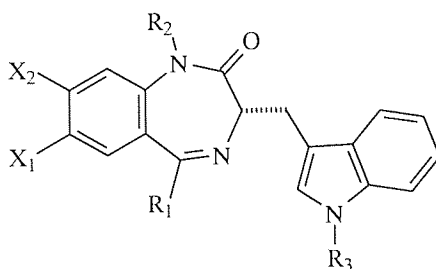
The SAR optimisation from the privileged structure (**63**) via the N₁ methylated benzodiazepine (**66**) to a 5-methylated natural product like molecule (**90-S**) is outlined in figure 5.7. All compounds were purified and characterised.

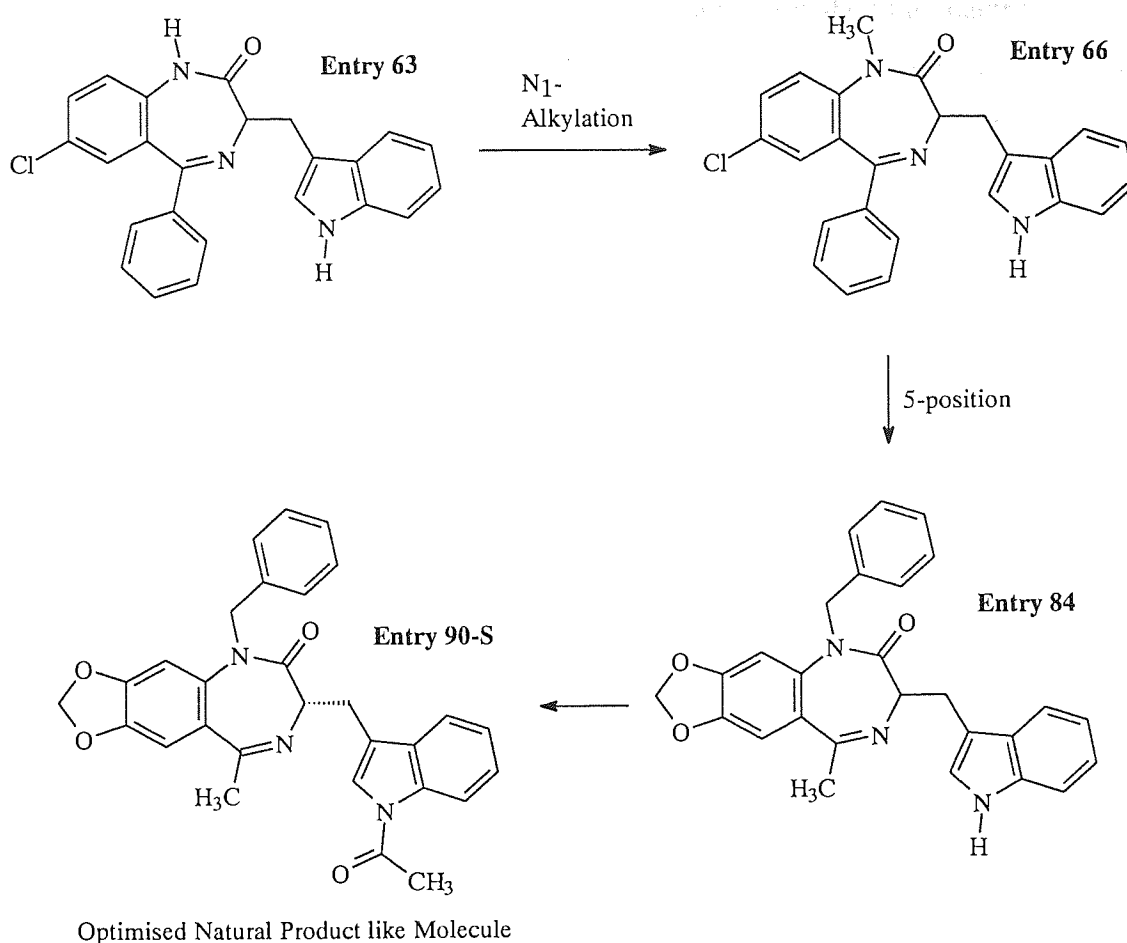

Figure 5.7: SAR-studies: From a privileged structure to an optimised natural product-like molecule (Asperlicin 1.4 μM)

In the literature binding was enhanced by N_1 alkylation with esters and ketones, especially with the t-butyl ketone¹⁴¹ for the ureido-1,4-benzodiazepines. Here, mono-alkylated α -halogenoesters on the amide nitrogen led to a slightly decreased of bioactivity towards the CCK_B receptor (**68**, **70**) while they were inactive on the CCK_A receptor. The di-alkylation resulted in all cases in a complete loss of binding (**67**, **69**, **71**, **73**, **75**) either on the CCK_A or CCK_B receptor. The methylation on N_1 position (**66**) of the template (**63**) led to a slight loss of bioactivity towards both receptor subtypes. This compound served as lead structure to Asperlicin analogues and was further chemically modified by acetylation on the indole nitrogen (**76**), showing an IC_{50} of 3 micromolar on the A receptor subtype.

However, the preparation of this starting material (**66**) also furnished the inactive dimethylated product (**67**). The easy chemical accessibility was the important part of this project and based on the observations, that alkylation reactions other than with methyl bromide showed a higher regioselectivity, the 1,4-benzodiazepine template was changed to a series of N1-benzylated aminoacetophenones **B**, **C** and **D** in order to explore the SAR further. The subsequent replacement of the phenyl ring in the 5-position by a methyl group (**77**, **79**, **81**, **82 R** & **83 S**) led to a loss of bioactivity while their benzylated analogues on the amide nitrogen (**78**, **80**, **84**, **85 R** and **86 S**) were active. These results indicate that one ring structure either on 5-position exemplified for the privileged template (**63**) or here on the N1-position of the 1,4-benzodiazepine template is an essential part for bioactivity. Interestingly, those N1-benzylated compounds with electron rich substituents on the 7- and 9- position (**80** and **84**) of the 1,4-benzodiazepine scaffold showed bioactivity on the CCK_A receptor while the compounds were inactive on the B subtype compared to the 1,4-benzodiazepine template (**63**). Furthermore the preparation of those N1-benzylated electron-rich compounds was easier.

The N-acylation of the indole nitrogen of the most active CCK_A ligand (**84**) gave also here the best results with acetyl chloride (**87**). The chemical yield decreased for propionyl chloride (**88**) and long chain acid chlorides, without giving a significantly higher binding, so that acetylation was ideal combining ease of access and enhanced bioactivity.

Finally, the influence of the configuration at the C3 centre was investigated because stereochemistry plays an important role in selectivity and potency of Devazepide and of Merck's ureido-1,4-benzodiazepines¹²⁹. For example Devazepide (MK 328, S-isomer) is a CCK_A selective ligand, while Merck's L-365,260 (R-isomer according to CIP nomenclature¹⁹⁶) is 550 times more potent on the B receptor to its counterpart the S-isomer¹⁸³ (Figure 5.8). The isomers (**64 R**, **65 S**) of the privileged 1,4-benzodiazepine template reflected the discrepancy on bioactivity and selectivity over the CCK receptor subtypes. However, according to the CIP nomenclature, the S-isomer of the BZD template (**65 S**) showed approximately 2-fold times higher bioactivity on the CCK_B receptor, while the R-isomer (**64 R**) was more selective on CCK_A receptors.

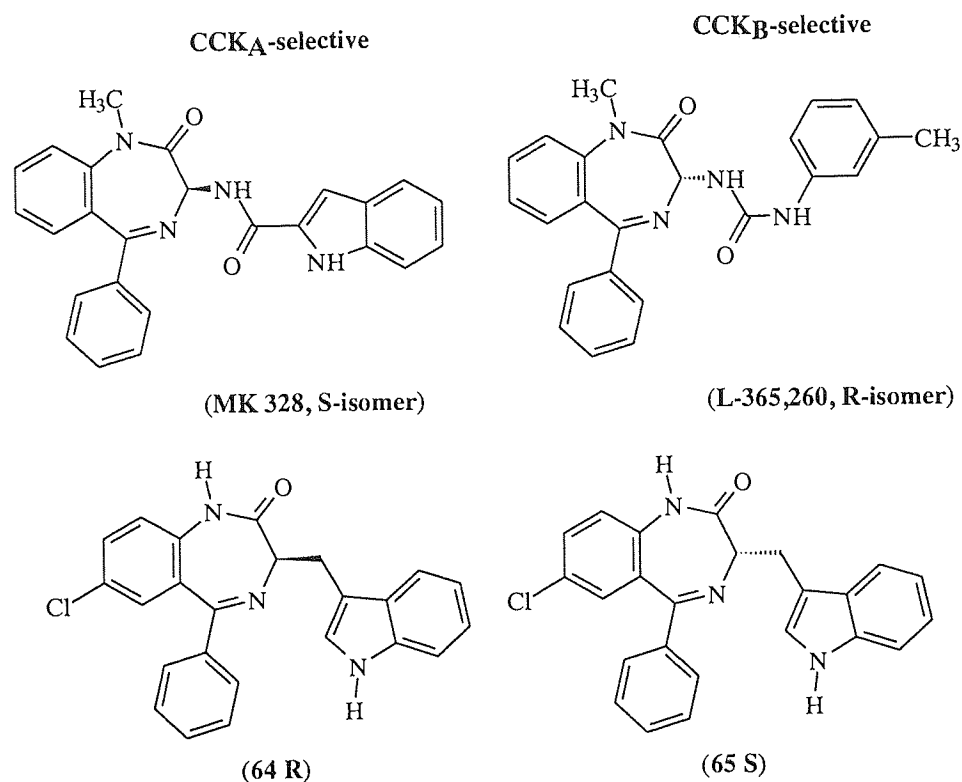

Figure 5.8: Chiral structures of CCK_A and CCK_B selective ligands

The isomers of the template with the electron-rich dioxyphenylene ring system (**82 R**, **83 S**) were used for the specific alkylation/acylation reactions to Asperlicin analogues. While the R-isomer (**64 R**) of the privileged template was approximately 2-fold times more active towards the CCK_A receptor compared to its counterpart, here the S-isomer of the N1-benzylated compound (**90 S**) was the more active benzodiazepine isomer of this series showing an IC₅₀ of 2 micromolar on the A receptor subtype as presented in figure 5.9.

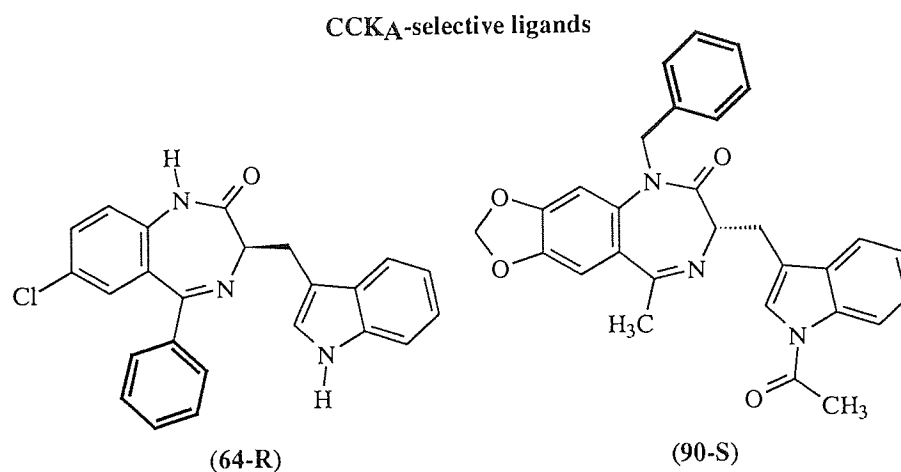

Figure 5.9: Structures of chiral CCK_A ligands

For the discrepancy on bioactivity of the CCK_A receptors of these isomers might to name that the essential ring structure for bioactivity of compound (**64 R**) is on the 5-position, while for compound (**90 S**) the benzyl group is opposite side on the N1-position of the benzodiazepine skeleton. The stereochemistry has shown that the most active chiral compound (**90 S**) has the same configuration than the natural occurring (S)-Asperlicin. However it should be noted that the stereocentre of this compound (**90 S**) could not be determined in ¹H-NMR studies by using Eu shift reagent, because of overlapping of signals.

The biological results of the alkylated and acylated 3-(indolylmethyl)-1,4-benzodiazepines are outlined in the following diagram.

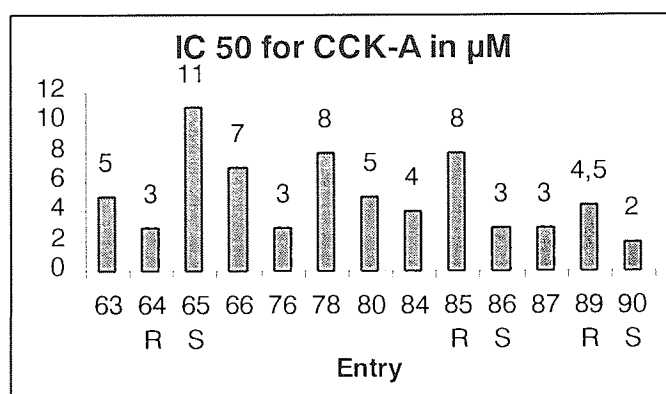

Diagram 5.1 Comparison of biological activity of selected alkylated and acylated 3-(indolylmethyl)-1,4-benzodiazepines.

Based on these studies it was established that a phenyl ring on the 5-position or a benzyl ring on the 1-position of the 1,4-benzodiazepine skeleton (Figure 5.7) is essential for bioactivity on the CCK receptor subtypes. Furthermore the acetylation on the indole nitrogen of 3-(indolylmethyl)-1,4-benzodiazepines have led to a further increase in bioactivity towards the CCK_A receptor while these compound were inactive on the B receptor subtype. Although the bioactive privileged templates (**64 R**, **65 S**, Figure 5.8) were formed with little racemisation it was established that the stereochemistry did not play an important role in selectivity and potency of those ligands.

By comparison the biologically inactive dimethylated compound (67) with the acetylated analogue on the indole nitrogen (76) as shown in figure 5.10 demonstrated that the “small” structural change, here by the acetyl group, is critical for bioactivity and selectivity towards CCK receptors.

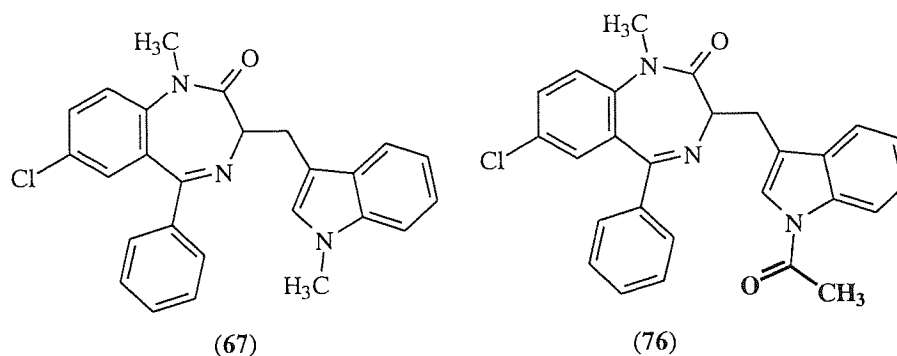

Figure 5.10: Comparison of the biological inactive dimethylated 3-(indolylmethyl)-1,4-benzodiazepines with the CCK_A selective Asperlicin analogue

In summary the heterocycle was built up in one step, in which the electron rich 2-amino-4,5-methylenedioxyacetophenone (ketone **D**) was incorporated into the synthetic target (Figure 5.7). The N₁ benzylation of the indolmethyl-1,4-benzodiazepine, followed by the N-indole acetylation furnished the desired bioactive molecules in only three steps.

New drugs have been traditionally developed from “old drugs” but one important approach in drug discovery still remains, the identification of novel lead structures from nature. It is well known that this is a costly and time-consuming approach¹⁹⁷.

Combinatorial chemistry^{7,12} has been devised to speed up this drug discovery process with various modifications, including the innovative step that can be carried out with or without solid phase support^{9,178}. An example of a so-called synthesis of natural product-like molecules in which nature’s inspiration was combined with chemical accessibility of the non-toxic benzodiazepine scaffold⁹⁵ has been presented.

The 1,4-benzodiazepine structure containing an indolyl-methyl side chain was recognised as the privileged structure and has been modified further in two selective alkylation/acylation steps. By this approach a natural product-like molecule was created showing an IC_{50} of $2 \mu M$ (Asperlicin $1.4 \mu M$). The naturally occurring lead compound provided a chemical target which was easy to synthesize and biologically active. Snider¹⁹⁸ prepared Asperlicin in over 15 steps in 8% overall yield, while by our approach, a natural product-like molecule with almost the same bioactivity could be prepared in three steps in 22% yield.

Chapter 6

Synthesis and Biological Evaluation of 4H-[1,2,4]triazolo[4,3-a][1,4]benzodiazepines as Cholecystokinin-Antagonists

One of the most successful 1,4-benzodiazepine worldwide is Alprazolam (**91**, Xanax®), a triazolo 1,4-benzodiazepine analogue that is readily absorbed in man when orally administered¹⁹⁹. Although, 4-unsubstituted triazolo 1,4-benzodiazepine derivatives like Alprazolam shows high affinity to the GABA_A/benzodiazepine receptor complex with the resulting side-effects, it was reported²⁰⁰ that the introduction of a triazole fused ring of CCK_B antagonist L-365,260 (**92**) and Devazepide (L-364, 718, **93**) as CCK_A antagonist (Figure: 6.1) shows binding of cholecystokinin (CCK) in the subnanomolar range.

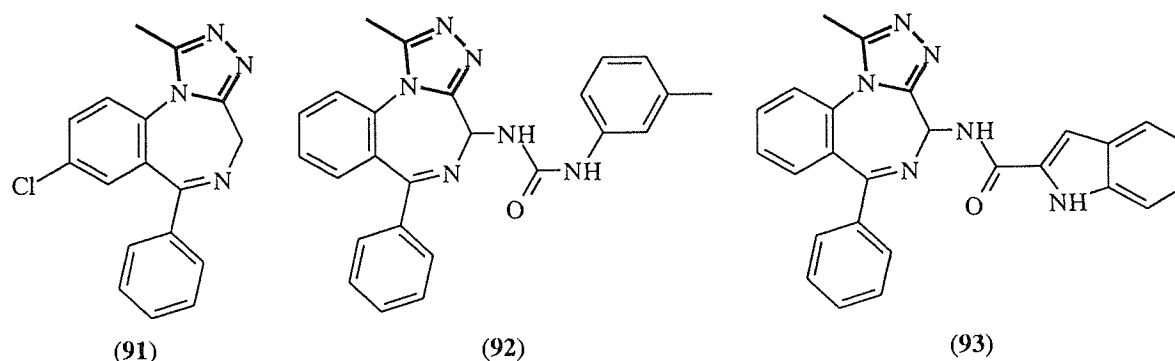

Figure 6.1: Structures of Alprazolam (**91**) and of 4-substituted triazolo-1,4-benzodiazepines

The biological evaluation of the triazole fused ring CCK_B antagonist (**94**) and (**95**) as CCK_A antagonist (Figure: 6.2), which might enhance binding to the CCK receptors with the improvement of bioavailability was pursued. Furthermore, Alprazolam (**91**), exemplified for 4-unsubstituted 1,4-benzodiazepines with affinity to the GABA_A/benzodiazepine receptor, was prepared in order to investigate the possible biological correlation of these receptors.

The essential benzodiazepine templates were prepared by 5-chloro-2-aminobenzophenone and 2 eq. of α -amino acids as ethyl ester hydrochlorides in boiling pyridine for 48 hours with a catalytic amount of DMAP¹⁸⁴ according to published methods¹⁸⁵⁻¹⁸⁸. While glycine formed the seven-membered ring structure (**96**) only in 19 % yields, nor-valine generated 62% of (**97**) and tryptophan in 58 % of 3-indolylmethyl-1,4-benzodiazepine (**98**). These templates were converted to their thioamides (Figure 6.3) in order to increase the essential nucleophilicity of the lactam. N-nordesmethyl diazepam (**96**) formed the thioamide (**99**) with tetraphosphorus decasulfide (P₄S₁₀) in refluxing pyridine in 76% yield, while the 3-substituted templates formed the desired products in only 35% for (**100**) and 17% for (**101**). The exchange of tetraphosphorus decasulfide to 2,4-bis(4-methoxyphenyl)-2,4-dithioxo-1,2,3,4-dithiadiphosphetane (Lawesson's reagent)²⁰¹ increased the yields of the desired products significantly. The reaction of 3-substituted-1,4-benzodiazepines with Lawesson's reagent furnished 75% of (**100**) and 54% of (**101**). The desired triazolo benzodiazepine derivatives were then prepared by treatment with approximately 3 eq. of acetylhydrazide in refluxing butanol via the intermediate (**102**). It is noteworthy, that the cyclisation of the intermediates were carried out successfully only in solvents with high boiling points such as butanol (b.p. = 117.7°C).

These synthetic methods lend themselves to the preparation of A) the lactams (**96, 97, 98**), B) the thioamides (**99, 100, 101**) and C) the triazolo benzodiazepines (**91, 94, 95**) as presented in figure 6.3.

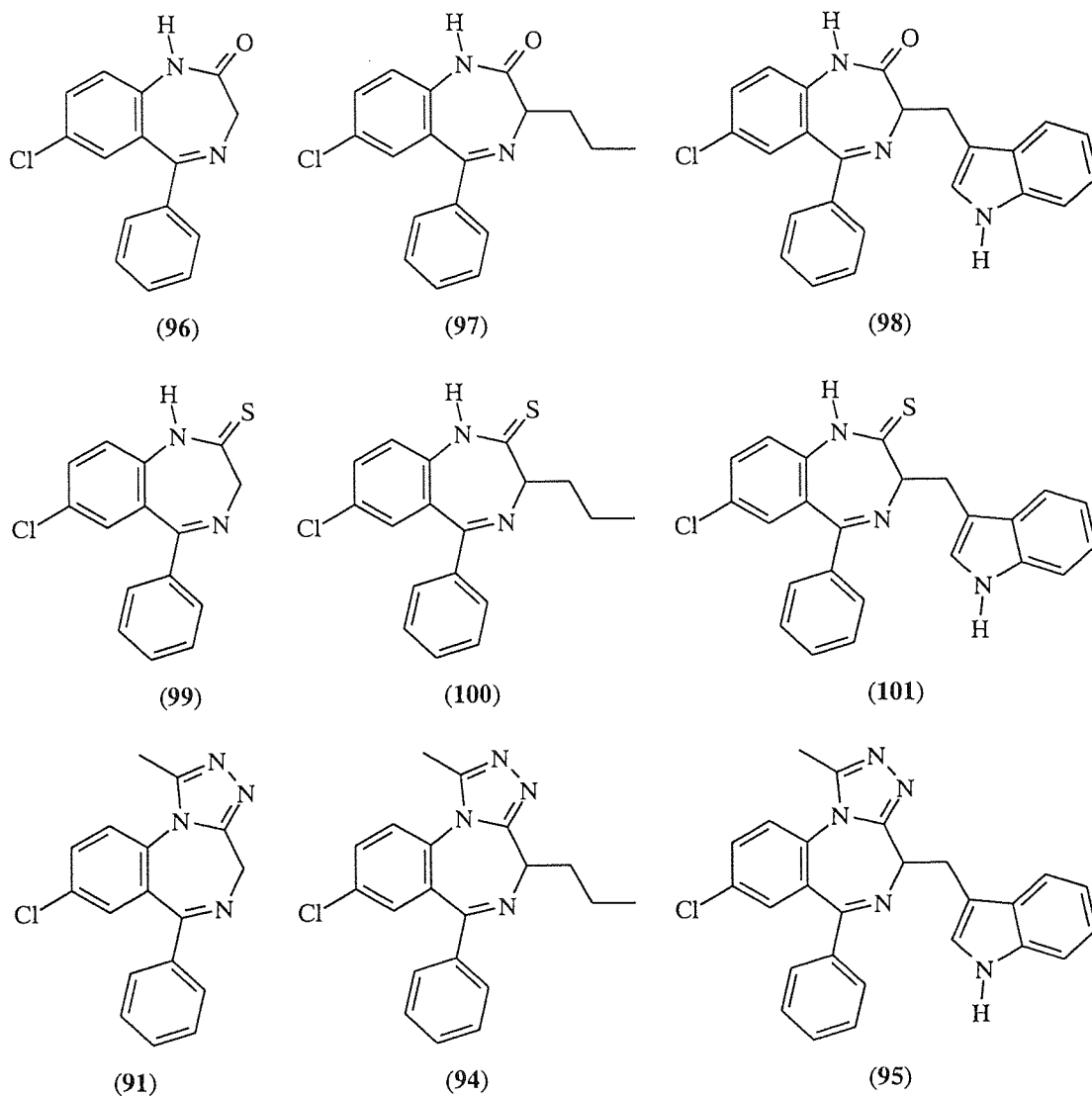

Figure 6.3: Substituted 1,4-benzodiazepines as lactams, thioamides and triazolo derivatives

6.2. Pharmacology of triazolo-1,4-benzodiazepines and their precursors

All CCK_B binding assays were carried out with L-365,260 or with MK 329 for the CCK_A receptor subtype as internal standards in triplicate. The results are summarised in table 6.1.

Table 6.1: Biological evaluation of triazolo-1,4-benzodiazepines and their chemical precursors

Entry	R	Yield [%]	CCK _A [μ M]	CCK _B [μ M]
96	H	19	>50	>50
97	Propyl	62	13	0.6
98	Indolylmethyl	58	3	15
99	H	14	>50	>50
100	Propyl	46	11	0.3
101	Indolylmethyl	31	11	9
91	H	11	>50	>50
94	Propyl	34	25	32
95	Indolylmethyl	17	2	22

In this limited study the effects of the biological evaluation in binding to the CCK_A/CCK_B receptor of triazolo benzodiazepines and their chemical precursors as thioamides were examined. The evaluation was performed with purified compounds.

As a result of this study, the presence of the additional triazolo ring of 3-indolylmethyl-1,4-benzodiazepine (**95**) has an influence on both potency and selectivity. A comparison among the results of the two receptor binding assay reveals that the triazolo 3-indolylmethyl-1,4-benzodiazepine (**95**) exhibited selectivity for the peripheral CCK receptor type A, while this compound showed a decreased bioactivity on the CCK_B receptor. The 3-propyl triazolo benzodiazepine (**94**) showed here a decreased bioactivity on the CCK_A and CCK_B receptor. By comparison 3-substituted-benzodiazepines as thioamides (**100**, **101**) with their amide analogues (**97**, **98**) showed in general improved binding towards the CCK_B receptor subtype. In this context, 3-propyl-BZD thioamide (**100**) possessed an increased CCK_B potency by a factor of two showing an IC₅₀ of 300 nM compared to the previous CCK_B lead structure (**97**). The enhanced CCK_B activity of thioamide benzodiazepines clearly demonstrated the strong correlation to the sulfated CCK forms. These sulphated forms of CCK and gastrin are more potent²⁰² than the non-sulphated forms.

For example, Huang reported the importance of sulfation of gastrin or cholecystokinin⁶⁹ (CCK) on affinity for gastrin and CCK receptors. The obtained results correlate well with the reported studies.

Furthermore, certain diazepam (e.g. diazepam, lorazepam) antagonise the effects of CCK in the periphery^{203,204} and in the central nervous system, which is an as yet undefined mechanism. Here, 3-unsubstituted BZD's (**96**, **99**) did not possess bioactivity. In agreement with these results, it was confirmed that CCK antagonist potencies of "classical" substituted benzodiazepines depend critically on the 3-position or on the 4-position of triazolo benzodiazepines. Alprazolam (**91**), an unsubstituted triazolo benzodiazepine did not possess bioactivity of the CCK receptor subtypes. The substituent attached to the 4-position of the triazolo benzodiazepine ring, which was the optimum for peripheral CCK antagonist potency was again found to be the indole moiety. The biological results of these compounds are outlined in diagram 6.1.

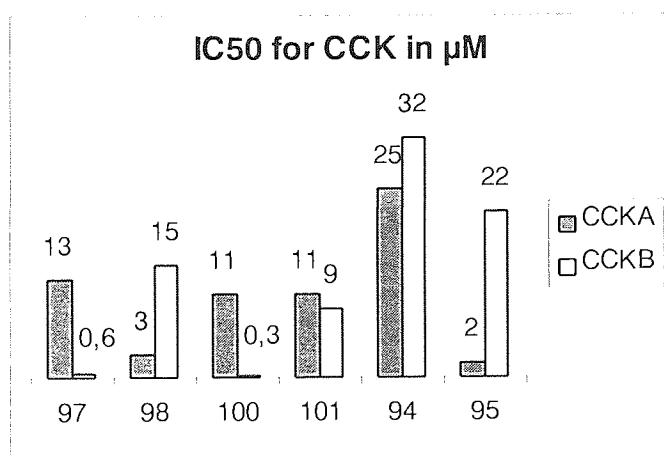

Diagram 6.1: CCK_A/CCK_B binding of 3-propyl- and 3-indolylmethyl-1,4-benzodiazepines as thioamides and triazolo derivatives.

In this limited series, the structural modification by introduction of an additional triazolo ring of the 3-indolylmethyl-BZD skeleton (**95**) showed enhanced binding to the peripheral CCK receptor (Figure 6.4). This result demonstrates that the previous findings (Asperlicin analogues) can be extended to the triazolo benzodiazepine class with similar effect, which might also have a better bioavailability. Surprisingly, 3-propyl-BZD thioamide (**100**) showed an increased CCK_B potency and was the most active racemic CCK_B ligand.

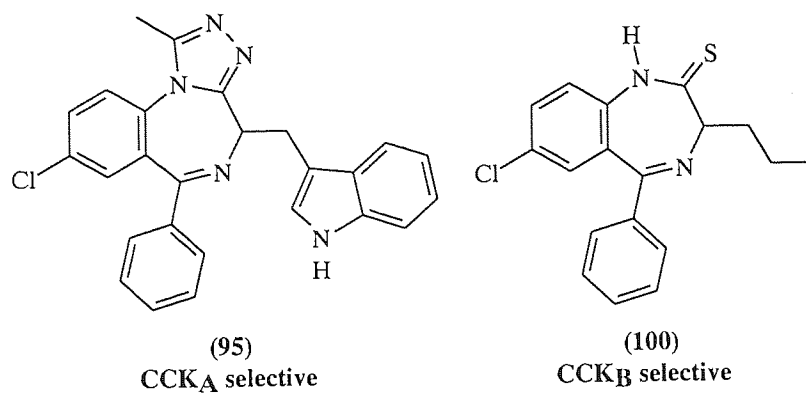

Figure 6.4: Selected substituted 1,4-benzodiazepine derivatives, with enhanced binding towards CCK_A and CCK_B receptor.

Chapter 7

Synthesis and Biological Evaluation of 3-Functionalised 1,4-benzodiazepines

The fact that 3-functionalised p-hydroxybenzyl-1,4-benzodiazepine are selective antagonist of the gastrointestinal hormone cholecystokinin (CCK_A) in nanomolar activity was an important discovery. By comparison this highly active compound (**103**, Figure: 7.1) with 3-benzyl-1,4-benzodiazepine (**104**) as non-selective CCK antagonist with micromolar potency, demonstrated that the “small” structural modification has shown a pronounced effect of bioactivity and selectivity over the CCK receptor subtypes. The enhanced bioactivity of (**103**) was caused by a better interaction of the hydroxyl group probably via hydrogen bonding with the CCK_A receptor. Unfortunately the chemical yield of 3-functionalised p-hydroxybenzyl-1,4-benzodiazepine by combinatorial solid phase organic chemistry approach (SPOC) and by classical solution phase chemistry (Chapter 7.2) was low but however, this compound served as a lead structure. Thus for search for new CCK ligands, the preparation and biological evaluation of 1,4-benzodiazepines with functionalised groups at 3-position were pursued. It is possible that they might also show enhanced binding and selectivity over the CCK receptor subtypes. Furthermore these CCK ligands might improve oral efficacy and bioavailability²⁰⁵.

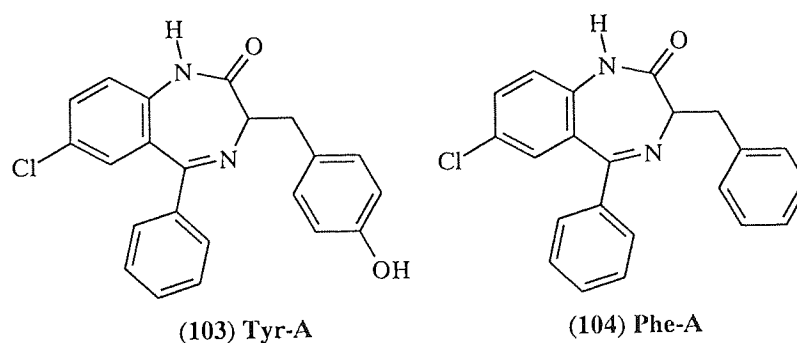

Figure 7.1: 3-(p-hydroxybenzyl)-1,4-benzodiazepine as CCK_A selective antagonist and 3-benzyl-1,4-benzodiazepine as non-selective CCK antagonist

7.1. Bioisosteric modifications

In this approach, the exchange of the hydrocarbon residue next to carbon-3 of the heterocyclic seven-membered ring (Figure 7.2) CCK_B (**105**, Nva-A) and CCK_A (**103**, Tyr-A) selective compounds, containing an amino functionality provided bioisosteric modifications to yield 3-alkylamino-/anilino-1,4-benzodiazepines (**106**, **107**). A new convergent synthetic method was developed in which the seven-membered heterocyclic ring template was constructed by the use of 3-hydroxy-1,4-benzodiazepine (Oxazepam®). Subsequent reactions of Oxazepam® via their activated 3-chloro-1,4-benzodiazepine with nucleophiles (Scheme 7.1) lead to the introduction of 3-substituents without requiring construction of the diazepine ring from the chemical precursors each time a different substituent was desired.

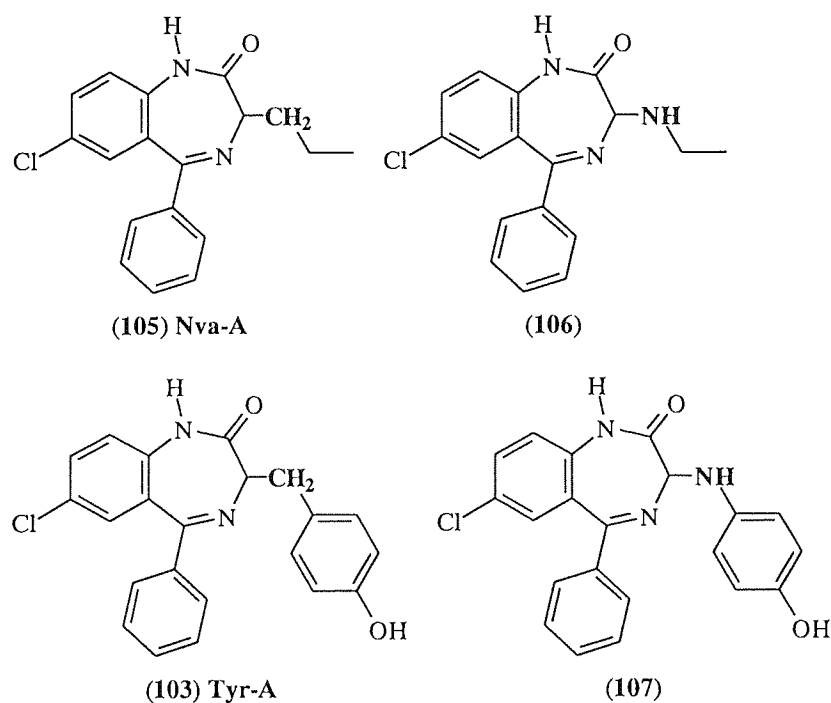
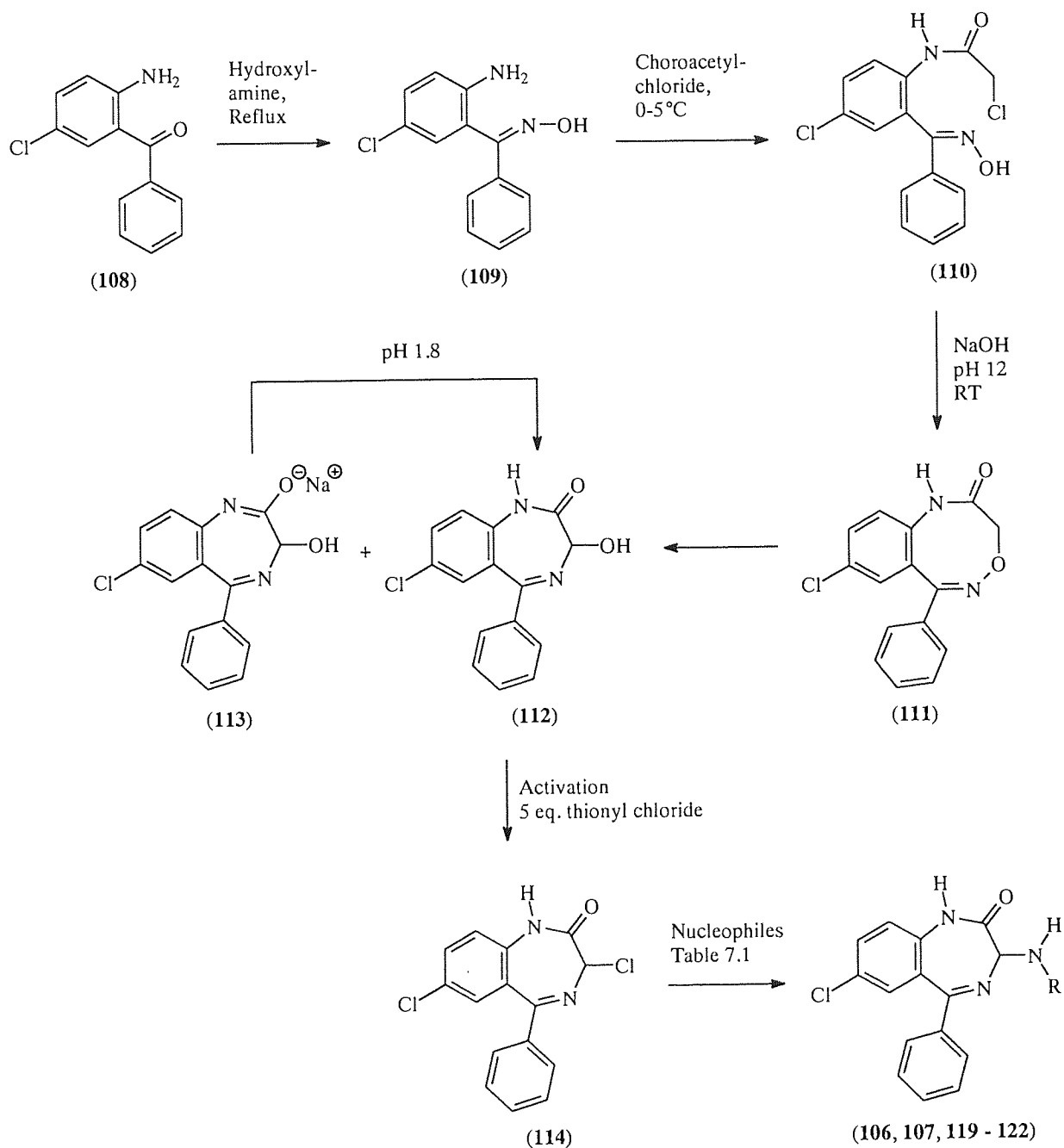

Figure 7.2: Bioisosteric modifications of the 1,4-benzodiazepine skeleton (synthetic targets)

7.1.1. Synthesis of 3-(alkylamino/anilino)-1,4-benzodiazepines

Scheme 7.1 illustrates an overview of the synthesis of the 3-(alkylamino/anilino)-1,4-benzodiazepines via the key compound Oxazepam® (112).



Scheme 7.1: Synthesis of 3-(alkylamino-/anilino)-1,4-benzodiazepines via Oxazepam®

In this context 2-chloroacetamidobenzophenone oxime (**110**), prepared by 5-chloro-2-aminobenzophenone (**108**) and hydroxylamine hydrochloride under reflux followed by acylation with chloroacetyl chloride, furnished in alkaline medium at pH = 12 the desired key compound Oxazepam® (**112**) via 4,1,5-benzoxadiazoin-2-ones¹⁴⁷ (**111**) in three synthetic steps. In addition to Oxazepam (**112**), this reaction also furnished Oxazepam as the sodium salt (**113**). Although the sodium salt derivative (**113**) showed the C₃ hydrogen characteristically for 3-substituted-1,4-benzodiazepines at $\delta = 4.2$ ppm the typical N1:-H signal at $\delta = 8.6$ ppm in ¹H-NMR studies was absent. However the sodium salt derivative (**113**) could be easily converted into (**112**) in an acidified solution (pH \approx 1.8). The reaction afforded Oxazepam® in 62% yield based on (**110**). While Oxazepam reacted with 5 eq. of thionyl chloride to form Oxazepam-chloride²⁰⁶ (**114**) in 50 % yield, the reaction with (**113**) only furnished this compound in moderate yields. Subsequent reaction of the reactive compound (**114**) with 2 eq. of nucleophiles afforded the desired target compounds as presented in figure 7.5.

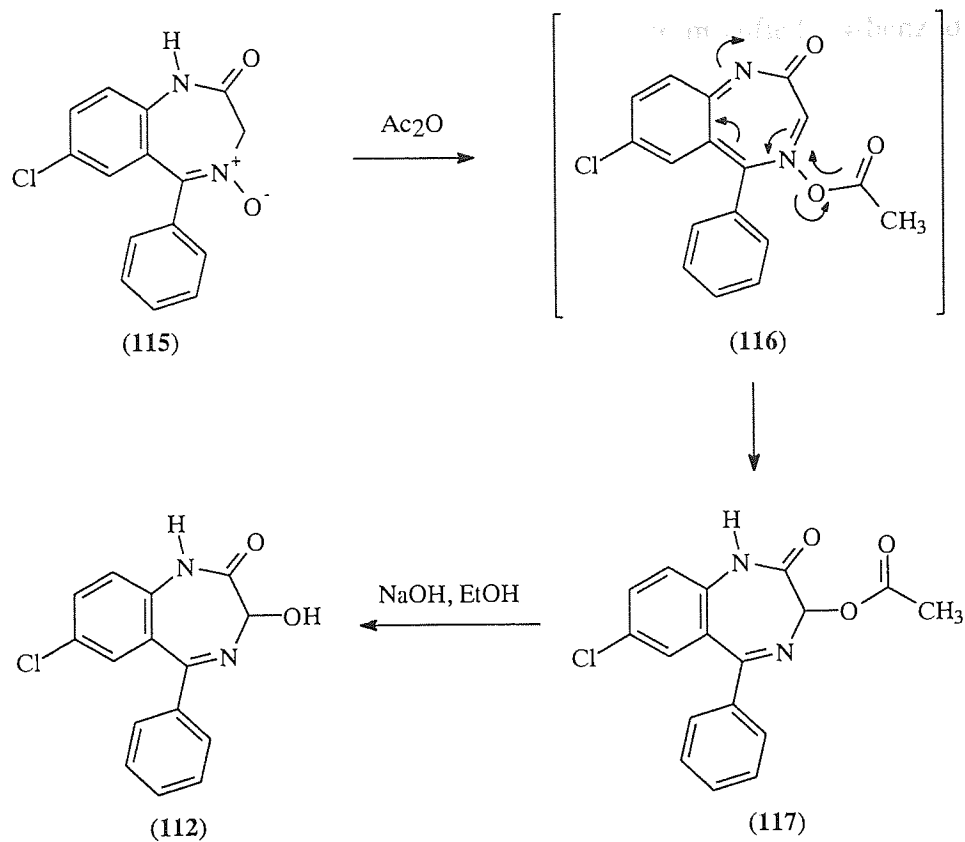

Apart from this preparation of the key Oxazepam® compound the reaction via Polonovski rearrangement¹⁴⁶ (**116**, Scheme 7.2) was initially investigated. For this approach the starting material 1,4-benzodiazepin-2-one 4-oxide (**115**) which was prepared by *N*-nordesmethyl diazepam and peracetic acid was reacted with acetic anhydride and delivered the 3-acetoxy-compound (**117**). However the target compound Oxazepam® (**112**) was formed by alkaline hydrolysis of (**117**) in only moderate yields.



Scheme 7.2: Preparation method of Oxazepam® via Polonovski rearrangement

In order to furnish the target compounds by bioisosteric modifications simple alkylamines and aniline derivatives were selected as presented in table 7.1. Furthermore, ammonia was employed in order to synthesise 3-aminobenzodiazepine²⁰⁷, which is the most important key compound for generating the highly active CCK_B ureidobenzodiazepine (L-365,260) and CCK_A amidobenzodiazepine (Devazepide), respectively.

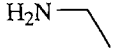
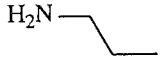
Table 7.1: Nucleophiles used in the synthesis of bioisosteric-modified 1,4-benzodiazepines

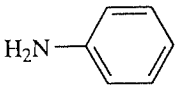
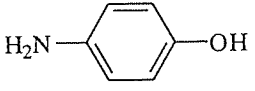
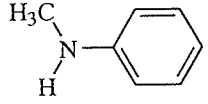
A) Ammonia NH_3	B) Methylamine H_2NCH_3	C) Ethylamine 	D) Propylamine 
E) Butylamine 	F) Aniline 	D) p-Hydroxyaniline 	H) Methylaniline 

It was anticipated that the reaction of Oxazepam-3-chloride (**114**) with ammonia at -34°C and methylamine would furnish the desired heterocyclic seven-membered ring. In practise, the reaction took a different course and numerous attempts failed to produce even traces of the products. $^1\text{H-NMR}$ spectra indicated the absence of carbon-3 proton, which is characteristic for benzodiazepines. The IR-spectra did not show the typical carbonyl-band at $1650\text{-}1700\text{ cm}^{-1}$. Instead, in addition to uncharacterisable decomposition and/or polymerisation products were isolated varying amounts of probably 4-phenylquinalzolines (**118 a** and **118 b**, Figure 7.4). The literature reports²⁰⁸ that Oxazepam can rearrange to form six-membered rings under alkaline conditions. In contrast, the reaction with higher alkylamines for example with ethylamine formed the expected target compound (**106**) and similarly with aniline derivatives without the considerable formation of by-products.

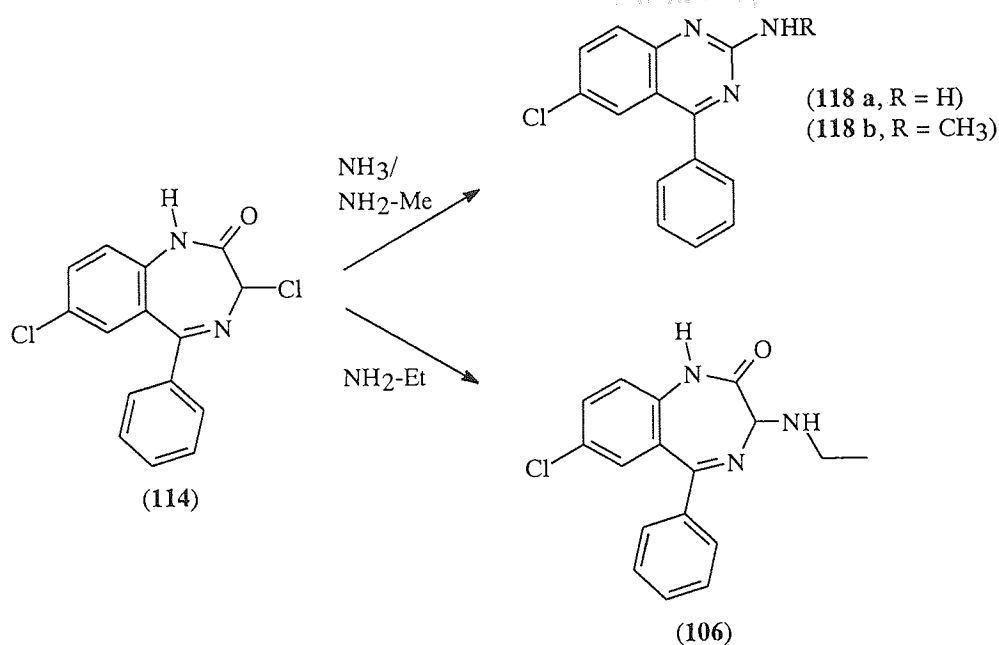

Figure 7.4: Unexpected formation of 4-phenylquinalzolinones (118 a and 118 b) compared with the successful formation of 3-ethylamino-1,4-benzodiazepine (106)

This synthetic method can be used to prepare both A) 3-alkylamino-1,4-benzodiazepines (106, 119, 120) and B) 3-anilino-1,4-benzodiazepines (107, 121, 122) as outlined in figure 7.5.

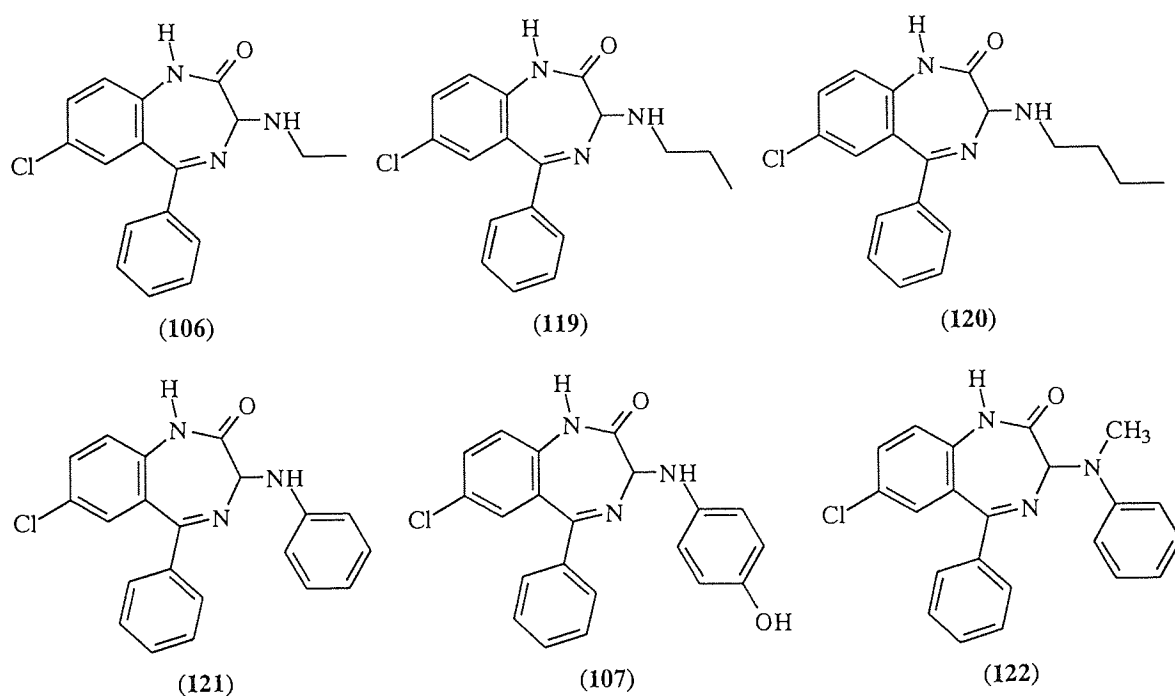
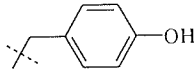
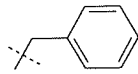
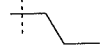
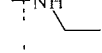
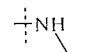
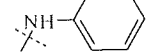
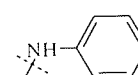
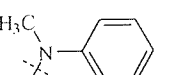



Figure 7.5: 3-(Alkylamino/anilino)-1,4-benzodiazepines

7.1.2. Pharmacology of 3-(alkylamino/anilino)-1,4-benzodiazepines

The compounds were tested as antagonists of CCK_A and CCK_B receptor binding assays CCK by using guinea pig pancreas or guinea pig cerebral cortex, respectively. These data are summarised in table 7.2 and were compared with CCK_A (**103**, Tyr-A), CCK_B (**105**, Nva-A) selective antagonists as well as with the non-selective antagonist (**104**, Phe-A).

Table 7.2: Biological evaluation of 3-(alkylamino/anilino)-1,4-benzodiazepines

Entry	R ₃	Yield [%]	CCK _A [μ M]	CCK _B [μ M]
103		---	0.65	19
104		---	7	2.5
105		---	13	0.6
106		25	>50	>50
119		35	>50	>50
120		40	>50	>50
121		55	8	10
107		45	15	>50
122		65	7	2.5

In this limited study the effects of biological evaluation in the binding of CCK_A/CCK_B receptor of 3-(alkylamino/anilino)-1,4-benzodiazepines were examined. The replacement of the alkane propyl side chain of the CCK_B selective antagonist (**105**) by alkylamines (**106**, **119**, **120**) led to a lost of binding towards the CCK_A and CCK_B subtype receptor. 3-anilino-1,4-benzodiazepines (**107**, **121**) showed a moderate bioactivity on the CCK_A receptor while compound (**122**) possessed similar bioactivity on the CCK receptor subtypes as the non-selective 3-benzyl-1,4-benzodiazepine (**104**).

An overview of bioactivity of these compounds is summarised in the following diagram 7.1.

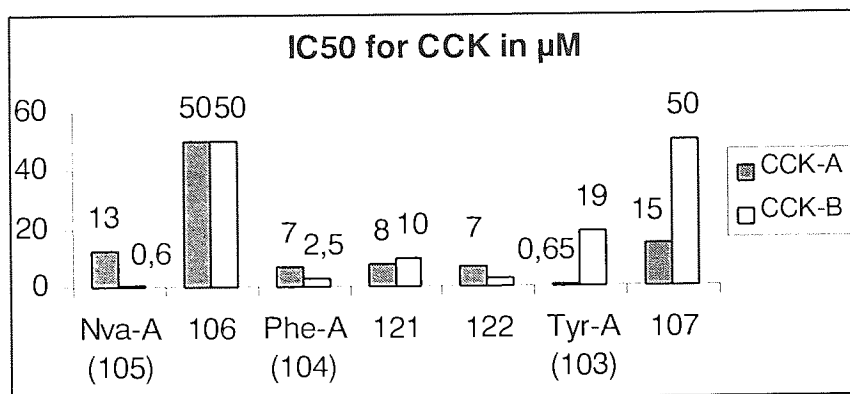

Diagram 7.1: Comparison of biological activity of selected 3-(alkyl-/aryl)-1,4-benzodiazepines with 3-(alkylamino/anilino)-1,4-benzodiazepines

In conclusion, by comparison the potent and selective CCK_A antagonist (**103**) with the significantly decreased bioactivity of (**107**), demonstrated that the hydrocarbon residue next to the carbon-3 of the heterocyclic seven-membered ring is essential for bioactivity.

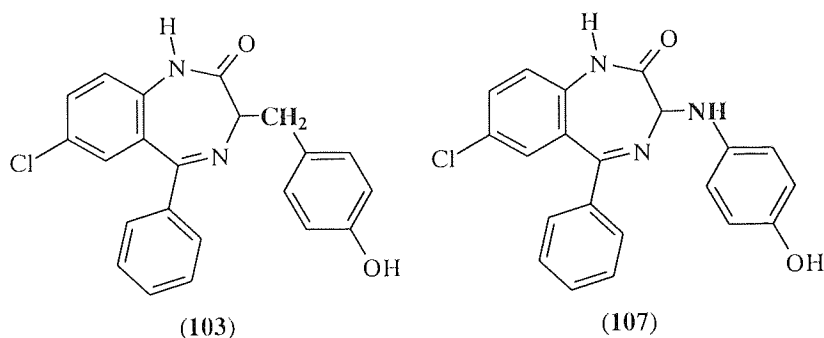

Figure 7.6: 3-(p-hydroxybenzyl)-1,4-benzodiazepine as CCK_A selective antagonist, compared with the biological inactive 3-(p-hydroxyanilino)-1,4-benzodiazepine

7.2. 3-substituted-1,4-benzodiazepines with C-terminal functional groups

The biological evaluations showed that a “small” structural modification of 3-substituted-1,4-benzodiazepines has shown a pronounced effect of bioactivity and selectivity over the CCK receptor subtypes especially for the CCK_A selective antagonist 3-p-hydroxybenzyl-1,4-benzodiazepine with the C-terminal hydroxyl group. The CCK_B selective 3-n-propyl-1,4-benzodiazepine (**105**) with nanomolar potency, prompted further examinations by replacement of the lipophilic C-3 alkyl side chain with substituents containing functional groups. However, the synthesis and biological evaluation of these compounds (**123**) with a hydrocarbon residue next to carbon-3 with C-terminal functional groups as presented in figure 7.7. was considered.

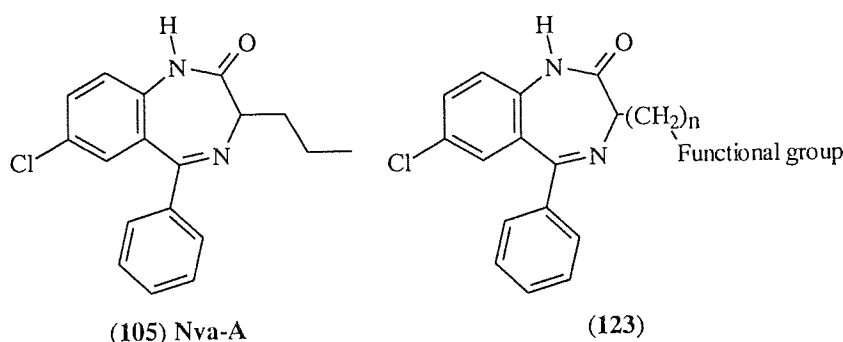
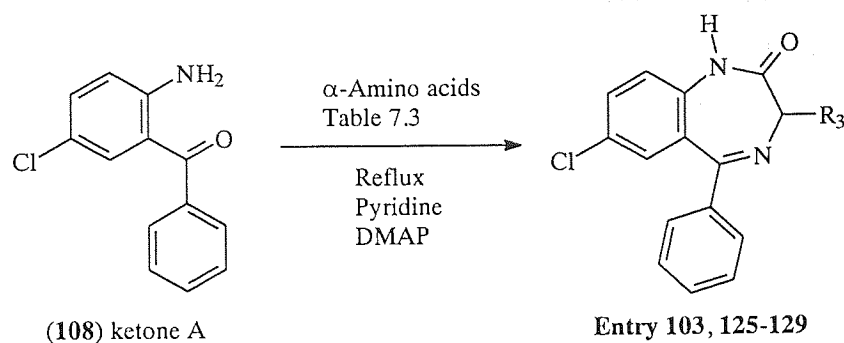

Figure 7.7: CCK_B lead structure and the privileged 1,4-benzodiazepines scaffold containing C-terminal functionalised side chain on 3-position (synthetic target)

7.2.1. Solution phase synthesis of 3-functionalised-1,4-benzodiazepines

Scheme 7.3 summarises the synthesis of benzodiazepines¹⁸⁵⁻¹⁸⁸ which was achieved by parallel solution phase synthesis using 2 eq. of the salts of α -amino acid ethyl esters and 5-chloro-2-aminobenzophenone (ketone A) in boiling pyridine for 72 hours, using a catalytic amount of DMAP¹⁸⁴.



Scheme 7.3: Synthesis of 3-substituted-1,4-benzodiazepines containing functional groups by direct fusion

Five readily available α -amino acids containing functional groups and aminomalonic acid diethyl esters (Table 7.3) were selected in order to furnish these target compounds. Tyrosine was selected in order to verify the biological activity of the CCK_A selective antagonist. The aminomalonic acid diethyl esters led to the successful formation of the target compound (126, Figure 7.9).

Table 7.3: α -Amino acid esters used as building blocks

Serine Ser	Threonine Thr	Homoserine hSer
S-methyl- cysteine Cys	Aminomalonic acid diethyl ester 	Tyrosine Tyr

Remark: pPhe = p-Hydroxyphenyl-

The cyclisation to the appropriate 3-substituted-1,4-benzodiazepines led to an overall yield of about 26–62 %. This wide variation resulted because many of the reactions were carried out only once and no further attempts were made to establish the optimal conditions. While the reaction with the α -amino acid cysteine with the free thiol group was unsuccessful, the “protected” S-methyl-cysteine formed the desired target compound (**129**, Figure 7.9). After the reaction was completed, pyridine was removed under reduced pressure. The residue was diluted in ethyl acetate, filtered and evaporated in vacuo. The reaction products were separated from the unchanged 5-chloro-2-aminobenzophenone by flash chromatography, because of their poor crystallisation properties.

In contrast to the successful condensation of homoserine (hSer) with 5-chloro-2-amino-benzophenone (**128**, Figure 7.8), the reaction with serine (Ser) furnished unexpected decomposition and/or polymerisation products. In addition to these by-products, there were isolated in little amounts a probably six-membered ring system (**124**) with 288g/mol. Confirmation of this six-membered ring could be seen in the absence of the carbon-3 proton in $^1\text{H-NMR}$ studies at $\delta = 4.2$ ppm, which is characteristic for benzodiazepines. The IR spectrum showed peaks of a typical carbonyl- and a hydroxyl functional group. The preparation of the desired target compound (**126**) was changed according to published methods^{209,210}. This included the condensation of aminomalonic acid diethyl ester with 5-chloro-2-aminobenzophenone, which afforded the heterocyclic seven-membered ring (**125**). Subsequent reduction with NaBH_4 furnished the target compound (**126**).

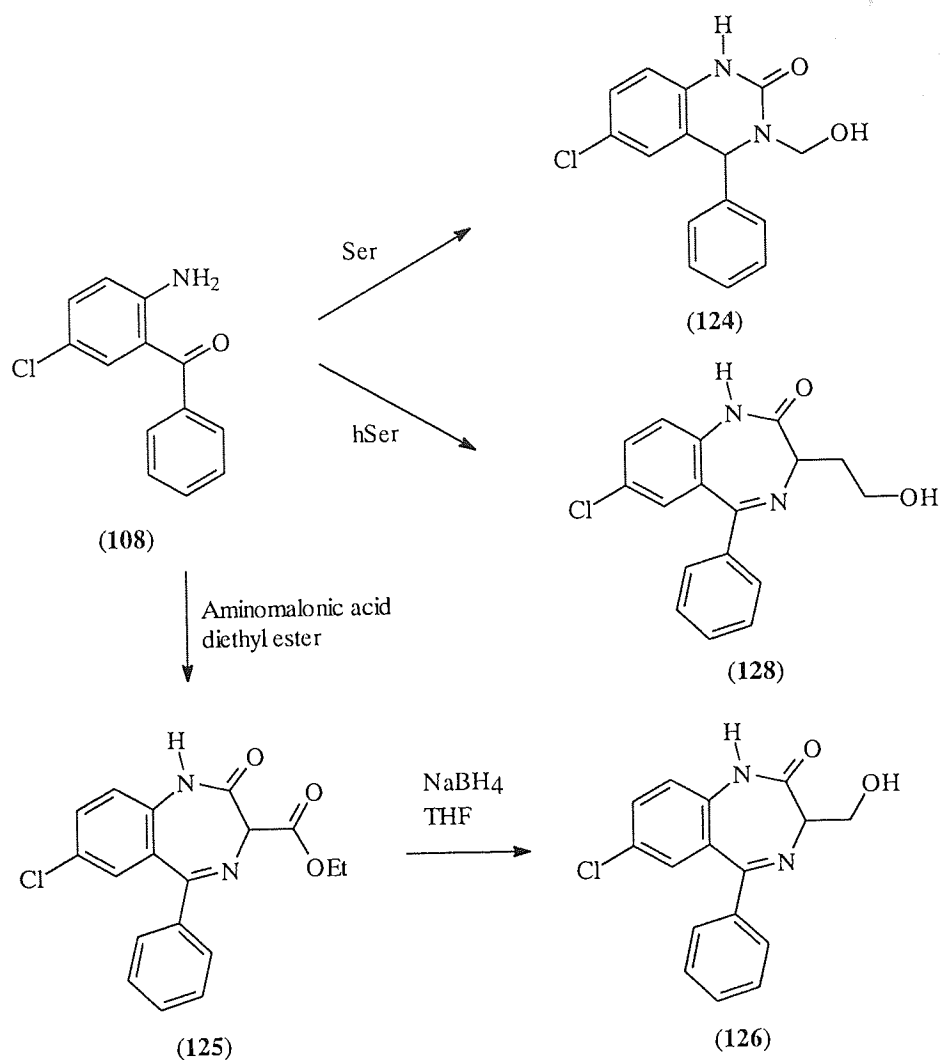
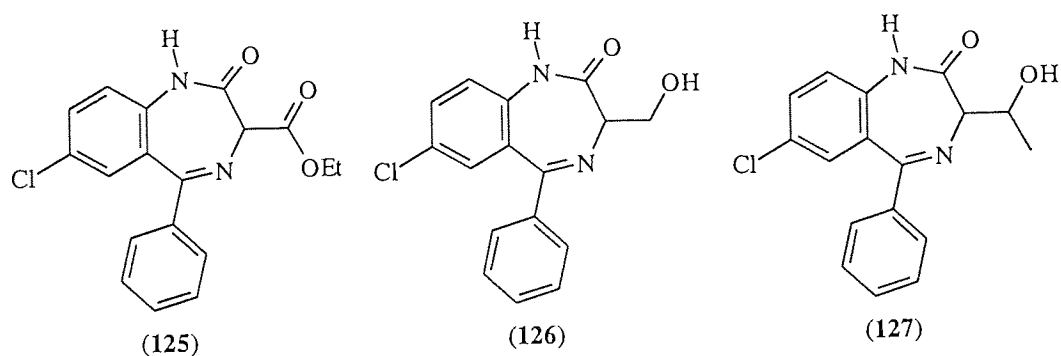

Figure 7.8: Proposed by-product formation of the substrates 5-chloro-2-amino-benzophenone and serine, their chemical resolution and the successful condensation of homoserine with the aromatic ketone via direct fusion

The structures of 3-substituted benzodiazepines containing functional groups are outlined in figure 7.9.



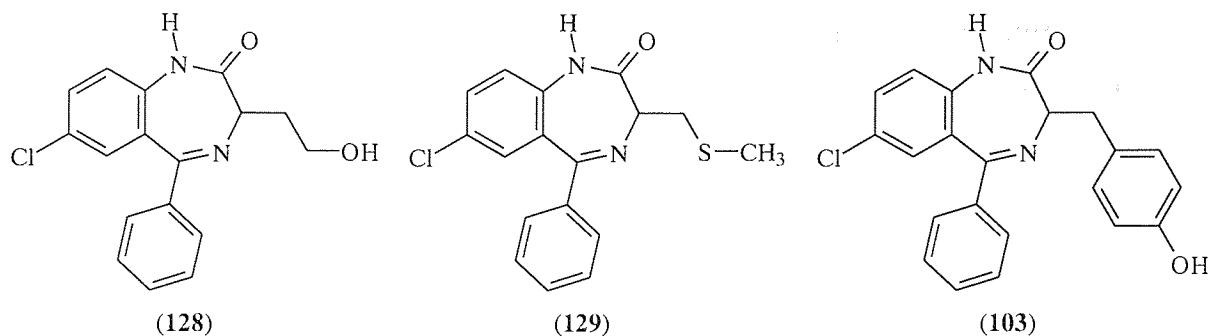

Figure 7.9: Overview of 3-substituted benzodiazepines containing functional groups

7.2.2. Pharmacology of 3-functionalised-1,4-benzodiazepines

The compounds prepared as shown in following table were tested as antagonists of CCK_A and CCK_B receptor binding assays. Apparently, no binding was observed for concentrations >50 micromolar. These data are summarised in table 7.4 as they were compared with those of the CCK_A (**103**, Tyr-A) and CCK_B (**105**, Nva-A) selective antagonists.

Table 7.4: 3-Substituted-1,4-benzodiazepines containing functional groups

Entry	R ₃	Yield [%]	CCK_A [μ M]	CCK_B [μ M]
103		26	0.65	19
105		62	13	0.6
125		60	>50	>50
126		45	>50	>50
127		22	>50	>50
128		25	>50	>50
129		28	31	20

In this study the effects of evaluation in binding to the CCK_A and CCK_B receptor of 3-substituted benzodiazepines were examined. The evaluation was performed with purified compounds. A comparison among the results of the two receptor subtypes binding assay reveals that 3-(p-hydroxybenzyl)-1,4-benzodiazepine (**103**, Tyr-A) exhibited selectivity for the peripheral CCK receptor, whereas 3-(n-propyl)-1,4-benzodiazepine (**105**, Nva-A) was CCK_B selective. Here, the investigated 3-substituted benzodiazepines containing functionalities (**125**, **126**, **127**, **128**) did not possess bioactivity either on the CCK_A or CCK_B receptor whilst compound (**129**) showed a significant decrease in affinity towards both CCK receptors.

It is noteworthy, that the postulated compound (**124**, Figure 7.8) arising from the substrates 5-chloro-2-aminobenzophenone and serine showed initially a respective CCK_B potency in the range of 30-70 nm. Unfortunately, the repeated preparation using another serine batch (Fa. Fluka) formed the product with the identical molecular mass (288g/mol), but did not possess CCK_B potency. The synthesis of the desired benzodiazepine (**126**) via aminomalonic acid diethyl ester and subsequent reduction with NaBH₄ showed characteristically the carbon-3 proton in ¹H-NMR studies. However, this benzodiazepine derivative did not show binding towards the CCK subtypes. These results lead to the assumption that an impurity of the previous used serine batch has probably caused the observed biological activity.

The comparison of the potent and selective CCK_B antagonist (**105**, Nva-A) with the biological inactive (**128**) as presented in figure 7.10, demonstrated the importance of the lipophilic side chain. This result is in contrast to the CCK_A selective antagonist 3-(p-hydroxybenzyl)-benzodiazepine (**103**, Tyr-A), which possessed bioactivity in the nanomolar range.

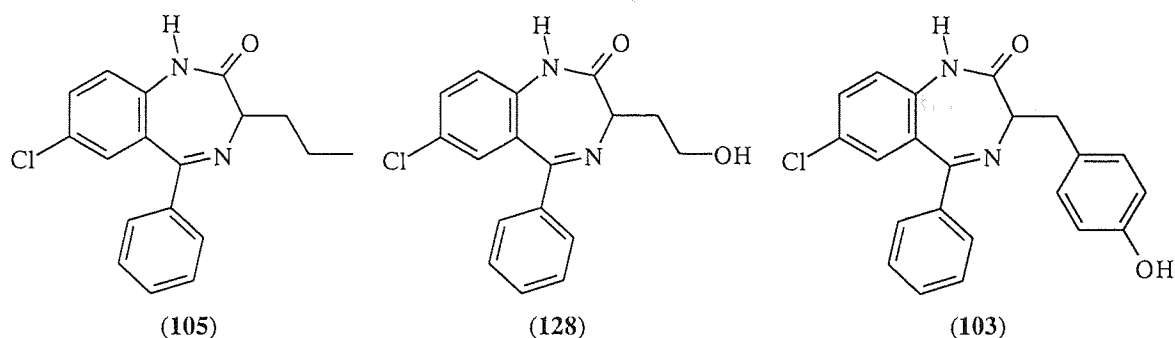

Figure 7.10: 3-propyl-1,4-benzodiazepine as CCK_B selective antagonist (105), compared with the biological inactive 1,4-benzodiazepine bearing the homoserine moiety (128) and the CCK_A selective antagonist 3-(p-hydroxybenzyl)-1,4-benzodiazepine (103)

In summary, the 1,4-benzodiazepine structure containing the p-hydroxylbenzyl side chain was recognised as the privileged structure as a CCK_A antagonist and provided a series of benzodiazepines, which were prepared by bioisosteric modifications. By this approach the most potent 3-anilino-1,4-benzodiazepine (**122**) represented a CCK non-selective antagonist such as the 3-benzyl-1,4-benzodiazepine (**104**, Phe-A). The replacement of an anilino- by an alkyl amino-moiety on the carbon-3 of the 1,4-benzodiazepine skeleton led to a loss of bioactivity.

The selective CCK_B antagonist, the 1,4-benzodiazepine structure containing a propyl alkyl side chain, was structurally modified in the second approach. In this approach the replacement of the lipophilic C-3 alkyl side chain by substituents containing functional groups resulted in a loss of binding towards CCK receptors. The results described in these studies of structural modified benzodiazepines demonstrate that a “small” change is critical for bioactivity and selectivity over the CCK receptor subtypes.

Synthesis and Biological Evaluation N₁-C₃-Dialkylated 1,4-Benzodiazepines

For the possible treatment of anxiety or panic, a selective CCK_B antagonist was desirable. Contrary to the 3-benzylated-1,4-benzodiazepine (**104**, Phe-A) as non-selective CCK antagonist, 3-alkylated benzodiazepines showed bioactivity towards the CCK_B receptor. SAR studies of these compounds with the different length of alkyl side chains have shown an optimum of bioactivity for the C₃ unit, which probably acts with high binding affinity towards the lipophilic pocket of the CCK_B subtype receptor. For the lead optimisation process this specific non-peptidal CCK_B selective 3-n-propyl-1,4-benzodiazepine (**105**, Nva-A) with nanomolar potency, prompted further examinations of analogue compounds, in order to enhance their CCK_B antagonist activity. This lead structure was further structurally modified by selective C-3 and N-1 alkylation reactions. For this approach several aspects were considered.

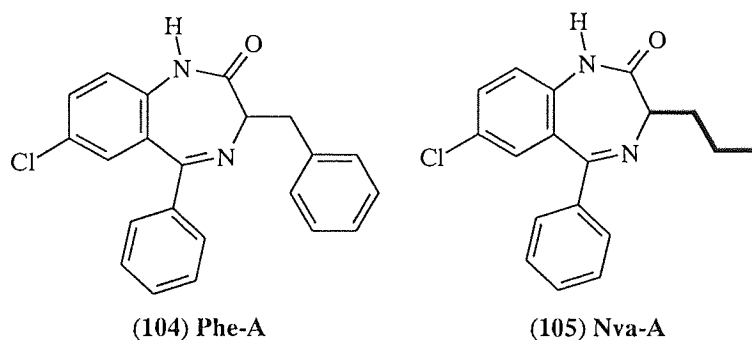

Figure 8.1: 3-substituted-1,4-benzodiazepines

Generally, certain structures might have the capacity to interact effectively with multiple receptors¹⁴³ and the affinity of benzodiazepines to the GABA_A/benzodiazepine receptor complex⁶¹ was taken into account for the lead optimisation process. The classical benzodiazepines, used for the treatment of anxiety, mainly act by binding to a specific regulatory site on the GABA_A receptor^{137,138}.

For example, the tranquillising effects on the GABA receptors^{142,145} of the benzodiazepine family are generally increased through an electron-withdrawing group (nitro, chloro) at position 7, a phenyl ring on position 5 and especially an ortho-halogen on the 5-phenyl ring as shown in the following figure.

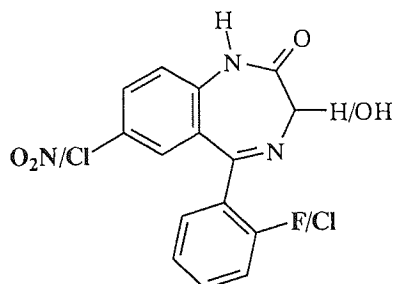

Figure 8.2: SAR essentials of classical 1,4-benzodiazepines with enhanced affinity to GABA_A receptor

The known interaction of CCK with GABA¹⁴⁰ prompted first the investigation of 3-n-propyl-benzodiazepine derivatives as selective CCK_B antagonists with different substituents on the 5 and 7-position by changing the ketone function, in order to distinguish the affinity of these compounds between the receptors. For this approach new synthesised 2-aminophenylcyclohexylketones (Chapter 3) were used to furnish compounds containing a cyclohexyl ring on 5-position and a chlorine or methoxy group on 7-position. Furthermore it was from interest to investigate the biological effect of the stereochemistry at C-3 of the CCK_B lead structure, as it was reported that this has a pronounced effect on bioactivity of CCK_B selective 3-ureido benzodiazepines¹⁸³.

Secondly, since it was established that the replacement of the lipophilic C-3 alkyl side chain of the CCK_B lead structure by alkylamines or by substituents containing C-terminal functional groups did not possess bioactivity on the CCK receptor subtypes (Chapter 7.1 and 7.2), further biological evaluations were focused on target compounds with other lipophilic side chains.

Finally, a substituent on the N1 position was desirable, which might enhance firstly binding and secondly to differentiate between the CCK and the GABA_A/benzodiazepine receptor complex because contrary to the enhanced bioactivity of the CCK_B selective N1-alkylated 3-ureido-1,4-benzodiazepine with t-butyl ketone¹⁴¹, a substituent on the N1 position blocks GABA_A binding¹⁴². For this approach a suitable chemical route was desirable in order to provide sufficient quantities of the selective CCK_B lead structures for further *in vivo* evaluations. In summary figure 8.3 represents all aspects of the changes that for this lead optimisation process could be effected.

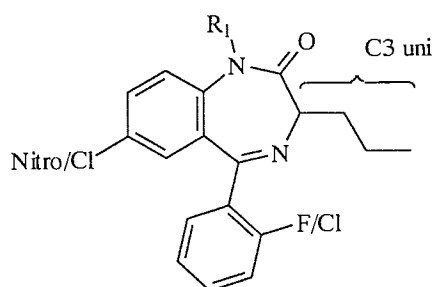
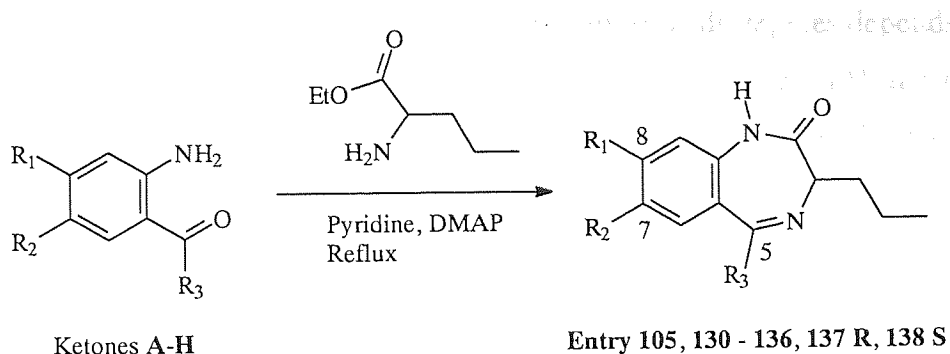

Figure 8.3: Approach for the generation of novel N₁-C₃-dialkylated 1,4-benzodiazepines (synthetic targets)

8.1. Synthesis of 5, 7, 8 substituted 3-n-propyl-1,4-benzodiazepines (ketone optimisation)

Scheme 8.1 summarises the synthesis of benzodiazepinones¹⁸⁵⁻¹⁸⁸, which was achieved by parallel solution phase synthesis using 2 eq. of the salts of nor-valine ethyl ester and ketone building blocks (Table 8.1) in boiling pyridine for 48-72 hours, using a catalytic amount of DMAP¹⁸⁴. This synthetic method lends itself to the preparation of a larger variety of benzodiazepinones bearing various substituents in position 5-, 7- and 8-position in a one step in order to optimise the ketone moiety.



Scheme 8.1: Synthesis of 3-propyl-1,4-benzodiazepines - optimisation of the ketone moiety

Five readily available ketones and three new ketones (**F**, **G**, **H**) which were synthesised either by Grignard or Friedel-Crafts reaction sequence (Chapter 3), were selected in order to provide this chemical diversity around the 3-n-propyl benzodiazepine scaffold.

Table 8.1: Ketones used as building block

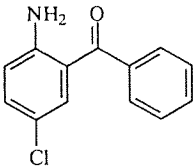
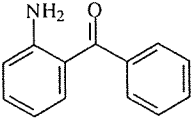
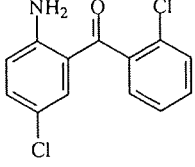
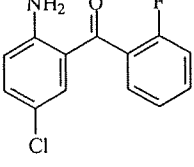
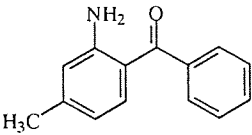
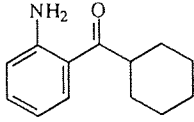
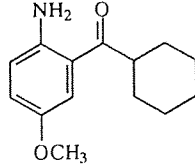
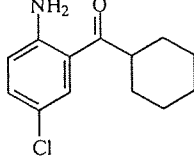
<p>A) 2-Amino-5-chloro-benzophenone</p> 	<p>B) 2-Amino-benzophenone</p> 	<p>C) 2-Amino-2',5-dichloro-benzophenone</p> 	<p>D) 2-Amino-5-chloro-2'-fluoro-benzophenone</p> 
<p>E) 2-Amino-4-methyl-benzophenone</p> 	<p>F) 2-Amino-phenyl-cyclohexylketone</p> 	<p>G) 5-Methoxy-2-amino-phenyl-cyclohexylketone</p> 	<p>H) 5-Chloro-2-amino-phenyl-cyclohexylketone</p> 

The yield of this direct conversion of the substrates into benzodiazepines depends here on the the ketone building blocks and low yields of the target compounds (**131** and **132**, Figure 8.4) were obtained bearing the ortho-substituted phenyl ring on the 5 position (ketones **C**, **D**) probably due to the steric hindrance caused by this ortho-substituent on the phenyl ring. After the reaction was completed, the solvent was removed under reduced pressure and the reaction products were separated from the unchanged amino ketones by flash chromatography. The amino ketones (**C**, **D**, **G** and **H**) however exhibited similar solubility and chromatographic properties as their 3-n-propyl benzodiazepine derivatives and thus a repeated chromatography was often required for their complete separation. The IR spectra of those substituted 1,4-benzodiazepines exhibited the amide carbonyl bands at 1680–1720 cm^{-1} and $^1\text{H-NMR}$ spectra (deuteriochloroform) included the characteristic singlet at around $\delta = 4.2$ ppm for the proton on carbon-3 for 1,4-benzodiazepines. Figure 8.4 represents the racemic 5-, 7- and 8-substituted 1,4-benzodiazepine templates.

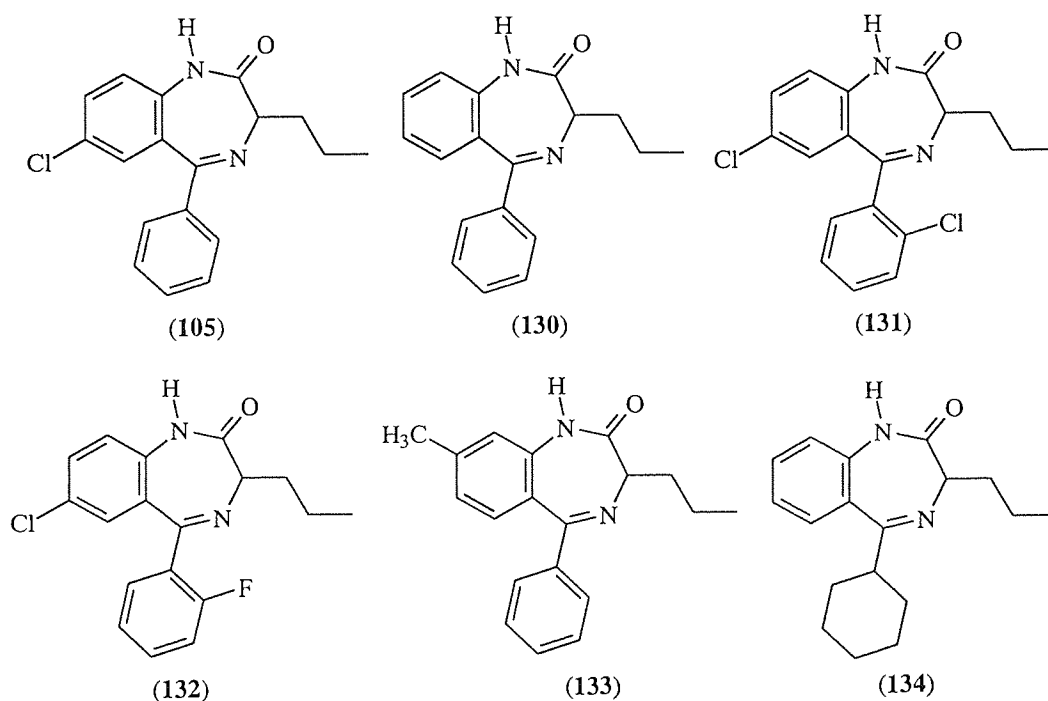

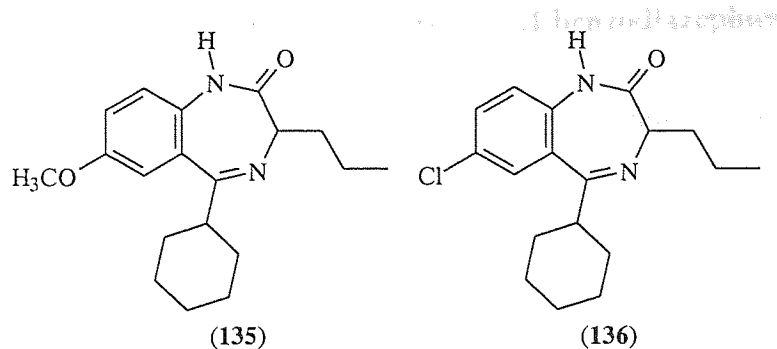

Figure 8.4: 5, 7, 8-substituted 3-n-propyl-1,4-benzodiazepines, based on the 2-aromatic amino ketone moiety

In order to investigate the stereochemistry of the CCK_B lead structure (**105**) the ketone building block **A** was reacted with D- and L-nor-valine ethyl ester HCl in boiling pyridine for only 8 hours. The synthesis of these 1,4-benzodiazepine isomers (Figure 8.5) was formed with the same configuration as the parent amino acid with little racemisation. The optical rotation of the R-form of this light yellow coloured template (**137 R**) showed a value of $[\alpha]_{546}^{25} = -17.2^\circ$ and the ratio of R- and S-benzodiazepine isomers was determined with 15 mol % of Eu shift reagent¹ in ¹H-NMR experiments as described in Chapter 5.

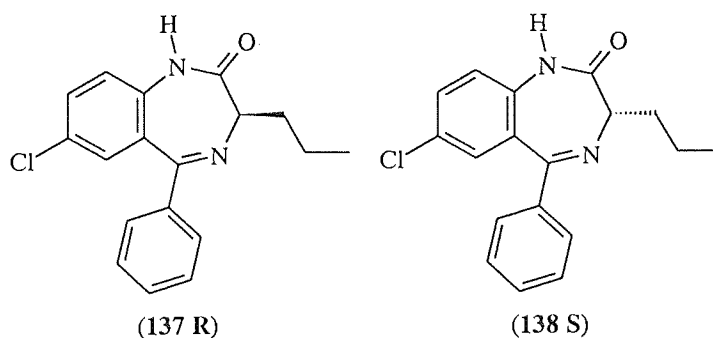

Figure 8.5: Chiral structures of the CCK_B lead structure

¹ Europium tris[3-(heptafluoropropylhydroxymethylen)-(+)-camphorate

8.1.1. Pharmacology of 5, 7, 8 substituted 3-n-propyl-1,4-benzodiazepines

All compounds, which were purified and fully characterised were found to be inactive on the CCK_A receptor above $20 \mu M$ and showed potency as CCK_B antagonists. These binding assays were carried out with L-365,260 and 3-n-propyl-benzodiazepine (**105**) as internal standards in triplicate. In table 8.2 the influence of the variation of 3-n-propyl 1,4-benzodiazepines on 5, 7 and 8 position is outlined, which was based on the aromatic amino ketones.

Table 8.2: Variation of the ketone moiety of 3-propyl-1,4-benzodiazepines

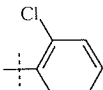
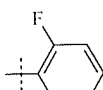
entry	R ₁	R ₂	R ₃	Yield [%]	CCK_B [μM]
105	H	Cl	Phenyl	62	0.6
130	H	H	Phenyl	65	2.3
131	H	Cl		20	3.8
132	H	Cl		31	4.6
133	-CH ₃	H	Phenyl	58	7.5
134	H	H	Cyclohexyl	64	1.7
135	H	-OCH ₃	Cyclohexyl	68	6.1
136	H	Cl	Cyclohexyl	61	0.4
137 R	H	Cl	Phenyl	42	1.5
138 S	H	Cl	Phenyl	42	0.35

In this limited study it was established that the SAR corresponding with the ketone nucleus of the benzodiazepine is opposite to the SAR on the $GABA_A$ receptor¹⁴⁵.

Acceptor substituents in the 7 and the ortho-position on the 5-phenyl ring enhance binding on the $GABA_A$ /benzodiazepine site (nitro, Cl, F) for 3-unsubstituted-1,4-benzodiazepines, while 3-substituted compounds (**131**, **132**) significantly decreased CCK_B activity compared with the lead structure (**105**). The replacement of the 5-phenyl group (**130**) by a 5-cyclohexyl ring (**134**) in the 3-propyl-1,4-benzodiazepine template does not result in the expected increase of activity, as was observed for the same refined structure in Merck's 3-ureido-1,4-benzodiazepines¹¹⁴.

Donor substituents in the 8 position (-CH₃, **133**) and in the 7 position (-OCH₃, **135**) lead to a loss of activity, whereas the electron-withdrawing chlorine and the cyclohexyl ring in the 5-position were considered to be essential parts of a novel fully optimised selective CCK_B ligand (**136**). Finally, the influence of the configuration at the C3 centre of the CCK_B lead structure was investigated. The racemic CCK_B lead structure (**105**) showed an IC₅₀ of 600 nM on the B receptor subtype. Merck's most potent ureido-benzodiazepines have L configuration (R-isomer) with selectivity towards the B receptor subtype. Here, the generated L (S-isomer) 3-propyl-1,4-benzodiazepine (**138 S**) showed approximately two fold increase in bioactivity on the B receptor subtype. The biological results of substituted 3-propyl-1,4-benzodiazepines, based on the ketone moiety is outlined in the following diagram.

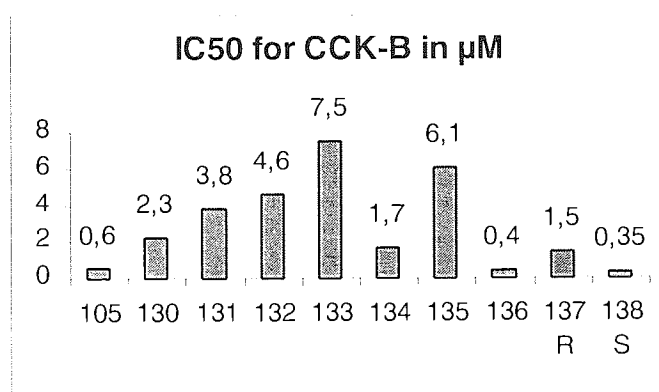

Diagram 8.1: Comparison of biological activity of selected 3-n-propyl-1,4-benzodiazepines with various substituents in position 5, 7, 8.

Three selected structures of 1,4-benzodiazepines from this optimisation process with various substituents around the benzodiazepine skeleton, based on the ketone moiety are outlined in figure 8.6. Compound (**105**) was the CCK_B lead structure and was generated by the cheapest readily available ketone building block (ketone **A**). Compound (**132**) might enhance binding to the GABA_A/benzodiazepine receptor complex, but showed reduced bioactivity as CCK_B selective antagonist. The novel optimised selective CCK_B ligand was found to be compound (**136**). However, this compound showed only a slight increase in bioactivity compared to the CCK_B lead structure (**105**) and the synthesis of this compound involved the additional preparation of the o-aromatic amino ketone (Chapter 3).

Thus, further optimisation process was focused on the development of a suitable chemical route of the CCK_B lead structure (105), which contains the readily available 5-chloro-2-aminobenzophenone (ketone A).

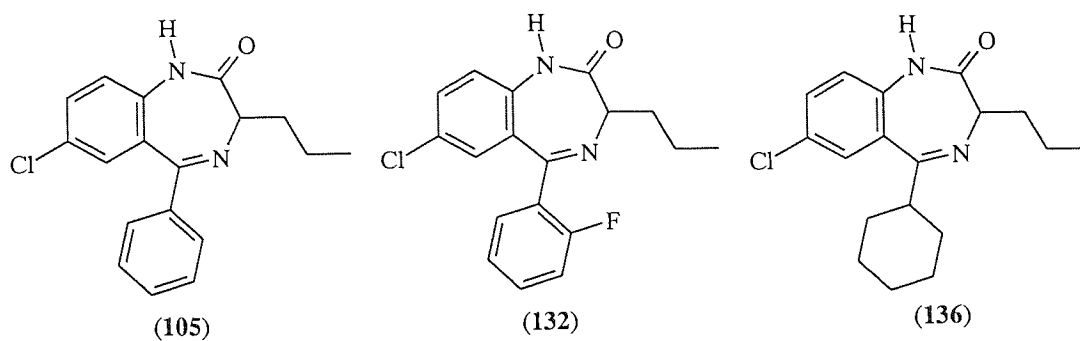

Figure 8.6: Substituted 3-n-propyl-1,4-benzodiazepines as non- or CCK_B selective antagonists

8.2. C3-Alkylation of 7-chloro-N1-methyl-1,4-benzodiazepine (Diazepam®)

Continued efforts to improve CCK_B antagonist activity the lead optimisation process, was focused on the CCK_B lead structure (Figure 8.7) by replacement of the propyl group with other lipophilic side chains, as it was established, that 3-substituted-1,4-benzodiazepines with alkyl side chains containing functional groups did not possess bioactivity (Chapter 7).

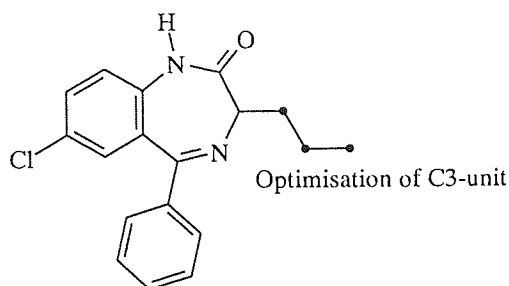
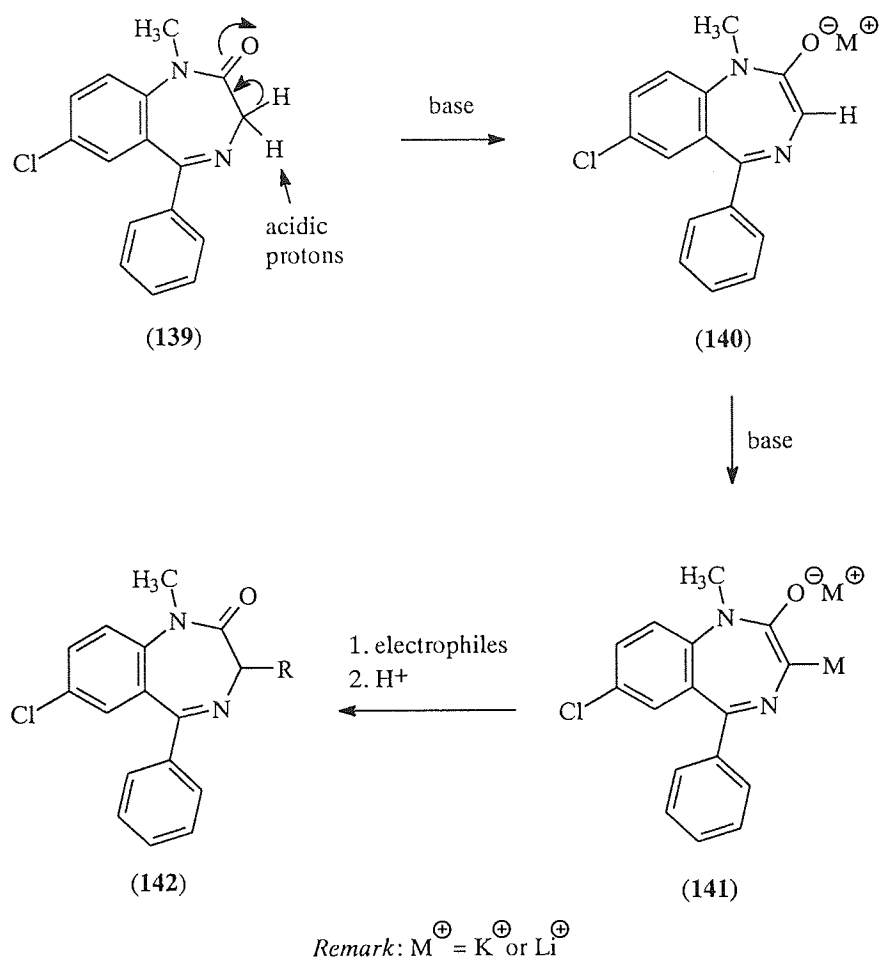

Figure 8.7: Optimisation of C3-unit of the CCK_B lead structure

The preparation method of the 3-substituted-1,4-benzodiazepine skeleton via direct fusion by the ketone and the α -amino acid ethyl ester in pyridine was linked with a time consuming separation process. A new synthesis of the desired target compounds was desirable and this approach was based on the concept that 3-substituted benzodiazepines, which incorporate the readily available 5-chloro-2-aminobenzophenone, are available directly from Diazepam® through metallated derivatives (Scheme 8.2). This preparation method was reported widely in the literature^{211,212,213}. Subsequent reactions of Diazepam® with electrophilic reagents lead to the introduction of 3-substituents without requiring construction of the diazepine ring from chemical precursors each time a different substituent was desired. The building block Diazepam® represents several advantages with respect to its synthesis on a large scale with good yields and easy purification steps. This method allows good diversity by using commercial available electrophiles.

The metallation of Diazepam® (**139**) to their 3-substituted derivatives is outlined in the following scheme.



Scheme 8.2: Optimisation of the C3-unit via metallation of Diazepam®

The carbonyl group of the benzodiazepine nucleus can act as a weak protonic acid and lead to the “enol” formation (**140**) by base catalysed agents. An excess of a strong base can abstract an acidic α -hydrogen atom²¹⁴ to yield (**141**). Subsequent reactions with electrophiles lead to the desired 3-substituted target compounds (**142**). The electron withdrawing effect of the carbonyl group can also apply to the amide nitrogen. The previous alkylation of the amide nitrogen is therefore necessary to deliver Diazepam® (**142**), which was used for the metallation process.

Furthermore, the expected interaction of the functional groups for the metallation of Diazepam® had not to be considered because this approach was focussed on the preparation of target compounds with lipophilic side chains since it was established that analogues with substituents containing functional groups did not possess any bioactivity (Chapter 7).

8.2.1. Synthesis of Diazepam®

Scheme 8.3 summarised the synthesis of the starting material Diazepam® (139) for the metallation process, which was synthesised according to the standard literature²¹⁵ procedure.

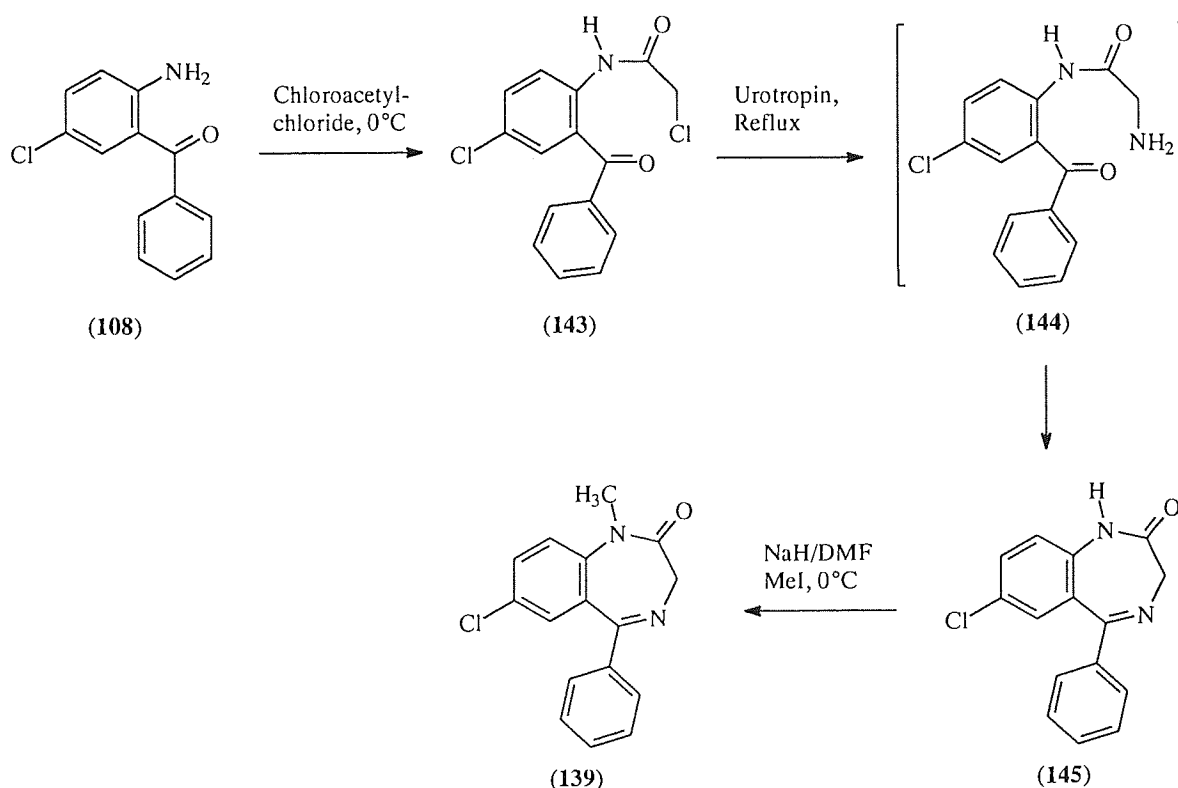

Scheme 8.3: Synthesis of 7-chloro-1-methyl-5-phenyl-1,4-benzodiazepine (Diazepam®)

In this context 5-chloro-2-aminobenzophenone (**108**) was acylated with chloroacetylchloride, yielding 2-benzoylchloroacetanilide (**143**) which cyclised by using urotropin (known as Delepine reaction), with potassium iodide as catalysts, via the uncharacterised derivative (**144**) to the 7 membered N-nordesmethyl diazepam (**145**). Attempts to isolate the aminoacetamido compound (**144**) by this method from the chloroacetamido compound (**143**) resulted only in the isolation of the cyclised benzodiazepinone. Alkylation of the formed N-nordesmethyl diazepam (**145**) with methyl iodide in DMF¹⁹³ at 0-5°C gave Diazepam® (**139**) in almost quantitative yield, whereas the alkylation with sodium methoxide¹⁴⁶ at room temperature lead to this product in 60-70 % yield.

8.2.2. C3-Alkylation of Diazepam®

Two different metallation procedures have been devised for the modification of the Diazepam nucleus. While the C3-alkylation reactions using potassium tert-butoxide^{208,212,213} in absolute ethanol or toluene formed the products in low yields, the treatment of Diazepam® with 2 eq. of lithium diisopropylamide (LDA)²¹¹ in THF produced, via the red coloured solution containing the carbanion (**146**) with alkyl iodides and aldehydes, the desired 3-substituted benzodiazepines (Figure 8.7).

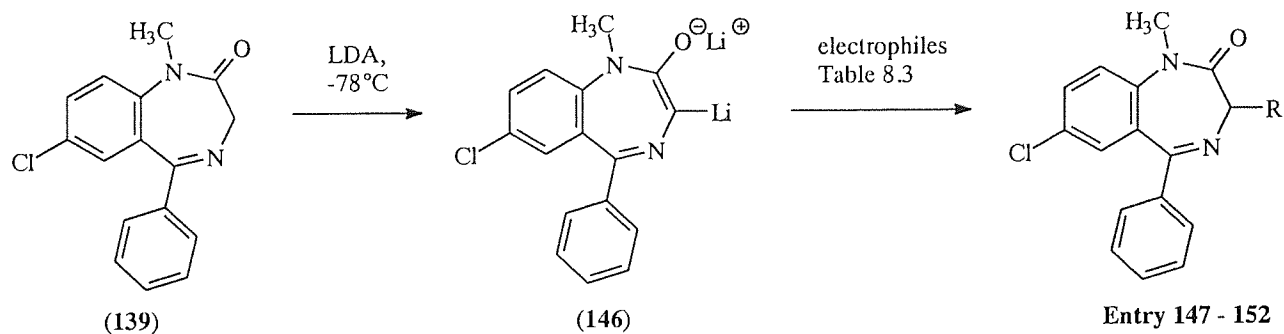

Scheme 8.4: Metallation of Diazepam®

Table 8.3: Alkylating agents used for metallation process of Diazepam®

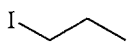
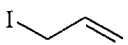
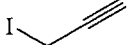
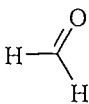
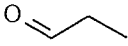
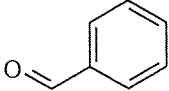
Propyl iodide 	Allyl iodide 	Propargyl iodide 
Formaldehyde 	Propionaldehyde 	Benzaldehyde 

The first series of alkylation reactions were carried out with propyl-, allyl- and propargyl iodide yielding 3-substituted benzodiazepines in 20-30% yields. In order to increase yields of the target compounds high reactive substrates as aldehydes were used. While formaldehyde, obtained by thermolysis of paraformaldehyde, did not form the desired 3-substituted product, the reaction with other aldehydes at room temperature formed 3-substituted benzodiazepines in good yields (Figure 8.7). The reaction with propionaldehyde gave in the first step 3-(1-hydroxy)-propyl benzodiazepine (**150**), while longer reaction times lead to the exclusive formation of bioactive propylidene derivative (**151**). It is noteworthy that the reactions with benzaldehyde lead to the phenylidene derivative (**157**) exclusively and amounts of the corresponding “carbinol” could not be isolated. The successful metallation of Diazepam on C-3 has been confirmed by comparison $^1\text{H-NMR}$ spectra. Diazepam showed the characteristic pattern entered at $\delta = 4.4$ ppm produced by the two protons on carbon 3, whilst 3-substituted benzodiazepines, containing a proton on C-3 (**147–150**), showed the characteristic pattern, which appeared at $\delta = 4.15-4.55$ ppm.

Entry **147–149** represents the reaction with alkyl iodides, while entry **150–157** shows the compounds prepared by aldehydes.

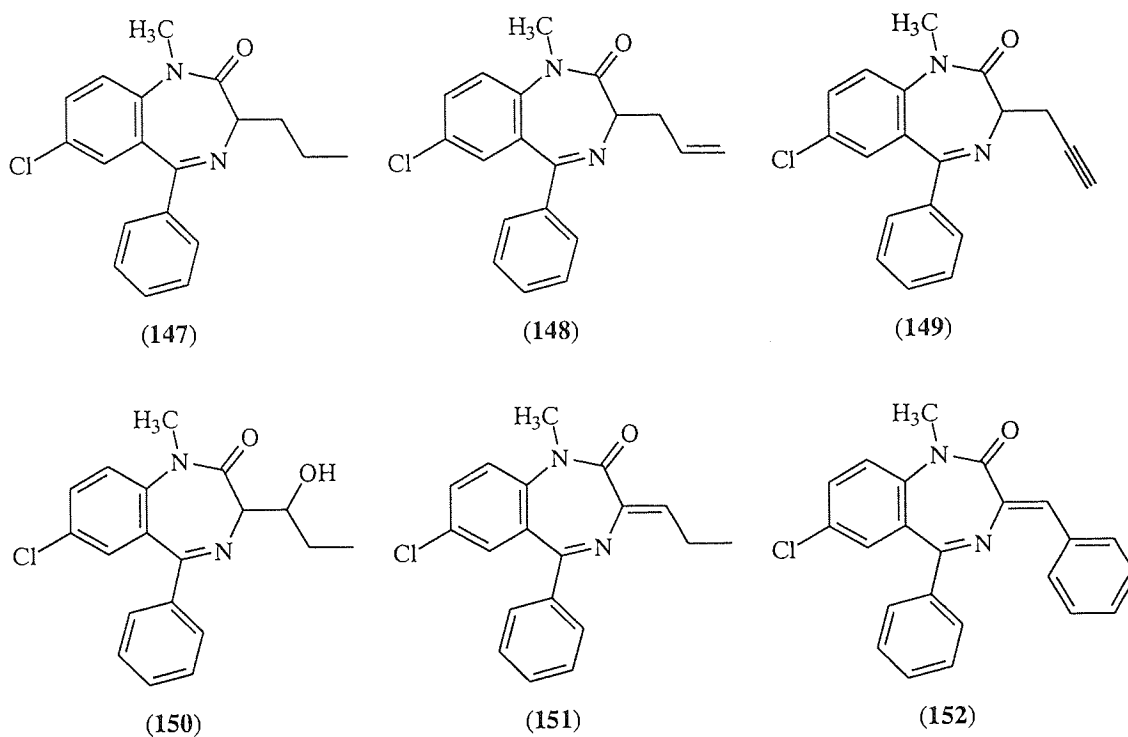

Figure 8.7: 3-substituted-N1-methyl-1,4-benzodiazepines via C3-alkylation of Diazepam®

Furthermore, the synthesis of similar compounds such as the CCK_B selective 3-ureido-1,4-benzodiazepine L-365.260 was also considered. However, the metallation of Diazepam® (Figure 8.8) with bromoacetic acid ethyl ester²⁰⁹ or with bromo acetonitrile furnished the 3-substituted benzodiazepines in 15-20% yields and subsequent reactions of (153) by aminolysis at 80°C with aniline/cyclohexylamine or by Grignard reactions with phenylmagnesiumbromide of (154) delivered the target compounds (155, 156) in only trace amounts.

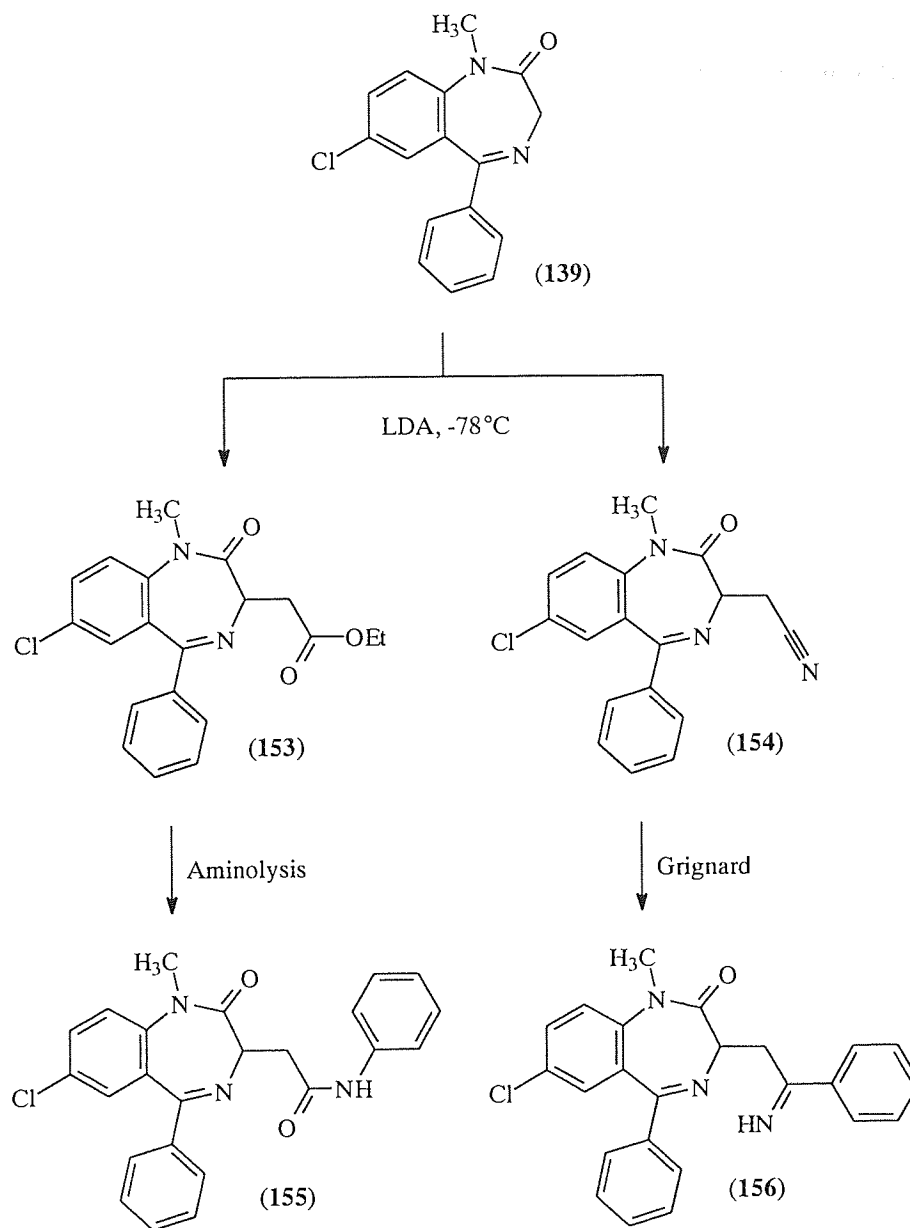



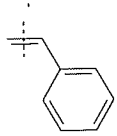

Figure 8.8: Attempted approach of 3-(phenylacetamido)- and 3-(iminophenylethyl)-1,4-BZD's as CCK_B selective antagonist via metallation process of Diazepam®

8.2.3. Pharmacology 3-substituted-N1-methyl-1,4-benzodiazepines

The SAR optimisation of 3-substituted 1,4-benzodiazepines with the variation of the C3 unit is outlined in table 8.4. All compounds were inactive on the CCK_A receptor above 50 μ M and showed some potency as CCK_B antagonists. These binding assays were carried out in triplicate with L-365.260 as internal standard. The generated compounds were compared with those of the agent Diazepam[®] and the CCK_B selective 3-n-propyl-benzodiazepine antagonist (**105**, Nva-A).

Table 8.4: Variation of the C3-unit (alkylation in the 3-position)

Entry	R ₁	R ₃	Yield [%]	CCK _B [μ M]
139 (Diazepam [®])	-CH ₃	H	---	>50
105 (Nva-A)	H	Propyl	---	0.6
147	-CH ₃	Propyl	20	5.0
148	-CH ₃		30	2.5
149	-CH ₃		20	2.2
150	-CH ₃		30	>50
151	-CH ₃		30	4.5
152	-CH ₃		40	14

Diazepam[®] was, as expected, inactive. The substituents attached to the 3-position of the benzodiazepine ring, were thus necessary for CCK antagonist potency.

The replacement of the propyl- by an allyl- and propargyl group has shown improved binding towards the CCK_B subtype receptor. These compounds (**148**, **149**) with a C-terminal unsaturated double or triple bonds led to an approximately two-fold increase in potency compared to (**147**) with the saturated propyl group. If the double bond is attached to the carbon-3 of the heterocyclic ring (**151**), the bioactivity was significantly lower compared to the C-terminal double bond analogue (**148**). The 3-phenylidene benzodiazepine (**152**) was 3 fold lower inactive than the propylidene derivative (**151**).

The most active compounds by this approach were (**148**, **149**) with the C-terminal unsaturated double or triple bonds showing an IC₅₀ of 2.2 and 2.5 micromolar. However, by comparison these compounds with the N1-unalkylated CCK_B lead structure (**105**, Nva-A) indicated that the methyl group on N1 position led to loss of bioactivity. Additionally, 3-(1-hydroxy)-propyl-benzodiazepine (**150**) did not possess CCK activity and confirmed previous results which were obtained for 3-substituted-1,4-benzodiazepines with the alkyl side chains containing functional groups (Chapter 7).

The biological results of these compounds, prepared by alkylation in the 3-position of the Diazepam[®] template are outlined in the following diagram 8.2.

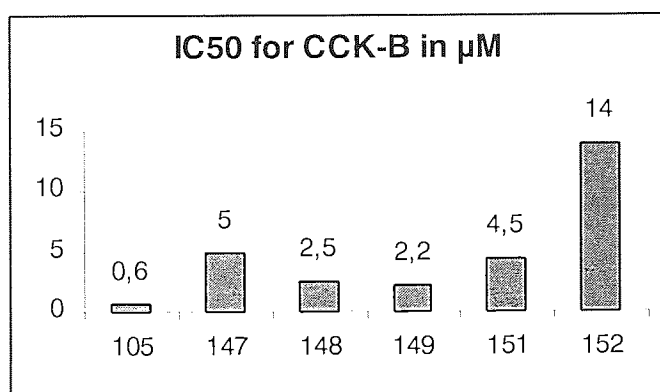

Diagram 8.2: Comparison of biological activity of selected 3-substituted-N1-methyl-1,4-benzodiazepines

Three selected structures of 1,4-benzodiazepines of this optimisation process and the CCK_B lead structure (**105**, Nva-A) are outlined in figure 8.9. In contrast to the biologically inactive 3-functionalised-1,4-benzodiazepine (**150**), the analogues containing the lipophilic side chain (**147**, **148**) possessed CCK activity in micromolar range and confirmed previous results, that the lipophilic side chain is an essential part for biological activity. However, the optimised selective CCK_B ligand of this series (**148**), possessed a 3-fold lower potency compared to CCK_B lead structure (**105**, Nva-A), which was based on the N1-methyl group. Thus another substituent on the N1 was desirable for the further optimisation process and led to the development of new preparation methods for the desired benzodiazepine template. Furthermore, this preparation method, the C-3 alkylation via metallation process of Diazepam[®], required the exact performance of the reaction conditions and was in general more difficult than the N-1 alkylation as presented in the next section.

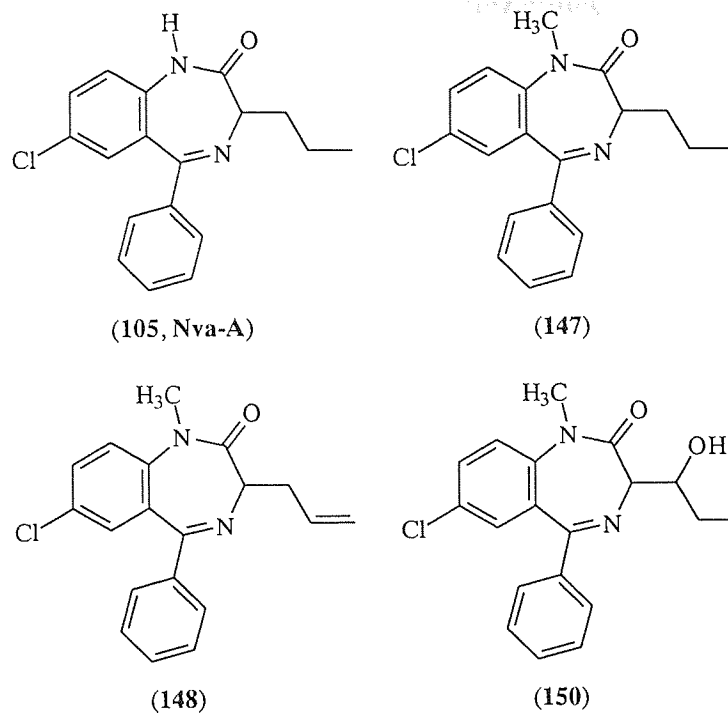

Figure 8.9: Selected 3-substituted 1,4-benzodiazepines with various C3-alkyl units

8.3. N1-Alkylation of 7-chloro-3-propyl-1,4-benzodiazepines

The non-peptidal CCK_B selective 3-substituted benzodiazepines have shown an optimum of bioactivity with the straight C₃ alkyl side chain. The outstanding final optimisation of the CCK_B lead structure (105) by N1-alkylation¹⁸¹ was investigated for compounds (157) as shown in figure 8.10. These compounds might improve Cholecystokinin binding with potentially decreased binding to the GABA_A/benzodiazepine receptor complex, as it was reported that a substituent on the N1 position blocks GABA_A binding¹⁴⁵. For this approach the synthesis was focused here on N1-alkylated compounds containing functionalised groups. This was supported by the reported enhanced bioactivity of the CCK_B selective N1-alkylated 3-ureido-1,4-benzodiazepines to their t-butyl ketone¹⁴¹ (158) and to their N1-benzoylmethyl-analogues (159, YM022¹²⁰). These compounds have shown to be significantly more potent antagonists of pentagastrin than Merck's L-365.260.

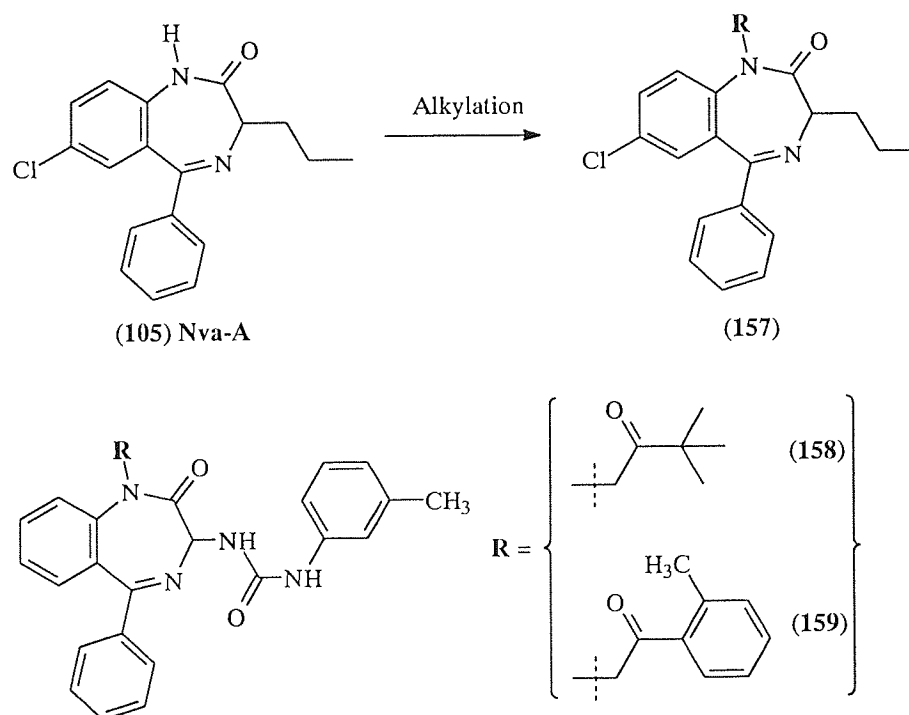

Figure 8.10: N1-alkylation of the CCK_B lead structure 3-propyl-1,4-benzodiazepine and structures of N1-alkylated 3-ureido-1,4-benzodiazepines with enhanced CCK_B potency

For this approach several aspects were considered to build the adequate benzodiazepine template. The fact that a Diazepam analogue, used for the C3-alkylation with a substituent containing a functional group at the N1 position, cannot be alkylated on C-3 without difficulties because of the possible interaction of functional groups by the metallation process with LDA, restrict the application of this method. Furthermore, the observed increased potency of 3-allyl- or 3-propargyl-N1-methyl-1,4-benzodiazepines by this approach would involve the synthesis of allyl- or propargylglycine according to the literature²¹⁶ starting with diethyl acetamidomalonate (**160**) in order to generate compound (**164**) for the N1-alkylation process as presented in figure 8.11. The subsequent condensation of the corresponding α -amino acid as allylglycine ethylester HCl (**163**) with 5-chloro-2-aminobenzophenone (ketone **A**) via direct fusion would led to the desired N1-unalkylated product (**164**) for this optimisation process. However this preparation method involves several synthetic steps and might be linked with a time-consuming separation process of the final product (**164**).

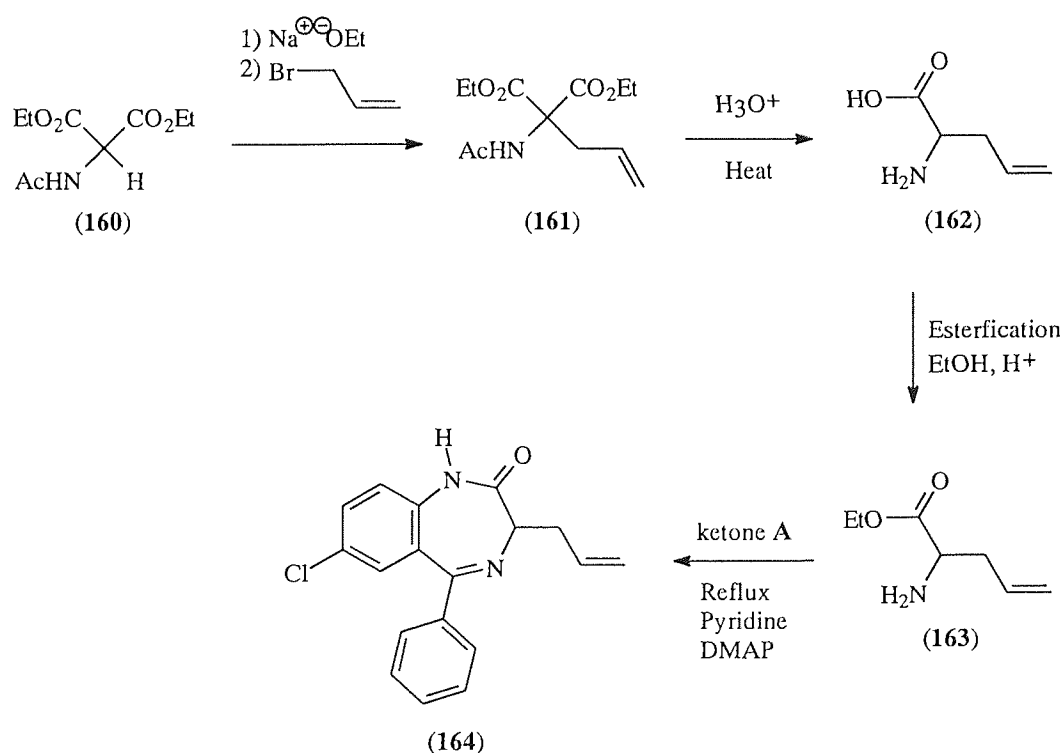

Figure 8.11: Proposed synthesis of 7-chloro-3-substituted-1,4-benzodiazepine containing the lipophilic alkyl C3-unit with a C-terminal double bond

This preparation method of 3-substituted-1,4-benzodiazepines with the lipophilic alkyl side chain has presented considerable difficulties and was found to be a time consuming separation process and a new preparation method of the desired benzodiazepine template were desirable. The optimisation process resulted from a comprehensive study of chemistry and two new preparation methods have been developed, in order to furnish sufficient material of the benzodiazepine template for further chemical modification at the amide nitrogen.

Generally, these preparation methods are based on the amide bond formation in the first synthesis step (Scheme 8.5 and 8.6) according to the published preparation methods^{172,195} starting with 2-aminobenzophenone derivatives and substrates as activated by carbonyl halides followed by basic triggered cyclisation step to the desired 1,4-benzodiazepine template. However, the failed synthesis of the Asperlicin template (Chapter 6) has shown, that strong polar activated α -amino acid chlorides, as hydrochlorides did not form the target amide with the unpolar 2-aminobenzophenones in different solvent mixtures. Thus, the amino group of α -amino acids was exchanged with a halide by using α -bromo-butyric acid chloride for this approach.

8.3.1. Development route 1: From 5-nitrobenzophenone to the 7-chloro-3-propyl-1,4-benzodiazepine template as building block for N1-alkylation

For the scale up synthesis of the desired CCK_B lead structure as a building block for the N1-alkylation, 5-nitro-2-aminobenzophenone was used as the starting material. This preparation method is summarised in scheme 8.5 and led to the successful preparation of the desired benzodiazepine template (**105**) via 7-amino-3-propyl-1,4-benzodiazepine (**168**), while 5-chloro-2-aminobenzophenone, when used as the starting material delivered this benzodiazepine template in only moderate yields.

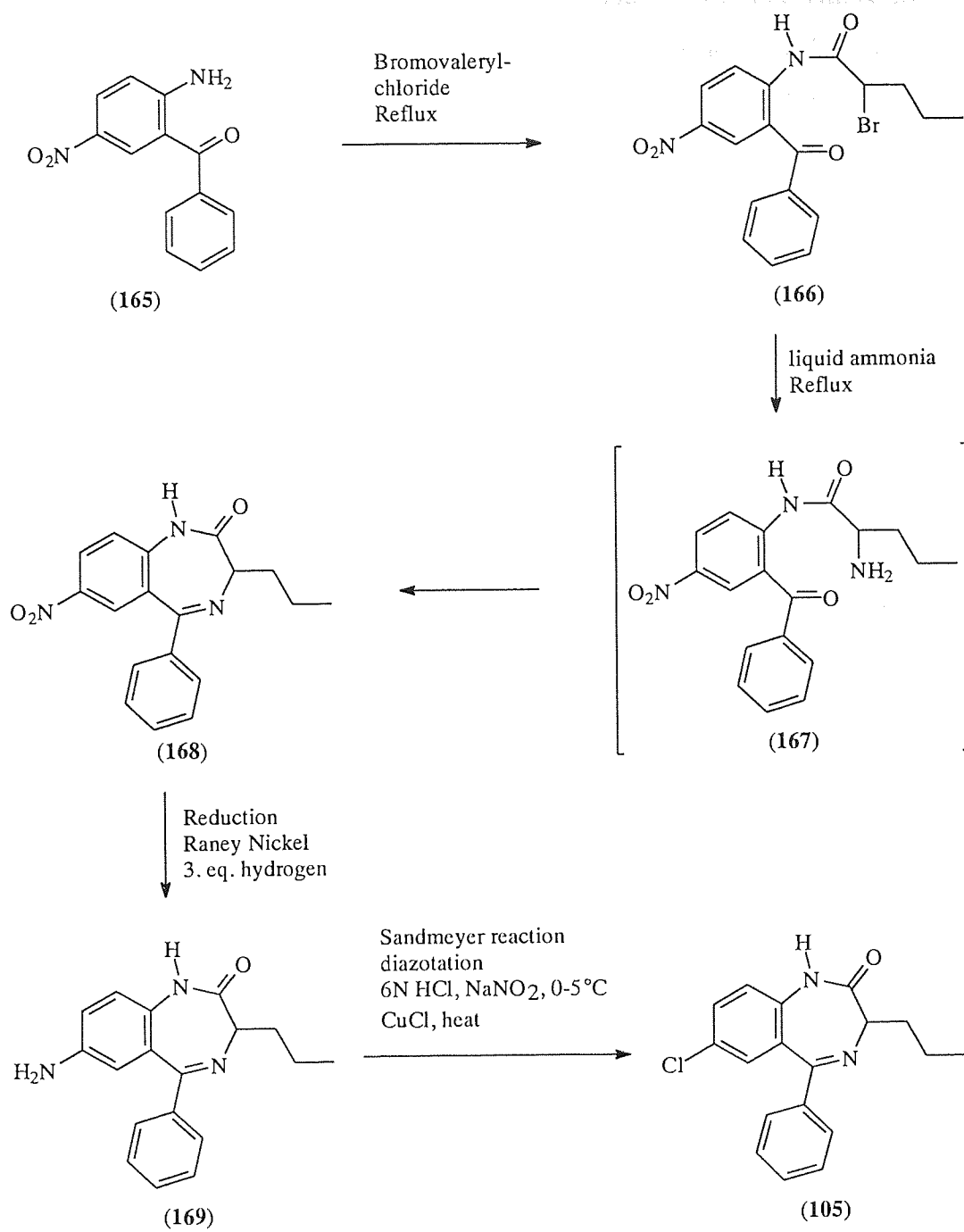

Scheme 8.5: Development route 1; N1-alkylation of 7-chloro-3-propyl-1,4-benzodiazepine

In this context 5-nitro-2-aminobenzophenone (**165**) formed under reflux with α -bromo-butyrac acid chloride, which was prepared by 2-bromopentanoic acid and 1.5 eq. of thionyl chloride under reflux, to give the corresponding acetanilide derivative (**166**) in good yields. Subsequent reaction of the acetanilide derivative in refluxing liquid ammonia furnished via cyclisation step the nitro-benzodiazepine (**168**) in 60% yield based on the precursor (**166**). Attempts to isolate the aminoacetamido compound (**167**) by this method from the acetanilide derivative resulted only in the isolation of the cyclised benzodiazepine. As mentioned previously, changes in substituents of the 2-aminobenzophenone derivatives on 5-position markedly affected the properties of the products obtained. When 5-chloro-2-aminobenzophenone or 2-aminobenzophenone was treated with liquid ammonia, using conditions under which the nitro-benzodiazepine (**168**) was synthesised in good yield; the corresponding benzodiazepines were isolated in only moderate yields. Sternbach and coworkers²¹⁷ had reported appropriate results for 3-unsubstituted benzodiazepines. Furthermore, unlike the synthesis of Diazepam® Urotropine cannot be used to the formation of the 7-membered ring system and gave decreased yields with an increased length of the alkyl side chain at carbon-3 for nitro-benzodiazepine (**168**). Nitro-benzodiazepine was then hydrogenated at 25°C and 1 atmosphere pressure in the presence of wet (ethanol) Raney nickel. The hydrogenation delivered 7-amino-benzodiazepine (**169**) after the uptake of 3 eq. of hydrogen. The replacement by chlorine via Sandmeyer reaction²¹⁷ of the amino group delivered the desired benzodiazepine template (**105**) in total yield of 23 % based on the starting material (**165**). All 1,4-benzodiazepine products showed in the ¹H-NMR spectra the characteristic proton on C-3 which appeared at around $\delta = 4.0\text{--}4.15$ ppm.

While nitro-benzodiazepine (**168**) was hydrogenated successfully in the presence of wet (ethanol) Raney nickel, in contrast to the use of the catalysts platinum or palladium, the reduction of the nitro group with tin and hydrochloric acid under reflux lead to the formation of decomposition products of the benzodiazepine template. However the reduction with Raney nickel and hydrogen required exact monitoring of the reaction conditions and can deliver after the uptake of more than 3 eq. of hydrogen 7-amino-tetrahydro-benzodiazepine (**170**) as presented in figure 8.12.

The mass spectra showed a strong peak at 295 g/mol (expected 293 g/mol) and $^1\text{H-NMR}$ and $^{13}\text{C-NMR}$ studies demonstrated the presence of new signals at $\delta = 6.0$ p.p.m. and at $\delta = 68$ p.p.m. for the carbon atom on the 5 position of the benzodiazepine skeleton. Santilli and coworkers²¹⁸ had reported appropriate results for the hydrogenation of 7-nitro-5-phenyl-1,4-benzodiazepine.

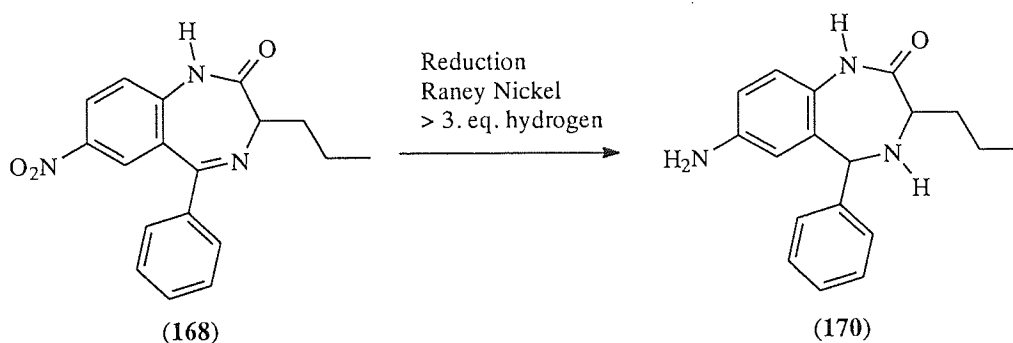

Figure 8.12: Formation of 7-Amino-3-propyl-1,3,4,5-tetrahydro-1,4-benzodiazepine

8.3.2. N1-Alkylation of 7-chloro-3-propyl-1,4-benzodiazepine

In order to provide a high diversity of N1-alkylated benzodiazepines 10 readily available alkylating agents (Table 8.5) were selected. Furthermore, the substrates 1-chloropinacolone and phenacyl bromide were selected, as it was reported¹⁹⁴ that these alkylating agents have shown enhanced CCK_B binding for 3-ureido benzodiazepines^{135,141}. The N₁-alkylated target compounds (Figure 8.14) were obtained by treatment of the parent NH amide (**105**) with sodium hydride in DMF¹⁹³ followed by the alkylating agents at ambient temperature as shown in figure 8.13. The alkylation with electrophiles such as phthalimide, morpholino and piperidine derivatives have been carried out at 50°C. The N₁-hydroxymethyl-benzodiazepine (**171**) was obtained by formaldehyde, which was obtained by thermal decomposition of paraformaldehyde.

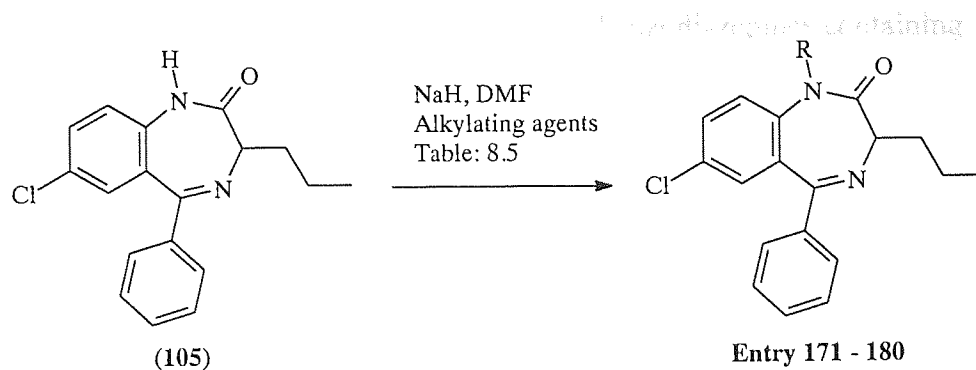
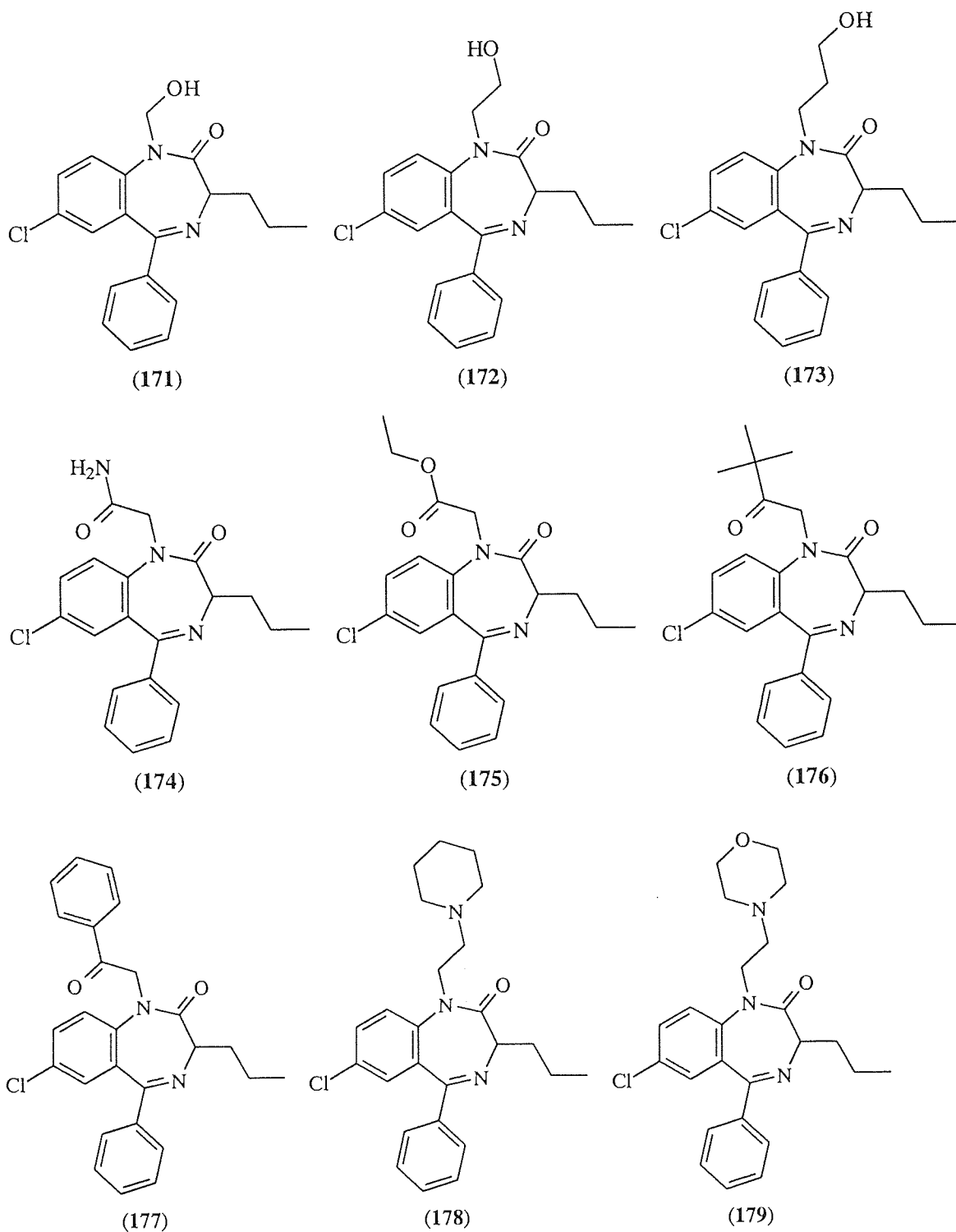

Figure 8.13: N1-alkylation of the CCK_B lead structure, 7-chloro-3-propyl-1,4-benzodiazepine

Table 8.5: Alkylating agents used for N1-alkylation of the CCK_B lead structure
7-chloro-3-propyl-1,4-benzodiazepine (Route 1)

Formaldehyde 	2-Bromoethanol 	3-Bromo-1-propanol 	2-Bromoacetamide
Ethyl chloracetat 	1-Chloro-pinacolone 	Phenacyl bromide 	N-(2-bromoethyl) piperidine
N-(2-bromoethyl) morpholine 	N-(3-bromopropyl) phthalimide 		

The structures of the generated N1-alkylated 3-propyl benzodiazepines containing functional groups are outlined in figure 8.14.



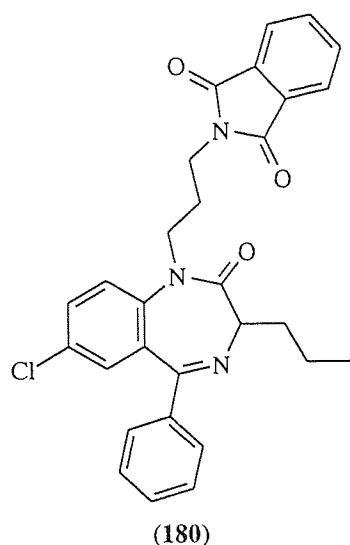











Figure 8.14: N1-alkylated 7-chloro-3-propyl-1,4-benzodiazepines containing functionalised groups

8.3.3. Pharmacology of N1-alkylated 7-chloro-3-propyl-1,4-benzodiazepines (Route 1)

In table 8.5 the influence of the N1-alkylation of the CCK_B lead structure is outlined. All compounds were inactive on the CCK_A receptor above 50 μ M and showed potency as CCK_B antagonists. These binding assays were carried out with L-365,260 as internal standards in triplicate and the generated compounds were compared with the CCK_B selective antagonist 7-chloro-3-n-propyl-benzodiazepine (**105**, Nva-A). Additionally, the chemical precursors of this CCK_B selective antagonist with the nitro (**168**) and the amino group (**169**) on the 7-position were tested.

Table 8.6: Variation of R₁: N-alkylated 7-chloro-3-propyl-1,4-benzodiazepines (Route 1)

Entry	R ₇	R ₁	Yield [%]	CCK _B [μ M]
105 (Nva-A)	Cl	H	---	0.6
168	NO ₂	H	---	>50
169	NH ₂	H	---	>50
171	Cl		77	>50
172	Cl		43	>50
173	Cl		31	>50
174	Cl		32	>50
175	Cl		63	11
176	Cl		42	1.5
177	Cl		48	1.2
178	Cl		50	>50
179	Cl		54	>50
180	Cl		32	>50

In these studies it was established that the replacement of the chlorine of the CCK_B lead structure (**105**) on the 7 position by a nitro (**168**) or an amino group (**169**) led to loss of bioactivity towards the CCK_B receptor. This result indicated that the chlorine is thus essential for bioactivity.

As previously reported N1-alkylation might have enhanced binding on the CCK_B receptor but with the majority of electrophiles containing the functional groups the bioactivity was either lower than the N1-unalkylated CCK_B lead structure (**105**, Nva-A) or completely lost. A substituent on the N1 is desirable, firstly to enhance to binding and secondly to differentiate between the CCK and the GABA_A/benzodiazepine receptor complex⁶¹, as it was known that any substituent in N1 position block GABA_A binding. In the literature¹⁹⁴ binding was enhanced by N1-alkylation with t-butyl ketone¹⁴¹ (**158**) and with benzoylmethyl^{120,135,136} (**159**) for 3-ureido-benzodiazepines. Here, the N1-alkylated compounds (**176**, **177**) showed approximately 2-3 fold decreased bioactivity towards the CCK_B receptor than the unalkylated CCK_B lead structure (**105**). The N1-alkylation with the α -halogenoester (**175**) or with the α -halogen acetamide (**174**) led to a significantly loss of activity. More complex electrophiles formed piperidino-, morpholino- and phthalimido-benzodiazepines (**178-180**). These compounds did not displace CCK or compounds with hydroxyl containing alkyl groups (**171-173**).

The biological results of relevant alkylated 3-propyl-1,4-benzodiazepines are outlined in the following diagram.

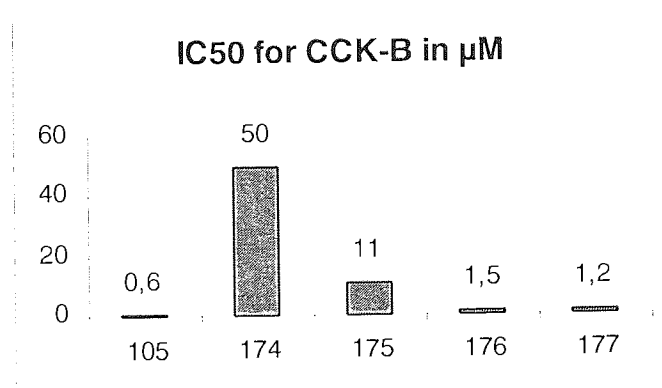

Diagram 8.3: Comparison of biological activity of selected N1-alkylated 7-chloro-3-propyl-1,4-benzodiazepines containing functionalised groups

The optimised N1-alkylated compounds (Figure 8.15) containing functionalised groups in this series possessed approximately 2-3 fold lower potency to its counterpart the unalkylated CCK_B lead structure. This is in contrast to the reported enhanced bioactivity of N1-alkylated 3-ureido-benzodiazepines with the t-butyl ketone¹⁴¹ or with the benzoylmethyl^{120,135,136} group. According to these results, lipophilic groups might be essential for bioactivity on the N1 position and the further optimisation process was focussed on compounds containing lipophilic substituents on this position.

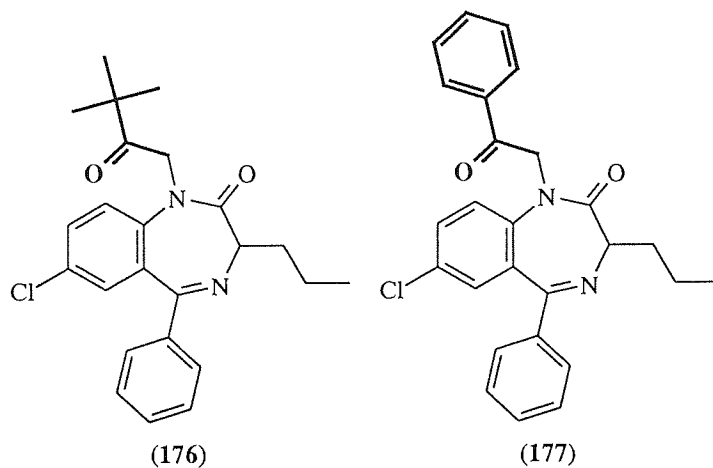

Figure 8.15: Unexpected decreased bioactivity of N1-alkylated 3-propyl-benzodiazepines containing the t-butyl ketone or the benzoylmethyl group

8.3.4. Development route 2: Large scale solution phase synthesis of the 7-chloro-3-propyl-1,4-benzodiazepine template as building block for N1-alkylation

Since it was established that N1-alkylated compounds containing functionalised groups showed decreased binding towards the CCK_B receptor subtype, the preparation and biological evaluation of N1-alkylated compounds containing lipophilic groups which might enhance CCK binding was pursued.

Furthermore, for this approach a suitable preparation method of the CCK_B lead structure was desirable. The previous synthesis sequence afforded the desired benzodiazepine template in 23 % yield as an oily product via 7-amino-3-propyl-1,4-benzodiazepine and the Sandmeyer reaction. In order to avoid these additional synthesis steps it was desirable to use 5-chloro-2-aminobenzophenone as the starting material. However the failed cyclisation step of the adequate acetanilide derivative (**181**, Figure 8.16) by liquid ammonia to the benzodiazepine template lead to the further development of a preparation method for the optimisation process. A new synthesis was developed analogous to the preparation method for the synthesis of Oxazepam^{®147}, in which the substrate 5-chloro-2-aminobenzophenone oxime (**187**, Scheme 8.6) furnished under basic conditions the heterocyclic seven-membered ring system. This route was the method of choice and was found to be suitable for the large scale preparation of the benzodiazepine template.

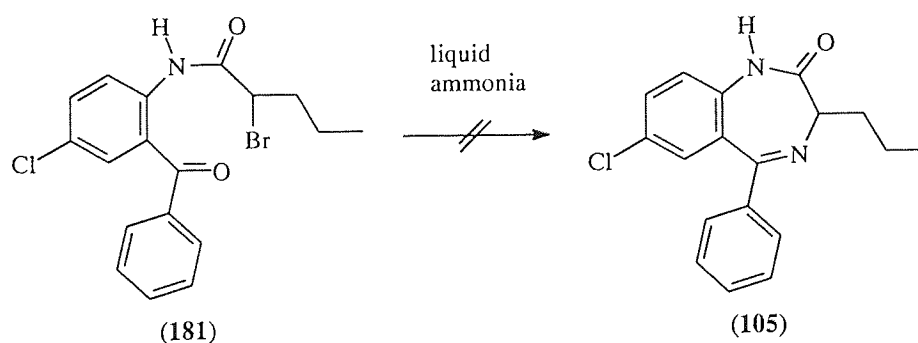
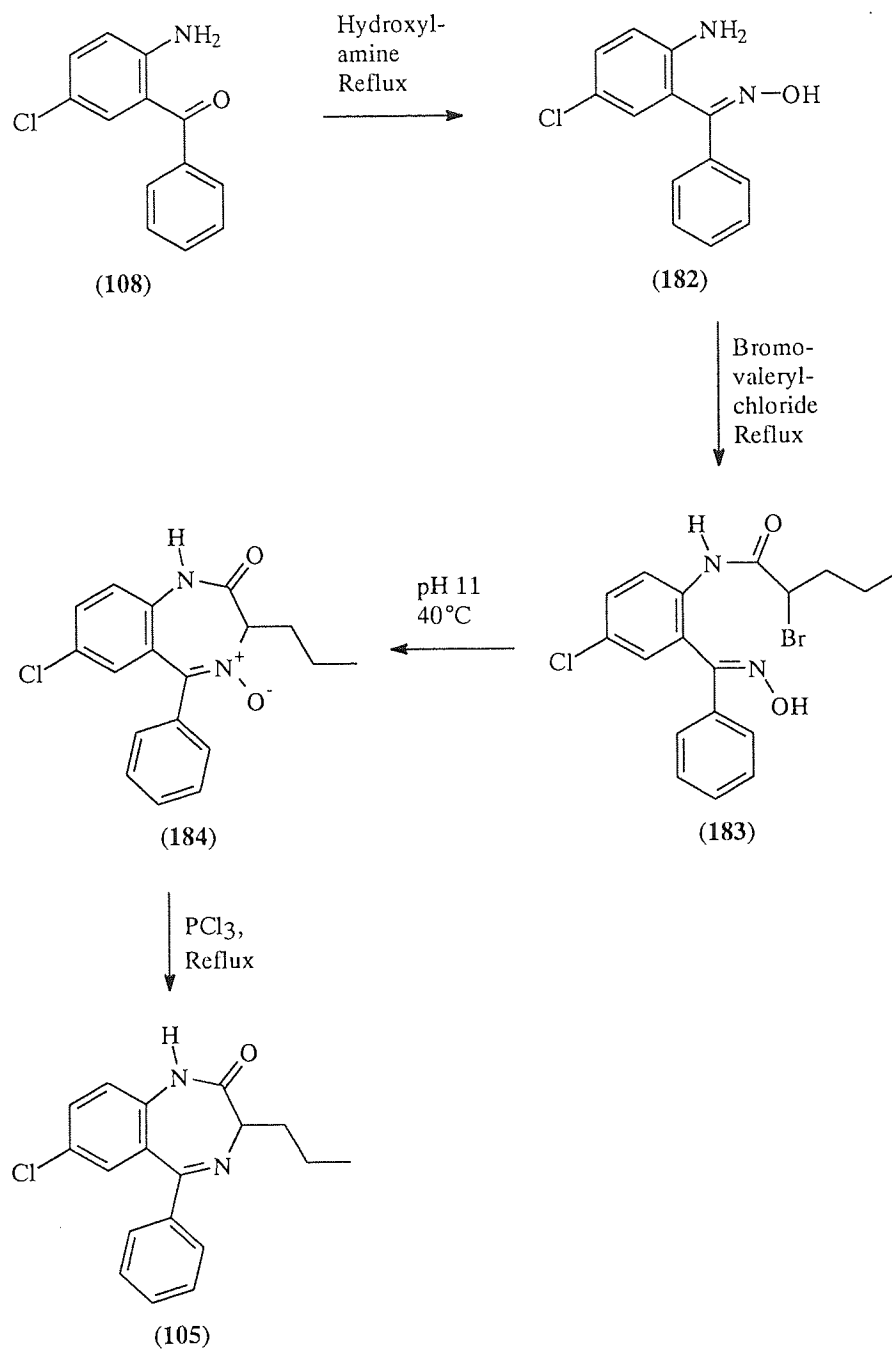

Figure 8.16: Attempted approach for the generation of the CCK_B lead structure 7-chloro-3-propyl-1,4-benzodiazepine by route 1

Furthermore, this route did not require exact monitoring of the whole reaction process like route 1. The following scheme summarises this preparation procedure.



Scheme 8.6: Development route 2; synthesis of 7-chloro-3-propyl-1,4-benzodiazepine

In this context 5-chloro-2-aminobenzophenone (**108**) was converted into the corresponding oxime (**182**) with hydroxylamine hydrochloride under reflux for 3 days. This was then subsequently reacted under reflux for 4 hours with 2-bromo-butyric acid chloride to give the desired amide (**183**) with traces of (**184**) and the benzodiazepine template (**105**). While longer reaction times under reflux in 1,2-dichloroethane did not improve the yields of benzodiazepines, the heterocyclic seven-membered ring was formed as the N-oxide (**184**) in 52% yield based on (**183**) under basic conditions corresponding to the preparation of Oxazepam®. This chemically pure compound crystallised from the reaction mixture. The reaction proved to be reliable and was suitable for the preparation of (**184**) on large scale. In order to avoid the possible formation of 3-propyl-1,3,4,5-tetrahydro-1,4-benzodiazepine by using Raney nickel and hydrogen as was observed in the previous section (Figure 8.12), the N-oxide benzodiazepine (**184**) was reduced to the building block (**105**) with 3 eq. of phosphorus trichloride successfully under reflux according to the published methods^{146,219}.

8.3.4.1. Mechanism for the formation of the building block

According to the synthesis of Oxazepam®, in an alkaline medium, 2-haloacetamido-benzophenone oximes undergo intramolecular O-alkylation with the formation of 8-membered rings, i.e. the 4,1,5-benzoxadiazocin-2-ones (Chapter 7, Scheme 7.1). These compounds readily rearrange with alkali to form 3-hydroxy-benzodiazepine (Oxazepam®). However, the difference of this method as reported for Oxazepam® was the formation of the N-oxide benzodiazepine (**184**) as presented in scheme 8.7 and not the expected 3-hydroxy-propyl-1,4-benzodiazepine (**186**). This was readily achieved by comparison of ¹H-NMR spectra. The ¹H-NMR spectra of the N-oxide showed the characteristic proton on C-3, which appeared at $\delta = 4.3$ ppm. Infrared spectra indicated the presence of the N-oxide at 1238 cm^{-1} . These results indicated the successful formation of the heterocyclic seven-membered ring in alkaline conditions.

Sternbach reported in his synthesis of Oxazepam[®], the isolation of the 8-membered ring, when the reaction was interrupted after a short time. Attempts, to isolate the appropriate 8-membered ring (**185**) failed and demonstrated that the reaction with the additional propyl group probably followed another mechanism, in which the nitrogen of the oxime (**183**) would add by nucleophilic attack to the carbon atom next to the carbonyl unit displacing the leaving group to form the seven-membered ring as the N-oxide.

Furthermore decreased yields were expected with an increased length of the alkyl side chain, if the reaction follows the complex mechanism according to the reported method for Oxazepam[®]. The postulated mechanism was supported by the observation, that the acylation of 5-chloro-2-amino-benzophenone oxime (**182**, Scheme 8.6) with α -bromo-butiric acid chloride under reflux in 1,2-dichloroethane furnished the amide (**183**), traces of the N-oxide compound (**184**) and the desired benzodiazepine template (**105**).

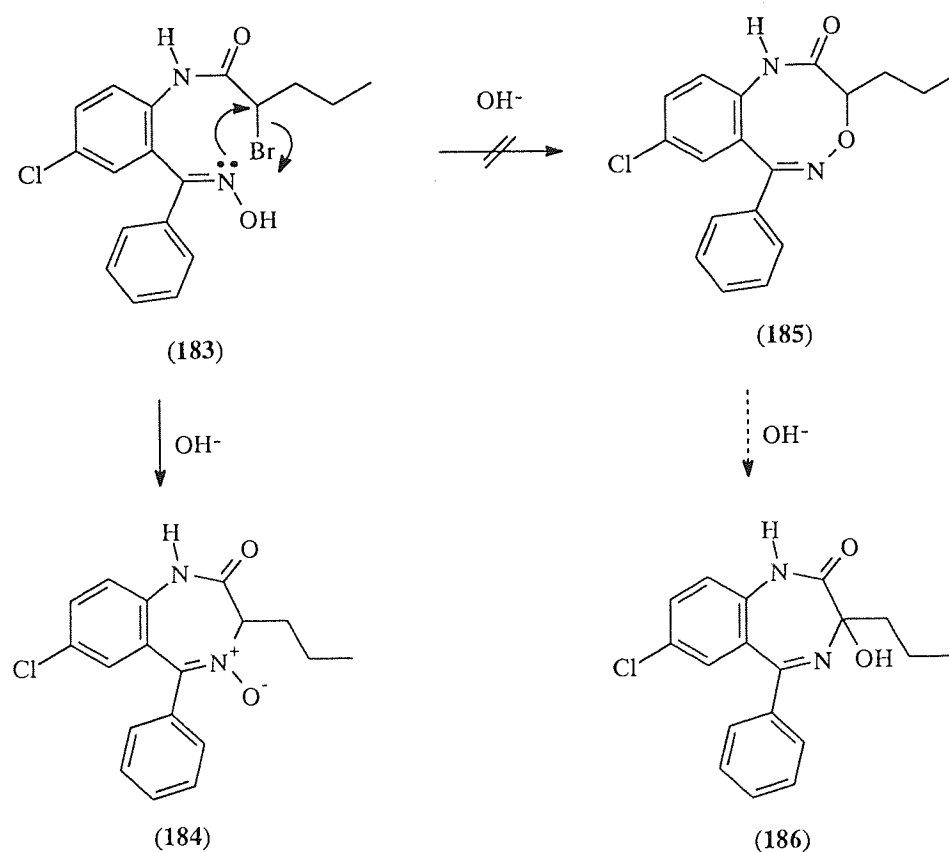

Scheme 8.7: Proposed mechanism for the formation of 7-chloro-3-propyl-1,4-benzodiazepine in alkaline conditions

8.3.5. N₁-Alkylation of 7-chloro-3-propyl-1,4-benzodiazepine ing lipophilic groups

The N₁-alkylated target compounds (Figure 8.18) were obtained by treatment of the parent NH amide (**105**) with sodium hydride in DMF¹⁹³ followed by the alkylating agents at ambient temperature in particularly good yields. Ten readily available lipophilic alkylating agents were selected (Table 8.7) in order to improve the bioactivity of the N₁-alkylated-3-propyl-1,4-benzodiazepines. According to the enhanced bioactivity of 3-substituted Diazepam analogues with the C-3 alkyl side chain and C-terminal unsaturated double or triple bonds, allyl- and propargyl bromides were thus selected.

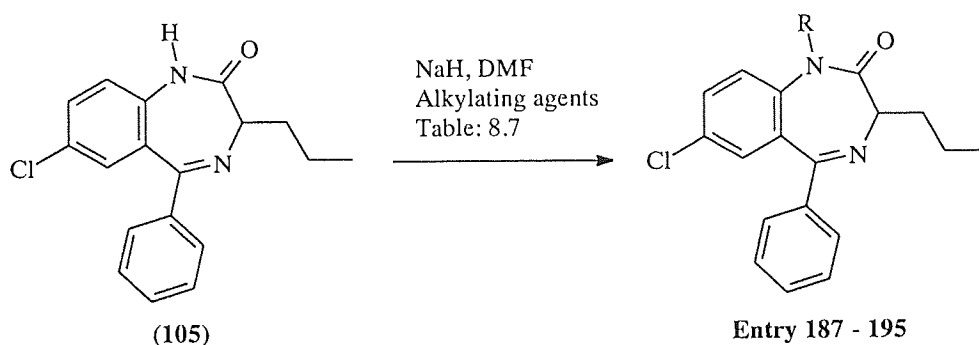

Figure 8.17: N₁-alkylation of the CCK_B lead structure, 7-chloro-3-propyl-1,4-benzodiazepine

Table 8.7: Alkylating agents used for N₁-alkylation of 7-chloro-3-propyl-1,4-benzodiazepine (Route 2)

Ethyl bromide 	Propyl bromide 	Butyl bromide 	Sec. Butyl bromide 	Allyl bromide
Propargyl bromide 	Bromo acetonitrile 	Benzyl bromide 	Phenethyl bromide 	

The structures of N1-alkylated 3-propyl benzodiazepines containing lipophilic groups prepared by route 2 are outlined in figure 8.18.

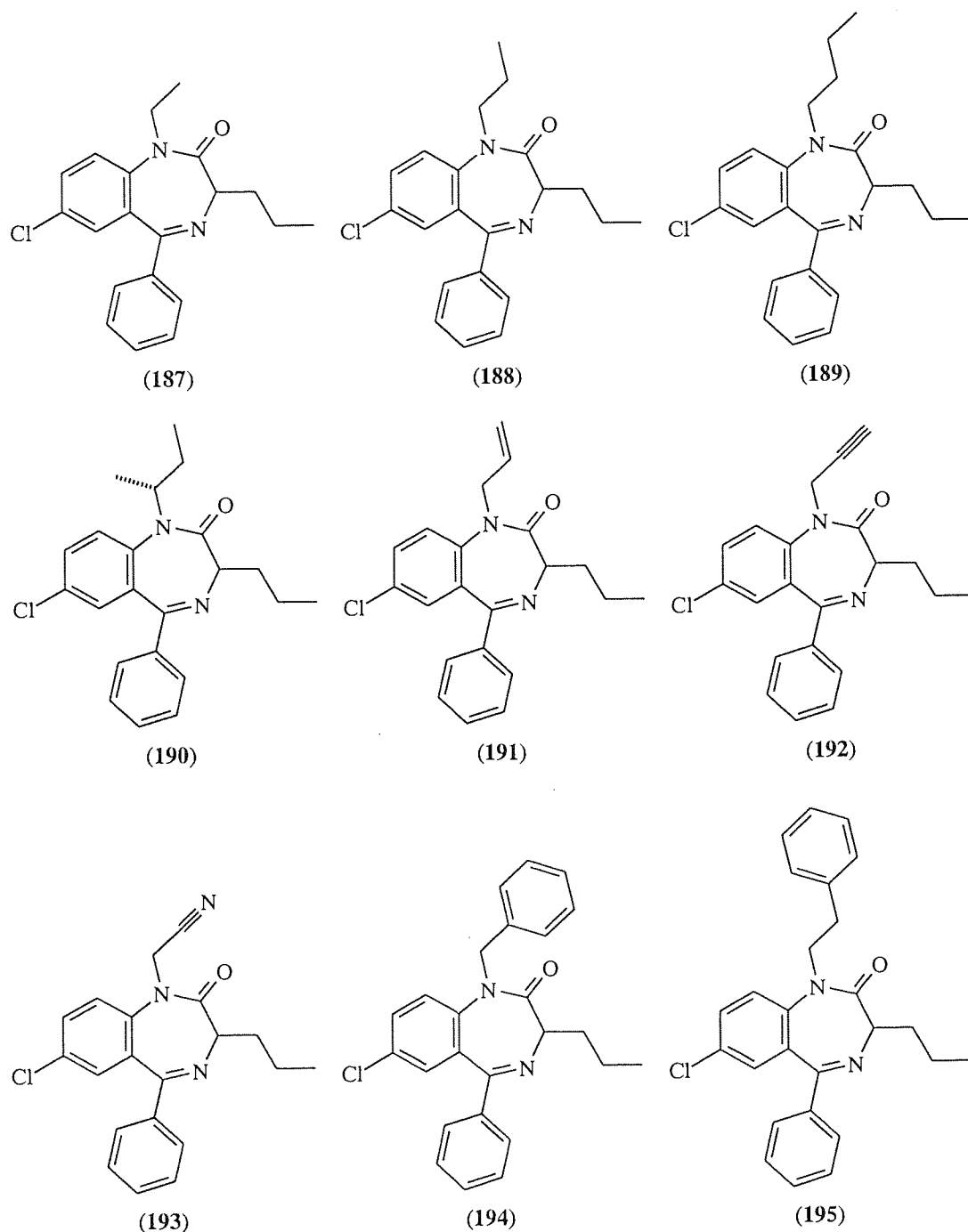
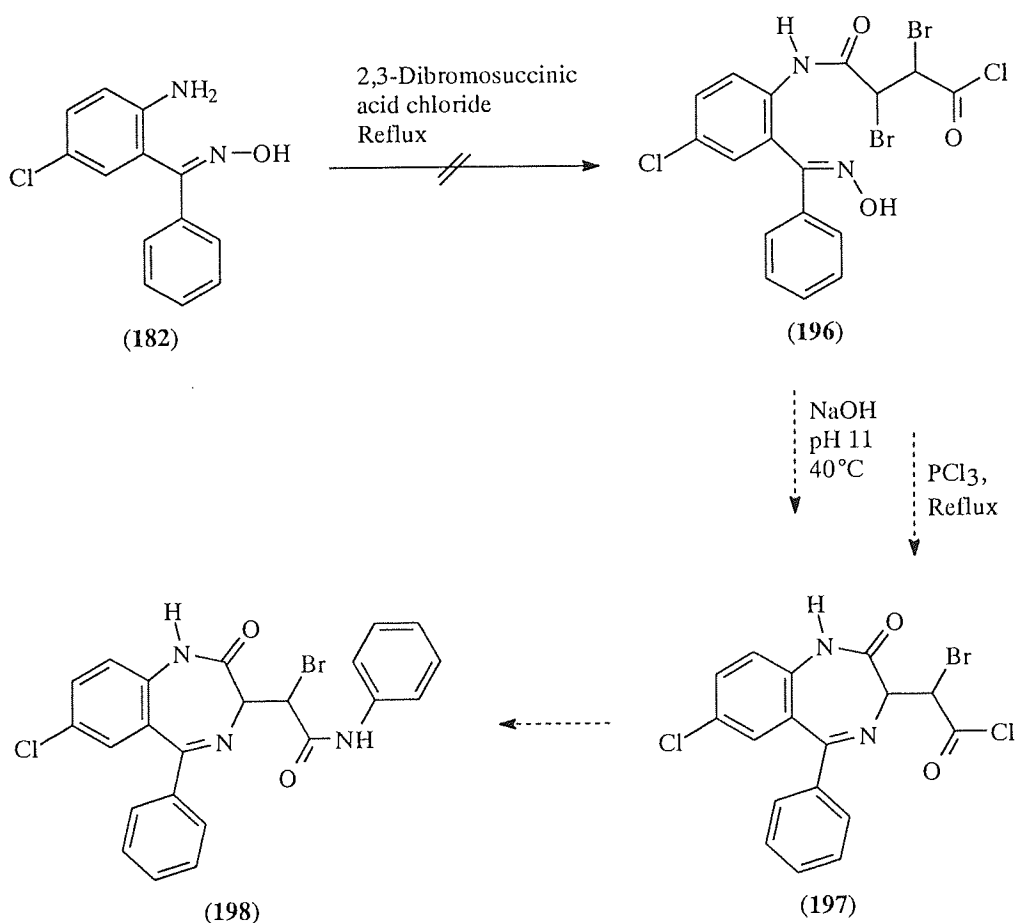

Figure 8.18: N1-alkylated 7-chloro-3-propyl-1,4-benzodiazepines containing lipophilic groups

Furthermore, it was also considered to synthesise similar compounds such as the CCK_B selective 3-ureido-1,4-benzodiazepine L-365.260 since it was established that this was the most successful synthesis sequence for 3-substituted benzodiazepines on a large scale. Scheme 8.8 represents this chemical route to furnish 3-phenylacetamide benzodiazepine (198) starting with 5-chloro-2-aminobenzophenone oxime (182). In order to increase the chemoselectivity of this preparation method the substrate 2,3-dibromosuccinic acid was selected. However, contrary to 2-bromopentanoic acid, which was used for the preparation of the CCK_B lead structure, several attempts to convert the highly functionalised and polar 2,3-dibromosuccinic acid into their acid chlorides with thionyl chloride or phosphorus pentachloride under reflux produced the “activated” acid chlorides in only low yields, while mainly uncharacterisable decomposition products were formed.







Scheme 8.8: Proposed synthesis sequence for the formation of 3-phenylacetamide benzodiazepines

8.3.6. Pharmacology of N1-alkylated 7-chloro-3-propyl-1,4-benzodiazepines (Route2)

All compounds, which were purified and fully characterised were inactive on the CCK_A receptor above 50 μ M and showed potency as CCK_B antagonists. These binding assays were carried out with L-365,260 and 3-n-propyl-benzodiazepine as internal standards in triplicate. In Table 8.8 the influence of N1-alkylation of the CCK_B lead structure prepared by route 2 is outlined.

Table 8.8: Variation of R₁: N-alkylated 7-chloro-3-propyl-1,4-benzodiazepines (Route 2)

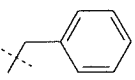
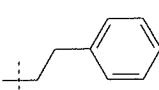
Entry	R ₁	Yield [%]	CCK _B [μ M]
105 (Nva-A)	H	---	0.6
187	Ethyl	92	7.1
188	Propyl	91	8.5
189	Butyl	88	17
190		84	21
191		89	0.4
192		86	0.4
193		82	0.9
194		86	>50
195		84	>50

The bioactivity of N1-alkylated 1,4-benzodiazepines containing functionalised groups obtained by route 1 was either significantly lower than the unalkylated CCK_B lead structure (**105**) or lost. In this series, it was observed that by attaching the cyanomethyl group (**193**) to the 1-position the bioactivity was tolerated or slightly decreased. The best results were delivered by the allyl (**191**) and the propargyl group (**192**), and lead to enhance CCK_B potency showing an IC₅₀ of 400 nm.

In contrast, all saturated alkyl groups (**187-190**) at the amide nitrogen lead to significant loss of bioactivity. The replacement of the propyl- (**188**) by an allyl- (**191**) or the propargyl group (**192**) has shown a pronounced effect on bioactivity. While compound (**188**) with the propyl group showed an IC_{50} of 8.5 micromolar, the N1-alkylated compounds with the allyl (**191**) or the propargyl group (**192**) were approximately 20 fold more active on the CCK_B receptor. N1-alkylated benzodiazepines bearing aryl groups (**194, 195**) did not possess any bioactivity.

The biological results of relevant alkylated 3-propyl-1,4-benzodiazepines are outlined in diagram 8.4.

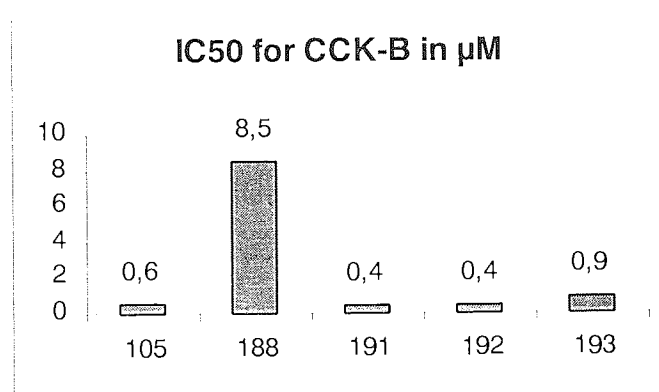

Diagram 8.4: Comparison of biological activity of selected N1-alkylated 7-chloro-3-propyl-1,4-benzodiazepines containing lipophilic groups

The CCK_B lead structure and two selected compounds of this optimisation process as shown in figure 8.19 have been prepared by the cheapest ketone building block. The N1-propargyl compound (**192**) showed enhanced bioactivity compared to the CCK_B lead structure, while the N1-cyanomethyl compound (**193**) showed a slightly reduced bioactivity.

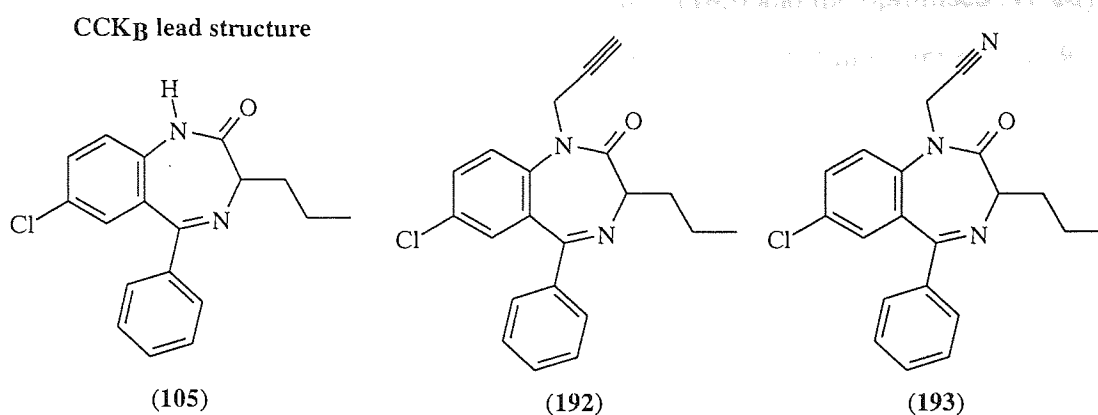

Figure 8.19: 7-Chloro-3-propyl-1,4-benzodiazepine and selected structures of N1-alkylated analogues

In summary, the C-3 alkyl unit of 3-substituted 1,4-benzodiazepines was found to show the highest binding affinity towards the lipophilic pocket of the CCK_B subtype receptor. Optimisation on the benzodiazepine moiety by varying the 5, 7, 8-position by changing the ketone of the molecule was completed and showed opposite SAR studies, compared with the GABA_A receptor¹⁴⁵.

The C3-alkylation of Diazepam® pointed out, that alkyl side chains with the C3 alkyl unit incorporating a C-terminal unsaturated double or triple bonds increased the affinity towards the CCK_B receptor. However, the preparation of the N₁-unalkylated compound bearing these alkyl side chains is chemically more difficult. Therefore, the final SAR optimisation process by alkylation on the N₁ position was focussed on the CCK_B lead structure 3-propyl-1,4-benzodiazepine. This compound was available on a large scale without the considerable use of column chromatography.

The studies of N1-alkylation of the CCK_B lead structure resulted in improved Cholecystinin binding. An allyl- and propargyl group was identified as an ideal N₁ substituent, as it enhanced the CCK binding with potentially decreased activity on the GABA_A receptor. Generally, the optimisation process of 3-substituted 1,4-benzodiazepines was carried out successfully and was completed with *in vivo* studies in mice.

The pharmacological effects of the CCK_B lead structure (**105**) and the optimised N1-allyl analogue (**196**) were compared with Diazepam[®] (**139**) as presented in figure 8.20 at 30 min after intraperitoneal injection in mice.

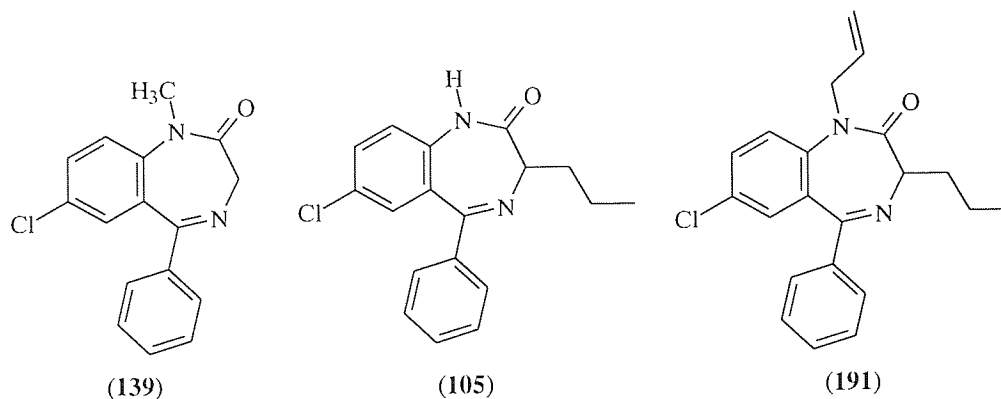

Figure 8.20: Results of *in vivo* studies of selected 1,4-benzodiazepines

The suitable models for testing anxiolytic drugs are the elevated plus-maze²²⁰, test in the dark-light box, the measurement of motor activity (anxiety) and tail flick test (pain). The results of the pharmacological effects are summarised in table 8.9.

Table 8.9: In vivo data of selected benzodiazepines

Compound	Time spent in open arm [sec.]	Time spent in Light [sec.]	Motor activity [sec.]	Tail flick threshold [sec.]
Propylene glycol	71.00 ± 17.68	15.80 ± 6.02	29.83 ± 2.34	8.20 ± 0.63
Diazepam [®] (139) [2 mg/kg]	132 ± 16.2	589.80 ± 7.39 ^a	3.62 ± 0.46 ^a	7.52 ± 0.70
CCK _B lead structure (105) [100 mg/kg]	146 ± 12.22 ^b	367.80 ± 78.59 ^{a,b}	8.54 ± 1.03 ^a	8.60 ± 0.74
(196) [100 mg/kg]	175.00 ± 31.17 ^{a,b}	355.40 ± 71.74 ^{a,b}	4.94 ± 0.46 ^a	6.74 ± 0.17

^a $p < 0.05$ when compared to control; ^b $p < 0.05$ when compared to Diazepam treated group

Remark: Diazepam[®] at dose 2 mg/kg seems to be high since most of the animals were sedated

The CCK_B lead structure (**105**) and the optimised compound (**191**) were dissolved in propylene glycol (PG), while Diazepam® in injection form was used and diluted with PG. The control mice were injected with PG at the same volume/body weight (0.05ml/10g) with a group size of 5 mice. The time spent in open arm was recorded from the observation period of 5 min in the elevated plus-maze test, while the time spent in light was recorded from the observation period of 10 min in the light-dark box test. The motor activity was recorded as the time when the mice could hold on to the sieve at 180° position and the tail flick threshold was measured by measuring the response time of mice in a hot water bath (50°C).

In the first model anxiolytics cause an increase in the time spent in the open arm of the maze, whilst anxiogenic treatment increases the time spent in the closed arm according to the literature for the elevated plus-maze test²²⁰. It was established by this test method that the generated CCK_B ligands possessed anxiolytic properties. Furthermore, treated mice with anxiolytics increased the time spent in light. Apart from the best results obtained for Diazepam®, which is known to bind at the specific regulatory site on the GABA_A receptor^{61,137,138} with the resulting side effects such as sedation, the CCK_B ligands showed their bioactivity on the central nervous system. The anxiolytic properties of these CCK_B ligands were also established by measurement of the motor activity and by measurement of the tail flick threshold for pain of treated mice. In general, these results have shown that CCK_B antagonists are involved in regulation of anxiety and pain without showing the side-effects of sedation. Furthermore, it is noteworthy that Merck's 3-ureido benzodiazepine L-365,260 has been tested as well. Although L-365,260 shows *in vitro* high affinity to the CCK_B receptor subtype, this compound did not show any *in vivo* activity. This might be due to its low aqueous solubility and confirmed reported results of distribution studies in mice¹¹³, which showed a very low brain uptake (<0.8% dose/gram) after intravenous injections.

In general, the high chemical and metabolic stability of these CCK_B ligands is the key feature. Several alternative chemical approaches to vary the substituents around the 1,4-benzodiazepine template have been developed, including a route that is suitable for scale up of the desired target molecule in order to provide sufficient quantities for further *in vivo* evaluations.

Chapter 9

Summary and Conclusion

With the in-depth study into the various approaches to combinatorial chemistry of multi-substituted 1,4-benzodiazepines, which were biological evaluated as CCK_A and CCK_B antagonists, the following conclusions were reached.

The solid phase approach was the best method for the lead discovery process and delivered numerous amounts of information with an outline of SAR essentials for biological activity, whereas the classical synthesis in solution was chosen for the lead optimisation process of selected compounds to ascertain their detailed bioactivity. The combination of both methodologies led to the successful and biological identification of lead structures.

Generally, all lead structures either as CCK_A and CCK_B antagonists, which inhibited binding incorporated 5-chloro-2-aminobenzophenone, indicating that this particular aminobenzophenone plays an important role in interactions with cholecystinin receptors. In accordance with all biological results, it was confirmed that CCK antagonist potencies and selectivity over the receptor subtypes of benzodiazepines depend critically on the 3-position of the benzodiazepine skeleton. The 1,4-benzodiazepine derivatives incorporating the benzyl moiety at the most relevant 3 position (**Phe**-series) possessed activity in the low micro molar range and were non-selective, while indolylmethyl-derivatives (**Trp**-series) showed higher potency with a moderate CCK_A selectivity. These 1,4-benzodiazepin-2-ones bearing the tryptophan moiety were further chemically modified by selective alkylation and acylation reactions to Asperlicin analogues, which showed enhanced CCK_A activity. The fully optimised Asperlicin related compound, possessed a similar CCK_A activity as the natural occurring compound. The further structural modification of this 3-indolylmethyl-1,4-benzodiazepine skeleton by introduction of an additional triazolo ring on 1 and 2 position showed similar bioactivity on the peripheral CCK_A receptor. This result demonstrates that the previous findings (Asperlicin analogues) could be extended to the triazolo benzodiazepine class with similar effect, which might also have a better bioavailability.

Furthermore, the p-hydroxybenzyl derivatives, based on a Tyr moiety, have shown an interesting CCK_A potency and selectivity. This compound served as a lead structure for analogous compounds modified by bioisosteric modifications. However, the bioactivity of these compounds was either moderate or lost. In agreement with the enhanced bioactivity of 3-indolylmethyl-1,4-benzodiazepine with the additional triazolo ring on 1 and 2 position, the compound with the p-hydroxybenzyl moiety on 3 position (Figure: 10.1), might lead to the most active CCK_A selective ligand. Unfortunately, this compound could not be prepared and thus requires further investigations.

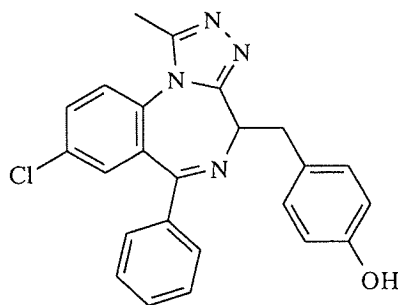

Figure 10.1: Proposed structure of fully optimised 3-substituted-1,4-benzodiazepine as CCK_A ligand

For the possible treatment against anxiety or panic however, the selective CCK_B antagonist was desirable. Contrary to the 3-benzylated-1,4-benzodiazepine as non-selective CCK antagonist, 3-alkylated-1,4-benzodiazepines showed bioactivity towards the CCK_B receptor and SAR studies of these compounds with different lengths of side chains have shown optimum of bioactivity with the lipophilic C3-unit alkyl side chain, which acts with high binding affinity towards the lipophilic pocket of the CCK_B subtype receptor. This lead structure was further structurally modified by selective C-3 and N-1 alkylation reactions and resulted in enhanced bioactivity by the introduction of a C-3 alkyl unit with the C-terminal unsaturated double or triple bonds. *In vivo* studies of this potent CCK_B lead structure and their further optimised N1-allyl analogues showed anxiolytic properties without side effects such as sedation, which is common for GABA_A binding. Based on all SAR studies obtained in this work the bioactivity might be further enhanced by the postulated compound (Figure: 10.2), which could not be afforded due to time.

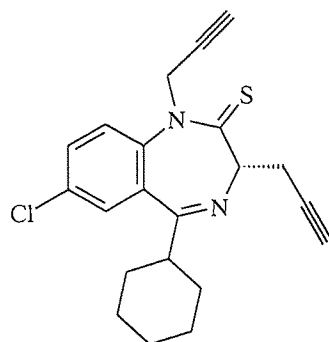

Figure 10.2: Proposed structure of fully optimised 3-substituted-1,4-benzodiazepine as CCK_B ligand

Chapter 10

Experimental

General methods

Mass spectrometric analyses were obtained in APCI⁺ and APCI⁻ mode on a Hewlett-Packard 5989B quadrupole mass spectrometer using a HP 59987A APCI-electrospray LC/MS interface. IR spectra were recorded as KBr discs on a Mattson 3000 FT-IR spectrophotometer. ¹H NMR and ¹³C NMR spectra were recorded on a Bruker AC 250 instrument (250 MHz) with TMS as internal standard. Flash chromatography was performed using Sorbsil C60 silica gel. Analytical TLC was carried out on 250 μm, 20 x 20 cm silica gel plates (Aldrich) using ultraviolet light for visualization. Melting points were determined on a Gallenkamp capillary Melting Point Apparatus. Rotations were measured on Hilger Polarimeter M412 with 100 Polarimeter tube. Refraction indexes were obtained with Hand Held Refractometer "Delta Range" from Bellingham and Stanley.

The combinatorial solution phase syntheses were carried out, on a Carousel reactions stationsTM RR 98030 with 12 Place Carousel Reaction Station and Reflux Head and 12 x flexible Tubing from Radleys on a RCT basic hotplate from IKA Labortechnik with IKATRON[®]ETS D3 temperature controller or by using a Heating Block TECHNE Dri-Block[®] DB-3A.

Pharmacology

¹³¹I-CCK-8 receptor binding assay: CCK_A and CCK_B receptor binding assays were performed by using guinea pig or rat pancreas or guinea pig cerebral cortex, respectively. Membranes from male guinea pig brain tissues were prepared according to the modification described by Saita et al.¹⁷⁶ (1994). Cerebral cortex was homogenised in sucrose, centrifuged and stored at -70°C until use. Pancreatic membranes were similarly obtained as described by Charpentier et al.¹⁷⁷ (1988). After the incubation procedure the radioactivity retained on the filter was counted by liquid scintillation spectroscopy.

All CCK_B binding assays were carried out with L-365,260 or with MK 329 for the CCK_A receptor subtype as internal standards in triplicate.

Tissue preparation: The tissue was weighed after dissection, homogenised in 25 ml ice cold 0.32 M sucrose for 15 strokes at 500 rpm, centrifuged at 1000 g (3000 rpm) for 10 minutes, and then re-centrifuged supernatant at 20,000 g (13000 rpm) for 20 minutes. The pellets were taken and re-dispersed in required volume assay buffer (5 strokes of homogeniser at 500 rpm). The final tissue concentration was 1 g original weight to 120 ml buffer and the tissue was stored in aliquots at -70 °C.

Binding assay: Radioligand (¹²⁵I-Bolton Hunter labelled CCK, NEN) at 25 pM and drugs were incubated with membranes (0.1 mg/ml) in 20mM Hepes, 1 mM EGTA, 5 mM MgCl₂, 150 mM NaCl, 0.25 mg/ml bacitracin, pH 6.5, for 2 hours at room temperature. Incubations were terminated by centrifugation. The membrane pellets were washed twice with water and bound radioactivity was measured in a γ-counter.

Remark: CCK_B-binding assay

This was essentially as described for the CCK_A assay except that cerebral cortex was used instead of pancreas and the NaCl was left out of the assay buffer.

Synthesis of 2-Aminophenylcyclohexylketones

Preparation of 2-aminophenylcyclohexylketone (14)

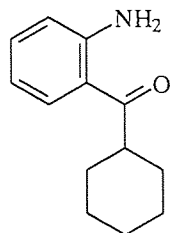

A solution of 34.2g (210 mmol) of cyclohexylbromide in 120 ml of anhydrous ethyl ether was slowly added to a stirred suspension of 7.0 g (290 mmol) of magnesium turnings in 50 ml of anhydrous ethyl ether at a rate adjusted to keep the solution refluxing continuously. After the addition was complete the reaction mixture was refluxed for an additional 30 minutes, and then a solution of 8.3 g (70 mmol) of anthranilonitrile in 100 ml of anhydrous ethyl ether was added dropwise and the resulting mixture was refluxed for another hour. After cooling it was slowly poured into 400 ml of ice water (precipitate formed). Then 300 ml of 3N HCl was added, the mixture was stirred at room temperature for 1 hr, and the organic phase was separated.

The aqueous phase, containing 2-aminophenylcyclohexylketimine hydrochloride, was made basic with Na_2CO_3 and extracted with ethyl ether. The organic layer was washed with water, brine, dried (magnesium sulfate) and filtered. 2-Aminophenylcyclohexylketimine was refluxed overnight with a mixture of 75 ml of toluene and 75 ml of 25 % HCl while stirring. The product 2-aminophenylcyclohexylketone hydrochloride was filtered off and washed with toluene. The free base was obtained by addition of 5% sodium bicarbonate solution. The filtrate was concentrated in vacuo and the residue was crystallised from ethanol yielding 5g (38%) of the desired product (based on anthranilonitrile) as yellow prisms, mp 55-56°C.

APCI + m/s: m/z = 204 (80%), 186 (20%).

TLC (Ether): R_f = 0.8.

IR (KBr disc) ν_{max} = 3450, 3338, 2928, 2849, 1631, 1552, 1480, 1449, 1245, 1160 cm^{-1} .

$^1\text{H-NMR}$ (CDCl_3) δ (p.p.m) 1.1-1.5 and 1.6-2.1 (two br m, 11H, cyclohexyl H), 6.3 (s, 2H, C2:- NH_2), 6.8 (m, 2H, arom. H), 7.2 (m, 1H, arom. H), 7.8 (m, 1H, arom. H).

Preparation of 5-chloro-2-aminophenylcyclohexylketone (15)

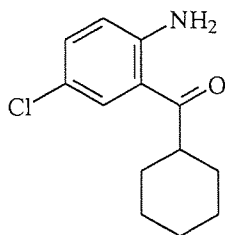

The title product (1.2g, 32%) was obtained by the previous described method using 2.4g (16 mmol) of 2-amino-5-chlorobenzonitrile and 50 mmol of cyclohexylbromide.

APCI + m/s: m/z = 238.

TLC (Ether): R_f = 0.9.

$^1\text{H-NMR}$ (CDCl_3) δ (p.p.m) 0.9-2.2 (br m, 11 H, cyclohexyl H), 6.7 (s, 2H, C2:- NH_2), 7.23 (m, 1H, arom. H), 7.67 (m, 2H, arom. H).

$^{13}\text{C-NMR}$ (CDCl_3) δ (p.p.m) 25.5, 29.5, 43.5, 117.4, 120.9, 128.8, 133.8, 149.2, 199.3.

Preparation of N-(4-methoxyphenyl)acetamide (N-acetanisidine - 33)

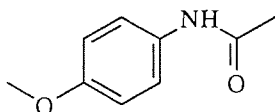

A solution of 12.3g (0.1 mol) of 5-methoxyaniline (anisidine) in 95 ml acetic anhydride (1 mol) was refluxed for 3-4 hours. The solvent was removed by distillation under reduced pressure. The residue was extracted with toluene, and washed with water. The organic layer was dried over anhydrous sodium sulfate, filtered, and the solvent evaporated. The residue was crystallised from toluene/hexane to afford 15.8g (95%) of the title product.

APCI + m/s: m/z = 166.

TLC (Ether): R_f = 0.65.

$^1\text{H-NMR}$ (CDCl_3) δ (p.p.m) 2.43 (s, 3H, - NHCOCH_3), 3.75 (s, 3H, - OCH_3), 6.87 (m, 2H, arom. H), 7.51 (m, 2H, arom. H), 9.81 (s, 1H, - NHCOCH_3).

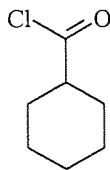
Preparation of cyclohexanecarboxylic acid chloride

A mixture of 12.8 g (0.1 mol) of cyclohexanecarboxylic acid and thionyl chloride (35.7 g \cong 22.2 ml, 0.3 mol) was stirred and gently refluxed. After completion, when the development of HCl and sulfur dioxide stopped (4 hours), the excess of thionyl chloride was removed by distillation under reduced pressure at 25°C. The oily residue was distilled at 15 torr, 75-79°C to yield 11.7 g (81%) of cyclohexanecarboxylic acid chloride as colourless oil.

APCI + m/s: m/z = 143.

TLC (Ether): R_f = 0.88.

d^{20} : 1.1 g/cm³.

n^{20} : 1.47.

¹H-NMR (CDCl₃) δ (p.p.m) 1.0-2.4 (br m, 10H, cyclohexyl H), 2.75 (m, 1H, CH).

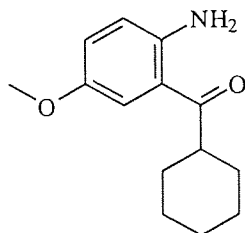
Preparation of 2-amino-5-methoxyphenylcyclohexylketone (16)

To a solution of 4.15g (25 mmol) of *N*-acetanisidine and 4.45g (\cong 4 ml, 31.25 mmol) of cyclohexanecarboxylic acid chloride in 25 ml carbon disulfide, 5.8g (43.75 mmol) of anhydrous aluminium chloride was added slowly in portions at 20–25°C. After about 10 min, evolution of hydrogen chloride was noted. The reaction mixture was stirred for 1 hour at 25°C and then under reflux temperature for 1 hour. After cooling, the carbon disulfide layer was removed by distillation. The residue was extracted with toluene and washed. The organic layer was dried over anhydrous sodium sulfate, filtered, and the solvent evaporated in vacuo to leave a viscous residue. The residue containing 2-acetamido-5-methoxyphenyl-cyclohexylketone (APCI + m/s: m/z = 276) and 2-acetamido-5-hydroxy-phenyl-cyclohexylketone (APCI + m/s: m/z = 261) [not isolated] was recrystallised from a mixture of toluene and hexane. The products were hydrolysed by refluxing for 3 hour in 200 ml of ethanol and 200 ml of 6N hydrochloric acid.

The reaction mixture was concentrated to dryness in vacuo, the residue was then slurried with water, made alkaline with ammonia, and then extracted with toluene. After drying over sodium sulfate, the solvent was removed by distillation in vacuo to give 2-amino-5-methoxyphenylcyclohexylketone and 2-amino-5-hydroxyphenylcyclohexylketone. To an ice cooled solution of both products in ether, an ethereal solution of diazomethane was added slowly, until the gas evolution had stopped. The excess of diazomethane was removed by bubbling nitrogen through the reaction mixture. The mixture was concentrated in vacuo and the product was crystallised in toluene/hexane to yield 1.7 g (29%) of the desired product.

APCI + m/s: $m/z = 236$.

mp: 105-107°C.

TLC (Ether): $R_f = 0.9$

$^1\text{H-NMR}$ (CDCl_3) δ (p.p.m) 1.0-1.5 & 1.6-2.1 (two br m, 10H, cyclohexyl H), 2.61 (m, 1H, cyclohexyl H), 3.85 (s, 3H, $-\text{OCH}_3$), 6.79 (s, 2H, C2:- NH_2), 7.15 (m, 1H, arom. H), 7.58 (m, 2H, arom. H).

$^{13}\text{C-NMR}$ (CDCl_3) δ (p.p.m) 24.9, 30.4, 45.1, 55.4 ($-\text{OCH}_3$), 114.2, 120.1, 122.9, 145.3, 150.4, 192.7.

2-Amino-5-hydroxyphenylcyclohexylketone (36)

A small amount of the title compound was purified by preparative TLC with ether as eluent and was analysed.

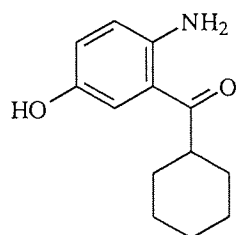

APCI + m/s: $m/z = 220$.

TLC (Ether): $R_f = 0.76$.

$^1\text{H-NMR}$ (CDCl_3) δ (p.p.m) 0.9-2.0 (br m, 10 H, cyclohexyl H), 2.34 (m, 1H, cyclohexyl H), 6.69 (m, 3H, C2:- NH_2 & C5:- OH), 7.12 (m, 1H, arom. H), 7.63 (m, 2H, arom. H).

$^{13}\text{C-NMR}$ (CDCl_3) δ (p.p.m) 23.1, 29.9, 47.6, 114.8, 119.5, 121.6, 147.5, 153.4, 199.3.

General procedure for construction of combinatorial library

(I-size crowns)

The preparation of the full size library was carried out on I-size crowns: 168 crowns, 14 groups of 12 I-size crowns were swollen in 10 ml of DMF/DCM 1:4 and at the same time, 14 Fmoc protected amino acids (5 mmol) were activated with 1.2 eq. of DIC in DMF for 15 minutes until the solution was completely clear. 14 groups of 12 crowns were reacted with the DIC activated amino acids in presence of a catalytic amount (0.05 mmol) of DMAP at ambient temperature over night. This coupling process of the amino acid to the resin was repeated at least once. In order to remove all unreacted amino acid, the crowns were washed with DCM/DMF three times, followed by DMF. The Fmoc group was subsequently cleaved by using a 20% solution of piperidine in DMF at room temperature over several hours. The 168 crowns were washed 3 times with DMF, DMF/DCM and dichloroethane. 14 groups of 12 crowns each were coded and regrouped in 12 groups containing 14 different resin bound amino acids. They were treated with a 25% solution of the **ketones A-L** in dichloroethane. The imine formation was carried out at 60°C over a period of 2 days. They were washed 3 times with dichloromethane, DMF and DCM until the washing liquids were colourless.

Cleavage Method A: The crowns were dispensed in 168 individual vials and the benzodiazepine was cleaved and formed in TFA at 60°C over one day. TFA was removed with a constant steam of argon giving the desired BDZ as oil, which were used directly in an initial screening.

Cleavage Method B (Trp, Tyr, Asp): The crowns were reacted with a solution of 1% DMAP in pyridine over 2 days at 75°C. Silica gel was added and the remaining paste was dried giving a brown powder, which was extracted with a mixture of E/PE 1:1.

Entry 37-50: (Amino acid-Series)

1,4-benzodiazepin-2-one 199

Abu-A: 7-Chloro-3-ethyl-5-phenyl-1,3-dihydro-2H-1,4-benzodiazepin-2-one (37)

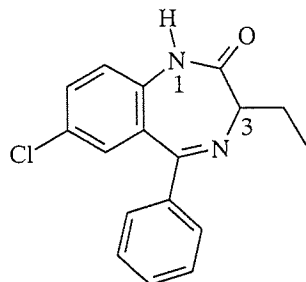

APCI + m/s: m/z = 299 (40%), 254 (60%).

TLC (Ether): $R_f = 0.78$.IR (KBr) $\nu_{\max} = 3187, 3056, 2935, 1685$ (C=O), 1606, 1457, 1334, 829, 668 cm^{-1} .

$^1\text{H-NMR}$ (CDCl_3) δ (p.p.m) 0.99 (tr, $J = 6$ Hz, 3 H, C3:- CH_2CH_3), 2.3 (m, 2H, C3:- CH_2CH_3), 4.15 (tr, $J = 6$ Hz, 1 H, C3:- H), 7.15-7.7 (m, 8 arom. H), 9.59 (s, 1 H, N1:- H).

$^{13}\text{C-NMR}$ (CDCl_3) δ (p.p.m) 11.6 (C3:- CH_2CH_3), 17.8 (C3:- CH_2CH_3), 64.2 (C-3), 121.9, 128.6, 129.0, 129.5, 129.7, 130.6, 130.8, 131.4, 137.3, 139.4, 167.9, 172.8.

AC-A: 7-Chloro-3-hexyl-5-phenyl-1,3-dihydro-2H-1,4-benzodiazepin-2-one (38)

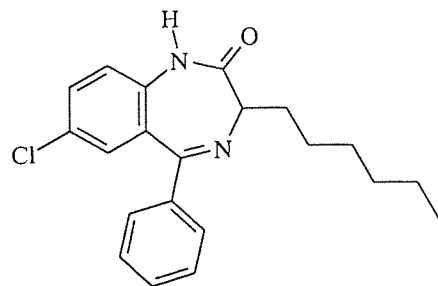

APCI + m/s: m/z = 355 (90%), 254 (10%).

TLC (Ether): $R_f = 0.88$.IR (KBr disc) $\nu_{\max} = 3183, 3101, 2955, 1688$ (C=O), 1608, 1484, 1330, 983, 690 cm^{-1} .

$^1\text{H-NMR}$ (CDCl_3) δ (p.p.m) 1.02 (t, 3H, $J = 7$ Hz, CH_3), 1.25-1.90 (m, 8H, CH_2), 2.35 (m, 2H, C3:- CH_2), 4.05 (tr, 1H, $J = 5$ Hz, C3:- H), 7.15-7.7 (m, 8 arom. H), 9.85 (s, 1H, N1:- H).

$^{13}\text{C-NMR}$ CDCl_3) δ (p.p.m) 14.0, 23.1, 29.3, 24.8, 31.8, 62.7 (C-3), 118.3, 121.1, 128.6, 129.2, 129.5, 129.7, 131.2, 131.4, 137.3, 140.8, 167.8, 171.8.

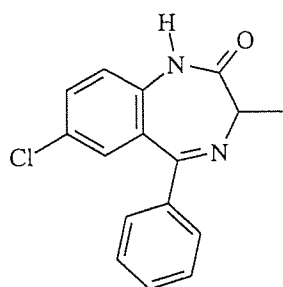
Ala-A: 7-Chloro-3-methyl-5-phenyl-1,3-dihydro-2H-1,4-benzodiazepin-2-one (39)

APCI + m/s: m/z = 285 (90%), 255 (10%).

TLC (Ether): R_f = 0.58.

IR (KBr disc) ν_{\max} = 3418, 3199, 3106, 2936, 1691(C=O), 1474, 1319, 1098, 821, 693 cm⁻¹.

¹H-NMR (CDCl₃) δ (p.p.m) 1.72 (d, J = 6.4 Hz, 3 H, C3:-CH₃), 4.2 (q, J = 6 Hz, 1 H, C3:-H), 7.1-7.5 (m, 8 H, arom. H), 9.43 (s, 1 H, N1:-H).

¹³C-NMR (CDCl₃) δ (p.p.m) 16.8 (C3:-CH₃), 58.7 (C3:-CH₃), 122.6, 128.4, 129.0, 129.4, 130.4, 131.7, 137.5, 139.0, 164.5, 172.7.

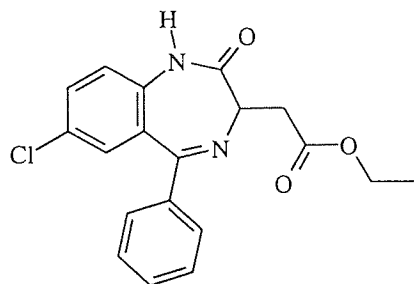
Asp-A: Ethyl 2-(7-chloro-2-oxo-5-phenyl-2,3-dihydro-1H-1,4-benzodiazepin-3-yl)acetate, 7-Chloro-3-ethyloxycarbonylmethyl-5-phenyl-1,3-dihydro-2H-1,4-benzodiazepin-2-one (40)

APCI + m/s: m/z = 357 (90%), 285 (10%).

TLC (Ether): R_f = 0.65.

IR (KBr disc) ν_{\max} = 3318, 3195, 3106, 2942, 1717 (C=O), 1610, 1481, 1347, 1170 cm⁻¹.

¹H-NMR (CDCl₃) δ (p.p.m) 1.29 (tr, J = 7.1 Hz, 3 H, OCH₂CH₃), 3.32 (q, J = 7 Hz, 2 H, OCH₂CH₃), 4.18 (m, 3 H, C3:-CH₂, C3:-H), 7.3-7.55 (m, 8 H, arom. H), 9.73 (s, 1 H, N1:-H).

¹³C-NMR (CDCl₃) δ (p.p.m) 14.2 (OCH₂CH₃), 36.5 (C3:-CH₂-CO₂Et), 58.2, 60.2 (C-3), 121.4, 128.6, 129.2, 129.9, 130.6, 130.8, 131.8, 137.3, 139.8, 168.5, 171.4, 172.3.

Gly-A: 7-Chloro-5-phenyl-1,3-dihydro-2H-1,4-benzodiazepin-2-one (41)

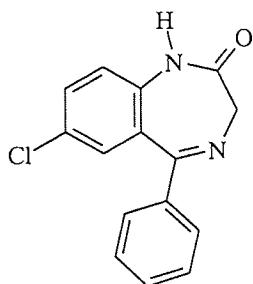

APCI + m/s: m/z = 271.

TLC (Ether): R_f = 0.4.

IR (KBr disc) ν_{\max} = 3207, 2960, 1679 (C=O), 1604, 1476, 1093, 794 cm⁻¹.

¹H-NMR (DMSO- δ_6) δ (p.p.m) 4.31 (s, 2 H, C3:-H₂), 7.1-7.65 (m, 8 H, arom. H), 9.65 (s, 1 H, N1:-H).

¹³C-NMR (DMSO- δ_6) δ (p.p.m) 56.2 (C-3), 121.9, 128.6, 129.5, 129.7, 130.8, 131.4, 137.3, 139.4, 164.8, 168.7.

Ile-A: 3-(*sec*-Butyl)-7-chloro-5-phenyl-1,3-dihydro-2H-1,4-benzodiazepin-2-one (42)

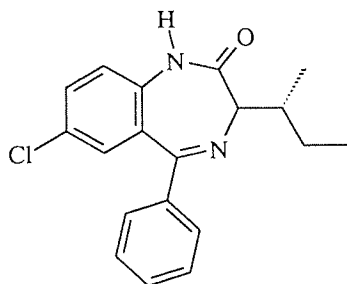

APCI + m/s: m/z = 327.

TLC (Ether): R_f = 0.66.

IR (KBr disc) ν_{\max} = 3185, 3108, 2957, 1675 (C=O), 1481, 1386, 1228, 836, 693 cm⁻¹.

¹H-NMR (CDCl₃) δ (p.p.m) Mixture of isomers 1.0 (m, 6 H, C3:-CH(CH₃)CH₂CH₃), 1.25 (m, 2 H, C3:-CH(CH₃)CH₂CH₃), 4.32 (d, J = 6 Hz, 1 H, C3:-H), 7.20-7.80 (m, 8 H, arom. H), 8.87 (s, 1 H, N1:-H).

¹³C-NMR (CDCl₃) δ (p.p.m) 11.9, 17.5, 24.5, 39.5, 61.4 (C-3), 122.9, 128.4, 129.0, 129.7, 130.0, 130.8, 132.8, 137.3, 164.9, 172.5.

Leu-A: 7-Chloro-3-isobutyl-5-phenyl-1,3-dihydro-2H-1,4-benzodiazepin-2-one (43)

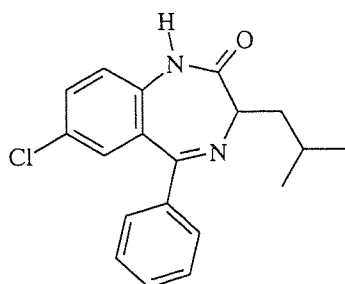

APCI + m/s: m/z = 327.

TLC (Ether): R_f = 0.72.

IR (KBr disc) ν_{\max} = 3179, 3098, 2948, 1706 (C=O), 1606, 1478, 1320, 1236, 1128, 821 cm⁻¹.

¹H-NMR (CDCl₃) δ (p.p.m) 0.87+1.05 (dd, J = 7 Hz, 6 H, C3:-CH₂CH(CH₃)₂), 1.34 (m, 1 H), 1.96 (m, 2 H, C3:-CH₂CH(CH₃)₂), 4.25 (tr, J = 6 Hz, 1 H, C3:-H), 7.3-7.6 (m, 8 H, arom. H), 9.65 (s, 1 H, N1:-H).

¹³C-NMR (CDCl₃) δ (p.p.m) 21.6 (C3:-CH₂CH(CH₃)₂), 24.8, 39.5 (C3:-CH₂CH(CH₃)₂), 61.9 (C-3), 121.9, 128.6, 129.0, 129.5, 130.5, 133.0, 137.3, 139.4, 168.0, 172.6.

Nle-A: 3-Butyl-7-chloro-5-phenyl-1,3-dihydro-2H-1,4-benzodiazepin-2-one (44)

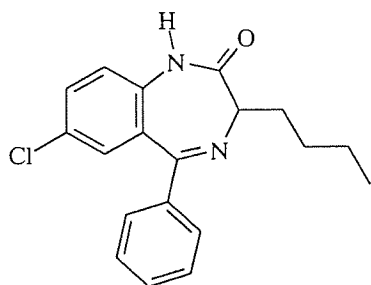

APCI + m/s: m/z = 327.

TLC (Ether): R_f = 0.8.

IR (KBr disc) ν_{\max} = 3214, 3125, 2952, 2871, 1681 (C=O), 1604, 1481, 1320, 1094, 833 cm⁻¹.

¹H-NMR (CDCl₃) δ (p.p.m) 0.98 (tr, 3H, J=7 Hz, CH₃), 1.25-1.7 (m, 4H, CH₂), 2.25 (m, 2H, C3:-CH₂), 4.05 (t, 1H, J = 4Hz, C3:-H), 7.2-7.55 (m, 8 arom. H), 10.1 (s, 1H, N1:-H).

¹³C-NMR (CDCl₃) δ (p.p.m) 14.0 (C3:-CH₂CH₂CH₃), 22.4, 28.1, 31.9, 63.8 (C-3), 121.4, 128.5, 129.2, 129.5, 129.7, 130.6, 131.4, 132.4, 137.3, 140.2, 164.8, 167.9, 172.8.

Nva-A: 7-Chloro-5-phenyl-3-propyl-1,3-dihydro-2H-1,4-benzodiazepin-2-one (45)

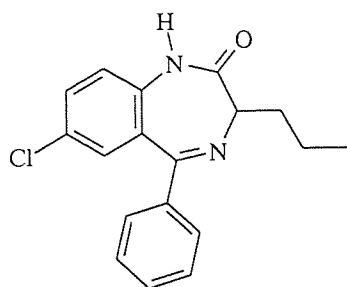

APCI + m/s: m/z = 313 (80%), 268 (15%), 264 (5%).

TLC (Ether): R_f = 0.72.

IR (KBr disc) ν_{\max} = 3218, 3123, 2962, 1687 (C=O), 1608, 1480, 1320, 1220, 826 cm^{-1} .

$^1\text{H-NMR}$ (CDCl_3) δ (p.p.m) 0.99 (t; 3H, J = 7 Hz, C3:-(CH_2) $_2$ $\underline{\text{C}}\text{H}_3$), 1.3-1.5 (m, 2H, C3:- CH_2 $\underline{\text{C}}\text{H}_2$ CH_3), 2.23 (m, 2H, C3:- $\underline{\text{C}}\text{H}_2$ CH_2 CH_3), 4.08 (tr, 1H, J = 5Hz, C3:- $\underline{\text{H}}$), 7.15-7.7 (m, 8 arom. H), 10.3 (s, 1H, N1:-H).

$^{13}\text{C-NMR}$ (CDCl_3) δ (p.p.m) 14.5 (C3:-(CH_2) $_2$ $\underline{\text{C}}\text{H}_3$), 19.3 (C3:- CH_2 $\underline{\text{C}}\text{H}_2$ CH_3), 33.1 (C3:- $\underline{\text{C}}\text{H}_2$ CH_2 CH_3), 63.2 (C3:-(CH_2) $_2$ $\underline{\text{C}}\text{H}_3$), 122.8, 124.9, 129.1, 130.2, 130.8, 131.6, 135.7, 137.4, 168.0, 172.5.

Met-A: 7-Chloro-3-(2-methylsulfanylethyl)-5-phenyl-1,3-dihydro-2H-1,4-benzodiazepin-2-one (46)

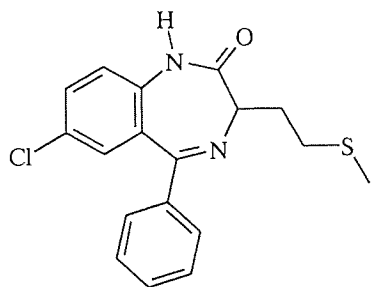

APCI + m/s: m/z = 345 (90%), 240 (10%).

TLC (Ether): R_f = 0.85.

IR (KBr disc) ν_{\max} = 3435, 3199, 2923, 1688 (C=O), 1608, 1476, 1382, 1320, 831, 693 cm^{-1} .

$^1\text{H-NMR}$ (CDCl_3) δ (p.p.m) 1.7 (br s, 3 H, C3:-(CH_2) $_2$ $\underline{\text{S}}\text{CH}_3$), 2.3-3.1 (m, 4 H), 4.08 (tr, J = 5 Hz, 1 H, C3:- $\underline{\text{H}}$), 7.3-7.8 (m, 8 H, arom. H), 8.76 (s, 1 H, N1:- $\underline{\text{H}}$).

$^{13}\text{C-NMR}$ (CDCl_3) δ (p.p.m) 16.9 (C3:-(CH_2) $_2$ $\underline{\text{S}}\text{CH}_3$), 26.6, 31.8, 62.9 (C-3), 121.9, 125.6, 129.7, 130.6, 131.2, 131.9, 137.3, 140.2, 165.2, 171.8.

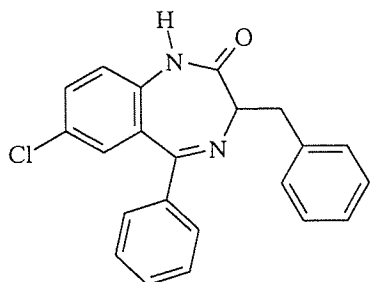
Phe-A: 3-Benzyl-7-chloro-5-phenyl-1,3-dihydro-2H-1,4-benzodiazepin-2-one (47)

APCI + m/s: m/z = 361.

TLC (Ether): R_f = 0.72.IR (KBr disc) ν_{\max} = 3205, 3058, 2933, 1706 (C=O), 1476, 1320, 1234, 1091, 736, 699 cm⁻¹.

¹H-NMR (CDCl₃) δ (p.p.m) 3.67 (d, J = 6.9 Hz, 2 H, C3:-CH₂-Ph), 4.12 (tr, J = 7 Hz, 1 H, C3:-H), 7.10-7.45 (m, 13 H, arom. H), 9.45 (s, 1 H, N1:-H).

¹³C-NMR (CDCl₃) δ (p.p.m) 37.6 (C3:-CH₂-Ph), 64.9 (C-3), 122.5, 126.2, 128.3, 128.6, 129.2, 129.6, 130.4, 131.8, 136.9, 138.7, 169.3, 171.9.

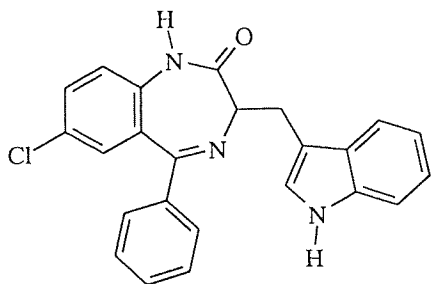
Trp-A: 7-Chloro-3-(1H-indol-3-ylmethyl)-5-phenyl-1,3-dihydro-2H-1,4-benzodiazepin-2-one (48)

APCI + m/s: m/z = 400 (90%), 271 (10%).

TLC (Ether): R_f = 0.28.IR (KBr disc) ν_{\max} = 3411, 3220, 2921, 1677 (C=O), 1600, 1481, 1322, 1226, 1095, 829 cm⁻¹.

¹H-NMR (CDCl₃) δ (p.p.m) 3.68 (tr, J = 9 Hz, 1 H, C3:-H), 3.82 (m, 2 H, C3:-CH₂-indole), 7.0-7.7 (m, 13 H, arom. H), 8.05 (br s, 1 H, indole NH), 8.68 (br s, 1 H, N1:-H).

¹³C-NMR (CDCl₃) δ (p.p.m) 26.9 (C3:-CH₂-indole), 64.2 (C-3), 111.0, 118.9, 119.1, 120.6, 121.9, 128.6, 129.0, 129.5, 129.7, 130.8, 131.6, 136.5, 137.3, 139.4, 168.0, 171.8.

Tyr-A: 7-Chloro-3-(4-hydroxybenzyl)-5-phenyl-1,3-dihydro-2H-1,4-benzodiazepin-2-one (49)

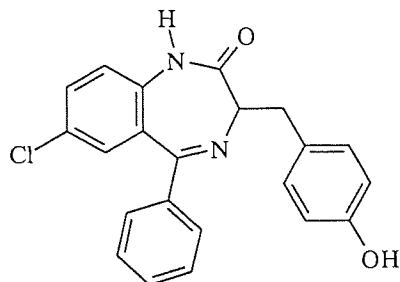

APCI + m/s: $m/z = 377$.

TLC (Ether): $R_f = 0.65$.

IR (KBr disc) $\nu_{\max} = 3445$ (OH), 2915, 2873, 1721 (C=O), 1587, 1490, 1353, 1272, 975 cm^{-1} .

$^1\text{H-NMR}$ (CDCl_3) δ (p.p.m) 3.68 (m, 2 H, C3:- CH_2 -p-hydroxyphenyl), 4.08 (m, 1 H, C3:- H), 7.3-7.65 (m, 12 H, arom. H), 8.32 (s, 1 H, N1:- H).

$^{13}\text{C-NMR}$ (CDCl_3) δ (p.p.m) 37.3 (C3:- CH_2 -p-hydroxyphenyl), 64.9 (C-3), 122.3, 126.1, 128.6, 129.5, 129.7, 130.8, 131.4, 137.3, 139.4, 169.4, 171.9.

Val-A: 7-Chloro-3-isopropyl-5-phenyl-1,3-dihydro-2H-1,4-benzodiazepin-2-one (50)

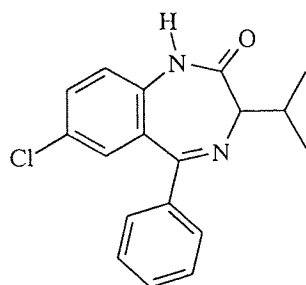

APCI + m/s: $m/z = 313$.

TLC (Ether): $R_f = 0.67$.

IR (KBr disc) $\nu_{\max} = 3114, 3060, 2973, 2929, 1695$ (C=O), 1602, 1482, 1328, 1233, 823 cm^{-1} .

$^1\text{H-NMR}$ (CDCl_3) δ (p.p.m) 1.08+1.21 (dd, $J=7$ Hz, 6 H, C3:- $\text{CH}(\text{CH}_3)_2$), 3.75 (m, 1 H, C3:- $\text{CH}(\text{CH}_3)_2$), 4.12 (d, $J = 6$ Hz, 1 H, C3:- H), 7.3 - 7.6 (m, 8 H, arom. H), 9.0 (s, 1 H, N1:- H).

$^{13}\text{C-NMR}$ (CDCl_3) δ (p.p.m) 18.5 (C3:- $\text{CH}(\text{CH}_3)_2$), 28.9 (C3:- $\text{CH}(\text{CH}_3)_2$), 69.3 (C-3), 122.6, 128.6, 129.2, 130.4, 131.0, 131.8, 136.8, 138.6, 165.3, 170.8.

Entry 51 - 62 (Leucine and all ketones):

Leu-A: 7-Chloro-3-isobutyl-5-phenyl-1,3-dihydro-2H-1,4-benzodiazepin-2-one (51)

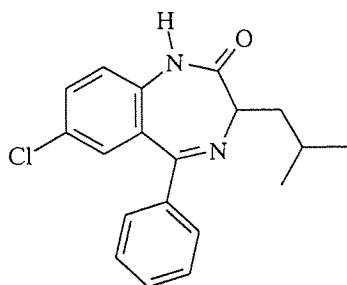

APCI + m/s: m/z = 327.

TLC (Ether): R_f = 0.72.IR (KBr disc) ν_{\max} = 3204, 3083, 2954, 1691 (C=O), 1606, 1484, 1382, 1236, 821, 695 cm⁻¹.

¹H-NMR (CDCl₃) δ (p.p.m) 0.87+1.05 (dd, J = 7 Hz, 6 H, C3:-CH₂CH(CH₃)₂), 1.34 (m, 1 H), 1.96 (m, 2 H, C3:-CH₂CH(CH₃)₂), 4.11 (t, J = 6 Hz, 1 H, C3:-H), 7.3-7.6 (m, 8 H, arom. H), 9.65 (s, 1 H, N1:-H).

¹³C-NMR (CDCl₃) δ (p.p.m) 21.6 (C3:-CH₂CH(CH₃)₂), 24.8, 39.5 (C3:-CH₂CH(CH₃)₂), 61.9 (C-3), 121.9, 128.6, 129.0, 129.5, 130.5, 133.0, 137.3, 139.4, 168.0, 172.6.

Leu-B: 3-Isobutyl-5-phenyl-1,3-dihydro-2H-1,4-benzodiazepin-2-one (52)

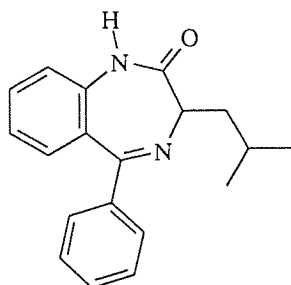

APCI + m/s: m/z = 293.

TLC (Ether): R_f = 0.64.IR (KBr disc) ν_{\max} = 3436, 3193, 3056, 2962, 1681 (C=O), 1324, 1482, 1324, 1231, 763 cm⁻¹.

¹H-NMR (CDCl₃) δ (p.p.m) 0.88+1.05 (dd, J = 7 Hz, 6 H, C3:-CH₂CH(CH₃)₂), 1.35 (m, 1 H, C3:-CH₂CH(CH₃)₂), 2.05 (m, 2 H, C3:-CH₂CH(CH₃)₂), 4.06 (t, J = 6 Hz, 1 H, C3:-H), 7.15-7.55 (m, 9 H, arom. H), 9.22 (s, 1H, N1:-H).

¹³C-NMR (CDCl₃) δ (p.p.m) 23.2 (C3:-CH₂CH(CH₃)₂), 24.5, 39.5 (C3:-CH₂CH(CH₃)₂), 61.3 (C-3), 122.5, 126.9, 129.0, 129.7, 130.6, 131.4, 136.1, 138.7, 158.3, 167.9, 170.2.

Leu-C: 7-Chloro-5-(2-chlorophenyl)-3-isobutyl-1,3-dihydro-2H-1,4-benzodiazepin-2-one (53)

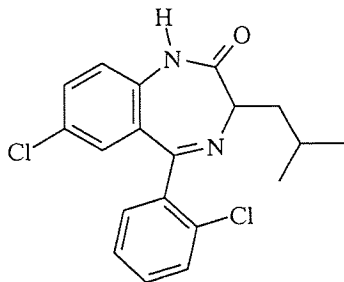

APCI + m/s: m/z = 361 (95%), 266 (5%).

TLC (Ether): R_f = 0.77.

IR (KBr disc) ν_{\max} = 3098, 2950, 1691 (C=O), 1606, 1484, 1324, 1251, 938, 825 cm⁻¹.

¹H-NMR (CDCl₃) δ (p.p.m) 0.86+1.02 (dd, J = 7 Hz, 6 H, C3:-CH₂CH(CH₃)₂), 1.3 (m, 1 H, C3:-CH₂CH(CH₃)₂), 1.92 (m, 2 H, C3:-CH₂CH(CH₃)₂), 4.13 (tr, J = 7 Hz, 1 H, C3:-H), 7.1-7.7 (m, 7 H, arom. H), 8.98 (s, 1H, N1:-H).

¹³C-NMR (CDCl₃) δ (p.p.m) 21.2 (C3:-CH₂CH(CH₃)₂), 23.2, 41.9 (C3:-CH₂CH(CH₃)₂), 63.1 (C-3), 122.7, 124.3, 128.6, 129.5, 130.4, 131.6, 132.0, 136.1, 164.7, 171.7.

Leu-D: 7-Chloro-5-(2-fluorophenyl)-3-isobutyl-1,3-dihydro-2H-1,4-benzodiazepin-2-one (54)

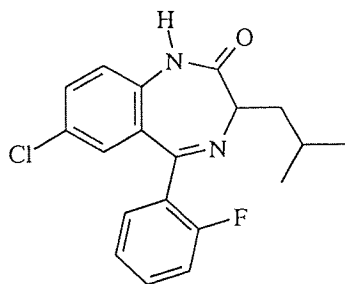

APCI + m/s: m/z = 345.

TLC (Ether): R_f = 0.77.

IR (KBr disc) ν_{\max} = 3442, 3204, 3079, 2958, 1693 (C=O), 1610, 1484, 1261, 1100 cm⁻¹.

¹H-NMR (CDCl₃) δ (p.p.m) 0.85+1.03 (dd, J=7 Hz, 6 H, C3:-CH₂CH(CH₃)₂), 1.35 (m, 1 H), 1.95 (m, 2 H, C3:-CH₂CH(CH₃)₂), 4.02 (t, J=7 Hz, 1 H, C3:-H), 7.0 (m, 1H, arom. H), 7.2 (m, 2H, arom. H), 7.4-7.55 (m, 4 H, arom. H), 8.69 (s, 1H, N1:-H).

¹³C-NMR (CDCl₃) δ (p.p.m) 19.8 (C3:-CH₂CH(CH₃)₂), 23.5, 38.1 (C3:-CH₂CH(CH₃)₂), 63.1 (C-3), 115.6, 121.9, 124.1, 124.8, 129.1, 129.7, 130.6, 132.4, 162.6, 165.8, 172.3.

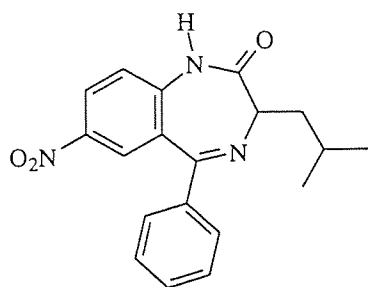
Leu-E: 3-Isobutyl-7-nitro-5-phenyl-1,3-dihydro-2H-1,4-benzodiazepin-2-one (55)

APCI + m/s: m/z = 338 (80%), 295 (10%), 243 (10%).

TLC (Ether): R_f = 0.48.

IR (KBr disc) ν_{\max} = 3444, 3212, 3081, 2952, 1688 (C=O), 1607, 1528, 1484, 1337, 997 cm⁻¹.

¹H-NMR (CDCl₃) δ (p.p.m) 0.88+1.03 (dd, J = 7 Hz, 6 H, C3:-CH₂CH(CH₃)₂), 1.25 (m, 1H), 2.25 (br m, 2H, C3:-CH₂CH(CH₃)₂), 4.05 (tr, J = 7 Hz, 1 H, C3:-H), 7.35-7.55 (m, 6 H, arom. H), 8.25 (d, 1H), 8.40 (q, 1H), 8.78 (s, 1H, N1:-H).

¹³C-NMR (CDCl₃) δ (p.p.m) 19.8 (C3:-CH₂CH(CH₃)₂), 29.6, 41.2 (C3:-CH₂CH(CH₃)₂), 61.9 (C-3), 116.7, 129.2, 129.7, 131.0, 131.5, 137.8, 138.4, 141.4, 155.3, 165.8, 171.4.

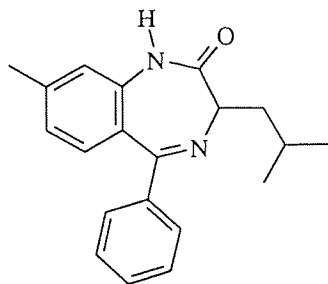
Leu-F: 3-Isobutyl-8-methyl-5-phenyl-1,3-dihydro-2H-1,4-benzodiazepin-2-one (56)

APCI + m/s: m/z = 307.

TLC (Ether): R_f = 0.75.

IR (KBr disc) ν_{\max} = 3224, 2952, 2871, 1706 (C=O), 1613, 1590, 1473, 1320, 1212, 750 cm⁻¹.

¹H-NMR (CDCl₃) δ (p.p.m) 0.85-1.05 (dd, J = 7 Hz, 6 H, C3:-CH₂CH(CH₃)₂), 1.32 (m, 1 H), 2.0 (br m, 2H, C3:-CH₂CH(CH₃)₂), 2.41 (s, 3H, aryl-CH₃), 4.03 (tr, J = 7 Hz, 1 H, C3:-H), 6.94 (d, 1H, arom. H), 7.35-7.55 (m, 7 H, arom. H), 9.35 (s, 1H, N1:-H).

¹³C-NMR (CDCl₃) δ (p.p.m) 21.5, 23.7, 24.6, 39.6 (C3:-CH₂CH(CH₃)₂), 61.3 (C-3), 121.9, 128.6, 129.5, 129.9, 130.6, 131.4, 137.3, 139.4, 141.2, 165.0, 171.5.

Leu-G: 5-(2-ethyloxycarbonylphenyl)-3-isobutyl-1,3-dihydro-2H-1,4-benzodiazepin-2-one; Ethyl 2-(3-isobutyl-2-oxo-2,3-dihydro-1H-1,4-benzodiazepin-5-yl)benzoate (57)

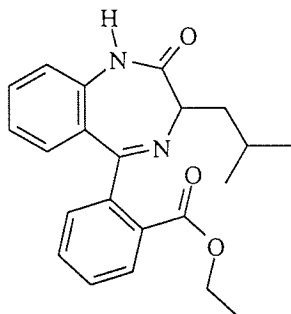

APCI + m/s: m/z = 365 (80%), 276 (20%).

TLC (Ether): R_f = 0.36.

IR (KBr disc) ν_{\max} = 3297, 3179, 3041, 2955, 1725 (C=O), 1658, 1585, 1484, 1233, 761 cm⁻¹.

¹H-NMR (CDCl₃) δ (p.p.m) 0.9-1.05 (dd, J = 7 Hz, 6 H, C3:-CH₂CH(CH₃)₂), 1.4 (tr, 3H, J = 7 Hz, OCH₂CH₃), 1.7 -2.0 (br m, 2H, C3:-CH₂CH(CH₃)₂), 4.3-4.5 (m, 3H, C3:-H + OCH₂CH₃), 7.1-8.1 (br m, 6H, arom. H), 8.4 (m, 1H, arom. H), 8.9 (m, 1H, arom. H), 9.6 (s, 1H, N1:-H).

¹³C-NMR (CDCl₃) δ (p.p.m) 14.3, 20.2, 24.0, 39.0 (C3:-CH₂CH(CH₃)₂), 63.6 (C-3), 120.1, 121.5, 124.5, 128.4, 128.9, 129.5, 130.4, 131.6, 133.8, 164.5, 167.1, 167.8.

Leu-H: 2-Isobutyl-2,4-dihydro-3H-fluoreno[1,9-ef][1,4]diazepin-3-one (58)

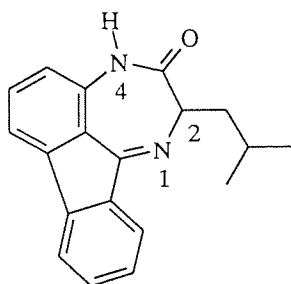

APCI + m/s: m/z = 291.

TLC (Ether): R_f = 0.83.

IR (KBr disc) ν_{\max} = 3436, 3204, 3096, 2955, 1666 (C=O), 1594, 1467, 1380, 786, 751 cm⁻¹.

¹H-NMR (CDCl₃) δ (p.p.m) 0.96 (q, J=6 Hz, 6H, C2:-CH₂CH(CH₃)₂), 1.35 (m, 1 H), 1.90 (m, 2 H, C2:-CH₂CH(CH₃)₂), 4.35 (tr, J=7 Hz, 1 H, C2:-H), 6.82 (d, J = 8 Hz, 1H, arom. H), 7.3-7.5 (m, 4 H, arom. H), 7.6 (m, 1H, arom. H), 7.85 (m, 1H, arom. H), 9.0 (s, 1H, N4:-H).

¹³C-NMR (CDCl₃) δ (p.p.m) 20.9 (C2:-CH₂CH(CH₃)₂), 23.5, 33.8, 41.8, 62.9 (C-2), 110.8, 113.5, 121.6, 124.9, 126.1, 127.8, 142.1, 142.6, 167.2.

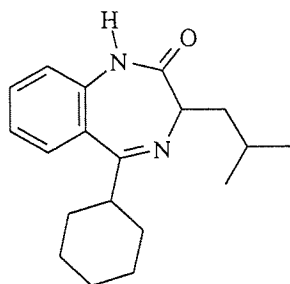
Leu-I: 5-Cyclohexyl-3-isobutyl-1,3-dihydro-2H-1,4-benzodiazepin-2-one (59)

APCI + m/s: m/z = 299.

TLC (Ether): R_f = 0.81.IR (KBr disc) ν_{\max} = 3291, 3062, 2925, 2854, 1659 (C=O),
1575, 1490, 1160, 748 cm^{-1} .

$^1\text{H-NMR}$ (CDCl_3) δ (p.p.m) 1.0 (d, $J=7$ Hz, 6 H, C3:- $\text{CH}_2\text{CH}(\text{CH}_3)_2$), 1.15-2.2 (br m, 13H, C3:- $\text{CH}_2\text{CH}(\text{CH}_3)_2$ & cyclohexyl H), 3.05 (d, 1H), 4.05 (m, 1H, C3:- H), 7.0-7.3 (m, 2 H, arom. H), 7.5 (m, 1H, arom. H), 7.8 (m, 1H, arom. H), 8.75 (s, 1H, N1:- H).

$^{13}\text{C-NMR}$ (CDCl_3) δ (p.p.m) 22.8, 26.1, 30.8, 32.1, 41.5 (C3:- $\text{CH}_2\text{CH}(\text{CH}_3)_2$), 61.3 (C-3), 116.2, 120.5, 124.3, 126.5, 132.9, 148.2, 164.5, 173.2.

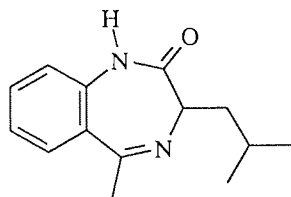
Leu-J: 3-Isobutyl-5-methyl-1,3-dihydro-2H-1,4-benzodiazepin-2-one (60)

APCI + m/s: m/z = 231.

TLC (Ether): R_f = 0.24.IR (KBr disc) ν_{\max} = 3079, 2958, 2358, 1694 (C=O), 1627, 1386,
1312, 1150, 757 cm^{-1} .

$^1\text{H-NMR}$ (CDCl_3) δ (p.p.m) 0.78+0.92 (dd, $J = 7$ Hz, 6 H, C3:- $\text{CH}_2\text{CH}(\text{CH}_3)_2$), 1.5 (m, 1H), 2.0 (m, 2H, C3:- $\text{CH}_2\text{CH}(\text{CH}_3)_2$), 2.55 (s, 3 H, C5:- CH_3), 3.99 (tr, $J = 7$ Hz, 1 H, C3:- H), 7.10-7.65 (m, 4 H, arom. H), 9.76 (s, 1H, N1:- H).

$^{13}\text{C-NMR}$ (CDCl_3) δ (p.p.m) 21.8, 23.2, 25.8, 39.5 (C3:- $\text{CH}_2\text{CH}(\text{CH}_3)_2$), 60.4 (C-3), 121.1, 123.8, 128.9, 131.2, 136.5, 167.9, 172.1.

Leu-K: 3-Isobutyl-7,8-dimethoxy-5-methyl-1,3-dihydro-2H-1,4-benzodiazepin-2-one
(61)

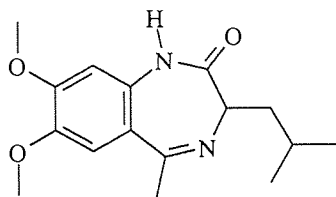

APCI + m/s: m/z = 291.

TLC (Ether): R_f = 0.31.

IR (KBr disc) ν_{\max} = 3488, 2958, 1675 (C=O), 1509, 1380, 1265, 1172, 860, 784 cm^{-1} .

$^1\text{H-NMR}$ (CDCl_3) δ (p.p.m) 0.80-0.93 (dd, $J = 7\text{Hz}$, 6H, C3:- $\text{CH}_2\text{CH}(\text{CH}_3)_2$), 1.85-2.2 (br m, 3 H), 2.45 (s, 3H, C5:- CH_3), 3.88 (s, 6 H, OCH_3), 4.13 (tr, $J = 7\text{ Hz}$, 1 H, C3:- H), 6.56+6.94 (two s, 2H, arom. H), 9.14 (s, 1H, N1:- H).

$^{13}\text{C-NMR}$ (CDCl_3) δ (p.p.m) 23.1 (C3:- $\text{CH}_2\text{CH}(\text{CH}_3)_2$), 27.8, 38.8 (C3:- $\text{CH}_2\text{CH}(\text{CH}_3)_2$), 56.1 (OCH_3), 61.1 (C-3), 102.3, 122.8, 135.6, 141.2, 151.5, 164.2, 167.1.

Leu-L: 7-Isobutyl-9-methyl-5,7-dihydro-6H-[1,3]dioxolo[4,5-h] [1,4]benzodiazepin-6-one
(62)

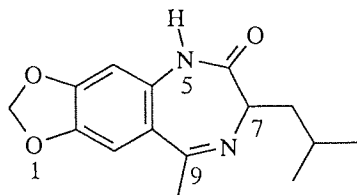

APCI + m/s: m/z = 275.

TLC (Ether): R_f = 0.32.

IR (KBr disc) ν_{\max} = 3445, 3198, 3104, 2959, 1671 (C=O), 1631, 1482, 1245, 1037, 929 cm^{-1} .

$^1\text{H-NMR}$ (CDCl_3) δ (p.p.m) 0.80+0.94 (dd, $J=7\text{Hz}$, 6 H, C7:- $\text{CH}_2\text{CH}(\text{CH}_3)_2$), 1.3 (m, 1H), 1.8-2.2 (br m, 2H, C7:- $\text{CH}_2\text{CH}(\text{CH}_3)_2$), 2.4 (s, 3 H, C9:- CH_3), 4.08 (t, $J = 7\text{ Hz}$, 1H, C7:- H), 6.05 (s, 2 H, $-\text{OCH}_2\text{O}-$), 6.95+7.25 (ds, 2H, arom. H), 8.8 (s, 1H, N5:- H).

$^{13}\text{C-NMR}$ (CDCl_3) δ (p.p.m) 23.2, 24.3, 25.8, 39.4 (C7:- $\text{CH}_2\text{CH}(\text{CH}_3)_2$), 60.5 (C-7), 102.2 ($-\text{OCH}_2\text{O}-$), 122.7, 132.1, 144.3, 149.9, 166.2, 171.3.

General experimental for the formation of the Asperlicin substructures: (Entry 63, 77, 79, 81)

A mixture of tryptophan ethyl ester HCl (50 mmol) and 25 mmol of the ketone building blocks **A**, **B**, **C**, **D** was refluxed for 2 days in 75 ml of pyridine and 2g of DMAP as catalyst. After completion, the reaction mixtures were concentrated in vacuo to a small volume and filtered in order to remove unreacted tryptophan ethyl ester HCl. 10 g of Silica gel was added to the organic phase and the paste was heated until a powder was obtained. The unreacted ketone building blocks were washed out with petroleum ether, followed by extraction of the desired benzodiazepine templates with ether. After the removal of the solvent the target molecules were recrystallised with ethanol or were further purified by flash chromatography with ether as eluent.

Experimental for the formation of chiral Asperlicin substructures (Entry 64 R, 65 S, 82 R, 83 S)

According to the previous described procedure, 5 mmol of the ketones **A** and **D** were reacted with 10 mmol of tryptophan ethyl ester HCl in 15 ml of pyridine for 8–10 hours.

7-Chloro-3-(1*H*-indol-3-ylmethyl)-5-phenyl-1,3-dihydro-2*H*-1,4-benzodiazepin-2-one (63)

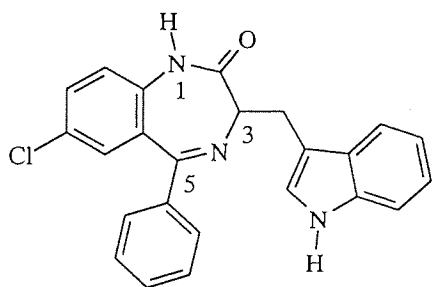

APCI + m/s: m/z = 400.

mp: 148-150°C.

TLC (Ether): R_f = 0.30.

IR (KBr disc) ν_{\max} = 3411, 3220, 2921, 1677 (C=O),
1600, 1481, 1322, 1226, 1095, 829 cm⁻¹.

¹H-NMR (CDCl₃) δ (p.p.m) 3.65 (m, 2 H, C3:-CH₂-indole), 4.09 (tr, J=9 Hz, 1 H, C3:-H), 7.0-7.7 (m, 13 H, arom. H), 8.05 (br s, 1 H, indole NH), 8.68 (br s, 1 H, N1:-H).

¹H-NMR (CDCl₃, 15 mol% Europium shift reagent) δ (p.p.m) 1.0-1.9 (Europium shift reagent), 3.55-3.84 (br m, 2 H, C3:-CH₂-indole), 4.29+4.62 (two s, 1H, C3:-H), 6.8-8.0 (br m, 8 arom. H), 10.8 (s, 1H, N1:-H).

^{13}C -NMR (CDCl_3) δ (p.p.m) 26.9 ($\text{C3}:-\underline{\text{C}}\text{H}_2\text{-indole}$), 64.2 ($\underline{\text{C}}\text{-3}$), 111.0, 118.9, 119.1, 120.6, 121.9, 128.6, 129.0, 129.5, 129.7, 130.8, 131.6, 136.5, 137.3, 139.4, 168.0, 171.8.

(3R)-7-Chloro-3-(1H-indol-3-ylmethyl)-5-phenyl-1,3-dihydro-2H-1,4-benzodiazepin-2-one (64 R)

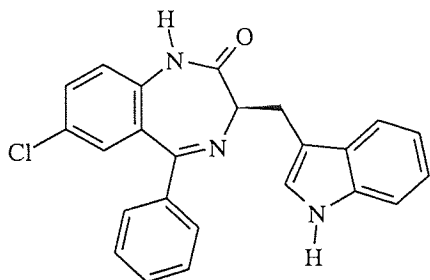

$[\alpha]_{546}^{25} : -45.2^\circ$ ($c = 1$, ethanol)

^1H -NMR (CDCl_3 , 15 mol% Europium shift reagent)

δ (p.p.m) 1.0-1.9 (Europium shift reagent), 3.49-3.80 (br m, 2 H, $\text{C3}:-\underline{\text{C}}\text{H}_2\text{-indole}$), 4.58 (s, 1H, $\text{C3}:-\underline{\text{H}}$), 6.9-8.0 (br m, 8 arom. H), 10.9 (s, 1H, $\text{N1}:-\text{H}$).

(3S)-7-Chloro-3-(1H-indol-3-ylmethyl)-5-phenyl-1,3-dihydro-2H-1,4-benzodiazepin-2-one (65 S)

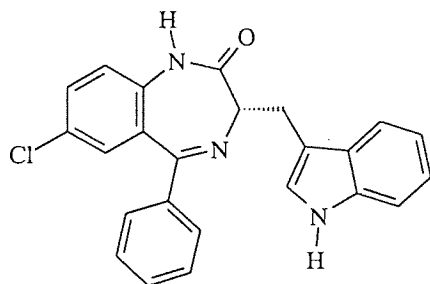

$[\alpha]_{546}^{25} : +43.1^\circ$ ($c = 1$, ethanol)

^1H -NMR (CDCl_3 , 15 mol% Europium shift reagent)

δ (p.p.m) 1.0-1.9 (Europium shift reagent), 3.49-3.86 (br m, 2 H, $\text{C3}:-\underline{\text{C}}\text{H}_2\text{-indole}$), 4.29 (s, 1H, $\text{C3}:-\underline{\text{H}}$), 6.9-8.1 (br m, 8 arom. H), 11.4 (s, 1H, $\text{N1}:-\text{H}$).

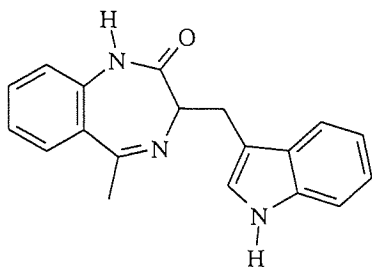
3-(1*H*-Indol-3-ylmethyl)-5-methyl-1,3-dihydro-2*H*-1,4-benzodiazepin-2-one (77)

APCI + m/s: m/z = 304.

TLC (Ether): R_f = 0.20.IR (KBr) ν_{max} = 3209, 2918, 1648 (C=O), 1513, 1423, 1328, 1108, 869, 754 cm⁻¹.

¹H-NMR (CDCl₃) δ (p.p.m) 2.4 (s, 3H, C5:-CH₃), 3.78 (m, 2H, C3:-CH₂-indole), 4.23 (s, 1 H, C3:-H), 7.0-7.7 (m, 9 arom. H), 8.85 (s, 1H, N1:-H).

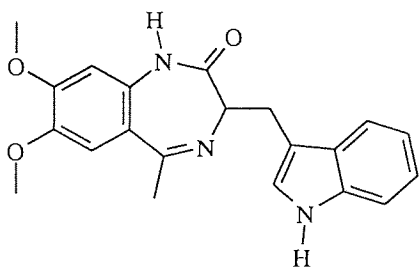
3-(1*H*-Indol-3-ylmethyl)-7,8-dimethoxy-5-methyl-1,3-dihydro-2*H*-1,4-benzodiazepin-2-one (79)

APCI + m/s: m/z = 364 (70%), 350 (20%), 336 (10%).

TLC (Ether): R_f = 0.24.IR (KBr) ν_{max} = 3345, 2921, 1669 (C=O), 1513, 1459, 1382, 1262, 1097, 869, 746 cm⁻¹.

¹H-NMR (CDCl₃) δ (p.p.m) 2.45 (s, 3H, C5:-CH₃), 3.72 (m, 2H, C3:-CH₂-indole), 3.91 (s, 6H, O-CH₃), 4.28 (m, 1 H, C3:-H), 6.90-7.8 (m, 7 arom. H), 8.7 (s, 1H, N1:-H).

¹³C-NMR (CDCl₃) δ (p.p.m) 27.8, 29.3, 55.5 (O-CH₃), 61.2 (C-3), 107.0, 107.8, 110.8, 113.2, 118.7, 120.8, 121.1, 121.5, 127.2, 136.5, 148.6, 168.3, 169.3.

7-(1*H*-Indol-3-ylmethyl)-9-methyl-5,7-dihydro-6*H*-[1,3]dioxolo[4,5-*h*]
[1,4]benzodiazepin-6-one (81)

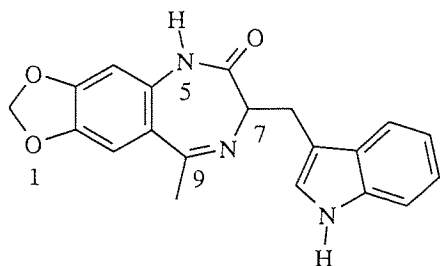

APCI + m/s: m/z = 348.

TLC (Ether): R_f = 0.25.

IR (KBr) ν_{\max} = 3413, 2923, 2853, 1683 (C=O), 1625, 1508, 1480, 1388, 1247, 1039, 746 cm⁻¹.

¹H-NMR (CDCl₃) δ (p.p.m) 2.34 (s, 3H, C9:-CH₃), 3.69 (m, 2H, C7:-CH₂-indole), 4.08 (m, 1H, C7:-H), 6.0 (s, 2H, -O-CH₂-O-), 6.90-7.8 (m, 7 arom. H), 8.1 (s, 1H, N5:-H).

¹H-NMR (CDCl₃, 15 mol% Europium shift reagent) δ (p.p.m) 1.0-3.1 (br m, Europium shift reagent), 3.75-4.0 (br m, 2H, C7:-CH₂-indole), 4.25+4.67 (two s, 1H, C7:-H), 6.2-6.35 (m, 2H, -O-CH₂-O-), 7.1-8.2 (br m, 7 arom. H), 11.4 (s, 1H, N1:-H).

¹³C-NMR (CDCl₃) δ (p.p.m) 26.1 28.6, 62.1 (C-7), 102.3 (O-CH₂-O), 106.5, 110.9, 118.7, 119.1, 121.6, 135.9, 143.8, 166.6, 168.2.

(3*R*)-7-(1*H*-Indol-3-ylmethyl)-9-methyl-5,7-dihydro-6*H*-[1,3]dioxolo[4,5-*h*]
[1,4]benzodiazepin-6-one (82 R)

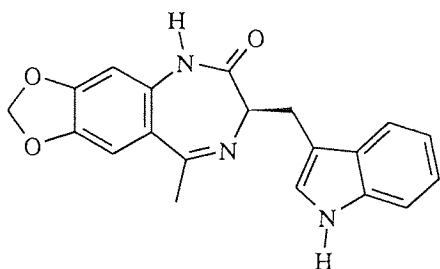

¹H-NMR (CDCl₃, 15 mol% Europium shift reagent) δ (p.p.m) 1.1-2.95 (br m, Europium shift reagent), 3.68-4.05 (br m, 2H, C7:-CH₂-indole), 4.63 (s, 1H, C7:-H), 6.3-6.4 (m, 2H, -O-CH₂-O-), 7.1-8.05 (br m, 7 arom. H), 11.0 (s, 1H, N1:-H).

(3*S*)-7-(1*H*-Indol-3-ylmethyl)-9-methyl-5,7-dihydro-6*H*-[1,3]dioxolo[4,5-*h*]
[1,4]benzodiazepin-6-one (83 *S*)

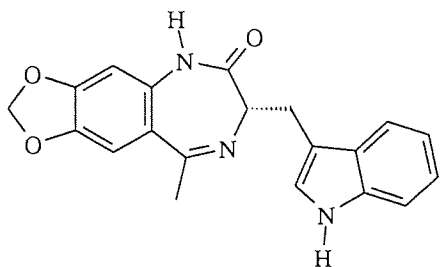

¹H-NMR (CDCl₃, 15 mol% Europium shift reagent)
 δ (p.p.m) 1.05-3.1 (br m, Europium shift reagent),
 3.75-4.05 (br m, 2H, C7:-CH₂-indole), 4.39 (s, 1H,
 C7:-H), 6.25-6.3 (m, 2H,-O-CH₂-O-), 7.1-8.0
 (br m, 7 arom. H), 10.8 (s, 1H, N1:-H).

General experimental for the mono-alkylation of the 3-indolylmethyl-benzodiazepine templates

A 50 % suspension of NaH in mineral oil (1.2 mmol) was added portionwise to a solution of the of the NH parent templates **63**, **77**, **79** and **81** (1 mmol) in 10 ml of dry DMF. After stirring for 15-30 min at room temperature the mixture was cooled with ice and the alkylating agent (1.2 mmol) was added dropwise to the mixture. The alkylation was completed after 0.5 hours at 0-5°C for methyl bromide (**Entry 66**) whilst the alkylations with other electrophiles were completed after 1-2 hours at ambient temperature. The progresses of these reactions were controlled by TLC. For work up, dilute HCl (2%) was added and the suspension (pH 6) was extracted with EtOAc. The extract was washed with brine, dried (Na₂SO₄), concentrated under reduced pressure giving a mixture of mono- and dialkylated Asperlicin analogues and separated by flash chromatography or preparative TLC with ether/petrol ether (1:2) as eluent.

7-Chloro-3-(1*H*-indol-3-ylmethyl)-1-methyl-5-phenyl-1,3-dihydro-2*H*-1,4-benzodiazepin-2-one (66)

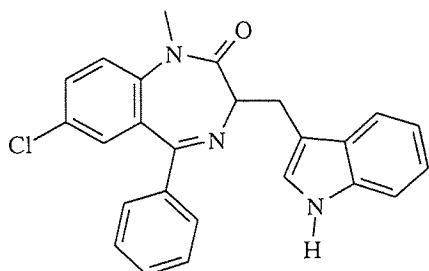

1 mmol (0.4 g) of the NH parent compound **63** was methylated on the amide nitrogen in DMF (10 ml) using a 50 % suspension of NaH in mineral oil (1.2 mmol) and methyl bromide (0.17 g \approx 75 μ l, 1.2 mmol) at 0-5°C. The reaction was completed at this temperature after 30 min. The mixture was quenched

with 2% HCl (pH 6) and extracted with EtOAc. The organic phase was washed with brine, dried (Na₂SO₄), concentrated in vacuo, and further purified by column chromatography with ether/petrol ether (1:2) to give 199 mg (48% yield) of the title compound.

APCI + m/s: m/z = 414 (80%), 400 (20%).

TLC (Ether): R_f = 0.38.

IR (KBr disc) ν_{\max} = 3399, 3208, 2901, 1684 (C=O), 1589, 1479, 1337, 1248, 1105 cm⁻¹.

¹H-NMR (CDCl₃) δ (p.p.m) 3.18 (s, 3H, N1:-CH₃), 3.79 (d, J = 8 Hz, 2 H, C3:-CH₂-indole), 4.1 (t, J = 9 Hz, 1 H, C3:-H), 7.0-7.7 (m, 13 H, arom. H), 8.05 (br s, 1 H, indole NH).

¹³C-NMR (CDCl₃) δ (p.p.m) 30.8 (C3:-CH₂-indole), 36.8 (N1:-CH₃), 61.0 (C-3), 111.0, 112.6, 118.9, 119.1, 120.6, 121.2, 121.9, 128.6, 129.0, 129.5, 129.9, 130.6, 130.9, 131.4, 132.5, 137.0, 137.3, 139.4, 168.2, 172.8.

7-Chloro-1-(3,3-dimethyl-2-oxobutyl)-3-(1H-indol-3-ylmethyl)-5-phenyl-1,3-dihydro-2H-1,4-benzodiazepin-2-one (68)

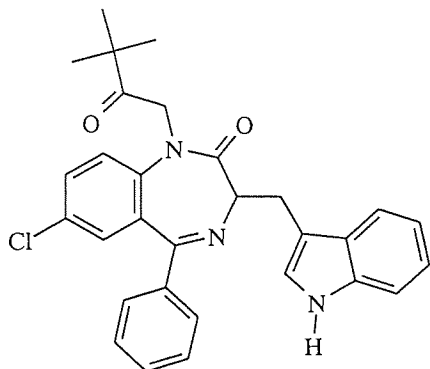

APCI + m/s: m/z = 498.

TLC (Ether): R_f = 0.45.

IR (KBr) ν_{\max} = 3407, 2963, 1717, 1677 (C=O), 1602, 1476, 1320, 1076, 738 cm⁻¹.

¹H-NMR (CDCl₃) δ (p.p.m) 1.25 (s, 9H, CH₃), 3.71 (d, 2H, J=8 Hz, C3:-CH₂-indole), 4.18 (t, J = 9 Hz, 1 H, C3:-H), 7.0-7.7 (m, 13 H, arom. H), 8.19 (s, 1 H, indole NH).

¹³C-NMR (CDCl₃) δ (p.p.m) 27.1 (C(CH₃)₃), 43.5, 53.2 (N1:-CH₂-COtBu), 64.1 (C-3), 111.0, 112.6, 118.9, 119.1, 120.6, 121.7, 121.9, 128.6, 129.0, 129.5, 129.7, 130.6, 130.8, 131.4, 131.6, 136.5, 137.3, 139.4, 162.5, 169.7, 209.1.

7-Chloro-1-ethyloxycarbonylmethyl-3-(1H-indol-3-ylmethyl)-5-phenyl-1,3-dihydro-2H-1,4-benzodiazepin-2-one; 2-[7-Chloro-3-(1H-indol-3-ylmethyl)-2-oxo-5-phenyl-2,3-dihydro-1H-1,4-diazepin-1-yl] ethyl acetate (70)

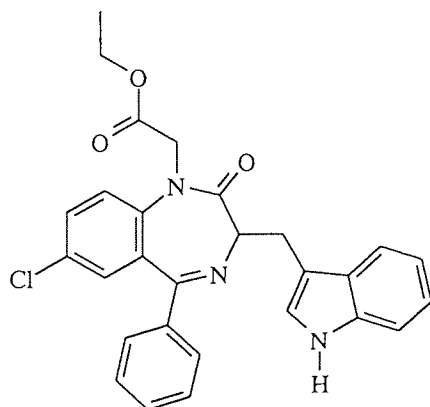

APCI + m/s: m/z = 486.

TLC (Ether): R_f = 0.46.

IR (KBr) ν_{\max} = 3360, 2901, 2851, 1731, 1680 (C=O), 1579, 1467, 1230, 1199, 807 cm⁻¹.

¹H-NMR (CDCl₃) δ (p.p.m) 1.28 (t, 3H, J=8Hz, OCH₂CH₃), 3.91 (m, 2H, OCH₂CH₃), 4.01 (m, 2H), 4.59 (m, 1H, C3:-H), 7.1-7.65 (m, 13H, arom. H), 8.1 (s, 1 H, indole NH).

¹³C-NMR (CDCl₃) δ (p.p.m) 14.2 (OCH₂CH₃), 38.9 (C3:-CH₂-indole), 53.4 (N1:-CH₂-CO₂Et), 60.1 (OCH₂CH₃), 63.7 (C-3), 108.4, 110.9, 112.3, 112.8, 118.2, 118.9, 119.4, 121.5, 122.6, 123.1, 127.8, 128.4, 128.5, 129.4, 129.6, 129.8, 130.4, 131.1, 131.4, 135.9, 136.6, 138.4, 141.4, 167.0, 172.9.

7-Chloro-1-cyclopentyl-3-(1*H*-indol-3-ylmethyl)-5-phenyl-1,3-dihydro-2*H*-1,4-benzodiazepin-2-one (72)

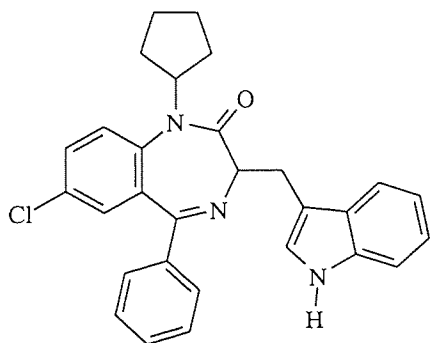

APCI + m/s: m/z = 468.

TLC (Ether): R_f = 0.51.

IR (KBr) ν_{\max} = 3440, 3211, 2952, 2867, 1681 (C=O), 1604, 1476, 1324, 1229, 1022 cm⁻¹.

¹H-NMR (CDCl₃) δ (p.p.m) 1.3-2.25 (m, 9H, cyclopentyl H), 3.77 (m, 2H, C3:-CH₂-indole), 4.26

(tr, 1 H, J=9 Hz, C3:-H), 7.05-7.6 (m, 13 H, arom. H), 8.15 (s, 1 H, indole NH).

¹³C-NMR (CDCl₃) δ (p.p.m) 20.8, 29.1, 36.9 (C3:-CH₂-indole), 54.9 (N1:-C), 62.1 (C-3), 111.1, 112.6, 118.9, 119.2, 121.8, 122.7, 123.3, 127.6, 128.3, 128.7, 129.7, 130.5, 130.9, 131.7, 135.9, 136.8, 138.6, 165.1, 169.9.

7-Chloro-1-cycloheptyl-3-(1*H*-indol-3-ylmethyl)-5-phenyl-1,3-dihydro-2*H*-1,4-benzodiazepin-2-one (74)

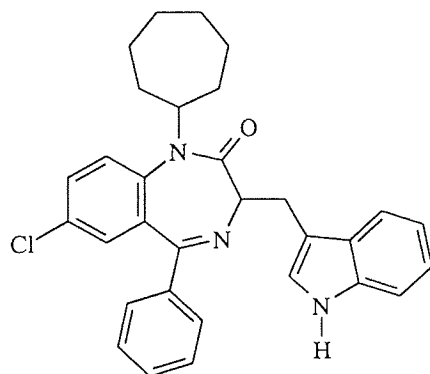

APCI + m/s: m/z = 496.

TLC (Ether): R_f = 0.65.

IR (KBr) ν_{\max} = 3214, 3058, 2927, 2851, 1683 (C=O), 1604, 1457, 1320, 1232, 736 cm⁻¹.

¹H-NMR (CDCl₃) δ (p.p.m) 1.35-2.25 (m, 13H, cycloheptyl H); 3.75 (d, 2H, J = 7 Hz, C3:-CH₂-indole), 4.31 (t, 1H, J = 8 Hz, C3:-H), 7.0-7.6 (m, 13H, arom. H), 8.25 (s, 1 H, indole NH);

¹³C-NMR (CDCl₃) δ (p.p.m) 24.1, 29.1, 32.8, 38.1 (C3:-CH₂-indole), 51.9 (N1:-C), 64.1 (C-3), 110.9, 112.6, 118.9, 119.2, 121.8, 122.7, 123.3, 127.6, 128.3, 128.7, 129.7, 130.5, 130.9, 131.7, 135.9, 136.8, 138.6, 165.1, 169.9.

1-Benzyl-3-(1*H*-indol-3-ylmethyl)-5-methyl-1,3-dihydro-2*H*-1,4-benzodiazepin-2-one (78)

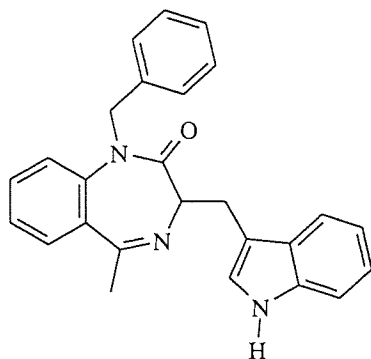

APCI + m/s: m/z = 393.

TLC (Ether): R_f = 0.52.

IR (KBr) ν_{\max} = 3386, 2998, 2810, 1702 (C=O), 1602, 1508, 1472, 1258, 1084, 746 cm^{-1} .

$^1\text{H-NMR}$ (CDCl_3) δ (p.p.m) 2.35 (s, 3H, C5:- CH_3), 3.75, 3.93 (m, 2H, N1:- CH_2 -Ph), 4.38 (m, 1H, C3:-H), 7.0-7.8 (m, 14 arom. H), 8.17 (s, 1 H, indole NH).

1-Benzyl-3-(1*H*-indol-3-ylmethyl)-7,8-dimethoxy-5-methyl-1,3-dihydro-2*H*-1,4-benzodiazepin-2-one (80)

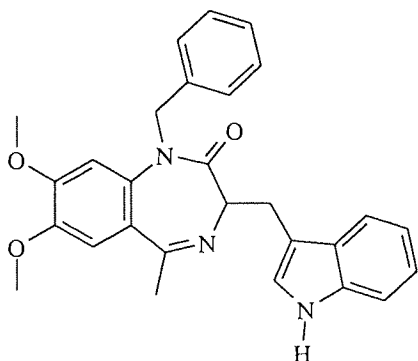

APCI + m/s: m/z = 454 (50%), 438 (50%).

TLC (Ether): R_f = 0.58.

IR (KBr) ν_{\max} = 3413, 2923, 2853, 1683 (C=O), 1602, 1508, 1472, 124, 1084, 745 cm^{-1} .

$^1\text{H-NMR}$ (CDCl_3) δ (p.p.m) 2.4 (s, 3H, C5:- CH_3), 3.65 (m, 2H, C3:- CH_2 -indole), 3.9 (s, 6H, O- CH_3), 4.12 (m, 2H, N1:- CH_2 -Ph), 4.41 (m, 1H, C3:-H), 6.90-7.9 (m, 12 arom. H), 8.26 (s, 1 H, indole NH).

$^{13}\text{C-NMR}$ (CDCl_3) δ (p.p.m) 27.0, 30.2, 36.1, 46.3, 56.3 (O- CH_3), 65.8 (C-3), 108.1, 108.9, 112.3, 121.0, 123.0, 123.9, 126.2, 127.2, 127.9, 128.6, 129.1, 135.5, 136.1, 148.2, 162.6, 166.3.

5-Benzyl-7-(1*H*-indol-3-ylmethyl)-9-methyl-5,7-dihydro-6*H*-[1,3]dioxolo[4,5-*h*][1,4]benzodiazepin-6-one (84)

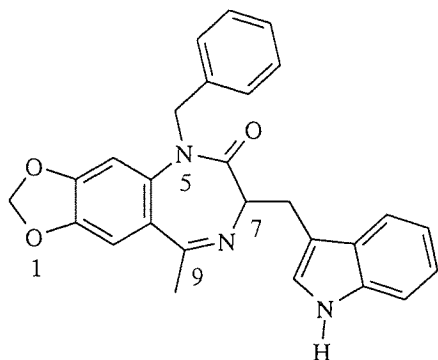

A 50 % suspension of NaH in mineral oil (1.2 mmol) was added portionwise to a solution of the template **81** (350 mg, 1 mmol) in DMF (10 ml). After stirring for 30 min, benzyl bromide (205 mg \approx 142 μ l, 1.2 mmol) was added dropwise to the mixture with ice cooling and the solution was stirred for 2 hours at RT. For work up, dilute HCl (2%) was added and the

suspension (pH 6) was extracted with EtOAc. The extract was washed with brine, dried (Na_2SO_4), concentrated under reduced pressure and further purified by column chromatography to give 372 mg (85% yield) of the title compound.

APCI + m/s: m/z = 438.

TLC (Ether): R_f = 0.68.

IR (KBr) ν_{max} = 3438, 2927, 1627 (C=O), 1596, 1438, 1233, 1166, 1098, 925, 744 cm^{-1} .

$^1\text{H-NMR}$ (CDCl_3) δ (p.p.m) 2.5 (s, 3H, C9:- CH_3), 3.67 (m, 2H, C7:- CH_2 -indole), 4.42 (m, 1H, C7:- H), 6.63 (s, 2H, -O- CH_2 -O-), 6.90-7.7 (m, 12 arom. H), 8.23 (s, 1 H, indole NH).

$^{13}\text{C-NMR}$ (CDCl_3) δ (p.p.m) 27.2, 28.6, 51.8 (N5:- CH_2 -Ph), 63.4 (C-7), 102.8 (O- CH_2 -O), 105.2, 112.3, 118.4, 121.5, 123.7, 127.2, 128.4, 136.7, 149.3, 152.9, 166.7, 169.6.

General experimental for the di-alkylation of the 3-indolylmethyl-benzodiazepine templates

A 50 % suspension of NaH in mineral oil (1.2 mmol) was added portionwise to a solution of the parent template **63**, **77**, **79**, **81** (0.5 mmol) in DMF (5 ml) at ambient temperature. After stirring for 30 min at RT the alkylating agent (1.2 mmol) was added dropwise to the mixture and the reaction temperature was increased to 50°C. Generally the reaction was completed after several hours at that temperature and was controlled by TLC. For work up, water was added and the reaction mixture was extracted with EtOAc. The combined organic phases were washed with brine, dried (Na₂SO₄) and then concentrated under reduced pressure to give mono- and dialkylated (main products) Asperlicin analogues which were further purified by column chromatography using ether/petrol ether (1:2).

7-Chloro-1-methyl-3-[(1-methyl-1*H*-indol-3-yl)methyl]-5-phenyl-1,3-dihydro-2*H*-1,4-benzodiazepin-2-one (**67**)

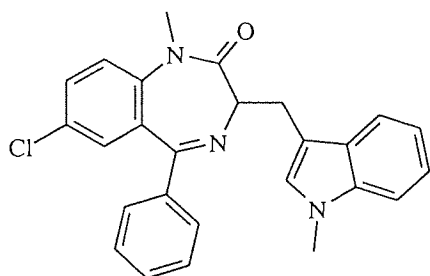

To the reaction mixture of 0.5 mmol (0.2 g) of the template **63** in 5 ml DMF, an excess of a 50 % suspension of NaH in mineral oil (1.2 mmol) was added dropwise at RT. After stirring for 30 min at this temperature, methyl bromide (0.17 g \approx 75 μ l, 1.2 mmol) was added dropwise to the mixture at RT and the reaction temperature was increased to 30-35°C. The reaction was completed at this temperature after 1 hour. Dilute HCl was added and the suspension was extracted with EtOAc. The extract was washed with brine, dried (Na₂SO₄) and then concentrated under reduced pressure to give a mixture of mono- and dimethylated (main product) products which were further purified by column chromatography using ether/petrol ether (1:2) giving 180 mg (85%) of the title compound.

APCI + m/s: m/z = 428.

TLC (Ether): R_f = 0.45.

IR (KBr) ν_{\max} = 3056, 2948, 2859, 1687 (C=O), 1608, 1472, 1320, 1126, 745 cm⁻¹.

$^1\text{H-NMR}$ (CDCl_3) δ (p.p.m) 3.42 (s, 3H, N1:- CH_3), 3.66 (m, 2H, C3:- CH_2 -indole), 4.1-4.4 (overlapping m, 4H, C3:- H & indole N:- CH_3), 7.05-7.65 (m, 12H, arom. H).

$^{13}\text{C-NMR}$ (CDCl_3) δ (p.p.m) 35.8, 36.8, 61.0 (C-3), 111.0, 112.6, 118.9, 119.1, 120.8, 121.2, 126.7, 128.6, 129.0, 129.5, 129.9, 130.6, 130.9, 131.4, 132.5, 137.0, 137.3, 139.4, 165.4, 172.8.

7-Chloro-1-(3,3-dimethyl-2-oxobutyl)-3-[(1-(3,3-dimethyl-2-oxobutyl))-1*H*-indol-3-yl)methyl]-5-phenyl-1,3-dihydro-2*H*-1,4-benzodiazepin-2-one (69)

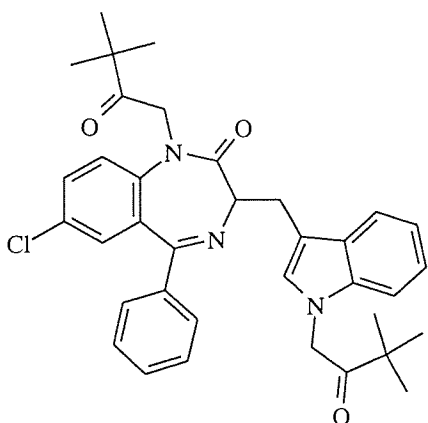

APCI + m/s: $m/z = 596$ (80%), 498 (20%).

TLC (Ether): $R_f = 0.70$.

IR (KBr) $\nu_{\text{max}} = 3413, 3054, 2969, 1724, 1691$ (C=O), 1476, 1326, 1179, 1067, 996, 742 cm^{-1} .

$^1\text{H-NMR}$ (CDCl_3) δ (p.p.m) 1.27 (s, 18H, CH_3), 3.82 (d, 2H, $J = 8$ Hz, C3:- CH_2 -indole), 4.11 (t, $J = 7$ Hz, 1 H, C3:- H), 7.0-7.7 (m, 13 H, arom. H).

$^{13}\text{C-NMR}$ (CDCl_3) δ (p.p.m) 27.2 ($\text{C}(\text{CH}_3)_3$), 43.4, 53.2, 63.9 (C-3), 111.0, 113.2, 118.9, 119.1, 120.6, 121.7, 126.8, 128.6, 129.0, 129.5, 129.7, 130.6, 130.8, 131.4, 131.6, 137.3, 139.4, 140.8, 167.4 (C-5), 169.7, 208.4.

7-Chloro-1-ethyloxycarbonylmethyl-3-[(1-ethyloxycarbonylmethyl)-1*H*-indol-3-yl)methyl]-5-phenyl-1,3-dihydro-2*H*-1,4-benzodiazepin-2-one (71)

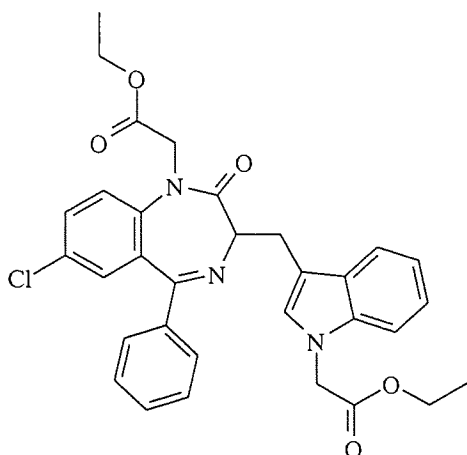

APCI + m/s: $m/z = 572$ (75%), 558 (25%).

TLC (Ether): $R_f = 0.67$.

IR (KBr) $\nu_{\max} = 3382, 2929, 2851, 1743, 1685, 1579, 1467, 1256, 1199, 1023 \text{ cm}^{-1}$.

$^1\text{H-NMR}$ (CDCl_3) δ (p.p.m) 1.25 (m, 6H, OCH_2CH_3), 3.84 (m, 4H, OCH_2CH_3), 4.1-4.4 (m, 3H), 7.1-7.65 (m, 13H, arom. H).

$^{13}\text{C-NMR}$ (CDCl_3) δ (p.p.m) 13.8 (OCH_2CH_3), 37.2 ($\text{C}3\text{:}-\text{CH}_2\text{-indole}$), 53.2, 59.2, 64.4 ($\text{C}-3$), 108.4, 110.9, 112.3, 112.8, 118.2, 118.9, 119.4, 121.5, 122.6, 123.1, 127.8, 128.4, 128.5, 129.4, 129.6, 129.8, 130.4, 131.1, 131.4, 135.9, 136.6, 138.4, 141.4, 168.3, 170.2, 173.9.

7-Chloro-1-cyclopentyl-3-[(1-cyclopentyl)-1*H*-indol-3-yl)methyl]-5-phenyl-1,3-dihydro-2*H*-1,4-benzodiazepin-2-one (73)

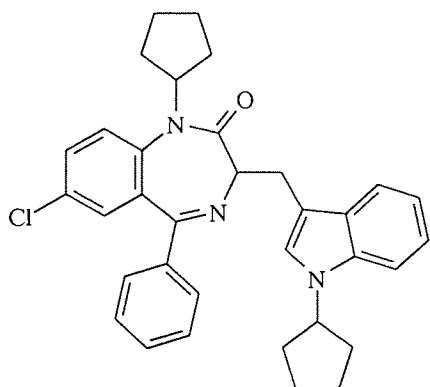

APCI + m/s: $m/z = 536$ (80%), 468 (20%).

TLC (Ether): $R_f = 0.76$.

IR (KBr) $\nu_{\max} = 3453, 3363, 2906, 2851, 1729$ (C=O), 1623, 1459, 1324, 736 cm^{-1} .

$^1\text{H-NMR}$ (CDCl_3) δ (p.p.m) 0.8-2.1 (m, 18 H, cyclopentyl H), 3.69 (d, 2H, $J=7 \text{ Hz}$, $\text{C}3\text{:}-\text{CH}_2\text{-indole}$), 4.33 (t, 1H, $J=9 \text{ Hz}$, $\text{C}3\text{:}-\text{H}$), 7.0-7.6 (m, 13H, arom. H).

7-Chloro-1-cycloheptyl-3-[(1-cycloheptyl)-1*H*-indol-3-yl]methyl]-5-phenyl-1,3-dihydro-2*H*-1,4-benzodiazepin-2-one (75)

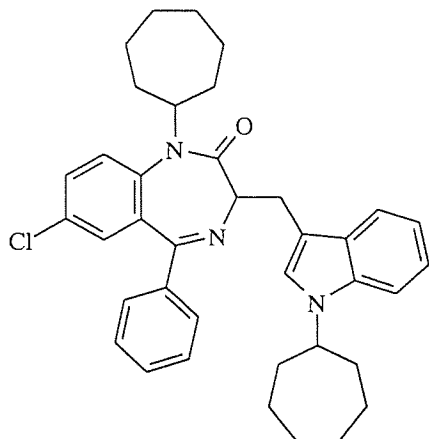

APCI + m/s: $m/z = 592$ (90%), 496 (10%).

TLC (Ether): $R_f = 0.84$.

IR (KBr) $\nu_{\max} = 3447, 2921, 2851, 1683$ (C=O), 1589, 1463, 1380, 1266, 850, 739 cm^{-1} .

$^1\text{H-NMR}$ (CDCl_3) δ (p.p.m) 0.82-2.25 (m, 26 H, cycloheptyl H), 3.68 (m, 2H, C3:- CH_2 -indole), 4.31 (m, 1H, C3:- H), 7.1-7.65 (m, 13 H, arom. H).

General experimental for the acylation of the 3-indolylmethyl-benzodiazepine

0.4 mmol of N1-monoalkylated benzodiazepines **66** and **84** were reacted with 2.5 eq. of acetyl chloride or propionic acid chloride at 50°C over night until the reaction had gone to completion as monitored by TLC. The remaining oily residue was dissolved in ether and was washed with brine. The acylated compounds **76**, **87** and **88** were purified further by chromatography with ether as eluent.

3-[(1-Acetyl-1*H*-indol-3-yl)methyl]-7-chloro-1-methyl-5-phenyl-1,3-dihydro-2*H*-1,4-benzodiazepin-2-one (76)

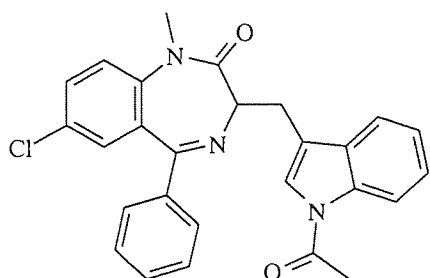

APCI + m/s: m/z = 456 (55%), 413 (30%), 400 (15%).

TLC (Ether): R_f = 0.32.

¹H-NMR (CDCl₃) δ (p.p.m) 2.6 (m, 3H, acetyl CH₃), 3.24 (s, 3H, N1:-CH₃), 3.84 (m, 2H), 4.42 (m, 1H), 6.9-8.05 (m, 12 arom. H).

¹³C-NMR (CDCl₃) δ (p.p.m) 24.2, 29.8, 35.8 (N1:-CH₃), 62.3, (C-3), 119.1, 121.6, 122.2, 122.8, 126.3, 128.4, 129.6, 129.9, 130.6, 131.0, 131.4, 132.5, 137.3, 136.7, 139.4, 142.0, 145.3, 163.2, 165.4.

7-[(1-Acetyl-1*H*-indol-3-yl)methyl]- 5-benzyl-9-methyl-5,7-dihydro-6*H*-[1,3]dioxolo [4,5-*h*][1,4]benzodiazepin-6-one (87)

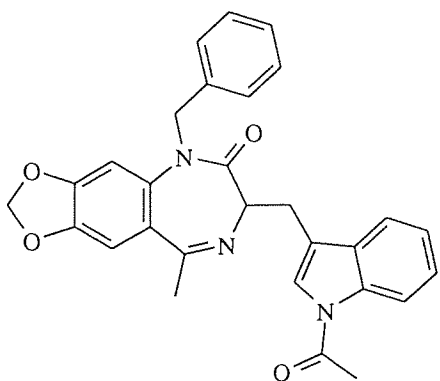

A 50 % suspension of NaH in mineral oil (1 mmol) was added portionwise to a solution of the template **84** (0.4 mmol, 175 mg) in DMF (4 ml). After stirring for 30 min at room temperature, acetyl chloride (78.5 mg, 71 μl, 1 mmol) was added dropwise to the mixture with ice cooling and the reaction temperature was increased to 50°C. After stirring over night, water was

added and the suspension was extracted with ether. The extract was washed with brine, dried (Na₂SO₄), concentrated under reduced pressure and further purified by preparative TLC with ether as eluent to give 121mg (63% yield, based on template **84**) of the desired product.

APCI + m/s: m/z = 480 (70%), 438 (10%), 365 (20%).

mp: 138-142°C.

TLC (Ether): R_f = 0.38.

IR (KBr) ν_{max} = 3297, 3179, 3041, 2955, 1725, 1658, 1585, 1233, 925 cm⁻¹.

$^1\text{H-NMR}$ (CDCl_3) δ (p.p.m) 2.3 (m, 3H, C9:- CH_3), 2.6 (m, 3H, acetyl CH_3), 3.8 (m, 2H), 4.8 (m, 1H), 5.2 (m, 1H), 6.2 (s, 2H, -O- CH_2 -O-), 6.80-7.8 (m, 12 arom. H).

$^{13}\text{C-NMR}$ (CDCl_3) δ (p.p.m) 22.6, 29.7, 52.2, 61.8, 102.2 (O- CH_2 -O), 122.3, 123.1, 126.3, 127.1, 128.5, 129.1, 138.3, 139.3, 145.9, 150.7, 166.7, 169.0.

7-[(1-Propionyl-1*H*-indol-3-yl)methyl]-5-benzyl-9-methyl-5,7-dihydro-6*H*-[1,3]dioxolo[4,5-*h*][1,4] benzodiazepin-6-one (88)

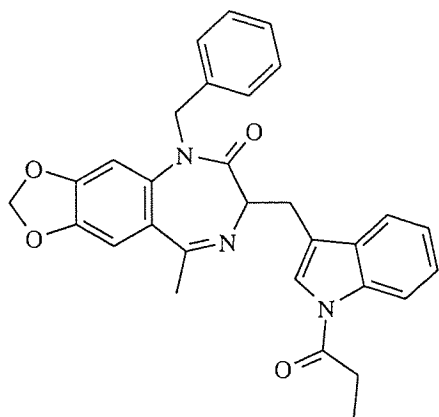

The desired product (91mg, 52%) was obtained by the previous described method using 0.4 mmol of the template **84** (175 mg) and 1 mmol of propionic acid chloride (92.5 mg \approx 85 μl).

APCI + m/s: m/z = 495.

TLC (Ether): R_f = 0.42.

$^1\text{H-NMR}$ (CDCl_3) δ (p.p.m) 1.2 (m, 3H, COCH_2CH_3), 2.45 (m, 3H, C9:- CH_3), 3.8-4.8 (m, 7H), 6.2 (s, 2H, -O- CH_2 -O-), 6.80-7.8 (m, 12 arom. H).

General experimental for the formation of 4H-[1,2,4]triazolo[4,3-a][1,4]benzodiazepine substructure

A solution of 20 mmol (4.62 g) of 5-chloro-2-aminobenzophenone and 40 mmol of α -amino acids as ethyl ester hydrochlorides [glycine (5.6 g), nor-valine (7.9 g) and tryptophan (11.4 g)] in 40 ml pyridine, containing 3% of DMAP as a catalyst, were refluxed under nitrogen for 48. During the first 6 hr 20 ml of the solvent was slowly distilled and replaced by fresh pyridine in order to remove the water and alcohol, which were formed during the reaction. After completion, the reaction mixtures were concentrated in vacuo and the residues washed with 50 ml of water and dissolved in ethyl acetate (100 ml). The organic phase was filtered (isolation of unreacted α -amino acids), dried over sodium sulphate and evaporated in vacuo. The reaction products were separated from the unchanged 5-chloro-2-amino-benzophenone by flash column chromatography on silica gel (50 mesh) and eluted with ether. After the removal of the solvent in vacuo the target molecules were used for subsequent reactions.

7-Chloro-5-phenyl-1,3-dihydro-2H-1,4-benzodiazepin-2-one (96)

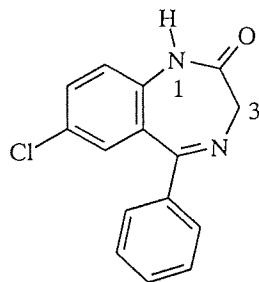

APCI + m/s: $m/z = 271$.

TLC (Ether): $R_f = 0.4$.

IR (KBr disc) $\nu_{\max} = 3207, 2960, 1679$ (C=O), 1604, 1476, 1093, 794 cm^{-1} .

$^1\text{H-NMR}$ (DMSO) δ (p.p.m) 4.31 (s, 2 H, C3:- H_2), 7.1-7.65 (m, 8 H, arom. H), 9.65 (s, 1 H, N1:- H).

$^{13}\text{C-NMR}$ (CDCl_3) δ (p.p.m) 56.2 (C-3), 121.9, 128.6, 129.5, 129.7, 130.8, 131.4, 137.3, 139.4, 164.8, 168.7.

7-Chloro-5-phenyl-3-propyl-1,3-dihydro-2H-1,4-benzodiazepin-2-one (97)

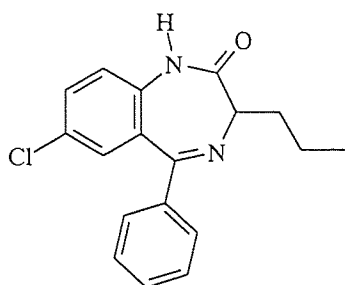

APCI + m/s: m/z = 313 (80%), 268 (15%), 264 (5%).

TLC (Ether): R_f = 0.72.

IR (KBr disc) ν_{\max} = 3218, 3123, 2962, 1687 (C=O), 1608, 1480, 1320, 1220, 826 cm⁻¹.

¹H-NMR (CDCl₃) δ (p.p.m) 0.99 (t; 3H, J=7 Hz, C3:-(CH₂)₂CH₃), 1.3-1.5 (m, 2H, C3:-CH₂CH₂CH₃), 2.23 (m, 2H, C3:-CH₂CH₂CH₃), 4.08 (t, 1H, J = 5Hz, C3:-H), 7.15-7.7 (m, 8 arom. H), 10.3 (s, 1H, N1:-H).

¹³C-NMR (CDCl₃) δ (p.p.m) 14.5 (C3:-(CH₂)₂CH₃), 19.3 (C3:-CH₂CH₂CH₃), 33.1 (C3:-CH₂CH₂CH₃), 63.2 (C3:-(CH₂)₂CH₃), 122.8, 124.9, 129.1, 130.2, 130.8, 131.6, 135.7, 137.4, 168.0, 172.5.

7-Chloro-3-(1H-indol-3-ylmethyl)-5-phenyl-1,3-dihydro-2H-1,4-benzodiazepin-2-one (98)

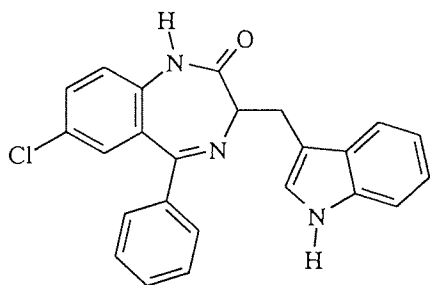

APCI + m/s: m/z = 400 (90%), 271 (10%).

TLC (Ether): R_f = 0.28.

IR (KBr disc) ν_{\max} = 3411, 3220, 2921, 1677 (C=O), 1600, 1481, 1322, 1226, 1095, 829 cm⁻¹.

¹H-NMR (CDCl₃) δ (p.p.m) 3.68 (t, J = 9 Hz, 1 H, C3:-H), 3.82 (m, 2 H, C3:-CH₂-indole), 7.0-7.7 (m, 13 H, arom. H), 8.05 (br s, 1 H, indole NH), 8.68 (br s, 1 H, N1:-H).

¹³C-NMR (CDCl₃) δ (p.p.m) 26.9 (C3:-CH₂-indole), 64.2 (C-3), 111.0, 118.9, 119.1, 120.6, 121.9, 128.6, 129.0, 129.5, 129.7, 130.8, 131.6, 136.5, 137.3, 139.4, 168.0, 171.8.

Experimental for the formation of thioamides:

Preparation of 7-chloro-5-phenyl-1,3-dihydro-2H-1,4-benzodiazepine-2-thione (99)

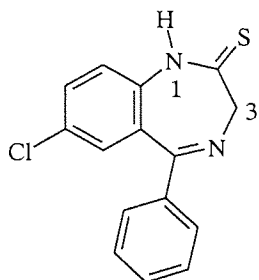

A stirred mixture of the template **96** (1.74 g, 6.4 mmol), dry pyridine (50 ml) and P_4S_{10} (3.12 g, 7 mmol) was refluxed under nitrogen for 4 hours, cooled, and concentrated in vacuo. The suspension of the residue in ice water was extracted with DCM (50 ml). The organic phase was washed with brine, dried (Na_2SO_4), concentrated in vacuo, and further purified by column chromatography on silica gel

(50 mesh) and eluted with ether. The ethereal solution was concentrated giving 1.4 g (76%) of the title compound.

APCI + m/s: m/z = 287.

mp 245-247°C.

TLC (Ether): R_f = 0.58.

IR (KBr disc) ν_{max} = 3445, 2921, 2852, 1676, 1577, 1472, 1382, 1175, 994, 771 cm^{-1} .

1H -NMR ($CDCl_3$) δ (p.p.m) 4.43 (br s, 2 H, C3:-H₂), 7.15-7.55 (m, 8 H, arom. H), 10.4 (br s, 1 H, N1:-H).

^{13}C -NMR ($CDCl_3$) δ (p.p.m) 67.5 (C-3), 126.8, 128.6, 129.0, 129.8, 130.8, 131.7, 138.0, 163.9 (C-5), 194.8 (C=S).

Preparation of 7-Chloro-5-phenyl-3-propyl-1,3-dihydro-2H-1,4-benzodiazepin-2-thione (100)

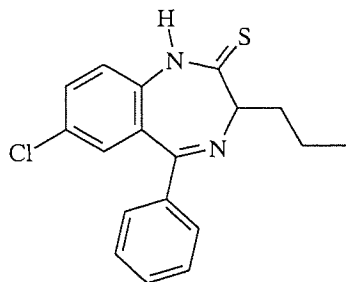

The title product (1.48 g, 75%) was prepared by using 1.8 g (6 mmol) of template **97** and Lawesson's reagent (2.67 g, 6.6 mmol) in 50 ml refluxing pyridine. The reaction was completed after 8-10 hours. The reaction mixture was cooled, concentrated in vacuo and the suspension of the residue in ice water was extracted with DCM (50 ml). The organic phase was filtered, dried and evaporated in vacuo and the product was further purified by column chromatography with ether as eluent.

APCI + m/s: m/z = 329 (80%), 295 (10%), 268 (10%).

mp: 238-242°C.

TLC (Ether): R_f = 0.85.

IR (KBr disc) ν_{\max} = 3440, 2952, 1614, 1569, 1475, 1318, 1160, 1027, 828, 698 cm⁻¹.

¹H-NMR (CDCl₃) δ (p.p.m) 0.9–1.7 (br m, 5H), 2.1–2.5 (m, 2H), 4.09 (m, 1 H, C3:-H), 7.2–7.6 (m, 8 arom. H), 11.6 (s, 1H, N1:-H).

¹³C-NMR (CDCl₃) δ (p.p.m) 14.5 (C3:-(CH₂)₂CH₃), 19.5, (C3:-CH₂CH₂CH₃), 36.3 (C3:-CH₂CH₂CH₃), 67.1 (C-3), 124.9, 128.3, 128.9, 129.8, 130.2, 130.6, 131.8, 135.2, 137.8, 169.2, 202.3 (C=S).

7-Chloro-3-(1*H*-indol-3-ylmethyl)-5-phenyl-1,3-dihydro-2*H*-1,4-benzodiazepin-2-thione (101)

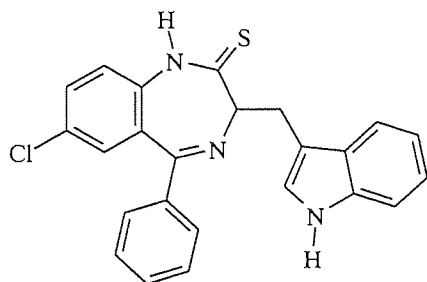

1.21 g (54%) of the product was obtained by the previously described method using 2.16 g (5.4 mmol) of template **98** and Lawesson's reagent (2.5 g, 6.2 mmol) in 50 ml refluxing pyridine for 18-20 hours. The product was purified by column chromatography with ether as eluent.

APCI + m/s: $m/z = 416$ (90%), 287 (10%).

TLC (Ether): $R_f = 0.6$.

IR (KBr disc) $\nu_{\max} = 3268, 3077, 2882, 1604, 1567, 1467, 1328, 1150, 1025, 829 \text{ cm}^{-1}$.

$^1\text{H-NMR}$ (CDCl_3) δ (p.p.m) 3.81 (m, 2H, C3:- CH_2 -indole), 4.49 (m, 1 H, C3:- H), 7.0-7.7 (m, 13 H, arom. H), 8.2 (s, 1 H, indole NH), 9.8 (s, 1 H, N1:-H).

Experimental for the formation of 4*H*-[1,2,4]triazolo[4,3-*a*] [1,4]benzodiazepines

8-Chloro-1-methyl-6-phenyl-4*H*-[1,2,4]triazolo[4,3-*a*][1,4]benzodiazepine (91)

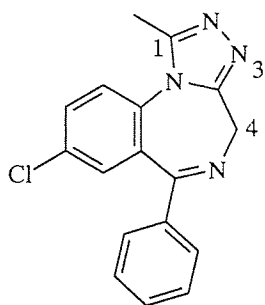

The stirred mixture of 0.8 g (2.8 mmol) of benzodiazepine-2-thione (Template **99**), acethydrazide (0.56 g, 7.6 mmol), and *n*-BuOH (25 ml) was refluxed for 4 hr with a slow stream of nitrogen bubbling through the reaction mixture. The mixture was cooled, concentrated in vacuo, and the residue was suspended in ice water (20 ml). The solid product was collected by filtration

and dissolved in EtOAc. The solution was dried (K_2CO_3) and concentrated in vacuo. The product was purified by column chromatography with ether/10% methanol as eluent giving 675 mg (78%) of the product.

APCI + *m/s*: *m/z* = 309.

mp: 228°C.

TLC (ether/10% methanol): R_f = 0.2.

IR (KBr disc) ν_{max} = 3401, 3062, 1660, 1606, 1542, 1484, 1448, 1378, 1312, 998 cm^{-1} .

1H -NMR ($CDCl_3$) δ (p.p.m) 2.67 (s, 3H, C1:- \underline{CH}_3), 4.11 (d, 1H, $J=13.8$ Hz), 5.51 (d, 1H, $J=13.8$ Hz), 7.25-7.6 (m, 8 H, arom. H).

8-Chloro-1-methyl-6-phenyl-4-propyl-4H-[1,2,4]triazolo[4,3-a][1,4]benzodiazepine (94)

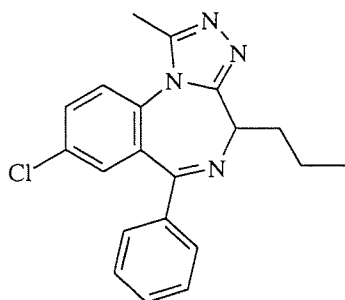

The title product (0.68 g, 75%) was prepared by using 0.86 g (2.6 mmol) of template **100**, acethydrazide (0.58 g, 7.8 mmol), in refluxing n-butanol (25 ml) for 12 hours.

The reaction mixture was cooled, concentrated in vacuo and the suspension of the residue in ice water was extracted with EtOAc (50 ml). The organic phase was dried (K_2CO_3),

filtered, and evaporated in vacuo. The product was further purified by column chromatography with ether/10% methanol as eluent.

APCI + m/s: m/z = 351.

mp: 217-219°C.

TLC (ether/10% methanol): $R_f = 0.45$.

IR (KBr disc) $\nu_{max} = 3420, 2925, 2865, 1604, 1531, 1482, 1424, 1301, 1096, 695 \text{ cm}^{-1}$.

$^1\text{H-NMR}$ ($CDCl_3$) δ (p.p.m) 1.0 (s, 3H, (C3:-(CH_2) $_2$ CH $_3$)), 1.4–1.9 (br m, 4H, C3:-(CH_2) $_2$ CH $_3$), 2.61 (s, 3H, C1:-CH $_3$), 4.52 (s, 1H, C4:-H), 7.2–7.7 (m, 8 H, arom. H).

$^{13}\text{C-NMR}$ ($CDCl_3$) δ (p.p.m) 12.1 (C4:-(CH_2) $_2$ CH $_3$), 22.5, 31.7, 56.5 (C-4), 124.6, 128.3, 129.2, 130.7, 130.9, 131.2, 131.4, 132.1, 138.4, 165.9.

8-Chloro-4-(1*H*-indol-3-ylmethyl)-1-methyl-6-phenyl-4*H*-[1,2,4]triazolo[4,3-*a*]
[1,4]benzodiazepine (95)

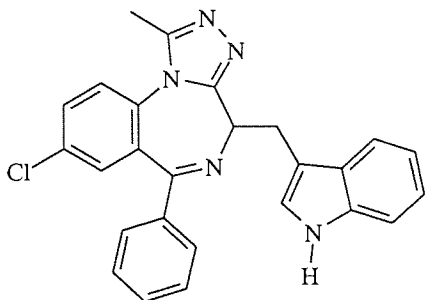

The desired product (665 mg, 54%) was obtained by the previously described method using 1.2 g (3 mmol) of template **101**, acethydrazide (0.6 g, 8.1 mmol), in refluxing *n*-butanol (25 ml) for 24 hours.

APCI + *m/z*: *m/z* = 440 (60%), 429 (40%).

TLC (ether/10% methanol): *R_f* = 0.55.

IR (KBr disc) ν_{max} = 3420, 2964, 1679, 1641, 1465, 1378, 1157, 1099, 740, 699 cm^{-1} .

¹H-NMR (CDCl₃) δ (p.p.m) 2.43 (s, 3H, C1:-CH₃), 3.0 (m, 2H, C4:-CH₂-indole),

7.0–7.8 (m, 13 H, arom. H), 8.2 (s, 1 H, indole NH).

Experimental for the formation of 3-(alkylamino-/anilino)-1,4-benzodiazepin-2-ones

Preparation of the starting material (2-amino-5-chlorophenyl)(phenyl)methanone oxime (109)

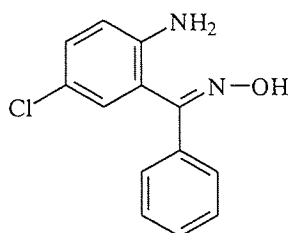

A solution of 18.5 g (80 mmol) of 2-amino-5-chloro-benzophenone and 11.2 g (160 mmol) of hydroxylamine hydrochloride in a mixture of 110 ml ethanol and 15 ml pyridine (10% excess) was stirred and refluxed for 72 hours. Solvent was removed by distillation under reduced pressure to a small

volume and the residue was partitioned between water and ether. The organic phase was washed with water, dried over anhydrous sodium sulphate, and concentrated to dryness. Warming the residue with toluene gave 13.8 g crystalline oxime, 80% yield. Recrystallisation from a mixture of ethyl acetate and hexane gave light yellow crystals, mp 151-153°C.

APCI + m/s: m/z = 247 (30%), 231 (70%).

TLC (Ether): $R_f = 0.5$.

IR (KBr) $\nu_{\max} = 3428, 3343, 3179, 3045, 2859, 1629, 1490, 1253, 1148, 992, 693 \text{ cm}^{-1}$.

$^1\text{H-NMR}$ (DMSO- δ_6) δ (p.p.m) 4.79 (s, 2H, C2:-NH $_2$), 6.8 (m, 2 arom. H), 7.15 (s, 1 arom. H), 7.35–7.45 (m, 5H, Phenyl-H), 11.5 (s, 1H, =N-OH).

$^{13}\text{C-NMR}$ (DMSO- δ_6) δ (p.p.m) 117.8, 121.1, 127.2, 128.9, 129.4, 129.6, 136.2, 144.9, 153.7 (C=NOH).

Preparation of 2-chloro-*N*-{4-chloro-2-[(hydroxyimino)(phenyl)methyl]phenyl}acetamide (110)

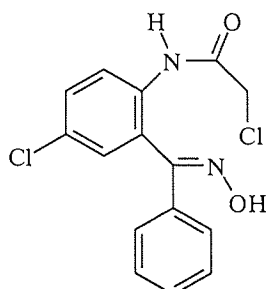

A solution of the starting material (13.8 g, 55 mmol) in 500 ml ether was stirred with 200 ml of water and cooled in an ice bath to 0-5°C. 4.85 ml of chloroacetyl chloride (6.9 g, 61 mmol) in 100 ml ether was added dropwise, while maintaining the reaction mixture slightly basic by addition of an ice cold dilute (2%) sodium hydroxide. The reaction was stirred for 30 min at 0-5°C and for 2 hours at room temperature after all of the acid chloride had been added. The ether layer was separated, washed with water, dried over sodium sulphate, and concentrated to dryness. The residue was crystallised from a mixture of ethyl acetate and hexane. An additional amount was obtained from the mother liquors following heating with toluene. The yield was 85% (15.1 g). The product formed colourless plates melting at 171-172° C. APCI + m/s: m/z = 323 (10%), 305 (80%), 271 (10%).

TLC (Ether): $R_f = 0.75$.

IR (KBr disc) $\nu_{\max} = 3258, 3164, 2857, 1658, 1535, 1392, 1297, 994, 800, 698 \text{ cm}^{-1}$.

$^1\text{H-NMR}$ (CDCl_3) δ (p.p.m) 4.2 (s, 2H), 7.0-7.6 (m, 8arom. H), 8.8 (s, 1H, N:-H).

$^{13}\text{C-NMR}$ (CDCl_3) δ (p.p.m) 48.8 (-NHCOCH₂Cl), 125.7, 126.9, 130.5, 132.2, 132.6, 133.8, 135.7, 137.8, 155.0 (C=N-OH), 164.7 (-NHCOCH₂Cl).

Preparation of 7-chloro-1,3-dihydro-3-hydroxy-5-phenyl-2H-1,4-benzodiazepine-2-one (Oxazepam - 112)

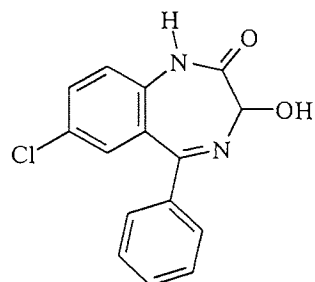

The solution of the precursor **110** (9.69 g, 30 mmoles) in a mixture of 200 ml ethanol and 65 ml of 2N sodium hydroxide was stirred for 2 hours at room temperature. The solution was then cooled to 0-5°C and precipitation of the chemically pure Oxazepam and the identified sodium salt of Oxazepam occurred.

The solid was removed by filtration, dissolved in 150 ml of 66% aqueous ethanol (pH 11.8) and acidified to pH 1.8 with 3N hydrochloric acid. Filtration separated Oxazepam. A second crop was obtained from the mother liquors by adding sodium chloride. The filtrate was acidified to pH 1.8 and an additional amount of Oxazepam was separated by filtration. The solid (5.4g, 62% yield) was dried in a vacuum oven at 80°C. Oxazepam may be recrystallised with ethanol (mp 196-198°C) or directly used for subsequent reactions. The title compound was identical with the reference substance obtained from sigma-aldrich.

APCI + m/s: m/z = 287 (70%), 269 (30%).

TLC (Ether): $R_f = 0.28$; TLC (Ether/5% Methanol): $R_f = 0.58$.

IR (KBr disc) $\nu_{\max} = 3340, 3220, 2946, 1710$ (C=O), 1602, 1328, 1127, 825, 700 cm^{-1} .

$^1\text{H-NMR}$ (DMSO- δ_6) δ (p.p.m) 4.69 (s, 1H, C3:-H), 6.35 (s, 1H, C3:-OH), 7.2-7.6 (m, 8H, arom. H), 8.6 (s, 1H, N1:-H).

$^{13}\text{C-NMR}$ (DMSO- δ_6) δ (p.p.m) 68.3 (C-3), 115.2, 120.3, 121.5, 122.1, 122.4, 13.4, 124.3, 126.4, 128.7, 130.2, 134.1, 165.9, 170.8.

7-Chloro-3-hydroxy-5-phenyl-3H-1,4-benzodiazepin-2-olate Oxazepam sodium salt (113)

A small amount of the sodium salt of Oxazepam was analysed.

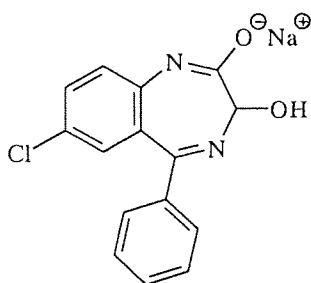

APCI + m/s: m/z = 287 (50%), 269 (50%).

TLC (Ether/5% Methanol): $R_f = 0.25$.

IR (KBr disc) $\nu_{\max} = 3403, 3212, 2930, 1690$ (C=O), 1600, 1559, 1450, 1330, 1210, 1125 cm^{-1} .

$^1\text{H-NMR}$ (DMSO- δ_6) δ (p.p.m) 4.24 (s, 1H, C3:-H), 5.9 (s, 1H, C3:-OH), 6.95 (d, 2H), 7.27 (d, 1H), 7.3-7.5 (m, 5H, phenyl H).

$^{13}\text{C-NMR}$ (DMSO- δ_6) δ (p.p.m) 83.5 (C-3), 118.2, 122.1, 122.9, 123.7, 124.8, 128.1, 132.4, 135.1, 162.7, 168.4.

Synthesis of 3,7-dichloro-5-phenyl-1,3-dihydro-2H-1,4-benzodiazepine-2-one (114)

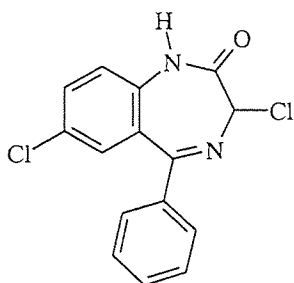

5 g of Oxazepam (17.5 mmol) was finely powdered and treated with 5 eq. of thionyl chloride (10.4 g \approx 6.3 ml, 88 mmol) at RT. An immediate reaction took place with the formation of a yellow solid. The reaction temperature was increased to 40°C. After 30 minutes the reaction was completed and unreacted thionyl chloride was removed by vacuum evaporation

overnight. The solid was dissolved in anhydrous dimethoxyethane and filtered to remove any insoluble material. The solution was slowly diluted with hexane to afford 2.5 g of the title compound, which was directly used for subsequent reactions.

APCI + m/s: m/z = 305 (50%), 287 (20), 269 (30%).

IR (KBr disc) ν_{\max} = 3418, 3060, 1704 (C=O), 1606, 1476, 1322, 1226, 694 cm^{-1} .

$^1\text{H-NMR}$ (CDCl_3) δ (p.p.m) 5.7 (s, 1H, C3:-H), 7.2-7.6 (m, 8H, arom. H), 9.8 (s, 1H, N1:-H).

General experimental for the formation of 3-(alkylamino-/anilino)-1,4-benzodiazepin-2-ones

A solution of 0.5 g (1.6 mmol) 3,7-dichloro-benzodiazepine in 2.5 ml of dimethoxyethane was added to 2.5 ml of a solution of 2 eq. of alkyl- and arylamines in dimethoxyethane at about 0-5°C. The mixture was stirred and allowed to warm to room temperature. Generally the reactions were completed after 1-2 hours at ambient temperature for alkylamines (except the reaction with ethylamine (b.p. 17°C, which was stirred at 5-10°C) and after 4-6 hours at 50°C for aniline derivatives, which was controlled by TLC. The reaction mixture was concentrated in vacuo, and the residue was suspended in 15 ml 5 % sodium bicarbonate solution. The suspension was extracted twice with 10 ml EtOAc. The combined organic layers containing the desired products as a free base were separated, washed with brine, dried over sodium sulphate and filtered. On concentration to a small volume, the products were purified by column chromatography on silica gel (50 mesh) or preparative TLC eluted with ether.

7-Chloro-3-(ethylamino)-5-phenyl-1,3-dihydro-2H-1,4-benzodiazepin-2-one (106)

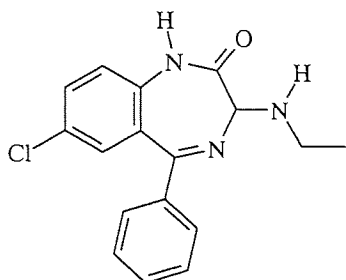

116 mg (25%) of the title product was prepared by using 0.45 g (1.47 mmol) of 3,7-dichloro-benzodiazepine and 0.17 ml (3 mmol) of ethylamine at 5-10°C for 2 hours. The mixture was concentrated in vacuo and the suspension of the residue in dilute sodium bicarbonate solution was extracted with EtOAc. The organic phase was filtered, dried and evaporated in vacuo. On concentration to a small volume, the product was purified by preparative TLC with ether as eluent.

APCI + m/s: m/z = 314 (30%), 296 (60%), 269 (10%).

TLC (Ether): $R_f = 0.4$.

IR (KBr) $\nu_{\max} = 3384, 3147, 2982, 2858, 1702, 1608, 1476, 1320, 1092, 867, 708 \text{ cm}^{-1}$.

$^1\text{H-NMR}$ (DMSO- d_6) δ (p.p.m) 1.25 (t, 3H, $J=7\text{Hz}$, C3:-NHCH $_2$ CH $_3$), 2.5-2.7

(m, 2H, C3:-NHCH $_2$ CH $_3$), 4.58 (m, 1H, C3:-H), 7.25-7.8 (m, 8 arom. H & N1:-H).

$^{13}\text{C-NMR}$ (DMSO- d_6) δ (p.p.m) 15.2 (C3:-NHCH $_2$ CH $_3$), 42.3 (C3:-NHCH $_2$ CH $_3$), 71.3 (C-3), 123.4, 128.2, 129.6, 130.4, 131.2, 136.5, 140.8, 166.3, 169.3.

7-Chloro-3-(propylamino)-5-phenyl-1,3-dihydro-2H-1,4-benzodiazepin-2-one (119)

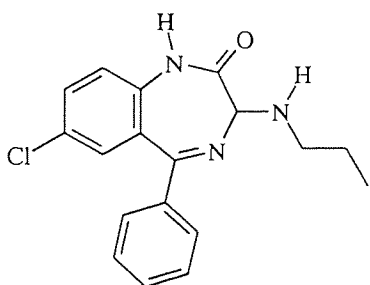

APCI + m/s: m/z = 328 (30%), 296 (50%), 269 (20%).

TLC (Ether): $R_f = 0.4$.

IR (KBr) $\nu_{\max} = 3408, 3205, 3009, 2912, 1756, 1662, 1502, 1387, 1148, 887, 699 \text{ cm}^{-1}$.

$^1\text{H-NMR}$ (DMSO- d_6) δ (p.p.m) 1.38 (tr, 3H, $J=7\text{Hz}$, C3:-NHCH $_2$ CH $_2$ CH $_3$), 2.3-2.85

(m, 4H, C3:-NHCH $_2$ CH $_2$ CH $_3$), 4.76 (m, 1H, C3:-H), 7.25-7.8 (m, 8 arom. H), 8.05

(s, 1 H, N1:-H).

7-Chloro-3-(butylamino)-5-phenyl-1,3-dihydro-2H-1,4-benzodiazepin-2-one (120)

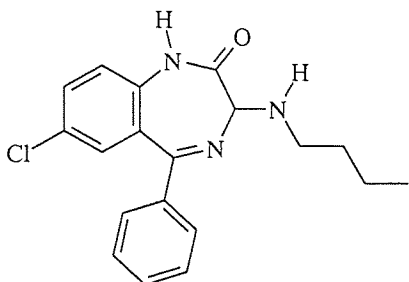

APCI + m/s: m/z = 342 (50%), 296 (30%), 269 (20%).

TLC (Ether): R_f = 0.5.

IR (KBr) ν_{\max} = 3451, 3241, 3027, 2903, 1691, 1643, 1502, 1367, 1106, 902, 712 cm⁻¹.

¹H-NMR (DMSO-d₆) δ (p.p.m) 1.05 (t, 3H, J = 7Hz, C3:-NH(CH₂)₃CH₃), 1.90-2.55 (m, 6H, C3:-NH(CH₂)₃CH₃), 4.68 (m, 1H, C3:-H), 7.15-7.8 (m, 8 arom. H), 8.0 (s, 1 H, N1:-H).

3-Anilino-7-chloro-5-phenyl-1,3-dihydro-2H-1,4-benzodiazepin-2-one (121)

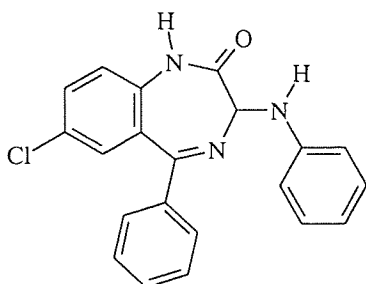

A mixture of 0.48 g (1.5 mmol) 3,7-dichloro-benzodiazepine and 0.29 ml (0.3 g, 3.2 mmol) of aniline in 5 ml of dimethoxyethane was stirred for 4 hours at 50°C. The mixture was concentrated in vacuo and the suspension of the residue in dilute sodium bicarbonate solution was extracted with EtOAc. The organic phase was filtered,

dried, concentrated in vacuo, and further purified by column chromatography on silica gel (50 mesh) and eluted with ether. The ethereal solution was concentrated to give 0.31 g (55%) of the title compound.

APCI + m/s: m/z = 364/362 (60%), 287 (20%), 271/269 (25%).

TLC (Ether): R_f = 0.6.

IR (KBr disc) ν_{\max} = 3445, 2915, 2873, 1721, 1587, 1490, 1353, 1272, 1075, 697 cm⁻¹.

¹H-NMR (CDCl₃) δ (p.p.m) 4.92 (m, 1H, C3:-H), 6.8-7.8 (m, 12 H, arom. H), 8.9 (s, 1 H, N1:-H).

7-Chloro-3-(4-hydroxyanilino)-5-phenyl-1,3-dihydro-2H-1,4-benzodiazepin-2-one (107)

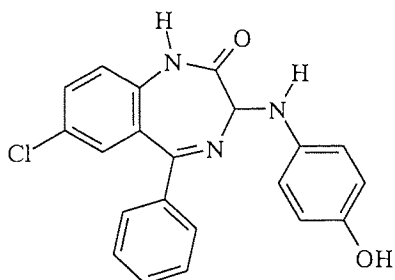

APCI + m/s: m/z = 380/378 (70%), 296 (25%), 269 (5%).

TLC (Ether): R_f = 0.6.

IR (KBr disc) ν_{\max} = 3439 (OH), 3005, 2916, 1682, 1567, 1471, 1295, 1231, 1105, 719 cm^{-1} .

$^1\text{H-NMR}$ (CDCl_3) δ (p.p.m) 4.85 (m, 1 H, C3:-H), 6.7-7.75 (m, 11 H, arom. H), 8.52 (s, 1 H, N1:-H).

7-Chloro-3-(methylanilino)-5-phenyl-1,3-dihydro-2H-1,4-benzodiazepin-2-one (122)

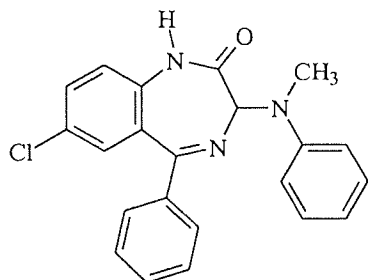

APCI + m/s: m/z = 379/376 (50%), 361 (20%), 296 (15%), 269 (15%).

TLC (Ether): R_f = 0.75.

IR (KBr disc) ν_{\max} = 3203, 3085, 2842, 1718, 1607, 1521, 1308, 1196, 699 cm^{-1} .

$^1\text{H-NMR}$ (CDCl_3) δ (p.p.m) 3.29 (s, 3 H, C3:-N-CH₃), 4.88 (m, 1 H, C3:-H), 6.7-7.75 (m, 12 H, arom. H), 8.55 (s, 1 H, N1:-H).

Solution phase synthesis of 3-substituted-1,4-benzodiazepin-2-ones containing functional groups

A solution of 5 mmol (1.15g) of 5-chloro-2-aminobenzophenone and 10 mmol of α -amino acids as ethyl ester hydrochlorides or aminomalononic acid diethyl ester HCl in 20 ml pyridine, containing 3 % of DMAP as a catalyst, was refluxed under nitrogen. Generally the reactions were completed after 72 hours for the desired BZD's containing functional groups, which could be monitored by TLC. During the first 8-10 hours 10 ml of the solvent was slowly distilled and replaced by fresh pyridine in order to remove the water and alcohol, which were formed during the reaction. After completion, the mixtures were concentrated in vacuo and the residues washed with 25 ml of water and dissolved in ethyl acetate (50 ml). The ethyl acetate solution was filtered (isolation of undissolved not reacted α -amino acids), dried over sodium sulphate and evaporated in vacuo. The reaction products were separated from the unchanged 5-chloro-2-aminobenzophenone by column chromatography on silica gel (50 mesh) eluted with ether. The product fractions were evaporated in vacuo to give the title compounds as slightly yellow compounds, which were dried in vacuo under reduced pressure. The target molecules were recrystallised with ethanol or acetonitrile.

7-Chloro-3-(4-hydroxybenzyl)-5-phenyl-1,3-dihydro-2H-1,4-benzodiazepin-2-one (103)

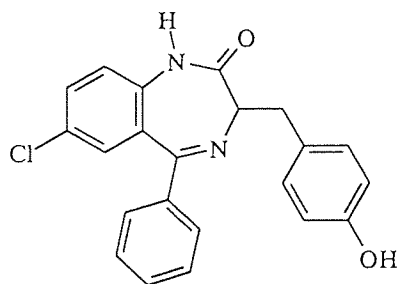

APCI + m/s: $m/z = 377$.

TLC (Ether): $R_f = 0.65$.

IR (KBr disc) $\nu_{\max} = 3445$ (OH), 2915, 2873, 1721 (C=O), 1587, 1490, 1353, 1272, 975 cm^{-1} .

$^1\text{H-NMR}$ (CDCl_3) δ (p.p.m) 3.68 (m, 2 H, C3:- CH_2 -p-hydroxyphenyl), 4.08 (m, 1 H, C3:-H), 7.3-7.65 (m, 12 H, arom. H), 8.32 (s, 1 H, N1:-H).

$^{13}\text{C-NMR}$ (CDCl_3) δ (p.p.m) 37.3 (C3:- CH_2 -p-hydroxyphenyl), 64.9 (C-3), 122.3, 126.1, 128.6, 129.5, 129.7, 130.8, 131.4, 137.3, 139.4, 169.4, 171.9.

Preparation of ethyl 7-chloro-2-oxo-5-phenyl-2,3-dihydro-1*H*-1,4-benzodiazepine-3-carboxylate (125)

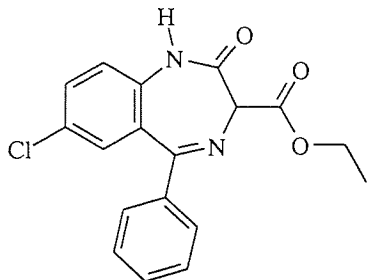

The stirred mixture of the substrates 5-chloro-2-amino-benzophenone (1.15g, 5 mmol) and aminomalonic acid diethyl ester HCl (2.12 g, 10 mmol) was refluxed in 20 ml of pyridine with 3% of DMAP. After 72 hours, solvent was removed by distillation in vacuo. The suspension of the residue in ice water was extracted with ethyl acetate

(3 x 20 ml). The combined organic phase was washed with brine, dried (Na_2SO_4), concentrated in vacuo, and further purified by column chromatography on silica gel (50 mesh) and eluted with ether. The ethereal solution was concentrated to give 1.03g (60%) of 1,4-benzodiazepine-3-ethyl carboxylate.

APCI + m/s: m/z = 343 (90%), 271 (10%).

TLC (Ether): $R_f = 0.45$.

IR (KBr disc) $\nu_{\text{max}} = 3343, 2977, 1755, 1702, 1602, 1481, 1312, 1206, 834, 703 \text{ cm}^{-1}$.

$^1\text{H-NMR}$ (CDCl_3) δ (p.p.m) 1.20 (t, 3H, $J=7 \text{ Hz}$, OCH_2CH_3), 4.4 (m, 3H, C3:-H & OCH_2CH_3), 7.15– 7.6 (m, 8 arom. H), 10.0 (s, 1H, N1:-H).

$^{13}\text{C-NMR}$ (CDCl_3) δ (p.p.m) 14.1 (OCH_2CH_3), 61.8 (C-3), 123.2, 128.2, 128.7, 129.3, 129.8, 129.9, 130.4, 130.7, 132.1, 165.1, 167.5.

Preparation of 7-chloro-3-(hydroxymethyl)-5-phenyl-1,3-dihydro-2*H*-1,4-benzodiazepin-2-one (126)

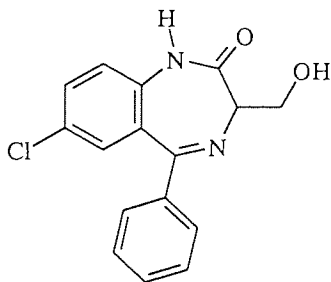

The 1,4-benzodiazepine-3-ethyl carboxylate (1.0 g, 2.91 mmol) was dissolved in dry THF (10 ml), and, to the resulting solution, NaBH_4 (0.3 g, 7.9 mmol) was added. After 2.5 hr, ice-water (30 ml) was added to the mixture, and resulting slurry was extracted by ethyl acetate (3 x 20 ml).

Organic extracts were washed with water (3 x 20 ml), dried (Na_2SO_4) and concentrated in vacuo. Crude product was recrystallised, from the solvent mixture MeOH/Et₂O/light petroleum affording crystalline product and further purification by column chromatography eluted with ether afforded 0.66 g (75%) of the title product.

APCI + m/s: m/z = 301 (90%), 283 (5%), 271 (5%).

mp: 121-123°C.

TLC (Ether): R_f = 0.68.

IR (KBr disc) ν_{max} = 3430 (OH), 2929, 1687, 1455, 1382, 1322, 1035, 695 cm^{-1} .

¹H-NMR (CDCl_3) δ (p.p.m) 4.1-4.5 (br m, 3 H, C3:-H & C3:-CH₂OH), 7.0-7.55 (m, 8 H, arom. H), 9.5 (s, 1 H, N1:-H).

¹³C-NMR (CDCl_3) δ (p.p.m) 62.4, 66.2, 122.7, 128.4, 128.8, 129.2, 129.6, 130.5, 130.8, 131.8, 136.5, 138.2, 165.4, 172.3.

7-Chloro-3-(1-hydroxy-ethyl)-5-phenyl-1,3-dihydro-2H-1,4-benzodiazepin-2-one (127)

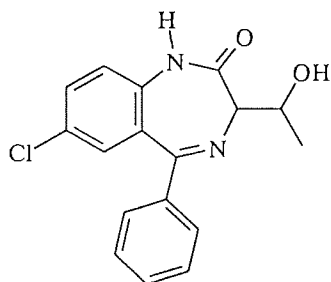

APCI + m/s: m/z = 315 (10%), 297 (90%).

mp: 118-121°C.

TLC (Ether): R_f = 0.71.

IR (KBr disc) ν_{max} = 3440, 3207, 3085, 2957, 1681 (C=O), 1609, 1480, 1382, 1322, 821, 698 cm^{-1} .

¹H-NMR (CDCl_3) δ (p.p.m) main diastereomer 1.91 (d, J = 7.1 Hz, 3 H, CH₃), 2.26 (m, 1 H), 4.12 (d, J = 7 Hz, 1 H, C3:-H), 7.3-7.7 (m, 8 H, arom. H), 8.23 (s, 1 H, N1:-H).

¹³C-NMR (CDCl_3) δ (p.p.m) 17.1, 67.2, 71.5 (C-3), 122.9, 128.6, 129.0, 129.5, 130.1, 130.6, 131.2, 131.4, 138.2, 139.0, 164.8, 172.5.

7-Chloro-3-(2-hydroxyethyl)-5-phenyl-1,3-dihydro-2H-1,4-benzodiazepin-2-one (128)

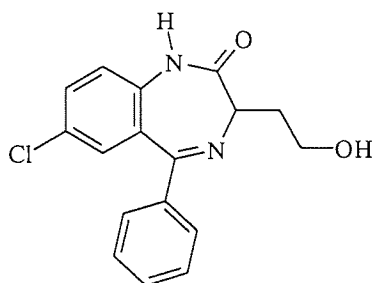

APCI + m/s: m/z = 315 (90%), 297 (5%), 214 (5%).

TLC (Ether): R_f = 0.68.

IR (KBr disc) ν_{\max} = 3444, 3212, 2956, 1683 (C=O), 1612, 1481, 1326, 1050, 695 cm⁻¹.

¹H-NMR (CDCl₃) δ (p.p.m) 2.2–2.5 (br m, 2H), 3.6–4.1 (br m, 3H), 7.15–7.85 (m, 8 H, arom. H), 9.75 (s, 1 H, N1:-H).

¹³C-NMR (CDCl₃) δ (p.p.m) 32.8 (C3:-CH₂CH₂OH), 60.1, 61.4, 122.8, 128.9, 129.1, 129.8, 130.8, 131.1, 137.1, 141.5, 166.6, 167.2.

7-Chloro-3-(1-methylsulfanylmethyl)-5-phenyl-1,3-dihydro-1,3-dihydro-2H-1,4-benzodiazepin-2-one (129)

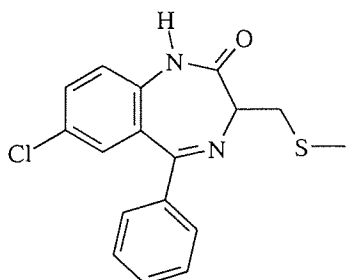

APCI + m/s: m/z = 329 (90%), 255 (5%), 248 (5%).

TLC (Ether): R_f = 0.82.

IR (KBr disc) ν_{\max} = 3203, 2908, 1659, 1600, 1455, 1379, 820, 687 cm⁻¹.

¹H-NMR (CDCl₃) δ (p.p.m) 1.95 (s, 3 H, C3:-CH₂SCH₃), 3.55 (m, 2 H, C3:-CH₂SCH₃), 4.95 (s, 1 H, C3:-H), 6.9–8.1 (br m, 9 H, 8 arom. H & N1:-H).

¹³C-NMR (CDCl₃) δ (p.p.m) 14.1 (C3:-CH₂SCH₃), 26.8 (C3:-CH₂SCH₃), 61.8 (C-3), 115.9, 122.8, 128.1, 128.3, 128.8, 129.5, 129.7, 132.6, 137.1, 143.8, 168.7, 173.4.

Solution phase synthesis of multi-substituted 3-propyl-1,4-benzodiazepines to optimise the ketone moiety

A solution of 5 mmol of 2-aminophenyl ketones (A-H) and 10 mmol of nor-valine ethyl ester hydrochloride (≈ 2 g) in 20 ml pyridine, containing 3% of DMAP as a catalyst, was refluxed under nitrogen. During the first 8-10 hours 10 ml of the solvent was slowly distilled and replaced by fresh pyridine in order to remove the water and alcohol, which were formed during the reaction. Generally the reaction was completed after 48 hours for the desired BZD's whilst the reaction with dihalogen 2-aminophenylketones (C, D) was carried out for 72 hours. For the investigation of the stereochemistry nor-valine ethyl ester hydrochloride was reacted with the ketone building block A (5-chloro-2-amino-benzophenone) for 8-10 hours. After completion, the reaction mixtures were worked up as described before.

7-Chloro-5-phenyl-3-propyl-1,3-dihydro-2H-1,4-benzodiazepin-2-one (105)

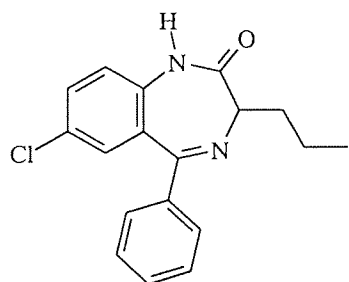

APCI + m/s: $m/z = 313$ (80%), 268 (15%), 264 (5%).

mp: 197-198°C.

TLC (Ether): $R_f = 0.72$.

IR (KBr disc) $\nu_{\max} = 3218, 3123, 2923, 1687$ (C=O), 1604, 1476, 1320, 1220, 826 cm^{-1} .

$^1\text{H-NMR}$ (CDCl_3) δ (p.p.m) 0.99 (tr, 3H, $J=7$ Hz, C3:-(CH_2) $_2$ CH $_3$), 1.3-1.5 (m, 2H, C3:-CH $_2$ CH $_2$ CH $_3$), 2.23 (m, 2H, C3:-CH $_2$ CH $_2$ CH $_3$), 4.11 (tr, 1H, $J=5$ Hz, C3:-H), 7.15-7.7 (m, 8 arom. H), 10.3 (s, 1H, N1:-H).

$^1\text{H-NMR}$ (CDCl_3 , 15 mol% Europium shift reagent) δ (p.p.m) 1.0-2.9 (br m, Europium shift reagent), 4.19+4.64 (two s, 1H, C3:-H), 6.8-8.0 (br m, 8 arom. H), 11.1 (s, 1H, N1:-H).

$^{13}\text{C-NMR}$ (CDCl_3) δ (p.p.m) 14.5 (C3:-(CH_2) $_2$ CH $_3$), 19.3 (C3:-CH $_2$ CH $_2$ CH $_3$), 33.2 (C3:-CH $_2$ CH $_2$ CH $_3$), 63.2 (C-3), 122.8, 124.9, 129.1, 130.2, 130.8, 131.6, 135.7, 137.4, 168.0, 172.5.

(3R)-7-chloro-5-phenyl-3-propyl-1,3-dihydro-2H-1,4-benzodiazepin-2-one (137 R)

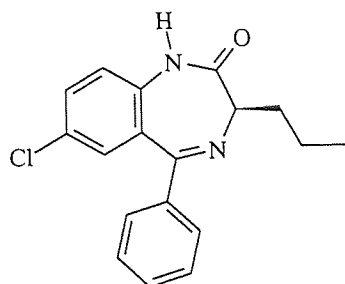

$[\alpha]_{546}^{25} : -17.3^\circ$ (c = 1, ethanol)

$^1\text{H-NMR}$ (CDCl_3 , 15 mol% Europium shift reagent)

δ (p.p.m) 1.0-3.0 (br m, Europium shift reagent), 4.68

(s, 1H, C3:-H), 6.8-8.0 (br m, 8 arom. H), 10.8

(s, 1H, N1:-H).

(3S)-7-chloro-5-phenyl-3-propyl-1,3-dihydro-2H-1,4-benzodiazepin-2-one (138 S)

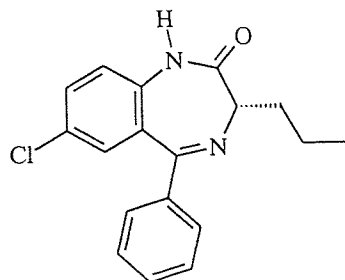

$[\alpha]_{546}^{25} : +15.6^\circ$ (c = 1, ethanol)

$^1\text{H-NMR}$ (CDCl_3 , 15 mol% Europium shift reagent) δ (p.p.m)

1.0-2.9 (br m, Europium shift reagent), 4.28 (s, 1H, C3:-H),

6.8-8.0 (br m, 8 arom. H), 11.4 (s, 1H, N1:-H).

5-Phenyl-3-propyl-1,3-dihydro-2H-1,4-benzodiazepin-2-one (130)

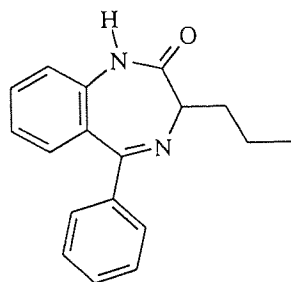

APCI + m/s: m/z = 279 (70%), 234 (30%).

TLC (Ether): $R_f = 0.70$.

IR (KBr) $\nu_{\text{max}} = 3214, 3151, 2954, 1690$ (C=O), 1594, 1461, 1320, 1202, 763, 693 cm^{-1} .

$^1\text{H-NMR}$ (CDCl_3) δ (p.p.m) 0.97 (tr, 3H, J=7 Hz, C3:- $(\text{CH}_2)_2\text{CH}_3$), 1.3-1.5

(m, 2H, C3:- $\text{CH}_2\text{CH}_2\text{CH}_3$), 2.23 (m, 2H, C3:- $\text{CH}_2\text{CH}_2\text{CH}_3$), 3.99 (tr, 1H, J=5Hz, C3:-H),

7.15-7.7 (m, 8 arom. H), 10.3 (s, 1H, N1:-H).

$^{13}\text{C-NMR}$ (CDCl_3) δ (p.p.m) 14.5 (C3:- $(\text{CH}_2)_2\text{CH}_3$), 18.4 (C3:- $\text{CH}_2\text{CH}_2\text{CH}_3$), 34.5

(C3:- $\text{CH}_2\text{CH}_2\text{CH}_3$), 65.0 (C-3), 122.0, 123.9, 128.4, 129.6, 130.7, 131.9, 136.0, 137.4,

167.2, 171.9.

7-Chloro-5-(2-chlorophenyl)-3-propyl-1,3-dihydro-2H-1,4-benzodiazepin-2-one (131)

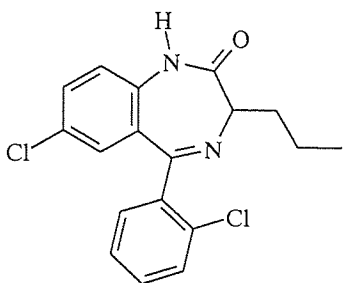

A mixture of 1.3 g (4.9 mmol) of 2-amino-2',5-dichloro-benzophenone and 2 g nor-valine ethyl ester HCl (10 mmol) was refluxed in 20 ml of pyridine with 3% of DMAP. After 96 hours, solvent was removed by distillation in vacuo. The suspension of the residue in ice water was extracted with ethyl acetate (3 x 20 ml). The combined organic phase was washed with brine, dried (Na₂SO₄), concentrated in vacuo, purified by column chromatography on silica gel (50 mesh) and eluted with ether to give 0.34 g (20%) of the title product.

APCI + m/s: m/z = 347 (80%), 302 (5%), 279 (15%).

TLC (Ether): R_f = 0.9.

TLC (Ether/Petrol ether [1:10]): R_f = 0.75.

IR (KBr) ν_{\max} = 2959, 2931, 1687 (C=O), 1607, 1465, 1322, 1085, 829, 752 cm⁻¹.

¹H-NMR (CDCl₃) δ (p.p.m) 0.99 (tr, 3H, J=7 Hz, C3:-(CH₂)₂CH₃), 1.41 (m, 2H, C3:-CH₂CH₂CH₃), (m, 2H, C3:-CH₂CH₂CH₃), 4.15 (t, 1H, J = 5Hz, C3:-H), 6.7 (m, 1H), 7.2-7.6 (m, 5 arom. H), 7.9 (m, 1H), 9.6 (s, 1H, N1:-H).

¹³C-NMR (CDCl₃) δ (p.p.m) 14.8 (C3:-(CH₂)₂CH₃), 20.9 (C3:-CH₂CH₂CH₃), 34.8 (C3:-CH₂CH₂CH₃), 64.5 (C-3), 121.9, 124.5, 126.8, 128.0, 129.7, 130.1, 131.1, 132.2, 134.9, 137.2, 167.1, 170.1.

7-Chloro-5-(2-fluorophenyl)-3-propyl-1,3-dihydro-2H-1,4-benzodiazepin-2-one (132)

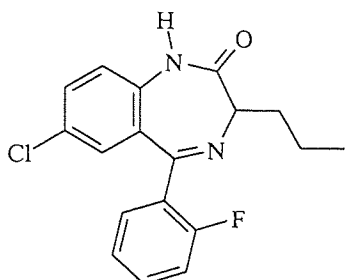

APCI + m/s: $m/z = 331$ (70%), 286 (30%).

TLC (Ether): $R_f = 0.87$.

TLC (Ether/Petrol ether [1:10]): $R_f = 0.73$.

IR (KBr) $\nu_{\max} = 3193, 3083, 2957, 1688$ (C=O), 1614, 1486, 1454, 1324, 1218, 1104 cm^{-1} .

$^1\text{H-NMR}$ (CDCl_3) δ (p.p.m) 0.98 (t; 3H, $J=7$ Hz, C3:-(CH_2) $_2$ $\underline{\text{CH}}_3$), 1.45 (m, 2H, C3:- $\underline{\text{CH}}_2\text{CH}_2\text{CH}_3$), 2.0-2.3 (m, 2H, C3:- $\underline{\text{CH}}_2\text{CH}_2\text{CH}_3$), 4.09 (t, 1H, $J = 5$ Hz, C3:- $\underline{\text{H}}$), 7.0-7.65 (m, 7 arom. H), 9.75 (s, 1H, N1:-H).

$^{13}\text{C-NMR}$ (CDCl_3) δ (p.p.m) 14.3 (C3:-(CH_2) $_2$ $\underline{\text{CH}}_3$), 19.3 (C3:- $\underline{\text{CH}}_2\text{CH}_2\text{CH}_3$), 33.0 (C3:- $\underline{\text{CH}}_2\text{CH}_2\text{CH}_3$), 63.1 (C-3), 116.7, 124.3, 124.8, 125.3, 126.3, 127.4, 128.4, 129.1, 131.0, 136.8, 161.3, 167.2, 171.6.

8-Methyl-5-phenyl-3-propyl-1,3-dihydro-2H-1,4-benzodiazepin-2-one (133)

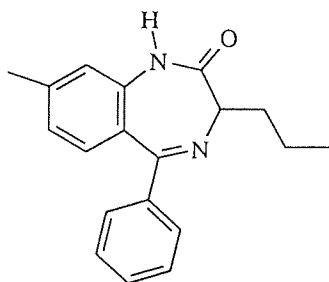

APCI + m/s: $m/z = 291$ (85%), 276 (15%).

TLC (Ether): $R_f = 0.8$.

IR (KBr) $\nu_{\max} = 3214, 3151, 2954, 1690$ (C=O), 1594, 1461, 1320, 1202, 763, 693 cm^{-1} .

$^1\text{H-NMR}$ (CDCl_3) δ (p.p.m) 0.97 (tr, 3H, $J=7$ Hz, C3:-(CH_2) $_2$ $\underline{\text{CH}}_3$), 1.3-1.5 (m, 2H, C3:- $\underline{\text{CH}}_2\text{CH}_2\text{CH}_3$), 2.23 (m, 2H, C3:- $\underline{\text{CH}}_2\text{CH}_2\text{CH}_3$), 2.41 (s, 3H, aryl- $\underline{\text{CH}}_3$), 4.18 (t, 1H, $J = 5$ Hz, C3:- $\underline{\text{H}}$), 7.15-7.7 (m, 8 arom. H), 10.3 (s, 1H, N1:-H).

$^{13}\text{C-NMR}$ (CDCl_3) δ (p.p.m) 14.5 (C3:-(CH_2) $_2$ $\underline{\text{CH}}_3$), 18.4 (C3:- $\underline{\text{CH}}_2\text{CH}_2\text{CH}_3$), 33.1 (C3:- $\underline{\text{CH}}_2\text{CH}_2\text{CH}_3$), 63.2 (C-3), 122.8, 124.9, 129.1, 130.2, 130.8, 131.6, 135.7, 137.4, 168.0, 172.5.

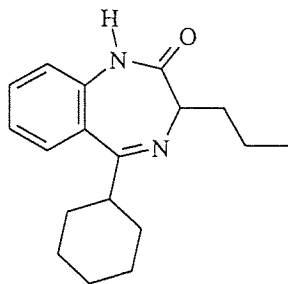
5-Cyclohexyl-3-propyl-1,3-dihydro-2H-1,4-benzodiazepin-2-one (134)

APCI + m/s: m/z = 285 (90%), 237 (5%), 201 (5%).

TLC (Ether): R_f = 0.80.

IR (KBr) ν_{\max} = 2931, 2849, 1677 (C=O), 1540, 1473, 1326, 1150, 763 cm^{-1} .

$^1\text{H-NMR}$ (CDCl_3) δ (p.p.m) 0.97 (tr, 3H, $J=7$ Hz, C3:-(CH_2) $_2$ $\underline{\text{CH}}_3$), 1.3-2.2

(m, 14H, C3:- $\underline{\text{CH}}_2\text{CH}_2\text{CH}_3$ + cyclohexyl H), 2.75 (m, 1H), 4.61 (m, 1H, C3:- $\underline{\text{H}}$), 7.2-7.7 (m, 4 arom. H), 8.9 (s, 1H, N1:-H).

$^{13}\text{C-NMR}$ (CDCl_3) δ (p.p.m) 14.8 (C3:-(CH_2) $_2$ $\underline{\text{CH}}_3$), 20.6 (C3:- $\underline{\text{CH}}_2\text{CH}_2\text{CH}_3$), 26.6, 31.2, 33.8 (C3:- $\underline{\text{CH}}_2\text{CH}_2\text{CH}_3$), 39.4, 64.2 (C-3), 119.6, 122.6, 129.4, 130.9, 131.5, 138.9, 167.2, 169.0.

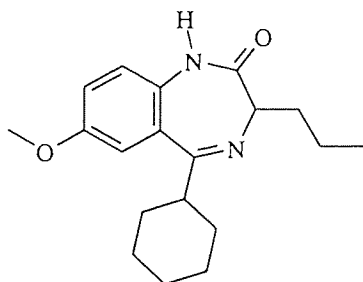
7-Methoxy-5-cyclohexyl-3-propyl-1,3-dihydro-2H-1,4-benzodiazepin-2-one (135)

APCI + m/s: m/z = 309 (90%), 268 (10%).

TLC (Ether): R_f = 0.87.

TLC (Ether/Petrol ether [1:10]): R_f = 0.73.

IR (KBr) ν_{\max} = 3196, 3064, 2952, 2832, 1672 (C=O), 1475, 1362, 1037, 801 cm^{-1} .

$^1\text{H-NMR}$ (CDCl_3) δ (p.p.m) 0.99 (t; 3H, $J=7$ Hz, C3:-(CH_2) $_2$ $\underline{\text{CH}}_3$), 1.3-2.2 (m, 14H,

C3:- $\underline{\text{CH}}_2\text{CH}_2\text{CH}_3$ +cyclohexyl H), 3.86 (s, 3H, C7:-O- $\underline{\text{CH}}_3$), 4.38 (m, 1H, C3:- $\underline{\text{H}}$), 6.9 (m, 1H), 7.2-7.7 (m, 7 arom. H), 8.9 (s, 1H, N1:-H).

$^{13}\text{C-NMR}$ (CDCl_3) δ (p.p.m) 13.9 (C3:-(CH_2) $_2$ $\underline{\text{CH}}_3$), 22.0 (C3:- $\underline{\text{CH}}_2\text{CH}_2\text{CH}_3$), 25.9, 32.3, 37.8 (C3:- $\underline{\text{CH}}_2\text{CH}_2\text{CH}_3$), 39.4, 54.1 (C7:-O- $\underline{\text{CH}}_3$), 65.9 (C-3), 102.3, 114.7, 123.7, 124.9, 127.9, 129.5, 130.9, 135.6, 136.9, 151.2 (C7:-O- $\underline{\text{CH}}_3$), 166.5, 169.2.

7-Chloro-5-cyclohexyl-3-propyl-1,3-dihydro-2H-1,4-benzodiazepin-2-one (136)

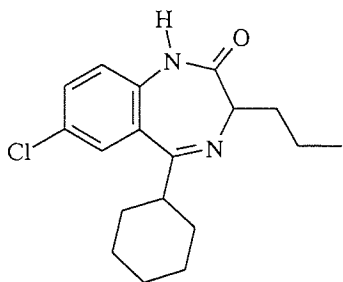

APCI + m/s: m/z = 319 (75%), 300 (20%), 238(5%).

TLC (Ether): R_f = 0.9.

TLC (Ether/Petrol ether [1:10]): R_f = 0.75.

IR (KBr) ν_{\max} = 2925, 2856, 1685 (C=O), 1494, 1258, 1027, 1082, 801 cm^{-1} .

$^1\text{H-NMR}$ (CDCl_3) δ (p.p.m) 0.97 (t; 3H, $J=7$ Hz, C3:-(CH_2) $_2$ $\underline{\text{C}}\text{H}_3$), 1.3-2.1

(m, 14H, C3:- $\underline{\text{C}}\text{H}_2$ $\underline{\text{C}}\text{H}_2$ CH_3 +cyclohexyl H), 2.45 (m, 1H), 4.65 (m, 1H, C3:- $\underline{\text{H}}$), 7.25

(q, 1H, $J=7$ Hz), 7.52 (q, 1H, $J=7.5$ Hz), 7.7 (m, 1H), 9.1 (s, 1H, N1:-H).

$^{13}\text{C-NMR}$ (CDCl_3) δ (p.p.m) 14.4 (C3:-(CH_2) $_2$ $\underline{\text{C}}\text{H}_3$), 21.3 (C3:- $\underline{\text{C}}\text{H}_2$ $\underline{\text{C}}\text{H}_2$ CH_3), 25.9, 32.3,

39.1 (C3:- $\underline{\text{C}}\text{H}_2$ $\underline{\text{C}}\text{H}_2$ CH_3), 39.4, 64.9 ($\underline{\text{C}}-3$), 120.9, 126.3, 127.4, 129.7, 131.3, 136.8, 167.5,

168.7.

C3-Alkylation of 7-chloro-N1-methyl-1,4-benzodiazepine (Diazepam®)

Preparation of the starting material *N*-(2-benzoyl-4-chlorophenyl)-2-chloroacetamide (143)

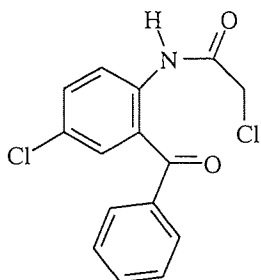

A solution of 2-amino-5-chlorobenzophenone (11.6 g, 50 mmol) in 75 ml of anhydrous ether was stirred and cooled in an ice bath to 0-5°C. 4.4 ml of chloroacetyl chloride (6.2 g, 55 mmol) in 25 ml ether was added dropwise, while the formed HCl was removed with a slow stream of nitrogen bubbling through the reaction mixture.

Precipitation of the title compound occurred and the yellow color of the solution gradually faded. The suspension was stirred for half an hour at 0-5°C and for 2 hours at room temperature. The solid product was collected by filtration and crystallised with toluene to give 14 g (91%) of the product.

APCI + m/s: m/z = 308 (90%), 231 (10%).

TLC (Ether): R_f = 0.82.

¹H-NMR (CDCl₃) δ (p.p.m) 4.2 (s, 2H, NHCOCH₂Cl), 7.3-7.8 (m, 8H, arom. H), 11.5 (s, 1H, NHCOCH₂Cl).

Preparation of 7-Chloro-5-phenyl-1,3-dihydro-2H-1,4-benzodiazepin-2-one (N-nordesmethyldiazepam – 145)

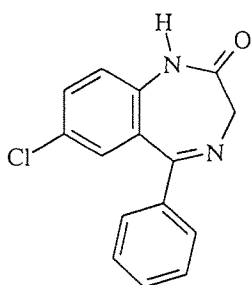

A mixture of the precursor (13 g, 42 mmol, 11.9 g of urotropine (85 mmol), 20 ml 2N aqueous HCL, 80 ml methanol and 10 ml water were added (pH of solvent mixture was ≈ 5) and refluxed for 16 hours. The mixture was cooled in an ice bath and the precipitated crystals were filtered. The crystals were washed with a 10 ml ice-cold mixture of methanol/water (1:1). The product was dried at 60°C under reduced pressure overnight. 9.4 g (82%) of N-nordesmethyldiazepam was obtained.

APCI + m/s: $m/z = 271$.

TLC (Ether): $R_f = 0.4$.

IR (KBr disc) $\nu_{\max} = 3207, 2960, 1679$ (C=O), 1604, 1476, 1093, 794 cm^{-1} .

$^1\text{H-NMR}$ (DMSO- δ_6) δ (p.p.m) 4.38 (s, 2 H, C3:- H_2), 7.1-7.65 (m, 8 H, arom. H), 10.0 (s, 1 H, N1:- H).

$^{13}\text{C-NMR}$ (DMSO- δ_6) δ (p.p.m) 55.2 (C-3), 121.9, 128.6, 129.5, 129.7, 130.8, 131.4, 137.3, 139.4, 164.8, 168.7.

Conversion of nor-desmethyldiazepam into Diazepam with iodomethane (139)

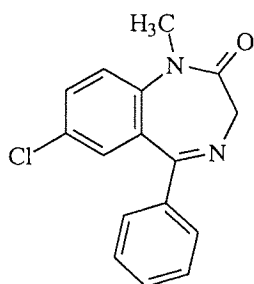

8.2 g of Nor-desmethyldiazepam (30 mmol) and sodium hydride (1.54 g of a 50% suspension in mineral oil, 32 mmol) were stirred in 150 ml of dry DMF under nitrogen in an ice bath. After 30 min, iodomethane (1.85 ml, 30 mmol) was added dropwise and the mixture was stirred additional 30 min in the cold. The solvent was removed in vacuo and the residue was treated with water and extracted with EtOAc (3 x 200 ml). The combined organic layers were washed with brine, dried (MgSO_4), filtered and concentrated under reduced pressure. The residue was either chromatographed on silica with 5% (v/v) diethyl ether in DCM or crystallised from DCM with ether (1:1) to give 7.85 g (92%) of Diazepam. The product was identical with the reference substance obtained from sigma-aldrich.

APCI + m/s: $m/z = 285$.

TLC (Ether): $R_f = 0.46$; TLC (5% Ether/DCM): $R_f = 0.32$.

$^1\text{H-NMR}$ (CDCl_3) δ (p.p.m) 3.28 (s, 3H, N1:- CH_3), 4.42 (s, 2H, C3:- H_2), 7.12–7.6 (m, 8 arom. H).

Conversion with dimethylsulphate

To a solution of 2.87 g (0.01 mol) of N-nordesmethyl diazepam and 0.46 g (11.5 mmol) of sodium methoxide in 80 ml of water and 20 ml of ethanol was added dropwise with stirring 1 ml (1.33 g, 10.6 mmol) of dimethylsulphate at RT. After 1 hour the reaction mixture was chilled and filtered. Recrystallisation of the product from DCM with ether (1:1) gave 1.91 g (67 %) of Diazepam.

General procedure for generation of Diazepam anion

To a flame-dried, argon-flushed, 125 ml three-necked flask, equipped with a thermometer, a magnetic stirrer, and an argon inlet and containing 20 ml of anhydrous THF, was added 1.2 ml (0.81 g, 8 mmol) of diisopropylamine. The solution was cooled to -78°C , and 7.35 ml (8 mmol) of 1.6 M n-butyllithium solution in hexane was added via syringe. The solution was stirred for 10-15 min and then warmed to room temperature for 30 min. After the mixture was cooled back to -78°C , a 5 ml anhydrous THF solution of Diazepam (1.14 g, 4 mmol) was added through a syringe and the reaction mixture was brought to room temperature over 30 min. The resulting dark red solution of the Diazepam anion was cooled back to -20°C and was used in specific reactions with the molar quantity equal to the amount of the Diazepam anion of alkyl iodides (**Entry 147-149**) or aldehydes (**Entry 150-152**).

Preparation of 7-Chloro-1-methyl-5-phenyl-3-propyl-1,3-dihydro-2H-1,4-benzodiazepin-2-one (147)

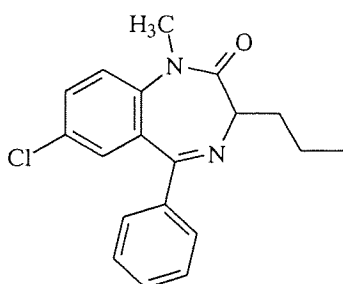

To the solution of the Diazepam anion (1.14 g, 4 mmol), 0.36 ml (\approx 0.5 g, 4 mmol) of propyl iodide in 2.5 ml of THF was added through a syringe at -20°C . The mixture was stirred, allowed to come to room temperature over a period of 30 min and was stirred overnight. For work up, the solution was treated with water and dilute HCL to pH 6-7 and the THF layer was decanted. The organic phase was concentrated in vacuo and the remaining oily residue was dissolved in ethyl acetate (50 ml), which was washed with brine, dried (Na_2SO_4), filtered and concentrated under reduced pressure. The oil, obtained after evaporation of the extract, was chromatographed with hexane-ethyl acetate (5:1) as eluent to give the title product, which was further purified by column chromatography with the same solvent mixture as eluent. Evaporation of the solvent gave 390 mg (30%) of the product.

APCI + m/s: m/z = 327 (90%), 279 (10%).

TLC (Ether): $R_f = 0.75$

IR (KBr) $\nu_{\max} = 2971, 2861, 1715, 1669$ (C=O), 1461, 1253, 1114, 1073, 738, 705 cm^{-1} .

$^1\text{H-NMR}$ (CDCl_3) δ (p.p.m) 0.99 (t; 3H, $J=7$ Hz, C3:-(CH_2) $\underline{\text{C}}\text{H}_3$), 1.35-1.52 (m, 2H, C3:-(CH_2) $\underline{\text{C}}\text{H}_3$), 1.99 (m, 2H, C3:- $\underline{\text{C}}\text{H}_2\text{CH}_2\text{CH}_3$), 3.48 (s, 3H, N1:- $\underline{\text{C}}\text{H}_3$); 4.17 (tr, 1H, $J=5\text{Hz}$, C3:- $\underline{\text{H}}$), 7.2-7.87 (m, 8 arom. H).

$^{13}\text{C-NMR}$ (CDCl_3) δ (p.p.m) 14.1 (C3:-(CH_2) $\underline{\text{C}}\text{H}_3$), 19.1 (C3:- $\underline{\text{C}}\text{H}_2\text{CH}_2\text{CH}_3$), 28.9 (N1:- $\underline{\text{C}}\text{H}_3$), 35.0 (C3:- $\underline{\text{C}}\text{H}_2\text{CH}_2\text{CH}_3$), 68.0 ($\underline{\text{C}}-3$), 122.6, 128.5, 129.5, 130.8, 131.3, 138.1, 141.2, 167.7, 171.7.

3-Allyl-7-chloro-1-methyl-5-phenyl-1,3-dihydro-2H-1,4-benzodiazepin-2-one (148)

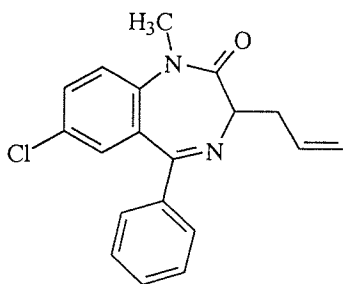

APCI + m/s: m/z = 325 (80%), 311 (10%), 299 (5%), 285 (5%).

TLC (Ether): $R_f = 0.85$.

IR (KBr) $\nu_{\max} = 3436, 2923, 2856, 1668$ (C=O), 1607, 1484, 1386, 1320, 1263, 1094, 1031 cm^{-1} .

$^1\text{H-NMR}$ (CDCl_3) δ (p.p.m) 2.45 (m, 2 H), 3.28 (s, 3 H, N1:- $\underline{\text{C}}\text{H}_3$), 4.19 (m, 1H, C3:- $\underline{\text{H}}$), 4.8-5.6 (br m, 3 H, C3:- $\underline{\text{C}}\text{H}_2\text{CH}=\underline{\text{C}}\text{H}_2$), 7.1-7.85 (m, 8 arom. H).

$^{13}\text{C-NMR}$ (CDCl_3) δ (p.p.m) 32.8 (N1:- $\underline{\text{C}}\text{H}_3$), 36.8, 62.1 ($\underline{\text{C}}-3$), 122.2, 124.4, 127.1, 127.9, 129.4, 130.1, 131.7, 133.5, 136.4, 143.2, 167.4, 168.2.

7-Chloro-1-methyl-5-phenyl-3-prop-2-ynyl-1,3-dihydro-2H-1,4-benzodiazepin-2-one (149)

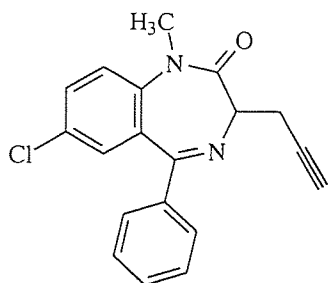

APCI + m/s: m/z = 323 (80%), 285 (15%), 241(5%).

TLC (Ether): R_f = 0.85.

IR (KBr) ν_{\max} = 3058, 2954, 2968, 2280 (C≡C), 1668 (C=O), 1612, 1480, 1318, 1253, 923 cm⁻¹.

¹H-NMR (CDCl₃) δ (p.p.m) 2.0-2.4 (m, 3 H, 3.45 (s, 3 H, N1:-CH₃), 4.4 (m, 1 H, C3:-H), 7.2-7.75 (m, 8 arom. H).

¹³C-NMR (CDCl₃) δ (p.p.m) 21.9 (C3:-CH₂C≡CH), 35.4 (N1:-CH₃), 65.7 (C-3), 122.3, 127.1, 128.0, 129.5, 130.8, 131.7, 136.5, 141.4, 166.5, 170.8.

Preparation of 7-chloro-3-(1-hydroxypropyl)-1-methyl-5-phenyl-1,3-dihydro-2H-1,4-benzodiazepin-2-one (150)

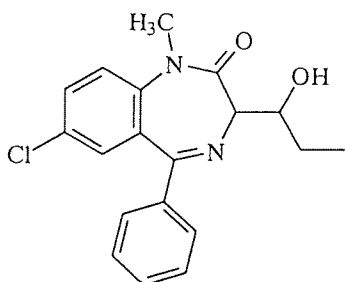

To the Diazepam anion solution (4 mmol) was added 0.29 ml (4 mmol) of propionaldehyde in 5 ml of THF through a syringe at -20°C. The reaction mixture was allowed to come to room temperature over a period of 30 min and was stirred for additional 30 min at this temperature. The mixture was then decomposed with dilute HCL (pH of aqueous layer was 6-7) and

the THF layer was decanted. THF was removed in vacuo and the remaining oily residue was dissolved in ethyl acetate (50 ml). The organic phase was washed with brine, dried (Na₂SO₄), filtered and concentrated in vacuo. The oil obtained from the dried extract was passed through a column of silica gel with toluene/ethyl acetate (2:1) to yield 410 mg (31%) of the title product.

APCI + m/s: m/z = 343 (60%), 285 (40%).

TLC (Ether): R_f = 0.4.

IR (KBr) ν_{\max} = 3484(OH), 2957, 2911, 1669 (C=O), 1476, 1397, 1318, 1110, 1044 cm⁻¹.

$^1\text{H-NMR}$ (CDCl_3) δ (p.p.m) 1.08 (tr, 3H, $J=7\text{Hz}$, $\text{C3:}-\text{CH}(\text{OH})\text{CH}_2\text{CH}_3$), 1.4-1.9 (m, 2H, $\text{C3:}-\text{CH}(\text{OH})\text{CH}_2\text{CH}_3$), 3.42 (s, 3H, $\text{N1:}-\text{CH}_3$), 4.55 (d, 1H, $J=7\text{Hz}$, $\text{C3:}-\text{H}$), 7.25-7.6 (m, 8 arom. H).

$^{13}\text{C-NMR}$ (CDCl_3) δ (p.p.m) 12.9 ($\text{C3:}-\text{CH}(\text{OH})\text{CH}_2\text{CH}_3$), 25.6, 35.0 ($\text{N1:}-\text{CH}_3$), 67.8 (C-3), 72.9, 122.8, 128.4, 129.4, 130.2, 131.5, 139.2, 142.6, 167.3, 170.8.

Preparation of 7-chloro-1-methyl-5-phenyl-3-[(*E,Z*)propylidene]-1*H*-1,4-benzodiazepin-2-one (151)

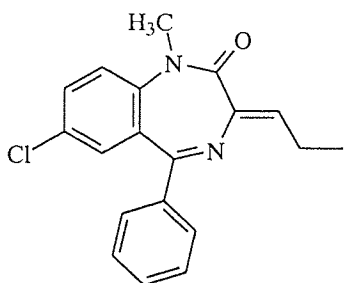

The title product was obtained by the previous described method using the Diazepam anion solution (4 mmol) containing 4 mmol of propionaldehyde, which was stirred for 6 hours at RT. The product obtained was worked up as described before and further purified by column chromatography with toluene/ethyl acetate (2:1) as eluent. Evaporation of the solvent mixture gave 0.378 g (29%) of 3-[(*E,Z*)propylidene]-benzodiazepine.

APCI + m/s: $m/z = 325$ (95%), 241 (5%).

TLC (Ether): $R_f = 0.7$.

IR (KBr) $\nu_{\text{max}} = 3230, 3064, 2965, 1663$ (C=O), 1612, 1480, 1318, 1251, 1125, 825 cm^{-1} .

$^1\text{H-NMR}$ (CDCl_3) δ (p.p.m) 1.15 (tr, 3H, $J=7$ Hz, ($\text{C3:}=\text{CHCH}_2\text{CH}_3$), 2.35 (m, 2H, $\text{C3:}=\text{CHCH}_2\text{CH}_3$), 3.5 (s, 3H, $\text{N1:}-\text{CH}_3$), 5.7 (tr, 1H, $J=7\text{Hz}$, $\text{C3:}=\text{CHCH}_2\text{CH}_3$), 7.2-7.8 (m, 8 arom. H).

$^{13}\text{C-NMR}$ (CDCl_3) δ (p.p.m) 13.4 ($\text{C3:}=\text{CHCH}_2\text{CH}_3$), 20.0 ($\text{C3:}=\text{CHCH}_2\text{CH}_3$), 35.4 ($\text{N1:}-\text{CH}_3$), 122.0, 126.7, 128.8, 129.4, 130.5, 131.2, 137.7, 141.6, 164.2, 167.5.

Preparation of 7-Chloro-1-methyl-5-phenyl-3-[(*E,Z*)-phenylmethylidene]-1*H*-1,4-benzodiazepin-2-one (152)

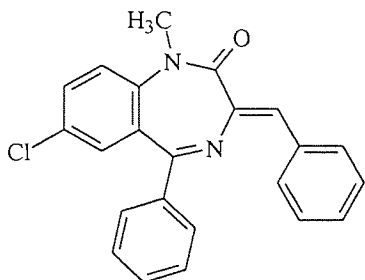

A mixture of the Diazepam anion solution and 0.4 ml of benzaldehyde (4 mmol) in 5 ml of anhydrous THF was stirred at RT for 16 hours. The obtained product was worked up as described before and further purified by column chromatography with ether as eluent to give 640 mg (41%) of the product.

APCI + m/s: $m/z = 373$ (85%), 339 (10%), 285 (5%); TLC (Ether): $R_f = 0.85$.

$^1\text{H-NMR}$ (CDCl_3) δ (p.p.m) 3.4 (s, 3H, N1:- CH_3), 6.7 (s, 1H), 7.2-7.9 (m, 13 arom. H).

$^{13}\text{C-NMR}$ (CDCl_3) δ (p.p.m) 36.5 (N1:- CH_3), 122.5, 128.2, 128.6, 129.3, 129.6, 130.2, 130.8, 131.5, 135.2, 136.4, 138.3, 139.2, 167.3, 170.8.

Large scale solution phase synthesis of 7-chloro-3-propyl-benzodiazepine used as building block for N1-alkylation (Route 1)

Preparation of the starting material 2-bromo-1-chloropentan-1-one

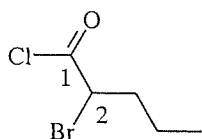

A mixture of 29g (21 ml, 0.16 mol) 2-bromopentanoic acid and 17.5 ml of thionyl chloride (28.5 g, 0.24 mol) was heated on a water bath under reflux. The reaction was completed when the generation of HCl and sulfur dioxide stopped (approximately after 2–3 hr). The excess of thionyl chloride was removed at 25°C in vacuo and the residue was distilled at 15 torr and 70–75°C yielding 25 g (78%) of the product as colourless oil.

APCI + m/s: m/z = 200.

TLC (Ether): $R_f = 0.81$.

d^{20} : 1.5 g/cm³.

n^{20} : 1.48.

¹H-NMR (CDCl₃) δ (p.p.m) 1.0 (m, 3H, C2:-CH₂CH₂CH₃), 1.5-1.95 (br m, 4H, C2:-CH₂CH₂CH₃), 4.25 (tr, 1H, J = 4Hz, C2:-H).

Preparation of N-(2-benzoyl-4-nitrophenyl)-2-bromopentanamide (167)

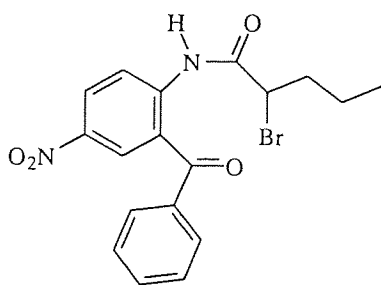

A solution of 50 mmol (12.05 g) of 2-amino-5-nitrobenzophenone and 13.5 ml (0.1 mol) 2-bromo-1-chloropentan-1-one in 100 ml of 1,2-dichloroethane was refluxed for 3-4 hours and the generated HCl was removed with a slow stream of argon bubbling through the reaction mixture. The 2-amino-5-nitrobenzophenone was dissolved in 1,2-dichloroethane under heat (10 min). The yellow colour of the solution gradually faded. The solution was then cooled to 0–5°C and 100 ml of ice-cold dilute sodium hydroxide solution was added (pH of aqueous layer was 8-9). The organic layer was separated, dried (magnesium sulfate), filtered and concentrated in vacuo.

The residue was crystallised twice with 300 ml of a toluene/ethyl acetate (5:1) mixture to give 15.4 g (76%) of the title product.

APCI - m/s: m/z = 405 (80%), 323 (20%).

TLC (Ether): R_f = 0.6.

$^1\text{H-NMR}$ (CDCl_3) δ (p.p.m) 0.98 (tr, 3H, $J=7\text{Hz}$, C2:- $\text{CH}_2\text{CH}_2\text{CH}_3$), 1.4–2.1 (two m, 4H, C2:- $\text{CH}_2\text{CH}_2\text{CH}_3$), 4.46 (tr, 1H, $J=4.5\text{ Hz}$, C2:- H), 7.26–7.75 (m, 5 arom. H), 8.4 (m, 2 arom. H), 8.9 (m, 1 arom. H), 11.7 (s, 1H, N:-H).

$^{13}\text{C-NMR}$ (CDCl_3) δ (p.p.m) 13.1, 20.5, 37.4, 50.4, 121.3, 122.8, 128.9, 129.8, 133.5, 137.1, 141.7, 145.2, 167.4, 197.1.

Preparation of 7-nitro-5-phenyl-3-propyl-1,3-dihydro-2H-1,4-benzodiazepin-2-one (168)

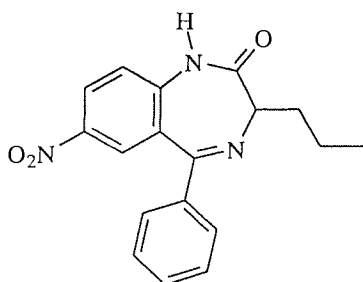

12.1 g (30 mmol) of the precursor and 0.5g of potassium iodide (as catalyst) has been dissolved in 100 ml of liquid ammonia. The mixture was stirred for 5 hours while the ammonia was refluxing (dry ice condenser). After completion, ammonia was evaporated at room temperature overnight. The residue was crystallised in ethanol to give

6 g (62%) of the product.

APCI - m/s: m/z = 323 (55%), 307 (25%), 295 (20%).

TLC (Ether): R_f = 0.56.

mp: 241-245°C.

IR (KBr disc) ν_{max} = 3449, 3338, 1640 (C=O), 1476, 1313, 1297 ($-\text{NO}_2$), 1093, 765 cm^{-1} .

$^1\text{H-NMR}$ (CDCl_3) δ (p.p.m) 0.98 (tr, 3H, $J=7\text{ Hz}$, C3:- $(\text{CH}_2)_2\text{CH}_3$), 1.25-1.9 (m, 4H, C3:- $(\text{CH}_2)_2\text{CH}_3$), 4.13 (tr, 1H, $J = 4\text{Hz}$, C3:- H), 7.2-7.75 (m, 6 arom. H), 7.9 (d, 1 arom. H), 8.1 (d, 1 arom. H), 8.5 (s, 1H, N1:-H).

$^{13}\text{C-NMR}$ ($\text{CDCl}_3/\text{MeOD}$) δ (p.p.m) 14.3 (C3:- $(\text{CH}_2)_2\text{CH}_3$), 21.4, 35.4, 62.8 (C-3), 122.6, 128.5, 129.2, 129.5, 130.6, 131.4, 132.4, 137.3, 164.8, 168.9 172.8.

Preparation of 7-amino-5-phenyl-3-propyl-1,3-dihydro-2H-1,4-benzodiazepin-2-one (169)

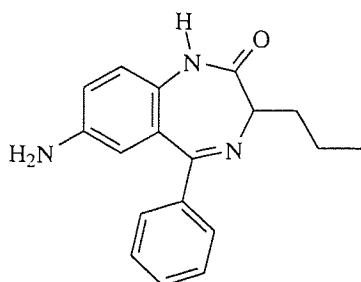

A solution of 10.3 g (32 mmol) of the precursor in 300 ml of ethanol was hydrogenated at 25°C and 1 atm. in the presence of 0.6 g (30% of the molar quantity equal to 7-Nitro-3-propyl-BZD) of wet (ethanol) Raney nickel. The hydrogenation was stopped after the uptake of 2.1 litre (96 mmol) of hydrogen. The solution was filtered from the catalyst and concentrated in vacuo to give yellow needles, which were filtered and recrystallised from ethanol yielding 7.3 g (77%) of the title product.

APCI - m/s: m/z = 293 (80%), 241 (20%).

TLC (Ether): R_f = 0.45.

Mp: 188-194°C.

IR (KBr) ν_{\max} = 3432, 3262, 2960, 2859, 1646 (C=O), 1532, 1498, 1318, 1241, 825 cm^{-1} .

$^1\text{H-NMR}$ (CDCl_3) δ (p.p.m) 0.95 (s, 3H, C3:-(CH_2) $_2$ CH_3), 1.3–1.8 (two m, 4H, C3:-(CH_2) $_2$ CH_3), 3.65 (br s, 2H, C7:- NH_2), 4.12 (m, 1H, C3:- H), 6.8-7.0 (two m, 2H, arom. H), 7.3–7.8 (m, 6 arom. H), 9.45 (s, 1H, N1:-H).

$^{13}\text{C-NMR}$ (CDCl_3) δ (p.p.m) 13.7 (C3:-(CH_2) $_2$ CH_3), 27.3 (C3:- CH_2 CH_2 CH_3), 33.6 (C3:- CH_2 CH_2 CH_3), 65.3 (C-3), 118.6, 120.6, 123.4, 125.1, 128.2, 129.2, 131.6, 138.4, 141.2, 168.2, 171.9.

7-Amino-5-phenyl-3-propyl-1,3,4,5-tetrahydro-2H-1,4-benzodiazepin-2-one (170)

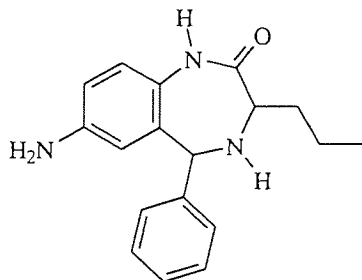

A solution of 0.5 g (1.55 mmol) of 7-nitro-3-propyl-BZD in 15 ml of ethanol was hydrogenated at 25°C and 1 atm. in the presence of 30 mg (0.5 mmol) of wet Raney nickel as previously carried out for compound 169. The reduction was carried out in order to verify this by-product with approximately 4.5 times excess of hydrogen (150 ml of hydrogen, \approx 6.7 mmol) to give the title compound, which was purified by column chromatography or preparative TLC with a toluene/ethyl acetate (4:1) mixture as eluent.

APCI - m/s: m/z = 295 (60%), 241 (40%).

TLC (Ether): R_f = 0.45.

$^1\text{H-NMR}$ (CDCl_3) δ (p.p.m) 1.02 (s, 3H, C3:-(CH_2) $_2$ $\underline{\text{C}}\text{H}_3$), 1.3–2.0 (two m, 4H, C3:-(CH_2) $_2$ $\underline{\text{C}}\text{H}_3$), 3.13 (br s, 2H, C7:- $\underline{\text{N}}\text{H}_2$), 3.95 (m, 1H, C3:- $\underline{\text{H}}$), 6.06 (s, 1H), 6.95 (d, 1H, arom. H), 7.25–7.8 (m, 6 arom. H), 8.05 (d, 1H, arom. H), 10.2 (s, 1H, N1:-H).
 $^{13}\text{C-NMR}$ ($\text{DMSO}-\delta_6$) δ (p.p.m) 15.2 (C3:-(CH_2) $_2$ $\underline{\text{C}}\text{H}_3$), 23.1 (C3:- CH_2 $\underline{\text{C}}\text{H}_2\text{CH}_3$), 65.2, 67.4, 113.2, 119.3, 121.6, 124.3, 125.4, 127.9, 128.2, 130.0, 134.3, 145.8, 172.6.

Preparation of 7-chloro-5-phenyl-3-propyl-1,3-dihydro-2H-1,4-benzodiazepin-2-one (105)

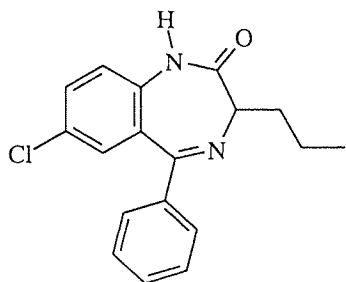

A solution of 22 mmol (6.45 g) of 7-amino-3-propyl-1,3-dihydro-BZD, **173**) in 30 ml of 6N hydrochloric acid was diazotised with an aqueous solution of 25 mmol (1.7g) of sodium nitrite at 0-5°C. The resulting solution was added slowly to 12 g (0.12 mol) of cuprous (I)-chloride dissolved in 120 ml of 3N hydrochloric acid. The mixture was then heated on a water bath for 30 min to complete the liberation of nitrogen. After cooling, the green solid was collected on a filter and dissolved in DCM (100 ml). Copper salts were removed by washing the DCM solution with aqueous ammonia and the almost colourless DCM solution was separated, dried (magnesium sulphate) and filtered. The organic phase was evaporated to give slight yellow coloured oil, which was crystallised from ethanol giving 4.3 g (60%) of the title product.

APCI + m/s: m/z = 313 (80%), 268 (15%), 264 (5%).

mp: 197-199°C.

TLC (Ether): R_f = 0.72.

IR (KBr disc) ν_{max} = 3218, 3123, 2962, 1687 (C=O), 1608, 1480, 1320, 1220, 826 cm^{-1} .

$^1\text{H-NMR}$ (CDCl_3) δ (p.p.m) 0.99 (t; 3H, J=7 Hz, C3:-(CH_2) $_2$ $\underline{\text{C}}\text{H}_3$), 1.3-1.5 (m, 2H, C3:- CH_2 $\underline{\text{C}}\text{H}_2\text{CH}_3$), 2.23 (m, 2H, C3:- $\underline{\text{C}}\text{H}_2\text{CH}_2\text{CH}_3$), 4.08 (tr, 1H, J=5Hz, C3:- $\underline{\text{H}}$), 7.15-7.7 (m, 8 arom. H), 10.3 (s, 1H, N1:-H).

$^{13}\text{C-NMR}$ (CDCl_3) δ (p.p.m) 14.5 (C3:-(CH_2) $_2$ $\underline{\text{C}}\text{H}_3$), 19.3 (C3:- CH_2 $\underline{\text{C}}\text{H}_2\text{CH}_3$), 33.1 (C3:- $\underline{\text{C}}\text{H}_2\text{CH}_2\text{CH}_3$), 63.2 (C3:-(CH_2) $_2$ $\underline{\text{C}}\text{H}_3$), 122.8, 124.9, 129.1, 130.2, 130.8, 131.6, 135.7, 137.4, 168.0, 172.5.

General experimental for the N1-alkylation of 3-propyl-benzodiazepines

A 50 % suspension of sodium hydride in mineral oil (58 mg, 1.2 mmol) was added to a solution of the NH parent template **105** (0.3g, 1 mmol) in 10 ml of dry DMF.

After stirring for 15-30 min at room temperature the mixture was cooled with ice and the alkylating agent (1.2 mmol) was added dropwise to the mixture. The mixture was stirred and allowed to come to room temperature. Generally the reaction was completed after 1-2 hours at room temperature (**Entry 172-177**), whilst the alkylation with electrophiles such as phenethanoyl-, piperidino-, morpholino- and phthalimido derivatives (**Entry 178-180**) was completed after 4-5 hours at 50°C as observed by TLC. The N₁-hydroxymethyl-BZD (**Entry 171**) was obtained by the reaction with formaldehyde.

For work up, water was added and the reaction mixture was extracted with EtOAc (3 times). The combined organic phases were washed with brine, dried (Na₂SO₄) and then concentrated under reduced pressure giving the desired N1-alkylated products, which were further purified by column chromatography or preparative TLC with ether as eluent.

Preparation of 7-chloro-1-(hydroxymethyl)-5-phenyl-3-propyl-1,3-dihydro-2H-1,4-benzodiazepin-2-one (171)

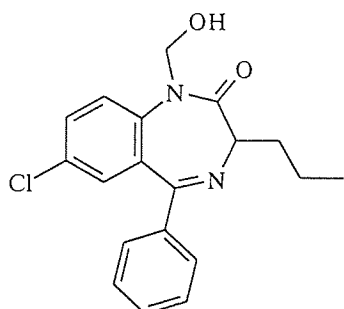

0.31 g of the NH template (1mmol) and sodium hydride (58 mg of a 50% suspension in mineral oil, 1.2 mmol) were stirred in 10 ml of dry DMF under nitrogen. After 30 min, the mixture was cooled to 0-5°C, and an excess of formaldehyde, obtained by thermal decomposition of paraformaldehyde (14 mg, 4.65 mmol) was bubbled through the reaction mixture by a nitrogen stream. After stirring in the cold for 15 min, 20 ml of water was added and the suspension was extracted with EtOAc (3 x 15 ml). The extract was washed with brine, dried (Na₂SO₄), concentrated under reduced pressure and further purified by column chromatography with ether as eluent, giving 264 mg (77%) of the desired compound.

APCI + m/s: m/z = 343 (95%), 313 (5%).

TLC (Ether): R_f = 0.55.

IR (KBr) ν_{\max} = 3420 (OH), 2962, 2869, 1667 (C=O), 1542, 1382, 1320, 1062, 825 cm⁻¹.

¹H-NMR (CDCl₃) δ (p.p.m) 0.99 (t, 3H, J=7Hz, C3:-CH₂CH₂CH₃); 1.2-1.7 (m, 4H, C3:-CH₂CH₂CH₃), 3.3-3.6 (br s, 1H, N1:-CH₂-OH), 4.28 (q, 1H, C3:-H), 7.0-7.5 (m, 8 arom. H).

¹³C-NMR (CDCl₃) δ (p.p.m) 14.3 (C3:-CH₂CH₂CH₃), 17.9 (C3:-CH₂CH₂CH₃), 29.1 (C3:-CH₂CH₂CH₃), 68.2 (C-3), 96.0 (N1:-CH₂-OH), 121.5, 128.3, 128.5, 128.9, 130.4, 130.6, 132.2, 139.0, 141.8, 166.8, 169.3.

7-Chloro-1-(2-hydroxyethyl)-5-phenyl-3-propyl-1,3-dihydro-2H-1,4-benzodiazepin-2-one (172)

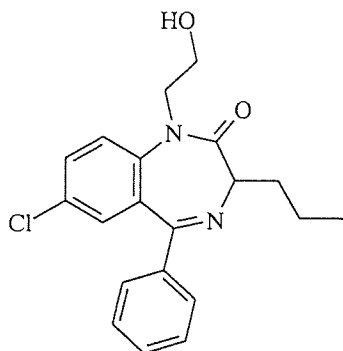

APCI + m/s: m/z = 357 (65%), 313 (35%).

TLC (Ether): R_f = 0.6.

IR (KBr) ν_{\max} = 3428 (OH), 2954, 2867, 1675 (C=O), 1579, 1405, 1326, 1076, 823, 676 cm⁻¹.

¹H-NMR (CDCl₃) δ (p.p.m) 0.97 (t, 3H, J=7Hz, C3:-CH₂CH₂CH₃), 1.1-2.3 (m, 4H, C3:-CH₂CH₂CH₃), 3.53 (tr, 2H), 3.8-4.0 (m, 3H, N1:-CH₂-CH₂-OH), 4.2 (m, 1H, C3:-H), 7.2-7.6 (m, 8 arom. H).

¹³C-NMR (CDCl₃) δ (p.p.m) 14.5 (C3:-CH₂CH₂CH₃), 19.3, 33.4 (C3:-CH₂CH₂CH₃), 51.5, 61.2 (C-3), 102.4, 124.3, 128.4, 129.4, 130.5, 131.4, 136.8, 141.8, 168.2, 170.1.

7-Chloro-1-(3-hydroxypropyl)-5-phenyl-3-propyl-1,3-dihydro-2H-1,4-benzodiazepin-2-one (173)

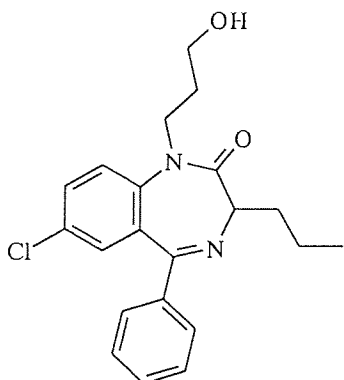

APCI + m/s: m/z = 371 (90%), 313 (10%).

TLC (Ether): R_f = 0.7.

IR (KBr) ν_{\max} = 3461 (OH), 2930, 2835, 1669 (C=O), 1579, 1415, 1313, 1039, 801, 715, 699 cm⁻¹.

¹H-NMR (CDCl₃) δ (p.p.m) 1.0 (t, 3H, J=7Hz, C3:-CH₂CH₂CH₃), 1.2-2.4 (m, 6H), 3.1-3.8 (m, 4H), 4.5 (m, 1H, C3:-H), 7.25-7.55 (m, 8 arom. H).

¹³C-NMR (CDCl₃) δ (p.p.m) 14.1 (C3:-CH₂CH₂CH₃), 19.3 (C3:-CH₂CH₂CH₃), 30.8, 33.5 (C3:-CH₂CH₂CH₃), 58.2, 63.5 (C-3), 97.2, 123.8, 128.4, 129.3, 130.2, 131.2, 136.2, 141.8, 167.4, 170.0 p.p.m.

2-(7-Chloro-2-oxo-5-phenyl-3-propyl-2,3-dihydro-1H-1,4-benzodiazepin-1-yl)acetamide (174)

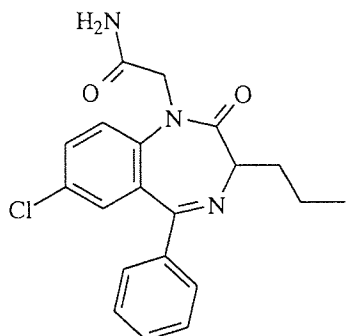

APCI + m/s: m/z = 370 (90%), 313 (5%), 279 (5%).

TLC (Ether): R_f = 0.45.

IR (KBr) ν_{max} = 3405, 2955, 2869, 1723 (C=O), 1463, 1278, 1128, 1069, 740, 690 cm⁻¹.

¹H-NMR (CDCl₃) δ (p.p.m) 0.99 (t, 3H, J=7Hz,

C3:-CH₂CH₂CH₃), 1.3-1.8 (m, 4H, C3:-CH₂CH₂CH₃), 4.2

(s, 2H, N1:-CH₂-CO-NH₂), 4.55 (m, 1H, C3:-H), 5.82+6.45 (2 s, 2H, N1:-CH₂-CONH₂), 7.25-7.7 (m, 8 arom. H).

¹³C-NMR (CDCl₃) δ (p.p.m) 13.9 (C3:-CH₂CH₂CH₃), 22.9 (C3:-CH₂CH₂CH₃), 28.9

(C3:-CH₂CH₂CH₃), 57.1 (N1:-CH₂-CO-NH₂), 65.3 (C3:-H), 126.4, 128.2, 128.6, 129.5, 130.4, 130.8, 131.2, 131.6, 135.0, 139.4, 141.2, 167.7, 170.6, 192.3 (N1:-CH₂-CO-NH₂).

Ethyl 2-(7-chloro-2-oxo-5-phenyl-3-propyl-2,3-dihydro-1H-1,4-benzodiazepin-1-yl)acetate (175)

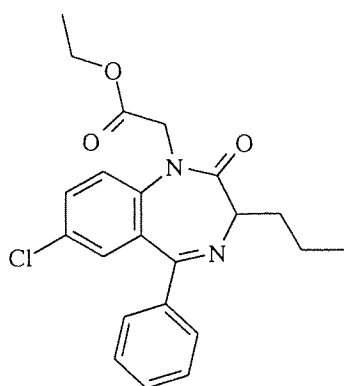

APCI + m/s: m/z = 399 (90%), 313 (5%), 268 (5%).

TLC (Ether): R_f = 0.65.

IR (KBr) ν_{max} = 2958, 2865, 1717, 1677 (C=O), 1580, 1461, 1268, 1201, 1069, 823 cm⁻¹.

¹H-NMR (CDCl₃) δ (p.p.m) 0.9-1.1 (m, 6H, C3:-CH₂)₂CH₃+ N1:-CH₂-CO₂CH₂CH₃), 1.2-1.85 (m, 4H, C3:-CH₂CH₂CH₃),

4.15 (m, 4H, N1:-CH₂-CO₂CH₂CH₃), 4.5 (q, 1H, J=5Hz,

C3:-H), 7.25-7.8 (m, 8 arom. H).

¹³C-NMR (CDCl₃) δ (p.p.m) 13.2 (N1:-CH₂-CO₂CH₂CH₃), 14.0 (C3:-CH₂CH₂CH₃), 19.6

(C3:-CH₂CH₂CH₃), 33.6 (C3:-CH₂CH₂CH₃), 49.2 (N1:-CH₂-CO₂CH₂CH₃), 61.5, 63.8,

122.8, 128.6, 128.9, 129.4, 130.6, 131.3, 136.4, 140.2, 166.9, 169.8.

7-Chloro-1-(3,3-dimethyl-2-oxobutyl)-5-phenyl-3-propyl-1,3-dihydro-2H-1,4-benzodiazepin-2-one (176)

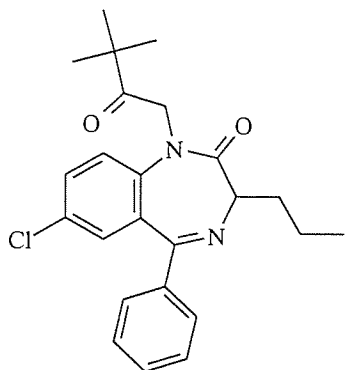

APCI + m/s: $m/z = 411$ (90%), 313 (5%), 268 (5%).

TLC (Ether): $R_f = 0.75$.

IR (KBr) $\nu_{\max} = 2957, 2875, 1717, 1675, 1598, 1482, 1283, 1121, 1069, 736, 690 \text{ cm}^{-1}$.

$^1\text{H-NMR}$ (CDCl_3) δ (p.p.m) 0.8-1.05 (m, 12H, C3:- $\text{CH}_2\text{CH}_2\text{CH}_3$ +N1:- $\text{CH}_2\text{-COC}(\text{CH}_3)_3$, 1.4-1.9 (m, 4H, C3:- $\text{CH}_2\text{CH}_2\text{CH}_3$), 4.25 (s, 2H, N1:- $\text{CH}_2\text{-COC}(\text{CH}_3)_3$), 4.45 (tr, 1H, $J=6.5\text{Hz}$, C3:- H), 7.0 - 7.75 (m, 8 arom. H).

$^{13}\text{C-NMR}$ (CDCl_3) δ (p.p.m) 13.9 (C3:- $\text{CH}_2\text{CH}_2\text{CH}_3$), 19.6 (C3:- $\text{CH}_2\text{CH}_2\text{CH}_3$), 26.4

(N1:- $\text{CH}_2\text{-COC}(\text{CH}_3)_3$), 33.5 (C3:- $\text{CH}_2\text{CH}_2\text{CH}_3$), 53.3 (N1:- $\text{CH}_2\text{-COC}(\text{CH}_3)_3$), 63.8 (C3:- H), 122.3, 128.2, 128.9, 129.6, 130.5, 131.2, 136.8, 141.7, 167.2, 169.3, 209.4 (N1:- $\text{CH}_2\text{-COC}(\text{CH}_3)_3$).

7-Chloro-1-(2-oxo-2-phenylethyl)-5-phenyl-3-propyl-1,3-dihydro-2H-1,4-benzodiazepin-2-one (177)

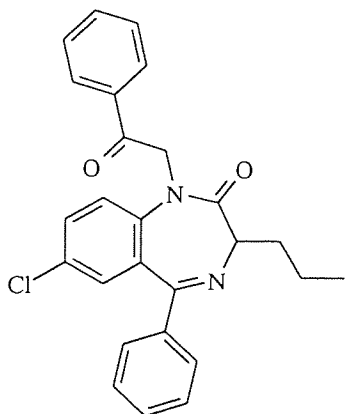

APCI + m/s: $m/z = 431$ (80%), 313 (10%), 279 (10%).

TLC (Ether): $R_f = 0.8$.

IR (KBr) $\nu_{\max} = 2969, 2871, 1717, 1688, 1598, 1465, 1255, 1116, 1076, 740, 693 \text{ cm}^{-1}$.

$^1\text{H-NMR}$ (CDCl_3) δ (p.p.m) 1.0 (t, 3H, $J=7\text{Hz}$, C3:- $(\text{CH}_2)_2\text{CH}_3$); 1.25-1.9 (m, 4H, C3:- $(\text{CH}_2\text{CH}_2\text{CH}_3)$), 4.27 (m, 3H, C3:- H +N1:- $\text{CH}_2\text{-CO-Ph}$), 7.0-8.0 (m, 13 arom. H).

$^{13}\text{C-NMR}$ (CDCl_3) δ (p.p.m) 14.1 (C3:- $\text{CH}_2\text{CH}_2\text{CH}_3$), 22.3 (C3:- $\text{CH}_2\text{CH}_2\text{CH}_3$), 32.5

(C3:- $\text{CH}_2\text{CH}_2\text{CH}_3$), 53.3 (N1:- $\text{CH}_2\text{-CO-Ph}$), 63.8 (C-3), 123.2, 128.1, 128.7, 129.1, 130.9, 131.2, 131.5, 135.2, 136.9, 137.3, 139.9, 167.9, 169.0, 191.5 (N1:- $\text{CH}_2\text{-CO-Ph}$).

7-Chloro-5-phenyl-1-(2-piperidin-1-ylethyl)-3-propyl-1,3-dihydro-2H-1,4-benzodiazepin-2-one (178)

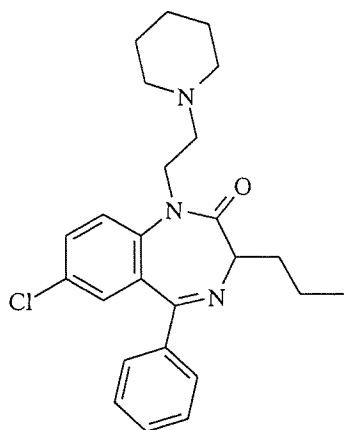

APCI + m/s: $m/z = 424$.

TLC (Ether): $R_f = 0.7$.

IR (KBr) $\nu_{\max} = 3443, 2928, 2866, 1675$ (C=O), 1476, 1315, 1112, 699 cm^{-1} .

$^1\text{H-NMR}$ (CDCl_3) δ (p.p.m) 0.95 (tr, 3H, $J=7\text{Hz}$, C3:- $\text{CH}_2\text{CH}_2\text{CH}_3$), 1.1-1.9 (m, 10H, N1:- $\text{CH}_2\text{-CH}_2\text{-Pi-}\beta,\gamma\text{-H}$ + C3:- $\text{CH}_2\text{CH}_2\text{CH}_3$), 2.1-2.4 (m, 2H), 2.65-2.8 (m, 4H, N1:- $\text{CH}_2\text{-CH}_2\text{-Pi-}\alpha\text{-H}$), 3.46 (m, 1H), 3.95 (m, 1H), 4.41 (m, 1H, C3:- H), 7.25-7.60 (m, 8 arom. H).

$^{13}\text{C-NMR}$ (CDCl_3) δ (p.p.m) 14.1 (C3:- $\text{CH}_2\text{CH}_2\text{CH}_3$), 19.2 (C3:- $\text{CH}_2\text{CH}_2\text{CH}_3$), 22.3, 25.4, 30.8, 33.9 (C3:- $\text{CH}_2\text{CH}_2\text{CH}_3$), 47.3, 53.9, 58.2, 63.5 (C3:- H), 127.3, 128.1, 130.4, 130.7, 131.4, 136.5, 141.5, 167.4, 169.6.

7-Chloro-1-(2-morpholin-4-ylethyl)-5-phenyl-3-propyl-1,3-dihydro-2H-1,4-benzodiazepin-2-one (179)

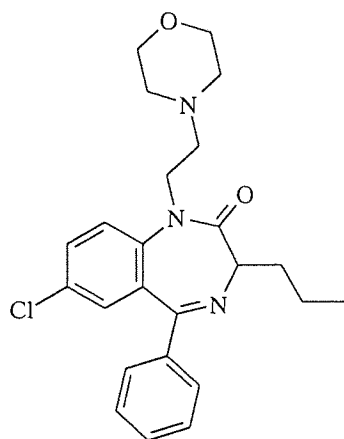

APCI + m/s: $m/z = 426$.

TLC (Ether): $R_f = 0.75$.

IR (KBr) $\nu_{\max} = 3432, 2954, 2853, 1675$ (C=O), 1476, 1320, 1118, 817, 695 cm^{-1} .

$^1\text{H-NMR}$ (CDCl_3) δ (p.p.m) 0.97 (tr, 3H, $J=7\text{Hz}$, C3:- $(\text{CH}_2)_2\text{CH}_3$), 1.2-1.65 (m, 4H, C3:- $(\text{CH}_2)_2\text{CH}_3$), 2.1-2.55 (m, 8H, N:- $(\text{CH}_2)_2\text{-Mo-}\alpha,\beta\text{-H}$), 3.45 (m, 4H, N:- $(\text{CH}_2)_2\text{-Mo}$), 4.38 (m, 1H, C3:- H), 7.25-7.65 (m, 8 arom. H).

$^{13}\text{C-NMR}$ (CDCl_3) δ (p.p.m) 14.1 (C3:- $\text{CH}_2\text{CH}_2\text{CH}_3$), 19.3 (C3:- $\text{CH}_2\text{CH}_2\text{CH}_3$), 33.5 (C3:- $\text{CH}_2\text{CH}_2\text{CH}_3$), 43.2, 53.9, 55.2, 63.3, (C-3), 66.8, 123.4, 128.2, 129.6, 130.4, 131.2, 136.5, 140.8, 166.3, 169.3.

Preparation of 2-[3-(7-chloro-2-oxo-5-phenyl-3-propyl-2,3-dihydro-1H-1,4-benzodiazepin-1-yl)propyl]-1H-isoindole-1,3(2H)-dione (180)

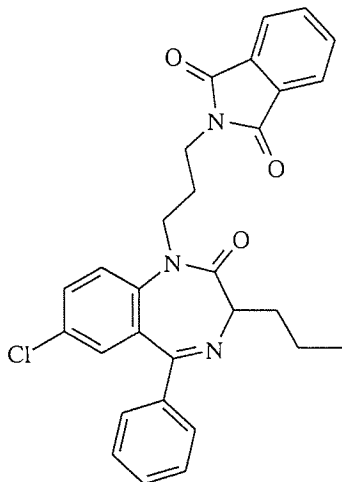

A 50 % suspension of sodium hydride in mineral oil (58 mg, 1.2 mmol) was added portionwise to a solution of the parent template (0.31 g, 1mmol) in DMF (7 ml). After stirring for 30 min at room temperature N-(3-bromopropyl)-phthalimide (333 mg, 1.2 mmol) in 3 ml DMF was added dropwise to the mixture and the reaction temperature was increased to 50°C. After stirring for 5 hours, water was added and the suspension was extracted with EtOAc. The extract was washed with brine, dried (Na₂SO₄), concentrated under

reduced pressure and further purified by column chromatography and preparative TLC with ether as eluent giving 160 mg (32%) of the desired product.

APCI + m/s: m/z = 500 (75%), 313 (20%), 268 (5%).

TLC (Ether): R_f = 0.8.

IR (KBr) ν_{\max} = 3467, 2960, 2869, 1771, 1710, 1677, 1602, 1462, 1372, 1037 cm⁻¹.

¹H-NMR (CDCl₃) δ (p.p.m) 0.98 (tr, 3H, J=7Hz, C3:-CH₂CH₂CH₃), 1.1-2.4 (m, 6H, C3:-CH₂CH₂CH₃)+N1:-CH₂-CH₂-CH₂-Phth), 3.4-3.95 (m, 4H), 4.45 (m, 1H, C3:-H), 7.1-7.9 (m, 12 arom. H).

¹³C-NMR (CDCl₃) δ (p.p.m) 14.1 (C3:-CH₂CH₂CH₃), 19.3 (C3:-CH₂CH₂CH₃), 33.5, 35.5, 44.8, 51.9, 63.4 (C3:-H), 123.3, 128.7, 129.6, 129.9, 130.2, 131.4, 131.9, 133.6, 136.2, 142.1, 166.5, 169.2.

Large scale solution phase synthesis of 7-chloro-3-propyl-benzodiazepine used as building block for N1-alkylation (Route 2)

Preparation of the starting material (2-amino-5-chlorophenyl)(phenyl)methanone oxime (182)

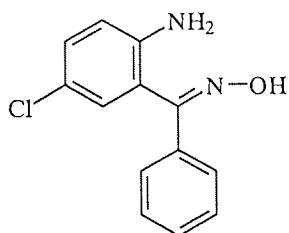

A solution of 18.5 g (80 mmol) of 2-amino-5-chloro-benzophenone and 11.2 g (160 mmol) of hydroxylamine hydrochloride in a mixture of 120 ml ethanol and 15 ml pyridine (10% excess) was stirred and refluxed for 72 hours. The solvent was removed by distillation under reduced pressure to a small volume and the residue was partitioned between water and ether. The organic phase was washed with water, dried over anhydrous sodium sulfate, and concentrated to dryness. Warming the residue with toluene gave 15.2 g crystalline oxime, 77% yield. Recrystallisation from a mixture of ethyl acetate and hexane gave light yellow crystals, mp 151-153°C.

APCI + m/s: m/z = 247 (30%), 231 (70%).

TLC (Ether): $R_f = 0.5$.

IR (KBr) $\nu_{\max} = 3428, 3343, 3179, 3045, 2859, 1629, 1490, 1253, 1148, 992, 693 \text{ cm}^{-1}$.

$^1\text{H-NMR}$ (DMSO- δ_6) δ (p.p.m) 4.79 (s, 2H, C2:-NH₂), 6.8 (m, 2 arom. H), 7.15 (s, 1 arom. H), 7.35–7.45 (m, 5H, phenyl-H), 11.5 (s, 1H, =N-OH).

$^{13}\text{C-NMR}$ (DMSO- δ_6) δ (p.p.m) 117.8, 121.1, 127.2, 128.9, 129.4, 129.6, 136.2, 144.9, 153.7 (C=NOH).

Preparation of the starting material 2-bromo-1-chloropentan-1-one

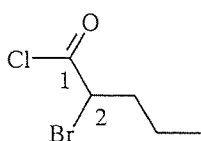

The title product (25g, 76%) was prepared as colourless oil as described in the previous section using 30 g (21.7 ml, 0.165 mol) of 2-bromopentanoic acid and 18.5 ml of thionyl chloride (30 g, 0.25 mol). The substrates were gently refluxed for 3 hours. Excess of thionyl chloride has been removed in vacuo and the residue was distilled under reduced pressure.

APCI + m/s: $m/z = 200$.

TLC (Ether): $R_f = 0.81$.

d^{20} : 1.5 g/cm³.

n^{20} : 1.48.

¹H-NMR (CDCl₃) δ (p.p.m) 1.0 (m, 3H, C2:-CH₂CH₂CH₃), 1.5-1.95 (br m, 4H, C2:-CH₂CH₂CH₃), 4.25 (tr, 1H, J = 4Hz, C2:-H).

Preparation of 2-bromo-N-{4-chloro-2-[(hydroxyimino)(phenyl)methyl] phenyl} pentanamide (183)

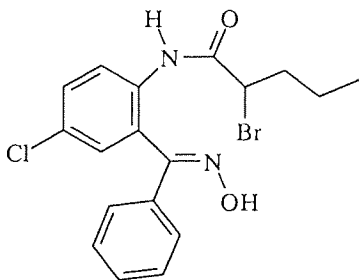

A solution of 13 g (53 mmol) of the starting material **182** and 13.5 ml (20 g, 0.1 mol) of 2-bromo-1-chloropentan-1-one in 100 ml of 1,2-dichloroethane was refluxed for 4 hours. Most of the hydrogen chloride formed was expelled by an argon inlet stream through the reaction mixture. The solution was then cooled to 0-5°C and 100 ml of a mixture of ice-cold dilute sodium hydroxide solution and water was added (pH of aqueous layer was 8-9). The organic layer was separated, dried (magnesium sulfate), filtered and concentrated in vacuo. The crystalline residue was recrystallised with 50 ml of toluene giving 18.1 g (83%) of the title product as a slightly yellow coloured crystals.

APCI + m/s: $m/z = 393$ (50%, fragmentation, minus OH), 329 (30%), 313 (20%).

TLC (Ether): $R_f = 0.7$.

IR (KBr) $\nu_{\max} = 3378$ (OH), 2962, 2857, 1721 (C=O), 1513, 1384, 1285, 1120, 1071, 695 cm⁻¹.

$^1\text{H-NMR}$ (CDCl_3) δ (p.p.m) 1.0 (m, 3H, $J=7\text{Hz}$, C2:- $\text{CH}_2\text{CH}_2\text{CH}_3$), 1.25–2.0 (m, 4H, C2:- $(\text{CH}_2)_2\text{CH}_3$), 4.25 (m, 1H, C2:- H), 7.0–8.0 (m, 7 arom. H), 10.1 (s, 1H, N:-H).

Preparation of 7-chloro-2-oxo-5-phenyl-3-propyl-2,3-dihydro-1H-1,4-benzodiazepin-4-ium-4-olate (184)

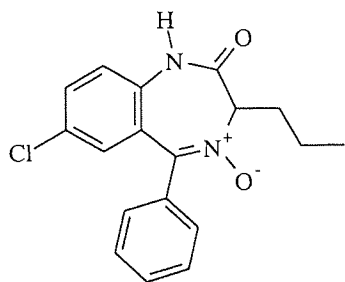

The solution of the precursor **183** (16.4 g, 40 mmol) in a mixture of 300 ml ethanol and 90 ml of 2N sodium hydroxide (pH 11–12) was stirred overnight at 35–40°C. Sodium chloride was added and the solution was cooled to 0–5°C. The title compound precipitated and was filtered off.

The chemically pure reaction product (6.8 g, 52% yield) was dried in a vacuum oven at 80°C overnight and was directly used for subsequent reactions.
APCI + m/s: m/z = 329 (80%), 313 (20%).

TLC (Ether): $R_f = 0.45$.

IR (KBr) $\nu_{\text{max}} = 3189, 3070, 2935, 1694$ (C=O), 1486, 1321, 1238 (N-oxide), 825 cm^{-1} .

$^1\text{H-NMR}$ (CDCl_3) δ (p.p.m) 1.0 (tr, 3H, $J=7$ Hz, C3:- $(\text{CH}_2)_2\text{CH}_3$), 1.3–1.6 (m, 2H, C3:- $\text{CH}_2\text{CH}_2\text{CH}_3$), 2.1+2.5 (two br s, 2H, C3:- $\text{CH}_2\text{CH}_2\text{CH}_3$), 4.32 (tr, 1H, $J = 5\text{Hz}$, C3:- H), 7.0–7.6 (m, 8 arom. H), 10.1 (s, 1H, N1:-H).

$^{13}\text{C-NMR}$ (CDCl_3) δ (p.p.m) 14.0 (C3:- $(\text{CH}_2)_2\text{CH}_3$), 19.4 (C3:- $\text{CH}_2\text{CH}_2\text{CH}_3$), 36.9 (C3:- $\text{CH}_2\text{CH}_2\text{CH}_3$), 69.6 (C3:- $(\text{CH}_2)_2\text{CH}_3$), 123.2, 128.1, 129.9, 130.1, 130.5, 130.8, 131.5, 135.0, 136.4, 165.4, 170.1.

Preparation of 7-chloro-5-phenyl-3-propyl-1,3-dihydro-2H-1,4-benzodiazepin-2-one
(105)

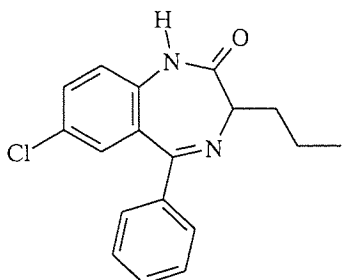

To a suspension of 6.6 g (20 mmol) of 3-propyl-BZD 4 N-oxide (**184**) in 100 ml of chloroform, 5.3 ml (8.4 g, 61 mmol) of phosphorus trichloride was added. The mixture was stirred and refluxed for 1 hour. After cooling to 0-5°C, 100 ml of 10% potassium hydroxide solution and ice were added. The mixture was then stirred for additional 30 min energetically. The organic phase was separated and concentrated in vacuo. The residue was partitioned between chloroform and ice-cold 5% sodium bicarbonate solution. The organic layer was dried (magnesium sulfate), filtered and concentrated in vacuo to dryness giving 5.9 g (94%) of the title product. The product was dried at 60°C under reduced pressure overnight and was directly used for alkylation reactions.

APCI + m/s: m/z = 313 (80%), 268 (15%), 264 (5%).

TLC (Ether): $R_f = 0.72$.

IR (KBr disc) $\nu_{\max} = 3218, 3123, 2962, 1687$ (C=O), 1608, 1480, 1320, 1220, 826 cm^{-1} .

$^1\text{H-NMR}$ (CDCl_3) δ (p.p.m) 0.99 (tr, 3H, $J=7$ Hz, C3:-(CH_2) $_2$ CH $_3$), 1.3-1.5 (m, 2H, C3:- CH_2 CH $_2$ CH $_3$), 2.23 (m, 2H, C3:- CH_2 CH $_2$ CH $_3$), 4.08 (t, 1H, $J=5$ Hz, C3:-H), 7.15-7.7 (m, 8 arom. H), 10.3 (s, 1H, N1:-H).

$^{13}\text{C-NMR}$ (CDCl_3) δ (p.p.m) 14.5 (C3:-(CH_2) $_2$ CH $_3$), 19.3 (C3:- CH_2 CH $_2$ CH $_3$), 33.1 (C3:- CH_2 CH $_2$ CH $_3$), 63.2 (C3:-(CH_2) $_2$ CH $_3$), 122.8, 124.9, 129.1, 130.2, 130.8, 131.6, 135.7, 137.4, 168.0, 172.5.

General experimental for the N1-alkylation of 3-propyl-benzodiazepines

A 50 % suspension of sodium hydride in mineral oil (58 mg, 1.2 mmol) was added to a solution of the NH parent template **105** (0.31 g, 1 mmol) in 10 ml of dry DMF. After stirring for 15-30 min at room temperature the mixture was cooled with ice and the alkylating agent (1.2 mmol) was added dropwise to the mixture. The mixture was stirred and allowed to come to room temperature. Generally the reaction was completed after 2 hours at room temperature for aryl bromides (**Entry 194, 195**) and after 0.5-1 hours for alkyl bromides (**Entry 187–193**). For work up, water was added and the reaction mixture was extracted with EtOAc (3 times). The combined organic phases were washed with brine, dried (Na_2SO_4) and then concentrated under reduced pressure giving the N1-alkylated products, which were further purified by column chromatography or preparative TLC with ether as eluent.

7-Chloro-1-ethyl-5-phenyl-3-propyl-1,3-dihydro-2H-1,4-benzodiazepin-2-one (187)

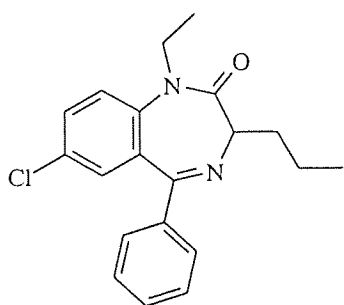

APCI + m/s: $m/z = 343$ (90%), 268 (10%).

TLC (Ether): $R_f = 0.80$.

IR (KBr) $\nu_{\max} = 2990, 2863, 1723, 1673, 1602, 1482, 1255, 1124, 1080, 693 \text{ cm}^{-1}$.

$^1\text{H-NMR}$ (CDCl_3) δ (p.p.m) 1.01 (tr, 3H, $J=7 \text{ Hz}$, C3:-(CH_2) $_2$ CH $_3$), 1.35-1.50 (m, 5H, C3:-(CH_2 CH $_2$ CH $_3$ + N1:-CH $_2$ CH $_3$), 2.23 (m, 2H, C3:-CH $_2$ CH $_2$ CH $_3$), 3.65 (q, 2H, N1:-CH $_2$ CH $_3$); 4.33 (t, 1H, $J = 5 \text{ Hz}$, C3:-H), 7.2-7.87 (m, 8 arom. H).

$^{13}\text{C-NMR}$ (CDCl_3) δ (p.p.m) 13.3, 14.1, 22.9 (C3:-CH $_2$ CH $_2$ CH $_3$), 28.2 (N1:-CH $_2$ -CH $_3$), 35.0 (C3:-CH $_2$ CH $_2$ CH $_3$), 68.0 (C-3), 122.6, 128.5, 129.5, 130.8, 131.3, 138.1, 141.2, 167.7, 171.7.

7-Chloro-5-phenyl-1,3-dipropyl-1,3-dihydro-2H-1,4-benzodiazepin-2-one (188)

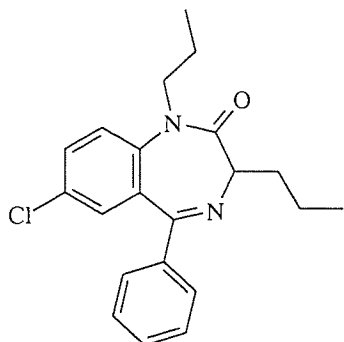

APCI + m/s: $m/z = 356$ (95%), 268 (5%).

TLC (Ether): $R_f = 0.85$.

IR (KBr) $\nu_{\max} = 2973, 2908, 1714, 1681, 1457, 1251, 1112, 1070, 738 \text{ cm}^{-1}$.

$^1\text{H-NMR}$ (CDCl_3) δ (p.p.m) 0.73 (tr, 3H, N1:-(CH_2) $_2$ CH $_3$), 1.0 (tr, 3H, $J=7$ Hz, C3:-(CH_2) $_2$ CH $_3$), 1.43-1.7 (m, 6H), 3.48 (m, 2H, N1:-CH $_2$ CH $_2$ CH $_3$), 4.25 (m, 1H, C3:-H), 7.26-7.87 (m, 8 arom. H).

$^{13}\text{C-NMR}$ (CDCl_3) δ (p.p.m) 10.8, 14.1, 19.3, 22.9, 48.4 (N1:-CH $_2$ CH $_2$ CH $_3$), 63.5 (C3:-H), 123.7, 128.4, 128.7, 130.3, 130.8, 132.4, 140.9, 166.9, 167.7.

1-Butyl-7-chloro-5-phenyl-3-propyl-1,3-dihydro-2H-1,4-benzodiazepin-2-one (189)

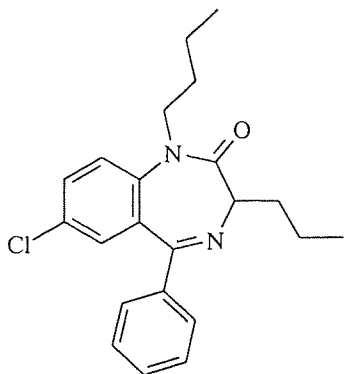

APCI + m/s: $m/z = 369$ (90%), 279 (10%).

TLC (Ether): $R_f = 0.85$.

IR (KBr) $\nu_{\max} = 2924, 2867, 1717, 1683, 1461, 1283, 1121, 740, 695 \text{ cm}^{-1}$.

$^1\text{H-NMR}$ (CDCl_3) δ (p.p.m) 0.95-1.9 (m, 14H, C3:-(CH_2) $_2$ CH $_3$ + N1:-CH $_2$ CH $_2$ CH $_2$ CH $_3$), 4.1-4.3 (m, 3H, C3:-H + N1:-CH $_2$ (CH $_2$) $_2$ CH $_3$), 7.25-7.7 (m, 8 arom. H).

$^{13}\text{C-NMR}$ (CDCl_3) δ (p.p.m) 13.5, 13.9, 19.3, 19.6, 28.8, 38.6, 68.1 (C3:-H), 123.7, 128.3, 128.7, 129.3, 130.8, 132.4, 139.1, 140.5, 167.7, 169.7.

1-(*sec*-Butyl)-7-chloro-5-phenyl-3-propyl-1,3-dihydro-2*H*-1,4-benzodiazepin-2-one
(190)

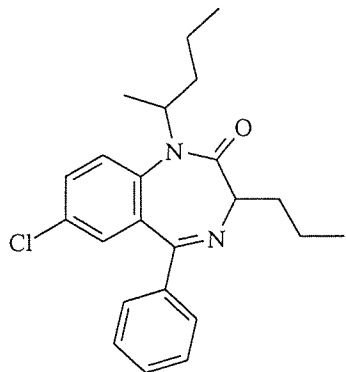

APCI + m/s: m/z = 369 (90%), 313 (10%).

TLC (Ether): R_f = 0.85.

IR (KBr) ν_{\max} = 2955, 2857, 1737 (C=O), 1683, 1461, 1378, 1272, 1116, 1069, 960, 740, 695 cm⁻¹.

¹H-NMR (CDCl₃) δ (p.p.m) 0.85-1.9 (m, 15H, C3:-(CH₂)₂CH₃ + N1:-CH(CH₃)CH₂CH₃), 4.2 (m, 2H, C3:-H + N1:-CH(CH₃)CH₂CH₃), 7.3-7.7 (m, 8 arom. H).

¹³C-NMR (CDCl₃) δ (p.p.m) 11.5, 14.1, 18.7, 19.4, 28.8, 30.3, 38.6, 67.9 (C-3), 128.3, 128.7, 129.1, 130.4, 130.8, 132.4, 138.1, 140.9, 167.6, 169.1.

Preparation of 1-allyl-7-chloro-5-phenyl-3-propyl-1,3-dihydro-2*H*-1,4-benzodiazepin-2-one (191)

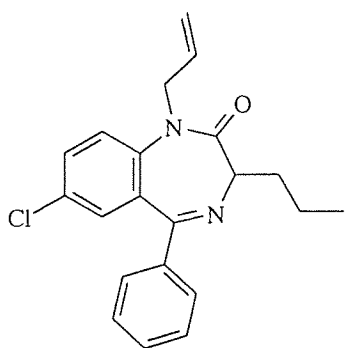

A 50 % suspension of sodium hydride in mineral oil (58 mg, 1.2 mmol) was added portionwise to a solution of the NH template **105** (0.31 g, 1mmol) in 10 ml of DMF. After stirring for 30 min at room temperature 0.1 ml of allyl bromide (145 mg, 1.2 mmol) was added dropwise to the mixture. After stirring for 1 hour, water was added and the suspension was extracted with EtOAc. The extract was washed with brine,

dried (Na₂SO₄), concentrated under reduced pressure and further purified by column chromatography with ether as eluent giving 380 mg (90%) of the desired product.

APCI + m/s: m/z = 353.

TLC (Ether): R_f = 0.85.

IR (KBr) ν_{\max} = 3062, 2954, 2867, 1671 (C=O), 1602, 1557, 1482, 1403, 14, 1197, 1131, 921 cm⁻¹.

$^1\text{H-NMR}$ (CDCl_3) δ (p.p.m) 0.73 (t, 3H, $\text{N1:-(CH}_2\text{CH}_2\text{CH}_3)$), 1.01 (t; 3H, $J=7$ Hz, $\text{C3:-(CH}_2\text{)}_2\text{CH}_3$), 1.25-1.9 (m, 4H, $\text{C3:-(CH}_2\text{CH}_2\text{CH}_3)$), 3.52 (m, 2H, $\text{N1:-(CH}_2\text{CH=CH}_2)$), 4.56 (m, 1H, C3:-H), 5.06-5.13 (m, 2H, $\text{N1:-(CH}_2\text{CH=CH}_2)$), 5.8-5.85 (m, 1H, $\text{N1:-(CH}_2\text{CH=CH}_2)$), 7.25-7.6 (m, 8 arom. H).

$^{13}\text{C-NMR}$ (CDCl_3) δ (p.p.m) 14.2 ($\text{C3:-(CH}_2\text{CH}_2\text{CH}_3)$), 19.3, 33.6, 50.1, 63.5 (C-3), 117.1 ($\text{N1:-(CH}_2\text{CH=CH}_2)$), 123.3, 129.4, 129.8, 130.4, 131.3, 131.8, 132.9, 138.2, 141.2, 167.1, 169.4.

7-Chloro-5-phenyl-3-propyl-1-prop-2-ynyl-1,3-dihydro-2H-1,4-benzodiazepin-2-one (192)

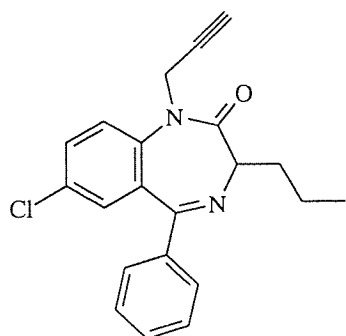

APCI + m/s: $m/z = 351$.

TLC (Ether): $R_f = 0.87$.

IR (KBr) $\nu_{\text{max}} = 3295, 2954, 2867, 2270$ ($\text{C}\equiv\text{C}$), 1691 (C=O), 1478, 1407, 1324, 1193 cm^{-1} .

$^1\text{H-NMR}$ (CDCl_3) δ (p.p.m) 1.01 (tr, 3H, $J=7$ Hz, $\text{C3:-(CH}_2\text{)}_2\text{CH}_3$), 1.2-1.8 (m, 4H, $\text{C3:-(CH}_2\text{CH}_2\text{CH}_3)$), 2.35 (m, 1H, $\text{N1:-(CH}_2\text{C}\equiv\text{CH)}$), 4.0-4.5 (m, 3H, $\text{C3:-H+N1:-(CH}_2\text{C}\equiv\text{CH)}$), 7.25-8.0 (m, 8 arom. H).

$^{13}\text{C-NMR}$ (CDCl_3) δ (p.p.m) 10.1 ($\text{C3:-(CH}_2\text{)}_2\text{CH}_3$), 19.3 ($\text{C3:-(CH}_2\text{CH}_2\text{CH}_3)$), 33.5, 36.8, 63.3 (C-3), 72.1, 122.9, 128.3, 129.5, 129.8, 130.5, 131.1, 138.2, 140.5, 167.3, 169.6.

2-(7-Chloro-2-oxo-5-phenyl-3-propyl-2,3-dihydro-1H-1,4-benzodiazepin-1-yl)acetonitrile (193)

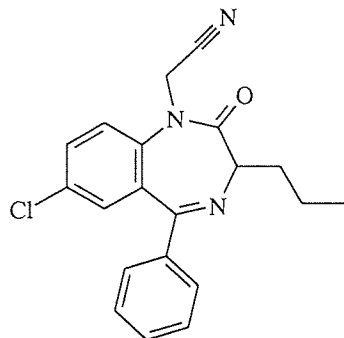

APCI + m/s: m/z = 352 (90%), 268 (10%).

TLC (Ether): R_f = 0.85.

IR (KBr) ν_{\max} = 2930, 2861, 2280 (C≡N), 1723, 1687, 1598, 1324, 1265, 744 cm⁻¹.

¹H-NMR (CDCl₃) δ (p.p.m) 1.01 (t, 3H, C3:-(CH₂)₂CH₃), 1.1-1.9 (m, 4H, C3:-CH₂CH₂CH₃), 3.5-3.6 (two m, 2H, N1:-CH₂-C≡N), 4.5 (q, 1H, C3:-H), 7.1-7.9 (m, 8 arom. H).

¹³C-NMR (CDCl₃) δ (p.p.m) 14.1 (C3:-CH₂CH₂CH₃), 19.8 (C3:-CH₂CH₂CH₃), 33.4 (C3:-CH₂CH₂CH₃), 38.9 (N1:-CH₂-C≡N), 62.9 (C3:-H), 115.4 (N1:-CH₂-C≡N), 122.8, 128.4, 128.9, 129.4, 130., 130.9, 131.5, 137.4, 139.2, 167.4, 169.3.

1-Benzyl-7-chloro-5-phenyl-3-propyl-1,3-dihydro-2H-1,4-benzodiazepin-2-one (194)

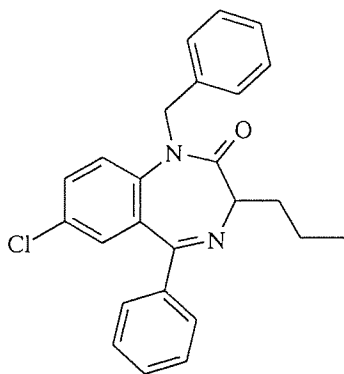

APCI + m/s: m/z = 403 (95%), 313 (5%).

TLC (Ether): R_f = 0.9.

IR (KBr) ν_{\max} = 2925, 2865, 1717, 1673, 1600, 1447, 1272, 1121, 738, 693 cm⁻¹.

¹H-NMR (CDCl₃) δ (p.p.m) 0.9-1.9 (m, 7H, C3:-(CH₂)₂CH₃), 4.05 (m, 2H, N1:-CH₂-Ph), 4.52 (m, 1H, C3:-H), 7.0-7.75 (m, 8 arom. H).

¹³C-NMR (CDCl₃) δ (p.p.m) 14.2 (C3:-(CH₂)₂CH₃), 22.9 (C3:-(CH₂CH₂CH₃), 33.7 (C3:-CH₂CH₂CH₃), 49.9 (N1:-CH₂-Ph), 63.4 (C3:-H), 123.9, 127.3, 127.6, 127.8, 128.4, 130.4, 130.9, 131.2, 132.4, 136.5, 138.1, 140.3, 167.4, 169.7.

7-Chloro-1-phenethyl-5-phenyl-3-propyl-1,3-dihydro-2H-1,4-benzodiazepin-2-one
(195)

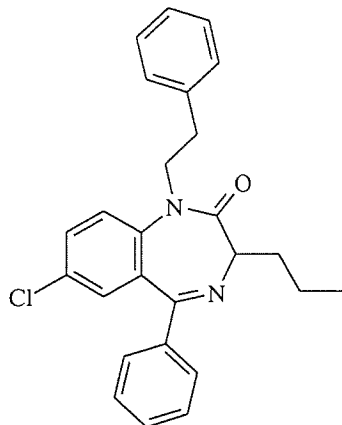

APCI + m/s: $m/z = 417$ (85%), 313 (5%), 279 (10%).

TLC (Ether): $R_f = 0.9$.

IR (KBr) $\nu_{\max} = 2957, 2924, 2857, 1717, 1683, 1461, 1283, 1121, 1069, 740, 695 \text{ cm}^{-1}$.

$^1\text{H-NMR}$ (CDCl_3) δ (p.p.m) 0.98 (tr, 3H, C3:-(CH_2) $_2$ CH $_3$), 1.45-1.75 (m, 4H, C3:-(CH_2) $_2$ CH $_3$), 4.25 (m, 3H, C3:-H + N1:-CH $_2$ -CH $_2$ -Ph), 6.8-7.75 (m, 13 arom. H).

$^{13}\text{C-NMR}$ (CDCl_3) δ (p.p.m) 14.1 (C3:-CH $_2$ CH $_2$ CH $_3$), 22.9 (C3:-CH $_2$ CH $_2$ CH $_3$), 30.1 (C3:-CH $_2$ CH $_2$ CH $_3$), 38.6, 68.1 (C3:-H), 123.9, 126.4, 126.9, 128.5, 128.7, 130.8, 132.3, 136.6, 139.3, 141.3, 167.2 (C=O), 168.8.

References

1. Greenlee, W.J. and Desai, M., (1998), Combinatorial chemistry library design using pharmacophore diversity, *Current Opinion in Drug Discovery and Development*, **1** (1), 3-18.
2. Wang, G.T.; Li, S., Wideburg, N., Krafft, G.A. and Kempf, D.J., (1995), Synthetic chemical diversity: Solid phase synthesis of libraries of C2 symmetrical inhibitors of HIV protease containing diamino diol and diamino alcohol cores., *J. Med. Chem.*, **38**, 2995-3002.
3. Petsko, G.A; Verdine, G.L.; Broach, J.R.; Thorner, J.; Hogan, J.C. and Blundell, T.L., (1996), Developments in techniques of pharmaceutical chemistry are poised to revolutionize the design of drugs beyond previous expectations. But what are our current expectations and what does the future hold?, *Nature*, **384**, 1-26.
4. Gordon, E.M.; Barret, R.W.; Dower, W.J.; Fodor, S.P.A. and Gallop, M.A., (1994), Applications of combinatorial technologies to drug discovery. Combinatorial organic synthesis, library screening strategies, *J. Med. Chem.*, **37** (9), 1385-1401 and Gallop, M.A., (1994), Applications of combinatorial technologies to drug discovery. Combinatorial organic synthesis, library screening strategies, and future directions., *J. Med. Chem.*, **37**, 1233-1251.
5. Terrett, N.K., (1998), *Combinatorial Chemistry*, Oxford Chemistry Masters, Oxford University Press, pp 3-5.
6. Geysen, L., (1984), Use of peptide synthesis to probe viral antigens for epitopes to a resolution of a single amino acid., *Proc. Natl. Acad. Sci. USA*, **81**, 3998-4002.
7. Thompson, L.A. and Ellman, J.A., (1996), Synthesis and application of small molecule libraries, *Chem. Rev.*, **96**, 555-600.
8. Setti, E.L. and Micetich, R., (1996), General methods for the drug design – an opinion, *Current Med. Chem.*, **3**, 317-324.

9. Balkenhohl, F.; Bussche-Hunnefeld, C., Lansky, A. and Zechel, C., (1996), Combinatorial synthesis of small organic molecules, *Angew. Chem. Int. Ed. Engl.*, **35**, 2288-2337.
10. Sim, M.M. and Ganesan, A., (1997), Solution-phase synthesis of a combinatorial thiohydantoin library, *J. Org. Chem.*, **62**, 3230-3235.
11. Gordon, E.M.; Barret, R.W.; Dower, W.J.; Fodor, S.P.A. and Gallop, M.A., (1994), Applications of combinatorial technologies to drug discovery. Combinatorial organic synthesis, library screening strategies, *J. Med. Chem.*, **37** (9), 1385-1401.
12. Terrett, N.K.; Gardener, M.; Gordon, D.W.; Kobylecki, R.J. and Steele, J., (1995), Combinatorial synthesis - The design of compound libraries and their application to drug discovery, *Tetrahedron*, **51**, 8135-8173.
13. Merrifield, R.B., (1985), Solid phase synthesis, *Angew. Chem. Ed. Engl.*, **24**, 799-809.
14. de Witt, S. H. and Czarnik, A. W., (1995), Applied solid phase chemistry for the drug discovery process, *Current Opinion In Biotechnology*, **6**, 640-645.
15. Bunin, B. A. and Ellman, J. A., (1992), A general and expedient method for the solid phase synthesis of 1,4-benzodiazepine derivatives, *J. Am. Chem. Soc.*, **114**, 10997-10998.
16. Fruchtel, J.S. and Jung G., (1997), Organic chemistry on solid supports, *Angew Chem.*, **35**, 17-42.
17. Cargill, J.F. and Lebl, M., (1996), New methods in combinatorial chemistry - robotics and parallel synthesis, *Current Opinion in Chemical Biology*, **1** (1), 67-71.
18. Parlow, J.J.; Devraj, R.V. and South, M.S., (1999), Solution-phase chemical library synthesis using polymer-assisted purification techniques, *Current Opinion in Chemical Biology*, **3** (3), 320-336.

19. Gravert, D.J. and Janda, K. D., (1997), Synthesis on soluble polymers: new reactions and the construction of small molecules, *Current Opinion in Chemical Biology*, **1** (1), 107-113.
20. Martin, Y.C., (1992), 3D-Database searching in drug design, *J. Med. Chem.*, **35**, 2145-2154.
21. Hopfinger, A.J. and Duca, J.S., (2000), Extraction of pharmacophore information from high-throughput screens, *Current Opinion in Biotechnology*, **11** (1), 97-103.
22. Walters, W.P. and Murcko, M.A., (1999), Recognizing molecules with drug-like properties, *Current Opinion in Chemical Biology*, **3** (4), 384-387.
23. Montgomery, S.A., (1993), Psychopharmacology of Panic, British Association for Psychopharmacology Monograph No. 12, pp, 75-76.
24. Klein, D.F., (1964), Anxiety: New research and changing concepts (Klein, D.F. and Rabkin, J.G., eds.), Raven Press, pp. 235-263.
25. Millet B.; Bayle F.J. and Olie J.P., (1988), Prospects for anxiolytic therapy: a reflection from different viewpoints, *DDT*, Vol. **3**, no 10, 471-479.
26. Gorman, J.M.; Askanazi, J.; Liebowitz, M.R.; Fryer, A.J.; Stein, J.; Kinney, J.M. and Klein, D.F., (1984), Response to hyperventilation in a group of patients with panic disorders., *Amer. Journal of Psychiatry*, **141**, 857-891.
27. Margraf, J.; Ehlers, A. and Roth, W.T., (1986), Sodium lactate and panic attacks: a review and critique, *Psychosomatic Medicine*, **48**, 23-51.
28. Nutt, D.J.; Glue, P.; Lawson, C.W. and Wilson, S., (1990), Flumazenil provocation of panic attacks: evidence for altered benzodiazepine receptor sensitivity in panic disorder., *Archives of General Psychiatry*, **47**, 917-925.

29. Wilson, T.M.; Henke, B.R.; Momtahan, T.M.; Myers, P.L.; Sugg, E.E.; Unwalla, R.J.; Croom, D.K.; Dougherty, R.W.; Grizzle, M.K.; Johnson, M.F.; Queen, K.L.; Rimele, T.J.; Yingling, J.D. and James, M.K., (1996), 3-[2-(N-Phenylacetamide)]-1,5-benzodiazepines: Orally active, binding selective CCK-A agonists, *J. Med. Chem.*, **39**, 3030-3034.
30. de Montigny, C., (1989), Cholecystokinin tetrapeptide induces panic-like attacks in healthy volunteers., *Arch. Gen. Psychiatry*, **46**, 511-517.
31. Bradwejn, J.; Koszycki, D. and Meterissian, G., (1990), Cholecystokinin tetrapeptide induces panic attacks in patients with panic disorder., *Can. J. Psychiatry*, **35**, 83-85.
32. Bradwejn, J.; Koszycki, D. and Shriqui, C., (1991), Enhanced sensitivity to cholecystokinin tetrapeptide in panic disorder., *Arch. Gen. Psychiatry*, **48**, 603-610.
33. Ravard, S. and Dourish, C.T., (1990), Cholecystokinin and anxiety., *Trends Pharmacol. Sci.*, **11**, 271-273.
34. Ivy, A.C. and Goldberg, E.A., (1928), The Discovery of a substance released from the upper intestine and produced gallbladder contractions, *Am. J. Physiol.*, **86**, 599-606.
35. D'Amato, M.; Varro, A. and Dimaline, R., (1996), CCK_B/gastrin receptor antagonists, *Physiol. Res.*, **76**, 767-798 and Olsson, C. and Holmgren, S., (2001), The control of gut motility, *Comparative Biochemistry and Physiology - Part A: Molecular & Integrative Physiology*, **128** (3), 479-501.
36. Yassin, R.R., (1999), Signaling pathways mediating gastrin's growth-promoting effects, *Peptides*, **20** (7), 885-898.
37. Wilborg, O., (1984), Gastrin. Isolation, characterisation and functions. In: Gastrointestinal hormones., *Proc. Nat. Acad. Sci. USA*, **81**, 1067-1069.

38. Stening, G.F. and Grossman, M.I., (1969), Gastrin-related peptides as stimulant of pancreatic and gastric secretion, *Amer. J. Physiol.* **217**, 262-266.
39. Man, V. and Yorpes, J.E., (1968), Secretion, cholecystokinin, pancreozinine and gastrin, *Eur. J. Biochem.*, **6**, 156-162.
40. H. Mineo, H., Iwaki, N., Kogishi, K., Zabielski, R., Onaga, T., and Kato, S., (1995), Effects of intravenous infusions of cholecystokinin (CCK)-8 on exocrine and endocrine pancreatic secretion in conscious sheep., *Comparative Biochemistry and Physiology Part A: Physiology.*, 111 (1), 133-138.
41. Mutt, J. and Jorpes, J.E.; (1971), Hormonal polypeptides of the upper intestine., *Biochem. J.*, **125**, 57-58.
42. Horwell, D.C.; Beeby, A.; Clark, C.R. and Hughes, J., (1987), Synthesis and binding affinities of cholecystokinin (30-33) as probes for central nervous system cholecystokinin receptors., *J. Med. Chem.*, **30**, 729-732.
43. Eysselein, V.E.; Reeve, J.R. and Eberlein, G., (1986), Cholecystokinin gene structure and molecular forms in tissue and blood., *Gastroenterology*, **24**, 645-659.
44. Böhme, G.A. and Blanchard, J.C., (1992), Cholecystokinins and their receptors. Functional aspects, *Therapie*, **47** (6), 541-548.
45. Lattmann, E. and Singh, H., (2000), Small organic molecules as cholecystokinin antagonists., *J. Sc. (KKU)*, **34** (in the press).
46. Lin, C.W.; Shiosaki, K.; Miller, T.R.; Witte, D.G.; Bianchi, B.R.; Wolfram, C.A.; Kopecka, H.; Craig, R.; Wagenaar, F. and Nadzan, A.M., (1991), Characterization of two novel cholecystokinin tetrapeptide (30-33), *Mol. Pharmacol.*, **39** (3), 346-351.
47. Noble, F. and Roques, B.P., (1999), CCK-B receptor: Chemistry, molecular biology, biochemistry and pharmacology, *Progress in Neurobiology*, **58** (4) 349-379.

48. Clark, C.R.; Dauni, P. and Hughes, J., (1986), A study of the cerebral cortex cholecystokinin receptor using two radiolabelled probes: Evidence for a common CCK 8 and CCK 4 cholecystokinin receptor binding Site., *J. Neurochem.*, **46**, 1094-1101.
49. Takeda, Y.; Hoshino, M.; Yanaihara, N.; Yanaihara, C. and Isobe, J., (1989), Comparison of CCK-8 receptors in the pancreas and brain of rats using CCK-8 analogues., *Jpn. J. Pharmacol.*, **49**, 471-481.
50. Dirieux, C.; Pelaprat, D.; Charpentier, B.; Morgat, J.L. and Roques, B.P., (1988), Characterization of [³H] CCK binding sites in mouse and rat brain., *Neuropeptides*, **12**, 141-148.
51. Saito, A.; Goldfine, I.D. and Williams, J.A., (1981), Characterization of receptors for cholecystokinin and related peptides in mouse cerebral cortex., *J. Neurochem.*, **37**, 483-490.
52. Wank, S.A., (1995), Cholecystokinin receptors, *Amer. J. Physiol.*, **269** (5), 628-646.
53. Dockray, G.J.R., (1976), Immunochemical evidence of cholecystokinin-like peptides in brain, *Nature*, **264**, 568-570.
54. Morley, V.E., (1990), Appetite regulation by gut peptides, *Annu. Rev. Nutr.*, **10**, 383-395.
55. Wang, X.J.; Wang, X.H. and Hans, S., (1990), Cholecystokinin octapeptide antagonised opioid analgesia mediated by kappa-receptors in the spinal cord of the rat, *Brain Res.*, **523**, 5-10.
56. Payeur, K., (1993), Psychiatric comorbidity in patients with generalized anxiety disorder, *Eur. Psychiatry*, **21**, 101-105.

57. Bradwejn, J.; Koszycki, D.; Annable, L.; Couetoux du Tertre, A.; Bourin, M.; Palmour, R. and Ervin, F., (1992), The cholecystokinin hypothesis of panic anxiety disorders, *J. Psychopharmacol.*, **6**, 354-361.
58. Evans, B.E.; Rittle, K.E.; Bock, M.G.; DiPardo, R.M.; Freidinger, R.M.; Whitter, W.L.; Lundell, G.F.; Veber, D.F.; Anderson, P.S.; Chang, R.S.L.; Lotti, V.J.; Cerino, D.J.; Chen, T.B.; Kling, P.J.; Kunkel, K.A.; Springer, J.P. and Hirshfield, J., (1988), Methods for drug discovery: Development of potent, selective, orally effective cholecystokinin antagonists, *J. Med. Chem.*, **31**, 2235-2246.
59. Lodge, D.J.; Short, J.L.; Mercer, L.D.; Beart, P.M. and Lawrence, A.J., (2000), CCK/dopamine interactions in fawn-hooded and wistar-kyoto rat brain, *Peptides*, **21** (3), 379-386.
60. Harro, J.; Marcusson, J. and Orelund, L., (1992), Changes at cholecystokinin receptors induced by long-term treatment with diazepam and haloperidol, *European Neuropsychopharmacology*, **2**, 57-63 and Acosta, G.B., (2000), A possible interaction between CCKergic and GABAergic systems in the rat brain, *Comparative Biochemistry and Physiology - Part C: Pharmacology, Toxicology and Endocrinology*, **128** (1), 11-17.
61. Mohler, H., (1992), GABA_A-receptor subtypes differing in alpha-subunit composition display unique pharmacological properties, *Arzneim.-Forsch./Drug Res.*, **42** (2a), 211-218.
62. Fuxe, K.; Anderson, K.; Locatelli, V.; Agnat, L.F.; Hokfelt, T.; Skirball, L. and Mutt, V., (1980), Cholecystokinin peptides produce marked reduction of dopamine turnover in discrete areas in the rat brain, following intraventricular injection., *Eur. J. Pharmacol.*, **67**, 325-331.
63. Harro, T.; Jossan, S.S. and Orelund, L., (1992), Changes in cholecystokinin receptor binding in rat brain after selective damage of the locus coeruleus projections by DSP-4 treatment, *Arch. Pharmacol.*, **364**, 425-431.

64. Pittaway, K.M. and Hill, R.G., (1987), Cholecystokinin and pain. Pain and headache., *J. Psychopharmacol.*, **9**, 213-246.
65. Hays, S.E.; Beinfeld, M.C.; Jensen, R.T.; Goodwin, F.K. and Paul, S.M.; (1980), Demonstration of a putative receptor site for cholecystokinin in rat brain., *Neuropeptides*, **1**, 53-52.
66. Altar, C.A.; (1989), Cholecystokinin receptor subtypes and neuromodulation., *Prog. NeuroPsychopharmacol. Biol. Psychiat.*, **13**, 381-383.
67. Moran, T.H., (1986), Behavioral recovery following acid lesions and fetal implants of the striatum occurs independent of dopaminergic mechanisms., *Brain Research*, **362**, 175-179.
68. de Weerth, A.; Pisegna, J.R.; Huppi, K. and Wank, A., (1993), Molecular cloning, functional expression and chromosomal localisation on the human cholecystokinin type A receptor., *Biochem. Biophys. Res. Commun.*, **2**, 811-818.
69. Huang, S.C.; Yu, D-H.; Wank, S.A.; Mantey, S.; Gardener, J. D. and Jensen, R.T., (1989), Importance of sulfation of gastrin or cholecystokinin (CCK) on affinity for gastrin and CCK receptors, *Peptides*, **10**, 785-789.
70. Innis, R.B. and Synder, S.H., (1986), Distinct cholecystokinin receptors in brain and pancreas., *Proc. Natl. Acad. Sci. USA.*, **77**, 6917-6921.
71. Knight, M.; Tamminga, C.A.; Steardo, L.; Beck, M.E.; Barone, P. and Chase, T.N., (1984), Cholecystokinin-octapeptide fragments: binding to brain cholecystokinin receptors., *Eur. J. Pharmacol.*, **105**, 49-55.
72. Lee, Y.M.; Beinborn, M.; McBride, E.W.; Miller, L.J.; Lu, M.; Kolakovki, L.F. and Kopin, A.S., (1993), The human brain cholecystokinin-B/gastrin receptor-cloning and characterisation., *J. Biol. Chem.*, **268**, 8164-8169.

73. Yoder, D.G. and Moody, T.W., (1987), High affinity binding of cholecystokinin to small cell lung cells., *Peptides*, **8**, 103-107.
74. Vidal, Y.; Plana, R.R.; Cifarelli, A. and Bizzarri, D., (1980), Effects of antigastrin drugs on the interaction of ¹²⁵I-human gastrin with rat gastric mucosa membranes., *Hepata-Gastroenterol.*, **27**, 41-47.
75. Stening, G.F. and Grossman, M.I., (1969), Gastrin-related peptides as stimulant of pancreatic and gastric secretion, *Amer. J. Physiol.* **217**, 262-266.
76. Jensen, R.T.; Zhou, Z.C.; Murphy, R.B.; Jones, S.W. and Setnikar, I., (1986), Structural features of various proglumide-related cholecystokinin receptor antagonists., *Am. J. Physiol.*, **251**, 839-846.
77. Makovec, F.; Bani, M.; Chiste, R.; Revel, L. and Rovati, L.C., (1986), Differentiation of central and peripheral cholecystokinin receptors by new glutaramic acid derivatives and cholecystokinin-antagonistic activity., *Arzmeim-Forsch./Drug Res.*, **36**, 98-102.
78. Wakatsuki, K.; Saito, T.; Saeki, M.; Ninomiya, K.; Kasai H.; Kimura, K. and Fuji, M., (1997), Cholecystokinin antagonistic activities of loxiglumide., *Arzmeim-Forsch./Drug Res.*, **47** (10), 1130-1133.
79. Peikin, S.R.; Costenbader, C.L. and Gardner, J.D., (1979), Actions of derivatives of cyclic nucleotides on dispersed acini from guinea pig pancreas., *J. Biol. Chem.*, **254** (24), 5321-5327.
80. Boden, P.R.; Higginbottom, M.; Hill, D.R.; Horwell, D.C.; Hughes, J., Rees, D.C.; Roberts, E.; Singh, L.; Suman-Chauhan, N. and Woodruff, G.N., (1993), Cholecystokinin dipeptoid antagonists: Design, synthesis and anxiolytic profile of some novel CCK-A and CCK-B and "mixed" CCK-A/CCK-B antagonists, *J. Med. Chem.*, **36**, 552-565.

81. Kerwin, J.F., Wagenaar, F.; Kopecka, H.; Lin, hun Wel and Miller, T., (1991), Cholecystokinin antagonists: (R)-Tryptophan-based hybrid antagonists of high affinity and selectivity for CCK-A receptors, *J. Med. Chem.* **34** (12), 3350-3359.
82. Clark, C.R.; Dauni, P. and Hughes, J., (1986), A study of the cerebral cortex cholecystokinin receptor using two radiolabelled probes: Evidence for a common CCK 8 and CCK 4 cholecystokinin receptor binding Site., *J. Neurochem.*, **46**, 1094-1101.
83. Stark, H.A.; Sharp, C.M.; Sutliff, V.E.; Martinez, J. and Jensen, R.T., (1989), CCK-JMV-180: Peptides that distinguishes high affinity cholecystokinin receptors from low affinity cholecystokinin., *Biochem. Biophys. Acta.*, **1010**, 145-150.
84. Rasmussen, K.; Czachura, J.F.; Stockton, M.E. and Howbert, J.J., (1993), Electrophysiological effects of diphenylpyrazolidinone cholecystokinin-B and cholecystokinin-A antagonists on midbrain dopamine neurons., *J. Pharmacol. Exp. Ther.*, **264**, 480-488.
85. Howbert, J.J.; Lobb, K.L.; Britton, T.C.; Mason, N.R. and Bruns, R.F., (1993), Diphenylpyrazolidinone and benzodiazepine cholecystokinin antagonists: A case of convergent evolution in medicinal chemistry., *Bioorg. Med. Chem. Lett.*, **3**, 875-880.
86. Bertrand, P.; Guyon, D.; Dubroeuq, M.C.; Doble, A., and Barreau, M., (1994), Evaluation of brain penetration of CCK-B antagonists using an ex-vivo binding assay., *Eur. J. Pharmacol.*, **262**, 233-245.
87. Rasmussen, K.; Stockton, M.E.; Czachura, J.F. and Howbert, J.J., (1995), Cholecystokinin and schizophrenia: The selective CCK-B antagonists decreases midbrain dopamine unit activity., *Expert Opin. Invest. Drugs.*, **4**, 313-322.
88. Takeda, Y.; Kawagoe, K.; Yokomizo, A.; Yokomizo, Y.; Hosokami, T. Shimoto, Y.; Tabuchi, Y.; Ogihara, Y.; Otsubo, R.; Honda, Y. and Yokohama, S., (1998), Synthesis of phenoxyacetic acid derivatives as highly potent antagonists of gastrin/cholecystokinin-B receptors, *Chem. Pharm Bull.*, **46** (6), 951-961.

89. Hagishita, S.; Murakami, Y.; Seno, K.; Kamata, S. and Haga, N., (1997), *Bioorg. Med. Chem.*, **5**, 1695-1714.
90. Kalindjian, S.B.; Harper, E.A. and Pether, M.J., (1995), The synthesis of a radioligand with high potency and selectivity for CCK-B/gastrin receptors., *J. Med. Chem.*, **38**, 4294-4302.
91. Sternbach, L.H. and Reeder, E., (1961), Quinazolines and 1,4-benzodiazepines. The rearrangement of 6-chloro-2-chloromethyl-4-phenylquinazoline 3-oxide into 2-amino derivatives of 7-chloro-5-phenyl-3H-1,4-benzodiazepine 4-oxide, *J. Org. Chem.*, **26**, 1111-1118.
92. Haefely, W., (1983), Alleviation of anxiety - the benzodiazepine saga In: Parnham, M.J. and Bruinvels, J. (eds). *Discoveries in Pharmacology., Psycho- and Neuropharmacology*, **1**, 269-292, Amsterdam: Elsevier
93. Archer, G.A. and Sternbach, L.H., (1968), *Chem. Rev.*, **68**, 747-742 and Elderfeld, R.C., (1967), *Heterocycl. Compounds*, **9**, 332-372.
94. Puia, G., (1991), Influence of recombinant gamma-aminobutyric acid-A receptor subunit composition on the action of allosteric modulators of gamma-aminobutyric acid-gated Cl-currents., *Molecular Pharm.*, **39**, 691-698.
95. Sioufi, A. and Dubois, P., (1990) Chromatography of benzodiazepines., *J. Chromatogr.*, **531**, 459-480.
96. Camerman, A., (1972), 3D-Structure of Diazepam, *Journal of Amer. Soc.*, **94**, 268-270.
97. Masafumi, F.; Yuji, T.; Katsumi, H. and Kazuo, K., (1980), Detection and determination of pharmacologically active benzodiazepines in rat brain after the administration of 2-o-chlorobenzoyl-4-chloro-N-methyl-N'-glycylglycinanilide, using a combination of high-pressure liquid chromatography and radioreceptor assay, *Chem.Pharm.Bull.*, **28** (5), 1378-1386.

98. Kubota, K.; Sugaya, K.; Sunagane, N. and Matsuda, F., (1985), Cholecystokinin antagonism by benzodiazepines in the contractile response of the isolated guinea pig gallbladder., *Eur. J. Pharmacol.*, **110**, 225-231.
99. Kubota, K.; Sugaya, K.; Fuji, F. and Sunagane, N., (1985), Inhibition of cholecystokinin response in the gallbladder by dibenamine and its protection by benzodiazepines., *Jpn. J. Pharmacol.*, **39**, 274-276.
100. Sugaya, K.; Matsuda, I.; Uruno, T. and Kubota, K., (1984), Studies on the CCK antagonism by benzodiazepines: Displacement of CCK by benzodiazepines in the binding in mouse brain CCK receptor., *Jpn. J. Pharmacol.*, **40**, 114p.
101. Kubota, K.; Sugaya, K.; Koizumi, Y. and Toda, M., (1989), Cholecystokinin antagonism by anthramycin in the central nervous system in mice., *Brain Res.*, **485**, 62-66.
102. Miller, L.J., (1984), Characterisation of cholecystokinin receptors on human gastric smooth muscle tumours., *Am. J. Physiol.*, **247**, 402-410.
103. Bock, M.G.; DiPardo, R.M.; Rittle, K.E., et al., (1986), Cholecystokinin antagonists. Synthesis of asperlicin analogues with improved potency and water solubility, *J. Med. Chem.*, **29**, 1941-1952.
104. Hosontanti, R.; Chowdhury, P.; McKay, D. and Rayford, P.L., (1988), Effect of L-364,718, a new CCK antagonist, on amylase secretion in isolated rat pancreatic acini., *Pancreas*, **3**, 95-98.
105. Anderson, L. and Dockray, G.L., (1988), The cholecystokinin antagonist L-364,718 inhibits the action of cholecystokinin but not bombesin on rat pancreatic secretion in vivo., *Euro. J. Pharmacol.*, **146**, 307-311.
106. Silver, A.J.; Flood, J.F.; Song, A.M. and Morley, J.E., (1989), Evidence for a physiological role for CCK in the regulation of food intake in mice., *Am. J. Physiol.*, **256**, 646-652.

107. Dunlop, J.; (1998), CCK receptor antagonists, *Gen Pharmacol.* **31** (4), 519-524.
108. Hill, D.R.; Shaw, T.M.; Graham, W. and Woodruff, G.N., (1989), Autoradiographical detection of cholecystokinin-A receptors in primate brain using ¹²⁵I bolton Hunter CCK-8 and 3H-MK-329., *J. Neurosci.*, **10**, 1070-1081.
109. Evans, B.E.; Rittle, K.E.; Bock, M.G.; DiPardo, R.M.; Freidinger, R.M.; Whitter, W.L.; Veber, D.F. and Anderson, P.S., (1986), Design of potent, orally effective, non peptidal antagonists of the peptide hormone cholecystokinin, *Proc. Natl. Acad. Sci. USA*, **83**, 4918-4922.
110. Dourish, C.T.; Rycroft, W. and Iversen, S.D., (1989), Postponement of satiety by blockade of brain cholecystokinin-B receptors., *Science.*, **245**, 1509-1511.
111. Kubota, K.; Sugaya, K.; Koizumi, Y. And Toda, M., (1989), Cholecystokinin antagonism by anthramycin in the central nervous system in mice., *Brain Res.*, **485**, 62-66.
112. Bock, M.G.; DiPardo, R.M. and Evans B.E., (1989), Benzodiazepine gastrin and brain cholecystokinin receptor ligands. L-365,260., *J. Med. Chem.*, **32**, 13-24.
113. Haradahira, T.; Inoue, O.; Kobayashi, K. and Suzuki, K., (1998), Synthesis and evaluation of ¹¹C-labeled nonpeptide antagonists for cholecystokinin receptors: [¹¹C] L-365,260 and [¹¹C]L-365,346., *Nucl. Med. Biol.*, **25** (3), 203-208.
114. Chamber, M.S.; Hobbs, S.C.; Flecher, S.R.; Matassa, V.G.; Mitchell, P.J.; Watt, A.P.; Baker R.; Freedman, S.B.; Patel, S. and Smith, A.J., (1993), L-708,474: The C5-cyclohexyl analogue of L-365,260, a selective high affinity ligand for the CCK-B/gastrin receptor, *Bioorganic & Medicinal Chemistry Letters*, **3**, 1919-1924.

115. Showell, G.A.; Bourrain, S.; Neduvelil, J.G.; Fletcher, A.E.; Baker, R.; Watt, A.P.; Fletcher, A.E.; Freedman, S.P.; Kemp, J.A.; Marshall, G.R.; Patel, S.; Smith, A.J. and Matassa, V.G., (1994), High affinity and potent, water soluble 5-amino-1,4-benzodiazepine CCK_B/gastrin receptor antagonists containing a cationic solubilizing group, *J. Med. Chem.*, **37**, 719-721.
116. Castro, L.C.; Broughton, H.B.; Russell, M.G.N.; Rathbone, R. and Watt, A.P., (1997), 5-(Piperidin-2-yl)- and 5-(homopiperidin-2-yl)-1,4-benzodiazepines: High-affinity, basic ligands for the cholecystokinin-B receptor., *J. Med. Chem.*, **40** (16), 2491-2501.
117. Bock, M.G.; DiPardo, R.M.; Mellin, E.C. and Newton, N.C., (1994), Second-generation benzodiazepine CCK-B antagonists. Development of subnanomolar analogues with selectivity and water solubility., *J. Med. Chem.*, **37**, 722-724.
118. Semple, G.; Ryder, H.; Kendrick, D.A.; Szelke, M.; Ohta, M.; Satoh, M.; Nisida, A.; Akuzawa, S.; Miyata, K.; Rooker, D.P. and Batt, A.R., (1997), (3R)-N(tert-butylcarbonylmethyl)-2,3-dihydro-2-oxo-5-(2-pyridyl)-1H-1,4-benzodiazepin-3-yl)-N³-(3-(methylamino)phenyl)urea (YF476): A potent and orally active gastrin/CCK-B antagonist, *J. Med. Chem.*, **40**, 331-341.
119. Yuji, S.; Hidenori, Y.; Yumiko, H.; Akito, N.; Keito, M. and Kazuo, H., (1994), Characterisation of YM022: its CCK_B/gastrin receptor binding profile and antagonism to CCK-8-induced Ca²⁺ mobilization; *European Journal of Pharmacology, Molecular Pharmacology Section*, **269**, 249-254.
120. Semple, G.; Ryder, H.; Kendrick, D.A.; Szelke, M.; Ohta, M.; Satoh, M.; Nisida, A.; Akuzawa, S. and Miyata, K., (1996), Synthesis and biological activity of 1-alkylcarbonylmethyl analogues of YM022, *Bioorganic and Medicinal Chemistry Letters*, **6**, 51-54.
121. Masato, S.; Yutaka, K.; Yoshinori, O.; Akito, N. and Keiji, M., (1995), New 1,4-benzodiazepin-2-one derivatives as gastrin/cholecystokinin-B antagonists., *Chem. Pharm. Bull.*, **43** (12), 2159-2167.

122. Padia, J.K.; Chilvers, H.; Daum, P.; Pinnock, R.; Suman-Chauhan, N.; Webdale, L. and Trivedi, B.K., (1997), Design and synthesis of novel non-peptides CCK-B receptor antagonists, *Bioorganic and Medicinal Chemistry Letters*, **7**, 805-810.
123. Finizia, G.; Donati, D.; Oliosi, B.; Tranquillini, M.E. and Ursini, A., (1996), Synthesis and evaluation of novel 1,5-benzodiazepines as potent and selective CCK-B ligands. Effect of the substitution of the N-5 phenyl with alkyl groups., *Bioorganic and Medicinal Chemistry Letters*, **24** (6), 2957-2962.
124. Wilson, T.M.; Henke, B.R.; Momtahan, T.M.; Myers, P.L.; Sugg, E.E.; Unwalla, R.J.; Croom, D.K.; Dougherty, R.W.; Grizzle, M.K.; Johnson, M.F.; Queen, K.L.; Rimele, T.J.; Yingling, J.D. and James, M.K., (1996), 3-[2-(N-Phenylacetamide)]-1,5-benzodiazepines: Orally active, binding selective CCK-A agonists, *J. Med. Chem.*, **39**, 3030-3034 and Bailey, N.; Box, P.C.; Car, R.A.E.; Cooke, J.W.B.; Evans, B.; Finch, H.; Head, J.E.; Pass, M.; Shah, P. and Wheatcroft, J.R., (1997), Novel 1,5-benzodiazepindione gastrin/CCK_B antagonists, *Bioorganic and Medicinal Chemistry Letters*, **7**, 381-286.
125. Hirst, G.C.; Aquino, C.; Birkemo, L.; Croom, G.K. and Dezube, M., (1996), Discovery of 1,5-benzodiazepines with peripheral cholecystokinin (CCK-A) receptor agonist activity (II): Optimization of the C3 amino substituent., *J. Med. Chem.*, **39** (26), 5236-5245.
126. PCT-WO 99 64 403; Int. Cl.: C 07 D – 243/12. Zeria Pharma Co. Ltd., Saitama (JP); Ind.: [166] 7 (2000).
127. Trivedi, K. and Bharat, J., (1994), Cholecystokinin receptor antagonists: Current status, *Current Medicinal Chemistry*, **1**, 313-327 and Francesco, M., (1993), CCK-B/gastrin- receptor antagonists, *Drugs of the Future*, **18**, 919-931.
128. Makovec, F. and D'Amato, M., (1997), CCK_B/gastrin receptor antagonists as potential drugs for peptic ulcer therapy, *DDT*, **2**, 283-293.

129. Evans, B.E.; Rittle, K.E.; Bock, M.G.; DiPardo, R.M.; Freidinger, R.M.; Whitter, W.L.; Lundell, G.F.; Veber, D.F.; Anderson, P.S.; Chang, R.S.L.; Lotti, V.J.; Gilbert, K.F.; Garsky, V.M.; Leighton, J.L.; Carson, K.I.; Mellin, E.C.; Smith, A.J. and Patel, S., (1993), Development of 1,4-benzodiazepine cholecystokinin type B antagonists, *J. Med. Chem.*, **36**, 4276-4292.
130. Wilson, T.M.; Henke, B.R.; Momtahan, T.M.; Myers, P.L.; Sugg, E.E.; Unwalla, R.J.; Croom, D.K.; Dougherty, R.W.; Grizzle, M.K.; Johnson, M.F.; Queen, K.L.; Rimele, T.J.; Yingling, J.D. and James, M.K., (1996), 3-[2-(N-Phenylacetamide)]-1,5-benzodiazepines: Orally active, binding selective CCK-A agonists, *J. Med. Chem.*, **39**, 3030-3034 and deMontigny, C., (1989), Cholecystokinin tetrapeptide induces panic-like attacks in healthy volunteers., *Arch. Gen. Psychiatry*, **46**, 511-517 and Bradwejn, J.; Koszycki, D. and Meterissian, G., (1990), Cholecystokinin tetrapeptide induces panic attacks in patients with panic disorder., *Can. J. Psychiatry*, **35**, 83-85.
131. Ravard, S. and Dourish, C.T., (1990), Cholecystokinin and anxiety., *Trends Pharmacol. Sci.*, **11**, 271-273.
132. Parsons, W.H.; Patchett, A.A.; Hollaway, M.K.; Smith, G.M. and Davidson, J.L., (1989), Cholecystokinin antagonist. Synthesis and biological evaluation of 2-substituted benzolactams., *J. Med. Chem.*, **32**, 1681-1685.
133. Bailey, N.; Box, P.C.; Car, R.A.E.; Cooke, J.W.B.; Evans, B.; Finch, H.; Head, J.E.; Pass, M.; Shah, P. and Wheatcroft, J.R., (1997), Novel 1,5-benzodiazepindione gastrin/CCK_B antagonists, *Bioorganic and Medicinal Chemistry Letters*, **7**, 381-286.
134. Padia, J.K.; Chilvers, H.; Daum, P.; Pinnock, R.; Suman-Chauhan, N.; Webdale, L. and Trivedi, B.K., (1997), Design and synthesis of novel non-peptides CCK-B receptor antagonists, *Bioorganic and Medicinal Chemistry Letters*, **7**, 805-810.

135. Yuji, S.; Hidenori, Y.; Yumiko, H.; Akito, N.; Keito, M. and Kazuo, H., (1994), Characterisation of YM022: its CCK_B/gastrin receptor binding profile and antagonism to CCK-8-induced Ca²⁺ mobilization; *European Journal of Pharmacology, Molecular Pharmacology Section*, **269**, 249-254.
136. Masato, S.; Yutaka, K.; Yoshinori, O.; Akito, N. and Keiji, M., (1995), New 1,4-benzodiazepin-2-one derivatives as gastrin/cholecystokinin-B antagonists., *Chem. Pharm. Bull.*, **43** (12), 2159-2167.
137. Puia, G., (1991), Influence of recombinant gamma-aminobutyric acid-A receptor subunit composition on the action of allosteric modulators of gamma-aminobutyric acid-gated Cl-currents., *Molecular Pharm.*, **39**, 691-698.
138. Haefely, W., (1985), *Advances in Drug Research*, Academic Press, vol. **14**, pp 165-322.
139. Hughes, J.; Boden, P.; Costall, B.; Domeney, A. and Kelly, E., (1990), Development of a class of selective cholecystokinin type B receptor antagonists having potent anxiolytic activity., *Proc. Natl. Acad. Sci. USA*, **87**, 6728-6732.
140. Harro, J.; Marcusson, J. and Oreland, L., (1992), Changes at cholecystokinin receptors induced by long-term treatment with diazepam and haloperidol, *European Neuropsychopharmacology*, **2**, 57-63 and Acosta, G.B., (2000), A possible interaction between CCKergic and GABAergic systems in the rat brain, *Comparative Biochemistry and Physiology - Part C: Pharmacology, Toxicology and Endocrinology*, **128** (1), 11-17.

141. Satoh, M.; Okamoto, Y.; Koshio, H.; Ohta, M.; Nisida, A.; Akuzawa, S.; Miyata, K.; Mase, T. and Semple, G., (1996), Biological activity of YM022. Novel (3-amino substituted phenyl) urea derivatives of 1,4-benzodiazepin-2-one as gastrin/ cholecystokinin-B receptor agonists, *Chem. Pharm. Bull.*, **44**, 1412-1414.
- Semple, G.; Ryder, H.; Kendrick, D.A.; Szelke, M.; Ohta, M.; Satoh, M.; Nisida, A.; Akuzawa, S. and Miyata, K., (1996), Synthesis and biological activity of 1-alkylcarbonylmethyl analogues of YM022, *Bioorganic and Medicinal Chemistry Letters*, **6**, 51-54.
142. Garattini, S.; Mussini, E. and Randall, L.O.; (1969), *The Benzodiazepines*, Raven Press, New York, pp 13-26.
143. Evans, B.E., Rittle, K.E., Bock, M.G., DiPardo, R.M., Freidinger, R.M., Whitter, W.L., Lundell, G.F., Veber, D.F., Anderson, P.S., Chang, R.S. and Cerino, D.J., (1988), Methods for drug discovery: Development of potent, selective, orally effective cholecystokinin-A antagonists, *J. Med. Chem.*, **31**, 2235-2246.
144. Hirohashi, T.; Inaba, S.; Ishizumik, K.; Kobayashi, T.; Maruyama, I.; Mori, K.; Okamoto, T.; Yamamoto, H. and Yamamoto, M., Novel aminobenzophenone derivatives – Chemical intermediates, tranquillisers, anticonvulsants, hypnotics., Sumitomo Chemical Co. Ltd. Jp, United States Patent 3.732.285.
145. Martin, I. L. and Lattmann, E., (1999), Benzodiazepine recognition site ligands and GABA-A receptors., *Exp. Opin. Ther. Patents*, **9**, 1347-1358.
146. Bell, C.S.; Sulkowski, T.S.; Gochman, C. and Childress, S., (1962), 1,3-Dihydro-2H-1,4-benzodiazepin-2-ones and their 4-oxides; *J. Org. Chem.*, **27**, 562-566.
147. Stempel, A.; Douvan, I.; Reeder, E. and Sternbach, L.H., (1967), Quinazolines and 1,4-benzodiazepines. 4,1,5-Benzoxadiazocin-2-ones, a novel ring system, *J. Org. Chem.*, **32**, 2417-2425.

148. Chattaway, J. and Lewis, J., (1904), *J. Chem. Soc.*, **85**, 589-591 & Angel, J., (1912), *J. Chem. Soc.*, **101**, 515-518 & Ger. Patent 630 03, (1936) & Kränzlein, G.; Meissner, Th.; Ullmann, F. and Denzler, W., (1906), *Chem. Ber.*, **39**, 4332-4336.
149. Olah, G.A., (1963-1964), Friedel-Crafts and related reactions, Wiley, New York, Edition 1 and 2 and Taylor. R., (1990), Electrophilic aromatic substitution, Wiley, New York, pp 222-238.
150. Staskun, B., (1964), Nuclear acylations of arylamines, *J. Org. Chem.*, **29**, 2856-2860.
151. Balkus, K.J.; Khanmamedova, A.K. and Woo, R., (1998), Fries rearrangement of acetanilide over zeolite catalysts, *Journal of Molecular Catalysis A: Chemical*, **134** (1-3), 137-143.
152. Misra, B. K. ; Rao, Y. R. and Mahapatra, S. N., (1983), Friedel-Crafts acylation of some aromatic compounds with 2-isocyanatobenzoyl chloride, *Indian J. Chem. Sect. B*, **22** (11), 1132-1138 and Acharya, B. P. and Ramachandra Rao, Y., (1987), Friedel-Crafts acylation with 2-isocyanatobenzoyl chlorides: The structure of the intermediate complex, *J. Chem. Res. Miniprint*, **4**, 1001-1035.
153. Toshihyuki, H.; Hirokaki, M.; Hideo, N.; Toshio, T. and Yamamoto, H., (1970), Process for producing benzodiazepine derivatives; Sumitomo Chemical Co. Ltd, Jp, United States Patent 3.524.848.
154. Masahiro, K.; Kazuo, S.; Kiyoshige, O.; Hiroyuki, A. and Takeshi, O., (1991), Asymmetric reduction of 2-aminobenzophenone using yeast, *rhodosporidium toruloides*, *Chem. Pharm. Bull.*, **39** (10), 2498-2501.
155. Sternbach, L.H., Fryer, R.I., Metlesics, W., Sach, G. and Stempel, A., (1962), Quinazolines and 1,4-benzodiazepines. o-Aminobenzophenones., *J. Org. Chem.* **27**, 3781-3788.
156. Lothrop, W.C. and Goodwin, P.A., (1943), A new modification of the ullmann synthesis of fluorene derivatives., *J. Am. Chem. Soc.*, **65**, 363-367.

157. Antolini, L.; Vezzosi, I.M.; Battaglia, L.P. and Corradi, A.B., (1985), Crystal and molecular structures of 2-aminobenzophenone and 2-aminodiphenylmethanol., *J. Chem. Soc. Perkin Trans.*, **2**, 237-240.
158. Henecka, H., (1973), The Fries rearrangement, *Methoden Org. Chem.* (Houben-Weyl), Vol. 7 (2a), pp 379-412.
159. Sternbach, L.H.; Fryer, R.I.; Metlesics, W.; Sach, G. and Stempel, A., (1962), Quinazolines and 1,4-benzodiazepines. o-Aminobenzophenones., *J. Org. Chem.*, **27**, 3781-3788 and Sternbach, L.H. and Reeder, E., (1961), Quinazolines and 1,4-Benzodiazepines. Transformations of 7-chloro-2-methylamino-5-phenyl-3H-1,4-benzodiazepine 4-oxide, *J. Org. Chem.*, **26**, 4936-4942.
160. Ahmed, S.S. and Farooqui, T.A., (1976), A new method for rearrangement of anilines, *Tetrahedron Letters*, **36**, 1976, 3217-3220.
161. Sternbach, L.H.; Reeder, E. and Metlesics, W., (1961), Quinazolines and 1,4-benzodiazepines. Substituted 2-amino-5-phenyl-3H-1,4-benzodiazepine 4-oxides., *J. Org. Chem.*, **26**, 4488-4498 and Sternbach, L. H.; Fryer, R. I.; Metlesics, W.; Reeder, E.; Sach, G. and Stempel, A., (1962), Quinazolines and 1,4-benzodiazepines. Halo-, methyl- and methoxy-substituted 1,3-dihydro-5-phenyl-2H-1,4-benz-2-ones, *J. Org. Chem.*, **27**, 3788-3796.
162. Sternbach, L.H. and Reeder, E., (1961), Quinazolines and 1,4-benzodiazepines. Transformations of 7-chloro-2-methylamino-5-phenyl-3H-1,4-benzodiazepine 4-oxide, *J. Org. Chem.*, **26**, 4936-4942.
163. Boehm, T.L., Showalter, H.D.H., (1996), Solid phase syntheses, *J. Org. Chem.*, **61**, 6498-6499.
164. Pirrung. M.C., (1997), Spatially addressable combinatorial libraries, *Chem. Rev.*, **97**, 473-488.

165. Bunin, B.A., Plunkett, M.J. and Ellman, J.A., (1994), The combinatorial synthesis and chemical evaluation of a 1,4-benzodiazepam library, *Proc. Natl. Acad. Sci. USA*, **91**, 4708-4712.
166. Camps, F.J. and Cartells, J., (1974), Organic synthesis with functionalised polymers- synthesis of 1,3-dihydro-5-phenyl-2H-1,4-benzodiazepin-2-ones., *Analles de Quimica*, **70**, 848-849.
167. de Witt S. H.; Kiely J. S.; Stankowic C.J.; Schroeder, M.C. and Pavia, M. R., (1993), Synthesis of small organic molecules on multi probe pins. Examples: Hydantoins, benzodiazepines., *Proc. Natl. Acad. Sci.* **90**, 6909-6913.
168. Stevens, Y.S.; Bunin, B.A.; Plunkett, M.J. and Ellman, J.A., (1996), Non-nucleic acid inhibitors of protein-DNA interactions identified trough combinatorial chemistry., *J. Amer. Chem. Soc.*, **118**, 10650-10651.
169. Ellman, J.A.; Boojamra, C.G.; Burow, K.M. and Thompson, L.A., (1997), Solid phase synthesis of 1,4-benzodiazepine-2,5-diones. Library, preparation and demonstration of synthesis generality, *J. Org. Chem.*, **62**, 1240-1256 and Ellman, J.A.; Boojamra, C.G. and Burow, K.M., (1995), An expedient and high-yielding method for the solid phase synthesis of diverse 1,4-benzodiazepine-2,5-diones, *J. Org. Chem.*, **60**, 5742-5743.
170. Plunkett, M.J. and Ellman, J.A., (1995), Solid phase synthesis of structurally diverse 1,4-benzodiazepine derivatives using the stille coupling reaction, *J. Am. Chem. Soc.*, **117**, 3306-3307.
171. Plunkett, M.J. and Ellman, J.A., (1997), Germanium and silicon linking strategies for traceless solid phase synthesis, *J. Org. Chem.*, **62**, 2885-2893.
172. Stembach, L.H.; Fryer, R.I.; Metlesics, W.; Sach, G. and Stempel, A., (1962), Quinazolines and 1,4-benzodiazepines. V. o-Aminobenzophenones., *Organic Synthesis*, **37**, 3781-3796.

173. Jones, J., (1999), Amino acid and peptide synthesis, Oxford Chemistry Primers, Oxford Science Publications, pp 19-20.
174. Shuttleworth, S.J.; Allin, S.M. and Sharma, K. P., (1997), Functionalised polymers: Recent developments and new applications in synthetic organic chemistry, *Chem. Rev.*, **97**, 1217-1239 and Gravert, D.J. and Janda, K.D., (1997), Organic synthesis on soluble polymer supports: Liquid phase methodologies, *Chem. Rev.*, **98**, 489-509.
175. Lattmann, E., Billington, D.C., Arayarat, P. Singh, H. and Offel, M., (1999), Preparation of a novel resin derived from ion exchange resin and its evaluation in peptide and benzodiazepine synthesis., *Science Asia* **25**, 107-112.
176. Saita Y., Yazawa H., Honma, Y., Nishida A., Miyata K. and Honda K., (1994), Characterization of YM022: its CCKB/gastrin receptor binding profile and antagonism to CCK-8-induced Ca²⁺ mobilization., *Eur. J. Pharmacol.*, **269**, 249-254.
177. Charpentier, B.; Pelaprat, D.; Durieux, C.; Dor, A.; Reibaud, M.; Blanchard, J.C. and Roques, B.P., (1988), Cyclic cholecystokinin analogues with high selectivity for central receptors., *Proc Natl Acad Sci U S A*, **85**, 1968-1972.
178. Nefzi, A.; Ostresh, J.M. and Houghten, R.A., (1997), The current status of heterocyclic combinatorial libraries, *Chem. Rev.*, **97**, 449-472.
179. United States Pharmacopeia XXII; Validation of compendial methods, pp. 1710-1712.
180. Menius, J.A.; Laskody, R.G.; Domanico, P.L.; Goetz, A.S.; Saussy, D.L. and Rimele, T., Glaxo-Wellcome Research Institute, Research Triangle Park, North Carolina, 27709, Tel: (919)483-6106, Fax: (919) 483-2494, <http://www.netsci.org/Science/Screening/feature05.html>

181. Satoh, M.; Okamoto, Y.; Koshio, H.; Ohta, M., Nisida, A.; Akuzawa, S.; Miyata, K.; Mase, T. and Semple, G., (1996), Biological activity of YM022. Novel (3-amino substituted phenyl)urea derivatives of 1,4-benzodiazepin-2-one as gastrin/cholecystokinin-B receptor agonists, *Chem. Pharm. Bull.*, **44**, 1412-1414.
182. Evans, B.E.; Rittle, K.E.; Bock, M.G.; DiPardo, R.M.; Freidinger, R.M.; Whitter, W.L.; Veber, D.F. and Anderson, P.S., (1986), Design of potent, orally effective, non-peptidal antagonists of the peptide hormone cholecystokinin, *Proc. Natl. Acad. Sci. USA*, **83**, 4918-4922.
183. Bock, M.G.; DiPardo, R.M. and Evans B.E., (1989), Benzodiazepine gastrin and brain cholecystokinin receptor ligands. L-365,260., *J. Med. Chem.*, **32**, 13-24.
184. Hoefle, G., Steglich, W. and Vorbrueggen, H. (1978) 4-Dialkylaminopyridines as highly active acylation catalysts., *Angew. Chem. Int. Ed. Engl.* **17**, 569-583.
185. Chimirri, A.; Grasso, S.; Romeo, G. and Zappalla, M., (1988), Novel fused ring 1,4-benzodiazepines: Synthesis of [1,4]oxathiano[5,6-b][1,4]benzodiazepin-2-ones, *Heterocycles*, **27** (6), 1445-1450.
186. Archer, G.A. and Sternbach, L.H., (1964), Quinazolines and 1,4-benzodiazepines. Synthesis and transformations of 5-phenyl-1,4-benzodiazepin-2-thiones, *J. Org. Chem.*, **29**, 231-233.
187. Sternbach, L.H., Fryer, R.I., Metlesics, W., Sach, G. and Stempel, A., (1962), Quinazolines and 1,4-benzodiazepines. o-Aminobenzophenones., *J. Org. Chem.* **27**, 3781-3788.
188. Sternbach, L. H.; Fryer, R. I.; Metlesics, W.; Reeder, E.; Sach, G. and Stempel, A., (1962), Quinazolines and 1,4-benzodiazepines. Halo-, methyl- and methoxy-substituted 1,3-dihydro-5-phenyl-2H-1,4-benzodiazepin-2-ones, *J. Org. Chem.*, **27**, 3788-3796.

189. Evans, B.E.; Rittle, K.E.; Bock, M.G.; DiPardo, R.M.; Freidinger, R.M.; Whitter, W.L.; Lundell, G.F.; Veber, D.F.; Anderson, P.S.; Chang, R.S.L.; Lotti, V.J.; Gould, N.P.; Homnicks, C.F.; Cerino, D.J.; King, P.J.; Kunkel, K.A.; Springer, J.P. and Hirshfield, J. (1987), Design of nonpeptidal ligands for a peptide receptor: Cholecystokinin antagonists, *Proc. Natl. Acad. Sci. USA*, **30**, 1229-1239 and Evans, B.E.; Rittle, K.E.; Bock, M.G.; DiPardo, R.M.; Freidinger, R.M.; Whitter, W.L.; Veber, D.F. and Anderson, P.S., (1986), Design of potent, orally effective, nonpeptidal antagonists of the peptide hormone cholecystokinin, *Proc. Natl. Acad. Sci. USA*, **83**, 4918-4922.
190. Kempe, M. and Abderhalden, E. (1907), Kenntnis des tryptophans und einiger seiner derivate., *J. Physiolo. Chem.*, **52**, 207-218.
191. Jones, J., Amino acid and peptide synthesis, Oxford Science Publications, Oxford University Press (1994), pp 50-51.
192. Sunjic, V.; Kaifez, F.; Stromar, L.; Blazevic, N. and Kolbah, D.J., (1973), Chiral 1,4-benzodiazepines. Synthesis and properties of 1,4-benzodiazepin-2-ones containing α -amino acids as a part of the 1,4-diazepine-ring., *J. Heterocyclic Chem.*, **10**, 591-599.
193. Evans, B.E.; Rittle, K.E.; Bock, M.G.; DiPardo, R.M. and Freidinger, R.M., (1987), Design of nonpeptidal ligands for a peptide receptor: Cholecystokinin antagonists, *J. Med. Chem.*, **30** (7), 1229-1239.
194. Satoh, Y.; Matsudo, T.; Sogabe, H.; Itoh, H.; Tada, T.; Kinoshita, T.; Yoshida, K. and Takaya, T., (1994), Studies on a novel, potent and orally effective cholecystokinin A antagonist, FK-480. Synthesis and structure-activity relationships of FK-480 and related compounds, *Chem. Pharm. Bull.*, **42**, 2071-2083 and Semple, G.; Ryder, H.; Kendrick, D.A.; Szelke, M.; Ohta, M.; Satoh, M.; Nisida, A.; Akuzawa, S.; Miyata, K.; Rooker, D.P. and Batt, A.R., (1997), (3R)-N(tert-Butylcarbonylmethyl)-2,3-dihydro-2-oxo-5-(2-pyridyl)-1H-1,4-benzodiazepin-3-yl)-N'-(3-(methylamino) phenyl)urea (YF476): A potent and orally active gastrin/CCK-B antagonist, *J. Med. Chem.*, **40**, 331-341.

195. Natzanishi, M.; Tahara, T. and Araki, K., (1973), Studies on psychotropic drugs. Synthesis and structure-activity relationships on 5-phenyl-1,3-dihydro-2H-thieno[2,3-e] [1,4]diazepin-2-one, *J. Med. Chem.*, **16**, 214-219.
196. Hellwinkel, H., Nomenklatur der organischen chemie, Springer Verlag, Heidelberg 1986.
197. Makovec, F. and D'Amato, M., (1997), CCK_B/gastrin receptor antagonists as potential drugs for peptic ulcer therapy, *DDT*, **2**, 283-293.
198. Snider, B.B, and Foxman, F., (1998), Totalsynthesis of (-)-asperlicin and asperlicin C., *J. Am. Chem. Soc.*, **120**, 6417-6418.
199. Bertram, G.K., (1995), Basic and Clinical Pharmacology, 6th edition, Publisher Appleton and Lange, Norwalk, Connecticut, p. 335.
200. Bock, M.G.; DiPardo, R.M.; Evans, B.E.; Rittle, K.E.; Veber, D.F.; Freidinger, R.M.; Chang, R.S. and Lotti, V.J., (1988), Cholecystokinin antagonists. Synthesis and biological evaluation of 4-substituted 4H-[1,2,4]triazolo[4,3-a][1,4]benzodiazepines; *J. Med. Chem.*, **31** (1), 176-181.
201. Scheibye, S.; Pederson, B.S. and Lawesson, S.O., (1978), Dithiadiphosphetane and their application for the organic synthesis, *Bull. Soc. Chim. Belg.*, **87**, 227-232.
202. Zavros, Y. and Shulkes, A., (1997), Cholecystokinin (CCK) regulates somatostatin secretion through both the CCK-A and CCK-B/gastrin receptors in sheep., *J. of Physiol. (London)*, **505** (3), 811-821.
203. Kubota, K., Sugaya, K., Matsuda, I. and Matsuoka, Y., (1985), Cholecystokinin antagonism by benzodiazepines in the contractile response of the isolated guinea pig gallbladder., *Jpn. J. Pharmacol.*, **37**, 101-106.
204. Meldrum, L.A.; Bojarski, J.D. and Calam, D., (1986), Benzodiazepines inhibit the action of cholecystokinin., *J. Eur. Pharmacol.*, **123**, 427-431.

205. Evans, B.E.; Rittle, K.E.; Bock, M.G.; DiPardo, R.M.; Freidinger, R.M.; Whitter, W.L.; Lundell, G.F.; Veber, D.F.; Anderson, P.S. and Chang, R.S., (1988), Methods for drug discovery: Development of potent, selective, orally effective cholecystinin antagonists, *J. Med. Chem.*, **12**, 2235-2246.
206. Bell, S.C. and Childress, S.J., (1965), United States Patent 3.198.9789.
207. Bock, M.G., DiPardo, R.M., Evans, B.E., Rittle, K.E., Veber, D.F., Freidinger, R.M., Hirshfield, J. and Springer, J.P., (1987), Synthesis and resolution of 3-amino-1,3-dihydro-5-phenyl-2H-1,4-benzodiazepin-2-ones; *J. of Org. Chem.*, **52**, 3232-3239.
208. Walser, A.; Silverman, G. and Fryer, R., (1973), Quinazolines and 1,4-benzodiazepines. Preparation of pyrrolo[2,1-c]-1,4-benzodiazepines, *J. Org. Chem.*, **38**, 3502-3507.
209. Avadagic, A.; Lesac, A.; Majer, Z.; Hollosi, M. and Sunjic, V., (1988), Preparation of 3-functionalised 1,4-benzodiazepin-2-ones., *Helv. Chim. Acta.*, **81** (8), 1567-1582.
210. Schmitt, J., (1970); 1,4-Benzodiazepin-2-ones having a carboxylic acid ester or amide group in the 3-position, United States Patent 3.516.988.
211. Reiter, B.E., Sachdeva, Y.P. and Wolfe, J.F., (1981), Metallation of Diazepam and use of the resulting carbanion intermediate in a new synthesis of 3-substituted derivatives., *J. Org. Chem.*, **46**, 3945-3949.
212. Bogat-skii, A.V., Andronati, S.A., Zhilina, Z.I., Kobzareva, O.V., Shabatyrn, P.A., Ivanova, R.Yu. and Chumachenko, T.K., (1975), 1,4-Benzodiazepines, their cyclic homologs and analogs: Synthesis and properties of 3-(arylmethylene)- and 3-(heterylmethylene)-1,3-dihydro-2H-1,4-benzodiazepin-2-ones; *Zhurnal Obshchei Khimii*, **45** (2), 396-401.
213. Berghot, M.A., (1992), Heterocyclic groups [b]-annulated to the 1,4-benzodiazepine system., *Arch. Pharm. (Weinheim)*, **325**, 285-289.

214. Elvidge, J.A.; Jones, J.A.; O'Brien, C.; Evans, E.A. and Sheppard, H.C., (1974), Base catalysed hydrogen exchange; *Adv.Heterocycl.Chem.*, **16**, 1-18.
215. F. Hoffmann-La Roche & Co. Aktiengesellschaft, Basel/Schweiz, Swiss Patent 2.233.482.
216. Leukart, O.; Cavieyel, M.; Eberle, A.; Escher, E.; Tun-Kyi, A. and Schwyzer, R., (1976), Synthesis of L-propagylglycine and derivatives., *Hel. Chimica Acta*, **59**, 2181-2183.
217. Sternbach, L.H.; Fryer, R.I.; Metlesics, W.; Sach, G. and Steiger, N., (1962), Quinazoles and 1,4-benzodiazepine. Nitro-substituted 5-phenyl-1,4-benzodiazepine derivatives., *J. Org. Chem.*, **27** (6), 261-265.
218. Santilli, A. and Osdene, T.S., (1964), 5H-1,4-Benzodiazepin-5-ones. Ring closure reactions of substituted 2-aminobenzamides., *J. Org. Chem.*, **29**, 1998-2003.
219. Stempel, A.; Reeder, E. and Sternbach, L.H., (1965), Quinazoles and 1,4-benzodiazepines. Mechanism for ring enlargement of quinazoline 3-oxide with alkali to 1,4-benzodiazepin-2-one 4-oxides., *J. Org. Chem.*, **30**, 4267-4271.
220. Pellow, S.; Chopin, P.; File, S.E. and Briley, M., (1990), Validation of open: Closed armed entries in an elevated plus maze as a measure of anxiety in the rat., *J. Neurosci.*, **11**, 271-273.

Publications

E. Lattmann, D.C. Billington, P. Arayarat, H. Singh, M. Offel; (1999); Preparation of a Novel Resin Derived from Ion-Exchange Resin and its Evaluation in Peptide and Benzodiazepine Synthesis; *Science Asia* **25**, 107-112.

E. Lattmann, D.C. Billington, D. Poyner, M. Offel; (2001); Synthesis and Evaluation of Asperlicin analogues as Non-peptidal Cholecystokinin-Antagonists; *Drug Design and Discovery*, **17**, 219-230.

E. Lattmann, D.C. Billington, D. Poyner, M. Offel; (2001); Solid Phase of 3-Alkylated-1,4-Benzodiazepines as Non-peptidal Cholecystokinin (CCK)-Antagonists; *Pharm. Pharm. Lett.*, **11**, 5-8.

E. Lattmann, D.C. Billington, D. Poyner, M. Offel; Combinatorial Solid Phase Synthesis of Multi-Substituted-1,4-Benzodiazepines and their Evaluation as Non-peptidal Cholecystokinin-Antagonists; *Drug Design and Discovery* (submitted for publication and accepted).

E. Lattmann, Jintana Sattayasai, David Billington, David R. Poyner, Prapawadee Puapairoj, Siriporn Tiamkao, Wanchai Airarat, Harjit Singh and Michael Offel; Synthesis and Evaluation of N₁-Substituted-3-propyl-1,4-Benzodiazepin-2-ones as Cholecystokinin (CCK₂)-Receptor Ligands; *Pharm. Pharm. Lett.* (submitted for publication).