

## Arduino-Uno Based Mobile Data Logger with GPS Feature

Muhammad Abu Bakar Sidik<sup>\*1,2</sup>, Mohd Qamarul Arifin Rusli<sup>1</sup>, Zuraimy Adzis<sup>1</sup>, Zolkafle Buntat<sup>1</sup>, Yanuar Zulardiansyah Arief<sup>1</sup>, Hamizah Shahroom<sup>1</sup>, Zainuddin Nawawi<sup>2</sup>,  
Muhammad Irfan Jambak<sup>2</sup>

<sup>1</sup> Institute of High Voltage and High Current (IVAT), Universiti Teknologi Malaysia,  
81310 UTM Johor Bahru, Malaysia

<sup>2</sup> Department of Electrical Engineering, Faculty of Engineering, Universitas Sriwijaya, Indonesia

\*Corresponding author, e-mail: abubakar@fke.utm.my

### Abstract

*Lightning activity correlates with the formation of thunderclouds which increase the atmospheric electric field (AEF) between the cloud and the earth. Observations of the development of the AEF will allow the prediction of lightning activities close to a particular location. In research and development, the data logger plays an important role to observe and collect data from AEF sensors. The data logger must be reliable and effective. High investment costs are involved in acquiring a data logger, and choosing a suitable data logger is not easy. Institut Voltan dan Arus Tinggi (IVAT) is developing AEF sensor. Along with that sensor development a data logger development is also required. In this paper, a mobile data logger is developed by using Arduino-Uno. This mobile data logger is equipped with a GPS module, which provides accurate positioning in the collection of data. Laboratory and field tests were carried out to observe the performance of the mobile data logger system. The results showed that the developed data logger works properly.*

**Keywords:** mobile, data logger, low cost, global positioning system, atmospheric electric field

### 1. Introduction

Much research has focused on the application of sensors and data logger systems in many fields of science and engineering, such as meteorology, geoscience, geophysics, aeronautics, and aerospace. In obtaining accurate data for performing analyses, the process of data recording is critical in the application of a data logger system.

Recent studies have measured temperature and humidity levels. Gasparese utilised an Arduino Uno board that was connected to a PC with a graphical user interface (GUI) to monitor the desired parameters [1], and Khairi et al. developed a wireless temperature monitoring system [2]. The data were sent through a wireless network in which the data could be observed by using an LCD and portable computer. Similar studies were also presented by Goswami et al., Ibrahim, Kumar et al., and Singh and Sud. [3]-[6]. However, applications of portable and mobile data logging with sensors are also in demand [7]-[9].

Generally, any mobile application is equipped with a global positioning system (GPS) in order to provide the coordinates, time, speed and distance. The GPS has been utilised widely in both scientific research and business, such as navigating for the accurate prediction of traffic flow information, surveying for errors in highway measurements, tracking and surveillance of high altitude UAVs, mobile phone operations, interfacing with GPRS as an outdoor remote wireless data collection, a portable, wearable system that enhances athletes' performances [10]-[14], and many more.

Furthermore, in outdoor activities, lightning is a natural phenomenon of which people should be aware. Lightning activity correlates with the formation of thunderclouds, which increase the atmospheric electric field (AEF) between the cloud and the earth. Observations of the development of the AEF will allow the prediction of lightning activities close to a particular location. These observations are particularly important in countries with high isokeraunic levels [15]-[17].

With regard to AEF, a study using an electric field mill was carried out to develop a thunderstorm warning alarm system [18]. It was based on the measurement of variations in the

AEF stationary observation stations.

However, the construction of a stationary observation unit has required a high investment in equipment and installations, including land, tower, antenna, data acquisition, and computer. However, rapid developments in technology have made it possible to develop an effective mobile data logger system at a much lower cost. Interestingly, little research has investigated mobile data logging related to AEF measurement.

This paper presents the development of a low-cost mobile data logger device to record temperature, humidity, AEF magnitude, and location coordinates. The system is developed by using the Arduino-Uno board environment (Arduino-Uno) and Arduino 1.0.5 open project software. In the next study, a low-cost online data logging system integrated with mobile observation stations will be developed.

## 2. Development process

The development process consists of two parts: the selection of components and the programming code. The harmonization of the two parts will determine the overall performance of the device.

### 2.1. Components overview

The performance of a mobile data logger device is determined by the selection of components. Our review of previous studies showed that Arduino-Uno is suitable for application in a mobile data logger. Several applications have been developed by using Arduino-Uno, such as in motion, sound, and respond control. The application has been widely used in environmental monitoring, such as observing climate change, green house monitoring, gas sensors and so on [18]-[21].

Arduino-Uno uses the Atmega328 programmable integrated circuit with 6 analogue inputs and 14 digital i/o pins. Arduino-Uno operates at 5 V, which is acceptable in most sensor devices. In this current work, five analogue inputs were used to receive input signals from a temperature and humidity sensor. In addition, the digital i/o was used for the GPS module, LEDs, LCD module, and SD Card module. Figure 1 presents all components of the design.

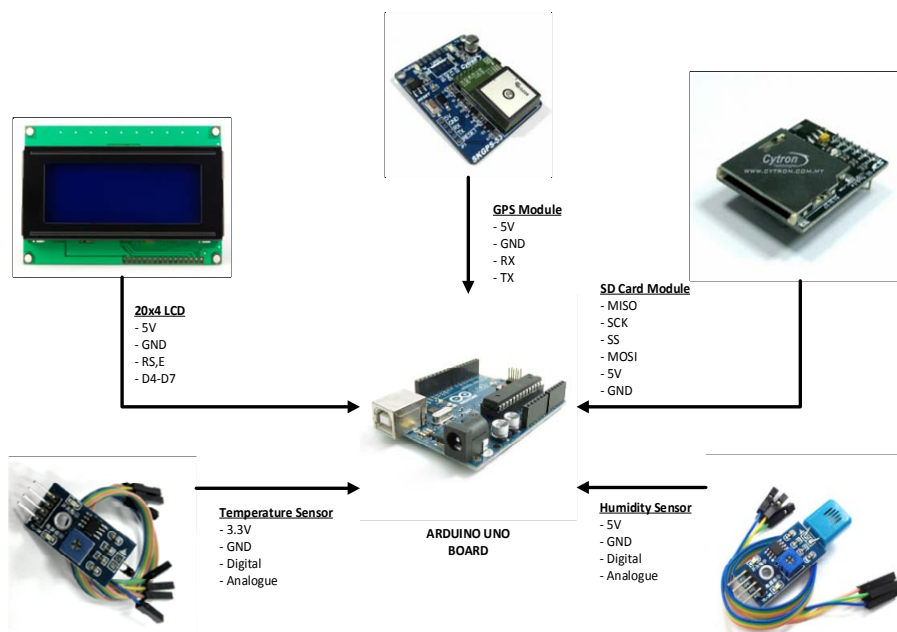

Figure 1. Arduino Uno board and all related sensors and modules

A NTC thermistor-based temperature module (NTC-module) was selected to observe and collect temperature data from the surroundings. The NTC-module is suitable for mobile applications, and its sensitivity fulfils the design requirements of the current work. Compared with the LM35 temperature sensor, the NTC-module is more sensitive and makes fewer reading errors. It comes with two outputs: analogue and digital. Because its power supply ranges from 3.3 V to 5 V DC, the NTC-module can be used immediately. Furthermore, because of its small size (3 cm x 1.6 cm) the NTC-module is easily put into position, which reduces the development cost [22].

In addition to the temperature, an important parameter for observation is the surrounding humidity. Temperature and humidity have a relative correlation, and both parameters will be used to describe the weather conditions. A humidity sensor module with a pre-mounted HR202 humidity sensor was utilized to observe variations in humidity. It operates at 3.3 V to 5 V DC, and it can be used immediately to measure humidity. Operating in 20-95% RH with accuracy of  $\pm 5\%$  RH, it is suitable for many applications [13].

Furthermore, a SKM53 GPS Starter Kit (GPS-module) was utilized to acquire the position of the data being collected. The GPS module is equipped with an embedded patch GPS antenna 18.2 x 18.2 x 4.0 mm<sup>3</sup>. It provides a solid fix, even in harsh GPS visibility environments, as well as high-performance navigation in stringent applications. It includes an ultra-high sensitivity (-165 dBm) receiver and an internal back-up battery. Its entire dimensions are 39 x 50 mm<sup>2</sup>. In addition to the position data, the GPS-module also provides information regarding altitude, time, date, and speed. The almanac data is provided by satellites. The position is obtained by determining its distance from visible satellites and by using the triangulation method to calculate it. GPS data is configured according to standards set by the National Marine Electronics Association (NMEA). In the current study, the information taken from the GPS module included the position, date, and time.

All data were saved in a secure digital (SD) card, which is a typical flash-based memory card designed specifically to meet the security, performance, and environmental requirements of this study. The SD card was secured in the SD card module BB-SD-0071 SD card breakout board. It very compatible with Arduino and can be operated with a power supply of only 3 V or 5 V DC. The module also has a built in logic-level shifter, so for the data interface, it can be connected directly to the Arduino Uno board without an external circuit.

Finally, a 20 x 4 character LCD was used for instant display during the data logging. The LCD 20x4 was selected because its size is adequate and it is able to display a great amount of data. The components and devices connected to Arduino are shown in Table 1.

## 2.2. Programming flowchart

Arduino provides the "Aduino.exe" freeware for users developing programming codes. An extensive reference library of components is included with the freeware, which was developed by various supportive Arduino communities. C language was used to write the programming code in the Arduino freeware environment. It consists of main a programme and a subroutine programme. As shown in Figure 2, the code starts by importing all related library items to the main programme, which configure the Arduino microcontroller and sensor modules. Subsequently, the global variables are declared. The output- and input-direction ports of the microcontroller are based on the GPS module, the LCD, the temperature and humidity sensor module, as well as other sensors.

The subroutine flowchart is shown in Figure 3. In a normal condition, the subroutine would operate in a loop continuously, unless it was stopped by the observer. In the first step, the microcontroller would be requested to detect the sensors' availability. If the sensors were not found, an error message then would appear. Otherwise, the next command would be executed.

Table 1. Components and Devices

DEVICE		ARDUINO UNO
Type	Pin	Pin
Temperature Sensor Module	Vcc	3V and AREF
	GND	GND
	D0	
Humidity Sensor Module	A0	A0
	Vcc	5V
	GND	GND
Another sensor	D0	
	A0	A1
	A0	A2
Rotating Electric Field Mill	A0	A3
GPS Module	Vcc	5V
	GND	GND
	TX	RX
	RX	
LED 1		D2
LED 2		D3
LED 3		D12
SD Card Module	MISO	D13
	SCK	D12
	MOSI	D11
	SS	D10
	Vcc	5V
	GND	GND
	GND	GND
LCD 20x4	Vcc	5V
	POT	
	RS	D4
	VDD	GND
	E	D5
	DB4	D6
	DB5	D7
	DB6	D8
	DB7	D9
	LED+	
	LED-	GND

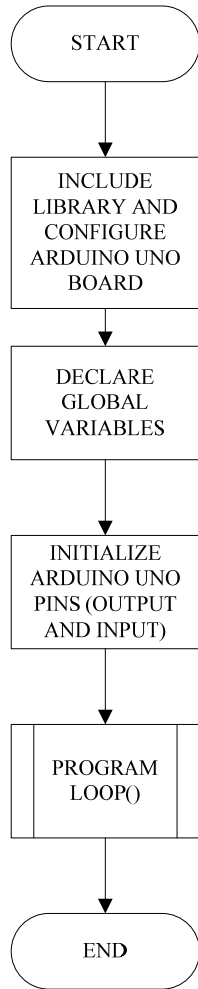

Figure 2. Flow chart of the Main Program

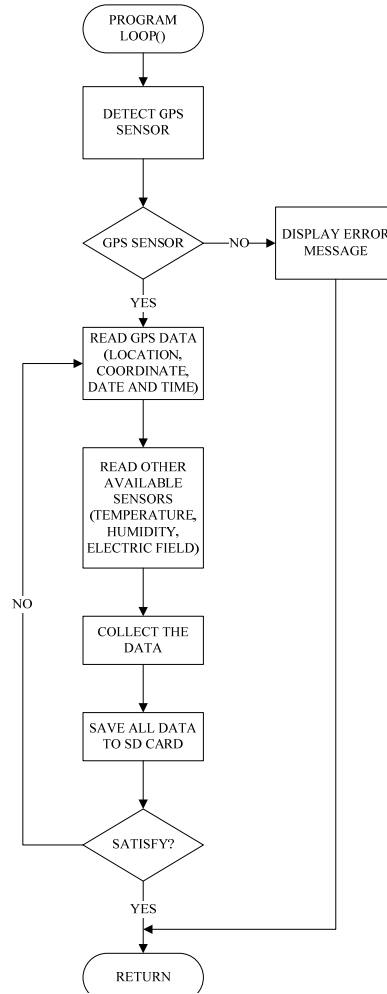

Figure 3. Flowchart of PROGRAM LOOP

**3. Results and discussion**

The assembled components are shown in Figure 4. This prototype is utilised in the testing process. A proper casing design will be carried out after the results of the testing are confirmed.

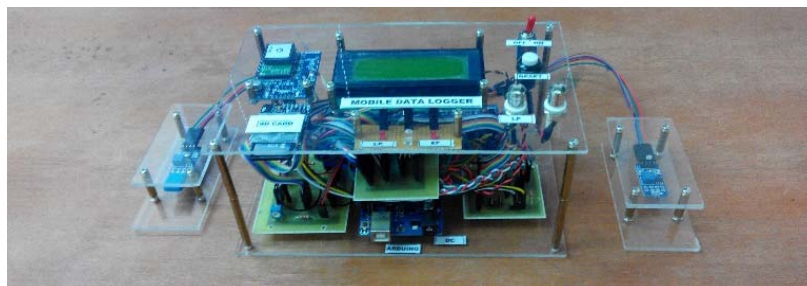

Figure 4. Mobile data logger

The testing was carried out both inside and outside the laboratory (field-testing). All tests were carried out to examine the harmonization of all components of the device.

### 3.1. Laboratory Experiment

Testing inside the laboratory was carried out first. The testing included observations of the surrounding temperature and humidity. The experiment was carried out in the Actuator and System Laboratory, Universiti Teknologi Malaysia, UTM Johor Bahru. It was conducted on 20 March 2014 at 12:05 pm. Based on the GPS data, the latitude and longitude of the location were 1.559380 N and 103.642433 E, respectively. The observation was carried out for a duration of one minute with 500 data retrieved; therefore, the data intervals were approximately 0.12 second. In other words, the speed of the data collection was 8.33 data per second. Figure 5 and Figure 6 illustrate the results of temperature and humidity observations, respectively. The results showed that in the first 5 seconds, the data oscillated before reaching a steady state. This instability was related to the energising process of the Arduino Uno board.

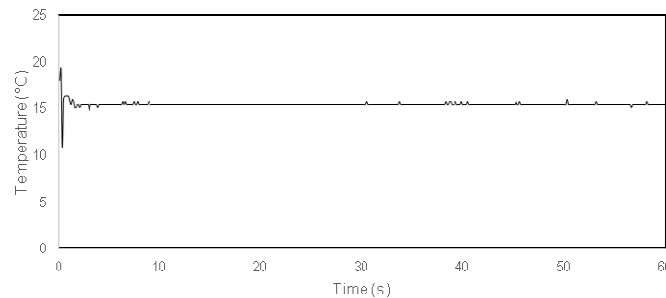

Figure 5. Temperatures with Time

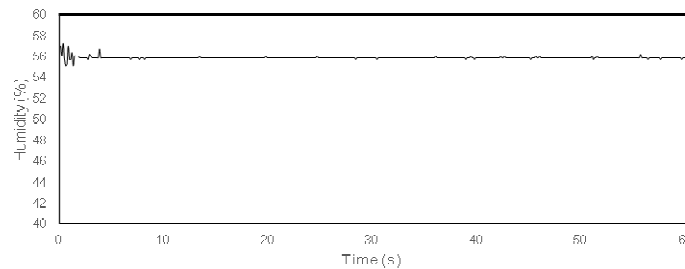

Figure 6. Humidity with Time

### 3.2. Field testing

In the field-testing, the humidity and temperature sensors were located on the roof of a car, as shown in Figure 7, and the prototype data logger, equipped with the GPS system, was placed inside the vehicle.

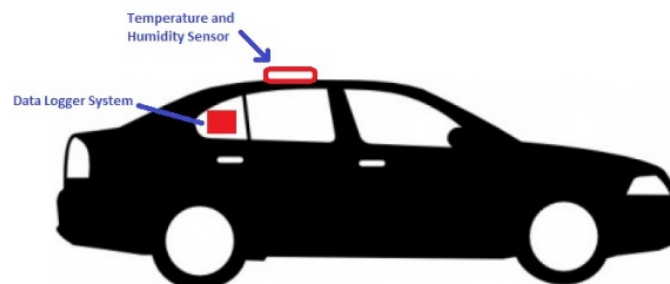

Figure 7. Sensors and data logger placement

The vehicle moved for about 1 hour, 9 minutes, and 30 seconds (i.e., from 14:26:31 to 15:36:01), collecting the surrounding temperature and humidity levels, as well as the date, time, latitude and longitude. The data were collected at intervals of 1 second. There were 1,092 data logged during the data collection. A part of the collected data, which was retrieved from SD cards by using Microsoft Excel, is shown in Figure 8.

	A	B	C		D	E	F
1	Date	Time	Lat	Long	T	H	EF
2	21/05/2014	14:26:31	1.5415,103.6321		31.79	55.25	
3	21/05/2014	14:26:32	1.5414,103.6319		31	55.25	
4	21/05/2014	14:26:33	1.5414,103.6316		30.76	55.25	
5	21/05/2014	14:26:36	1.5414,103.6314		29.85	55.09	
6	21/05/2014	14:26:37	1.5414,103.6313		29.59	55.09	
7	21/05/2014	14:26:38	1.5414,103.6313		30.05	55.09	
8	21/05/2014	14:26:39	1.5414,103.6313		29.9	55.25	
9	21/05/2014	14:26:41	1.5414,103.6312		30.85	55.25	
10	21/05/2014	14:26:42	1.5414,103.6312		31	55.25	
11	21/05/2014	14:26:43	1.5414,103.6312		30.91	55.09	
12	21/05/2014	14:26:44	1.5414,103.6311		31	55.25	
13	21/05/2014	14:26:45	1.5414,103.6311		30.76	55.25	
14	21/05/2014	14:26:46	1.5414,103.6311		30.4	55.25	
15	21/05/2014	14:26:47	1.5414,103.6311		30.55	55.25	
16	21/05/2014	14:26:48	1.5414,103.6311		30.4	55.25	
17	21/05/2014	14:26:49	1.5414,103.6310		30.73	55.25	
18	21/05/2014	14:26:50	1.5413,103.6310		30.73	55.25	
19	21/05/2014	14:26:51	1.5413,103.6310		30.85	55.25	
20	21/05/2014	14:26:56	1.5413,103.6309		30.82	55.41	

Figure 8. Snapshot data from MS Excel

The data sample is presented in Figure 9, which indicates that at first, the temperature increased greatly when the sensor was positioned at the beginning of the observation. After about 3 minutes, the temperature tended to stabilize and slowly increased to more than 40 °C. A light rain started when the car had been moving for about 15 minutes, which caused the temperature to drop sharply. However, the observed humidity level was constant, indicating that the humidity sensor did not respond to the change in the surrounding conditions.

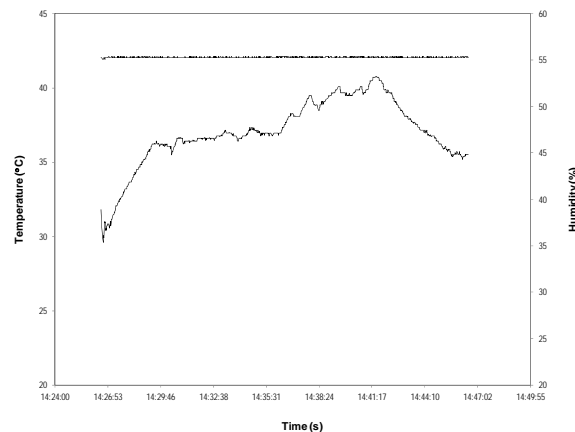

Figure 9. Part of collected data of temperature and humidity over 20 minutes

In order to verify the operation of the temperature and humidity sensors, a test was conducted by comparing the temperature and humidity data from the prototype device with a device certified by SIRIM Berhad. The devices were positioned close together for 10 minutes prior to the data collection to ensure that all sensors were adapted to the surrounding conditions. Table 2 shows that the two devices had different readings. The trend of the temperature was similar, with an average discrepancy of 3.18 °C. Further calibration work could be carried out to solve this problem.

The discrepancies in the humidity data between the two devices were extreme. Hence, further investigations of the capacity of the HR202 humidity sensor applied in the mobile data logger will be conducted.

Table 2. Comparison Results of Temperature and Humidity

Date	Time	Place	Developed device		Product is certified by SIRIM	
			T (°C)	H (%)	T (°C)	H (%)
06/02/2014	12:04 p.m.	IVAT Laboratory	25.21	53.83	29.5	73
07/02/2014	2.45 p.m.	AHU Room	28.01	54.88	31	78
08/02/2014	3:20 p.m.	FKE study corner	25.05	58.74	27	77
09/02/2014	3:51 p.m.	Sensor and Actuator Laboratory	23.03	50.42	26.5	46

In addition, to validate the GPS data, the GPS data was transferred to the Google maps tracking software. The results illustrated in Figure 10 show that the GPS collected the coordinate data accurately; thus, its performance was satisfactory.

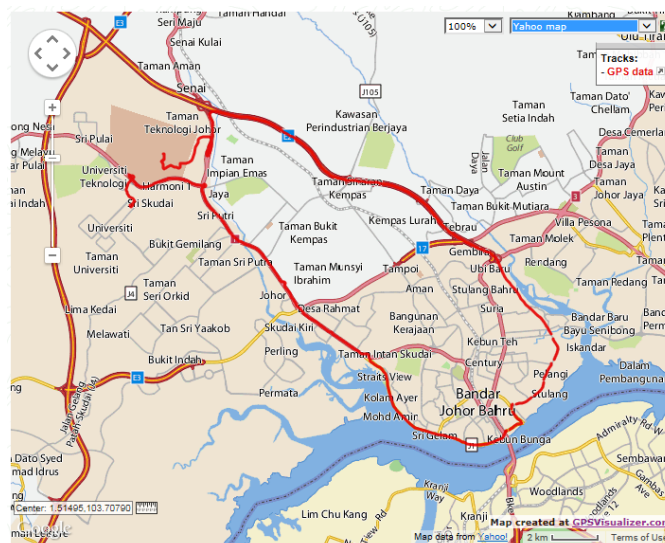

Figure 10. Location Tracking Map

The prototype device was designed to be as compact as possible so that it could be carried and positioned easily. It can be powered by using the USB port of computer notebook or a cigarette lighter inside an automobile. It also could be powered through a DC barrel-type power connector.

The total amount of space used by the programming code was 24.24 kbytes of 32 kbytes in Atmega32's flash memory. However, a problem was found regarding the data collection from sensors, in which the microprocessor (Atmega32) could not read the sensors concurrently. Consequently, when data from the first sensor was stored inside the flash



memory, the data would not merge with new data from another sensor. In order to address this problem, time delay and memory discharging commands also should be added to the programming section. The command code should be placed before the next sensor was accessed.

In addition to the temperature and humidity sensor port, the prototype device is also equipped with a port for rotating the electric field mill (REFM). Usually, the REFM is utilised to observe the AEF magnitude. Because the output of the REFM is a DC signal, it can be attached to the prototype device. Figure 11 shows a typical output signal from a developing REFM. However, because the development of REFM for mobile applications is ongoing, the current paper could not present a result related to the mobile data logger.

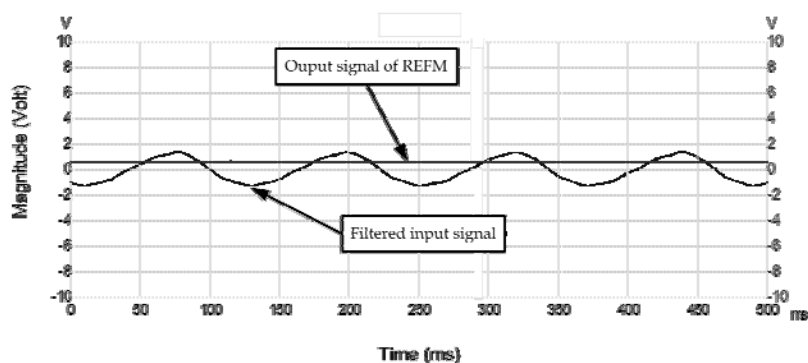

Figure 11. Typical output signal from developing REFM

Another important component of the mobile device is the GPS module. The GPS module utilises satellite information to provide output data. Information about the time and date provided by satellites is very accurate. In the current study, the GPS module needed at least a 10-minute start-up before reliable data was obtained because the module needed to search for and read the signals from satellites. The distance of the module from the satellites also affected the duration of the start-up.

Currently, the device developed here is only used offline. The collected data, which were automatically saved in the SD card, were retrieved and analysed using a PC. However, an online system will be developed in the future [23]-[25]. In the meantime, the SD Card can be still utilised as back-up storage if the online system presents problems.

#### 4. Conclusion

The design and development of a low-cost mobile data logger was successfully carried out. The laboratory and outdoor testing results showed that the developed device satisfactorily performed the required observations and data logging. All components worked properly at an acceptable speed. The device performed well when applied with a DC input signal.

#### References

- [1] G Gasparese. *Development of a low-cost system for temperature monitoring*. 2013 36th International Conference on Telecommunications and Signal Processing, TSP 2013, Rome. 2013: 340-343.
- [2] NA Khairi, AB Jambek, TW Boon, U Hashim. *Design and analysis of a wireless temperature monitoring system*. RSM 2013: 2013 IEEE Regional Symposium on Micro and Nano Electronics. 2013: 105-108.
- [3] A Goswami, T Bezboruah, KC Sarma. An embedded design for automatic temperature controller. *International Journal of Advanced Engineering & Application*. 2011; 1: 88-93.
- [4] D Ibrahim. Microcontroller based temperature monitoring and control. *Elsevier Science & Technology Books*. 2002: 2-61.

- [5] A Kumar, IP Singh, SK Sud. *Design and development of multi-channel data logger for built environment*. International MultiConference of Engineers and Computer Scientists 2010, IMECS 2010. 2010: 993-998.
- [6] NM Singh, KC Sarma. Design and development of low cost pc based real time temperature and humidity monitoring system. *International Journal of Electronics and Computer Science Engineering*. 2012; 1: 1588-1592.
- [7] S Nur HM, W Suhaimizan WZ, A Joret, M Mahadi AJ. *Design and development of wireless stethoscope with data logging function*. 2013 IEEE International Conference on Control System, Computing and Engineering, ICCSCE 2013, Penang, Malaysia. 2013: 132-135.
- [8] PS Ross, A Bourke, B Fresia. A multi-sensor logger for rock cores: Methodology and preliminary results from the Matagami mining camp, Canada. *Ore Geology Reviews*. 2013; 53: 93-111.
- [9] TH Khan, KA Wahid. A portable wireless body sensor data logger and its application in video capsule endoscopy. *Microprocessors and Microsystems*. 2014; 38: 42-52.
- [10] CT Li, XW Han, YZ Sun. *Design of dynamic vehicle navigation terminal based on GPS/GPRS*. 2014; 472: 237-241.
- [11] SY Jiang, ZW Wei. *GPS application in highway survey*. 2014; 838-841: 2004-2009.
- [12] C Vincenzo A, VR Baraniello, L Cicala. *High altitude UAV navigation using IMU, GPS and camera*. 2013: 647-654.
- [13] H Wang, Z Chen. *The outdoor data collection system with GPRS*. 2014; 846-847: 1098-1101.
- [14] M Arebey, MA Hannan, H Basri. *Integrated communication for truck monitoring in solid waste collection systems*. 2013; 8237: 70-80.
- [15] MAB Sidik, H Ahmad. On the Study of Modernized Lightning Air Terminal. *International Review of Electrical Engineering-Iree*. 2008; 3: 1-8.
- [16] MAB Sidik, H Ahmad, ZA Malek, Z Buntat, N Bashir, MIA Zarin, et al. *Induced Voltage on Objects under Six-Phase Transmission Line*. 2011 IEEE Region 10 Conference Tencon 2011. 2011: 968-970.
- [17] MAB Sidik, H Ahmad, Z Salam, Z Buntat, OL Mun, N Bashir, et al. Study on the effectiveness of lightning rod tips in capturing lightning leaders. *Electrical Engineering*. 2013; 95: 367-381.
- [18] J Lopez, E Perez, J Herrera, D Aranguren, L Porras. *Thunderstorm warning alarms methodology using electric field mills and lightning location networks in mountainous regions*. Lightning Protection (ICLP), 2012 International Conference on. 2012: 1-6.
- [19] P Parwekar, A Gupta, S Arora. *Application of Sensor in Shoe*. 2014; 247: 409-416.
- [20] DK Fisher, R Sui. An inexpensive open-source ultrasonic sensing system for monitoring liquid levels. *Agricultural Engineering International: CIGR Journal*. 2013; 15: 328-334.
- [21] C Peng, J Yang, B Xue, Y Chen, X Zhu, Y Zhang, et al. Development of a low-power broadband seismometer-integrated data logger. *Acta Seismologica Sinica*. 2014; 36: 146-155.
- [22] MJA Khan, MR Imam, J Uddin, MAR Sarkar. *Automated fire fighting system with smoke and temperature detection*. 2012: 232-235.
- [23] YH Xiong, SY Wan, Y He, D Su. Design and implementation of a prototype cloud video surveillance system. *Journal of Advanced Computational Intelligence and Intelligent Informatics*. 2014; 18: 40-47.
- [24] N Sultan. Making use of cloud computing for healthcare provision: Opportunities and challenges. *International Journal of Information Management*. 2014; 34: 177-184.
- [25] LH Xu, LL Yang, RH Wei. *Design of a greenhouse visualization system based on cloud computing and android system*. 2014; 519-520: 1453-1458.