

## Model and Analysis of Wind Speed Profile using Artificial Neural Network - Feasibility Study in Peninsular Malaysia

Muhammad Nizam Kamarudin<sup>a\*</sup>, Abdul Rashid Husain<sup>b</sup>, Mohamad Noh Ahmad<sup>b</sup>, Zaharuddin Mohamed<sup>b</sup>

<sup>a</sup>Faculty of Electrical Engineering, Universiti Teknikal Malaysia Melaka (UTeM), 76100 Durian Tunggal, Melaka, Malaysia

<sup>b</sup>Faculty of Electrical Engineering, Universiti Teknologi Malaysia, 81310 UTM Johor Bahru, Johor, Malaysia

\*Corresponding author: [nizamkamarudin@utem.edu.my](mailto:nizamkamarudin@utem.edu.my)

### Article history

Received :13 October 2014

Received in revised form :

2 December 2014

Accepted :15 March 2015

### Graphical abstract

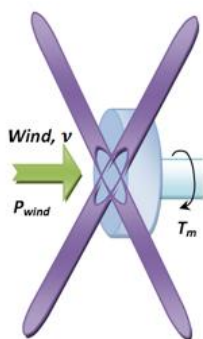

### Abstract

Accurate modeling of wind speed profile is crucial as the wind speed dynamics are non-deterministic, having chaotic behavior and highly nonlinear in nature. Therefore, obtaining mathematical model of such wind speed profile is rather difficult and vague. In this brief manuscript, the wind speed distribution in Peninsular Malaysia is modeled via the real-time wind data obtained from the Malaysian Meteorological Services (MMS). Artificial neural network (ANN) has been exploited to train the data such that the exact model of wind speed can be identified. The induced wind speed model worthwhile for control engineers to develop control apparatus for wind turbine systems at the selected area of studies. With the wind speed distribution profile, turbine output power can be analyzed and were discussed thoroughly.

*Keywords:* Wind speed; artificial neural network; wind turbine

### Abstrak

Pemodelan yang tepat bagi profil kelajuan angin adalah penting kerana dinamik kelajuan angin semulajadi adalah tidak tentu, mempunyai tingkah laku yang huru-hara dan sangat tidak linear. Oleh itu, mendapatkan model matematik profil kelajuan angin agak sukar dan samar-samar. Dalam manuskrip ringkas ini, pengagihan kelajuan angin di Semenanjung Malaysia dimodelkan melalui data angin masa sebenar yang diperolehi daripada Jabatan Kajiucua Malaysia (MMS). Rangkaian neural tiruan (ANN) telah digunakan untuk melatih data supaya model sebenar kelajuan angin boleh dikenal pasti. Profil kelajuan angin ini diharap dapat digunakan oleh jurutera kawalan bagi membangunkan alat kawalan untuk sistem turbin angin di kawasan kajian ini dijalankan. Dengan profil kelajuan angin ini juga, kuasa keluaran turbin boleh dianalisis dan dibincangkan dengan teliti.

*Kata kunci:* Kelajuan angin; rangkaian neural tiruan; kincir angin

© 2015 Penerbit UTM Press. All rights reserved.

### 1.0 INTRODUCTION

Winds are movements of air masses in the atmosphere originated by temperature changes. The most striking characteristic of the wind flow is its variability. Plus, wind flow dynamics, are highly nonlinear, non-deterministic and have chaotic behavior. As such, obtaining exact wind speed model is crucial for the design engineer whose construct control apparatus for the wind turbine systems. Transition from polluted fossil energy to an environmental friendly wind energy has sprout the research in wind turbine systems. In the European countries, research and development of wind turbine technology is rather encouraging. However, in the Asian continental, the development in wind turbine technology is rather slow. Few studies on evaluation of wind energy feasibility in Asian continental have been reported. For instance, wind turbine feasibility studies in Jordan [1] and Peninsular Malaysia [2], [3]. The knowledge of wind speed distribution profile is necessary for

design engineers as the wind speeds render tip-speed-ratio and hence, determine the power coefficient of the turbine. The gust flow might be beyond the cut-out speed that need to be treated by using appropriate control approach in order to avoid damage in the aero-turbine part. Therefore, the wind speed distribution profiles are the essential part to be considered when designing a control scheme at the simulation stages.

In this manuscript, ANNs are used to model the wind speed profiles. ANNs are known as a powerful data modeling tool which able to capture and represent complex input-output relationships. The advantage of ANNs lies in their ability to represent both linear and nonlinear relationships and in their ability to learn these relationships directly from the data being modeled. In this manuscript, the purpose of ANNs is to create a wind speed model that correctly maps the random input to the known wind output obtained from wind speed distribution. The random signal is used as a test input as it has a flat frequency spectrum. To reach main

result, the accurate wind speed distribution from the MMS that has been published in [3] is used as the known wind speed output. In [3], the authors concluded that most of the regions in Peninsular Malaysia (i.e. Langkawi, Penang, Kuala Terengganu, Kota Bharu) are having limited wind energy potential except Mersing (see Figure 1). For the rest of this manuscript, a multilayer feed-forward ANN is used to model the wind speed profile.

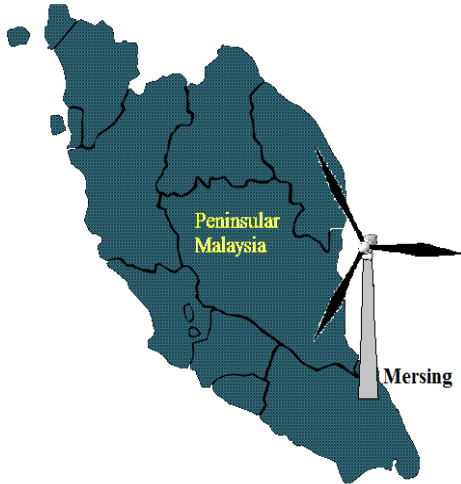

Figure 1 Wind distribution area as recorded in [3]

The overall structure of the study takes the form of four sections including this introductory section. Section 2 discusses the modeling of wind speed distribution profile. Section 3 discusses the result. Section 4 concludes the findings.

## 2.0 THEORETICAL BACKGROUND OF WIND TURBINE

Wind turbines work by converting the kinetic energy from the wind into rotational energy in the turbine. The rotational energy is then converted into electrical energy. The energy conversion depends on the wind speed and the swept area of the turbine. Figure 2 shows the swept area; that is the region where the turbine can capture the kinetic energy.

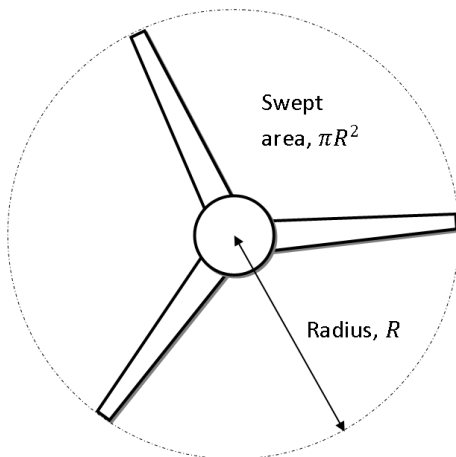

Figure 2 Turbine swept area

Instantaneous power produced by the wind can be denoted as:

$$P_{wind} = \frac{1}{2} \rho \pi R^2 v^3 \quad (1)$$

where  $\pi R^2$  is the swept area of the turbine.  $\rho$  is the air density with value depends of air temperature. This power is transmitted to the hub of the turbine in order to produce the aerodynamic power as expressed in shown Equation (2).

$$P_m = \frac{1}{2} C_p(\lambda, \beta) \rho \pi R^2 v^3 \quad (2)$$

$\beta$  is the pitch angle,  $\lambda$  is the tip speed ratio which directly proportional to the wind speed  $v$  times the angular rotor speed, and inversely proportional to the radius of the rotor blades,  $R$ . Whereas  $C_p$  is the power coefficient. Note that Equation (1) and Equation (2) are the standard power expression that can be derived from the third equation of motion cum Newton's Law which previously appeared in [4-10]. Practically, the turbine would not be able to capture 100% of kinetic energy from the wind. This gives a fact that the aerodynamic power produced by the turbine that need to be fed to the generator must be limited by a factor  $C_p$  (one may recall Equation (2)).  $C_p$  is provided by the turbine manufacturer via the look-up table [11]. However in [12-14], the empirical expression for  $C_p$  is presented as in Equation (3).

$$C_p(\lambda, \beta) = 0.5 \left( 116 \frac{1}{\phi} - 0.4\phi\beta - 5 \right) e^{-21\frac{1}{\phi}} \quad (3)$$

where the function  $\phi$  is given as:

$$\frac{1}{\phi} = \frac{1}{\lambda + 0.08\beta} - \frac{0.035}{1 + \beta^3} \quad (4)$$

For a regulated pitch angle at  $\beta = 0^\circ$ , one may obtain the optimum tip speed ratio  $\lambda_{opt} = 7.953925991$ , and the maximum power coefficient  $C_{p(max)} = 0.4109631031$ . This means that the turbine converts a maximum 41.09% of the kinetic energy into a rotational energy.

As discussed earlier, wind speed and swept area determine the amount of aerodynamic power generated by the turbine. The radius of turbine blades determines the swept area. According to [9], high speed turbines with two blades normally capture a maximum 40%-50% of kinetic energy. Whereas slow speed turbines with more number of blades capture between 20%-40% of kinetic energy from the wind. For one-mass turbine structure, aerodynamic power is transferred directly to the generator for electricity generation. For two-mass turbine structure, the aerodynamic power is supplied to the mechanical gearing system that separating the low speed and the high speed subsystem in the generator.

## 3.0 ANN WIND SPEED MODEL METHODOLOGY

In this section, the real-time wind data obtained from the Malaysian Meteorological Services (MMS) in [3] is used to develop a neural network wind speed profile. Table 1 tabulates the useful nomenclature to facilitate the modeling methodologies in what follow.

**Table 1** Table of nomenclature

Symbols	Definition
$x_i$	Inputs to the neural network neurons
$w_i$	Weights of the neurons inputs
$b_i$	Thresholds of the neuron layer
$v$	Wind speed ( $m \cdot s^{-1}$ )
$\rho$	Air density ( $Kg \cdot m^{-3}$ )
$C_p(\lambda, \beta)$	Power coefficient
$\lambda$	Tip speed ratio
$\beta$	Pitch angle ( $deg$ )
$R$	Blade radius ( $m$ )

The unit of structure of ANNs is the neuron which consists of a summer and an activation function. Let the inputs to the neuron are denoted as  $x_1, x_2, x_3 \dots x_n$  with corresponding weights  $w_1, w_2, w_3 \dots w_n$ . All inputs are multiplied by their corresponding weights and added together with the threshold term  $b_i$  to form the net input to the neuron, as shown in Equation (5). To obtain the network output, the net function in Equation (5) is activated by the activation functions.

$$net = \sum_{i=1}^n x_i w_i + b_i \tag{5}$$

Initially, 3 layers feed-forward ANN for wind speed profile is created. The input vector is a test input data containing a set of normally distributed continuous-time flat frequency spectrum random signal. The hidden layer consists of 10 neurons while the output layer consists of 1 neuron. The activation functions used in the hidden layer is a *tan-sigmoid* transfer function. For the output layer, a linear transfer function is used as the activation function. The wind speed output expression is shown in Equation (6).

$$v = \left( \frac{1 - e^{-2(\sum_{i=1}^{10} x_i w_{1,i} + b_{1,i})}}{1 + e^{-2(\sum_{i=1}^{10} x_i w_{1,i} + b_{1,i})}} \right) w_{2,i} + b_{2,i} \tag{6}$$

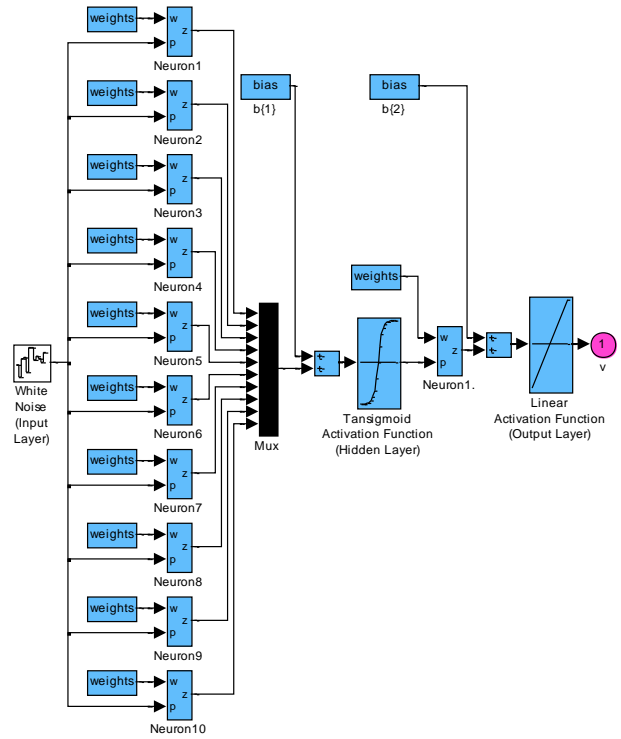

**Figure 3** Architecture of 3 layers feed-forward neural network for wind speed model - for 10 neurons case

The neural network wind speed profile is shown in Figure 3. After the networks have been created, they are trained. All weights  $w_{1,i}, w_{2,i}$  and threshold terms  $b_{1,i}, b_{2,i}$  are iteratively updated to minimize an error function between the targeted wind speed distribution in [3] and the network outputs. The network is trained using Levenberg-Marquardt training algorithm. The best training performance is obtained at 5 iterations with mean square of error around 0.185 (see Figure 4). Table 2 tabulates the updated  $w_{1,i}, w_{2,i}, b_{1,i}$  and  $b_{2,i}$ .

**Table 2** Updated weights and threshold - for 10 neurons case

Hidden Layer		Output Layer	
Weight $w_{1,i}$	Threshold $b_{1,i}$	Weight $w_{2,i}$	Threshold $b_{2,i}$
$w_{1,1} = -8.6865947504261527$	$b_{1,1} = 20.576199199488737$	$w_{2,1} = 0.72753075758510366$	$b_{2,i} = 2.194518488494118$
$w_{1,2} = 8.6167321599088744$	$b_{1,2} = -17.494362008666045$	$w_{2,2} = -1.09006557732933800$	
$w_{1,3} = -8.6320097632973969$	$b_{1,3} = 14.376516846240744$	$w_{2,3} = -0.21314452933412584$	
$w_{1,4} = -8.6963082748051814$	$b_{1,4} = 11.215377418942882$	$w_{2,4} = -0.32668500695320518$	
$w_{1,5} = 8.6284959720942762$	$b_{1,5} = -8.1569893800281683$	$w_{2,5} = 0.14699077356112150$	
$w_{1,6} = -8.6191206335319350$	$b_{1,6} = 5.077457884831599$	$w_{2,6} = -1.18689070412913540$	
$w_{1,7} = 8.5775087821821341$	$b_{1,7} = -2.0830518748241462$	$w_{2,7} = -0.052285317115747285$	
$w_{1,8} = -8.631052936335303$	$b_{1,8} = -1.1782506581797774$	$w_{2,8} = 0.688942422511690470$	
$w_{1,9} = 8.6250493181832297$	$b_{1,9} = 4.2964594041705872$	$w_{2,9} = -0.048923091134644207$	
$w_{1,10} = 8.83587389976753630$	$b_{1,10} = 7.1616918998149126$	$w_{2,10} = 0.1569205394621947000$	

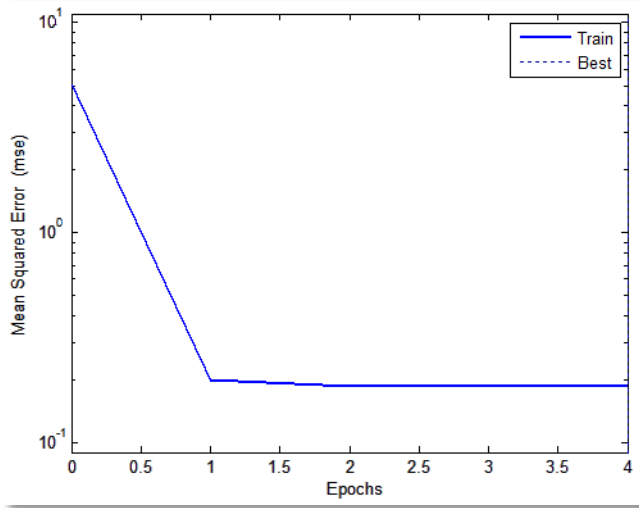

Figure 4 Training performance

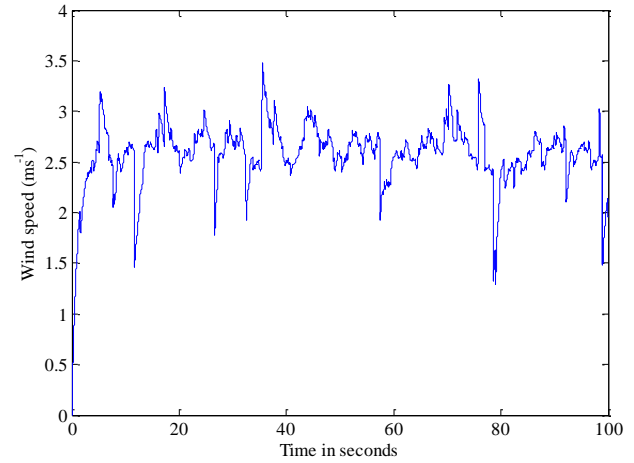

Figure 6 Wind speed probability distribution

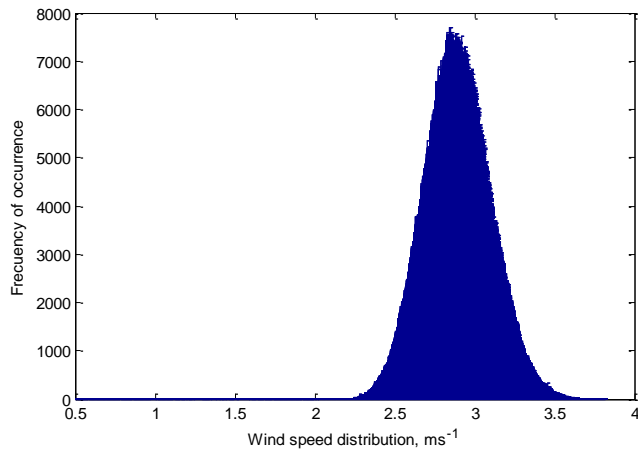

Figure 5 Wind speed pattern for 30 neurons feed-forward ANN wind speed model

4.0 RESULTS AND ANALYSIS

In the neural network training, the number of neurons give significant effect to the correlation of wind model. Figure 5 shows wind speed pattern for 30 neurons feed-forward ANN wind speed model. The wind speed probability distribution is shown in Figure 6. With  $N$  wind speed data, the mean speed can be computed as

$$v_{mean} = \frac{1}{N} \sum_{k=1}^N v(k) \approx 2.5739 \text{ ms}^{-1} \tag{7}$$

with a variance of

$$Var_v = \frac{1}{N} \sum_{k=1}^N (v(k) - v_{mean})^2 \approx 0.0981 \tag{8}$$

This implies a standard deviation of the wind speed pattern of about 0.3131 as shown in the wind speed probability distribution in Figure 6. The wind speeds at Mersing seem to be around the cut-in speed range (around  $3 \text{ ms}^{-1}$  as shown in the previous Figure 6). Most high power turbine manufacturers such as Enercon Ltd [15] and Wind Energy Solution Ltd. [16] apply the cut-in and cut-out speed about  $3 \text{ ms}^{-1}$  and  $25 \text{ ms}^{-1}$  respectively. To overcome the rotor inertia, large turbines require high wind speed to operate, and thus capture more kinetic energy from the wind. Typical modern wind turbines have a radius of 20 to 45 meters and are rated between 500 kW and 2 MW. Thus, in this case study, small size turbine with a blade radius of 10 meters can be installed for a rated power about 16KW at  $3.8 \text{ ms}^{-1}$  rated speed. With 41.1% of the kinetic energy being captured by the turbine, the cut-in speed must be  $1 \text{ ms}^{-1}$  to operate the system. The aerodynamic power produced by the turbine with 10 meters blade radius is around 5KW as depicted in Figure 8.

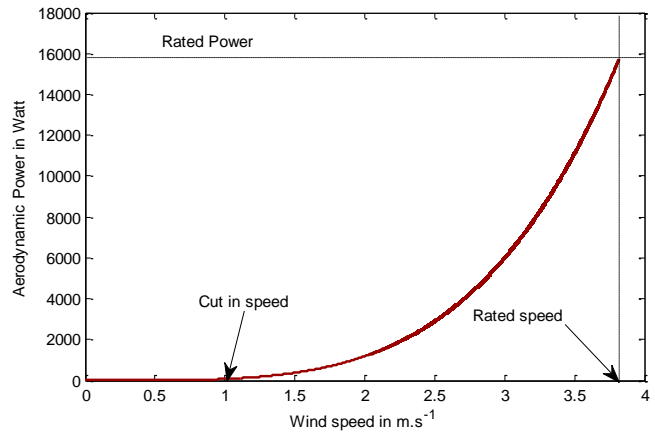

Figure 7 Power curve

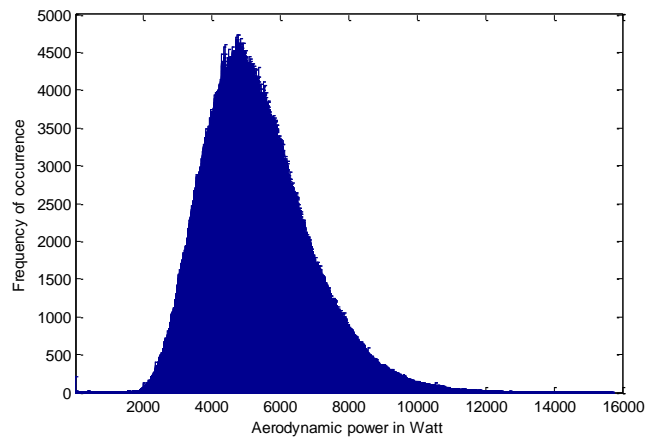

Figure 8 Aerodynamic power distribution

## 5.0 CONCLUSIONS

In this paper, wind speed distribution profile is modeled using a multilayer feed-forward artificial neural network. The wind speed profile is useful in the design and simulation phase for the development of wind turbine control approach such as fixed pitch / variable pitch - variable speed controller. However, in this case study, low average wind speed distribution reveal the fact that large size wind turbine is not suitable to be installed at the selected area (i.e. Mersing in Peninsular Malaysia). The developer need to consider some specific characteristic for installation, such as low power small size wind turbine with low cut-in speed. Plus, the system may require complex power electronic conversion system to step up the power to the utilities (see [17-18]).

## Acknowledgement

We acknowledge the Ministry of Education Malaysia, Universiti Teknikal Malaysia Melaka (UTeM) and the Universiti Teknologi Malaysia (UTM) for research facilities and research collaboration.

## References

- [1] A. S. Al-Mashakbeh. 2011. Feasibility Study of Using Wind Turbines with Diesel Generators Operating at One of the Rural Sides in Jordan. *Journal of Theoretical and Applied Information Technology*. 30(2): 109–114.
- [2] K. Sopian, M. Y. Othman and A. Wirsat. 1995. The Wind Energy Potential of Malaysia. *Renewable Energy*. 6(8): 1005–1016.
- [3] M. R. S. Siti, M. Norizah and M. Syafrudin. 2011. The Evaluation of Wind Energy Potential in Peninsular Malaysia. *International Journal of Chemical and Environmental Engineering*. 2(4): 284–291.
- [4] Y. D. Song, B. Dhinakaran, and X. Y. Bao. 2000. Variable Speed Control of Wind Turbines using Nonlinear and Adaptive Algorithm. *Journal of Wind Engineering and Industrial Aerodynamics*. 85: 293–308.
- [5] B. Boukhezzer, L. Lupu, H. Siguerdidjane and M. Hand. 2007. Multivariable Control Strategy for Variable Speed Variable Pitch Wind Turbine. *Renewable Energy*. 32(8): 1273–1287.
- [6] U. Ozbay, E. Zergeroglu and S. Sivrioglu. 2008. Adaptive Backstepping Control of Variable Speed Wind Turbines. *International Journal of Control*. 81(6): 910–919.
- [7] B. Beltran, T. Ahmed-Ali and M. E. H. Benbouzid. 2009. High Order Sliding Mode Control of Variable Speed Wind Turbines. *IEEE Transactions on Industrial Electronics*. 56: 3314–3321.
- [8] B. Boukhezzer and H. Siguerdidjane. 2011. Nonlinear Control of a Variable-Speed Wind Turbine Using a Two-Mass Model. *IEEE Transaction on Energy Conversion*. 26(1): 149–162.
- [9] V. Thapar, G. Agnihotri and V. K. Sethi. 2011. Critical Analysis of Methods for Mathematical Modelling of Wind Turbine. *Renewable Energy*. 36(11): 3166–3177.
- [10] M. N. Kamarudin, A. R. Husain and M. N. Ahmad. 2014. Variable Speed Wind Turbine with External Stiffness and Rotor Deviation Observer. *Applied Mechanics and Materials*. 661: 154–159.
- [11] F. A. Inthamoussou, F. D. Bianchi, H. D. Battista and R. J. Mantz. 2014. LPV Wind Turbine Control with Anti-windup Features Covering the Complete Wind Speed Range. *IEEE Transaction on Energy Conversion*. 29: 259–266.
- [12] A. W. Manyonge, R. M. Ochieng, F. N. Onyango and J. M. Shichikha. 2012. Modelling of Wind Turbine in a Wind Energy Conversion System: Power Coefficient Analysis. *Applied Mathematical Sciences*. 6(91): 4527–4536.
- [13] P. M. Anderson and A. Bose. 1983. Stability Simulation of Wind Turbine Systems. *IEEE Transaction on Power Apparatus and Systems*. PAS-102(12): 3791–3795.
- [14] O. Belghazi and M. Cherkaoui. 2012. Pitch Angle Control for Variable Speed Wind Turbines using Genetic Algorithm Controller. *Journal of Theoretical and Applied Information Technology*. 39(1): 6–10.
- [15] Enercon Ltd. <http://www.enercon.de/en-en/20.htm>.
- [16] Wind Energy Solution Ltd. <http://www.windenergysolutions.nl/>
- [17] J. L. Dominguez-Garcia, O. Gomis-Bellmunt, L. Trilla-Romero and A. Junyent-Ferre. 2012. Indirect Vector Control of a Squirrel Cage Induction Generator Wind Turbine. *Computers and Mathematics with Applications*. 64: 102–114.
- [18] M. N. Kamarudin and S. M. Rozali. 2008. Simulink Implementation of Digital Cascade Control DC Motor Model - A Didactic Approach. 2<sup>nd</sup> IEEE International Conference on Power and Energy. 1043–1048.