

## Hardware Development of Reflection Mode Ultrasonic Tomography System for Monitoring Flaws on Pipeline

Norsuhadat Nordin<sup>a</sup>, Mariani Idroas<sup>a\*</sup>, Zainal Zakaria<sup>a</sup>, M. Nasir Ibrahim<sup>b</sup>

<sup>a</sup>Faculty of Petroleum and Renewable Energy Engineering, Universiti Teknologi Malaysia, 81310 UTM Johor Bahru, Johor, Malaysia

<sup>b</sup>Faculty of Electrical Engineering, Universiti Teknologi Malaysia, 81310 UTM Johor Bahru, Johor, Malaysia

\*Corresponding author: [mariani@petroleum.utm.my](mailto:mariani@petroleum.utm.my)

### Article history

Received : 15 August 2014

Received in revised form :

5 January 2015

Accepted : 10 February 2015

### Graphical abstract

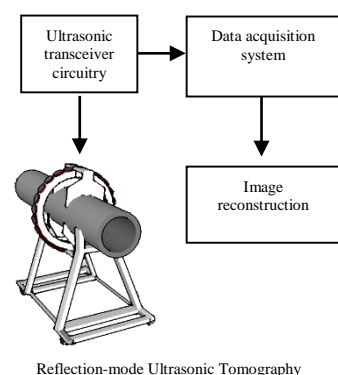

### Abstract

The pipeline inspection is a key requirement to maintain structural health and pipeline integrity for oil and gas transportation over countries. Pipe failure is a critical problem that needs to be endured within the operational work. The defects or flaws existence on pipeline surface is one of the most leading factors to pipe failures. A new approach of non-destructive technique is implemented to monitor flaws on pipeline by using reflection-mode ultrasonic tomography system. This paper details on the hardware development of ultrasonic tomography system based on reflection mode detection. The system consists of ultrasonic transceiver sensors mounted circularly and contactless to the pipe surface. The modeling work described the ultrasonic ring configuration, ultrasonic signal behavior, sensors arrangement and image grid estimation. The developed instrumentation system is used to detect external and internal flaws on pipe surface. The results show that the reflection-mode ultrasonic tomography is capable to differentiate flaws detected based on the calculated depth verified from the distance measured and through the reconstructed image.

**Keywords:** Pipeline; ultrasonic; flaws; tomography; modelling

© 2015 Penerbit UTM Press. All rights reserved.

### 1.0 INTRODUCTION

Pipeline is the heart of a system for transporting and distributing products from the source to consumers. Pipelines are the priority assets for industrial especially for oil and gas industry. It needs to be maintained and evaluated on a regular basis due to the structural ageing and failure problems [1]. These pipelines are exposed to a variety of changing environmental conditions that lead to corrosion and any damage that can lead to pipe failure. Flaws or defects such as holiday, pinhole, notches and gouges which existed within the pipe surface may lead to rapid corrosion occurred on the pipe wall [2].

Ultrasonic testing is a well-known Non-Destructive Technique (NDT) used for pipeline inspection due to its advantages such as low cost, ease of operation and high sensitivity [3]. It has been used extensively for distance measurement, flaw detection, gauging and measuring parameters of material structure [4]. It is important to optimize the inspection methods for effective flaws detection. Therefore, it is crucial to choose the right tool for flaws or defects inspected [5]. In NDT, the inspection only provides the quantitative measurement such as location of defects, size and other physical characteristics. Hence, an ultrasonic tomography

technique has been introduced recently for pipeline inspection as it is capable in generating the cross sectional image of the inspected area circumferentially.

The reflection-mode ultrasonic tomography technique has upgraded the conventional ultrasonic testing by the combination of ultrasonic sensing system, data acquisition system, and image reconstruction system [6]. It involves with the acquisition of measurement signals from the ultrasonic sensors located on the periphery of an object. The outputs obtained from the ultrasonic sensors are combined to reconstruct the images using appropriate algorithm [7]. In any ultrasonic tomography methods, the reconstructed image is based on the interaction between the ultrasonic waves and medium concerned [8]. An investigation of gas holdup distribution in a two-phase bubble column has been implemented by Supardan *et al.* [9] using ultrasonic computed tomography. Amount of 12 ultrasonic transmitter and receiver with 2 MHz in frequency are separately arranged non-symmetrically and used to perform the tomographic data acquisition. Abdul Rahim *et al.* [10] had implemented the ultrasonic tomography system for monitoring the composition of water and oil flow based on the time propagation of the ultrasonic wave from transmitter to receiver.

The application of tomography for flaw detection in oil and gas field is a new technique, which can offer an accurate measurement with overall view of circumferential pipe image with flaw existence (pipe thickness profile). The developed system is an alternative to the current available inspection method in oil and gas industries. This paper describes the hardware development of ultrasonic tomography system for monitoring flaws on pipeline surface.

**2.0 HARDWARE DEVELOPMENT**

The hardware development of the reflection-mode ultrasonic tomography system consists of ultrasonic sensing system and instrumentation setup. The ultrasonic sensing system is fabricated based on the mathematical models on ultrasonic behaviour. The reflection mode for sensing purposes was implemented for ultrasonic signal detection. The reflection-mode technique is based on the measurement of the position, and the change of the physical properties of wave reflected on an interface [11]. The overall instrumentation system is basically consists of ultrasonic sensing system, ultrasonic sensor circuitry, data acquisition, and image reconstruction system, as shown in Figure 1.

The ultrasonic sensing system is designed with twenty-eight transceiver sensors mounting around the pipe at a specific distance to the pipe. The transceiver sensors are operated by a module circuitry unit. Theoretically, the reflected energy from the test specimen will be received back by the ultrasonic sensor, which is then being converted into a voltage by the receiver circuit and being amplified into the display unit [12]. The voltages obtained from the measurement are collected through the data acquisition and being interpreted to determine the measured distance. Based on the distance computed, an image of the inspected pipe with flaws existence is generated.

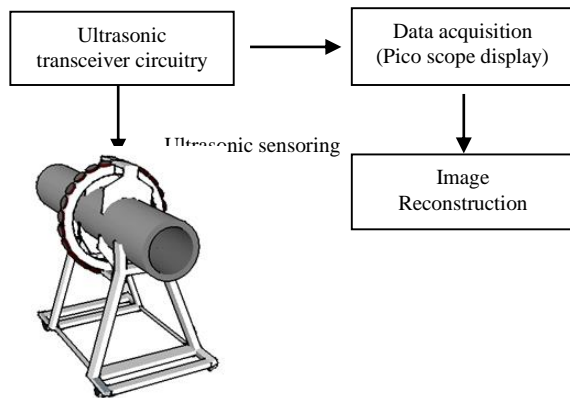

Figure 1 Reflection-mode ultrasonic tomography system

The ultrasonic tomographic instrumentation system is designed based four models, which are modelling on instrumentation design configuration, ultrasonic signal behavior, sensor and its arrangement, and image grid.

**2.1 Modelling on instrumentation design configuration**

Modelling on instrumentation design configuration is significant in order to setup the overall equipment involved in the system. The main part of the ultrasonic tomography system is the sensing system [13]. The ultrasonic signal propagation will detect the change on pipe surface due to the existence of flaws

circumferentially based on reflection mode. The ultrasonic sensing system is shown in Figure 2, which is designed specifically with the ultrasonic ring transducer array and the pipe used. A dual element transducer that is known as a transceiver is used for the sensing system. The ultrasonic transceiver has an advantage of two functions, where it has the capability of functioning as a transmitter at one time and as a receiver at the other time [14].

The ultrasonic transceiver Model UB300-18GM40-I-V1 with 390 kHz frequencies is chosen due to its specification that match with the required sensing range (30-300 mm), suitable diameter (18 mm) and acceptable cost compared to other transducer. A fix distance of 50 mm from the transducer array to the pipe surface is selected, in order to optimize the number of sensors in the ultrasonic ring. Based on the model, twenty eight (28) ultrasonic transceivers are used in the ultrasonic ring to cover circumferential of the pipe. The ultrasonic ring’s holder or pipe guide is used to clamp and to guide the ultrasonic sensor ring to move freely along the pipe. There are two pairs of ring’s arms with 50 mm in distance to the pipe surface as shown in Figure 2. A carbon steel pipe with Fusion Bonded Epoxy (FBE) coating and 219.1 mm diameter is used for inspection. A pipe support of 1000 mm height is used to hold the pipe in horizontal direction and to provide stability during experimental work.

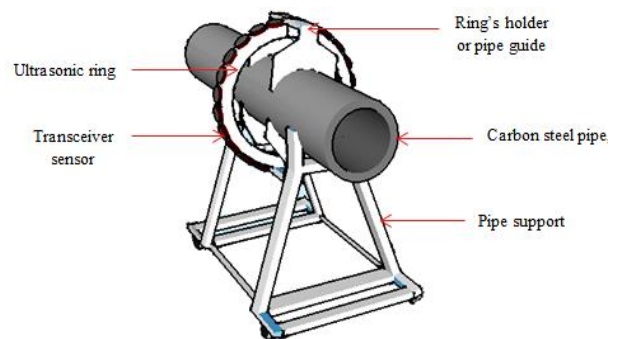

Figure 2 Ultrasonic tomographic sensing configurations

Figure 3 shows the schematic diagram of a complete ultrasonic sensing ring with twenty eight sensors’ plunger. The details on measurement and sensor arrangement for this ultrasonic sensing ring are described under modelling of number of sensor and its arrangement.

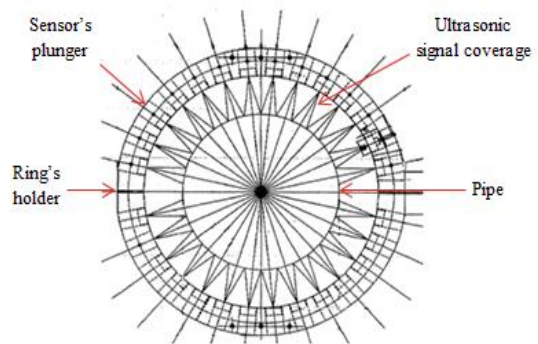

Figure 3 Ultrasonic sensing ring

**2.2 Modelling on ultrasonic signal behaviour**

Modelling on ultrasonic signal behaviour is important in determining the proper sensing mode of ultrasonic wave

propagation. The ultrasonic energy incident to the target material is propagated either based on transmission, reflection or attenuation mode. The ultrasonic propagation energy depends on the acoustic impedance of two materials,  $Z$ . It is important to determine the percentage of energy reflected from the target material to ensure that the ultrasonic signal can detect the flaws on the pipe surface based on the distance of reflected signal. As the difference in impedance between two materials is greater, the amount of reflected energy will also be higher [10].

Acoustic impedance is important in the determination of acoustic transmission and reflection at the boundary of two materials having different acoustic impedance. Equation (1) shows the related formula for  $Z$  developed by Charles [12] where  $\rho$  is a material density and  $V$  is a material velocity

$$Z = \rho \times V, \tag{1}$$

The reflection and transmission coefficient or percentage of energy incident is introduced as shown in Equations (2) and (3). The acoustic impedances of medium 1 (air) with  $Z_1$  and medium 2 (pipe coating) with  $Z_2$ .

$$\text{Reflection, } P_r(\%) = \left( \frac{Z_2 - Z_1}{Z_2 + Z_1} \right)^2 \times 100 \tag{2}$$

$$\text{Transmission, } P_t(\%) = 1 - P_r, \tag{3}$$

The value of acoustic impedance stated by Blitz and Simpson (1996) for air is  $0.0004 \text{ kg/m}^2 \cdot \text{s} \times 10^6$  and FBE coating material is  $2.7 \text{ kg/m}^2 \cdot \text{s} \times 10^6$ . Through the calculation using Equation (2) and Equation (3), the percentage of signal reflected from the surface to the sensor through air is 99.94 % while the transmitted signal into the surface is 0.06 %. Therefore, the reflection mode is used as the ultrasonic sensing mode for the system.

**2.3 Modelling on number of sensor and its arrangement**

The transducer array or sensor arrangement is crucial for acquiring the data needed to produce a meaningful image [11]. In designing the transducer configuration in the sensing system for flaw detection around the pipe surface, each ultrasonic transceiver sensor is arranged closely side by side within a specific distance in the ring shape. The number of sensors and its arrangement are determined according to area of ultrasonic signal and beam angle approximation. Based on the testing conducted, the area of ultrasonic signal covered for each transceiver sensor is approximately 20 mm by horizontal and vertical positions. The ultrasonic transceiver sensor is arranged accordingly to the area with acceptable gaps between the sensors and to avoid overlapping of ultrasonic signal from each sensor. The arrangement of all ultrasonic sensors is shown in Figure 4.

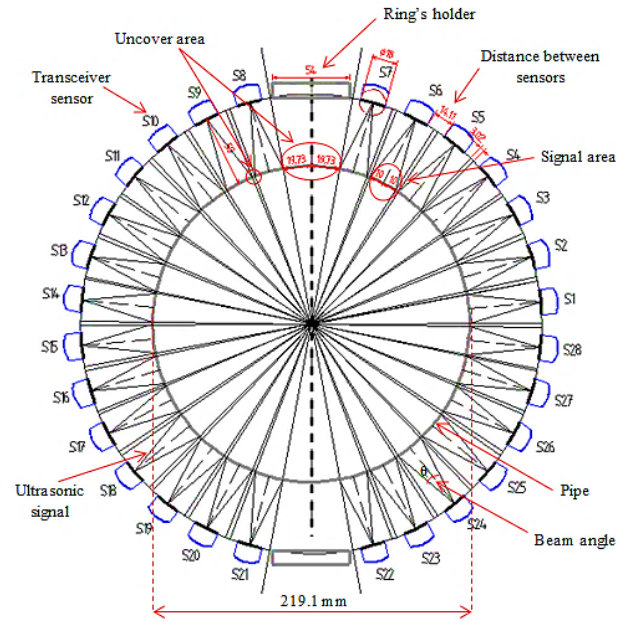

Figure 4 Sensor arrangement in ultrasonic sensing ring

The distance from the ultrasonic sensing ring to the pipe is within the sensing range of ultrasonic transceiver used, which is 50 mm. The ideal arrangement of sensor based on area of ultrasonic signal utilized twenty eight (28) of ultrasonic transceiver sensors. The calculated beam angle is about 22.4°. From the sensor arrangement, the distance between the sensors is approximately 14.11 mm side by side.

**2.4 Modelling on image grid estimation**

The purpose of modelling on image grid is to identify the number of pixels of reconstructed. The image grid depends on the beam angle of the ultrasonic sensor. By mapping the beam angle projected on the pipe wall (as shown in Figure 5), the size of image grid is 20 mm x 20 mm. The schematic diagram of the ultrasonic signal area covered on the pipe surface for half of ultrasonic sensing ring is illustrated in Figure 5.

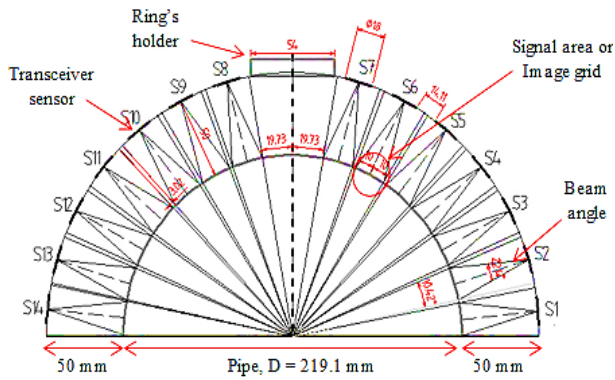

Figure 5 Mapping of ultrasonic signal area on pipe surface

The size of the image grid is assumed to be the same. The distance from the sensor to the surface might be increased or decreased from the normal distance (no-defect).

### 3.0 EXPERIMENTAL WORK

Several experiments are carried out on detection of external and internal (loss) flaws on the pipe surface, to verify the capability of the reflection-mode ultrasonic tomography system. Different sizes of flaws, which are based on depth, are simulated. Figure 6 shows the experimental setup.



Figure 6 Experimental setup

For each measurement, the ultrasonic output reading is taken for three times and the average reading of the detected flaw is calculated. The output signal is in voltage where the average voltage is calculated before being converted into distance using the linear equation obtained from the distance calibration.

#### 3.1 Monitoring external flaw on pipe surface

An experiment on detection of external flaws on the pipe surface is carried out in order to verify the detection of different external flaw size based on depth. Figure 7 shows the external flaws simulated on the pipe surface at four different locations, which are at point 4, 6, 10 and 11 of ultrasonic sensing ring. The measurement started with the sensor positioned at point 4 and continued with point 6, 10 and finally at point 11 with the same procedures of measurement.



Figure 7 External flaws simulated on the pipe surface

#### 3.2 Monitoring Internal Flaw on Pipe Surface

The experiment is continued with the detection of internal flaws (material loss) on the pipe surface to determine the depth of internal flaws, based on the distance measurement. Figure 8 shows the internal flaws simulated on the pipe surface using grinder.



Figure 8 Internal flaws simulated on the pipe surface

Several flaws have been created on the pipe surface with difference size at point 1, point 3, point 13 and point 16 of the ultrasonic sensing ring. The measurement started with the sensor at point 1 and continued to the point 3, point 13 and point 16.

### 4.0 RESULTS AND DISCUSSIONS

Both experimental works on monitoring external flaws and internal flaws (material loss) on pipe surface have been successfully carried out using the reflection-mode ultrasonic tomography system. The measurement data are considered and collected for twenty eight (28) points of ultrasonic sensors located at the ultrasonic ring. The average output voltage is calculated and used to determine the distance measured by the ultrasonic signal. The linear equation obtained from the calibration process is  $V = 0.0801D - 2.8064$ , with the average accuracy of 99.82% for a sensing range of 40-60 mm.

The high accuracy computed in the distance calibration shows that the performance of ultrasonic transceiver used in the system is good [15]. The depth of flaws existence is calculated based on the calibration equation. An image of overall pipe with flaws existence is then computed.

#### 4.1 Results on external flaw on pipe surface

The results obtained from the experiment of monitoring external flaws on pipe surface are tabulated in Table 1.

**Table 1** Experimental data for external flow on pipe surface

Point (sensor)	Actual Distance (mm)	Average Voltage (V)	Measured Distance (mm)	Depth, Δ (mm)
1	50	1.20	50.0	0.0
2	50	1.20	50.0	0.0
3	50	1.20	50.0	0.0
4	50	1.10	48.7	-1.3
5	50	1.20	50.0	0.0
6	50	1.05	48.1	-1.9
7	50	1.20	50.0	0.0
8	50	1.20	50.0	0.0
9	50	1.20	50.0	0.0
10	50	1.14	49.3	-0.7
11	50	1.15	49.4	-0.6
12	50	1.20	50.0	0.0
13	50	1.20	50.0	0.0
14	50	1.20	50.0	0.0
15	50	1.20	50.0	0.0
16	50	1.20	50.0	0.0
17	50	1.20	50.0	0.0
18	50	1.20	50.0	0.0
20	50	1.20	50.0	0.0
21	50	1.20	50.0	0.0
22	50	1.20	50.0	0.0
23	50	1.20	50.0	0.0
24	50	1.20	50.0	0.0
25	50	1.20	50.0	0.0
26	50	1.20	50.0	0.0
27	50	1.20	50.0	0.0
28	50	1.20	50.0	0.0

The negative (-) sign showed decreasing of distance from the sensor to the pipe compared to the actual distance. The reduction of distance indicated the existence of external flaw on the pipe surface. It showed that the output voltage is reduced as the distance is decreased. Based on the result, a reconstructed image of pipe profile with external flaws existence is generated and shown in Figure 9.

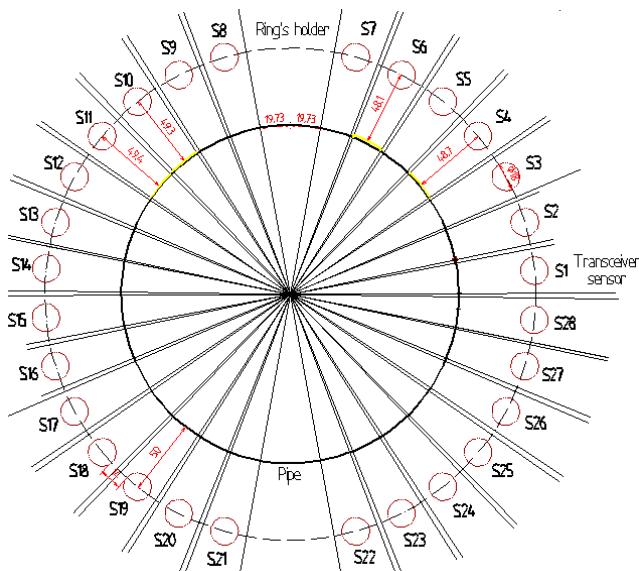

**Figure 9** Reconstructed image of pipe profile with external flaws existence

The reconstructed image visualized the location of external flaw (yellow line) on the pipe surface, which is at position 4, 6, 10 and

11. It shows that the existence of external flaws on pipe surface increased the thickness of the pipe.

**4.2 Results on internal flaw on pipe surface**

Table 2 shows the results obtained from the experiment of monitoring internal flaws (material loss) on the pipe surface.

**Table 2** Experimental data for internal pipe surface

Point (sensor)	Actual Distance (mm)	Average Voltage (V)	Measured Distance (mm)	Depth, Δ (mm)
1	50	1.35	51.9	1.9
2	50	1.20	50.0	0.0
3	50	1.36	52.0	2.0
4	50	1.20	50.0	0.0
5	50	1.20	50.0	0.0
6	50	1.20	50.0	0.0
7	50	1.20	50.0	0.0
8	50	1.20	50.0	0.0
9	50	1.20	50.0	0.0
10	50	1.20	50.0	0.0
11	50	1.20	50.0	0.0
12	50	1.20	50.0	0.0
13	50	1.37	52.1	2.1
14	50	1.20	50.0	0.0
15	50	1.20	50.0	0.0
16	50	1.27	50.9	0.9
17	50	1.20	50.0	0.0
18	50	1.20	50.0	0.0
20	50	1.20	50.0	0.0
21	50	1.20	50.0	0.0
22	50	1.20	50.0	0.0
23	50	1.20	50.0	0.0
24	50	1.20	50.0	0.0
25	50	1.20	50.0	0.0
26	50	1.20	50.0	0.0
27	50	1.20	50.0	0.0
28	50	1.20	50.0	0.0

The positive (+) sign shows increasing of distance from the sensor to the pipe compared to the actual distance, which indicated the existence of internal flaw on the pipe surface. It shows that the output voltage is increased as the distance is increased. Based on the results, a reconstructed image of pipe profile with internal flaws is generated and shown in Figure 10.

It can be seen that the existence of internal flaws (blue line) on the pipe surface affects the thickness of pipe wall. These flaws may reduce the pipe thickness, which can lead to severe damage in future. The location of internal flaw on the pipe surface can be seen clearly at position 1, 3, 13 and 16.

Based on the results, it can be concluded that the ultrasonic detection signals based on reflection mode has successfully detected different size of flaws. The depth or size of flaws detected can be up to minimum 0.4 mm, which is the transceiver resolution. The area of the flaws existed is assumed to be equal to the image area of ultrasonic signal. The purpose of the reconstructed image is to visualize the orientation, size and shape of the flaws existence. The data produced from the experimental work and the reconstructed image provides useful information of the pipe condition for maintenance and safety consideration purposes.

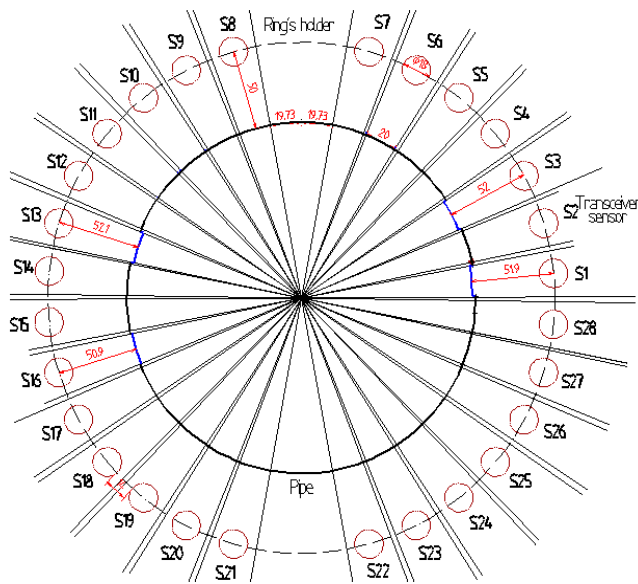

**Figure 10** Reconstructed image of pipe profile with internal flaws existence (material loss).

## 5.0 CONCLUSION

There is a potential of reflection-mode ultrasonic tomography system to be applied for pipeline inspection purposes. The preliminary objective of the research has been achieved. The fabrication of ultrasonic sensing system is successfully implemented. The reflection mode has been successfully applied to detect different flaws on the pipe surface based on distance measurements. The developed instrumentation system is capable in monitoring pipe condition for maintaining the pipe integrity and safety requirement.

## Acknowledgement

The authors would like to thank Ministry of Education (MOE) and University Teknologi Malaysia for funding the study through the Geran Universiti Penyelidikan (GUP), Vote No. (04H24).

## References

- [1] NDT Global. 2014. Crack Detection and Pipeline Integrity Solutions. [Brochure]. Rusia: NDT Global.
- [2] M. Beller, E. Holden, and N. Uzelac. 2001. Cracks in Pipelines and How to Find Them. *Pipes & Pipelines International*.
- [3] J. Li, and J. L. Rose. 2002. Angular-Profile Tuning of Guided Waves in Hollow Cylinders Using a Circumferential Phased Array. *IEEE*. 49(12).
- [4] J. Blitz, and G. Simpson. 1996. *Ultrasonic Methods of Non-Destructive Testing*. 1st ed. London, UK: Chapman & Hall.
- [5] M. Beller, and H. Schoenmaker. 1996. Pipeline Inspection: A Turnkey Approach. *Pipeline Pigging and Integrity Monitoring Conference*. Jakarta
- [6] R. Abdul Rahim, M. H. Fazalul Rahiman, and K. S. Chan. 2004. On Monitoring Liquid/Gas Flow Using Ultrasonic Tomography. *Jurnal Teknologi*. 40(D): 77–88.
- [7] S. Ibrahim, M. A. Md Yunus, M. T. Md Khairi, and M. Faramarzi. 2014. A Review on Ultrasonic Process Tomography System. *Jurnal Teknologi* 70: 3.
- [8] S. Z. Mohd. Muji, R. Abdul Rahim, M. H. Fazalul Rahiman, S. Sahlan, M. F. Abdul Shaib, M. J. Pussapanathan, and, E. J. Mohammad. 2011. Optical Tomography: A Review on Sensor Array, Projection Arrangement and Image Reconstruction Algorithm. *International Journal of Innovative Computing, Information and Control*. 7(7(A)): 3839–3856.
- [9] M. D. Supardan, Y. Masudab, A. Maezawab, and S. Uchidab. 2007. The Investigation of Gas Holdup Distribution in A Two-Phase Bubble Column using Ultrasonic Computed Tomography. *Chemical Engineering Journal*. 130: 125–133.
- [10] R. Abdul Rahim, N. W. Nyap, and M. H. Fazalul Rahiman. 2007. Hardware Development of Ultrasonic Tomography for Composition Determination of Water and Oil Flow. *Sensor & Transducer Journal*. 75: 904–913.
- [11] M. H. Fazalul Rahiman, R. Abdul Rahim, H. Abdul Rahim, and N. M. Nor Ayob. 2012. Design and Development of Ultrasonic Process Tomography. In Santos (Ed.). *Ultrasonic Waves*. 211–226.
- [12] J. H. Charles. 2003. Ultrasonic Testing. In: Robert, C.M. and Samuel A. W. *Handbook of Non-Destructive Evaluation*. US: McGraw-Hill. 301–416.
- [13] M. Yang, H. I. Schlager, B. S. Hoyle, M. S. Beck, and C. Lenn. 1999. Real-time Ultrasound Process Tomography for Two-phase Flow Imaging using a Reduced Number of Transducers. *IEEE Transactions on Ultrasonic, Ferroelectrics and Frequency Control*. 46.
- [14] Z. Zulkamay. 2010. Simulation of the Two-Phase Liquid-Gas Flow through Ultrasonic Transceivers Application in Ultrasonic Tomography. *Sensors & Transducers*.
- [15] P. M. Donald. 1999. Choosing an Ultrasonic Sensor for Proximity or Distance Measurement Part 2: Optimizing Sensor Selection. *Unpublished*.