

An energy integrated, multi-microgrid, MILP approach for residential distributed energy system planning – A South Australian case-study

Carmen Wouters^a, Eric S. Fraga^{b,*}, Adrian M. James^a

^a*School of Energy and Resources, University College London (UCL), Adelaide SA 5000, Australia*

^b*Centre for Process Systems Engineering, Department of Chemical Engineering, University College London (UCL), London WC1E 6BT, UK*

Abstract

The integration of distributed generation units and microgrids in the current grid infrastructure requires an efficient and cost effective local energy system design. A mixed-integer linear programming model is presented to identify such optimal design. The electricity as well as the space heating and cooling demands of a small residential neighbourhood are satisfied through the consideration and combined use of distributed generation technologies, thermal units and energy storage with an optional interconnection with the centralised grid. Moreover, energy integration is allowed in the form of both optimised pipeline networks and microgrid operation. The objective is to minimise the total annualised cost of the system to meet its yearly energy demand. The model integrates the operational characteristics and constraints of the different technologies for several scenarios in a South Australian setting and is implemented in GAMS. The impact of energy integration is analysed, leading to the identification of key components for residential energy systems. Additionally, a multi-microgrid concept is introduced to allow for local clustering of households within neighbourhoods. The robustness of the model is shown through sensitivity analysis, up-scaling and an effort to address the variability of solar irradiation.

Keywords: energy integration, microgrid, mixed-integer linear programming, tri-generation, variability

1. Introduction

1.1. Background

The conventional centralised energy system faces challenges regarding climate as well as growing global energy needs [1]. Residential consumers in the system are globally responsible for 30 to 40% of the energy consumption in developed countries [1]. Incorporating new technologies into residential areas is thus often seen as a way to address the governing energy system challenges as well as to incorporate new multi-dimensional needs of society, e.g. reduction of carbon emissions, increase of renewable energy and increase of end-consumer awareness and participation [2–4]. Small-scale energy generation technologies located close to or at the premises of end-consumers in the grid (so called distributed generation (DG) units) are one example of new energy system developments in the residential sector. DG units are suggested to play a major role in the future since they are able to exploit locally available renewable energy resources while increasing energy system efficiency [3–5]. DG units are ideally combined into highly efficient energy integrated distributed energy systems and microgrid (MG) environments that are tailored to location specific needs and local requirements. MGs are a combination of locally controlled sources (DG units), sinks (energy loads) and storage units at the distribution level with a potential interconnection with the

centralised electricity grid [6, 7]. In a MG environment the locally controlled loads, energy generation and storage units are balanced at all times through a central control unit, the MG central controller, which provides increased reliability and flexibility of supply [6, 7]. Future energy systems are predicted to consist of multiple locally controlled MGs (a multi-MG) that each can interact with the central grid [8]. In order for MGs and multi-MG systems to emerge on a large scale it is important that the design and operation of these systems is cost effective, reliable and efficient. As countries not only differ in climatological and geographical conditions but also regarding policy environment, this building block of the future energy system is highly location specific in design and operational characteristics [6].

1.2. Distributed energy systems modelling

Optimisation models regarding distributed energy systems and MGs can be subdivided based on their scale. First, models that focus on either the detailed *electrical* or *thermodynamic* behaviour of components, and second, models that employ a *superstructure* approach focussing on energy in- and outflows and both thermal and electrical integration.

Electrical models focus on the network challenges and interactions that arise with installing generation at the distribution level such as bi-directional power flows, protection systems, active and reactive power flows, islanding, voltage and frequency control and management of DG systems, MGs and multi-MGs [8–11]. Tsikalakis et al. [12] provided a study of several procedures for the optimisation of MG central control

*Principal corresponding author

Email address: e.fraga@ucl.ac.uk (Eric S. Fraga)

behaviour under different market participation schemes. A particle swarm approach optimising inverter controller parameters to enhance MG stability was for example presented by Hassan et al. [13]. A comprehensive review regarding electrical modelling and control of MGs and distributed energy systems is provided by Mahmoud et al. [14] and Basak et al. [15].

Thermodynamic models focus on mass flows, entropy and temperature and pressure drops within thermal networks. Obara [16], for example, proposed a genetic algorithm for the design of a fuel cell and heating network, minimising cost. A detailed multi-objective thermodynamic optimisation of a combined heat and power (CHP) system was presented by Ahmadi et al. [17] employing genetic algorithms. An overview of entropy generation analysis and minimisation research as a tool for the design and optimisation of engineering systems is presented by Sciacovelli et al. [18].

Superstructure models optimise the total energy integration of a system looking at heating and cooling networks as well as MG operation, i.e. the sharing of locally generated energy. Each technology is characterised by constant parameters and seen as a black-box with energy in- and outflows. Within these models, several optimisation techniques and sets of technologies are employed. Linear and mixed-integer linear programming (MILP) approaches are mostly used as they allow flexibility and robustness for problems with a high degree of variables and complexity [19].

A first group of superstructure models focusses on the optimisation of thermal integration looking at district heating and cooling networks and the behaviour of heat generating technologies such as CHPs and tri-generation. Söderman and Peterson [20] presented a cost minimisation MILP approach for the optimisation of cooling networks and co-generation systems. An MILP was also suggested by Lozano et al. [21] for the cost optimisation of a combined heating and cooling network under legal constraints.

A second group of superstructure models tries to encompass both thermal and electrical integration of different consumer areas. Hawkes and Leach [22] proposed a linear programming approach for the cost optimisation of the design of a commercial MG including expected islanding requirements. They raised the issue of fair settlement between participants. A deterministic cost minimising MILP was also suggested by Mehleri et al. [23, 24] including dispatchable and renewable technologies and heat and electricity integration of a residential neighbourhood. A similar MILP approach was employed by Weber and Shah [25], Weber et al. [26] and Ren and Gao [27, 28] for larger distribution areas, so called ‘eco-towns’, focussing on district heating networks and CHPs. Keirstead et al. [29] provided an MILP based technology urban resource network model focussing on the impact of CHP planning restrictions (analysed in [29]) considering both micro units as well as larger centralised options. Also bio-mass networks for the energy supply of a larger urban area through MILP optimisation are addressed by Keirstead et al. [30]. Omu et al. [19] additionally provided a comprehensive explanation of the trade-off between accuracy of the model and the robustness of the optimisation method. They developed the DENO model building further on previous

work in the field focussing on thermal distribution networks in a neighbourhood setting. Additional cooling integration in distributed energy system optimisation is one of the latest developments [31]. The DER-CAM tool is another model that also presented an energy integrated MILP approach [32]. Gu et al. [31], Keirstead et al. [33], Manfren et al. [34] and Mancarella [35] presented comprehensive reviews of the challenges involved with optimisation of distributed energy systems as well as reviews of literature.

1.3. Contributions of this work

A superstructure energy integrated deterministic MILP model for a small residential neighbourhood is proposed in this paper building further on efforts in the field by the authors [36] as well as by Mehleri et al. [23, 24], Weber and Shah [25] and Keirstead et al. [29]. New functionalities lead to the following contributions to the work in the field:

- additional DG and storage options are introduced in the form of small-scale wind turbines, absorption chillers and battery banks
- a full energy integrated approach is employed focussing not only on electricity integration and/or heat integration but also cooling through residential tri-generation
- a non-feedback loop approach is adopted for heating and cooling networks through the addition of a binary selection variable that only allows each house to either receive or send from or to a pipeline network at all times and closed network loops are not allowed
- a similar non-feedback loop approach is adopted for MG operation, i.e. the sharing of locally generated electricity
- a multi-MG approach is at the time of writing only considered within electrical analysis models [8]. The proposed superstructure optimisation approach in this work can also deal with multiple MG ‘pools’
- an approach for dealing with variability of primary renewable energy sources in MILP models is presented
- an Australian case-study, a country with a high potential for DG units and MGs, is under research

A multi-generation modelling approach is presented with detailed spacial and temporal resolution: an hour-based time interval over a yearly planning horizon. The question addressed is how energy integration and related generation units influence the design and operational decisions through a comparison of selected design scenarios in a residential setting.

1.4. Paper organisation

The adopted methodology and details of the mathematical model are given in sections 2 and 3 respectively. Section 4 provides information regarding the case-study setting, Adelaide in South Australia (SA), as well as the analysis performed. Section 5 provides the results of the considered energy system design scenarios as well as detailed analysis regarding the robustness of the model. Conclusions are provided in section 6.

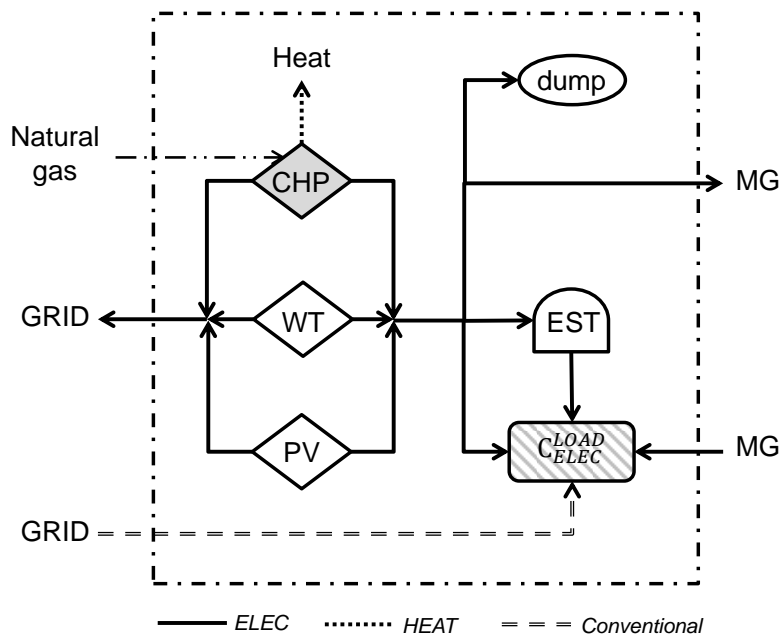

(a) Black-box diagram electricity supply alternatives

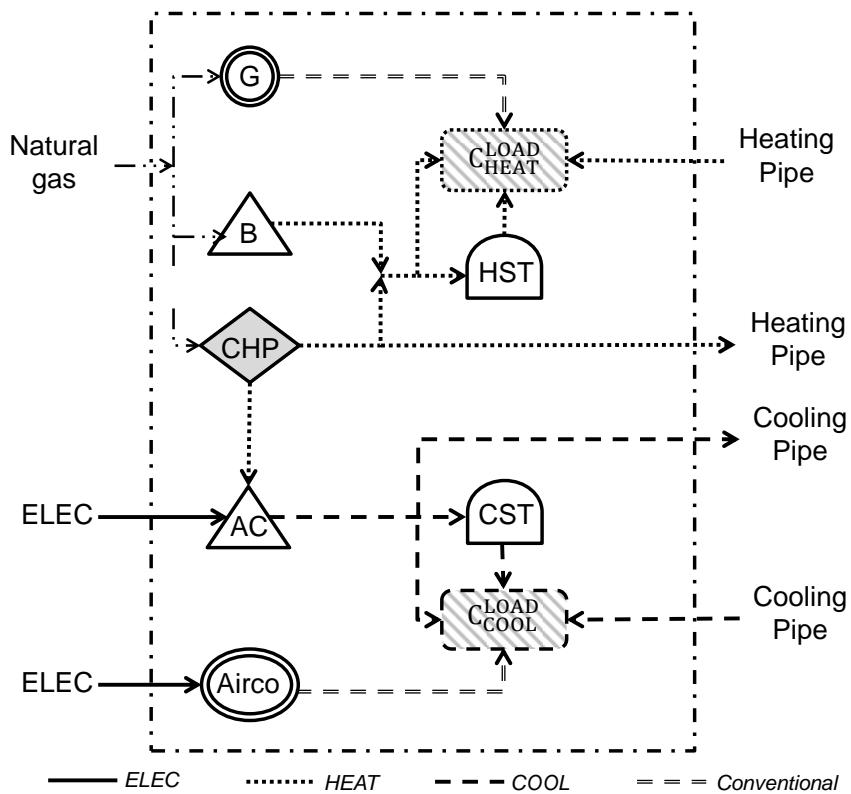

(b) Black-box diagram heating and cooling supply alternatives

Figure 1: Black-box diagrams of the considered generation and supply alternatives of each household in the neighbourhood to meet space heating, space cooling and electricity demands. Note that the CHP unit is the coupling between the electrical and thermal supply.

2. Methodology

2.1. Problem description

A decision making strategy to identify the potential of distributed generation units and energy integration for a specific case-study at a neighbourhood level is presented. The design and operational behaviour of the small system is obtained while minimising the overall annualised cost to meet its yearly demands with regard to electricity, space heating and space cooling. The optimisation is based on the selection of different energy generation and supply alternatives. Figure 1 presents the black-box diagrams of the technology alternatives as well as the potential power and energy flows for each house in the neighbourhood. The CHP unit provides the link between electrical and thermal supply. Each house can meet its demands through the consideration and combined use of DG units - i.e. photovoltaic units (PV), small-scale wind turbines and micro CHP units -, heat generating technologies, energy storage units and cooling technologies with an optional interconnection with the central electricity grid.¹ Additionally, a dump load can be installed for safety requirements in case of excess generation in the network. Moreover, cooling technologies require electricity for cooling generation. The neighbourhood can be heat and cooling integrated through an optimised pipeline network that allows for thermal transfer between households. Furthermore, a MG can be installed, leading to electrical integration of the neighbourhood.

2.2. Model requirements

The model is formulated as an MILP and the optimisation is executed in GAMS [37] using the CPLEX 12.4.0.1 solver with an OPTCR of 0%.² A yearly planning horizon is adopted with a typical day (24 hourly intervals) in each season for the endogenous and exogenous parameters and variables of the problem. The cost optimisation requires location specific input data.

Given:

- *Area specific climatological data*: average hourly solar irradiation [kW m^{-2}] and wind speeds [m s^{-1}] for a typical day in each season
- *Technical specifications* of the energy infrastructure, generation, storage and supply technologies
- *Cost data*: capital and operation and maintenance (OM) costs as well as utility energy tariffs
- *Country specific regulations*: government support schemes such as feed-in tariffs (FITs), carbon tax and upper limits on installed capacities of DG units

¹Note that different implementation choices for electrical storage are possible in a residential setting. Since the main focus of the model is self-generation combined with interaction with the central grid, it is opted that each house has the option to install a battery bank, which can only be charged through self-generation, not external feeds (microgrid or central grid). Alternative implementations could be the focus of future investigation.

²OPTCR refers to the relative gap between the best estimate and the integer value of the solution to an optimisation and determines the quality of the integer solution. The OPTCR is obtained as $\frac{\text{best estimate} - \text{best integer}}{\max(\text{best estimate}, \text{best integer})}$ (and 1 if the sign of best estimate and best integer differ). If the relative gap is set to zero in a linear model, global optimum is obtained [37].

- *Spatial distribution of hourly average energy demands*: for each household for a typical day in each season [kW]

Determine:

- *Total annualised cost* of the neighbourhood as a whole to meet its total energy demand
- *Optimal design* (capacity and allocation) of the selected units in the neighbourhood
- *Optimal dispatch schedule* of the selected units in hourly average intervals under given demand profiles

Objective

minimise the total annual cost for the neighbourhood as a whole to meet its yearly energy demand under various operational, technical, economic, environmental and regulatory constraints

The following assumptions are adopted in accordance with other superstructure models in literature [22, 23, 25, 27, 28]:

1. Constant energy conversion efficiencies are used for the technologies. In reality, the efficiency depends on the rating and loading of the unit.
2. Ramp-up and ramp-down times of the units are neglected since the latter are optimally dispatched to ensure full functionality when required.
3. Reliability and availability is not explicitly addressed since the combination of the selected units is assumed to meet the local demand at all times, excluding scheduled and unscheduled outages and spare units.
4. Pipelines are assumed to have no inherent OM cost as these would arise from pumps in the network. Since the pipelines are very short (≤ 100 m), no pumps are assumed to be installed in the network.
5. MG operation is assumed to be installed in a neighbourhood with an existing electrical infrastructure. The protection systems are thus already in place and the MG investment cost is therefore limited to the central control unit.

3. Energy integrated distributed energy system model

The model consists of an objective function bound by design and operational constraints of the available technologies as well as energy integration constraints and energy balance equations. The developed model builds further on the efforts in the field, in particular by Mehleri et al. [23, 24], Weber and Shah [25] and Keirstead et al. [29], as well as of the authors [36]. The most relevant equations are detailed below and the full model is included in Appendix A.

3.1. Objective function

The objective is to minimise the total annualised cost, C^{TOT} , which consists of the annualised investment cost, C_{tech}^{INV} , of the installed technologies *tech*, the OM and fuel costs, C_{tech}^{OM} and C_{tech}^{FUEL} , the cost of purchasing electricity from the grid by each house *i*, $C_{BUY,i}^{GRID}$, and the carbon tax imposed, C_i^{CT} . Furthermore,

the neighbourhood can create an income through grid export, $C_{SELL,i}^{GRID}$:

$$\begin{aligned} \min C^{TOT} = & \sum_{tech} C_{tech}^{INV} + \sum_{tech} (C_{tech}^{OM} + C_{tech}^{FUEL}) \\ & + \sum_i (C_{BUY,i}^{GRID} + C_i^{CT}) - \sum_i C_{SELL,i}^{GRID} \end{aligned} \quad (1)$$

3.2. Technology design and operational constraints

3.2.1. Energy generation and storage units

The technologies are all bound by design and operational constraints. The thermal technologies are boilers, gas heaters, air-conditioning units and absorption chillers, which have bounds on their capacity as well as a binary selection variable to decide on the installation of a unit in a house.

The possible DG units are PV units, small-scale wind turbines and CHP units. The electricity generated by each of the DG technologies consists of a part to feed the load of the accommodating house, to export to the grid, to circulate through the MG and to store in the battery. The waste heat generated by the CHPs can be used for heating purposes or can be fed into the absorption chillers for cooling purposes. The PV and wind turbine output is bound by the available average solar irradiation and wind speed in each hour respectively as well as a rated capacity. Country specific regulations, furthermore, place an upper bound on the installed capacity and daily export of residential PV units. In Adelaide this is bound to 10 kW and 45 kWh per day respectively [38]. The wind turbines are modelled based on the Weibull distribution with a shape parameter of 2 [39, 40]. The modelling of the CHP units largely follows the behaviour of the thermal technologies. The storage units are modelled based on a daily roll-over where the energy stored in the first hour of the day is a function of the energy stored in the last hour of the previous day.

3.2.2. Pipelines

The behaviour of the heating pipeline network is detailed below. The cooling network is modelled similarly. A binary decision variable, $YP_{i,j}$, decides whether a pipeline is installed between houses i and j . The pipeline is assumed to provide uni-directional heat transfer at all times. Furthermore, the maximum heat transferred between each pair of houses in each hour h of each season s , $QH_{i,j,s,h}$, is bound by an appropriate upper bound, U^{PIPE} , which indirectly provides a limit on pipe dimensions. This bound is set sufficiently big as to not pre-restrict the model but allow for ideal optimal pipeline transfer.

$$QH_{i,j,s,h} \leq U^{PIPE} \cdot YP_{i,j} \quad \forall i, j, s, h \text{ and } i \neq j \quad (2)$$

$$YP_{i,j} + YP_{j,i} \leq 1 \quad \forall i, j \text{ and } i \geq j \quad (3)$$

Multiple pipeline networks can be installed in the neighbourhood. OH_i is a positive integer variable, which indicates for each house the visiting order in the pipeline network. Since no closed loops are allowed and the system is uni-directional, the order of each house i connected to one network should be strictly increasing from the source house(s) to the house(s) at

the end of the network. This constraint is expressed through equation 4 motivated by the travelling salesman route problem (see for example [24, 41]). $|i|$ indicates the total number of houses in the neighbourhood:

$$OH_j \geq OH_i + 1 - |i| \cdot (1 - YP_{i,j}) \quad \forall i, j \text{ and } i \neq j \quad (4)$$

Only CHPs can send hot water to the network, $PH_{CHP,i,s,h}^{PIPE}$, which then can be transferred between a pair of houses, $QH_{i,j,s,h}$, to meet part of the heat load of a house, $QH_{i,s,h}^{LOAD}$, or can be passed on to other houses in the network, see figure 2.

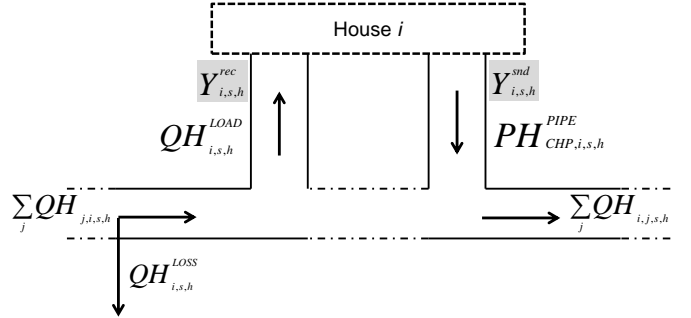

Figure 2: Schematic of pipeline operation of house i . Grey=Binary variable.

The thermal balances are given for all i, j, s, h where $i \neq j$:

$$PH_{CHP,i,s,h}^{PIPE} + \sum_j QH_{j,i,s,h} - QH_{i,s,h}^{LOSS} = QH_{i,s,h}^{LOAD} + \sum_j QH_{i,j,s,h} \quad (5)$$

$$PH_{CHP,i,s,h}^{PIPE} - \sum_i QH_{i,s,h}^{LOSS} = \sum_i QH_{i,s,h}^{LOAD} \quad (6)$$

The thermal losses, $QH_{i,s,h}^{LOSS}$, are evaluated by the sum over houses i of the heat transfer between houses j and i multiplied with a fixed percentage heat loss in function of distance between the pair. When connected to a pipeline network, each house can in each hour either receive or send hot water, determined by the binary variables $Y_{i,s,h}^{rec}$ and $Y_{i,s,h}^{snd}$ respectively:

$$Y_{i,s,h}^{rec} + Y_{i,s,h}^{snd} \leq 1 \quad \forall i, s, h \quad (7)$$

Certain combinations of technologies and operations are restricted. When a house has a gas heater installed - determined through binary variable $B_{G,i}$ - it cannot be connected to the network. Additionally, a house can either have a CHP unit (binary variable $B_{CHP,i}$) or a gas heater or boiler (binary variable $B_{techTH,i}$) to meet its heating demands:

$$B_{G,i} + Y_{i,s,h}^{rec/snd} \leq 1 \quad \forall i, s, h \quad (8)$$

$$B_{CHP,i} + B_{techTH,i} \leq 1 \quad \forall i \quad (9)$$

All components are assumed to be 100 % available. If a CHP unit is installed in a house, it will thus be dimensioned to meet the heat load of that house plus potential pipeline transfer. Hence a house with a CHP unit is assumed to either send or pass through heat to or from the pipeline network, not receive.

$$B_{CHP,i} + Y_{i,s,h}^{rec} \leq 1 \quad \forall i, s, h \quad (10)$$

The heat send to and from a pipe to a house is bound by a maximum utilisation rate of respectively, U^{snd} , and the total heat load of the house, $C_{HEAT,i,s,h}^{LOAD}$, respectively.

$$PH_{CHP,i,s,h}^{PIPE} \leq U^{snd} \cdot Y_{i,s,h}^{snd} \quad \forall i, s, h \quad (11)$$

$$QH_{i,s,h}^{LOAD} \leq C_{HEAT,i,s,h}^{LOAD} \cdot Y_{i,s,h}^{rec} \quad \forall i, s, h \quad (12)$$

3.3. Operational constraints

3.3.1. Energy balances and grid interactions

The electricity load of each house together with potential dump loads - only available in case of MG operation - and electricity for the operation of cooling technologies is satisfied through a combination of self-generation by DG units, MG operation, grid import and batteries. The thermal balances comprise both heating and cooling and are met by a combination of self-generation, pipeline transfer and storage.

3.3.2. Microgrid operation

A house can either send or receive electricity to or from the grid decided through binary variables $X_{i,s,h}^{snd}$ and $X_{i,s,h}^{rec}$ respectively. Whenever MG operation is installed - decided through binary variable Z - the neighbourhood interacts as a whole:

$$X_{i,s,h}^{snd} + X_{i,s,h}^{rec} \leq 1 \quad \forall i, s, h \quad (13)$$

$$X_{i,s,h}^{snd/rec} - X_{i-1,s,h}^{snd/rec} \leq 1 - Z \quad \forall i, s, h \text{ and } i > 1 \quad (14)$$

$$X_{i-1,s,h}^{snd/rec} - X_{i,s,h}^{snd/rec} \leq 1 - Z \quad \forall i, s, h \text{ and } i > 1 \quad (15)$$

A binary selection variable, $MGC_{i,j,s,h}$, is adopted to indicate whether electricity is shared between a pair of houses through MG operation.

$$MGC_{i,j,s,h} + MGC_{j,i,s,h} \leq Z \quad \forall i, j, s, h \text{ and } i \neq j \quad (16)$$

Electricity send to, $PE_{techDG,i,s,h}^{CIRC}$, or received from, $PE_{rec,i,s,h}^{MG}$, the MG by a house can be divided into house pair interactions, $PE_{i,j,s,h}^{snd}$ and $PE_{i,j,s,h}^{rec}$, that are bound by an upper level U^{MGC} :

$$\sum_{techDG} PE_{techDG,i,s,h}^{CIRC} = \sum_j PE_{i,j,s,h}^{snd} \quad \forall i, j, s, h \text{ and } i \neq j \quad (17)$$

$$PE_{rec,i,s,h}^{MG} = \sum_j PE_{i,j,s,h}^{rec} \quad \forall i, j, s, h \text{ and } i \neq j \quad (18)$$

$$PE_{i,j,s,h}^{snd/rec} \leq U^{MGC} \cdot MGC_{i,j,s,h} \quad \forall i, j, s, h \text{ and } i \neq j \quad (19)$$

The electricity balance of MG operation should be respected in each hour for each house and for the neighbourhood as a whole. The transfer loss is evaluated by multiplying the transferred electricity with a constant distance dependent loss percentage.

$$PE_{i,j,s,h}^{snd} - PE_{i,j,s,h}^{LOSS} = PE_{i,j,s,h}^{rec} \quad \forall i, j, s, h \text{ and } i \neq j \quad (20)$$

$$\sum_{techDG} \sum_i PE_{techDG,i,s,h}^{CIRC} - \sum_i \sum_j PE_{i,j,s,h}^{LOSS} = \sum_i PE_{rec,i,s,h}^{MG} \quad \forall i, j, s, h \text{ and } i \neq j \quad (21)$$

Lastly, the total generated electricity by DG units for MG circulation is bound by an upper level U^{MG} :

$$\sum_{techDG} \sum_i \sum_s \sum_h PE_{techDG,i,s,h}^{CIRC} \leq U^{MG} \cdot Z \quad \forall i, j, s, h \text{ and } i \neq j \quad (22)$$

3.4. Multi-microgrid

Multi-MG behaviour is introduced through a set p , for the different MG 'pools' with each a central control unit. The binary selection variable, $HP_{i,p}$, decides if a house belongs to a pool. MG related binary variables, Z and MGC , become additionally dependent on a pool, so are equations 14 and 15:

$$X_{i,s,h}^{rec/snd} - X_{i-1,s,h}^{rec/snd} \leq 2 - (HP_{i,p} + HP_{i-1,p}) \quad \forall i, s, h \text{ and } i > 1 \quad (23)$$

$$X_{i-1,s,h}^{rec/snd} - X_{i,s,h}^{rec/snd} \leq 2 - (HP_{i-1,p} + HP_{i,p}) \quad \forall i, s, h \text{ and } i > 1 \quad (24)$$

A house can only belong to a pool if the latter exists. Each pool is constraint by a minimum, $|i|_{Lo}$, and maximum, $|i|_{Up}$, allowable number of houses:

$$HP_{i,p} \leq Z_p \quad \forall i, p \quad (25)$$

$$|i|_{Lo} \cdot Z_p \leq \sum_i HP_{i,p} \leq |i|_{Up} \cdot Z_p \quad \forall p \quad (26)$$

A house can at most belong to one pool. Furthermore, the MG connection between two houses can only exist if they both belong to the same pool and MG operation is installed in that pool:

$$\sum_p HP_{i,p} \leq 1 \quad \forall i \quad (27)$$

$$MGC_{i,j,p,s,h} \leq \min(HP_{i,p}, HP_{j,p}, Z_p) \quad \forall i, j, p, s, h \text{ and } i \neq j \quad (28)$$

$$\sum_p MGC_{i,j,p,s,h} \leq 1 \quad \forall i, j, s, h \text{ and } i \neq j \quad (29)$$

A house can only circulate or receive electricity through a MG pool if it belongs to that pool:

$$\sum_{techDG} \sum_s \sum_h PE_{techDG,i,s,h}^{CIRC} \leq U^{MG} \cdot \sum_p HP_{i,p} \quad \forall i \quad (30)$$

$$\sum_s \sum_h PE_{rec,i,s,h}^{MG} \leq U^{MG} \cdot \sum_p HP_{i,p} \quad \forall i \quad (31)$$

4. Case-study: an Adelaide based neighbourhood

Australia is a country with potential to incorporate DG units and MGs to avoid investment in long transmission lines to cover the extended distances between load centres. Especially end-of-line installations could help to avoid significant costs of upgrading already existent long lines in remote areas to help meeting the locally increasing demand. Since SA has a high level of daily solar irradiation, 4 – 5 kWh day⁻¹ m⁻² [42], while having remote load centres, it is selected as case-study. The developed model is deterministic and requires input data framed by the location. The considered fictive neighbourhood consists of five average, typical houses in one retrofitted geographical area. The lay-out of the neighbourhood together with the total yearly energy demands of each house are given in table 1. Each house has a daily profile of hourly demands. The electricity demands for a typical day in winter, summer and mid-season are presented in figure 3a for one house (h₃) in the neighbourhood and are derived from aggregated measurement data received from

Table 1: Distance [m] between each pair of households [23] as well as the yearly energy demands of each house in terms of electricity (E) and heating (H) and cooling (C) [kWh y^{-1}]. Each row presents from one house the distance to the other houses in the neighbourhood as well as its yearly energy demands.

house	Distances					Yearly demands		
	h ₁	h ₂	h ₃	h ₄	h ₅	E	H	C
h ₁	0	30	40	50	70	3353	14138	2731
h ₂	30	0	30	20	40	3772	15905	3073
h ₃	40	30	0	50	70	4191	17672	3414
h ₄	50	20	50	0	20	4610	19439	3756
h ₅	70	40	70	20	0	5029	21207	4097

the SA distribution system operator. The heating and cooling demands are derived using the Degree Day method compared with aggregated measurement data [43, 44] and are presented in figure 3b for one house (h₃) in the neighbourhood. The remaining houses have in percentage varying demands with h₅ the highest and h₁ the lowest. Note that in winter and summer there is respectively no cooling and heating requirement.

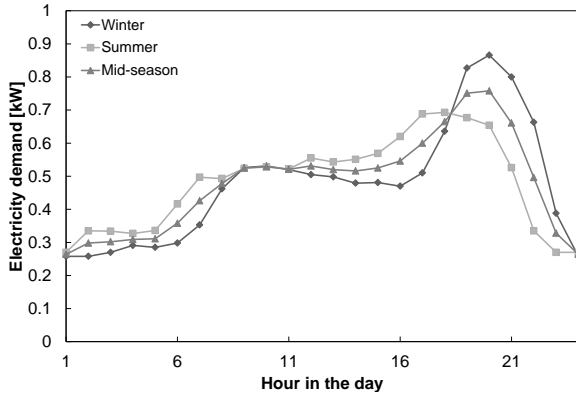

(a) Electricity demand for a typical day in each season, including lighting and household appliances but excluding cooling requirements

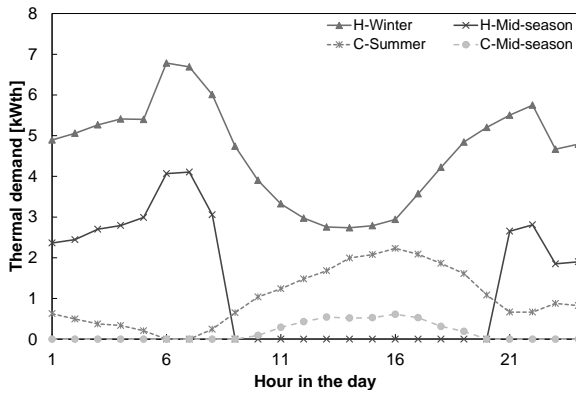

(b) Thermal demand for a typical day in each season. C=space cooling, H=space heating

Figure 3: Daily profiles of hourly averaged electricity and thermal demands of a representative house (h₃) in the neighbourhood [kW].

The hourly profiles of solar irradiation on a tilted surface are given in figure 4a for a typical day in each season. The solar irradiation data are retrieved from [42] and [45] and are used to derive the global solar irradiance on a tilted surface of 35° (see for instance [46]). The hourly profiles of wind speeds at

15 m above ground level are given in figure 4b. The data are obtained from [42] and are transformed to an appropriate hub height using the power law wind speed conversion with a power law exponent of 1/7 [47].

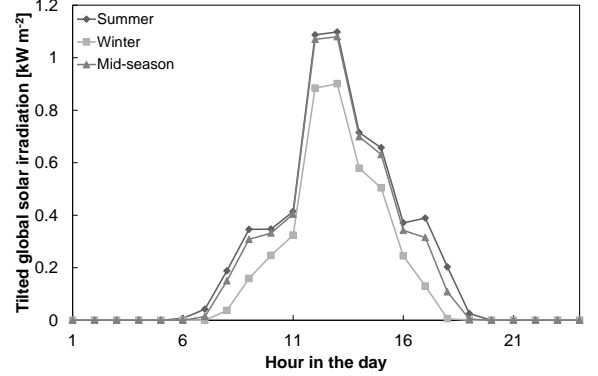

(a) Daily profiles of hourly averaged tilted global solar irradiation for a typical day in each season (kW m^{-2})

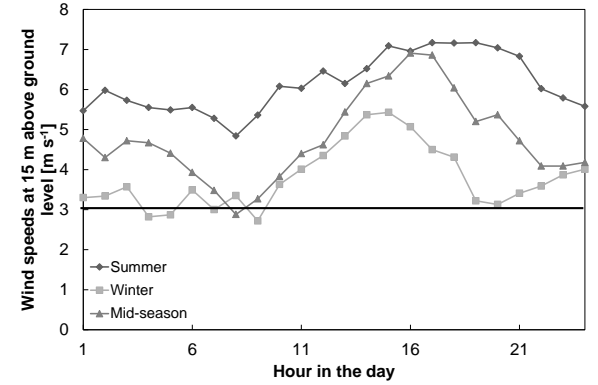

(b) Daily profiles of hourly averaged wind speeds at 15 m above ground level for a typical day in each season (m s^{-1}). The horizontal line indicates the cut-in wind speed of the turbines

Figure 4: Daily profiles of hourly averaged solar irradiation and wind.

The technologies each depend on technical characteristics to model their behaviour. These are detailed in table 2 for the thermal technologies.

Table 2: Characteristics of the thermal technologies: thermal efficiency (n_{tech}^{TH} or COP), upper (U_{tech}) and lower (L_{tech}) capacity limit.

	AC [21, 48]	airco [49]	B [24, 29, 30, 50]	CST/HST [16, 25]	G [24, 30]
n_{tech}^{TH}/COP	0.7	3	85%	-	75%
U_{tech} [kW]	20	30	35	50	35
L_{tech} [kW]	1.5	1.5	5	0.150	5

The small-scale wind turbines are considered to be wall mounted and characterised by a rated capacity (1.5 kW), a cut-in (3 m s^{-1}), a cut-out (25 m s^{-1}) and a rated wind speed (11 m s^{-1}) [22, 51]. The PV units are poly-crystalline units with a rated capacity of 0.15 kW_{peak} m^{-2} and an electrical efficiency of 12 % [24, 52]. The upper limit of the installed capacity of residential PV units in Adelaide translates to an upper surface area of 67 m² [38]. Each house can have one CHP unit in the

range of 1 to 20 kW_{elec} with an electrical efficiency of 25 % and a heat to electricity ratio of 2.7 kW_{therm} kW_{elec}⁻¹. The batteries are characterised by a depth of charge of 30 % and an installed capacity from 1 to 100 kWh [51, 53]. A charge controller complements each installed battery. The energy losses that occur while charging and discharging are presented in table 3 together with the other losses that can occur in the system.

Table 3: Loss terms in the system [25, 51, 53, 54]

Term	β	$\delta\chi$	ϵ	ζ	η	χ
Loss	0.1	15	0.03	10	0.1	10
Unit	[% m ⁻¹]	[%]	[% km ⁻¹]	[%]	[%]	[%]

The capital costs of the technologies are annualised using a capital recovery factor, expressed through: $CRF = (r \cdot (1 + r)^n) / ((1 + r)^n - 1)$ [23]. n is here the life time of the component, set to 20 years for all technologies. Batteries are set to have a life time of 5 years [22, 24, 25]. The interest rate, r , is set to 7.5% [24, 25]. The costs of the different units are given in table 4. The only components with a fixed OM cost are PV units, 15 [AUD kW_{peak}⁻¹ y⁻¹], wind turbines, 72 [AUD kW_{peak}⁻¹ y⁻¹] and batteries, 2.5 [AUD kWh_{peak}⁻¹ y⁻¹] [23, 39].

The average utility tariffs employed are a gas price of 0.128 AUD kWh⁻¹ and an electricity tariff of 0.344 AUD kWh⁻¹ [57, 58]. In SA there is only a FIT for residential PV export. The new tariff, since the second half of 2014, is a minimum retailer payment of 0.06 AUD kWh⁻¹ [59].

Regarding carbon measures, Australia had a carbon tax in place of 24 AUD tonCO₂⁻¹ in the financial year 2013 to 2014 with the plan of joining the European trading scheme in 2014. This tax has, however, been abolished as of the 1st of July 2014 [60]. No carbon tax is thus currently in place in Australia. The carbon intensity of grid electricity is 0.650 kgCO₂ kWh⁻¹ and for natural gas 0.216 kgCO₂ kWh⁻¹ [61].

4.1. Case-studies and selected energy system design scenarios

The optimisation is performed with respect to selected system scenarios to assess the influence of energy integration on cost, technology allocation and dispatch. The scenarios are implemented through fixing decision variables for each optimisation. The researched scenarios are presented below. Note that DG units here allude to both DG units and storage.

1. *Conventional*: each house receives electricity from the grid, heat from a gas heater and cooling through an air-conditioning unit
2. *Conventional with DGs*: DG units and thermal energy units can be installed in each house
3. *MG operation*: DG units, thermal units and MG operation are installed, no pipeline network is allowed
4. *MG operation with heat integration*: DG units, MG operation and a heating network can be installed, no cooling pipeline network is allowed nor gas heaters or boilers
5. *MG operation and thermal integration*: DG units, MG operation and a heating/cooling pipeline network can be installed, no gas heaters, boilers or air-conditioning units

6. Optimal design: no restrictions on presented model

Subsequently, an analysis is performed to assess the robustness of the model:

- *Upscaling* of the neighbourhood is analysed with and without multi-MG behaviour
- *Sensitivity analysis* is performed on utility energy tariffs
- *Variability* of solar irradiation is analysed through the addition of output level profiles with a daily occurrence rate

5. Results and Discussion

5.1. Selected energy system design scenarios

Table 5 summarises results of the selected design scenarios. A break down of the total annual cost is presented together with key operational values.

Table 5: Summary of results of the selected energy system design scenarios: cost break down [AUD y⁻¹], yearly CO₂ emissions [tonCO₂ y⁻¹], yearly import, export and MG electricity [kWh y⁻¹] and the installation of a MG.

Scenario	1	2	3	4	5	6
Costs						
C^{TOT}	25974	22689	22390	26904	28780	22264
C^{INV}	674	2948	3600	5987	4765	3798
C^{OM}	1054	1374	1316	1006	1022	1294
C^{FUEL}	15080	13318	14011	17772	22614	14235
C^{GRID}	9165	5331	3784	2512	498	3267
C^{BUY}	-	283	321	372	121	329
C^{SELL}	-	-	-	-	-	-
Others						
CO ₂	42.8	32.5	30.8	34.7	39.1	30.2
PE^{GRID}	26644	15497	11001	7302	1449	9496
PE^{GRID}	-	4714	5600	29636	27149	5953
PE^{MG}_{rec}	-	-	3952	1374	1147	5181
Features						
MG	No	No	Yes	Yes	Yes	Yes

Figure 5a compares the presented scenarios in terms of installed units. Only forced heat and cooling integration will lead to the installation of absorption chillers and CHP units in each house as in scenarios 4 and 5. The installation of co-generation reduces the installed capacity of PV units in each house. PV units are installed in each scenario with DG units since sun is abundant and a FIT can provide an income through electricity export. Note that no scenario has small-scale wind turbines or batteries installed.

A comparison of the electrical operational behaviour of the installed DG units in each scenario is provided in Figure 7. The DG units installed for electricity generation are PV units and CHP units. The yearly electricity generated by the PV units is mainly used for self-supply to decrease the dependency on the high electricity price in the SA market or is exported to the grid to take advantage of the FIT in the market. When each house has a CHP unit (scenarios 4 and 5), the majority of the generated electricity is exported to the central grid since the CHPs are heat following and as a result generate excess electricity. CHPs provide the majority of the electricity used for MG operation.

A combination of heat and electricity integration together with thermal energy units leads to the most cost effective design

Table 4: Technology cost terms: Investment cost (C_{tech}^C [AUD kW⁻¹_{installed}]) [16, 21–25, 29, 49, 55, 56] and variable OM cost (C_{tech}^{omv} [AUD kWh⁻¹]) [22–24]. Units are presented where different.

Tech	AC	airco	B	CHP	Cont	CST	dump	EST	G	HST	WT	MGCC	Pipes	PV
C_{tech}^C	540	300	150	3100	350	60	150	300	100	30	3500	1860	60	2000
C_{tech}^{omv}	0.015	0.01	0.01	0.015	–	0.0015	–	[AUD kWh ⁻¹] 0.01	0.01	0.0015	0.01	–	[AUD m ⁻¹] –	0.01

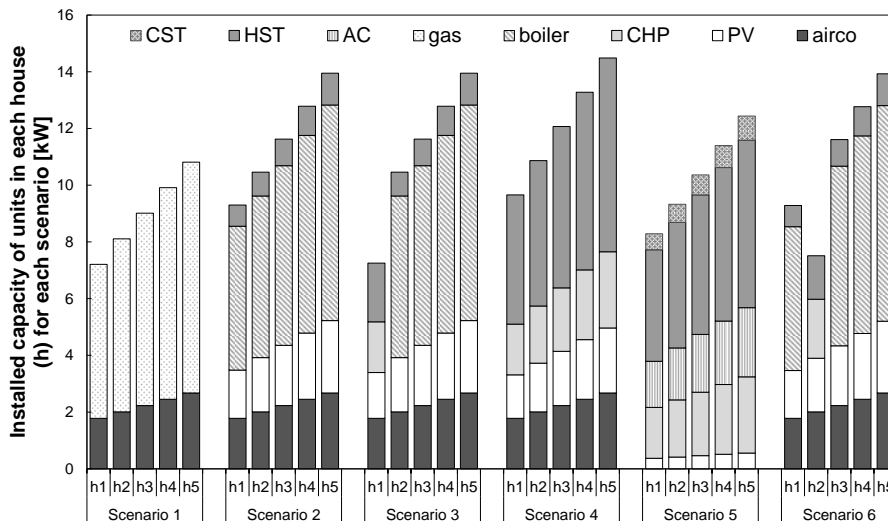

(a) Installed units (kW) in each household (h) for each scenario

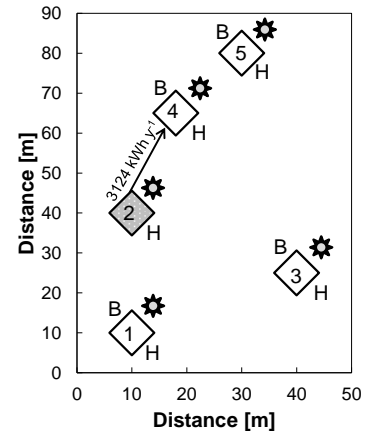

(b) Neighbourhood lay-out, Scenario 6

Figure 5: Neighbourhood design features. Diamonds=houses, grey diamond=CHP unit, arrow=heating pipeline with yearly heat transfer [kWh y⁻¹], sun=PV. Note that no small-scale wind turbines or batteries are installed.

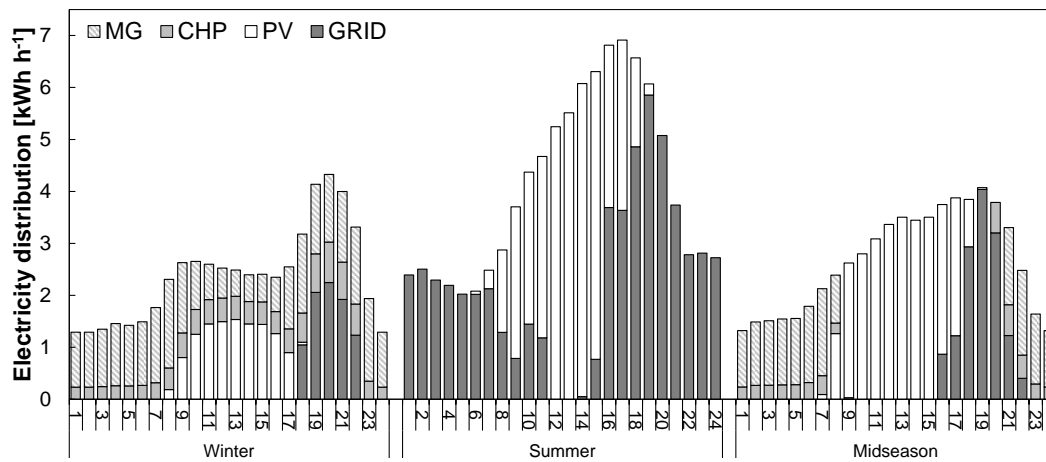

Figure 6: Neighbourhood electricity supply distribution to meet total local demand for a typical day (24 hours) in each season [kWh h⁻¹], scenario 6. Note that the summer electricity demand includes cooling through air-conditioning systems.

(see Scenario 6). The optimal design is illustrated in figure 5b and the distribution of the total neighbourhood electricity demand is given for a typical day in each season in figure 6. No cooling integration is adopted but air-conditioning units are installed in each house. Since the CHP electricity generation follows the heat demand, electricity import occurs during summer and mid-season at times with limited or no heat demand in the neighbourhood. Additionally, MG operation is only employed when heating is required, i.e. in winter and mid-season, since the CHP is responsible for the electricity for MG operation. Since electricity from PV units is the only way to create an income to offset costs, it will be exported where possible, mainly during midday hours with lower electricity demands. The optimal design shows that the elevated electricity price together with a limited FIT favours local energy generation and supply through the installation of PV units as well as MG operation facilitated by the installed CHP unit. No small-scale wind turbines, dump loads, absorption chillers or batteries are installed. The model statistics for the optimal case are given in table 6.

Table 6: Model statistics

CPU time		63.399 s	
Blocks of equations	116	Single equations	31421
Blocks of variables	81	Single variables	23553
Non zero elements	110626	Discrete variables	3686

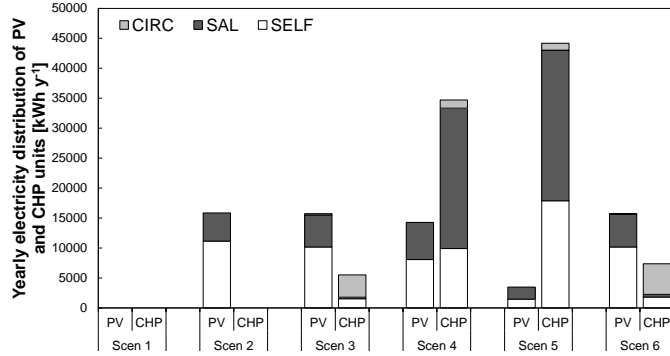

Figure 7: Summary of the yearly electricity distribution [kWh y^{-1}] of all the PV and CHP units in the neighbourhood for each scenario.

5.2. Scalability

The presented model is subsequently optimised for a neighbourhood with respectively 10 and 20 houses. The neighbourhood designs are presented in the figure 8. Both cases have PV units (1.7 - 2.5 kW) and air-conditioning units (1.8 - 2.7 kW) installed in each house, CHP unit(s) (2.4 - 3.3 kW) and an operational MG. A similar trend can be seen as in the optimal design of the five-house neighbourhood (see scenario 6). Heat integration does not comprise all households and cooling integration as well as wind turbines and batteries are not cost effective yet.

5.3. Multi-microgrid approach

Multi-MG behaviour is introduced through a limit of peak electricity demand per MG pool (set to 15 kW). This leads to

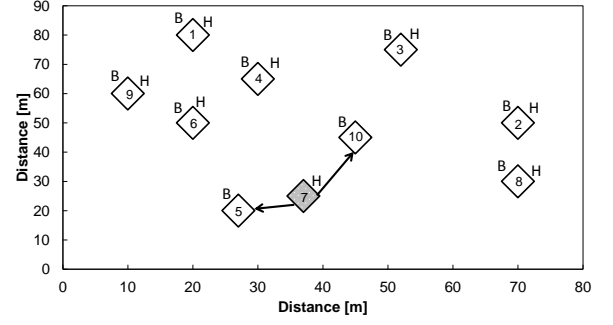

(a) Scenario 6 with 10 houses

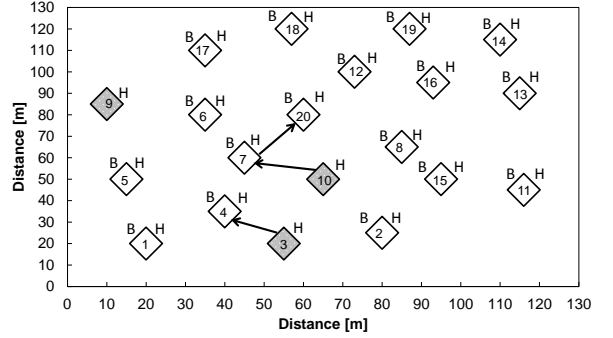

(b) Scenario 6 with 20 houses

Figure 8: Lay-out of the neighbourhood with 10 and 20 houses. All houses have air-conditioning and PV units installed. Diamonds=houses, grey diamond=CHP unit, arrows=heating pipeline connection.

approximately a maximum of 5 houses per pool. The obtained design is illustrated in figure 9. Two MG pools are implemented with each the maximum allowed number of 5 houses. Two CHPs are installed in the neighbourhood, one per pool, i.e. 1.9 kW (h_6) and 2.1 kW (h_7). Two pipelines are installed connecting houses within the same pool. Note that the pool separation is only restricting electricity integration. PV units (1.7 - 2.5 kW), heat storage tanks (0.7 - 1.5 kW) and air-conditioning units (1.8 - 2.7 kW) are installed in a each house.

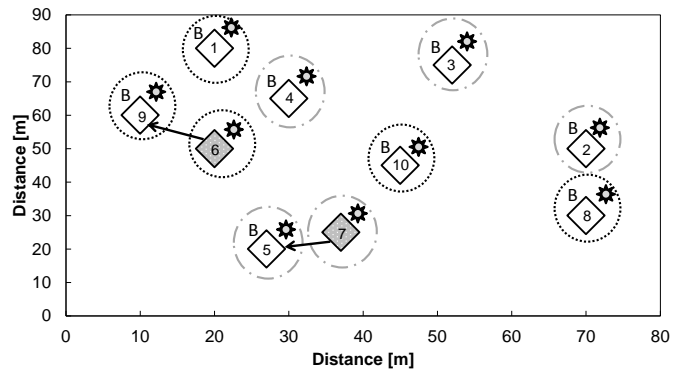

Figure 9: Lay-out of the neighbourhood with 10 houses and multiple MGs. All houses have air-conditioning, heat storage and PV units installed. Diamonds=houses, grey diamond=CHP unit, sun=PV unit, arrow=heating pipeline connection, dashed circles=pools.

5.4. Sensitivity analysis

Since a deterministic modelling approach is employed, uncertainty of input data can affect energy system design and operation. Sensitivity analysis is performed in this section to analyse the robustness of the model and gain insight in the influence of key parameters on design and operational decisions. Among the numerous input parameters of the model, utility energy prices show a high level of uncertainty. The analysis thus focusses on both the utility electricity and gas tariffs, which are incrementally increased by 20% until a doubling of current tariffs, see figure 10. The total annualised cost changes most with increasing gas tariff and the neighbourhood design changes most with increasing electricity tariff.

An increasing gas tariff leads to the same design as in scenario 6 until an increase above 40% from which the neighbourhood reaches a constant design without CHP unit, pipelines or MG operation. An increasing electricity tariff leads to more significant design changes. One CHP unit is installed in all cases in house 2 together with a pipeline to house 4 and MG operation. The capacity of the CHP unit increases gradually from 2.1 to 3 kW. The total PV unit capacity increases gradually from 6.3 to 11 kW until an increase above 40% from which it again gradually decreases to 6.4 kW. From a tariff increase above 40%, the house with the CHP unit does no longer have a PV unit. Moreover, an absorption chiller and accompanying cold storage unit are additionally installed in house 2. Furthermore, small-scale wind turbines start to appear from one unit (h_5) from an increase above 20% to four units from an increase above 60%. A trend towards increasing self-sufficiency with increasing electricity tariff can thus be concluded.

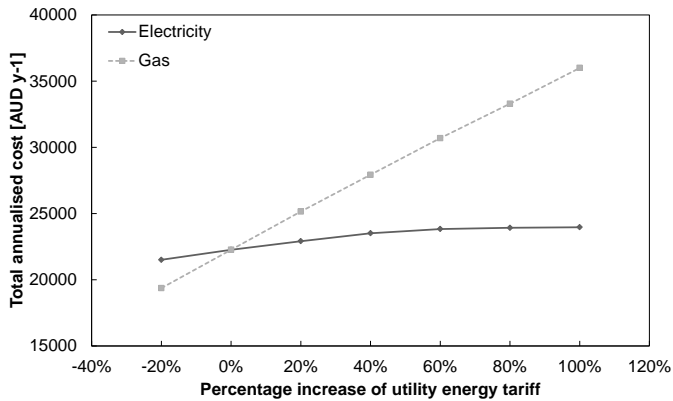

Figure 10: Total annualised cost versus percentage increase of utility energy tariffs of electricity and gas [AUD y^{-1}].

5.5. Variability analysis

Deterministic modelling employs average input data, which can affect the optimal design obtained. Especially the unpredictability of the availability of renewable energy sources is not accounted for through this approach. This section tries to incorporate a measure of variability of PV unit output through the use of real time PV output data from Adelaide. The collected data for 2010 are broken up into daily PV output levels in kWh per m^2 per day. Figure 11 indicates the number of days

throughout the year that each daily PV output level occurs in each season. An hourly profile is then obtained per output level by averaging the daily output profiles that fall within each level for each season. The output for each PV panel for a typical day in each season is then determined through a weighted average based on days of occurrence in each season of the PV output levels per installed square meter.

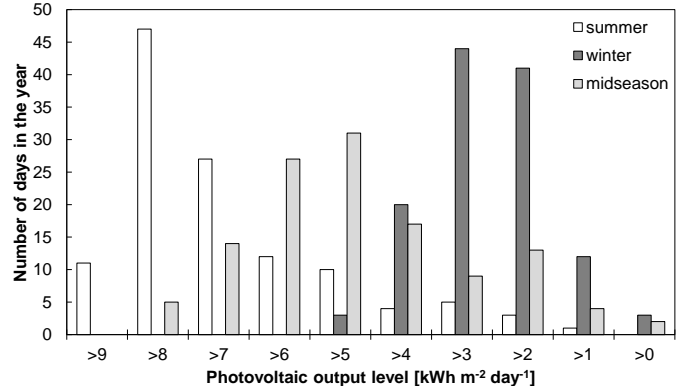

Figure 11: Occurrence rate of different daily PV output levels in each season [kWh $m^{-2} day^{-1}$].

The new optimal design leads to a cost decrease of 2.3% compared to the previous approach (see scenario 6). The overall design is not significantly affected by the introduction of variability. The only difference is a slight reduction in installed PV unit capacity from a range of 1.7–2.5 kW without variability incorporation to 1.4–2.1 kW with variability incorporation. The yearly PV electricity generation decreases by 16.5%. Additionally, over 80% of the PV electricity is used for self-supply and 17% for export compared to respectively 65% and 35% without variability. The incorporation of variability thus limitedly affects the overall design but does influence the operational interaction with the central grid.

6. Conclusion

A deterministic superstructure MILP approach for residential distributed energy system planning was proposed. A full energy integration approach was presented including MG operation, heating and cooling integration and several types of DG and storage units. Selected energy system design scenarios were compared for an SA case-study. Partial heat integration as well as MG operation has been shown to be the most cost effective design. CHP units are here key components to efficiently integrate residential neighbourhoods. PV units additionally provide a way to create an income through an available FIT in the market. The model led to consistent results when up-scaled to a neighbourhood of 10 and 20 houses. Additionally, a multi-MG approach was successfully presented for larger neighbourhoods to allow several MG ‘pools’ in a system. The obtained design is shown to have a trend towards increasing self-sufficiency with increasing electricity tariff. Furthermore, variability of solar irradiation does not significantly impact neighbourhood design but rather DG dispatch. Future research will look for alternative

neighbourhood designs as well as at the impact of grid export restrictions. Additionally, further analysis could provide policy recommendations to decision makers as to which technologies to focus on as well as to how to set-up these future energy integrated neighbourhoods.

Acknowledgement

The authors gratefully acknowledge the financial support from BHP Billiton in the form of a PhD scholarship for C. Wouters. They also wish to acknowledge the support received from J. Bennett (SA Power Networks), A. Nance (UCL), E.M. Polykarpou (UCL) and K. Ronaszegi (UCL).

Appendix A. Mathematical Model

Appendix A.1. Terms of the objective function

The annualised investment cost, C^{INV} , sums the annualised costs of the selected technologies, which consists of a unit capital cost of each technology $tech$, C_{tech}^C , multiplied with either a constant installed capacity and a binary selection variable $B_{tech,i}$ for each house i (for units with a discrete capacity) or an optimised capacity variable $DG_{tech,i}^{MAX}$ (for units with a capacity range). In case of PV units, this is an optimised surface A_i^{PV} times a rated capacity C_{prat} . The investment cost is annualised through a unit specific capital recovery factor, CRF_{tech} . The units presented are the thermal technologies ($techTH$), energy storage units ($techsto$), PV units (PV), small-scale wind turbines (WT), CHP units (CHP), thermal pipelines ($PIPE$) and a MG central control unit ($MGCC$):

$$\begin{aligned}
C^{INV} = & \sum_{techTH} \sum_i CRF_{techTH} \cdot C_{techTH}^C \cdot DG_{techTH,i}^{MAX} \\
& + \sum_{techsto} \sum_i CRF_{techsto} \cdot C_{techsto}^C \cdot DG_{techsto,i}^{MAX} \\
& + \sum_i CRF_{PV} \cdot C_{PV}^C \cdot A_i^{PV} \cdot C_{prat} \\
& + \sum_i CRF_{WT} \cdot C_{WT}^C \cdot B_{WT,i} \cdot Prats \\
& + \sum_i CRF_{CHP} \cdot C_{CHP}^C \cdot DG_{CHP,i}^{MAX} \\
& + \sum_{i \neq j} \sum_j CRF_{PIPE} \cdot C_{PIPE}^C \cdot YP_{i,j} \cdot l_{i,j} \\
& + CRF_{MGCC} \cdot C_{MGCC}^C \cdot Z
\end{aligned} \tag{A.1}$$

The annualised operation and maintenance cost, C^{OM} , includes the fixed and variable OM costs of the technologies. The fixed cost is based on installed capacity, for example, annual cleaning and maintenance of PV units. The variable cost is regular maintenance based on hourly usage. The terms included are the variable cost of the operation of all technologies and the fixed cost of PV units, small-scale wind turbines and batteries (EST) as well as the pipelines ($PIPE$). d_s represents

the number of days in each season s . Note that the capacity unit for batteries is kWh compared to kW for the other technologies.

$$\begin{aligned}
C^{OM} = & \sum_{tech} \sum_i \sum_s \sum_h hr \cdot d_s \cdot C_{tech}^{omv} \cdot PE_{tech,i,s,h}^{GEN} \\
& + \sum_i C_{PV}^{omf} \cdot C_{prat} \cdot A_i^{PV} + \sum_i C_{WT}^{omf} \cdot Prats \cdot B_{WT,i} \\
& + \sum_i C_{EST}^{omf} \cdot DG_{EST,i}^{MAX} + \sum_{i \neq j} \sum_j l_{i,j} \cdot C_{PIPE}^{omf} \cdot YP_{i,j}
\end{aligned} \tag{A.2}$$

The thermal heating technologies include boilers and gas heaters as well as CHP units and are natural gas fuelled. This attracts a fuel cost related to the prevailing gas tariff (T_{GAS}) and the heating generated throughout the year ($PH_{techTH,i,s,h}^{GEN}$) dependent on the thermal efficiency of the component (n_{techTH}^{TH}):

$$\begin{aligned}
C^{FUEL} = & \sum_{techTH} \sum_i \sum_s \sum_h hr \cdot d_s \cdot PH_{techTH,i,s,h}^{GEN} \cdot \frac{T_{GAS}}{n_{techTH}^{TH}} \\
& + \sum_i \sum_s \sum_h hr \cdot d_s \cdot PE_{CHP,i,s,h}^{GEN} \cdot \frac{T_{GAS}}{n_{CHP}^{ELEC}}
\end{aligned} \tag{A.3}$$

Electricity can additionally be purchased from the central grid. The annual electricity cost, C_{BUY}^{GRID} , depends on the prevailing electricity tariff (T_{ELEC}) and the electricity purchased throughout the year ($PE_{i,s,h}^{GRID}$):

$$C_{BUY}^{GRID} = \sum_i \sum_s \sum_h hr \cdot d_s \cdot T_{ELEC} \cdot PE_{i,s,h}^{GRID} \tag{A.4}$$

An annual carbon tax tariff, C^{CT} , can be directly imposed on the neighbourhood depending on the prevailing tariff (CT), the imported electricity and the gas consumed on-site by the boilers (B), gas heaters (G) and CHP units. The carbon intensities of the grid (CI_{ELEC}) and natural gas (CI_{GAS}) are included.

$$\begin{aligned}
C^{CT} = & \sum_i \sum_s \sum_h CT \cdot hr \cdot d_s \cdot [CI_{ELEC} \cdot PE_{i,s,h}^{GRID} \\
& + CI_{GAS} \cdot \sum_{techTH} \frac{PH_{techTH,i,s,h}}{n_{techTH}^{TH}} + CI_{GAS} \cdot \frac{PE_{CHP,i,s,h}}{n_{CHP}^{ELEC}}]
\end{aligned} \tag{A.5}$$

Additionally, an annual income, C_{SELL}^{GRID} , can be created through export of locally generated electricity by the DG units $techDG$ ($PE_{techDG,i,s,h}^{SAL}$) through the prevailing FITs in the market (T_{techDG}^{SAL}):

$$C_{SELL}^{GRID} = \sum_{techDG} \sum_i \sum_s \sum_h hr \cdot d_s \cdot T_{techDG}^{SAL} \cdot PE_{techDG,i,s,h}^{SAL} \tag{A.6}$$

Appendix A.2. Technology design and operational constraints

Appendix A.2.1. Thermal energy technologies

Thermal technologies (boilers, gas heaters, air-conditioning units and absorption chillers) generate heat (H) or cooling (C), $PH/C_{techT,i,s,h}^{GEN}$, which is bound by upper ($U_{techT}^{PH/C}$) and lower

bounds ($L_{techT}^{PH/C}$) on their installed capacity ($DG_{techT,i}^{MAX}$) and a binary selection variable ($B_{techT,i}$):

$$L_{techT}^{PH/C} \cdot B_{techT,i} \leq PH/C_{techT,i,s,h}^{GEN} \leq DG_{techT,i}^{MAX} \quad \forall i, s, h \quad (A.7)$$

$$DG_{techT,i}^{MAX} \leq U_{techT}^{PH/C} \cdot B_{techT,i} \quad \forall i \quad (A.8)$$

The heat generated by the boilers, $PH_{B,i,s,h}^{GEN}$, and the cooling generated by the absorption chillers, $PC_{AC,i,s,h}^{GEN}$, is divided in a part for self use ($SELF$) and a part for thermal storage (STO). The absorption chiller can also serve pipelines ($PIPE$).

$$PH_{B,i,s,h}^{GEN} = PH_{B,i,s,h}^{SELF} + PH_{B,i,s,h}^{STO} \quad \forall i, s, h \quad (A.9)$$

$$PC_{AC,i,s,h}^{GEN} = PC_{AC,i,s,h}^{SELF} + PC_{AC,i,s,h}^{STO} + PC_{AC,i,s,h}^{PIPE} \quad \forall i, s, h \quad (A.10)$$

Additionally, restrictions regarding technology combinations in each house are presented through relations between respective binary selection variables; a gas heater can not be installed with a boiler or heat storage unit, and, an air-conditioning unit (*airco*) can not be installed with an absorption chiller (*AC*):

$$B_{G,i} + B_{B,i} \leq 1 \quad \forall i \quad (A.11)$$

$$B_{HST,i} + B_{G,i} \leq 1 \quad \forall i \quad (A.12)$$

$$B_{AC,i} + B_{airco,i} \leq 1 \quad \forall i \quad (A.13)$$

Appendix A.2.2. Distributed generation technologies

The PV output, $PE_{PV,i,s,h}^{GEN}$, is bound by the available average solar irradiation in each hour ($It_{s,h}$) as well as a rated capacity and efficiency (n_{PV}^{ELEC}). Country specific regulations place an upper bound on the installed capacity (C_{prat}) and daily export of residential PV units.

$$PE_{PV,i,s,h}^{GEN} \leq \min(A_i^{PV} \cdot C_{prat}; A_i^{PV} \cdot It_{s,h} \cdot n_{PV}^{ELEC}) \quad \forall i, s, h \quad (A.14)$$

$$A_i^{PV} \leq A_{UP}^{PV} \quad \forall i \quad (A.15)$$

$$\sum_h hr \cdot PE_{PV,i,s,h}^{GEN} \leq 45 \quad \forall i, s \quad (A.16)$$

The wind turbine output, $PE_{WT,i,s,h}^{GEN}$, is bound by the available wind speed in each hour ($V_{s,h}$) as well as a rated capacity ($Prat$) and a binary variable ($B_{WT,i}$). The turbines are modelled based on the Weibull distribution with shape parameter, kw , and characterised by a cut-in (V_{CI}), a rated (V_R) and a cut-out (V_{CO}) wind speed:

For $V_{CI} \leq V_{s,h} < V_R$

$$PE_{WT,i,s,h}^{GEN} = Prat \cdot B_{WT,i} \cdot \frac{V_{s,h}^{kw} - V_{CI}^{kw}}{V_R^{kw} - V_{CI}^{kw}} \quad \forall i, s, h \quad (A.17)$$

For $V_R \leq V_{s,h} < V_{CO}$

$$PE_{WT,i,s,h}^{GEN} = Prat \cdot B_{WT,i} \quad \forall i, s, h \quad (A.18)$$

For $V_{CO} \leq V_{s,h} < V_{CI}$

$$PE_{WT,i,s,h}^{GEN} = 0 \quad \forall i, s, h \quad (A.19)$$

The CHP output, $PE_{CHP,i,s,h}^{GEN}$ is bound by upper (U_{CHP}^{PE}) and lower bounds (L_{CHP}^{PE}) on its installed capacity ($DG_{CHP,i}^{MAX}$) and a binary selection variable ($B_{CHP,i}$):

$$L_{CHP}^{PE} \cdot B_{CHP,i} \leq PE_{CHP,i,s,h}^{GEN} \leq DG_{CHP,i}^{MAX} \quad \forall i, s, h \quad (A.20)$$

$$DG_{CHP,i}^{MAX} \leq U_{CHP}^{PE} \cdot B_{CHP,i} \quad \forall i \quad (A.21)$$

The waste heat from electricity generation by the CHPs, determined through the heat to electricity ration HER , can be used for heating purposes ($PH_{CHP,i,s,h}^{HEAT}$) or for cooling purposes ($PH_{CHP,i,s,h}^{COOL}$):

$$PE_{CHP,i,s,h}^{GEN} \cdot HER = PH_{CHP,i,s,h}^{HEAT} + PH_{CHP,i,s,h}^{COOL} \quad \forall i, s, h \quad (A.22)$$

The portion used for heating either meets the load of the accommodating house ($SELF$), is stored in the hot water tank (STO) or is transferred through the pipeline network ($PIPE$):

$$PH_{CHP,i,s,h}^{HEAT} = PH_{CHP,i,s,h}^{SELF} + PH_{CHP,i,s,h}^{STO} + PH_{CHP,i,s,h}^{PIPE} \quad \forall i, s, h \quad (A.23)$$

The cooling generated by the absorption chiller ($PC_{AC,i,s,h}^{GEN}$) through the heat provided by the CHP unit is determined by its coefficient of performance (COP_{AC}):

$$PC_{AC,i,s,h}^{GEN} = PH_{CHP,i,s,h}^{COOL} \cdot COP_{AC} \quad \forall i, s, h \quad (A.24)$$

The electricity generated by DG units, $PE_{techDG,i,s,h}^{GEN}$, consists of a part to feed the load of the accommodating house ($SELF$), to export to the grid (SAL), to circulate through the MG ($CIRC$) or to store in the battery (STO):

$$PE_{techDG,i,s,h}^{GEN} = PE_{techDG,i,s,h}^{SELF} + PE_{techDG,i,s,h}^{SAL} + PE_{techDG,i,s,h}^{CIRC} + PE_{techDG,i,s,h}^{STO} \quad \forall i, s, h \quad (A.25)$$

Appendix A.2.3. Storage units

The thermal power stored in the storage tank, $PS_{i,s,h}^{STO}$, is a function of what is stored in the previous hour minus a static loss percentage (ζ) plus an inflow ($PS_{i,s,h}^{IN}$) minus an outflow ($PS_{i,s,h}^{OUT}$), and based on a daily roll-over:

$$PS_{i,s,h}^{STO} = (1 - \zeta) \cdot PS_{i,s,h-1}^{STO} + PS_{i,s,h}^{IN} - PS_{i,s,h}^{OUT} \quad \forall i, s, h \quad (A.26)$$

The inflow is equal to the thermal power generated by either the CHP units and boilers or absorption chillers for respectively hot or cold storage:

$$PS_{i,s,h}^{IN} = (PH_{B,i,s,h}^{STO} + PH_{CHP,i,s,h}^{STO}) \text{ or } PC_{AC,i,s,h}^{STO} \quad \forall i, s, h \quad (A.27)$$

The storage tank can additionally not be loaded over its maximum capacity, $DG_{STO,i}^{MAX}$:

$$(1 - \zeta) \cdot PS_{i,s,h-1}^{STO} + PS_{i,s,h}^{IN} \leq DG_{STO,i}^{MAX} \quad \forall i, s, h \quad (A.28)$$

The outflow during an hour cannot exceed the thermal power stored in the previous hour:

$$PS_{i,s,h}^{OUT} \leq (1 - \zeta) \cdot PS_{i,s,h-1}^{STO} \quad \forall i, s, h \quad (A.29)$$

Furthermore, the units are bound by upper (U_{STO}^{PH}) and lower (L_{STO}^{PH}) bounds on their installed capacity:

$$L_{STO}^{PH} \cdot B_{STO,i} \leq DG_{STO,i}^{MAX} \leq U_{STO}^{PH} \cdot B_{STO,i} \quad \forall i, s, h \quad (A.30)$$

$$PS_{STO,i,s,h}^{STO} \leq DG_{STO,i}^{MAX} \quad \forall i, s, h \quad (A.31)$$

The batteries are modelled similarly to the thermal storage units with additional charge (χ) and discharge ($\delta\chi$) rates, maximum charge ($max\chi$) and discharge rates ($max\delta\chi$), upper (U_{EST}^{ES}) and lower (L_{EST}^{ES}) limits on the state of charge, a depth of charge (DOC) and a binary decision variable, $B_{EST,i}$:

$$ES_{EST,i,s,h}^{STO} = (1 - \eta) \cdot ES_{EST,i,s,h-1}^{STO} + hr * (1 - \chi) \cdot PS_{EST,i,s,h}^{IN} - hr * \frac{PS_{EST,i,s,h}^{OUT}}{(1 - \delta\chi)} \quad \forall i, s, h \quad (A.32)$$

The in- and output energy can respectively not exceed the installed capacity and the stored energy in the previous hour:

$$hr * (1 - \chi) \cdot PS_{EST,i,s,h}^{IN} + (1 - \eta) \cdot ES_{EST,i,s,h-1}^{STO} \leq DG_{EST,i}^{MAX} \quad \forall i, s, h \quad (A.33)$$

$$hr * \frac{PS_{EST,i,s,h}^{OUT}}{(1 - \delta\chi)} \leq (1 - \eta) \cdot ES_{EST,i,s,h-1}^{STO} \quad \forall i, s, h \quad (A.34)$$

The battery is charged through contributions of the DG units, i.e. PV units, CHP units and small-scale wind turbines:

$$PS_{EST,i,s,h}^{IN} = \sum_{techDG} PE_{techDG,i,s,h}^{STO} \quad \forall i, s, h \quad (A.35)$$

The in- and output energy is restricted by maximum charge and discharge rates in function of the installed capacity:

$$hr * (1 - \chi) \cdot PS_{EST,i,s,h}^{IN} \leq max\chi \cdot DG_{EST,i}^{MAX} \quad \forall i, s, h \quad (A.36)$$

$$hr * \frac{PS_{EST,i,s,h}^{OUT}}{(1 - \delta\chi)} \leq max\delta\chi \cdot DG_{EST,i}^{MAX} \quad \forall i, s, h \quad (A.37)$$

Additionally, the energy stored and the installed capacity is bound by upper and lower levels:

$$L_{EST}^{ES} \cdot B_{EST,i} \leq DG_{EST,i}^{MAX} \leq U_{EST}^{ES} \cdot B_{EST,i} \quad \forall i \quad (A.38)$$

$$(1 - DOC) \cdot DG_{EST,i}^{MAX} \leq ES_{EST,i,s,h}^{STO} \quad \forall i, s, h \quad (A.39)$$

Appendix A.3. Operational constraints

Appendix A.3.1. Energy balances

The electrical load of each house, $C_{ELEC,i,s,h}^{LOAD}$, together with a potential dump load ($Pdl_{i,s,h}$) and electricity for the operation of the absorption chiller and air-conditioning units (characterised by respective electricity to cooling ratios, AC_{ELEC} and COP_{airco}) should be satisfied through a combination of grid import ($PE_{i,s,h}^{GRID}$), MG operation ($PE_{rec,i,s,h}^{MG}$), self-generated electricity by the DG units ($PE_{techDG,i,s,h}^{SELF}$) and battery out-flow ($PS_{EST,i,s,h}^{OUT}$):

$$\begin{aligned} C_{ELEC,i,s,h}^{LOAD} + Pdl_{i,s,h} + PC_{AC,i,s,h}^{GEN} \cdot AC_{ELEC} + \frac{PC_{airco,i,s,h}^{GEN}}{COP_{airco}} \\ = PE_{i,s,h}^{GRID} + PE_{rec,i,s,h}^{MG} + \sum_{techDG} PE_{techDG,i,s,h}^{SELF} \\ + PS_{EST,i,s,h}^{OUT} \quad \forall i, s, h \end{aligned} \quad (A.40)$$

The heating, $C_{HEAT,i,s,h}^{LOAD}$, and cooling loads, $C_{COOL,i,s,h}^{LOAD}$, are met by a combination of self-generation by gas heaters ($PH_{G,i,s,h}^{GEN}$), boilers ($PH_{B,i,s,h}^{SELF}$) and CHP units ($PH_{CHP,i,s,h}^{SELF}$) or air-conditioning units ($PC_{airco,i,s,h}^{GEN}$) and absorption chiller ($PC_{AC,i,s,h}^{SELF}$) and pipeline transfer ($QH/C_{i,s,h}^{LOAD}$) or storage out-flow ($PS_{STO,i,s,h}^{OUT}$) for all i, s, h :

$$C_{HEAT,i,s,h}^{LOAD} = PH_{G,i,s,h}^{GEN} + PH_{B,i,s,h}^{SELF} + PH_{CHP,i,s,h}^{SELF} + QH_{i,s,h}^{LOAD} + PS_{HST,i,s,h}^{OUT} \quad (A.41)$$

$$C_{COOL,i,s,h}^{LOAD} = PC_{airco,i,s,h}^{GEN} + PC_{AC,i,s,h}^{SELF} + QC_{i,s,h}^{LOAD} + PS_{CST,i,s,h}^{OUT} \quad (A.42)$$

Appendix A.3.2. Grid interactions

Each house can in each hour either import, $PE_{i,s,h}^{GRID}$, or export, $PE_{techDG,i,s,h}^{SAL}$, electricity up to a maximum ($U_{rec/snd}^{ELEC}$) or not interact. The binary decision variables $X_{i,s,h}^{rec}$ and $X_{i,s,h}^{snd}$ decide respectively whether a house receives or sends.

$$\sum_{techDG} PE_{techDG,i,s,h}^{SAL} \leq U_{snd}^{ELEC} \cdot X_{i,s,h}^{snd} \quad \forall i, s, h \quad (A.43)$$

$$PE_{i,s,h}^{GRID} \leq U_{rec}^{ELEC} \cdot X_{i,s,h}^{rec} \quad \forall i, s, h \quad (A.44)$$

Nomenclature

Abbreviations	
AC	Absorption chiller
airco	air-conditioning unit
B	Condensing boiler
C_{COOL}^{LOAD}	Electricity load [kW]
C_{ELEC}^{LOAD}	Electricity load [kW]
C_{HEAT}^{LOAD}	Heat load [kW]
CHP	Combined heat and power unit
CIRC	Electricity for circulation through MG
COOL/C	Cooling
Cont	Charge controller
CST	Cold storage unit
DG	Distributed generation unit
dump	Dump load
ELEC/E	Electricity
EST	Electrical storage unit
FIT	Feed-in tariff
Gas/G	Gas heater
GRID	Central electricity supply
h	House in the neighbourhood
HEAT/H	Heating
HST/H	Hot storage unit
MG	Microgrid
MGCC	Microgrid central controller
MILP	Mixed-integer linear programming
OM	Operation and maintenance
PIPE	Pipeline
PV	Photovoltaic unit
SA	South Australia
SAL	Electricity exported to the grid
SELF	Power for self-supply
STO	Hot or cold storage unit
WT	Small-scale wind turbine

Superscripts	
C	Capital cost
CIRC	Electricity circulation/sharing through microgrid
COOL	Cooling
CT	Carbon tax cost
ELEC	Electrical
ES	Energy stored
GEN	Power generation
GRID	Central electricity grid
FUEL	Fuel cost
HEAT	Heating
IN	Inflow
INV	Investment cost
LOAD	Power load
LOSS	Power loss
MAX	Maximum installed capacity
MG	Microgrid
MGC	Microgrid connection
OM	Operation and maintenance
omf	Fixed operation and maintenance cost
omv	Variable operation and maintenance cost
OUT	Outflow
PC	Cooling power
PE	Electrical power
PH	Heating power
PIPE	Pipeline
PV	Photovoltaic unit
rec	Received/Imported
SAL	Export
SELF	Self use
snd	Send/Exported
STO	Storage
TH	Thermal heating
TOT	Total cost
Sets/subscripts	
AC	Absorption chiller
airco	air-conditioning unit
B	Condensing boiler
BUY	Electricity import
CHP	Combined heat and power unit
CI	Cut-in
CO	Cut-out
COOL	Thermal cooling
CST	Cold storage unit
ELEC/elec	Electricity
EST	Electrical storage unit
G	Gas heater
GAS	Natural gas
<i>h</i>	Hours in a day
HEAT	Thermal heating
HST	Hot storage unit
<i>i, j</i>	Houses in the neighbourhood
Lo	Lower bound
MG	Microgrid
MGCC	Microgrid central control unit
<i>p</i>	Microgrid pools
PIPE	Pipeline
PV	Photovoltaic unit
R	Rated
<i>s</i>	Seasons in a year
SELL	Electricity export
STO	Stored/Storage technology
th/therm	Thermal

tech	technologies
techDG	Distributed generation technologies (CHP, PV, WT)
techsto	Storage technologies (CST, EST, HST)
techT	Thermal technologies (AC, airco, B, G)
techTH	Thermal heating technologies (B, G)
Up	Upper bound
WT	Small-scale wind turbine
Parameters	
AC	Absorption chiller electricity to cooling ratio [$\text{kW}_{\text{therm}} \text{kW}_{\text{elec}}^{-1}$]
C^{LOAD}	Hourly average power load [kW]
CI	Carbon intensity [$\text{kgCO}_2 \text{kWh}^{-1}$]
Cprat	Rated capacity PV units [%]
COP	Coefficient of performance [$\text{kW}_{\text{therm}} \text{kW}_{\text{elec}}^{-1}$]
CRF	Capital recovery factor
d	Days in a season
DOC	Battery depth of charge
HER	Heat to electricity ratio CHP unit [$\text{kW}_{\text{therm}} \text{kW}_{\text{elec}}^{-1}$]
hr	Hour
$ i $	Number of houses
I_t	Solar irradiation [kW m^{-2}]
kw	Weibull shape parameter
<i>l</i>	Distance between household pair [m]
L	Lower bound [kW or kWh]
$\text{max}\delta\chi$	Maximum battery discharge rate [%]
$\text{max}\chi$	Maximum battery charge rate [%]
<i>n</i>	Efficiency [%]
Prat	Rated capacity WT units [kW]
T	Utility tariff [AUD unit ⁻¹]
U	Upper bound [kW or kWh]
V	Wind speed [m s^{-1}]
β	Pipeline heat transfer losses [$\% \text{m}^{-1}$]
$\delta\chi$	Battery discharge rate [%]
ϵ	Electrical cable losses [$\% \text{km}^{-1}$]
ζ	Static loss percentage thermal storage [%]
η	Static loss percentage battery [%]
χ	Battery charge rate [%]
Continuous variables	
A	PV unit surface area [m^2]
C	Annualised cost [AUD y^{-1}]
DG	Installed capacity technology [kW or kWh]
ES	Energy stored [kWh]
OH	Visiting order of a house in the heating pipeline network (integer variable)
PC	Cooling power [kW]
Pdl	Power dumped [kW]
PE	Electrical power [kW]
PH	Heating power [kW]
PS	Power stored [kW]
QH	Heat transfer [kW]
Binary variables	
B	Technology decision variable
HP	Microgrid pool decision variable
MGC	Microgrid connection between household pair decision variable
X	Electricity import/export decision variable
Y	Pipeline receive/send decision variable
YP	Pipeline decision variable
Z	Microgrid existence decision variable

References

- [1] International Energy Agency IEA, Energy use in the new millennium - trends in the IEA countries, available online: <http://www.iea.org/publications/freepublications/publication/millennium.pdf> (last consulted on 28 July 2014) (2007).
- [2] S. Blumsack, A. Fernandez, Ready or not, here comes the smart grid!, Energy 37 (1) (2012) 61–68.
- [3] G. Pepermans, J. Driesen, D. Haeseldonckx, R. Belmans, W. D'haeseleer, Distributed generation: definition, benefits and issues, Energy Policy 33 (6) (2005) 787 – 798. doi:<http://dx.doi.org/10.1016/j.enpol.2003.10.004>.

- [4] K. Alanne, A. Saari, Distributed energy generation and sustainable development, *Renewable and Sustainable Energy Reviews* 10 (6) (2006) 539 – 558. doi:<http://dx.doi.org/10.1016/j.rser.2004.11.004>.
- [5] S. Carley, Distributed generation: An empirical analysis of primary motivators, *Energy Policy* 37 (5) (2009) 1648 – 1659. doi:<http://dx.doi.org/10.1016/j.enpol.2009.01.003>.
- [6] J. Romankiewicz, M. Qu, C. Marnay, N. Zhou, International microgrid assessment: Governance, incentives, and experience (imagine), China Energy Group, Environmental Energy Technologies Division, Lawrence Berkeley National Laboratory LBNL-6159E. Available online: <http://eande.lbl.gov/sites/all/files/imagine-eceee.pdf> (last consulted on 28 November 2013).
- [7] P. M. Costa, M. A. Matos, J. Peças Lopes, Regulation of microgeneration and microgrids, *Energy Policy* 36 (10) (2008) 3893 – 3904. doi:<http://dx.doi.org/10.1016/j.enpol.2008.07.013>.
- [8] J. Vasiljevska, J. Peças Lopes, M. Matos, Evaluating the impacts of the multi-microgrid concept using multicriteria decision aid, *Electric Power Systems Research* 91 (2012) 44–51.
- [9] H. Nikkhajoei, R. Lasseter, Distributed generation interface to the certs microgrid, *Power Delivery, IEEE Transactions on* 24 (3) (2009) 1598–1608. doi:10.1109/TPWRD.2009.2021040.
- [10] T. Loix, T. Wijnhoven, G. Deconinck, Protection of microgrids with a high penetration of inverter-coupled energy sources, in: *Integration of Wide-Scale Renewable Resources Into the Power Delivery System, 2009 CIGRE/IEEE PES Joint Symposium, IEEE, 2009*, pp. 1–6.
- [11] P. Piagi, R. Lasseter, Autonomous control of microgrids, in: *Power Engineering Society General Meeting, 2006. IEEE, 2006*, pp. 8 pp.–. doi:10.1109/PES.2006.1708993.
- [12] A. G. Tsikalakis, N. D. Hatziaziyriou, Centralized control for optimizing microgrids operation, in: *Power and Energy Society General Meeting, 2011 IEEE, IEEE, 2011*, pp. 1–8.
- [13] M. Hassan, M. Abido, Optimal design of microgrids in autonomous and grid-connected modes using particle swarm optimization, *Power Electronics, IEEE Transactions on* 26 (3) (2011) 755–769.
- [14] M. Mahmoud, S. Azher Hussain, M. Abido, Modeling and control of microgrid: An overview, *Journal of the Franklin Institute* 351 (5) (2014) 2822–2859.
- [15] P. Basak, S. Chowdhury, S. H. nee Dey, S. Chowdhury, A literature review on integration of distributed energy resources in the perspective of control, protection and stability of microgrid, *Renewable and Sustainable Energy Reviews* 16 (8) (2012) 5545 – 5556. doi:<http://dx.doi.org/10.1016/j.rser.2012.05.043>.
- [16] S. Obara, Equipment arrangement planning of a fuel cell energy network optimized for cost minimization, *Renewable Energy* 32 (3) (2007) 382–406. doi:10.1016/j.renene.2006.02.012.
- [17] P. Ahmadi, A. Almasi, M. Shahriyari, I. Dincer, Multi-objective optimization of a combined heat and power (chp) system for heating purpose in a paper mill using evolutionary algorithm, *International Journal of Energy Research* 36 (1) (2012) 46–63.
- [18] A. Sciacovelli, V. Verda, E. Sciubba, Entropy generation analysis as a design tool – a review, *Renewable and Sustainable Energy Reviews* 43 (2015) 1167–1181.
- [19] A. Omu, R. Choudhary, A. Boies, Distributed energy resource system optimisation using mixed integer linear programming, *Energy Policy* 61 (2013) 249–266.
- [20] J. Söderman, F. Pettersson, Structural and operational optimisation of distributed energy systems, *Applied Thermal Engineering* 26 (13) (2006) 1400–1408.
- [21] M. A. Lozano, J. C. Ramos, L. M. Serra, Cost optimization of the design of CHCP (combined heat, cooling and power) systems under legal constraints, *Energy* 35 (2) (2010) 794 – 805, ECOS 2008, 21st International Conference, on Efficiency, Cost, Optimization, Simulation and Environmental Impact of Energy Systems. doi:<http://dx.doi.org/10.1016/j.energy.2009.08.022>.
- [22] A. Hawkes, M. Leach, Modelling high level system design and unit commitment for a microgrid, *Applied Energy* 86 (7–8) (2009) 1253–1265. doi:10.1016/j.apenergy.2008.09.006.
- [23] E. Mehleri, H. Sarimveis, N. Markatos, L. Papageorgiou, Optimal design and operation of distributed energy systems: Application to greek residential sector, *Renewable Energy* 51 (2013) 331–342. doi:10.1016/j.renene.2012.09.009.
- [24] E. D. Mehleri, H. Sarimveis, N. C. Markatos, L. G. Papageorgiou, A mathematical programming approach for optimal design of distributed energy systems at the neighbourhood level, *Energy* 44 (1) (2012) 96–104. doi:10.1016/j.energy.2012.02.009.
- [25] C. Weber, N. Shah, Optimisation based design of a district energy system for an eco-town in the United Kingdom, *Energy* 36 (2) (2011) 1292–1308. doi:10.1016/j.energy.2010.11.014.
- [26] C. Weber, F. Maréchal, D. Favrat, Design and optimization of district energy systems, in: *Computer Aided Chemical Engineering, Vol. Volume 24, Elsevier, 2007*, pp. 1127–1132. doi:[http://dx.doi.org/10.1016/S1570-7946\(07\)80212-4](http://dx.doi.org/10.1016/S1570-7946(07)80212-4).
- [27] H. Ren, W. Gao, A MILP model for integrated plan and evaluation of distributed energy systems, *Applied Energy* 87 (3) (2010) 1001–1014. doi:10.1016/j.apenergy.2009.09.023.
- [28] H. Ren, W. Gao, Y. Ruan, Optimal sizing for residential CHP system, *Applied Thermal Engineering* 28 (5–6) (2008) 514–523. doi:10.1016/j.applthermaleng.2007.05.001.
- [29] J. Keirstead, N. Samsatli, N. Shah, C. Weber, The impact of CHP (combined heat and power) planning restrictions on the efficiency of urban energy systems, *Energy* 41 (1) (2012) 93–103. doi:10.1016/j.energy.2011.06.011.
- [30] J. Keirstead, N. Samsatli, A. M. Pantaleo, N. Shah, Evaluating biomass energy strategies for a {UK} eco-town with an {MILP} optimization model, *Biomass and Bioenergy* 39 (0) (2012) 306 – 316, biorefinery. doi:<http://dx.doi.org/10.1016/j.biombioe.2012.01.022>.
- [31] W. Gu, Z. Wu, R. Bo, W. Liu, G. Zhou, W. Chen, Z. Wu, Modeling, planning and optimal energy management of combined cooling, heating and power microgrid: A review, *International Journal of Electrical Power & Energy Systems* 54 (0) (2014) 26 – 37. doi:<http://dx.doi.org/10.1016/j.ijepes.2013.06.028>.
- [32] Department of Energy, Lawrence Berkeley National Laboratory, DER-CAM: Distributed Energy Resources Customer Adoption Model, <http://der.lbl.gov/der-cam> (last consulted on 28 July 2014) (2013).
- [33] J. Keirstead, M. Jennings, A. Sivakumar, A review of urban energy system models: Approaches, challenges and opportunities, *Renewable and Sustainable Energy Reviews* 16 (6) (2012) 3847 – 3866. doi:<http://dx.doi.org/10.1016/j.rser.2012.02.047>.
- [34] M. Manfren, P. Caputo, G. Costa, Paradigm shift in urban energy systems through distributed generation: Methods and models, *Applied Energy* 88 (4) (2011) 1032–1048.
- [35] P. Mancarella, Mes (multi-energy systems): An overview of concepts and evaluation models, *Energy* 65 (2014) 1–17.
- [36] C. Wouters, E. S. Fraga, A. M. James, E. M. Polykarpou, Mixed-integer optimisation based approach for design and operation of distributed energy systems, in: *Power Engineering Conference (AUPEC), 2014 Australasian Universities, IEEE, 2014*, pp. 1–6.
- [37] GAMS Development Corporation, Genetic Algebraic Modeling System, available online: <http://www.gams.com/dd/docs/bigdocs/GAMSUsersGuide.pdf> (last consulted on 30 October 2013) (December 2012).
- [38] SA Power Networks, Installing a solar PV system, available online: http://www.sapowernetworks.com.au/centric/customers/installing_a_solar_pv_system.jsp (last consulted on 31 July 2014).
- [39] H. Hassanzadehfard, S. Moghaddas-Tafreshi, S. Hakimi, Optimal sizing of an islanded micro-grid for an area in north-west Iran using particle swarm optimization based on reliability concept, in: *World Renewable Energy Congress 2011, 2011*, pp. 0–0.
- [40] J. Seguro, T. Lambert, Modern estimation of the parameters of the Weibull wind speed distribution for wind energy analysis, *Journal of Wind Engineering and Industrial Aerodynamics* 85 (1) (2000) 75–84. doi:10.1016/S0167-6105(99)00122-1.
- [41] S. Liu, J. M. Pinto, L. G. Papageorgiou, A tsp-based milp model for medium-term planning of single-stage continuous multiproduct plants, *Industrial & Engineering Chemistry Research* 47 (20) (2008) 7733–7743.
- [42] Australian Government - Bureau of Meteorology (BOM), Climate Data Online, available online: http://www.bom.gov.au/jsp/ncc/climate_averages/solar-exposure/index.jsp (last consulted 31 July 2014).
- [43] A. Durmayaz, M. Kadiolu, Z. Şen, An application of the degree-hours method to estimate the residential heating energy requirement and fuel consumption in istanbul, *Energy* 25 (12) (2000) 1245–1256.

- [44] Z. Agioutantis, A. Bekas, The potential of district heating using geothermal energy. a case study, greece, *Geothermics* 29 (1) (2000) 51–64.
- [45] I. Richardson and T. Murray, Integrated Domestic Electricity Demand and PV micro-generation Model -Single Dwelling Simulation Example for 24 hours (Excel), CREST (Centre for Renewable Energy Systems Technology), Department of Electronic and Electrical Engineering Loughborough University, Leicestershire LE11 3TU, UK.
- [46] D. Myers, *Solar Radiation: practical modelling for renewable energy applications*, CRC Press, Taylor & Francis group, US, 2013.
- [47] G. L. Johnson, *Wind energy systems*, Prentice-Hall Englewood Cliffs (NJ), 2001, available online: http://www.pssurvival.com/ps/windmills/Wind_Energy_Systems.Gary_L.Johnson.2001.pdf (last consulted on 29 November 2013).
- [48] A. T. Rezvan, N. S. Gharneh, G. Gharehpetian, Optimization of distributed generation capacities in buildings under uncertainty in load demand, *Energy and Buildings* 57 (2013) 58–64.
- [49] J. Söderman, Optimisation of structure and operation of district cooling networks in urban regions, *Applied thermal engineering* 27 (16) (2007) 2665–2676.
- [50] I. Staffell, Purchase cost of condensing boilers in the UK, available online: http://www.academia.edu/1216602/Purchase_Cost_of_Condensing_Boilers_in_the_UK (January 2008).
- [51] A. Roy, S. B. Kedare, S. Bandyopadhyay, Optimum sizing of wind-battery systems incorporating resource uncertainty, *Applied Energy* 87 (8) (2010) 2712–2727. doi:10.1016/j.apenergy.2010.03.027.
- [52] H. Ren, W. Gao, Y. Ruan, Economic optimization and sensitivity analysis of photovoltaic system in residential buildings, *Renewable Energy* 34 (3) (2009) 883–889. doi:10.1016/j.renene.2008.06.011.
- [53] C. Marnay, G. Venkataramanan, M. Stadler, A. Siddiqui, R. Firestone, B. Chandran, Optimal technology selection and operation of microgrids in commercial buildings, in: *IEEE Power Engineering Society General Meeting, 2007, 2007*, pp. 1–7. doi:10.1109/PES.2007.385847.
- [54] R. Lasseter, Microgrids and distributed generation, *Journal of Energy Engineering* 133 (3) (2007) 144–149. doi:10.1061/(ASCE)0733-9402(2007)133:3(144).
- [55] P. Costa, M. Matos, Economic Analysis of Microgrids Including Reliability Aspects, in: *International Conference on Probabilistic Methods Applied to Power Systems, 2006. PMAPS 2006, 2006*, pp. 1–8. doi:10.1109/PMAPS.2006.360236.
- [56] EPRI Electric Power Research Institute, Cost-Effectiveness of Energy Storage in California: Application of the EPRI Energy Storage Valuation Tool to Inform the California Public Utility Commission Proceeding R. 10-12-007, 3002001162, EPRI, Palo Alto. Available online: <http://www.epri.com> (last consulted on 30 July 2013).
- [57] Essential Services Commission of South Australia ESCOSA, 2012-13 annual gas retail tariff adjustment, available online: <http://www.escosa.sa.gov.au/article/newsdetail.aspx?p=183&id=924&view=newsletter> (last consulted on 31 July 2014).
- [58] Australian Energy Market Commission AEMC, South Australia: Electricity price trends to FY15, available online: <http://www.aemc.gov.au/Media/docs/South-Australia-information-sheet-a989a4d3-fc27-4676-ae3-e6e3f05bea58-0.PDF> (last consulted on 31 July 2014).
- [59] Government of South Australia, Solar feed-in scheme, available online: <http://www.sa.gov.au/topics/water-energy-and-environment/energy/energy-supply-and-sources/renewable-energy-sources/solar-energy/solar-photovoltaic-systems/solar-feed-in-scheme> (last consulted on 31 July 2014).
- [60] Australian Government - Department of Environment, Repealing the Carbon Tax, available online: <http://www.environment.gov.au/climate-change/repealing-carbon-tax> (last consulted on 31 July 2014).
- [61] Australian Government - Department of Climate Change and Energy Efficiency, Australian National Greenhouse Accounts, available online: http://www.climatechange.gov.au/sites/climatechange/files/documents/03_2013/nga-factors.pdf (last consulted on 31 July 2014).