

# **Dynamic Safety Analysis of Managed Pressure Drilling Operations**

By

©Majeed Olasunkanmi Abimbola

A thesis submitted to the School of Graduate Studies  
In partial fulfillment of the requirements for the degree of

**Doctor of Philosophy**  
**Faculty of Engineering and Applied Science**  
Memorial University of Newfoundland

**May 2016**

St. John's

Newfoundland, Canada

*Dedicated to*

*Almighty Allah for His infinite mercy and guidance in my life, my mother,  
step-mother, late step-mother, wife, kids – Raheemah, Abdulraheem and the  
newborn, Rahmah and siblings*

## **ABSTRACT**

The exploration and development of oil and gas reserves located in harsh offshore environments are characterized with high risk. Some of these reserves would be uneconomical if produced using conventional drilling technology due to increased drilling problems and prolonged non-productive time. Seeking new ways to reduce drilling cost and minimize risks has led to the development of Managed Pressure Drilling techniques. Managed pressure drilling methods address the drawbacks of conventional overbalanced and underbalanced drilling techniques. As managed pressure drilling techniques are evolving, there are many unanswered questions related to safety and operating pressure regimes. Quantitative risk assessment techniques are often used to answer these questions. Quantitative risk assessment is conducted for the various stages of drilling operations – drilling ahead, tripping operation, casing and cementing. A diagnostic model for analyzing the rotating control device, the main component of managed pressure drilling techniques, is also studied. The logic concept of Noisy-OR is explored to capture the unique relationship between casing and cementing operations in leading to well integrity failure as well as its usage to model the critical components of constant bottom-hole pressure drilling technique of managed pressure drilling during tripping operation. Relevant safety functions and inherent safety principles are utilized to improve well integrity operations. Loss function modelling approach to enable dynamic consequence analysis is adopted to study blowout risk for real-time decision making. The aggregation of the blowout loss categories, comprising: production, asset, human health, environmental response and reputation losses leads to risk estimation using dynamically determined probability of occurrence. Lastly, various sub-models developed for the stages/sub-operations of drilling operations and the consequence modelling approach are integrated for a holistic risk analysis of drilling operations.

## **ACKNOWLEDGEMENTS**

I would like to express my sincere and profound gratitude to my supervisor, Dr. Faisal I. Khan for his guidance and untiring support throughout my doctorate research at Memorial University of Newfoundland. I must assert that I have benefitted immensely from his versed expertise in the field of my research. His advice and resourceful suggestions have made my program a fruitful one. I am thankful to my supervisory committee members, Drs. Syed Imtiaz and Aziz Rahman for their critical comments and constructive remarks in improving the quality of the research. I am also thankful to one of my examiners, Dr. Stephen Butt, for his invaluable suggestions.

I am highly grateful to my mother, wife and children for being there for me through thick and thin. I am especially indebted to my brotherly friend, Saheed Busura, for his kindness during my programs.

## TABLE OF CONTENTS

Dynamic Safety Analysis of Managed Pressure Drilling Operations.....	i
ABSTRACT.....	iii
ACKNOWLEDGEMENTS.....	iv
TABLE OF CONTENTS.....	v
List of Tables .....	x
List of Figures.....	xii
List of Acronyms and Symbols .....	xv
Chapter 1.....	1
1.0 Introduction.....	1
1.1. Overview .....	1
1.2. Quantitative Risk Assessment Techniques .....	4
1.3. Objectives of the Research.....	6
1.5. Organization of the Thesis .....	7
References .....	10
Chapter 2.....	13
2.0 Novelty and Contribution .....	13
Chapter 3.....	15
3.0 Literature Review.....	15
3.1. Managed Pressure Drilling (MPD) .....	15
3.2. Managed Pressure Drilling Techniques .....	16
2.2.1. Constant Bottom-hole Pressure (CBHP) Drilling:.....	16
3.2.2. Pressurized Mud Cap Drilling (PMCD): .....	18
3.3. Quantitative risk assessment techniques .....	19
3.3.1. Fault Tree (FT).....	19
3.3.2. Event Tree (ET) .....	20
3.3.3. Bow-Tie (BT) approach.....	21
3.3.4. Bayesian Network.....	22
3.3.5. The Noisy–OR Gate.....	24
3.4. Blowout risk analysis using loss functions .....	27
References .....	31

Chapter 4.....	43
4.0 Dynamic safety risk analysis of offshore drilling.....	43
Preface.....	43
Abstract.....	43
4.1. Introduction.....	44
4.2. Drilling Techniques.....	48
4.2.1. Conventional Overbalanced Drilling (COBD).....	48
4.2.2. Underbalanced Drilling (UBD).....	48
4.2.3. Managed Pressure Drilling (MPD).....	49
4.2.4. Well Control Considerations.....	49
4.3. Dynamic Risk Assessment.....	50
4.3.1. Bow-Tie Risk Model of Drilling Operations.....	51
4.3.2. Predictive Probabilistic Model.....	59
4.3.3. Bow-Tie Model Analysis.....	61
4.4. Conclusion.....	76
References.....	77
Chapter 5.....	81
5.0 Safety and Risk Analysis of Managed Pressure Drilling Operation Using Bayesian Network.....	81
Preface.....	81
Abstract.....	81
5.1. Introduction.....	82
5.2. Managed Pressure Drilling Techniques.....	87
5.2.1. Constant Bottom-hole Pressure (CBHP) Drilling:.....	87
5.2.2. Pressurized Mud Cap Drilling (PMCD):.....	89
5.2.3. Dual Gradient Drilling (DGD):.....	90
5.3. Bayesian Network.....	90
5.4. Model Formulation and Analysis.....	93
5.4.1. Model formulation.....	93
5.4.2. Analysis of Models.....	98
5.5. Conclusion.....	111

Acknowledgment .....	112
List of Acronyms.....	112
References .....	114
Chapter 6.....	117
6.0 Risk-based safety analysis of well integrity operations.....	117
Preface.....	117
Abstract .....	117
6.1. Introduction .....	118
6.2. Critical Nature of Cementing Operation .....	120
6.3. Safety Analysis Techniques .....	121
6.3.1. Bow-Tie (BT).....	121
6.3.2 Bayesian Network.....	123
6.3.3. The Noisy–OR Gate.....	125
6.3.4. Mapping of Bow-tie to Bayesian Network .....	126
6.4. Model Description.....	127
6.5. Model Analysis .....	132
6.6. Conclusion.....	146
Acknowledgments.....	147
References .....	148
Chapter 7.....	155
7.0 Failure analysis of the tripping operation and its impact on well control.....	155
Preface.....	155
Abstract .....	156
7.1. Introduction .....	157
7.2. Tripping operation.....	159
7.3. Bayesian Network .....	160
7.4. Model Formulation and Analysis.....	162
7.4.1 Model Description .....	162
7.4.2 Results and Discussions.....	166
7.5. Conclusion.....	170
Acknowledgments.....	170

References .....	171
Chapter 8.....	173
8.0 Dynamic Blowout Risk Analysis using Loss Functions.....	173
Preface.....	173
Abstract .....	173
8.1. Introduction .....	174
8.2. Consequence modelling using loss function (LF).....	176
8.3. Blowout Risk Analysis.....	179
8.3.1. Determination of Blowout Frequency (probability), <i>Pbl</i> : .....	179
8.3.2. Identification of the applicable loss categories: .....	180
8.3.3. Determine the applicable loss functions for the loss categories: .....	180
8.3.4 Determine Total Loss as an Aggregation of Loss Categories( <i>Ltot</i> ):.....	191
8.3.5. Determine Blowout Risk: .....	192
8.4. Application of Loss Aggregation Methodology to a Case Study.....	192
8.5. Discussion .....	200
8.6. Conclusion.....	201
Acknowledgment .....	202
List of Acronyms.....	202
References .....	205
Chapter 9.....	212
9.0 Development of an Integrated Tool for Risk Analysis of Drilling Operations.....	212
Preface.....	212
Abstract .....	212
Keywords: .....	213
9.1. Introduction .....	213
9.2. Stages of drilling operations.....	218
9.3. Development of an integrated risk analysis methodology and related models .....	220
9.4. Analysis of Model .....	229
9.4.1 Predictive analysis of stages of drilling operations.....	229
9.4.2 Diagnostic analysis of the integrated model .....	235
9.5. Conclusion.....	236



Acknowledgments .....	236
References .....	237
Chapter 10.....	241
10.0 Summary, Conclusions and Recommendations.....	241
10.1. Summary.....	241
10.2. Conclusions .....	242
10.2.1. Development of a real time predictive model:.....	242
10.2.2. Bayesian theory application in bow-tie analysis of drilling operations: .....	243
10.2.3. Development of a dynamic risk assessment model for constant bottom-hole pressure drilling (CBHP) technique: .....	243
10.2.4. Development of a well integrity model: .....	244
10.2.5. Failure analysis of the tripping operation and its impact on well control:.....	244
10.2.6. Application of loss functions to blowout risk analysis: .....	245
10.2.7. Development of an integrated tool for risk analysis of drilling operations: .....	245
10.3. Recommendations .....	246

## List of Tables

Table 4.1 - Basic events and their probabilities (Bercha, 1978; OREDA, 2002).....	56
Table 4.2 - Consequence severity levels and loss values.....	58
Table 4.3 - Failure probabilities of the RCD with water and gasified fluid drilling mud .....	64
Table 4.4 - Prior failure probabilities of the safety barriers.....	65
Table 4.5 - Accident precursor data (cumulative) from a UBD operation over a period of 24 hours towards the major accident (catastrophe).....	66
Table 4.6 - Prior occurrence probabilities of consequences .....	68
Table 4.7 - Posterior (updated) failure probabilities of safety barriers.....	69
Table 4.8 - Occurrence frequencies of consequences/end events.....	70
Table 4.9 - Risk Profile of the end events in USD over the 24-hour period.....	74
Table 5.1 - Probability of failure on Demand of Components and Frequency of Occurrence of Actions/Events (Torstad, 2010; Grayson & Gans, 2012; Khakzad, et al., 2013b; Abimbola, et al., 2014) .....	99
Table 5.2 - Safety Barriers Probabilities of Failure on Demand (Torstad, 2010; Grayson & Gans, 2012; Abimbola, et al., 2014) .....	100
Table 5.3 - Underbalanced Scenario Predictive Frequency of Occurrence .....	102
Table 5.4 - Probability of failure on Demand of Components and Frequency of Occurrence of Actions/Events for Overbalanced Scenario (Torstad, 2010; Grayson & Gans, 2012; Khakzad, et al., 2013b; Abimbola, et al., 2014) .....	105
Table 5.5 - Overbalanced Scenario Predictive Frequency of Occurrence .....	106
Table 5.6 - RCD Components Probabilities of failure on Demand .....	109
Table 6.1 - Noisy-OR gate conditisonal probability table for well integrity failure node.....	129

Table 6.2 - Event Description and Probability (Torstad, 2010; Grayson & Gans, 2012; Khakzad, et al., 2013b; Abimbola, et al., 2014; Rathnayaka, et al., 2013).....	135
Table 6.3 - Consequence occurrence probabilities .....	137
Table 6.4 – Diagnostic analysis of critical elements.....	140
Table 6.5 – Aggregated basic events and safety barriers description and potential safety measures to reduce operation failure probabilities .....	142
Table 6.6 – Comparison of ratio of posterior probability to prior probability with Birnbsaum importance measure .....	155
Table 7.1 - Occurrence/failure probabilities of basic events (Crowl & Louvar, 2002; Torstad, 2010; Grayson & Gans, 2012; Gould, et al., 2012; Khakzad, et al., 2013b; Abimbola, et al., 2014; Abimbola, et al., 2015a).....	167
Table 9.1 – Predictive occurrence probabilities of the consequences for drilling ahead operation .....	230

## List of Figures

Figure 1.1 – Integrated Model for Risk Analysis of Drilling Operations .....	9
Figure 3.1 - A generic bow-tie diagram.....	22
Figure 3.2 – A generic directed acyclic graph .....	24
Figure 3.3 – Loss profiles of different loss functions .....	28
Figure 4.1 - Bow-tie Risk Model for drilling operations.....	52
Figure 4.2 - Fault Tree Model for Drilling Operations.....	54
Figure 4.3 - Fault Tree Model for Drilling operations Continued.....	55
Figure 4.4 - Event Tree Model for Consequence Analysis.....	59
Figure 4.5 - Bow-tie analysis algorithm .....	62
Figure 4.6 - Failure probabilities of RCD as a function of depth and mud density.....	68
Figure 4.7 - Occurrence frequency profiles for VC/oil spill and VCE/pool fire end events .....	71
Figure 4.8 - Occurrence frequency profiles for Sec. explosion/fire and Catastrophe consequences .....	72
Figure 4.9 - Risk profiles for VC/oil spill and VCE/ pool fire consequences .....	73
Figure 4.10 - Risk profiles for Sec. explosion/fire and Catastrophe consequences.....	74
Figure 5.1 - A typical well profile .....	84
Figure 5.2 - A typical Bayesian network .....	92
Figure 5.3 - Underbalanced Scenario Bow-Tie: $P_p < P_{wbs} < BHP$ .....	96
Figure 5.4 - Bow-Tie of Overbalanced Scenario of CBHP Techniques: $BHP < P_{ds} \leq P_{ls} \leq P_f$ .....	97

Figure 5.5 - Bayesian Network for Underbalanced Drilling Scenario.....	98
Figure 5.6 - Blowout Scenario Diagnostic Analysis.....	103
Figure 5.7 - Bayesian Network of Overbalanced Scenario of CBHP techniques.....	104
Figure 5.8 - Lost circulation Scenario of Overbalanced Condition of CBHP Techniques.....	107
Figure 5.9 - FT model of an offshore RCD .....	109
Figure 5.10 - Diagnostic analysis of RCD failure.....	111
Figure 6.1 – Factors contributing to blowouts, (a) 1971 – 1991 (b) 1992 – 2006 (Danenberger, 1993; Izon, et al., 2007) .....	119
Figure 6.2 - A generic bow-tie diagram.....	122
Figure 6.3 – A generic directed acyclic graph .....	124
Figure 6.4 - Casing operation fault tree .....	133
Figure 6.5 – Cementing operation fault tree .....	134
Figure 6.6 – Well integrity accident scenarios bow-tie model .....	135
Figure 6.7 – The equivalent BN model of well integrity operations during drilling operations	139
Figure 6.8 – Cement slurry formulation sub-model.....	141
Figure 7.1 – A Typical Bayesian Network .....	161
Figure 7.2 - Conventional drilling tripping operation.....	164
Figure 7.3 - MPD tripping operation .....	165
Figure 7.4 - RCD failure scenario in CBHP technique.....	169
Figure 8.1 – Loss profiles of different loss functions .....	177
Figure 8.2 – Blowout dynamic risk analysis methodology .....	184
Figure 8.3 – Loss categories identified related to drilling operations.....	185
Figure 8.4 – Production loss as a function of the BHP gradient deviation from the FPP gradient due to underbalance condition developed considering MINLF.....	194

Figure 8.5 – Asset loss profile as a function of the BHP gradient for two different maximum losses on either side of the target, the FPP gradient considering IBLF .....	195
Figure 8.6 – Human health loss profile indicating the variation of civil claims from injuries and fatalities with the BHP drawdown considering step function.....	196
Figure 8.7 - Environmental response in addition to the reputation loss profile against BHP gradient due to underbalance scenario considering MINLF.....	197
Figure 8.8 – Total loss profile as a function of the BHP gradient .....	198
Figure 8.9 – Blowout risk profile expressed as a function of the BHP gradient for COBD (a) and CBHP technique of MPD (b).....	199
Figure 9.1 – Factors contributing to blowouts from The US Outer Continental Shelf from (a) 1971 – 1991 and (b) 1992 – 2006 .....	217
Figure 9.2 – Integrated Methodology and Tool for Drilling Operations .....	224
Figure 9.3 – Bayesian Network for Underbalanced Drilling Scenario (Abimbola et al. 2015a)	225
Figure 9.4 – Bayesian Network of Overbalanced Scenario of CBHP techniques (Abimbola et al. 2015a) .....	226
Figure 9.5 – Bayesian Network equivalent of tripping-out operation in CBHP technique of MPD (Abimbola, et al., 2015b) .....	227
Figure 9.6 – The equivalent BN model of well integrity operations during drilling operations (Abimbola, et al., 2016b) .....	228
Figure 9.7 – Production loss risk profile for a blowout scenario.....	231
Figure 9.8 – Asset loss risk profile for a blowout and/or stuck pipe scenario.....	232
Figure 9.9 – Human health loss risk profile for a blowout scenario.....	233
Figure 9.10 – Environmental response loss risk profile for a blowout scenario.....	234

## List of Acronyms and Symbols

APD	Accident Precursor Data
BHP	Bottom Hole Pressure
BOP	Blowout Preventer
BN	Bayesian Network
BT	Bow-Tie
CBL	Cement Bond Log
CBHP	Constant Bottom Hole Pressure
CCS	Continuous Circulation System
COBD	Conventional Over-Balanced Drilling
CPT	Conditional Probability Table
DAG	Directed Acyclic Graph
DAPC	Dynamic Annular Pressure Control
DC&EMB	Damage Control and Emergency Management Barrier
DGD	Dual Gradient Drilling
DNV	Det Norske Veritas
DRA	Dynamic Risk Analysis
ECD	Equivalent Circulating Density
ET	Event Tree
FAR	Fatal Accident Rate
FG	Fracture Gradient
FIT	Formation Integrity Test
FMEA	Failure Modes and Effects Analysis

FPP	Formation Pore Pressure
FT	Fault Tree
HAZOP	Hazard and Operability
HAZID	Hazard Identification
IADC	International Association of Drilling Contractors
IBLF	Inverted Beta Loss Function
ICU	Intelligent Control Unit
IGLF	Inverted Gamma Loss Function
INLF	Inverted Normal Loss Function
LF	Loss Function
LHS	Left Hand Side
LOT	Leak off Test
MINLF	Modified Inverted Normal Loss Function
MODU	Mobile Offshore Drilling Unit
MPD	Managed Pressure Drilling
NPT	Non Productive Time
OSHA	Occupational Safety and Health Agency
PMCD	Pressurized Mud Cap Drilling
PP	Pore Pressure
PWD	Pressure measurement While Drilling
QLF	Quadratic Loss Function
QRA	Quantitative Risk Analysis
RAW	Risk Achievement Worth
RCD	Rotating Control Device
RHS	Right Hand Side
SAGD	Steam Assisted Gravity Drainage
SINLF	Spiring Inverted Normal Loss Function



<i>TOC</i>	Top of Cement
USIT	UltraSonic Imaging Tool
VDL	Variable Density Log
$BI_i$	Birnbaum Importance measure
$R_i$	Reliability
LWD	Logging While Drilling
MWD	Measurement While Drilling
POOH	Pulling Out of Open Hole
UBD	Underbalanced Drilling
ECD	Equivalent Circulating Density
IPB	Ignition Prevention Barrier
EPB	Escalation Prevention Barrier
FG	Fracture gradient
PP	Pore Pressure
VCE	Vapor Cloud Explosion
WI	Well integrity
<i>CEM</i>	Cementing
<i>CAS</i>	Casing
$P_h$	Hydrostatic pressure
$P_{ann}$	Annular frictional pressure
$P_p$	Pore pressure
$P_{wbs}$	Wellbore stability pressure
$P_{ds}$	Differential sticking pressure
$P_{ls}$	Lost circulation pressure
$P_f$	Fracture pressure
$BHP_{static}$	Static bottom-hole pressure
$BHP_{dynamic}$	Dynamic bottom-hole pressure

$P_{bp}$	Backpressure
$BE$	Basic event
$IE$	Intermediate event
$TE$	Top event
$SB$	Safety barrier
$C_i$	Consequence
$P(.), Pr(.)$	Probability
$P(. ..)$	Conditional probability
$I_p(. ..)$	Conditionally independent probability
$p_0$	Constant
$a_i, y_i, x_i$	Constants
$A_i, Y_i, X_i$	Random variables
$T$	Target
$L(x)$	Loss function for parameter, $x$
$L_i$	Loss category
$\Delta$	Parameter deviation from a target
$K_\Delta$	Observed loss value for a known deviation, $\Delta$
$K_{MAX}$	Maximum observable loss value
$\gamma$	Shape parameter
$k$	Strength
$\sigma$	Stress
$PC$	Component
$E(.)$	Expected value
$\exp(.)$	Exponential function
$\lambda$	Failure rate
$h$	True vertical height
$P_i$	Prior probability

Pp          Posterior probability

# Chapter 1

## 1.0 Introduction

### 1.1. Overview

Drilling techniques for underground resources have undergone tremendous improvement from the ancient water and brine wells to the present day directional, horizontal and extended reach wells. Based on drilling fluid density, oil and gas wells are drilled using one or a combination of three principal drilling techniques: Conventional Overbalanced Drilling (COBD), Under-Balanced Drilling (UBD) and Managed Pressure Drilling (MPD). In COBD, the hydrostatic pressure of the drilling fluid is maintained higher than the formation pore pressure. During dynamic condition, annular friction pressure which is the pressure due to circulation of drilling fluid is added to the hydrostatic pressure, increasing the overbalance further. Large amount of drilling mud additives such as bentonite and barite is used to achieve this overbalance. This method makes well control easy, simple and less expensive since the chances of a kick is significantly reduced; thus, it allows an open-to-atmosphere scenario for well drilling. However, it is highly susceptible to lost circulation, formation damage and reduced rate of penetration (ROP). The drilling mud deposits/forms mud cake around the walls of the well with some fines migrating into the formation. This plugs the natural porosity of the well and consequently reduces the reservoir permeability denoted as skin damage.

UBD involves the drilling of wells with drilling fluids designed to intentionally exert lower Bottom-Hole Pressure (BHP) than the formation pore pressure. In other words, both static and dynamic conditions lead to lower effective circulating BHP than the formation pore pressure. Due to lower BHP than formation pore pressure, kick, an influx of formation fluid into the wellbore, is expected. Kick when not properly controlled could evolve into a blowout, an uncontrollable flow

of formation fluid to the surface. Thus, UBD is often characterized as a high risk drilling technique. UBD is undertaken to reduce or eliminate lost circulation, formation damage and differential pipe sticking. By reducing formation damage, i.e. lower skin damage, well productivity is increased. ROP is increased due to less friction during drilling; bit life is increased, and use of costly mud is avoided with the use of light fluids. However, it is susceptible to wellbore instability; well control is complicated, requiring highly skilled personnel (Bennion, et al., 1998a; Bennion, et al., 1998b).

MPD, a derivative of UBD, uses drilling fluid which exerts BHP slightly higher than the formation pore pressure. The hydrostatic pressure of the mud column might be a little lower than the formation pore pressure, requiring some amount of surface back pressure to be added to provide the needed overbalance. It includes techniques known as variants or methods of MPD developed to solve drilling problems in difficult environments. MPD is used to reduce drilling cost due to Non-Productive Time (NPT) resulting from correcting drilling problems such as stuck pipe, lost circulation, and wellbore instability while increasing safety with specialized techniques and surface equipment. It is used to extend casing point in order to allow larger production tubing and increase production flow rate. MPD is an adaptive process since the annular wellbore pressure is varied according to the pressure condition of the well. The basic techniques (variants) of MPD include Constant Bottom-Hole Pressure (CBHP) drilling, Pressurized Mud Cap Drilling (PMCD) and Dual Gradient Drilling (DGD) (Haghshenas, et al., 2008). MPD is a middle course between COBD and UBD and is often used to drill in deep offshore, ultra-deep offshore and High Pressure and High Temperature (HPHT) formations. It is used to drill safely with total lost returns in highly fractured and cavernous formations.

Generally, drilling is a hazardous operation, making safety one of the major concerns. Safety of drilling operations is often characterized in terms of risk as a measure of accident likelihood and

magnitude of loss (Khan, 2001). Many rig accidents have occurred during drilling in the past. In 1981, drilling through a shallow gas pocket in the South China Sea by the Petromar V drillship led to an uncontrolled sub-sea blowout which eventually caused the drillship to capsize. Failure of the diverter and improper rig selection were among the quoted causal factors to the accident (Simon, 2006). In March 2001, a blowout resulted from an uncontrolled flow from a well after cementing on EnSCO 51 offshore Louisiana. The well flowed for 3 days before being killed leading to the complete destruction of the derrick and substructure of the rig (Simon, 2006). On the 21st of August 2009, at the Timor Sea offshore Australia, the Montara wellhead platform experienced a blowout at the H1 well that was later attributed to a failed casing shoe cementing. The worst of its kind in the Australian offshore industry led to the spill of about 400 barrels per day for over 10 weeks into the sea until it was killed with heavy mud from a relief well after 4 attempts on November, 3, 2009. The fortunate part of the accident was the safe evacuation of all 69 personnel on board; however, the cleanup operation was highly complex, requiring a very large volume of dispersants and many response teams (Christou & Konstantinidou, 2012; IAT, 2010). About four months later, on December 23, 2009, Transocean crew narrowly avoided a blowout on the Sedco 711 semi-submersible drilling rig in the Shell North Sea Bardolino field due to a misinterpreted positive pressure test from a damaged valve at the bottom of a well (Feilden, 2010). Again, four months later, on April 20, 2010, a blowout (unprecedented in terms of environmental and economic disaster) occurred in the history of the US oil and gas industry (Harvey, 2010; NOAA, 2015). 11 crew members died and 16 others were injured with the destruction and sinking of the Deepwater Horizon rig, and a spill of about 4 million barrels of oil into the Gulf of Mexico. Coincidentally, Transocean was involved in the drilling of the well and again, poor casing shoe cementing and poor interpretation of negative pressure test were identified as some of the

contributing factors (BOEMRE, 2011; Chief Counsel's Report, 2011). Recently, on January 30, 2014, a loss of well control resulted to a gas leak incident from a shallow gas pocket in the Gulf of Mexico offshore Louisiana (BSEE, 2014). The proximity of these events and the frequency, with which incidents occur in the industry, implies the existence of a vacuum in the safety culture. Risk assessments are often conducted in the design stage of the operation prior to implementation to reduce design risk. Operational risk is thus, unattended to; hence, the motivation for this research. This dissertation intends to fill the vacuum existing in the safety and risk assessment of oil and gas drilling operations. A detailed risk analysis of the operational phases or sub-operations involved in drilling operations is conducted.

## **1.2. Quantitative Risk Assessment Techniques**

Risk is defined by Center of Chemical Process safety (CCPS) as a measure of human injury, environmental damage, or economic loss in terms of both the incident likelihood and the magnitude of the loss or injury. Quantitative Risk Analysis (QRA) or risk analysis deals with quantitative estimate of risk using mathematical techniques based on engineering evaluation for combining estimates of incident consequences and frequencies (CCPS, 1999). Many techniques have been developed for quantitative risk analysis; the foremost among the conventional methods are Fault Tree (FT), Event Tree (ET) and Bow-tie (BT). The results of these analyses are used in risk assessment to evaluate the safety provided for preventing or mitigating the consequences of accidents. FT, the most widely used, for example, qualitatively, presents the logical relationship among the root causes to the top event through the gates. Quantitatively, it presents the magnitude of a failure if it occurs. However, these conventional risk assessment techniques are known to be static; failing to capture the variation of risks as operation or changes in the operation take place

(Wilcox & Ayyub, 2003; Ferdous, et al., 2010; Khakzad, et al., 2012). Besides, conventional risk assessment techniques make use of generic failure data. This makes them non case-specific and also, introduces uncertainty into the results. These limitations have led to the development of the dynamic risk assessment methods. These methods are meant to reassess risk in terms of updating initial failure probabilities of events (causes) and safety barriers as new information are made available during a specific operation. Two ways are currently used in revising prior failure probabilities: (i) Bayesian approaches through which new data in form of likelihood functions are used to update prior failure rates using Bayes' theorem (Won & Modarres, 1998; Chen, et al., 2004; Yi & Bier, 1998; Kalantarnia, et al., 2009). (ii) Non-Bayesian updating approaches in which new data are supplied by real time monitoring of parameters, inspection of process equipment and use of physical reliability models (Shalev & Tiran, 2007; Ferdous, et al., 2013; Huang, et al., 2001; Yang, et al., 2010; Abimbola, et al., 2014).

A Bayesian Network (BN) is a graphical inference technique that has been used in recent time in risk analysis. A BN is a probabilistic method for reasoning under uncertainty. It is based on Bayes' theorem which when defined for two events  $A$  and  $B$  such that  $P(A) \neq 0$  and  $P(B) \neq 0$ , then

$$P(A|B) = \frac{P(B|A)P(A)}{P(B)} \quad (1.1)$$

Equation (1.1) can be extended for  $n$  mutually exclusive and exhaustive events  $A_1, A_2, \dots, A_n$  such that  $P(A_j) \neq 0$  for all  $j$ ,

$$P(A_j|B) = \frac{P(B|A_j)P(A_j)}{P(B|A_1)P(A_1) + P(B|A_2)P(A_2) + \dots + P(B|A_n)P(A_n)} \quad (1.2)$$



for  $1 \leq j \leq n$  (Neapolitan, 2004; Jensen & Nielsen, 2007). BN has been used to model complex dependencies among random variables, proving as a robust and reliable fault detection and risk analysis tool (Boudali & Dugan, 2005; Meranbod, et al., 2005). It is a directed acyclic graph with nodes representing random variables and arcs denoting direct causal relationships between connected nodes. In a BN, nodes without arcs directing into them (i.e. have no parents) are root nodes and have marginal prior probabilities assigned to them while nodes with arcs directing into them are intermediate nodes and possess conditional probability tables (Bobbio et al., 2001; Neapolitan, 2009; Jensen & Nielsen, 2007; Khakzad et al., 2011).

### **1.3. Objectives of the Research**

The main objective of this research is to develop an integrated tool for the safety and risk analysis of drilling operations. This main objective is divided into five sub-objectives:

- To develop a dynamic risk assessment model based on physical reliability model and Baye's theorem for real time risk analysis of drilling operations.
- To develop dynamic risk analysis models applicable at different stages of drilling operations.
- To develop a comprehensive consequence model for blowout risk analysis by adopting the loss function approach.
- To develop an integrated tool for risk analysis of drilling operations
- To demonstrate the applications of the proposed approach to practical case studies

## 1.5. Organization of the Thesis

This thesis is written in manuscript (paper) format. The outlines of the following chapters are presented below:

Chapter 2 discusses the novelties and contributions of this thesis to the safety and risk analysis of drilling operations with a drive towards the newly evolving Constant Bottom-Hole Pressure (CBHP) technique of Managed Pressure Drilling (MPD).

Chapter 3 presents the literature review relevant to the research. This comprises a brief description of common drilling techniques and risk assessment methods.

Chapter 4 presents the developed physical reliability model for real time prediction of failure probabilities of critical drilling components based on constant stress and variable stress principles as well as Bayesian theory approach of updating safety barriers failure probabilities as new information are available. This chapter is published in the *Journal of Loss Prevention in the Process Industries* 2014; 30: 74-85.

Chapter 5 introduces Bow-Tie (BT) models for underbalanced and overbalanced pressure regimes. The BTs are mapped into Bayesian Networks (BN) to enable dependability and diagnostic analyses. The RCD is further analyzed to identify its safety critical components. This chapter is published in the *Safety Science Journal* 2015; 76:133-144.

Chapter 6 presents the casing and cementing operations models for a detailed safety and risk analysis. Noisy OR gate is explored to characterize the relationships between casing and cementing operations. Inherent safety technique and safety functions are applied to the basic events of the

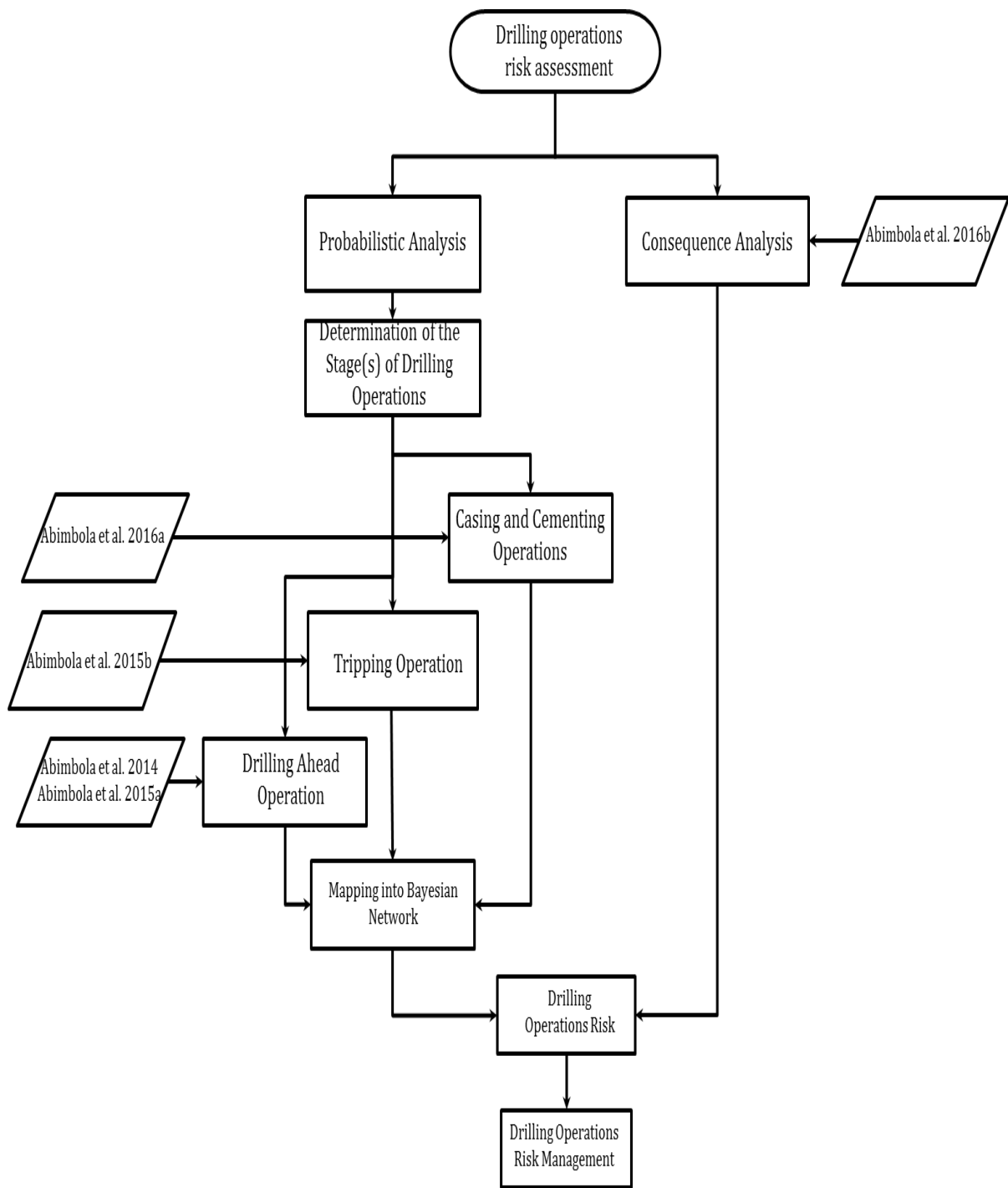
models to enhance the safety of the operations. This chapter has been published in the *Safety Science Journal*; 2016; 84:149-160.

Chapter 7 discusses a comparative analysis of tripping operation in COBD and CBHP technique of MPD. FT models of the operation are analyzed using BNs to identify the parallels and superiority of the latter over the former. This chapter is presented and published in: *The Proc. Of the 34th International Conference on Ocean, Offshore and Arctic Engineering, OMAE2015-42245, St. John's NL, Canada.*

Chapter 8 introduces the loss functions approach to blowout risk analysis. The consequence model explores various loss functions to model the identified blowout loss categories. This chapter is under review for publication in the *Journal of Risk Analysis*.

Chapter 9 presents the development of an integrated tool for risk analysis of drilling operations. The different models that have been developed are integrated for a complete analysis and management of risk during drilling operations. The structure of the model is presented in Fig. 1.1 as an embodiment to a holistic approach to risk analysis of drilling operations. This chapter is “In Press” with doi: 10.1016/j.psep.2016.04.012 in the *Journal of Process Safety and Environmental Protection*.

Chapter 10 is devoted to the summary of the thesis and the conclusions from this research. Recommendations for future work are provided here.



**Figure 1.1 – Integrated Model for Risk Analysis of Drilling Operations**

## References

- Abimbola, M., Khan, F. & Khakzad, N., 2014. Dynamic safety risk analysis of offshore drilling. *Journal of Loss Prevention in the Process Industries*, 30, pp.74–85.
- Abimbola, M. et al., 2015a. Safety and risk analysis of managed pressure drilling operation using Bayesian network. *SAFETY SCIENCE*, 76, pp.133–144. Available at: <http://dx.doi.org/10.1016/j.ssci.2015.01.010>.
- Abimbola, M., Khan, F., Garaniya, V. & Butt, S., 2015b. *Failure analysis of the tripping operation and its impact on well control*. St. John's, Proceedings of the 34th International Conference on Ocean, Offshore and Arctic Engineering.
- Abimbola, M., Khan, F. & Khakzad, N., 2016a. Risk-based safety analysis of well integrity operations. *SAFETY SCIENCE*, 84, pp.149–160. Available at: <http://dx.doi.org/10.1016/j.ssci.2015.12.009>.
- Abimbola, M. & Khan, F., 2016b. Dynamic Blowout Risk Analysis using Loss Functions. *Journal of Risk Analysis*, Volume (under review).
- Bennion, D. B., Lunan, B. & Saponja, J., 1998b. Underbalanced Drilling and Completion Operations to Minimize Formation Damage - Reservoir Screening Criteria for Optimum Application. *The Journal of Canadian Petroleum Technology*, Volume 9, pp. 36-49.
- Bennion, D. B., Thomas, F. B., Bietz, R. F. & Bennion, D. W., 1998a. Underbalanced Drilling - Praises and Perils. *SPE Drilling and Completion*, December, pp. 214-222.
- BOEMRE, 2011. *Report Regarding the Causes of the April 20, 2010 Macondo Well Blowout*, s.l.: The Bureau of Ocean Energy Management, Regulation and Enforcement.
- Boudali, H. & Dugan, J. B., 2005. A discrete-time Bayesian network reliability modeling and analysis framework. *Reliability Engineering and System Safety*, Volume 87, pp. 337-349.
- BSEE, 2014. *Bureau of Safety and Environment Enforcement*. [Online] Available at: <http://www.bsee.gov/BSEE-Newsroom/Press-Releases/2014/BSEE-Coast-Guard-Respond-to-Loss-of-Well-Control-in-the-Gulf-of-Mexico/> [Accessed 13 February 2014].
- CCPS, 1999. *Guidelines for Consequence Analysis of Chemical Releases*, New York: American Institute of Chemical Engineers.
- Chen, W., Bakshi, B., Goel, P. & Ungarala, S., 2004. Bayesian estimation via sequential Monte Carlo sampling: Unconstrained nonlinear dynamic systems. *Industrial and Engineering Chemistry Research*, 43(14), pp. 4012-4025.

- Chief Counsel's Report, 2011. *Macondo THE GULF OIL DISASTER*, Washington DC 20005: National Commission on the BP Deepwater Horizon Oil Spill and Offshore Drilling.
- Christou, M. & Konstantinidou, M., 2012. *Safety of offshore oil and gas operations: Lessons from past accident analysis*, Luxembourg: Joint Research Centre, European Commission.
- Feilden, T., 2010. *A near miss for the North Sea oil industry*. [Online]  
Available at:  
[http://www.bbc.co.uk/blogs/today/tomfeilden/2010/12/a\\_near\\_miss\\_for\\_the\\_north\\_sea.html](http://www.bbc.co.uk/blogs/today/tomfeilden/2010/12/a_near_miss_for_the_north_sea.html)
- Ferdous, R., Khan, F., Sadiq, R. & Amyotte, P., 2010. Fault and Event tree analyses for process systems risk analysis: uncertainty handling formulations. *Risk Analysis: An International Journal*, 31(1), pp. 86-107.
- Ferdous, R. et al., 2013. Analyzing system safety and risks under uncertainty using a bow-tie diagram: An innovative approach. *Process Safety and Environmental Protection*, Volume 91, pp. 1-18.
- Haghshenas, A., Paknejad, A. S., Reihm, B. & Schubert, J., 2008. The Why and Basic Principles of Managed Well-Bore Pressure. In: B. Reihm, et al. eds. *Managed Pressure Drilling*. Houston, Texas: Gulf Publishing Company, pp. 1-38.
- Harvey, S., 2010. California's legendary oil spill. *Los Angeles Times*, 13 June.
- Huang, D., Chen, T. & Wang, J., 2001. A Fuzzy set approach for event tree analysis. *Fuzzy Sets and Systems*, Volume 118, pp. 153-165.
- IAT, 2010. *Response to the Montara Wellhead Platform Incident - Report of the Incident Analysis Team (IAT)*, Australia: Australia Maritime Safety Authority.
- Jensen, F. V. & Nielsen, T. D., 2007. *Bayesian Networks and Decision Graphs*. New York: Springer.
- Kalantarnia, M., Khan, F. & Hawboldt, K., 2009. Dynamic risk assessment using failure assessment and Bayesian theory. *Loss Prevention in the Process Industries*, Volume 22, pp. 600-606.
- Khakzad, N., Khan, F. & Amyotte, P., 2012. Dynamic risk analysis using bow-tie approach. *Reliability Engineering and System Safety*, Volume 104, pp. 36-44.
- Khan, F., 2001. Use of maximum credible accident scenarios for realistic and reliable risk assessment. *Chemical Engineering Progress*, Volume 11, pp. 56-64.

- Meranbod, N., Soroush, M. & Panjapornpon, C., 2005. A method of sensor fault detection and identification. *Journal of Process Control*, 15(3), pp. 321-339.
- Neapolitan, R. E., 2004. *Learning Bayesian Networks*. Chicago: Prentice Hall Series.
- NOAA, 2015. *Deepwater Horizon Oil Spill*. [Online]  
Available at: <http://response.restoration.noaa.gov/deepwater-horizon-oil-spill>  
[Accessed 21 December 2015].
- Shalev, D. M. & Tiran, J., 2007. Conditioned-based fault tree analysis (CBTFA): A new method for improved fault tree analysis (FTA), reliability and safety calculations.. *Reliability and System Safety*, Volume 92, pp. 1231-1241.
- Simon, 2006. *Oil Rig Disasters*. [Online]  
Available at: [http://home.versatel.nl/the\\_sims/rig/i-blowout.htm](http://home.versatel.nl/the_sims/rig/i-blowout.htm)  
[Accessed 13 February 2014].
- Wilcox, C. R. & Ayyub, M. B., 2003. Uncertainty modeling of data and uncertainty propagation for risk studies. *IEEE Proceedings on Uncertainty Modeling and Analysis*, pp. 184-191.
- Won, J. & Modarres, M., 1998. Improved Bayesian method for diagnosing equipment partial failures in process plants. *Computers and Chemical Engineering*, Volume 10, pp. 1483-1502.
- Yang, X., Rogers, W. & Mannan, M., 2010. Uncertainty reduction for improved mishap probability prediction: application to level control of distillation unit. *Journal of Loss Prevention in the Process Industries*, 23(1), pp. 149-156.
- Yi, W. & Bier, V., 1998. An application of copulas to accident precursor analysis. *Management Science*, 44(12), pp. 257-270.

## Chapter 2

### 2.0 Novelty and Contribution

The novelties and contributions of this research is in the field of drilling operations safety improvement. The highlights of the contributions include:

- A new physical reliability model for real-time prediction of critical components failure probabilities. Through this model, the static nature of conventional risk assessment methods can be relaxed; enabling their application in dynamic risk analysis. This contribution is demonstrated in Chapter 4.
- A new methodology for the safety analysis of Constant Bottom-Hole Pressure (CBHP) drilling technique of Managed Pressure Drilling (MPD). Bow-tie models for both underbalanced and overbalanced pressure regimes were developed and mapped into BNs to conduct predictive as well as diagnostic analyses. This is an advancement into the safety analysis of evolving techniques of MPD. This contribution is presented in Chapter 5.
- An innovative model for the predictive as well as the diagnostic safety analysis of the most critical component of Managed Pressure Drilling – the Rotating Control Device (RCD). This contribution is also discussed in Chapter 5.
- A new well integrity model for the safety and risk assessment of casing and cementing operations. This model utilizes a Noisy-OR gate to capture the unique relationships between casing and cementing operations. This contribution is presented in Chapter 6.
- Application of safety functions and inherent safety principles to the causative elements of the well integrity model. Safety function keywords and inherent safety principles were suggested to improve the safety of well integrity operations. These techniques were hitherto limited to chemical process systems. This contribution is discussed in Chapter 6.



- A novel risk-based Bayesian network models for analyzing tripping out operation in Conventional Over-Balanced Drilling (COBD) method and Constant Bottom-Hole Pressure (CBHP) technique of MPD. This contribution is discussed in Chapter 7
- An innovative loss function modelling approach for blowout risk analysis. Loss function-based models are developed for the characterization of the loss categories applicable to a blowout scenario. The standardization of the models enables their applications to any formation depth without losing the originality of the models. This innovative contribution is presented in Chapter 8.
- An integrated tool for the safety analysis of drilling operations. The various sub-models that have been developed for the stages/sub-operations of drilling are integrated for a complete analysis of drilling operations prior to the completion of an oil and gas well. This contribution is discussed in Chapter 9.

## Chapter 3

### 3.0 Literature Review

#### 3.1. Managed Pressure Drilling (MPD)

MPD is defined by the International Association of Drilling Contractors (IADC) subcommittee on Underbalanced Operation and Managed Pressure Drilling (Minerals Management Service, 2008) as “an adaptive drilling process used to precisely control the annular pressure profile throughout the wellbore.” MPD is an adaptive drilling process such that the drilling plan is adjusted in conformance to the changing wellbore conditions. In fact, MPD is an overbalanced technique; hence, it supposedly avoids the flow of formation fluid into the wellbore. It is a closed-loop system which prevents the well from being open to the atmosphere through using a rotating control device (RCD); thus, it prevents the escape of poisonous gas to the atmosphere. The closed-system allows the casing back pressure to be adjusted precisely with a drilling choke when it is applicable to augment the hydrostatic pressure of the drilling fluid (Smith & Patel, 2012). MPD techniques are used to reduce loss of circulation or eliminate ballooning experienced in breathing formations, increase rate of penetration, extend casing points, reduce NPT resulting from stuck pipe and to safely drill in fractured and cavernous formations with total lost return (Haghshenas, et al., 2008). Uneconomical conventional overbalanced drilling of reserves could be rendered economical when drilled with MPD techniques. Further, offshore environments that are too risky to apply underbalanced drilling due to comparatively lower hydrostatic pressure than formation pore pressure could be drilled more safely with MPD techniques.

## 3.2. Managed Pressure Drilling Techniques

The improvement of offshore drilling in the oil and gas industry through the introduction of MPD techniques has been discussed in many literatures (Hannegan, 2005; Malloy, et al., 2009; Hannegan, 2011; Grayson & Gans, 2012; Hannegan, 2013). Among the available techniques for MPD, only the most widely used approaches - Constant Bottom-hole Pressure (CBHP) drilling, Pressurized Mud Cap Drilling (PMCD), and Dual Gradient Drilling (DGD) - are considered in this study (Haghshenas, et al., 2008):

### 2.2.1. Constant Bottom-hole Pressure (CBHP) Drilling:

CBHP technique comprises those methods in which the Bottom Hole Pressure (BHP) is always held constant or nearly constant at a specific depth whether the rig pump is on or off. In other words, the BHP is maintained within the drilling mud window defined by the lower and upper pressure limits. The lower pressure limit is the pore pressure while the upper limit is the formation fracture pressure with their difference known as the pressure margin (Fredericks, 2008).

In conventional overbalanced drilling, an open circulation system is employed, and the well is open to the atmosphere. When the rig pump is off or not circulating the mud, the static BHP is defined as:

$$BHP_{static} = P_h \quad (3.1)$$

where  $P_h$  is the hydrostatic pressure of the mud column,

When the rig pump is on and circulating the mud, the dynamic BHP is given by:

$$BHP_{dynamic} = P_h + P_{ann} \quad (3.2)$$

where  $P_{ann}$  is the annular frictional pressure due to circulating drilling fluid when the rig pump is on.

CBHP techniques use RCD to provide a closed circulating system with a drilling choke to adjust the back pressure so that the necessary BHP could be achieved under static and dynamic conditions as given by Eqs. (3.3) and (3.4), respectively:

$$BHP_{static} = P_h + P_{bp} \quad (3.3)$$

$$BHP_{dynamic} = P_h + P_{ann} + P_{bp} \quad (3.4)$$

where  $P_{bp}$  is the backpressure.

In CBHP techniques, either pressure or flow measurement is used as the primary control. In the former case (Fredericks, 2008), an automated Dynamic Annular Pressure Control (DAPC) system is used to maintain the BHP within the drilling mud window. The DAPC system is composed of a dedicated choke manifold, back pressure pump, integrated pressure manager and a hydraulics model. When the rig pump is off, such as during tripping (movement of drill string in or out of the well), pipe connection and when not drilling,  $P_{ann} = 0$ . This drop in BHP is compensated by a backpressure pump ( $P_{bp}$  in Eq. 3.3) along with the choke and RCD. When the rig pump is on, Eq. (3.4) is used to determine BHP condition within the drilling mud window. In this method, the integrated pressure manager compares the formation Pressure measurement While Drilling (PWD) data with the hydraulics model to provide real time constant BHP. The hydraulics model predicts the expected BHP and compares it with the prevalent BHP to decide if the BHP needs any adjustment. However, in the latter case, i.e. when flow measurement is used as primary control (Catak, 2008), an Intelligent Control Unit (ICU) compares the flow rate out of the well measured by a flow meter downstream of the RCD with the flow rate into the well determined with the rig pump strokes to detect kick and manipulate the automatic choke manifold accordingly. In some

classifications, MPD by Continuous Circulation System (CCS) is considered a CBHP method. CCS is used to always maintain constant BHP by eliminating changes in BHP during connections or otherwise. This is ensured through keeping a steady Equivalent Circulating Density (ECD) (Vogel & Brugman, 2008).

### **3.2.2. Pressurized Mud Cap Drilling (PMCD):**

PMCD is a technique for safe drilling with total lost returns in highly fractured, cavernous or vugular karstic (carbonate) formations in which the use of lost circulation material is futile. It is an improvement to mud cap or floating mud cap drilling. Mud cap or floating mud cap drilling is an open well system in which heavy mud is floated in the annulus at a point that balances the formation pressure above the fracture or vug taking fluid and drilled cuttings (Moore, 2008). PMCD is defined by IADC Benny et al., (2013) as “drilling with no returns to surface, where an annulus fluid column, assisted by surface pressure, is maintained above a formation that is capable of accepting fluid and cuttings”. The annulus fluid column in PMCD is meant to exert lower hydrostatic pressure than the formation pore pressure while back pressure provided by the RCD is used to balance the formation pressure. A sacrificial fluid, usually water or seawater, is run down the drill string and injected with the drilled cuttings into the exposed fracture or vug. Any influx of formation fluid including sour gas is forced back or bullheaded into the formation. Thus, wastage of costly mud is prevented in addition to a safe drilling process (Moore, 2008; Benny, et al., 2013).

### **3.2.3. Dual Gradient Drilling (DGD):**

DGD comprises those offshore MPD techniques in which two fluids are used to drill a well such that the lighter fluid - usually seawater - is above the seafloor and the heavier one below the mud

line in order to widen the narrow mud window and extend casing points. This leads to higher production rates as a result of larger wellbore compared to wells drilled conventionally, thus, improving the economy of the well. The techniques include “pump and dump” method in which the return is dumped to the sea floor, and riser-less mud return method in which well effluent flows back to the rig through small diameter return lines assisted by a subsea mud-lift pump. DGD requires less deck space due to the use of small diameter return lines instead of the conventional risers, enabling the use of smaller floating rigs in deepwater drilling (Cohen, et al., 2008).

### **3.3. Quantitative risk assessment techniques**

#### **3.3.1. Fault Tree (FT)**

Fault tree is a top-down diagnostic technique for identifying ways in which hazards can lead to accidents. It is a deductive technique which starts with an accident known as the top event or critical event and works backward toward the various scenarios ending with basic events that can lead to the top event through intermediate events (Crowl & Louvar, 2002). FT considers binary state for events and uses logic gates to express the relationships between events. Among the logic gates used, *AND*-gates and *OR*-gates are the most widely used. FT is simple and easy to use; hence, it is widely used in risk analysis of process system (Khan, 2001) and fault diagnosis (Bartlett, et al., 2009). FT gives both qualitative and quantitative representation of the modelled accident scenario. Qualitatively, it indicates the logical relationship among events leading to the top event. It shows the combination of events that must be present - minimal cut sets- for the top event to occur. On the other hand, the quantitative representation is achieved by the probability of the top event obtained from the Boolean algebraic combination of basic events through the intermediates to the top event.

However, the use of FT in the analysis of complex systems is marred by a high margin of error. Its assumption of independent events limits its use in modeling mutually exclusive events, common cause failures or events in which there are some forms of dependencies between events. Its use of generic and imprecise data leads to uncertainty in the result of the FTA. In addition, its binary state limits its application in multi-state events (Bobbio, et al., 2001; Khakzad, et al., 2011). Consequently, efforts have been made to reduce the uncertainties in FTA through the development of fuzzy based FT analysis (Ferdous et al. 2009; Markowski et al. 2009) and hybrid FTA (Lin & Wang 1997).

### **3.3.2. Event Tree (ET)**

Event tree is an inductive technique which begins with an initiating event and works toward possible final results or end events. It provides, qualitatively, the logical relationship of how a failure can occur and quantitatively, the probability of occurrence. As with FT, ET is widely used for its simplicity and easy to use. It is used in safety analysis and accident modeling to determine possible consequences that can result from the propagation of an accident through the success or fail states of safety systems. However, it also suffers from the use of generic and imprecise data. Meel and Seider (2006) advanced the use of ET through the development of plant-specific dynamic assessment methodology which utilizes accident precursor data to predict the frequencies of end-states abnormal events. In the same vein is the work of Kalantarnia et al. (2009) in which the posterior failure probabilities of safety barriers is determined by Bayesian updating mechanism. Further application of ET methodology to process accident modelling and an offshore drilling accident, utilizing FT principle for safety barriers and Bayesian updating mechanism using accident precursors was conducted by Rathnayaka et al. (2011, 2013).

### 3.3.3. Bow-Tie (BT) approach

Bow-tie is a risk analysis technique which combines an FT and an ET with the top event of the FT as the initiating event of the ET. It is used to analyze the primary causes and consequences of an accident. A BT diagram (as shown in Fig. 3.1) presents the logical relationship between the causes, expressed as basic events (BEs) on one side, through intermediate events (IEs), top event (TE) and safety barriers (SBs) to the possible consequences (Cs) on the other side. For illustrative purpose, considering Fig. 3.1, the occurrence probability of end-event  $C_2$  is given by

$$P(C_2) = P(TE).P(SB_1).P(1 - SB_2) \quad (3.5)$$

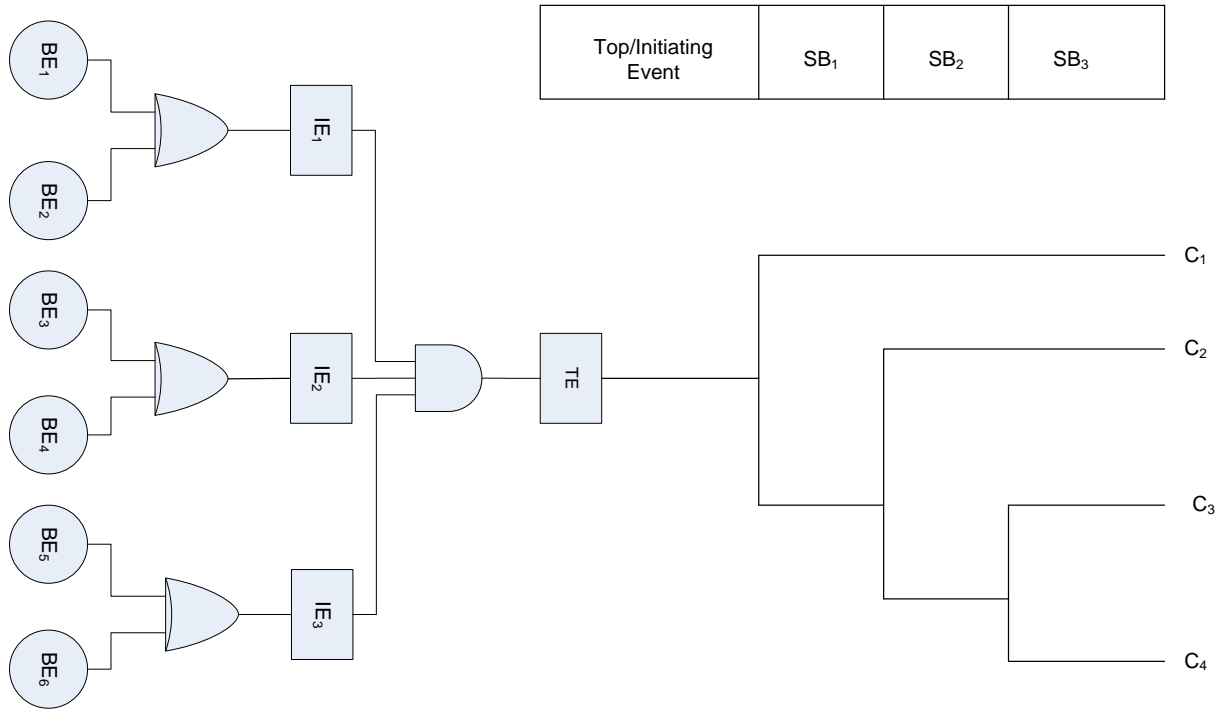
Similarly,

$$P(C_4) = P(TE).P(SB_1).P(SB_2).P(SB_3) \quad (3.6)$$

where  $P(TE)$  is the probability of top event determined by the Boolean algebraic combination of the occurrence probabilities of the basic events,  $P(BE_1), P(BE_2) \dots$  and  $P(BE_6)$ .  $P(SB_1), P(SB_2)$  and  $P(SB_3)$  represent the failure probabilities of the safety barriers  $SB_1, SB_2$  and  $SB_3$  respectively.

Bow-tie combines the advantages of FT and ET with its use found in many fields of science. Markowski and Kotynia (2011) used BT in a layer of protection analysis to model a complete accident scenario in a hexane distillation unit. Khakzad et al. (2012) applied BT in risk analysis of dust explosion accident in a sugar refinery. Forms of BT haven been applied in medical safety risk analysis (Wierenga, et al., 2009) and analysis of hazard and effects management process of vehicle operations (Eslinger, et al., 2004). Like its composites FT and ET, BT exhibits similar limitations and deficiencies of independency assumption and difficulty in its use for complex system analysis.





**Figure 3.1 - A generic bow-tie diagram**

Forms of BT have been developed to integrate dynamic risk assessment into conventional static BT. This includes the incorporation of physical reliability models and Bayesian updating mechanism for risk analysis of process systems (Khakzad et al. 2012), offshore drilling operations (Abimbola et al. 2014), and a refinery explosion accident in which fuzzy set and evidence theory are used to assess uncertainties (Ferdous et al. 2013).

### 3.3.4. Bayesian Network

Bayesian network is a directed acyclic graph in which nodes are random variables and directed arcs representing probabilistic dependencies and independencies among the variables. Bayesian network is a probabilistic method of reasoning under uncertainty (Abimbola, et al., 2015b). Consider, for instance, the Bayesian network in Fig. 3.2 with binary nodes.  $A_1$  is a root node without arcs directed into it while nodes  $A_3$  and  $A_5$  are leaf nodes without child nodes emanating from them. The root nodes are assigned with marginal prior probabilities while the intermediate

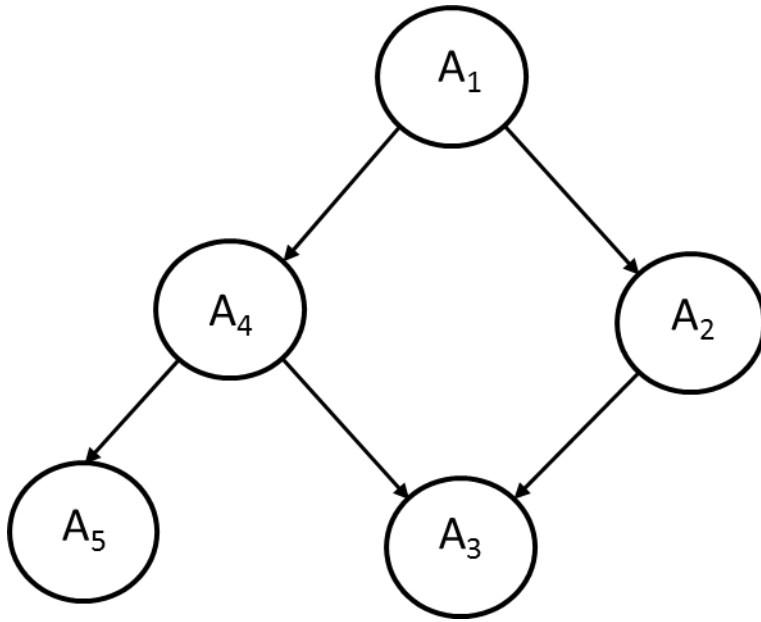
and leaf nodes are characterized with conditional probability tables. The states of  $A_1$  are  $a_1$  and  $\bar{a}_1$ . Similarly, for  $A_2 \dots A_5$ . The joint probability distribution,  $P$ , of the Bayesian network is expressed as Eq. 3.7.

$$P(a_1, a_2, \dots, a_5) = \prod_i^5 P(a_i | a_{\theta(i)}) \quad (3.7)$$

Where  $a_1, a_2, \dots, a_5$  are the states of variables  $A_1, A_2, \dots, A_5$  respectively and  $\theta(i)$ , the parent(s) of node  $i$ . Further expansion of Eq. 3.7 gives Eq. 3.8.

$$P(a_1, a_2, \dots, a_5) = P(a_5 | a_4). P(a_4 | a_3, a_1). P(a_3 | a_4, a_2). P(a_2 | a_1). P(a_1) \quad (3.8)$$

The directed acyclic graph and the joint probability distribution of the nodes are said to satisfy Markov condition if each variable,  $A_i$ , in the directed acyclic graph is conditionally independent of the set of all its non-descendants given its parents (Neapolitan, 2004). For instance,  $A_3$  is conditionally independent of non-descendants:  $A_1$  and  $A_5$  given its parents:  $A_2$  and  $A_4$ . Mathematically, this can be written as:  $I_P(A_3, \{A_1, A_5\} | \{A_2, A_4\})$ . Similarly, for  $I_P(A_5, A_4 | \{A_1, A_2, A_3, A_5\})$  in Fig. 3.2.



**Figure 3.2 - A generic directed acyclic graph**

This analysis can be generalized for  $n$  variables with  $k$  states, enabling modeling of complex dependencies among random variables. Bayesian networks are used for both predictive (forward propagation) and diagnostic (backward propagation) analyses. Marginal prior probabilities of root nodes and conditional probabilities of intermediate nodes lead to the marginal probabilities of the intermediate and leaf nodes in predictive analysis; while in diagnostic analysis, node state instantiation results in updated probabilities of conditionally dependent nodes (Abimbola et al. 2015a).

### **3.3.5. The Noisy-OR Gate**

Noisy-OR gate is a type of canonical interaction used to describe causal relationships among  $n$  binary variables and their common outcome. The simplifying assumptions are that: each cause is sufficiently able to lead to the outcome in the absence of other causes except it is inhibited; the ability of each cause to lead to the outcome is independent of the presence of other causes; and the

outcome can only occur if at least one of the causes is present and not inhibited (Neapolitan, 2009). Considering, for instance, node,  $A_3$ , in Fig. 3.2, the outcome of nodes  $A_2$  and  $A_4$  as a Noisy-OR gate, the above assumptions enable the specification of the entire  $4(2^2)$  conditional probabilities of  $A_3$ . If

$$P(A_3 = a_3 | A_2 = a_2, A_4 = \bar{a}_4) = p_2 \quad (3.9)$$

And

$$P(A_3 = a_3 | A_2 = \bar{a}_2, A_4 = a_4) = p_4 \quad (3.10)$$

$$P(A_3 = \bar{a}_3 | A_2 = a_2, A_4 = a_4) = (1 - p_2)(1 - p_4) \quad (3.11)$$

$$P(A_3 = \bar{a}_3 | A_2 = a_2, A_4 = \bar{a}_4) = 1 - p_2 \quad (3.12)$$

$$P(A_3 = \bar{a}_3 | A_2 = \bar{a}_2, A_4 = a_4) = 1 - p_4 \quad (3.13)$$

$$P(A_3 = \bar{a}_3 | A_2 = \bar{a}_2, A_4 = \bar{a}_4) = 1 \quad (3.14)$$

Hence, for  $n$  causal binary variables  $L_1, L_2, \dots, L_{n-1}, L_n$ , with an outcome  $M$ , if

$$P(m | \bar{l}_1, \bar{l}_2, \dots, l_j, \dots, \bar{l}_{n-1}, \bar{l}_n) = p_j \quad (3.15)$$

For a subset  $L_{sub}$  of instantiated  $L_j$ s,

$$P(m | L_{sub}) = 1 - \prod_{j: L_j \in L_{sub}} (1 - p_j) \quad (3.16)$$

This reduces the number of conditional probabilities to be specified in completely defining the conditional probability table. For multi-state variables, a variant of Noisy-OR gate, known as noisy-max is formed. Considering a situation where there is an outcome even though none of the

listed causes are present; an extension of the Noisy-OR gate known as leaky Noisy-OR gate is described. The leaky Noisy-OR gate is used to describe situations where all the applicable causes are not captured in a model. A background event with a probability,  $p_0$ , is specified such that (Onisko, et al., 2001; Jensen & Nielsen, 2007),

$$P(m|\bar{l}_1, \bar{l}_2, \dots, \bar{l}_{n-1}, \bar{l}_n) = p_0 \quad (3.17)$$

In comparison with the logical OR and AND gates, as shall be seen later in this research, the Noisy-OR gate is a middle course among the three gates, avoiding overestimation or underestimation of top event probabilities.

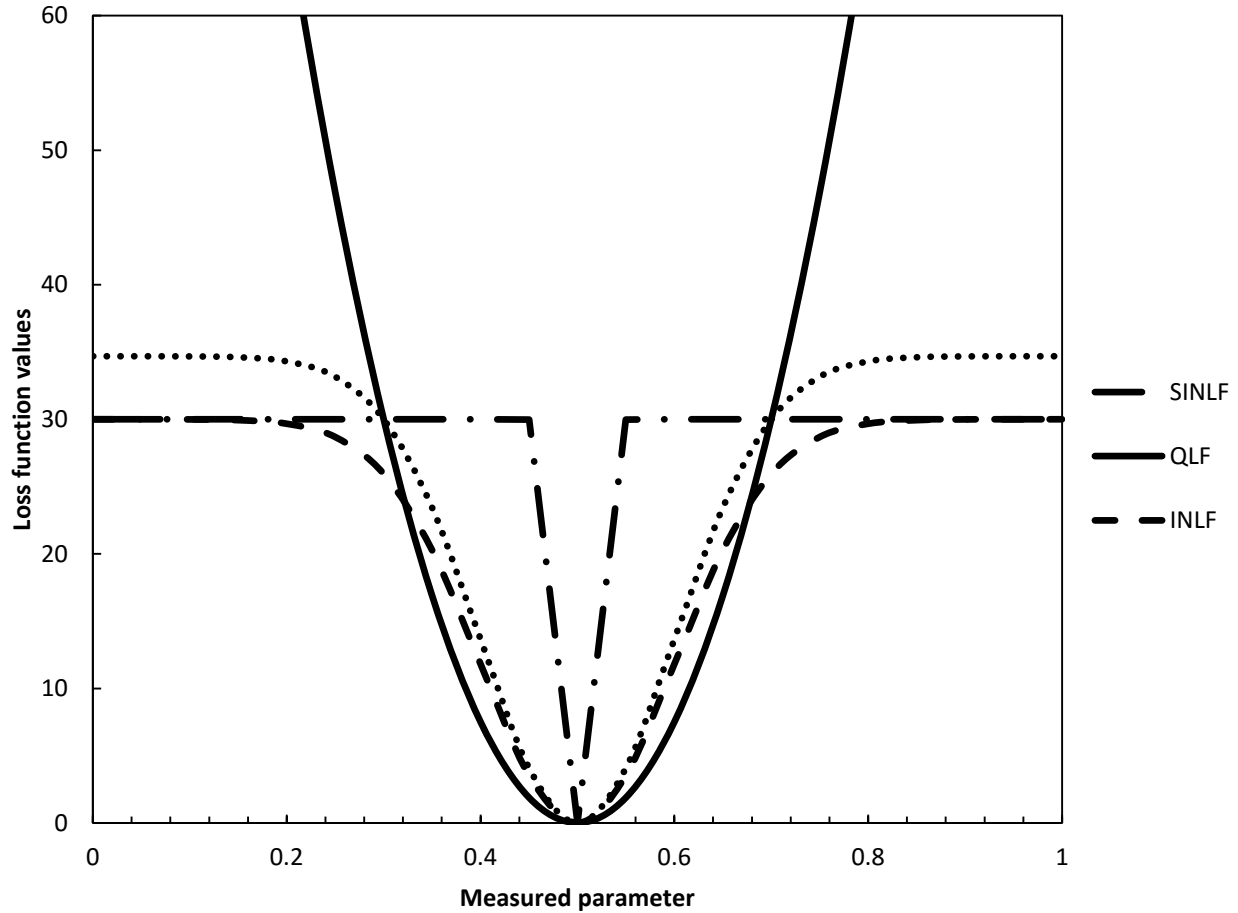
### 3.3.6. Mapping of Bow-tie to Bayesian Network

The bow-tie component parts, namely – fault tree and event tree are mapped separately following the algorithm discussed by Bobbio et al (2001), Bearfield and Marsh (2005) and Khakzad et al. (2013a). The fault tree graphical structure is transformed into a Bayesian network such that the basic, intermediate and top or critical events represent the root, intermediate and leaf nodes of the equivalent Bayesian network respectively. The connectivity in the FT is the same as the linkages between the nodes of the equivalent Bayesian network. The failure probabilities of the basic events represents the marginal prior probabilities of the root nodes. The intermediate and leaf nodes are assigned conditional probability tables whose estimated probabilities are determined based on the interpretation of the governing logic gates (Bobbio, et al., 2001; Khakzad, et al., 2013a). Similarly, in mapping event tree into a Bayesian network, the safety barriers are represented with safety nodes,  $SB_1, SB_2, \dots, SB_n$ , where  $n$  represents the number of safety barriers. A safety node,  $SB_{i+1}$ , is linked to the preceding safety node,  $SB_i$ , only if the failure probability of  $SB_{i+1}$  is conditionally dependent on the failure probability of  $SB_i$ . In other words,  $SB_{i+1}$  must be connected

to  $SB_i$  only if  $P(SB_{i+1}, |SB_i) \neq P(SB_{i+1}, |\overline{SB_i})$ . Similarly, for  $P(SB_{i+1}, |SB_{i-1}) \neq P(SB_{i+1}, |\overline{SB_{i-1}})$  and so on. This is also applicable to sequentially arranged safety barriers as discussed in this study. Further, safety nodes are linked to the consequence node only if the probabilities of the states of the consequence node are conditionally dependent on the success or failure probability of the safety nodes (Khakzad, et al., 2013a). The failure probabilities of the safety barriers are used in formulating the conditional probability tables of the safety nodes to reflect the causal relationships of the safety barriers. A conditional probability table is assigned to the consequence node which logically follow that of an AND-gate. In the Bayesian network equivalent of the bow-tie, a new state, a normal or safe state, is added to the consequence node, to account for the non-occurrence of the top event (Khakzad, et al., 2013a; Abimbola, et al., 2015a).

### 3.4. Blowout risk analysis using loss functions

Central to LFs application to quality loss analysis are the pioneering works of Taguchi (1986, 1989) in the last three decades, in which he proposed a Quadratic Loss Function (QLF) to quantify losses to the industry associated with deviations of product quality characteristics from their operational targets. The Taguchi's QLF exhibits symmetric and unbounded characteristics. A QLF profile with a target  $T = 0.5$ , over a measured parameter range of  $0 \leq x \leq 1$ , is shown in Fig. 3.3 from Eq. (3.18) (Sun, et al., 1996).



**Figure 3.3 - Loss profiles of different loss functions**

$$L(x) = \frac{K_{\Delta}}{\Delta^2} (x - T)^2 \quad (3.18)$$

A LF value,  $K_{\Delta}$ , of 10 is observed for a deviation,  $\Delta$  of 0.2. It is apparent from Fig. 3.3 that QLF is continuously increasing and unbounded. This has, however, limited its application, leading to the development of various modifications to the original QLF (Ryan, 2011; Berker, 1990; Phadke, 1989). Spiring (1993) proposed an Inverted Normal Loss Function (INLF) in response to the criticisms of QLF which enabled a user-specified maximum value; hence, a more realistic quantification of losses due to process deviations from target values. Considering a specified

maximum,  $K_{MAX}$ , of 30 and a shape parameter,  $\gamma$ , of  $\Delta/2$ , the LF profile is as shown in Fig. 3.3 deduced from Eq. (3.19).

$$L(x) = K_{MAX} \left[ 1 - \exp \left\{ -\frac{1}{2} \left( \frac{x - T}{\gamma} \right)^2 \right\} \right] \quad (3.19)$$

A special case of INLF known as Spiring Inverted Normal Loss Function (SINLF) for which  $\gamma = \Delta/4$ , is also shown in Fig. 3.3. A comparative analysis between INLF and SINLF showed that the latter exhibits a more rapid response to changes in the measured parameter than the former. This is because, about 99.97% of  $K_{MAX}$  would have been attained for  $T \pm \Delta$  deviations. Furthermore, a Modified Inverted Normal Loss Function (MINLF) was proposed by Sun et al. (1996) to enable the specification of user's perception of attained loss. As shown in Eq. (3.20), this is achieved with the specification of  $K_{\Delta}$ , which is different from the maximum loss, that occurs at a deviation,  $\Delta$ , from the target. The shape parameter,  $\gamma$ , a function of  $\Delta$ , defines the slope of the function around the target value.

$$L(x) = \frac{K_{\Delta}}{1 - \exp \left\{ -\frac{1}{2} \left( \frac{\Delta}{\gamma} \right)^2 \right\}} \left[ 1 - \exp \left\{ -\frac{1}{2} \left( \frac{x - T}{\gamma} \right)^2 \right\} \right] \quad (3.20)$$

Figure 3.20 showed a MINLF profile for  $K_{\Delta} = 30$ ,  $\Delta = 0.2$ ,  $\gamma = \Delta/2$ . The flexibility of MINLF is enabled with an application related closely to the Taguchi's method of QLF. For various values of  $\gamma$ , ranging from  $\Delta/0.1$  to  $\Delta/5$ , the MINLF approximates the QLF to INLF through SINLF. Other forms of univariate and inverted probability LFs in use include the Inverted Beta Loss Function (IBLF) (Leung & Spiring, 2002), uniform distribution, Tukey's Symmetric Lambda distribution, Laplace distribution and the Inverted Gamma Loss Function (IGLF). The essence of these inverted



probability LFs is to enable varieties and better representation of actual process losses (Leung & Spiring, 2004).

In multivariate LFs, more than one variable is used to determine the losses due to deviations from set-points. Pignatiello (1993) defined a QLF to reflect the predominant notion that every manufactured product exhibit more than one characteristic by which its overall quality is determined. On the work of Artiles-Leon (1999), principal component analysis was applied by Ma and Zhao (2004) for the improvement of multivariate response approach to optimization. These studies have been in the field of quality engineering. Recently, Zadakbar et al (2014) developed economic consequence models for process risk analysis. Potential losses were identified with applicable LFs to represent a comprehensive approach to process accident risk assessment. In the same vein, Hashemi et al (2014) improved on the work of Chang et al (2011) to apply common LFs to an operational risk-based analysis of a reactor system.

## References

- Abimbola, M., Khan, F., Khakzad, N. & Butt, S., 2015a. Safety and Risk Analysis of Managed Pressure Drilling Operation Using Bayesian Network. *Safety Science*. Volume 76, pp. 133-144.
- Adams, N. J., 1985. *Drilling Engineering-A Complete Well Planning Approach*. Tulsa, Oklahoma: PennWell Publishing Company.
- Ahmed, T. & Mckinney, P. D., 2005. *Advanced Reservoir Engineering*. Massachusset: Gulf Professional Publishing.
- Al-Mutairi, E. M., Suardin, J. A., Mannan, M. S. & El-Halwagi, M. M., 2008. An optimization approach to the integration of inherently safer design and process scheduling. *Juornal of Loss PRevention in the Process Industries*, Volume 21(5), pp. 543-549.
- Anderson, L. B., 1998. Stochastic modeling for the analysis of blowout risk in exploration drilling. *Reliability Engineering and System Safety*, Volume 68, pp. 53-63.
- Arild, O., Ford, E. P., Loberg, T. & Baringbing, J. W. T., 2009. *KickRisk - A Well Specific Approach to the Quantification of Well Control Risks*. Jakarta, Indonesia, SPE 124024.
- Arnold & Itkin LLP, 2014. *Oil Rig Explosion Attorneys*. [Online]  
Available at: <http://www.oilrigexplosionattorneys.com/Oil-Rig-Explosions/History-of-Offshore-Accidents.aspx>  
[Accessed 26 February 2014].
- Artiles-Leon, N., 1996. A pragmatic approach to multi-response problems using loss functions. *Quality Engineering*, Volume 9, pp. 213-220.
- Aven, T. & Nokland, T. E., 2010. On the use of uncertainty importance measures in reliability and risk analysis. *Reliability Engineering and System Safety*, Volume 95, pp. 127-133.
- Bartlett, M., Hurdle, E. & Kelly, M., 2009. Integrated system fault diagnostics utilizing diagraph and FT-based approach. *Reliability Engineering and System Safety*, Volume 94, pp. 1107-1115.
- Bearfield, G. & Marsh, W., 2005. Generalising event trees using Bayesian networks with a case study of train derailment.. *Lecture Notes in Computer Science 3688*, pp. 52-66.
- Bedford, T. & Cooke, R., 2001. *Probabilistic Risk Analysis: Foundations and Methods*. UK: Cambridge University Press.

- Beltran, J. C. et al., 2010. *Managed Pressure Drilling Brings Added Value to Production Casings Cementing Operations Increasing Success Rates and Quality in HPHT Fractured Narrow Window Wells*. Kuala Lumpur, Malaysia, SPE/IADC 130313.
- Bennion, D. B., Lunan, B. & Saponja, J., 1998b. Underbalanced Drilling and Completion Operations to Minimize Formation Damage - Reservoir Screening Criteria for Optimum Application. *The Journal of Canadian Petroleum Technology*, Volume 9, pp. 36-49.
- Bennion, D. B., Thomas, F. B., Bietz, R. F. & Bennion, D. W., 1998a. Underbalanced Drilling - Praises and Perils. *SPE Drilling and Completion*, December, pp. 214-222.
- Benny, A. M. H., Karnugroho, A., Sosa, J. & Toralde, J. S. S., 2013. *Combining Pressurized Mud Cap Drilling (PMCD) and Early Kick Detection (EKD) Techniques for Fractured Formations Overlying a High Pressure Reservoir in Offshore Kalimantan*. Jakarta, Indonesia, SPE 165893.
- Bercha, F. G., 1978. *Probabilities of Blowouts in Canadian Arctic Waters*, Canada: Environmental Protection Service. Economic and Technical Review, Report EPS 3-EC-78-12.
- Berker, T. B., 1990. *Engineering Quality by Design: Interpreting the Taguchi Approach*. New York: Marcel Dekker.
- Birnbaum, Z. W., 1969. On the importance of different components in a multicomponent system. In: P. R. Krishnaiah, ed. *Multivariate analysis-II*. New York: Academic Press, pp. 581-592.
- Bobbio, A., Portinale, L., Minichino, M. & Ciancamerla, E., 2001. Improving the analysis of dependable systems by mapping fault trees into Bayesian networks. *Reliability Engineering and System Safety*, Volume 71, pp. 249-260.
- BOEMRE, 2011. *Report Regarding the Causes of the April 20, 2010 Macondo Well Blowout*, s.l.: The Bureau of Ocean Energy Management, Regulation and Enforcement.
- BOEMRE, 2011. *Report Regarding the Causes of the April 20, 2010 Macondo Well Blowout*. s.l.:The Bureau of Ocean Energy Management, Regulation and Enforcement.
- Bommer, P., 2008. *A Primer of OILWELL DRILLING*. 7th ed. Texas: The University of Texas.
- Borgonovo, E., Apostolakis, G. E., Tarantola, S. & Saltelli, A., 2003. Comparison of global sensitivity analysis techniques and importance measures in PSA. *Reliability Engineering and System Safety*, Volume 79, pp. 175-185.
- Boudali, H. & Dugan, J. B., 2005. A discrete-time Bayesian network reliability modeling and analysis framework. *Reliability Engineering and System Safety*, Volume 87, pp. 337-349.

- Bourgoyne, A. T. J., Millheim, K. K., Chenevert, M. E. & Young, F. S. J., 1986. *Applied Drilling Engineering*. Richardson(TX): Society of Petroleum Engineers.
- BP, 2010. *Deepwater Horizon Accident Investigation Report*, s.l.: BP.
- BSEE, 2014. *Bureau of Safety and Environment Enforcement*. [Online]  
Available at: <http://www.bsee.gov/BSEE-Newsroom/Press-Releases/2014/BSEE-Coast-Guard-Respond-to-Loss-of-Well-Control-in-the-Gulf-of-Mexico/>  
[Accessed 13 February 2014].
- Catak, E., 2008. MPD with Flow Measurement as the Primary Control. In: B. Rehm, et al. eds. *Managed Pressure Drilling*. Houston, Texas: Gulf Publishing Company, pp. 109-126.
- CCPS, 1999. *Guidelines for Consequence Analysis of Chemical Releases*, New York: American Institute of Chemical Engineers.
- CCR, 2011. *Macondo - The Gulf Oil Disaster*. s.l.:National Commission on the BP Deepwater Oil Spill and Offshore Drilling. Chief Counsel's Report.
- Chang, Y., Khan, F. & Ahmed, S., 2011. A risk-based approach to design warning system for processing facilities. *Process Safety Environmental Protection*, Volume 89, pp. 310-316.
- Cheok, M. C., Parry, G. W. & Sherry, R. R., 1998. Use of importance measures in risk-informed regulatory applications. *Reliability Engineering and System Safety*, Volume 60, pp. 213-226.
- Chief Counsel's Report, 2011. *Macondo THE GULF OIL DISASTER*, Washington DC 20005: National Commission on the BP Deepwater Horizon Oil Spill and Offshore Drilling.
- Christou, M. & Konstantinidou, M., 2012. *Safety of offshore oil and gas operations: Lessons from past accident analysis*, Luxembourg: Joint Research Centre, European Commission.
- Cohen, J., Stave, R., Schubert, J. & Elieff, B., 2008. Dual-Gradient Drilling. In: B. Rehm, et al. eds. *Managed Pressure Drilling*. Houston, Texas: Gulf Publishing Company, pp. 181-226.
- Crespo, F. et al., December 2012. Surge-and-Swab Pressure Predictions for Yield-Power-Law Drilling Fluids. *SPE Drilling & Completion*, pp. 574-585.
- Crowl, D. A. & Louvar, J. F., 2002. *Chemical Process Safety - Fundamentals with Applications*. Second ed. New Jersey: Prentice Hall PTR.
- Curcuro, G., Galante, G. M. & La Fata, C. M., 2012. Epistemic Uncertainty in fault tree analysis approached by the evidence theory. *Journal of Loss Prevention in the Process Industries*, 25(4), pp. 667-676.

- Danenberger, E. P., 1993. *Outer Continental Shelf Drilling Blowouts, 1971 - 1991*. Texas, OTC 7248.
- de Dianous, V. & Fievez, C., 2006. ARAMIS project: A more explicit demonstration of risk control through the use of bow-tie diagrams and the evaluation of safety barrier performance. *Journal of Hazardous Materials*, Volume 130, pp. 220-233.
- Decision Systems Laboratory, University of Pittsburgh, n.d. *GENIE*. [Online]  
Available at: <http://genie.sis.pitt.edu/>  
[Accessed 24 January 2014].
- Delvosalle, C., Fievez, C., Pipart, A. & Debray, B., 2006. ARAMIS project: A comprehensive methodology for the identification of reference accident scenarios in process industries. *Journal of Hazardous Materials*, Volume 130, pp. 200-219.
- Dervo, H. J. & Blom-Jensen, B., 2004. *Comparison of quantitative blowout risk assessment approaches*. SPE 86706. Calgary, 7th SPE International Conference on Health, Safety, and Environment in Oil and Gas Exploration and Production. March 29 -31.
- Deshpande, A., 2011. Fuzzy fault tree analysis: revisited. *International Journal of Systems Assurance Engineering and Management*, Volume 2, pp. 3-13.
- DHSG, 2011. *Final Report on the Investigation of MAcondo Well Blowout..* s.l.: Deepwater Horizon Study Group.
- Dow Chemical Company, 1993. *Dow's chemical exposure index guide*. 2nd ed. New York: American Institute of Chemical Engineers (AIChE).
- Dow Chemical Company, 1994. *Fire & explosion index hazard classification guide*. 7th ed. New York: American Institute of Chemical Engineers (AIChE).
- Ebeling, C. E., 1997. *An Introduction to Reliability and Maintainability Engineering*. 1st ed. New York: McGraw-Hill Companies Inc..
- Edwards, D. W. & Lawrence, D., 1993. Assessing the inherent safety of chemical process routes: is there a relation between plant cost and inherent safety?. *Transactions of IChemE*, Volume 71 (Pt B), pp. 252-258.
- Engevik, M. O., 2007. *Risk Assessment of Underbalanced and Managed Pressure Drilling Operations*. MSc. Thesis, Norway: NTNU.
- Eskesen, S. D., Tengborg, P., Kampmann, J. & Veicherts, T. H., 2004. Guidelines for tunneling risk management: International Tunnelling Association, Working Group No. 2. *Tunnelling and Underground Space Technology*, Volume 19, pp. 217-237.

- Eslinger, K., Ure, D. & Kutlay, S., 2004. *Risk Management and Analysis of Driving Hazard Using Bow Tie Model*. Alberta, SPE 86846.
- Etowa, C. B., Amyotte, P. R., J, P. M. & KHan, F. I., 2002. Quantification of Inherent safety aspects of the Dow indices. *Journal of Loss Prevention in the Process Industries*, Volume 15, pp. 477-487.
- Feilden, T., 2010. *A near miss for the North Sea oil industry*. [Online] Available at: [http://www.bbc.co.uk/blogs/today/tomfeilden/2010/12/a\\_near\\_miss\\_for\\_the\\_north\\_sea.html](http://www.bbc.co.uk/blogs/today/tomfeilden/2010/12/a_near_miss_for_the_north_sea.html)
- Ferdous, R. et al., 2009. Handling data uncertainties in event tree analysis. *Process Safety and Environmental Protection*, 87(5), pp. 283-292.
- Ferdous, R. et al., 2012. Handling and updating uncertain information in bow-tie analysis. *Journal of Loss Prevention in the Process Industries*, 25(1), pp. 8-19.
- Ferdous, R. et al., 2013. Analyzing system safety and risk under uncertainty using a bow-tie diagram: An innovative approach. *Process safety and Environmental Protection*, 91(1-2), pp. 1-18.
- Fowler, J. H. & Roche, J. R., 1994. System safety analysis of well-control equipment. *SPE Drilling and Completion*, Volume 3, pp. 193-198.
- Fowler, J. H. & Roche, J. R., 1994. System Safety Analysis of Well-Control Equipment. SPE26844. *Drilling and Completion*, pp. 193-198.
- Fredericks, P., 2008. Constant Bottom-Hole Pressure with Pressure as a Primary Control. In: B. Rehm, et al. eds. *Managed Pressure Drilling*. Houston, Texas: Gulf Publishing Company, pp. 81-107.
- Gentile, M., Rogers, W. J. & Mannan, M. S., 2003. Development of an inherent safety index based on fuzzy logic. *AIChE*, Volume 49(4), pp. 959-968.
- Gough, G. & Graham, R., 2008. *Offshore Underbalanced Drilling - The Challenge at Surface*. Orlando, Florida, IADC/SPE 112779.
- Gould, K. S., Ringstad, A. J. & van de Merwe, K., 2012. *Human Reliability Analysis in Major Accident Risk Analyses i the Norwegian Petroleum Industry*. Stavanger, Norway, SAGE .
- Grayson, B. & Gans, A. H., 2012. *Closed Loop Circulating Systems Enhance Well Control and Efficiency With Precise Wellbore Monitoring and Management Capabilities*. Milan, Italy, SPE, p. 12.

- Guo, B., Lyons, W. C. & Ghalambor, A., 2007. *Petroleum Production Engineering - A computer-Assisted Approach*. Lafayette: Elsevier Science & Technology Books.
- Gupta, J. P. & Edwards, D. W., 2003. A simple graphical method for measuring inherent safety. *Journal of Hazardous Materials*, Volume 104, pp. 15-30.
- Haghshenas, A., Paknejad, A. S., Reihm, B. & Schubert, J., 2008. The Why and Basic Principles of Managed Well-Bore Pressure. In: B. Reihm, et al. eds. *Managed Pressure Drilling*. Houston, Texas: Gulf Publishing Company, pp. 1-38.
- Hannegan, D., 2013. *Operational Reliability Assessment of Conventional vs. MPD on Challenging Offshore Wells*. Amsterdam, SPE/IADC 163523.
- Hannegan, D. M., 2005. *Managed Pressure Drilling in Environments - Case Studies*. Amsterdam, The Netherland, SPE/IADC 92600.
- Hannegan, D. M., 2011. *MPD- Drilling Optimization Technology, Risk Management Tool, or Both?*. Denver, Colorado, SPE 146644.
- Hannegan, D. M. & Wanzer, G., 2003. *Well Control Considerations - Offshore Applications of Underbalanced Drilling Technology*. SPE/IADC 79854. Amsterdam, The Netherlands, SPE.
- Hashemi, S. J., Ahmed, S. & Khan, F., 2014. Loss Functions and their Applications in Process Safety Assessment. *American Institute of Chemical Engineers*, 33(3), pp. 285-291.
- Heriot-Watt University Drilling Engineering Manual, n.d. *Drilling Engineering*, Edinburgh: Department of Petroleum Engineering.
- Holand, P., 1991. Subsea blowout-preventer systems reliability and testing. *SPE Drilling Engineering*, Volume 4, pp. 293-298.
- Holand, P., 1999. *Reliability of Subsea BOP systems for Deepwater Application*, s.l.: Phase II DW. Project Report STF38 A99426.
- Holand, P., 2001. *Deepwater Kicks and BOP Performance*, s.l.: Project Report STF38 A01419.
- Holand, P. & Rausand, M., 1987. Reliability of Subsea BOP systems. *Reliability Engineering*, Volume 19, pp. 263 - 275.
- Holland, P., 1991. Subsea Blowout-Preventer Systems: Reliability and Testing. *SPE Drilling Engineering*, 6(04), pp. 293-298.
- Holland, P., 2001. Reliability of Deepwater Subsea Blowout Preventers. SPE 70129. *Drilling and Completion*, pp. 12-18.

- IAT, 2010. *Response to the Montara Wellhead Platform Incident - Report of the Incident Analysis Team (IAT)*, Australia: Australia Maritime Safety Authority.
- ICI Mond Division, 1985. *The Mond index*. 2nd ed. Northwich: Imperial Chemical Industries.
- Incident Analysis Team, 2010. *Response to the Montara Wellhead Platform Incident*, Australia: Australian Maritime Safety Authority.
- Izon, D., Danenberger, E. & Mayes, M., 2007. Absence of fatalities in blowouts encouraging in MMS study of OCS incidents 1992-2006. *DRILLING CONTRACTOR*, July/August, pp. 84-90.
- Jensen, F. V. & Nielsen, T. D., 2007. *Bayesian Networks and Decision Graphs*. 2nd ed. New York: Springer.
- Kalantarnia, M., Khan, F. & Hawboldt, K., 2009. Dynamic risk assessment using failure assessment and Bayesian theory. *Loss Prevention in the Process Industries*, Volume 22, pp. 600-606.
- Kalantarnia, M., Khan, F. & Hawboldt, K., 2010. Modeling of BP Texas City refinery accident using dynamic risk assessment approach. *Process Safety and Environmental Protection*, Volume 89, pp. 75-88.
- Kato, S. & Adams, N. J., 1991. *Quantitative Assessment of Blowout Data as it Relates to Pollution Potential*. SPE 23289. The Hague, SPE. November 10-14.
- Khakzad, N., Khan, F. & Amyotte, P., 2011. Safety analysis in process facilities: Comparison of fault tree and Bayesian network approaches. *Reliability Engineering and System Safety*, Volume 96, pp. 925-932.
- Khakzad, N., Khan, F. & Amyotte, P., 2012. Dynamic risk analysis using bow-tie approach. *Reliability Engineering and System Safety*, Volume 104, pp. 36-44.
- Khakzad, N., Khan, F. & Amyotte, P., 2013a. Dynamic safety analysis of process systems by mapping bow-tie into Bayesian network. *Process Safety and Environmental Protection*, Volume 91, pp. 46-53.
- Khakzad, N., Khan, F. & Amyotte, P., 2013b. Quantitative risk analysis of offshore drilling operations: A Bayesian approach. *Safety Science*, Volume 57, pp. 108-117.
- Khakzad, N., Khan, F. & Amyotte, P., 2013. Quantitative risk analysis of offshore drilling operations: A Bayesian approach. *Safety Science*, Volume 57, pp. 108-117.
- Khan, F., 2001. Use of maximum credible accident scenarios for realistic and reliable risk assessment. *Chemical Engineering Progress*, Volume 11, pp. 56-64.



- Khan, F. I. & Amyotte, P. R., 2003. How to make inherent safety practice a reality. *Canadian Journal of Chemical Engineering*, Volume 81, pp. 2-16.
- Khan, F. I. & Amyotte, P. R., 2004. Integrated inherent safety index (I2SI): a tool for inherent safety evaluation. *Process Safety Progress*, Volume 23(2), pp. 136-148.
- Khan, F. I. & Amyotte, P. R., 2005. I2SI: a comprehensive quantitative tool for inherent safety and cost evaluation. *Journal of Loss Prevention in the Process Industries*, Volume 18, pp. 310-326.
- Khan, F. I., Sadiq, R. & Amyotte, P. R., 2003. Evaluation of available indices for inherent safer design options. *Process Safety Progress*, Volume 22(2), pp. 83-97.
- Kletz, T. A., 1978. What you don't have, can't leak. *Chemistry and Industry*, Volume 6, pp. 287-292.
- Kletz, T. A., 1991. *Plant design for safety: A User-friendly Approach*. New York: Hemisphere Publishing Corporation.
- Kletz, T. A. & Amyotte, P. R., 2010. *Process plants: A handbook for inherent safer design*. 2nd ed. Boca Raton, Florida: Taylor & Francis.
- Koller, G., Fischer, U. & Hungerbuhler, K., 2001. Comparison of methods suitable for assessing the hazard potential of chemical processes during early design phases. *Transactions of IChemE*, Volume 79 (Pt B), pp. 157-166.
- Leading Edge Advantage, 2002. *Introduction to Underbalanced Drilling*, Aberdeen: Leading Edge Advantage Ltd..
- Leong, C. T. & Shariff, A. M., 2009. Process route index (PRI) to assess level of explosiveness for inherent safety quantification. *Journal of Loss Prevention in the Process Industries*, Volume 22(2), pp. 216-221.
- Leung, B. P. K. & Spiring, F. A., 2002. The inverted beta loss function: properties and applications. *IIE Transactions*, Volume 34, pp. 1101-1109.
- Leung, B. P. K. & Spiring, F. A., 2004. Some Properties of the Family of Inverted Probability Loss Functions. *Quality Technology and Quantitative Management*, Volume 1, pp. 125-147.
- Malloy, K. P. et al., 2009. *Managed-Pressure Drilling: What It Is and What It Is Not*. San Antonio, Texas, IADC/SPE 122281.
- Markowski, A. S. & Kotynia, A., 2011. "Bow-tie" model in layer of protection analysis. *Process Safety and Environmental Protection*, Volume 89, pp. 205-213.

- Ma, Y. & Zhao, F., 2004. An improved multivariate loss function approach to optimization. *Journal of System Science and System Engineering*, Volume 13, pp. 318-325.
- Meel, A. & Seider, W. D., 2006. Plant-specific dynamic failure assessment using Bayesian theory. *Chemical Engineering Science*, Volume 61, pp. 7036-7056.
- Minerals Management Service, 2008. *Notice to Lessees and Operators of Federal Oil, Gas, and Sulphur Leases in the Outer Continental Shelf, Gulf of Mexico OCS Region: Managed Pressure Drilling Projects. Report, NTL 2008-G07*. [Online]  
Available at:  
[http://www.iadc.org/committees/ubo\\_mpd/Documents/MMS%20NTL%202008-G07.pdf](http://www.iadc.org/committees/ubo_mpd/Documents/MMS%20NTL%202008-G07.pdf)  
[Accessed 9 January 2014].
- MMS, 2002. *Investigation of Blowout to High Island Block A 368 OCS-G 2433*, New Orleans: OCS Report Minerals Management Service (MMS 2002-080).
- Moore, D., 2008. Mud Cap Drilling. In: B. Rehm, et al. eds. *Managed Pressure Drilling*. Houston, Texas: Gulf Publishing Company, pp. 155-180.
- Neapolitan, R. E., 2004. *Learning Bayesian Networks*. Chicago: Prentice Hall Series.
- Neapolitan, R. E., 2009. *Probabilistic Methods for Bioinformatics: with an Introduction to Bayesian Networks*. 1st ed. Massachusetts: Morgan Kaufmann.
- NORSOK, 2004. *Well integrity in drilling and well operations. NORSOK STANDARD D-010*. 3rd ed. Lysaker: Standards Norway.
- Onisko, A., Druzdel, M. J. & Wasyluk, H., 2001. Learning Bayesian network parameters from small data sets: application of Noisy-OR gates. *International Journal of Approximate Reasoning*, Volume 27, pp. 165-182.
- OREDA, 2002. *Offshore Reliability Data Handbook*. 4th ed. s.l.:SINTEF.
- Palaniappan, C., Srinivasan, R. & Tan, R., 2002. Expert system for the design of inherently safer processes. 1-route selection stage & 2-flowsheet development stage. *Industrial & Engineering Chemistry Research*, Volume 41(26), pp. 6698-6722.
- Pearl, J., 1988. *Probabilistic Reasoning in Intelligent Systems*. San Mateo: Morgan Kaufmann.
- Phadke, M. S., 1989. *Quality Engineering Using Robust Design*. New York: Prentice Hall.
- Pignatiello, J. J., 1993. Strategies for robust multiresponse quality engineering. *IIE Transactions*, Volume 25, pp. 5-15.
- Pitblado, R., Bjerager, P. & Andreassen, E., 2010. *Key Aspects of an Effective U.S. Offshore Safety Regime*. [Online]

Available at: [http://www.dnvusa.com/Binaries/1008-001%20Offshore%20Update\\_Key%20aspects\\_tcm153-430982.pdf](http://www.dnvusa.com/Binaries/1008-001%20Offshore%20Update_Key%20aspects_tcm153-430982.pdf)  
[Accessed 9 January 2014].

Pruitt, 2012. *The Pruitt RCD at work*. [Online]

Available at: <http://pruitt.com/>  
[Accessed 20 January 2014].

Purba, J. H., 2014. A Fuzzy-based reliability approach to evaluate basic events of fault tree analysis for nuclear power plant probabilistic safety assessment. *Annals of Nuclear Energy*, Volume 70, pp. 21-29.

Rathnayaka, S., Khan, F. & Amyotte, P., 2011. SHIPP methodology: Predictive accident modeling approach. Part II. Validation with case study. *Process Safety and Environmental Protection*, Volume 89, pp. 75-88.

Rathnayaka, S., Khan, F. & Amyotte, P., 2013. Accident modeling and risk assessment framework for safety critical decision-making: application to deepwater drilling operation. *Proceedings of the Institution of Mechanical Engineers, Part O: Journal of Risk and Reliability*, Volume 227, pp. 86-105.

Rathnayaka, S., Khan, F. & Amyotte, P., 2014. Risk-based process plant design considering inherent safety. *Safet Science*, Volume 70, pp. 438-464.

Rehm, B., 2012. Introduction. In: B. Rehm, et al. eds. *Underbalanced Drilling - Limits and Extremes*. Houston: Gulf Publishing Company, pp. 1-38.

Rehm, B., Haghshenas, A., Paknejad, A. S. & Schubert, J., 2008. Situational Problems in MPD. In: B. Rehm, et al. eds. *Managed Pressure Drilling*. Houston: Gulf Publishing Company, pp. 39-78.

Rehm, B. et al., 2008. *Managed Pressure Drilling*. Houston, Texas: Gulf Publishing Company.

Reuters, 2015. *BP's fine for 2010 oil spill capped at \$13.7 billion*. [Online]  
Available at: <http://www.reuters.com/article/2015/01/16/us-bp-trial-idUSKBN0KO2N020150116>  
[Accessed 15 March 2015].

Ryan, T. P., 2011. *Statistical Methods for Quality Improvement*. 3rd ed. New York: Wiley Series.

Schlumberger, 2014. *wiper trip*. [Online]

Available at: [http://www.glossary.oilfield.slb.com/en/Terms/w/wiper\\_trip.aspx](http://www.glossary.oilfield.slb.com/en/Terms/w/wiper_trip.aspx)  
[Accessed 11 December 2014].

- Shalev, D. M. & Tiran, J., 2007. Conditioned-based fault tree analysis (CBTFA): A new method for improved fault tree analysis (FTA), reliability and safety calculations.. *Reliability and System Safety*, Volume 92, pp. 1231-1241.
- Shariff, A. M. et al., 2006. Inherent safety tool for explosion consequences study. *Journal of Loss Prevention in the Process Industries*, Volume 19, pp. 409-418.
- Shariff, A. M. & Zaini, D., 2010. Toxic release consequence analysis tool (TORCAT) for inherently safer design plant. *Journal of Hazardous Materials*, Volume 182, pp. 394-402.
- Simon, 2006. *Oil Rig Disasters*. [Online]  
Available at: [http://home.versatel.nl/the\\_sims/rig/i-blowout.htm](http://home.versatel.nl/the_sims/rig/i-blowout.htm)  
[Accessed 13 February 2014].
- Si, S., Levitin, G., Dui, H. & Sun, S., 2013. Component state-based integrated importance measure for multi-state systems. *Reliability Engineering and System Safety*, Volume 116, pp. 75-83.
- Skalle, P., 2014. *Pressure Control During Oil Well Drilling*. 5th ed. s.l.:bookboon.com.
- Skogdalen, J. E. & Vinnem, J. E., 2012. Quantitative risk analysis of oil and gas drilling, using Deepwater Horizon as a case study. *Reliability Engineering and System Safety*, Volume 100, pp. 58-66.
- Smith, J. R. & Patel, B. M., 2012. A Proposed Method for Planning the Best Initial Response to Kicks During Managed-Pressure Drilling Operations. *SPE Drilling & Completion*, June.pp. 194-203.
- Spiring, F. A., 1993. The reflected normal loss function. *Canadian Journal of Statistics*, Volume 21, pp. 321-330.
- Srinivasan, R. & Natarajan, S., 2012. Developments in inherent safety: a review of the progress during 2001-2011 and opportunities ahead. *Process Safety and Environment Protection*, Volume 90(5), pp. 389-403.
- Sun, F.-B., Laramée, J.-Y. & Ramberg, J. S., 1996. On Spiring's normal loss function. *The Canadian Journal of Statistics*, Volume 24, pp. 241-249.
- Taguchi, G., 1986. *Introduction to Quality Engineering: Designing Quality into Products and Processes*. White Plains, NY: Kraus.
- Taguchi, G., 1989. *Quality Engineering in Production Systems*. New York: McGraw-Hill.
- Tian, S., Medley, G. H. & Stone, C. R., 2009. Understanding yield point: Effect on pressure surges critical to managing deep, difficult MPD wells. *Drilling Contractor*, 3 November.

- Torstad, E., 2010. *Closed Loop Systems Reduce the Probability of Loss of Well Control*, September 30: DNV presentation.
- Torstad, E., 2010. *Closed Loop Systems Reduce the Probability of Loss of Well Control*. s.l.:DNV presentation.
- Tugnoli, A., Cozzani, V. & Landucci, G., 2007. A consequence based approach to the quantitative assessment of inherent safety. *AIChE Journal*, 53(12), pp. 3171-3182.
- Tugnoli, A., Landucci, G., Salzano, E. & Cozzani, V., 2012. Supporting the selection of process and plant design options by Inherent Safety KPIs. *Journal of Loss Prevention in the Process Industries*, Volume 23, pp. 830-842.
- Tuset, G. D., 2014. *Operational Barrier Elements in Critical Drilling Operations*, Trondheim: Department of Marine Technology, NTNU.
- Tyler, B. J., 1985. Using the Mond index to measure inherent hazards. *Plant operations Progress*, Volume 4, pp. 172-175.
- Vogel, R. & Brugman, J., 2008. Continuous Circulation System. In: B. Rehm, et al. eds. *Managed Pressure Drilling*. Houston, Texas: Gulf Publishing Company, pp. 127-142.
- Weatherford, 2012. *Weatherford Pressure Control Systems*. [Online]  
Available at:  
<http://www.weatherford.com/weatherford/groups/web/documents/weatherfordcorp/wft142070.pdf>  
[Accessed 20 January 2014].
- Wiegerinck, W., Kappen, B. & Burgers, W., 2010. Bayesian Networks for Expert Systems: Theory and Practical Applications. In: R. Babuska & F. C. A. Groen, eds. *Interactive Collaborative Systems*. Delft, The Netherlands: Springer, pp. 547-578.
- Wierenga, P. C. et al., 2009. Application of the Bow-Tie Model in Medical Safety Risk Analysis. *Drug Safety*, Volume 32, pp. 663-673.
- Zadakbar, O., Khan, F. & Imitiaz, S., 2014. Development of Economic Consequence Methodology for Process Risk Analysis. *Risk Analysis*, pp. 1-19.

## Chapter 4

### 4.0 Dynamic safety risk analysis of offshore drilling

#### Preface

*A version of this chapter has been published in the **Journal of Loss Prevention in the Process Industries 2014; 30: 74-85**. I am the primary author. Along with Co-author, Faisal Khan, I developed the conceptual model and subsequently translated this to the numerical model. I have carried out most of the data collection and analysis. I have prepared the first draft of the manuscript and subsequently revised the manuscript, based on the feedback from Co-authors and also peer review process. As Co-author, Faisal Khan assisted in developing the concept and testing the model, reviewed and corrected the model and results. He also contributed in reviewing and revising the manuscript. As Co-author, Nima Khakzad, contributed through support in developing the model, testing, reviewing and revising the manuscript.*

#### Abstract

The exploration and production of oil and gas involve the drilling of wells using either one or a combination of three drilling techniques based on drilling fluid density - conventional overbalanced drilling, managed pressure drilling and underbalanced drilling. The conventional overbalanced drilling involves drilling of wells with mud which exerts higher hydrostatic bottom-hole pressure than the formation pore pressure. Unlike the conventional overbalanced drilling, underbalanced drilling involves designing the hydrostatic pressure of the drilling fluid to be lower than the pore pressure of the formation being drilled. During circulation, the equivalent circulating density is used to determine the bottom-hole pressure conditions. Due to lower hydrostatic pressure, underbalanced drilling portends higher safety risk than its alternatives of conventional

overbalanced drilling and managed pressure drilling. The safety risk includes frequent kicks from the well and subsequent blowout with potential threat to human, equipment and the environment.

Safety assessment and efficient control of well is critical to ensure a safe drilling operation. Traditionally, safety assessment is done using static failure probabilities of drilling components which failed to represent a specific case. However, in this present study, a dynamic safety assessment approach for is presented. This approach is based on Bow-tie analysis and real time barriers failure probability assessment of offshore drilling operations involving subsurface Blowout Preventer. The Bow-tie model is used to represent the potential accident scenarios, their causes and the associated consequences. Real time predictive models for the failure probabilities of key barriers are developed and used in conducting dynamic risk assessment of the drilling operations. Using real time observed data, potential accident probabilities and associated risks are updated and used for safety assessment. This methodology can be integrated into a real time risk monitoring device for field application during drilling operations.

**Keywords:** Dynamic Risk assessment, Drilling techniques, Kick, Blowout, Bow-tie approach, Predictive probabilistic model

#### **4.1. Introduction**

The exploration and production of oil and gas involve the drilling of wells. Wells are drilled using either one or a combination of three drilling techniques based on drilling fluid density: conventional overbalanced drilling (COBD), managed pressure drilling (MPD), and underbalanced drilling (UBD) (Rehm, 2012). In COBD, the hydrostatic pressure of the drilling fluid (mud) column in the well is higher than the pore pressure of the formation. It involves the

use of water based mud, oil based mud or synthetic drilling fluid which contains weighting materials to keep the bottom-hole pressure (BHP) above the formation pore pressure. This technique is relatively economical as it requires the least expertise and easiest well control as heavy mud is used; however, it is susceptible to lost circulation, reduced rate of penetration (ROP) and formation damage which affects reservoir productivity (Bennion, et al., 1998a).

On the other hand, in UBD, the effective circulating bottom-hole pressure of the drilling fluid is intentionally designed to be lower than the pressure of the formation being drilled. This technique leads to a reduction in the possibility of lost circulation and formation damage; an increase in reservoir productivity (to as much as 60% more than COBD (Gough & Graham, 2008)), ROP, bit life; an elimination of the need for costly mud systems and disposal of exotic mud with the use of water and light fluids; a minimization of differential pipe sticking, extensive and expensive completion and stimulation operations; and enables flow testing while drilling. However, it is susceptible to well bore instability; suffers from an inability to use conventional measurement while drilling (MWD) technology; increases the cost of drilling due to the use of more equipment than conventional overbalanced drilling; requires highly skilled personnel as well control is complicated; and a carefully developed well plan is required (Bennion, et al., 1998b; Leading Edge Advantage, 2002). This drilling method is often characterized as high risk drilling.

MPD, a derivative of UBD, has been defined by the International Association of Drilling Contractors (IADC) (Minerals Management Service, 2008) as "an adaptive drilling process used to precisely control the annular pressure profile throughout the wellbore. The objectives are to ascertain the downhole pressure environment limits and to manage the annular pressure profile accordingly." It reduces lost circulation and formation damage, while increasing ROP. However,



more equipment, higher expertise for well control and higher risks are involved than conventional overbalanced drilling (Haghshenas, et al., 2008).

The choice of drilling technique is determined by the formation pressure (abnormally, normally or sub-normally pressured), nature of reservoir fluid (gas, condensate or black oil), type of well (exploratory, development, re-entry), formation geology (fractured or unconsolidated reservoirs), accessibility (onshore or offshore), economics, equipment availability, government policies or regulations and associated risks. Since most formation and reservoir properties are characterized with high uncertainty - exploratory and development drilling operations are associated with various forms of risks which have led to major rig accidents in the past: Ocean Ranger rig accident, in February, 1982, Deepwater Horizon drilling rig explosion, in April, 2010, Vermillion Oil Rig 380 explosion, in September, 2010 and Chevron Nigeria limited oil rig explosion, in January, 2012 (Arnold & Itkin LLP, 2014)

As drilling is a hazardous operation, safety is one of the major concerns. Safety is often measured in terms of risk (Khan, 2001). Risk is defined as a measure of accident likelihood and the magnitude of loss (fatality, environmental damage and/or economic loss). Risk analysis involves the estimation of accident consequences and frequencies using engineering and mathematical techniques (Crowl & Louvar, 2002). Various techniques have been developed for quantitative risk analysis; the foremost among the conventional methods are fault tree and event tree analyses. The results of these analyses are used in risk assessment to evaluate the safety provided for preventing or mitigating the consequences of accidents. Conventional risk assessment techniques are known to be static; failing to capture the variation of risks as operation or changes in the operation take place (Khakzad, et al., 2012). Besides, conventional risk assessment techniques make use of generic failure data; making them to be non case-specific and also, introduces uncertainty into the

results. These limitations have led to the development of dynamic risk assessment method. Dynamic risk assessment method is meant to reassess risk in terms of updating initial failure probabilities of events (causes) and safety barriers as new information are made available during a specific operation. Two ways are currently used in revising prior failure probabilities: (i) Bayesian approaches through which new data in form of likelihood functions are used to update prior failure rates using Bayes' theorem (Meel & Seider, 2006; Kalantarnia, et al., 2009; Kalantarnia, et al., 2010; Khakzad, et al., 2012). (ii) Non-Bayesian updating approaches in which new data are supplied by real time monitoring of parameters, inspection of process equipments and use of physical reliability models (Shalev & Tiran, 2007; Khakzad, et al., 2012; Ferdous, et al., 2013).

Underbalanced drilling is undertaken to maximize hydrocarbon recovery while minimizing drilling problems. However, it is associated with safety concerns as a result of the BHP being always less than the formation pore pressure which increases the possibility of kicks and blowout, thus, endangers personnel, facilities as well as the environment. There are a few studies on the risk analysis of overbalanced drilling (Bercha, 1978; Anderson, 1998; Skogdalen & Vinnem, 2012; Rathnayaka, et al., 2013; Khakzad, et al., 2013a) and modeling of BOP systems (Holland, 1991; Fowler & Roche, 1994; Holland, 2001). The study of MPD and UBD is limited to Safety and Operability (SAFOP) analysis (Engevik, 2007).

The present study is aimed at conducting a dynamic quantitative risk assessment of drilling operations using advanced approach that can use real time data from the operation. The main objectives of this study are: (i) to develop a detailed quantitative risk analysis model that helps to assess and update the risk during drilling operation and (ii) to identify most vulnerable causes that have propensity to cause accident (blowout). Knowing these will help to design blowout

prevention and mitigation measures. The study is focused on offshore application of three drilling techniques with subsurface blowout preventer (BOP). A brief description of drilling techniques and a description of dynamic risk methodology are presented in subsequent sections.

## **4.2. Drilling Techniques**

### **4.2.1. Conventional Overbalanced Drilling (COBD)**

COBD involves drilling of a well with a drilling mud whose hydrostatic pressure is deliberately kept higher than the BHP. It is the basis of rotary drilling, thus, the commonest technique in the oil and gas industry. It is practiced because of its ease of well control, requiring the least planning, least expensive as the basic equipment of rotary drilling are used and the least number of crew members of all drilling techniques. The mud composition stabilizes the wellbore and is also compatible with all types of MWD tools ; however, it has the least rate of penetration due to heavy mud used and could lead to lost circulation, stuck piping and formation damage (for details, please see Adams, 1985; Bourgoyne, et al., 1986).

### **3.2.2. Underbalanced Drilling (UBD)**

UBD includes drilling techniques employing appropriate equipment and controls to drill a well at a wellbore pressure less than the pore pressure in any part of the exposed formations in order to bring formation fluid to the surface (IADC) (Rehm, 2012). It is classified into two categories based on the type of drilling fluid: single phase fluids and two-phase (gaseous and compressible) fluids. The single phase fluid drilling comprises all underbalanced drilling techniques that do not use compressible gases as drilling fluid. It includes water, oil and additives such as glass beads. Two-phase fluid drilling, otherwise known as compressible fluid drilling, utilizes compressible fluids such as air, mist, foam and aerated mud (Leading Edge Advantage, 2002). Other forms of UBD

are coiled tubing drilling, liner drilling and casing while drilling. In UBD operation, COBD equipment are used in addition to specialized facilities which include: rotating control device (RCD), snubbing unit, drill-string non return valves, compressors for gas generation (if applicable) and dedicated choke manifold (for details, please see Bennion, et al., 1998a; Bennion et al., 1998b; Hannegan & Wazner, 2003; Leading Edge Advantage, 2002; Gough & Graham, 2008).

#### **4.2.3. Managed Pressure Drilling (MPD)**

MPD like UBD is a closed-loop fluid system requiring some of the UBD's specialized equipment: RCD, drill-string non-return valve and a dedicated choke manifold. It uses a single-phase drilling fluid to produce minimal friction losses. It is also described as near-balanced drilling as the mud hydrostatic pressure is kept close to the formation pore pressure, hence, it is called a constant bottom-hole pressure drilling technique. MPD unlike UBD avoids kicks during drilling. It has the ability to reduce non-productive time, making it a candidate for offshore drilling consideration (for details, please see Haghshenas, et al., 2008; Cohen et al., 2008; Fredericks, 2008; Vogel & Brugmann, 2008; Rehm, et al., 2008; Smith & Patel, 2012).

#### **4.2.4. Well Control Considerations**

Well control operations deal with the procedures to be undertaken when formation fluids start flowing into the well bore and displacing the drilling fluid. This flow of formation fluids into the wellbore is called kick while the uncontrolled flow to the surface is known as blowout. In COBD, the primary well control is the drilling mud. During well control operations, early detection of kicks is sought. The well is shut in with the blowout preventer (BOP) – first with the annular preventer, followed by the pipe ram and lastly, with the shear ram in a very dangerous situation. Depending on the method (Driller's method or Engineer's method), kick fluid is circulated to the surface using Kill mud (heavy mud) to bring the well under control via the kill/choke lines

(Bourgoyne, et al., 1986). However, in UBD, since less BHP compared to formation pore pressure is desired; flow of formation fluid into the well is induced. Instead of shutting in the well, the kick fluid is circulated in a controlled manner with the combination of the rotating control device, diverter line and the choke system to the surface. Control over too much or too little flow of formation fluid into the well is done by changing the BHP through increasing or decreasing the choke pressure, changing the drilling fluid density for single phase flow, changing the liquid to gas ratio with two-phase fluid and changing the pump rate. The drilled cuttings together with the formation fluid mix with the drilling fluid and flow via the annulus en route to the surface. The mixture is separated at the surface into its constituents, i.e. drilling fluid, drilled cuttings, formation fluids of oil, water and natural gas. The oil is stored temporarily in an atmospheric storage tank while the natural gas is stored, flared or re-injected into the annulus with the air (or nitrogen) to lighten the column of fluid (Hannegan & Wanzer, 2003; Gough & Graham, 2008).

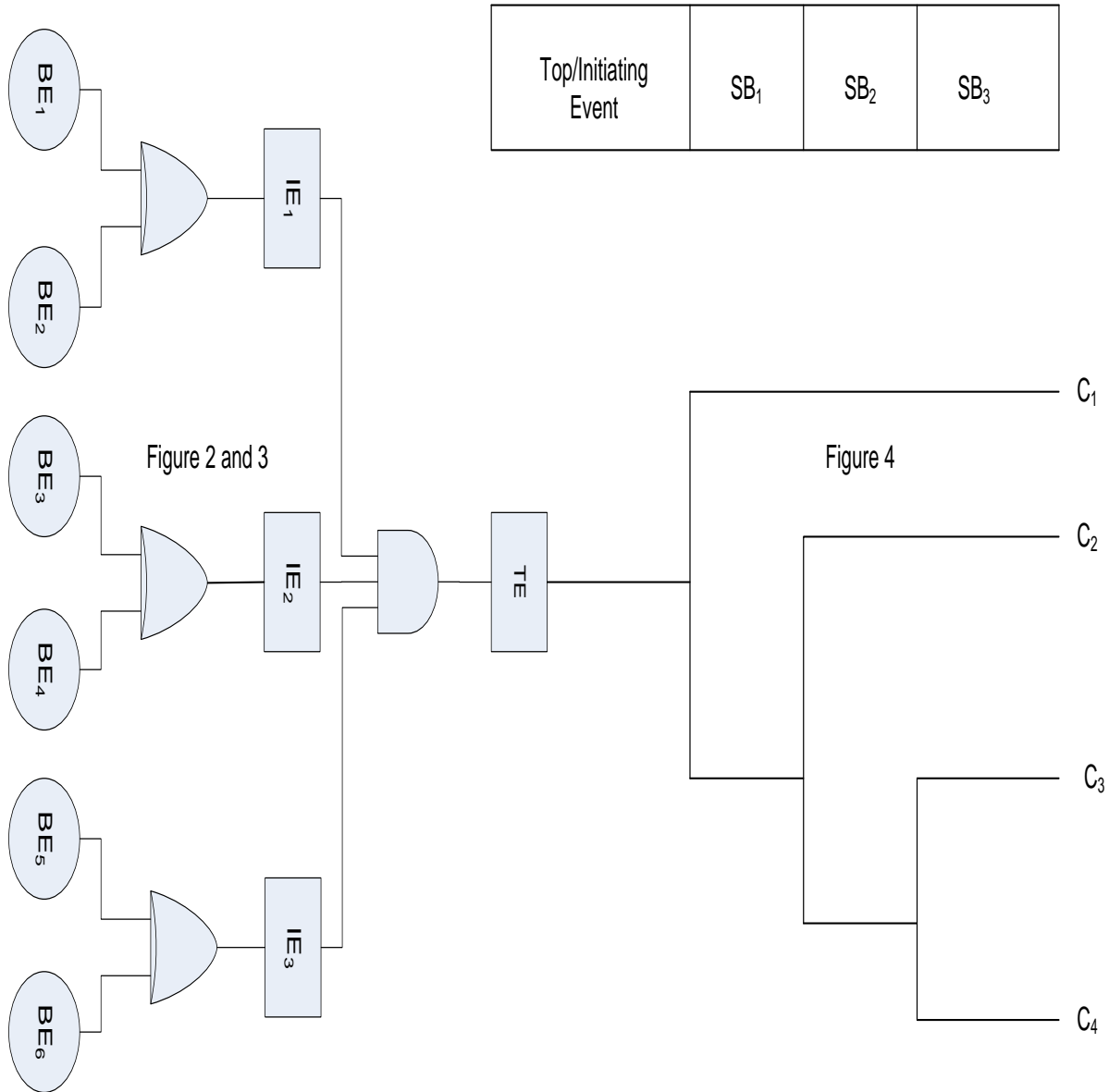
### **4.3. Dynamic Risk Assessment**

Conventional risk assessment methods such as fault tree and event tree analyses have commonly been used in accident modeling and risk quantification. These methods are simple and provide quick results and inferences. The combination of fault and event trees forms a Bow-tie (BT) risk model. A BT model has the top event of the fault tree as the initiating event of the event tree. The BT diagram presents a logical relationship between the causes (expressed as basic events) to the consequences through safety barriers. Markowski and Kotynia (2011) used BT in layer of protection analysis to model a complete accident scenario in a hexane distillation unit. Similarly, forms of BT have been applied in medical safety risk analysis and hazard and effects management process of vehicle operations (Wierenga et al., 2009; Eslinger et al., 2004). Due to the limitations

of conventional risk assessment techniques stated in section 1, recent studies have led to the development of advanced dynamic risk assessment methods. These dynamic risk assessment methods are meant to update the initial failure probabilities events (causes) and safety barriers as new information are available. A few studies are reported using dynamic risk approach in dust explosion accident (Khakzad, et al., 2012), a Bayesian approach to quantitative risk analysis of offshore drilling operations (Khakzad, et al., 2013a) and an accident modeling and risk assessment of a deepwater drilling operation (Rathnayaka, et al., 2013). In this present work, a dynamic bow-tie risk model for offshore drilling operations is developed and analyzed for safety critical operation decision-making.

#### **4.3.1. Bow-Tie Risk Model of Drilling Operations**

A bow-tie risk model for offshore application of COBD, UBD and MPD is developed (Figure 4.1). In the diagram, BE, IE and TE represent the basic event (component or action), intermediate event and top event respectively of the fault trees of Figures 4.2 and 4.3. TE, SB and C are the initiating event, safety barrier and consequence of the event tree in Figure 4.4. Only the well section is modeled in this study, surface facilities are not included. The potential causes of kick are based on the work of Kato and Adams (1991). The well control mechanism prevents the occurrence of a kick as in COBD and MPD or mitigates its effects as in UBD. The well control mechanism also prevents a kick from resulting to a blowout; hence, is placed side by side with kick in the fault tree in Figure 4.2.



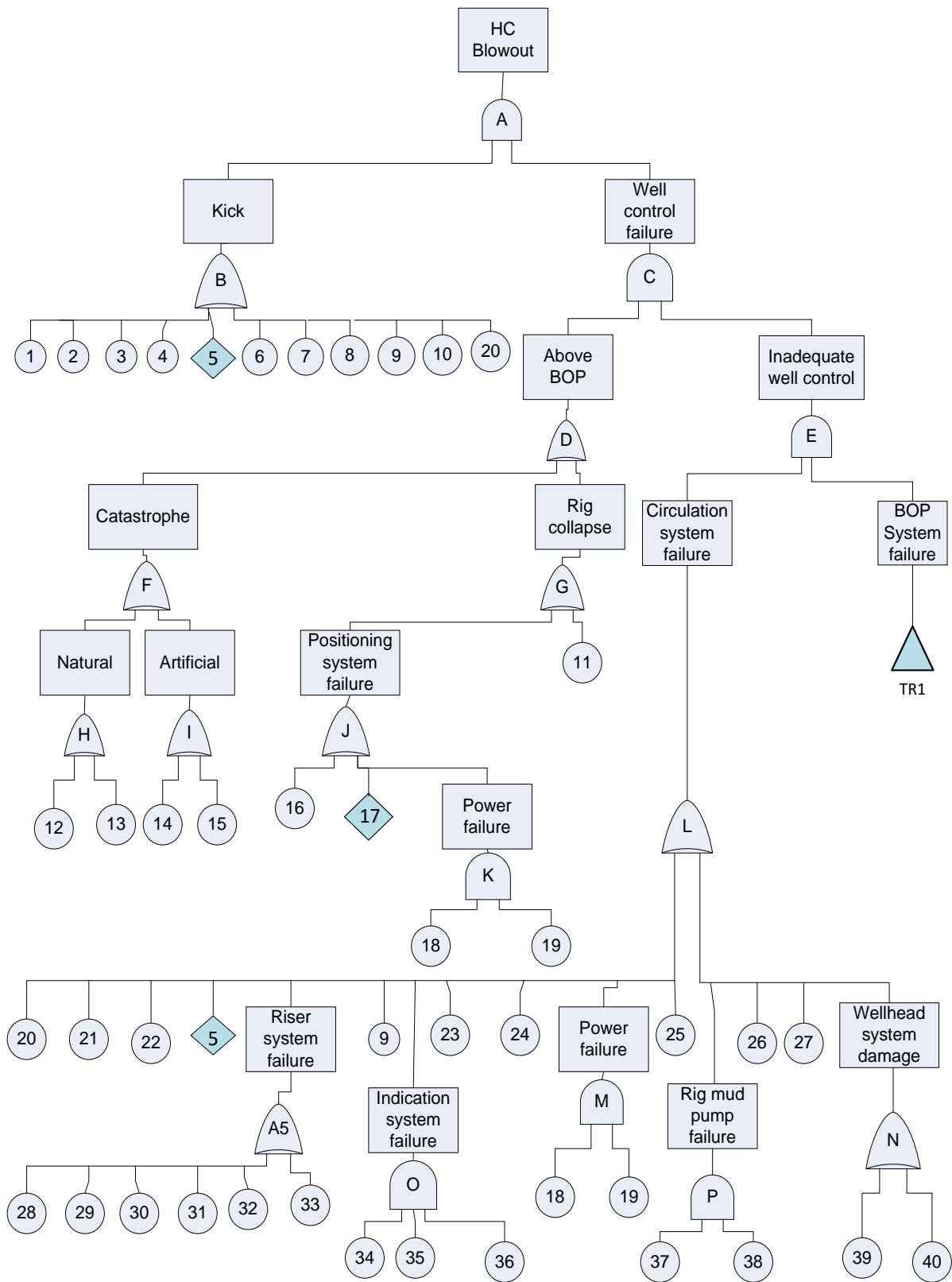
**Figure 4.1 - Bow-tie Risk Model for drilling operations.**

The collapse of the rig, natural and artificial disasters which can lead to loss of well control are external to the BOP system. The BOP system prevents or mitigates the effects of the collapse of a rig, natural and artificial disasters and the eventual loss of primary well control in the circulation system. The BOP system comprises rotating control device (RCD), the snubbing unit, the diverter system and the conventional subsea BOP stack. The success of UBD and MPD operation relies on

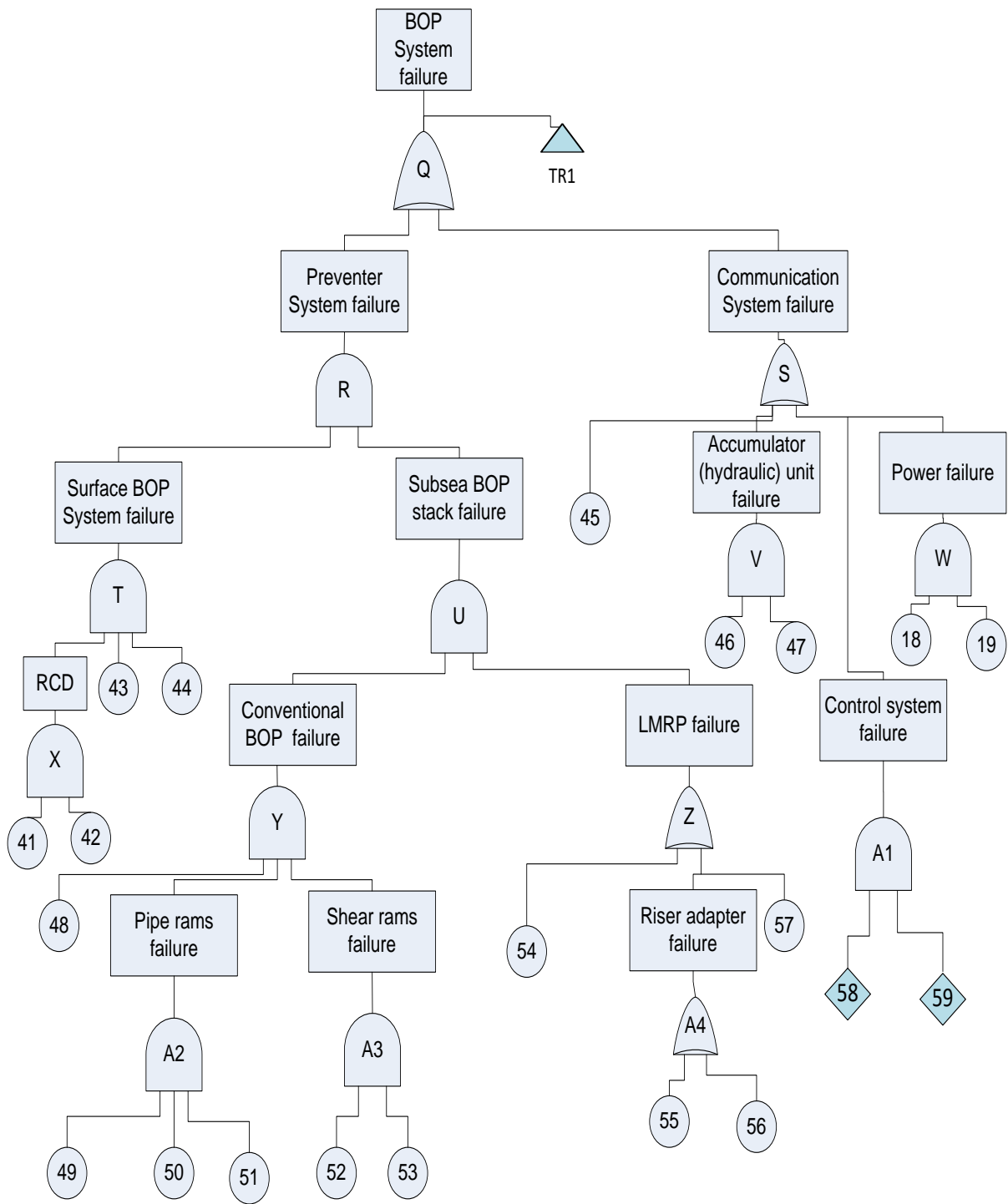
the well control mechanism of the RCD with particular emphasis on the seal in conjunction with a dedicated choke manifold (Hannegan & Wanzer, 2003). The snubbing unit serves as back up for the RCD. In COBD operation, the diverter system is provided for shallow gas handling to prevent premature formation fracturing. Ultimately, well control is assured with the conventional subsea BOP stack.

The BOP stack comprises the lower marine riser package (LMRP), the lower annular preventer and the ram preventers – upper pipe ram or variable bore ram, middle pipe ram, lower pipe ram, casing shear ram and blind shear ram. These dictate the general structures of the fault trees in Figures 4.2 and 4.3. In the formulation of the model, efforts were focused on safety critical components and actions. In other words, only the fault condition or failure mode of the components which is critical to the failure of the system and resulting to undesired condition (hydrocarbon blowout) is studied. Components such as the redundant fail-safe valves connecting the choke and kill lines to the BOP and the choke and kill lines themselves are not duplicated in the fault tree; rather, their aggregated failure probabilities are used. The characteristics of the components and their corresponding probabilities are presented in Table 4.1 (Bercha, 1978; OREDA, 2002).





**Figure 4.2 - Fault Tree Model for Drilling Operations.**



**Figure 4.3 - Fault Tree Model for Drilling operations Continued.**

**Table 4.1 - Basic events and their probabilities (Bercha, 1978; OREDA, 2002)**

<b>Basic event</b>	<b>Description</b>	<b>Probability</b>
1	Abnormal pressured zone	1.50E-01
2	Swabbing	5.40E-02
3	Gas cut mud	3.00E-05
4	Inadequate hole fill up	2.00E-03
5	Bad cementing	1.00E-03
6	Gas pocket/shallow gas	3.00E-05
7	Stuck pipe	1.00E-03
8	Drillpipe failure	5.00E-05
9	Insufficient ECD	5.00E-02
10	Loss circulation	2.70E-03
11	Poor design	5.00E-04
12	Storm/Hurricane	3.00E-05
13	Ice	3.00E-05
14	War/Vandalism	3.00E-05
15	Collision of ships	3.00E-05
16	Operator error (positioning)	2.00E-03
17	Dynamic positioning failure	5.00E-04
18	Primary power failure	5.00E-04
19	Secondary power failure	5.00E-04
20	Casing failure	6.40E-04
21	Drill pipe failure	5.00E-04
22	Choke/kill lines failure	3.60E-04
23	ESD valve failure	1.30E-04
24	Fail safe valves failure	2.20E-04
25	Operator error (mud engineering)	1.00E-03
26	Choke manifold failure	4.51E-03
27	Drill pipe non-return valve failure	1.30E-04
28	Riser connector failure	1.00E-04
29	Riser stand failure	1.00E-04
30	Telescopic joint failure	1.00E-04
31	Wave motion compensator failure	1.00E-04
32	Tensioner failure	1.00E-04
33	Automatic fill up valve failure	1.00E-05
34	Pit level indicator failure	2.00E-04
35	Pump stroke failure	2.00E-04
36	Mud flow indicator failure	2.00E-04
37	Main pump failure	4.30E-03
38	Backup pump failure	4.30E-03
39	Wellhead housing damage	1.00E-05
40	Wellhead connector failure	1.00E-05

41	Primary RCD seal failure	6.70E-03
42	Backup RCD seal failure	6.70E-03
43	Diverter system failure	3.60E-03
44	Snubbing unit failure	4.30E-03
45	Operator error (BOP)	2.00E-03
46	Primary accumulators failure	1.00E-05
47	Backup accumulators failure	1.00E-05
48	Lower annular preventer failure	2.60E-04
49	Upper/Variable pipe ram failure	2.50E-05
50	Middle pipe ram failure	2.50E-05
51	Lower pipe ram failure	2.50E-05
52	Blind shear ram failure	1.00E-05
53	Casing shear ram failure	1.00E-06
54	Upper annular preventer failure	2.60E-04
55	Upper flexible joint failure	1.00E-05
56	Lower flexible joint failure	1.00E-05
57	LMRP connector failure	1.00E-05
58	Main control system failure	2.52E-02
59	Acoustic backup control system failure	2.52E-02

The event tree (Figure 4.4) part of the Bow-Tie model comprises of three safety barriers, namely: Ignition Prevention Barrier (IPB), Escalation Prevention Barrier (EPB) and Damage Control & Emergency Management Barrier (DC&EMB). The IPB includes means for preventing ignition by sparks, friction, impact or hot surface which include hydrocarbon detection and alarm system, hot surface shields, sparks and friction inhibitors. EPB comprises fire and gas detection, suppression and alarm system, automatic sprinkler system and onsite fire extinguishers. DC&EMB involves external intervention such as firefighting service to reduce and control the damage resulting from the escalating fire and explosions. Also, it includes training of crew members on emergency response procedures and provision of facilities for safe escape and evacuation from the site (Rathnayaka, et al., 2011).

The success of IPB prevents blowout from resulting to a primary vapor cloud explosion or pool fire. However, a minor to significant vapor cloud/oil spill to the marine environment is experienced depending on the duration. Vapor cloud explosion/pool fire occurs if the IPB fails, leading to a significant pollution to the environment with minor injuries to personnel. Secondary explosions and fire occur as a result of the failure of IPB and EPB. A significant damage to the rig and the environment is recorded with life threatening injuries to a few deaths. Finally, event leads to a catastrophe characterized with a severe damage to the well, rig, long term environmental damage as a result of prolonged oil spill and multiple fatalities. Though consequence severity levels and their corresponding loss values are case specific and vary among companies; a summary of the consequence severities and their loss values used in this study is presented in Table 4.2.

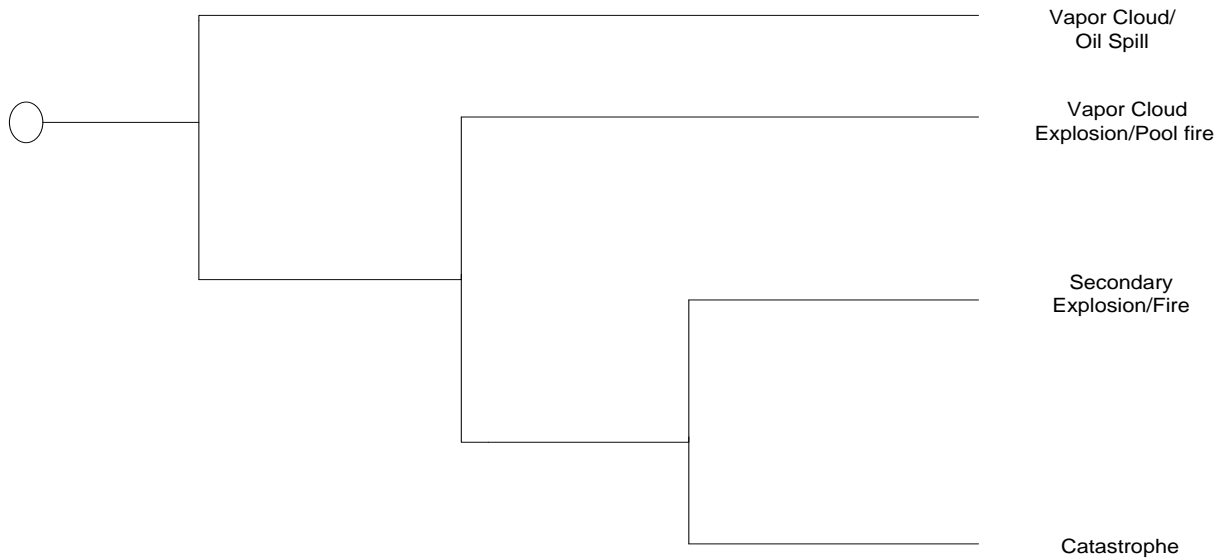
**Table 4.2 - Consequence severity levels and loss values**

<b>Event</b>	<b>Severity level</b>	<b>Description</b>	<b>Loss value (M USD)</b>
Vapor cloud/oil spill	1	Minor to significant vapor cloud/oil spill	100
Vapor cloud explosion (VCE)/pool fire	2	VCE/pool fire occurs due to ignition, significant pollution to the environment, minor injury to personnel	200
Secondary explosion/fire	3	Multiple explosions occur with prolonged fire, major damage to rig, environment, life threatening injuries to a few fatalities	750

Catastrophe	4	Continuous fire with severe damage to well, rig, environment, multiple fatalities	5000
-------------	---	---	------

---

Hydrocarbon Blowout	Ignition Prevention Barrier (IPB)	Escalation Prevention Barrier (EPB)	Damage Control and Emergency Management Barrier (DC&EMB)	Consequence
---------------------	-----------------------------------	-------------------------------------	--	-------------



**Figure 4.4 - Event Tree Model for Consequence Analysis**

**4.3.2. Predictive Probabilistic Model**

Drilling equipment are often rated by their working pressures. The components such as the rotating control device (RCD), choke manifold, BOP, valves, choke and kill lines, snubbing unit and diverter system are designated with their working pressure ratings which signify the pressures

beyond which they are bound to fail. The real time predictive failure probabilities of these components are modeled using physical reliability model of constant strength and random stress of exponential distributions (Ebeling, 1997). The strength,  $k$ , represents the working pressure rating of the component while the stress,  $\sigma$ , is the formation pressure present during drilling. The component fails when the load (stress) is greater than its strength. Mathematically,

the failure probability of the component (PC) is given as:

$$P(PC \text{ failure}) = P(\sigma > k) = \int_k^{\infty} f_{\sigma}(\sigma) d\sigma \quad (4.1)$$

Thus, for exponential stress distribution:

$$P(PC \text{ failure}) = \int_k^{\infty} \lambda \exp(-\lambda\sigma) d\sigma = \exp(-\lambda k) \quad (4.2)$$

The mean of exponential distribution is given as:

$$E(\sigma) = 1/\lambda \quad (4.3)$$

$$P(PC \text{ failure}) = \exp(-k/E(\sigma)) \quad (4.4)$$

Where  $E(\sigma)$  is the expected value of the measured formation pressure. The formation pressure is measured using mud pulse telemetry tool in COBD and MPD and electromagnetic telemetry tool in UBD or other logging while drilling (LWD)/measurement while drilling (MWD) tools. The components highlighted above are at a true vertical height  $h$  (ft) from the bottom hole, thus, Eq. 4.4 becomes:

$$P(PC \text{ failure}) = \exp(-k/(E(\sigma) - 0.052 * ECD * h)) \quad (4.5)$$

where  $ECD$  (ppg) is the equivalent circulating density of the mud comprising the mud hydrostatic pressure and the frictional pressure loss in the annulus.  $k$  and  $E(\sigma)$  are both in *psi*.  $E(\sigma)$  can also be expressed as a function of  $h$  as

$$E(\sigma) = 0.433h \quad (4.6)$$

for fresh water formation fluid or as

$$E(\sigma) = 0.465h \quad (4.7)$$

for salt water formation fluid (Adams, 1985; Bourgoyne, et al., 1986).

The failure probabilities of the safety barriers ( $SB$ ) of the event tree are updated by Bayes's theorem (Eq. 4.8) with the accident precursor data (APD) gathered as the drilling operation progresses, leading to posterior failure probabilities (Bedford & Cooke, 2001)

$$P(SB_i/APD) = P(APD/SB_i)P(SB_i)/\sum P(APD/SB_i)P(SB_i) \quad (4.8)$$

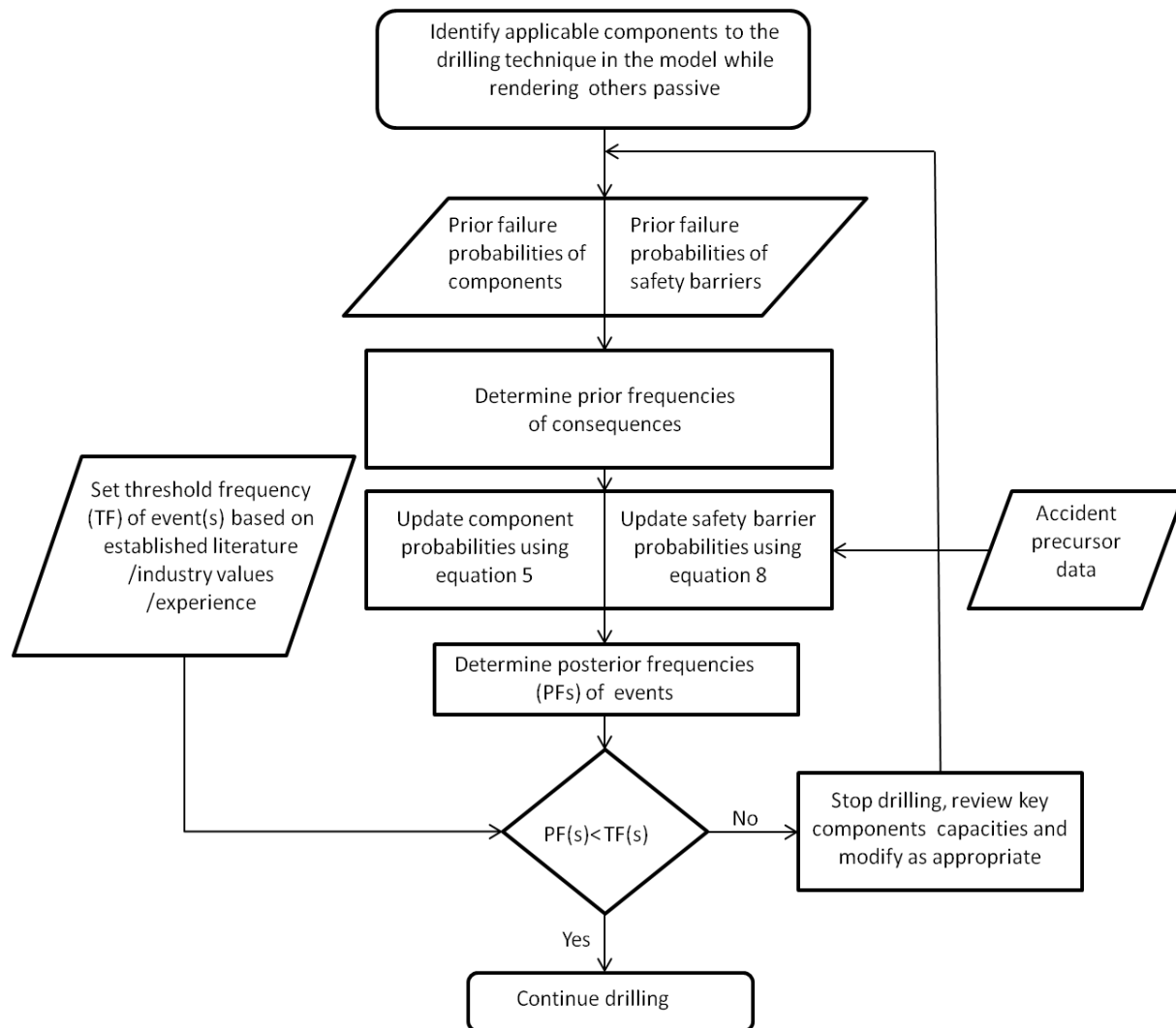
where  $P(SB_i)$  is the prior failure probability of  $SB_i$ ,  $P(APD/SB_i)$  is the likelihood function derived from the accident precursor data and  $\sum P(APD/SB_i)P(SB_i)$ , is the normalizing factor. Thus, the occurrence frequencies of the various consequences of the event tree are updated through Bayes theorem.

### 4.3.3. Bow-Tie Model Analysis

The Bow-tie model analysis follows the algorithm shown in Figure 4.5. The components applicable to the drilling technique are identified. The prior failure probabilities of these components and that of the safety barriers are determined. These are used to compute the probabilities of blowout occurring and subsequently, the prior frequencies of the consequences. As drilling progresses, failure probabilities of components are updated using Equation 5. In addition, accident precursor data are collected and used to update the probabilities of the safety barriers. Both are used to obtain the posterior (updated) frequencies of the consequences. These are compared with the threshold frequency of end event(s) set by established literature/industry



values/based on experience. Drilling operation is continued if the posterior frequencies are less than the threshold frequency; otherwise, drilling is halted, a review of component capacities or pressure ratings and necessary modifications are made before drilling operation progresses. In this way, safety is ensured, unnecessary downtime and accidents are prevented.



**Figure 4.5 - Bow-tie analysis algorithm**

A comparison is made between COBD and UBD considering the following conditions:

- permeability of the formation is sufficiently high
- the reservoir is sufficiently pressured as to support hydrocarbon influx into the well (kick) and the subsequent blowout if all the relevant barriers fail
- for COBD, rotating control device (RCD), dedicated choke manifold and snubbing unit are not used.

With the probabilities presented in Table 4.1, the occurrence probability of a blowout for COBD is estimated as  $7.97E-04$ . For UBD operation, the probability of a blowout is estimated as  $5.70E-03$  as a result of insufficient ECD. It is noticed that the chance of having a blowout is increased by a factor of 7 in UBD operation as opposed to COBD.

Furthermore, in the course of drilling, the primary well control (drilling mud) is relied on for COBD while the functions of RCD and the choke manifold together with the drilling fluid of insufficient mud weight are employed to provide primary well control for UBD operation. The well is then not shut in with the BOP except when well control is in danger; thus, the functions of the BOP for both techniques and the snubbing unit are relaxed. Under this condition, occurrence probability of a blowout for COBD is estimated as  $1.50E-02$  while for UBD, the occurrence probability is estimated as  $5.80E-03$ . It is observed that the occurrence probability of a blowout in COBD almost tripled that of UBD. This shows the importance of RCD in assuring the safe operation of UBD. RCD has been identified critical to ensure the success of UBD (Hannegan & Wanzer, 2003). It is worth mentioning that seals are critical elements of RCD, thus, must be best designed and maintained.

The failure probability of RCD seals with a redundant pair arrangement in the above analysis is  $6.70E-03$ . Assuming a salt water formation and using Eqs. (4.5) and (4.7), a well depth of 4000 ft

should not be exceeded for gasified drilling fluid of density 4 ppg and a well depth of 20000 ft for water drilling mud could be achieved while keeping the failure probability of RCD below 6.70E-03 as shown in Table 4.3 and Figure 4.6. This behavior of water drilling mud is supported by the observations in MPD where the density of the drilling fluid is kept as close as possible to the formation pressure. However, with the modern formation pressure measurement while drilling tools, precise stress determination is ensured. The prior failure probabilities of the safety barriers are listed in Table 4.4. A set of accident precursor data from a UBD operation is presented in Table 4.5. These are the cumulative number of abnormal events that were observed over the period of 24 hours towards the major accident (catastrophe). For example, the cumulative number of vapor cloud/oil spill end event at the 22nd hour is 13 as shown in Table 4.5. The accident precursor data are used to update the failure probabilities of the safety barriers - Ignition Prevention Barrier (IPB), Escalation Prevention Barrier (EPB) and Damage Control and Emergency Management Barrier (DC&EMB).

**Table 4.3 - Failure probabilities of the RCD with water and gasified fluid drilling mud**

Depth, <i>h</i> (ft)	Stress, $E(\sigma)$ , (psi)	Strength, $k$ , (psi)	Failure probabilities	
			Water	Gasified fluid
500	232.5	5000	$\approx 0$	$\approx 0$
1000	465	5000	$\approx 0$	$\approx 0$
1500	697.5	5000	$\approx 0$	2.33E-06
2000	930	5000	$\approx 0$	5.96E-05
2500	1162.5	5000	$\approx 0$	4.17E-04
3000	1395	5000	$\approx 0$	1.53E-03
3500	1627.5	5000	$\approx 0$	3.85E-03
4000	1860	5000	$\approx 0$	7.72E-03
4500	2092.5	5000	$\approx 0$	1.33E-02
5000	2325	5000	$\approx 0$	2.04E-02
5500	2557.5	5000	$\approx 0$	2.91E-02
6000	2790	5000	$\approx 0$	3.91E-02

6500	3022.5	5000	$\approx 0$	5.01E-02
7000	3255	5000	$\approx 0$	6.21E-02
7500	3487.5	5000	$\approx 0$	7.47E-02
8000	3720	5000	$\approx 0$	8.79E-02
8500	3952.5	5000	$\approx 0$	1.01E-01
9000	4185	5000	2.64E-08	1.15E-01
9500	4417.5	5000	6.62E-08	1.29E-01
10000	4650	5000	1.51E-07	1.43E-01
10500	4882.5	5000	3.20E-07	1.57E-01
11000	5115	5000	6.31E-07	1.71E-01
11500	5347.5	5000	1.17E-06	1.84E-01
12000	5580	5000	2.07E-06	1.98E-01
12500	5812.5	5000	3.50E-06	2.11E-01
13000	6045	5000	5.67E-06	2.24E-01
13500	6277.5	5000	8.88E-06	2.37E-01
14000	6510	5000	1.34E-05	2.49E-01
14500	6742.5	5000	1.98E-05	2.61E-01
15000	6975	5000	2.84E-05	2.73E-01
15500	7207.5	5000	3.98E-05	2.85E-01
16000	7440	5000	5.46E-05	2.96E-01
16500	7672.5	5000	7.36E-05	3.08E-01
17000	7905	5000	9.73E-05	3.18E-01
17500	8137.5	5000	1.27E-04	3.29E-01
18000	8370	5000	1.63E-04	3.39E-01
18500	8602.5	5000	2.06E-04	3.49E-01
19000	8835	5000	2.57E-04	3.59E-01
19500	9067.5	5000	3.18E-04	3.69E-01
20000	9300	5000	3.89E-04	3.78E-01

**Table 4.4 - Prior failure probabilities of the safety barriers**

<b>Safety Barrier, <math>SB_i</math></b>	<b>Ignition Prevention Barrier (IPB)</b>	<b>Escalation Prevention Barrier (EPB)</b>	<b>Damage Control and Emergency Management Barrier (DC&amp;EMB)</b>
Failure probability, $p(SB_i)$	2.72E-02	8.60E-03	1.50E-03

**Table 4.5 - Accident precursor data (cumulative) from a UBD operation over a period of 24 hours towards the major accident (catastrophe)**

<b>Hour</b>	<b>Vapor cloud/Oil spill</b>	<b>VCE /Pool fire</b>	<b>Secondary Explosion/ Fire</b>	<b>Catastrophe</b>
1	1	-	-	-
2	1	-	-	-
3	2	1	-	-
4	2	1	-	-
5	2	1	-	-
6	3	1	-	-
7	3	1	-	-
8	4	1	-	-
9	5	2	-	-
10	6	2	-	-
11	6	2	-	-
12	7	2	-	-
13	7	2	-	-
14	8	2	-	-
15	9	2	-	-
16	10	3	-	-
17	10	3	-	-
18	11	3	-	-
19	11	3	-	-
20	11	3	-	-

21	12	4	-	-
22	13	5	1	-
23	14	6	2	-
24	15	7	3	1

---

The prior occurrence frequencies of the consequences with a blowout probability estimated as 5.80E-03 are presented in Table 4.6. The updated failure probabilities of safety barriers are shown in Table 4.7 (bold and italic) using Eq. 4.8. For illustration purpose, at the 22nd hour, for IPB, the likelihood function is determined by the ratio of the number of failures (5+1) to the total number of abnormal events (successes and failures, 13+5+1) at that instant. That is,

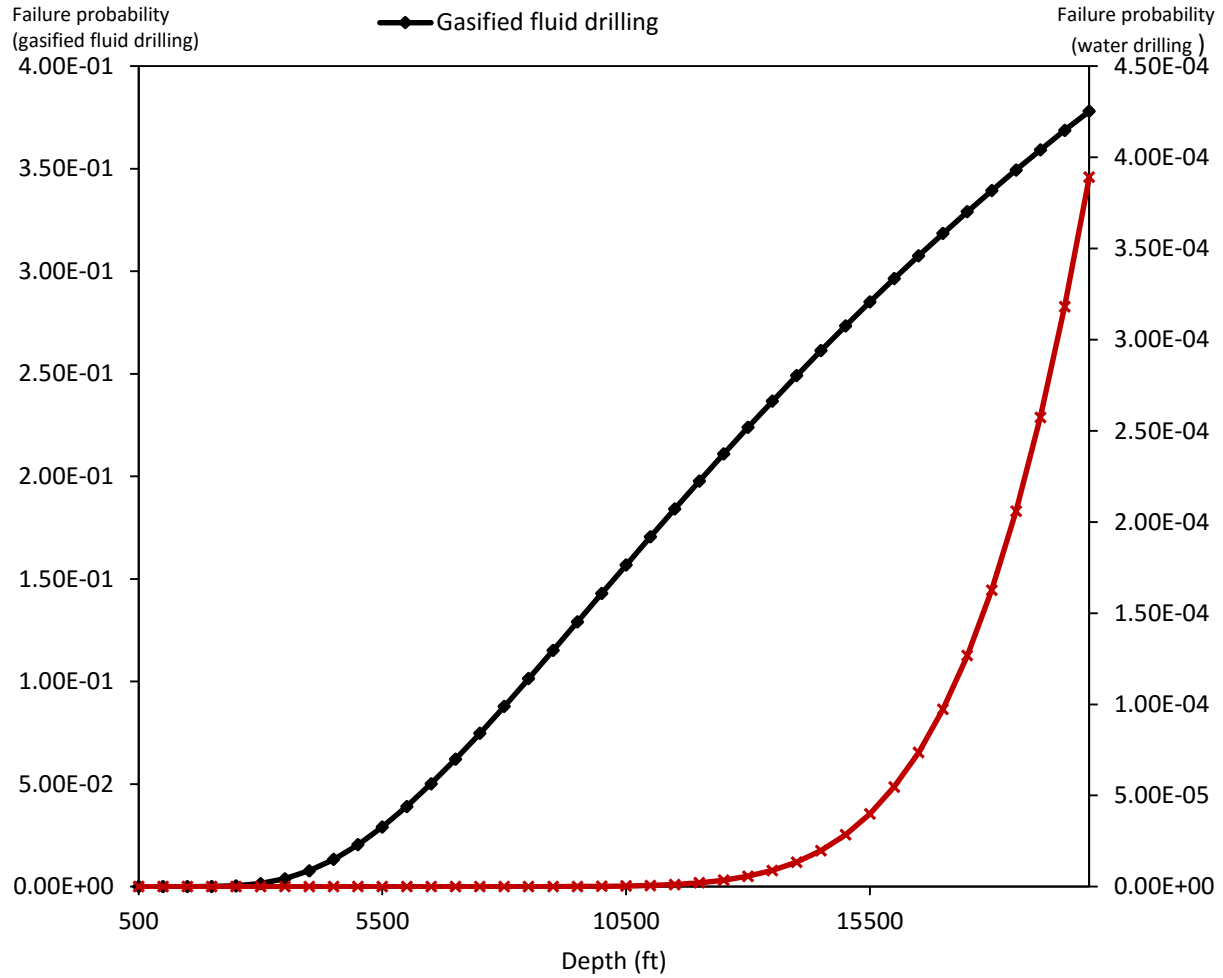
$$p(APD/SB_{IPB}) = 6/19 = 0.3158$$

The posterior probability of IPB at the 22nd hour is calculated as:

$$p(SB_{IPB}/APD) = p(APD/SB_{IPB})p(SB_{IPB})/\sum(p(APD/SB_{IPB})p(SB_{IPB}))$$

$$p(SB_{IPB}/APD) = (0.3158)(2.72E - 02)/((0.3158)(2.72E - 02) + (.6842)(.9728))$$

$$= 1.27E - 02$$



**Figure 4.6 - Failure probabilities of RCD as a function of depth and mud density.**

**Table 4.6 - Prior occurrence probabilities of consequences**

Vapor cloud/ oil spill	VCE/Pool fire	Secondary explosion/Fire	Catastrophe
5.64E-03	1.56E-04	1.35E-06	2.04E-09

**Table 4.7 - Posterior (updated) failure probabilities of safety barriers**

<b>Hour</b>	<b>IPB</b>	<b>EPB</b>	<b>DC&amp;EMB</b>
1	2.72E-02	8.60E-03	1.50E-03
2	2.72E-02	8.60E-03	1.50E-03
3	<b>1.38E-02</b>	8.60E-03	1.50E-03
4	<b>1.38E-02</b>	8.60E-03	1.50E-03
5	<b>1.38E-02</b>	8.60E-03	1.50E-03
6	<b>9.23E-03</b>	8.60E-03	1.50E-03
7	<b>9.23E-03</b>	8.60E-03	1.50E-03
8	<b>6.94E-03</b>	8.60E-03	1.50E-03
9	<b>1.11E-02</b>	8.60E-03	1.50E-03
10	<b>9.23E-03</b>	8.60E-03	1.50E-03
11	<b>9.23E-03</b>	8.60E-03	1.50E-03
12	<b>7.93E-03</b>	8.60E-03	1.50E-03
13	<b>7.93E-03</b>	8.60E-03	1.50E-03
14	<b>6.94E-03</b>	8.60E-03	1.50E-03
15	<b>6.18E-03</b>	8.60E-03	1.50E-03
16	<b>8.32E-03</b>	8.60E-03	1.50E-03
17	<b>8.32E-03</b>	8.60E-03	1.50E-03
18	<b>7.57E-03</b>	8.60E-03	1.50E-03
19	<b>7.57E-03</b>	8.60E-03	1.50E-03
20	<b>7.57E-03</b>	8.60E-03	1.50E-03
21	<b>9.23E-03</b>	8.60E-03	1.50E-03
22	<b>1.27E-02</b>	<b>1.73E-03</b>	1.50E-03
23	<b>1.57E-02</b>	<b>2.88E-03</b>	1.50E-03
24	<b>2.01E-02</b>	<b>4.93E-03</b>	<b>5.01E-04</b>

The posterior failure probabilities of the safety barriers and the probability of blowout are used to determine occurrence frequencies or probabilities of end events by event tree analysis and presented in Table 4.8. The posterior occurrence frequency of vapor cloud/oil spill for a blowout probability of 5.80E-03 at the 22nd hour is:  $5.80E - 03 * (1 - 1.27E - 02) = 5.73E - 03$

The risk value of vapor cloud/oil spill is then:  $5.73E - 03 * 100,000,000 = \$573,000$

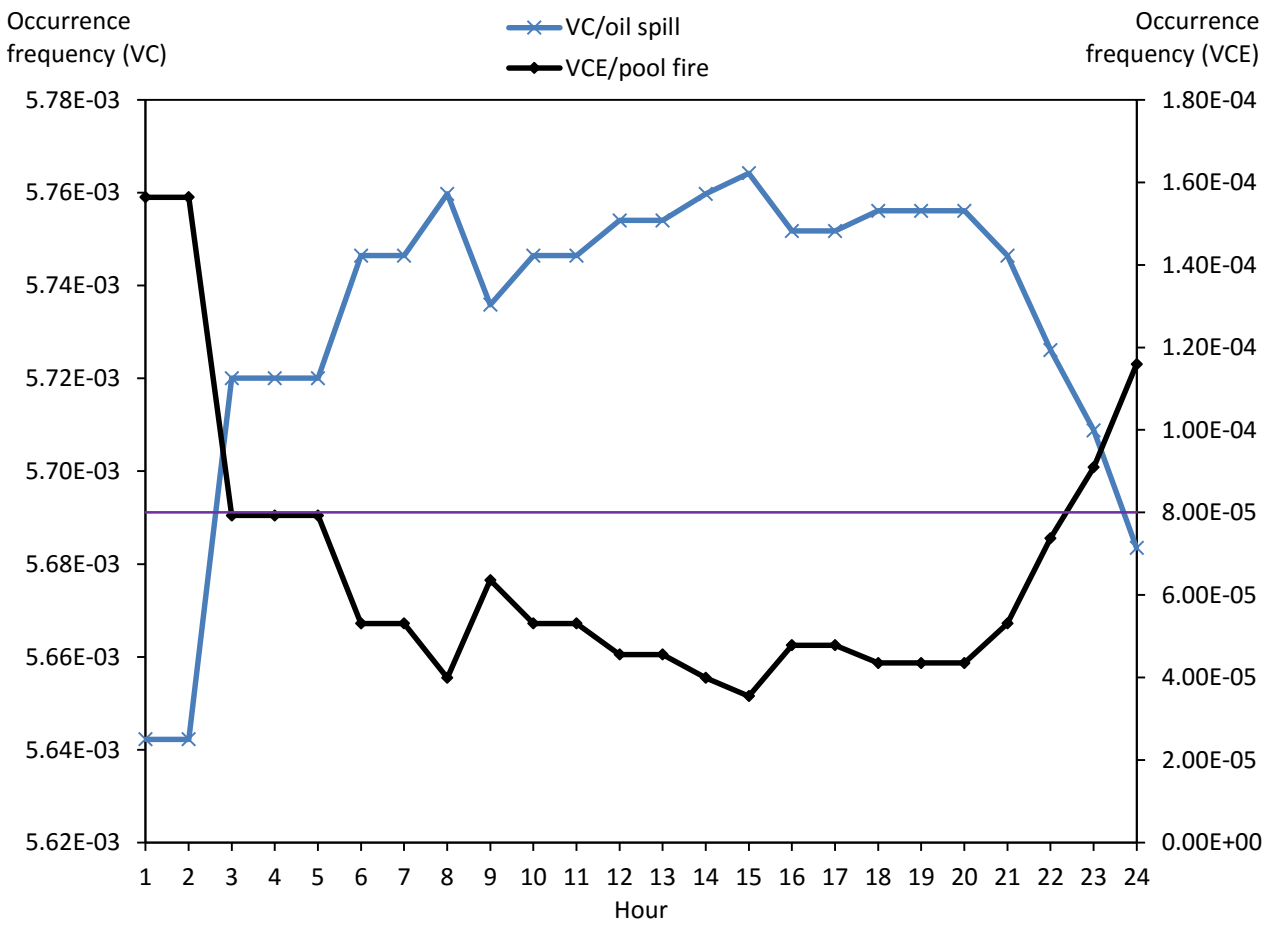


**Table 4.8 - Occurrence frequencies of consequences/end events**

<b>Hour</b>	<b>Vapor Cloud/Oil spill</b>	<b>VCE/pool fire</b>	<b>Sec. Explosion/Fire</b>	<b>Catastrophe</b>
1	5.64E-03	1.56E-04	1.35E-06	2.04E-09
2	5.64E-03	1.56E-04	1.35E-06	2.04E-09
3	5.72E-03	7.93E-05	6.87E-07	1.03E-09
4	5.72E-03	7.93E-05	6.87E-07	1.03E-09
5	5.72E-03	7.93E-05	6.87E-07	1.03E-09
6	5.75E-03	5.31E-05	4.60E-07	6.91E-10
7	5.75E-03	5.31E-05	4.60E-07	6.91E-10
8	5.76E-03	3.99E-05	3.46E-07	5.19E-10
9	5.74E-03	6.36E-05	5.51E-07	8.28E-10
10	5.75E-03	5.31E-05	4.60E-07	6.91E-10
11	5.75E-03	5.31E-05	4.60E-07	6.91E-10
12	5.75E-03	4.56E-05	3.95E-07	5.93E-10
13	5.75E-03	4.56E-05	3.95E-07	5.93E-10
14	5.76E-03	3.99E-05	3.46E-07	5.19E-10
15	5.76E-03	3.55E-05	3.08E-07	4.62E-10
16	5.75E-03	4.78E-05	4.14E-07	6.22E-10
17	5.75E-03	4.78E-05	4.14E-07	6.22E-10
18	5.76E-03	4.35E-05	3.77E-07	5.66E-10
19	5.76E-03	4.35E-05	3.77E-07	5.66E-10
20	5.76E-03	4.35E-05	3.77E-07	5.66E-10
21	5.75E-03	5.31E-05	4.60E-07	6.91E-10
22	5.73E-03	7.38E-05	1.28E-07	1.92E-10

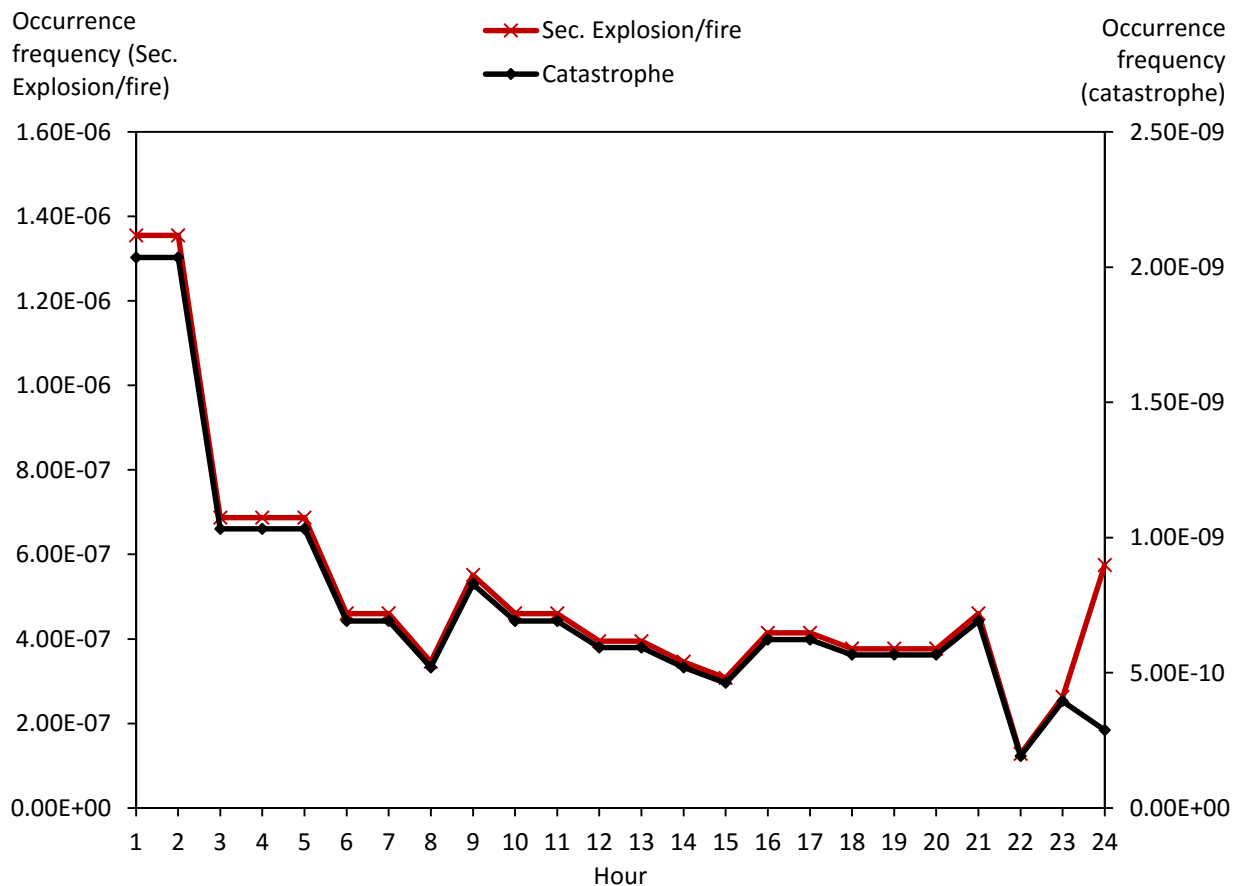
23	5.71E-03	9.09E-05	2.63E-07	3.94E-10
24	5.68E-03	1.16E-04	5.75E-07	2.88E-10

For other abnormal events that were not observed during the period of the investigation, the prior estimates of the failure probabilities of the corresponding safety barriers are used for event tree analysis. A closer look at the occurrence frequency profiles of the end events (Fig. 4.7) reveals a progressive increase in the occurrence frequency of VCE/pool fire the failure (in consonance with a decreasing trend in the frequency of VC/oil spill event of lesser severity) after the 21st hour.

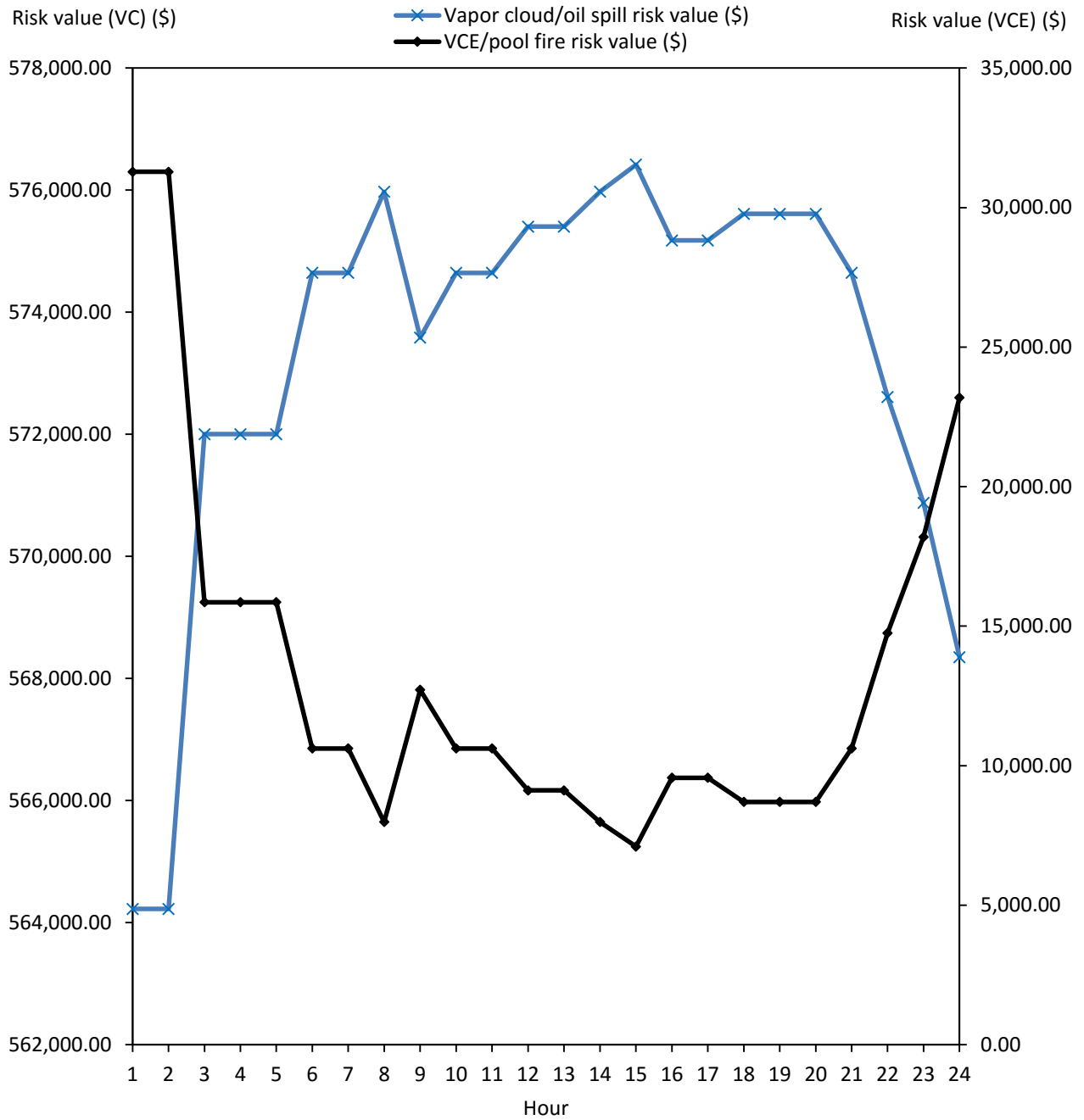


**Figure 4.7 - Occurrence frequency profiles for VC/oil spill and VCE/pool fire end events**

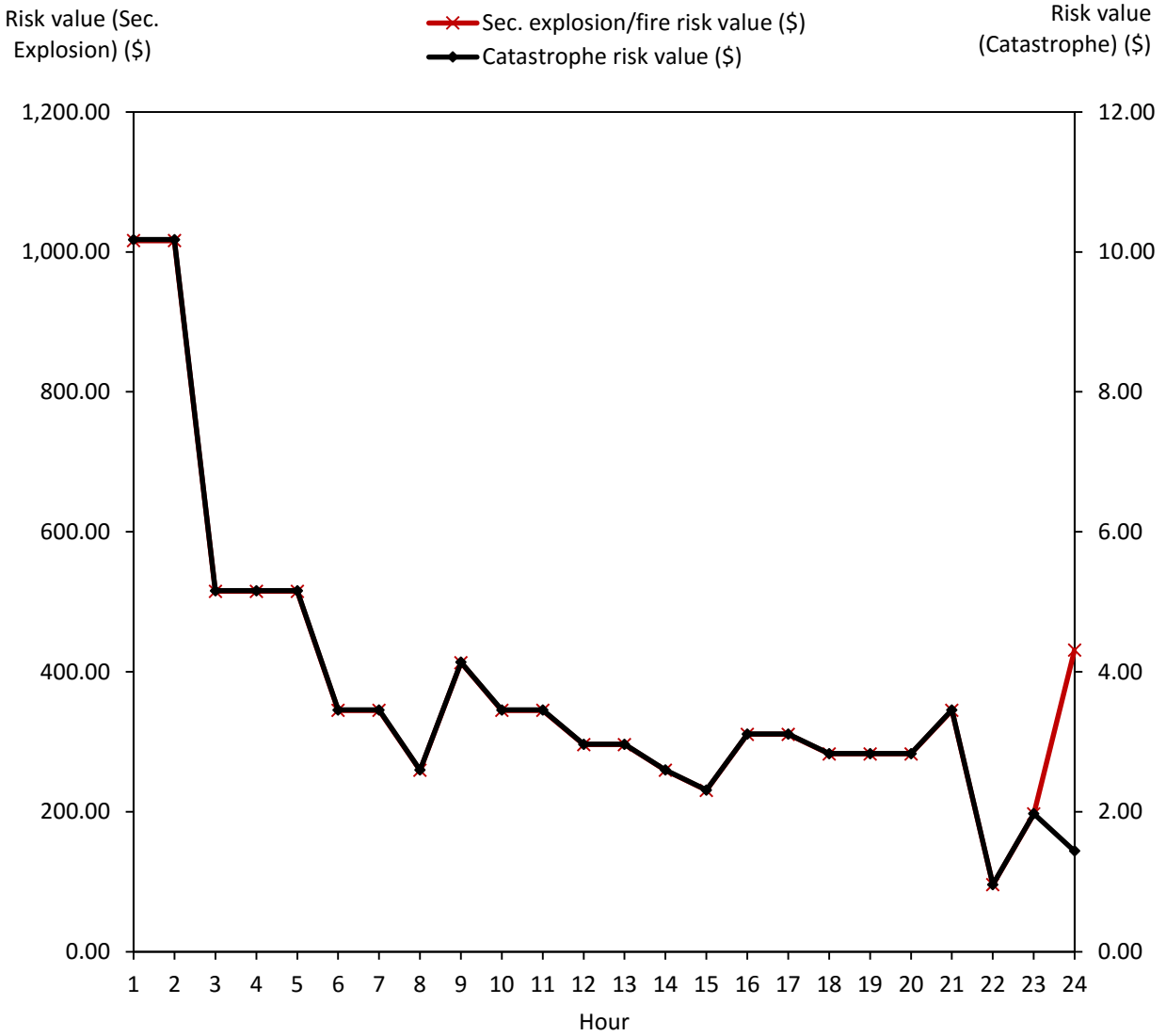
This is due to a reduction in the effectiveness or failure of the IPB as discussed in Section 3.3.1. If the threshold frequency for VCE/pool fire event had been set at a value of  $8.00E-05$ , the drilling operation would have been halted at the 22nd hour and a review of the operation carried out. This would have prevented the catastrophic event that was likely at the 24th hour. This is corroborated by an increase in the frequencies of secondary explosion/fire and catastrophic events at the 22nd hour (Fig. 3.8). A decrease in the frequency of the catastrophic event after the 23rd hour is due to insufficient data at the 24th hour. A similar explanation holds for the risk profiles presented in Figs. 3.9 and 3.10 from Table 3.9.



**Figure 4.8 - Occurrence frequency profiles for Sec. explosion/fire and Catastrophe consequences**



**Figure 4.9 - Risk profiles for VC/oil spill and VCE/ pool fire consequences**



**Figure 4.10 - Risk profiles for Sec. explosion/fire and Catastrophe consequences**

**Table 4.9 - Risk Profile of the end events in USD over the 24-hour period**

Hour	Vapor cloud/oil spill risk value (\$)	VCE/pool fire risk value (\$)	Sec. explosion/fire risk value (\$)	Catastrophe risk value (\$)
1	564,224.00	31,280.65	1,016.03	10.18
2	564,224.00	31,280.65	1,016.03	10.18
3	572,003.24	15,855.97	515.02	5.16

4	572,003.24	15,855.97	515.02	5.16
5	572,003.24	15,855.97	515.02	5.16
6	574,644.22	10,619.45	344.93	3.45
7	574,644.22	10,619.45	344.93	3.45
8	575,973.87	7,983.02	259.30	2.60
9	573,584.91	12,719.85	413.15	4.14
10	574,644.22	10,619.45	344.93	3.45
11	574,644.22	10,619.45	344.93	3.45
12	575,403.26	9,114.41	296.04	2.96
13	575,403.26	9,114.41	296.04	2.96
14	575,973.87	7,983.02	259.30	2.60
15	576,418.45	7,101.49	230.66	2.31
16	575,175.34	9,566.34	310.72	3.11
17	575,175.34	9,566.34	310.72	3.11
18	575,610.62	8,703.25	282.69	2.83
19	575,610.62	8,703.25	282.69	2.83
20	575,610.62	8,703.25	282.69	2.83
21	574,644.22	10,619.45	344.93	3.45
22	572,610.54	14,753.32	95.84	0.96
23	570,878.82	18,189.77	196.94	1.97
24	568,346.41	23,192.23	430.89	1.44

---

#### **4.4. Conclusion**

This study has proposed a bow-tie model for real time risk analysis of drilling operations. The bow-tie, qualitatively, illustrates the logical relationships between the components of the drilling operations and the consequences through the safety barriers. Quantitatively, it links the failure probabilities of the components and the safety barriers to the frequencies of the consequences. A predictive failure probabilistic model also has been proposed for determining failure probabilities of basic components of during drilling operations. The dynamic model is capable of updating the failure probabilities of the components of the bow-tie, thus, overcoming the static nature of common risk assessment techniques. This study has identified key components of drilling operations as shown in the fault trees.

Different drilling techniques such as COBD and UBD are compared. In COBD, the components are the drilling mud, riser and its components, choke and kill lines, failsafe valves, and the BOP. While in UBD, in addition to those listed for COBD, the most important component is RCD. Others are a dedicated choke manifold, drill-pipe non return valve and snubbing unit.

A well designed RCD capable of withstanding prevailing pressures will ensure safe application of UBD in harsh environments. The results from the comparative analysis of COBD and UBD shows that if the RCD is well designed and selected UBD could be made safer than COBD as the occurrence probability of COBD tripled that of UBD during drilling.

The event tree is updated through Bayes theorem by utilizing the accident precursors information collected during the drilling operation. The threshold frequency of the end event(s) determined is/are compared with the posterior frequencies to determine whether to continue drilling or review the existing condition to avoid accident. Thus, the drilling operation is effectively managed, non-

productive time is minimized and accidents could be prevented. Through a case study, it was clearly shown that by using accident precursors in risk updating, the drilling operation would have been halted at the 22nd hour, thus, preventing the catastrophic event that was likely to occur at the 24th hour. This methodology can be integrated into a real time risk monitoring device for field application during drilling operations.

## References

- Adams, N. J. (1985). *Drilling Engineering-A Complete Well Planning Approach*. Tulsa, Oklahoma: PennWell Publishing Company.
- Anderson, L. B. (1998). Stochastic modeling for the analysis of blowout risk in exploration drilling. *Reliability Engineering and System Safety*, 68, 53-63.
- Arnold & Itkin LLP. (2014). *Oil Rig Explosion Attorneys*. Retrieved February 26, 2014, from <http://www.oilrigexplosionattorneys.com/Oil-Rig-Explosions/History-of-Offshore-Accidents.aspx>
- Bedford, T., & Cooke, R. (2001). *Probabilistic Risk Analysis: Foundations and Methods*. UK: Cambridge University Press.
- Bennion, D. B., Lunan, B., & Saponja, J. (1998b). Underbalanced Drilling and Completion Operations to Minimize Formation Damage - Reservoir Screening Criteria for Optimum Application. *The Journal of Canadian Petroleum Technology*, 9, 36-49.
- Bennion, D. B., Thomas, F. B., Bietz, R. F., & Bennion, D. W. (1998a, December). Underbalanced Drilling - Praises and Perils. *SPE Drilling and Completion*, pp. 214-222.
- Bercha, F. G. (1978). *Probabilities of Blowouts in Canadian Arctic Waters*. Fisheries and Environment Canada. Canada: Environmental Protection Service. Economic and Technical Review, Report EPS 3-EC-78-12.
- Bourgoyne, A. T., Millheim, K. K., Chenevert, M. E., & Young, F. S. (1986). *Applied Drilling Engineering*. Richardson, TX: Society of Petroleum Engineers.
- Cohen, J., Stave, R., Schubert, J., & Elieff, B. (2008). Dual-Gradient Drilling. In B. Rehm, J. Schubert, A. Haghshenas, A. S. Paknejad, & J. Hughes (Eds.), *Managed Pressure Drilling* (pp. 181-226). Houston, Texas: Gulf Publishing Company.



- Crowl, D. A., & Louvar, J. F. (2002). *Chemical Process Safety - Fundamentals with Applications* (Second ed.). New Jersey: Prentice Hall PTR.
- Ebeling, C. E. (1997). *An Introduction to Reliability and Maintainability Engineering* (1st ed.). New York: McGraw-Hill Companies Inc.
- Engevik, M. O. (2007). *Risk Assessment of Underbalanced and Managed Pressure Drilling Operations. MSc. Thesis*. Norway: NTNU.
- Eslinger, K., Ure, D., & Kutlay, S. (2004). Risk Management and Analysis of Driving Hazard Using Bow Tie Model. *SPE International Conference*. Alberta: SPE 86846.
- Ferdous, R., Khan, F., Sadiq, R., Amyotte, P., & Veitch, B. (2013). Analyzing system safety and risks under uncertainty using a bow-tie diagram: An innovative approach. *Process Safety and Environmental Protection*, 91, 1-18.
- Fowler, J. H., & Roche, J. R. (1994). System Safety Analysis of Well-Control Equipment. SPE26844. *Drilling and Completion*, 193-198.
- Fredericks, P. (2008). Constant Bottom-Hole Pressure with Pressure as a Primary Control. In B. Rehm, J. Schubert, A. Haghshenas, A. S. Paknejad, & J. Hughes (Eds.), *Managed Pressure Drilling* (pp. 81-107). Houston, Texas: Gulf Publishing Company.
- Gough, G., & Graham, R. (2008). Offshore Underbalanced Drilling - The Challenge at Surface. *Drilling Conference*. Orlando, Florida: IADC/SPE 112779.
- Haghshenas, A., Paknejad, A. S., Reihm, B., & Schubert, J. (2008). The Why and Basic Principles of Managed Well-Bore Pressure. In B. Reihm, J. Schubert, A. Haghshenas, A. S. Paknejad, & J. Hughes (Eds.), *Managed Pressure Drilling* (pp. 1-38). Houston, Texas: Gulf Publishing Company.
- Hannegan, D. M., & Wanzer, G. (2003). Well Control Considerations - Offshore Applications of Underbalanced Drilling Technology. SPE/IADC 79854. *SPE/IADC Drilling Conference. February 19-21*. Amsterdam, The Netherlands: SPE.
- Holland, P. (1991). Subsea Blowout-Preventer Systems: Reliability and Testing. *SPE Drilling Engineering*, 6(04), 293-298.
- Holland, P. (2001). Reliability of Deepwater Subsea Blowout Preventers. SPE 70129. *Drilling and Completion*, 12-18.
- Kalantarnia, M., Khan, F., & Hawboldt, K. (2009). Dynamic risk assessment using failure assessment and Bayesian theory. *Loss Prevention in the Process Industries*, 22, 600-606.

- Kalantarnia, M., Khan, F., & Hawboldt, K. (2010). Modeling of BP Texas City refinery accident using dynamic risk assessment approach. *Process Safety and Environmental Protection*, 89, 75-88.
- Kato, S., & Adams, N. J. (1991). Quantitative Assessment of Blowout Data as it Relates to Pollution Potential. SPE 23289. *First International Conference on Health, Safety and Environment*. The Hague: SPE. November 10-14.
- Khakzad, N., Khan, F., & Amyotte, P. (2012). Dynamic risk analysis using bow-tie approach. *Reliability Engineering and System Safety*, 104, 36-44.
- Khakzad, N., Khan, F., & Amyotte, P. (2013a). Quantitative risk analysis of offshore drilling operations: A Bayesian approach. *Safety Science*, 57, 108-117.
- Khan, F. (2001). Use of maximum credible accident scenarios for realistic and reliable risk assessment. *Chemical Engineering Progress*, 11, 56-64.
- Leading Edge Advantage. (2002). *Introduction to Underbalanced Drilling*. Aberdeen: Leading Edge Advantage Ltd.
- Markowski, A. S., & Kotynia, A (2011). "Bow-tie" model in layer of protection analysis. *Process Safety and Environmental Protection*, 89, 205-213.
- Meel, A., & Seider, W. D. (2006). Plant-specific dynamic failure assessment using Bayesian theory. *Chemical Engineering Science*, 61, 7036-7056.
- Minerals Management Service. (2008, June 15). *Notice to Lessees and Operators of Federal Oil, Gas, and Sulphur Leases in the Outer Continental Shelf, Gulf of Mexico OCS Region: Managed Pressure Drilling Projects. Report, NTL 2008-G07*. Retrieved January 9, 2014, from [http://www.iadc.org/committees/ubo\\_mpd/Documents/MMS%20NTL%202008-G07.pdf](http://www.iadc.org/committees/ubo_mpd/Documents/MMS%20NTL%202008-G07.pdf)
- OREDA. (2002). *Offshore Reliability Data Handbook* (4th ed.). SINTEF.
- Rathnayaka, S., Khan, F., & Amyotte, P. (2011). SHIPP methodology: Predictive accident modeling approach. Part II. Validation with case study. *Process Safety and Environmental Protection*, 89, 75-88.
- Rathnayaka, S., Khan, F., & Amyotte, P. (2013). Accident modeling and risk assessment framework for safety critical decision-making: application to deepwater drilling operation. *Proceedings of the Institution of Mechanical Engineers, Part O: Journal of Risk and Reliability*, 227, 86-105.

- Rehm, B. (2012). Introduction. In B. Rehm, A. Haghshenas, A. Paknejad, A. Al-Yami, J. Hughes, & J. Schubert (Eds.), *Underbalanced Drilling - Limits and Extremes* (pp. 1-38). Houston: Gulf Publishing Company.
- Rehm, B., Haghshenas, A., Paknejad, A. S., & Schubert, J. (2008). Situational Problems in MPD. In B. Rehm, J. Schubert, A. Haghshenas, A. S. Paknejad, & J. Hughes (Eds.), *Managed Pressure Drilling* (pp. 39-78). Houston: Gulf Publishing Company.
- Shalev, D. M., & Tiran, J. (2007). Conditioned-based fault tree analysis (CBTFA): A new method for improved fault tree analysis (FTA), reliability and safety calculations. *Reliability and System Safety*, 92, 1231-1241.
- Skogdalen, J. E., & Vinnem, J. E. (2012). Quantitative risk analysis of oil and gas drilling, using Deepwater Horizon as a case study. *Reliability Engineering and System Safety*, 100, 58-66.
- Smith, J. R., & Patel, B. M. (2012, June). A Proposed Method for Planning the Best Initial Response to Kicks During Managed-Pressure Drilling Operations. *SPE Drilling & Completion*, 194-203.
- Vogel, R., & Brugman, J. (2008). Continuous Circulation System. In B. Rehm, J. Schubert, A. Haghshenas, A. S. Paknejad, & J. Hughes (Eds.), *Managed Pressure Drilling* (pp. 127-142). Houston, Texas: Gulf Publishing Company.
- Wierenga, P. C., Lie-A-Huen, L., de Rooij, S. E., Klazinga, N. S., Guchelaar, H., & Smorenburg, S. M. (2009). Application of the Bow-Tie Model in Medical Safety Risk Analysis. *Drug Safety*, 32, 663-673.

## Chapter 5

### 5.0 Safety and Risk Analysis of Managed Pressure Drilling Operation Using Bayesian Network

#### Preface

*A version of this chapter has been published in the Safety Science Journal 2015; 76:133-144. I am the primary author. Along with Co-author, Faisal Khan, I developed the conceptual model and subsequently translated this to the numerical model. I have carried out most of the data collection and analysis. I have prepared the first draft of the manuscript and subsequently revised the manuscript, based on the feedback from Co-authors and also peer review process. As Co-author, Faisal Khan assisted in developing the concept and testing the model, reviewed and corrected the model and results. He also contributed in reviewing and revising the manuscript. As Co-authors, Nima Khakzad and Stephen Butt, contributed through support in developing the model, testing, reviewing and revising the manuscript.*

#### Abstract

The exploration and development of oil and gas resources located in extreme and harsh offshore environments are characterized with high safety risk and drilling cost. Some of these resources would be either uneconomical if extracted using conventional overbalanced drilling due to increased drilling problems and prolonged non-productive time, or too risky to adopt underbalanced drilling technique. Seeking new ways to reduce drilling cost and minimize risks has led to the development of managed pressure drilling techniques. Managed pressure drilling methods address the drawbacks of conventional overbalanced and underbalanced drilling

techniques. As managed pressure drilling techniques are evolving, there are many unanswered questions related to safety and operating pressure regime. This study investigates the safety and operational issues of constant bottom-hole pressure drilling techniques which are used in managed pressure drilling compared to conventional overbalanced drilling. The study first uses bow-tie models to map safety challenges and operating pressure regimes in constant bottom-hole pressure drilling techniques. Due to the difficulties in modeling dependencies and updating the belief on the operational data, the bow-ties are mapped into Bayesian networks. The Bayesian networks are thoroughly analyzed to assess the safety critical elements of constant bottom-hole pressure drilling techniques and their safe operating pressure regime.

**Keywords:** Managed pressure drilling, Rotating control device, Bayesian network analysis, Bow-tie approach, Blowout prevention, Lost circulation

## **5.1. Introduction**

In the quest to reduce Non-Productive Time (NPT) and drilling cost in fractured and narrow mud pressure window environments, a set of drilling techniques known as Managed Pressure Drilling (MPD) has been developed. MPD is defined by the International Association of Drilling Contractors (IADC) subcommittee on Underbalanced Operation and Managed Pressure Drilling (Minerals Management Service, 2008) as “an adaptive drilling process used to precisely control the annular pressure profile throughout the wellbore.” MPD is an adaptive drilling process such that the drilling plan is adjusted in conformance to the changing wellbore conditions. In fact, MPD is an overbalanced technique; hence, it supposedly avoids the flow of formation fluid into the wellbore. It is a closed-loop system which prevents the well from being open to the atmosphere through using a rotating control device (RCD). The closed-system allows the casing back pressure

to be adjusted precisely with a drilling choke when it is applicable to augment the hydrostatic pressure of the drilling fluid (Smith & Patel, 2012). An added benefit of the closed-loop circulation is that potentially dangerous gases are prevented from escaping on the rig, a drawback of conventional drilling. MPD techniques are used to reduce NPT resulting from correcting drilling problems; extend casing points; increase the rate of penetration; safely drill in fractured and cavernous formations with total lost return; limit loss of circulation; and eliminate lost circulation – kick sequence (Haghshenas, et al., 2008).

Uneconomical conventional overbalanced drilling of reserves could be rendered economical when drilled with MPD techniques. Further, offshore environments that are too risky to apply underbalanced drilling due to comparatively lower hydrostatic pressure than formation pore pressure could be drilled safer with MPD techniques.

Generally, a drilling operation comprises several sub-operations and/or stages. These sub-operations include: drilling ahead, tripping, static condition, casing and cementing (Arild, et al., 2009). During drilling ahead, the formation is disintegrated by the cutting action of the drill bit. The drilling fluid carries the cuttings up to the surface as drilling progresses. This sub-operation constitutes the major portion of the productive time of the drilling operations. A well (Figure 5.1) is drilled in a form resembling an inverted telescope with the larger size at the top. First, the conductor hole is drilled very shallow so that the conductor casing can be installed to stabilize earth near the top of the well and facilitate the drilling of the surface hole. The surface hole is drilled to the base of the fresh water zone or aquifer for the surface casing to establish a seal across the fresh water zone or aquifer when cemented. This may be followed by an intermediate hole for the intermediate casing to help stabilize the formations and isolate abnormally pressured zones.

Lastly, the production hole for the production casing is drilled across the productive interval of the formation.

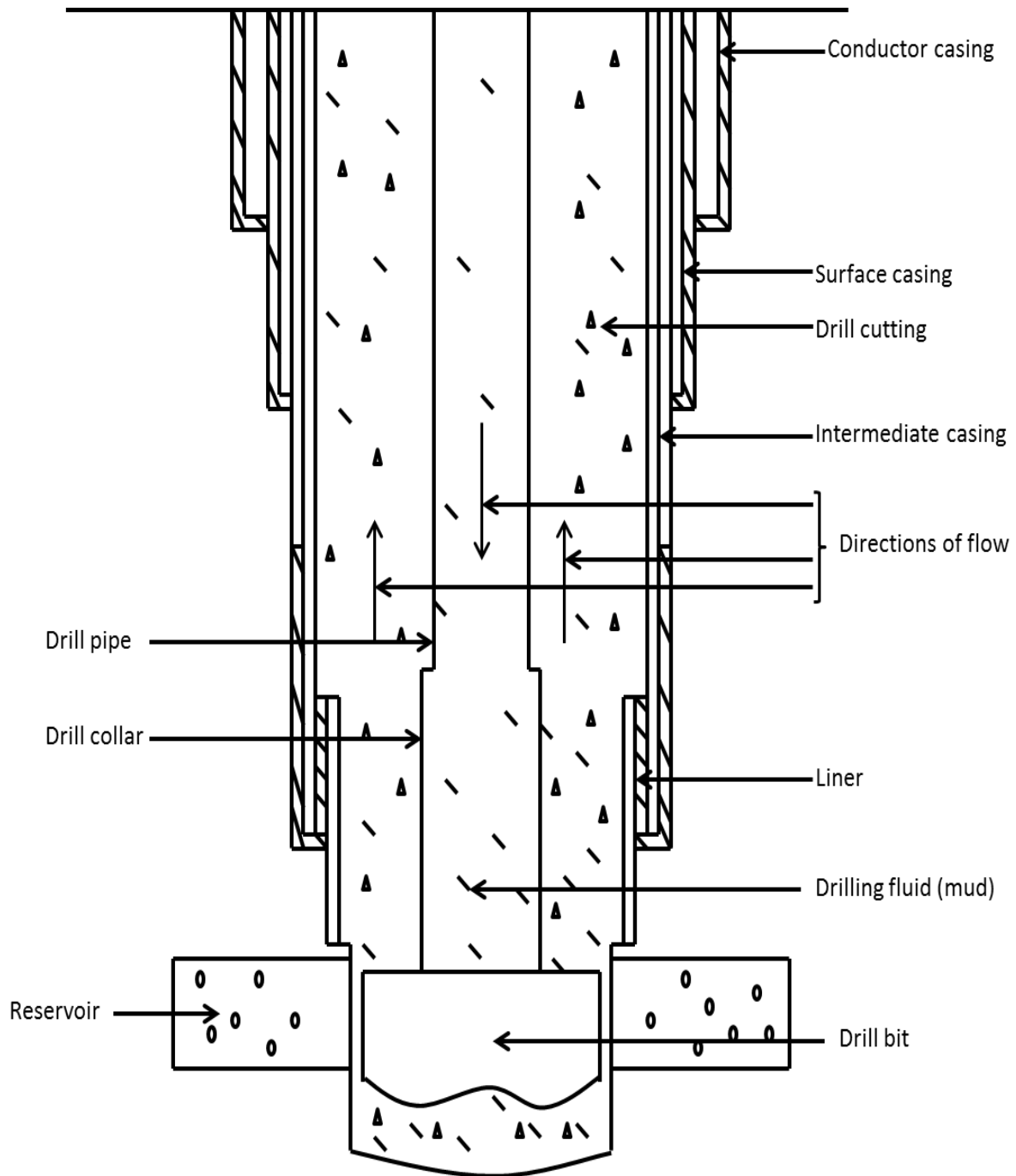


Figure 5.1 - A typical well profile (Hossain & Al-Majed, 2015)

Tripping operation involves the running of a drill string out of the well and then into the well to continue the drilling operation. This is done for example to replace a dull drill bit, make or break a drill string connection and to install or repair a bottom hole assembly. Moving the drill string out of the well can give rise to a swabbing effect in which the BHP would be reduced equivalent to the volume of the drill-string. On the contrary, when the drill string is running into the well, a surging effect would occur in which the BHP would increase equivalent to the volume of the drill string. Static condition is a stage in which there is no circulation of the mud and the drilling has been stopped in the well. The rig pump is off and the BHP is either balanced only by the hydrostatic pressure of the mud column or supplemented by some backpressure. Casing operation is the running of casings into an open hole. Each casing size is run in succession into the open hole. Casings include: conductor casing, surface casing, intermediate casing and production casing. The conductor casing is the outermost casing. It may be cemented or driven into the formation. The surface casing is run in the surface hole and cemented back to the surface to protect the aquifer. The intermediate casings are used to cover up problem prone portion of the well en route to the reservoir. The production casing or liner is the pipe that is cemented across the productive interval of the reservoir. The production casing is perforated during completion operation to allow the flow of formation fluid to the surface. Cementing operations involve the operations of mixing cement slurry with additives to achieve a desired property and the pumping of the slurry into the annulus between the casing and the open hole through the internal diameter of the casings. The cement when set holds the casings in place and prevents the well permanently from collapsing. A well is cased and cemented in succession. The general sequence involves conductor casing, surface casing, the intermediate casing, and lastly, the production casing or liner, depending on the well design. This study is limited to drilling ahead, static and tripping sub-operations of drilling for both



Constant Bottom Hole Pressure (CBHP) drilling method of MPD and Conventional Over-Balanced Drilling (COBD). Other sub-operations of casing and cementing are considered in further studies.

Safety of drilling operations is often characterized in terms of risk as a measure of accident likelihood and magnitude of loss (Khan, 2001). Many authors have studied conventional overbalanced drilling technique and assessed the risk of well control events using quantitative risk analysis methods such as fault tree (FT) (Bercha, 1978; Pitblado, et al., 2010), event tree (ET) (Rathnayaka, et al., 2013), bow-tie (BT) (Khakzad, et al., 2013b; Abimbola, et al., 2014) and Bayesian Network (BN) (Khakzad, et al., 2013b). Khakzad et al. (2013b) developed a BT model to identify root causes of kicks in offshore overbalanced drilling and the failures of safety barriers which allow a kick to develop into a blowout. This study converted BT into BN to model common cause failures and capture dependencies among contributing factors of kicks and blowouts. Grayson and Gans (2012) applied a FT to model blowout in MPD and compared the result with that of the conventional overbalanced drilling (COBD) analysis conducted by Pitblado et al. (2010). Although FT and other conventional risk analysis techniques have been widely used in the field of drilling safety, their accuracy have been always questioned due to the assumption of independency inherent in them. Further, the results of such study cannot be easily updated given change in environmental and operational conditions of the system of interest (Khakzad, et al., 2011). These limitations can be relaxed to a great extent in BN, making it a more sophisticated tool for probabilistic risk analysis. However, the use of BN in risk analysis of MPD is yet to be explored. This study is aimed at comparing CBHP, as a technique used in MPD and COBD from a safety and operating regime perspective. CBHP technique is used as an alternative to COBD as they have similar applications. Other MPD techniques such as pressurized mud cap drilling and

dual gradient drilling as discussed in Section 2 are case specific with different applications. To this end, the authors have used BN to model possible unwanted situations (accident scenarios) to do a detailed risk assessment. This helps to identify the critical contributing factors, analyzing them in detail provides deeper understanding of the efficacy of relevant safety measures and well control.

A brief description of various MPD techniques is presented in Section 5.2. Section 5.3 reviews the fundamentals of BN. The newly developed BN models and their analyses are discussed in detail in section 5.4. Section 5.5 provides the conclusion of the study.

## **5.2. Managed Pressure Drilling Techniques**

The improvement of offshore drilling for oil and gas through the introduction of MPD techniques has been discussed in many publications (Hannegan, 2005; Malloy, et al., 2009; Hannegan, 2011; Grayson & Gans, 2012; Hannegan, 2013). Among the available techniques for MPD, the most widely used approaches include Constant Bottom-hole Pressure (CBHP) drilling, Pressurized Mud Cap Drilling (PMCD), and Dual Gradient Drilling (DGD) (Haghshenas, et al., 2008). These are considered in the present study.

### **5.2.1. Constant Bottom-hole Pressure (CBHP) Drilling:**

CBHP technique comprises those methods in which the Bottom Hole Pressure (BHP) is held constant or nearly constant at a specific depth whether the rig pump is on or off. In other words, the BHP is maintained within the drilling mud window defined by the lower and upper pressure limits. The lower pressure limit is the pore pressure while the upper limit is the formation fracture pressure with their difference known as the pressure margin (Fredericks, 2008).

In conventional overbalanced drilling, an open circulation system is employed, and the well is open to the atmosphere. When the rig pump is off or not circulating the mud, the static BHP is defined as:

$$BHP_{static} = P_h \quad (5.1)$$

where  $P_h$  is the hydrostatic pressure of the mud column,

When the rig pump is on and circulating the mud, the dynamic BHP is given by:

$$BHP_{dynamic} = P_h + P_{ann} \quad (5.2)$$

where  $P_{ann}$  is the annular frictional pressure due to circulating drilling fluid when the rig pump is on.

CBHP techniques use the RCD to provide a closed circulating system with a drilling choke to adjust the back pressure so that the necessary BHP could be achieved under static and dynamic conditions as given by Equations (5.3) and (5.4), respectively:

$$BHP_{static} = P_h + P_{bp} \quad (5.3)$$

$$BHP_{dynamic} = P_h + P_{ann} + P_{bp} \quad (5.4)$$

where  $P_{bp}$  is the backpressure.

In CBHP techniques, either pressure or flow measurement is used as the primary control. In the former case (Fredericks, 2008), an automated Dynamic Annular Pressure Control (DAPC) system is used to maintain the BHP within the drilling mud window. The DAPC system comprises: a dedicated choke manifold, back pressure pump, integrated pressure manager and a hydraulics model. When the rig pump is off, such as during tripping (movement of drill string in or out of the well), pipe connection and when not drilling,  $P_{ann} = 0$ . This drop in BHP is compensated by a backpressure pump ( $P_{bp}$  in Equation 4.3) along with the choke and RCD. When the rig pump is

on, Equation (5.4) is used to determine BHP condition within the drilling mud window. In this method, the integrated pressure manager compares the formation Pressure measurement While Drilling (PWD) data with the hydraulics model to provide real time constant BHP. The hydraulics model predicts the expected BHP and compares it with the prevalent BHP to decide if the BHP needs any adjustment. However, in the latter case, i.e. when flow measurement is used as primary control (Catak, 2008), an Intelligent Control Unit (ICU) compares the flow rate out of the well measured by a flow meter downstream the RCD with the flow rate into the well (determined from the rig pump stroke count) to detect kicks and manipulate the automatic choke manifold accordingly. In some classifications, MPD by Continuous Circulation System (CCS) is considered a CBHP method. CCS is used to maintain constant BHP by eliminating changes in BHP during connections or otherwise. It is ensured by maintaining a steady Equivalent Circulating Density (ECD) (Vogel & Brugman, 2008).

### **5.2.2. Pressurized Mud Cap Drilling (PMCD):**

PMCD is a technique for safe drilling with total lost returns in highly fractured, cavernous or vugular karstic (carbonate) formations. These formations are such that the use of lost circulation material to enable safe drilling has proven to be ineffective. PMCD is an improvement to mud cap or floating mud cap drilling. Mud cap or floating mud cap drilling is an open well system in which heavy mud is floated in the annulus at a point that balances the formation pressure above the fracture or vug taking fluid and drilled cuttings (Moore, 2008). PMCD is defined by the IADC (Benny, et al., 2013) as “drilling with no returns to surface, where an annulus fluid column, assisted by surface pressure, is maintained above a formation that is capable of accepting fluid and cuttings”. The annulus fluid column in PMCD is meant to exert lower hydrostatic pressure than the formation pore pressure while back pressure provided by the RCD is used to balance the

formation pressure. A sacrificial fluid, usually water or seawater is run down the drill string and injected with the drilled cuttings into the exposed fracture or vug. Any influx of formation fluid including sour gas is forced back or bullheaded into the formation. Thus, wastage of costly mud is prevented in addition to a safe drilling process (Moore, 2008; Benny, et al., 2013).

### **5.2.3. Dual Gradient Drilling (DGD):**

DGD comprises those offshore MPD techniques in which two fluids are used to drill a well such that the lighter fluid - usually seawater - is above the seafloor and the heavier one below the mud line in order to widen the narrow mud window and extend casing points. This leads to comparatively larger wellbore, resulting to higher production; thus, improving the economy of the well. The techniques include “pump and dump” method in which the return is dumped to the sea floor, and riser-less mud return method in which well effluent flows back to the rig through small diameter return lines assisted by a subsea mud-lift pump. DGD requires less deck space due to the use of small diameter return lines instead of the conventional risers, enabling the use of smaller floating rigs in deep-water drilling (Cohen, et al., 2008).

## **5.3. Bayesian Network**

Bayesian network (BN) is a widely used probabilistic method for reasoning under uncertainty. The uncertainty is due to the difficulty in modelling all the different conditions and exceptions that characterize a finite set of observations. A BN is based on a well-defined Bayes theorem represented by a Directed Acyclic Graph (DAG) with nodes representing random variables and arcs denoting direct causal relationships between connected nodes. In a BN, for example, as shown in Figure 5.2, nodes without arcs directing into them – have no parents – are root nodes ( $Y_1$  and

$Y_2$ ), have marginal prior probabilities assigned to them while nodes with arcs directing into them are intermediate nodes ( $Y_3, Y_4, Y_5$  and  $Y_6$ ), possessing Conditional Probability Tables (CPTs). The node such as,  $Y_7$ , which has no children is a leaf node (Jensen & Nielsen, 2007). Considering the DAG of Figure 5.2, the joint probability distribution of the BN is the product of the conditional probability distributions of the variables  $Y_1 = y_1, Y_2 = y_2, \dots, Y_7 = y_7$ .

$$P(y_1, y_2, \dots, y_7) = \prod_{i=1}^7 P(y_i | y_{\emptyset(i)}) \quad (5.5)$$

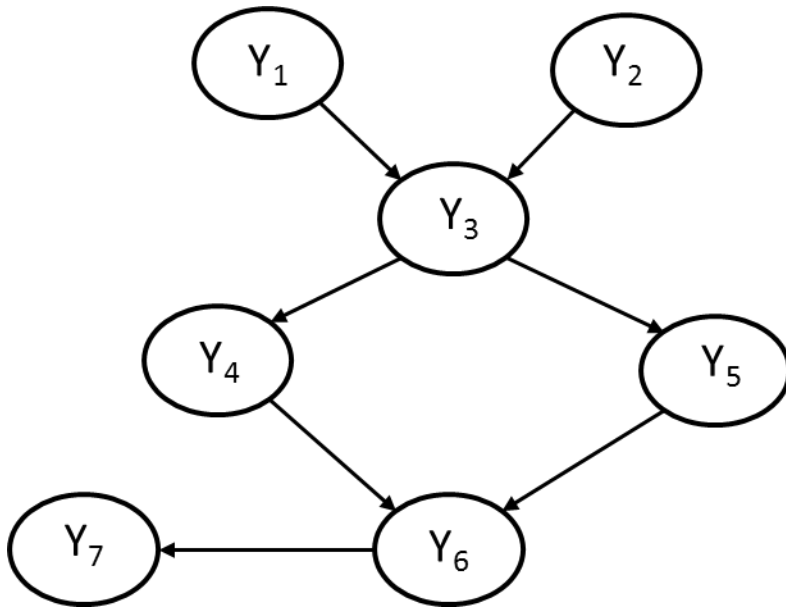
Where  $\emptyset(i)$  in equation (5.5) are the parents of node  $i$  in the DAG and  $y_1, y_2, \dots, y_7$  are the states of variables  $Y_1, Y_2, \dots, Y_7$ . Thus, equation (5.6) gives the joint probability distribution of the BN in Figure 5.2.

$$P(y_1, y_2, \dots, y_7) = P(y_7 | y_6)P(y_6 | y_4, y_5)P(y_4 | y_3)P(y_5 | y_3)P(y_3 | y_1, y_2)P(y_1)P(y_2) \quad (4.6)$$

The conditional probability distributions such as  $P(y_4 | y_3)$  can be obtained by Equation (5.7)

$$P(y_4 | y_3) = \frac{P(y_4, y_3)}{P(y_3)} \quad (5.7)$$

This can be generalized for  $n$  continuous or discrete variables with  $k$  states. This enables the modeling of complex dependencies among random variables. Thus, making BN a robust and reliable fault detection and risk analysis tool. It also enables the modeling of multi state discrete variables of interest which are often difficult with other conventional Quantitative Risk Analysis (QRA) techniques such as fault tree (FT). Beside the graphical representation which relates the conditional dependencies among variables; the BN enables probabilistic inference which is the drawing of conclusions based on observations in the model (Wiegerinck, et al., 2010).



**Figure 5.2 - A typical Bayesian network**

A BN can be used to perform both forward and backward analysis. In forward analysis, the marginal probabilities of intermediate and leaf nodes are computed on the basis of marginal prior probabilities of root nodes and conditional probabilities of intermediate nodes. In the backward analysis, however, the states of some nodes are instantiated and the updated probabilities of conditionally dependent nodes are calculated (Bobbio, et al., 2001; Khakzad, et al., 2013a). The forward propagation is also known as predictive analysis while the backward propagation is referred as diagnostic analysis.

## 5.4. Model Formulation and Analysis

### 5.4.1. Model formulation

The drilling sub-operations of drilling ahead, static and tripping operations are analyzed for CBHP techniques in MPD. The CBHP techniques are modeled considering pressure and flow measurements as primary controls and are based on equipment configurations of Fredericks (2008) and Catak (2008). BTs are developed for possible BHP conditions (Fredericks, 2008) as shown in Equation (5.8) representing - underbalanced, normal (or near-balanced) and overbalanced scenarios of CBHP techniques. The FT part of the BT is an extension of the FT of Grayson and Gans (2012) for MPD and also based on the findings by Izon et al. (2007) and Rehm et al. (2008) (Rehm, et al., 2008). The mapping of the BTs into BNs follows the algorithm proposed by Khakzad et al. (2013a).

$$P_p < P_{wbs} < BHP < P_{ds} \leq P_{ls} \leq P_f \quad (5.8)$$

where  $P_p$ , is the pore pressure,  $P_{wbs}$ , is the wellbore stability pressure,  $P_{ds}$ , is the differential sticking pressure,  $P_{ls}$ , the lost circulation pressure and  $P_f$ , the fracture pressure. The Left Hand Side (LHS) of BHP, the lower bound, comprising the pore pressure and wellbore instability defines the underbalanced drilling scenario while the Right Hand Side (RHS) of BHP, the upper bound, consisting of the differential sticking pressure, lost circulation pressure and fracture pressure describes the possible pressure regimes in the overbalanced scenario. The underbalanced drilling scenario often lead to wellbore instability for an unconsolidated or weak formation, a kick which can culminate to a blowout and other escalated consequences depicted in Figure 5.3. This arises from an underbalanced scenario created as a result of an insufficient mud weight, unexpected pore pressure, swabbing, lost circulation, ballooning effect or gas cut mud in conjunction with a failure



of the MPD system in preventing the underbalance. The unexpected pore pressure can be caused by the presence of a shallow gas (or liquid) or abnormal pressured zone. The pore pressure could be identified in situ by the MPD system. Similarly, the fracture gradient can be identified by the MPD system to prevent loss of circulation. The MPD system comprises MPD control system, MPD system hardware, power supply and the operator. The MPD system hardware includes the RCD; rig pump; CBHP tools of PWD tool, DAPC choke manifold, DAPC pump for CBHP by pressure measurement; and flow meter and rig choke manifold for CBHP by flow measurement. To forestall the occurrence of the consequences of the underbalanced scenario, four safety barriers have been considered: MPD system, blowout preventer (BOP), ignition prevention barrier, and external intervention barrier. The MPD system prevents the occurrence of wellbore collapse and a kick. Upon the failure of the MPD system, the BOP is relied on for the well control. Total well control failure occurs as a result of the failure of the BOP. Fire and explosions are prevented by the installation of ignition prevention barriers such as hot surface shields, sparks and friction inhibitors and hydrocarbon detection and alarm system. External intervention barrier mitigates the ensuing fire and explosions that occur due to the failure of the ignition prevention barrier. The external prevention barrier includes fire-fighting mechanisms both on site and external, evacuation of personnel, drilling of relief well to stop the blowout, etc. (Abimbola, et al., 2014). For the overbalanced drilling scenario, it is assumed that there are no overlaps in the pressures of the RHS of BHP in Equation (5.8) to allow for distinct or separate consequences. The overbalanced drilling condition (Figure 5.4) could lead to differential pipe sticking or stuck-pipe, lost circulation and fractured formation. The time spent in remedying these consequences constitutes part of the Non-Productive Time (NPT). As lost circulation can occur before fracturing a formation, the rate of loss of circulation is increased in a fractured formation. Central to both scenarios is the normal or

near balanced pressure condition defined as BHP in Equation (5.8). The overbalanced scenario can be caused by surging effect due to excessive running speed during tripping in or high pump pressure; excessive mud weight or back pressure from Formation Integrity Test (FIT) or Leak off Test (LOT). MPD system is the only available barrier that can effectively manage the BHP to prevent differential pipe sticking or stuck pipe, lost circulation and fractured formation.

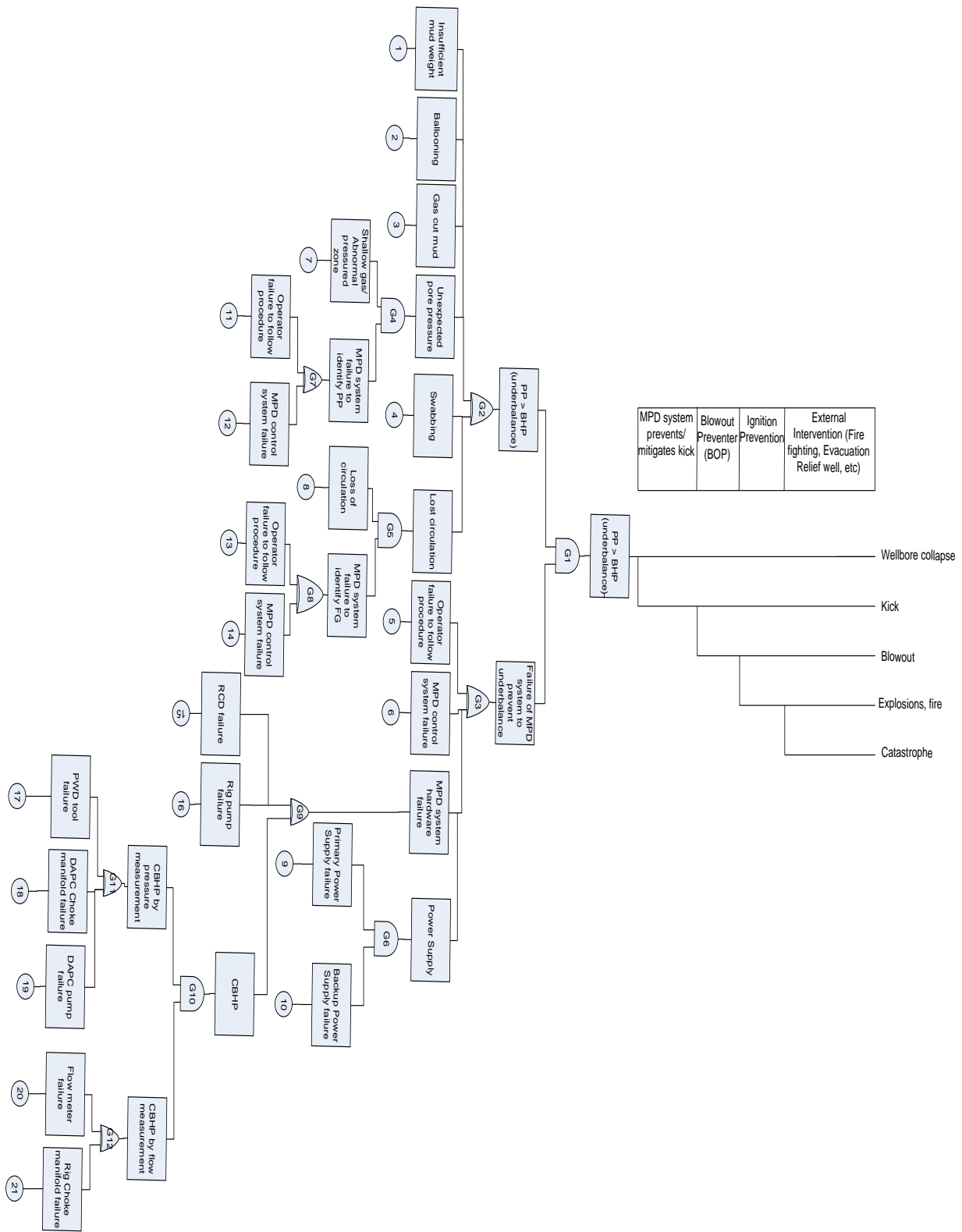
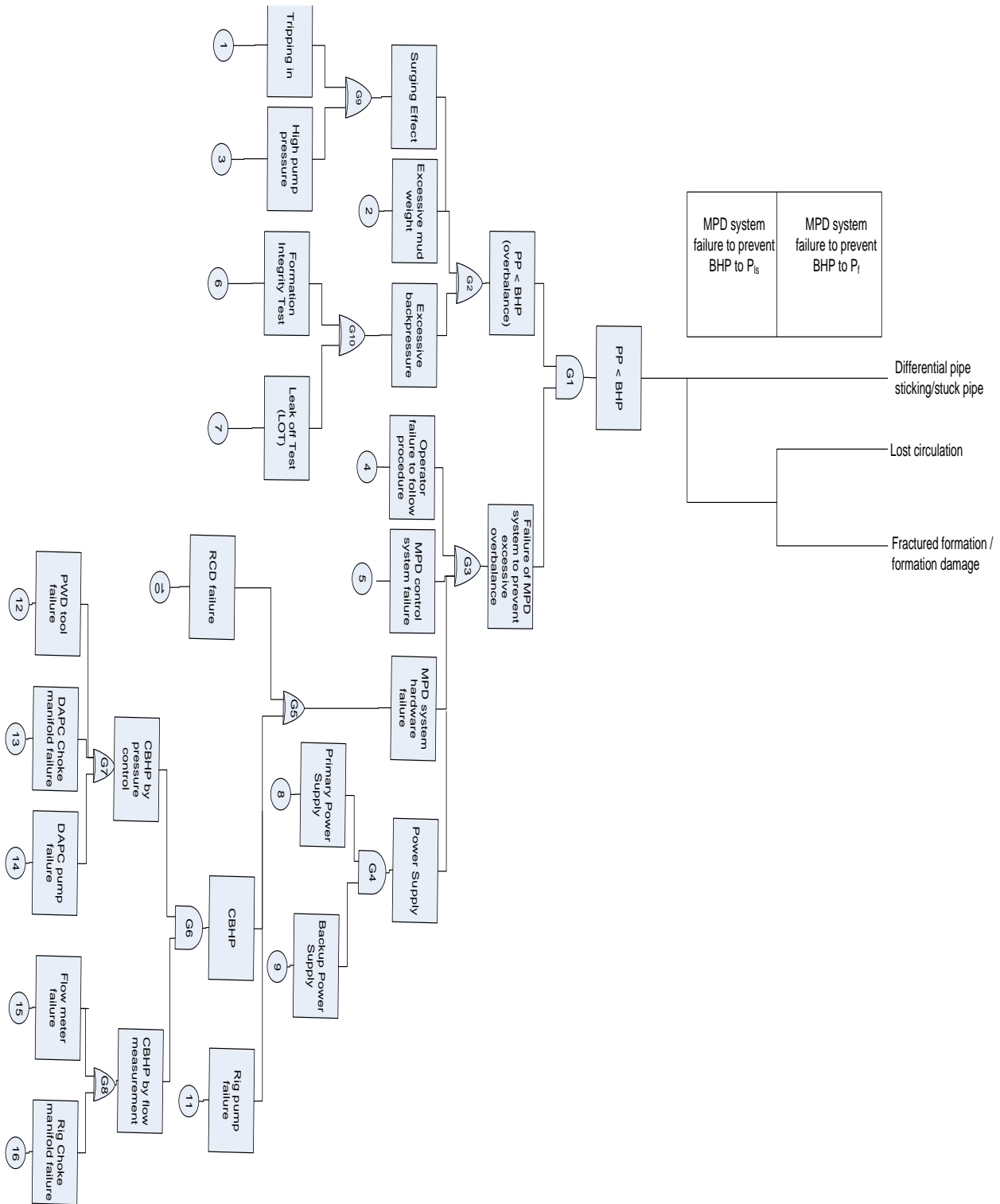


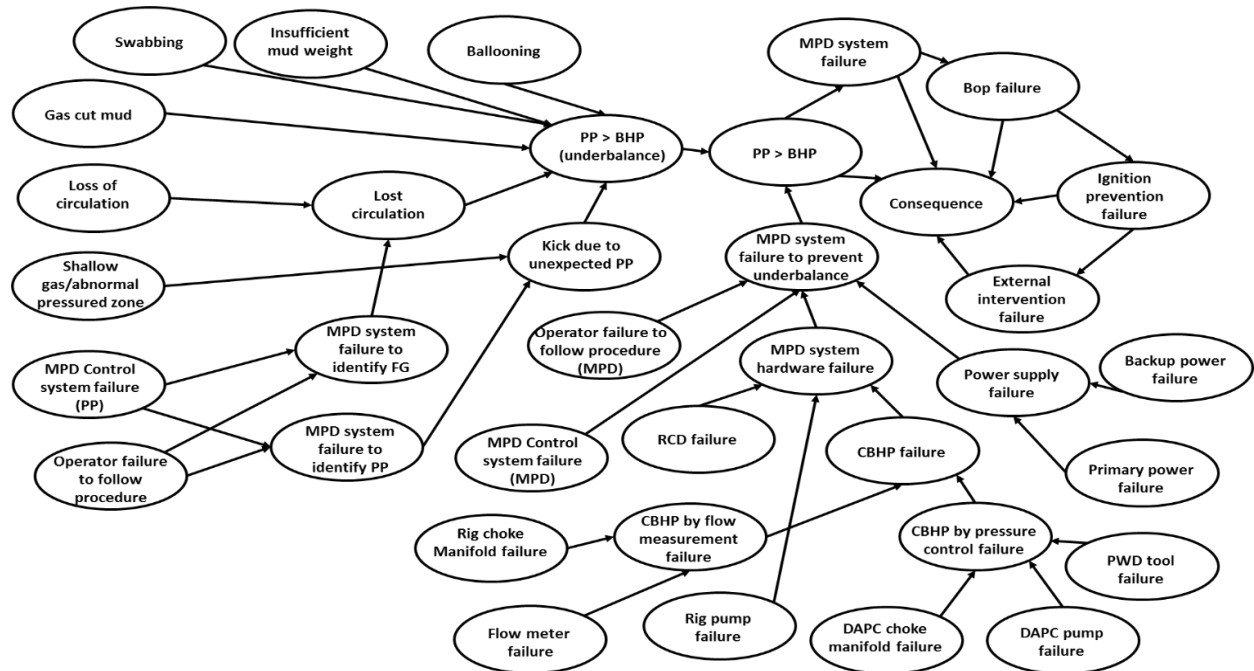
Figure 5.3 - Underbalanced Scenario Bow-Tie: Pp<Pwbs<BHP



**Figure 5.4 - Bow-Tie of Overbalanced Scenario of CBHP Techniques:  $BHP < P_{ds} \leq P_{ts} \leq P_f$**

### 5.4.2. Analysis of Models

The BT for underbalanced drilling scenario is presented in Figure 5.3 while Figure 5.5 shows the equivalent BN. The BNs in this study are analyzed using GeNIe 2.0 software developed by the Decision System Laboratory of the University of Pittsburgh and available at <http://genie.sis.pitt.edu/>. The assigned occurrence frequencies of basic events/actions and probabilities of failure on demand for the equipment and the safety barriers presented in Tables 5.1 and 5.2 are sourced from Torstad (2010), Grayson and Gans (2012), Khakzad et al. (2013b) and Abimbola et al. (2014). To facilitate the dependency modeling of the consequence node to the top event, a new state - near balanced condition - is added to the consequence node to account for the non-occurrence of the top event (i.e. Pore Pressure (PP) > BHP).



**Figure 5.5 - Bayesian Network for Underbalanced Drilling Scenario**

**Table 5.1 - Probability of failure on Demand of Components and Frequency of Occurrence of Actions/Events (Torstad, 2010; Grayson & Gans, 2012; Khakzad, et al., 2013b; Abimbola, et al., 2014)**

<b>Event</b>	<b>Description</b>	<b>Prior Probability (P<sub>i</sub>)</b>	<b>Posterior Probability (P<sub>p</sub>)</b>	<b>Ratio P<sub>p</sub>/ P<sub>i</sub></b>
1	Insufficient mud weight	5.00E-02	4.18E-01	8.36
2	Ballooning	2.00E-02	1.67E-01	8.35
3	Gas cut mud	3.00E-05	2.51E-04	8.37
4	Swabbing	5.00E-02	4.53E-01	9.06
5	Operator failure to follow procedure (MPD)	1.00E-03	1.23E-02	12.30
6	MPD control system failure (MPD)	1.00E-04	1.23E-03	12.30
7	Shallow gas/Abnormal pressured zone	2.69E-01	2.08E-01	1.01
8	Loss of circulation	2.70E-02	2.72E-02	1.01
9	Primary power supply failure	2.50E-02	3.19E-02	1.28
10	Backup power supply failure	2.50E-02	3.19E-02	1.28
11	Operator failure to follow procedure (PP)	1.00E-03	2.68E-03	2.68
12	MPD control system failure (PP)	1.00E-04	2.68E-04	2.68
13	Operator failure to follow procedure (FG)	1.00E-03	2.68E-03	2.68
14	MPD control system failure (FG)	1.00E-04	2.68E-04	2.68

15	RCD failure	4.00E-02	4.91E-01	12.30
16	Rig pump failure	4.00E-02	4.91E-01	12.30
17	PWD tool failure	1.10E-04	1.39E-04	1.26
18	DAPC choke manifold failure	2.50E-02	3.16E-02	1.26
19	DAPC pump failure	4.00E-02	5.06E-02	1.27
20	Flow meter failure	1.10E-04	1.88E-04	1.71
21	Rig choke failure	2.50E-02	4.23E-02	1.69

**Table 5.2 - Safety Barriers Probabilities of Failure on Demand (Torstad, 2010; Grayson & Gans, 2012; Abimbola, et al., 2014)**

<b>Barrier</b>	<b>Description</b>	<b>Failure Probability</b>
1	MPD system	8.14E-02
2	Blowout preventer (BOP)	7.00E-04
3	Ignition prevention	1.07E-02
4	External intervention (fire-fighting, evacuation, drilling of relief well etc.)	2.71E-02

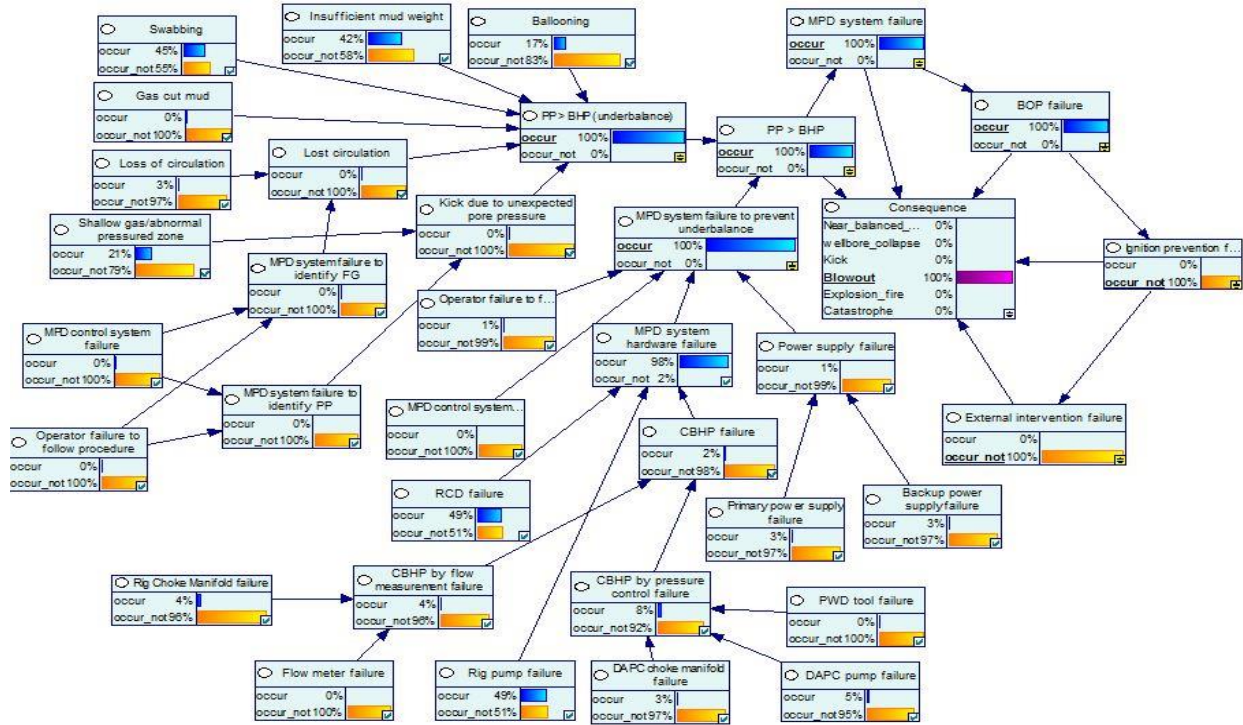
By forward propagation, the frequency of occurrence of an underbalanced condition (the top event) is estimated as  $9.75E-03$ . The detailed results are presented in Table 5.3. It is to be noted that the frequency of occurrence of a blowout in this case study, i.e.  $4.96E-07$ , is of the same order of magnitude as that of Grayson and Gans (2012), i.e.  $3.46E-07$ . Assuming a blowout occurrence (Fig. 5.6) by instantiating the consequence node to blowout state, a backward propagation is conducted showing that the MPD system and the BOP would have failed as a result of an underbalanced condition. The main contributing factors identified are the MPD hardware system failure comprising the RCD, the rig pump, the MPD control system and operator error. The posterior probabilities of these contributing factors are more than 12 times as much as their prior probabilities (5th column of Table 5.1). The underbalanced condition is due to swabbing effect, gas cut mud, insufficient mud weight and wellbore ballooning. It is worth noting that the effects of presence of shallow gas/abnormal pressured zones and lost circulation which would have been dominating as other factors in causing the underbalanced condition are suppressed by effective determination of pore pressure (PP) and fracture gradient (FG) respectively as shown in the BT of Figure 5.3.

Considering the failure of RCD, the frequency of occurrence of a kick increases to  $9.73E-03$  while that of a blowout to  $6.09E-06$ . In this situation, the primary well control element is only the drilling mud. This situation is similar to conventional overbalanced drilling. This blowout frequency is of the same order of magnitude as that calculated by Khakzad et al. (2013b) for conventional overbalanced drilling, i.e.  $2.55E-06$ . This highlights the safety critical nature of RCD for the success of MPD.



**Table 5.3 - Underbalanced Scenario Predictive Frequency of Occurrence**

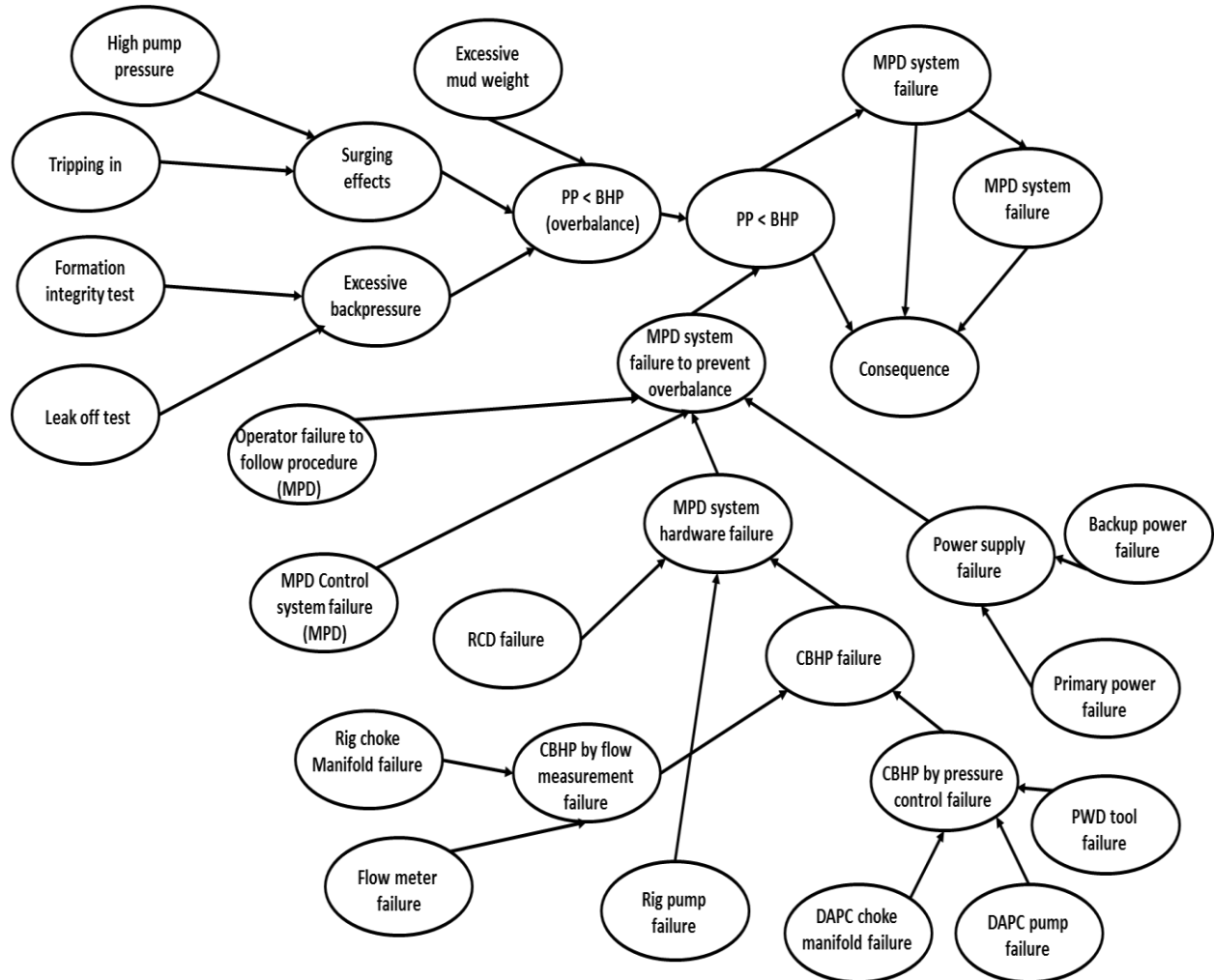
<b>End Event</b>	<b>Description</b>	<b>Predictive Occurrence frequency</b>
1	Near balanced Condition	9.90E-01
2	Wellbore collapse	8.96E-03
3	Kick	7.93E-04
4	Blowout	<b>4.96E-07</b>
5	Explosions, fire, major injury to few deaths, minimal environmental pollution	5.78E-08
6	Catastrophe (loss of rig, fatalities, major environmental damage)	1.61E-09



**Figure 5.6 - Blowout Scenario Diagnostic Analysis**

Considering an exceedingly overbalanced MPD scenario, the BT and the corresponding BN are presented in Figures 5.4 and 5.7 respectively. The occurrence frequencies of basic events/actions and the probabilities of failure on demand of equipment used in the analysis are listed in Table 5.4. The failure probability of the MPD system safety barrier, in this case, is the same as that in Table 5.2. The end events occurrence frequencies are presented in Table 5.5. A closer look into a lost circulation scenario (Fig. 5.8) showed that the MPD system would have failed to prevent the overbalanced condition of the drilling operation from causing damage to the well. Similarly, the key elements in this case are the RCD, the rig pump, the MPD control system and the operator's poor handling of the drilling operation. The significance of these factors may be gauged by the fact that the posterior probabilities increased by multiple factors (5th column, Table 5.4). The

overbalanced causal factors as shown in the BT of Fig. 5.4 are the surging effects of tripping into the well and high pump pressure as well as excessive back pressure as a result of FIT or LOT.



**Figure 5.7 - Bayesian Network of Overbalanced Scenario of CBHP techniques**

**Table 5.4 - Probability of failure on Demand of Components and Frequency of Occurrence of Actions/Events for Overbalanced Scenario (Torstad, 2010; Grayson & Gans, 2012; Khakzad, et al., 2013b; Abimbola, et al., 2014)**

<b>Event</b>	<b>Description</b>	<b>Prior Probability (P<sub>i</sub>)</b>	<b>Posterior Probability (P<sub>p</sub>)</b>	<b>Ratio (P<sub>p</sub>/ P<sub>i</sub>)</b>
1	Tripping in	5.40E-02	1.18E-01	2.19
2	Excessive mud weight	5.00E-02	1.09E-01	2.18
3	High pump pressure	2.00E-01	4.36E-01	2.18
4	Operator failure to follow procedure	1.00E-03	1.23E-02	<b>12.30</b>
5	MPD control system failure	1.00E-04	1.23E-03	<b>12.30</b>
6	Formation Integrity Test (FIT)	5.00E-02	1.09E-01	2.18
7	Leak off Test (LOT)	2.07E-01	4.52E-01	2.18
8	Primary power supply failure	2.50E-02	3.19E-02	1.28
9	Backup power supply failure	2.50E-02	3.19E-02	1.28
10	RCD failure	4.00E-02	4.91E-01	<b>12.30</b>
11	Rig pump failure	4.00E-02	4.91E-01	<b>12.30</b>
12	PWD tool failure	1.10E-04	1.39E-04	1.26
13	DAPC choke manifold failure	2.50E-02	3.16E-02	1.26

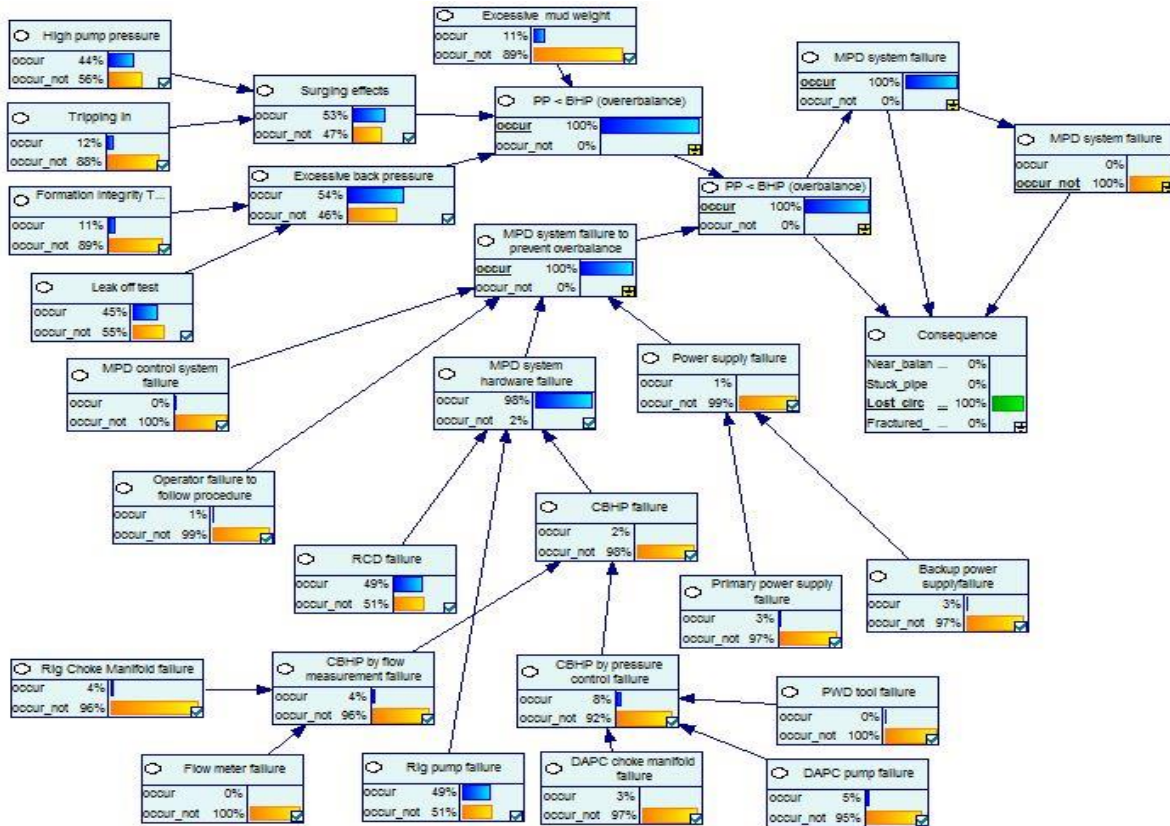
14	DAPC pump failure	4.00E-02	5.06E-02	1.27
15	Flow meter failure	1.10E-04	1.88E-04	1.71
16	Rig choke manifold failure	2.50E-02	4.26E-02	1.70

---

**Table 5.5 - Overbalanced Scenario Predictive Frequency of Occurrence**

<b>End Event</b>	<b>Description</b>	<b>Predictive Occurrence frequency</b>
1	Near balanced Condition	9.63E-01
2	Differential sticking/Stuck pipe	3.43E-02
3	Lost circulation	2.79E-03
4	Fractured formation	2.48E-04

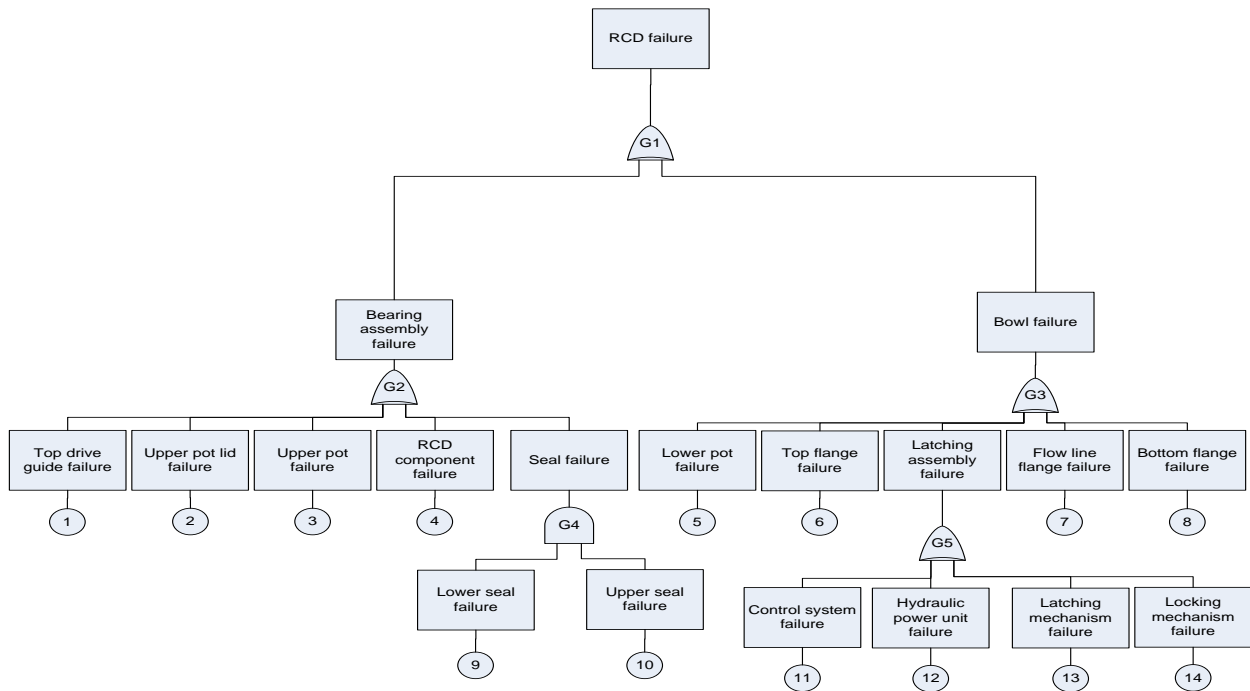
---



**Figure 5.8 - Lost circulation Scenario of Overbalanced Condition of CBHP Techniques**

In the above scenarios investigated, the critical roles of RCD, rig pump, MPD control system and proper handling of the drilling operation to the success of CBHP techniques of MPD are highlighted. The rig pump failure probability can be reduced by running pumps in parallel and providing backups. MPD control systems are becoming more sophisticated and reliable in recent time. Relevant and adequate training should be provided to drilling personnel to reduce errors during drilling. To examine the RCD components, an FT model of an RCD with dual elastomeric sealing elements, which is typical of offshore application, is presented in Fig. 5.9. The nomenclature of the parts of the RCD modeled is based on Weatherford Model 7875 Below-Tension-Ring RCD (Weatherford, 2012) and Pruitt RCD (Pruitt, 2012). An RCD is made up of

two principal parts: the bearing assembly and the bowl. The bearing assembly houses dual elastomeric sealing elements, RCD component, upper pot, upper pot lid and a top drive guide. The bowl has at its top edge a latching assembly which clamps the bearing assembly to the lower part (bowl). The operation of the latching assembly with a locking mechanism is controlled via a hydraulic power unit. Well effluent flowing into the lower pot of the bowl is stripped off the drill string through a flow line flange to a separator. The bowl has a bottom flange by which the RCD is attached to the top of an annular BOP or a riser. The probabilities of failure on demand of the component parts are presented in Table 5.6. Most of these failure probabilities are based on expert judgment. The predictive analysis resulted in a failure probability of  $4.40E-02$  for RCD in consonance with that calculated in the predictive analysis of the underbalanced scenario of CBHP techniques discussed earlier. Further diagnostic analysis (Figure 5.10) reveals that about 93% of the failure is due to the bearing assembly, 91% of which is attributed to the seal failure, pointing to the critical role of the sealing elements in the safe operation of the RCD and MPD. Following in the order of importance, is the bowl failure with latching assembly and the locking mechanism as the main contributors. The operation of the latching assembly is influenced by the latching mechanism and the hydraulic power unit. This shows that the most probable explanation for the failure of an RCD would be the failure of the bearing assembly, particularly, the seal failure.



**Figure 5.9 - FT model of an offshore RCD**

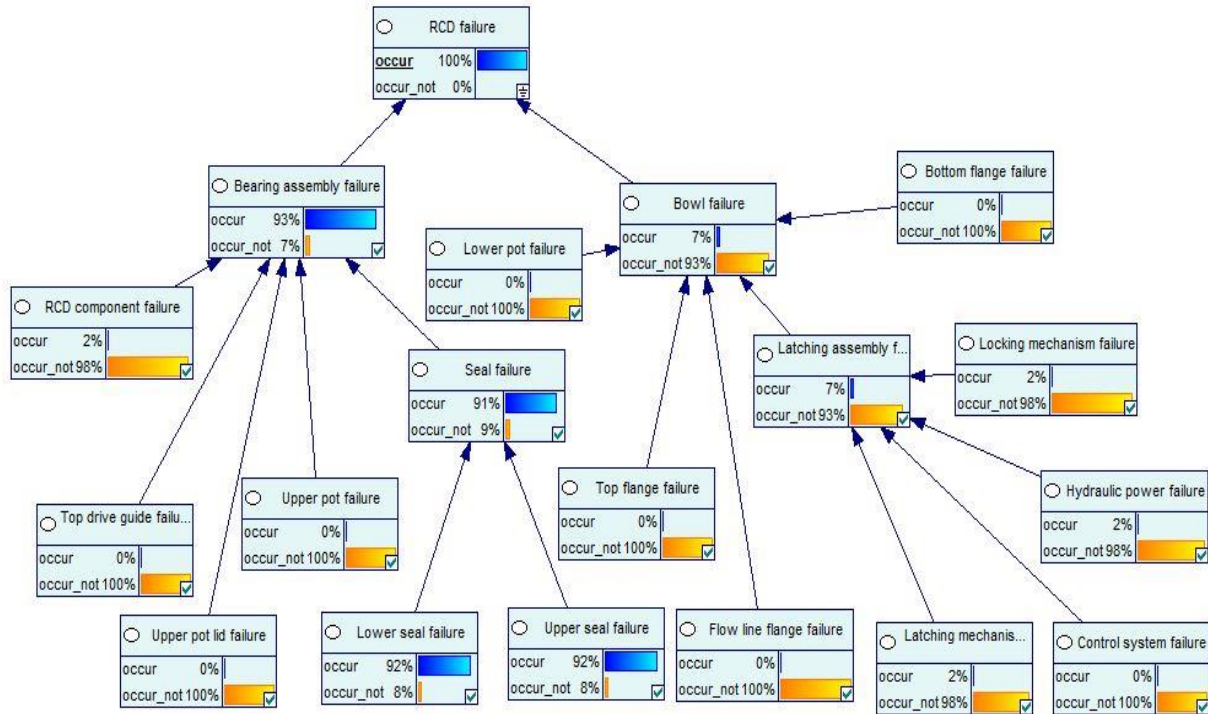
**Table 5.6 - RCD Components Probabilities of failure on Demand**

Component	Description	Prior Probability (P <sub>i</sub> )	Posterior probability (P <sub>p</sub> )
1	Top drive guide failure	1.00E-05	2.27E-04
2	Upper pot lid failure	1.00E-05	2.27E-04
3	Upper pot failure	1.00E-05	2.27E-04
4	RCD component failure	1.00E-03	2.27E-02
5	Lower pot failure	1.00E-05	2.27E-04



6	Top flange failure	1.00E-05	2.27E-04
7	Flow line flange failure	1.00E-05	2.27E-04
8	Bottom flange failure	1.00E-05	2.27E-04
9	Lower seal failure	2.00E-01	9.24E-01
10	Upper seal failure	2.00E-01	9.24E-01
11	Control system failure	1.00E-04	2.27E-03
12	Hydraulic power unit failure	1.00E-03	2.27E-02
13	Latching mechanism failure	1.00E-03	2.27E-02
14	Locking mechanism failure	1.00E-03	2.27E-02

---



**Figure 5.10 - Diagnostic analysis of RCD failure**

## 5.5. Conclusion

This study presents a risk assessment methodology based on BN for analyzing the safety critical components and consequences of possible pressure regimes in CBHP techniques of MPD. Based on the pressure regimes, different scenarios - underbalanced, overbalanced and normal or near balanced conditions were defined and investigated in detail for potential unwanted conditions. The bow-tie models were developed and mapped into BNs to conduct predictive as well as diagnostic analyses. In each scenario, the safety critical components and events relevant to the success of CBHP techniques were identified by estimating their posterior probabilities. These include the RCD, the rig pump, the MPD control system, and proper handling of the drilling operation by the drilling crew (human factor). The RCD, as the most important critical component, was further

analyzed to identify the most probable explanation of its failure, leading to the bearing assembly at the seal failure. It was concluded that the sealing elements need to be improved to further enhance the performance of the RCD and subsequently, the CBHP techniques. Further research is needed in studying risks associated with casing and cementing operations, riser system operation and dynamic positioning of Mobile Offshore Drilling Unit (MODU) for deep-water applications.

## **Acknowledgment**

The authors acknowledge the financial support of Natural Sciences and Engineering Research Council (NSERC), Vale Research Chair grant and Research & Development Corporation of Newfoundland and Labrador (RDC).

## **List of Acronyms**

BHP = Bottom Hole Pressure

BN = Bayesian Network

BT = Bow-Tie

CBHP = Constant Bottom Hole Pressure

CCS = Continuous Circulation System

COBD = Conventional Over-balanced Drilling

CPT = Conditional Probability Table

DAG = Directed Acyclic Graph

DAPC = Dynamic Annular Pressure Control

DGD = Dual Gradient Drilling

ECD = Equivalent Circulating Density

ET = Event Tree

FG = Fracture Gradient

FIT = Formation Integrity Test

FT = Fault Tree

IADC = International Association of Drilling Contractors

ICU = Intelligent Control Unit

LHS = Left Hand Side

LOT = Leak off Test

MODU = Mobile Offshore Drilling Unit

MPD = Managed Pressure Drilling

NPT = Non Productive Time

PMCD = Pressurized Mud Cap Drilling

PP = Pore Pressure

PWD = Pressure measurement While Drilling

QRA = Quantitative Risk Analysis

RHS = Right Hand Side

RCD = Rotating Control Device

## References

- Abimbola, M., Khan, F. & Khakzad, N., 2014. Dynamic Safety risk analysis of offshore drilling. *Journal of Loss Prevention in the Process Industries*, Volume 30, pp. 74-85.
- Arild, O., Ford, E. P., Loberg, T. & Baringbing, J. W. T., 2009. *KickRisk - A Well Specific Approach to the Quantification of Well Control Risks*. Jakarta, Indonesia, SPE 124024.
- Benny, A. M. H., Karnugroho, A., Sosa, J. & Toralde, J. S. S., 2013. *Combining Pressurized Mud Cap Drilling (PMCD) and Early Kick Detection (EKD) Techniques for Fractured Formations Overlying a High Pressure Reservoir in Offshore Kalimantan*. Jakarta, Indonesia, SPE 165893.
- Bercha, F. G., 1978. *Probabilities of Blowouts in Canadian Arctic Waters*, Canada: Environmental Protection Service. Economic and Technical Review, Report EPS 3-EC-78-12.
- Bobbio, A., Portinale, L., Minichino, M. & Ciancamerla, E., 2001. Improving the analysis of dependable systems by mapping fault trees into Bayesian networks. *Reliability Engineering and System Safety*, Volume 71, pp. 249-260.
- Catak, E., 2008. MPD with Flow Measurement as the Primary Control. In: B. Rehm, et al. eds. *Managed Pressure Drilling*. Houston, Texas: Gulf Publishing Company, pp. 109-126.
- Cohen, J., Stave, R., Schubert, J. & Elieff, B., 2008. Dual-Gradient Drilling. In: B. Rehm, et al. eds. *Managed Pressure Drilling*. Houston, Texas: Gulf Publishing Company, pp. 181-226.
- Fredericks, P., 2008. Constant Bottom-Hole Pressure with Pressure as a Primary Control. In: B. Rehm, et al. eds. *Managed Pressure Drilling*. Houston, Texas: Gulf Publishing Company, pp. 81-107.
- Grayson, B. & Gans, A. H., 2012. *Closed Loop Circulating Systems Enhance Well Control and Efficiency With Precise Wellbore Monitoring and Management Capabilities*. Milan, Italy, SPE, p. 12.
- Haghshenas, A., Paknejad, A. S., Reihm, B. & Schubert, J., 2008. The Why and Basic Principles of Managed Well-Bore Pressure. In: B. Reihm, et al. eds. *Managed Pressure Drilling*. Houston, Texas: Gulf Publishing Company, pp. 1-38.
- Hannegan, D., 2013. *Operational Reliability Assessment of Conventional vs. MPD on Challenging Offshore Wells*. Amsterdam, SPE/IADC 163523.

- Hannegan, D. M., 2005. *Managed Pressure Drilling in Environments - Case Studies*. Amsterdam, The Netherland, SPE/IADC 92600.
- Hannegan, D. M., 2011. *MPD- Drilling Optimization Technology, Risk Management Tool, or Both?*. Denver, Colorado, SPE 146644.
- Hossain, E. M., & Al-Majed, A. A. (2015). *Fundamentals of Sustainable Drilling*. USA: Scrivener and Welly.
- Jensen, F. V. & Nielsen, T. D., 2007. *Bayesian Networks and Decision Graphs*. 2nd ed. New York: Springer.
- Khakzad, N., Khan, F. & Amyotte, P., 2011. Safety analysis in process facilities: Comparison of fault tree and Bayesian network approaches. *Reliability Engineering and System Safety*, Volume 96, pp. 925-932.
- Khakzad, N., Khan, F. & Amyotte, P., 2013a. Dynamic safety analysis of process systems by mapping bow-tie into Bayesian network. *Process Safety and Environmental Protection*, Volume 91, pp. 46-53.
- Khakzad, N., Khan, F. & Amyotte, P., 2013b. Quantitative risk analysis of offshore drilling operations: A Bayesian approach. *Safety Science*, Volume 57, pp. 108-117.
- Khan, F., 2001. Use of maximum credible accident scenarios for realistic and reliable risk assessment. *Chemical Engineering Progress*, Volume 11, pp. 56-64.
- Malloy, K. P. et al., 2009. *Managed-Pressure Drilling: What It Is and What It Is Not*. San Antonio, Texas, IADC/SPE 122281.
- Minerals Management Service, 2008. *Notice to Lessees and Operators of Federal Oil, Gas, and Sulphur Leases in the Outer Continental Shelf, Gulf of Mexico OCS Region: Managed Pressure Drilling Projects. Report, NTL 2008-G07*. [Online]  
Available at:  
[http://www.iadc.org/committees/ubo\\_mpd/Documents/MMS%20NTL%202008-G07.pdf](http://www.iadc.org/committees/ubo_mpd/Documents/MMS%20NTL%202008-G07.pdf)  
[Accessed 9 January 2014].
- Moore, D., 2008. Mud Cap Drilling. In: B. Rehm, et al. eds. *Managed Pressure Drilling*. Houston, Texas: Gulf Publishing Company, pp. 155-180.
- Pitblado, R., Bjerager, P. & Andreassen, E., 2010. *Key Aspects of an Effective U.S. Offshore Safety Regime*. [Online]  
Available at: [http://www.dnvusa.com/Binaries/1008-001%20Offshore%20Update\\_Key%20aspects\\_tcm153-430982.pdf](http://www.dnvusa.com/Binaries/1008-001%20Offshore%20Update_Key%20aspects_tcm153-430982.pdf)  
[Accessed 9 January 2014].

- Pruitt, 2012. *The Pruitt RCD at work*. [Online]  
Available at: <http://pruitt.com/>  
[Accessed 20 January 2014].
- Rathnayaka, S., Khan, F. & Amyotte, P., 2013. Accident modeling and risk assessment framework for safety critical decision-making: application to deepwater drilling operation. *Proceedings of the Institution of Mechanical Engineers, Part O: Journal of Risk and Reliability*, Volume 227, pp. 86-105.
- Rehm, B., Haghshenas, A., Paknejad, A. S. & Schubert, J., 2008. Situational Problems in MPD. In: B. Rehm, et al. eds. *Managed Pressure Drilling*. Houston: Gulf Publishing Company, pp. 39-78.
- Smith, J. R. & Patel, B. M., 2012. A Proposed Method for Planning the Best Initial Response to Kicks During Managed-Pressure Drilling Operations. *SPE Drilling & Completion*, June, pp. 194-203.
- Torstad, E., 2010. *Closed Loop Systems Reduce the Probability of Loss of Well Control*, September 30: DNV presentation.
- Vogel, R. & Brugman, J., 2008. Continuous Circulation System. In: B. Rehm, et al. eds. *Managed Pressure Drilling*. Houston, Texas: Gulf Publishing Company, pp. 127-142.
- Weatherford, 2012. *Weatherford Pressure Control Systems*. [Online]  
Available at:  
<http://www.weatherford.com/weatherford/groups/web/documents/weatherfordcorp/wft142070.pdf>  
[Accessed 20 January 2014].
- Wiegerinck, W., Kappen, B. & Burgers, W., 2010. Bayesian Networks for Expert Systems: Theory and Practical Applications. In: R. Babuska & F. C. A. Groen, eds. *Interactive Collaborative Systems*. Delft, The Netherlands: Springer, pp. 547-578.

## Chapter 6

### 6.0 Risk-based safety analysis of well integrity operations

#### Preface

*A version of this chapter has been published in the **Safety Science Journal 2016; 84:149-160**. I am the primary author. Along with Co-author, Faisal Khan, I developed the conceptual model and subsequently translated this to the numerical model. I have carried out most of the data collection and analysis. I have prepared the first draft of the manuscript and subsequently revised the manuscript, based on the feedback from Co-authors and also peer review process. As Co-author, Faisal Khan assisted in developing the concept and testing the model, reviewed and corrected the model and results. He also contributed in reviewing and revising the manuscript. As Co-author, Nima Khakzad, contributed through support in developing the model, testing, reviewing and revising the manuscript.*

#### Abstract

Assurance of well integrity is critical and important in all stages of operation of oil and gas reservoirs. In this study, well integrity is modeled during casing and cementing operations. Two different approaches are adapted to model potential failure scenarios. The first approach analyzes failure scenarios using Bow-Tie model, which offers a better visual representation of the logical relationships among the contributing factors through Boolean gates. The second approach takes advantage of Bayesian network, both to model conditional dependencies and to perform



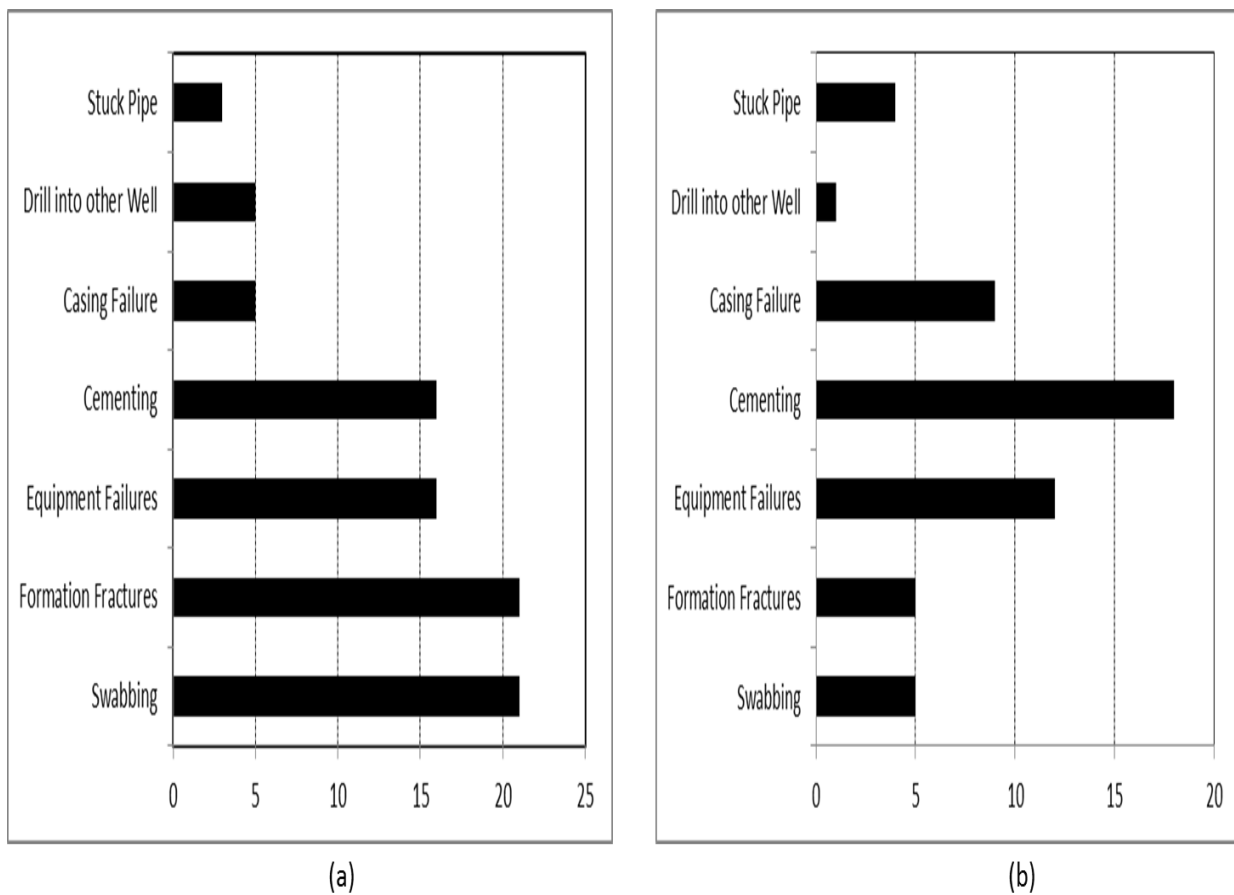
probability updating. The analysis identified Managed Pressure Drilling system, logging tool, slurry formulation, casing design, casing handling and running method, surge and swab pressures as critical elements of the well integrity model. A diagnostic analysis on the slurry formulation further identified pilot test(s) and the interpretation of the test(s) as key elements to ensuring integrity of cementing operation. Relevant safety functions and inherent safety principles to improve well integrity operations are also explored.

**Keywords:** Well integrity, Cementing, Blowout, Managed pressure drilling, Bayesian network analysis, Inherent safety techniques

## **6.1. Introduction**

Well integrity relies on the application of technical, operational and organizational techniques to reduce the risk of uncontrolled release of formation fluids throughout the entire life cycle of a well (NORSOK, 2004). The operations of well integrity during drilling operations include the casing and cementing of drilled wellbore. Studies conducted by Danenberger (1993) and Izon et al. (2007) on blowouts in the Outer Continental Shelf of the U.S between 1971 and 2006 (**Fig. 6.1**) identified casing failure and cementing as prominent contributing factors. Most of the investigatory reports on the causes of Macondo well blowout on April 20, 2010 attribute failures in the cementing operations to the accident (DHSG, 2011; CCR, 2011; BOEMRE, 2011; BP, 2010). The study of some of the factors which influence drilling ahead operations can be found in Abimbola et al. (2014, 2015a). Safety and risk analysis of casing and cementing operations are studied in the present work. Safety analysis of process systems and the assessment of their risks are often

quantified using quantitative risk analysis techniques. Quantitative risk analysis has been expressed as the systematic identification and quantification of hazards to predict their effects on the individuals, property or environment (Skogdalen & Vinnem 2012). Among the quantitative risk analysis tools, those commonly used are: fault tree analysis, event tree analysis, bow-tie, Failure Mode and Effect Analysis (FMEA) and Bayesian network. Fault tree analysis is widely recommended for its simple and effective approach in estimating the frequency or probability of critical events in a deductive process (Deshpande, 2011; Eskesen, et al., 2004). However, it is incapable of handling multi-state variables and conditional dependencies, and performing probability updating as new information or evidence becomes available (Khakzad, et al., 2011).



**Figure 6.1 – Factors contributing to blowouts, (a) 1971 – 1991 (b) 1992 – 2006 (Danenberger, 1993; Izon, et al., 2007)**

Event tree analysis and bow-tie have also been identified with similar characteristics (Ferdous, et al., 2009; Ferdous, et al., 2012). Consequently, variants of these methods have been developed that can be updated, such as the use of evidence theory to update the reliability data of rare events (Curcuru, et al., 2012); use of fuzzy based reliability approaches for fault tree analysis (Purba, 2014); event tree analysis (Ferdous, et al., 2009) and the resulting bow-tie (Ferdous, et al., 2012; Ferdous, et al., 2013). Recently, fault tree and bow-tie based models have been mapped into Bayesian network in dynamic risk analysis for dependability analysis and ease of updating mechanism (Khakzad, et al., 2013b; Abimbola, et al., 2015a). Further discussions on quantitative risk analysis in modeling accident scenarios and applicable quantitative risk analysis tools can be found in Khakzad, et al. (2012) and Rathnayaka, et al. (2013). This part of the dissertation aims to achieve two main objectives. The first is to model and analyze casing and cementing operations as part of well integrity operations. From the analysis, safety critical elements of the operations will be identified. The second is to demonstrate the application of safety functions and inherent safety techniques to the well integrity operations in order to improve the reliability of the operations. The critical nature of cementing operation towards ensuring the integrity of the well is discussed in Section 6.2. Safety analysis techniques and the methodology adopted for this study are presented in Section 6.3. Section 6.4 presents the models of this study while the analysis is detailed in Section 6.5. Section 6.6 is devoted to the conclusion from the study.

## **6.2. Critical Nature of Cementing Operation**

During casing and cementing operations, liners are used for isolation of lost circulation and abnormally pressured zones so as to permit drilling ahead (drilling liner); covering up worn out or damaged section of an existing casing or liner (stub liner); and casing-off of the production interval

of a well (production liner). It is very difficult, in practice, to obtain a good cement job on a liner. This is because of the small annular clearance between the liner and the open hole section; leading to difficulty in running (due to surge pressure) and centralizing the liner in the narrow open hole section across the producing zone; difficulty in achieving a good cement placement in the small annular clearance; and high tendency of lost circulation problems due to high pressure drop when circulating around the liner. The cement slurry for this section is often prone to contamination by the drilling mud; and there is often a difficulty in achieving an adequate liner movement for good cement placement. Thus, there is the need to investigate the critical nature of casing and cementing operations of the production zone.

### 6.3. Safety Analysis Techniques

#### 6.3.1. Bow-Tie (BT)

Bow-tie is a risk analysis technique which combines a fault tree (FT) and an event tree (ET) with the top event of the FT as the initiating event of the ET. It is used to analyze the primary causes and consequences of an accident. A BT diagram (as shown in **Fig. 6.2**) presents the logical relationship between the causes, expressed as basic events (BEs) on one side, through intermediate events (IEs), top event (TE) and safety barriers (SBs) to the possible consequences (Cs) on the other side. For illustrative purpose, considering **Fig. 6.2**, the occurrence probability of end-event  $C_2$  is given by

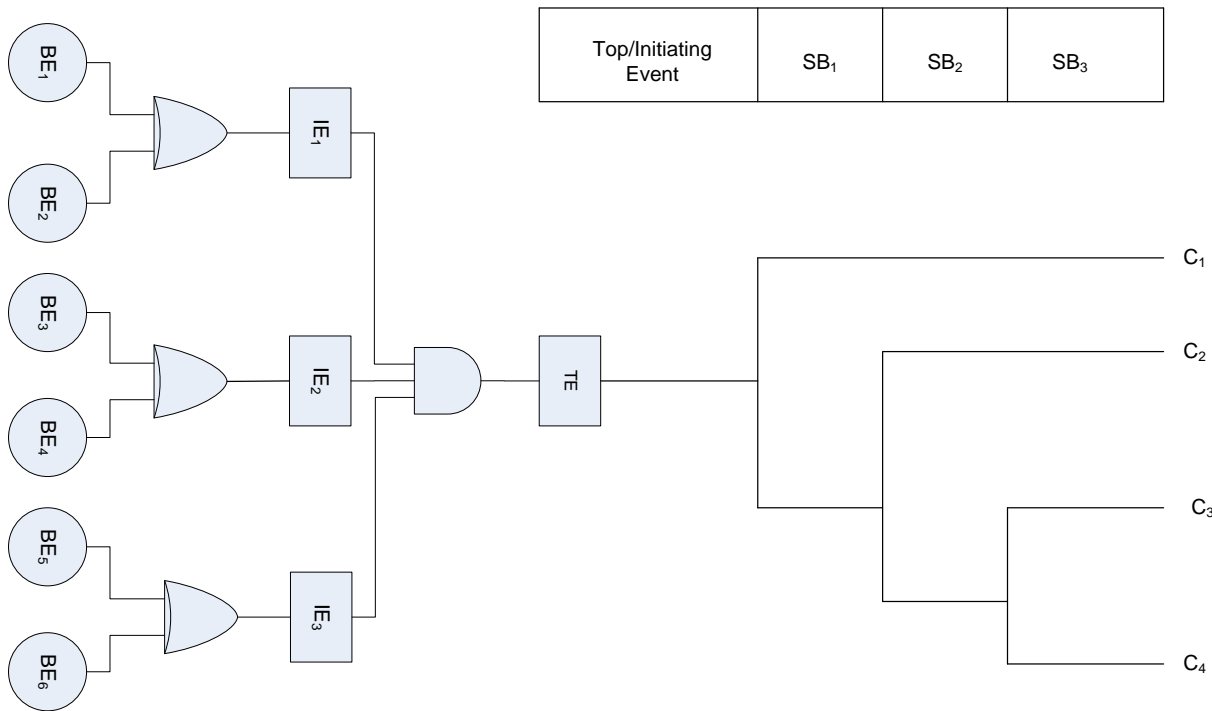
$$P(C_2) = P(TE).P(SB_1).P(1 - SB_2) \quad (6.1)$$

Similarly,

$$P(C_4) = P(TE).P(SB_1).P(SB_2).P(SB_3) \quad (6.2)$$

where  $P(TE)$  is the probability of top event determined by the Boolean algebraic combination of the occurrence probabilities of the basic events,  $P(BE_1), P(BE_2) \dots$  and  $P(BE_6)$ .  $P(SB_1), P(SB_2)$  and  $P(SB_3)$  represent the failure probabilities of the safety barriers  $SB_1, SB_2$  and  $SB_3$  respectively.

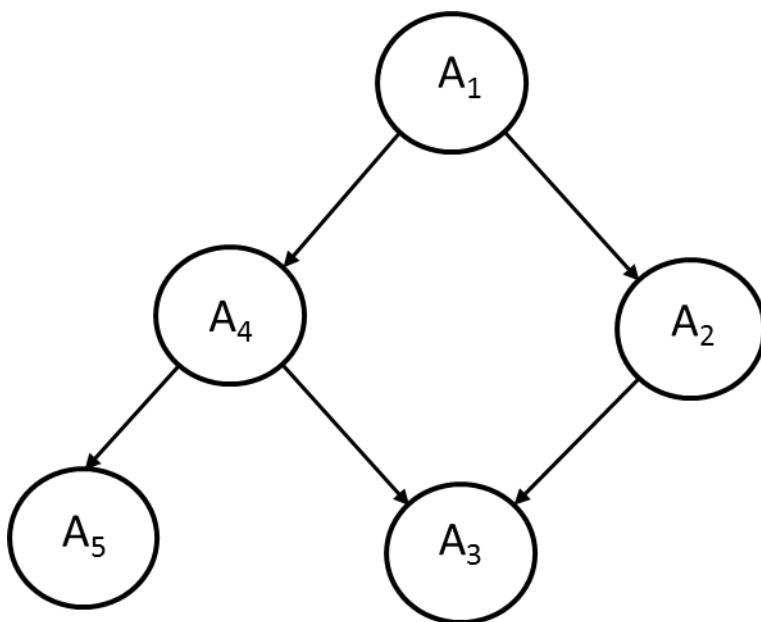
Bow-tie combines the advantages of FT and ET with its use found in many fields of science. Markowski and Kotynia (2011) used BT in a layer of protection analysis to model a complete accident scenario in a hexane distillation unit. Khakzad et al. (2012) applied BT in risk analysis of dust explosion accident in a sugar refinery. Forms of BT haven been applied in medical safety risk analysis (Wierenga, et al., 2009) and analysis of hazard and effects management process of vehicle operations (Eslinger, et al., 2004). Like its composites FT and ET, BT exhibits similar limitations and deficiencies of independency assumption and difficulty in its use for complex system analysis.



**Figure 6.2 - A generic bow-tie diagram**



The directed acyclic graph and the joint probability distribution of the nodes are said to satisfy Markov condition if each variable,  $A_i$ , in the directed acyclic graph is conditionally independent of the set of all its non-descendants given its parents (Neapolitan, 2004). For instance,  $A_3$  is conditionally independent of non-descendants:  $A_1$  and  $A_5$  given its parents:  $A_2$  and  $A_4$ . Mathematically, this can be written as:  $I_p(A_3, \{A_1, A_5\} | \{A_2, A_4\})$ . Similarly for  $I_p(A_5, \{A_1, A_2, A_3, A_5\} | A_4)$  in **Fig. 6.3**.



**Figure 6.3 – A generic directed acyclic graph**

This analysis can be generalized for  $n$  variables with  $k$  states, enabling modeling of complex dependencies among random variables. Bayesian networks are used for both predictive (forward propagation) and diagnostic (backward propagation) analyses. Marginal prior probabilities of root nodes and conditional probabilities of intermediate nodes lead to the marginal probabilities of the intermediate and leaf nodes in predictive analysis; while in diagnostic analysis, node state

instantiation results in updated probabilities of conditionally dependent nodes (Abimbola et al. 2015a).

### 6.3.3. The Noisy-OR Gate

Noisy-OR gate is a type of canonical interaction used to describe causal relationships among  $n$  binary variables and their common outcome. The simplifying assumptions are that: each cause is sufficiently able to lead to the outcome in the absence of other causes except it is inhibited; the ability of each cause to lead to the outcome is independent of the presence of other causes; and the outcome can only occur if at least one of the causes is present and not inhibited (Neapolitan, 2009). Considering, for instance, node,  $A_3$ , in **Fig. 6.3**, the outcome of nodes  $A_2$  and  $A_4$  as a Noisy-OR gate, the above assumptions enable the specification of the entire  $4(2^2)$  conditional probabilities of  $A_3$ . If

$$P(A_3 = a_3 | A_2 = a_2, A_4 = \bar{a}_4) = p_2 \dots \dots \dots (6.5)$$

And

$$P(A_3 = a_3 | A_2 = \bar{a}_2, A_4 = a_4) = p_4 \dots \dots \dots (6.6)$$

$$P(A_3 = \bar{a}_3 | A_2 = a_2, A_4 = a_4) = (1 - p_2)(1 - p_4) \dots \dots \dots (6.7)$$

$$P(A_3 = \bar{a}_3 | A_2 = a_2, A_4 = \bar{a}_4) = 1 - p_2 \dots \dots \dots (6.8)$$

$$P(A_3 = \bar{a}_3 | A_2 = \bar{a}_2, A_4 = a_4) = 1 - p_4 \dots \dots \dots (6.9)$$

$$P(A_3 = \bar{a}_3 | A_2 = \bar{a}_2, A_4 = \bar{a}_4) = 1 \dots \dots \dots (6.10)$$

Hence, for  $n$  causal binary variables  $L_1, L_2, \dots, L_{n-1}, L_n$ , with an outcome  $M$ , if





between the nodes of the equivalent Bayesian network. The failure probabilities of the basic events represents the marginal prior probabilities of the root nodes. The intermediate and leaf nodes are assigned conditional probability tables whose estimated probabilities are determined based on the interpretation of the governing logic gates (Bobbio, et al., 2001; Khakzad, et al., 2013a). Similarly, in mapping event tree into a Bayesian network, the safety barriers are represented with safety nodes,  $SB_1, SB_2, \dots, SB_n$ , where  $n$  represents the number of safety barriers. A safety node,  $SB_{i+1}$ , is linked to the preceding safety node,  $SB_i$ , only if the failure probability of  $SB_{i+1}$  is conditionally dependent on the failure probability of  $SB_i$ . In other words,  $SB_{i+1}$  must be connected to  $SB_i$  only if  $P(SB_{i+1}, |SB_i) \neq P(SB_{i+1}, |\overline{SB_i})$ . Similarly, for  $P(SB_{i+1}, |SB_{i-1}) \neq P(SB_{i+1}, |\overline{SB_{i-1}})$  and so on. This is also applicable to sequentially arranged safety barriers as discussed in this study. Further, safety nodes are linked to the consequence node only if the probabilities of the states of the consequence node are conditionally dependent on the success or failure probability of the safety nodes (Khakzad, et al., 2013a). The failure probabilities of the safety barriers are used in formulating the conditional probability tables of the safety nodes to reflect the causal relationships of the safety barriers. A conditional probability table is assigned to the consequence node which logically follow that of an AND-gate. In the Bayesian network equivalent of the bow-tie, a new state, a normal or safe state, is added to the consequence node, to account for the non-occurrence of the top event (Khakzad, et al., 2013a; Abimbola, et al., 2015a).

#### **6.4. Model Description**

Well integrity operations, in this study, are limited to the integrity and satisfactory performance of both casing and cementing operations of a well. Part of the assumptions of this study is that a

hydrocarbon bearing zone, with sufficient reservoir pressure to support the flow of hydrocarbon to the surface if a well integrity operation failure results, is encountered. It is to be noted that, in practice, well integrity failures are mostly characterized with cementing failures compared to failures in the casing operations. This is because the well is overbalanced with the primary well control element (heavy mud for conventional technique or light drilling fluid with some back-pressure for CBHP technique). Cementing operation partly involves the displacement of the primary well control element (mud) with pre-flush and spacer that can exert less bottom hole pressure than the primary well control element; making it (cementing operation) a more critical process. Besides, some defects in the casing operation such as the creation of lost circulation zone as a result of a surge pressure are remedied with a good cementing operation; thus, requiring that most failures in the casing operation need to be complemented by a failure in the cementing operation in order to result to well integrity failures. However, a failure in cementing operation alone is enough to give rise to a well integrity failure. For example, a poor cement job around the casing shoe in the reservoir region implies a higher probability of reservoir fluid influx regardless of the integrity of the casing operation. Hence, a Noisy-OR (N-OR) gate, with a conditional probability table presented in **Table 6.1**, is applicable to the model herein discussed. The choice of  $P_{\alpha}$  in **Table 6.1** is based on the belief to which casing operation contributes to the well integrity failure. For instance, let well integrity (WI) failure be denoted as:

$P(WI = Yes) = P(WI)$  and  $P(WI = No) = P(\overline{WI})$ . Similarly, for casing (CAS) failure and cementing (CEM) failure. Assuming,  $P(CAS) = x$  and  $P(CEM) = y$ ,

$$\begin{aligned}
 P(WI) = & P(WI|CAS, CEM)P(CAS)P(CEM) + P(WI|CAS, \overline{CEM})P(CAS)P(\overline{CEM}) \\
 & + P(WI|\overline{CAS}, CEM)P(\overline{CAS})P(CEM) + P(WI|\overline{CAS}, \overline{CEM})P(\overline{CAS}) \dots \dots \dots (6.14)
 \end{aligned}$$

Thus, from **Table 6.1**,

$$P(WI) = (1)(x)(y) + (P_\alpha)(x)(1 - y) + (1)(1 - x)y + (0)(1 - x)(1 - y) \dots \dots (6.15)$$

$$P(WI) = xP_\alpha - xyP_\alpha + y \dots \dots \dots (6.16)$$

$$P(\overline{WI}) = 1 - P(WI) = 1 + xyP_\alpha - xP_\alpha - y \dots \dots \dots (6.17)$$

**Table 6.1 - Noisy-OR gate conditional probability table for well integrity failure node**

<i>Casing failure</i>	<i>Yes</i>		<i>No</i>	
<i>Cementing failure</i>	<i>Yes</i>	<i>No</i>	<i>Yes</i>	<i>No</i>
<i>Yes</i>	1	$P_\alpha$	1	0
<i>No</i>	0	$1 - P_\alpha$	0	1

This gives a value between that of an OR gate (maximum) and an AND gate (minimum) due to the non-zero value of  $P_\alpha$ :  $0 < P_\alpha < 1$ . This implies an optimum representation of the well integrity operations. For  $x = 0.5$  and  $y = 0.4$ ,

*OR gate,  $P_\alpha = 1$  :*  $P(WI) = (0.5) - (0.5)(0.4) + (0.4) = 0.7$

*Noisy – OR gate,  $P_\alpha = 0.6$  :*  $P(WI) = (0.5)(0.6) - (0.5)(0.4)(0.6) + (0.4) = 0.58$

*AND gate:*  $P(WI) = (0.5)(0.4) = 0.2$

The casing failure occurs when both there is a failure in the casing string and the casing evaluation method fails to detect the failure as shown in **Fig. 6.4**. The casing components include: casing sealing assembly and casing hanger/spool of the wellhead and casing coupling. Unlike the casing collapse failure which can occur during casing operation as a result of lateral formation stress, due

to caving-in or well collapse; the burst of the casing is not considered as it often occurs over the life of the well (long term failure) and not during the process of casing operation. Casing evaluation methods entail the use of logs such as casing inspection logs and pressure tests (positive and negative pressure tests) to identify failures in the operation. Depending on the appropriate mechanism, a log, pressure tests or the combination of logs and pressure tests are deployed to evaluate the casing operation. The running of casing in and out of the well can produce surge pressure which causes lost circulation and fractured formation, and swab pressure which leads to a kick respectively at the bottom-hole. Constant Bottom Hole Pressure (CBHP) technique of Managed Pressure Drilling helps to maintain the wellbore pressure within the narrow mud window (Tian, et al., 2009; Crespo, et al., December 2012). Managed pressure drilling system is a system of devices used to precisely control the annular pressure profile throughout the wellbore. It includes for constant bottom hole pressure drilling technique of MPD, a combination of rotating control device and a dedicated choke manifold in addition to a back pressure pump, integrated pressure manager, separator and flow lines (Fredericks, 2008; Torstad, 2010; Beltran, et al., 2010; Abimbola, et al., 2015a).

Considering the cementing operation, a failure in the cementing job (**Fig. 6.5**) is as a result of a zonal isolation failure and the inability to detect the fault with the cement evaluation techniques. Zonal isolation is a measure of the effectiveness of the hydraulic barrier created between casing and the formation. This is further characterized as formation – cement and cement – casing bonds, and a measure of cement placement. Formation-cement-casing bond could fail by cement slurry contamination, inadequate mud cake removal and cement shrinkage. Incomplete cement placement can result from either insufficient cement height placement or inadequate cement placement. The low top of cement (TOC) could be caused by pumping insufficient cement slurry

volume, u-tubing effect as a result of failure of the float collar valve and the float shoe, wrong or no placement of wiper plugs (top and bottom plugs) or by cement slurry loss to natural or induced fractures. The TOC is detected with the use of either a temperature log or radioactive tracers. It is worth mentioning that the temperature log is run few hours after cement placement to determine the TOC. As such, it is not for the overall cementing evaluation. This determines its localized position in the insufficient cement height placement section in the fault tree model. The poor cement placement often emanates from existence of mud channels from inadequate mud removal, cement slurry filtration loss or from cementing equipment failure. The cement evaluation techniques include: Cement Bond Log/Variable Density Log (CBL/VDL), Ultrasonic Imaging Tool (USIT) and pressure tests (positive and negative or inflow tests).

Further diagnosis of cement slurry contamination reveals formation fluid and drilling mud as potential contaminants. This could result from defective cementing techniques, poor slurry formulation or an error in the execution of the cementing job. Similar explanation holds for whole cement slurry loss and cement slurry filtration loss. The failure of cementing equipment is centered on the failure of the key components and/or events such as pumping system failure, MPD system failure or operator error during cementing job execution.

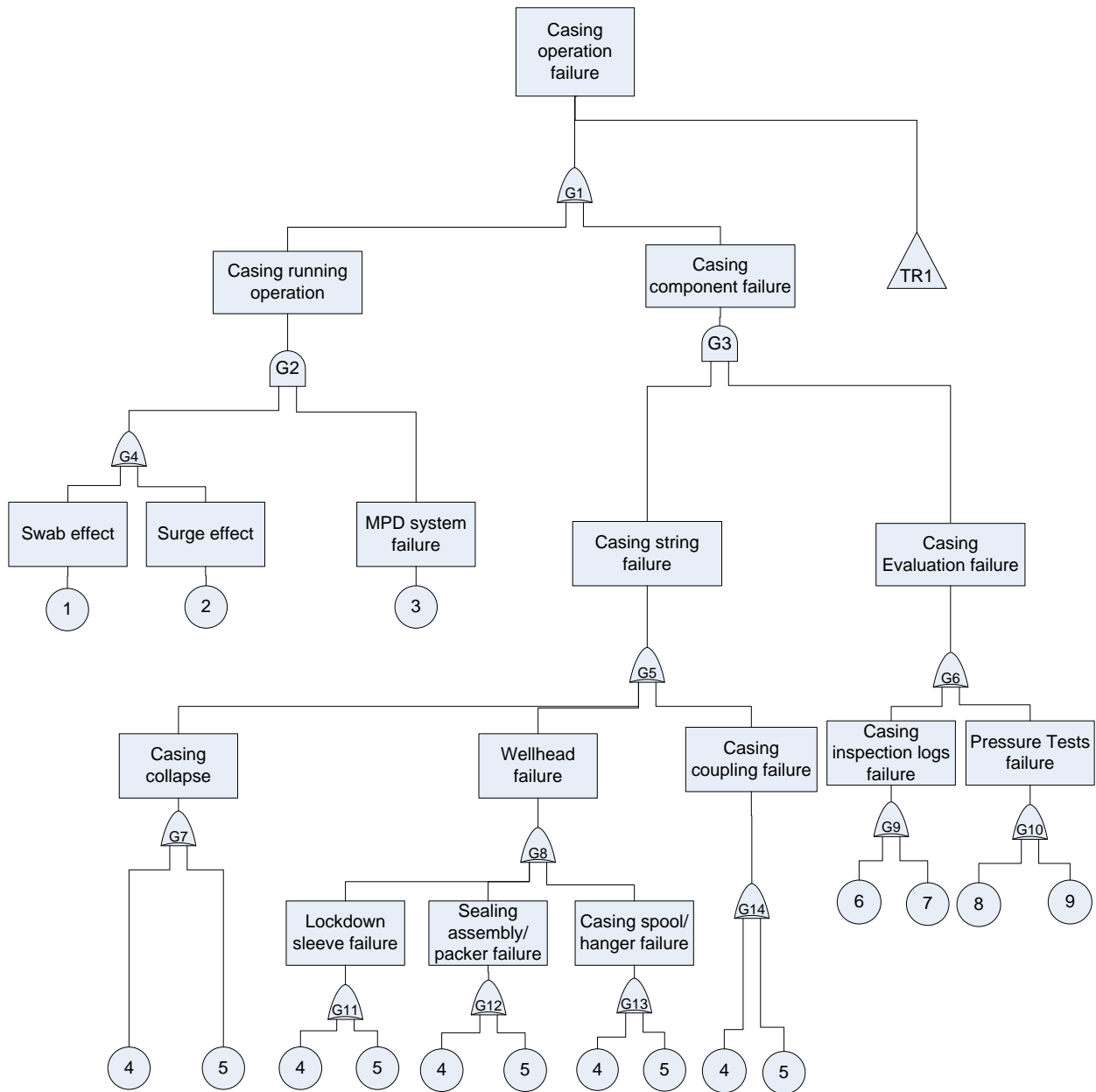
The fault trees (**Fig. 6.4** with transfer 1 (TR1) gate and **Fig. 6.5** with transfer 2 (TR2) gate) are linked to the event tree through a Noisy-OR gate in order to form a bow-tie, representative of the well integrity accident model shown in **Fig. 6.6**. The safety barrier elements of the event tree comprises the blowout preventer, the ignition prevention and mitigation barriers such as hot surface shields, insulation, spark inhibitors, fire and gas detection system, and automatic sprinklers. External intervention includes: firefighting operation, personnel evacuation, and the

implementation of blowout contingency plan of vertical intervention and the drilling of a relief well.

## 6.5. Model Analysis

In this study, both float collar and float shoe are presumably installed as is currently the best practice in the industry. Also, the possible logs that could be run during casing and cementing are included in the analysis even though all might not be adopted for a specific scenario. In order to overcome the limitations inherent in the conventional methods of fault tree and event tree, such as enabling dependability and diagnostic analyses, (Khakzad, et al., 2012; Khakzad, et al., 2013b; Abimbola, et al., 2015a), the fault trees (**Figs. 6.4 and 6.5**) and the bow-tie (**Fig. 6.6**) are mapped into a Bayesian network and analyzed. The mapping algorithm has been explained in Section 6.3.4.

Discussions on the fundamentals and advantages of Bayesian network over other conventional methods can be found in Pearl (1988), Jensen and Nielsen (2007), and Khakzad et al. (2011). The Bayesian networks in this study are analyzed using GeNIe 2.0 software developed by the Decision System Laboratory of the University of Pittsburgh and available at <http://genie.sis.pitt.edu/>. The assigned occurrence/failure probabilities for the basic events and the safety barriers presented in **Table 6.2** are determined over the period of the operation (Torstad, 2010; Grayson & Gans, 2012; Khakzad, et al., 2013a; Abimbola, et al., 2014; Rathnayaka, et al., 2013).



**Figure 6.4 - Casing operation fault tree**



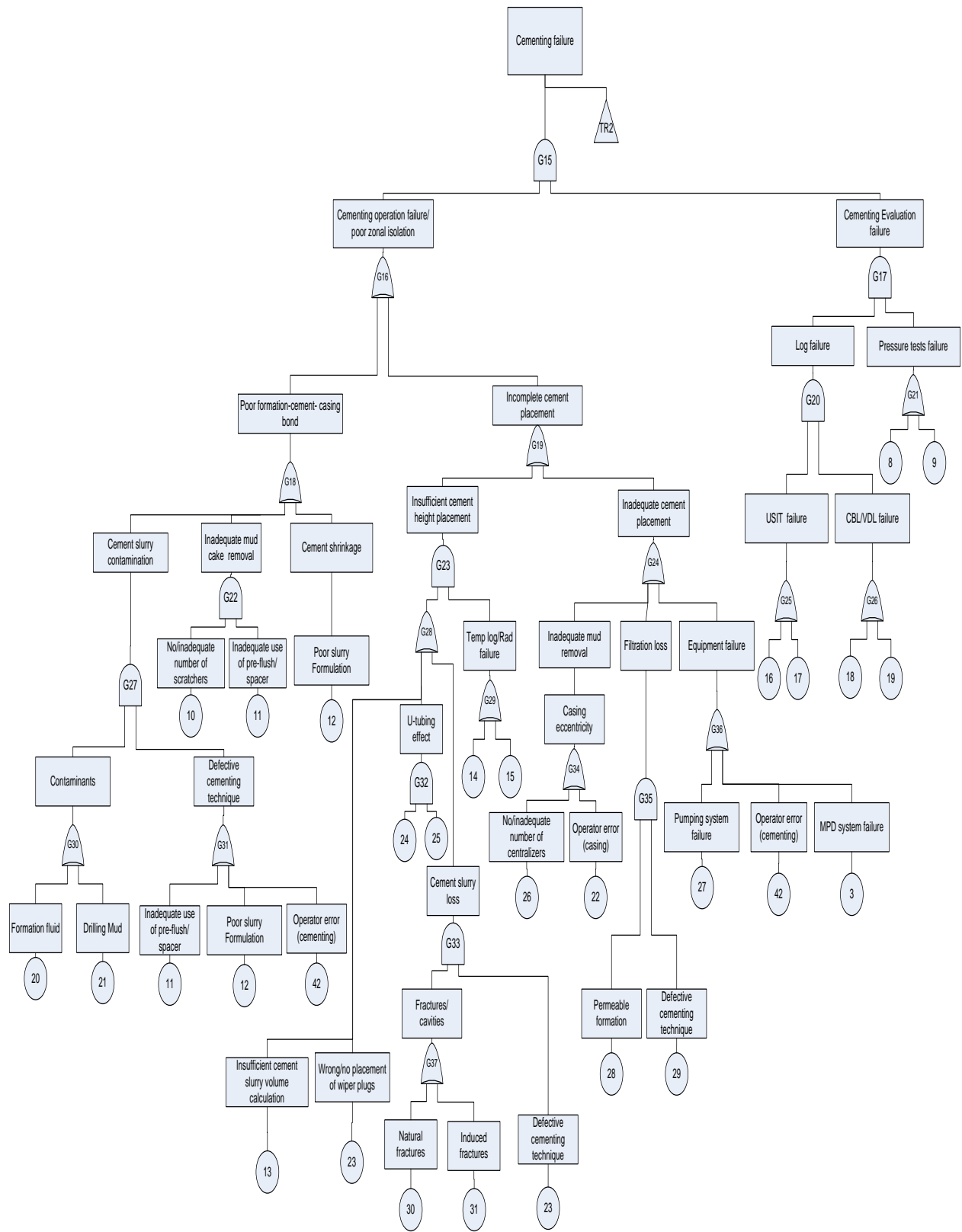
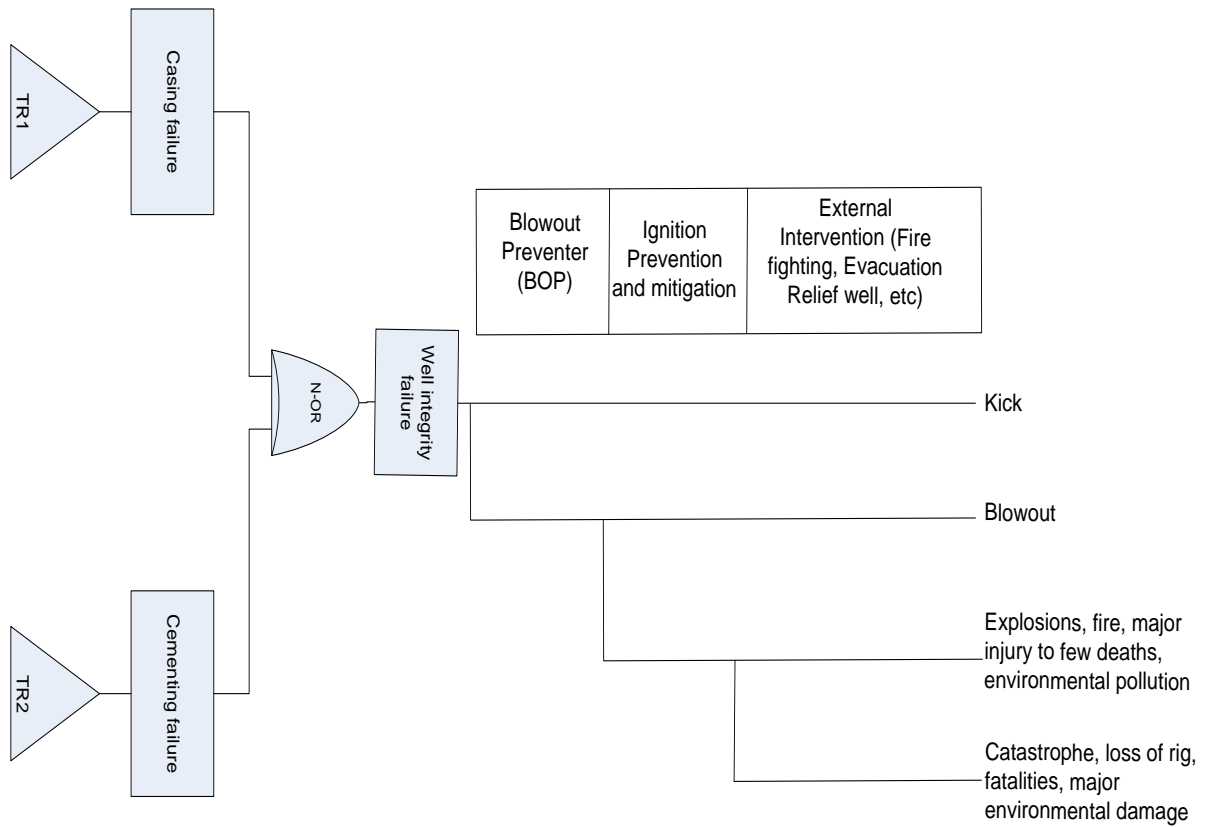


Figure 6.5 – Cementing operation fault tree



**Figure 6.6 – Well integrity accident scenarios bow-tie model**

**Table 6.2 - Event Description and Probability (Torstad, 2010; Grayson & Gans, 2012; Khakzad, et al., 2013b; Abimbola, et al., 2014; Rathnayaka, et al., 2013)**

Number	Event Description	Prior Probability
1	Swab pressure	1.00E-02
2	Surge pressure	5.39E-02
3	MPD system failure	1.10E-03
4	Poor design - wrong selection of component	1.00E-02
5	Poor handling/running method	3.30E-02
6	Logging tool failure (casing inspection log)	1.00E-03
7	Inaccurate interpretation of log	1.00E-02
8	Pressure Tests failure	2.50E-02
9	Inaccurate interpretation of test results	1.00E-02
10	No/inadequate number of scratchers	1.00E-04

11	Inadequate use of pre-flush/spacer	3.30E-02
12	Poor slurry formulation	2.00E-02
13	Insufficient cement slurry volume calculation	1.00E-02
14	Logging tool failure (Temp/Radioactive tracer)	1.00E-03
15	Inaccurate interpretation of log (Temp/Radioactive tracer)	1.00E-02
16	Tool failure (USIT)	1.00E-03
17	Inaccurate interpretation of result (USIT)	1.00E-02
18	Logging tool failure (CBL/VDL)	1.00E-03
19	Inaccurate interpretation of log (CBL/VDL)	1.00E-02
20	Formation fluid (contaminating cement slurry)	2.00E-01
21	Drilling mud (contaminating cement slurry)	1.00E-01
22	Operator error during casing operation	1.50E-02
23	Wrong/no placement of wiper plugs	1.00E-04
24	No/failure of float collar	2.50E-03
25	No/failure of float shoe	2.50E-03
26	No/inadequate number of centralizers	1.00E-03
27	Pumping system failure	4.00E-02
28	Permeable formation	1.00E-01
29	Defective cementing technique	6.66E-02
30	Natural fractures	1.50E-04
31	Induced fractures	1.50E-03
32	Wrong cement type	1.00E-03
33	Incorrect amount of dry cement	1.00E-02
34	Incorrect amount of mix-water	1.00E-02
35	Wrong additive(s)	1.00E-03
36	Wrong volume of additive(s)	1.00E-02
37	Pilot Tests failure	2.50E-02
38	Inaccurate interpretation of pilot test result	1.00E-02
39	Blowout Preventer (BOP)	7.00E-04
40	Ignition Prevention and Mitigation	1.07E-02
41	External Intervention (fire fighting, evacuation, relief well)	2.71E-02
42	Operator error during cementing operation	1.50E-02

To minimize the effects of generic data used in this analysis, a ratio of posterior probabilities to prior probabilities is determined. Thus, emphasis is laid on the order of magnitude and not on the generic probability values. A validation of this approach is presented in **Appendix 6-A**. Further, in facilitating the dependency modeling of the consequence node to the top event, a new state – normal condition - is added to the consequence node to account for the non-occurrence of the top event (i.e. well integrity failure). Running the Bayesian network in **Fig. 6.7**, the well integrity prior

failure probability is 6.920E-05 resulting from a casing failure probability of 8.60E-05 and a cementing failure probability of 3.61E-07. These give the prior probabilities of the consequences as shown in **Table 6.3**.

**Table 6.3 - Consequence occurrence probabilities**

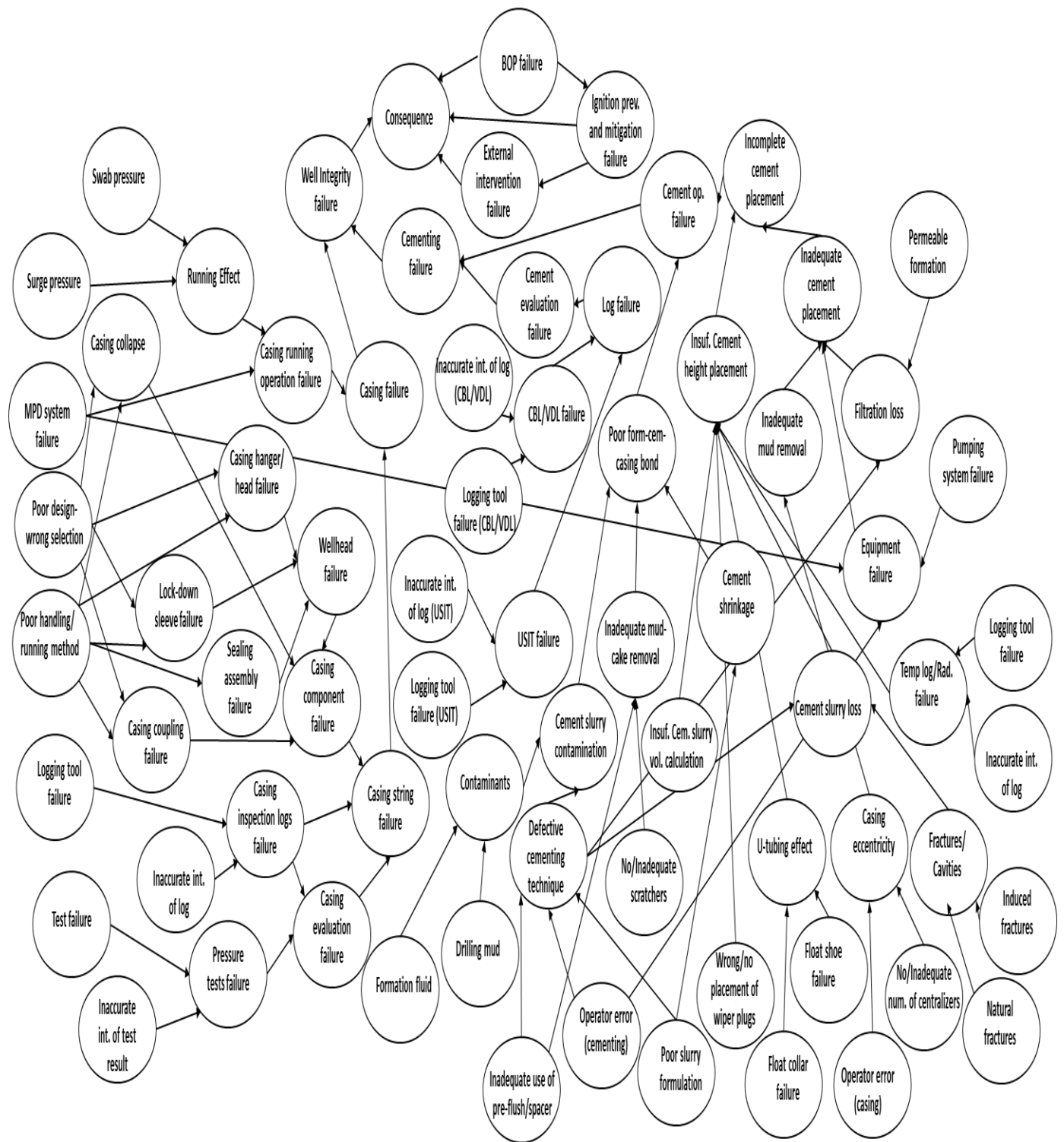
<b>Consequence</b>	<b>Probability</b>
Normal condition	9.99E-01
Kick	6.92E-05
Blowout	4.33E-08
Explosions/fire	5.04E-09
Catastrophe	1.40E-10

In line with the definition of the Noisy-OR gate, a casing operation failure could lead to an 80% probability of well integrity failure, resulting in increased posterior probabilities, for instance, of the kick and the blowout by a factor of about 11,569. A failure in the cementing operation certainly leads to a well integrity failure, with the occurrence probabilities of the consequences increased by a factor of about 14,462, confirming that even though the correctness of the casing operation is indispensable, absolute attention should be paid to the details of a cementing job; thus, validating the model.

A diagnostic analysis of model shows that a blowout scenario would have been caused by a well integrity failure due to the blowout preventer failure. A well integrity failure would require an increased posterior failure probability of 5.22E-03 in the cementing process (by a factor of 14,460), coupled with over 99% failure in the casing operation.

This would have been contributed by about 81.9% of casing running effects and 18.9% failure in the casing string. The posterior (diagnostic) probabilities of the critical basic events are presented in **Table 6.4**. It is observed that the causal factors of highest importance can be ranked as: managed

pressure drilling system failure, logging tool failure and the interpretation of logs, poor slurry formulation, pressure test failure and its interpretation, poor casing design, handling and running method, surge and swab pressures. The main advantage of the managed pressure drilling system is to neutralize the effects of surge and swab that are prevalent during the operations; hence, highly critical to the success of the operations.



**Figure 6.7 – The equivalent BN model of well integrity operations during drilling operations**

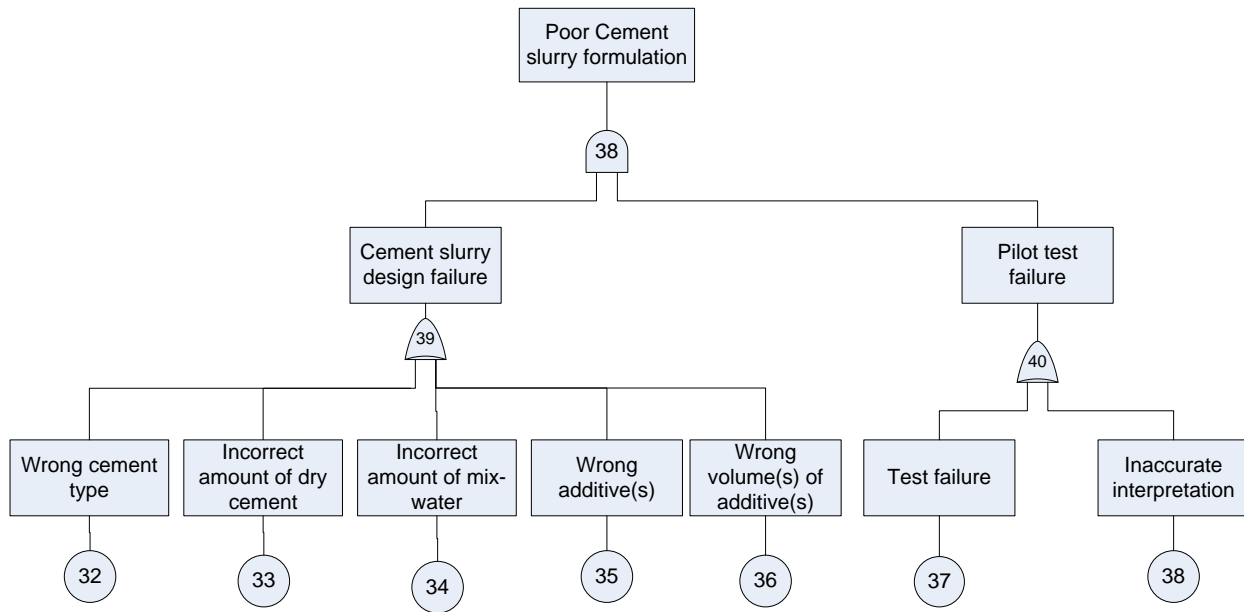
**Table 6.4 – Diagnostic analysis of critical elements**

<b>Event Number</b>	<b>Event Description</b>	<b>Prior Probability (<math>P_i</math>)</b>	<b>Posterior Probability (<math>P_f</math>)</b>	<b>Ratio (<math>\frac{P_f}{P_i}</math>)</b>
1	Swab pressures	1.00E-02	1.29E-01	1.29
2	Surge pressure	5.39E-02	6.96E-01	1.29
3	MPD system failure	1.10E-03	8.07E-01	733.64
4	Poor design - wrong selection of component	1.00E-02	5.23E-02	5.23
5	Poor handling/running method	3.30E-02	1.73E-01	5.24
6	Logging tool failure (casing inspection log)	1.00E-03	1.80E-02	18
7	Inaccurate interpretation of log	1.00E-02	1.80E-01	18
8	Pressure Tests failure	2.50E-02	1.60E-01	6.4
9	Inaccurate interpretation of test results	1.00E-02	6.38E-02	6.38
11	Inadequate use of pre-flush/spacer	3.30E-02	3.36E-02	1.02
12	Poor slurry formulation	2.00E-02	2.11E-01	10.55
16	Tool failure (USIT)	1.00E-03	1.47E-03	1.47
17	Inaccurate interpretation of result (USIT)	1.00E-02	1.47E-02	1.47
18	Logging tool failure (CBL/VDL)	1.00E-03	1.47E-03	1.47
19	Inaccurate interpretation of log (CBL/VDL)	1.00E-02	1.47E-02	1.47
22	Operator error during casing operation	1.50E-02	1.58E-02	1.05
26	No/inadequate number of centralizers	1.00E-03	1.06E-03	1.06
27	Pumping system failure	4.00E-02	4.22E-02	1.06
29	Defective cementing technique	6.66E-02	6.90E-02	1.04
42	Operator error during cementing operation	1.50E-02	1.58E-02	1.05

A sensitivity analysis on the well integrity failure highlighted the managed pressure drilling system as the most important element to the prevention of well integrity failure. To a lesser degree are surge and swab pressures, logging tool and the pressure tests. From a measure of the strength of influence, it was identified that the slurry formulation and casing eccentricity exerted the most influence to the critical event. Casing eccentricity is avoided by adequate use of centralizers. Another sensitivity analysis on cementing operation highlighted: CBL/VDL, USIT, Pressure tests, managed pressure drilling system, poor slurry formulation, operator error, inadequate use of

centralizers, pumping system, and inadequate use of pre-flush/spacer as the most important basic events.

Considering a further analysis of poor cement formulation, a sub model is developed (**Fig. 6.8**) and analyzed with its Bayesian network equivalence. A sensitivity analysis showed an average value of 1.7% for the root causes of cement slurry design and an average value of 1.6% for pilot test test(s) root causes. Another measure of the strength of influence identified pilot test failure and the inaccurate interpretation of the test results as key elements to ensuring a successful cement slurry formulation.



**Figure 6.8 – Cement slurry formulation sub-model**

Safety functions and inherent safety principles are applied to the models presented. These are implemented in the model by applying them to the basic events of the fault trees and safety barriers of the event tree as presented in **Table 6.5**. This approach is indispensable to ensure success in the design and execution of drilling liner, production liner or production casing. A review of safety



functions and inherent safety techniques can be found elsewhere (Khan & Amyotte, 2003; Khan & Amyotte, 2004; Khan & Amyotte, 2005; Kletz & Amyotte, 2010; Srinivasan & Natarajan, 2012; Rathnayaka, et al., 2014; de Dianous & Fievez, 2006; Delvosalle, et al., 2006).

**Table 6.5 – Aggregated basic events and safety barriers description and potential safety measures to reduce operation failure probabilities**

<b>Event</b>	<b>Description</b>	<b>Safety function</b>	<b>Inherent safety principle</b>
1	Swab pressure	Prevent driller’s error through training (Prevent)	Provide running speed monitoring mechanism (simplification)
2	Surge pressure	Prevent driller’s error through training (Prevent)	Provide running speed monitoring mechanism (simplification)
3	MPD system failure	Prevent system failure through preventive maintenance (Prevent)	Substitute system control devices with high safety instrumented level (SIL) instrument (substitution)
4	Poor design - wrong selection of component	Avoid design error by fool-proofing (Avoid)	
5	Poor handling/running method	Prevent operator error through training (Prevent)	
6	Logging tool failure	Prevent tool failure through preventive maintenance (Prevent)	Substitute tool with highly advanced and sophisticated device (substitution)
7	Inaccurate interpretation of log	Prevent operator error through training (Prevent)	Simplify logs for easy interpretation (simplification)
8	Pressure Tests failure	Prevent operator error through training (Prevent)	
9	Inaccurate interpretation of test results	Prevent operator error through training (Prevent)	Simplify logs for easy interpretation (simplification)

10	No/inadequate number of scratchers	Prevent the use of inadequate number of scratchers through supervision before casing running (Prevent)	
11	Inadequate use of pre-flush/spacer	Avoid design error in pre-flush and spacer volume calculation and limit the effects of error by introducing error margin in cement slurry design (Avoid, Limit)	Moderate the effects of error in pre-flush and spacer volume determination by incorporating tolerance in volume determination and cement slurry design (moderation, simplification)
12	Poor slurry formulation	Avoid design error in cement slurry formulation (Avoid)	Limit the effects of error in slurry design by incorporating error tolerance in the formulation (moderation, simplification)
13	Insufficient cement slurry volume calculation	Avoid design error in cement slurry volume determination (Avoid)	
14	Logging tool failure (Temp/Radioactive tracer)	Prevent tool failure through preventive maintenance (Prevent)	Substitute tool with highly advanced and sophisticated device (substitution)
15	Inaccurate interpretation of log (Temp/Radioactive tracer)	Prevent operator error through training (Prevent)	Simplify logs for easy interpretation (simplification)
16	Tool failure (USIT)	Prevent tool failure through preventive maintenance (Prevent)	Substitute tool with highly advanced and sophisticated device (substitution)
17	Inaccurate interpretation of result (USIT)	Prevent operator error through training (Prevent)	Simplify results for easy interpretation (simplification)
18	Logging tool failure (CBL/VDL)	Prevent tool failure through preventive maintenance (Prevent)	Substitute tool with highly advanced and sophisticated device (substitution)
19	Inaccurate interpretation of log (CBL/VDL)	Prevent operator error through training (Prevent)	Simplify logs for easy interpretation (simplification)
20	Formation fluid (contaminating cement slurry)	Avoid cement slurry contamination through efficient cementing practice; prevent operator error through training;	Limit the effects of error in slurry design by incorporating error

		limit effects of contamination by introducing tolerance and additives in slurry design (Avoid, Prevent, Limit)	tolerance in the formulation (moderation, simplification)
21	Drilling mud (contaminating cement slurry)	Avoid cement slurry contamination through efficient cementing practice; prevent operator error through training; limit effects of contamination by introducing tolerance in slurry design (Avoid, Prevent, Limit)	Limit the effects of error in slurry design by incorporating error tolerance in the formulation (moderation, simplification)
22	Operator error during casing	Prevent operator error through training (Prevent)	Limit the effects of operator error through checks, design fool proofing, advancement in control system (moderation)
23	Wrong/no placement of wiper plugs	Prevent operator error through training (Prevent)	
24	No/failure of float collar		Substitute equipment with highly reliable float collar (substitution)
25	No/failure of float shoe		Substitute equipment with highly reliable float shoe (substitution)
26	No/inadequate number of centralizers	Prevent the use of inadequate number of centralizers through supervision before casing running (Prevent)	
27	Pumping system failure	Reduce failure by providing adequate redundancy (Reduce)	Substitute equipment with advanced, sophisticated and highly reliable pumps(substitution)
28	Permeable formation	Reduce the effect of permeable formation by incorporating additives in the slurry formulation (Reduce)	
29	Defective cementing technique	Avoid the use of defective cementing technique through reviewing and training of operators (Avoid)	
30	Natural fractures	Reduce the effect of presence of natural fractures by incorporating additives in the slurry formulation (Reduce)	

31	Induced fractures	Prevent induced fractures by conducting proper casing running and cementing operations; reduce the effect of induced fractures by incorporating additives in the slurry formulation (Prevent, Reduce)	
32	Blowout preventer	Prevent blowout preventer failure through preventive maintenance; reduce failure by providing adequate redundancy onsite; Avoid premature failure by detecting malfunction through testing (Prevent, Reduce, Avoid)	Substitute the equipment with newer highly advanced and reliable blowout preventer; substitute the control system with controllers with higher safety instrumented levels (substitution)
33	Ignition Prevention and Mitigation Barrier		Substitution: substitute safety barrier with highly reliable and advanced devices Moderation: install fire walls and ignition inhibitors around sources of ignition Simplification: simplify the understanding and operation of critical devices on location
34	External Intervention (fire fighting, evacuation, relief well)		Substitution: substitute safety barrier devices with highly reliable and advanced instruments with controllers of higher safety instrumented levels Moderation: install automatic sprinklers on location Simplification: simplify evacuation procedures while decongesting egress routes
42	Operator error during cementing	Prevent operator error through training (Prevent)	Limit the effects of operator error through checks, design fool proofing, advancement in control system (moderation)

---

## 6.6. Conclusion

This part of the dissertation presents a bow-tie model for analyzing the integrity of casing and cementing operations of a well. A Noisy-OR gate is used for linking casing and cementing operations to the well integrity top event. The bow-tie model is mapped into a Bayesian network to allow updating mechanism and for dependency modeling which are parts of the limitations of the conventional risk assessment methods. To minimize the effects of generic data used in this analysis, emphasis is placed on the ratio of posterior probabilities to prior probabilities in the discussion of the analysis. The order of magnitude of the posterior probabilities of the causal factors identified managed pressure drilling system, logging tool, slurry design or formulation, casing design, casing handling and running method, surge and swab pressures as critical elements of the well integrity model. Sensitivity analysis and influence diagram of the model further tailored the success of the cementing operation to the optimal performance of pumping system, adequate use of centralizers, pre-flush and spacer, CBL/VDL, pressure tests and absence of operator error. A diagnostic or backward analysis on slurry formulation highlighted pilot test and interpretation of the test as key steps to a successful cement slurry formulation in addition to accurate selection of cement type (or class), additive(s) and determination of their volumes and mix-water volume

calculation. Further improvements to the operations are suggested through the implementation of safety functions and inherent safety principles on the basic events and safety barriers of the models.

## **Acknowledgments**

The authors acknowledge the financial support of Natural Sciences and Engineering Research Council (NSERC), Vale Research Chair grant, Research & Development Corporation of Newfoundland and Labrador (RDC) and Atlantic Canada Opportunities Agency (ACOA).

## References

- Abimbola, M., Khan, F. & Khakzad, N., 2014. Dynamic safety risk analysis of offshore drilling. *Journal of Loss Prevention in the Process Industries*, 30, pp.74–85.
- Abimbola, Majeed, Faisal Khan, Nima Khakzad, and Stephen Butt. 2015a. "Safety and Risk Analysis of Managed Pressure Drilling Operation Using Bayesian Network." *SAFETY SCIENCE* 76. Elsevier Ltd: 133–44. doi:10.1016/j.ssci.2015.01.010.
- Abimbola, Majeed, Faisal Khan, Vikram Garaniya, and Stephen Butt. "Failure analysis of the tripping operation and its impact on well control." St. John's: Proceedings of the 34th International Conference on Ocean, Offshore and Arctic Engineering, (2015b).
- Adams, N. J. *Drilling Engineering-A Complete Well Planning Approach*. Tulsa, Oklahoma: PennWell Publishing Company, 1985.
- Al-Mutairi, E. M, J. A Suardin, M. S Mannan, and M. M. El-Halwagi. "An optimization approach to the integration of inherently safer design and process scheduling." *Juornal of Loss Prevention in the Process Industries* 21(5) (2008): 543-549.
- Aven, T, and T. E. Nokland. "On the use of uncertainty importance measures in reliability and risk analysis." *Reliability Engineering and System Safety* 95 (2010): 127-133.
- Bearfield, G. & Marsh, W., 2005. Generalizing event trees using Bayesian networks with a case study of train derailment.. *Lecture Notes in Computer Science* 3688, pp. 52-66.
- Beltran, J. C, C Lupo, F Gallo, H Duno, and L. Medina. "Managed Pressure Drilling Brings Added Value to Production Casings Cementing Operations Increasing Success Rates and Quality in HPHT Fractured Narrow Window Wells." Kuala Lumpur, Malaysia: SPE/IADC 130313, 2010.

- Birnbaum, Z. W. "On the importance of different components in a multicomponent system." In *Multivariate analysis-II*, edited by P. R. Krishnaiah, 581-592. New York: Academic Press, 1969.
- Bobbio, A, L Portinale, M Minichino, and E. Ciancamerla. "Improving the analysis of dependable systems by mapping fault trees into Bayesian networks." *Reliability Engineering and System Safety* 71 (2001): 249-260.
- BOEMRE. *Report Regarding the Causes of the April 20, 2010 Macondo Well Blowout*. The Bureau of Ocean Energy Management, Regulation and Enforcement, 2011.
- Bommer, Paul. *A Primer of OILWELL DRILLING*. 7th. Texas: The University of Texas, 2008.
- Borgonovo, E, G. E Apostolakis, S Tarantola, and A. Saltelli. "Comparison of global sensitivity analysis techniques and importance measures in PSA." *Reliability Engineering and System Safety* 79 (2003): 175-185.
- Boudali, H, and J. B. Dugan. "A discrete-time Bayesian network reliability modeling and analysis framework." *Reliability Engineering and System Safety* 87 (2005): 337-349.
- Bourgoyne, Adam T. Jr, Keith K Millheim, Martin E Chenevert, and F. S. Jr. Young. *Applied Drilling Engineering*. Richardson, TX: Society of Petroleum Engineers, 1986.
- BP. *Deepwater Horizon Accident Investigation Report*. BP, 2010.
- CCR. *Macondo - The Gulf Oil Disaster*. National Commission on the BP Deepwater Oil Spill and Offshore Drilling. Chief Counsel's Report, 2011.
- Cheok, M. C, G. W Parry, and R. R. Sherry. "Use of importance measures in risk-informed regulatory applications." *Reliability Engineering and System Safety* 60 (1998): 213-226.
- Crespo, Freddy, Ramadan Ahmed, Majed Enfis, Arild Saasen, and Mahmood Amani. "Surge-and-Swab Pressure Predictions for Yield-Power-Law Drilling Fluids." *SPE Drilling & Completion*, December 2012: 574-585.
- Crowl, D. A, and J. F. Louvar. *Chemical Process Safety - Fundamentals with Applications*. Second. New Jersey: Prentice Hall PTR, 2002.
- Curcuro, G, G. M Galante, and C. M. La Fata. "Epistemic Uncertainty in fault tree analysis approached by the evidence theory." *Journal of Loss Prevention in the Process Industries* 25, no. 4 (2012): 667-676.
- Danenberger, E. P. "Outer Continental Shelf Drilling Blowouts, 1971 - 1991." Texas: OTC 7248, 1993.



- de Dianous, V, and C. Fievez. "ARAMIS project: A more explicit demonstration of risk control through the use of bow-tie diagrams and the evaluation of safety barrier performance." *Journal of Hazardous Materials* 130 (2006): 220-233.
- Decision Systems Laboratory, University of Pittsburgh. *GENIE*. School of Information Sciences, University of Pittsburgh. n.d. <http://genie.sis.pitt.edu/> (accessed January 24, 2014).
- Delvosalle, C, C Fievez, A Pipart, and B. Debray. "ARAMIS project: A comprehensive methodology for the identification of reference accident scenarios in process industries." *Journal of Hazardous Materials* 130 (2006): 200-219.
- Deshpande, A. "Fuzzy fault tree analysis: revisited." *International Journal of Systems Assurance Engineering and Management* 2 (2011): 3-13.
- DHSG. *Final Report on the Investigation of MAcondo Well Blowout*. Deepwater Horizon Study Group, 2011.
- Dow Chemical Company. *Dow's chemical exposure index guide*. 2nd. New York: American Institute of Chemical Engineers (AIChE), 1993.
- . *Fire & explosion index hazard classification guide*. 7th. New York: American Institute of Chemical Engineers (AIChE), 1994.
- Edwards, D. W, and D. Lawrence. "Assessing the inherent safety of chemical process routes: is Eslinger, K., Ure, D. & Kutlay, S., 2004. *Risk Management and Analysis of Driving Hazard Using Bow Tie Model*. Alberta, SPE 86846.
- Eskesen, S. D, P Tengborg, J Kampmann, and T. H. Veicherts. "Guidelines for tunneling risk management: International Tunnelling Association, Working Group No. 2." *Tunnelling and Underground Space Technology* 19 (2004): 217-237.
- Etowa, C. B, P. R Amyotte, Pegg. M. J, and F. I. KHan. "Quantification of Inherent safety aspects of the Dow indices." *Journal of Loss Prevention in the Process Industries* 15 (2002): 477-487.
- Ferdous, R, F Khan, R Sadiq, P Amyotte, and B. Veitch. "Analyzing system safety and risk under uncertainty using a bow-tie diagram: An innovative approach." *Process safety and Environmental Protection* 91, no. 1-2 (2013): 1-18.
- Ferdous, R, F Khan, R Sadiq, P Amyotte, and B. Veitch. "Handling and updating uncertain information in bow-tie analysis." *Journal of Loss Prevention in the Process Industries* 25, no. 1 (2012): 8-19.
- Ferdous, R, F Khan, R Sadiq, P Amyotte, and B. Veitch. "Handling data uncertainties in event tree analysis." *Process Safety and Environmental Protection* 87, no. 5 (2009): 283-292.

- Fredericks, P. "Constant Bottom-Hole Pressure with Pressure as a Primary Control." In *Managed Pressure Drilling*, edited by B Rehm, J Schubert, A Haghshenas, A. S Paknejad and J. Hughes, 81-107. Houston, Texas: Gulf Publishing Company, 2008.
- Gentile, M, W. J Rogers, and M. S. Mannan. "Development of an inherent safety index based on fuzzy logic." *AIChE* 49(4) (2003): 959-968.
- Grayson, B, and A. H. Gans. "Closed Loop Circulating Systems Enhance Well Control and Efficiency With Precise Wellbore Monitoring and Management Capabilities." *SPE/IADC Managed Pressure Drilling and Underbalanced Operations*. Milan, Italy: SPE, 2012. 12.
- Gupta, J. P, and D. W. Edwards. "A simple graphical method for measuring inherent safety." *Journal of Hazardous Materials* 104 (2003): 15-30.
- Heriot-Watt University Drilling Engineering Manual. *Drilling Engineering*. Edinburgh: Department of Petroleum Engineering, n.d.
- ICI Mond Division. *The Mond index*. 2nd. Northwich: Imperial Chemical Industries, 1985.
- Izon, David, E.P Danenberger, and Melinda Mayes. "Absence of fatalities in blowouts encouraging in MMS study of OCS incidents 1992-2006." *DRILLING CONTRACTOR*, July/August 2007: 84-90.
- Jensen, F. V, and T. D. Nielsen. *Bayesian Networks and Decision Graphs*. New York: Springer, 2007.
- Khakzad, Nima, Faisal Khan, and Paul Amyotte. 2013a. "Dynamic Safety Analysis of Process Systems by Mapping Bow-Tie into Bayesian Network." *Process Safety and Environmental Protection* 91 (1-2). Institution of Chemical Engineers: 46-53. doi:10.1016/j.psep.2012.01.005.
- Khakzad, N, F Khan, and P. Amyotte. "Quantitative risk analysis of offshore drilling operations: A Bayesian approach." *Safety Science* 57 (2013b): 108-117.
- Khakzad, N, F Khan, and P. Amyotte. "Safety analysis in process facilities: Comparison of fault tree and Bayesian network approaches." *Reliability Engineering and System Safety* 96 (2011): 925-932.
- Khakzad, Nima, Faisal Khan, and Paul Amyotte. "Dynamic risk analysis using bow-tie approach." *Reliability Engineering and System Safety* 104 (2012): 36-44.
- Khan, F. I, and P. R. Amyotte. "How to make inherent safety practice a reality." *Canadian Journal of Chemical Engineering* 81 (2003): 2-16.

- Khan, F. I, and P. R. Amyotte. "I2SI: a comprehensive quantitative tool for inherent safety and cost evaluation." *Journal of Loss Prevention in the Process Industries* 18 (2005): 310-326.
- Khan, F. I, and P. R. Amyotte. "Integrated inherent safety index (I2SI): a tool for inherent safety evaluation." *Process Safety Progress* 23(2) (2004): 136-148.
- Khan, F. I, R Sadiq, and P. R. Amyotte. "Evaluation of available indices for inherent safer design options." *Process Safety Progress* 22(2) (2003): 83-97.
- Kletz, Trevor A, and Paul R. Amyotte. *Process plants: A handbook for inherent safer design*. 2nd. Boca Raton, Florida: Taylor & Francis, 2010.
- Kletz, Trevor A. *Plant design for safety: A User-friendly Approach*. New York: Hemisphere Publishing Corporation, 1991.
- Kletz, Trevor A. "What you don't have, can't leak." *Chemistry and Industry* 6 (1978): 287-292.
- Koller, G, U Fischer, and K. Hungerbuhler. "Comparison of methods suitable for assessing the hazard potential of chemical processes during early design phases." *Transactions of IChemE* 79 (Pt B) (2001): 157-166.
- Leong, C. T, and A. M. Shariff. "Process route index (PRI) to assess level of explosiveness for inherent safety quantification." *Journal of Loss Prevention in the Process Industries* 22(2) (2009): 216-221.
- MMS. *Investigation of Blowout to High Island Block A 368 OCS-G 2433*. New Orleans: OCS Report Minerals Management Service (MMS 2002-080), 2002.
- Neapolitan, Richard E. *Learning Bayesian Networks*. Chicago: Prentice Hall Series, 2004.
- . *Probabilistic methods for bioinformatics: with an introduction to Bayesian networks*. Chicago: Morgan Kaufmann, 2009.
- NORSOK. *Well integrity in drilling and well operations. NORSOK STANDARD D-010*. 3rd. Lysaker: Standards Norway, 2004.
- Onisko, Agnieszka, Marek J Druzdel, and Hanna Wasyluk. "Learning Bayesian network parameters from small data sets: application of Noisy-OR gates ." *International Journal of Approximate Reasoning* 27 (2001): 165-182.
- Palaniappan, C, R Srinivasan, and R. Tan. "Expert system for the design of inherently safer processes. 1-route selection stage & 2-flowsheet development stage." *Industrial & Engineering Chemistry Research* 41(26) (2002): 6698-6722.
- Pearl, J. *Probabilistic Reasoning in Intelligent Systems*. San Mateo: Morgan Kaufmann, 1988.

- Purba, J. H. "A Fuzzy-based reliability approach to evaluate basic events of fault tree analysis for nuclear power plant probabilistic safety assessment." *Annals of Nuclear Energy* 70 (2014): 21-29.
- Rathnayaka, S, F Khan, and P Amyotte. "Risk-based process plant design considering inherent safety." *Safet Science* 70 (2014): 438-464.
- Rathnayaka, S, F Khan, and P. Amyotte. "Accident modeling and risk assessment framework for safety critical decision-making: application to deepwater drilling operation." *Proceedings of the Institution of Mechanical Engineers, Part O: Journal of Risk and Reliability* 227 (2013): 86-105.
- Rehm, B, A Haghshenas, A. S Paknejad, and J. Schubert. "Situational Problems in MPD." In *Managed Pressure Drilling*, edited by B Rehm, J Schubert, A Haghshenas, A. S Paknejad and J. Hughes, 39-78. Houston: Gulf Publishing Company, 2008.
- Shariff, A. M, and D. Zaini. "Toxic release consequence analysis tool (TORCAT) for inherently safer design plant." *Journal of Hazardous Materials* 182 (2010): 394-402.
- Shariff, A. M, R Rusli, C. T Leong, V. R Radhakrishan, and A. Buang. "Inherent safety tool for explosion consequences study." *Journal of Loss Prevention in the Process Industries* 19 (2006): 409-418.
- Si, Shubin, Gregory Levitin, Hongyan Dui, and Shudong Sun. "Component state-based integrated importance measure for multi-state systems." *Reliability Engineering and System Safety* 116 (2013): 75-83.
- Skogdalen, Jon Espen, and Jan Erik Vinnem. 2012. "Combining Precursor Incidents Investigations and QRA in Oil and Gas Industry." *Reliability Engineering & System Safety* 101 (May). Elsevier: 48–58. doi:10.1016/j.res.2011.12.009.
- Srinivasan, R, and S. Natarajan. "Developments in inherent safety: a review of the progress during 2001-2011 and opportunities ahead." *Process Safety and Environment Protection* 90(5) (2012): 389-403.
- Tian, Shifeng, George H Medley, and Charles R. Stone. "Understanding yield point: Effect on pressure surges critical to managing deep, difficult MPD wells." *Drilling Contractor*, November 3, 2009.
- Torstad, E. *Closed Loop Systems Reduce the Probability of Loss of Well Control*. September 30: DNV presentation, 2010.
- Tugnoli, A, V Cozzani, and G. Landucci. "A consequence based approach to the quantitative assessment of inherent safety." *AIChE Journal* 53, no. 12 (2007): 3171-3182.

Tugnoli, Alessandro, Gabriele Landucci, Ernesto Salzano, and Valerio Cozzani. "Supporting the selection of process and plant design options by Inherent Safety KPIs." *Journal of Loss Prevention in the Process Industries* 23 (2012): 830-842.

Tyler, B. J. "Using the Mond index to measure inherent hazards." *Plant operations Progress* 4 (1985): 172-175.

Wierenga, P. C. et al., 2009. Application of the Bow-Tie Model in Medical Safety Risk Analysis. *Drug Safety*, Volume 32, pp. 663-673.

### Appendix 6-A

The above methodology of the ratios is compared with Birnbaum importance measures (Birnbaum, 1969). Birnbaum importance measure is defined by a measure of a change in the system reliability with respect to a change in component reliability. It presents the contribution of the component reliability to the system reliability. Birnbaum importance measure  $BI_i$ , is expressed as:

$$BI_i = \frac{dR_s}{dR_i} \dots \dots \dots (A - 1)$$

Where  $dR_s$ , is the change in the system reliability due to a change in reliability,  $dR_i$ , of component  $i$ . For independent component states, a partial derivative is obtained (Aven & Nokland, 2010). In this study,  $BI_i$  is conducted on failure probabilities for selected components as shown in **Table 6**, since *failure probability* =  $1 - reliability$ . Studies on other importance measures, such as improvement potential, risk achievement worth (RAW), risk reduction worth (RRW), Fussell-Vesely and criticality importance factor, can be found elsewhere (Cheok, et al., 1998; Borgonovo, et al., 2003; Aven & Nokland, 2010; Si, et al., 2013).

**Table 6.6 – Comparison of ratio of posterior probability to prior probability with Birnbaum importance measure**

Component, $i$	Component Probability		Well integrity failure probability		$BI_i$	$\frac{BI_{i1}}{BI_{i2}}$	Ratio, $R$ $\left(\frac{P_f}{P_i}\right)$	$\frac{R_1}{R_2}$
	Initial	Final	Initial	Final				
MPD system failure	1.10E-03	1.00E-04	6.92E-05	1.85E-05	5.07E-02	<b>41.54</b>	733.64	<b>40.76</b>
Logging tool failure	1.00E-03	1.00E-04	6.92E-05	6.81E-05	1.22E-03	<b>1.03</b>	18	<b>1</b>
Inaccurate int. of log	1.00E-02	1.00E-03	6.92E-05	1.19E-03	1.19E-03		18	

## Chapter 7

### 7.0 Failure analysis of the tripping operation and its impact on well control

#### Preface

*A version of this chapter has been presented and published in the **Proceedings of ASME 34th Internal Conference on Ocean, Offshore and Arctic Engineering (OMAE2015-42245)**. I am the primary author. Along with Co-author, Faisal Khan, I developed the conceptual model and*

*subsequently translated this to the numerical model. I have carried out most of the data collection and analysis. I have prepared the first draft of the manuscript and subsequently revised the manuscript, based on the feedback from Co-authors and also peer review process. As Co-author, Faisal Khan assisted in developing the concept and testing the model, reviewed and corrected the model and results. He also contributed in reviewing and revising the manuscript. As Co-authors, Vikram Garaniya and Stephen Butt, contributed through support in developing the model, testing, reviewing and revising the manuscript.*

## **Abstract**

As the cost of drilling and completion of offshore well is soaring, efforts are required for better well planning. Safety is to be given the highest priority over all other aspects of well planning. Among different element of drilling, well control is one of the most critical components for the safety of the operation, employees and the environment. Primary well control is ensured by keeping the hydrostatic pressure of the mud above the pore pressure across an open hole section. A loss of well control implies an influx of formation fluid into the wellbore which can culminate to a blowout if uncontrollable. Among the factors that contribute to a blowout are: stuck pipe, casing failure, swabbing, cementing, equipment failure and drilling into other well. Swabbing often occurs during tripping out of an open hole. In this study, investigations of the effects of tripping operation on primary well control are conducted. Failure scenarios of tripping operations in conventional overbalanced drilling and managed pressure drilling are studied using fault tree analysis. These scenarios are subsequently mapped into Bayesian Networks to overcome fault tree modelling limitations such as dependability assessment and common cause failure. The analysis of the BN models identified RCD failure, BHP reduction due to insufficient mud density and lost

circulation, DAPC integrated control system, DAPC choke manifold, DAPC back pressure pump, and human error as critical elements in the loss of well control through tripping out operation.

## **7.1. Introduction**

Well control deals with all activities that are directed towards the prevention of influx of formation fluid into the well and the attendant management of the formation fluid in case of influx by monitoring and maintaining the bottom hole pressure of the drilling fluid. The prevention of influx is achieved by primary well control while the management of an influx is conducted with secondary well control procedures. In Conventional Over-Balanced Drilling (COBD), primary well control is achieved with the Bottom Hole Pressure (BHP) exerted by the hydrostatic pressure of the heavy drilling mud during static condition, with an additional annular frictional pressure during dynamic condition or mud circulation. Generally, the mud system is exposed to atmospheric condition. However, in Constant Bottom-Hole Pressure (CBHP) technique of Managed Pressure Drilling (MPD), BHP is determined by the hydrostatic pressure of the mud in addition to a surface backpressure during static condition, besides the annular frictional pressure during dynamic conditions. The backpressure is controlled with the choke manifold through the closed system provided with a Rotating Control Device (RCD). The loss of primary well control often leads to a kick – the influx of formation fluid into the wellbore - which if not controlled by secondary well control could lead to a blowout – the uncontrolled flow of formation fluid through the wellbore to the surface - and other associated severe consequences such as fire and explosions, rig collapse, personnel injuries, fatalities and environmental damage. Danenberger (1993) conducted a study of 87 blowouts in the Outer Continental Shelf (OCS) of the US between 1971 and 1991. Out of the 87 blowouts, most of which had more than one contributing factors, 21 were due to swabbing and



fractured formation, 16 were caused by equipment failures and cementing, 5 were caused by a casing failure and drilling into other well, and 3 were due to a stuck pipe. Another study by Izon et al. (2007) on well incidents in the OCS of the US identified 39 blowouts between 1992 and 2006 reported the following common causes: cementing (46%), equipment failure (13%), swabbing (13%), stuck pipe (10%) and drilling into other well (3%). Apparently, swabbing was prominent amongst all the identified causal factors. Swabbing is the lifting of well fluids while tripping the drill string out of the wellbore. This creates a vacuum (an underbalanced condition) known as swabbing effect translated into a pressure decrease referred to as swab pressure in the wellbore leading to the influx of formation fluid. Conversely, the running in of drill string creates a pressure increase known as surge pressure. Well drilling involves a multiple number of tripping operations. Tripping operation is arguably the most frequent operation in well drilling. In this study, a comparative analysis of tripping out operation in COBD and CBHP techniques is conducted. The CBHP technique is one of the variants of MPD techniques. This aim of the study is to identify critical safety elements of the operation which can enhance the safety of the operation. Fault Trees (FTs) of tripping out operation for the above mentioned two techniques are developed. To enable conditional dependability and diagnostic analyses, the FTs are mapped into Bayesian Networks (BNs). This study is limited to the effect of tripping out of the well for both COBD and CBHP technique. Further discussions on COBD technique and MPD techniques can be found in the literatures (Bommer, 2008; Bourgoyne, et al., 1986; Beltran, et al., 2010; Grayson & Gans, 2012; Rehm, et al., 2008; Skalle, 2014). The remainder of the part of the dissertation is organized as follows. Section 7.2 discusses tripping operations in COBD and CBHP technique. In Section 7.3, a brief description of BN is presented. The description of the models and their analyses are presented in Section 7.4 while Section 7.5 is devoted to conclusion from the work.

## 7.2. Tripping operation

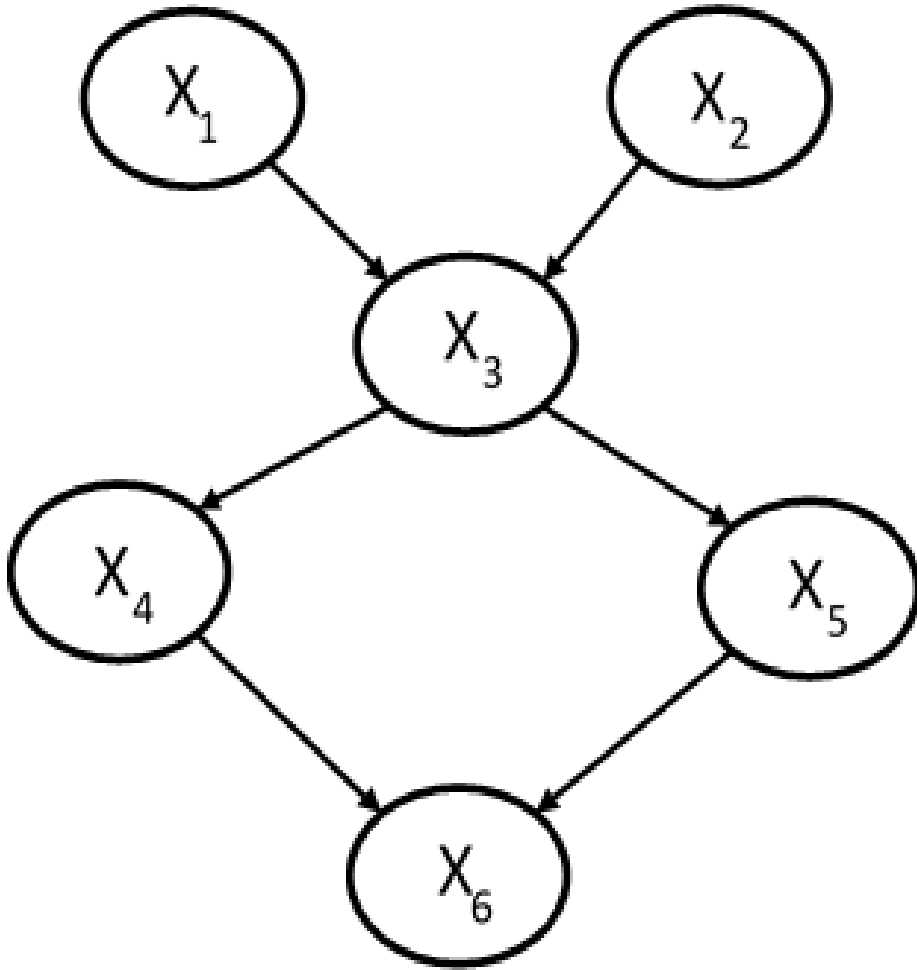
Tripping operation is the running of a drill string into and out of a well. The making of a round trip or simply a trip is described as the pulling of a drill string at a particular depth out and then, running it into the well back to the initial depth. The running in of drill string is known as tripping in while the pulling of the drill string is referred to as tripping out. Tripping operation is often done to replace a worn out drill bit; damaged drill pipe; install or replace damaged bottom hole assembly such as Measurement While Drilling (MWD), Logging While Drilling (LWD) tools, directional drilling tool; conduct drill stem testing; and for wiper tripping – an abbreviated tripping in the open hole section of a troublesome zone (Schlumberger, 2014).

In COBD, when tripping out of the well, for example, to replace a worn out (or dull) drill bit, pipe connections are usually broken in stands and placed in the fingerboard. The volume of mud in the wellbore falls by an amount equal to the product of the annular capacity and the length of the drillstring pulled out. The volume reduction is replaced by an equal volume of mud from a trip tank. The active mud system is bypassed during tripping operation due to its large cross sectional area which hinders accurate volume monitoring. The trip tank gives a finer volume resolution due to its smaller cross sectional area compared to the mud pit tank. Any discrepancies between the volume pulled out and the volume replaced signal an abnormal condition. If less volume is required to replace the pulled volume; then, there could have been an influx of formation fluid. Conversely, if more volume is required to replace the pulled volume; then, a lost circulation could have occurred. Similarly, during tripping into the well, the drillstring displaces mud volume equal to the product of the annular capacity and the length of the drillstring (Bommer, 2008; Skalle, 2014; Tuset, 2014). For CBHP technique, the running of the drillstring is under pressure through an

activated annular seal of the RCD by stripping operation (Skalle, 2014; Beltran, et al., 2010). A safety measure against swabbing is to add a trip margin to the mud weight.

### 7.3. Bayesian Network

Bayesian network (BN) is a widely used probabilistic method for reasoning under uncertainty. The uncertainty is due to the difficulty in modelling all the different conditions and exceptions that characterize a finite set of observations. A BN is based on a well-defined Bayes theorem represented by a Directed Acyclic Graph (DAG) with nodes representing random variables and arcs denoting direct causal relationships between connected nodes. In a BN shown in Fig. 7.1, nodes without arcs directing into them – have no parents – are root nodes ( $X_1$  and  $X_2$ ), with the marginal prior probabilities assigned to them while the nodes with arcs directing into them are intermediate nodes ( $X_3$ ,  $X_4$  and  $X_5$ ) and possess Conditional Probability Tables (CPTs). The node such as,  $X_6$ , which has no children is a leaf node (Jensen & Nielsen, 2007). Considering the DAG of Fig. 7.1, the joint probability distribution of the BN is the product of the conditional probability distributions of the variables  $X_1 = x_1, X_2 = x_2, \dots, X_6 = x_6$ .



**Figure 7.1 - A Typical Bayesian Network**

$$P(x_1, x_2, \dots, x_6) = \prod_{i=1}^6 P(x_i | x_{\emptyset(i)}) \quad (7.1)$$

Where  $\emptyset(i)$  in Eq. (7.1) are the parents of node  $i$  in the DAG and  $x_1, x_2, \dots$ , are the states of variables  $X_1, X_2, \dots, X_6$ . Thus, Eq. (7.2) gives the joint probability distribution of the BN in Fig. 7.1.

$$P(x_1, x_2, \dots, x_6) = P(x_6 | x_4, x_5)P(x_4 | x_3)P(x_5 | x_3)P(x_3 | x_1, x_2)P(x_1)P(x_2) \quad (7.2)$$

The conditional probability distributions such as  $P(x_4 | x_3)$  can be obtained by (Eq. (7.3))

$$P(x_4 | x_3) = \frac{P(x_4, x_3)}{P(x_3)} \quad (7.3)$$

This can be generalized for  $n$  continuous or discrete variables with  $k$  states. This enables the modeling of complex dependencies among random variables. Thus, making BN a robust and reliable fault detection and risk analysis tool. It also enables the modeling of multi state discrete variables of interest which are often difficult with other conventional Quantitative Risk Analysis (QRA) techniques such as fault tree (FT). Beside the graphical representation which relates the conditional dependencies among variables; the BN enables probabilistic inference which is the drawing of conclusions based on observations in the model (Wiegerinck, et al., 2010).

A BN can be used to perform both forward and backward analysis. In forward analysis, the marginal probabilities of intermediate and leaf nodes are computed on the basis of marginal prior probabilities of root nodes and conditional probabilities of intermediate nodes. In the backward analysis, however, the states of some nodes are instantiated and the updated probabilities of conditionally dependent nodes are calculated (Bobbio, et al., 2001; Khakzad, et al., 2013a). The forward propagation is also known as predictive analysis while the backward propagation is referred as diagnostic analysis.

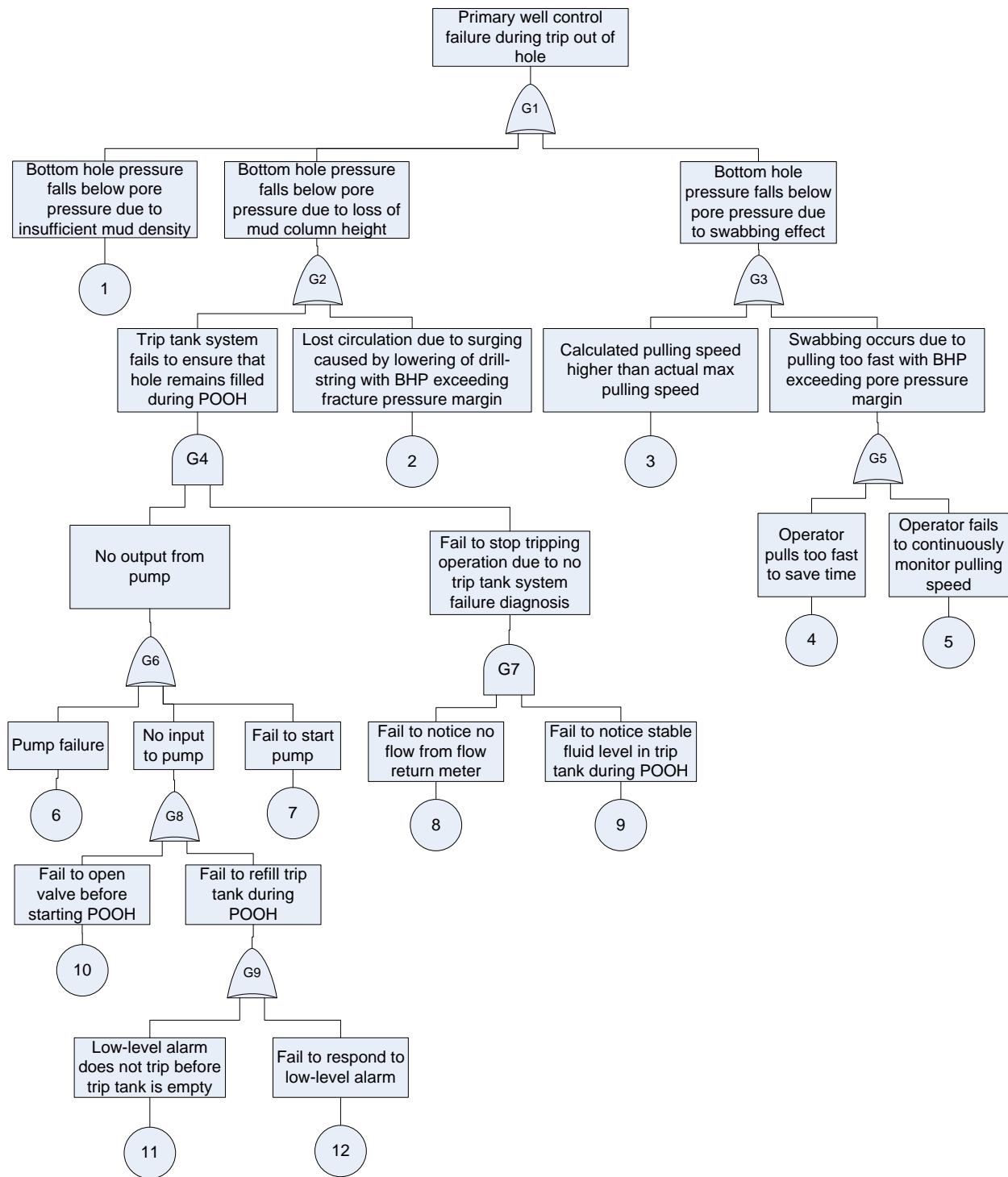
## **7.4. Model Formulation and Analysis**

### **7.4.1 Model Description**

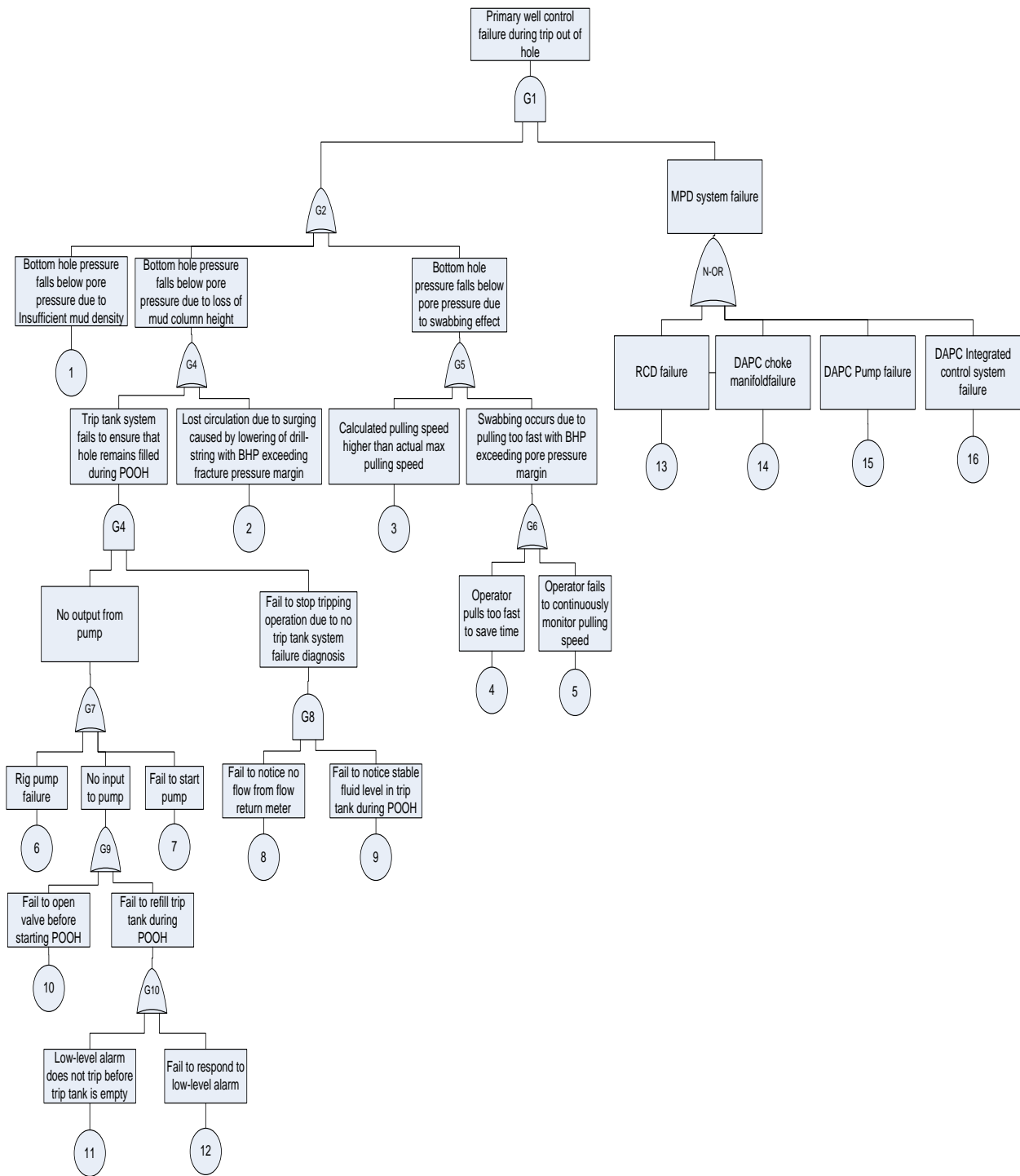
The COBD tripping-out model presented is an improvement to that developed by (Tuset, 2014) simulated in DrillSIM-6000 module. Preliminary assumptions used in this drilling scenario are:

- The rig pump failure in the model represents a pump system in which there are backups; hence, the failure probability is an aggregated failure probability of the system. Similarly, for the trip tank whereby two are usually provided and the valves.
- The drill bit is at the bottom of the wellbore.
- The failure to respond to the alarms is an aggregated failure of all the responsible personnel.
- The target depth does not include shallow formations in which a shallow kick is envisaged.
- An automated system is chosen for the CBHP technique of MPD.

The failure of primary well control during tripping out of hole can be due to a reduction in the BHP below the pore pressure as a result of insufficient mud density, loss of mud column height or swabbing effect as depicted in Fig. 7.2. Mud column height can be lost by loss of circulation caused due to surging during tripping into the well, or failure of the trip tank system to ensure that the wellbore is filled during pulling out of open hole (POOH). This could be due to no output from the pump and the driller's failure to stop tripping operation. The potential causes of no output from the pump include: pump failure, no input of mud to the pump and failure to start the pump. The failure to open valve(s) before POOH and not refilling trip tank during POOH are the potential causes of no input to the pump. On the other hand, swabbing effect could be due to calculated pulling speed exceeding actual maximum pulling speed or the driller, erratically, pulls too fast such that the pore pressure margin is exceeded. For CBHP technique (Fig. 7.3), in addition to the provisions of COBD, an MPD system, comprising mainly an RCD, dedicated choke manifold, backpressure pump and a Dynamic Annular Pressure Control (DAPC) integrated control system are included (Fredericks, 2008).



**Figure 7.2 - Conventional drilling tripping operation**



**Figure 7.3 - MPD tripping operation**



To better model the MPD system and capture the uniqueness of the critical MPD equipment, a noisy OR gate is adopted. This is because of the order of importance that characterizes the equipment. The failure of the RCD, for instance, absolutely leads to the MPD system; whereas, the failure of the back pressure pump do not lead to the failure of the MPD system. However, the efficiency of the system is compromised when the backpressure pump is needed. This uniqueness is lacking in the common conventional logic gates. The composition of the conditional probability table of the noisy OR gate is based on expert judgment. These fault tree models are mapped into BNs as discussed in (Abimbola, et al., 2015a).

#### **7.4.2 Results and Discussions**

The BNs in this study are analyzed using GeNIe 2.0 software developed by the Decision System Laboratory of the University of Pittsburgh. The occurrence/failure probabilities for the basic events presented in Table 7.1 are sourced from a number of references (Crowl & Louvar, 2002; Torstad, 2010; Grayson & Gans, 2012; Gould, et al., 2012; Khakzad, et al., 2013b; Abimbola, et al., 2014; Abimbola, et al., 2015a).

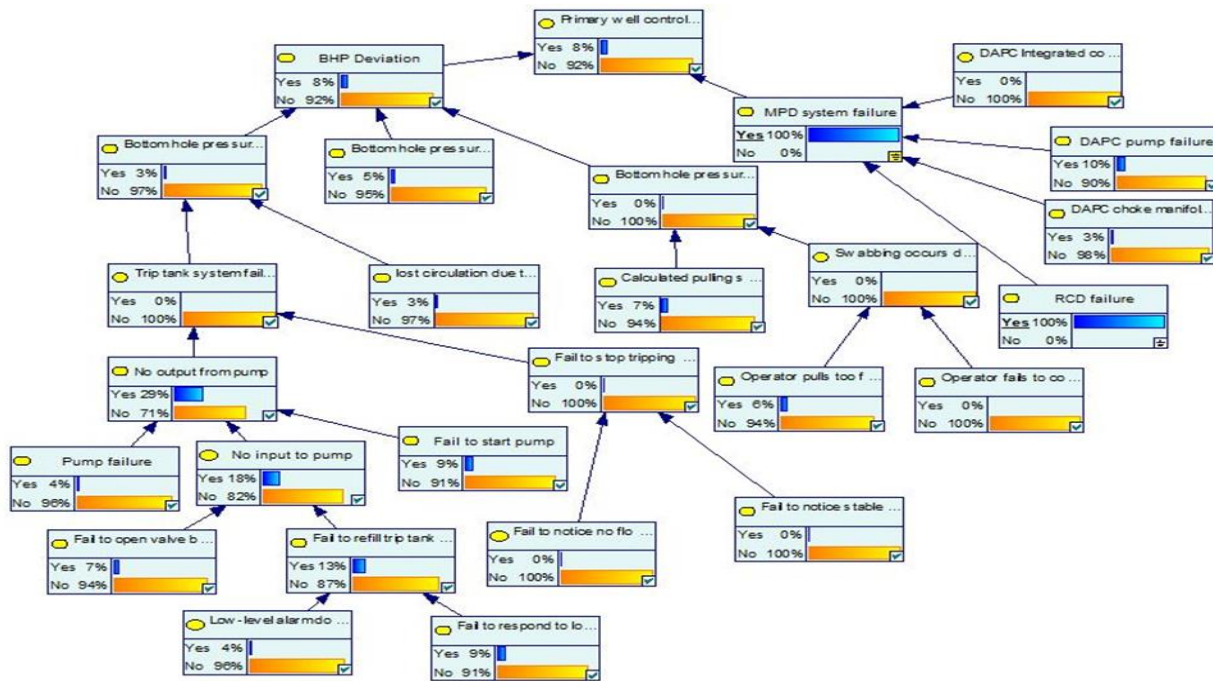
**Table 7.1 - Occurrence/failure probabilities of basic events (Crowl & Louvar, 2002; Torstad, 2010; Grayson & Gans, 2012; Gould, et al., 2012; Khakzad, et al., 2013b; Abimbola, et al., 2014; Abimbola, et al., 2015a)**

Event	Event Description	Prior Probability, $P_i$	Post Probability, $P_f$	Ratio = $\frac{P_f}{P_i}$
1	Bottom hole pressure falls below pore pressure due to Insufficient mud density	5.00E-02	6.61E-01	<b>13.22</b>
2	Lost circulation due to surging caused by lowering of drill-string with BHP exceeding fracture pressure margin	2.70E-02	3.57E-01	<b>13.22</b>
3	Calculated pulling speed higher than actual max pulling speed	6.50E-02	6.50E-02	1.00
4	Operator pulls too fast to save time	6.50E-02	6.50E-02	1.00
5	Operator fails to continuously monitor pulling speed	2.00E-04	2.10E-04	<b>1.05</b>
6	Pump failure	4.00E-02	4.00E-02	1.00
7	Fail to start pump	9.10E-02	9.10E-02	1.00
8	Fail to notice no flow from flow return meter	2.00E-04	2.00E-04	1.00
9	Fail to notice stable fluid level in trip tank during POOH	2.00E-04	2.00E-04	1.00
10	Fail to open valve before starting POOH	6.50E-02	6.50E-02	1.00

11	Low-level alarm does not trip before trip tank is empty	4.00E-02	4.00E-02	1.00
12	Fail to respond to low-level alarm	9.10E-02	9.10E-02	1.00
13	RCD failure	4.00E-02	5.47E-01	<b>13.68</b>
14	DAPC choke manifold failure	2.50E-02	2.10E-01	<b>8.40</b>
15	DAPC Pump failure	1.00E-01	3.30E-01	<b>3.30</b>
16	DAPC Integrated control system failure	1.00E-04	1.10E-03	<b>11.00</b>

---

The probability of primary well control failure, by forward propagation, in COBD and CBHP technique are  $7.57E-02$  and  $5.54E-03$  respectively. Apparently, the CBHP technique is about 13.66 times safer than COBD method. Considering the fact that a tripping out of well is undertaken in a COBD method, by firstly, ensuring that there is a no flow condition in the well for a minimum of 15 minutes before the tripping out operation (Tuset, 2014), the probability of primary well control is reduced to  $2.70E-02$ . This still makes the CBHP technique, safer by an order of about 4.87. This illustrates the outperformance of CBHP technique over the COBD method. Considering an RCD failure scenario (Fig. 7.4), the probability of a primary well control failure in the CBHP technique is increased to  $7.57E-02$ , equaling that of the COBD as discussed earlier. This is due to the failure of the MPD system as a result of the failure of the RCD, reducing the system to that of a COBD method.



**Figure 7.4 - RCD failure scenario in CBHP technique**

Furthermore, a sensitivity analysis on the primary well control failure node, identified BHP reduction by insufficient mud density and lost circulation as the most critical elements; in addition to RCD failure, choke manifold, DAPC integrated control system and DAPC backpressure pump for COBD and CBHP techniques respectively. Considering a diagnostic analysis for both techniques, the posterior failure probabilities are presented in Table 7.1. Based on the ratio of the probabilities (5th column, Table 7.1), a methodology which has been validated in Abimbola et al (2016a), the order of importance of the basic elements are: RCD failure, BHP reduction due to insufficient mud density and lost circulation, DAPC integrated control system and choke manifold, and DAPC back pressure pump.

## **7.5. Conclusion**

This study presents a comparative analysis of both COBD and CBHP technique of MPD considering the effect of tripping out of the well on primary well control. FT models of the operation in the two techniques are developed and mapped into BNs to enable dependability and diagnostic analysis. The CBHP technique is found to be safer in the two scenarios, compared. Further diagnostic analysis of the models identified RCD failure, BHP reduction due to insufficient mud density and lost circulation, DAPC integrated control system, DAPC choke manifold, DAPC back pressure pump, and human error as critical elements of the operation.

## **Acknowledgments**

The authors acknowledge the financial support of Natural Sciences and Engineering Research Council (NSERC), Vale Research Chair grant and Research & Development Corporation of Newfoundland and Labrador (RDC).

## References

- Abimbola, M., Khan, F. & Khakzad, N., 2014. Dynamic Safety risk analysis of offshore drilling. *Journal of Loss Prevention in the Process Industries*, Volume 30, pp. 74-85.
- Abimbola, M., Khan, F. & Khakzad, N., 2016a. Risk-Based Safety Analysis of Well Integrity Operations. *Safety Science*. Volume 84, pp. 149-160.
- Abimbola, M., Khan, F., Khakzad, N. & Butt, S., 2015a. Safety and Risk Analysis of Managed Pressure Drilling Operation Using Bayesian Network. *Safety Science*. Volume 76, pp. 133-144.
- Beltran, J. C. et al., 2010. *Managed Pressure Drilling Brings Added Value to Production Casings Cementing Operations Increasing Success Rates and Quality in HPHT Fractured Narrow Window Wells*. Kuala Lumpur, Malaysia, SPE/IADC 130313.
- Bobbio, A., Portinale, L., Minichino, M. & Ciancamerla, E., 2001. Improving the analysis of dependable systems by mapping fault trees into Bayesian networks. *Reliability Engineering and System Safety*, Volume 71, pp. 249-260.
- Bommer, P., 2008. *A Primer of OILWELL DRILLING*. 7th ed. Texas: The University of Texas.
- Bourgoyne, A. T. J., Millheim, K. K., Chenevert, M. E. & Young, F. S. J., 1986. *Applied Drilling Engineering*. Richardson(TX): Society of Petroleum Engineers.
- Crowl, D. A. & Louvar, J. F., 2002. *Chemical Process Safety - Fundamentals with Applications*. Second ed. New Jersey: Prentice Hall PTR.
- Danenberger, E. P., 1993. *Outer Continental Shelf Drilling Blowouts, 1971 - 1991*. Texas, OTC 7248.
- Fredericks, P., 2008. Constant Bottom-Hole Pressure with Pressure as a Primary Control. In: B. Rehm, et al. eds. *Managed Pressure Drilling*. Houston, Texas: Gulf Publishing Company, pp. 81-107.
- Gould, K. S., Ringstad, A. J. & van de Merwe, K., 2012. *Human Reliability Analysis in Major Accident Risk Analyses i the Norwegian Petroleum Industry*. Stavanger, Norway, SAGE .
- Grayson, B. & Gans, A. H., 2012. *Closed Loop Circulating Systems Enhance Well Control and Efficiency With Precise Wellbore Monitoring and Management Capabilities*. Milan, Italy, SPE, p. 12.
- Izon, D., Danenberger, E. & Mayes, M., 2007. Absence of fatalities in blowouts encouraging in MMS study of OCS incidents 1992-2006. *DRILLING CONTRACTOR*, July/August, pp. 84-90.

- Jensen, F. V. & Nielsen, T. D., 2007. *Bayesian Networks and Decision Graphs*. 2nd ed. New York: Springer.
- Khakzad, N., Khan, F. & Amyotte, P., 2013a. Dynamic safety analysis of process systems by mapping bow-tie into Bayesian network. *Process Safety and Environmental Protection*, Volume 91, pp. 46-53.
- Khakzad, N., Khan, F. & Amyotte, P., 2013b. Quantitative risk analysis of offshore drilling operations: A Bayesian approach. *Safety Science*, Volume 57, pp. 108-117.
- Rehm, B., Haghshenas, A., Paknejad, A. S. & Schubert, J., 2008. Situational Problems in MPD. In: B. Rehm, et al. eds. *Managed Pressure Drilling*. Houston: Gulf Publishing Company, pp. 39-78.
- Rehm, B. et al., 2008. *Managed Pressure Drilling*. Houston, Texas: Gulf Publishing Company.
- Schlumberger, 2014. *wiper trip*. [Online]  
Available at: [http://www.glossary.oilfield.slb.com/en/Terms/w/wiper\\_trip.aspx](http://www.glossary.oilfield.slb.com/en/Terms/w/wiper_trip.aspx)  
[Accessed 11 December 2014].
- Skalle, P., 2014. *Pressure Control During Oil Well Drilling*. 5th ed. s.l.:bookboon.com.
- Torstad, E., 2010. *Closed Loop Systems Reduce the Probability of Loss of Well Control*, September 30: DNV presentation.
- Tuset, G. D., 2014. *Operational Barrier Elements in Critical Drilling Operations*, Trondheim: Norwegian University of Science and Technology (NTNU).
- Wiegerinck, W., Kappen, B. & Burgers, W., 2010. Bayesian Networks for Expert Systems: Theory and Practical Applications. In: R. Babuska & F. C. A. Groen, eds. *Interactive Collaborative Systems*. Delft, The Netherlands: Springer, pp. 547-578.

## Chapter 8

### 8.0 Dynamic Blowout Risk Analysis using Loss Functions

#### Preface

*A version of this chapter has been submitted for review in the **Journal of Risk Analysis**. I am the primary author. Along with Co-author, Faisal Khan, I developed the conceptual model and subsequently translated this to the numerical model. I have carried out most of the data collection and analysis. I have prepared the first draft of the manuscript and subsequently revised the manuscript, based on the feedback from Co-authors and also peer review process. As Co-author, Faisal Khan assisted in developing the concept and testing the model, reviewed and corrected the model and results. He also contributed in reviewing and revising the manuscript.*

#### Abstract

Most risk analysis approaches are static; failing to capture evolving conditions. Blowout, the most feared accident during a drilling operation, is a complex and dynamic event. The traditional risk analysis methods are useful in the early design stage of drilling operation while falling short during evolving operational decision-making. A new dynamic risk analysis approach is presented to capture evolving situations through dynamic probability and consequence models. The dynamic consequence models are developed in terms of loss functions. These models are subsequently integrated with the dynamic probability to estimate operational risk, providing a real-time risk analysis. The real-time evolving situation is considered dependent on the changing bottom-hole pressure as drilling progresses. The application of the methodology and models are demonstrated with a case study of an offshore drilling operation evolving to a blowout.



**Keywords:** Blowout risk analysis, Dynamic risk analysis, Bottom-hole pressure, Loss functions, Equivalent Circulating Density

## **8.1. Introduction**

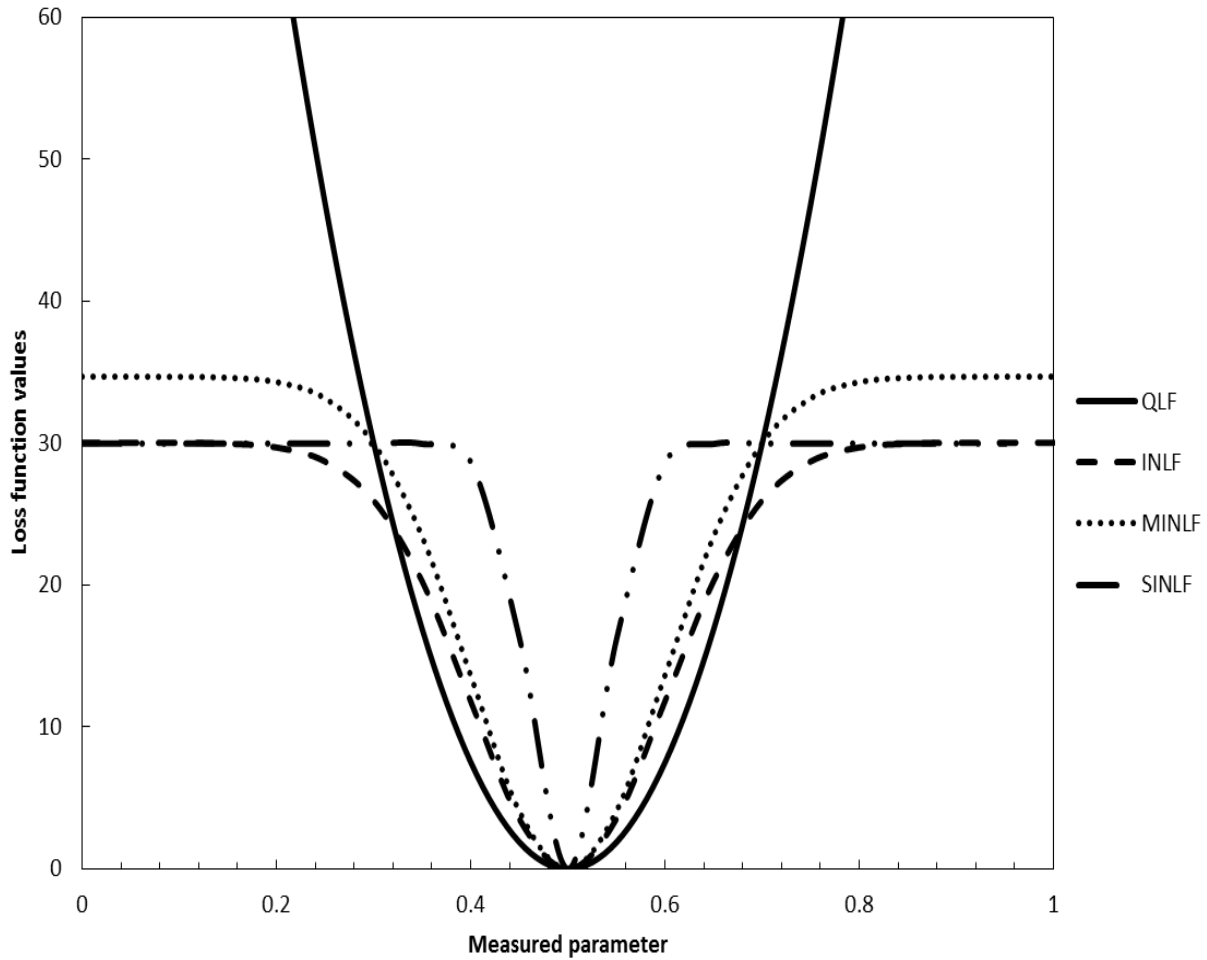
The traditional risk analysis approach consists of the likelihood of blowout and its associated losses. This is generally conducted during the early stage of design. Accordingly, safety measures are designed so that these probabilities can be minimized to an acceptable level. This approach has been widely tested and used in the industry. However, it has been observed that this does not always work, as this is a design risk whereas the concerns of drilling operation well control are actually operational risk. In operational risk, both the probability of a blowout and the consequences are dependent on time as well as the changing operational condition. Consequently, for safe operation, operational risk needs to be identified, assessed and minimized as the drilling proceeds (Meel & Seider, 2006). There have been sufficient contributions made in order to quantify the probability of a blowout as being time and situation-dependent so that it becomes dynamic and operational. However, the second part which is equally important, the consequence, is often considered as empirical constant values, which provide erroneous risk estimations. This work undertakes an approach to better define the consequences as situation and time dependent. Loss functions (LFs) modelling approach is adopted as a mechanism to develop these consequence models. This is the first work to investigate the use of LFs towards quantification of drilling operational risk.

Quantitative Risk Analysis (QRA) is the systematic identification and quantification of hazards to predict their effects on the individuals, property or environment (Aven, 2010; Skogdalen & Vinnem, 2012). QRA comprises hazard identification, probability assessment, consequence analysis and risk determination. Hazard identification involves the use of techniques such as process hazard checklist, hazard surveys, hazard identification (HAZID), hazard and operability (HAZOP), safety reviews, what-if analysis, fault tree, failure modes and effects analysis (FMEA) to identify hazards in a process. Probability assessment entails the determination of the failure probability or frequency of occurrence of a failure in an operation. QRA tools of Fault Tree (FT), Event Tree (ET), Bow-Tie (BT), and Bayesian Networks (BN) are often used to model an accident scenario in a process. QRA is transformed into Dynamic Risk Analysis (DRA) when QRA changes with time. Case-specific data are used to update the generic data used in risk assessment during the design phase of the system (Khakzad et al., 2012). Vandebussche et al. (2012) developed a well-specific blowout risk assessment methodology for determining the blowout probability by considering the flow rates and duration of the blowout as well as risk factors such as pressure margins, permeability, pore pressure, drilling crew experience, cement performance and logging runs in adjusting the blowout probability to reflect the existing well condition. However, the methodology is limited in application as it is based on blowout statistics in the Gulf of Mexico and North Sea. Blowout software such as BlowFlow (Arild et al., 2008; Karlsen & Ford, 2014) has also been developed for a risk-based evaluation of a blowout scenario in determining blowout flowrates, volumes and durations. Probabilistic models for analysing blowout using the conventional overbalanced drilling technique (Berg Andersen, 1998; Khakzad et al., 2013; Rathnayaka et al., 2013; Abimbola et al., 2014) and the constant bottom-hole pressure (CBHP) technique of managed pressure drilling (MPD) (Abimbola et al., 2015a) have been developed in

recent years. Apparently, there exists minimal work on the consequence analysis of a blowout. Current literature addresses well killing decision trees (Adams et al., 1993; Lage et al., 2013), relief well drilling (Rygg et al., 1992; Al-murri et al., 2012; Al-saleh et al., 2014) and spill response (Etkin, 2000, 2001, 2004). Worth et al. (2008) conducted a comparative blowout risk assessment for Steam Assisted Gravity Drainage (SAGD) pilot wells in Venezuela. These wells were characterized with different completion patterns in which 3 consequence measures of life safety, environmental and economic costs were considered in their risk assessment. However, this study is case-specific to heavy oils while failing to capture other loss categories discussed in this study.

## **8.2. Consequence modelling using loss function (LF)**

Central to LFs application to quality loss analysis are the pioneering works of Taguchi (1986, 1989) in the last three decades, in which he proposed a Quadratic Loss Function (QLF) to quantify losses to the industry associated with deviations of product quality characteristics from their operational targets. The Taguchi's QLF exhibits symmetric and unbounded characteristics. A QLF profile with a target  $T = 0.5$ , over a measured parameter range of  $0 \leq x \leq 1$ , is shown in Fig. 8.1 from Eq. (8.1) (Sun, et al., 1996).



**Figure 8.1 – Loss profiles of different loss functions**

$$L(x) = \frac{K_{\Delta}}{\Delta^2} (x - T)^2 \quad (8.1)$$

A LF value,  $K_{\Delta}$ , of 10 is observed for a deviation,  $\Delta$  of 0.2. It is apparent from Fig. 8.1 that QLF is continuously increasing and unbounded. This has, however, limited its application, leading to the development of various modifications to the original QLF (Ryan, 2011; Berker, 1990; Phadke, 1989). Spiring (1993) proposed an Inverted Normal Loss Function (INLF) in response to the criticisms of QLF which enabled a user-specified maximum value; hence, a more realistic

quantification of losses due to process deviations from target values. Considering a specified maximum,  $K_{MAX}$ , of 30 and a shape parameter,  $\gamma$ , of  $\Delta/2$ , the LF profile is as shown in Fig. 8.1 deduced from Eq. (8.2).

$$L(x) = K_{MAX} \left[ 1 - \exp \left\{ -\frac{1}{2} \left( \frac{x - T}{\gamma} \right)^2 \right\} \right] \quad (8.2)$$

A special case of INLF known as Spiring Inverted Normal Loss Function (SINLF) for which  $\gamma = \Delta/4$ , is also shown in Fig. 8.1. A comparative analysis between INLF and SINLF showed that the latter exhibits a more rapid response to changes in the measured parameter than the former. This is because, about 99.97% of  $K_{MAX}$  would have been attained for  $T \pm \Delta$  deviations. Furthermore, a Modified Inverted Normal Loss Function (MINLF) was proposed by Sun et al. (1996) to enable the specification of user's perception of attained loss. As shown in Eq. (8.3), this is achieved with the specification of  $K_{\Delta}$ , which is different from the maximum loss, that occurs at a deviation,  $\Delta$ , from the target. The shape parameter,  $\gamma$ , a function of  $\Delta$ , defines the slope of the function around the target value.

$$L(x) = \frac{K_{\Delta}}{1 - \exp \left\{ -\frac{1}{2} \left( \frac{\Delta}{\gamma} \right)^2 \right\}} \left[ 1 - \exp \left\{ -\frac{1}{2} \left( \frac{x - T}{\gamma} \right)^2 \right\} \right] \quad (8.3)$$

Figure 8.1 showed a MINLF profile for  $K_{\Delta} = 30$ ,  $\Delta = 0.2$ ,  $\gamma = \Delta/2$ . The flexibility of MINLF is enabled with an application related closely to the Taguchi's method of QLF. For various values of  $\gamma$ , ranging from  $\Delta/0.1$  to  $\Delta/5$ , the MINLF approximates the QLF to INLF through SINLF. Other forms of univariate and inverted probability LFs in use include the Inverted Beta Loss Function (IBLF) (Leung & Spiring, 2002), uniform distribution, Tukey's Symmetric Lambda distribution, Laplace distribution and the Inverted Gamma Loss Function (IGLF). The essence of these inverted

probability LFs is to enable varieties and better representation of actual process losses (Leung & Spiring, 2004).

In multivariate LFs, more than one variable is used to determine the losses due to deviations from set-points. Pignatiello (1993) defined a QLF to reflect the predominant notion that every manufactured product exhibit more than one characteristic by which its overall quality is determined. On the work of Artiles-Leon (1999), principal component analysis was applied by Ma and Zhao (2004) for the improvement of multivariate response approach to optimization. These studies have been in the field of quality engineering. Recently, Zadakbar et al. (2014) developed economic consequence models for process risk analysis. Potential losses were identified with applicable LFs to represent a comprehensive approach to process accident risk assessment. In the same vein, Hashemi et al. (2014) improved on the work of Chang et al. (2011) to apply common LFs to an operational risk-based analysis of a reactor system.

### **8.3. Blowout Risk Analysis**

The algorithm for the proposed blowout risk analysis is presented in Fig. 8.2. The steps in the flowchart are explained as follows:

**8.3.1. Determination of Blowout Frequency (probability),  $P_{bl}$ :** This involves the determination of blowout frequency or probability using quantitative risk analysis techniques of fault tree (FT), event tree (ET), bow-tie (BT) or Bayesian network (BN). On the use of FT, Bercha (1978) was among the pioneering authors that modelled the occurrence of blowout during overbalanced drilling for both offshore and artificial island locations in the Beaufort arctic region. Berg Andersen (1998) analyzed a kick scenario

while having the drill bit at the bottom-hole, from which low equivalent circulating density and loss of mud to external environment and formation were identified as the probable causative elements. In using FT, Torstad (2010) developed a relational hierarchy of events for QRA of well control in conventional overbalanced drilling. Grayson and Gans, (2012) improved on the existing FT of conventional overbalanced drilling, developed by DNV, to model a closed loop scenario applicable to MPD while conducting a comparative analysis between the former and the latter. On the other hand, Rathnayaka et al. (2013) extended the application of an event tree in modelling the blowout of the Macondo well in the Gulf of Mexico. Bow-tie models were developed by Khakzad et al. (2013) and Abimbola et al. (2014) for blowout analysis considering various possible consequences. Recently, BN has been used for blowout analysis for both conventional overbalanced drilling condition (Khakzad et al. 2013) and MPD (Abimbola et al. 2015a). Since the focus of this study is on the consequence analysis, readers are referred to the aforementioned resources for further study.

**8.3.2. Identification of the applicable loss categories:** The applicable loss categories to the blowout scenario are identified and listed as in Fig. 8.3. The categories are: production loss, asset loss, human health loss, environmental response loss and company reputation loss.

**8.3.3. Determine the applicable loss functions for the loss categories:** The LF that best represents each loss category is determined and assigned. This assignment is done based on pre-informed knowledge of the loss categories from the industry field experience and extensive literature review.

**8.3.3.1. Production Loss ( $L_1$ ):** This comprises losses incurred from the spilled oil, liberated natural gas and associated time wasted until the well killing operation is successful. These are designated as lost product cost and Non Productive Time (NPT) cost respectively. The expected production LF is modeled with the MINLF due to its flexibility, enabling the application of a specific loss scenario. The MINLF reduces to either a QLF or an INLF depending on the characteristics of the shape parameter. The expected MINLF is characterized with a mean and variance in addition to the deviation, target and shape parameters. This enables the use of probability distributions that best represent the parameters, rather than the use of exact numbers that do not reflect the reality. The expected production loss is expressed as Eq. (8.4).

$$L_1 = \frac{K_{\Delta}}{1 - \exp\left\{-\frac{1}{2}\left(\frac{\Delta}{\gamma}\right)^2\right\}} \left[ 1 - \frac{\gamma}{\sqrt{\sigma^2 + \gamma^2}} \exp\left\{-\frac{(\rho_{BHP} - \rho_F)^2}{2(\sigma^2 + \gamma^2)}\right\} \right] \quad (8.4)$$

Where,  $K_{\Delta}$ , the production loss at a known negative pressure gradient deviation,  $\Delta$ , from the formation pore pressure gradient equivalent is represented as:

$$K_{\Delta} = \int_0^t \{(q_o - q_{or})Pr_o + q_g Pr_g + C_R\} dt \quad (8.5)$$

$$q_g = \frac{GORq_o}{1000} \quad (8.6)$$

$\rho_F$  and  $\rho_{BHP}$  are the pressure gradient equivalents of formation pore pressure (FPP), the target value and the drilling fluid BHP, in *psi/ft* respectively.

$\Delta$  = The specified negative pressure gradient deviation of  $\rho_{BHP}$  from  $\rho_F$ .



$\gamma$  = The shape parameter, which is a function of  $\Delta$ . This is equal to  $\Delta/4$ , for SINLF and  $\Delta/0.1$ , for QLF (Sun, et al., 1996).

$\sigma^2$  = The variance of the mean BHP gradient.

It must be stated that the preference of pressure gradient over absolute pressure values in field units is to enable the standardization of the governing factor, the absolute bottom hole pressure of the mud during static condition or the Equivalent Circulating Density (ECD) of the mud which determines the dynamic pressure characteristics of the wellbore in relation to the formation pore pressure. However, the models in this study may be modified to represent absolute pressure values and tailored to specific applications as desired.

Considering the ECD of the mud as the determinant of the dynamic condition of the wellbore during drilling operations. The ECD is given by Eq. (8.7),

$$MD_d = \frac{APL}{0.052 * D} + MW_s \quad (8.7)$$

By converting  $MD_d$  in  $ppg$  to  $psi/ft$ , Eq (8.7) is multiplied by the conversion factor, 0.052.

$$\rho_{ECD} = \frac{APL}{D} + 0.052MW_s \quad (8.8)$$

where

$MD_d$  = Equivalent circulating density in  $ppg$

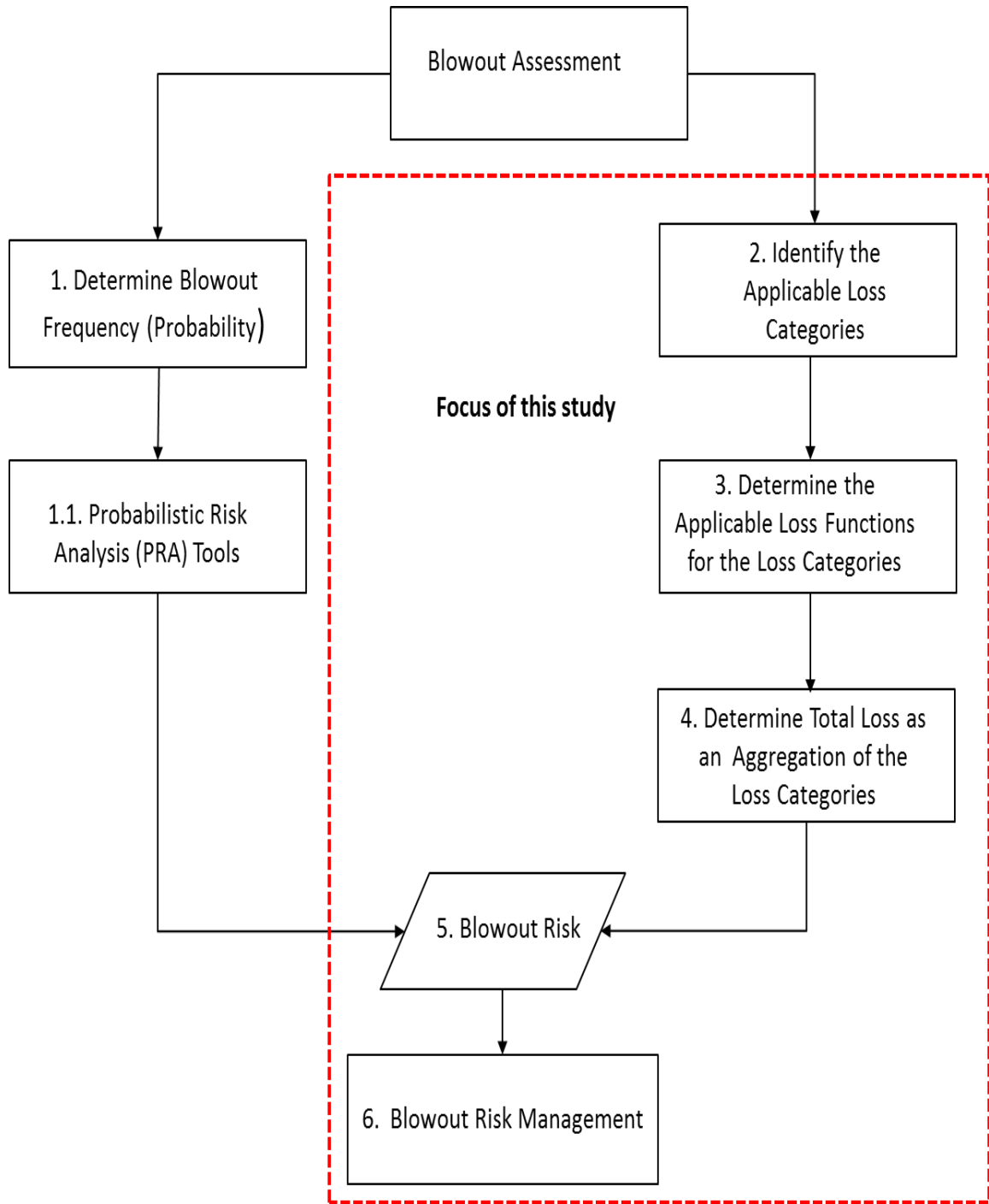
$APL$  = Annular Pressure Loss in  $psi$

$D$  = True vertical depth in  $ft$

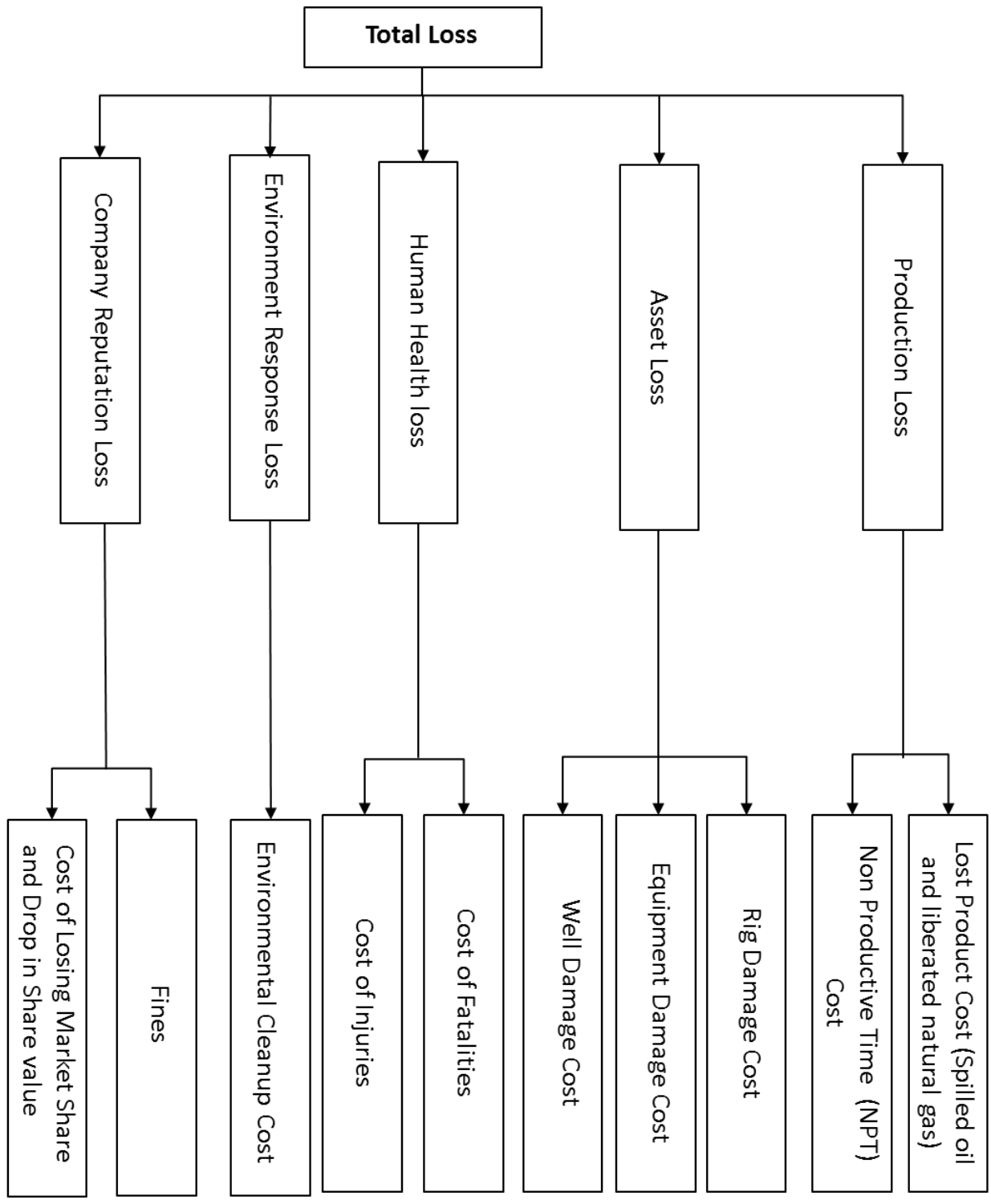
$MW_s$  = the current Mud Weight in  $ppg$

$\rho_{ECD}$  = Equivalent circulating density in  $psi/ft$

Consequently,  $\rho_{BHP}$  may be substituted with  $\rho_{ECD}$  for real time analysis of the models in this study.



**Figure 8.2 – Blowout dynamic risk analysis methodology**



**Figure 8.3 – Loss categories identified related to drilling operations**

Where  $q_o$ , is the blowout oil flow rate in ( $stb/day$ );  $Pr_o$ , is the price of a barrel of oil ( $$/stb$ );  $q_g$ , is the blowout gas flow rate ( $Mscf/day$ );  $Pr_g$ , is the price of gas ( $$/Mcf$ );  $GOR$ , is the gas oil ratio ( $scf/stb$ );  $C_R$ , is the fixed operating cost of a rig ( $$/day$ ); and  $q_{or}$ , is the recovery rate of spilled oil ( $stb/day$ ), (if mechanical recovery method is used as a remediation technique) (Ahmed & McKinney, 2005). It is very difficult to precisely determine either the oil or gas flow rate during a blowout. This is because the control over the wellhead pressure is lost, which exerts influence over the flowing BHP with which the reservoir drawdown is determined. Under these conditions, the oil and gas flow rates are usually determined with high uncertainties. In addition, the flow rates decline with time due to depletion of the reservoir as the reservoir pressure falls rapidly. For instance, Hsieh (2010) in a reservoir depletion simulation study conducted for the M56 reservoir, bearing the Macondo well during the Deepwater Horizon blowout, argued that the initial reservoir pressure and oil flowrate were 11,850 psi and 63,600 stb/day and decreased to 9,400 psi and 52,600 stb/day respectively prior to shutting in the well on the 86<sup>th</sup> day of oil discharge. Consequently, a suitable production decline analysis model (exponential, harmonic or hyperbolic) (Guo, et al., 2007) that better characterize the blowout scenario should be adopted; rather than assuming a steady reservoir pressure and flowrate. However, this is also difficult in practice as no production data usually exists before the occurrence of a blowout during the drilling and cementing of a well. Hence a simulated flow analysis is often the norm in the industry.

**8.3.3.2. Asset Loss ( $L_2$ ):** This includes the loss incurred as a result of the damage to a

well, rig and rig equipment as a result of wellbore collapse, kick or blowout. These are due to negative pressure deviations from the formation pore pressure (that is, underbalance). On the other hand, a positive pressure deviation leads to differential pipe sticking, lost circulation or fractured formation (that is, overbalance). Due to the asymmetric nature of the losses for the deviations with different maxima from the formation pore pressure target value; an IBLF model results to a better description of the scenario (Leung & Spiring, 2002). A typical beta function is shown in Eq. (8.9).

$$f(x) = \frac{1}{B(\alpha, \beta)} x^{\alpha-1} (1-x)^{\beta-1} \quad (8.9)$$

$$L(x, T) = \begin{cases} K_1 \left( 1 - \frac{\pi_1(x, T)}{m_1} \right) & \text{if } 0 < x < T \\ K_2 \left( 1 - \frac{\pi_2(x, T)}{m_2} \right) & \text{if } T < x < 1 \end{cases} \quad (8.10)$$

Where  $K_1$  and  $K_2$  in Eq. (8.10) are maximum losses on either side of the target with  $m_1$  and  $m_2$  as their respective suprema. Further expansion of Eq. (8.10).

$$L(x, T) = \begin{cases} K_1 \langle 1 - C_1 [x(1-x)^{(1-T)/T}]^{\alpha_1-1} \rangle & \text{if } 0 < x < T \\ K_2 \langle 1 - C_2 [x(1-x)^{(1-T)/T}]^{\alpha_2-1} \rangle & \text{if } T < x < 1 \end{cases} \quad (8.11)$$

$$C_1 = [T(1-T)^{(1-T)/T}]^{1-\alpha_1}, \quad C_2 = [T(1-T)^{(1-T)/T}]^{1-\alpha_2}$$

$$\alpha_1 - 1 = \frac{T(\beta_1 - 1)}{1 - T}, \quad \alpha_2 - 1 = \frac{T(\beta_2 - 1)}{1 - T}$$

Considering a formation pore pressure as the target by which the BHP is determined,  $K_1$  represents the maximum loss due to wellbore collapse, kick or

blowout. On the other hand,  $K_2$  is the maximum loss due to differential pipe sticking, lost circulation or fractured formation.  $\alpha_1$  and  $\alpha_2$ , are the shape parameters for the underbalance and overbalance regimes respectively. Considering these parameters, the asset loss is best represented by Eq. (8.12).

$$L_2 = \begin{cases} K_1 \langle 1 - C_1 [\rho_{BHP} (1 - \rho_{BHP})^{(1-\rho_F)/\rho_F}]^{\alpha_1-1} \rangle & \text{if } 0 < \rho_{BHP} < \rho_F \\ K_2 \langle 1 - C_2 [\rho_{BHP} (1 - \rho_{BHP})^{(1-\rho_F)/\rho_F}]^{\alpha_2-1} \rangle & \text{if } \rho_F < \rho_{BHP} < 1 \end{cases} \quad (8.12)$$

$$C_1 = [\rho_F (1 - \rho_F)^{(1-\rho_F)/\rho_F}]^{(1-\alpha_1)}, \quad C_2 = [\rho_F P_F (1 - \rho_F)^{(1-\rho_F)/\rho_F}]^{(1-\alpha_2)}$$

As IBLF is scale invariant under a linear transformation, Eq. (8.12) can be easily represented as in Eq. (8.13).

$$L_2 = \begin{cases} K_1 \langle 1 - C_1 [P_{BHP} (1 - P_{BHP})^{(1-P_F)/P_F}]^{\alpha_1-1} \rangle & \text{if } P_{AIR} < P_{BHP} < P_F \\ K_2 \langle 1 - C_2 [P_{BHP} (1 - P_{BHP})^{(1-P_F)/P_F}]^{\alpha_2-1} \rangle & \text{if } P_F < P_{BHP} < P_{OV} \end{cases} \quad (8.13)$$

$$C_1 = [\rho_F (1 - \rho_F)^{(1-\rho_F)/\rho_F}]^{\alpha_1-1}, \quad C_2 = [\rho_F (1 - \rho_F)^{(1-\rho_F)/\rho_F}]^{\alpha_2-1}$$

$P_{AIR}$  is the BHP of air;  $P_{BHP}$ , is the BHP;  $P_F$ , is the formation pore pressure (FPP);  $P_{OV}$ , is the overburden stress in field units.

**8.3.3.3. Human Health Loss ( $L_3$ ):** This comprises the loss incurred as a result of insurance and civil claims from injuries and fatalities occurring on the rig due to the blowout accident. Zadakbar et al (2014) proposed a step (instant) function for quantifying losses due to injuries and fatalities from explosions and fire. Insurance and civil claims from injuries are classified into: individual minor injuries; individual major non-recoverable injuries and small group minor injuries; and large

group major non-recoverable injuries. In this scenario, the losses representing injuries and fatalities are segmented into the pressure drawdown – the difference between FPP and BHP - represented by the pressure gradients of the FPP and the BHP within which they occur.

$$L_3 = \begin{cases} L_{I,\rho_{F1}} + L_{F,\rho_{F1}} & , & \rho_F > \rho_{BHP} > \rho_{F1} \\ L_{I,\rho_{F2}} + L_{F,\rho_{F2}} & , & \rho_{F1} > \rho_{BHP} > \rho_{F2} \\ \vdots & \vdots & \vdots \\ L_{I,\rho_{Fn}} + L_{F,\rho_{Fn}} & , & \rho_{Fn} > \rho_{BHP} > 0 \end{cases} \quad (8.14)$$

Where  $L_{I,\rho_{Fn}}$ , and  $L_{F,\rho_{Fn}}$ , are the cumulative losses due to injury and fatalities respectively from the beginning of the blowout incident to the pressure drawdown.

The pressure drawdown is ascertained by the difference of the absolute pressure equivalents of the pressure gradients.

Alternatively, considering Occupational Safety and Health Administration (OSHA) and Fatal Accident Rate (FAR) methodologies (Crowl & Louvar, 2002) are used for the prediction of the number of injuries and fatalities respectively. Finally, the human health loss may be determined as:

$$L_3 = L_{inj} + L_{fat} \quad (8.15)$$

$$L_{inj} = N_{inj} I_{avg} \quad (8.16)$$

$$N_{inj} = \frac{RI * Total\ hours\ worked\ by\ all\ crew\ members}{Base\ hours\ exposed} \quad (8.17)$$

And

$$L_{fat} = N_{fat} F_{avg} \quad (8.18)$$

$$N_{fat} = \frac{FAR * Total\ hours\ worked\ by\ all\ crew\ members}{Base\ hours\ exposed} \quad (8.19)$$



$$FAR = \frac{\text{Number of fatalities per year}}{\text{Typical number of crew members}} \quad (8.20)$$

Where  $L_{inj}$ , is the loss due to injuries;  $N_{inj}$ , is the number of injuries;  $I_{avg}$ ; is the average civil claim per injured person;  $RI$ , Rate of injury occurrence;  $L_{fat}$ , the loss due to fatalities;  $N_{fat}$ , is the number of fatalities and  $F_{avg}$ , is the average civil claim per death.

**8.3.3.4. Environment Response Loss ( $L_4$ ) :** It is the loss incurred in cleaning up the environment of spilled oil in addition to the fine levied on the company by the regulators. Etkin (2000) presented a cleanup cost estimation technique that takes into consideration many factors such as oil type, shoreline oil, location type, spill size, cleanup strategy and regional cost differences into the overall spill response cost estimation. The model is expressed as Eq. (8.21).

$$C_{ei} = C_n r_i I_i t_i o_i m_i s_i A_i \quad (8.21)$$

Where  $C_{ei}$ , is the estimated total response cost for scenario,  $i$ ;  $C_n$ , the general cost per unit spilled in nation,  $n$ ;  $r_i$ , regional location modifier factor for scenario,  $i$ ;  $I_i$ , local location modifier for scenario,  $i$ ;  $t_i$ , oil type modifier factor for scenario,  $i$ ;  $o_i$ , shoreline oiling modifier factor for scenario,  $i$ ;  $m_i$ , cleanup methodology modifier factor for scenario,  $i$ ;  $s_i$ , spill size modifier factor for scenario,  $i$ , and  $A_i$ , specified spill amount for scenario,  $i$ .  $A_i$  is expressed with a MINLF as in Eq. (8.22).

$$A_i = \frac{V_o}{1 - \exp\left\{-\frac{1}{2}\left(\frac{\Delta}{\gamma}\right)^2\right\}} \left[ 1 - \frac{\gamma}{\sqrt{\sigma^2 + \gamma^2}} \exp\left\{-\frac{(\rho_{BHP} - \rho_F)^2}{2(\sigma^2 + \gamma^2)}\right\} \right] \quad (8.22)$$

Where  $V_o$  is the volume of spilled reservoir fluid for a specified reservoir drawdown, represented as a difference in pressure gradient. It is worth mentioning that the environmental response loss largely depends on the magnitude of the production loss; hence, the justification for their similar LF of MINLF.

**8.3.3.5. *Company Reputation Loss*( $L_5$ ):** it is very difficult to quantify the effect of a blowout on the reputation of a company. Various indices have been suggested that include: the fall in stock price of the company; fines such as criminal charges on natural resources damages; civil claims; economic damages to private parties, punitive damages and the safety rating of a company (Richardson, 2010; Cohen, 2010; Cohen et al., 2011). These are often expressed as per unit volume of the oil spilled. Further research in this regard is recommended to better characterize the impact of blowout on the reputation of a company.

**8.3.4 Determine Total Loss as an Aggregation of Loss Categories( $L_{tot}$ ):** The total loss is determined by aggregating the applicable losses to the specific scenario considered. There are various ongoing studies on the methods of aggregating the component losses in the literature. One of such is an investigation into the degree of dependencies among the component losses in which the use of copula function is proposed for process safety risk assessment (Hashemi et al., 2015). In this study, a simplified approach is adopted, involving the summation of the component losses as expressed in Eq. (8.23).

$$L_{tot} = \sum_{i=1}^n L_i \quad (8.23)$$

Where,  $n$ , is the number of the applicable losses from the loss categories in Section 8.3.3.

**8.3.5. Determine Blowout Risk:** Finally, the blowout risk is expressed as Eq. (8.24):

$$R_{bl} = P_{bl} \times L_{tot} \quad (8.24)$$

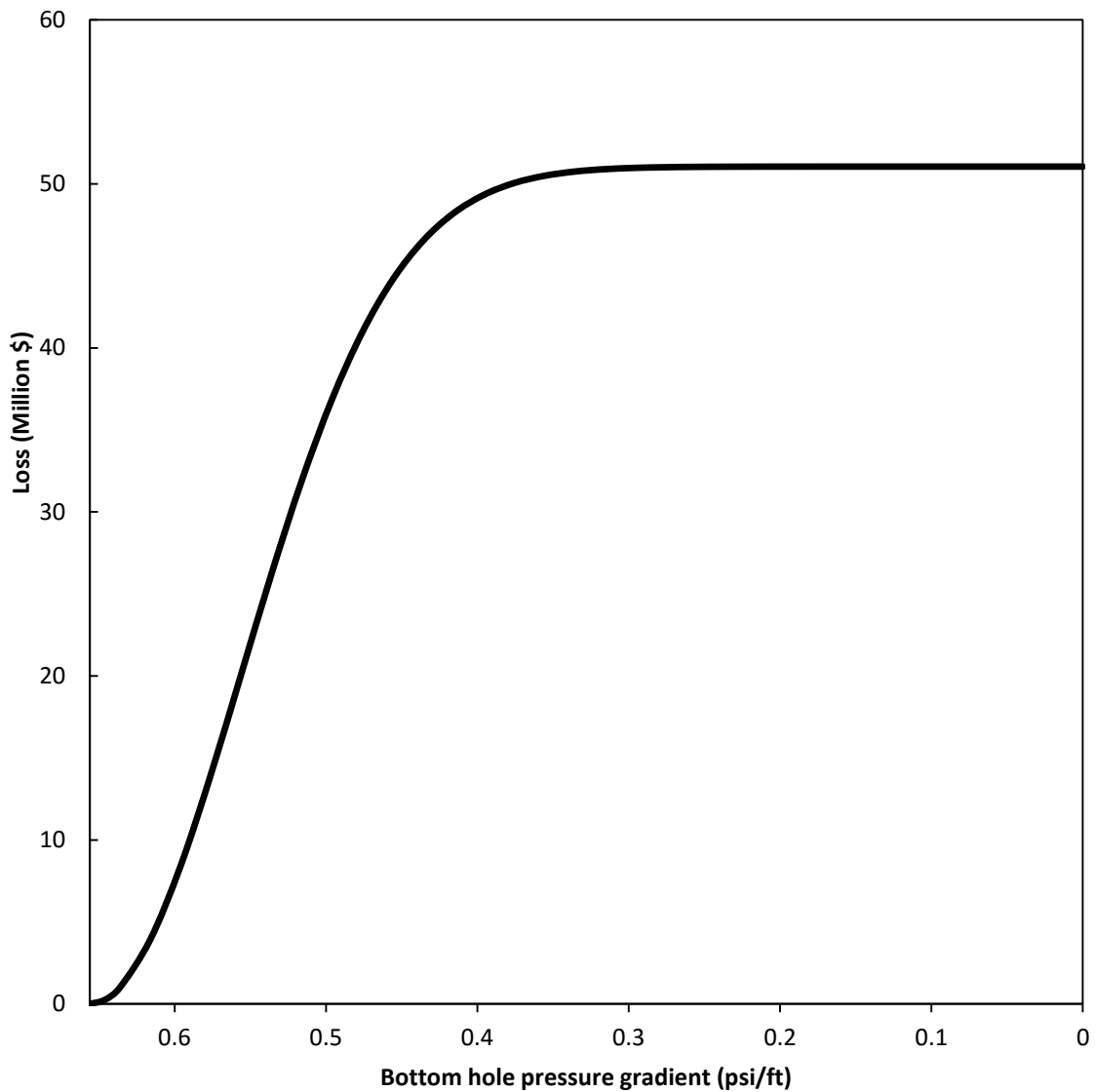
#### **8.4. Application of Loss Aggregation Methodology to a Case Study**

The developed methodology is applied to a deep water drilling operation in which a blowout occurred while drilling an exploratory well. The well depth is about 18,000 ft. below sea level. The pressure gradient equivalent of the initial reservoir pressure is 0.656 psi/ft. About 3 million barrels of oil were spilled, leading to the death of 9 crew members and injuries of different degrees to 15 personnel. In the blowout risk analysis, the operational cost of the rig, sequel to the occurrence of the blowout, is considered insignificant compared to the blowout scenario. Mechanical recovery method is not used; hence, no oil was recovered from the spill. The proposed methodology as presented in Fig. 8.2 is implemented. The details of each step are discussed below:

**Step 1:** The blowout probability is determined using probabilistic risk analysis tools. For a typical offshore drilling scenario, a similar study has been undertaken to determine the probability of a blowout considering different drilling techniques of conventional overbalanced drilling (COBD) and underbalanced drilling (UBD) (Abimbola et al., 2014). Abimbola et al. (2015a) has developed a dynamic model that enables updating of the blowout probability of a MPD using BN. In this study, both the blowout probability for COBD and CBHP technique of MPD in Abimbola et al. (2014) and Abimbola et al. (2015a) respectively have been adopted for a comparative analysis. These blowout probabilities are 7.97E-04 and 4.96E-07 respectively.

**Step 2:** The loss categories identified for this case study include: production loss, asset loss, human health loss, environmental response loss and company reputation loss. Detailed explanation of the loss categories has been presented in Section 3.3.

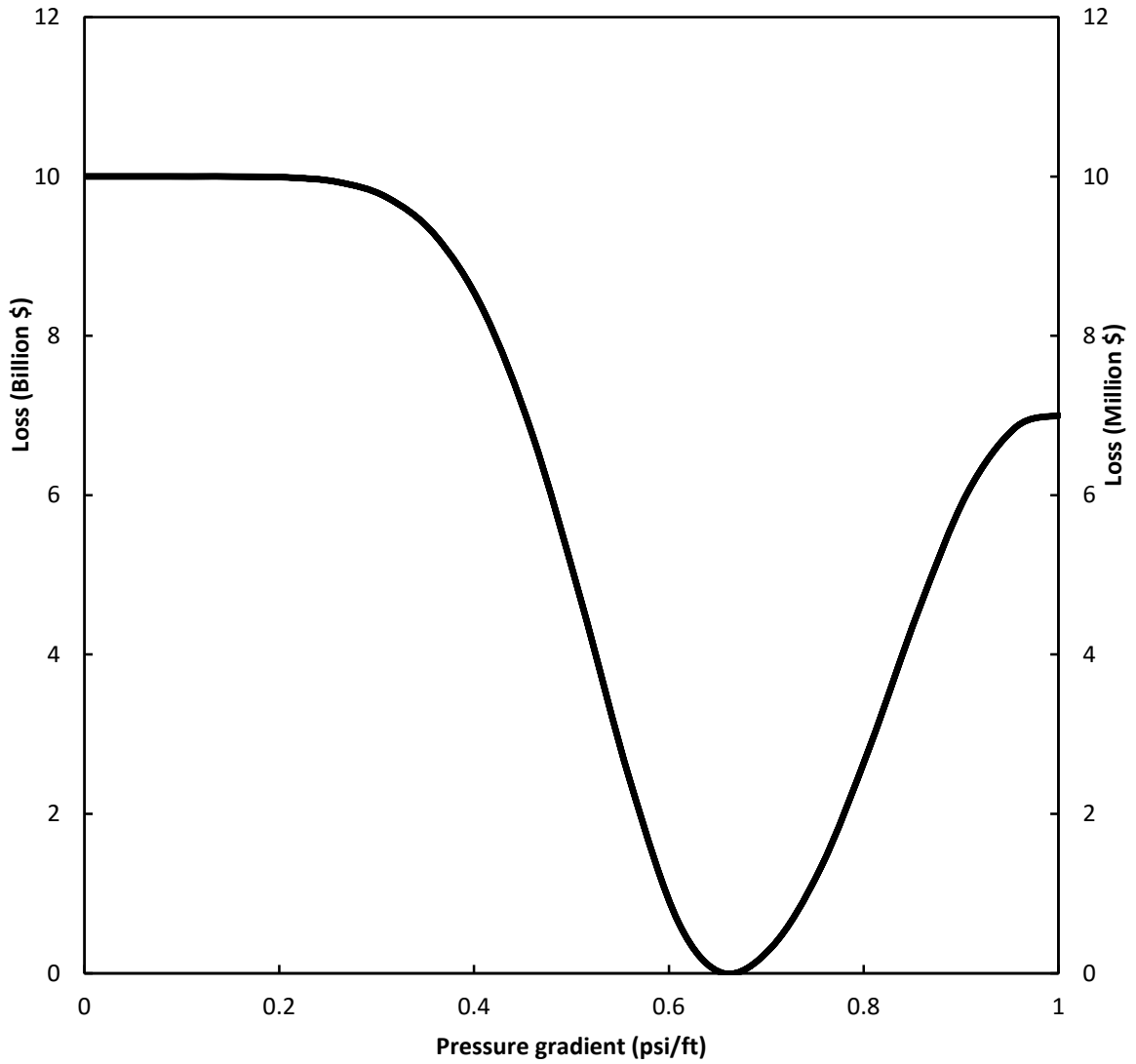
**Step 3:** The LFs for each of the loss categories are analyzed. To assess the production loss, the shape parameter,  $\gamma$ , is set at  $\Delta/0.5$ , considering the specific knowledge of the loss scenario in the given region. The production loss,  $K_{\Delta}$ , is determined as \$ 6 million for a pressure gradient deviation of 0.05 psi/ft. The production loss expressed as a function of BHP gradient as it varies from the FPP gradient is presented in Fig. 8.4.



**Figure 8.4 – Production loss as a function of the BHP gradient deviation from the FPP gradient due to underbalance condition developed considering MINLF**

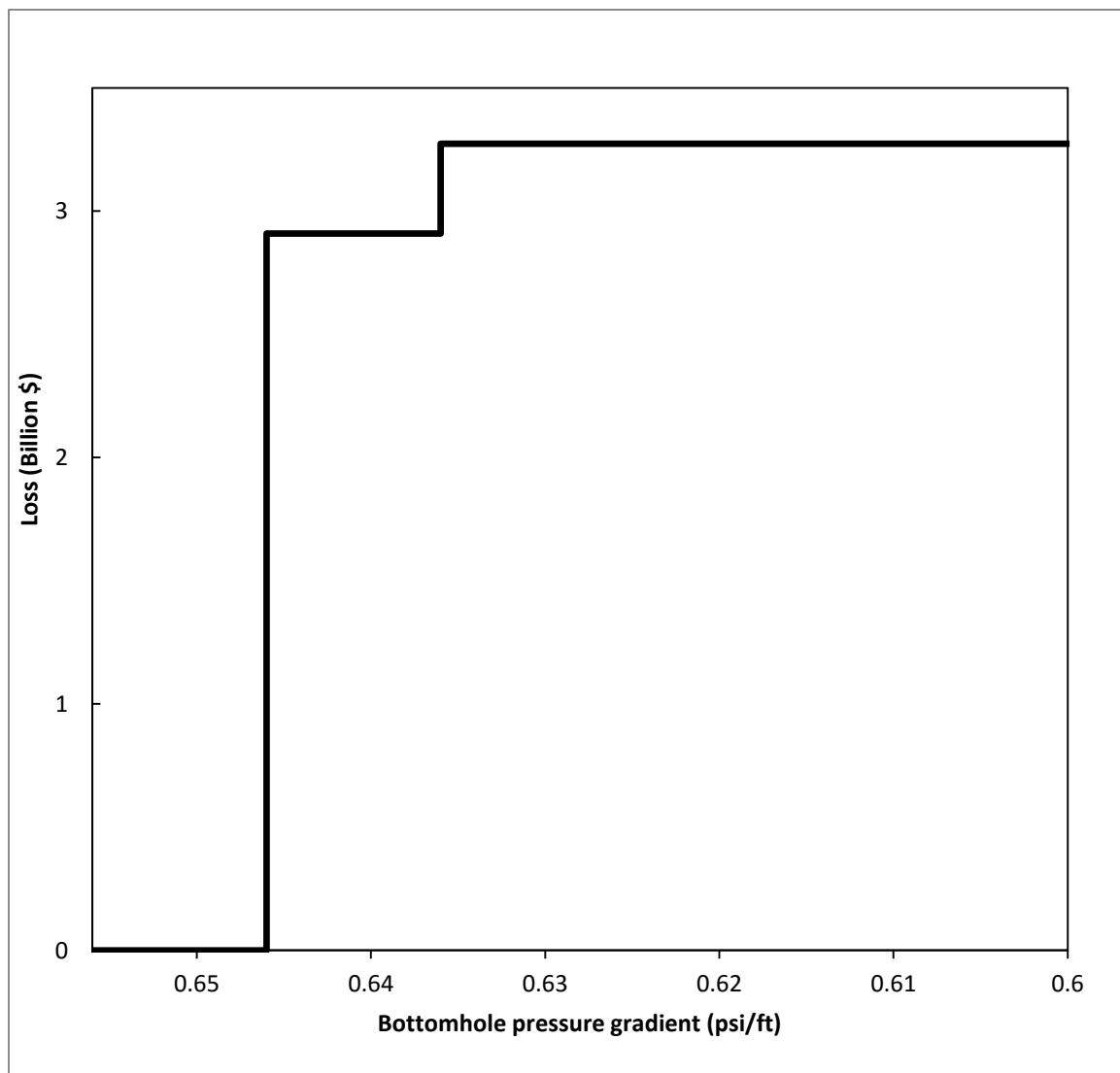
In evaluating the asset loss,  $K_1$  is set at \$ 10 billion while  $K_2$  is \$7 million,  $\alpha_1 = 10.5$  and  $\alpha_2 = 6.5$ .  $C_1$  is determined as  $1.12E+04$  while  $C_2$  is calculated as  $2.21E+02$ . The asset loss profile is shown in Fig. 8.5. The shape of the loss profile changes with variations in the shape

parameters,  $\alpha_1$  and  $\alpha_2$ . Optimum values, based on expert knowledge, were adopted for these parameters.



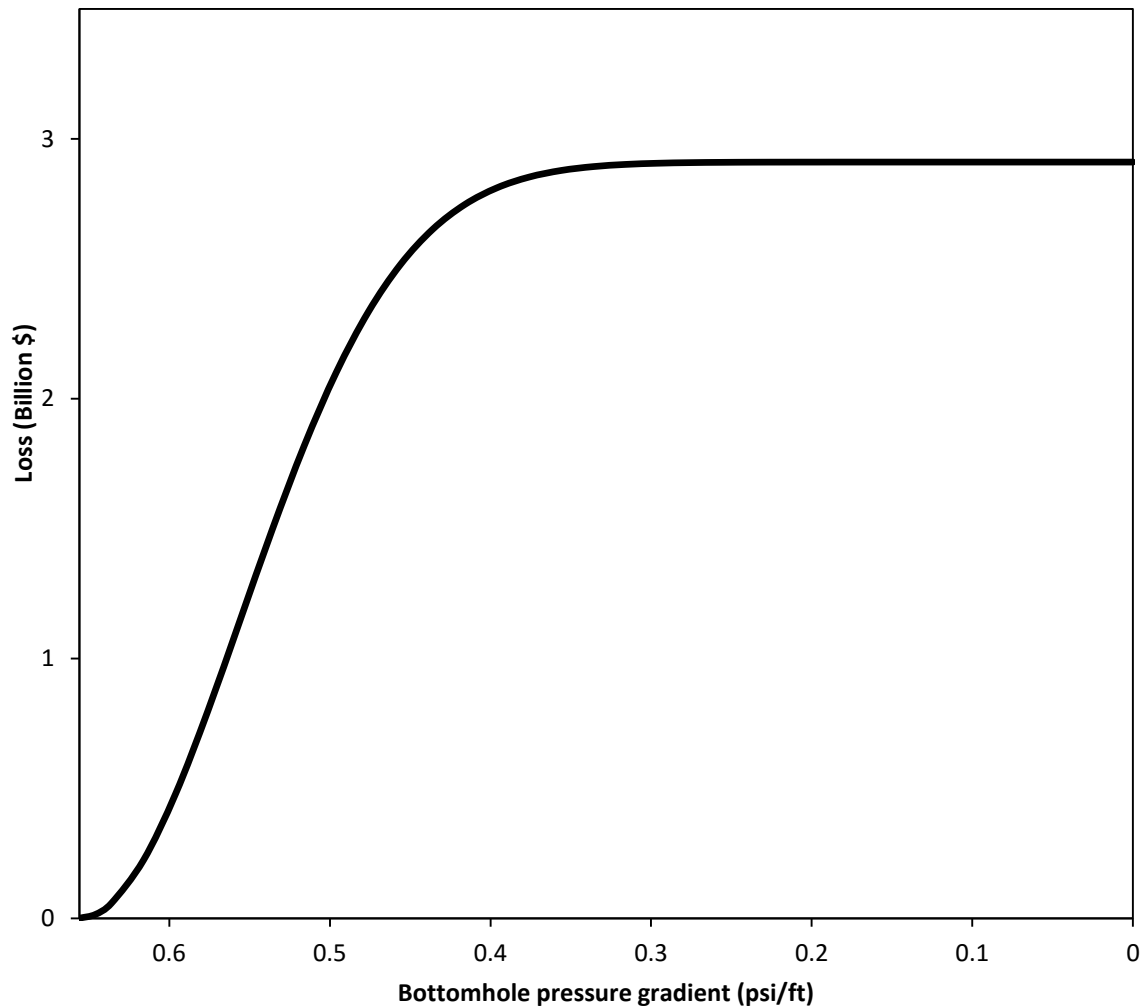
**Figure 8.5 - Asset loss profile as a function of the BHP gradient for two different maximum losses on either side of the target, the FPP gradient considering IBLF**

The human health loss comprising the loss from injuries and fatalities determined by step function is prominent during the early stage of the blowout. Considering the region under study, the average civil claim per death is about \$ 364 million. The loss profile is presented in Fig. 8.6. This represents a 3-step loss profile for the human health loss.



**Figure 8.6 - Human health loss profile indicating the variation of civil claims from injuries and fatalities with the BHP drawdown considering step function**

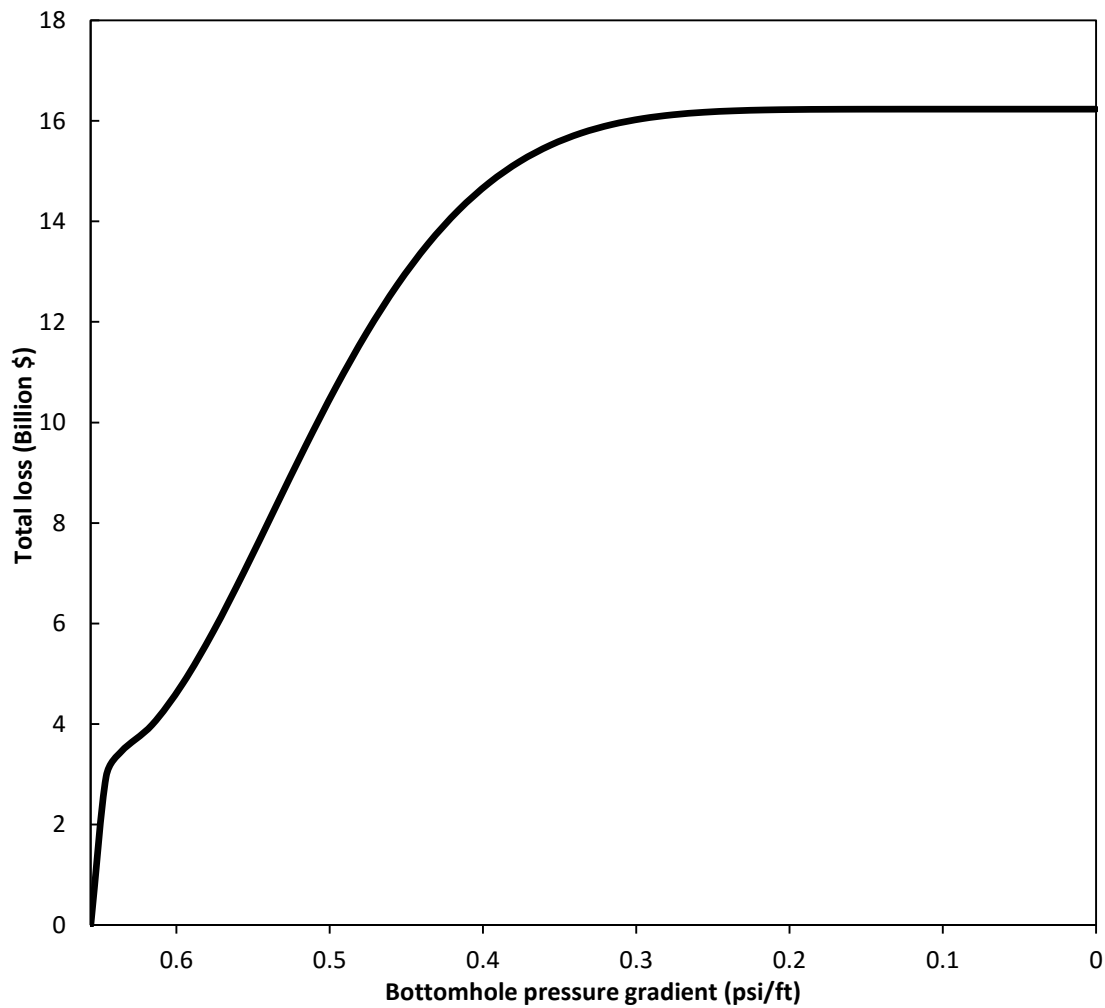
The environmental response loss for the region of the case study has the following parameters:  $C_n = \$35/\text{gallon}$ ;  $r_i = 1$ ;  $I_i = 0.46$ ;  $t_i = 0.55$ ;  $o_i = 1.06$ ;  $m_i = 0.46$ ;  $s_i = 0.01$ ;  $V_o = 1.26$  billion gallons. The unit reputation loss determined for the blowout scenario in the region under study is \$200 per gallon of oil spilled. Since both the reputation and environmental response losses are dependent on the amount of oil spilled, they are aggregated and presented in Fig. 8.7.



**Figure 8.7 - Environmental response in addition to the reputation loss profile against BHP gradient due to underbalance scenario considering MINLF**

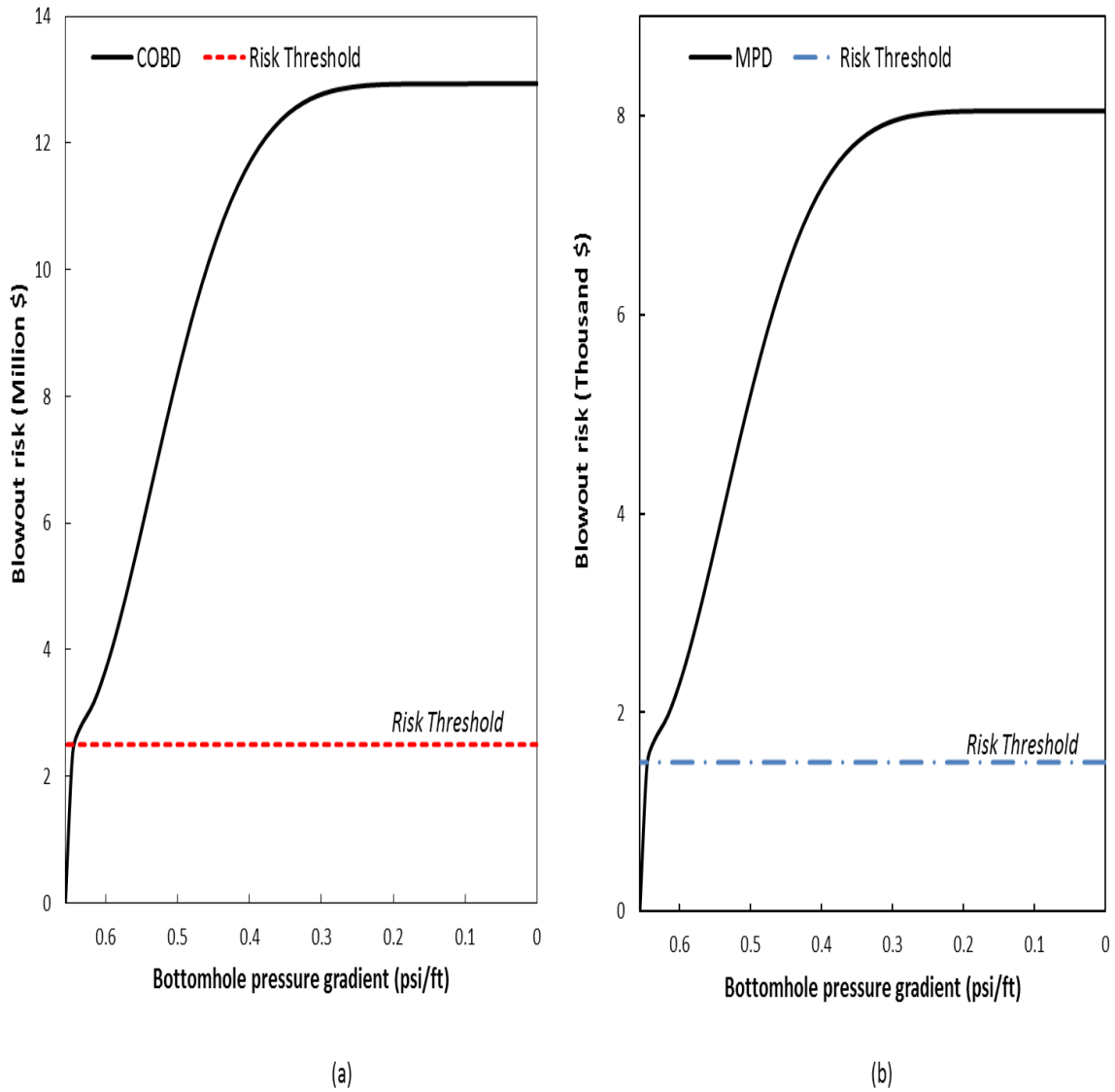


**Step 4:** The total loss is determined by summing up the individual categories of loss against the corresponding BHP gradient. Figure 8.8 presents the total loss profile as a function of the BHP gradient.



**Figure 8.8 – Total loss profile as a function of the BHP gradient**

**Step 5:** From the blowout probability and the total loss, the blowout risk is determined using Eq. (8.22). The blowout risk profile is shown in Fig. 8.9 against the BHP gradient.



**Figure 8.9 – Blowout risk profile expressed as a function of the BHP gradient for COBD (a) and CBHP technique of MPD (b)**

## 8.5. Discussion

It is apparent from Fig. 8.4 that higher loss is incurred due to larger deviations from the target FPP gradient of 0.656 psi/ft. Maximum loss is attained at a BHP gradient deviation of about 0.526 psi/ft. It is worth mentioning that the target pressure gradient is not static during blowout condition; rather, it reduces and shifts to the left of the original target value. However, the shape of the loss profile remains the same over the course of the blowout accident. In Fig. 8.5, both the underbalance and overbalance regimes which can lead to a blowout; and stuck pipe, loss circulation and fractured formation respectively are represented. Since blowout which can occur in an underbalanced condition is studied; the overbalanced (right of the target pressure gradient) region is not considered in the total loss. In the step function profile of Fig. 8.6, most part of the human health loss occurs during the early part of the blowout when there is rapid change in the BHP gradient. This is generally the case for other loss categories; hence, the steep curvature in the loss profiles. The loss profiles stabilize around the maximum anticipated loss in the long run, as expected. The blowout risk profiles of Fig. 8.9 take semblance of the total loss profile since it involves factoring in the probability of blowout on the total loss. Considering the operational risk management strategy for the COBD (Fig. 8.9a), the blowout risk threshold is set at \$2.5 million. If the blowout risk is less than the risk threshold, the drilling operation may be continued with the crew at alert as the risk approaches the risk threshold. However, if the blowout risk exceeds the risk threshold, the drilling operation should be halted and revised while the safety barriers such as the RCD, BOP system, kick detection mechanisms, flow and pressure measurement devices are adjusted, replaced or supplemented in order to prevent the escalation to a blowout accident. A similar characteristic is observed for the CBHP

technique (Fig. 8.9b) with a set risk threshold of \$1500. By this scheme, the blowout risk is monitored and managed while being prevented from escalation. Apparently, if the same risk threshold of \$2.5 million were applied to both techniques; the CBHP technique would not require any revision as the whole risk profile falls below the risk threshold. This is tantamount to over-specification and will not improve the drilling operation. Conversely, if a risk threshold of \$1500 were applied to both techniques; the COBD method would be operated with frequent interruptions. The CBHP technique allows a very low risk threshold compared to the COBD due to the outperformance of the former over the latter. Finally, studies considering various degrees of dependency among the loss categories and the sensitivities of the loss profiles to changes in the parameters of the loss functions should be conducted.

## **8.6. Conclusion**

This study presents a methodology for conducting a blowout risk analysis comprising both a probability of occurrence and a detailed consequence analysis. The blowout probability is determined using various probabilistic risk analysis tools while, on the other hand, the categories of the consequences, including: production loss, asset loss, human health loss, environmental response loss and reputation loss are modeled with appropriate LFs. Both the production and environmental response loss are modeled with MINLF in the underbalanced region of the pressure regime. The asset loss is modeled using an IBLF with different maximum losses on either side of the target pressure gradient and the human health loss represented with a step function. The profiles of loss categories show that most part of the losses occur during the early stage of the deviation from the target. The loss profiles stabilize

after about 0.3psi/ft from the target pressure gradient. This study has enabled the standardization of the measured parameter from absolute bottom hole pressure to pressure gradients; thus, enabling the universality of the application of the loss models to any depth of the formation with minimal alteration of the loss model parameters. The operational risk management strategy enables the setting of a risk threshold by which the blowout risk is controlled to prevent escalation of the blowout risk. This has been used to illustrate the outperformance of CBHP technique over the COBD method of drilling. Lastly, further studies to investigate dependencies among the LFs and sensitivities of the loss profiles to changes in the parameters of the loss functions are thus recommended for enhanced analysis.

## **Acknowledgment**

The authors acknowledge the financial support of Natural Sciences and Engineering Research Council (NSERC), Atlantic Canada Opportunities Agency (ACOA), Vale Research Chair grant and Research & Development Corporation of Newfoundland and Labrador (RDC).

## **List of Acronyms**

BHP = Bottom Hole Pressure

BN = Bayesian Network

BT = Bow Tie

CBHP = Constant Bottom Hole Pressure

COBD = Conventional Over-Balanced Drilling

DNV = Det Norske Veritas

DRA = Dynamic Risk Analysis

ET = Event Tree

FAR = Fatal Accident Rate

FMEA = Failure Modes and Effects Analysis

FPP = Formation Pore Pressure

FT = Fault Tree

HAZID = Hazard Identification

HAZOP = Hazard and Operability

IBLF = Inverted Beta Loss Function

IGLF = Inverted Gamma Loss Function

INLF = Inverted Normal Loss Function

LF = Loss Function

MINLF = Modified Inverted Normal Loss Function

MPD = Managed Pressure Drilling

NPT = Non Productive Time

OSHA = Occupational Safety and Health Agency

QLF = Quadratic Loss Function

QRA = Quantitative Risk Analysis

SAGD = Steam Assisted Gravity Drainage

SINLF = Spiring Inverted Normal Loss Function

UBD = Underbalanced Drilling

## References

- Abimbola, M., Khan, F. & Khakzad, N., 2014. Dynamic safety risk analysis of offshore drilling. *Journal of Loss Prevention in the Process Industries*, 30, pp.74–85.
- Abimbola, M., Khan, F., Khakzad, N. & Butt, S., 2015a. Safety and risk analysis of managed pressure drilling operation using Bayesian network. *Safety Science*, 76, pp.133–144. Available at: <http://dx.doi.org/10.1016/j.ssci.2015.01.010>.
- Adams, J., Kuhlman, L.G. & Adams, N., 1993. OTC 7120 Contingency PLanning for Offshore Blowouts.
- Ahmed, T. & Mckinney, P. D., 2005. *Advanced Reservoir Engineering*. Massachusset: Gulf Professional Publishing.
- Al-murri, T., El-faghi, F. & Al-meer, K., 2012. SPE 156119 The First Relief Well Drilled in Qatar to Intersect , Kill , and Abandon an Underground Blowout. , (May 2008), pp.1–15.
- Al-saleh, A., Rajagopalan, A. & Mckinnell, D.C., 2014. IADC / SPE 167984 Directional Challenges and Planning of Relief Well to Resolve an HP / HT Well Blowout.
- Arild, Ø. et al., 2008. IADC / SPE 114568 BlowFlow - a New Tool Within Blowout Risk Management. In *IADC/SPE Asia Pacific Drilling Technology Conference and Exhibition*. Jakarta, Indonesia: IADC/SPE 114568.
- Arild, O., Ford, E. P., Loberg, T. & Baringbing, J. W. T., 2009. *KickRisk - A Well Specific Approach to the Quantification of Well Control Risks*. Jakarta, Indonesia, SPE 124024.
- Artiles-Leon, N., 1996. A pragmatic approach to multi-response problems using loss functions. *Quality Engineering*, Volume 9, pp. 213-220.
- Aven, T., 2010. On how to define, understand and describe risk. *Reliability Engineering and System Safety*, 95(6), pp.623–631. Available at: <http://dx.doi.org/10.1016/j.ress.2010.01.011>.
- Benny, A. M. H., Karnugroho, A., Sosa, J. & Toralde, J. S. S., 2013. *Combining Pressurized Mud Cap Drilling (PMCD) and Early Kick Detection (EKD) Techniques for Fractured Formations Overlying a High Pressure Reservoir in Offshore Kalimantan*. Jakarta, Indonesia, SPE 165893.
- Bercha, F. G., 1978. *Probabilities of Blowouts in Canadian Arctic Waters*, Canada: Environmental Protection Service. Economic and Technical Review, Report EPS 3-EC-78-12.



- Berg Andersen, L., 1998. Stochastic modelling for the analysis of blowout risk in exploration drilling. *Reliability Engineering & System Safety*, 61(1-2), pp.53–63. Available at: <http://linkinghub.elsevier.com/retrieve/pii/S0951832097000677>.
- Bommer, P., 2008. *A Primer of Oilwell Drilling* 7th Editio., Petroleum Extension Service, University of Texas.
- Bourgoyne, A. et al., 1986. *Applied drilling engineering* 1st Edition.
- Berker, T. B., 1990. *Engineering Quality by Design: Intepreting the Taguchi Approach*. New York: Marcel Dekker.
- Bobbio, A., Portinale, L., Minichino, M. & Ciancamerla, E., 2001. Improving the analysis of dependable systems by mapping fault trees into Bayesian networks. *Reliability Engineering and System Safety*, Volume 71, pp. 249-260.
- Cai, B. et al., 2012. Performance evaluation of subsea blowout preventer systems with common-cause failures. *Journal of Petroleum Science and Engineering*, 90-91, pp.18–25. Available at: <http://dx.doi.org/10.1016/j.petrol.2012.04.007>.
- Catak, E., 2008. MPD with Flow Measurement as the Primary Control. In: B. Rehm, et al. eds. *Managed Pressure Drilling*. Houston, Texas: Gulf Publishing Company, pp. 109-126.
- Chang, Y., Khan, F. & Ahmed, S., 2011. A risk-based approach to design warning system for processing facilities. *Process Safety Environmental Protection*, Volume 89, pp. 310-316.
- Cohen, J., Stave, R., Schubert, J. & Elieff, B., 2008. Dual-Gradient Drilling. In: B. Rehm, et al. eds. *Managed Pressure Drilling*. Houston, Texas: Gulf Publishing Company, pp. 181-226.
- Cohen, M.A. et al., 2011. *Deepwater Drilling : Law, Policy, and Economics of Firm Organization and Safety*, Available at: <http://ssrn.com/abstract=1744215>.
- Cohen, M.A., 2010. *Deterring Oil Spills: Who Should Pay and How Much?*, Available at: <http://www.rff.org/Publications/Pages/PublicationDetails.aspx?PublicationID=21161>.
- Crowl, D. A. & Louvar, J. F., 2002. *Chemical Process Safety*. 2nd ed. Houston: Prentice Hall.
- Danenberger, E.P., 1993. OTC 7248 Outer Continental Shelf Drilling Blowouts , 1971-1991. , 11.
- Etkin, D.S., 2001. Comparative Methodologies for Estimating on-Water Response Costs for Marine Oil Spills. *International Oil Spill Conference Proceedings*, 2001, pp.1281–1289. Available at: <http://ioscproceedings.org/doi/abs/10.7901/2169-3358-2001-2-1281>.
- Etkin, D.S., 2004. MODELLING OIL SPILL RESPONSE AND DAMAGE COSTS. In *Freshwater Spills Symposium*.
- Etkin, D.S. (Environmental R.C., 2000. Worldwide Analysis of Marine Oil Spill Cleanup Cost Factors. In *Arctic an Marine Oilspill Program Technical Seminar*.

- Fredericks, P., 2008. Constant Bottom-Hole Pressure with Pressure as a Primary Control. In: B. Rehm, et al. eds. *Managed Pressure Drilling*. Houston, Texas: Gulf Publishing Company, pp. 81-107.
- Ferdous, R. et al., 2013. Analyzing system safety and risks under uncertainty using a bow-tie diagram: An innovative approach. *Process Safety and Environmental Protection*, 91(1-2), pp.1–18. Available at: <http://dx.doi.org/10.1016/j.psep.2011.08.010>.
- Ferdous, R. et al., 2009. Methodology for computer aided fuzzy fault tree analysis. *Process Safety and Environmental Protection*, 87(4), pp.217–226.
- Grayson, B. & Gans, A. H., 2012. *Closed Loop Circulating Systems Enhance Well Control and Efficiency With Precise Wellbore Monitoring and Management Capabilities*. Milan, Italy, SPE, p. 12.
- Guo, B., Lyons, W. C. & Ghalambor, A., 2007. *Petroleum Production Engineering - A computer-Assisted Approach*. Lafayette: Elsevier Science & Technology Books.
- Haghshenas, A., Paknejad, A. S., Reihm, B. & Schubert, J., 2008. The Why and Basic Principles of Managed Well-Bore Pressure. In: B. Reihm, et al. eds. *Managed Pressure Drilling*. Houston, Texas: Gulf Publishing Company, pp. 1-38.
- Hannegan, D., 2013. *Operational Reliability Assessment of Conventional vs. MPD on Challenging Offshore Wells*. Amsterdam, SPE/IADC 163523.
- Hannegan, D. M., 2005. *Managed Pressure Drilling in Environments - Case Studies*. Amsterdam, The Netherland, SPE/IADC 92600.
- Hannegan, D. M., 2011. *MPD- Drilling Optimization Technology, Risk Management Tool, or Both?*. Denver, Colorado, SPE 146644.
- Hashemi, S.J., Ahmed, S. & Khan, F.I., 2015. Loss scenario analysis and loss aggregation for process facilities. *Chemical Engineering Science*. Available at: <http://linkinghub.elsevier.com/retrieve/pii/S0009250915000901>.
- Hashemi, S. J., Ahmed, S. & Khan, F., 2014. Loss Functions and their Applications in Process Safety Assessment. *American Institute of Chemical Engineers*, 33(3), pp. 285-291.
- Hsieh, P. (U. S.G.S.O.-F.R. 2010-1266, 2010. *Computer Simulation of Reservoir Depletion and Oil Flow from the Macondo Well Following the Deepwater Horizon Blowout*,
- Izon, B.D., Danenberger, E.P. & Mayes, M., 2007. Absence of fatalities in blowouts encouraging in MMS study of OCS incidents 1992-2006. , (August).
- Jensen, F. V. & Nielsen, T. D., 2007. *Bayesian Networks and Decision Graphs*. 2nd ed. New York: Springer.

- Karlsen, H.C. & Ford, E.P., 2014. IPTC 17622 BlowFlow - Next Generation Software for Calculating Blowout Rates. In *International Petroleum Technology Conference*. Doha, Qatar: IPTC 17622.
- Khakzad, N., Khan, F. & Amyotte, P., 2011. Safety analysis in process facilities: Comparison of fault tree and Bayesian network approaches. *Reliability Engineering and System Safety*, Volume 96, pp. 925-932.
- Khakzad, N., Khan, F. & Amyotte, P., 2012. Dynamic risk analysis using bow-tie approach. *Reliability Engineering & System Safety*, 104(null), pp.36–44. Available at: <http://dx.doi.org/10.1016/j.ress.2012.04.003> [Accessed August 11, 2013].
- Khakzad, N., Khan, F. & Amyotte, P., 2013a. Dynamic safety analysis of process systems by mapping bow-tie into Bayesian network. *Process Safety and Environmental Protection*, Volume 91, pp. 46-53.
- Khakzad, N., Khan, F. & Amyotte, P., 2013b. Quantitative risk analysis of offshore drilling operations: A Bayesian approach. *Safety Science*, Volume 57, pp. 108-117.
- Khan, F., 2001. Use of maximum credible accident scenarios for realistic and reliable risk assessment. *Chemical Engineering Progress*, Volume 11, pp. 56-64.
- Lage, A. et al., 2013. Blowout Contingency and Risk-Reduction Measures for High-Rate Subsea Gas Wells in Mexilhao. *IADC/SPE Drilling Conference*. Available at: <http://www.onepetro.org/doi/10.2118/99164-MS>.
- Leung, B.P.K. & Spiring, F. a., 2002. The inverted beta loss function: Properties and applications. *IIE Transactions (Institute of Industrial Engineers)*, 34, pp.1101–1109.
- Leung, B. P. K. & Spiring, F. A., 2004. Some Properties of the Family of Inverted Probability Loss Functions. *Quality Technology and Quantitative Management*, Volume 1, pp. 125-147.
- Lin, C.-T. & Wang, M.-J.J., 1997. Hybrid fault tree analysis using fuzzy sets. *Reliability Engineering & System Safety*, 58(3), pp.205–213.
- Ma, Y. & Zhao, F., 2004. An improved multivariate loss function approach to optimization. *Journal of System Science and System Engineering*, Volume 13, pp. 318-325.
- Malloy, K. P. et al., 2009. *Managed-Pressure Drilling: What It Is and What It Is Not*. San Antonio, Texas, IADC/SPE 122281.
- Markowski, A.S., Mannan, M.S. & Bigoszevska, A., 2009. Fuzzy logic for process safety analysis. *Journal of Loss Prevention in the Process Industries*, 22(6), pp.695–702. Available at: <http://linkinghub.elsevier.com/retrieve/pii/S0950423008001435> [Accessed March 26, 2014].

- Meel, A. & Seider, W.D., 2006. Plant-specific dynamic failure assessment using Bayesian theory. *Chemical Engineering Science*, 61(21), pp.7036–7056. Available at: <http://linkinghub.elsevier.com/retrieve/pii/S0009250906004209> [Accessed August 13, 2014].
- Minerals Management Service, 2008. *Notice to Lessees and Operators of Federal Oil, Gas, and Sulphur Leases in the Outer Continental Shelf, Gulf of Mexico OCS Region: Managed Pressure Drilling Projects. Report, NTL 2008-G07*. [Online] Available at: [http://www.iadc.org/committees/ubo\\_mpd/Documents/MMS%20NTL%202008-G07.pdf](http://www.iadc.org/committees/ubo_mpd/Documents/MMS%20NTL%202008-G07.pdf) [Accessed 9 January 2014].
- Moore, D., 2008. Mud Cap Drilling. In: B. Rehm, et al. eds. *Managed Pressure Drilling*. Houston, Texas: Gulf Publishing Company, pp. 155-180.
- Neapolitan, R.E., 2004. *LEARNING BAYESIAN NETWORKS FIRST.*, PRENTICE HALL.
- Nelsen, R., 2006. An introduction to copulas. , (June), p.269.
- Phadke, M. S., 1989. *Quality Engineering Using Robust Design*. New York: Prentice Hall.
- Pignatiello, J. J., 1993. Strategies for robust multiresponse quality engineering. *IIE Transactions*, Volume 25, pp. 5-15.
- Pitblado, R., Bjerager, P. & Andreassen, E., 2010. *Key Aspects of an Effective U.S. Offshore Safety Regime*. [Online] Available at: [http://www.dnvusa.com/Binaries/1008-001%20Offshore%20Update\\_Key%20aspects\\_tcm153-430982.pdf](http://www.dnvusa.com/Binaries/1008-001%20Offshore%20Update_Key%20aspects_tcm153-430982.pdf) [Accessed 9 January 2014].
- Pruitt, 2012. *The Pruitt RCD at work*. [Online] Available at: <http://pruitt.com/> [Accessed 20 January 2014].
- Rathnayaka, S., Khan, F. & Amyotte, P., 2013. Accident modeling and risk assessment framework for safety critical decision-making: application to deepwater drilling operation. *Proceedings of the Institution of Mechanical Engineers, Part O: Journal of Risk and Reliability*, Volume 227, pp. 86-105.
- Rehm, B., Haghshenas, A., Paknejad, A. S. & Schubert, J., 2008. Situational Problems in MPD. In: B. Rehm, et al. eds. *Managed Pressure Drilling*. Houston: Gulf Publishing Company, pp. 39-78.
- Reuters, 2015. *BP's fine for 2010 oil spill capped at \$13.7 billion*. [Online] Available at: <http://www.reuters.com/article/2015/01/16/us-bp-trial->

idUSKBN0KO2N020150116

[Accessed 15 March 2015].

- Richardson, N., 2010. *Deepwater Horizon and Spill Liability Law*, Available at:  
<http://www.rff.org/Publications/Pages/PublicationDetails.aspx?PublicationID=21163>.
- Ryan, T. P., 2011. *Statistical Methods for Quality Improvement*. 3rd ed. New York: Wiley Series.
- Rygg, O.B. et al., 1992. Dynamic Two-Phase Flow Simulator : A Powerful Tool for Blowout and Relief Well Kill Analysis.
- Skogdalen, J.E. & Vinnem, J.E., 2012. Combining precursor incidents investigations and QRA in oil and gas industry. *Reliability Engineering & System Safety*, 101, pp.48–58. Available at:  
<http://linkinghub.elsevier.com/retrieve/pii/S0951832011002729> [Accessed August 29, 2014].
- Smith, J. R. & Patel, B. M., 2012. A Proposed Method for Planning the Best Initial Response to Kicks During Managed-Pressure Drilling Operations. *SPE Drilling & Completion*, June.pp. 194-203.
- Spiring, F. A., 1993. The reflected normal loss function. *Canadian Journal of Statistics*, Volume 21, pp. 321-330.
- Sun, F.-B., Laramee, J.-Y. & Ramberg, J. S., 1996. On Spiring's normal loss function. *The Canadian Journal of Statistics*, Volume 24, pp. 241-249.
- Taguchi, G., 1986. *Introduction to Quality Engineering: Designing Quality into Products and Processes*. White Plains, NY: Kraus.
- Taguchi, G., 1989. *Quality Engineering in Production Systems*. New York: McGraw-Hill.
- Torstad, E., 2010. *Closed Loop Systems Reduce the Probability of Loss of Well Control*. s.l.:DNV presentation.
- Torstad, E., 2010. *Closed Loop Systems Reduce the Probability of Loss of Well Control*, September 30: DNV presentation.
- Vogel, R. & Brugman, J., 2008. Continuous Circulation System. In: B. Rehm, et al. eds. *Managed Pressure Drilling*. Houston, Texas: Gulf Publishing Company, pp. 127-142.
- Weatherford, 2012. *Weatherford Pressure Control Systems*. [Online]  
Available at:  
<http://www.weatherford.com/weatherford/groups/web/documents/weatherfordcorp/wft14>

2070.pdf

[Accessed 20 January 2014].

Wiegerinck, W., Kappen, B. & Burgers, W., 2010. Bayesian Networks for Expert Systems: Theory and Practical Applications. In: R. Babuska & F. C. A. Groen, eds. *Interactive Collaborative Systems*. Delft, The Netherlands: Springer, pp. 547-578.

Zadakbar, O., Khan, F. & Imitiaz, S., 2014. Development of Economic Consequence Methodology for Process Risk Analysis. *Risk Analysis*, pp. 1-19.

## Chapter 9

### 9.0 Development of an Integrated Tool for Risk Analysis of Drilling Operations

#### Preface

*A version of this chapter is “In Press” with doi: 10.1016/j.psep.2016.04.012 in the **Journal of Process Safety and Environmental Protection**. I am the primary author. Along with Co-author, Faisal Khan, I developed the conceptual model and subsequently translated this to the numerical model. I have carried out most of the data collection and analysis. I have prepared the first draft of the manuscript and subsequently revised the manuscript, based on the feedback from Co-authors and also peer review process. As Co-author, Faisal Khan assisted in developing the concept and testing the model, reviewed and corrected the model and results. He also contributed in reviewing and revising the manuscript.*

#### Abstract

Most risk analysis of drilling operations failed to distinguish and capture evolving risk during different stages of drilling operations. This part of the dissertation presents a new integrated dynamic risk analysis methodology. This methodology comprises models applicable at different stages of drilling operations. These models capture evolving situations in terms of changes in the probability and consequences of unwanted scenario (unstable well condition). The dynamic consequence models are developed in terms of loss functions dependent on changing bottom-hole pressure during different stages of drilling operation. The proposed methodology is tested using

real life case. It is observed that the proposed methodology help monitoring and maintaining well stability during different stages of drilling operations.

**Keywords:** Blowout risk analysis, Well integrity operations, Tripping operation, Loss functions, Bottom-hole pressure

## 9.1. Introduction

On the 21st of August 2009, at the Timor Sea offshore Australia, the Montara wellhead platform experienced a blowout at the H1 well. The probable cause was later identified as a failed casing shoe cementing. It was the worst of its kind in the Australian offshore industry which led to the spill of about 400 barrels of crude oil per day for over 10 weeks into the sea until it was killed with heavy mud from a relief well after 4 attempts on November, 3, 2009. The fortunate part of the accident was the safe evacuation of all 69 personnel on board; however, the cleanup operation was highly complex, consuming large volumes of dispersants and many response teams (Christou & Konstantinidou, 2012; IAT, 2010). About four months later, on December 23, 2009, Transocean crew narrowly avoided a blowout on the Sedco 711 semi-submersible drilling rig in the Shell North Sea Bardolino field due to a misinterpreted positive pressure test from a damaged valve at the bottom of a well (Feilden, 2010). Again, four months later, on April 20, 2010, an unprecedented blowout occurred in the history of the US oil and gas industry. 11 crew members died and 16 others were injured with the destruction and sinking of the Deepwater Horizon rig, and a spill of about 4 million barrels of oil into the Gulf of Mexico. Coincidentally, Transocean was involved in the drilling of the well and again, poor casing shoe cementing and poor interpretation of negative pressure test were identified as some of the contributing factors (BOEMRE, 2011; Chief Counsel's Report, 2011). The proximity of these events and the frequency, with which incidents occur in the



industry, implies the existence of a vacuum in the safety culture of personnel involved in the operations. Risk assessments are often conducted in the design stage of the operations prior to the implementation to reduce design risk whereas the mechanisms to reduce operational risks are less rigorously implemented. This dissertation seeks to bridge the existing gap in the safety and risk assessment of oil and gas drilling operations. In so doing, a detailed risk analysis of the operational phases or sub-operations involved in drilling operations is conducted.

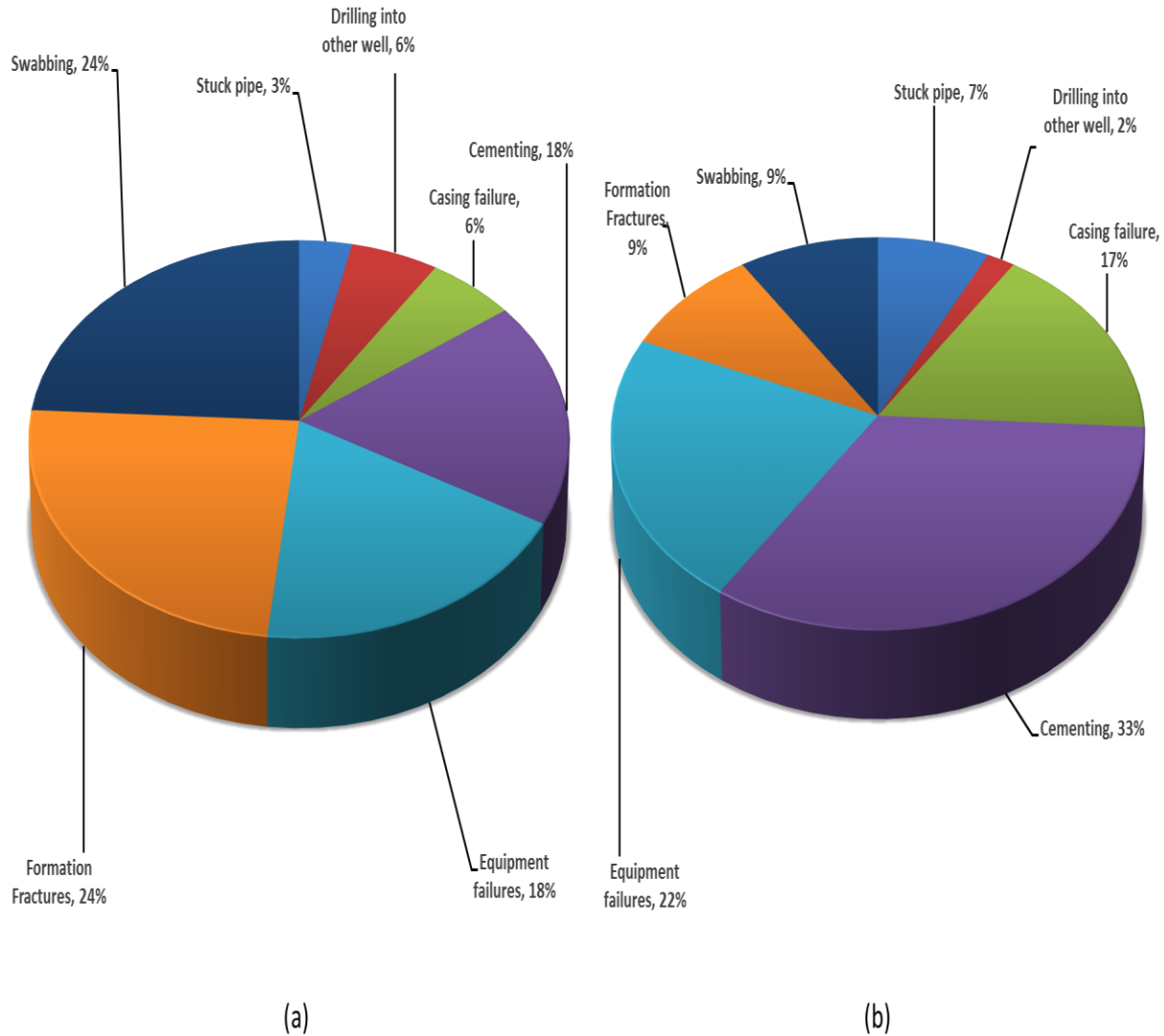
A sound knowledge of the stages/phases of drilling operations is essential for an accurate and reliable risk assessment of drilling operations. According to Arild et al (2009),(Arild et al. 2009) there are five (5) operational phases of drilling operations, namely: drilling ahead, tripping, static conditions, casing and cementing operations. These operational phases are studied in this part of the dissertation. A brief description of these stages is presented in Section 2. It is our belief that a detailed understanding of these stages of drilling operations will help forestall or reduce future occurrences of accidents. Among the factors contributing to a blowout include: cementing, swabbing, equipment failure, stuck pipe and drilling into other well (Danenberger 1993; Izon et al. 2007). A summary of the findings from the studies of Danenberger (1993) and Izon et al (2007) on the incidents in The US Outer Continental Shelf is presented in Fig. 1. It is observed that these factors transcend all the stages of drilling operations. A blowout is an uncontrolled flow of hydrocarbons (oil and gas) from a well to the surface (surface blowout) or to an adjacent underground formation (underground blowout). A blowout occurs when a kick – an influx of formation fluid into the wellbore when the bottom hole pressure falls below the formation pore pressure - is not detected or has not been properly killed when detected. The killing of a kick involves the use of well control methods in preventing a kick from resulting to a blowout.

Studies on risk assessment and analysis of drilling operations have looked into various aspects of drilling without a linkage among the sub-operational stages. For instance, in evaluating the performance of the blowout preventer (BOP) system during drilling operations, Cai et al. (2012) conducted a reliability analysis based on Markov method to establish the preferential stack configuration for subsea BOP systems. In the study, seven independent Markov models were developed for the segmented BOP system modules to investigate common-cause failures. The subsea control pods and control stations were determined to be of higher priority in the design of subsea BOP system (Cai et al. 2012). In the use of reliability data to calculate the failure rates of BOP components and rig downtime, Holand and Rausand (1987), and Holand (1991, 1999, 2001) estimated the availability of subsea BOP systems using fault tree analysis (FTA) method (Holand & Rausand, 1987; Holand, 1991; Holand, 1999; Holand, 2001). Fowler and Roche (1994) used both Failure Modes and Effects Analysis (FMEA) for the reliability analysis of a BOP and a hydraulic control system, and FTA in tracing undesired events to their primary causes (Fowler & Roche, 1994).

In addition to the studies on the BOP, modelling of blowout phenomenon to determine the causal relationships among successive events, leading to its occurrence has been conducted. Foremost was Bercha (1978) in the development of a fault tree model for the analysis of drilling operations in the Canadian arctic waters on both artificial island and offshore rigs. As the study employs a static model and specific to the Canadian arctic region; the deductions from the study are of less applicability to other tropical regions of the world. Andersen (1998) presented a fault tree model for the stochastic analysis of a kick as an initiating event to a blowout during exploration drilling. In line with the studies of the aforementioned authors, Khakzad et al. (2013b) conducted a quantitative risk analysis of offshore drilling using bow-tie and Bayesian network techniques for

dependability and updating analysis. A bow-tie technique was also employed by Abimbola et al. (2014) using physical reliability models and Bayesian theory principle to update failure probabilities of basic events and safety barriers respectively in the analysis of varied drilling techniques. For well specific blowout risk assessment and management, Arild et al. (2008, 2009) developed a BlowFlow software to determine blowout occurrence frequency and KickRisk model for the quantification of risk during well control. BlowFAM has also been developed, based on SINTEF database, considering reservoir characteristics, drilling activities and management parameters in adjusting blowout probability to well specific values (Derivo and Blom-Jensen, 2004). From the foregoing discussion, it is observed that these studies failed to examine in detail each stage and/or sub-operation of drilling operations highlighted earlier. As these stages do not occur at the same time during drilling operations, it is thus essential, to develop a dedicated model for each of these sub operations. Besides, managed pressure drilling techniques which are fast replacing the conventional drilling techniques are not considered in the aforementioned studies. Apart from the works of Khakzad et al. (2013b) and Abimbola et al. (2014) which adapt Bayesian theory principle, other studies employ the use of static probabilistic tools, leading to uncertainties in the results of the studies. Further, nominal values are usually adopted for the consequence component of risk calculations. Apparently, this does not represent the reality as the magnitude of the consequence changes over the course of the accident. In this study, loss function approach is incorporated into the risk analysis to address the drawbacks of static consequence analysis. This research aims at developing sub-models for these stages of drilling operations and integrating them for a holistic approach to risk analysis of drilling operations.

Section 9.2 discusses the different stages of drilling operations. Section 9.3 explains the developed models and their integration for risk analysis. In Section 9.4, the analysis of the integrated model is presented and discussed while Section 9.5 is devoted to the conclusion from the study.



**Figure 9.1 – Factors contributing to blowouts from The US Outer Continental Shelf from (a) 1971 – 1991 and (b) 1992 – 2006**

## 9.2. Stages of drilling operations

Considering the sub-operational phases of drilling operations, the drilling ahead operation or simply drilling is the drilling process through which drill cuttings are removed from the formation by the cutting action of the drill bit. The drilling fluid besides balancing the formation pore pressure at the wellbore and lubricating the drilling process, carries the cuttings to the surface as drilling progresses. This constitutes the major portion of the productive time of the drilling operations since an access is created towards the target depth. A well is drilled in a form resembling an inverted telescope with the larger size at the top. The first shallow section of the well is for the conductor casing which prevents the collapse of unconsolidated formation around the top of the well while drilling the surface hole. The surface hole is drilled to the base of the fresh water zone or aquifer for the surface casing to establish a seal across the fresh water zone or aquifer when cemented. This may be followed by an intermediate hole for the intermediate casing to help stabilize the formation and isolate abnormally pressured zones. Lastly, the production hole for the production casing is drilled across the productive interval of the formation. Further discussion can be found in Bommer (2008) and Bourgoynne et al. (1986).

Tripping operation is the movement of drill string out of the well or its replacement in the well. The movement out of the well is associated with a swabbing effect caused by a reduction in the BHP, equivalent to the volume of the drill-string moved out while drill-string replacement in the well causes a surging effect by an increase in BHP, equivalent to the volume of the drill-string replaced. In conducting tripping-out operation, the drill-string is suspended on the rotary table with the slips around the tool joint. The connection between two stands of drill-pipes is broken with an iron roughneck and the isolated drill pipe stand transferred to the fingerboard or catwalk. This completes the process of pulling one stand of drill-pipe out of the wellbore during tripping-out

operation. This is continued until the whole length of the drill-string is pulled out. As the mud column in the wellbore falls by an amount equal to the product of the annular capacity and the length of the drill-string pulled out; an equivalent amount of mud volume is flowed into the well from the trip tank to keep the BHP constant. The active mud pit system is bypassed during tripping operation due to its large cross sectional area that hinders accurate volume monitoring. A trip tank system with a smaller cross section enables finer volume resolution for precision in volume measurement (Tuset, 2014; Abimbola, et al., 2015b).

Static conditions include the stages in which there is no circulation of the mud and no increase is made in the depth of the well. The rig pump is off and the BHP is balanced by the hydrostatic pressure of the mud column only or supplemented by some backpressure. Apparently, as no activities are being conducted in the well during this state; no problems are envisaged during this stage and hence, is not considered in detail in this study.

Casing operation is the running of casings of a particular size into an open hole. Each casing size is run in succession together into the open hole. Casings in use include: conductor casing, surface casing, intermediate casing and production casing. The conductor casing is the first outermost casing and may be cemented or driven into the formation. The surface casing is run in the surface hole and cemented back to the surface to protect an aquifer. The intermediate casings are used to isolate problematic regions; such as abnormal pressured zones, lost circulation zones, fractures etc.; of the well en route to the reservoir. The production casing or liner is run across the reservoir, bearing the hydrocarbon. The production casing is perforated during completion operation to allow the flow of hydrocarbon to the surface. Cementing operations involve the formulation of a cement slurry, based on the predetermined characteristics and the pumping of the slurry into the annulus between the casing and the open hole through the internal diameter of the casings. The cement

when set holds the casings in place and secures the well permanently from collapsing. A well is cased and cemented in succession. The general sequence involves conductor casing, surface casing, the intermediate casing, and lastly, the production casing or liner, depending on the well design. Again, further discussions on casing and cementing operations can be found in (Bourgoyne et al. 1986; Bommer 2008).

### 9.3. Development of an integrated risk analysis methodology and related models

The operational phases highlighted in Section 9.1 are the focus of this research. A segmented sub-model has been developed for each of the phases discussed in Section 9.2. The structure of the integrated methodology is shown in Fig. 9.2. The drilling ahead operation sub-models comprise the underbalanced and overbalanced pressure regimes. These sub-models are presented in Figs 9.3 and 9.4. Discussions on these models can be found in Abimbola et al. (2015a). For the tripping operation, the tripping-out operation model developed in Abimbola et al. (2015b) for CBHP technique of MPD is considered and shown in Fig. 9.5. This is because of the dominance of well control problems from underbalanced condition during tripping-out operation over tripping-in operation. A well integrity model-comprising casing and cementing operations discussed in Abimbola et al. (2016a) is presented in Fig. 9.6. Furthermore, the loss function approach to consequence modelling, presented in Abimbola and Khan (2016b) is adopted for the analysis of the loss categories of the consequences. The expected production loss arising from the loss hydrocarbon during a blowout accident is given by Eq. (9.1).

$$L_1 = \frac{K_{\Delta}}{1 - \exp\left\{-\frac{1}{2}\left(\frac{\Delta}{\gamma}\right)^2\right\}} \left[ 1 - \frac{\gamma}{\sqrt{\sigma^2 + \gamma^2}} \exp\left\{-\frac{(\rho_{BHP} - \rho_F)^2}{2(\sigma^2 + \gamma^2)}\right\} \right] \quad (9.1)$$

Where,  $K_{\Delta}$ , is the production loss at a known bottom-hole pressure (BHP) deviation,  $\Delta$ , from the formation pore pressure is represented as:

$$K_{\Delta} = \int_0^t \{(q_o - q_{or})Pr_o + q_g Pr_g + C_R\} dt \quad (9.2)$$

$$q_g = \frac{GORq_o}{1000} \quad (9.3)$$

$\rho_F$  and  $\rho_{BHP}$  are the pressure gradient equivalents of formation pore pressure (FPP), the target value and the drilling fluid BHP, in *psi/ft* respectively.

$\Delta$  = The specified negative pressure gradient deviation of  $\rho_{BHP}$  from  $\rho_F$ .

$\gamma$  = The shape parameter, which is a function of  $\Delta$ . This is equal to  $\Delta/4$ , for SINLF and  $\Delta/0.1$ , for QLF (Sun, et al., 1996).

$\sigma^2$  = The variance of the mean BHP gradient.

Considering the ECD of the mud as the determinant of the dynamic condition of the wellbore during drilling operations. The ECD is given by Eq. (9.4),

$$MD_d = \frac{APL}{0.052 * D} + MW_s \quad (9.4)$$

By converting  $MD_d$  in *ppg* to *psi/ft*, Eq (9.4) is multiplied by the conversion factor, 0.052.

$$\rho_{ECD} = \frac{APL}{D} + 0.052MW_s \quad (9.5)$$

where



$MD_a$  = Equivalent circulating density in  $ppg$

$APL$  = Annular Pressure Loss in  $psi$

$D$  = True vertical depth in  $ft$

$MW_s$  = the current Mud Weight in  $ppg$

$\rho_{ECD}$  = Equivalent circulating density in  $psi/ft$

The asset loss resulting from the damage to a well, equipment and rig from a blowout is determined by Eq. (9.6) or Eq. (9.7), considering absolute pressures.

$$L_2 = \left\{ \begin{array}{ll} K_1 \langle 1 - C_1 [\rho_{BHP} (1 - \rho_{BHP})^{(1-\rho_F)/\rho_F}]^{(\alpha_1-1)} \rangle & \text{if } 0 < \rho_{BHP} < \rho_F \\ K_2 \langle 1 - C_2 [\rho_{BHP} (1 - \rho_{BHP})^{(1-\rho_F)/\rho_F}]^{(\alpha_2-1)} \rangle & \text{if } \rho_F < \rho_{BHP} < 1 \end{array} \right\} \quad (9.6)$$

$$C_1 = [\rho_F (1 - \rho_F)^{(1-\rho_F)/\rho_F}]^{(1-\alpha_1)}, \quad C_2 = [\rho_F P_F (1 - \rho_F)^{(1-\rho_F)/\rho_F}]^{(1-\alpha_2)}$$

$$L_2 = \left\{ \begin{array}{ll} K_1 \langle 1 - C_1 [P_{BHP} (1 - P_{BHP})^{(1-P_F)/P_F}]^{(\alpha_1-1)} \rangle & \text{if } P_{AIR} < P_{BHP} < P_F \\ K_2 \langle 1 - C_2 [P_{BHP} (1 - P_{BHP})^{(1-P_F)/P_F}]^{(\alpha_2-1)} \rangle & \text{if } P_F < P_{BHP} < P_{OV} \end{array} \right\} \quad (9.7)$$

$$C_1 = [\rho_F (1 - \rho_F)^{(1-\rho_F)/\rho_F}]^{(\alpha_1-1)}, \quad C_2 = [\rho_F (1 - \rho_F)^{(1-\rho_F)/\rho_F}]^{(\alpha_2-1)}$$

$K_1$  represents the maximum loss due to wellbore collapse, kick or blowout. On the other hand,  $K_2$  is the maximum loss due to differential pipe sticking, lost circulation or fractured formation.  $\alpha_1$  and  $\alpha_2$ , are the shape parameters for the underbalanced and overbalanced pressure regimes respectively.

The human health loss due to civil claims from injuries and fatalities is denoted by a step function in Eq. (9.8).

$$L_3 = \begin{cases} L_{I,\rho_{F1}} + L_{F,\rho_{F1}} & , & \rho_F > \rho_{BHP} > \rho_{F1} \\ L_{I,\rho_{F2}} + L_{F,\rho_{F2}} & , & \rho_{F1} > \rho_{BHP} > \rho_{F2} \\ \vdots & , & \vdots \\ L_{I,\rho_{Fn}} + L_{F,\rho_{Fn}} & , & \rho_{Fn} > \rho_{BHP} > 0 \end{cases} \quad (9.8)$$

Where  $L_{I,\rho_{Fn}}$ , and  $L_{F,\rho_{Fn}}$ , are the cumulative losses due to injury and fatalities respectively from the beginning of the blowout incident to the pressure drawdown. The pressure drawdown is ascertained by the difference of the absolute pressure equivalents of the pressure gradients.

The environmental response loss from the environmental clean-up and accruable fines is estimated using Eq. (9.9).

$$C_{ei} = C_n r_i I_i t_i o_i m_i s_i A_i \quad (9.9)$$

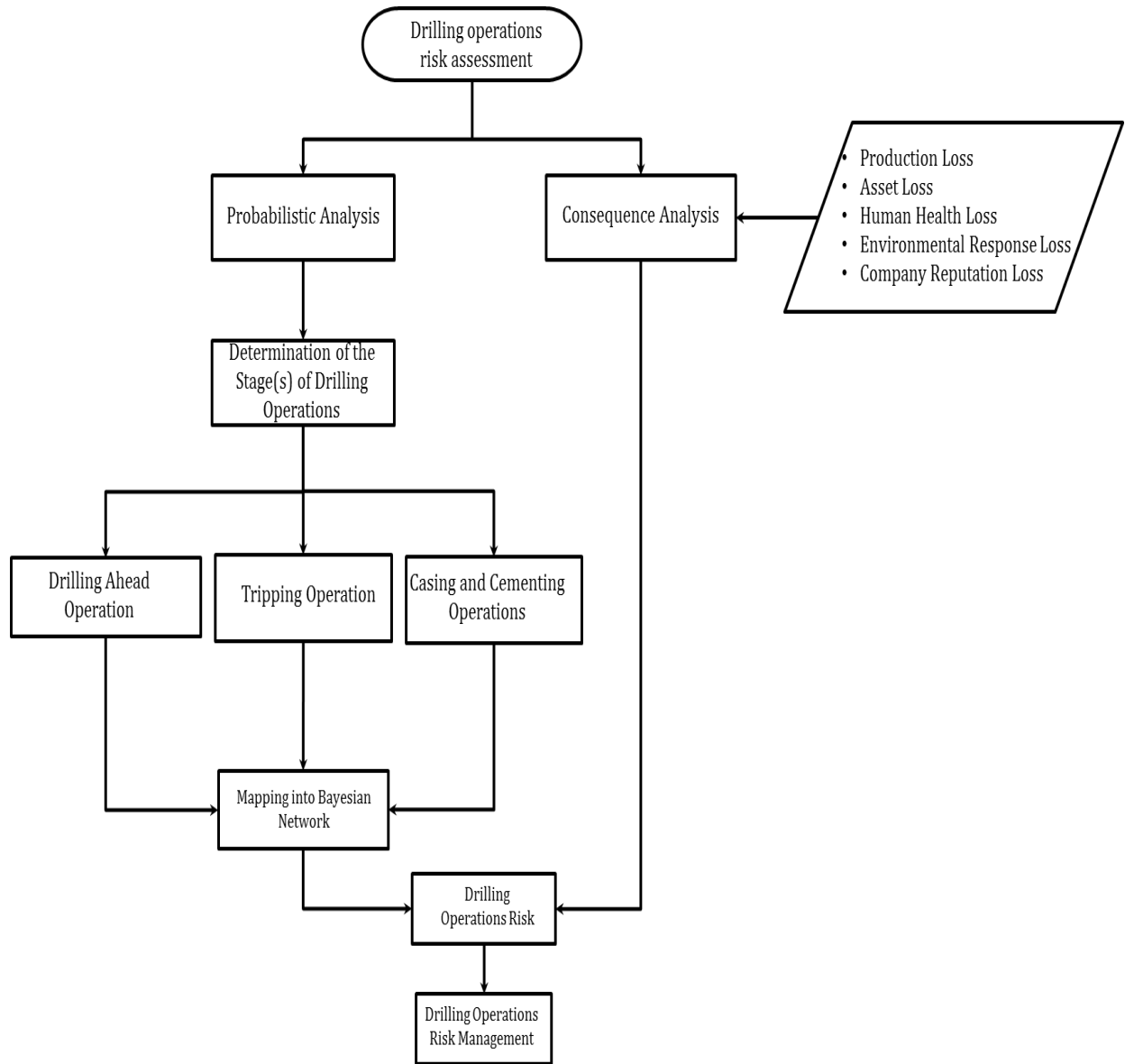
Where  $C_{ei}$ , is the estimated total response cost for scenario,  $i$ ;  $C_n$ , the general cost per unit spilled in nation,  $n$ ;  $r_i$ , regional location modifier factor for scenario,  $i$ ;  $I_i$ , local location modifier for scenario,  $i$ ;  $t_i$ , oil type modifier factor for scenario,  $i$ ;  $o_i$ , shoreline oiling modifier factor for scenario,  $i$ ;  $m_i$ , cleanup methodology modifier factor for scenario,  $i$ ;  $s_i$ , spill size modifier factor for scenario,  $i$ , and  $A_i$ , specified spill amount for scenario,  $i$ .  $A_i$  is determined with Eq. (9.10).

$$A_i = \frac{V_o}{1 - \exp\left\{-\frac{1}{2}\left(\frac{\Delta}{\gamma}\right)^2\right\}} \left[ 1 - \frac{\gamma}{\sqrt{\sigma^2 + \gamma^2}} \exp\left\{-\frac{(\rho_{BHP} - \rho_F)^2}{2(\sigma^2 + \gamma^2)}\right\} \right] \quad (9.10)$$

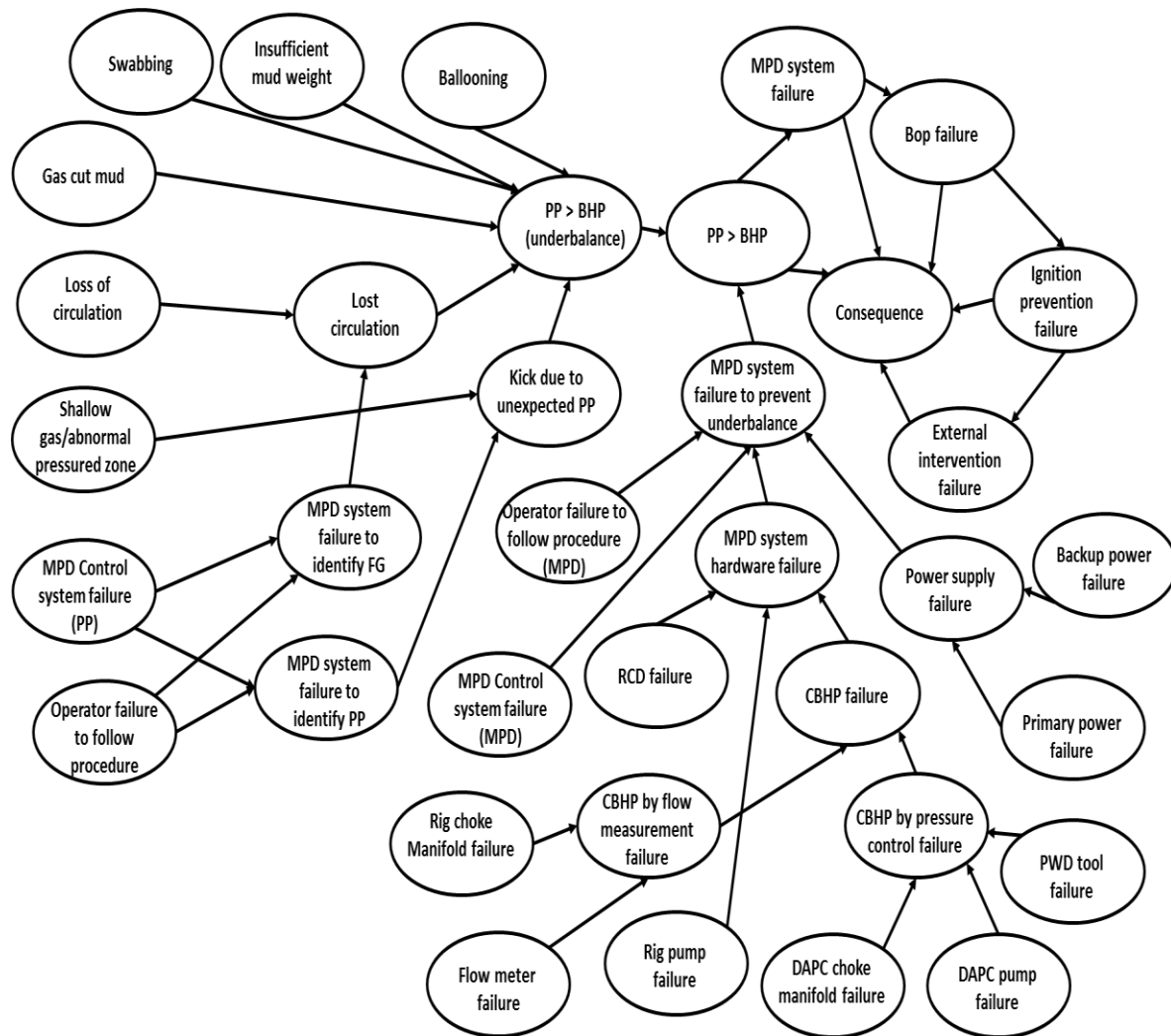
Where  $V_o$  is the volume of spilled reservoir fluid for a specified reservoir drawdown, represented as a difference in pressure gradient. Lastly, the company reputation loss is determined from the assessment of the prevailing factors per unit volume of the oil spilled (Abimbola & Khan, 2016b).

The integrated model analysis involves the determination of the stage at which risk-based analysis is desired. The probabilistic risk analysis is performed with the appropriate sub-model that has

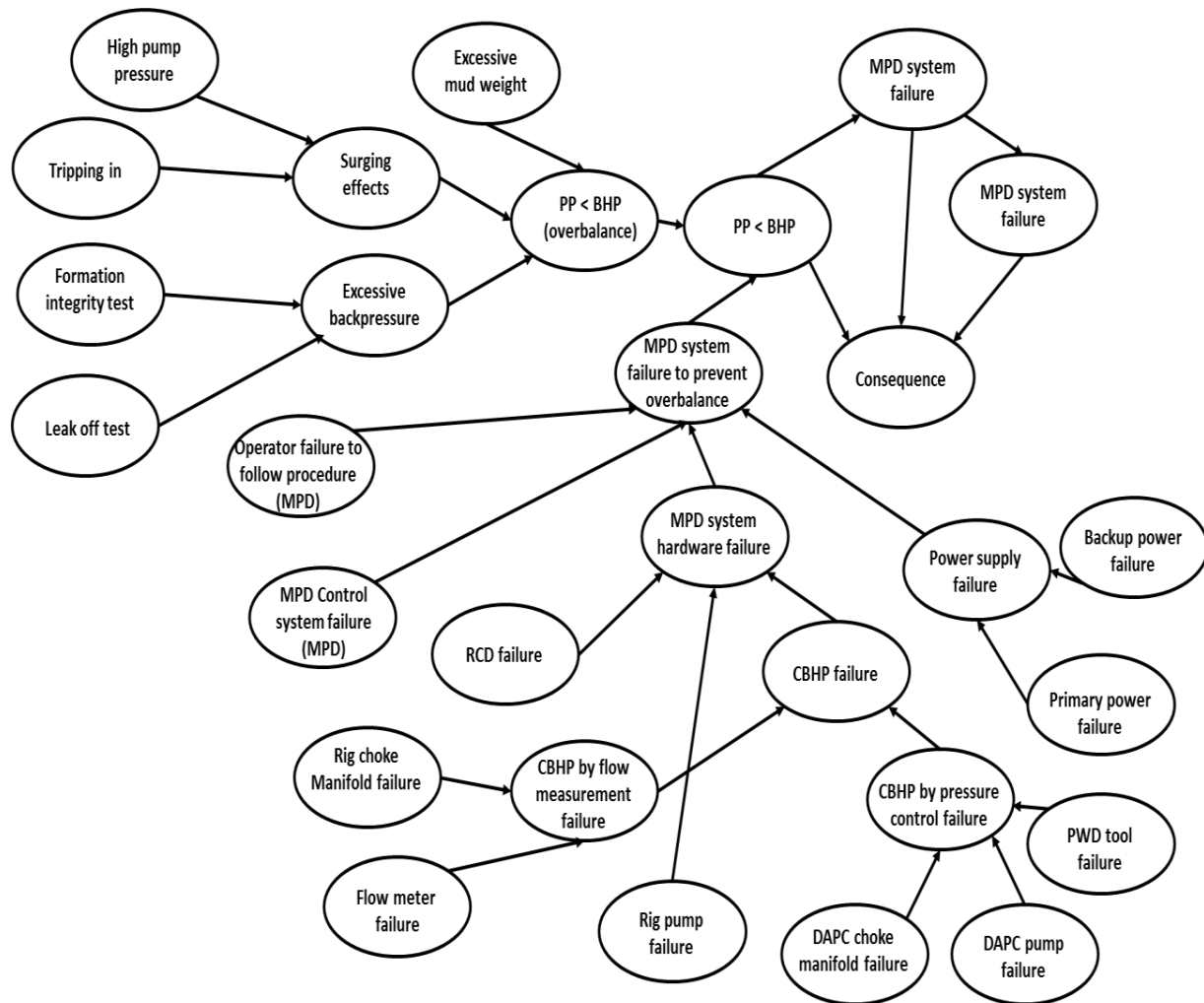
been presented in addition to the consequence analysis. Finally, risk management involving revision and adjustment of critical elements of the operation is executed so as to reduce the risk below the risk threshold or as low as reasonably practicable.



**Figure 9.2 – Integrated Methodology and Tool for Drilling Operations**



**Figure 9.3 – Bayesian Network for Underbalanced Drilling Scenario (Abimbola et al. 2015a)**



**Figure 9.4 – Bayesian Network of Overbalanced Scenario of CBHP techniques (Abimbola et al. 2015a)**



**Figure 9.5 – Bayesian Network equivalent of tripping-out operation in CBHP technique of MPD (Abimbola, et al., 2015b)**



## 9.4. Analysis of Model

The integrated model is analyzed as a BN model. The analysis is conducted using GeNIe 2.0 software developed by the Decision System Laboratory of the University of Pittsburgh and available at <http://genie.sis.pitt.edu/>. The assumptions of the analysis have been discussed in the afore-mentioned references of the sub-models.

### 9.4.1 Predictive analysis of stages of drilling operations

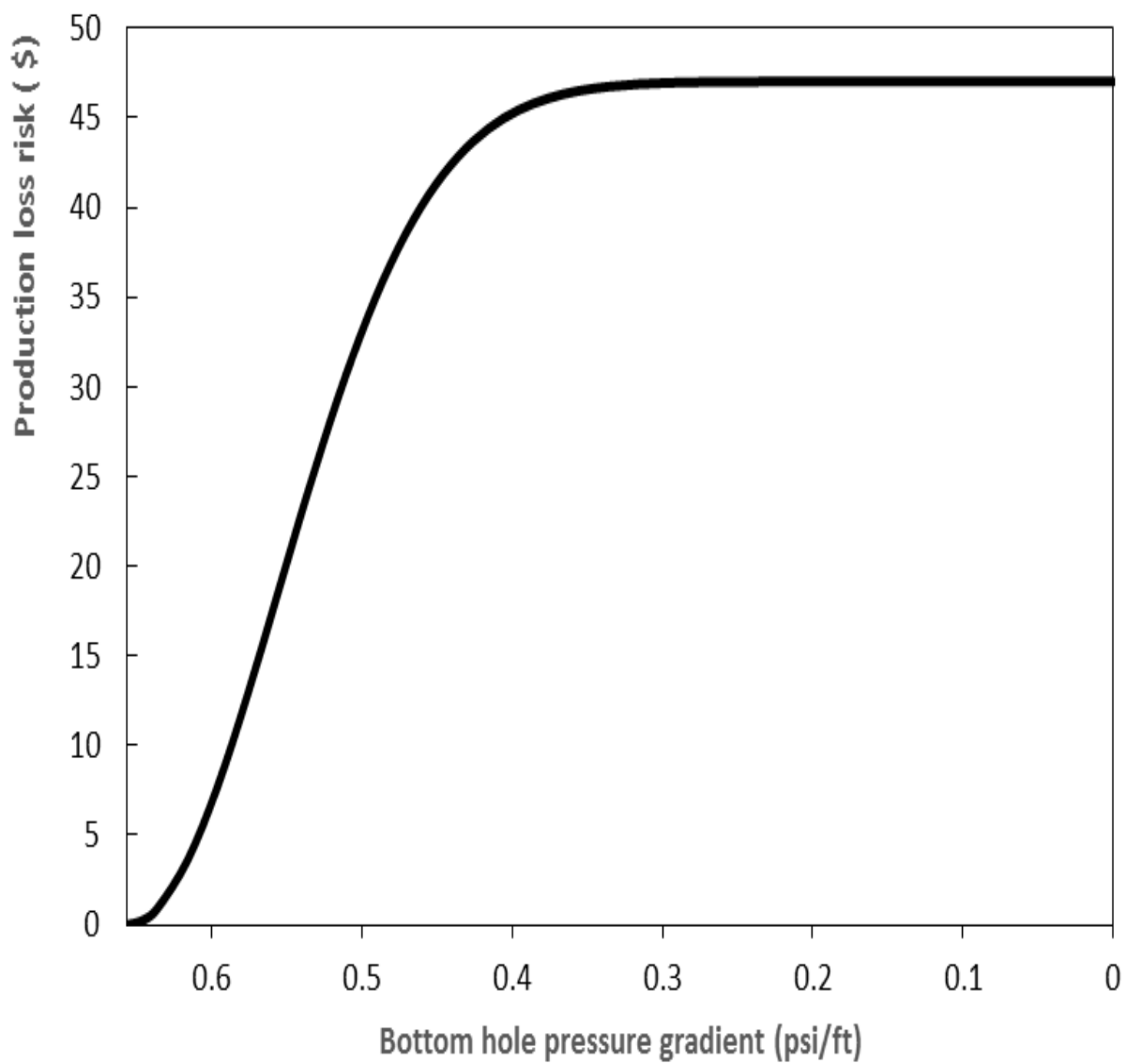
The drilling ahead operation is analyzed by instantiating other branches of the model that are not related to the operation to a no-failure state. A predictive analysis of drilling ahead operation gives a blowout occurrence frequency of  $9.21\text{E-}07$ . This is of the same order of magnitude as that of Grayson and Gans (2012). Other consequences occurrence frequencies presented in Table 9.1 are also of the same order of magnitudes as those in Abimbola et al. (2015a). The slight variations are due to the incorporation of other components such as the riser and BOP control systems which were hitherto not considered in detail but were parts of the integrated model. Besides, tripping operation is isolated from the drilling ahead operation as an independent phase of drilling operations. The production loss risk profile from the product loss considering a blowout scenario (Abimbola & Khan, 2016b) is shown in Fig. 9.7. The target bottom-hole pressure gradient is 0.656 psi/ft with a production loss,  $K_{\Delta}$ , determined as \$ 6 Million for a pressure gradient deviation,  $\Delta$ , of 0.05psi/ft. Though the maximum expected production loss was about \$ 50 Million; the corresponding production loss risk is reduced to about \$ 47 due to the low frequency of occurrence of a blowout. The overbalanced scenario is determined with the frequency of occurrence of a differential stuck-pipe. This is obtained as  $2.13\text{E-}02$ .



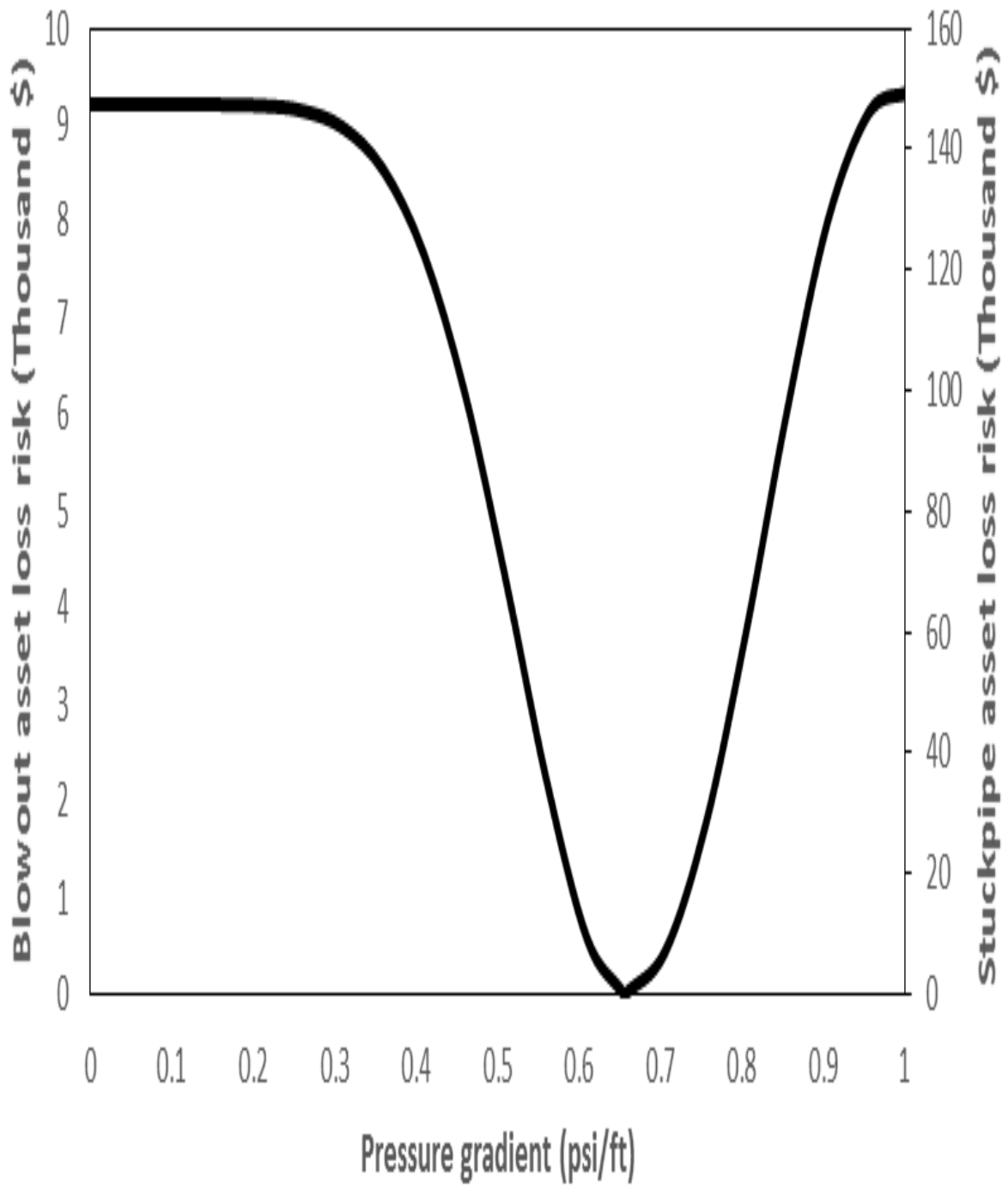
Considering the asset loss risk profile using the aforementioned frequencies of occurrence for both the underbalanced (blowout) and overbalanced (stuck pipe) scenarios. The asset loss risk profile is presented in Fig. 9.8 using Eq. (9.6). The human health loss risk which accounts for the injuries and deaths that can occur as a result of a blowout is represented in Fig. 9.9. The risk profile increased step-wisely as the bottom hole pressure deviated from the targeted formation pore pressure. The environmental response loss risk profile is shown in Fig. 9.10, bearing semblance to the production loss risk profile. The above analysis can be repeated for all the other stages of drilling operations.

**Table 9.1 – Predictive occurrence probabilities of the consequences for drilling ahead operation**

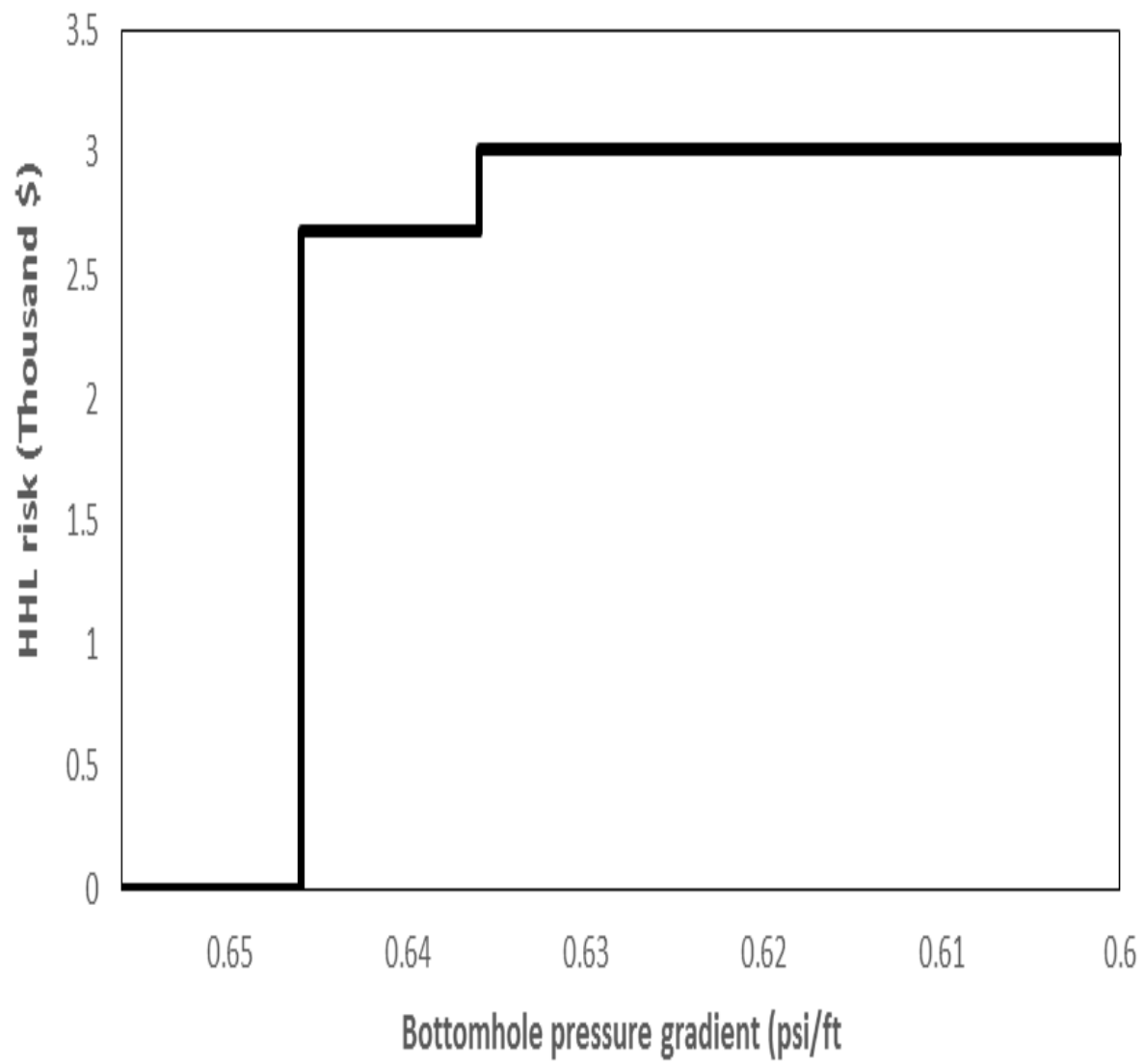
<b>Consequence</b>	<b>Description</b>	<b>Predictive occurrence probabilities</b>
1	Near balanced condition	9.99E-01
2	Wellbore collapse	9.45E-04
3	Kick	8.27E-05
4	Blowout	9.21E-07
5	Explosions, fire, major injury to few deaths, minimal environmental pollution	1.07E-07
6	Catastrophe (loss of rig, multiple fatalities, major environmental damage)	2.99E-09



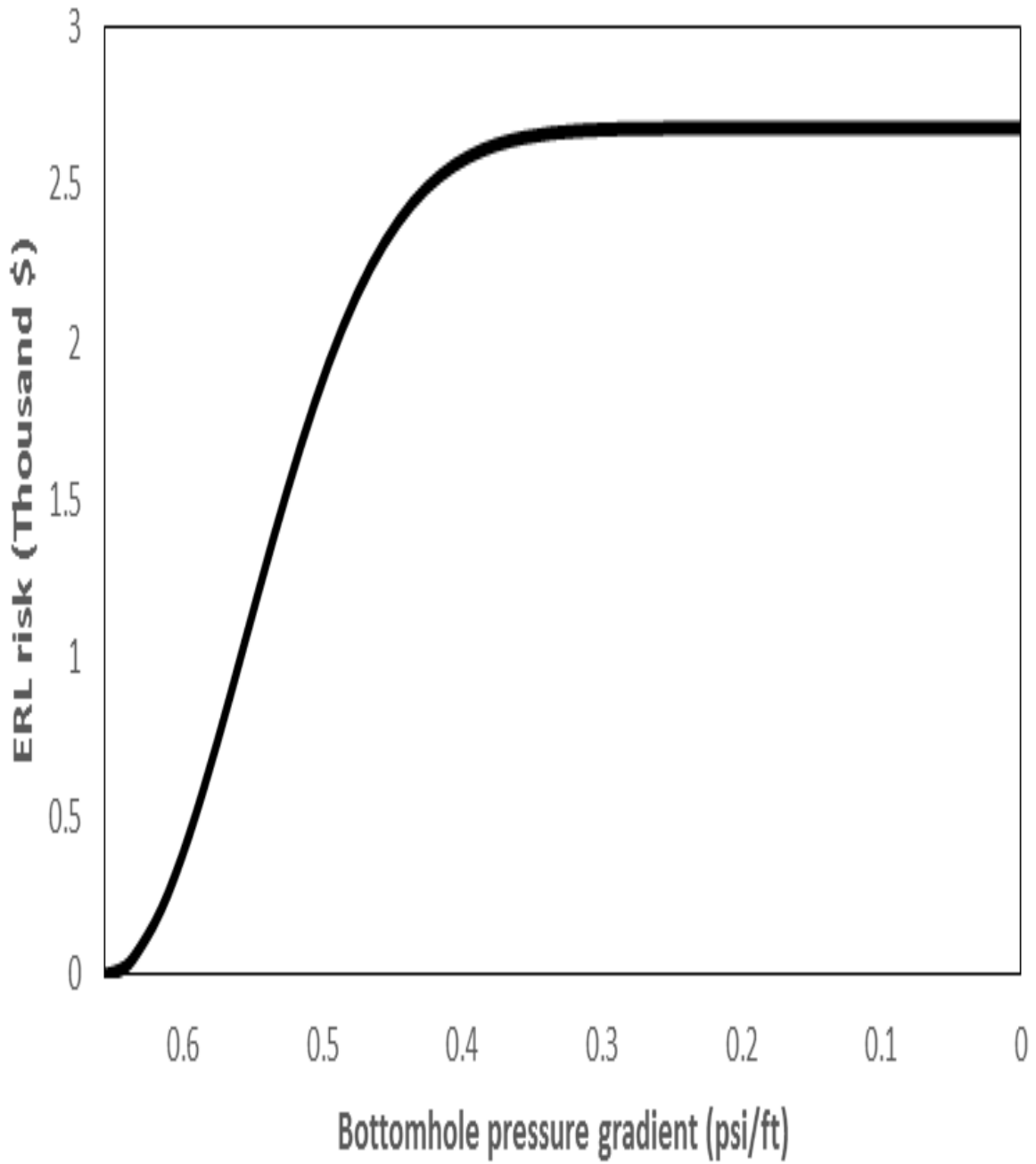
**Figure 9.7 – Production loss risk profile for a blowout scenario**



**Figure 9.8 – Asset loss risk profile for a blowout and/or stuck pipe scenario**



**Figure 9.9 – Human health loss risk profile for a blowout scenario**



**Figure 9.10 – Environmental response loss risk profile for a blowout scenario**

#### **9.4.2 Diagnostic analysis of the integrated model**

Aside the findings of the independent diagnostic analysis of the sub-models developed, it is observed that tripping-out operation contributes most (77.27%) to underbalanced condition, followed by well integrity operations (20.40%) of casing and cementing operations and 8.16% for drilling ahead operations. This is in agreement with the findings of Danenberger (1993) and Izon et al. (2007) which identified swabbing (an effect of a failure in tripping-out operation) and cementing failure as the most prominent contributing factors to a blowout. Considering the fact that sufficient mud density is ensured before tripping-out operation is conducted; a failure in tripping-out operation attributed 84.22% of the failure to swabbing effect with 18.05% due to the BHP falling below pore pressure as a result of a fall in the mud column height. Swabbing effect could be due to either the calculated pulling speed exceeded the actual maximum pulling speed or due to the driller's error in pulling too fast with BHP falling outside the pore pressure margin. On the other hand, a fall in the mud column height might be either due to lost circulation caused by surging while lowering the drill-string, or the trip tank system failed to ensure hole fill-up during pulling out of open hole.

A failure in the cementing operation, completely leads to the failure of well integrity operations; whereas a failure in the casing operation will contribute about 80% to the failure of the well integrity operations. The occurrence of a blowout during casing and cementing operation would be due to an increased posterior probability of cementing operation by a factor of about 19.73 (from  $4.14E-07$  to  $8.17E-06$ ) while that of casing operation would have increased more than 99% of the prior probability.

Furthermore, a sensitivity analysis on the contributors to the underbalanced condition revealed that the MPD system hardware; comprising the RCD, MPD control system, in addition to the riser

system and the rig pump; are paramount in preventing the adverse effects of kicks, ballooning, gas cut mud as well as the pressure effects of swabbing and surging. The strength of influence diagram identified kicks due to unexpected pore pressure and lost circulation as major contributors to failure during drilling ahead operation. The major determinants of well integrity operations include: poor slurry formulation, casing eccentricity and casing running effects (surging and swabbing).

## **9.5. Conclusion**

An integrated model has been developed for the safety analysis of the stages/sub-operations of drilling operations. The stages include drilling ahead, tripping, casing and cementing operations. The predictive analysis enables the monitoring of risk through the analysis of the risk profiles of the applicable consequences identified, and the management of risk through the review of critical safety components when risk thresholds are exceeded. The diagnostic analysis identified, in succession, the degree of contributions to blowout occurrence the following sub-operations: tripping-out, well integrity with prominence in the cementing operation, and drilling ahead operations. A sensitivity analysis on the integrated model identified the paramount role of the MPD system in preventing the adverse effects of kicks due to abnormal formation pore pressure, ballooning, gas cut mud and the pressure effects of swabbing and surging.

## **Acknowledgments**

The authors acknowledge the financial support of Natural Sciences and Engineering Research Council (NSERC), Vale Research Chair grant, Research & Development Corporation of Newfoundland and Labrador (RDC) and Atlantic Canada Opportunities Agency (ACOA).

## References

- Abimbola, M., Khan, F. & Khakzad, N., 2014. Dynamic safety risk analysis of offshore drilling. *Journal of Loss Prevention in the Process Industries*, 30, pp.74–85.
- Abimbola, M. et al., 2015a. Safety and risk analysis of managed pressure drilling operation using Bayesian network. *SAFETY SCIENCE*, 76, pp.133–144. Available at: <http://dx.doi.org/10.1016/j.ssci.2015.01.010>.
- Abimbola, M., Khan, F., Garaniya, V. & Butt, S., 2015b. *Failure analysis of the tripping operation and its impact on well control*. St. John's, Proceedings of the 34th International Conference on Ocean, Offshore and Arctic Engineering.
- Abimbola, M., Khan, F. & Khakzad, N., 2016a. Risk-based safety analysis of well integrity operations. *SAFETY SCIENCE*, 84, pp.149–160. Available at: <http://dx.doi.org/10.1016/j.ssci.2015.12.009>.
- Abimbola, M. & Khan, F., 2016b. Dynamic Blowout Risk Analysis using Loss Functions. *Journal of Risk Analysis*, Volume (under review).
- Ahmed, T. & Mckinney, P. D., 2005. *Advanced Reservoir Engineering*. Massachusset: Gulf Professional Publishing.
- Arild, Ø. et al., 2009. SPE 124024 KickRisk — A Well Specific Approach to the Quantification of Well Control Risks. , pp.1–9.
- Artiles-Leon, N., 1996. A pragmatic approach to multi-response problems using loss functions. *Quality Engineering*, Volume 9, pp. 213-220.
- Bearfield, G. & Marsh, W., 2005. Generalising event trees using Bayesian networks with a case study of train derailment.. *Lecture Notes in Computer Science 3688*, pp. 52-66.
- Berker, T. B., 1990. *Engineering Quality by Design: Intepreting the Taguchi Approach*. New York: Marcel Dekker.
- BOEMRE, 2011. *Report Regarding the Causes of the April 20, 2010 Macondo Well Blowout*, s.l.: The Bureau of Ocean Energy Management, Regulation and Enforcement.
- Bommer, P., 2008. *A Primer of Oilwell Drilling 7th Editio.*, Petroleum Extension Service, University of Texas.
- Bourgoyne, A. et al., 1986. *Applied drilling engineering 1st Editio.*,
- BSEE, 2014. *Bureau of Safety and Environment Enforcement*. [Online] Available at: <http://www.bsee.gov/BSEE-Newsroom/Press-Releases/2014/BSEE-Coast->



Guard-Respond-to-Loss-of-Well-Control-in-the-Gulf-of-Mexico/  
[Accessed 13 February 2014].

- Cai, B. et al., 2012. Performance evaluation of subsea blowout preventer systems with common-cause failures. *Journal of Petroleum Science and Engineering*, 90-91, pp.18–25.  
Available at: <http://dx.doi.org/10.1016/j.petrol.2012.04.007>.
- Chang, Y., Khan, F. & Ahmed, S., 2011. A risk-based approach to design warning system for processing facilities. *Process Safety Environmental Protection*, Volume 89, pp. 310-316.
- Chief Counsel's Report, 2011. *Macondo THE GULF OIL DISASTER*, Washington DC 20005: National Commission on the BP Deepwater Horizon Oil Spill and Offshore Drilling.
- Christou, M. & Konstantinidou, M., 2012. *Safety of offshore oil and gas operations: Lessons from past accident analysis*, Luxembourg: Joint Research Centre, European Commission.
- Crespo, F. et al., December 2012. Surge-and-Swab Pressure Predictions for Yield-Power-Law Drilling Fluids. *SPE Drilling & Completion*, pp. 574-585.
- Crowl, D. A. & Louvar, J. F., 2002. *Chemical Process Safety*. 2nd ed. Houston: Prentice Hall.
- Danenberger, E. P., 1993. *Outer Continental Shelf Drilling Blowouts, 1971 - 1991*. Texas, OTC 7248.
- Dervo, H. J. & Blom-Jensen, B., 2004. *Comparison of quantitative blowout risk assessment approaches*. SPE 86706. Calgary, 7th SPE International Conference on Health, Safety, and Environment in Oil and Gas Exploration and Production. March 29 -31.
- Feilden, T., 2010. *A near miss for the North Sea oil industry*. [Online]  
Available at:  
[http://www.bbc.co.uk/blogs/today/tomfeilden/2010/12/a\\_near\\_miss\\_for\\_the\\_north\\_sea.html](http://www.bbc.co.uk/blogs/today/tomfeilden/2010/12/a_near_miss_for_the_north_sea.html)
- Fowler, J. H. & Roche, J. R., 1994. System safety analysis of well-control equipment. *SPE Drilling and Completion*, Volume 3, pp. 193-198.
- Guo, B., Lyons, W. C. & Ghalambor, A., 2007. *Petroleum Production Engineering - A computer-Assisted Approach*. Lafayette: Elsevier Science & Technology Books.
- Hashemi, S. J., Ahmed, S. & Khan, F., 2014. Loss Functions and their Applications in Process Safety Assessment. *American Institute of Chemical Engineers*, 33(3), pp. 285-291.
- Holand, P., 1991. Subsea blowout-preventer systems reliability and testing. *SPE Drilling Engineering*, Volume 4, pp. 293-298.

- Holand, P., 1999. *Reliability of Subsea BOP systems for Deepwater Application*, s.l.: Phase II DW. Project Report STF38 A99426.
- Holand, P., 2001. *Deepwater Kicks and BOP Performance*, s.l.: Project Report STF38 A01419.
- Holand, P. & Rausand, M., 1987. Reliability of Subsea BOP systems. *Reliability Engineering*, Volume 19, pp. 263 - 275.
- IAT, 2010. *Response to the Montara Wellhead Platform Incident - Report of the Incident Analysis Team (IAT)*, Australia: Australia Maritime Safety Authority.
- Izon, D., Danenberger, E. & Mayes, M., 2007. Absence of fatalities in blowouts encouraging in MMS study of OCS incidents 1992-2006. *DRILLING CONTRACTOR*, July/August, pp. 84-90.
- Jensen, F. V. & Nielsen, T. D., 2007. *Bayesian Networks and Decision Graphs*. New York: Springer.
- Khakzad, N., Khan, F. & Amyotte, P., 2013a. Dynamic safety analysis of process systems by mapping bow-tie into Bayesian network. *Process Safety and Environmental Protection*, Volume 91, pp. 46-53.
- Leung, B. P. K. & Spiring, F. A., 2002. The inverted beta loss function: properties and applications. *IIE Transactions*, Volume 34, pp. 1101-1109.
- Leung, B. P. K. & Spiring, F. A., 2004. Some Properties of the Family of Inverted Probability Loss Functions. *Quality Technology and Quantitative Management*, Volume 1, pp. 125-147.
- Ma, Y. & Zhao, F., 2004. An improved multivariate loss function approach to optimization. *Journal of System Science and System Engineering*, Volume 13, pp. 318-325.
- Neapolitan, R. E., 2004. *Learning Bayesian Networks*. Chicago: Prentice Hall Series.
- Neapolitan, R. E., 2009. *Probabilistic methods for bioinformatics: with an introduction to Bayesian networks*. Chicago: Morgan Kaufmann.
- Onisko, A., Druzdel, M. J. & Wasyluk, H., 2001. Learning Bayesian network parameters from small data sets: application of Noisy-OR gates. *International Journal of Approximate Reasoning*, Volume 27, pp. 165-182.
- Pearl, J., 1988. *Probabilistic Reasoning in Intelligent Systems*. San Mateo: Morgan Kaufmann.
- Phadke, M. S., 1989. *Quality Engineering Using Robust Design*. New York: Prentice Hall.

- Pignatiello, J. J., 1993. Strategies for robust multiresponse quality engineering. *IIE Transactions*, Volume 25, pp. 5-15.
- Reuters, 2015. *BP's fine for 2010 oil spill capped at \$13.7 billion*. [Online] Available at: <http://www.reuters.com/article/2015/01/16/us-bp-trial-idUSKBN0KO2N020150116> [Accessed 15 March 2015].
- Ryan, T. P., 2011. *Statistical Methods for Quality Improvement*. 3rd ed. New York: Wiley Series.
- Spiring, F. A., 1993. The reflected normal loss function. *Canadian Journal of Statistics*, Volume 21, pp. 321-330.
- Sun, F.-B., Laramée, J.-Y. & Ramberg, J. S., 1996. On Spiring's normal loss function. *The Canadian Journal of Statistics*, Volume 24, pp. 241-249.
- Taguchi, G., 1986. *Introduction to Quality Engineering: Designing Quality into Products and Processes*. White Plains, NY: Kraus.
- Taguchi, G., 1989. *Quality Engineering in Production Systems*. New York: McGraw-Hill.
- Tian, S., Medley, G. H. & Stone, C. R., 2009. Understanding yield point: Effect on pressure surges critical to managing deep, difficult MPD wells. *Drilling Contractor*, 3 November.
- Torstad, E., 2010. *Closed Loop Systems Reduce the Probability of Loss of Well Control*. s.l.:DNV presentation.
- Tuset, G. D., 2014. *Operational Barrier Elements in Critical Drilling Operations*, Trondheim: Department of Marine Technology, NTNU.
- Zadakbar, O., Khan, F. & Imitiaz, S., 2014. Development of Economic Consequence Methodology for Process Risk Analysis. *Risk Analysis*, pp. 1-19.

## Chapter 10

### 10.0 Summary, Conclusions and Recommendations

#### 10.1. Summary

The present work has demonstrated the use of Bow-tie, Bayesian network and Loss functions in dynamic risk assessment and safety analysis of drilling operations with advancement into managed pressure drilling techniques. It is apparent from the literature that most risk and safety analyses of drilling operations have been limited to reducing design risk, HAZOP and enhancing evacuation procedures. However, development of risk-based monitoring mechanisms and conducting dynamic risk assessment during various stages of drilling operations is sparingly undertaken or lacking. This research has been conducted to bridge the gap existing in the risk assessment and safety analysis of drilling operations.

From this work, a physical reliability model for predictive monitoring of drilling ahead operation is developed. In conjunction with Bayesian updating principle for safety barrier failure probabilities using accident precursors, a complete dynamic risk assessment mechanism has been developed for drilling operations. Furthermore, bow-tie models for drilling ahead and cementing operations have been developed to enabled detailed analysis of these operations with extension to constant bottom-hole pressure drilling technique of managed pressure drilling. Besides, a failure analysis of tripping operations in both conventional overbalanced drilling and constant bottom-hole pressure drilling has been conducted to identify safety critical elements of the operation and to demonstrate the out-performance of the latter over the former.

Bow-tie approach has been preferred over other risk assessment methodology due to its simplicity and logical connection of the causal factors of an accident to the possible consequences through a

top event and safety barriers. However, as with its component parts of fault tree and event tree, which are static and not easily updated or used to model conditional dependencies among related events, bow-tie is limited in its applications. Consequently bow-tie has been adapted through the application of physical reliability models or mapping into Bayesian network. Bayesian network enables both predictive and diagnostic analysis in addition to multi-state analysis, conditional dependency modelling and probability updating.

A novel approach to loss functions application to blowout risk analysis in consequence modelling has been conducted. The selected loss function models were modified to incorporate formation pressure as pressure gradient. This has enabled dynamic risk assessment and management through risk threshold monitoring and revision.

Finally, an integrated tool for risk analysis of drilling operations has been developed. This provides an improved analysis of the distinct stages of drilling operations, enabling a better characterization of the operations.

## **10.2. Conclusions**

The main conclusions of this work are:

### **10.2.1. Development of a real time predictive model:**

This study has developed a physical reliability model based on constant strength-variable stress principle for real time failure probability prediction during drilling operation. This model is applicable to the critical components of various drilling techniques of conventional overbalanced drilling, underbalanced drilling and managed pressure drilling. Through this model, the static

nature of conventional risk assessment methods can be relaxed; enabling their application in dynamic risk analysis.

### **10.2.2. Bayesian theory application in bow-tie analysis of drilling operations:**

This study has extended the application of Bayesian theory to probability updating for safety barriers in a bow-tie model for both onshore and offshore drilling conditions in a practical usable manner. Safety related events during drilling, identified as accident precursors, are used for real-time updating of safety barrier failure probabilities. This has been demonstrated in Chapter 4 using a typical case study for a varied comparative analysis of the drilling methods of conventional overbalanced drilling and underbalanced drilling.

### **10.2.3. Development of a dynamic risk assessment model for constant bottom-hole pressure drilling (CBHP) technique:**

This study has developed a risk assessment methodology based on Bayesian network for analyzing the safety critical components and consequences of possible pressure regimes in CBHP techniques of managed pressure drilling. Based on the pressure regimes, different scenarios - underbalanced, overbalanced and normal or near balanced conditions were defined and investigated in detail for potential unwanted conditions. Bow-tie models were developed and mapped into BNs to conduct predictive as well as diagnostic analyses. In each scenario, the safety critical components and events relevant to the success of CBHP techniques were identified by estimating their posterior probabilities. Furthermore, a diagnostic model for the most critical component of CBHP - rotating control device (RCD) – was developed to analyze its sub-components. This has led to the

identification of the bearing assembly failure of the RCD as the most probable explanation to the failure of the CBHP technique.

#### **10.2.4. Development of a well integrity model:**

This study has developed a well integrity model for analyzing casing and cementing operations of an oil and gas well. This model utilized the characteristics of a Noisy-OR gate to capture the unique relationships between casing and cementing operations in leading to well integrity failure. The order of magnitudes of ratios of posterior probabilities to prior probabilities was used to identify the degree of contributions of the critical components to the well integrity failure. Safety functions and inherent safety principles were further presented for each primary causes as well as the safety barriers to improve the reliability of well integrity operations.

#### **10.2.5. Failure analysis of the tripping operation and its impact on well control:**

This study has presented a comparative analysis of both COBD and CBHP technique of MPD considering the effects of tripping-out operation from on primary well control. FT models of the operation in the two techniques were developed and mapped into BNs to enable dependability and diagnostic analysis. The CBHP technique was found to be safer in the two scenarios, compared. Further diagnostic analysis of the models identified RCD failure, BHP reduction due to insufficient mud density and lost circulation, DAPC integrated control system, DAPC choke manifold, DAPC back pressure pump, and human error as critical elements of the operation.

#### **10.2.6. Application of loss functions to blowout risk analysis:**

This study has presented an innovative approach in the application of loss functions to blowout risk analysis. Blowout loss categories were identified and modelled with suitable loss functions that best presented their features. The standardization of the measured parameter from absolute bottom hole pressure to pressure gradients has enabled the universality of the application of the loss models to any depth of the formation with minimal alteration of the loss model parameters. Through the setting of risk threshold, an operational risk management strategy was developed by which the blowout risk was controlled to prevent escalation.

#### **10.2.7. Development of an integrated tool for risk analysis of drilling operations:**

This study has developed an integrated model for the safety analysis of the stages/sub-operations of drilling operations. These stages include: drilling ahead, tripping, casing and cementing operations. The predictive analysis enabled the monitoring of risk through the analysis of the risk profiles of the applicable consequences identified, and the management of risk through the review of critical safety components when risk thresholds were exceeded. The diagnostic analysis identified, in succession, the degree of contributions to blowout occurrence the following sub-operations: tripping-out, well integrity with prominence in the cementing operation, and drilling ahead operations. A sensitivity analysis on the integrated model identified the paramount role of the MPD system in preventing the adverse effects of kicks due to abnormal formation pore pressure, ballooning, gas cut mud and the pressure effects of swabbing and surging.



### 10.3. Recommendations

This study has attempted to introduce new concepts in the safety analysis of managed pressure drilling techniques. However, there still exists gaps that could be further worked on. These include:

- The concept presented in this study involving the safety analysis of drilling operations can be extended to other managed pressure drilling techniques such as: dual gradient drilling and pressurized mud cap drilling. This is because this work has discussed mainly the constant bottom-hole pressure drilling technique of managed pressure drilling.
- Completion operations consisting of activities such as production tubing and Christmas tree installations, perforations, hydraulic fracturing, etc. towards the preparation of the well for oil and gas production have not been discussed in this study. Dynamic safety analysis of completion operations can be conducted to improve the safety of the operation and enhance production.
- Safety assessment of the mobile offshore drilling unit (MODU) or other drilling and production rigs used in the industry has not been fully explored. These can be further studied, particularly, looking into risk-based structural and control systems analysis of MODU.
- Methodologies of reducing uncertainties in the analysis of the models should be investigated. This includes, but not limited to independent-causality-except-inhibited assumption in populating conditional probability tables. Other methodologies that could be explored include: Markov Chain Monte Carlo, hierarchical Bayesian networks, fuzzy Bayesian network may be explored to reduce uncertainties in the data analysis.
- Dependency which often exist among the blowout loss categories has not been discussed in this study. The use of copula function has been suggested in the literature and can be

explored. In so doing, the marginal error of the analysis in representing the reality can be greatly reduced.