

A NEW TEST SYSTEM FOR THE IN-LINE MONITORING OF AUTOCLAVE EXHAUST TREATMENT: A STUDY OF UNCERTAINTY

Carsten Grumbach and Peter Czermak (peter.czermak@kmub.thm.de)
Institute of Bioprocess Engineering and Pharmaceutical Technology, Technische Hochschule Mittelhessen, University of Applied Sciences, Wiesenstrasse 14, 35390 Giessen, Germany.

The development of test systems to monitor the filtration of exhaust gases from laboratory autoclaves is driven by emerging laboratory safety regulations. The water intrusion test is suitable for this purpose, and therefore the test was adapted to account for the risks inherent in the filter systems used for the treatment of exhaust gas. To validate the test principle, the uncertainty of calibration and measurement was investigated using two commercial test gauges (Palltronic® Flowstar XC, Sartochek 4). The calibration data revealed a good fit ($R^2 = 0.988$) over a measurement range of 0.0-3.0 mg/mL, confirming the stability of the test system. The uncertainty of the new test system corresponds to other measurement gauges in a range of ± 0.01 (for low flow rates) to ± 0.05 (for high flow rates). These data highlight the potential of our device for the development of reliable test systems for small plants, with adjusted costs for design, integration and qualification.

INTRODUCTION

The thermal inactivation of natural or genetically modified microorganisms in biological and medical laboratories usually takes place in a steam sterilizer (autoclave) under specifically defined parameters for pressure, temperature and time. The capacity of these agents for infection and proliferation must be irreversibly destroyed, including any dormant forms. The ejection of these organisms from the autoclave chamber through the exhaust or waste water outflow should be prevented, particularly in the case of high risk organisms^{1,2}.

The release of vaporized biological agents into the work area is prevalent during the autoclave heating phase, when air is removed from the chamber and steam begins to flow. Sterile filtration is often used to deactivate harmful microorganisms in the autoclave exhaust by passing the exhaust through a hydrophobic membrane filter, which completely removes microorganisms from the exhaust air stream. However, the use of sterile filtration carries particular risks under certain conditions, under which filter integrity has not yet been tested³. In principle, it is possible to assess the integrity of these filters, and it is considered necessary for such assessments to be carried out. Current guidelines concerning the testing of filter integrity are expected to become mandatory, reflecting the potential risks that are inherent in such systems⁴.

Narrow pore filter cartridges with a pore size of 0.2 μm can reliably retain bacteria⁵. However, microscopic damage or inconspicuous changes in the pore structure can reduce the integrity of the sterilization system, yet the defects will not be visible at the macroscopic level. Such defects could be revealed by using particularly sensitive measurements, described herein as a filter integrity test. The quality of sterile filters is a prin-

cipal responsibility of the filter manufacturer. Due to the destructive nature of load stress tests using suitable organisms, limits have been established to support non-destructive filter integrity testing.

RISKS ASSOCIATED WITH STERILE FILTRATION OF AUTOCLAVE EXHAUST GAS

The fineness and pore size of a filter determines its microbiological safety, performance and overall lifetime. In addition to the selection of a suitable process for the filter, the choice of process conditions also influences its integrity and durability. The manufacturer's specifications for the maximum pressure and temperature that can safely be applied to the filter must be observed because stability can only be ensured within these limits⁶. The parameters reported by the manufacturer indicating the longevity of a sterile filter normally refer to ideal filtration conditions. In the event of an autoclave malfunction or failure of the filter elements (Figure 1), hazardous airborne biomaterials can freely enter the work area. Therefore, it is necessary to implement appropriate air filtration mechanisms when autoclaving pathogenic material.

The lifespan of a sterile filter depends on its exposure during the autoclaving process. Frequent changes in the types of laboratory material placed in the autoclave (i.e. liquids, solids and laboratory waste) and the corresponding changes in sterilization specifications cause the filter to experience varying levels of stress that can revise the manufacturer's original longevity estimates and render them inaccurate when applied in practice. Factors that have a particular impact on the filter include the frequency of use, method of sterilization, duration of the sterilization process and the nature of the impurities which pass through the exhaust system.

If the vacuum pump in the autoclave takes in large amounts of steam at high temperatures, the filter element can fail rapidly because it is exposed to an increase in differential pressure under these conditions. Another common problem is the faulty in-line sterilization of filter elements (Figure 1).

In order to sterilize the filter element, specific sterilization conditions within the autoclave chamber must be directed into the exhaust filtration system, and held there for a predetermined length of time. Condensate may accumulate in the filtration system, and the filter can then fail to achieve the necessary sterile conditions. The accumulation of condensate is often associated with a lack of insulation, long supply lines, and the failure to remove condensate as it forms. Any condensate forming around the filter casing must be removed and directed back into the autoclave chamber in order to avoid deleterious effects. This can be achieved by using a joint that is countercurrent in the main line. Failure to remove condensate from the filter can reduce the effective filtration area, which increases the stress on the apparatus as a whole. Unsuccessful in-line sterilization of the air filter therefore risks recontamination of the product by returning condensate that has already been removed from the filter. Furthermore, inadequate ventilation in the filter system may cause excess pressure changes or overpressure that lead to sudden failure of the filter, and the risk of additional damage to the O-ring seal required for filter attachment (Figure 1).

Based on the many risks presented above, the filtration of exhaust air within the autoclave may potentially be unsafe with regard to the protection of products and personnel. It should be assumed that filters that are already installed or in use are no longer reliable, because they may be allowing contaminants back into

the work space. Although filter manufacturers and suppliers of sterile filters provide recommendations for changing the filter, these estimates are based on ideal filtration and sterilization conditions⁷. Typical recommendations suggest filter changing intervals of between 20 and 100 cycles. Exhaust filters are replaced at predefined intervals according to the manufacturer's recommendations without knowing whether replacement is actually necessary.

The cost of filter replacement must also be taken into account. Waste sterilization alone, with up to five sterilization cycles per autoclave per day, can amount to several tens of thousands of euros in total cost if operators observe the shortest recommended replacement intervals. However, even compliance with the shortest recommended intervals does not provide a qualitative assurance of filter integrity. A sensitive method to monitor filter integrity at regular intervals is therefore required, which can also ensure successful sterilization by means of integrated pre-treatment and post-treatment processing.

INTEGRITY TESTING

Testing the integrity of sterile filters provides microbiological evidence that the application of a certain number of bacteria to the filter element results in a sterile filtrate and provides a necessary quality assurance measure for sterile filtration. However, this type of test is destructive. Filter elements are therefore subjected to bacterial stress tests specific for the appropriate products and process conditions for the purpose of product/process specific validation.

According to ASTM guidelines⁸, a filter may only be classified as a sterile filter if it still delivers a sterile filtrate after the application up to 10^7 *Brevundimonas*

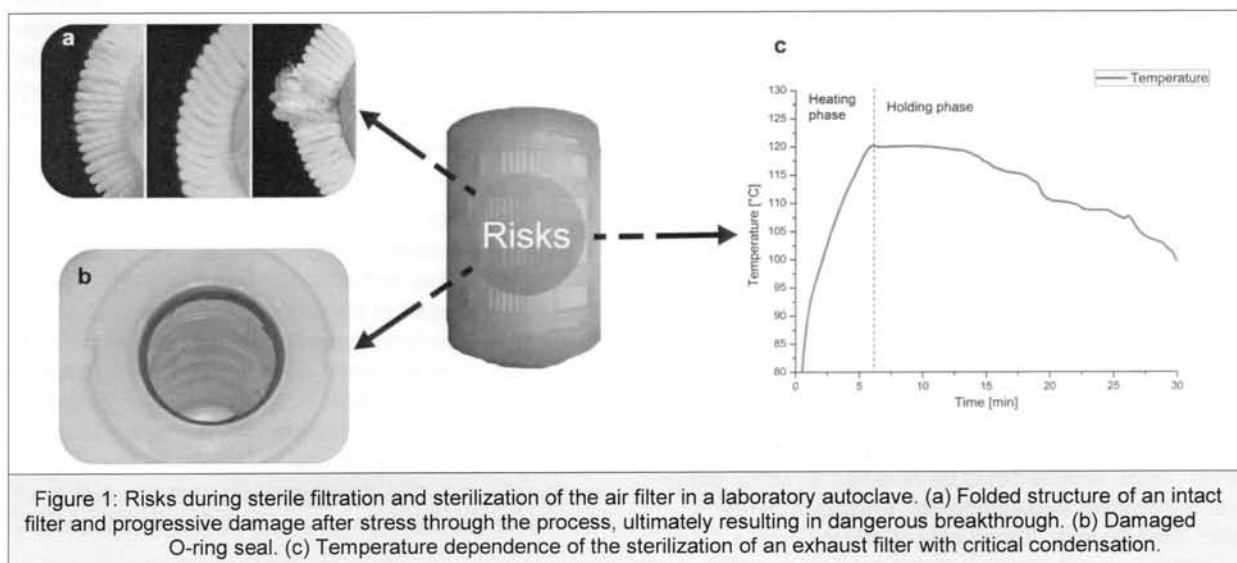

Figure 1: Risks during sterile filtration and sterilization of the air filter in a laboratory autoclave. (a) Folded structure of an intact filter and progressive damage after stress through the process, ultimately resulting in dangerous breakthrough. (b) Damaged O-ring seal. (c) Temperature dependence of the sterilization of an exhaust filter with critical condensation.

diminuta per square centimetre of filter surface. This test provides an immensely high 'worst-case' bacterial density, which emphasizes the reliability of such a test. The manufacturers of filter elements are responsible for the correlation of test scores and microbiological data for product validation. If these destructive load tests are used with more suitable model organisms, definite limits for non-destructive integrity tests can be defined⁹.

WATER INTRUSION TEST

Gas permeable hydrophobic membrane filter elements are typically used for decontaminating autoclave exhaust. The water intrusion test is a suitable method for testing the integrity of a hydrophobic membrane filter. Here, the hydrophobic filter element is flooded with water while a test pressure less than the penetration pressure of the filter is applied to the measuring system. Any water vapour on the filter due to evaporation will then pass through the filter membrane. The water intrusion rate (WIR) can be calculated by measuring the pressure drop during this process, which can then be correlated with the bacterial retention rate of the filter^{10,11}. Any rupture or failure of the filter elements can be detected and prevented early on using this method.

The simplest test is the static pressure drop method, which has three stages. The first stage is the pressure build-up phase, which is used to achieve and stabilize the necessary critical constant pressure conditions for the test. The intrusion flow is then measured according to the filter stabilization time until it stabilizes at a constant flow. The intrusion flow from the pressure drop is determined in the subsequent measurement phase¹². Pressurization of the system eliminates any air that is trapped in the membrane and allows water vapour to flow through the membrane at a rate that initially declines due to the effect of filter compaction. After the stabilization period, the water vapour passes at a constant rate through the membrane according to specific test parameters, including the filter surface area, pressure, temperature and conductivity of the water¹³.

DESCRIPTION OF TEST REQUIREMENTS

Many commercial test systems are designed with generic filter measurements and cost about the same as an autoclave¹⁴. These are rarely available for use in small systems due to the expense, but the costs can be mitigated by tests designed and qualified for specific filter types and sizes. In addition, such a test system should be easy to adapt for a variety of different autoclaves.

In the static pressure drop test described above, the

exact net volume of gas in the measuring system is a critical parameter¹⁵. Many test systems automatically determine the net volume of the filter cartridge housing before the intrusion measurement. This basic test method can be emulated using a single pressure sensor and a precision pressure regulator¹⁶, assuming the test gas above the filter element can be adjusted in a reproducible manner. Such an approach circumvents the relatively complex procedure required to determine the net volume. Another important requirement involves the aforementioned temperature radiation problem. If the thermal radiation from the autoclave chamber is allowed to affect the thermodynamics of the test gas then the accuracy of the results is significantly reduced¹³. A special device which shields the test gas from external thermal radiation was developed to address the issue, and it can be designed to fit a variety of filter sizes. With this added measurement, long test durations and cooling periods are not required. Furthermore, the filling procedure during the test allows a definite volume of gas to be set within the measuring system.

In addition to the requirements of the test system, the test must also be adapted to meet any specific demands placed on the autoclave exhaust filter system. These crucial test requirements include successful condensate recovery from the exhaust air filter housing, and successful in-line sterilization of the air filter. The prevailing standards for autoclave sterilization require the removal of incurring condensation within the exhaust filter system. Therefore, the success of filter element sterilization depends on system monitoring to ensure that the water necessary for the integrity test is not contaminated, and that it is directed into the waste water disposal after the test. Furthermore, care must be taken during installation of the exhaust filter system so that the test system remains bubble free in order to avoid dead zones within the system that would distort the net gas volume and reduce the accuracy of each measurement.

TECHNOLOGICAL CONCEPT AND SYSTEM DESCRIPTION

The objective of the technology described herein is to develop a modular test system that can easily be adapted for different autoclaves, particularly laboratory and large scale autoclaves, along with relevant freeze drying facilities. The basic concept of the system comprises a precision pressure sensor, a precision pressure reducing valve and a valve circuit that together form a self-contained unit which can be integrated into different systems and facilities either direct or long distance monitoring. The filter readings and changeovers are documented automatically and the results are presented as a printout. Integrated interfaces allow data transfer to the autoclave to modify the sterilization



Figure 2: Water intrusion test (final prototype) consisting of a measuring device with a pressure transducer, overflow vessel, valve switch and pressure control.

protocol or to access the process control systems directly.

The test system has three main components (Figure 2): a pressure sensor to measure the intrusion flow across the filter element, a valve system that switches the test system to the appropriate test phase positions, and a precise pressure controller to regulate the pressures from test to test and to facilitate automated drying and emptying of the test system. The valve system controls the sequential steps necessary for the test, i.e. filling, pressure build-up, stabilization, measuring and final draining of the system. A special valve switch avoids the formation of dead spots, both in the test system and the exhaust filter system.

During the stabilization phase, the stability of the intrusion flow requires exact pressure conditions. The pressure drop generated as a result of the flow rate must be maintained at the exact test pressure using a fine pressure reducer. After the stabilization phase, the measuring system is closed and a pressure drop across the now stabilized flow is measured. This pressure drop allows the water intrusion rate to be calculated.

Integration into the Target System

The test system can be adapted for autoclave exhaust filter systems by incorporating two lines with valves (Figure 3). The first valve opens and closes the measurement line from the filter system to the test system, whereas the second facilitates filling and draining before and after the test. A temperature sensor monitors filter sterilization during autoclaving. The components are controlled and the sensor readouts are processed by microcontroller hardware coupled to the controller hardware of the autoclave. The test system does not increase the use of electricity, tap water or com-

pressed air compared to the standard autoclave sterilization cycle.

Pre-treatment and Post-treatment of the Filters

The collapse of the sterilization conditions in the filter system often occurs during filter sterilization, but drying the filter element after sterilization can help to prevent condensed water trapped inside the filter drainage layers from obstructing the sterilization process. Filter drying can also facilitate pre-treatment before testing, so the new test system allows the automated drying of the filter element. The filter element can also be cooled at intervals using the test system after sterilization until the test temperature is reached.

Calibration

The accuracy of a measuring device can only be determined by calibration. An integrity test unit is defined in metrological terms by its ability to determine flow through the filter membrane precisely at defined pressures. Additional calibration of the flow using a reference¹⁷ must be carried out following calibration of the pressure transducer. Flow calibration can be used for initial calibration of the test system, followed by periodic inspection to recalibrate the pressure sensor. The filter system is disconnected from the downstream line during calibration and switched to an additional line for calibration, which allows defined gravimetric flow to be recorded using a balance (Figure 4).

The flow references required for calibration are generated using a needle valve and gravimetric data are recorded on a laboratory scale. Figure 5 shows the experimental setup of the measurement system, which produces defined flow references that are generated by test pressures and simulated by a needle valve (Swagelok SS-4MG).

The flow rates are calculated as follows:

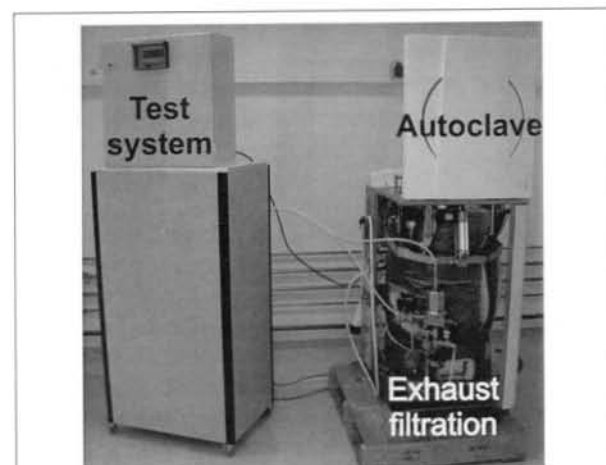

Figure 3: New test system (top left) adapted to the exhaust filter system of a Tuttnauer 3870 ELV D laboratory autoclave.

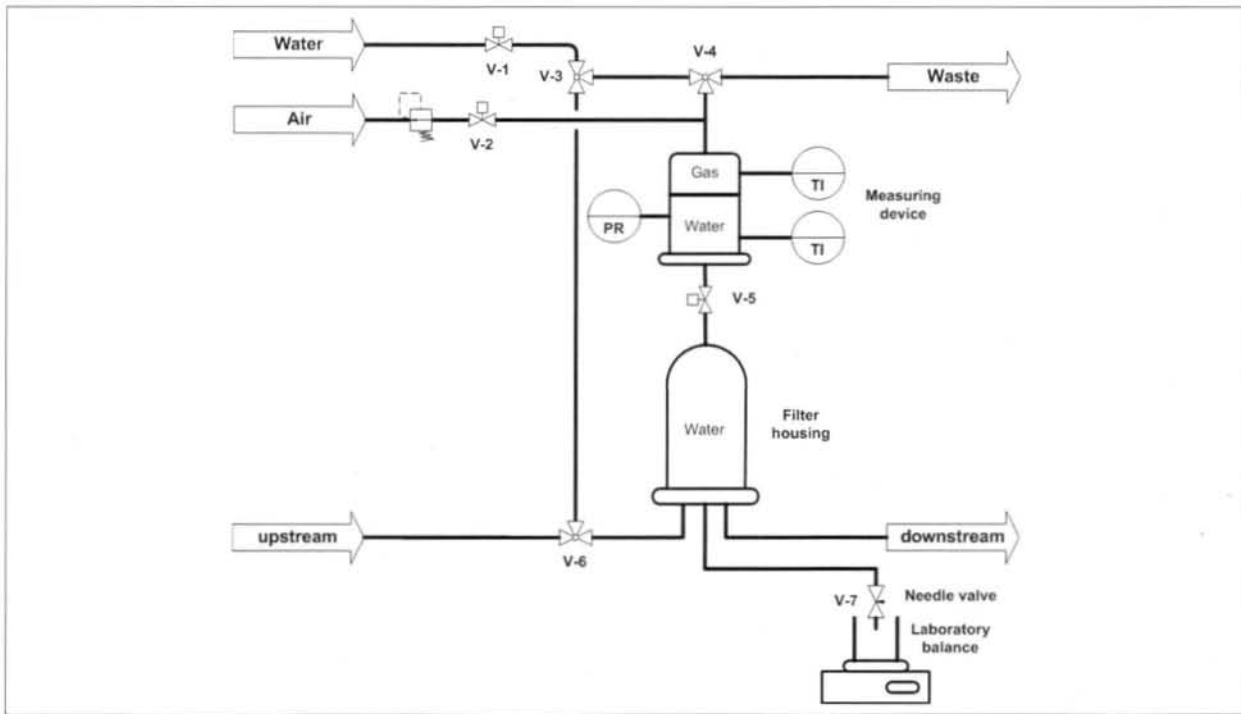

Figure 4: Measuring system flowsheet, showing the measurement setup (schematic representation), filter housing, valve switch, pressure control and sensors with references (laboratory scale and needle valve) for calibration.

$$WIR = \frac{\Delta p \bar{V}_m}{\Delta t (\rho_{end} + \rho_{atm})}; T = \text{const.} \quad (1)$$

The flow rate is calculated from the pressure drop ΔP during the measuring period Δt with a known net volume, averaged over the series of measurements, generated by the flow. The pressure at the end of measurement consists of the test pressure P_{end} and the atmospheric pressure P_{atm} . The flow references meas-

ured on the laboratory scale are calculated as follows:

$$WIR = (\text{reference}) = \frac{m_{end}}{\rho \Delta t} \quad (2)$$

The reference flow $WIR_{reference}$ is calculated from the water mass m_{end} , recorded using the balance, its density ρ and the measuring duration Δt . For each individual measurement, the test pressure P is stabilized to

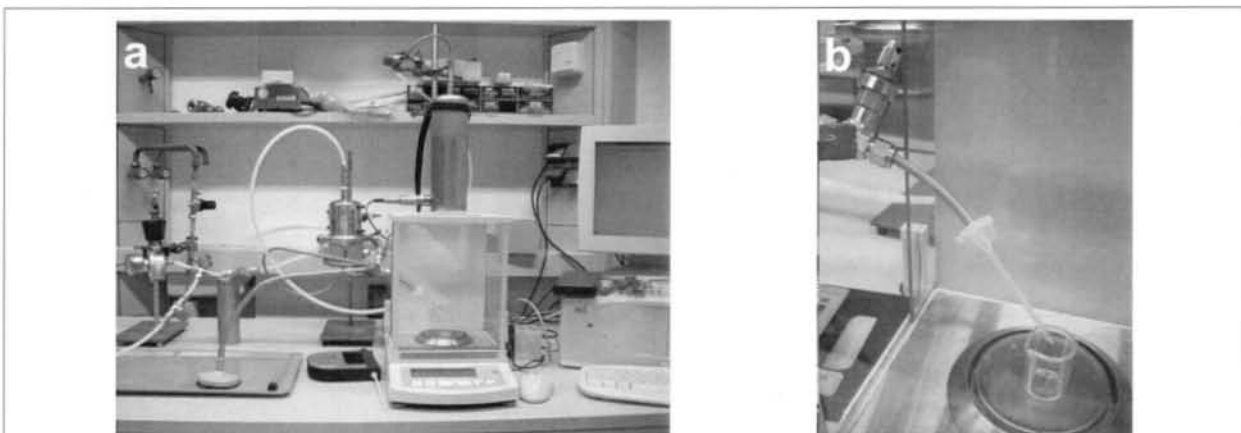

Figure 5: (a) Water intrusion test with the setup for calibration consisting of a laboratory scale and needle valve. (b) Close-up image of the needle valve with a dosage line for precise gravimetric dosing.

2500 mbar for a period of $t = 3$ mins. In Table 1, the recorded values of the measurement series for calibration are presented with 16 measuring points.

During calibration, the temperature is held at $293.63 \text{ K} \leq T \leq 297.59 \text{ K}$. The temperature of the gas bubble in the measurement setup fluctuated throughout the measuring range ($291.34 \text{ K} \leq T \leq 294.19 \text{ K}$). In a single measurement, the temperature increased steadily, i.e. the temperature gradient remained constant.

The temperature in the water phase of the measuring device differed slightly from that of the gas phase and increased during measurement more than the gas phase. The maximum temperature difference in the gas bubble during calibration (ΔT) was 0.47 K. This temperature change was observed at low flow rates because the corresponding measurement times were longer ($t = 17.67$ mins.) and therefore the ambient temperature had a stronger impact on the measurement. The pressure at the beginning of each measurement was $P = 2500$ mbar (overpressure). The flow values determined by the test system correlated ($R^2 > 0.8$) with those generated by the flow controller. Figure 6 confirms the correlation of both flow rates and the reproducible volume setting of the measuring device.

Uncertainty Analysis

The uncertainties of calibration and measurement were assessed by determining the expanded uncertainty U , following the Guide of the Expressions of Uncertainty in Measurement (GUM) on the basis of type A and type B standard uncertainties and the coverage factor k^{18} . By increasing k , the uncertainties of measurement can be expressed as the accuracy, which

represents the deviation from the true, but unknown, measurement.

Uniform dimensions must be used for the type A and type B uncertainties in order to measure the intrusion of water. Type A uncertainties are based on statistical estimates of the standard uncertainty u . Thus the type A uncertainty of the compressed gas volume V_m during calibration can be calculated as follows¹⁸:

$$u = \frac{s}{\sqrt{n}} \quad (3)$$

The standard uncertainty u is calculated from the standard deviation s and the number of measurements n . Type B uncertainties are estimates of uncertainty, e.g. based on certificates of calibration, manufacturers' specifications or the accuracy of the instruments. Type B standard uncertainties are calculated using equations (4)-(6) and are added to the type A standard uncertainties to yield a combined uncertainty value¹⁹, U_c :

$$u_{\text{rectangular}} = \frac{a}{\sqrt{3}} \quad (4)$$

$$u_{\text{triangular}} = \frac{a}{\sqrt{6}} \quad (5)$$

$$u_{\text{normal}} = \frac{u}{k} \quad (6)$$

The standard uncertainties (u) for rectangular and triangular distributions are calculated over half the width between the upper and lower limits of the distributions.

T_{start} (K)	T_{end} (K)	ΔP (mbar)	Δt (min)	m_{end} (g)	ρ (g/ml)	$WIT_{\text{reference}}$ (ml/min)	WIT (ml/min)	V_m (ml)
294.74	294.73	104	1.20	1.50	0.9978	1.25	1.23	49.12
294.82	294.82	103	1.30	1.42	0.9979	1.09	1.12	46.96
294.90	294.89	100	1.03	1.33	0.9977	1.29	1.37	45.31
294.95	294.93	94	0.50	1.34	0.9977	2.69	2.66	48.54
295.06	295.05	98	0.95	1.41	0.9977	1.49	1.46	49.06
295.12	295.11	106	1.13	1.50	0.9977	1.33	1.32	48.21
295.22	295.23	105	5.90	1.53	0.9978	0.26	0.25	49.65
295.27	295.27	106	2.55	1.46	0.9978	0.57	0.59	46.93
295.33	295.32	102	2.60	1.48	0.9979	0.57	0.55	49.44
295.36	295.35	103	2.43	1.44	0.9979	0.59	0.60	47.63
295.60	295.61	107	8.97	1.43	0.9979	0.16	0.17	45.53
295.62	295.64	106	8.40	1.45	0.9978	0.17	0.18	46.61
295.66	295.64	100	1.58	1.36	0.9979	0.86	0.89	46.34
295.66	295.67	99	1.05	1.46	0.9978	1.39	1.33	50.30
295.69	295.67	101	0.92	1.47	0.9979	1.61	1.56	49.56
295.70	295.69	101	0.80	1.49	0.9979	1.87	1.79	50.23

Table 1: Calibration data for the measuring system.

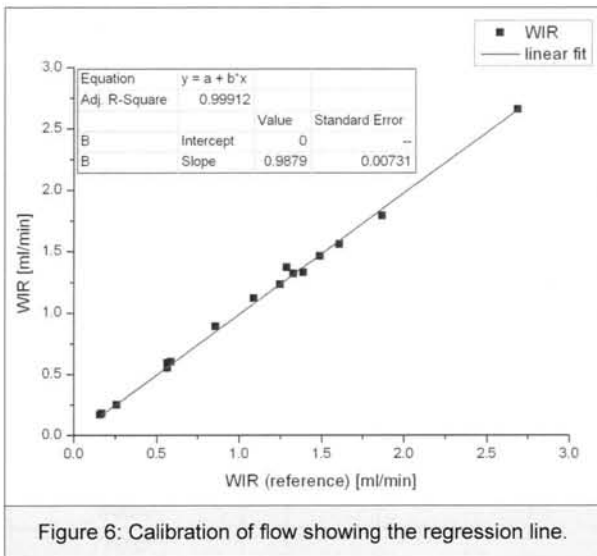

Figure 6: Calibration of flow showing the regression line.

The standard uncertainty of the normal distribution is calculated using the expanded uncertainty U and the coverage factor k as shown in equation (7).

$$u_c = \sqrt{\sum_{i=1}^{i=n} (c_i u_i)^2} \quad (7)$$

The number n of standard uncertainties u_i and the sensitivity coefficients c_i of all sources i which make a contribution to uncertainty can be added together to yield

the combined standard uncertainty u_c as shown in equation (8).

$$U = k u_c \quad (8)$$

The expanded uncertainty U is calculated over the coverage factor k in the field of metrology: $k = 2 \approx 95\%$ ²⁰ and the combined standard uncertainty u_c .

The volumes of the compressed gas bubble in the measurement setup, which were used to calculate the corresponding type A uncertainties, are presented in Table 2 for three measuring ranges. For the following calculations, it was assumed that the individual contributions of uncertainty were not correlated.

Tables 3 and 4 itemize the uncertainty budget for measurements in the form of type A and type B uncertainties for the calibration procedure in the flow range 0 -0.4 ml/min, including the combined uncertainty u_c and expanded uncertainty U . Table 5 summarizes the expanded uncertainties for calibration and measurement in the ranges >0.4-1.0 ml/min and >1.0 ml/min.

According to the calculations in Table 5, an increase in expanded uncertainty over the measurement range, expressed as absolute values, is observed for both the measurement and the calibration. Expressed in relative terms, comparable expanded uncertainty values were observed for all three measurement ranges. The overall uncertainty slope is particularly dependent on

Measurement no.	Measurement range		
	0-0.4 ml/min	> 0.4-1.0 ml/min	> 1.0 ml/min
	V_m (ml/min)	V_m (ml/min)	V_m (ml/min)
1	0.16865	0.61862	1.54486
2	0.16834	0.62172	1.55134
3	0.18425	0.63585	1.59988
4	0.18322	0.64568	1.50978
5	0.16736	0.59826	1.47634
6	0.16692	0.61235	1.57576
7	0.18066	0.62944	1.52931
8	0.17363	0.61871	1.51630
9	0.16084	0.59947	-
10	0.16178	0.58701	-
11	0.15989	0.59733	-
12	0.18039	0.57578	-
13	-	0.60310	-
14	-	0.58016	-
Standard deviation, s (ml/min)	0.00887	0.02081	0.03896
Standard uncertainty, u (ml/min)	0.00256	0.00556	0.01377

Table 2: Determination of type A standard uncertainties of the gas volume V_m .

No.	Source of uncertainty	Value	WIR (converted) (ml/min)	Probability distribution	Divisor	C	Standard deviation, u (ml/min)
1	Pressure transducer (calibration certificate)	4.5 mbar	0.00048	normal	2	1	0.00024
2	Pressure (accuracy of reading)	0.5 mbar	0.00087	rectangular	$3^{0.5}$	1	0.00050
3	Pressure difference (accuracy of reading)	0.5 mbar	0.00087	triangular	$6^{0.5}$	1	0.00035
4	Time difference (accuracy of reading)	0.5 s	0.00017	triangular	$6^{0.5}$	1	0.00007
5	Balance (accuracy of reading)	0.00005	0.000006	rectangular	$3^{0.5}$	1	0.000004
6	Density meter (manufacturer specification)	0.001 g/ml (Typ. A + B)	0.00019	-	1	1	0.00019
7	Density (accuracy of reading)	0.00005 g/ml	0.000009	rectangular	$3^{0.5}$	1	0.000005
8	Uncertainty, V_m	-	0.00256	-	1	1	0.00256
	Combined uncertainty, u_c						0.003
	Expanded uncertainty, U , $k = 2$						0.01

Table 3: Itemized uncertainty budget for the calibration in the measurement range 0-0.4 ml/min.

No.	Source of uncertainty	Value	WIR (converted) (ml/min)	Probability distribution	Divisor	C	Standard deviation u (ml/min)
1	Pressure transducer (calibration certificate)	4.5 mbar	0.00048	normal	2	1	0.00024
2	Pressure (accuracy of reading)	0.5 mbar	0.00074	rectangular	$3^{0.5}$	1	0.00042
3	Pressure difference (accuracy of reading)	0.5 mbar	0.00074	triangular	$6^{0.5}$	1	0.0003
4	Time difference (accuracy of reading)	0.5 s	0.00012	triangular	$6^{0.5}$	1	0.00005
5	Calibration (combined measurement uncertainty)		0.003	-	1	1	0.003
	Combined uncertainty, u_c						0.003
	Expanded uncertainty, U , $k = 3$						0.01

Table 4: Itemized uncertainty budget for the WIR measurement in the range 0-0.4 ml/min.

the slope of the time difference recording accuracy (~ 0.5 s). During calibration, the measurement period can be very short at high flow rates. Because the water intrusion rate in air filters is not greater than 1.0 ml/min, the higher expanded uncertainty for calibration and measurement is not relevant for this operation mode in the new test system.

The new test device is more accurate than two commercial systems (Palltronic® Flowstar XC and Sartochek 4) at low flow rates. The new system achieves an accuracy of ± 0.01 ml/min at low flow rates compared to the Palltronic® Flowstar XC ($\pm 3\%$ or ± 0.02 ml/min)²¹. The accuracy of the new system at medium flow rates (± 0.03 ml/min) and fast flow rates (± 0.05 ml/min) is similar to the Palltronic®

Flowstar XC. The Sartochek 4 has a reported accuracy of $\pm 5\%$ regardless of the measurement range²². In terms of absolute values, the new system is more accurate than the Sartochek 4 at flow rates > 0.2 ml/min but less accurate at flow rates of ≤ 0.2 ml/min. However, basing indications of accuracy solely on percentages incurs the risk that the accuracy at lower flow rates is likely to be exaggerated. For this reason, absolute values or combinations of absolute and relative values are preferable.

CONCLUSIONS

The major risks associated with the treatment of exhaust gas from laboratory autoclaves include the in-

Measurement range	Range of temperature (K)	U (Calibration) (ml/min), $k = 2$	U (Measure) (ml/min), $k = 3$
0 - 0.4 ml/min	291.67 - 294.18	± 0.01	± 0.01
> 0.4 ml/min - 1.0 ml/min	291.34 - 294.19	± 0.02	± 0.03
> 1.0 ml/min	291.52 - 293.55	± 0.04	± 0.05

Table 5: Expanded uncertainty U for the new test system over different measurement ranges.

sufficient in-line sterilization of filter elements, which can place the filter under extreme stress, lead to the recontamination of the product, and compromise personnel safety. These issues can be avoided by integrated integrity tests if it is possible to develop a test system that meets the special requirements of laboratory autoclaves. In addition to the reliable detection of failed filters, an integrity test also ensures that air treatment and filter sterilization are completed successfully.

The integration of a test system requires robust process design. The integrity testing of membrane filters appears simple, but relies on many interacting factors that introduce complexity and require careful consideration. In addition, such test systems must be economically suitable for small scale devices and processes, but this can influence the precise requirements of the systems and filter elements that are tested. Under these conditions, it is possible to develop a reliable test system for small plants, with adjusted costs for design, integration and qualification.

ACKNOWLEDGEMENT

The authors would like to thank the Hessischen Ministerium für Wissenschaft und Kunst for the financial support of our project 'Development of a modular, universally applicable water intrusion test (WIT) for small plants'. In addition, the authors thank our project partner biomedis Laborservice GmbH for the productive and mutually beneficial collaboration.

REFERENCES

1. *Technical Rules for Biological Agents, TRBA 100, Protective measures for specific and non-specific activities involving biological agents in laboratories*, 2006. Committee for Biological Agents, ABAS.
2. Verordnung über die Sicherheitsstufen und Sicherheitsmaßnahmen bei gentechnischen Arbeiten in gentechnischen Anlagen (Gentechniksicherheitsverordnung) in der Fassung der Bekanntmachung vom 14 March 1995, BGBl. I S. 2768.
3. Grumbach C., Schulte-Lünzum H. and Czermak P., 2013. Abluftfiltration unter der Lupe, Risiken bei der Sterilfiltration der Autoklavenabluft, *Techno. Pharm.*, **3**(6), 322-327.
4. *Einbauempfehlung für Neuanlagen, Nachrüstung oder Ergänzung, zur Wahl der Abluftbehandlung von Autoklaven*, Beschluss 3/2009, Committee for Biological Agents, ABAS, ELATEC.
5. *ASTM Standard F838-83*, American Society For Testing Material (ASTM), 1983 (amended 1988).
6. Brendel-Thimmel U., Jaenchen R. and Schlamp F., 2006. Sterilfiltration von flüssigkeiten und gasen, *Chemie Ingenieur Technik*, **78**(11), 1655-1665.
7. Jornitz M.W. and Meltzer T.H., 2008. *Filtration and Purification in the Biopharmaceutical Industry*, Informa Healthcare, New York.
8. *Standard Test Method for Determining Bacterial Retention of Membrane Filters Utilized for Liquid Filtration*, Committee D19.F838-05, ASTM, 2005.
9. Meyer J., 2011. *Einführung in die Integritätstestung von Membranfiltern*, SPI8000-d11041, Sartorius Stedim Biotech.
10. Czermak P. and Catapano G., 2003. Accuracy of automated flow-measuring devices used in the pharmaceutical industry for testing sterile filter integrity, *PDA Pharmaceutical Science and Technology*, **57**(4), 277-286.
11. Czermak P. and Catapano G., 2000. Automated integrity testing of hydrophobic filters based on water intrusion measurements: Comparative analysis of a refilling continuous-flow and a pressure-decay batch device, *European J. Parenteral Sciences*, **5**(3), 59-63.
12. Jornitz M.W. and Meltzer T.H., 2011. *Sterile Filtration: A Practical Approach*, Marcel Dekker, New York.
13. Jaenchen R., Schubert J. and Jafari S., 1997. Studies on the theoretical basis of the water intrusion test (WIT), *European J. Parenteral Sciences*, **2**(2), 39-45.
14. Grumbach C., Grace P., Czermak P., Pillich T., Rühl C. and Fey K., 2011. Einbauempfehlung für neuanlagen, sichere überwachung der abluftbehandlung von autoklaven mittels wasserintrusionstest mit hoher temperaturstabilität, *GIT Laborfachzeitschrift*, **55**(8), 540-542.
15. Grumbach C. and Czermak P., 2013. Sichere abluftfiltration an laborautoklaven - Integrierter wasserintrusionstest zur erfüllung der vorgaben im bereich der biotechnologie, *Filtrieren und Separieren*, **27**(6), 368-373.
16. *Filterelemente - Membranfilterelemente - Teil 12: Integritätsprüfung von hydrophoben Membranfil-*

- terelementen mit Wasser (Wasserintrusionstest), DIN 58356 – 12, NA 063 Normenausschuss Medizin (NaMed).
17. Kradolfer M. and Jaenchen R., 2008. *P&A Select Biotech*, 2, 28-30.
18. Bell S., 2001. *Measurement Good Practice Guide No. 11: A Beginner's Guide to Uncertainty of Measurement*, National Physical Laboratory, Teddington, UK.
19. UKAS – United Kingdom Accreditation Service: *M3003 The Expression of Uncertainty and Confidence in Measurement*, 2007.
20. Pesch B., 2003. *Grundlagen der Metrologie – Bestimmung der Messunsicherheit nach GUM*, Nordstedt: Books on Demand.
21. Pall Europe Ltd., 2003. *Palltronic® Flowstar XC Filter-Integritätstestgerät, Modelle FFSXC und FFSXCH, Betriebsanleitung*.
22. Sartorius AG, 2006. *Operating Instructions; Sartochek 4 Multinit, Filter Integrity Tester*.

CHALLENGE TESTING – CURRENT TECHNOLOGIES AND FUTURE PROSPECTS

Keith Brocklehurst, Andrew Hassall, Graham Rideal (info@whitehousescientific.com) and Abi Stewart
Whitehouse Scientific, Chester, CH3 7PB, UK.

Unlike test sieves, which have plain weaves and can be measured optically, complex 3D weaves of twilled construction do not allow light to pass and so cannot be measured optically. The apertures then have to be estimated by air flow rate studies (Porometry) or challenged by a wide distribution of particles such that those passing are measured to determine the cut point of the filter (Challenge Test). Historically, various sands such as Arizona test dusts have been used, but their irregular shapes mean that it is difficult to obtain an unambiguous measurement of aperture size. Using glass microspheres has partially solved the problem, but a small percentage of misshapes in the product can seriously overestimate the aperture size when the particle is expressed as the equivalent spherical diameter.

When an Image Analyser is used for particle measurement, it is now possible to electronically filter non-spherical particles from the size/shape distribution and thus provide much more accurate measurements of the aperture sizes. The method has been validated using plain weaves down to 20 µm, where optical measurements have been used to confirm the data, and then extended to complex twilled meshes down to 5 µm. At this size there are no other methods available to obtain unambiguous, NIST traceable results.

INTRODUCTION

Effect of Particle Size and Shape on Challenge Test Results

Particle size is often expressed as a single number, however, there is a tacit assumption that the particles are spherical as this is the only shape that can be defined by a single parameter. In reality, particles are rarely perfectly spherical, indeed Arizona road dust was originally used in Challenge Testing¹. If a filter is challenged by irregular particles, the particles passing will depend upon their orientation and the number of attempts at passing the filter – single or multi-pass methods. Furthermore, the size reported will also depend on the method of measurement (Figure 1).

One of the biggest problems in using irregular test dusts is that small changes in sample preparation, whether in grinding or classifying the powders can have a significant effect on the performance of the dust in filtration situations. Consequently, heavy users have to reserve large quantities of a particular batch from suppliers in order to maintain consistent results over a period of time. Spherical particles, on the other

hand, have a greater uniformity of shape and give much more reproducible results, especially if Image Analysis techniques are used. Here, the occasional irregular particle can be removed electronically from the results and spherical particles are therefore the

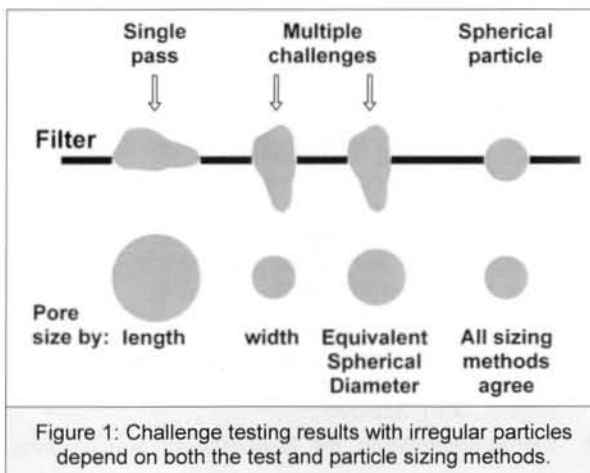
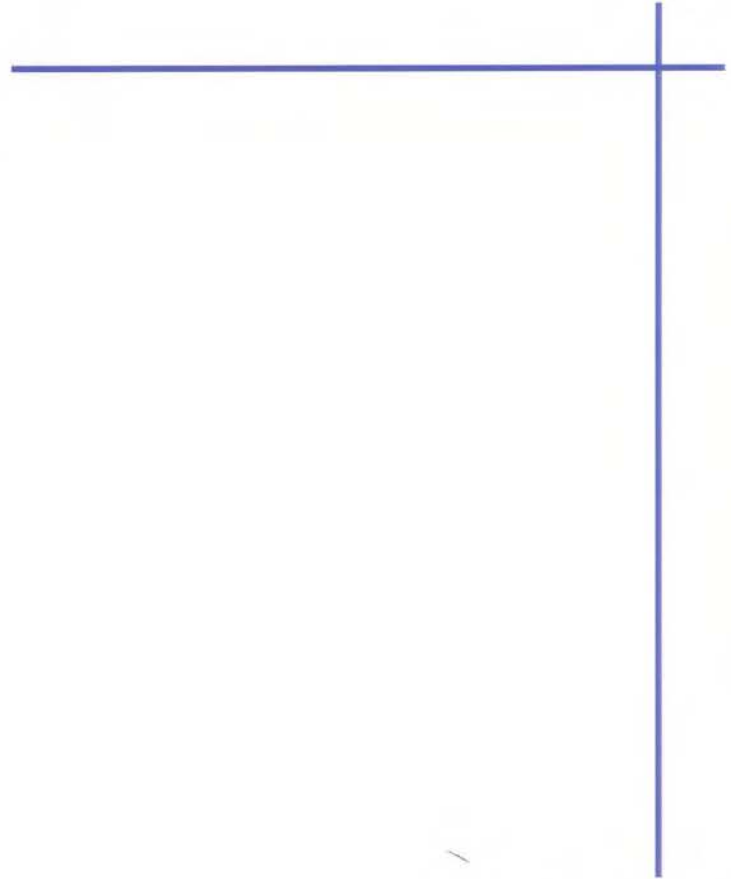

Figure 1: Challenge testing results with irregular particles depend on both the test and particle sizing methods.

FILTRATION

ISSN 1479-0602

the international journal for filtration and separation



The
FILTRATION
Society



FILTRATION is the official journal of The Filtration Society and the American Filtration & Separations Society

Volume 15 Number 4