

Spring 2015

# Beta-lactam antimicrobial dosing optimization in obese patients compared to non-obese patients using population pharmacokinetic/ pharmacodynamic approach

Eun Kyoung Chung  
*Purdue University*

Follow this and additional works at: [https://docs.lib.purdue.edu/open\\_access\\_dissertations](https://docs.lib.purdue.edu/open_access_dissertations)

 Part of the [Pharmacology Commons](#), and the [Pharmacy and Pharmaceutical Sciences Commons](#)

---

## Recommended Citation

Chung, Eun Kyoung, "Beta-lactam antimicrobial dosing optimization in obese patients compared to non-obese patients using population pharmacokinetic/pharmacodynamic approach" (2015). *Open Access Dissertations*. 441.  
[https://docs.lib.purdue.edu/open\\_access\\_dissertations/441](https://docs.lib.purdue.edu/open_access_dissertations/441)

This document has been made available through Purdue e-Pubs, a service of the Purdue University Libraries. Please contact [epubs@purdue.edu](mailto:epubs@purdue.edu) for additional information.

**PURDUE UNIVERSITY  
GRADUATE SCHOOL  
Thesis/Dissertation Acceptance**

This is to certify that the thesis/dissertation prepared

By Eun Kyoung Chung

**Entitled**

Beta-Lactam Antimicrobial Dosing Optimization in Obese Patients Compared to Non-Obese Patients  
Using Population Pharmacokinetic/Pharmacodynamic Approach

For the degree of Doctor of Philosophy

Is approved by the final examining committee:

Michael B. Kays

Sharon M. Erdman

James E. Tisdale

Kevin M. Sowinski

Brian R. Overholser

Sara K. Quinney

To the best of my knowledge and as understood by the student in the Thesis/Dissertation Agreement, Publication Delay, and Certification/Disclaimer (Graduate School Form 32), this thesis/dissertation adheres to the provisions of Purdue University's "Policy on Integrity in Research" and the use of copyrighted material.

Michael B. Kays

Approved by Major Professor(s): \_\_\_\_\_

Approved by: Joseph Thomas III

03/05/2015

Head of the Department Graduate Program

Date



BETA-LACTAM ANTIMICROBIAL DOSING OPTIMIZATION IN OBESE  
PATIENTS COMPARED TO NON-OBESE PATIENTS USING POPULATION  
PHARMACOKINETIC/PHARMACODYNAMIC APPROACH

A Dissertation

Submitted to the Faculty

of

Purdue University

by

Eun Kyoung Chung

In Partial Fulfillment of the

Requirements for the Degree

of

Doctor of Philosophy

May 2015

Purdue University

West Lafayette, Indiana

For my parents and my loving “home-away mom”, Mary McKeever

## ACKNOWLEDGEMENTS

It is my greatest pleasure to express my all due thanks and gratitude to all those who helped and supported me for this work. First and foremost, my praise and thanks go to my Lord, Jesus Christ for His blessings and guidance.

My deepest thanks go to my major advisor, Dr. Michael B. Kays, who introduced me to the area of antimicrobial pharmacokinetics and pharmacodynamics and supported me continuously throughout the Clinical Pharmacy Doctor of Philosophy program. Dr. Kays always provided constructive, valuable comments and instructions for me to achieve further professional growth, and I feel extremely privileged having him as my mentor. Without his mentorship, it would have been a lot harder to complete this work. Although my needs and demands were somewhat excessive, he never hesitated communicating with me to address those via many ways; he always made himself available through phone calls, texts, e-mails, as well as in-person meetings. I appreciate him for spending so much time with me to meet all my needs. Dr. Kays has always been a great mentor who shares his wisdom in life as well as a mentor for professional, academic growth. He has been a great listener for my concerns about almost everything, and I have always been able to find my comfort after talking with him. I am looking forward to further developing and maintaining our good relationship from now on.

I am also thankful for having Dr. Sharon M. Erdman as my clinical mentor for me to gain more clinical knowledge and experiences during my Ph.D. program. She has always been open-minded with my questions or suggestions, and she also trained me to grow a better clinician and clinical educator. She did not hesitate letting me participate in teaching her clerkship students, and she always engaged me in any potentially beneficial opportunities. In addition to her clinical and teaching mentorship, I also appreciate her supervision on the outpatient parenteral antimicrobial therapy (OPAT) program project. Despite her extremely busy schedules for teaching and clinical services, she always tried her best to set aside her time to help me complete this project, and thanks to her help, the manuscript is almost completed. I am looking forward to continuing to have our good relationship from now on and cannot wait to work with her for any future opportunities!

I would also like to thank each of my other committee members, Dr. James E. Tisdale, Dr. Kevin M. Sowinski, Dr. Brian R. Overholser, and Dr. Sara K. Quinney for their continuous support, help, and guidance during my Ph.D. training in this department. Dr. Tisdale always showed his continuous support for my professional, academic growth. I really appreciate his willingness to share his experiences and insights with me. Dr. Sowinski first introduced me to the area of pharmacokinetic and pharmacodynamic modeling and got me interested in this area during my Pharm.D. program. I thank him for giving me the opportunity to work with him and learn from him when I was a Pharm.D. student. Dr. Overholser was my preceptor for my clinical research clerkship rotation, and it was that time when I started building my confidence in clinical research and pursuing Ph.D. in clinical pharmacy/clinical pharmaceutical science. I would like to acknowledge him for being such a great preceptor and mentor during the last year of my

Pharm.D. program. I was very lucky to have him as my preceptor in that month as it was an important time to make a career decision, and without him, I might have made another career decision and would not be where I am now. Last, but not least, I would like to offer my thanks to Dr. Sara K Quinney who has always provided the best guidance and support for me, especially as the one who had gone through what I am going through. She was very approachable, and always willing to hear my concerns and provide feedback to address my concerns. She did not hesitate providing me opportunities to learn other clinical pharmacology studies than what I have been doing. I extremely enjoyed having her and working with her throughout my Ph.D. program, and I am looking forward to holding this good relationship with her from now on.

Also, it is my pleasure to thank all other graduate students, especially those in Indianapolis (Noha, Tyler, and Stephanie), and the members of the pharmacy practice department for their work to provide such a nice and comfortable work environment. All my fellow graduate students have been my great listeners I can turn to when I have concerns, and they were great co-workers for teaching assistant work. They will be greatly missed! In addition, I would like to thank all the administrative personnel (Jan, Mindy, Kate, and previous members including Beth, Crystal, and Betty) in facilitating our graduate program.

In addition, I deeply thank my co-investigators, Dr. S. Christian Cheatham, Dr. David W. Smith, Dr. Megan R. Fleming, and Dr. Katherine M. Shea for their help with patient recruitment and study medication order. I would like to thank Dr. Daniel P. Healy and Dr. Joetta M. Juenke for their help with the sample analyses. Also, I acknowledge Dr. Robert R. Bies for generously providing NONMEM software, which was essential



for the completion of this work, through the Computing Resources of the Disease and Therapeutic Response Modeling Program of the Indiana CTSI (#TR000006). In addition to NONMEM software, Dr. Bies and his current and previous student/fellows (Claire H. Li, Eric A. Sherer, Nieves Velez de Mendizabal, Ayman Akil, and Abhishek Gulati) provided valuable insights and tips to me for the completion of this project, and their help is greatly appreciated! I look forward to working with them for our ongoing and future studies!

Last, but definitely not least, I would love to thank my family, my parents, and my “home-away mom”, Mary McKeever, for their continuous support and help throughout my education training in the United States. Words are not enough to say how much I love and appreciate them! They have tirelessly provided me with all the financial, emotional, and spiritual support one can ever think of. I would not be where I am now without their sacrifices, support, and encouragement! Hopefully, I can provide comfort, support, and happiness to them throughout my life as they have done for me.

## TABLE OF CONTENTS

	Page
LIST OF TABLES .....	xi
LIST OF FIGURES .....	xiii
LIST OF ABBREVIATIONS.....	xvi
ABSTRACT.....	xix
INTRODUCTION .....	1
Significance of Obesity in Healthcare .....	1
Prevalence of Obesity .....	1
Obesity and Infectious Diseases .....	2
Impact of Obesity on Pharmacokinetics and Pharmacodynamics of Drugs.....	3
Absorption.....	3
Distribution.....	4
Metabolism.....	9
Excretion .....	17
Significance of Altered Pharmacokinetics of Antimicrobial Agents in Obesity.....	27
Population Pharmacokinetic/Pharmacodynamic Approach.....	31
Antimicrobial Pharmacodynamics.....	35
Beta-Lactam Antibiotics: Focus on Piperacillin/Tazobactam, Meropenem, and Cefepime .....	40

	Page
Chemistry.....	40
Mechanisms of Action and Resistance.....	42
Spectrum of Activity.....	43
Pharmacokinetics and Pharmacodynamics of Piperacillin/Tazobactam, Meropenem, and Cefepime.....	44
Absorption.....	44
Distribution.....	44
Metabolism.....	46
Excretion.....	47
Summary of the Pharmacokinetics of Piperacillin/Tazobactam, Meropenem, and Cefepime.....	49
Beta-Lactam Pharmacodynamics.....	51
Previous Studies Regarding Effect of Obesity on the Pharmacokinetics of Piperacillin/Tazobactam, Meropenem, and Cefepime.....	55
Study Objectives.....	58
Notes.....	62
<b>DETERMINATION OF OPTIMAL PIPERACILLIN/TAZOBACTAM REGIMENS IN OBESE PATIENTS COMPARED TO NON-OBESE PATIENTS.....</b>	<b>83</b>
Study Objectives.....	83
Methods.....	84
Study Design and Pharmacokinetic Data.....	84
Population Pharmacokinetic Analysis.....	89
Pharmacodynamic Analysis Using Monte Carlo Simulations.....	99
Results.....	100

	Page
Patient Characteristics .....	100
Population Pharmacokinetic Analysis .....	101
Monte Carlo Simulation; Pharmacodynamic Analysis.....	128
Notes .....	131
<b>DETERMINATION OF OPTIMAL MEROPENEM REGIMENS IN OBESE PATIENTS COMPARED TO NON-OBESE PATIENTS.....</b>	<b>135</b>
Study Objectives .....	135
Methods.....	136
Study Design and Pharmacokinetic Data .....	136
Population Pharmacokinetic Analysis .....	143
Pharmacodynamic Analysis Using Monte Carlo Simulations.....	150
Results.....	151
Patient Characteristics .....	151
Population Pharmacokinetic Analysis .....	154
Monte Carlo Simulation; Pharmacodynamic Analysis.....	177
Notes .....	181
<b>DETERMINATION OF OPTIMAL CEFEPIME REGIMENS IN OBESE PATIENTS COMPARED TO NON-OBESE PATIENTS .....</b>	<b>184</b>
Study Objectives .....	184
Methods.....	185
Study Design and Pharmacokinetic Data .....	185
Population Pharmacokinetic Analysis .....	189
Pharmacodynamic Analysis Using Monte Carlo Simulations.....	196

	Page
Results.....	197
Patient Characteristics .....	197
Population Pharmacokinetic Analysis .....	199
Monte Carlo Simulation; Pharmacodynamic Analysis.....	243
Notes .....	246
DISCUSSION AND CONCLUSION .....	248
Piperacillin/Tazobactam in Obese Patients Compared to Non-Obese Patients .....	248
Meropenem in Obese Patients Compared to Non-Obese Patients.....	257
Cefepime in Obese Patients Compared to Non-Obese Patients.....	262
Conclusions and Future Directions .....	269
Notes .....	275
SELECTED BIBLIOGRAPHY.....	286
VITA.....	314
PUBLICATIONS.....	325

## LIST OF TABLES

Table	Page
1. Comparison of drug clearance mediated by specific CYP isoenzyme between obese and non-obese subjects .....	12
2. Comparison of drug clearance mediated by specific phase II metabolizing enzyme(s) between obese and non-obese subjects .....	15
3. Comparison of drug clearance mediated by glomerular filtration between obese and non-obese individuals.....	19
4. Comparison of drug clearance at least partially mediated by active tubular secretion between obese and non-obese individuals.....	21
5. Physicochemical properties of piperacillin, tazobactam, meropenem, and cefepime.....	45
6. Pharmacokinetic properties of piperacillin/tazobactam, meropenem, and cefepime.....	49
7. Inclusion and exclusion criteria for Study 1 and Study 2 .....	85
8. Patient demographics [median (range) unless otherwise stated] .....	100
9. Final population pharmacokinetic model parameters of piperacillin and tazobactam .....	108
10. Steady-state piperacillin and tazobactam pharmacokinetic parameters [median (range)] estimated by the final population pharmacokinetic model in non-obese and obese patients .....	126
11. Inclusion and exclusion criteria for Study 3, Study 4, and Study 5.....	137
12. Meropenem dosing schemes for each study .....	139
13. Blood sampling scheme for meropenem studies .....	140

Table	Page
14. Patient demographics [median (range) unless otherwise stated] .....	152
15. Comparison of selected meropenem structural pharmacokinetic models among all tested meropenem structural pharmacokinetic models .....	154
16. Comparison of meropenem covariate models developed during the stepwise forward addition process .....	156
17. Final population pharmacokinetic model parameters of meropenem .....	161
18. Steady-state meropenem pharmacokinetic parameters [median (range)] estimated by the final population pharmacokinetic model in non-obese and obese patients .....	176
19. Inclusion and exclusion criteria for Study 6, Study 7, and Study 8 .....	185
20. Cefepime dosing schemes for each study .....	187
21. Blood sampling scheme for cefepime studies .....	187
22. Patient demographics [median (range) unless otherwise stated] .....	198
23. Comparison of selected cefepime structural pharmacokinetic models among all tested structural pharmacokinetic models .....	199
24. Comparison of cefepime covariate models developed during the stepwise forward addition process .....	228
25. Final population pharmacokinetic model parameters of cefepime .....	230
26. Steady-state cefepime pharmacokinetic parameters [median (range)] estimated by the final population pharmacokinetic model in non-obese and obese patients...	243
27. Summary of the pharmacokinetics and pharmacodynamics of piperacillin/tazobactam, meropenem, and cefepime in obesity compared to non-obese patients .....	271

## LIST OF FIGURES

Figure	Page
1. General chemical structures of penicillins, cephalosporins, aztreonam (monobactam), carbapenems, and tazobactam .....	41
2. Chemical structures of piperacillin, tazobactam, meropenem, and cefepime.....	42
3. One-compartment structural model.....	90
4. Two-compartment structural model.....	91
5. Three-compartment structural model.....	92
6. Goodness-of-fit plots of the final population pharmacokinetic model for piperacillin .....	103
7. Goodness-of-fit plots of the final population pharmacokinetic model for tazobactam .....	104
8. Visual predictive checks of the final piperacillin population pharmacokinetic model for each piperacillin/tazobactam dosage regimen.....	109
9. Visual predictive checks of the final tazobactam population pharmacokinetic model for each piperacillin/tazobactam dosage regimen.....	110
10. Observed and final model-predicted serum piperacillin concentration-time profiles for all 27 patients .....	111
11. Observed and final model-predicted serum tazobactam concentration-time profiles for all 25 patients .....	118
12. Probability of target attainment (PTA) for piperacillin at $\geq 50\% fT > MIC$ for 3 prolonged infusion regimens of piperacillin/tazobactam at specific minimum inhibitory concentrations (MICs) in non-obese and obese patients.....	128



Figure	Page
13. Probability of target attainment (PTA) for tazobactam at %time>threshold for (a) $\geq 70\%$ and (b) 100% for 3 prolonged infusion regimens of piperacillin/tazobactam at specific threshold concentrations in non-obese and obese patients .....	130
14. Goodness-of-fit plots of the final meropenem population pharmacokinetic model.....	162
15. Visual predictive checks of the final meropenem population pharmacokinetic model for each dosage regimen .....	164
16. Observed and final model-predicted serum meropenem concentration-time profiles for all 40 patients .....	165
17. Probability of target attainment (PTA) for meropenem at $\geq 40\%$ $fT > MIC$ for 5 dosing regimens, infused over (a) 30 minutes and (b) either 3 hours for q6h regimens or 4 hours for q8h regimens at specific minimum inhibitory concentrations (MICs) in non- obese and obese patients with creatinine clearance $> 50$ mL/min .....	178
18. Probability of target attainment (PTA) for meropenem at $\geq 54\%$ $fT > MIC$ for 5 dosing regimens, infused over (a) 30 minutes and (b) either 3 hours for q6h regimens or 4 hours for q8h regimens at specific minimum inhibitory concentrations (MICs) in non- obese and obese patients with creatinine clearance $> 50$ mL/min .....	179
19. Observed and predicted serum cefepime concentration-time profiles for all 30 patients using Model I in Table 23 (a two-compartment model with inter-individual variability estimated for CL and V1, proportional residual error, zero-order input, and first-order, linear elimination) .....	202
20. Observed and predicted serum cefepime concentration-time profiles for all 30 patients using Model K in Table 23 (a two-compartment model with inter-individual variability estimated for CL and Q, proportional residual error, zero-order input, and first-order, linear elimination).....	210
21. Observed and predicted serum cefepime concentration-time profiles for all 30 patients using Model F in Table 23 (a one-compartment model with inter-individual variability estimated for both CL and V, proportional residual error, zero-order input, and first-order, linear elimination).....	218
22. Goodness-of-fit plots of the final cefepime population pharmacokinetic model.....	231

Figure	Page
23. Visual predictive checks of the final cefepime population pharmacokinetic model for all patients receiving each of the following three dosing regimen; 1 g every 8 hours, infused over 4 hours; 2 g every 8 hours, infused over 4 hours; and 1 g every 6 hours, infused over 30 minutes .....	234
24. Observed and final model-predicted serum cefepime concentration-time profiles for all 30 patients .....	235
25. Probability of target attainment (PTA) for cefepime at $\geq 60\%$ fT>MIC for five intermittent-infusion (infused over 30 minutes) regimens of cefepime at specific minimum inhibitory concentrations (MICs) in non-obese and obese patients ...	244
26. Probability of target attainment (PTA) for cefepime at $\geq 60\%$ fT>MIC for five prolonged-infusion (infused over either 3 hours for q6h regimens or 4 hours for q8h and q12h regimens) regimens of cefepime at specific minimum inhibitory concentrations (MICs) in non- obese and obese patients.....	245

## LIST OF ABBREVIATIONS

AIC	Akaike information criterion
AUC	Area under the serum drug concentration-time curve over a specific time period
BMI	Body mass index
CFR	Cumulative fraction of response
CFU	Colony forming unit(s)
CL	Clearance
$C_{\max}$	Maximum drug concentration
$C_{\text{peak}}$	Peak drug concentration
CRCL	Creatinine clearance
CYP	Cytochrome P450
FDA	Food and Drug Administration
FFW	Fat-free weight
FOCE	First-order conditional estimation
$f_{T>MCC}$	The fraction of a dosing interval that unbound drug concentrations remain above a minimum critical concentration

$f_{T>MIC}$	The length of time, as a percentage of the dosing interval, in which the unbound drug concentrations exceed the minimum inhibitory concentration of the bacterial pathogen
GFR	Glomerular filtration rate
GST	Glutathione S-transferases
HPLC	High-performance liquid chromatography
IBW	Ideal body weight
ICU	Intensive care unit
IV	Intravenous(ly)
LBW	Lean body weight
MIC	Minimum inhibitory concentration
min	Minute(s)
N/A	Not applicable
NAT	N-acetyltransferases
N/R	None reported
N/S	Not significant
OFV	Objective function value
$\Delta$ OFV	Change in the objective function value
PTA	Probability of target attainment
Q	Inter-compartmental distribution clearance
q6h	Every 6 hours

q8h	Every 8 hours
q12h	Every 12 hours
SCr	Serum creatinine concentration
SD	Standard deviation
SE	Standard error
SULT	Sulfotransferases
$t_{1/2}$	Half-life
TBW	Total body weight
%time>threshold	The fraction of a dosing interval that unbound drug concentrations remain above a threshold concentration
TRUST	Tracking Resistance in the United States Today
TVCL	Typical value of clearance
TVV	Typical value of volume of distribution
UGT	Uridine diphosphate glucuronosyltransferases
V	Volume of distribution
V1	Volume of distribution in the central compartment
V2	Volume of distribution in the peripheral compartment
VPCs	Visual predictive checks
V <sub>ss</sub>	Volume of distribution at steady-state

## ABSTRACT

Chung, Eun Kyoung. Pharm.D., Ph.D., Purdue University, May 2015. Beta-Lactam Antimicrobial Dosing Optimization in Obese Patients Compared to Non-Obese Patients Using Population Pharmacokinetic/Pharmacodynamic Approach. Major Professor: Michael B. Kays.

Obesity is a significant global health problem and has been associated with altered pharmacokinetics and pharmacodynamics of many drugs. However, little is known regarding the effect of obesity on the pharmacokinetics and pharmacodynamics of many broad-spectrum, beta-lactam antibiotics such as piperacillin/tazobactam, meropenem, and cefepime. The objective of this study is to evaluate the population pharmacokinetics and pharmacodynamics of piperacillin/tazobactam, meropenem, and cefepime in hospitalized obese patients in order to determine dosing regimens that provide similar exposures between obese and non-obese patients.

For piperacillin/tazobactam, a retrospective analysis was conducted using prospectively collected serum concentration-time data from two previous studies (Study 1 and Study 2) published by our research group. Hospitalized, adult patients who required antimicrobial therapy for a suspected or documented bacterial infection were eligible to participate in both studies. In Study 2, only patients with total body weight (TBW) greater than 120 kg were eligible to be enrolled. Patients were classified as either obese [body mass index (BMI)  $\geq 30$  kg/m<sup>2</sup>] or non-obese (BMI  $< 30$  kg/m<sup>2</sup>). In Study 1, all

patients received piperacillin/tazobactam 4.5 g every 8 hours (q8h), infused over 4 hours. In Study 2, patients received piperacillin/tazobactam either 4.5 g or 6.75 g q8h, infused over 4 hours. After 2 or more days of therapy, serial blood samples were collected from an indwelling IV catheter immediately prior to drug administration, and at 1, 2, 3, 4 (end of infusion), 5, 6, 7 and 8 hours after the start of infusion. Piperacillin and tazobactam serum concentrations were determined by the previously validated high performance liquid chromatography (HPLC) method. Population pharmacokinetic parameters were estimated using NONMEM, and the final pharmacokinetic model was built by evaluating the effects of covariates on the pharmacokinetic parameters of piperacillin and tazobactam using the stepwise forward inclusion followed by the backward elimination process. Tested covariates included: 1) age; 2) sex; 3) body size descriptor, including TBW, ideal body weight (IBW), lean body weight (LBW), and BMI; 4) creatinine clearance (CRCL); and 5) admission to an intensive care unit (ICU; ICU=1, general medical ward=0). In the stepwise forward inclusion process, covariates that reduced the model objective function value (OFV)  $> 3.84$  ( $p < 0.05$ ;  $\chi^2$  distribution; 1 *df*) were considered significantly associated with the pharmacokinetic parameters in the model. In the backward elimination process, a covariate was removed if its elimination increased the model OFV by  $< 5.024$  ( $p > 0.025$ ;  $\chi^2$  distribution; 1 *df*). Using the final pharmacokinetic model, Monte Carlo simulations were performed for three 4-hour dosing regimens to calculate probability of target attainment (PTA) using  $\geq 50\%$   $T > MIC$ .

Overall, a convenience sample of 27 patients (11 non-obese and 16 obese) were studied. TBW ranged from 60 kg to 211 kg, BMI from 19.7 kg/m<sup>2</sup> to 72.9 kg/m<sup>2</sup>, and

measured creatinine clearance (CRCL) from 23 mL/min to 260 mL/min. Patient demographics [median (range)] in non-obese vs. obese group are: age, 53 (27-76) vs. 48 (35-69) years; CRCL, 88 (23-148) vs. 111 (28-260) mL/min; height, 175 (163-190) vs. 175 (157-190) cm; TBW, 74 (60-100) vs. 151 (98-211) kg; LBW, 54 (39-72) vs. 78 (50-94) kg; IBW, 71 (55-84) vs. 71 (50-84) kg; BMI, 24.8 (19.7-29.4) vs. 50.1 (32.7-72.9) kg/m<sup>2</sup>. The number of male patients was seven in non-obese and ten in obese patient groups, and the number of patients admitted to an intensive care unit (ICU) was seven each in non-obese and obese patient groups. Compared to non-obese patients, obese patients had significantly larger TBW, LBW, and BMI ( $p < 0.05$ ); other demographics were similar between non-obese and obese patients. Observed serum concentration-time profiles of both piperacillin and tazobactam were best described by a one-compartment model with zero-order input and first-order, linear elimination. The final model for piperacillin was: clearance (CL; L/h) =  $11.3 + [0.0646 * (CRCL - 105)] + [0.0579 * (BMI - 35)]$ ; and volume of distribution (V; L) =  $31.3 + [0.132 * (TBW - 120)]$ . The final model for tazobactam was: CL (L/h) =  $10.1 + [0.0272 * (CRCL - 105)]$ ; and V (L) = 34.3. For both piperacillin and tazobactam, obese patients had significantly increased CL and V compared to non-obese patients. The pharmacokinetic parameters [median (range)] in non-obese vs. obese patients were: piperacillin CL, 9.0 (4.8-14.2) vs. 13.1 (6.8-20.0) L/h ( $p=0.026$ ); piperacillin V, 24.6 (17.1-37.8) vs. 32.5 (19.8-69.8) L ( $p=0.014$ ); tazobactam CL, 6.8 (4.4-15.5) vs. 13.1 (5.6-26.4) L/h ( $p=0.005$ ); and tazobactam V, 17.1 (9.4-70.3) vs. 45.5 (10.5-116.6) L ( $p=0.019$ ). Based on the pharmacodynamic analysis using Monte Carlo simulation, at the piperacillin MICs  $\leq 16$  mg/L in the presence of tazobactam, which is the susceptibility breakpoint for Enterobacteriaceae and *Pseudomonas*



*aeruginosa*, PTA was > 90% for 4-hour infusion dosing regimens  $\geq 3.375$  g q8h in non-obese patients and  $\geq 4.5$  g q8h in obese patients, respectively.

For meropenem, a retrospective analysis was conducted using prospectively collected serum concentration-time data from three previous studies (Study 3, Study 4, and Study 5) published by our research group. Hospitalized, adult patients who required antimicrobial therapy for a suspected or documented bacterial infection were eligible to participate in all three studies. Although patients with CRCL less than 50 mL/min were eligible to participate in Study 3, they were excluded in Study 4 and 5 due to different study objectives. In Study 3, only patients with BMI  $\geq 40$  kg/m<sup>2</sup> were enrolled, and in Study 4, only patients with BMI  $\geq 40$  kg/m<sup>2</sup> or TBW  $\geq 100$  pounds over their IBW were enrolled. Patients were classified as either obese (BMI  $\geq 30$  kg/m<sup>2</sup>) or non-obese (BMI < 30 kg/m<sup>2</sup>). In Study 3, patients received the following meropenem dosing regimens: 500 mg q6h if CRCL > 60 mL/min; 500 mg q8h if CRCL was 40 to 60 mL/min; and 500 mg q12h if CRCL was 10 to 39 mL/min. In Study 4, all patients received either 500 mg or 1000 mg q6h. In Study 5, all patients received 1000 mg q8h. In all studies, all dosing regimens were infused over 30 minutes. After 2 or more days of therapy, serial blood samples were collected from an indwelling IV catheter as scheduled in each study: immediately prior to drug administration, 0.5 (end of infusion), 0.75, 1, 1.5, 2, 3, 4, 5, 6, 8 (if receiving q8h or q12h dosing regimens), and 12 hours (if receiving q12h dosing regimens) after the start of infusion in Study 3; prior to drug administration, 0.5 (end of infusion), 1, 2, 3, 4, and 6 hours after the start of infusion in Study 4; and prior to drug administration, 0.5 (end of infusion), 1, 1.5, 2, 3, 4, 5, 6, and 8 hours after the start of infusion in Study 5. Serum meropenem concentrations were determined by previously

described analytical methods: HPLC in Study 3 and Study 4; and ultraperformance liquid chromatography in Study 5. Population pharmacokinetic parameters were estimated using NONMEM, and the final pharmacokinetic model was built by evaluating the effects of covariates on the meropenem pharmacokinetic parameters using the stepwise forward inclusion followed by the backward elimination process. Tested covariates included: 1) age; 2) sex; 3) body size descriptor, including TBW, IBW, LBW, and BMI; 4) CRCL; and 5) admission to an ICU (ICU=1, general medical ward=0). In the stepwise forward inclusion process, covariates that reduced the model OFV  $> 3.84$  ( $p < 0.05$ ;  $\chi^2$  distribution; 1 *df*) were considered significantly associated with the pharmacokinetic parameters in the model. In the backward elimination process, a covariate was removed if its elimination increased the model OFV by  $< 5.024$  ( $p > 0.025$ ;  $\chi^2$  distribution; 1 *df*). Using the final pharmacokinetic model, Monte Carlo simulations were performed for five different meropenem dosing regimens to calculate PTA using  $\geq 40\%$  of  $T > MIC$ . Each dosing regimen was simulated as 30-minute infusion, 3-hour infusion for q6h regimens, and 4-hour infusion for q8h and q12h regimens.

Overall, a convenience sample of 40 patients (11 non-obese and 29 obese) were studied. TBW ranged from 57 kg to 305 kg, BMI from 19.2 kg/m<sup>2</sup> to 88.8 kg/m<sup>2</sup>, and CRCL from 15 mL/min to 186 mL/min. Patient demographics [median (range)] in non-obese vs. obese group are: age, 59 (20-79) vs. 57 (26-76) years; CRCL, 58 (15-182) vs. 87 (20-186) mL/min; height, 170 (165-183) vs. 170 (150-193) cm; TBW, 72 (57-88) vs. 149 (73-305) kg; LBW, 49 (40-66) vs. 66 (38-114) kg; IBW, 64 (57-78) vs. 64 (34-87) kg; BMI, 25.0 (19.2-28.6) vs. 53.7 (30.6-88.8) kg/m<sup>2</sup>. The number of male patients was seven in non-obese and 13 in obese patient groups, and the number of patients admitted

to an intensive care unit (ICU) was seven in non-obese and 18 in obese patient groups. Compared to non-obese patients, obese patients had significantly larger TBW, LBW, and BMI ( $p < 0.05$ ); other demographics were similar between non-obese and obese patients. Observed serum concentration-time profiles of meropenem were best described by a two-compartment model with zero-order input and first-order, linear elimination from the central compartment. The final meropenem model was:  $CL \text{ (L/h)} = 8.62 * (CRCL/85)^{0.533}$ ; volume of distribution in the central compartment ( $V1; \text{L}$ ) = 13.6; inter-compartmental distribution clearance ( $Q; \text{L/h}$ ) = 11.8; and volume of distribution in the peripheral compartment ( $V2; \text{L}$ ) = 14.5. There was no significant difference in CL, V1, Q, and V2 between non-obese and obese patient groups. The meropenem pharmacokinetic parameters [median (range)] in non-obese vs. obese patients were: CL, 5.5 (3.3-17.7) vs. 8.2 (3.0-18.1) L/h; V1, 14.3 (10.1-20.7) vs. 12.3 (5.6-47.4) L; Q, 10.8 (5.0-25.9) vs. 14.6 (0.6-66.4) L/h; and V2, 12.6 (9.7-20.1) vs. 14.5 (5.6-27.1) L. Based on the pharmacodynamic analysis using Monte Carlo simulation, at MICs  $\leq 2$  mg/L, which is the susceptibility breakpoint for *Pseudomonas aeruginosa*, PTA was  $> 90\%$  for dosing regimens  $\geq 500$  mg q8h in both non-obese and obese patient groups.

For cefepime, a retrospective analysis was conducted using prospectively collected serum concentration-time data from three previous studies (Study 6, Study 7, and Study 8) published by our research group. Hospitalized, adult patients who required antimicrobial therapy for a suspected or documented bacterial infection were eligible to participate in all three studies. In Study 8, only patients with BMI  $\geq 40$  kg/m<sup>2</sup> were enrolled while in Study 6 and Study 7, there was no weight restriction in the inclusion and exclusion criteria. Patients were classified as either obese (BMI  $\geq 30$  kg/m<sup>2</sup>) or non-

obese ( $BMI < 30 \text{ kg/m}^2$ ). In Study 6, patients received cefepime 1 g q6h if CRCL was  $\geq 60 \text{ mL/min}$  and 1 g q8h or q12h if CRCL was  $< 60 \text{ mL/min}$ . Patients received 1 g q8h in Study 7 and 2 g q8h in Study 8, respectively. All doses were infused over 30 minutes in Study 6 and over 4 hours in Study 7 and Study 8. After 2 or more days of therapy, serial blood samples were collected from an indwelling IV catheter as scheduled in each study: immediately prior to drug administration, 0.5 (end of infusion), 0.75, 1, 1.5, 2, 3, 4, 6, 8 (if receiving q8h dosing regimens), and 12 hours (if receiving q12h dosing regimens) after the start of infusion in Study 6; and prior to drug administration, 1, 2, 3, 4 (end of infusion), 5, 6, 7, and 8 hours after the start of infusion in Study 7 and 8. Serum cefepime concentrations were determined by previously described HPLC method. Population pharmacokinetic parameters were estimated using NONMEM, and the final pharmacokinetic model was built by evaluating the effects of covariates on the cefepime pharmacokinetic parameters using the stepwise forward inclusion followed by the backward elimination process. Tested covariates included: 1) age; 2) sex; 3) body size descriptor, including TBW, IBW, LBW, and BMI; 4) CRCL; and 5) admission to an ICU (ICU=1, general medical ward=0). In the stepwise forward inclusion process, covariates that reduced the model OFV  $> 3.84$  ( $p < 0.05$ ;  $\chi^2$  distribution; 1 *df*) were considered significantly associated with the pharmacokinetic parameters in the model. In the backward elimination process, a covariate was removed if its elimination increased the model OFV by  $< 5.024$  ( $p > 0.025$ ;  $\chi^2$  distribution; 1 *df*). Using the final pharmacokinetic model, Monte Carlo simulations were performed for five different cefepime dosing regimens to calculate PTA using  $\geq 60\%T > MIC$ . Each dosing regimen was simulated as

30-minute infusion, 3-hour infusion for q6h regimens, and 4-hour infusion for q8h and q12h regimens.

Overall, a convenience sample of 30 patients (10 non-obese and 20 obese) were studied. TBW ranged from 54 kg to 276 kg, BMI from 18.5 kg/m<sup>2</sup> to 92.5 kg/m<sup>2</sup>, and CRCL from 20 mL/min to 205 mL/min. Patient demographics [median (range)] in non-obese vs. obese group are: age, 44 (21-70) vs. 59 (32-81) years; CRCL, 101 (56-180) vs. 92 (20-205) mL/min; height, 178 (147-190) vs. 171 (147-183) cm; TBW, 74 (54-97) vs. 110 (81-276) kg; LBW, 60 (36-71) vs. 64 (42-96) kg; IBW, 73 (41-84) vs. 64 (41-78) kg; BMI, 22.5 (18.5-29.8) vs. 39.2 (30.9-92.5) kg/m<sup>2</sup>. The number of male patients was eight in non-obese and 13 in obese patient groups, and the number of patients admitted to an intensive care unit (ICU) was four in non-obese and 12 in obese patient groups.

Compared to non-obese patients, obese patients were significantly older and had significantly larger TBW and BMI ( $p < 0.05$ ); other demographics were similar between non-obese and obese patients. Observed serum concentration-time profiles of cefepime were best described by a one-compartment model with zero-order input and first-order, linear elimination. The final cefepime model was:  $CL \text{ (L/h)} = 8.06 + [0.0598 * (CRCL - 90)]$ ; and  $V \text{ (L)} = 39.2 + [0.323 * (TBW - 95)]$ . Obese patients had significantly increased V compared to non-obese patients ( $p < 0.05$ ), but CL was similar between non-obese and obese patients. The cefepime pharmacokinetic parameters [median (range)] in non-obese vs. obese patients were: CL, 8.0 (5.0-12.6) vs. 7.5 (3.6-27.9) L/h; and V, 27.6 (22.1-48.8) vs. 50.0 (19.3-94.5) L. Based on the pharmacodynamic analysis using Monte Carlo simulation, at MICs  $\leq 2$  mg/L, which is the susceptibility breakpoint for Enterobacteriaceae, PTA was  $> 90\%$  for dosing regimens  $\geq 1$  g q12h in both non-obese

and obese patient groups. At an MIC of 4 mg/L, PTA was > 90% for dosing regimens  $\geq$  1 g q8h in non- obese patients and  $\geq$  1 g q12h in obese patients. At an MIC of 8 mg/L, which is the susceptibility breakpoint for *Pseudomonas aeruginosa*, PTA was > 90% for 30-minute infusions of 1 g q6h and 2 g q8h in non- obese patients and dosing regimens  $\geq$  1 g q8h in obese patients. When prolonging the infusion times to 3 to 4 hours, dosing regimens  $\geq$  1 g q12h achieved the PTA > 90% at MICs  $\leq$  4 mg/L in both non-obese and obese patient groups. The PTA at an MIC of 8 mg/L was > 90% for prolonged-infusion dosing regimens  $\geq$  1 g q8h in both non-obese and obese patient groups

In conclusion, piperacillin and tazobactam pharmacokinetics are altered in obesity, and larger doses ( $\geq$  4.5 g q8h), infused over 4 hours, may be needed to provide similar exposures in obese patients compared with non-obese patients receiving  $\geq$  3.375 g q8h doses, infused over 4 hours. In contrast, meropenem pharmacokinetics are similar between obese and non-obese patients, so same dosages provide comparable pharmacodynamic exposures for susceptible organisms between obese and non-obese patients. Although cefepime pharmacokinetics are altered in obesity, same dosing regimens achieve similar pharmacodynamic exposures for susceptible organisms between obese and non-obese patients.

## INTRODUCTION

### Significance of Obesity in Healthcare

#### Prevalence of Obesity

Obesity is a major global health problem. The global obesity rate has been gradually increasing over the last three decades, and according to the World Health Organization, it has now reached epidemic numbers in many countries (Stevens et al. 2012; Food and Agriculture Organization of the United Nations, 2013; World Health Organization, 2014). In 2008, approximately 35% of adults were overweight (body mass index [BMI]  $\geq 25$  kg/m<sup>2</sup>) and 1 in every 9 adults were obese (BMI  $\geq 30$  kg/m<sup>2</sup>) globally. Obesity used to be considered a health problem only in Western, developed countries; however, as of 2008, the prevalence of obesity in the United States was lower than 20 other countries, most of which are non-Western countries (Food and Agriculture Organization of the United Nations, 2013; World Health Organization, 2014). In the United States, the overweight and obesity rates were 69.0% and 35.1%, respectively, in 2011-2012 (Ogden et al. 2014). Although the global prevalence of morbid obesity (BMI  $\geq 40$  kg/m<sup>2</sup>) is not well documented, some countries reported rates of morbid obesity: 4.4% of adult men and 8.3% of adult women in the United States in 2011-2012; 1.7% of

adult men and 3.1% of adult women in England in 2012 (Ogden et al. 2014; Public Health England, 2014). As the prevalence of obesity and morbid obesity increases, these patients are more likely to be encountered in clinicians' daily practices.

### Obesity and Infectious Diseases

Obesity is well known to increase morbidity and mortality of many diseases, including infectious diseases, cardiovascular diseases, and diabetes mellitus. In a previous study evaluating obesity-related mortality rate in an adult intensive care unit (ICU), obesity was significantly associated with increased ICU mortality due to higher risk of infectious complications, such as ventilator-associated pneumonia (Bercault et al. 2004). According to another previous study comparing the rate of nosocomial infections in surgical obese and non-obese patients, the rate of nosocomial infections, including wound infections, *Clostridium difficile* infection, pneumonia, and bacteremia, was significantly higher in obese patients compared to non-obese patients (Choban et al. 1995). The increased susceptibility and severity of infection in obese patients may be due to altered immunologic and inflammatory response associated with obesity (Falagas and Kompoti, 2006). In addition to increased risk of infection, obesity is significantly associated with antimicrobial treatment failure (Longo et al. 2013). In fact, in a recent study evaluating clinical outcomes in patients with complicated intra-abdominal infections, the infection cure rate in patients receiving piperacillin/tazobactam 3.375 g q6h intravenously (IV) infused over 30 minutes was lower in obese patients compared with non-obese patients (65% vs. 86%) (Zakrison et al. 2012). However, significantly more patients in the obese group had nonappendiceal diseases, mostly abscess, which



might have contributed to worse outcome (Zakrison et al. 2012). Also, obese group included more female patients compared to non-obese group, but the effect of sex difference on the clinical outcome of complicated intra-abdominal infections is not known yet (Zakrison et al. 2012). Another explanation for this lower treatment success rate in obese patients may be altered physiologic processes associated with obesity, which, in turn, may lead to changes in pharmacokinetics of many drugs.

### Impact of Obesity on Pharmacokinetics and Pharmacodynamics of Drugs

#### Absorption

There are limited data regarding the effect of obesity on drug absorption. Obesity is associated with higher cardiac output and significantly delayed gastric emptying time. Cardiac output was proportionally increased to the extent of obesity because of increased stroke volume (Alpert and Hashimi, 1993). According to a study evaluating gastric emptying time using  $^{13}\text{C}$ -octanoic acid in obese subjects compared to non-obese subjects, gastric emptying was significantly delayed in obesity compared to non-obesity (Jackson et al. 2004). This delayed gastric emptying may potentially lead to changes in the pharmacokinetics of orally administered drugs. However, perfusion and gastric emptying time cannot entirely determine the absorption of the drug; other factors such as physicochemical properties of the drug including molecular weight and lipophilicity play a role in the absorption process (Rowland and Tozer, 2011a). Actually, previous studies reported similar maximum concentration ( $C_{\text{max}}$ ), time to reach maximum or peak concentration ( $T_{\text{max}}$  or  $T_{\text{peak}}$ ), and bioavailability for orally administered cyclosporine,

dexfenfluramine, midazolam, and propranolol between obese individuals and non-obese individuals, suggesting no significant effect of obesity on the rate and extent of absorption of these drugs (Flechner et al. 1989; Cheymol, et al. 1995; Greenblatt et al. 1984; Bowman et al. 1986). Also, according to a recent study in otherwise healthy obese individuals with a BMI > 35 kg/m<sup>2</sup>, the C<sub>max</sub>, T<sub>max</sub>, and bioavailability for linezolid were comparable before and after Roux-en-Y gastric bypass surgery (Hamilton et al. 2013). These data suggest that obesity-associated alterations in the gastrointestinal tract physiology may not necessarily alter drug absorption. Additional studies are needed to determine whether the altered gastrointestinal tract physiology in obesity affects the absorption of many other orally administered drugs.

#### Distribution

In obese individuals, drug distribution is often altered due to several factors related to the changes in physiologic processes associated with obesity, but the direction and magnitude of the altered drug distribution depend on physicochemical properties of the drug such as its molecular weight, protein binding, and lipophilicity (Pai and Bearden, 2007; Jain et al. 2011). Obesity-related physiologic alterations which can impact the drug distribution include increased adipose tissue mass, increased lean body mass, increased tissue perfusion, increased cardiac output, and potentially increased plasma and tissue protein concentrations. The apparent volume of distribution (V) is the key pharmacokinetic parameter to describe the drug distribution in the body.

For many antimicrobial agents, obese patients can have larger V compared to non-obese patients (Janson and Thursky, 2012). This is intuitive for lipophilic

antibiotics, such as fluoroquinolones, because higher uptake of the drug into adipose tissue occurs in obesity due to increased absolute amount and relative proportion of adipose tissue in the obese patient compared to non-obese patient (Hanley et al. 2010; Jain et al. 2011). According to a previous study comparing the pharmacokinetics of single-dose 400 mg intravenous ciprofloxacin between obese (n=17) and non-obese (n=11) subjects, obese subjects had significantly lower  $C_{max}$ , smaller area under the concentration-time curve ( $AUC_{0-\infty}$ ), and larger steady-state V compared to non-obese subjects (Allard et al. 1993). Therefore, the doses of these drugs are generally escalated in obesity or based on total body weight (TBW) (Hanley et al. 2010). For hydrophilic antimicrobial agents, such as vancomycin and certain beta-lactams, V can also be increased in obesity because 1) obese individuals tend to have larger lean body weight (LBW) compared to non-obese individuals, 2) approximately 30% of adipose tissue consists of water, and 3) plasma volume is positively correlated with TBW (Pearson et al. 1995; Janmahasatian et al. 2005; Falagas and Karageorgopoulos, 2010; Hanley et al. 2010). In a previous study evaluating the effect of obesity on vancomycin pharmacokinetics, obese patients had significantly larger vancomycin V compared to non-obese patients (Vance-Bryan et al. 1993). Similar finding was reported in another study comparing vancomycin pharmacokinetics between morbidly obese and normal-weight subjects; compared to normal-weight individuals, morbidly obese individuals had significantly larger steady-state V of vancomycin (Blouin et al. 1982). According to another previous study comparing the pharmacokinetics and pharmacodynamics of ertapenem, a carbapenem beta-lactam antibiotic, among normal-weight (n=10), obese (n=10), and morbidly obese subjects (n=10), morbidly obese individuals had significantly

larger ertapenem  $V$  in the central compartment compared to normal weight or obese individuals; however, obese and normal-weight volunteers had similar ertapenem  $V$  in the central compartment (Chen et al. 2006). Therefore, although the magnitude of alterations in  $V$  may be different between lipophilic and hydrophilic drugs, obese individuals can have increased  $V$  compared to non-obese individuals for both lipophilic and hydrophilic drugs.

Theoretically, the drug distribution into excess body weight can be understood by comparing TBW-normalized  $V$  between obese and non-obese individuals (Hanley et al. 2010). For drugs with substantial uptake into adipose tissue such as lipophilic drugs, the TBW-normalized  $V$  is similar between obese and non-obese individuals. According to a previous study evaluating the pharmacokinetics of lorazepam (a lipophilic drug),  $V$  was significantly larger in obese individuals compared to non-obese individuals, and TBW-normalized  $V$  was similar between obese and non-obese individuals (Abernethy et al. 1983). Similarly, for trazodone (another lipophilic drug), both  $V$  and TBW-normalized  $V$  were significantly larger in obese subjects compared to control subjects. This significantly larger TBW-normalized  $V$  of trazodone in obesity compared to normal-weight individuals may be due to non-linear (e.g., power or exponential) relationship between trazodone  $V$  and TBW, suggesting more than proportional increase in trazodone  $V$  to the increase in TBW (Greenblatt et al. 1987). Therefore, these studies suggested lorazepam and trazodone are substantially distributed into excess body weight in obese individuals compared to normal-weight individuals as expected from their lipophilicity. Conversely, for drugs with incomplete or lack of distribution into excess body weight such as hydrophilic drugs, TBW-normalized  $V$  is significantly lower in obese individuals

compared to non-obese individuals. In a previous study evaluating the influence of weight on the pharmacokinetics of aminoglycosides (hydrophilic drugs) in normal-weight and obese patients, obese patients had significantly larger V compared to normal-weight patients for gentamicin, tobramycin, and amikacin (23.31 vs. 17.01 L, 29.01 vs. 18.31 L, 26.81 vs. 18.61 L, respectively;  $P < 0.01$ ) (Bauer et al. 1983). When V was normalized to TBW, obese patients had significantly smaller TBW-normalized V compared to normal-weight patients for gentamicin, tobramycin, and amikacin (0.17 vs. 0.25 L/kg, 0.19 vs. 0.26 L/kg, 0.18 vs. 0.26 L/kg, respectively;  $P < 0.01$ ). Therefore, this study suggested aminoglycosides (hydrophilic drugs) are substantially, but not completely, distributed into excess body weight in obesity. However, lipophilicity/hydrophilicity of the drug is not the only factor that determines the direction and magnitude of the change in V in obesity compared to non-obese individuals. Actually, in previous studies evaluating the pharmacokinetics of atracurium, cyclosporine, and digoxin, V for each drug was similar between obese and non-obese individuals, but TBW-normalized V for each drug was significantly smaller in obese individuals compared to control individuals (Varin et al. 1990; Flechner et al. 1989; Abernethy et al. 1981b). Although atracurium, cyclosporine, and digoxin are all considered lipophilic drugs, these previous studies suggested incomplete distribution of these drugs into excess fat tissue in obesity. However, compared to trazodone and lorazepam, atracurium, cyclosporine, and digoxin are less lipophilic, which may have resulted in similar V and significantly smaller TBW-normalized V between obese and control individuals. Conversely, although caffeine is considered a hydrophilic agent, a previous study suggested significantly larger V of caffeine in obese subjects compared to control subjects, but comparable TBW-

normalized  $V$  of caffeine between obese and control subjects (Abernethy et al. 1985). Therefore, predicting the direction and magnitude of the change in  $V$  of a specific drug solely based on its hydrophilicity/lipophilicity is challenging, and other factors such as protein binding should be considered. Ideally, each drug should be studied in obese patients compared to non-obese patients to understand any difference in its  $V$  between obese and non-obese individuals.

In addition to the lipophilicity/hydrophilicity of the drug, protein binding is another important characteristic in determining drug distribution. Two major plasma binding proteins include albumin and  $\alpha$ 1-acid glycoprotein. According to previous studies, contradictory data have been published regarding the effect of obesity on protein binding (Benedek et al. 1983; Benedek et al. 1984; Cheymol, 1987). In previous studies comparing serum binding protein concentrations and the binding of drugs between obese and non-obese individuals, obese subjects had comparable albumin concentrations to non-obese subjects; however, obese individuals had significantly higher serum  $\alpha$ 1-acid glycoprotein concentrations compared to non-obese individuals (Benedek et al. 1983; Benedek et al. 1984). Accordingly, the unbound fraction of phenytoin, which is primarily bound to albumin, was comparable between obese and non-obese subjects; for propranolol, which is primarily bound to  $\alpha$ 1-acid glycoprotein, the unbound fraction was significantly smaller in obese volunteers compared to non-obese volunteers (Benedek et al. 1983; Benedek et al. 1984). In contrast, in another previous study evaluating the pharmacokinetics of propranolol, plasma  $\alpha$ 1-acid glycoprotein concentrations were similar between obese and non-obese volunteers, so the bound fraction of propranolol was comparable between obese and non-obese subjects; however, plasma albumin

concentrations were significantly lower in obese individuals compared to non-obese individuals (Cheymol et al. 1987). In conclusion, the effect of obesity on protein binding appears inconclusive based on currently available data.

## Metabolism

The liver is the principal organ of drug metabolism. Obesity is associated with non-alcoholic steatohepatitis, and the fatty infiltration in the liver of obese individuals may damage the liver function and consequently, alter hepatic drug metabolism (Hanley et al. 2010; Jain et al. 2011; Brill et al. 2012). A previous study evaluated the impact of steatosis on cytochrome P450 (CYP) enzymes using the following substrates for the each CYP isoenzyme: 7-methoxyresorufin for CYP1A2, coumarin for CYP2A6, diclofenac for CYP2C9, chlozoxazone for CYP2E1, and testosterone for CYP3A4 (Donato et al. 2006). According to this previous study, CYP1A2 and 3A4 activities were significantly decreased in human liver microsomes prepared from steatotic human liver grafts compared to nonsteatotic human liver grafts; however, the activities of other CYP isoenzymes were similar between steatotic and nonsteatotic human liver grafts. Similarly, in animal models of steatosis without inflammation, liver microsomal CYP2E1 and CYP3A protein quantities were significantly decreased in both ducks and rats with induced steatosis without inflammation compared to control animals (Leclercq et al. 1998). However, in a study using an animal model of nutritionally-induced hepatic steatosis with confirmed histologic inflammation, hepatic microsomal CYP2E1 protein quantity and mRNA concentrations were significantly increased in the rats with hepatic steatosis with inflammation compared to control rats; in terms of the activities of other

CYP isoenzymes when assessed by microsomal catalytic activities using testosterone hydroxylation, activities of CYP2C11, CYP3A2, and CYP2A1 were significantly reduced in the steatohepatitis rat group compared to the control group (Weltman et al. 1996). Similarly, in a clinical study of nonalcoholic steatohepatitis patients to evaluate hepatic CYP2E1 and CYP3A activities by immunohistochemistry, CYP2E1 immunostaining intensity was increased, but CYP3A immunostaining intensity was decreased in nonalcoholic steatohepatitis patients compared to control liver tissue samples without steatohepatitis (Weltman et al. 1998). In addition, obesity is associated with increased blood volume, heart size, cardiac output, and splanchnic blood flow, which may increase hepatic blood flow and result in increased hepatic drug metabolism of high extraction ratio drugs (Alexander et al. 1962-1963; Alexander, 1964; Brill et al. 2012). Actually, in a previous study evaluating the population pharmacokinetics of continuous-infusion propofol, a high extraction ratio drug, propofol CL was significantly positively associated with total body weight ( $p < 0.01$ ) (Cortinez et al. 2010). However, obesity-associated non-alcoholic steatohepatitis may lead to sinusoidal narrowing, which may consequently decrease liver blood flow (Farrell et al. 2008). In a previous study evaluating the pharmacokinetics of lidocaine, another high extraction drug, lidocaine CL was similar between obese and control individuals in both men and women (Abernethy and Greenblatt, 1984). Therefore, the effect of obesity-associated morphological and functional alterations of the liver on drug metabolism appears to be drug-specific and depends on the extent of increased perfusion and the presence/severity of nonalcoholic fatty liver diseases.



Regarding phase I metabolizing enzymes, the direction and magnitude of the changes in the phase I drug metabolism appears to be isoenzyme-specific. Antipyrine is a commonly used drug to assess the hepatic oxidative metabolism capacity in humans because approximately 84-99% of a dose is excreted into urine as metabolites (Uchino et al. 1983; Engel et al. 1996). The CYP450 enzymes involved in the primary metabolic pathways for antipyrine include CYP1A2, 2B6, 2C8, 2C9, 2C18, and 3A, all of which account for approximately 50-80% of a given dose (Engel et al. 1996). Two previous studies compared the pharmacokinetics of antipyrine between obese and non-obese patients, and both studies found no significant difference in CL between obese and non-obese volunteers (Abernethy et al. 1981a; Caraco et al. 1995). However, either study did not investigate individual metabolic pathways of antipyrine metabolism in obese subjects compared to non-obese subjects. Actually, previous studies reported isoenzyme-specific changes in CYP450 activity in obesity (Jain et al. 2011; Brill et al. 2012; Janson and Thursky, 2012). Table 1 summarizes the comparison of drug clearance (CL) mediated by specific CYP isoenzyme between obese and non-obese subjects.

Table 1. Comparison of drug clearance mediated by specific CYP isoenzyme between obese and non-obese subjects

Substrate (route of administration)	CYP	Clearance				Reference
		Parameter	Obese <sup>a</sup>	Non-Obese <sup>a</sup>	P-value	
Triazolam (PO)	3A	CL/F	340 ± 44 mL/min	531 ± 38 mL/min	< 0.025	Abernethy et al. 1984
Midazolam (IV)	3A	CL	472 ± 38 mL/min	530 ± 34 mL/min	> 0.05	Greenblatt et al. 1984
Chlorzoxazone (PO)	2E1	CL <sub>w</sub> /F	27.5 (9.1-55.6) mL/min	9.9 (3.2-49.4) mL/min	< 0.001	Emery et al. 2003
Chlorzoxazone (PO)	2E1	CL <sub>w</sub> /F	26.8 (9.11-55.6) mL/min	16.6 (7.70-45.0) mL/min <sup>b</sup>	< 0.05	Emery et al. 2003
Chlorzoxazone (PO)	2E1	CL <sub>w</sub> /F	26.8 (9.11-55.6) mL/min	19.5 (7.65-50.4) mL/min <sup>c</sup>	> 0.05	Emery et al. 2003
Dexfenfluramine (IV)	2D6	CL	43.9 ± 21.0 L/h	37.3 ± 10.6 L/h	> 0.05	Cheyamol et al. 1995
Nebivolol (IV)	2D6	CL	71.6 ± 17.4 L/h	51.6 ± 11.6 L/h	< 0.05	Cheyamol et al. 1997
Caffeine (PO)	1A2	CL/F	135 ± 14 mL/min	112 ± 12 mL/min	> 0.05	Abernethy et al. 1985
Caffeine (PO)	1A2	CL/F	355.4 ± 119.4 mL/min	219.4 ± 45.4 mL/min	> 0.05	Kamimori et al. 1987

Table 1. Continued. Comparison of drug clearance mediated by specific CYP isoenzyme between obese and non-obese subject

Substrate (route of administration)	CYP	Clearance				Reference
		Parameter	Obese <sup>a</sup>	Non-Obese <sup>a</sup>	P-value	
Ibuprofen (PO)	2C9	CL/F	83.2 ± 5.8 mL/min	59.2 ± 4.1 mL/min	< 0.005	Abernethy and Greenblatt, 1985a
Phenytoin (IV)	2C9	CL <sub>metabolic</sub>	59 ± 10 mL/min	39 ± 3 mL/min	> 0.05	Abernethy and Greenblatt, 1985b
Diazepam (IV)	2C19	CL	38.1 (19.5-80.3) mL/min	27.3 (19.5-50.7) mL/min	< 0.025	Abernethy et al. 1981a
Desmethyldiazepam (PO)	2C19	CL	13.2 (7.4-18.2) mL/min	13.4 (5.7-21.8) mL/min	> 0.05	Abernethy et al. 1982b

<sup>a</sup> Data are presented as either mean ± standard deviation or median (range)

<sup>b</sup> Same patients at 6 weeks after vertical banded gastroplasty surgery for weight loss [Pre- and Post-surgery median (range) total body weight: 172 (104-273) kg vs. 145 (95-247 kg); P < 0.001]

<sup>c</sup> Same patients at 1 year after vertical banded gastroplasty surgery for weight loss [Pre- and Post-surgery median (range) total body weight: 172 (104-273) kg vs. 118 (61-208 kg); P < 0.001]

Abbreviations: CYP, cytochrome P450; PO, oral; IV, intravenous; CL/F, apparent oral clearance; CL, clearance; CL<sub>u</sub>/F, apparent unbound oral clearance; CL<sub>metabolic</sub>, metabolic clearance

Based on previous studies for specific isoenzymes (Table 1), the effect of obesity on CYP enzymes appears to be isoenzyme-specific. Obese individuals appear to have lower CYP3A, higher 2E1, and similar 1A2 activities compared to non-obese individuals; however, no conclusive data are available for CYP 2D6, 2C9, and 2C19 activities (Table 1). However, it should be noted that although the isoenzyme paired with each drug in Table 1 is the major elimination pathway for the drug, it is not the only elimination pathway for some drugs in Table 1 (e.g., dexfenfluramine). Also, other physiologic characteristics, such as liver blood flow, can also play a role in their CL (e.g., nebivolol). Therefore, cautions should be exercised when interpreting the results of the studies presented in Table 1.

Similar to phase I metabolizing enzymes, the direction and magnitude of the changes in the phase II drug metabolism appears to be enzyme-specific (Jain et al. 2011; Brill et al. 2012; Janson and Thursky, 2012). Table 2 summarizes the previous studies reporting the comparison of drug CL mediated by specific phase II metabolizing enzymes between obese and non-obese subjects.

Table 2. Comparison of drug clearance mediated by specific phase II metabolizing enzyme(s) between obese and non-obese subjects

Substrate (route of administration)	Enzyme(s)	Clearance Parameter	Clearance			Reference	
			Obese <sup>a</sup>	Non-Obese <sup>a</sup>	P-value		
Acetaminophen (IV)	UGT, SULT	CL	484 (324-646) mL/min (men)	323 (199-489) mL/min (men)	< 0.05	Abernethy et al. 1982a	
Acetaminophen (IV)	UGT, SULT	CL	312 (217-462) mL/min (women)	227 (149-338) mL/min (women)	< 0.05	Abernethy et al. 1982a	
Garenoxacin (PO)	UGT, SULT	CL	Obesity (defined as > 130% of IBW <sup>b</sup> ) was a positive significant covariate on CL:  $CL \text{ (mL/min)} = [83.4*(CRCL/86.9)^{0.436} + 0.764*(IBW-64.2) + 10.9*OBESE + 0.301*(AGE-49.5)]*(1-0.144*PSEU)$			< 0.00001	Van Wart et al. 2004
Procainamide (IV)	NAT	CL	51.7 ± 9.2 L/h	41.9 ± 14.0 L/h	0.085	Christoff et al. 1983	

Table 2. Continued. Comparison of drug clearance mediated by specific phase II metabolizing enzyme(s) between obese and non-obese subjects

Substrate (route of administration)	Enzyme(s)	Clearance				Reference
		Parameter	Obese <sup>a</sup>	Non-Obese <sup>a</sup>	P-value	
Busulfan (PO)	GST	CL/F	223. ± 53 mL/min <sup>c</sup>	190 ± 45 mL/min	< 0.001	Gibbs et al. 1999
Busulfan (PO)	GST	CL/F	250 ± 47 mL/min <sup>d</sup>	190 ± 45 mL/min	0.014	Gibbs et al. 1999

<sup>a</sup> Data are presented as either mean ± standard deviation or median (range)

<sup>b</sup> IBW (Ideal body weight) = 50 kg + [2.3 kg\*(height in inches - 60)] in males; 45.5 kg + [2.3 kg\*(height in inches - 60)] in females (Devine, 1974)

<sup>c</sup> BMI 27 to 35 kg/m<sup>2</sup>

<sup>d</sup> BMI > 35 kg/m<sup>2</sup>

Abbreviations: IV, intravenous; UGT, uridine diphosphate glucuronosyltransferases; SULT, sulfotransferases; CL, clearance; PO, oral; IBW, ideal body weight; CRCL, creatinine clearance; OBESE, obesity, defined as > 130% of IBW, as a categorical variable; PSEU, concomitant use of pseudoephedrine; NAT, N-acetyltransferases; GST, Glutathione S-transferases; CL/F, apparent oral clearance

Although there is a relative paucity of published data regarding phase II metabolizing enzymes, previous studies (Table 2) suggested enzyme-specific changes associated with obesity. Obese individuals appear to have increased UGT, SULT, and GST activities, but have similar NAT activity compared to non-obese individuals (Table 2). However, it should be noted that although the conjugating enzyme paired with each drug in Table 2 is the major elimination pathways for the drug, it is not the only elimination pathway for some drugs in Table 1 (e.g., acetaminophen). Also, these studies did not evaluate each individual metabolic pathway for a specific drug when more than one conjugating enzyme eliminate the drug substantially (e.g., acetaminophen, garenoxacin). Therefore, cautions should be exercised when interpreting the results of the studies presented in Table 2. More studies are needed to further elucidate the effect of obesity on phase II conjugating enzymes.

#### Excretion

The kidneys are the major organs of drug excretion. Drugs are renally excreted by three processes, including glomerular filtration, active tubular secretion, and tubular reabsorption. Renal CL of drugs substantially excreted by kidneys may be altered due to physiologic changes associated with obesity such as increased renal blood flow and increased glomerular filtration rate (GFR) (Jain et al. 2011; Brill et al. 2012). In a previous study evaluating the effect of weight loss after bariatric surgery on renal parameters in morbidly obese individuals, creatinine clearance (CRCL), which is a surrogate marker of GFR, was measured by 24-hour urine collection as shown in equation 1 and compared 1) between morbidly obese individuals and normal-weight

individuals at baseline and 2) between pre- and post- bariatric surgery in morbidly obese individuals (Navarro-Diaz et al. 2006):

$$CRCL = \frac{(\text{Urine volume collected over 24 hours}) \times U_{Cr} \times 1000}{P_{Cr} \times (1440 \text{ min})} \quad (1)$$

where  $U_{Cr}$  represents urine creatinine concentration and  $P_{Cr}$  represents plasma creatinine concentration. According to this study, morbidly obese patients had significantly increased creatinine clearance (CRCL) compared to normal-weight individuals ( $140.09 \pm 40.96$  vs.  $104.56 \pm 15.19$  mL/min) (Navarro-Diaz et al. 2006); at 12 months after bariatric surgery, morbidly obese patients lost significant weight ( $150.55 \pm 39.88$  vs.  $94.25 \pm 18.68$  kg), and their CRCL was also significantly reduced ( $139.51 \pm 41.90$  vs.  $119.59 \pm 44.24$  mL/min). In another previous study by Stokholm and colleagues, obese women without any signs of kidney diseases had significantly increased GFR, as determined by  $^{51}\text{Cr}$ -EDTA plasma CL, compared to normal-weight women (Stokholm et al. 1980). These elevated GFR may be due to enlarged kidney size and increased renal blood flow associated with obesity. According to a previous study by Rea and colleagues, obese kidney donors had significantly larger glomerular planar surface area and significantly increased iothalamate CL compared to non-obese donors (Rea et al. 2006). Additionally, in an animal model, obese dogs had significantly altered renal function compared to lean dogs due to significantly increased kidney weight, renal blood flow, and GFR (Henegar et al. 2001). The increased GFR in obese individuals may result in faster CL of drugs whose CL is primarily mediated by glomerular filtration process. Table 3 summarizes previous studies reporting the comparison of drug CL mediated by glomerular filtration between obese and non-obese individuals.



Table 3. Comparison of drug clearance mediated by glomerular filtration between obese and non-obese individuals

Substrate	CRCL			CL			Reference
	Obese <sup>a</sup>	Non-Obese <sup>a</sup>	P-value	Obese <sup>a</sup>	Non-Obese <sup>a</sup>	P-value	
Vancomycin	175 (118-247) mL/min <sup>b</sup>	132 (113-175) mL/min <sup>b</sup>	N/R	187.50 ± 64.69 mL/min	80.78 ± 11.28 mL/min	< 0.05	Blouin et al. 1982
Vancomycin	209 ± 35 mL/min <sup>c</sup>	110 ± 17 mL/min <sup>c</sup>	< 0.001	197 ± 77 mL/min	77 ± 22 mL/min	< 0.001	Bauer et al. 1998
Daptomycin	N/R <sup>d</sup>	N/R <sup>d</sup>	N/A	855.80 ± 7.65 mL/h	723.80 ± 6.39 mL/h	0.008	Dvorchik and Dampousse, 2005
Daptomycin	N/R <sup>d</sup>	N/R <sup>d</sup>	N/A	1015.83 ± 29.23 mL/h	696.41 ± 33.69 mL/h	0.003	Dvorchik and Dampousse, 2005
Dalteparin	4.79 ± 0.12 L/h <sup>e</sup>	4.93 ± 0.19 L/h <sup>e</sup>	> 0.05	1.30 ± 0.59 L/h	1.11 ± 0.28 L/h	> 0.05	Yee and Duffull, 2000

<sup>a</sup> Data are presented as either mean ± standard deviation or median (range)

<sup>b</sup> Measured using 24-hour urine collection (equation 1)

<sup>c</sup> Estimated using Salazar-Corcoran method in obese patients and Cockcroft-Gault method in normal-weight patients (Salazar and Corcoran, 1988; Cockcroft and Gault, 1976)

<sup>d</sup> All patients had CRCL ≥ 70 mL/min calculated by Cockcroft and Gault method using total body weight

<sup>e</sup> Estimated by Cockcroft-Gault method using the lower of lean body weight and total body weight

Abbreviations: CRCL, creatinine clearance; CL, clearance; N/R, none reported; N/A, not applicable

Based on previous studies for comparison of glomerular filtration-mediated drug CL between obese and non-obese individuals (Table 3), obesity appears to be significantly associated with increased CL of drugs primarily excreted by glomerular filtration process. Dalteparin CL was not significantly different between obese and non-obese individuals, but it should be noted 1) CRCL was similar between obese and non-obese individuals; and 2) dalteparin CL appeared more variable in obese individuals compared to non-obese individuals (Yee and Duffull, 2000).

Another mechanism of renal excretion of drugs is active tubular secretion. To date, no study has been published to compare the transporters responsible for active tubular secretion in kidneys between obese and non-obese individuals. However, several studies were conducted to compare the pharmacokinetics of drugs that are at least partially excreted by active tubular secretion between obese and non-obese individuals (Brill et al. 2012). Table 4 summarizes these studies reporting the comparison of drug CL mediated at least partially by active tubular secretion between obese and non-obese individuals.

Table 4. Comparison of drug clearance at least partially mediated by active tubular secretion between obese and non-obese individuals

Substrate	CRCL			CL			Reference
	Obese <sup>a</sup>	Non-Obese <sup>a</sup>	P-value	Obese <sup>a</sup>	Non-Obese <sup>a</sup>	P-value	
Procaineamide	131 ± 11 mL/min <sup>b</sup>	122 ± 30 mL/min <sup>b</sup>	> 0.05	4.19 ± 1.13 mL/min <sup>c</sup>	2.68 ± 0.85 mL/min <sup>c</sup>	< 0.05	Christoff et al. 1983
Ciprofloxacin	146.4 ± 29.0 mL/min <sup>b</sup>	127.3 ± 24.5 mL/min <sup>b</sup>	> 0.05	897.44 ± 159.57 mL/min	744.44 ± 120.51 mL/min	< 0.05	Allard et al. 1993
Cisplatin	N/R	N/R	N/A	60.0 (53.9-66.7) L/h	53.3 (51.7-54.9) L/h	0.007	Sparreboom et al. 2007
Topotecan	N/R	N/R	N/A	21.7 (15.4-30.7) L/h	19.6 (17.6-21.9) L/h	N/S	Sparreboom et al. 2007
Digoxin	N/R	N/R	N/A	328 (179-507) mL/min <sup>d</sup>	278 (93-413) mL/min <sup>d</sup>	> 0.05	Abernethy et al. 1981b

<sup>a</sup> Data are presented as either mean ± standard deviation or median (range) unless otherwise stated

<sup>b</sup> Measured using 24-hour urine collection [equation (1)]

<sup>c</sup> Renal clearance normalized to creatinine clearance

<sup>d</sup> Mean (range)

Abbreviations: CRCL, creatinine clearance; CL, clearance; N/R, none reported; N/A, not applicable

Based on previous studies for comparison of active tubular secretion-mediated drug CL between obese and non-obese individuals (Table 4), obesity appears to be associated with increased CL of drugs that are at least partially excreted by active tubular secretion. However, statistical significance was not reached for topotecan and digoxin CL, which may indicate drug-specific alteration in active tubular secretion in obesity compared to non-obese patients because possibly, different transporters may mediate active tubular secretion of different drugs.

Tubular reabsorption is another process contributing to renal excretion. Although active tubular reabsorption occurs for many endogenous substances such as glucose and electrolytes, most exogenous compounds such as drugs are reabsorbed by a passive process (Rowland and Tozer, 2011b). Studies on the impact of obesity on tubular reabsorption are limited. In a study comparing the pharmacokinetics of lithium between obese and normal-weight subjects, obese and non-obese individuals had similar CRCL, measured by 12-hour urine collection using equation 1 ( $137.5 \pm 39.7$  vs.  $119.3 \pm 13.0$  mL/min) (Reiss RA et al. 1994). However, obese individuals had significantly increased lithium CL compared to non-obese individuals ( $33.9 \pm 7.0$  vs.  $23.0 \pm 6.2$  mL/min;  $P = 0.005$ ), probably indicating decreased tubular reabsorption in obesity compared to normal-weight individuals. Although tubular reabsorption appears reduced in obesity based on the lithium study, more studies are needed for robust evaluation of the impact of obesity on tubular reabsorption.

Although obese individuals may have increased CL of renally eliminated drugs at baseline, they may develop kidney injury over time, resulting in decreased CL of renally eliminated drugs from their baseline. Chronic obesity is associated with co-morbidities

such as hypertension or diabetes mellitus, which can impair renal function. As patients with chronic obesity develop these co-morbidities over time, their kidney function becomes deteriorated, resulting in the decrease in GFR and consequent reduction in the CL of renally eliminated drugs. Actually, the association between obesity and kidney injury was confirmed in previous studies where BMI was significantly associated with the development of kidney disease and end-stage renal disease (Fox et al. 2004; Iseki et al. 2004). Therefore, when dosing renally eliminated drugs in obese patients, clinicians should evaluate the patient's renal function in addition to the body size so that the appropriate dosing regimen can be determined for the individual patient.

Another challenge regarding renal CL in obese patients is accurate estimation of GFR. To appropriately dose renally eliminated drugs, it is important to accurately estimate the patient's renal function. Unfortunately, currently available equations to calculate patients' renal function may not accurately reflect the true renal function in obese patients. In clinical practice, the commonly used renal function indicator is estimated CRCL as a surrogate of the GFR. The most commonly used equation to estimate CRCL in clinical practice is the Cockcroft-Gault method as shown in equation 2 (Cockcroft and Gault, 1976):

$$\text{CRCL (mL/min)} = \frac{(140 - \text{Age}) \times \text{Weight}}{\text{SCr} \times 72} \times (0.85 \text{ if female}) \quad (2)$$

where CRCL is creatinine clearance, age is in years, weight is in kg, and SCr is serum creatinine concentration in mg/dL. In the original study where equation 2 was developed by Cockcroft and Gault, all of the study participants were not obese, and TBW was used in the equation. However, for obese patients, especially morbidly obese patients, Dionne and colleagues reported overestimated CRCL when TBW was used in equation 2, but

underestimated CRCL when ideal body weight (IBW; equations 3 and 4) was used in equation 2 (Devine, 1974; Dionne et al. 1981):

$$\text{Ideal body weight (IBW)} = 50 \text{ kg} + [2.3 \text{ kg} * (\text{height in inches} - 60)] \text{ in males} \quad (3)$$

$$\text{Ideal body weight (IBW)} = 45.5 \text{ kg} + [2.3 \text{ kg} * (\text{height in inches} - 60)] \text{ in females} \quad (4)$$

To improve CRCL estimation in obesity, Salazar and Corcoran developed the CRCL formula (equations 5 and 6) in obesity using an obese rat model and validated the estimation method using data from obese patients (Salazar and Corcoran, 1988):

$$\text{CRCL (mL/min in males)} = \frac{(137 - \text{Age}) \times [(0.285 \times \text{TBW}) + (12.1 \times \text{Height}^2)]}{(51 \times \text{SCr})} \quad (5)$$

$$\text{CRCL (mL/min in females)} = \frac{(146 - \text{Age}) \times [(0.287 \times \text{TBW}) + (9.74 \times \text{Height}^2)]}{(60 \times \text{SCr})} \quad (6)$$

where age is in years, TBW is total body weight in kg, height is in meters, and SCr is serum creatinine concentration in mg/dL. However, according to Hanley and colleagues, regardless of which method is used, no body size descriptor is well validated to accurately estimate CRCL as a GFR index in obese individuals (Hanley et al. 2010). In fact, a recent study suggested estimated CRCL may not be an accurate estimate of GFR in obesity (Aggarwal et al. 2012). This study compared different estimation methods of renal function using Cockcroft-Gault, method (equation 2), MDRD4, (equation 7), and CKD-EPI (equations 8-15) with measured GFR in 164 potential kidney donors including 83 with a BMI < 30 kg/m<sup>2</sup>, 49 with a BMI between 30 kg/m<sup>2</sup> and 35 kg/m<sup>2</sup>, and 32 with a BMI > 35 kg/m<sup>2</sup> (Cockcroft and Gault, 1976; Levey et al. 2000; Levey et al. 2009):

$$\text{GFR (mL/min/1.73m}^2\text{)} = 186 \times \text{SCr}^{-1.154} \times \text{Age}^{-0.203} \times (0.742 \text{ if female}) \times (1.210 \text{ if black}) \quad (7)$$

$$\text{GFR(mL/min/1.73m}^2 \text{ in Black female with SCr} \leq 0.7 \text{ mg/dL)} = 166 \times (\text{SCr}/0.7)^{-0.329} \times (0.993)^{\text{Age}} \quad (8)$$

$$\text{GFR(mL/min/1.73m}^2 \text{ in Black female with SCr} > 0.7 \text{ mg/dL)} = 166 \times (\text{SCr}/0.7)^{-1.209} \times (0.993)^{\text{Age}} \quad (9)$$

$$\text{GFR(mL/min/1.73m}^2 \text{ in Black male with SCr} \leq 0.9 \text{ mg/dL)} = 163 \times (\text{SCr}/0.9)^{-0.411} \times (0.993)^{\text{Age}} \quad (10)$$

$$\text{GFR(mL/min/1.73m}^2 \text{ in Black male with SCr} > 0.9 \text{ mg/dL)} = 163 \times (\text{SCr}/0.9)^{-1.209} \times (0.993)^{\text{Age}} \quad (11)$$

$$\text{GFR(mL/min/1.73m}^2 \text{ in White or other female with SCr} \leq 0.7 \text{ mg/dL)} = 144 \times (\text{SCr}/0.7)^{-0.329} \times (0.993)^{\text{Age}} \quad (12)$$

$$\text{GFR(mL/min/1.73m}^2 \text{ in White or other female with SCr} > 0.7 \text{ mg/dL)} = 144 \times (\text{SCr}/0.7)^{-1.209} \times (0.993)^{\text{Age}} \quad (13)$$

$$\text{GFR(mL/min/1.73m}^2 \text{ in White or other male with SCr} \leq 0.9 \text{ mg/dL)} = 141 \times (\text{SCr}/0.9)^{-0.411} \times (0.993)^{\text{Age}} \quad (14)$$

$$\text{GFR(mL/min/1.73m}^2 \text{ in White or other male with SCr} > 0.9 \text{ mg/dL)} = 141 \times (\text{SCr}/0.9)^{-1.209} \times (0.993)^{\text{Age}} \quad (15)$$

where SCr is serum creatinine concentration in mg/dL. In this study, Aggarwal and colleagues suggested Cockcroft-Gault method using IBW underestimated GFR in obese individuals while MDRD4 and CKD-EPI methods overestimated GFR in obesity (Aggarwal et al. 2012). Demirovic and colleagues evaluated different estimation methods of renal function in morbid obesity, including the Cockcroft-Gault method (equation 2) using TBW, IBW (equations 3 and 4), adjusted body weight with a

correction factor of 0.3 or 0.4 (equation 16), fat free weight (FFW; equations 17 and 18), and LBW (equations 19 and 20) for the “weight” term in the Cockcroft-Gault formula (equation 2); the Salazar-Corcoran method (equations 5 and 6); and the MDRD4 method (equation 7) (Demirovic et al. 2009):

$$\text{Adjusted body weight} = \text{IBW} + C \cdot (\text{TBW} - \text{IBW}) \quad (16)$$

where C is a correction factor of 0.3 or 0.4,

$$\begin{aligned} \text{Fat free weight (FFW in male; kg)} &= 0.00139 \times (\text{Height in centimeters}^2) - 0.0801 \times \\ &R + 0.187 \times \text{TBW} + 39.83 \end{aligned} \quad (17)$$

$$\begin{aligned} \text{Fat free weight (FFW in female; kg)} &= 0.00151 \times (\text{Height in centimeters}^2) - \\ &0.0344 \times R + 0.140 \times \text{TBW} - (0.158 \times \text{Age}) + 20.387 \end{aligned} \quad (18)$$

where R is resistance measured using bioelectric impedance analysis,

$$\text{Lean body weight (LBW in male, kg)} = \frac{9270 \times \text{TBW}}{6680 + 216 \times \text{BMI}} \quad (19)$$

$$\text{Lean body weight (LBW in female, kg)} = \frac{9270 \times \text{TBW}}{8780 + 244 \times \text{BMI}} \quad (20)$$

When comparing estimated CRCL values with measured CRCL from 24-hour urine collection (equation 1), Cockcroft-Gault method using FFW (equation 21) or LBW (equation 22) provided CRCL estimates with lowest mean bias and relatively high precision and accuracy.

$$\text{CRCL} = \frac{(\text{Urine volume collected over 24 hours}) \times U_{\text{Cr}} \times 1000}{P_{\text{Cr}} \times (1440 \text{ min})} \quad (1)$$

where  $U_{\text{Cr}}$  represents urine creatinine concentration and  $P_{\text{Cr}}$  represents plasma creatinine concentration,

$$\text{CRCL (mL/min)} = \frac{(140 - \text{Age}) \times \text{FFW}}{\text{SCr} \times 72} \times (0.85 \text{ if female}) \quad (21)$$



$$\text{CRCL (mL/min)} = \frac{(140 - \text{Age}) \times \text{LBW}}{\text{SCr} \times 72} \times (0.85 \text{ if female}) \quad (22)$$

However, measurement of FFW requires special technology such as bioelectric impedance analysis. Therefore, use of LBW in the Cockcroft-Gault method (equation 22) was suggested as a more practical approach to estimate CRCL.

### Significance of Altered Pharmacokinetics of Antimicrobial Agents in Obesity

Overall, obesity is associated with altered physiologic processes, which may consequently lead to altered pharmacokinetics of many drugs including antibiotics. However, the direction and the magnitude of the pharmacokinetic changes of individual drugs in obesity depend on various factors as discussed above, and therefore, their prediction is challenging and need further elucidation. These pharmacokinetic changes in obesity raise an important clinical question of how to optimize antimicrobial dosing regimens in obese patients so that adequate antibiotic exposures can be achieved. Adequate initial empiric dosages of antibiotic therapy are critical in clinical practice because every hour delay in effective antimicrobial therapy is associated with significantly increased mortality, especially in patients with sepsis or septic shock (Dellinger et al. 2013). However, in a recent study evaluating adherence rates for hospital-wide antibiotic dosing recommendations for obese patients in the emergency department, the adherence rates ranged from 1.2% for ciprofloxacin to 8.0% for cefepime (Roe et al. 2012). Authors of this study concluded obese patients were frequently underdosed based on their hospital dosing guidelines. However, due to a relative paucity of currently published antimicrobial pharmacokinetic data, evidence-based dosing recommendations or adjustments for each antibiotic agent cannot be made in obesity (Pai

and Bearden, 2007). In fact, only a relatively small number of antimicrobials are dosed based on a body size descriptor (either weight or body surface area), and many antibiotics are still administered as fixed dosing regimens, i.e., one-size-fits-all approach (Pai, 2012). Therefore, the appropriate dosages for many antimicrobial agents are still unknown in obese patients. If obese patients truly require larger doses than non-obese patients, administration of the same antibiotic doses in obese patients as non-obese patients may result in adverse clinical outcomes, including treatment failure, increased morbidity or mortality, and emergence of antimicrobial resistance (Roe et al. 2012; Longo et al. 2013). Conversely, if obese patients do not actually require larger doses, but arbitrarily increased doses of the drug are administered, it may lead to increased risk for adverse drug events.

Provided the relative lack of published data characterizing the pharmacokinetics of antimicrobial agents in obesity and the importance of achieving adequate exposures from early in therapy for better clinical response, it is pertinent to use data from clinical studies in obese patients receiving antibiotic therapy that are commonly used for the treatment of infections, especially for serious infections such as nosocomial pneumonia. Once the pharmacokinetics of a specific antibiotic agent is characterized, dosing regimens may be determined for obese patients to achieve comparable exposures to non-obese patients. Actually, in a previous study by Forse and colleagues, both tissue and blood cefazolin concentrations were compared after the preoperative administration of surgical prophylactic dose of cefazolin 1 g between morbidly obese patients undergoing vertical banded gastroplasty procedure and normal-weight patients undergoing upper abdominal surgery (Forse et al. 1989). At incision and closure, morbidly obese patients had significantly lower blood and tissue cefazolin concentrations compared to normal-

weight patients. When cefazolin dose was increased to 2 g in morbidly obese patients, the rate of surgical site infection was significantly decreased from 16.5% (when 1 g was given for surgical prophylaxis) to 5.6% in morbidly obese patients. Therefore, authors concluded and recommended larger cefazolin dose (2 g) in morbidly obese patients compared to normal-weight individuals (1 g).

In this study, beta-lactam antibiotic class was selected to characterize their pharmacokinetics in obesity and determine doses for comparable pharmacodynamic exposures between obese and non-obese patients because beta-lactam antibiotics, particularly broad-spectrum agents such as piperacillin/tazobactam, meropenem, and cefepime, are commonly used for the treatment of serious infections, especially early in therapy as empiric therapy. Also, piperacillin/tazobactam, meropenem, and cefepime are a representative drug in penicillin, carbapenem, and cephalosporin subgroup of the beta-lactam antibiotic class, respectively, so this study may enable us to better understand the disposition of each of these subgroups of the beta-lactam antibiotic class. However, cautions should be exercised when extrapolating our study findings to other members of the same group of the beta-lactam class; according to Jain and colleagues, it may not be accurate to predict any alterations in the pharmacokinetics of a drug in obesity based on the data from other drugs in the same therapeutic class or with similar/same physicochemical properties, and previous studies summarized above support this challenge in predicting pharmacokinetic changes in obesity. Beta-lactam antibiotics are hydrophilic agents and most of them, specifically piperacillin/tazobactam, meropenem, and cefepime, are primarily ( $\geq 70\%$  of the administered dose) eliminated by kidneys with negligible metabolic elimination (Perry and Markham, 1999; Kuti et al. 2005; Baldwin et

al. 2008; Endimiani et al. 2008; Maxipime(TM) [package insert], 2012; Merrem(R) [package insert], 2013; Zosyn(R) [package insert], 2013). The absorption of piperacillin/tazobactam, meropenem, and cefepime, is minimal when they are administered orally, so all of them are only available as parenteral products (Maxipime(TM) [package insert], 2012; Merrem(R) [package insert], 2013; Zosyn(R) [package insert], 2013).

Because of the obesity-related physiologic changes, which may lead to pharmacokinetic alterations in obese individuals, in this study, we hypothesized obese patients have significantly increased CL or V or both of beta-lactam antimicrobial agents, particularly piperacillin/tazobactam, meropenem, and cefepime, so they need significantly different dosing regimens (e.g., larger and/or more frequent doses) to achieve similar pharmacodynamic exposures compared with non-obese patients. We assumed the same pharmacodynamic parameter and target of beta-lactam antibiotics between obese and non-obese patients because no published data suggest different pharmacodynamic parameter and/or target in obese individuals compared to non-obese individuals. Understanding the pharmacokinetics of beta-lactam antibiotics in obesity may contribute to optimization of antimicrobial therapy in obesity by applying any necessary dosage adjustments in this patient population. In addition, our study will add to the existing literature of the pharmacokinetics of various drugs, especially hydrophilic, renally eliminated drugs, in obesity, so that these drugs are more optimally dosed on the basis of scientific evidence in obese patients.

### Population Pharmacokinetic/Pharmacodynamic Approach

As stated above, obesity is associated with altered physiologic processes, which may in turn cause changes in the pharmacokinetics of drugs, indicating obesity, or body size descriptor, may account for the pharmacokinetic variability of certain drugs at least to some extent. In addition to obesity, many other patient characteristics may explain the variability in the drug disposition between different individuals, and it is important to address the relationship between individual characteristics and the pharmacokinetics of the drug so that we can understand any difference in drug exposure among patients with different characteristics and potentially, may individualize drug therapy based on patient characteristics. To address this relationship between patient characteristics and pharmacokinetics, population pharmacokinetic and pharmacodynamic study is a more useful tool compared to traditional pharmacokinetic study where individual pharmacokinetic parameters are estimated only, but no relationship between pharmacokinetic parameters and individual characteristics is established. Population pharmacokinetics is the study to evaluate the sources and correlations of variability in drug concentrations among patients who receive the drug at clinically relevant doses and constructs mathematical relationships to test the effects of physiologic characteristics on the pharmacokinetics of the drug (Food and Drug Administration, 1999; Mould and Upton, 2012). These mathematical relationships may be used through simulations to predict the drug exposure in patients who were not studied and eventually, individualize the dosing regimens of the drug on the basis of the patient's physiologic characteristics as well as the pharmacokinetic properties of the drug.

Typically, population pharmacokinetic studies can be conducted using 1) a two-stage approach or 2) a nonlinear mixed-effect modeling approach (Food and Drug Administration, 1999; Mould and Upton, 2012). In a two-stage approach, the pharmacokinetic parameters are estimated through regression methods in the first stage. Using these pharmacokinetic parameter estimates, descriptive statistics including mean, variance, and covariance of parameter estimates are calculated in the second stage. Also, in the second stage, the relationships between pharmacokinetic parameters and patient covariates can be established using statistical methods such as linear regression. However, the two-stage approach requires dense concentration-time data, and variabilities of pharmacokinetic parameter estimates tend to be over-estimated because inter-individual, inter-occasional when multiple occasions are studied, and residual errors are typically indistinguishable. As a result, simulations and predictions using the pharmacokinetic parameters and their variabilities estimated through a two-stage approach may not be robust or accurate. In contrast, a nonlinear mixed-effect modeling is a single stage approach where the study population is a unit of analysis to estimate the pharmacokinetic parameter distribution and the relationship between the pharmacokinetic parameters and patient covariates within the population. The pharmacokinetics in the study population are characterized by the population mean values and their variability within the population including inter-individual variability, inter-occasional variability if multiple occasions are studied, and residual variability. Consequently, the nonlinear mixed effect modeling approach may result in more robust accurate simulations and predictions with better error estimates (Food and Drug Administration, 1999; Mould and Upton, 2012).

Although nonlinear mixed effect modeling approach offers multiple advantages as stated above, there are disadvantages associated with this method. First, for robust error estimates and covariate effects on pharmacokinetic parameters, nonlinear mixed effect modeling approach typically requires larger sample size compared to traditional pharmacokinetic studies or standard two-stage approaches (Food and Drug Administration, 1999; Mould and Upton, 2012). Also, nonlinear mixed effect modeling requires more extensive computation, so it may be more difficult to analyze the data using this approach and understand the results of the analysis for those who are not familiar with the analysis method (Mould and Upton, 2012). In addition, the extensive computation requires more time to complete the data analysis, which is another penalty for the non-linear mixed effect modeling approach compared to the standard two-stage approach (Mould and Upton, 2012). Therefore, caution should be exercised when designing a study whether the advantages of the nonlinear mixed effect modeling approach may outweigh its disadvantages.

In order to design the optimal dosing regimen of a drug, it is important to consider its pharmacodynamic property as well as pharmacokinetic characteristics. Therefore, the relationship between the pharmacodynamics and pharmacokinetics of a drug should be established and considered when recommending an appropriate dosage. Altered pharmacokinetics of a drug does not always translate into altered response and consequent need to adjust of dosing regimens. Conversely, alternative dosing regimens may be considered in the absence of pharmacokinetic changes when substantial pharmacodynamic alterations are suggested to achieve optimal response. In some instances, both pharmacokinetics and pharmacodynamics are altered, so alternative

dosing regimens should be considered to account for changes in both pharmacokinetics and pharmacodynamics. For example, Varin and colleagues evaluated the pharmacokinetics and pharmacodynamics of atracurium, a neuromuscular blocker with a narrow therapeutic window, after the administration of 0.2 mg/kg of TBW in obese individuals compared to normal-weight individuals (Varin et al. 1990). According to the pharmacokinetic analysis, obese and non-obese individuals had similar CL ( $444 \pm 29$  vs.  $404 \pm 25$  mL/min), steady-state V ( $8.6 \pm 0.7$  vs.  $8.5 \pm 0.7$  L), and V in the central compartment ( $3.63 \pm 0.53$  vs.  $3.79 \pm 0.34$  L); however, obese patients had significantly smaller TBW-normalized steady-state V and V in the central compartment compared to non-obese patients ( $0.067 \pm 0.004$  vs.  $0.141 \pm 0.015$  L/kg and  $0.029 \pm 0.004$  vs.  $0.063 \pm 0.007$  L/kg, respectively). However, the  $EC_{50}$  from the pharmacokinetic-pharmacodynamic model was significantly higher in obese patients compared to non-obese patients using neuromuscular blockade as the pharmacodynamic parameter ( $470 \pm 46$  vs.  $312 \pm 33$  ng/mL), suggesting higher atracurium concentrations are required in obesity to achieve a similar extent of neuromuscular blockade to non-obese individuals. Therefore, despite the absence of significant difference in pharmacokinetic parameters, authors suggested dosing atracurium based on TBW, not IBW, in obesity for comparable degree of neuromuscular blockade between obese and non-obese patients. For antimicrobials, the effect of any alterations in the antibiotic pharmacokinetics on the pharmacodynamic target, such as the length of time, as a percentage of the dosing interval, in which the unbound drug concentrations exceed the minimum inhibitory concentration (MIC) of the bacterial pathogen for beta-lactam antibiotics, should be evaluated to determine appropriate dosing regimens.



## Antimicrobial Pharmacodynamics

Antimicrobial pharmacodynamics is the science of evaluating the relationship between antibiotic drug exposures and antimicrobial activity. Antimicrobial activity is generally classified as bactericidal or bacteriostatic activity (Amsden et al. 2010). Antibiotic agents with bactericidal activity can directly kill the bacterial pathogens. In contrast, antimicrobials with bacteriostatic activity only inhibit the reproduction of bacteria without directly killing the organism; however, at sufficiently high concentrations, many bacteriostatic agents demonstrate bactericidal activity. Traditionally, the MIC has been the most frequently used parameter to describe antimicrobial activity (Craig, 1998; Lodise et al. 2006). However, using MIC alone as a measure of pharmacodynamic activity has the following flaws: 1) the MIC is determined using fixed drug concentrations, 2) it fails to provide information on postantibiotic effect, defined as the continued inhibition of bacterial growth for varied periods of time after the anti-infective concentration is decreased to lower than the MIC for the antibiotic agent at the site of the infection, and 3) it does not capture the changes in antimicrobial concentrations over time in a given patient and between-individual variability in the antimicrobial pharmacokinetics. Therefore, incorporating pharmacokinetic characteristics of an antimicrobial agent along with the MIC has been suggested to overcome the limitations of using MIC to describe antimicrobial activity (Craig, 1998). Taking into account the bactericidal pattern of an antimicrobial agent, its pharmacokinetic characteristics, and the MIC, there are three major antimicrobial pharmacodynamic parameters that have been used in previous studies to establish the

relationship between antimicrobial pharmacokinetics and various pharmacodynamic measures such as clinical and/or microbiological improvement: 1) the length of time, as a percentage of the dosing interval, in which the unbound drug concentrations exceed the MIC of a bacterial pathogen ( $\%fT > \text{MIC}$ ); 2) the ratio of the area under the serum drug concentration-time curve over a specific time period to the MIC (AUC:MIC); and 3) the ratio of the maximum or peak drug concentration to the MIC ( $C_{\text{max}}:\text{MIC}$  or  $C_{\text{peak}}:\text{MIC}$ ) (Craig, 1998; Lodise et al. 2006; Amsden et al. 2010).

Typically, antimicrobial pharmacodynamics are studied by three approaches: in vitro models, animal models, and clinical studies (Amsden et al. 2010). The traditional in vitro model for pharmacodynamic studies of antimicrobials is the “hollow fiber model” system (Blaser et al. 1985). In this system where a growth medium is broth, bacteria are exposed to predetermined antibiotic concentrations, and antibiotics are eliminated from the system so that pharmacokinetic excretion may be simulated (Blaser et al. 1987). These models control bacterial inoculum and antimicrobial exposure, but they cannot evaluate the effects of the immune system on bacterial killing or growth inhibition (Amsden et al. 2010). Animal infectious diseases models are useful because they allow frequent sampling of various biological matrices including blood and tissue, and a broad range of doses can be tested with a wide range of organism inocula, so that the effects of change in a single variable (e.g., organism inocula, antimicrobial dose) at a time may be evaluated. Disadvantages associated with animal models include: 1) animal models typically require larger bacterial inocula to cause infection than humans; 2) drug elimination may be different in animals compared to humans; and 3) the interaction between the immune system and bacterial organisms in animals may be different

compared to humans. Lastly, clinical trials can be performed to establish the relationship between antimicrobial pharmacokinetics and pharmacodynamics using the following measures: 1) clinical endpoint such as cure/improvement vs. failure; 2) bacterial eradication from the site of infection or blood or both, documented by bacterial culture test; and 3) surrogate markers of infection such as fever or white blood cell count. However, most of these clinical studies are retrospective studies and few prospective studies have been published to date.

Bactericidal drugs can be further grouped into time-dependent or concentration-dependent agents. The bacterial killing activity of time-dependent bactericidal drugs such as beta-lactam antibiotics is dependent on the duration of time that the unbound antimicrobial concentrations remain above a certain critical concentration, e.g., MIC, defined as the lowest antimicrobial concentration that prevents visible growth of bacterial organisms in the growth media after a fixed time of incubation. For example, in a previous in vitro study reporting the time-kill curves for *Pseudomonas aeruginosa* with ticarcillin, a beta-lactam antibiotic in the penicillin subclass, at various concentrations, the bacterial killing was increased as concentrations increased from 0 to 4 times of the MIC; however, no additional bacterial killing was observed at concentrations ranging from 4 times of the MIC to 64 times of the MIC (Craig and Ebert, 1991). In contrast, the bacterial killing activity of concentration-dependent bactericidal drugs such as fluoroquinolones or aminoglycosides is proportional to the ratio of antimicrobial concentrations to the MIC. According to a previous study reporting the time-kill curves for *Pseudomonas aeruginosa* with tobramycin and ciprofloxacin, which are an aminoglycoside agent and fluoroquinolones agent, respectively, the bacterial killing was

continuously increased over the concentration range of 0 to 64 times of the MIC (Craig and Ebert, 1991).

For concentration-dependent bactericidal agents such as fluoroquinolones or aminoglycosides, previous studies suggested clinical/microbiological improvement is significantly associated with AUC:MIC or  $C_{\text{peak}}:\text{MIC}$  (Craig, 1998; Lodise et al. 2006; Amsden et al. 2010). In a previous study of patients treated with levofloxacin for the treatment of various infections, Preston and colleagues reported  $C_{\text{peak}}:\text{MIC}$  as a significant predictor for successful clinical response (cure or improvement) and microbiological outcome (eradication or presumed eradication) among tested pharmacodynamic parameters including  $T>\text{MIC}$ , AUC:MIC, and  $C_{\text{peak}}:\text{MIC}$  (Preston et al. 1998). Also, in a previous study of nosocomial pneumonia patients treated with levofloxacin, AUC:MIC ratio was significantly correlated with the bacterial eradication, but not with clinical success (Drusano et al. 2004). However, it should be noted  $C_{\text{peak}}:\text{MIC}$  and AUC:MIC are difficult to distinguish which one is a better predictor for the pharmacodynamic measure than the other in clinical studies because they are highly correlated (Amsden et al. 2010). For aminoglycosides, Kashuba and colleagues performed a clinical study of patients receiving gentamicin or tobramycin for the treatment of pneumonia caused by gram-negative bacteria. Probably due to the small sample size ( $n=78$ ) in their study, no pharmacodynamic parameter was significantly associated with clinical response (cure vs. failure), but among tested pharmacodynamic parameters including  $T>\text{MIC}$ , AUC:MIC, and  $C_{\text{max}}:\text{MIC}$ ,  $C_{\text{max}}:\text{MIC}$  was a significant predictor for the time to fever resolution and white blood cell count resolution (Kashuba et al. 1999).

For time-dependent bactericidal agents such as beta-lactam antibiotics, previous studies suggest  $T > MIC$  is a significant predictor of pharmacodynamic response (Craig, 1998; Lodise et al. 2006; Amsden et al. 2010). According to a previous study using the neutropenic mouse model with *Klebsiella pneumoniae* pneumonia,  $T > MIC$  showed the highest correlation with bacterial killing measured by the reduction in the bacterial inocula in the lung after 24 hours of therapy with cefotaxime, a beta-lactam antibiotic in the cephalosporin subclass compared to  $AUC:MIC$  and  $C_{max}:MIC$  (Craig, 1995). Clinical studies determining the most significant pharmacodynamic parameter to predict clinical and/or microbiological response for time-dependent bactericidal agents are scarce probably because of the high correlation among  $T > MIC$ ,  $AUC:MIC$ , and  $C_{max}:MIC$ , especially when the drug is administered as intermittent bolus (Amsden et al. 2010). In clinical studies of pneumonia patients treated with cefmenoxime, a beta-lactam antibiotic in the cephalosporin subclass,  $T > dynamic\ response\ concentration\ (DRC)$ , which is analogous to  $T > MIC$ , was better correlated with days to bacterial eradication from the lung compared to  $AUC:DRC$ , which is analogous to  $AUC:MIC$  (Schentag et al. 1984; Turnidge, 1998). In a previous randomized study of neutropenic patients with various infections, the infection cure rate was compared between patients receiving intermittent vs. continuous infusions of cefamandole, concurrently administered with intermittent infusions of carbenicillin (Bodey et al. 1979). Although statistical significance was not reached in this study probably due to small sample size, the infection cure rate was slightly higher in patients given cefamandole continuous infusions compared to intermittent infusions (65% vs. 57%), and this may be accounted for by a longer  $T > MIC$  achieved with continuous infusions vs. intermittent infusions.

For each antimicrobial class or agent, the pharmacodynamic parameters, including  $T > MIC$ ,  $AUC:MIC$ , and  $C_{max}:MIC$ , are evaluated to identify which one best predicts the clinical and/or microbiological outcomes of the drug. These antimicrobial pharmacodynamic parameters are used in Monte Carlo simulations to evaluate the pharmacodynamics of antimicrobial agents to determine their dosing regimens by maximizing the probability ( $> 90\%$ ) to achieve specific pharmacodynamic parameter target values at a specific MIC or for a specific population of bacterial pathogens. These pharmacodynamically-optimized dosing regimens should be validated in future clinical trials for their clinical safety and efficacy before they are used in clinical practice for the treatment of infectious diseases in patients.

Beta-Lactam Antibiotics: Focus on Piperacillin/Tazobactam, Meropenem, and Cefepime

### Chemistry

Beta-lactams refer to agents with a beta-lactam ring in their chemical structures (Figure 1).

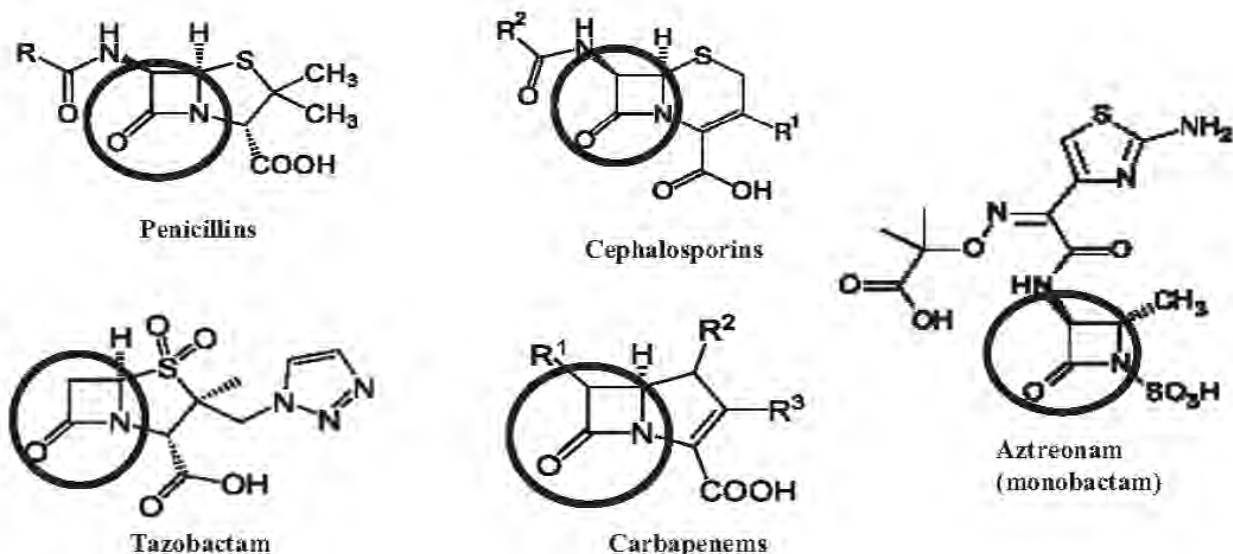

Figure 1. General chemical structures of penicillins, cephalosporins, aztreonam (monobactam), carbapenems, and tazobactam. Penicillins, cephalosporins, aztreonam (monobactam), and carbapenems belong to the beta-lactam antibiotic family. Tazobactam is a beta-lactamase inhibitor without antibiotic activity. Circled partial structure represents beta-lactam ring.

Antibiotics in the beta-lactam class are further divided into four subclasses on the basis of different substituted chemical structures fused to the beta-lactam ring as shown in Figure 1 (Mitscher, 2002). These four subclasses are: 1) penicillins; 2) cephalosporins; 3) carbapenems; and 4) monobactams. In this study, we studied: 1) piperacillin, in combination with tazobactam; 2) meropenem; and 3) cefepime. These belong to the subclass of penicillins, carbapenems, and cephalosporins, respectively. Figure 2 shows the chemical structures of piperacillin, tazobactam, meropenem, and cefepime.

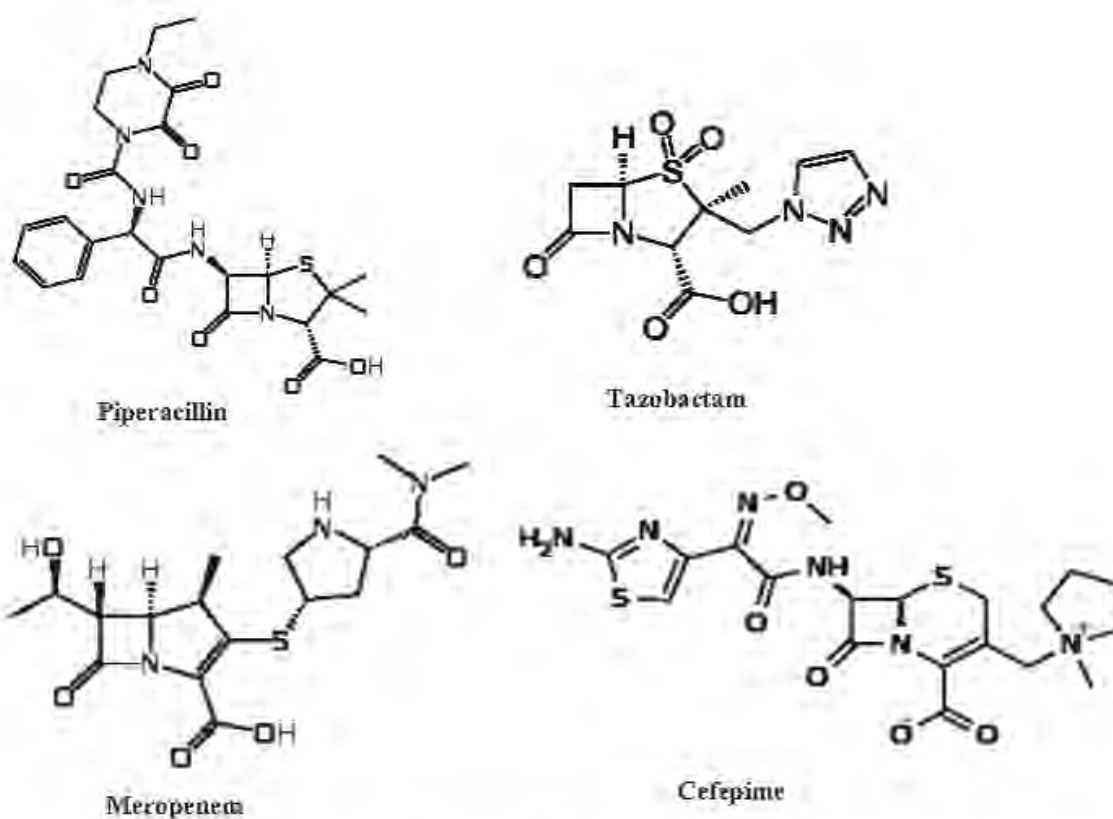

Figure 2. Chemical structures of piperacillin, tazobactam, meropenem, and cefepime.

### Mechanisms of Action and Resistance

The mechanism of action of beta-lactam antibiotics is inhibition of bacterial cell wall synthesis. Beta-lactam antibiotics selectively and irreversibly bind to enzymes called penicillin-binding proteins that are involved in the synthesis, assembly, and maintenance of the peptidoglycan structure of the bacterial cell wall (Mitscher, 2002). Inhibition of penicillin-binding proteins by beta-lactam antibiotics leads to interference of bacterial cell wall formation by inhibiting the final transpeptidation step of peptidoglycan synthesis. This results in decreased bacterial growth and bacterial cell lysis, eventually leading to bacterial cell death. However, bacterial pathogens can develop resistance



against beta-lactam antibiotics through the following mechanisms: 1) hydrolysis of the beta-lactam ring by beta-lactamase enzymes; 2) alteration in the target penicillin-binding proteins; and 3) decreased penetration through the outer cell membrane in gram-negative organisms (Chambers, 2007). To overcome resistance by beta-lactamases, beta-lactam antibiotic/beta-lactamase enzyme inhibitor combination products were developed. Currently available combinations include piperacillin/tazobactam, ampicillin/sulbactam, and amoxicillin/clavulanic acid. Due to their beta-lactamase inhibitor component, these products maintain their antibiotic activity against many beta-lactamase-producing organisms, resulting in broader-spectrum of antibacterial activity.

#### Spectrum of Activity

The spectra of activity among different beta-lactam antibiotic agents are varied, ranging from a relatively narrow spectrum of activity, mainly targeting Gram-positive, highly susceptible bacterial organisms such as streptococci (e.g., penicillin) and methicillin-susceptible *Staphylococcus aureus* (e.g., nafcillin, cefazolin) to a broad spectrum of activity including more resistant bacterial organisms such as *Pseudomonas aeruginosa* (e.g., piperacillin/tazobactam, meropenem, and cefepime). Due to their bactericidal activity, broad-spectrum beta-lactam antibiotics are commonly used for the treatment of serious infectious diseases such as nosocomial or ventilator-associated pneumonia (American Thoracic Society and Infectious Diseases Society of America, 2005). In this study, we selected piperacillin/tazobactam, meropenem, and cefepime to evaluate their pharmacokinetics in obese patients compared to non-obese patients because t, as broad-spectrum beta-lactam anti-infective agents, they are commonly recommended

and used for the treatment of serious infections, especially early in therapy as a part of the empiric treatment regimen. Therefore, attaining adequate exposures of these drugs in patients is critical to prevent bacterial resistance against these agents and improve clinical and/or microbiological response. Also, as piperacillin/tazobactam, meropenem, and cefepime belong to different subclasses of the beta-lactam family, we expect our study may expand our knowledge regarding the effect of obesity on the pharmacokinetics of each beta-lactam subclass compared to study with only one agent or subclass of the beta-lactam family.

### Pharmacokinetics and Pharmacodynamics of Piperacillin/Tazobactam, Meropenem, and Cefepime

#### Absorption

When enterally administered, piperacillin/tazobactam, meropenem, and cefepime are poorly absorbed (Chambers, 2010a; Andes and Craig, 2010; Chambers, 2010b). Therefore, they are available as parenteral products and should be administered parenterally (Maxipime(TM) [package insert], 2012; Merrem(R) [package insert], 2013; Zosyn(R) [package insert], 2013).

#### Distribution

Important physicochemical properties of piperacillin, tazobactam, meropenem, and cefepime, which may influence their distribution, are summarized in Table 5 (DrugBank, 2014; Law et al. 2014; Mitscher, 2002; Chambers, 2010a; Andes and Craig,

2010; Chambers, 2010b; Zosyn(R) [package insert], 2013; Merrem(R) [package insert], 2013; Maxipime(TM) [package insert]).

Table 5. Physicochemical properties of piperacillin, tazobactam, meropenem, and cefepime

	Piperacillin	Tazobactam	Meropenem	Cefepime
Molecular weight	517.555	300.291	383.463	480.561
Electric charge at physiologic pH	-1	-1	0	0
pKa	3.49	2.86	3.47	3.25
LogP <sup>a</sup>	-0.26	-1.4	-0.69	-0.37
Hydrophilic/ Lipophilic	Hydrophilic	Hydrophilic	Hydrophilic	Hydrophilic
Plasma protein binding	20-30%, primarily to albumin	20-30%, primarily to albumin	Negligible (~2%)	20%, primarily to albumin

<sup>a</sup> P = octanol:water partition coefficient, defined as the ratio of the concentration of the agent in octanol to the agent concentration in water

Due to their hydrophilicity, piperacillin/tazobactam, meropenem, and cefepime are primarily distributed into extracellular fluid including blood plasma and interstitial fluid (Chambers, 2010a; Andes and Craig, 2010; Chambers, 2010b). These agents may be expected to be minimally distributed into adipose tissue; however, because approximately 30% of adipose tissue consists of water, they can be substantially distributed into adipose tissue in obese individuals, especially those with morbid obesity (Falagas and Compoti, 2006). Plasma protein binding of piperacillin, tazobactam, meropenem, and cefepime are also shown in Table 5, ranging from almost negligible to 20-30% (Chambers, 2010a;

Andes and Craig, 2010; Chambers, 2010b; Zosyn(R) [package insert], 2013; Merrem(R) [package insert], 2013; Maxipime(TM) [package insert]). Except meropenem whose protein binding is almost negligible, piperacillin, tazobactam, and meropenem are primarily bound to albumin (Chambers, 2010a; Andes and Craig, 2010; Chambers, 2010b). Therefore, any conditions that may change plasma albumin concentrations, e.g., burn, may influence the fraction of plasma protein binding of piperacillin, tazobactam, and cefepime.

### Metabolism

Piperacillin, tazobactam, meropenem, and cefepime are minimally metabolized; no published data suggest the involvement of CYP or conjugating enzymes in their metabolism (Chambers, 2010a; Andes and Craig, 2010; Chambers, 2010b; Zosyn(R) [package insert], 2013; Merrem(R) [package insert], 2013; Maxipime(TM) [package insert]). In addition, they are inactivated by nonenzymatic degradation process (Chambers, 2010a; Andes and Craig, 2010; Chambers, 2010b; Zosyn(R) [package insert], 2013; Merrem(R) [package insert], 2013; Maxipime(TM) [package insert]).

According to a previous study using human liver S9 (supernatant), the investigators detected the formation of desethyl-piperacillin, which is the piperacillin metabolite, from piperacillin (Komuro et al. 1997). This metabolite accounted for approximately 6-9% of the piperacillin AUC (Minami et al. 1991). In terms of tazobactam, approximately 26% of the administered dose was found as an M1 metabolite, which does not have beta-lactamase inhibitory activity (Sorgel and Kinzig, 1993). In addition to M1 metabolite, approximately 1% of the renally excreted tazobactam dose

was recovered as a non-enzymatic degradation product (Sorgel and Kinzig, 1993). Regarding meropenem, a previous study in human volunteers demonstrated approximately 20% of the administered dose was recovered as a microbiologically inactive metabolite whose beta-lactam ring is opened (Bax et al. 1989). In this study, the investigators speculated the beta-lactam bond cleavage might be mediated by chemical hydrolysis, dehydropeptidase 1 (DHP-1), or other metabolic enzymes (Bax et al. 1989). However, as meropenem disappeared from the in vitro chemical hydrolysis system, non-enzymatic hydrolysis appeared responsible for converting meropenem to the beta-lactam ring cleavage product (Bax et al. 1989). According to a previous study evaluating the disposition of cefepime in human subjects, 87.9% of the administered cefepime dose was recovered in urine unchanged; for the remainder cefepime dose, 6.8%, 2.5%, and less than 1% of the administered cefepime dose was recovered in urine as N-methylpyrrolidine N-oxide, cefepime 7-epimer, and N-methylpyrrolidine, respectively (Barbhaiya et al. 1991). However, the enzymes mediating the formation of metabolites from their parent drugs (piperacillin, tazobactam, meropenem, and cefepime) have not been specified yet.

#### Excretion

Piperacillin, tazobactam, meropenem, and cefepime are primarily eliminated by the kidneys. Piperacillin and tazobactam are renally excreted by glomerular filtration and active tubular secretion (Sorgel and Kinzig, 1993). According to a previous study, administration of a single-dose probenecid 1 hour before piperacillin/tazobactam infusion decreased the renal CL of piperacillin and tazobactam by 21% and 25%, respectively

(Sorgel and Kinzig, 1993). This study finding suggests both tazobactam and piperacillin are excreted by active tubular secretion. The involvement of active tubular secretion was also suggested in more recent studies where incorporation of nonlinear elimination components in the piperacillin pharmacokinetic model improved the model fitting to the observed piperacillin concentration-time data (Vinks et al. 2003; Bulitta et al. 2010; Felton et al. 2012; Landersdorfer et al. 2012; Butterfield et al. 2014). Similarly, meropenem is also renally excreted by glomerular filtration and active tubular secretion (Moon et al. 1997). According to a previous meropenem pharmacokinetic study in healthy volunteers, co-administration of probenecid with meropenem significantly increased  $AUC_{0-\infty}$  by 55% and reduced CL and renal CL by 36%, respectively, compared to the administration of meropenem alone (Bax et al. 1989). However, both  $C_{max}$  and  $AUC_{0-\infty}$  were linearly related to the administered dose ranging from 0.25 to 1 g in the absence of probenecid, indicating active tubular secretion is not saturable in the clinically relevant concentration range (Bax et al. 1989). Therefore, the meropenem pharmacokinetics appear linear at clinically relevant doses. In terms of cefepime, to our knowledge, no previous studies have been performed to evaluate the effect of probenecid on cefepime, which could have provided data regarding the involvement of active tubular secretion in cefepime excretion. According to a previous cefepime pharmacokinetic study in healthy volunteers, the cefepime renal CL was comparable to CRCL, so the authors concluded that the renal excretion of cefepime may be primarily by glomerular filtration with negligible active tubular secretion (Barbhaiya et al. 1990).

## Summary of the Pharmacokinetics of Piperacillin/Tazobactam, Meropenem, and Cefepime

Based on the above discussion, Table 6 summarizes the pharmacokinetic properties of piperacillin/tazobactam, meropenem, and cefepime (Giron et al. 1981; Sorgel and Kinzig, 1993; Van der Auwera and Santella, 1993; Perry and Markham, 1999; Kuti et al. 2005; Baldwin et al. 2008; Endimiani et al. 2008; Chambers, 2010a; Andes and Craig, 2010; Chambers, 2010b Maxipime(TM) [package insert], 2012; Merrem(R) [package insert], 2013; Zosyn(R) [package insert], 2013).

Table 6. Pharmacokinetic properties of piperacillin/tazobactam, meropenem, and cefepime

Drugs	Piperacillin/Tazobactam		Meropenem	Cefepime
	Piperacillin	Tazobactam		
Class	Penicillin	Beta-lactamase inhibitor	Carbapenem	Cephalosporin
FDA-approved dosage <sup>a</sup>	3.375 to 4.5 g q6h, IV infused over 30 minutes <sup>b</sup>		500 mg to 1 g q8h, IV infused over 15 to 30 minutes	1 to 2 g q8h or q12h, IV infused over 30 minutes
Protein binding	20-30 %	20-30 %	Negligible (~2%)	20 %
Primary plasma binding protein	Albumin	Albumin	N/A	Albumin
V <sup>c</sup>	15-21 L	18-35 L	12-21 L	18-22 L
Primary elimination pathway	Renal (70-80%)	Renal (~80%)	Renal (~85%)	Renal (70-88%)

Table 6. Continued. Pharmacokinetic properties of piperacillin/tazobactam, meropenem, and cefepime

Drugs	Piperacillin/Tazobactam		Meropenem	Cefepime
	Piperacillin	Tazobactam		
Other elimination pathways	Metabolism or degradation (no enzyme specified); < 5% eliminated by biliary route	Metabolism or degradation (no enzyme specified); < 1% eliminated by biliary and fecal route	Metabolism or degradation (no enzyme specified); approximately 2% eliminated by fecal route	Metabolism or degradation (no enzyme specified)
CL <sup>c</sup>	14.5 L/h	12.1 L/h	188-328 mL/min	122-136 mL/min
Renal CL <sup>c</sup>	8 L/h	5.9 L/h	139-252 mL/min	96-116 mL/min
Elimination half-life <sup>c</sup>	0.7-1.2 hours	0.7-1.2 hour	1-2 hours	0.8-2 hours

<sup>a</sup> In patients with normal renal function

<sup>b</sup> The ratio of piperacillin:tazobactam dose is fixed at 8:1

<sup>c</sup> In healthy volunteers

Abbreviation: FDA, Food and Drug Administration; q6h, every 6 hours; q8h, every 8 hours; q12h, every 12 hours; IV, intravenously; V, volume of distribution; CL, clearance

According to previous studies published to date, there is a large variability in the pharmacokinetics of piperacillin/tazobactam, meropenem, and cefepime depending on patient populations (Perry and Markham, 1999; Kuti et al. 2005; Baldwin et al. 2008; Endimiani et al. 2008). Previous studies suggested substantial difference in CL or V or both of piperacillin/tazobactam, meropenem, and cefepime among healthy volunteers, patients with suspected or documented infections, critically ill patients, cystic fibrosis patients, and patients with burn injury possibly because of different physiologic processes among these populations (Occhipinti et al. 1997; Auclair and Ducharme, 1999; Kim et al.



2002; Bulitta et al. 2007; Bulitta et al. 2010; Landersdorfer et al. 2012; Jhee et al. 1995; Buck C et al, 2005; Li et al. 2005; Felton et al. 2012; Vinks et al. 2003; Butterfield et al. 2014; Shea et al. 2009; Alvarez et al. 2013; Sime et al. 2014; Felton et al. 2014; Sturm et al. 2014; Adnan et al. 2013; Roberts et al. 2010; Roberts et al. 2009; Lau et al. 1985; Shikuma et al. 1990; Bourget et al. 1996; Jeon et al. 2014; Leroy et al. 1992; Krueger et al. 2005; Cheatham et al. 2008; Ariano et al. 2005; Binder et al. 2013; Bui et al. 2001; Christensson et al. 1998; Kuti et al. 2004; Ramon-Lopez et al. 2014; Doh et al. 2010; Barbhaiya et al. 1990; Barbhaiya et al. 1991; Kalman et al. 1992; Barbhaiya et al. 1992; Bacher et al. 1992; Garrelts et al. 1999; Burgess et al. 2000; Kovarik et al. 1990; Kieft et al. 1993; Higuchi et al. 2008; Nicasio et al. 2009; Cheatham et al. 2011; Delattre et al. 2012; Lipman et al. 1999; Arguedas et al. 1992; Huls et al. 1993; Hamelin et al. 1993; Han et al. 2006; Bonapace et al. 1999; Sampol et al. 2000; Conil et al. 2007). Based on the discussions in previous sections, obesity may be another factor contributing to the pharmacokinetic variability of piperacillin/tazobactam, meropenem, and cefepime. Previous studies regarding the impact of obesity on the pharmacokinetics of piperacillin/tazobactam, meropenem, and cefepime will be discussed in more detail later.

#### Beta-Lactam Pharmacodynamics

Beta-lactam antibiotics, including piperacillin, meropenem, and cefepime, time-dependent bactericidal activity, with the exception of *Enterococcus* species, and the pharmacokinetic/pharmacodynamic parameter that best predicts the clinical and/or microbiologic outcomes is the  $\%T > MIC$  as discussed above (Craig, 1998; Lodise et al. 2006; Amsden et al. 2010). According to previous animal studies, antantimicrobial

concentrations do not have to exceed the MIC for the entire dosing interval (100%  $fT > MIC$ ) for net bactericidal activity (Vogelman et al 1988; Craig, 1995). In a study of the mouse thigh infection model, the net bactericidal activity, defined as no net bacterial growth compared to control animals without antibiotics, was achieved with  $\geq 50\%$   $fT > MIC$  for penicillins such as ticarcillin and  $\geq 60-70\%$   $fT > MIC$  for cefazolin against Gram-negative organisms such as *Escherichia coli* (Vogelman et al. 1988). However, in this study, virtually 100%  $fT > MIC$  appeared to be necessary to achieve the maximal bactericidal activity with no true additional bacterial killing. Another previous study of a neutropenic mouse model with *Klebsiella pneumoniae* pneumonia suggest  $\geq 60-70\%$   $fT > MIC$  for cefotaxime is associated with bactericidal activity (Craig, 1995). Using beta-lactam agents in different subclasses, i.e., penicillins, cephalosporins, and carbapenems, Craig and colleagues suggested the highest  $T > MIC$  was necessary for cephalosporins to achieve bactericidal activity, but lower with penicillins and lowest with carbapenems against the same bacterial organisms, especially against Gram-negative organisms (Craig et al. 1993). Based on these previous findings, the suggested and commonly used target values for beta-lactam  $\%fT > MIC$  to achieve the near-maximal bactericidal activity are: 1)  $\geq 50\%$   $fT > MIC$  for penicillins; 2)  $\geq 60$  to  $70\%$   $fT > MIC$  for cephalosporins; 3)  $\geq 40\%$   $fT > MIC$  for carbapenems; and 4)  $\geq 50$  to  $60\%$   $fT > MIC$  for aztreonam (the only approved monobactam in the United States) (Craig, 1998; Craig, 2003; Mouton, 2003; Drusano, 2004; Lodise et al. 2006; Vinks et al. 2007). However, these target values were primarily identified from in vitro and/or animal studies; limited clinical studies established the relationship between  $T > MIC$  and clinically relevant pharmacodynamic response such as clinical cure or microbiological eradication (Amsden et al. 2010). According to a

previous clinical study of patients with otitis media caused by *Streptococcus pneumoniae* and *Haemophilus influenzae*, > 40% T>MIC was associated with 85 to 100% of bacteriologic cure for beta-lactam antibiotics, but they did not demonstrate the subclass-specific target %fT>MIC values for penicillins, cephalosporins, and carbapenems (Craig and Andes, 1996).

In humans, the pharmacodynamic parameters and their targets may be different based on the host-pathogen interaction, the drug-bacteria pair, or infection site (Ariano et al. 2005; Li et al. 2007). In fact, according to a previous study evaluating meropenem pharmacodynamic targets in patients with lower respiratory tract infections,  $\geq 54\%$  fT>MIC was a significant predictor of microbiological success (Li et al. 2007). Also, another previous study of patients receiving cefepime for the treatment of documented or suspected infection suggested 83% and 95% of T>4.3\*MIC to achieve 80% and 90% of successful microbiologic response (Tam et al. 2002). In another study of patients receiving cefepime for treatment of bacteremia and sepsis, the rates of both clinical cure and bacterial eradication were significantly higher in patients with  $AUC_{0-24}:MIC \geq 250$  compared to those with  $AUC_{0-24}:MIC < 250$  (McKinnon et al. 2008). Also, patients with T>MIC 100% showed higher rates of both clinical cure and microbiological eradication compared to those with T>MIC < 100%. These studies further support the need for more clinical studies to identify appropriate pharmacodynamic parameters and targets associated with more clinically relevant pharmacodynamic response. Also, studies by Tam and colleagues and McKinnon and colleagues suggest the possibility of different pharmacodynamic parameters or targets depending on the patient population (e.g., patients with documented or suspected infection vs. patients with bacteremia and/or

sepsis) (Tam et al. 2002; McKinnon et al. 2008). Considering the altered immunologic and inflammatory responses in obese individuals as discussed above, obese patients may have different pharmacodynamic targets or parameters, but to date, there are no published data to determine appropriate pharmacodynamic parameters and/or targets of any antibiotics in obese patients.

In contrast to beta-lactam antibiotics, the pharmacodynamics of beta-lactamase inhibitors, such as tazobactam, are not clearly defined. However, previous studies suggest the pharmacodynamic parameters may be 1) the fraction of a dosing interval that unbound drug concentrations remain above a threshold (i.e., minimum critical concentration ( $\%time>threshold$  or also known as  $fT>MCC$ ); or 2) AUC (VanScoy et al. 2013; Lister et al. 1997; Strayer et al. 1994). In a recent study, VanScoy and colleagues identified  $\%time>threshold$  as the best pharmacokinetic-pharmacodynamic tazobactam parameter, when in combination with ceftolozane, to predict the tazobactam efficacy using different candidate threshold concentrations of 0.01, 0.05, 0.1, 0.25, 0.5, 0.75, and 1 mg/L among  $\%time>threshold$ , AUC, and  $C_{max}$  (VanScoy et al. 2013). Based on the evaluation of the data dispersion along the exposure axis and  $r^2$  values for the relationship between changes in bacterial growth at 24 hours and  $\%time>threshold$ , the threshold concentrations that best described the relationship between bacterial growth at 24 hours and  $\%time>threshold$  were 0.05 mg/L for low-to-moderate beta-lactamase expressors and 0.25 mg/L for high beta-lactamase expressors, respectively (VanScoy et al. 2013). At these threshold concentrations, the  $\%time>threshold$  of 70% was associated with 2- $\log_{10}$  reduction in colony forming units (CFU) at 24 hours for both low-to-moderate and high beta-lactamase producers (VanScoy et al. 2013).

In summary, although more data are necessary to identify the best pharmacodynamic parameter that describes the clinical and/or microbiological response, administration of antibiotic doses based on the pharmacokinetic and pharmacodynamic properties of antibiotics as well as patient characteristics may increase the probability of favorable clinical and/or microbiological outcomes (Dellit et al. 2007).

Previous Studies Regarding Effect of Obesity on the Pharmacokinetics of  
Piperacillin/Tazobactam, Meropenem, and Cefepime

According to previous studies evaluating the pharmacokinetics of piperacillin/tazobactam in obese patients compared to non-obese patients, piperacillin V and CL were increased compared to non-obese patients (Newman et al. 2007; Deman et al. 2012; Hites et al. 2013). However, two studies reported increased piperacillin V and comparable or even lower CL in obese patients compared to non-obese patients (Sturm et al. 2014; Hites et al. 2014). It should be noted that most of these studies compared the pharmacokinetic parameters of their obese study patients to control patients, so no statistical test was performed for comparison between obese and non-obese patients. Also, it is not clear if the apparent difference in the pharmacokinetic parameters observed between their obese study patients and historical control patients is due to differences in other characteristics except body size (Newman et al. 2007; Deman et al. 2012; Sturm et al. 2014; Hites et al. 2014). In addition, both studies by Newman and colleagues and Deman and colleagues are case reports with only one morbidly obese patient, so robust conclusion cannot be made regarding the impact of obesity on piperacillin/tazobactam pharmacokinetics. In the study by Hites and colleagues, they compared the

pharmacokinetics of piperacillin/tazobactam in obese, critically ill patients compared to non-obese control patients, but they only obtained two samples per patient: one immediately prior to the administration of the study dose, and the other at 2 hours after the initiation of the 30-minute infusion of the study drug (Hites et al. 2013). Therefore, an accurate full pharmacokinetic profile might have not been described in their study especially because peak concentration was not obtained right after the end of therapy, probably resulting in less accurate and robust estimate of  $V$  in this study. Also, because these studies included a very specific population of patients (e.g., surgical intensive care unit patients only, critically ill patients only, non-critically ill patients only), these study findings may not be applicable to general obese patient populations. In addition, none of the previous studies evaluated the tazobactam pharmacokinetics in obese patients compared to non-obese patients. Although piperacillin is the active antibiotic component in the piperacillin/tazobactam combination product, tazobactam is important for piperacillin to adequately exert its antibacterial activity (Lister et al. 1997; Strayer et al. 1994). In terms of meropenem, conflicting data have been published. In a study of obese critically ill patients by Hites and colleagues, meropenem  $V$  and  $CL$  were not significantly different between obese and non-obese critically ill patients (Hites et al. 2013). However, according to a study of obese non-critically ill patients by the same group, meropenem  $V$  and  $CL$  appeared increased in obese patients compared to historical non-obese patient cohorts although no statistical test was performed in this study (Hites et al. 2014). Therefore, it is not yet clear whether obesity significantly impacts meropenem pharmacokinetics.

Similarly, conflicting data are available regarding the impact of obesity on the pharmacokinetics of cefepime. In a study of obese critically ill patients by Hites and colleagues, cefepime V and CL were not significantly different between obese and non-obese critically ill patients (Hites et al. 2013). However, according to a study of obese non-critically ill patients by the same group, cefepime V and CL appeared increased in obese patients compared to historical non-obese patient cohorts, but no statistical test was performed in this study (Hites et al. 2014). In another study evaluating the pharmacokinetics of cefepime in morbidly obese patients, cefepime V and CL appeared elevated in their study patients compared to historical control (Rich et al. 2012). However, these patients did not have an active infection, and cefepime was given solely for study purpose; therefore, this study findings may not be applicable to those with active infection.

In addition, all of these previous studies were conducted using the traditional pharmacokinetic approach, so they have not established the mathematical relationship between patient characteristics and pharmacokinetic parameters of these drugs (Newman et al. 2007; Deman et al. 2012; Hites et al. 2013; Sturm et al. 2014; Hites et al. 2014; Rich et al. 2012). If the relationship between patient characteristics and pharmacokinetic parameters are established by using regression methods, pharmacokinetics of the drug in a specific patient may be predicted. Also, the traditional pharmacokinetic approach does not typically separate the error sources into inter-individual variability and residual error, so the inter-individual variability appears over-estimated, which may result in inaccurate, unreliable simulation results (Food and Drug Administration, 1999). In this context, population pharmacokinetic studies using nonlinear mixed effect modeling approach may

offer advantages over traditional pharmacokinetic studies due to 1) their ability to formulate the mathematical relationship between pharmacokinetic parameters and various patient characteristics and 2) more robust error estimates, which may result in more reliable simulation results (Food and Drug Administration, 1999; Mould and Upton, 2012).

### Study Objectives

Although the pharmacokinetics of beta-lactam antibiotics have been described extensively in various patient populations, there is still a relative paucity of published data regarding the pharmacokinetics and pharmacodynamics of beta-lactam antibiotics in obese patients compared to non-obese patients. Particularly, there is no population pharmacokinetic/pharmacodynamic study of beta-lactam antibiotics in obese patients compared to non-obese patients. Population pharmacokinetic studies establish the relationship between patient characteristics and pharmacokinetic parameters, which may be used to predict pharmacokinetic profiles of the drug for a specific patients based on the patient's characteristics (Food and Drug Administration, 1999; Mould and Upton, 2012). Also, when pharmacodynamic simulation is considered, a more robust error estimate obtained from the population pharmacokinetic study, compared to the traditional pharmacokinetic study, may result in more accurate simulation result (Food and Drug Administration, 1999; Mould and Upton, 2012). As explained above, obesity is associated with alterations in several physiologic processes, which may in turn change pharmacokinetics of drugs including antimicrobial agents, potentially resulting in the need for alternative dosing regimens of the drug in obese individuals.



Piperacillin/tazobactam, meropenem, and cefepime are selected in this study because they are broad-spectrum beta-lactam antibiotics that are commonly used for the treatment of serious infections such as nosocomial or ventilator-associated pneumonia, so treatment with adequate dosages, based on the patient characteristics as well as the pharmacokinetic/pharmacodynamic properties of the drug, from early in therapy is imperative to minimize mortality (American Thoracic Society and Infectious Diseases Society of America, 2005; Dellinger et al. 2013; Dellit et al. 2007). Characterization of the pharmacokinetics of these beta-lactam antibiotics will evaluate any difference in the pharmacokinetics of these drugs between obese and non-obese patients. Also, based on this pharmacokinetic analysis, pharmacodynamic simulations will determine whether an alternative dosing regimen is needed to achieve comparable drug exposures between obese and non-obese individuals. Evaluation of the pharmacokinetics and pharmacodynamics of these beta-lactam antibiotics may determine their dosing regimens in obesity for comparable drug exposures between obese and non-obese patients, potentially contributing to the optimization of dosing regimens in obesity and decrease in the adverse consequences associated with inappropriate dosages (e.g., treatment failure, emergence of bacterial resistance, or unnecessary toxicity). Also, the knowledge gained in this study regarding the pharmacokinetics of beta-lactam antibiotics in obesity will expand our understanding of the impact of obesity on the pharmacokinetics and pharmacodynamics of drugs.

Based on the discussion above, we hypothesized that obese patients require larger dosages of piperacillin/tazobactam, meropenem, and cefepime compared to non-obese patients. To address this hypothesis, the overall objective of this research is to

characterize the pharmacokinetics and pharmacodynamics of three commonly used broad-spectrum beta-lactam antibiotics (piperacillin/tazobactam, meropenem, and cefepime) in hospitalized obese patients with suspected or documented infection compared to non-obese patients with suspected or documented infection, using the population pharmacokinetic/pharmacodynamic approach. In this research, this overall objective will be achieved by addressing the following specific aims:

Aim 1: Describe the steady-state pharmacokinetics of piperacillin/tazobactam, meropenem, and cefepime in hospitalized obese and non-obese patients with suspected or documented infection. This aim will test the hypothesis that CL and/or V of piperacillin/tazobactam, meropenem, and cefepime, estimated by the nonlinear mixed-effect modeling approach, is increased in obese patients compared to non-obese patients. This aim will be achieved by comparing the piperacillin/tazobactam, meropenem, and cefepime pharmacokinetic parameters estimated from the population pharmacokinetic models that will be developed in this study for each drug between obese and non-obese patients.

Aim 2: Determine the piperacillin/tazobactam, meropenem, and cefepime dosing regimens in obesity for similar drug exposures between obese and non-obese patients with suspected or documented infection. This aim will test the hypothesis that obese patients require larger piperacillin/tazobactam, meropenem, and cefepime dosages compared to non-obese patients to achieve comparable drug exposures. This aim will be achieved by pharmacodynamic simulations to estimate the probability to attain the

pharmacodynamic targets of piperacillin/tazobactam, meropenem, and cefepime for various dosing regimens of each drug using the population pharmacokinetic model and the model parameter estimates for piperacillin/tazobactam, meropenem, and cefepime, respectively.

## Notes

- Abernethy, Darrell R., Marcia Divoll, David J. Greenblatt, and Barbara Ameer. "Obesity, Sex, and Acetaminophen Disposition." *Clinical Pharmacology and Therapeutics* 31, no. 6 (1982a): 783-90.
- Abernethy, Darrell R., and David J. Greenblatt. "Lidocaine Disposition in Obesity." *The American Journal of Cardiology* 53, no. 8 (1984): 1183-6.
- Abernethy, Darrell R., and David J. Greenblatt. "Ibuprofen Disposition in Obese Individuals." *Arthritis and Rheumatism* 28, no. 10 (1985a): 1117-21.
- Abernethy, Darrell R., and David J. Greenblatt. "Phenytoin Disposition in Obesity: Determination of Loading Dose." *Archives of Neurology* 42, no. 5 (1985b): 468-71.
- Abernethy, Darrell R., David J. Greenblatt, Marcia Divoll, Jerold S. Harmatz, and Richard I. Shader. "Alterations in Drug Distribution and Clearance Due to Obesity." *The Journal of Pharmacology and Experimental Therapeutics* 217, no. 3 (1981a): 681-5.
- Abernethy, Darrell R., David J. Greenblatt, Marcia Divoll, and Richard I. Shader. "Prolongation of Drug Half-Life Due to Obesity: Studies of Desmethyldiazepam (Clorazepate)." *Journal of Pharmaceutical Sciences* 71, no. 8 (1982b): 942-4.
- Abernethy, D. R., D. J. Greenblatt, M. Divoll, and R. I. Shader. "Enhanced Glucuronide Conjugation of Drugs in Obesity: Studies of Lorazepam, Oxazepam, and Acetaminophen." *The Journal of Laboratory and Clinical Medicine* 101, no. 6 (1983): 873-80.
- Abernethy, Darrell R., David J. Greenblatt, Marcia Divoll, Randall B. Smith, and Richard I. Shader. "The Influence of Obesity on the Pharmacokinetics of Oral Alprazolam and Triazolam." *Clinical Pharmacokinetics* 9, no. 2 (1984): 177-83.
- Abernethy, Darrell R., David J. Greenblatt, and Thomas W. Smith. "Digoxin Disposition in Obesity: Clinical Pharmacokinetic Investigation." *American Heart Journal* 102, no. 4 (1981b): 740-4.
- Abernethy, D. R., Elizabeth L. Todd, and Janice B. Schwartz. "Caffeine Disposition in Obesity." *British Journal of Clinical Pharmacology* 20, no. 1 (1985): 61-6.

- Adnan, Syamhanin, Janice Xuanhui Li, Steven C. Wallis, Michael Rudd, Paul Jarrett, David L. Paterson, Jeffrey Lipman, Andrew A. Udy, and Jason A. Roberts. "Pharmacokinetics of Meropenem and Piperacillin in Critically Ill Patients with Indwelling Surgical Drains." *International Journal of Antimicrobial Agents* 42, no. 1 (2013): 90-3.
- Aggarwal, Nidhi, Anna C. Porter, Ignatius Y. S. Tang, Bryan N. Becker, and Sanjeev K. Akkina. "Creatinine-Based Estimations of Kidney Function Are Unreliable in Obese Kidney Donors." *Journal of Transplant* 2012, (2012): 872894.
- Alexander, James K. "Obesity and Cardiac Performance." *The American Journal of Cardiology* 14, (1964): 860-5.
- Alexander, J. K., E. W. Dennis, W. G. Smith, K. H. Amad, W. C. Duncan, and R. C. Austin. "Blood Volume, Cardiac Output, and Distribution of Systemic Blood Flow in Extreme obesity." *Cardiovascular Research Center Bulletin* Winter, no. 1 (1962-1963): 39-44.
- Allard, Sylvie, Martina Kinzig, Guy Boivin, Fritz Sorgel, and Marc LeBel. "Intravenous Ciprofloxacin Disposition in Obesity." *Clinical Pharmacology and Therapeutics* 54, no. 4 (1993): 368-73.
- Alpert, Martin A., and M. Wail Hashimi. "Obesity and the Heart." *The American Journal of the Medical Sciences* 306, no. 2 (1993): 117-23.
- Alvarez, Jose C., Sonia I. Cuervo, Javier R. Garzon, Julio C. Gomez, Jorge Augusto Diaz, Edelberto Silva, Ricardo Sanchez, and Jorge A. Cortes. "Pharmacokinetics of Piperacillin/Tazobactam in Cancer Patients with Hematological Malignancies and Febrile Neutropenia after Chemotherapy." *BMC Pharmacology & Toxicology* 14, (2013): 59.
- American Thoracic Society, and Infectious Diseases Society of America. "Guidelines for the Management of Adults with Hospital-Acquired, Ventilator-Associated, and Healthcare-Associated Pneumonia." *American Journal of Respiratory and Critical Care Medicine* 171, no. 4 (2005): 388-416.
- Amsden, Guy W., Charles H. Ballow, Joseph S. Bertino, Jr., and Angela D. M. Kashuba. "Pharmacokinetics and Pharmacodynamics of Anti-Infective Agents." In *Principles and Practice of Infectious Diseases*, edited by Gerald L. Mandell, John E. Bennett and Raphael Dolin, 297-308. Philadelphia, PA: Churchill Livingstone Elsevier, 2010.
- Andes, David R., and William A. Craig. "Cephalosporins." In *Principles and Practice of Infectious Diseases*, edited by Gerald L. Mandell, John E. Bennett and Raphael Dolin, 323-340. Philadelphia, PA: Churchill Livingstone Elsevier, 2010.

- Arguedas, Adriano G., Harris R. Stutman, Margaret Zaleska, Catherine A. Knupp, Melvin I. Marks, and Eliezer Nussbaum. "Cefepime. Pharmacokinetics and Clinical Response in Patients with Cystic Fibrosis." *American Journal of Diseases of Children* 146, no. 7 (1992): 797-802.
- Ariano, Robert E., Anna Nyhlen, J. Peter Donnelly, Daniel S. Sitar, Godfrey K. M. Harding, and Sheryl A. Zelenitsky. "Pharmacokinetics and Pharmacodynamics of Meropenem in Febrile Neutropenic Patients with Bacteremia." *The Annals of Pharmacotherapy* 39, no. 1 (2005): 32-8.
- Auclair, Barbara, and Murray P. Ducharme. "Piperacillin and Tazobactam Exhibit Linear Pharmacokinetics after Multiple Standard Clinical Doses." *Antimicrobial Agents and Chemotherapy* 43, no. 6 (1999): 1465-8.
- Bacher, K., M. Schaeffer, H. Lode, C. E. Nord, K. Borner, and P. Koeppe. "Multiple Dose Pharmacokinetics, Safety, and Effects on Faecal Microflora, of Cefepime in Healthy Volunteers." *The Journal of Antimicrobial Chemotherapy* 30, no. 3 (1992): 365-75.
- Baldwin, Claudine M., Katherine A. Lyseng-Williamson, and Susan J. Keam. "Meropenem: A Review of Its Use in the Treatment of Serious Bacterial Infections." *Drugs* 68, no. 6 (2008): 803-38.
- Barbhaiya, R. H., S. T. Fogue, C. R. Gleason, C. A. Knupp, K. A. Pittman, D. J. Weidler, and R. R. Martin. "Safety, Tolerance, and Pharmacokinetic Evaluation of Cefepime after Administration of Single Intravenous Doses." *Antimicrobial Agents and Chemotherapy* 34, no. 6 (1990): 1118-22.
- Barbhaiya, Rashimi H., S. Thomas Fogue, Carol R. Gleason, Catherine A. Knupp, Kenneth A. Pittman, Donald J. Weidler, Hassan Movahhed, James Tenney, and R. Russel Martin. "Pharmacokinetics of Cefepime after Single and Multiple Intravenous Administrations in Healthy Subjects." *Antimicrobial Agents and Chemotherapy* 36, no. 3 (1992): 552-7.
- Barbhaiya, R. H., C. A. Knupp, S. T. Fogue, G. R. Matzke, C. E. Halstenson, J. A. Opsahl, and K. A. Pittman. "Disposition of the Cephalosporin Cefepime in Normal and Renally Impaired Subjects." *Drug Metabolism and Disposition* 19, no. 1 (1991): 68-73.
- Bauer, L. A., D. J. Black, and J. S. Lill. "Vancomycin Dosing in Morbidly Obese Patients." *European Journal of Clinical Pharmacology* 54, no. 8 (1998): 621-5.

- Bauer, L. A., W. A. Drew Edwards, E. Patchen Dellinger, and D. A. Simonowitz. "Influence of Weight on Aminoglycoside Pharmacokinetics in Normal Weight and Morbidly Obese Patients." *European Journal of Clinical Pharmacology* 24, no. 5 (1983): 643-7.
- Bax, R. P., W. Bastain, A. Featherstone, D. M. Wilkinson, M. Hutchison, and S. J. Haworth. "The Pharmacokinetics of Meropenem in Volunteers." *The Journal of Antimicrobial Chemotherapy* 24 Suppl A, (1989): 311-20.
- Benedek, I. H., W. D. Fiske, 3rd, W. O. Griffen, R. M. Bell, R. A. Blouin, and P. J. McNamara. "Serum Alpha1-Acid Glycoprotein and the Binding of Drugs in Obesity." *British Journal of Clinical Pharmacology* 16, no. 6 (1983): 751-4.
- Benedek, I. H., R. A. Blouin, and P. J. McNamara. "Serum Protein Binding and the Role of Increased Alpha1-Acid Glycoprotein in Moderately Obese Male Subjects." *British Journal of Clinical Pharmacology* 18, no. 6 (1984): 941-6.
- Bercault, Nicholas, Thierry Boulain, Kaldhoun Kuteifan, Manuel Wolf, Isabelle Runge, and Jean-Christian Fleury. "Obesity-Related Excess Mortality Rate in an Adult Intensive Care Unit: A Risk-Adjusted Matched Cohort Study." *Critical Care Medicine* 32, no. 4 (2004): 998-1003.
- Binder, Lutz, Harald Schworer, Sebastian Hoppe, Frank Streit, Silke Neumann, Annett Beckmann, Rolf Wachter, Michael Oellerich, and Philip D. Walson. "Pharmacokinetics of Meropenem in Critically Ill Patients with Severe Infections." *Therapeutic Drug Monitoring* 35, no. 1 (2013): 63-70.
- Blaser, Jurg, Benjamin B. Stone, and Stephen H. Zinner. "Two Compartment Kinetic Model with Multiple Artificial Capillary Units." *The Journal of Antimicrobial Chemotherapy* 15 Suppl A, (1985): 131-7.
- Blaser, Jurg, Benjamin B. Stone, Michael C. Groner, and Stephen H. Zinner. "Comparative Study with Enoxacin and Netilmicin in a Pharmacodynamic Model to Determine Importance of Ratio of Antibiotic Peak Concentration to MIC for Bactericidal Activity and Emergence of Resistance." *Antimicrobial Agents and Chemotherapy* 31, no. 7 (1987): 1054-60.
- Blouin, Robert A., Larry A. Bauer, Delwyn D. Miller, Kenneth E. Record, and Ward O. Griffen, Jr. "Vancomycin Pharmacokinetics in Normal and Morbidly Obese Subjects." *Antimicrobial Agents and Chemotherapy* 21, no. 4 (1982): 575-80.
- Bodey, Gerald D., Steven J. Ketchel, and Victorio Rodriguez. "A Randomized Study of Carbenicillin Plus Cefamandole or Tobramycin in the Treatment of Febrile Episodes in Cancer Patients." *The American Journal of Medicine* 67, no. 4 (1979): 608-11.

- Bonapace, Charles R., Roger L. White, Lawrence V. Friedrich, E. Douglas Norcross, and John A. Bosso. "Pharmacokinetics of Cefepime in Patients with Thermal Burn Injury." *Antimicrobial Agents and Chemotherapy* 43, no. 12 (1999): 2848-54.
- Bourget, Philippe, Anne Lesne-Hulin, Robert Le Reveille, Herve Le Bever, and Herve Carsin. "Clinical Pharmacokinetics of Piperacillin-Tazobactam Combination in Patients with Major Burns and Signs of Infection." *Antimicrobial Agents and Chemotherapy* 40, no. 1 (1996): 139-45.
- Bowman, S. L., S. A. Hudson, G. Simpson, J. F. Munro, and J. A. Clements. "A Comparison of the Pharmacokinetics of Propranolol in Obese and Normal Volunteers." *British Journal of Clinical Pharmacology* 21, no. 5 (1986): 529-32.
- Brill, Margreke J. E., Jeroen Diepstraten, Anne van Rongen, Simone van Kralingen, John N. van den Anker, and Catherijne A. Knibbe. "Impact of Obesity on Drug Metabolism and Elimination in Adults and Children." *Clinical Pharmacokinetics* 51, no. 5 (2012): 277-304.
- Buck, Christine, Norbert Bertram, Thomas Ackermann, Tilman Sauerbruch, Hartmut derendorf, and Wilhem Dieter Paar. "Pharmacokinetics of Piperacillin-Tazobactam: Intermittent Dosing versus Continuous Infusion." *International Journal of Antimicrobial Agents* 25, no. 1 (2005): 62-7.
- Bui, Khanh Q., Paul G. Ambrose, David P. Nicolau, Craig D. Lapin, Charles H. Nightingale, and Richard Quintiliani. "Pharmacokinetics of High-Dose Meropenem in Adult Cystic Fibrosis Patients." *Chemotherapy* 47, no. 3 (2001): 153-86.
- Bulitta, J. B., S. B. Duffull, M. Kinzig-Schippers, U. Holzgrabe, U. Stephan, G. L. Drusano, and F. Sorgel. "Systematic Comparison of the Population Pharmacokinetics and Pharmacodynamics of Piperacillin in Cystic Fibrosis Patients and Healthy Volunteers." *Antimicrobial Agents and Chemotherapy* 51, no. 7 (2007): 2497-507.
- Bulitta, Jurgen B., Martina Kinzig, Verena Jakob, Ulrike Holzgrabe, Fritz Sorgel, and Nicholas H. G. Holford. "Nonlinear Pharmacokinetics of Piperacillin in Healthy Volunteers--Implications for Optimal Dosage Regimens." *British Journal of Clinical Pharmacology* 70, no. 5 (2010): 682-93.
- Burgess, David S., Rhonda W. Hastings, and Thomas C. Hardin. "Pharmacokinetics and Pharmacodynamics of Cefepime Administered by Intermittent and Continuous Infusion." *Clinical Therapeutics* 22, no. 1 (2000): 66-75.



- Butterfield, Jill M., Thomas P. Lodise, Scott Beegle, Jonathan Rosen, Joshua Farkas, and Manjunath P. Pai. "Pharmacokinetics and Pharmacodynamics of Extended-Infusion Piperacillin/Tazobactam in Adult Patients with Cystic Fibrosis-Related Acute Pulmonary Exacerbations." *The Journal of Antimicrobial Chemotherapy* 69, no. 1 (2014): 176-9.
- Caraco, Y., E. Zylber-Katz, E. M. Berry, and M. Levy. "Antipyrine Disposition in Obesity: Evidence for Negligible Effect of Obesity on Hepatic Oxidative Metabolism." *European Journal of Clinical Pharmacology* 47, no. 6 (1995): 525-30.
- Chambers, Henry F. "Beta-Lactam & Other Cell Wall- & Membrane-Active Antibiotics." In *Basic and Clinical Pharmacology*, edited by Bertram G. Katzung, 726-744. New York: McGraw-Hill Companies, Inc., 2007.
- Chambers, Henry F. "Penicillins and Beta-Lactam Inhibitors." In *Principles and Practice of Infectious Diseases*, edited by Gerald L. Mandell, John E. Bennett and Raphael Dolin, 309-322. Philadelphia, PA: Churchill Livingstone Elsevier, 2010a.
- Chambers, Henry F. "Carbapenems and Monobactams." In *Principles and Practice of Infectious Diseases*, edited by Gerald L. Mandell, John E. Bennett and Raphael Dolin, 341-346. Philadelphia, PA: Churchill Livingstone Elsevier, 2010b.
- Cheatham, S. Christian, Michael B. Kays, David W. Smith, Matthew F. Wack, and Kevin M. Sowinski. "Steady-State Pharmacokinetics and Pharmacodynamics of Meropenem in Hospitalized Patients." *Pharmacotherapy* 28, no. 6 (2008): 691-8.
- Cheatham, S. Christian, Katherine M. Shea, Daniel P. Healy, Melissa L. Humphrey, Megan R. Fleming, Matthew F. Wack, David W. Smith, Kevin M. Sowinski, and Michael B. Kays. "Steady-State Pharmacokinetics and Pharmacodynamics of Cefepime Administered by Prolonged Infusion in Hospitalised Patients." *International Journal of Antimicrobial Agents* 37, no. 1 (2011): 46-50.
- Chen, M., A. N. Nafziger, G. L. Drusano, L. Ma, and J. S. Bertino, Jr. "Comparative Pharmacokinetics and Pharmacodynamic Target Attainment of Ertapenem in Normal-Weight, Obese, and Extremely Obese Adults." *Antimicrobial Agents and Chemotherapy* 50, no. 4 (2006): 1222-7.
- Cheymol, Georges, Jean-Marie Poirier, Jerome Barre, Andre Pradalier, and Jean. Dry. "Comparative Pharmacokinetics of Intravenous Propranolol in Obese and Normal Volunteers." *Journal of Clinical Pharmacology* 27, no. 11 (1987): 874-9.
- Cheymol, G., J. Weisseburger, J. M. Poirier, and C. Gellee. "The Pharmacokinetics of Dexfenfluramine in Obese and Non-Obese Subjects." *British Journal of Clinical Pharmacology* 39, no. 6 (1995): 684-87.

- Cheymol, G., R. Woestenborghs, E. Snoeck, R. Ianucci, J.-P. Le Moing, L. Naditch, J. C. Levron, and J. M. Poirier. "Pharmacokinetic Study and Cardiovascular Monitoring of Nebivolol in Normal and Obese Subjects." *European Journal of Clinical Pharmacology* 51, no. 6 (1997): 493-8.
- Choban, Patricia S., Rachel Heckler, Jean C. Burge, and Louis Flancbaum. "Increased Incidence of Nosocomial Infections in Obese Surgical Patients." *The American Surgeon* 61, no. 11 (1995): 1001-5.
- Christensson, B. A., B. Ljungberg, L. Eriksson, and I. Nilsson-Ehle. "Pharmacokinetics of Meropenem in Patients with Cystic Fibrosis." *European Journal of Clinical Microbiology and Infectious Diseases* 17, no. 12 (1998): 873-6.
- Christoff, P. B., D. R. Conti, C. Naylor, and W. J. Jusko. "Procainamide Disposition in Obesity." *Drug Intelligence and Clinical Pharmacy* 17, no. 7-8 (1983): 516-22.
- Cockcroft, Donald W., and M. Henry Gault. "Prediction of Creatinine Clearance from Serum Creatinine." *Nephron* 16, no. 1 (1976): 31-41.
- Conil, J. M., B. Georges, M. Lavit, T. Seguin, I. Tack, K. Samii, G. Chabanon, G. Houin, and S. Saivin. "Pharmacokinetics of Ceftazidime and Cefepime in Burn Patients: The Importance of Age and Creatinine Clearance." *International Journal of Clinical Pharmacology and Therapeutics* 45, no. 1 (2007): 529-38.
- Cortinez L. I., B. J. Anderson, A. Penna, L. Olivares, H. R. Munoz, N. H. G. Holford, M. M. R. F. Struys, and P. Sepulveda. "Influence of Obesity on Propofol Pharmacokinetics: Derivation of a Pharmacokinetic Model." *British Journal of Anaesthesia* 105, no. 4 (2010): 448-56.
- Craig, William A. "Interrelationship Between Pharmacokinetics and Pharmacodynamics in Determining Dosage Regimens for Broad-Spectrum Cephalosporins." *Diagnostic Microbiology and Infectious Diseases* 22, no. 1-2 (1995): 89-96.
- Craig, William A. "Pharmacokinetic/Pharmacodynamic Parameters: Rationale for Antibacterial Dosing of Mice and Men." *Clinical Infectious Diseases* 26, no. 1 (1998): 1-10; quiz 11-2.
- Craig, William A. "Basic Pharmacodynamics of Antibacterials with Clinical Applications to the Use of Beta-Lactams, Glycopeptides, and Linezolid." *Infectious Disease Clinics of North America* 17, no. 3 (2003): 479-501.
- Craig, William A., and David Andes. "Pharmacokinetics and Pharmacodynamics of Antibiotics in Otitis Media." *The Pediatric Infectious Disease Journal* 15, no. 3 (1996): 255-9.

- Craig, W. A., and S. C. Ebert. "Killing and Regrowth of Bacteria In Vitro: A Review." *Scandinavian Journal of Infectious Diseases. Supplementum* 74, (1990): 63-70.
- Craig, W. A., S. Ebert, and Y. Watanabe. "Differences in Time above MIC Required for Efficacy of Beta-Lactams in Animal Infection Models." Presented as a poster presentation (Abstract No. 86) at the 33<sup>rd</sup> Interscience Conference on Antimicrobial Agents and Chemotherapy; 1993; San Francisco, California.
- Delattre, Isabelle K., Flora T. Musuamba, Philippe Jacqmin, Fabio S. Taccone, Pierre-Francois Laterre, Roger K. Verbeeck, Frederique Jacobs, and Pierre Wallemacq. "Population Pharmacokinetics of Four Beta-Lactams in Critically Ill Septic Patients Comedicated with Amikacin." *Clinical Biochemistry* 45, no. 10-11 (2012): 780-6.
- Dellinger, R. Phillip, Mitchell M. Levy, Andrew Rhodes, Djillali Annane, Herwig Gerlach, Steven M. Opal, Jonathan E. Sevransky, Charles L. Sprung, Ivor S. Douglas, Roman Jaeschke, Tiffany M. Osborn, Mark E. Nunnally, Sean R. Townsend, Konrad Reinhart, Ruth M. Kleinpell, Derek C. Angus, Clifford S. Deutschman, Flavia R. Machado, Gordon D. Rubenfeld, Steven A. Webb, Richard J. Beale, Jean-Louis Vincent, and Rui Moreno. "Surviving Sepsis Campaign: International Guidelines for Management of Severe Sepsis and Septic Shock: 2012." *Critical Care Medicine* 41, no. 2 (2013): 580-637.
- Dellit, Timothy H., Robert C. Owens, John E. McGowan, Jr., Dale N. Gerding, Robert A. Weinstein, John P. Burke, W. Charles Huskins, David L. Paterson, Neil O. Fishman, Christopher F. Carpenter, P. J. Brennan, Marianne Billeter, and Thomas M. Hooton. "Infectious Diseases Society of America and the Society for Healthcare Epidemiology of America Guidelines for Developing an Institutional Program to Enhance Antimicrobial Stewardship." *Clinical Infectious Diseases* 44, no. 2 (2007): 159-77.
- Deman, Hanna, Jan Verhaegen, Ludo Willems, and Isabel Spriet. "Dosing of Piperacillin/Tazobactam in a Morbidly Obese Patient." *The Journal of Antimicrobial Chemotherapy* 67, no. 3 (2012): 782-3.
- Demirovic, Jasmmina A., Amy Barton Pai, and Manjunath P. Pai. "Estimation of Creatinine Clearance in Morbidly Obese Patients." *American Journal of Health-System Pharmacy* 66, no. 7 (2009): 642-8.
- Devine, Ben J. "Gentamicin Therapy." *Drug Intelligence and Clinical Pharmacology* 8, (1974): 650-5.
- Dionne, R. E., L. A. Bauer, G. A. Gibson, W. O. Griffen, Jr., and R. A. Blouin. "Estimating Creatinine Clearance in Morbidly Obese Patients." *American Journal of Hospital Pharmacy* 38, no. 6 (1981): 641-4.

- Doh, Kichan, Heungjeong Woo, Jun Hur, Hoejun Yim, Jimyon Kim, Hongseok Chae, Seunghoon Han, and Dong-Seok Yim. "Population Pharmacokinetics of Meropenem in Burn Patients." *The Journal of Antimicrobial Chemotherapy* 65, no. 11 (2010): 2428-35.
- Donato, M. Teresa, Agustin Lahoz, Nuria Jimenez, Gabriela Perez, Alfonso Serralta, Jose Mir, Jose V. Castell, and M. Jose Gomez-Lechon. "Potential Impact of Steatosis on Cytochrome P450 Enzymes of Human Hepatocytes Isolated from Fatty Liver Grafts." *Drug Metabolism and Disposition* 34, no. 9 (2006): 1556-62.
- Drusano, George L. "Antimicrobial Pharmacodynamics: Critical Interactions of 'Bug and Drug'." *Nature Reviews. Microbiology* 2, no. 4 (2004): 289-300.
- Drusano, George L., Sandra L. Preston, Cynthia Fowler, Michael Corrado, Barbara Weisinger, and James Kahn. "Relationship Between Fluoroquinolone Area under the Curve: Minimum Inhibitory Concentration Ratio and the Probability of Eradication of the Infecting Pathogen, in Patients with Nosocomial Pneumonia." *The Journal of Infectious Diseases* 189, no. 9 (2004): 1590-7.
- Dvorchik, Barry H., and David Damphousse. "The Pharmacokinetics of Daptomycin in Moderately Obese, Morbidly Obese, and Matched Nonobese Subjects." *Journal of Clinical Pharmacology* 45, no. 1 (2005): 48-56.
- Emery, Maurice G., Jeannine M. Fisher, Jenny Y. Chien, Eva D. Kharasch, E. Patchen Dellinger, Kris V. Kowdley, and Kenneth E. Thummel. "CYP2E1 Activity Before and After Weight Loss in Morbidly Obese Subjects with Nonalcoholic Fatty Liver Disease." *Hepatology* 38, no. 2 (2003): 428-35.
- Endimiani, Andrea, Federico Perez, and Robert A. Bonomo. "Cefepime: A Reappraisal in an Era of Increasing Antimicrobial Resistance." *Expert Review Anti-Infective Therapy* 6, no. 6 (2008): 805-24.
- Engel, Georg, Ute Hofman, Hugo Heidemann, Jose Cosme, and Michel Eichelbaum. "Antipyrine as a Probe for Human Oxidative Drug Metabolism: Identification of the Cytochrome P450 Enzymes Catalyzing 4-Hydroxyantipyrine, 3-Hydroxymethylantipyrine, and Norantipyrine Formation." *Clinical Pharmacology and Therapeutics* 59, no. 6 (1996): 613-23.
- Falagas, Matthew E., and Drosos E. Karageorgopoulos. "Adjustment of Dosing of Antimicrobial Agents for Bodyweight in Adults." *Lancet* 375, no. 9710 (2010): 248-51.
- Falagas, Matthew E., and Maria Kompoti. "Obesity and Infection." *The Lancet. Infectious Diseases* 6, no. 7 (2006): 438-46.

- Farrell, Geoff C., N. C. Teoh, and R. S. McCuskey. "Hepatic Microcirculation in Fatty Liver Disease." *The Anatomical Record* 291, no. 6 (2008): 684-92.
- Felton, T. W., W. W. Hope, B. M. Lomaestro, J. M. Butterfield, A. L. Kwa, G. L. Drusano, and T. P. Lodise. "Population Pharmacokinetics of Extended-Infusion Piperacillin-Tazobactam in Hospitalized Patients with Nosocomial Infections." *Antimicrobial Agents and Chemotherapy* 56, no. 8 (2012): 4087-94.
- Felton, T. W., K. McCalman, I. Malagon, B. Isalska, S. Whalley, J. Goodwin, A. M. Bentley, and W. W. Hope. "Pulmonary Penetration of Piperacillin and Tazobactam in Critically Ill Patients." *Clinical Pharmacology and Therapeutics* 96, no. 4 (2014): 438-48.
- Flechner, Stuart M., Magnus E. Colbeinsson, Janice Tam, and Burton Lum. "The Impact of Body Weight on Cyclosporine Pharmacokinetics in Renal Transplant Recipients." *Transplantation* 47, no. 5 (1989): 806-10.
- Food and Agriculture Organization of the United Nations, "The State of Food and Agriculture: Food Systems for Better Nutrition"  
<http://www.fao.org/docrep/018/i3300e/i3300e.pdf> (accessed October 7 2014).
- Food and Drug Administration, "Guidance for Industry, Population Pharmacokinetics"  
<http://www.fda.gov/downloads/Drugs/Guidances/UCM072137.pdf> (accessed October 15 2014).
- Forse, R. A., B. Karam, L. D. MacLean, and N. V. Christou. "Antibiotic Prophylaxis for Surgery in Morbidly Obese Patients." *Surgery* 106, no. 4 (1989): 750-7.
- Fox, Caroline S., Martin G. Larson, Eric P. Leip, Bruce Culleton, Peter W. F. Wilson, and Daniel Levy. "Predictor of New-Onset Kidney Disease in a Community-Based Population." *JAMA* 291, no. 7 (2004): 844-50.
- Garrelts, James C., and David J. Wagner. "The Pharmacokinetics, Safety, and Tolerance of Cefepime Administered as an Intravenous Bolus or as a Rapid Infusion." *The Annals of Pharmacotherapy* 33, no. 12 (1999): 1258-61.
- Gibbs, John P., Ted Gooley, Bruce Corneau, Georgia Murray, Patricia Stewart, Frederick R. Appelbaum, and John T. Slattery. "The Impact of Obesity and Disease on Busulfan Oral Clearance in Adults." *Blood* 93, no. 12 (1999): 4436-40.
- Giron, Jose A., Burt R. Meyers, and Shalom Z. Hirschman. "Biliary Concentrations of Piperacillin in Patients Undergoing Cholecystectomy." *Antimicrobial Agents and Chemotherapy* 19, no. 2 (1981): 309-11.

- Gray, David S., George A. Bray, Nabil Gemayel, and Karl Kaplan. "Effect of Obesity on Bioelectrical Impedance." *The American Journal of Clinical Nutrition* 50, no. 2 (1989): 255-60.
- Greenblatt, David J., Darrell R. Abernethy, Ann Locniskar, Jerold S. Harmatz, Raul A. Limjoco, and Richard I. Shader. "Effect of Age, Gender, and Obesity on Midazolam Kinetics." *Anesthesiology* 61, no. 1 (1984): 27-35.
- Greenblatt, David J., H. Friedman, Ethan S. Burstein, Joseph M. Scavone, Gershwin T. Blyden, Herman R. Ochs, Lawrence G. Miller, Jerold S. Harmatz, and Richard I. Shader. "Trazodone Kinetics: Effect of Age, Gender, and Obesity." *Clinical Pharmacology and Therapeutics* 42, no. 2 (1987): 193-200.
- Hamilton, Rhonda, Xia C. Thai, Darius Ameri, and Manjunath P. Pai. "Oral Bioavailability of Linezolid Before and After Roux-en-Y Gastric Bypass Surgery: Is Dose Modification Necessary in Obese Subject?" *The Journal of Antimicrobial Chemotherapy* 68, no. 3 (2013): 666-73.
- Han, Emily E., Paul M. Beringer, Pal Falck, Stan Louie, Purush Rao, Bertrand Shapiro, and Mark Gill. "Pilot Study of Continuous Infusion Cefepime in Adult Patients with Cystic Fibrosis." *The Journal of Antimicrobial Chemotherapy* 57, no. 5 (2006): 1017-9.
- Hanley, Michael J., Darrell R. Abernethy, and David J. Greenblatt. "Effect of Obesity on the Pharmacokinetics of Drugs in Humans." *Clinical Pharmacokinetics* 49, no. 2 (2010): 71-87.
- Henegar, Jeffrey R., Steven A. Bigler, Lisa K. Henegar, Suresh C. Tyagi, and John E. Hall. "Functional and Structural Changes in the Kidney in the Early Stages of Obesity." *Journal of the American Society of Nephrology* 12, no. 6 (2001): 1211-7.
- Higuchi, Kazuko, Kazuro Ikawa, Kayo Ikeda, Hiroki Ohge, Taijiro Sueda, Hitoshi Houchi, and Norifumi Morikawa. "Peritoneal Pharmacokinetics of Cefepime in Laparotomy Patients with Inflammatory Bowel Disease, and Dosage Considerations for Surgical Intra-Abdominal Infections Based on Pharmacodynamic Assessment." *Journal of Infection and Chemotherapy* 14, no. 2 (2008): 110-6.
- Hites, Maya, Fabio Silvio Taccone, Fleur Wolff, Frederic Cotton, Marjorie Beumier, Daniel De Backer, Sandrine Roisin, Sophie Lorent, Rudy Surin, Lucie Seyler, Jean-Louis Vincent, and Frederique Jacobs. "Case-Control Study of Drug Monitoring of Beta-Lactams in Obese Critically Ill Patients." *Antimicrobial Agents and Chemotherapy* 57, no. 2 (2013): 708-15.

- Hites, M., F. S. Taccone, F. Wolff, E. Maillart, M. Beumier, R. Surin, F. Cotton, and F. Jacobs. "Broad-Spectrum Beta-Lactams in Obese Non-Critically Ill Patients." *Nutrition & Diabetes* 4, (2014): e119.
- Huls, Christine E., Randall A. Prince, Dan K. Seilhemier, and John A. Bosso. "Pharmacokinetics of Cefepime in Cystic Fibrosis Patients." *Antimicrobial Agents and Chemotherapy* 37, no. 7 (1993): 1414-6.
- Huttunen, R., M. Karppelin, and J. Syrjanen. "Obesity and Nosocomial Infections." *The Journal of Hospital Infection* 85, no. 1 (2013): 8-16.
- Iseki, Kunitoshi, Yoshiharu Ikemiya, Kozen Kinjo, Taku Inoue, Chiho Iseki, and Shuichi Takishita. "Body Mass Index and the Risk of Development of End-Stage Disease in a Screened Cohort." *Kidney International* 65, no. 5 (2004): 1870-6.
- Jackson, S. J., F. E. Leahy, A. A. McGowan, L. J. C. Bluck, W. A. Coward, and S. A. Jebb. "Delayed Gastric Emptying in the Obese: An Assessment Using the Non-Invasive (13)C-Octanoic Acid Breath Test." *Diabetes, Obesity & Metabolism* 6, no. 4 (2004): 264-70.
- Jain, R., S. M. Chung, L. Jain, M. Khurana, S. W. Lau, J. E. Lee, J. Vaidyanathan, I. Zadezensky, S. Choe, and C. G. Sahajwalla. "Implications of Obesity for Drug Therapy: Limitations and Challenges." *Clinical Pharmacology and Therapeutics* 90, no. 1 (2011): 77-89.
- Janmahasatian, Sarayut, Stephen B. Duffull, Susan Ash, Leigh C. Ward, Nuala M. Byrne, and Bruce Green. "Quantification of Lean Bodyweight." *Clinical Pharmacokinetics* 44, no. 10 (2005): 1051-65.
- Janson, Brett, and Karin Thursky. "Dosing of Antibiotics in Obesity." *Current Opinion in Infectious Diseases* 25, no. 6 (2012): 634-49.
- Jeon, Sangil, Seunghoon Han, Jongtae Lee, Taegon Hong, Jeongki Paek, Heungjeong Woo, and Dong-Seok Yim. "Population Pharmacokinetic Analysis of Piperacillin in Burn Patients." *Antimicrobial Agents and Chemotherapy* 58, no. 7 (2014): 3744-51.
- Jhee, Stanford S., Jack W. Kern, Jin-Pil Burm, Albert E. Yellin, and Mark A. Gill. "Piperacillin-Tazobactam Pharmacokinetics in Patients with Intraabdominal Infections." *Pharmacotherapy* 15, no. 4 (1995): 472-8.
- Kalman, Debra, Steven L. Barriere, and B. Lamar Johnson, Jr. "Pharmacokinetic Disposition and Bactericidal Activities of Cefepime, Ceftazidime, and Cefoperazone in Serum and Blister Fluid." *Antimicrobial Agents and Chemotherapy* 36, no. 2 (1992): 453-7.

- Kamimori, G. H., S. M. Somani, R. G. Knowlton, and R. M. Perkins. "The Effects of Obesity and Exercise on the Pharmacokinetics of Caffeine in Lean and Obese Volunteers." *European Journal of Clinical Pharmacology* 31, no. 5 (1987): 595-600.
- Kashuba, Angela D. M., Anne N. Nafziger, George L. Drusano, and Joseph S. Bertino, Jr. "Optimizing Aminoglycoside Therapy for Nosocomial Pneumonia Caused by Gram-Negative Bacteria." *Antimicrobial Agents and Chemotherapy* 43, no. 3 (1999): 623-9.
- Kieft, H., A. I. M. Hoepelman, C. A. Knupp, A. van Dijk, J. M. Branger, A. Struyvenberg, and J. Verhoef. "Pharmacokinetics of Cefepime in Patients with the Sepsis Syndrome." *The Journal of Antimicrobial Chemotherapy* 32 Suppl B, (1993): 117-22.
- Kim, Myo-Kyoung, Blair Capitano, Holly M. Mattoes, Dawei Xuan, Richard Quintiliani, Charles H. Nightingale, and David P. Nicolau. "Pharmacokinetic and Pharmacodynamic Evaluation of Two Dosing Regimens for Piperacillin-Tazobactam." *Pharmacotherapy* 22, no. 5 (2002): 569-77.
- Komuro, Masahito, Toshimatsu Maeda, Hiroyoshi Hayakawa, Katherine L. Allen, and Carol E. Green. "The Formation of Desethyl-Piperacillin from Piperacillin by Human Liver S9 In Vitro." *Biopharmaceutics & Drug Disposition* 18, no. 3 (1997): 185-90.
- Kovarik, J. M., J. C. ter Maaten, C. M. A. Rademaker, M. Deenstra, I. M. Hoepelman, H.C. Hart, G. R. Matzke, and J. Verhoef. "Pharmacokinetics of Cefepime in Patients with Respiratory Infections." *Antimicrobial Agents and Chemotherapy* 34, no. 10 (1990): 1885-8.
- Krueger, Wolfgang A., Jurgen Bulitta, Martina Kinzig-Schippers, Cornelia Landersdorfer, Ulrike Holzgrabe, Kurt G. Naber, George L. Drusano, and Fritz Sorgel. "Evaluation by Monte Carlo Simulation of the Pharmacokinetics of Two Doses of Meropenem Administered Intermittently or as a Continuous Infusion in Healthy Volunteers." *Antimicrobial Agents and Chemotherapy* 49, no. 5 (2005): 1881-9.
- Kuti, Joseph L., Sheryl Horowitz, Charles H. Nightingale, and David P. Nicolau. "Comparison of Pharmacodynamic Target Attainment between Healthy Subjects and Patients for Ceftazidime and Meropenem." *Pharmacotherapy* 25, no. 7 (2005): 935-41.
- Kuti, Joseph L., Charles H. Nightingale, R. Frederic Knauff, and David P. Nicolau. "Pharmacokinetic Properties and Stability of Continuous-Infusion Meropenem in Adults with Cystic Fibrosis." *Clinical Therapeutics* 26, no. 4 (2004): 493-501.



- Landersdorfer, Cornelia B., Jurgen B. Bulitta, Carl M. Kirkpatrick, Martina Kinzig, Ulrike Holzgrabe, George L. Drusano, Ulrich Stephan, and Fritz Sorgel. "Population Pharmacokinetics of Piperacillin at Two Dose Levels: Influence of Nonlinear Pharmacokinetics on the Pharmacodynamic Profile." *Antimicrobial Agents and Chemotherapy* 56, no. 11 (2012): 5715-23.
- Lau, A., M. Lee, and R. Sharifi. "Pharmacokinetics of Piperacillin in Hospitalized Patients." *International Journal of Clinical Pharmacology, Therapeutics, and Toxicology* 23, no. 8 (1985): 391-4.
- Leclercq, Isabelle, Yves Horsmans, Jean-Pierre Desager, Nathalie Delzenne, and Andre-Pierre Geubel. "Reduction in Hepatic Cytochrome P-450 is Correlated to the Degree of Liver Fat Content in Animal Models of Steatosis in the Absence of Inflammation." *Journal of Hepatology* 28, no. 3 (1998): 410-16.
- Leroy, A., J. P. Fillastre, F. Borsa-Lebas, I. Etienne, and G. Humbert. "Pharmacokinetics of Meropenem (ICI 194,660) and Its Metabolite (ICI 213,689) in Healthy Subjects and in Patients with Renal Impairment." *Antimicrobial Agents and Chemotherapy* 36, no. 12 (1992): 2794-8.
- Levey, Andrew S., Tom Greene, John W. Kusek, and Gerald J. Beck. "A Simplified Equation to Predict Glomerular Filtration Rate from Serum Creatinine." *Journal of the American Society of Nephrology* 11, (2000): 155A.
- Levey, Andrew S., Lesley A. Stevens, Christopher H. Schmid, Yaping (Lucy) Zhang, Alejandro F. Castro, 3rd, Harold I. Feldman, John W. Kusek, Paul Eggers, Frederick Van Lente, Tom Greene, and Josef Coresh. "A New Equation to Estimate Glomerular Filtration Rate." *Annals of Internal Medicine* 150, no. 9 (2009): 604-12.
- Li, Chonghua, Xiaoli Du, Joseph L. Kuti, and David P. Nicolau. "Clinical Pharmacodynamics of Meropenem in Patients with Lower Respiratory Tract Infections." *Antimicrobial Agents and Chemotherapy* 51, no. 5 (2007): 1725-30.
- Li, Chonghua, Joseph L. Kuti, Charles H. Nightingale, Debra L. Mansfield, Adrian Dana, and David P. Nicolau. "Population Pharmacokinetics and Pharmacodynamics of Piperacillin/Tazobactam in Patients with Complicated Intra-abdominal Infection." *The Journal of Antimicrobial Chemotherapy* 56, no. 2 (2005): 388-95.
- Lipman, J., S. C. Wallis, and C. Rickard. "Low Plasma Cefepime Levels in Critically Ill Septic Patients: Pharmacokinetic Modeling Indicates Improved Troughs with Revised Dosing." *Antimicrobial Agents and Chemotherapy* 43, no. 10 (1999): 2559-61.

- Lister, Philip D., Andrea M. Prevan, and Christine C. Sanders. "Importance of Beta-Lactamase Inhibitor Pharmacokinetics in the Pharmacodynamics of Inhibitor-Drug Combinations: Studies with Piperacillin-Tazobactam and Piperacillin-Sulbactam." *Antimicrobial Agents and Chemotherapy* 41, no. 4 (1997): 721-7.
- Lodise, Thomas P., Ben M. Lomaestro, and George L. Drusano. "Application of Antimicrobial Pharmacodynamic Concepts into Clinical Practice: Focus on Beta-Lactam Antibiotics: Insights from the Society of Infectious Diseases Pharmacists." *Pharmacotherapy* 26, no. 9 (2006): 1320-32.
- Longo, Cristina, Gillian Bartlett, Brenda Macgibbon, Nancy Mayo, Ellen Rosenberg, Lyne Nadeau, and Stella S. Daskalopoulou. "The Effect of Obesity on Antibiotic Treatment Failure: A Historical Cohort Study." *Pharmacoepidemiology and Drug Safety* 22, no. 9 (2013): 970-6.
- Maxipime(TM) [package insert]. Lake Forest, IL: Hospira, Inc., 2012.
- McKinnon, Peggy S., Joseph A. Paladino, and Jerome J. Shentag. "Evaluation of Area under the Inhibitory Curve (AUC) and Time above the Minimum Inhibitory Concentration (T>MIC) as Predictors of Outcome for Cefepime and Ceftazidime in Serious Bacterial Infections." *International Journal of Antimicrobial Agents* 31, no. 4 (2008): 345-51.
- Merrem(R) [package insert]. Wilmington, DE: AstraZeneca Pharmaceuticals LP, 2013.
- Minami, Yoshinori, Masahito Komuro, Kumiko Sakawa, and Naobumi Ishida. "Desethyl Piperacillin, a New Active Metabolite of Piperacillin in Human." *The Journal of Antibiotics* 44, no. 2 (1991): 256-8.
- Mitscher, Lester A. "Antibiotics and Antimicrobial Agents." In *Foye's Principles of Medicinal Chemistry*, edited by David A. Williams and Thomas L. Lemke, 819-866. Philadelphia, PA: Lippincott Williams and Wilkins, 2002.
- Moon, Yong S. K., Karen C. Chung, and Mark A. Gill. "Pharmacokinetics of Meropenem in Animals, Healthy Volunteers, and Patients." *Clinical Infectious Diseases* 24 Suppl 2, (1997): S249-55.
- Mould, D. R., and R. N. Upton. "Basic Concepts in Population Modeling, Simulation, and Model-Based Drug Development." *CPT:Pharmacometrics & Systems Pharmacology* 1, (2012): e6.
- Mouton, Johan W. "Impact of Pharmacodynamics on Breakpoint Selection for Susceptibility Testing." *Infectious Disease Clinics of North America* 17, no. 3 (2003): 579-98.

- Navarro-Diaz, Maruja, Auumpta Serra, Ramon Romero, Josep Bonet, Beatriu Bayes, Merce Homs, Noelia Perez, and Jordi Bonal. "Effect of Drastic Weight Loss after Bariatric Surgery on Renal Parameters in Extremely Obese Patients: Long-Term Follow-Up." *Journal of the American Society of Nephrology* 17, no. 12 Suppl 3 (2006): S213-7.
- Newman, Diane, Marc H. Scheetz, Oluwadamilola A. Adeyemi, Mauro Montevicchi, David P. Nicolau, Gary A. Noskin, and Michael J. Postelnick. "Serum Piperacillin/Tazobactam Pharmacokinetics in a Morbidly Obese Individual." *The Annals of Pharmacotherapy* 41, no. 10 (2007): 1734-9.
- Nicasio, Anthony M., Robert E. Ariano, Sheryl A. Zelenitsky, Aryun Kim, Jared L. Crandon, Joseph L. Kuti, and David P. Nicolau. "Population Pharmacokinetics of High-Dose, Prolonged-Infusion Cefepime in Adult Critically Ill Patients with Ventilator-Associated Pneumonia." *Antimicrobial Agents and Chemotherapy* 53, no. 4 (2009): 1476-81.
- Occhipinti, Donna J., Susan L. Pendland, Lori L. Schoonover, Eric B. Rypins, Larry H. Danziger, and Keith A. Rodvold. "Pharmacokinetics and Pharmacodynamics of Two Multiple-Dose Piperacillin-Tazobactam Regimens." *Antimicrobial Agents and Chemotherapy* 41, no. 11 (1997): 2511-7.
- Ogden, Cynthia L., Margaret D. Carroll, Brian K. Kit, and Katherine M. Flegal. "Prevalence of Childhood and Adult Obesity in the United States, 2011-2012." *JAMA* 311, no. 8 (2014): 806-14.
- Pai, Manjunath P. "Drug Dosing Based on Weight and Body Surface Area: Mathematical Assumptions and Limitations in Obese Adults." *Pharmacotherapy* 32, no. 9 (2012): 856-68.
- Pai, Manjunath P., and David T. Bearden. "Antimicrobial Dosing Considerations in Obese Adult Patients." *Pharmacotherapy* 27, no. 8 (2007): 1081-91.
- Pearson, T. C., D. L. Guthrie, J. Simpson, S. Chinn, G. Barosi, A. Ferrant, S. M. Lewis, and Y. Najean. "Interpretation of Measured Red Cell Mass and Plasma Volume in Adults: Expert Panel on Radionuclides of the International Council for Standardization in Haematology." *British Journal of Haematology* 89, no. 4 (1995): 748-56.
- Perry, Caroline M., and Anthony Markham. "Piperacillin/Tazobactam: An Updated Review of Its Use in the Treatment of Bacterial Infections." *Drugs* 57, no. 5 (1999): 805-43.

- Preston, Sandra L., George L. Drusano, Adam L. Berman, Cynthia L. Fowler, Andrew T. Chow, Bruce Dornseif, Veronica Reichl, Jaya Natarajan, and Michael Corrado. "Pharmacodynamics of Levofloxacin: A New Paradigm for Early Clinical Trials." *JAMA* 279, no. 2 (1998): 125-9.
- Public Health England, "Severe Obesity"  
[http://www.noo.org.uk/NOO\\_about\\_obesity/morbid\\_obesity](http://www.noo.org.uk/NOO_about_obesity/morbid_obesity) (accessed October 7 2014).
- Ramon-Lopez, Amelia, Jane M. Allen, Alison H. Thomson, Bajlit S. Dheansa, S. Elizabeth James, Geoff W. Hanlon, Bruce Stewart, and J. Graham Davies. "Dosing Regimen of Meropenem for Adults with Severe Burns: A Population Pharmacokinetic Study with Monte Carlo Simulations." *The Journal of Antimicrobial Chemotherapy*, (2014).
- Rea, D. J., J. K. Heimbach, J. P. Grande, S. C. Textor, S. J. Taler, M. Prieto, T. S. Larson, F. G. Cosio, and M. D. Stegall. "Glomerular Volume and Renal Histology in Obese and Non-Obese Living Kidney Donors." *Kidney International* 70, no. 9 (2006): 1636-41.
- Reiss, Robert A., Curtis E. Haas, Shyam D. Karki, Barry Gumbiner, Stephen L. Welle, and Stanley W. Carson. "Lithium Pharmacokinetics in the Obese." *Clinical Pharmacology and Therapeutics* 55, no. 4 (1994): 392-8.
- Rich, Barrie S., Rebecca Keel, Vanessa P. Ho, Harma Turbendian, Cheguevara I. Afaneh, Gregory F. Dakin, Alfons Pomp, David P. Nicolau, and Philip S. Barie. "Cefepime Dosing in the Morbidly Obese Patient Population." *Obesity Surgery* 22, no. 3 (2012): 465-71.
- Roberts, Jason A., Carl M. J. Kirkpatrick, Michael S. Roberts, Andres J. Dalley, and Jeffrey Lipman. "First-Dose and Steady-State Population Pharmacokinetics and Pharmacodynamics of Piperacillin by Continuous or Intermittent Dosing in Critically Ill Patients with Sepsis." *International Journal of Antimicrobial Agents* 35, no. 2 (2010): 156-63.
- Roberts, Jason A., Michael S. Roberts, Thomas A. Robertson, Andrew J. Dalley, and Jeffrey Lipman. "Piperacillin Penetration into Tissue of Critically Ill Patients with Sepsis -- Bolus Versus Continuous Administration." *Critical Care Medicine* 37, no. 3 (2009): 926-33.
- Roe, Jada L., Joseph M. Fuentes, and Michael E. Mullins. "Underdosing of Common Antibiotics for Obese Patients in the ED." *The American Journal of Emergency Medicine* 30, no. 7 (2012): 1212-4.

- Rowland, Malcolm, and Thomas N. Tozer. "Absorption." In *Clinical Pharmacokinetics and Pharmacodynamics*, 183-216. Philadelphia, PA: Lippincott Williams and Wilkins, 2011a.
- Rowland, Malcolm, and Thomas N. Tozer. "Elimination." In *Clinical Pharmacokinetics and Pharmacodynamics*, 111-158. Philadelphia, PA: Lippincott Williams and Wilkins, 2011b.
- Salazar, Daniel E., and George B. Corcoran. "Predicting Creatinine Clearance and Renal Drug Clearance in Obese Patients from Estimated Fat-Free Body Mass." *The American Journal of Medicine* 84, no. 6 (1988): 1053-60.
- Sampol, Emmanuelle, Alexis Jacquet, Marc Viggiano, Victor Bernini, Jean-Claude Manelli, Bruno Lacarelle, and Alain Durand. "Plasma, Urine and Skin Pharmacokinetics of Cefepime in Burns Patients." *The Journal of Antimicrobial Chemotherapy* 46, no. 2 (2000): 315-7.
- Schentag, Jerome J., Ian L. Smith, Douglas J. Swanson, Carlo DeAngelis, Joseph E. Fracasso, Andras Vari, and John W. Vance. "Role for Dual Individualization with Cefmenoxime." *The American Journal of Medicine* 77, no. 6A (1984): 43-50.
- Shea, Katherine M., S. Christian Cheatham, Matthew F. Wack, David W. Smith, Kevin M. Sowinski, and Michael B. Kays. "Steady-State Pharmacokinetics and Pharmacodynamics of Piperacillin/Tazobactam Administered by Prolonged Infusion in Hospitalised Patients." *International Journal of Antimicrobial Agents* 34, no. 5 (2009): 429-33.
- Shikuma, Lois R., Bruce H. Ackerman, Ross H. Weaver, Lynn D. Solem, Richard G. Strate, Frank B. Cerra, and Darwin E. Zaske. "Thermal Injury Effects on Drug Disposition: A Prospective Study with Piperacillin." *Journal of Clinical Pharmacology* 30, no. 7 (1990): 632-7.
- Sime, Fekade Bruck, Michael S. Roberts, Morgyn S. Warner, Uwe Hahn, Thomas A. Robertson, Sue Yeend, Andy Phay, Sheila Lehman, Jeffrey Lipman, Sandra L. Peake, and Jason A. Roberts. "Altered Pharmacokinetics of Piperacillin in Febrile Neutropenic Patients with Hematological Malignancy." *Antimicrobial Agents and Chemotherapy* 58, no. 6 (2014): 3533-7.
- Sorgel, F., and M. Kinzig. "The Chemistry, Pharmacokinetics, and Tissue Distribution of Piperacillin/Tazobactam." *The Journal of Antimicrobial Chemotherapy* 31 Suppl A, (1993): 39-60.

- Stevens, Gretchen A., Gitanjali M. Singh, Yuan Lu, Goodarz Danaei, John K. Lin, Mariel M. Finucane, Adil N. Bahalim, Russel K. McIntire, Hialy R. Gutierrez, Melanie Cowan, Christopher J. Paciorek, Farshad Farzadfar, Leanne Riley, and Majid Ezzati. "National, Regional, and Global Trends in Adult Overweight and Obesity Prevalences." *Population Health Metrics* 10, no. 1 (2012): 22.
- Stokholm, K. H., J. Brochner-Mortensen, and P. F. Hoilund-Carlsen. "Increased Glomerular Filtration Rate and Adrenocortical Function in Obese Women." *International Journal of Obesity* 4, no. 1 (1980): 57-63.
- Strayer, Andy H., Deborah H. Gilbert, Phil Pivarnik, Antone A. Medeiros, Stephen H. Zinner, and Michael N. Dudley. "Pharmacodynamics of Piperacillin Alone and in Combination with Tazobactam against Piperacillin-Resistant and -Susceptible Organisms in an In Vitro Model of Infection." *Antimicrobial Agents and Chemotherapy* 38, no. 10 (1994): 2351-6.
- Sturm, Ashley W., Nichole Allen, Kelly D. Rafferty, Douglas N. Fish, Eric Toschlog, Mark Newell, and Brett Waibel. "Pharmacokinetic Analysis of Piperacillin Administered with Tazobactam in Critically Ill, Morbidly Obese Surgical Patients." *Pharmacotherapy* 34, no. 1 (2014): 28-35.
- Tam, Vincent H., Peggy S. McKinnon, Ronda L. Akins, Michael J. Rybak, and George L. Drusano. "Pharmacodynamics of Cefepime in Patients with Gram-Negative Infections." *The Journal of Antimicrobial Chemotherapy* 50, no. 3 (2002): 425-8.
- Turnidge, J. D. "The Pharmacodynamics of Beta-Lactams." *Clinical Infectious Diseases* 27, no. 1 (1998): 10-22.
- Uchino, H., T. Inaba, and W. Kalow. "Human Metabolism of Antipyrine Labelled with <sup>14</sup>C in the Pyrazolone Ring or in the N-Methyl Group." *Xenobiotica* 13, no. 3 (1983): 155-62.
- Vance-Bryan, Kyle, David R. P. Guay, Susan S. Gilliland, Keith A. Rodvold, and John C. Rotschafer. "Effect of Obesity on Vancomycin Pharmacokinetic Parameters as Determined by Using a Bayesian Forecasting Technique." *Antimicrobial Agents and Chemotherapy* 37, no. 3 (1993): 436-40.
- Van der Auwera, P., and P. J. Santella. "Pharmacokinetics of Cefepime: A Review." *The Journal of Antimicrobial Chemotherapy* 32 Suppl B, (1993): 103-15.

- VanScoy, Brian, Rodrigo E. Mendes, Anthony M. Nicasio, Mariana Castanheira, Catharine C. Bulik, Olanrewaju O. Okusanya, Sujata M. Bhavnani, Alan Forrest, Ronald N. Jones, Lawrence V. Friedrich, Judith N. Steenbergen, and Paul G. Ambrose. "Pharmacokinetics-Pharmacodynamics of Tazobactam in Combination with Ceftolozane in an In Vitro Infection Model." *Antimicrobial Agents and Chemotherapy* 57, no. 6 (2013): 2809-14.
- Van Wart, Scott, Luann Phillips, Elizabeth A. Ludwig, Rene Russo, Diptee A. Gajjar, Akintunde Bello, Paul G. Ambrose, Christopher Costanzo, Thaddeus H. Grasela, Roger Echols, and Dennis M. Grasela. "Population Pharmacokinetics and Pharmacodynamics of Garenoxacin in Patients with Community-Acquired Respiratory Tract Infections." *Antimicrobial Agents and Chemotherapy* 48, no. 12 (2004): 4766-77.
- Varin, France, Julie Ducharme, Yves Theoret, Jean-Guy Besner, David R. Bevan, and Francois Donati. "Influence of Extreme Obesity on the Body Disposition and Neuromuscular Blocking Effect of Atracurium." *Clinical Pharmacology and Therapeutics* 48, no. 1 (1990): 18-25.
- Vinks, Alexander A., Jan G. den Hollander, Shelley E. Overbeek, Roger W. Jelliffe, and Johan W. Mouton. "Population Pharmacokinetic Analysis of Nonlinear Behavior of Piperacillin During Intermittent or Continuous Infusion in Patients with Cystic Fibrosis." *Antimicrobial Agents and Chemotherapy* 47, no. 2 (2003): 541-7.
- Vogelman, B., S. Gudmundsson, J. Leggett, J. Turnidge, S. Ebert, and W. A. Craig. "Correlation of Antimicrobial Pharmacokinetic Parameters with Therapeutic Efficacy in an Animal Model." *The Journal of Infectious Diseases* 158, no. 4 (1988): 831-47.
- Weltman, Martin D., Geoffrey C. Farrell, Pauline Hall, Magnus Ingelman-Sundberg, and Christopher Liddle. "Hepatic Cytochrome P450 2E1 is Increased in Patients with Nonalcoholic Steatohepatitis." *Hepatology* 27, no. 1 (1998):128-33.
- Weltman, Martin D., Geoffrey C. Farrell, and Christopher Liddle. "Increased Hepatocyte CYP2E1 Expression in a Rat Nutritional Model of Hepatic Steatosis with Inflammation." *Gastroenterology* 111, no. 6 (1996):1645-53.
- World Health Organization, "Global Health Observatory Data Repository: Obesity (Body Mass Index  $\geq$  30) Data by Country"  
<http://apps.who.int/gho/data/node.main.A900?lang=en> (accessed October 7 2014).
- World Health Organization, "Obesity and Overweight"  
<http://www.who.int/mediacentre/factsheets/fs311/en/> (accessed October 7 2014).

- Yee, J. Y. V., and S. B. Duffull. "The Effect of Body Weight on Dalteparin Pharmacokinetics: A Preliminary Study." *European Journal of Clinical Pharmacology* 56, no. 4 (2000): 293-7.
- Zakrison, Tanya L., Darcy A. Hille, and Nicholas Namias. "Effect of Body Mass Index on Treatment of Complicated Intra-Abdominal Infections in Hospitalized Adults: Comparison of Ertapenem with Piperacillin-Tazobactam." *Surgical Infections* 13, no. 1 (2012): 38-42.
- Zosyn(R) [package insert]. Philadelphia, PA: Pfizer Injectables, 2013.



## DETERMINATION OF OPTIMAL PIPERACILLIN/TAZOBACTAM REGIMENS IN OBESE PATIENTS COMPARED TO NON-OBESE PATIENTS

### Study Objectives

The objectives of this study were:

Objective 1: To describe the steady-state pharmacokinetics of piperacillin/tazobactam in hospitalized obese and non-obese patients with suspected or documented infection. This objective will test the hypothesis that CL and/or V of piperacillin/tazobactam, estimated by the nonlinear mixed-effect modeling approach, is increased in obese patients compared to non-obese patients. This objective will be achieved by comparing the piperacillin/tazobactam pharmacokinetic parameters estimated from the population pharmacokinetic models that will be developed in this study between obese and non-obese patients.

Objective 2: To determine the appropriate piperacillin/tazobactam dosing regimens in obesity to achieve similar pharmacodynamic targets in obese patients compared with non-obese patients with suspected or documented infection. This objective will test the hypothesis that obese patients require larger piperacillin/tazobactam dosages compared to non-obese patients to achieve comparable drug exposures. This aim will be achieved by

pharmacodynamic simulations to estimate the probability to attain the pharmacodynamic targets of piperacillin/tazobactam over a range of MICs for piperacillin in the presence of tazobactam and threshold concentrations for tazobactam for various dosing regimens using the population pharmacokinetic model and the model parameter estimates for piperacillin/tazobactam.

## Methods

### Study Design and Pharmacokinetic Data

This is a retrospective analysis of prospectively collected serum concentration-time data from two previous studies published by our research group (Study 1 and Study 2) (Shea et al. 2009; Cheatham et al. 2013). The sample size was not determined a priori using power analysis, but a convenience sample using available data was used for this study. The inclusion and exclusion criteria of Study 1 and Study 2 are listed in Table 7.

Table 7. Inclusion and exclusion criteria for Study 1 and Study 2

	Study 1 (Shea et al. 2009)	Study 2 (Cheatham et al. 2013)
Inclusion criteria	<ul style="list-style-type: none"> <li>- Hospitalized at Methodist Hospital or St. Francis Hospital (Indianapolis, IN)</li> <li>- Aged <math>\geq 18</math> years</li> <li>- Required antimicrobial therapy for a suspected or documented bacterial infection</li> <li>- Had central venous access</li> </ul>	<ul style="list-style-type: none"> <li>- Hospitalized at St. Francis Hospital (Indianapolis, IN)</li> <li>- Total body weight <math>&gt; 120</math> kg</li> <li>- Aged <math>\geq 18</math> years</li> <li>- Required antimicrobial therapy for a suspected or documented bacterial infection</li> <li>- Had central venous access</li> </ul>
Exclusion criteria	<ul style="list-style-type: none"> <li>- Allergy to any beta-lactam antibiotic</li> <li>- History of drug or alcohol abuse</li> <li>- Pregnancy</li> <li>- History of any seizure disorder</li> <li>- Acute or chronic renal failure</li> <li>- Renal replacement therapy of any type</li> <li>- Hepatic dysfunction defined as serum bilirubin and alanine aminotransferase concentrations <math>\geq 2</math> and <math>\geq 4</math> times the normal upper limit, respectively</li> </ul>	<ul style="list-style-type: none"> <li>- History of allergy to penicillins of piperacillin/tazobactam</li> <li>- Severe renal dysfunction defined as creatinine clearance<sup>a</sup> <math>&lt; 10</math> mL/min or renal replacement therapy of any type</li> <li>- Pregnancy</li> <li>- Hepatic dysfunction defined as serum bilirubin and alanine aminotransferase concentrations <math>\geq 2</math> and <math>\geq 4</math> times the normal upper limit, respectively</li> </ul>

<sup>a</sup> Creatinine clearance (CRCL) was estimated by the modified Cockcroft-Gault method using lean body weight, actual serum creatinine concentration (equations 19, 20, 22):

$$\text{Lean body weight (LBW in male, kg)} = \frac{9270 \times \text{TBW}}{6680 + 216 \times \text{BMI}} \quad (19)$$

$$\text{Lean body weight (LBW in female, kg)} = \frac{9270 \times \text{TBW}}{8780 + 244 \times \text{BMI}} \quad (20)$$

$$\text{CRCL (mL/min)} = \frac{(140 - \text{Age}) \times \text{LBW}}{\text{SCr} \times 72} \times (0.85 \text{ if female}) \quad (22)$$

These studies were approved by the institutional review boards at each study site, and written informed consent was obtained from each patient or a first-degree relative if the patient was unable to give informed consent due to his or her medical condition

Patients were classified as either obese (BMI  $\geq 30$  kg/m<sup>2</sup>) or non-obese (BMI  $< 30$  kg/m<sup>2</sup>). Patients received piperacillin/tazobactam 4.5 g or 6.75 g q8h, infused over 4 hours, according to each study protocol to reflect the routine clinical practice at

Methodist Hospital, IU Health (Indianapolis, IN) for Study 1 patients and Methodist Hospital, IU Health (Indianapolis, IN) and St. Francis Hospital (Indianapolis, IN) for Study 2 patients (Shea et al. 2009; Cheatham et al. 2013). After 2 or more days of therapy, serial blood samples were collected from an indwelling IV catheter immediately prior to drug administration, and at 1, 2, 3, 4 (end of infusion), 5, 6, 7 and 8 hours after the start of infusion. At each time when blood sample was collected, the catheter was flushed with 10 mL of normal saline or heparin. The first 10 mL of blood draw was discarded to ensure flush solution was not mixed with the patient's blood samples. Afterwards, 10 mL blood samples were collected in non-anticoagulant (red top) tubes at each time point. Immediately after allowing the blood to coagulate, the samples were centrifuged and serum samples were stored at  $-70^{\circ}\text{C}$ . Serum samples were shipped on dry ice by overnight carrier to the Center for Anti-Infective Research and Development at Hartford Hospital (Hartford, CT) for samples obtained from Study 1 and to the University of Cincinnati Academic Health Center (Cincinnati, OH) for samples obtained from Study 2 for determination of piperacillin and tazobactam concentrations.

Piperacillin and tazobactam serum concentrations were determined by the previously validated high performance liquid chromatography (HPLC) method with an ultraviolet (UV) detector (Kim et al. 2002; Aughey et al. 1996; McWhinney et al. 2010). In Study 1 (Shea et al. 2009), piperacillin and tazobactam serum concentrations were measured simultaneously using a validated reverse-phase high-performance liquid chromatography (HPLC) assay with ultraviolet detection (Kim et al. 2002). The mobile phase consisted of two components: 10% sodium phosphate buffer (0.01 M, pH 2.7, v/v) and 90% HPLC-grade acetonitrile (MP1); 97% sodium phosphate buffer (0.01 M, pH 2.7,

v/v) and 3% HPLC-grade acetonitrile (MP2). Using a gradient controlled pump, the mobile phase was 5% MP1 and 95% MP2 from 0-10 minutes, 45% MP1 and 55% MP2 from 10-18 minutes, and 5% MP1 and 95% MP2 from 18-22 minutes. The flow rate was 1.2 mL/minute, and chromatographic separation was performed using a reverse-phase HPLC column (Bondpak C-18 guard-pak precolumn, Phenomenex Prodigy, 10 micron, 4.6 mm x 250 mm). Serum samples were allowed to thaw at room temperature, and penicillin G (internal standard, 25  $\mu$ L) was added to each sample (200  $\mu$ L). Protein precipitation was performed by adding 800  $\mu$ L of acetonitrile, vortexing for 30 seconds, and centrifuging at 2,000 x g for 10 minutes. Two mL of dichloromethane was added to the supernatant, vortexed for 30 seconds, and centrifuged at 2,000 x g for 10 minutes. The aqueous phase was then injected into the HPLC. For piperacillin, the standard curve was linear ( $r=0.998$ ) from 2 to 100  $\mu$ g/mL. The intra-run ( $n=10$ ) coefficients of variation for the low (6  $\mu$ g/mL) and high (80  $\mu$ g/mL) quality control samples were 3.2% and 2.1%, respectively. The inter-run ( $n=9$ ) coefficients of variation for the low and high quality control samples were 6.9% and 3.8%, respectively. For tazobactam, the standard curve was linear ( $r=0.999$ ) from 1 to 50  $\mu$ g/mL. The intra-run ( $n=10$ ) coefficients of variation for the low (3  $\mu$ g/mL) and high (40  $\mu$ g/mL) quality control samples were 2.5% and 4.0%, respectively. The inter-run ( $n=9$ ) coefficients of variation for the low and high quality control was 5.6% and 4.5%, respectively.

In Study 2 (Cheatham et al. 2013), piperacillin and tazobactam serum concentrations were determined separately using a validated high-performance liquid chromatography assay with ultraviolet detection as described previously (Augey et al.

1996; McWhinney et al. 2010). For piperacillin, the mobile phase consisted of 25% HPLC-grade acetonitrile and 75% sodium phosphate buffer (100 mM, pH 3.0, v/v). The flow rate was 1.0 mL/min, and chromatographic separation was performed using a reverse-phase HPLC column (Bondpak C-18 guard-pak precolumn, Phenomenex Prodigy, 10 micron, 4.6 mm x 250 mm). Serum samples were allowed to thaw at room temperature, and oxacillin (internal standard, 100  $\mu$ L) was added to each sample (200  $\mu$ L). Protein precipitation was performed by adding 600  $\mu$ L of acetonitrile, vortexing for 30 seconds, and centrifuging at 2,000 x g for 10 minutes. Chloroform (600  $\mu$ L) was added to the supernatant, vortexed for 30 seconds, and centrifuged at 2,000 x g for 10 minutes. The aqueous phase was then injected into the HPLC. The piperacillin standard curve was linear over the concentration range 1–400  $\mu$ g/mL ( $r = 0.999$ ). The within-day ( $n = 5$ ) coefficients of variation for spiked plasma control specimens of 4, 40 and 120  $\mu$ g/mL were 8.6%, 3.2% and 4.2%, respectively, and the between-day ( $n = 5$ ) coefficients of variation were 6.4%, 6.3%, and 5.6%. For tazobactam, the mobile phase consisted of 3.5% HPLC-grade acetonitrile and 96.5% ammonium acetate buffer (pH 5.0, v/v). The flow rate was 1.0 mL/min, and chromatographic separation was performed using a reverse-phase HPLC column (Bondpak C-18 guard-pak precolumn, Phenomenex Prodigy, 10 micron, 4.6 mm x 250 mm). Serum samples were allowed to thaw at room temperature, and ceftazidime (internal standard, 25  $\mu$ L) was added to each sample (500  $\mu$ L). Protein precipitation was performed by adding 1 mL of acetonitrile, vortexing for 30 seconds, and centrifuging at 2,000 x g for 10 minutes. Chloroform (3 mL) was added to the supernatant, vortexed for 30 seconds, and centrifuged at 2,000 x g for 10 minutes.

The aqueous phase was then injected into the HPLC. The tazobactam standard curve was linear over the concentration range 2–200  $\mu\text{g/mL}$  ( $r = 0.999$ ). The within-day ( $n = 5$ ) coefficients of variation for spiked plasma control specimens of 5, 50 and 100  $\mu\text{g/mL}$  were 6.9%, 2.0% and 8.4%, respectively, and the between-day ( $n = 5$ ) coefficients of variation were 14.9%, 3.9% and 9.0%.

### Population Pharmacokinetic Analysis

Serum concentration-time data for piperacillin and tazobactam from all individual patients were analyzed simultaneously by population compartmental pharmacokinetic modeling approach using NONMEM (version VII; Globomax LLC, Ellicott, MD, USA) (Bauer et al. 2009). NONMEM software was accessed via the cluster at the Indiana Clinical and Translational Science Institution thanks to Dr. Robert R. Bies. Pharmacokinetic models were built separately for piperacillin and tazobactam. For both drugs, the first-order conditional estimation (FOCE) method with interaction was used. As previous publications described piperacillin pharmacokinetics using one-, two-, and three-compartment models with linear or nonlinear elimination, one-, two-, and three-compartment models with zero-order input and either first-order (i.e., linear), Michaelis-Menten (i.e., nonlinear), and parallel linear-nonlinear elimination were evaluated as potential structural pharmacokinetic models for piperacillin (Auclair and Ducharme, 1999; Vinks et al. 2003; Lodise et al. 2004; Bulitta et al. 2007; Bulitta et al. 2010; Roberts et al. 2010; Felton et al. 2012; Landersdorfer et al. 2012; Alvarez et al. 2013; Hites et al. 2013; Butterfield et al. 2014; Jeon et al. 2014; Strum et al. 2014).

Figures 3 to 5 show the diagrams describing one-, two-, and three-compartment structural models. Differential equations describing one-, two-, and three-compartment structural models are shown in equations 27, 28-29, and 30-32, respectively.

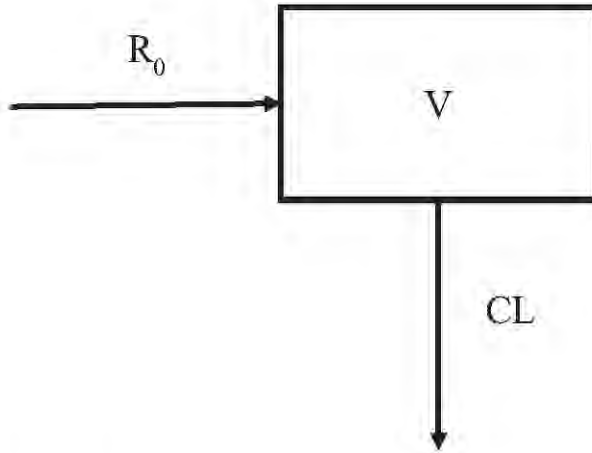

Figure 3. One-compartment structural model.  $R_0$ , the rate of drug infusion (mg/h);  $V$ , volume of distribution (L);  $CL$ , clearance (L/h).

$$\frac{dA}{dt} = R_0 - \left( \frac{CL}{V} \times A \right) \quad (23)$$

where  $\frac{dA}{dt}$  is the rate of change in the drug amount over time (mg/h),  $A$  is the amount of the drug in the body (system) (mg),  $R_0$  is the rate of drug infusion (mg/h),  $CL$  is clearance (L/h), and  $V$  is the volume of distribution (L).



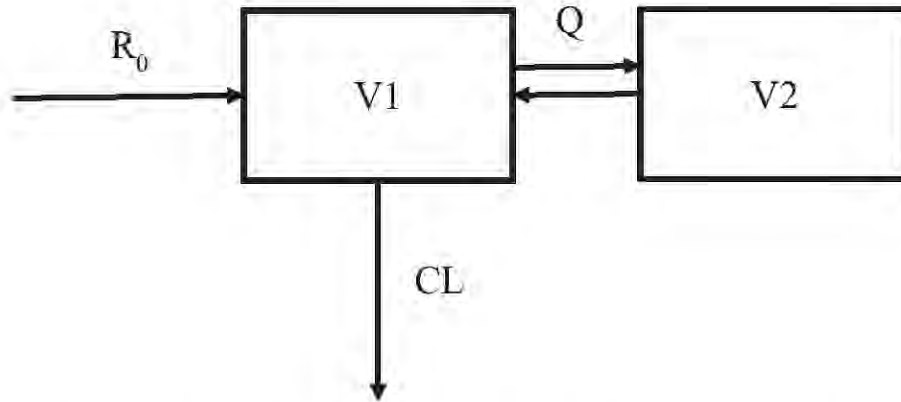

Figure 4. Two-compartment structural model.  $R_0$ , the rate of drug infusion (mg/h);  $V_1$ , volume of distribution in the central compartment (L);  $V_2$ , volume of distribution in the peripheral compartment (L);  $Q$ , inter-compartmental distribution clearance (L/h);  $CL$ , clearance (L/h).

$$\frac{dA_1}{dt} = R_0 + \left(\frac{Q}{V_2} \times A_2\right) - \left(\frac{Q}{V_1} \times A_1\right) - \left(\frac{CL}{V_1} \times A_1\right) \quad (24)$$

$$\frac{dA_2}{dt} = \left(\frac{Q}{V_1} \times A_1\right) - \left(\frac{Q}{V_2} \times A_2\right) \quad (25)$$

where  $\frac{dA_1}{dt}$  is the rate of change in the drug amount over time in the central compartment (mg/h),  $R_0$  is the rate of drug infusion (mg/h),  $Q$  is inter-compartmental distribution clearance (L/h),  $V_2$  is volume of distribution in the peripheral compartment (L),  $A_2$  is the amount of the drug in the peripheral compartment (mg),  $V_1$  is volume of distribution in the central compartment (L),  $A_1$  is the amount of the drug in the central compartment (mg),  $CL$  is clearance (L/h), and  $\frac{dA_2}{dt}$  is the rate of change in the drug amount over time in the peripheral compartment (mg/h).

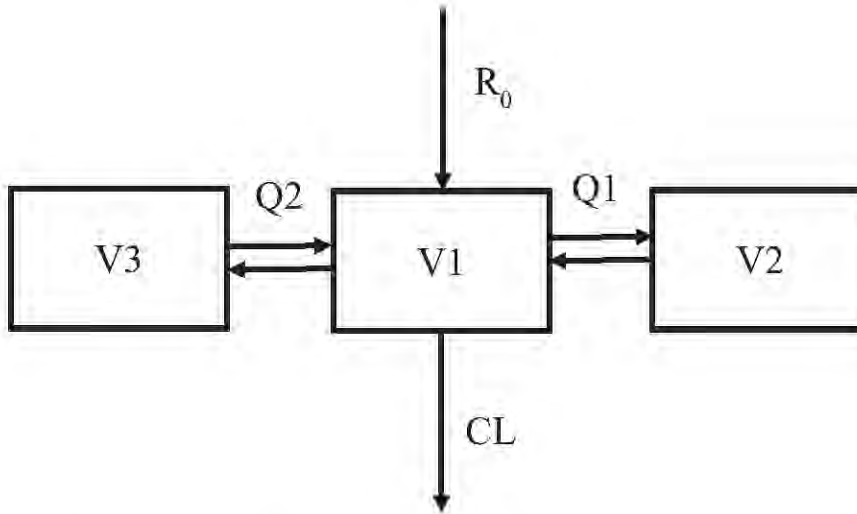

Figure 5. Three-compartment structural model.  $R_0$ , the rate of drug infusion (mg/h);  $V_1$ , volume of distribution in the central compartment (L);  $V_2$ , volume of distribution in the shallow peripheral compartment (L);  $V_3$ , volume of distribution in the deep peripheral compartment (L);  $Q_1$ , inter-compartmental distribution clearance between central and shallow peripheral compartments (L/h);  $Q_2$ , inter-compartmental distribution clearance between central and deep peripheral compartments (L/h);  $CL$ , clearance (L/h).

$$\frac{dA_1}{dt} = R_0 + \left(\frac{Q_1}{V_2} \times A_2\right) + \left(\frac{Q_2}{V_3} \times A_3\right) - \left(\frac{Q_1}{V_1} \times A_1\right) - \left(\frac{Q_2}{V_1} \times A_1\right) - \left(\frac{CL}{V_1} \times A_1\right) \quad (26)$$

$$\frac{dA_2}{dt} = \left(\frac{Q_1}{V_1} \times A_1\right) - \left(\frac{Q_1}{V_2} \times A_2\right) \quad (27)$$

$$\frac{dA_3}{dt} = \left(\frac{Q_2}{V_1} \times A_1\right) - \left(\frac{Q_2}{V_3} \times A_3\right) \quad (28)$$

where  $\frac{dA_1}{dt}$  is the rate of change in the drug amount over time in the central compartment (mg/h),  $R_0$  is the rate of drug infusion (mg/h),  $Q_1$  is inter-compartmental distribution clearance between central and shallow peripheral compartments (L/h),  $V_2$  is volume of distribution in the peripheral compartment (L),  $A_2$  is the amount of the drug in the shallow peripheral compartment (mg),  $Q_2$  is inter-compartmental distribution clearance between central and deep peripheral compartments (L/h),  $V_3$  is volume of distribution in the deep peripheral compartment (L),  $A_3$  is the amount of the drug in the deep peripheral

compartment (mg),  $V_1$  is volume of distribution in the central compartment (L),  $A_1$  is the amount of the drug in the central compartment (mg),  $CL$  is clearance (L/h),  $\frac{dA_2}{dt}$  is the rate of change in the drug amount over time in the shallow peripheral compartment, and  $\frac{dA_3}{dt}$  is the rate of change in the drug amount over time in the deep peripheral compartment. For nonlinear and parallel linear-nonlinear elimination models,  $CL$  in equations 27, 28, and 30 were substituted with equations 33 for nonlinear and 34 for parallel linear-nonlinear elimination models, respectively.

$$CL = \frac{V_{\max}}{K_m + C} \quad (29)$$

$$CL = \frac{V_{\max}}{K_m + C} + CL_{\text{linear}} \quad (30)$$

where  $CL$  is clearance (L/h),  $V_{\max}$  is the maximum rate of elimination for the saturable elimination process (mg/h),  $K_m$  is the drug concentration where the elimination rate is half maximal (mg/L),  $C$  is the drug concentration in the body (or system) for the one-compartment model or in the central compartment for the two- and three-compartment models (mg/L), respectively, and  $CL_{\text{linear}}$  is the clearance for the linear, non-saturable elimination process (L/h). If the two-compartment model did not describe the data better than the one-compartment model, the three-compartment model was not tested based on the principle of parsimony. Similarly, based on the principle of parsimony, if nonlinear elimination did not describe the data better than linear elimination, the models with parallel linear-nonlinear elimination were not tested. For tazobactam, only linear elimination was evaluated due to the lack of evidence suggesting nonlinearity in the tazobactam pharmacokinetics (Sorgel and Kinzig, 1993; Auclair and Ducharme, 1999; Vinks et al. 2003; Buck et al, 2005; Felton et al. 2012). The initial estimates of  $CL$  and  $V$

for each drug were the average of the parameter estimates obtained from our previous studies using non-compartmental and one-compartmental analyses (Shea et al. 2009; Cheatham et al. 2013). The initial estimates of parameters describing two-compartment, three-compartment, and nonlinear models (e.g., inter-compartmental distribution clearance,  $V$  in the central compartment,  $V$  in the peripheral compartment,  $V_{max}$ , and  $K_m$ ) were obtained from previous publications (Auclair and Ducharme, 1999; Vinks et al. 2003; Lodise et al. 2004; Bulitta et al. 2007; Bulitta et al. 2010; Roberts et al. 2010; Felton et al. 2012; Landersdorfer et al. 2012; Butterfield et al. 2014; Jeon et al. 2014). The initial estimate values were varied from 10-fold lower to 10-fold higher values to achieve global minima and obtain robust parameter estimates (Bauer et al. 2009). Inter-individual variability ( $\eta$ ) of population pharmacokinetic parameters was assumed to follow log-normal distribution with a mean of zero and variance of  $\omega^2$  (equation 31) (Mould and Upton, 2012). Possible correlations among the inter-individual variability for pharmacokinetic parameters in the model were examined. For residual errors ( $\varepsilon$ ) unexplained by the model, additive ( $\varepsilon_{add}$ ), proportional ( $\varepsilon_{prop}$ ), and combinational models were evaluated, and residual error was assumed to be normally distributed with a mean of zero and variance of  $\sigma^2$  (equations 32, 33, and 34) (Mould and Upton, 2012).

$$P_{ij} = TVP_j \times e^{\eta_{ij}} \quad (31)$$

$$Y_{ik} = IPRED_{ik} + \varepsilon_{add,ik} \quad (32)$$

$$Y_{ik} = IPRED_{ik} \times (1 + \varepsilon_{prop,ik}) \quad (33)$$

$$Y_{ik} = IPRED_{ik} \times (1 + \varepsilon_{prop,ik}) + \varepsilon_{add,ik} \quad (34)$$

where  $P_{ij}$  is the  $j^{\text{th}}$  pharmacokinetic parameter, such as CL and  $V$ , of the  $i^{\text{th}}$  patient,  $TVP_j$  is the typical population value of the  $j^{\text{th}}$  pharmacokinetic parameter,  $\eta_{ij}$  is a random

variable for the inter-individual variability of the  $j^{\text{th}}$  pharmacokinetic parameter for the  $i^{\text{th}}$  patient,  $Y_{ik}$  is the measured drug (i.e., piperacillin and tazobactam) concentration of the  $i^{\text{th}}$  patient at the  $k^{\text{th}}$  sampling time,  $IPRED_{ik}$  is the individual model-predicted drug concentration of the  $i^{\text{th}}$  patient at the  $k^{\text{th}}$  sampling time, and  $\varepsilon_{ik}$  is residual error of the  $i^{\text{th}}$  patient at the  $k^{\text{th}}$  sampling time. The best structural pharmacokinetic models with stochastic error terms for piperacillin and tazobactam were selected based on the visual inspection of observed concentration-time plots, goodness-of-fit plots, individual plots of observed and individual predicted concentration-time profiles, the change in the minimum objective function value ( $\Delta\text{OFV}$ ), and Akaike information criterion (AIC) (Akaike, 1974; American College of Clinical Pharmacology, 2011). In NONMEM, the objective function value (OFV) is -2 times the log of the model likelihood, and the likelihood is typically considered as a sum of squares (American College of Clinical Pharmacology, 2011). The change in the minimum objective function value ( $\Delta\text{OFV}$ ) follows a chi-square distribution and a decrease in OFV by  $> 3.84$  is considered statistically significant with 1 degree of freedom ( $df$ ) at the  $\alpha$  level of 0.05 using a chi-square test (American College of Clinical Pharmacology, 2011). Akaike information criterion (AIC) is defined in equation 35.

$$\text{AIC} = \text{OFV} + [2 \times (\text{number of parameters in the model})] \quad (35)$$

where AIC is Akaike information criterion and OFV is the model objective function value which is equal to -2 times the log of the model likelihood. Among the above listed diagnostic criteria for model selection,  $\Delta\text{OFV}$  took precedence over others.

The final pharmacokinetic model was built by evaluating the effects of covariates on the pharmacokinetic parameters of piperacillin and tazobactam using the stepwise

forward inclusion followed by the backward elimination process. Tested covariates included: 1) age (years); 2) sex; 3) body size descriptor, including TBW, IBW, LBW (Janmahasatian et al. 2005), and BMI; 4) CRCL; and 5) admission to an intensive care unit (ICU or general medical ward). Equations 3-4 and 19-20 were used to estimate IBW and LBW, respectively.

$$IBW = 50 \text{ kg} + [2.3 \text{ kg} * (\text{height in inches} - 60)] \text{ in males} \quad (3)$$

$$IBW = 45.5 \text{ kg} + [2.3 \text{ kg} * (\text{height in inches} - 60)] \text{ in females} \quad (4)$$

$$LBW \text{ (in male, kg)} = \frac{9270 \times TBW}{6680 + 216 \times BMI} \quad (19)$$

$$LBW \text{ (in female, kg)} = \frac{9270 \times TBW}{8780 + 244 \times BMI} \quad (20)$$

where IBW is ideal body weight (kg), LBW is lean body weight (kg), TBW is total body weight (kg), and BMI is body mass index ( $\text{kg}/\text{m}^2$ ). The admission to an intensive care unit was tested to evaluate the association between critical illness and pharmacokinetic parameters of piperacillin and tazobactam because critical illness was previously suggested to alter antibiotic pharmacokinetics (Roberts et al. 2014). CRCL was measured using either an 8-hour urine collection over the dosing interval or a 24-hour urine collection on the day blood samples were collected using equation 1 (Shea et al. 2009; Cheatham et al. 2013).

$$CRCL = \frac{(\text{Urine volume collected over 8 or 24 hours}) \times U_{Cr} \times 1000}{P_{Cr} \times (\text{time in minutes})} \quad (1)$$

where  $U_{Cr}$  is urine creatinine concentration,  $P_{Cr}$  is plasma creatinine concentration, and time in minutes is 480 minutes if using 8-hour urine collection or 1440 minutes if using 24-hour urine collection. Creatinine concentrations in urine and plasma samples from each patient were assayed at the clinical laboratories of the hospital where the patient was

hospitalized [i.e., either Methodist Hospital, IU Health (Indianapolis, IN) or St. Francis Hospital (Indianapolis, IN)].

Continuous covariates (e.g., age, body size descriptors including TBW, IBW, LBW, and BMI, and CRCL) were centered at their median values. The effect of each covariate on each pharmacokinetic parameter was evaluated using 1) linear, power, or exponential functions for continuous covariates and 2) additive or proportional functions for categorical covariates (e.g., sex and ICU admission). Covariates that reduced the model OFV  $> 3.84$  ( $p < 0.05$ ;  $\chi^2$  distribution; 1 *df*) were considered significantly associated with the pharmacokinetic parameters in the model. In each step, among statistically significant covariates, if any, only the covariate with the greatest decrease in the model OFV was kept in the model. Afterwards, the remaining covariates were tested and added to the model in the same manner. The full model was constructed when all of the significant covariates were added to the model and there was no other remaining covariate that significantly reduced the model OFV. The final model was constructed after removing covariates that were not significantly associated with the pharmacokinetic parameters from the full model in the stepwise backward elimination process. A covariate was removed if its elimination increased the model OFV by  $< 5.024$  ( $p > 0.025$ ;  $\chi^2$  distribution; 1 *df*). If there was more than one covariate that was not significant in the same step, the covariate with the smallest increase in the model OFV was removed, and this process was repeated until the elimination of every covariate in the model resulted in an increase in the model OFV by  $> 5.024$  ( $p < 0.025$ ;  $\chi^2$  distribution; 1 *df*).

The final model was evaluated by goodness-of-fit plots and individual plots of observed and individual predicted concentration-time profiles. The predictive accuracy

of the final pharmacokinetic model was examined by visual predictive checks (VPCs) (Byon et al. 2013). VPCs were performed by simulating serum concentration-time profiles for piperacillin and tazobactam using NONMEM (version VII; Globomax LLC, Ellicott, MD, USA) (Bauer et al. 2009). One thousand simulations were conducted using all of the study patients included to build the population pharmacokinetic model (n=27 for piperacillin, n=25 for tazobactam), resulting in 27,000- and 25,000-virtual simulated serum concentration time profiles of piperacillin and tazobactam, respectively. Fewer patients were included for tazobactam model building and simulation compared to piperacillin due to insufficient serum samples left to determine tazobactam concentrations after the determination of piperacillin concentrations. Curves for the 5<sup>th</sup>, 50<sup>th</sup>, and 95<sup>th</sup> percentiles of simulated drug concentrations were graphed with the observed concentrations, and they were grouped by dosage regimens (4.5 g q8h and 6.75 g q8h).

Descriptive statistics were used to summarize patient demographics and each pharmacokinetic parameter. All statistical analyses were performed in SPSS (SPSS Statistics for Windows, Version 20.0; SPSS Inc. IBM Corp. Armonk, NY). For categorical variables, chi-square or Fisher's exact test was used to test the differences between non-obese and obese patients. For continuous variables, normality was tested using Kolmogorov-Smirnov test. When normality assumption was met, differences between non-obese and obese patients were tested using the 2-tailed, unpaired t-test with either unequal or equal variances, depending on the Levene's test result for equal variance. When normality assumption was violated, Mann-Whitney U test was performed to test the differences between non-obese and obese patients. Statistical significance was defined as  $p < 0.05$ .



### Pharmacodynamic Analysis Using Monte Carlo Simulations

Pharmacodynamic exposures were modeled for the following three prolonged-infusion (4-hour infusion) piperacillin/tazobactam dosing regimens: 1) 3.375 g q8h 2) 4.5 g q8h and 3) 6.75 g q8h. Monte Carlo simulations for piperacillin and tazobactam were performed using NONMEM with 200 simulations of all patients included to build the population pharmacokinetic model (n=27 for piperacillin and n=25 for tazobactam, respectively), so 5,400- and 5,000-patient steady-state serum concentration-time curves for piperacillin and tazobactam, respectively, were created using the final pharmacokinetic model of each drug. All serum concentration-time curves were simulated in 0.1-hour intervals, and the unbound serum concentrations were calculated as simulated serum drug concentrations multiplied by the free fraction. For both drugs, the unbound fraction was assumed to be 0.7 because 1) both drugs are considered relatively low-protein binding drugs and 2) protein binding and/or unbound drug concentrations were not measured (Shea et al. 2009; Cheatham et al. 2013; Zosyn(R) [package insert], 2013). Based on the simulated unbound serum concentration-time profiles, the probability of target attainment (PTA) for piperacillin was calculated for each dosing regimen using the pharmacodynamic target of  $\geq 50\% fT > MIC$  at specific MICs ranging from 1 to 64 mg/L. The PTA for tazobactam was calculated for each dosing regimen using the pharmacodynamic targets of %time>threshold of 70% and 100% at specific threshold concentrations, which are the minimum critical concentrations for piperacillin efficacy, ranging from 0.05 to 4 mg/L (VanScoy et al. 2013). The dosing regimen with the PTA  $\geq 90\%$  was considered optimal (DeRyke et al. 2007).

## Results

Patient Characteristics

Overall, a convenience sample of 27 patients (17 men and 10 women) were studied. TBW ranged from 60 kg to 211 kg, BMI from 19.7 kg/m<sup>2</sup> to 72.9 kg/m<sup>2</sup>, and measured CRCL from 23 mL/min to 260 mL/min. No patients experienced adverse events related to piperacillin/tazobactam therapy during the study. Table 8 shows patient demographics for non-obese and obese patient groups.

Table 8. Patient demographics [median (range) unless otherwise stated]

Demographic characteristics	Non-obese (n=11)	Obese (n=16)	P-value
Male, no. of patients (%)	7 (63.6%)	10 (62.5%)	1.00 <sup>f</sup>
Age, years	53 (27-76)	48 (35-69)	0.634 <sup>g</sup>
Creatinine clearance, <sup>a</sup> mL/min	88 (23-148)	111 (28-260)	0.214 <sup>g</sup>
Height, cm	175 (163-190)	175 (157-190)	0.797 <sup>g</sup>
Total body weight, kg	74 (60-100)	151 (98-211)	< 0.001 <sup>h</sup>
Lean body weight, <sup>b</sup> kg	54 (39-72)	78 (50-94)	< 0.001 <sup>g</sup>
Ideal body weight, <sup>c</sup> kg	71 (55-84)	71 (50-84)	0.822 <sup>g</sup>
Body mass index (BMI), <sup>d</sup> kg/m <sup>2</sup>	24.8 (19.7-29.4)	50.1 (32.7-72.9)	< 0.001 <sup>h</sup>

Table 8. Continued. Patient demographics [median (range) unless otherwise stated]

Demographic characteristics	Non-obese (n=11)	Obese (n=16)	P-value
Intensive care unit admission, number of patients (%)	7 (63.6%)	7 (43.8%)	0.310 <sup>i</sup>
Piperacillin/tazobactam dosing, <sup>e</sup> number of patients (%)			
4.5 g q8h	11 (100.0%)	6 (37.5%)	N/A
6.75 g q8h	0	10 (62.5%)	N/A

$$^a \text{ Measured using equation 1: CRCL} = \frac{(\text{Urine volume collected over 24 hours}) \times U_{Cr} \times 1000}{P_{Cr} \times (1440 \text{ min})} \quad (1)$$

<sup>b</sup> Calculated using equations 19 in males and 20 in females, respectively:

$$\text{Lean body weight (LBW in male, kg)} = \frac{9270 \times \text{TBW}}{6680 + 216 \times \text{BMI}} \quad (19)$$

$$\text{Lean body weight (LBW in female, kg)} = \frac{9270 \times \text{TBW}}{8780 + 244 \times \text{BMI}} \quad (20)$$

<sup>c</sup> Calculated using equations 3 in males and 4 in females, respectively:

$$\text{Ideal body weight (IBW)} = 50 \text{ kg} + [2.3 \text{ kg} * (\text{height in inches} - 60)] \text{ in males} \quad (3)$$

$$\text{Ideal body weight (IBW)} = 45.5 \text{ kg} + [2.3 \text{ kg} * (\text{height in inches} - 60)] \text{ in females} \quad (4)$$

<sup>d</sup> Calculated by (total body weight in kg)/(height in m)<sup>2</sup>

<sup>e</sup> Infused over 4 hours

<sup>f</sup> P-value from Fisher's exact test between non-obese and obese patients

<sup>g</sup> P-value from unpaired t-test with equal variance between non-obese and obese

<sup>h</sup> P-value from unpaired t-test with unequal variance between non-obese and obese

<sup>i</sup> P-value from chi-square test between non-obese and obese patients

N/A: Not estimated

### Population Pharmacokinetic Analysis

For the population pharmacokinetic analysis, 198 piperacillin concentrations from 27 patients and 167 tazobactam concentrations from 25 patients were included. Fewer than the planned number of samples (243 samples from 27 patients) were included in the analysis because 1) 45 samples were not collected at the planned time points and 2)

the remaining volume of 31 samples after determination of piperacillin concentration was insufficient to determine tazobactam concentrations because HPLC had to be done on two separate occasions as the HPLC method could not simultaneously detect piperacillin and tazobactam. Observed serum concentration-time profiles of both piperacillin and tazobactam were best described by a one-compartment model with zero-order input and first-order, linear elimination (Figure 3). Figures 6 and 7 show the goodness-of-fit plots for the final population pharmacokinetic models for piperacillin and tazobactam, respectively.

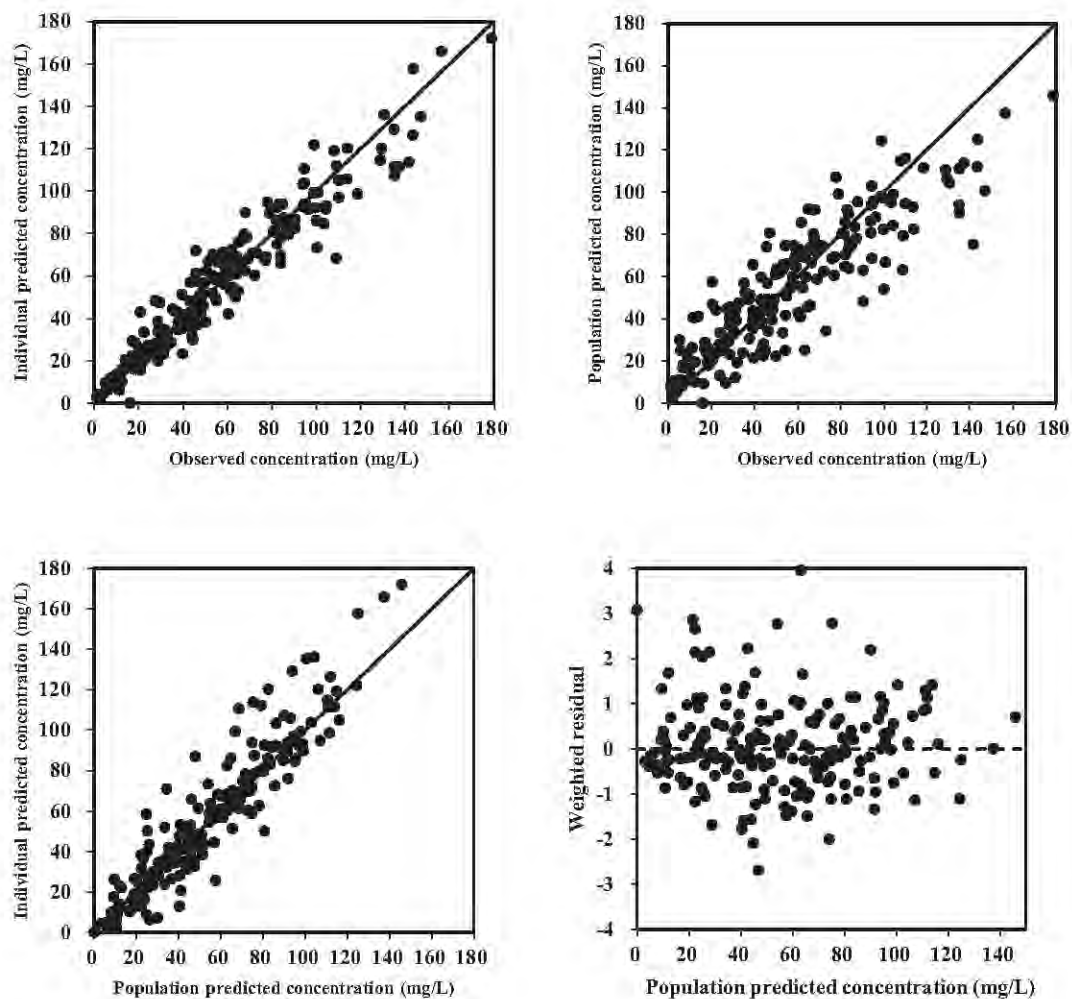

Figure 6. Goodness-of-fit plots of the final population pharmacokinetic model for piperacillin. The solid line represents the line of identity, and the dashed line corresponds to a residual of zero.

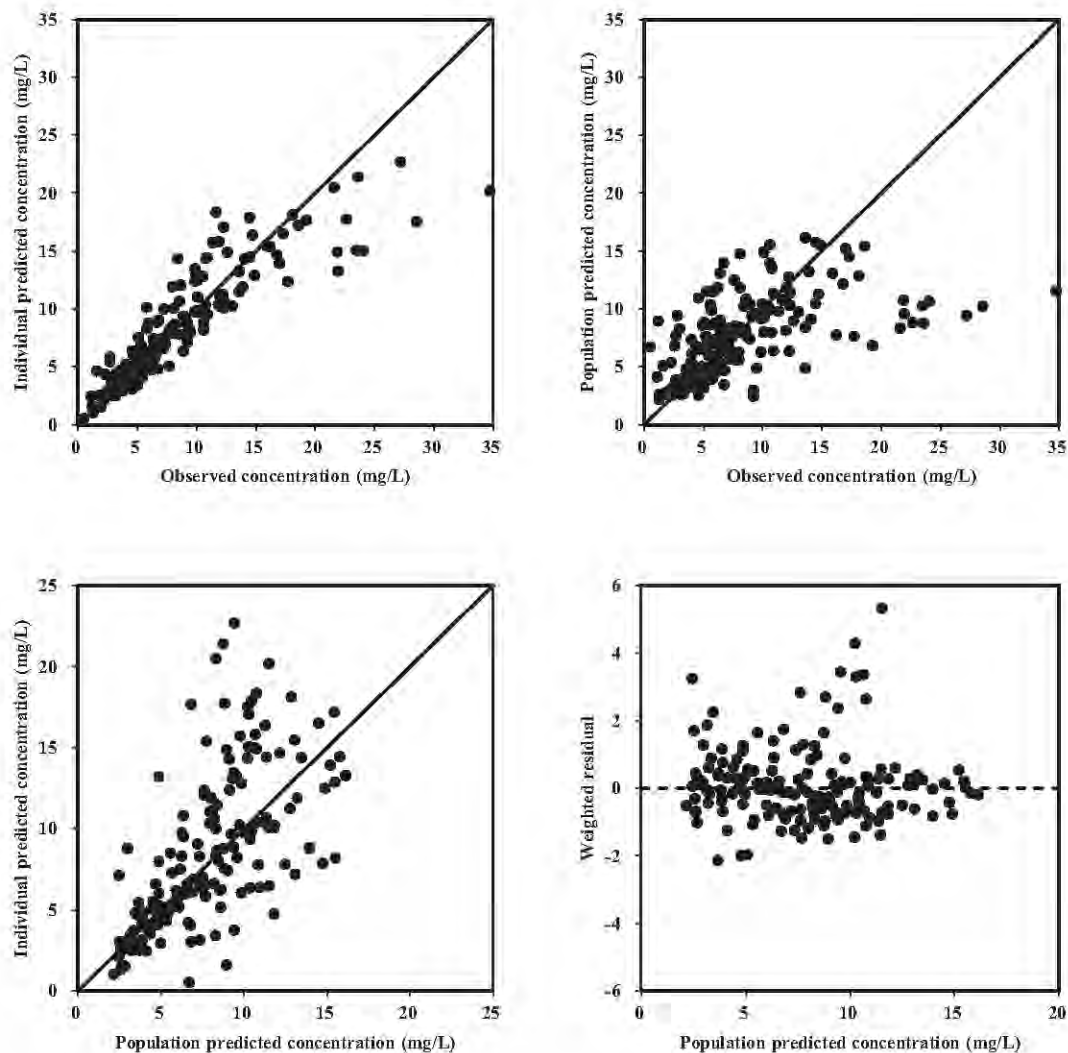

Figure 7. Goodness-of-fit plots of the final population pharmacokinetic model for tazobactam. The solid line represents the line of identity, and the dashed line corresponds to a residual of zero.

The distribution around the line of identity represents a rough visual estimation of residual error for the individual predicted vs. observed concentration plot, the sum of residual error and inter-individual variability for the population predicted vs. observed concentration plot, and inter-individual variability for the individual predicted vs. population predicted concentration plot. Based on the predicted vs. observed

concentration and weighted residual vs population predicted concentration plots, no apparent systematic bias was observed for the final piperacillin pharmacokinetic model; however, for tazobactam, some bias was observed due to under-prediction of higher concentrations (primarily at the range of  $\geq 15$  mg/L).

Model-derived pharmacokinetic parameters for both piperacillin and tazobactam were CL and V. Equations 36 to 38 were used to calculate the elimination rate constant (k), terminal half-life ( $t_{1/2}$ ), and  $AUC_{0-\tau}$ :

$$k \text{ (h}^{-1}\text{)} = CL/V \quad (36)$$

$$t_{1/2} \text{ (h)} = 0.693/k \quad (37)$$

$$AUC_{0-\tau} \text{ (mg} \cdot \text{h} \cdot \text{L}^{-1}\text{)} = \text{Dose}/CL \quad (38)$$

Inter-individual variability was estimated for both CL and V. For piperacillin, the model did not support the correlation between CL and V when tested by the OMEGA BLOCK functionality in NONMEM [ $\Delta OFV = -0.554$ ; correlation coefficient between CL and V ( $\rho_{CL-V}$ ) = 19.4%]. Residual error was best described by the combined, additive and proportional model. For tazobactam, the model supported the correlation between CL and V when tested by the OMEGA BLOCK functionality in NONMEM [ $\Delta OFV = -19.731$ ; correlation coefficient between CL and V ( $\rho_{CL-V}$ ) = 81.5%]. Residual error was best described by the proportional model.

Covariates that significantly decreased the model OFV and inter-individual variability in the stepwise forward process were CRCL added on to CL ( $\Delta OFV: -35.033$ ), TBW added on to V ( $\Delta OFV: -4.802$ ), BMI added on to CL ( $\Delta OFV: -5.306$ ), ICU admission added on to CL ( $\Delta OFV: -4.166$ ), and age added on to CL ( $\Delta OFV: -3.864$ ) for piperacillin (listed in the order of addition to the model); for tazobactam, CRCL was the

only covariate resulting in significant reduction in the model OFV ( $\Delta$ OFV: -4.555) when added on to CL. In the backward elimination step, age ( $\Delta$ OFV: 3.864) and ICU ( $\Delta$ OFV: 4.166) were removed from the piperacillin model. Therefore, the final model for piperacillin (OFV=1189.133) was:

$$CL \text{ (L/h)} = 11.3 + [0.0646*(CRCL-105)] + [0.0579*(BMI-35)] \quad (39)$$

$$V \text{ (L)} = 31.3 + [0.132*(TBW-120)] \quad (40)$$

The final model for tazobactam (OFV=527.795) was:

$$CL \text{ (L/h)} = 10.1 + [0.0272*(CRCL-105)] \quad (41)$$

$$V \text{ (L)} = 34.3$$

Table 9 summarizes the model-estimated population pharmacokinetic parameters and their associated inter-individual variability for piperacillin and tazobactam. Visual predictive checks with the 90% prediction intervals using the final population pharmacokinetic model, graphed with the observed drug concentrations, for each dosage regimen are shown in Figures 8 and 9 for piperacillin and tazobactam, respectively. The predicted concentrations were obtained using Monte Carlo simulation in NONMEM, and 5<sup>th</sup>, 50<sup>th</sup> (median), and 95<sup>th</sup> percentile predicted concentrations were estimated using the percentile functions. Based on the piperacillin VPC (Figure 8), most of the observed data were within the 90% prediction interval; however, it should be noted, for the piperacillin/tazobactam 4/0.5 g VPC, the observed concentrations above the 95<sup>th</sup> percentile predicted concentrations were from the same individual who had the minimum value of CRCL (23 mL/min). According to the tazobactam VPC (Figure 9), most of the observations were within the 90% prediction interval, but a few observations, especially around the  $C_{max}$ , were above the 95<sup>th</sup> percentile predicted concentrations, suggesting



some bias of the model because of under-prediction of higher concentrations. This deviation in the tazobactam VPC was consistent with under-predicted concentration at higher concentrations as suggested by Figure 7. The 95<sup>th</sup> percentile predicted tazobactam concentrations for 6.75 g q8h dosing group were substantially above the highest observed tazobactam concentrations at each time point probably because of the observations above the 95<sup>th</sup> percentile predicted concentrations in the 4.5 g q8h dosing group which appeared influential to the model. The final piperacillin model was able to adequately predict most observed piperacillin concentrations, but some bias was observed near maximum concentrations (Figure 10). For tazobactam, the final tazobactam model predicted the majority of observations, but biases were observed at higher concentrations, especially near maximum concentrations (Figure 11), as consistently suggested by Figures 7 and 9.

Table 9. Final population pharmacokinetic model parameters of piperacillin and tazobactam

Parameter	Final piperacillin model		Final tazobactam model	
	Estimate (%SE)	Shrinkage, %	Estimate (%SE)	Shrinkage, %
	TVCL = $\theta_1 + [\theta_3*(CRCL-105)] + [\theta_5*(BMI-35)]$ TVV = $\theta_2 + [\theta_4*(TBW-120)]$		TVCL = $\theta_1 + [\theta_3*(CRCL-105)]$ TVV = $\theta_2$	
$\theta_1$	11.3 (3.4)	N/A	10.1 (9.2)	N/A
$\theta_2$	31.3 (8.8)	N/A	34.3 (17.6)	N/A
$\theta_3$	0.0646 (10.3)	N/A	0.0272 (26.2)	N/A
$\theta_4$	0.132 (45.3)	N/A	N/A	N/A
$\theta_5$	0.0579 (35.2)	N/A	N/A	N/A
Inter-individual variability ( $\omega$ )				
$\omega_{CL}$	14.8% (44.0)	11.0	43.2% (29.8)	3.7
$\omega_V$	31.4% (62.4)	17.6	78.3% (28.2)	11.1
$\rho_{CL-V}$	N/A	N/A	80.6%	N/A
Residual error ( $\sigma$ )				
$\sigma_{proportional}$	15.5% (42.7)	12.5	27.3% (15.0)	11.2
$\sigma_{additive}$	5.27 mg/L (66.5)	10.0	N/A	N/A

Abbreviations: SE: standard error; TVCL: typical value of clearance (L/h); CRCL: creatinine clearance (mL/min); BMI: body mass index (kg/m<sup>2</sup>); TBW: total body weight (kg); TVV: typical value of volume of distribution (L); N/A: not applicable

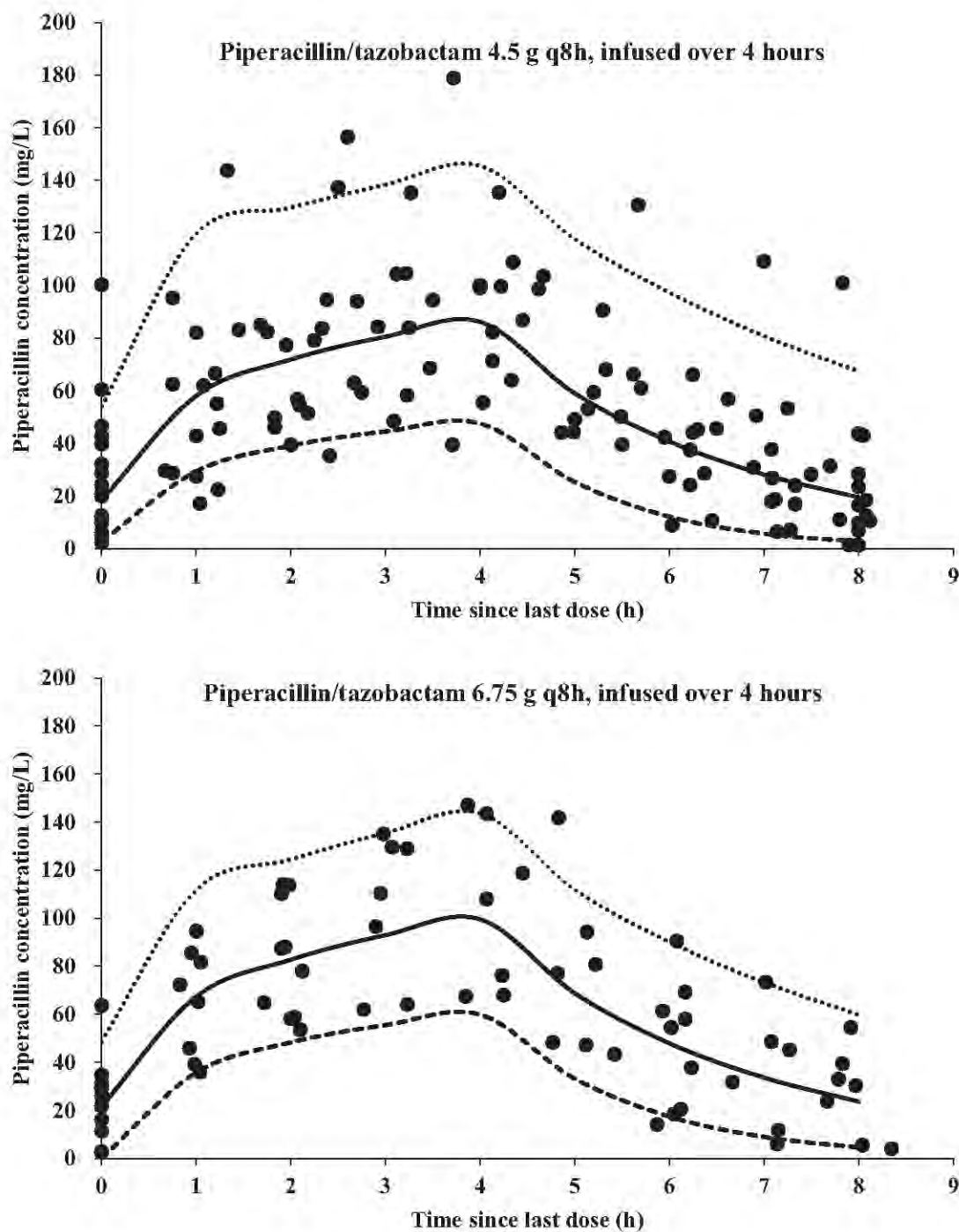

Figure 8. Visual predictive checks of the final piperacillin population pharmacokinetic model for each piperacillin/tazobactam dosage regimen. Filled circles (•), observed concentrations; square dashed lines (----), 95<sup>th</sup> percentile predicted concentrations; solid lines, median predicted concentrations; dotted dashed lines (·····), 5<sup>th</sup> percentile predicted concentrations.

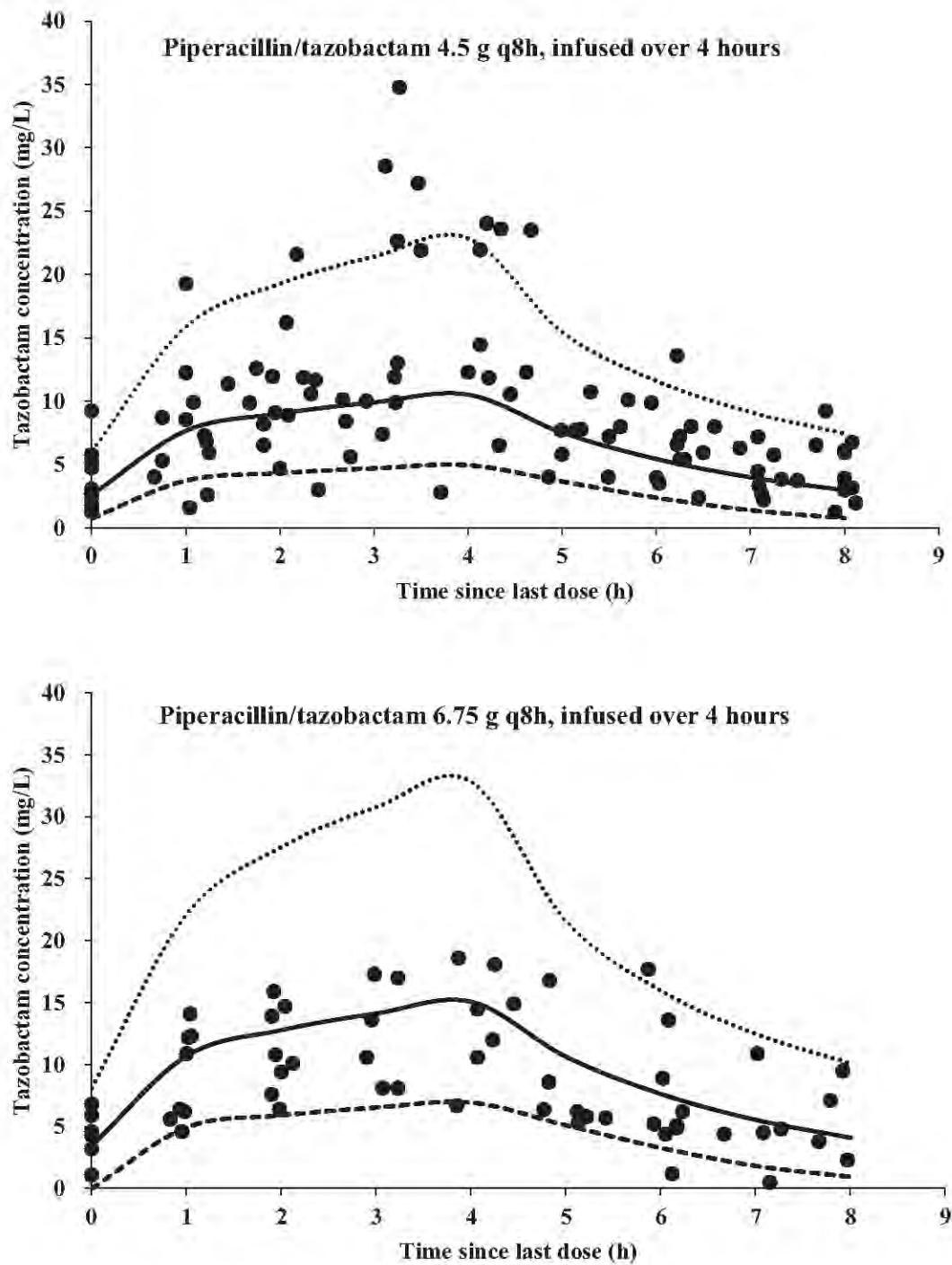

Figure 9. Visual predictive checks of the final tazobactam population pharmacokinetic model for each piperacillin/tazobactam dosage regimen. Filled circles ( $\bullet$ ), observed concentrations; square dashed lines (-----), 95<sup>th</sup> percentile predicted concentrations; solid lines, median predicted concentrations; dotted lines (.....), 5<sup>th</sup> percentile predicted concentrations.

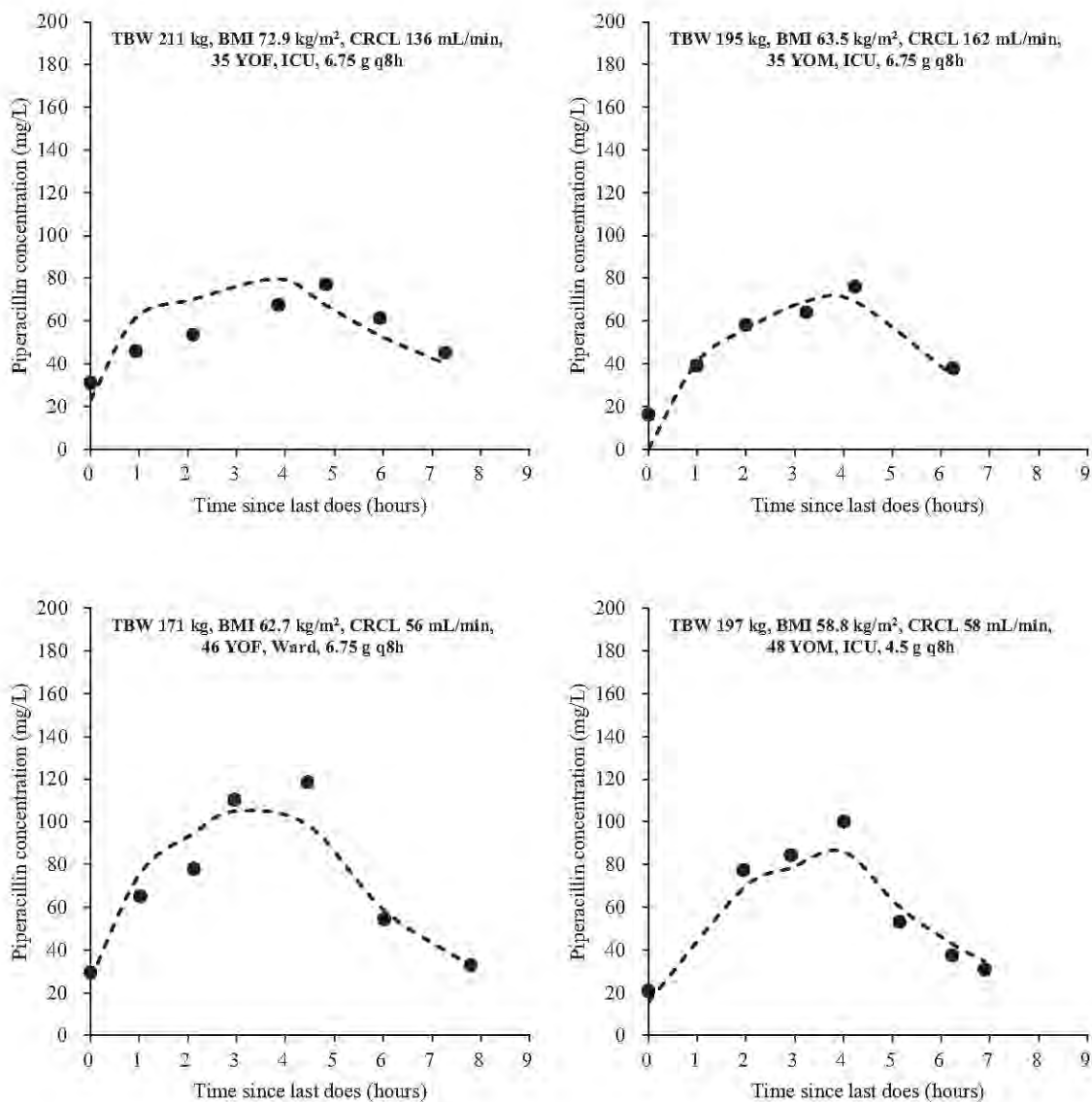

Figure 10. Observed and final model-predicted serum piperacillin concentration-time profiles for all 27 patients. Filled circles represent the observed piperacillin concentrations and dashed lines represent the model-predicted concentrations using the final population pharmacokinetic model.

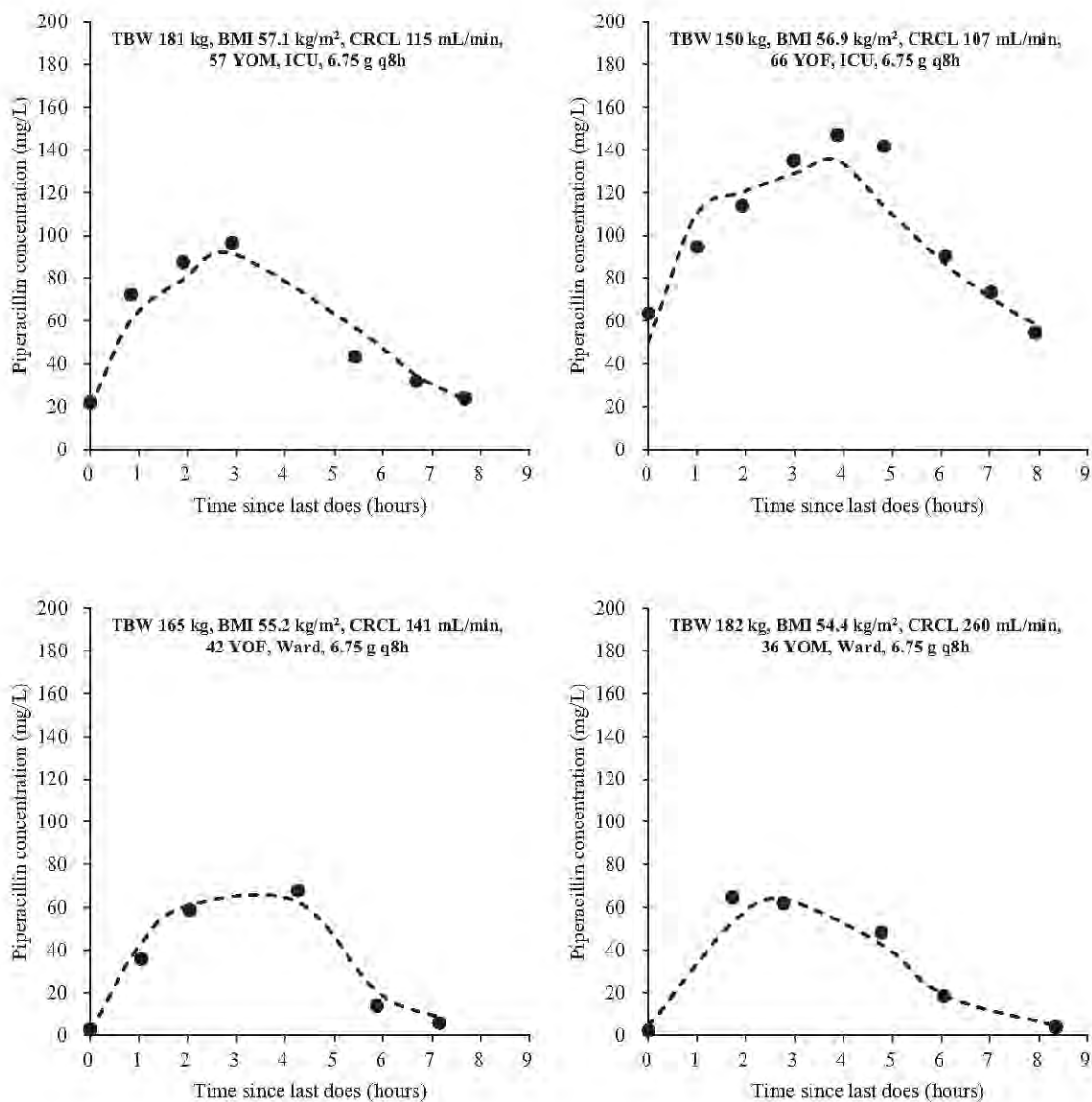

Figure 10. Continued. Observed and final model-predicted serum piperacillin concentration-time profiles for all 27 patients. Filled circles represent the observed piperacillin concentrations and dashed lines represent the model-predicted concentrations using the final population pharmacokinetic model.

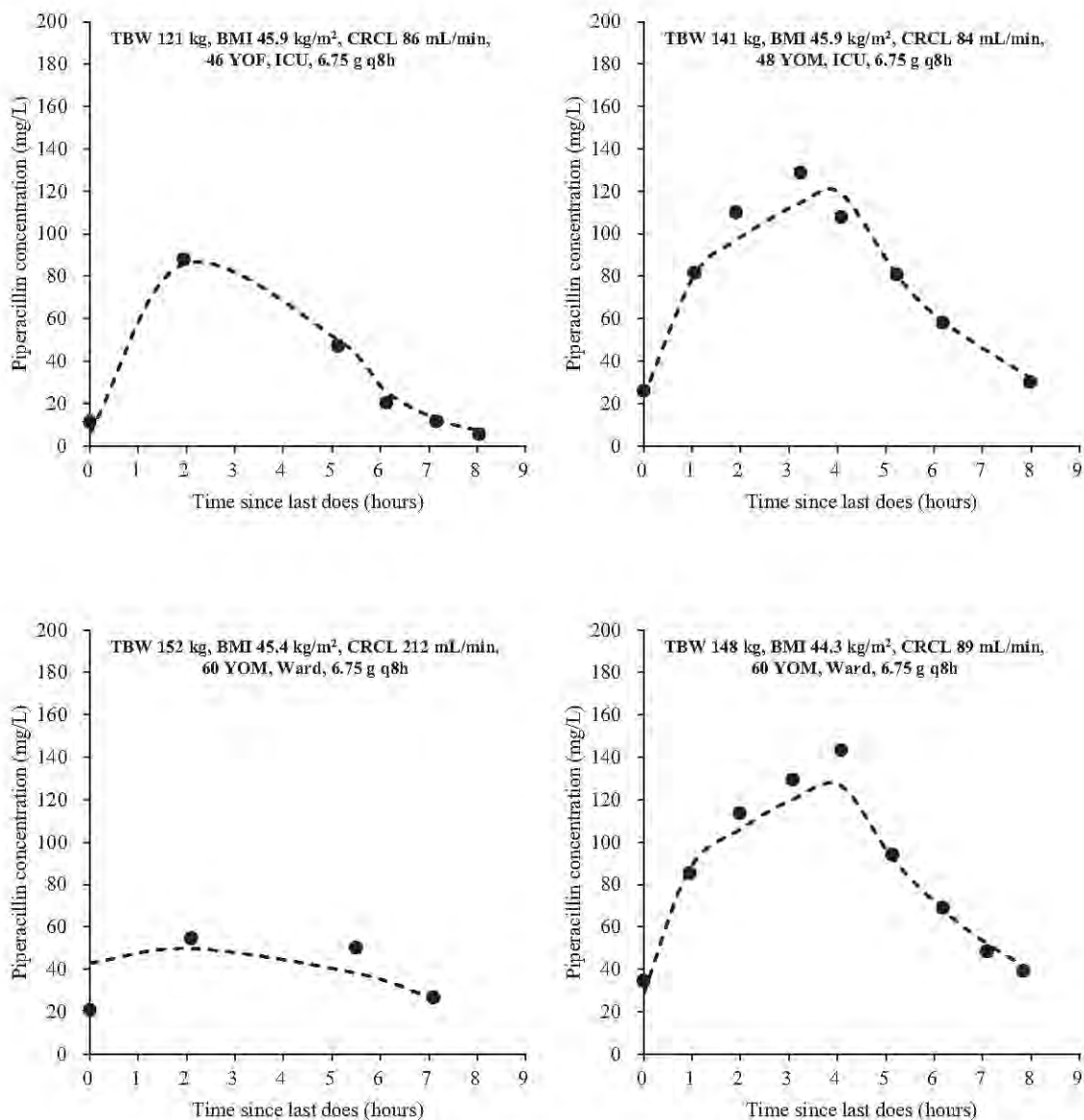

Figure 10. Continued. Observed and final model-predicted serum piperacillin concentration-time profiles for all 27 patients. Filled circles represent the observed piperacillin concentrations and dashed lines represent the model-predicted concentrations using the final population pharmacokinetic model.

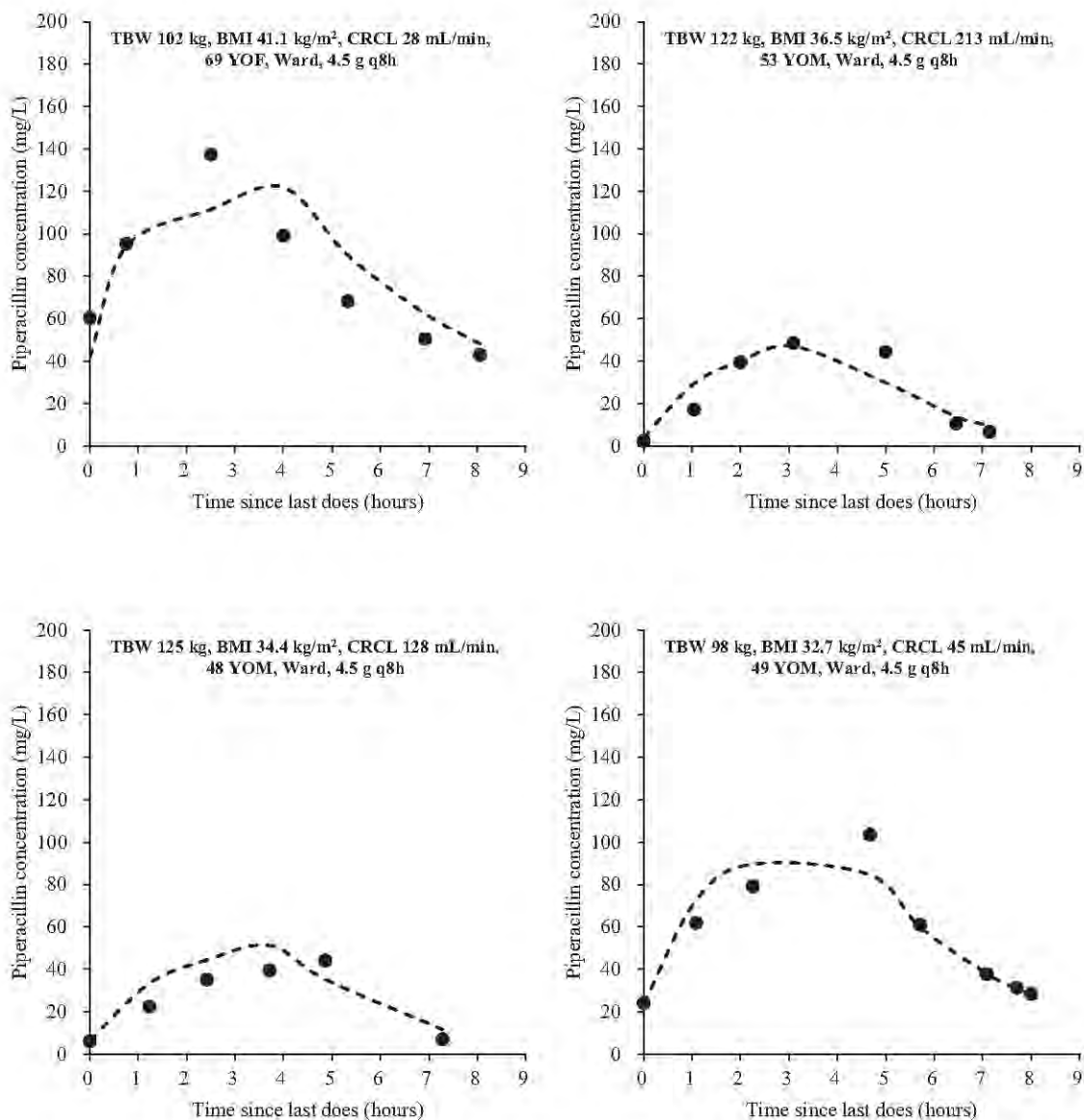

Figure 10. Continued. Observed and final model-predicted serum piperacillin concentration-time profiles for all 27 patients. Filled circles represent the observed piperacillin concentrations and dashed lines represent the model-predicted concentrations using the final population pharmacokinetic model.



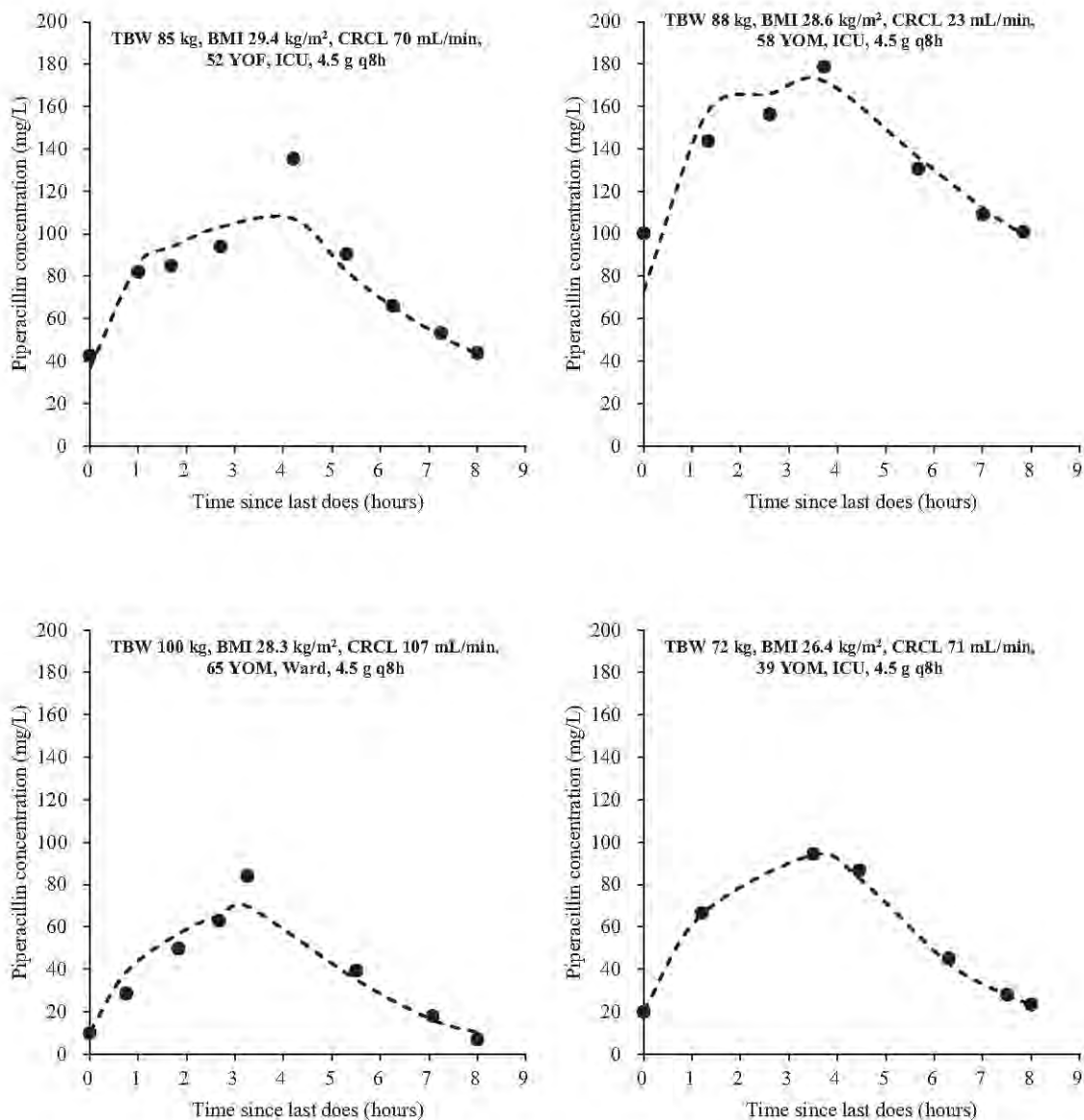

Figure 10. Continued. Observed and final model-predicted serum piperacillin concentration-time profiles for all 27 patients. Filled circles represent the observed piperacillin concentrations and dashed lines represent the model-predicted concentrations using the final population pharmacokinetic model.

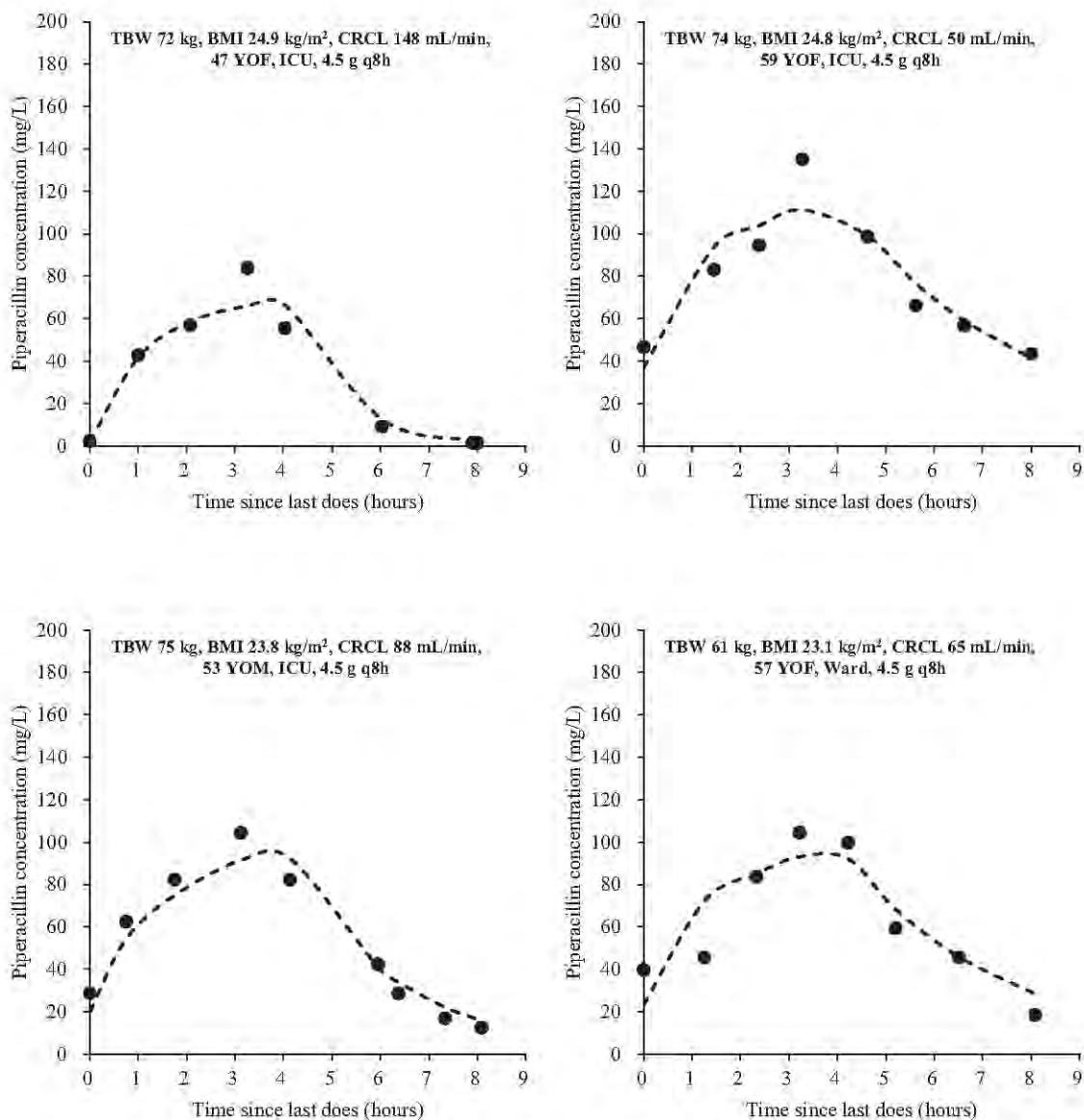

Figure 10. Continued. Observed and final model-predicted serum piperacillin concentration-time profiles for all 27 patients. Filled circles represent the observed piperacillin concentrations and dashed lines represent the model-predicted concentrations using the final population pharmacokinetic model.

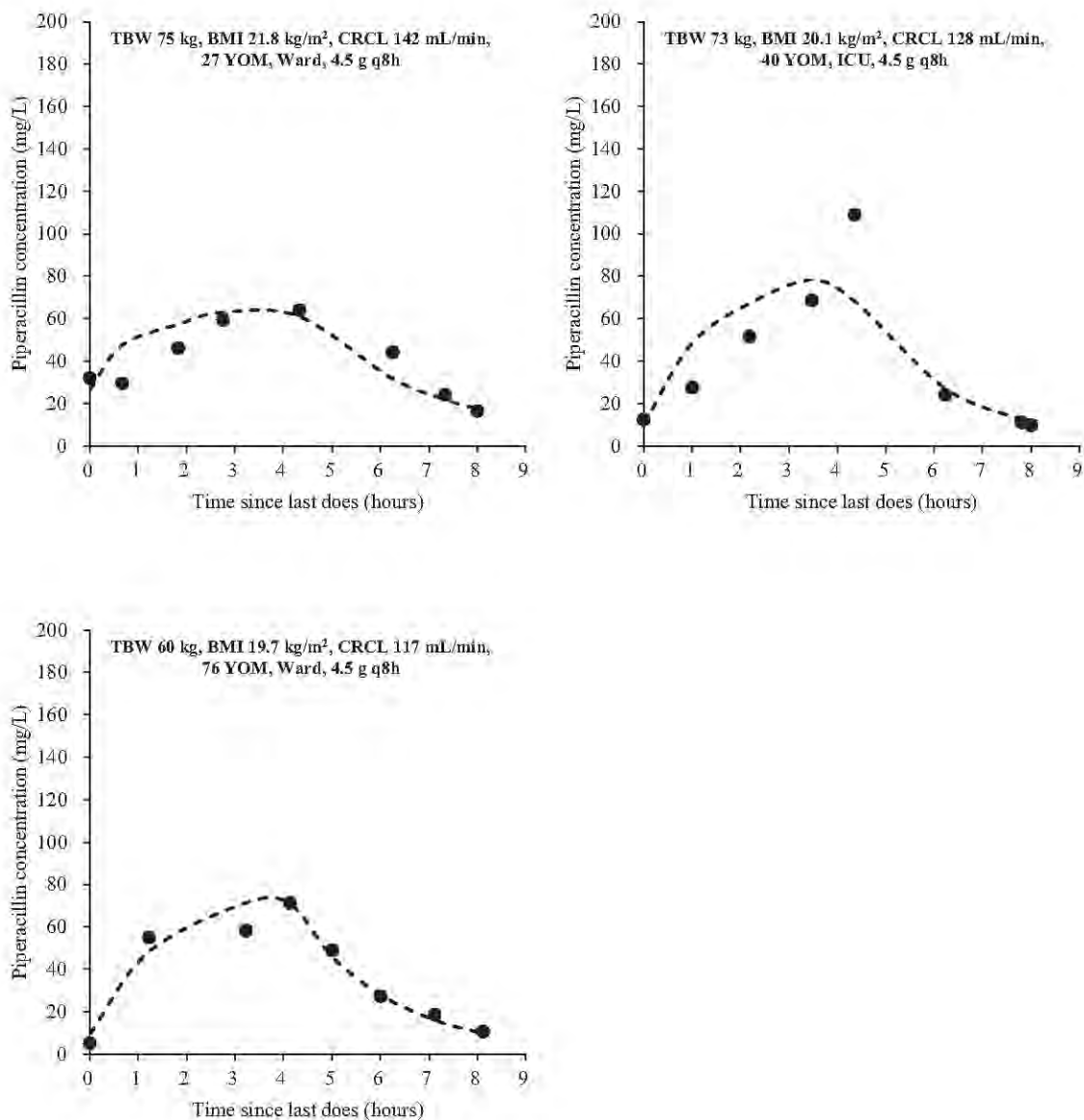

Figure 10. Continued. Observed and final model-predicted serum piperacillin concentration-time profiles for all 27 patients. Filled circles represent the observed piperacillin concentrations and dashed lines represent the model-predicted concentrations using the final population pharmacokinetic model.

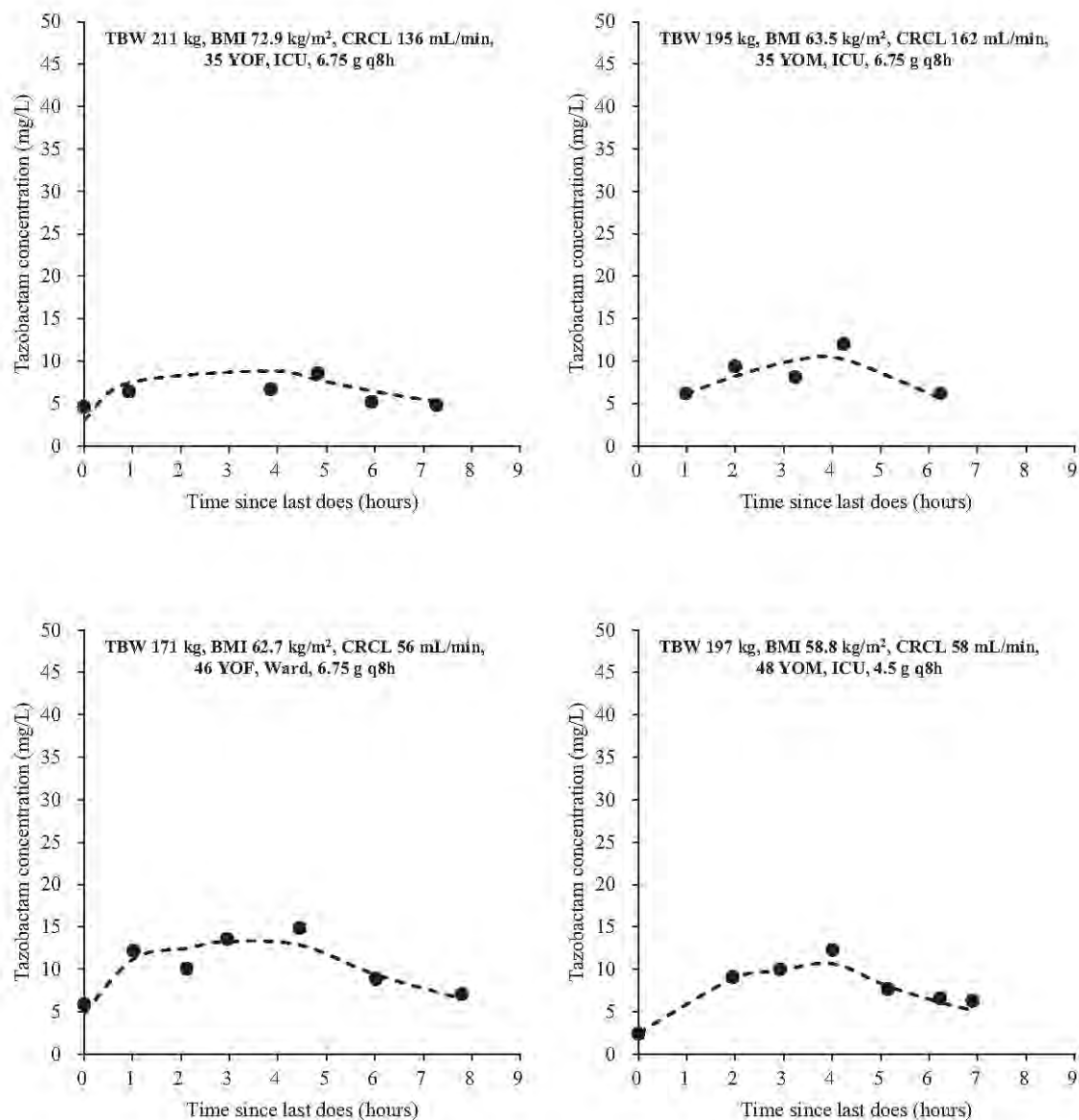

Figure 11. Observed and final model-predicted serum tazobactam concentration-time profiles for all 25 patients. Fewer concentration-time data from fewer patients were included for tazobactam analysis compared to piperacillin analysis because 1) 45 samples were not collected at the planned time points and 2) the remaining volume of 31 samples after determination of piperacillin concentration was insufficient to determine tazobactam concentrations because HPLC had to be done on two separate occasions as the HPLC method could not simultaneously detect piperacillin and tazobactam. Filled circles represent the observed tazobactam concentrations and dashed lines represent the model-predicted concentrations using the final population pharmacokinetic model.

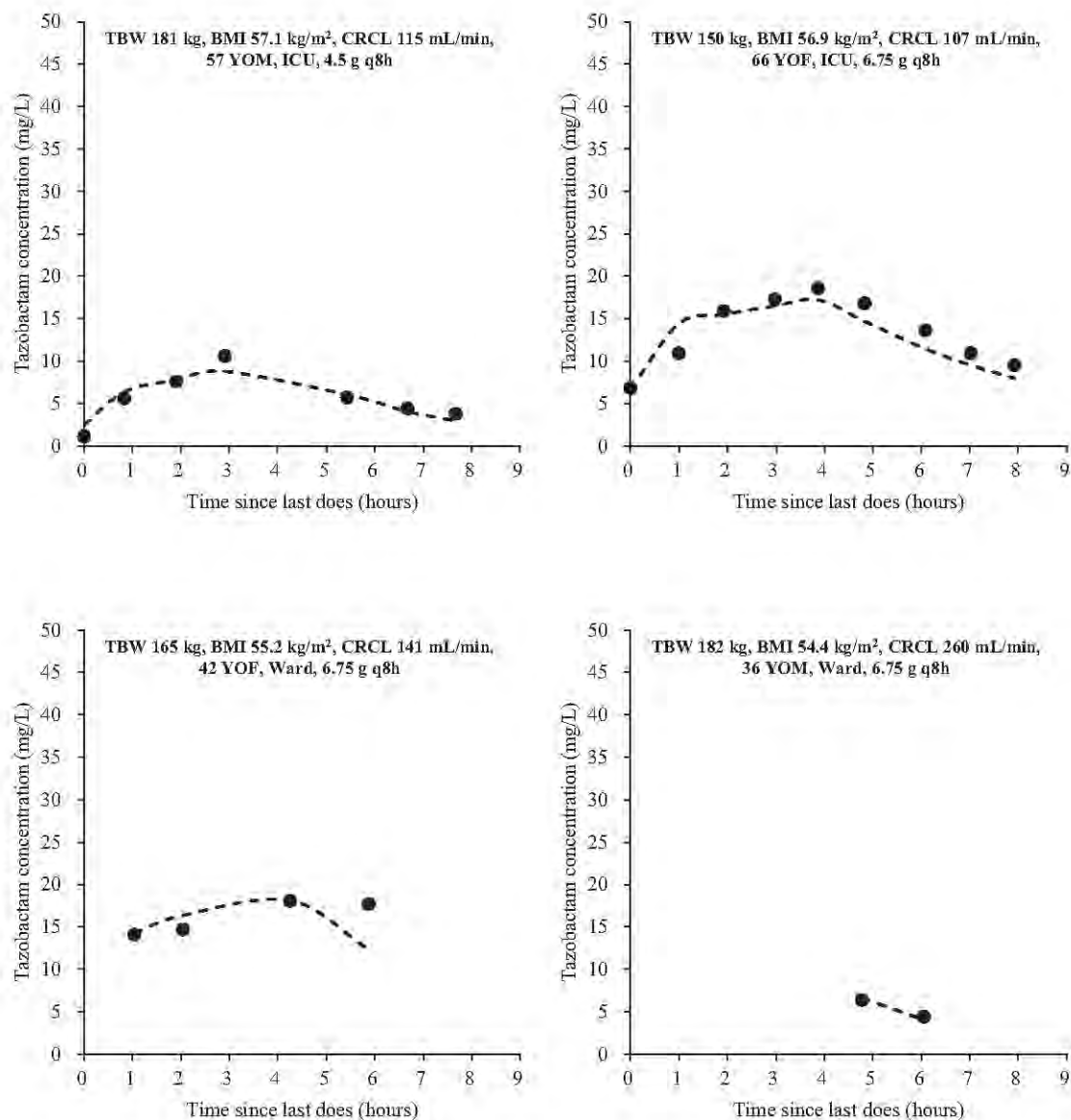

Figure 11. Continued. Observed and final model-predicted serum tazobactam concentration-time profiles for all 25 patients. Fewer concentration-time data from fewer patients were included for tazobactam analysis compared to piperacillin analysis because 1) 45 samples were not collected at the planned time points and 2) the remaining volume of 31 samples after determination of piperacillin concentration was insufficient to determine tazobactam concentrations because HPLC had to be done on two separate occasions as the HPLC method could not simultaneously detect piperacillin and tazobactam. Filled circles represent the observed tazobactam concentrations and dashed lines represent the model-predicted concentrations using the final population pharmacokinetic model.

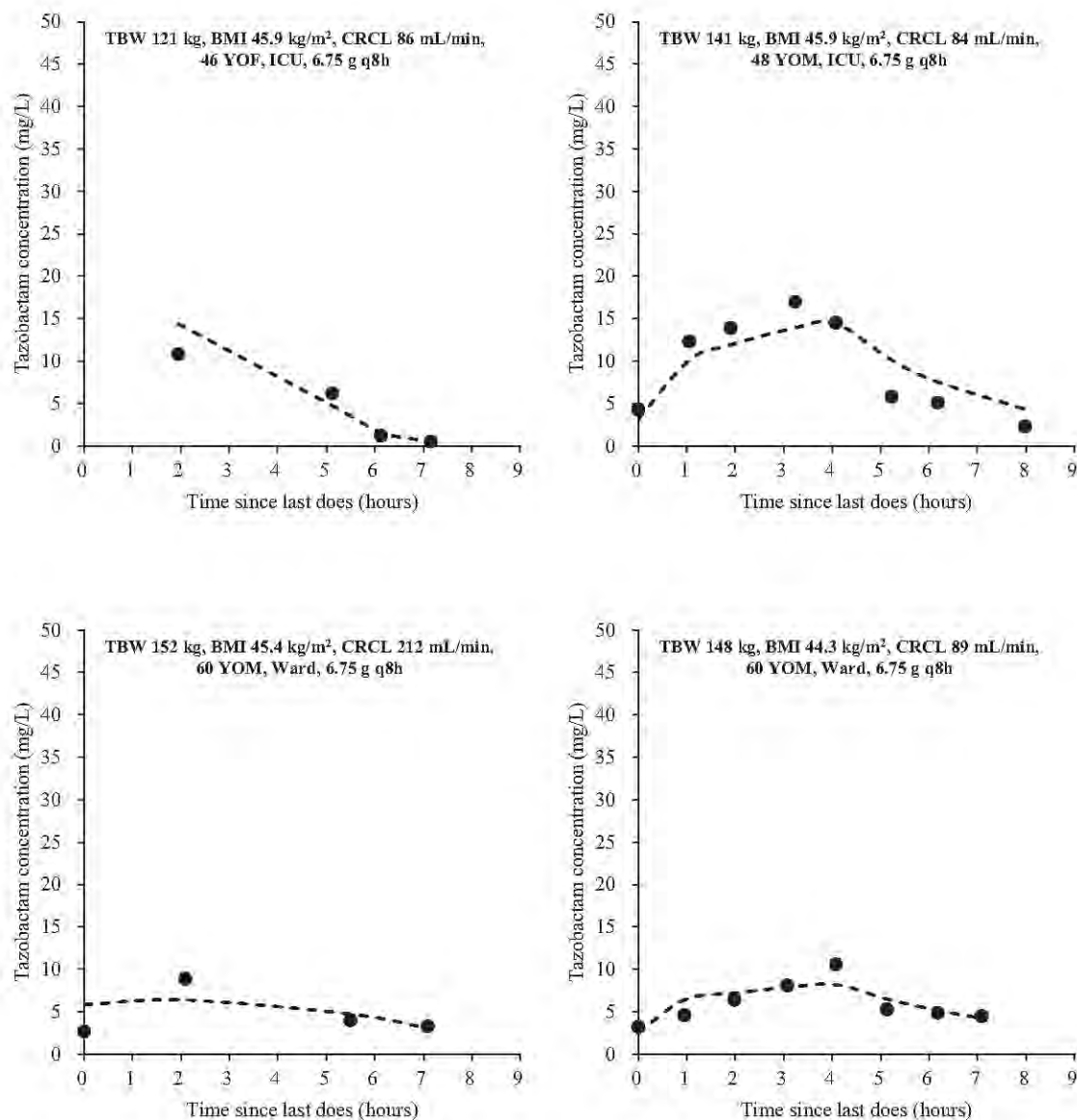

Figure 11. Continued. Observed and final model-predicted serum tazobactam concentration-time profiles for all 25 patients. Fewer concentration-time data from fewer patients were included for tazobactam analysis compared to piperacillin analysis because 1) 45 samples were not collected at the planned time points and 2) the remaining volume of 31 samples after determination of piperacillin concentration was insufficient to determine tazobactam concentrations because HPLC had to be done on two separate occasions as the HPLC method could not simultaneously detect piperacillin and tazobactam. Filled circles represent the observed tazobactam concentrations and dashed lines represent the model-predicted concentrations using the final population pharmacokinetic model.

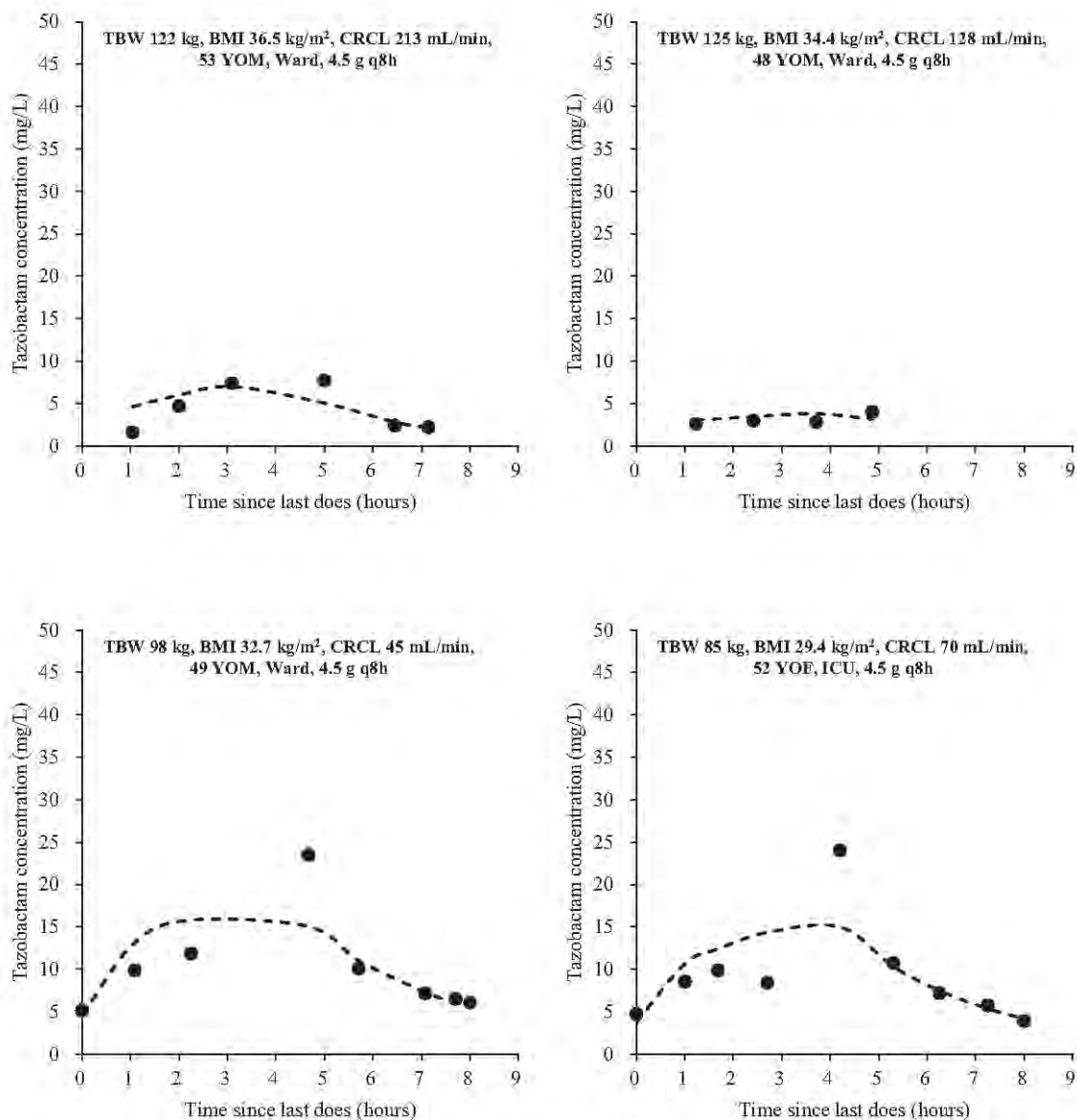

Figure 11. Continued. Observed and final model-predicted serum tazobactam concentration-time profiles for all 25 patients. Fewer concentration-time data from fewer patients were included for tazobactam analysis compared to piperacillin analysis because 1) 45 samples were not collected at the planned time points and 2) the remaining volume of 31 samples after determination of piperacillin concentration was insufficient to determine tazobactam concentrations because HPLC had to be done on two separate occasions as the HPLC method could not simultaneously detect piperacillin and tazobactam. Filled circles represent the observed tazobactam concentrations and dashed lines represent the model-predicted concentrations using the final population pharmacokinetic model.

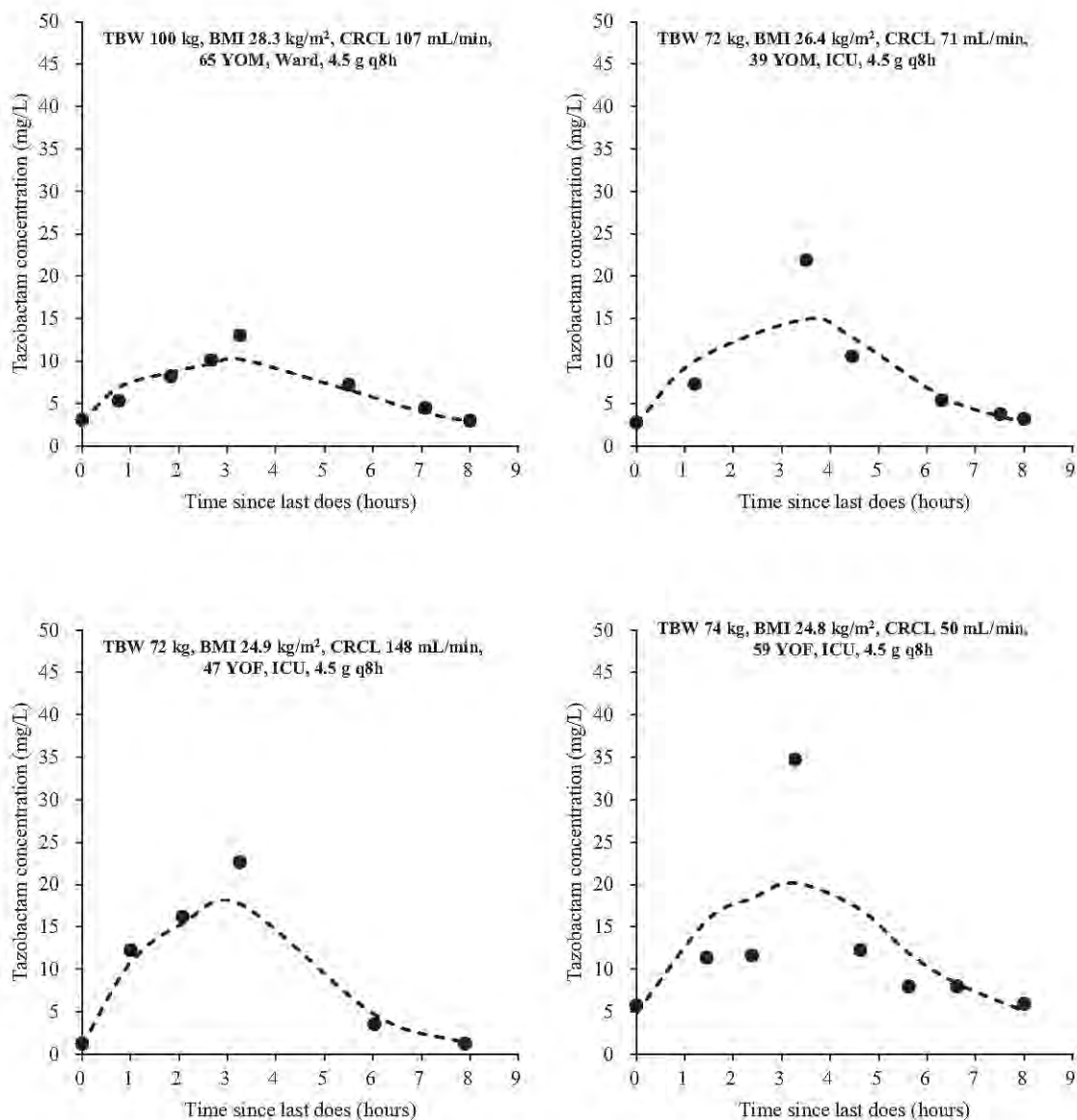

Figure 11. Continued. Observed and final model-predicted serum tazobactam concentration-time profiles for all 25 patients. Fewer concentration-time data from fewer patients were included for tazobactam analysis compared to piperacillin analysis because 1) 45 samples were not collected at the planned time points and 2) the remaining volume of 31 samples after determination of piperacillin concentration was insufficient to determine tazobactam concentrations because HPLC had to be done on two separate occasions as the HPLC method could not simultaneously detect piperacillin and tazobactam. Filled circles represent the observed tazobactam concentrations and dashed lines represent the model-predicted concentrations using the final population pharmacokinetic model.



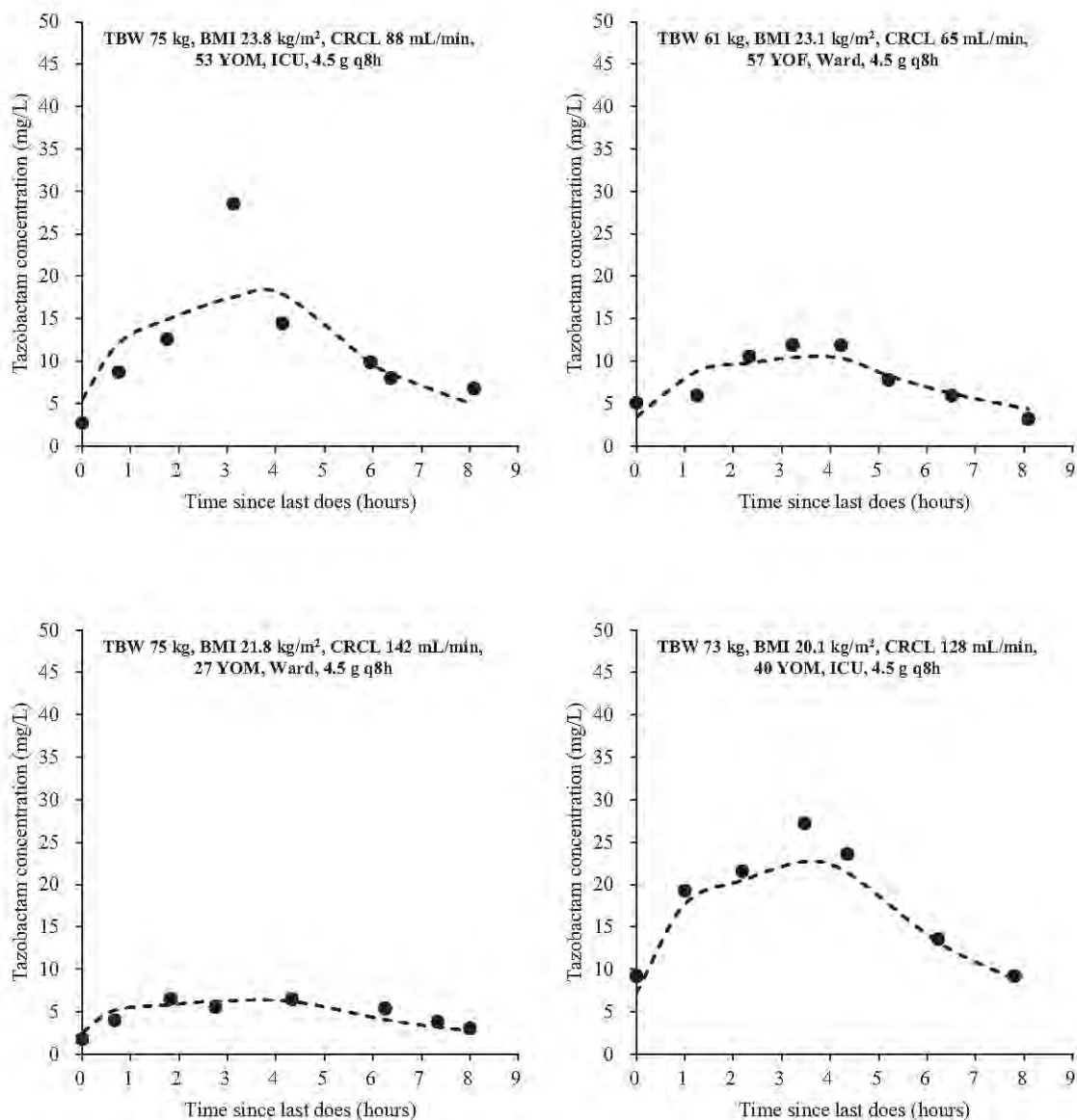

Figure 11. Continued. Observed and final model-predicted serum tazobactam concentration-time profiles for all 25 patients. Fewer concentration-time data from fewer patients were included for tazobactam analysis compared to piperacillin analysis because 1) 45 samples were not collected at the planned time points and 2) the remaining volume of 31 samples after determination of piperacillin concentration was insufficient to determine tazobactam concentrations because HPLC had to be done on two separate occasions as the HPLC method could not simultaneously detect piperacillin and tazobactam. Filled circles represent the observed tazobactam concentrations and dashed lines represent the model-predicted concentrations using the final population pharmacokinetic model.

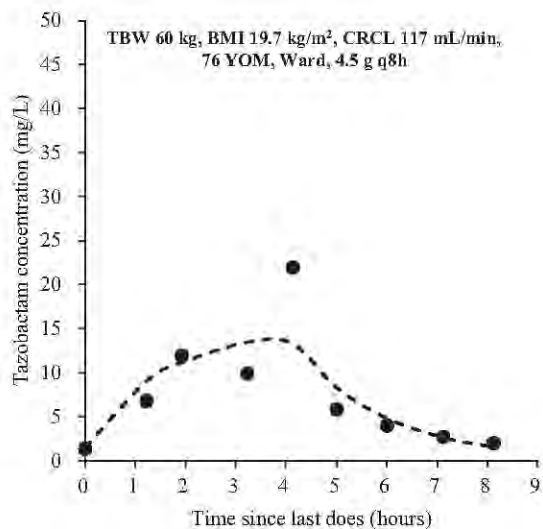

Figure 11. Continued. Observed and final model-predicted serum tazobactam concentration-time profiles for all 25 patients. Fewer concentration-time data from fewer patients were included for tazobactam analysis compared to piperacillin analysis because 1) 45 samples were not collected at the planned time points and 2) the remaining volume of 31 samples after determination of piperacillin concentration was insufficient to determine tazobactam concentrations because HPLC had to be done on two separate occasions as the HPLC method could not simultaneously detect piperacillin and tazobactam. Filled circles represent the observed tazobactam concentrations and dashed lines represent the model-predicted concentrations using the final population pharmacokinetic model.

Table 10 shows the median and range of the individual, empirical Bayesian pharmacokinetic parameter estimates of piperacillin and tazobactam, estimated by the final pharmacokinetic model for non-obese and obese patients. For piperacillin, obese patients had significantly larger CL and V and significantly smaller TBW-normalized CL and V compared to non-obese patients ( $p < 0.05$ ). For tazobactam, obese patients had significantly faster CL and larger V compared to non-obese patients ( $p < 0.05$ ).  $AUC_{0-\tau}$  for both piperacillin and tazobactam were not significantly different between obese and non-obese patients at the actual studied doses administered to patients in the study.

Table 10. Steady-state piperacillin and tazobactam pharmacokinetic parameters [median (range)] estimated by the final population pharmacokinetic model in non-obese and obese patients

Parameter	Piperacillin			Tazobactam		
	Non-obese (n=11)	Obese (n=16)	P-value	Non-obese <sup>a</sup> (n=10)	Obese <sup>a</sup> (n=15)	P-value
CL (L/h)	9.0 (4.8-14.2)	13.1 (6.8-20.0)	0.026 <sup>b</sup>	6.8 (4.4-15.5)	13.1 (5.6-26.4)	0.005 <sup>b</sup>
CL (L/h/kg)	0.12 (0.06-0.20)	0.08 (0.05-0.15)	0.004 <sup>b</sup>	0.09 (0.06-0.21)	0.08 (0.05-0.21)	0.292 <sup>c</sup>
V (L)	24.6 (17.1-37.7)	32.5 (19.8-69.8)	0.014 <sup>c</sup>	17.1 (9.4-70.3)	45.5 (10.5-116.6)	0.019 <sup>b</sup>
V (L/kg)	0.36 (0.24-0.50)	0.23 (0.15-0.44)	0.002 <sup>b</sup>	0.23 (0.13-0.94)	0.29 (0.09-0.93)	0.506 <sup>c</sup>
Terminal t <sub>1/2</sub> (h)	1.9 (0.8-4.8)	2.1 (1.0-3.2)	0.885 <sup>b</sup>	2.1 (1.0-3.1)	2.5 (0.6-4.2)	0.152 <sup>b</sup>

Table 10. Continued. Steady-state piperacillin and tazobactam pharmacokinetic parameters [median (range)] estimated by the final population pharmacokinetic model in non-obese and obese patients

Parameter	Piperacillin			Tazobactam		
	Non-obese (n=11)	Obese (n=16)	P-value	Non-obese <sup>a</sup> (n=10)	Obese <sup>a</sup> (n=15)	P-value
AUC <sub>0-τ</sub> (mg*h/L) <sup>d</sup>	444.4 (281.7-825.2)	435.6 (223.8-655.1)	0.796 <sup>b</sup>	74.1 (32.3-113.4)	53.4 (18.9-96.4)	0.094 <sup>b</sup>
AUC <sub>0-τ</sub> (mg*h/L) <sup>e</sup>	444.4 (281.7-825.2)	305.0 (199.9-588.3)	0.039 <sup>b</sup>	74.1 (32.3-113.4)	38.1 (18.9-88.8)	0.002 <sup>b</sup>

Abbreviations: CL, clearance; V, volume of distribution; Terminal t<sub>1/2</sub>, terminal elimination half-life; AUC<sub>0-τ</sub>, area under the serum concentration-time curve for one dosing interval

<sup>a</sup> Fewer concentration-time data from fewer patients were included for tazobactam analysis compared to piperacillin analysis because 1) 45 samples were not collected at the planned time points and 2) the remaining volume of 31 samples after determination of piperacillin concentration was insufficient to determine tazobactam concentrations because HPLC had to be done on two separate occasions as the HPLC method could not simultaneously detect piperacillin and tazobactam.

<sup>b</sup> P-value from unpaired t-test with equal variance

<sup>c</sup> P-value from Mann-Whitney U test

<sup>d</sup> AUC<sub>0-τ</sub> calculated at the actual studied doses given to patients in the study

<sup>e</sup> AUC<sub>0-τ</sub> calculated assuming all patients received 4.5 g every 8 hours infused over 4 hours

Monte Carlo Simulation; Pharmacodynamic Analysis

Figure 12 shows PTAs for piperacillin at the pharmacodynamic target of  $\geq 50\%$   $fT > MIC$  for the piperacillin/tazobactam dosing regimens at specific MICs in non-obese and obese patients. At MICs  $\leq 16$  mg/L, dosing regimens  $\geq 3.375$  g q8h, infused over 4 hours, achieved the PTA  $> 90\%$  in non-obese patients; in obese patients, dosing regimens  $\geq 4.5$  g q8h achieved the PTA  $> 90\%$ . At an MIC of 32 mg/L, only 6.75 g q8h in non-obese patients achieved the PTA  $> 90\%$ , and no regimen achieved the PTA  $> 90\%$  in either group at an MIC of 64 mg/L.

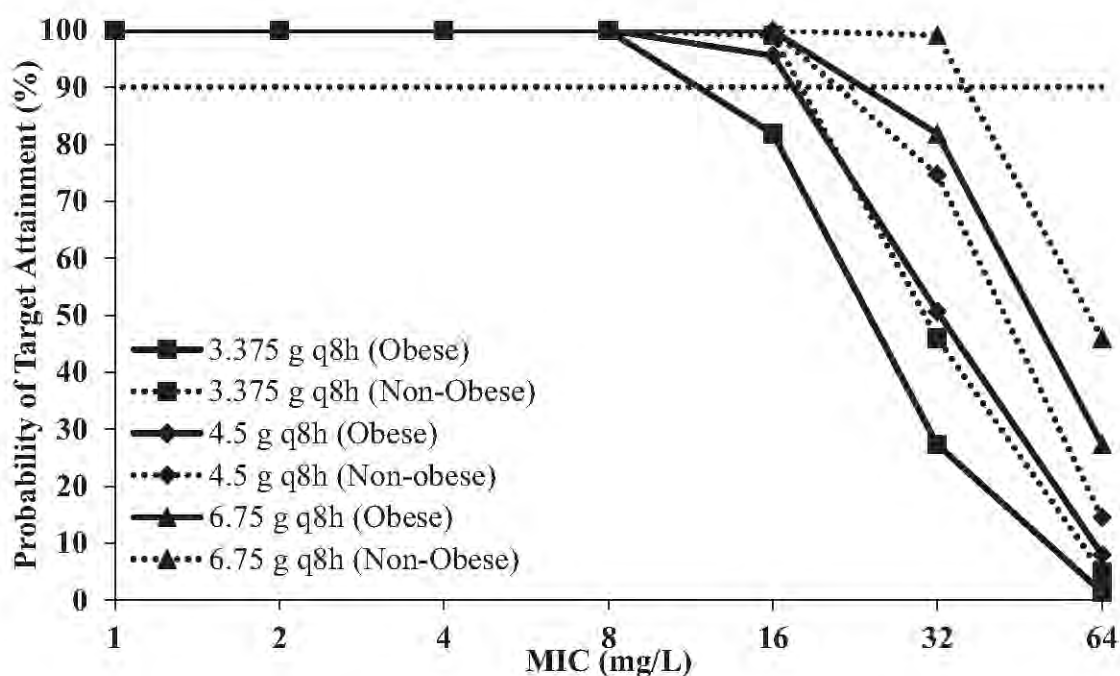

Figure 12. Probability of target attainment (PTA) for piperacillin at  $\geq 50\%$   $fT > MIC$  for 3 prolonged infusion regimens of piperacillin/tazobactam at specific minimum inhibitory concentrations (MICs) in non-obese and obese patients. The dotted, horizontal line represents the PTA of 90%.  $fT > MIC$ , time that unbound drug concentrations remain above the MIC; q8h, every 8 hours.

Figure 13 shows PTAs for tazobactam at the pharmacodynamic target of %time>threshold (a) 70% and (b) 100% for the piperacillin/tazobactam dosing regimens at specific threshold concentrations in obese and non-obese patients. For the %time>threshold of 70%, all simulated dosing regimens in both groups achieved > 90% PTA at threshold concentrations  $\leq 1$  mg/L. For the %time>threshold of 100%, all simulated regimens achieved a > 90% PTA at threshold concentrations  $\leq 0.25$  mg/L in all patients. Only 3.375 g q8h did not achieve > 90% PTA at a threshold concentration of 0.5 mg/L in obese patients. However, PTA decreased dramatically at threshold concentrations  $\geq 1$  mg/L.

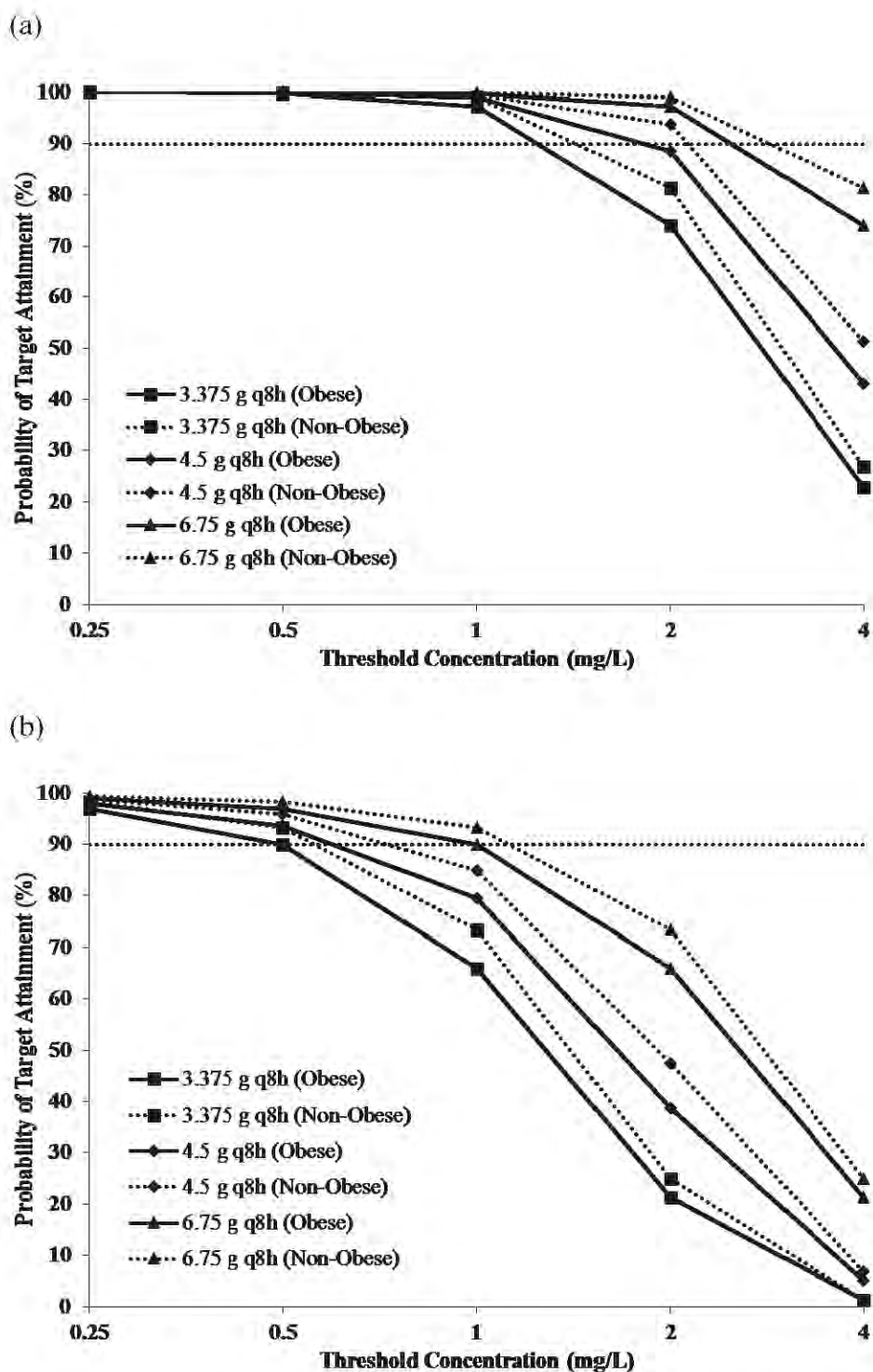

Figure 13. Probability of target attainment (PTA) for tazobactam at %time>threshold for (a)  $\geq 70\%$  and (b)  $100\%$  for 3 prolonged infusion regimens of piperacillin/tazobactam at specific threshold concentrations in non-obese and obese patients. The dotted, horizontal line represents the PTA of  $90\%$ . q8h, every 8 hours.



## Notes

- Akaike, Hirotugu. "A New Look at the Statistical Model Identification." *IEEE Transactions on Automatic Control* 19, no. 6 (1974): 716-23.
- Alvarez, Jose C., Sonia I. Cuervo, Javier R. Garzon, Julio C. Gomez, Jorge Augusto Diaz, Edelberto Silva, Ricardo Sanchez, and Jorge A. Cortes. "Pharmacokinetics of Piperacillin/Tazobactam in Cancer Patients with Hematological Malignancies and Febrile Neutropenia after Chemotherapy." *BMC Pharmacology & Toxicology* 14, (2013): 59.
- American College of Clinical Pharmacology, "Pharmacometrics"  
<http://accpl.org/pharmacometrics/theory.htm> (accessed January 23 2015).
- Auclair, Barbara, and Murray P. Ducharme. "Piperacillin and Tazobactam Exhibit Linear Pharmacokinetics after Multiple Standard Clinical Doses." *Antimicrobial Agents and Chemotherapy* 43, no. 6 (1999): 1465-8.
- Augey, Valerie, Pierre-Yves Grosse, Gregory Albert, Michel Audran, and Francoise Bressolle. "High-Performance Liquid Chromatographic Determination of Tazobactam and Piperacillin in Human Plasma and Urine." *Journal of Chromatography. B, Biomedical Applications* 682, no. 1 (1996): 125-36.
- Bauer, Robert J., Alison J. Boeckmann, Lewis B. Sheiner, and Stuart L. Beal. "NONMEM Users Guide." 1989-2009. Ellicott City, MD, USA: Icon Development Solutions, 2009.
- Buck, Christine, Norbert Bertram, Thomas Ackermann, Tilman Sauerbruch, Hartmut Derendorf, and Wilhem Dieter Paar. "Pharmacokinetics of Piperacillin-Tazobactam: Intermittent Dosing Versus Continuous Infusion." *International Journal of Antimicrobial Agents* 25, no. 1 (2005): 62-7.
- Bulitta, J. B., S. B. Duffull, M. Kinzig-Schippers, U. Holzgrabe, U. Stephan, G. L. Drusano, and F. Sorgel. "Systematic Comparison of the Population Pharmacokinetics and Pharmacodynamics of Piperacillin in Cystic Fibrosis Patients and Healthy Volunteers." *Antimicrobial Agents and Chemotherapy* 51, no. 7 (2007): 2497-507.
- Bulitta, Jurgen B., Martina Kinzig, Verena Jakob, Ulrike Holzgrabe, Fritz Sorgel, and Nicholas H. G. Holford. "Nonlinear Pharmacokinetics of Piperacillin in Healthy Volunteers--Implications for Optimal Dosage Regimens." *British Journal of Clinical Pharmacology* 70, no. 5 (2010): 682-93.

- Butterfield, Jill M., Thomas P. Lodise, Scott Beegle, Jonathan Rosen, Joshua Farkas, and Manjunath P. Pai. "Pharmacokinetics and Pharmacodynamics of Extended-Infusion Piperacillin/Tazobactam in Adult Patients with Cystic Fibrosis-Related Acute Pulmonary Exacerbations." *The Journal of Antimicrobial Chemotherapy* 69, no. 1 (2014): 176-9.
- Byon, W., M. K. Smith, P. Chan, M. A. Tortorici, S. Riley, H. Dai, J. Dong, A. Ruiz-Garcia, K. Sweeney, and C. Cronenberger. "Establishing Best Practices and Guidance in Population Modeling: An Experience with an Internal Population Pharmacokinetic Analysis Guidance." *CPT: Pharmacometrics & Systems Pharmacology* 2, (2013): e51.
- Cheatham, S. Christian, Megan R. Fleming, Daniel P. Healy, Christina. E. K. Chung, Katherine M. Shea, Melissa L. Humphrey, and Michael B. Kays. "Steady-State Pharmacokinetics and Pharmacodynamics of Piperacillin and Tazobactam Administered by Prolonged Infusion in Obese Patients." *International Journal of Antimicrobial Agents* 41, no. 1 (2013): 52-6.
- DeRyke, C. Andrew, Joseph L. Kuti, and David P. Nicolau. "Pharmacodynamic Target Attainment of Six Beta-Lactams and Two Fluoroquinolones against *Pseudomonas Aeruginosa*, *Acinetobacter Baumannii*, *Escherichia Coli*, and *Klebsiella* Species Collected from United States Intensive Care Units in 2004." *Pharmacotherapy* 27, no. 3 (2007): 333-42.
- Felton, T. W., W. W. Hope, B. M. Lomaestro, J. M. Butterfield, A. L. Kwa, G. L. Drusano, and T. P. Lodise. "Population Pharmacokinetics of Extended-Infusion Piperacillin-Tazobactam in Hospitalized Patients with Nosocomial Infections." *Antimicrobial Agents and Chemotherapy* 56, no. 8 (2012): 4087-94.
- Hites, Maya, Fabio Silvio Taccone, Fleur Wolff, Frederic Cotton, Marjorie Beumier, Daniel De Backer, Sandrine Roisin, Sophie Lorent, Rudy Surin, Lucie Seyler, Jean-Louis Vincent, and Frederique Jacobs. "Case-Control Study of Drug Monitoring of Beta-Lactams in Obese Critically Ill Patients." *Antimicrobial Agents and Chemotherapy* 57, no. 2 (2013): 708-15.
- Janmahasatian, Sarayut, Stephen B. Duffull, Susan Ash, Leigh C. Ward, Nuala M. Byrne, and Bruce Green. "Quantification of Lean Bodyweight." *Clinical Pharmacokinetics* 44, no. 10 (2005): 1051-65.
- Jeon, Sangil, Seunghoon Han, Jongtae Lee, Taegon Hong, Jeongki Paek, Heungjeong Woo, and Dong-Seok Yim. "Population Pharmacokinetic Analysis of Piperacillin in Burn Patients." *Antimicrobial Agents and Chemotherapy* 58, no. 7 (2014): 3744-51.

- Kim, Myo-Kyoung, Blair Capitano, Holly M. Mattoes, Dawei Xuan, Richard Quintiliani, Charles H. Nightingale, David P. Nicolau. "Pharmacokinetic and Pharmacodynamic Evaluation of Two Dosing Regimens for Piperacillin-Tazobactam." *Pharmacotherapy* 22, no. 5 (2002): 569-77.
- Landersdorfer, Cornelia B., Jurgen B. Bulitta, Carl M. Kirkpatrick, Martina Kinzig, Ulrike Holzgrabe, George L. Drusano, Ulrich Stephan, and Fritz Sorgel. "Population Pharmacokinetics of Piperacillin at Two Dose Levels: Influence of Nonlinear Pharmacokinetics on the Pharmacodynamic Profile." *Antimicrobial Agents and Chemotherapy* 56, no. 11 (2012): 5715-23.
- Lodise Jr., Thomas P., Ben Lomaestro, Keith A. Rodvold, Larry H. Danziger, and George L. Drusano. "Pharmacodynamic Profiling of Piperacillin in the Presence of Tazobactam in Patients through the Use of Population Pharmacokinetic Models and Monte Carlo Simulation." *Antimicrobial Agents and Chemotherapy* 48, no. 12 (2004): 4718-24.
- McWhinney, Brett C., Steven C. Wallis, Tara Hillister, Jason A. Roberts, Jeffrey Lipman, and Jacobus P. J. Ungerer. "Analysis of 12 Beta-Lactam Antibiotics in Human Plasma by HPLC with Ultraviolet Detection." *Journal of Chromatography. B, Analytical Technologies in the Biomedical and Life Sciences* 878, no. 22 (2010): 2039-43.
- Mould, D. R., and R. N. Upton. "Basic Concepts in Population Modeling, Simulation, and Model-Based Drug Development." *CPT:Pharmacometrics & Systems Pharmacology* 1, (2012): e6.
- Roberts, Jason A., Mohd H. Abdul-Aziz, Jeffrey Lipman, Johan W. Mouton, Alexander A. Vinks, Timothy W. Felton, William W. Hope, Andras Farkas, Michael N. Neely, Jerome J. Schentag, George Drusano, Otto R. Frey, Ursula Theuretzbacher, and Joseph L. Kuti. "Individualised Antibiotic Dosing for Patients Who Are Critically Ill: Challenges and Potential Solutions." *The Lancet. Infectious Diseases* 14, no. 6 (2014): 498-509.
- Roberts, Jason A., Carl M. J. Kirkpatrick, Michael S. Roberts, Andres J. Dalley, and Jeffrey Lipman. "First-Dose and Steady-State Population Pharmacokinetics and Pharmacodynamics of Piperacillin by Continuous or Intermittent Dosing in Critically Ill Patients with Sepsis." *International Journal of Antimicrobial Agents* 35, no. 2 (2010): 156-63.
- Shea, Katherine M., S. Christian Cheatham, Matthew F. Wack, David W. Smith, Kevin M. Sowinski, and Michael B. Kays. "Steady-State Pharmacokinetics and Pharmacodynamics of Piperacillin/Tazobactam Administered by Prolonged Infusion in Hospitalised Patients." *International Journal of Antimicrobial Agents* 34, no. 5 (2009): 429-33.

- Sorgel, F., and M. Kinzig. "The Chemistry, Pharmacokinetics, and Tissue Distribution of Piperacillin/Tazobactam." *The Journal of Antimicrobial Chemotherapy* 31 Suppl A, (1993): 39-60.
- Sturm, Ashley W., Nichole Allen, Kelly D. Rafferty, Douglas N. Fish, Eric Toschlog, Mark Newell, and Brett Waibel. "Pharmacokinetic Analysis of Piperacillin Administered with Tazobactam in Critically Ill, Morbidly Obese Surgical Patients." *Pharmacotherapy* 34, no. 1 (2014): 28-35.
- VanScoy, Brian, Rodrigo E. Mendes, Anthony M. Nicasio, Mariana Castanheira, Catharine C. Bulik, Olanrewaju O. Okusanya, Sujuta M. Bhavnani, Alan Forrest, Ronald N. Jones, Lawrence V. Friedrich, Judith N. Steenbergen, and Paul G. Ambrose. "Pharmacokinetics-Pharmacodynamics of Tazobactam in Combination with Ceftolozane in an In Vitro Infection Model." *Antimicrobial Agents and Chemotherapy* 57, no. 6 (2013): 2809-14.
- Vinks, Alexander A., Jan G. den Hollander, Shelley E. Overbeek, Roger W. Jelliffe, and Johan W. Mouton. "Population Pharmacokinetic Analysis of Nonlinear Behavior of Piperacillin During Intermittent or Continuous Infusion in Patients with Cystic Fibrosis." *Antimicrobial Agents and Chemotherapy* 47, no. 2 (2003): 541-7.
- Zosyn(R) [package insert]. Philadelphia, PA: Pfizer Injectables, 2013.

## DETERMINATION OF OPTIMAL MEROPENEM DOSING REGIMENS IN OBESE PATIENTS COMPARED TO NON- OBESE PATIENTS

### Study Objectives

The objectives of this study were:

Objective 1: To describe the steady-state pharmacokinetics of meropenem in hospitalized obese and non-obese patients with suspected or documented infection. This objective will test the hypothesis that CL and/or V of meropenem, estimated by the nonlinear mixed-effect modeling approach, is increased in obese patients compared to non-obese patients. This objective will be achieved by comparing the meropenem pharmacokinetic parameters estimated from the population pharmacokinetic model that will be developed in this study between obese and non-obese patients.

Objective 2: To determine the appropriate meropenem dosing regimens in obesity to achieve similar pharmacodynamic targets in obese patients compared with non-obese patients with suspected or documented infection. This objective will test the hypothesis that obese patients require larger meropenem dosages compared to non-obese patients to achieve comparable drug exposures. This aim will be achieved by pharmacodynamic simulations to estimate the probability to attain the meropenem pharmacodynamic targets

over a range of MICs for various dosing regimens using the population pharmacokinetic model and the model parameter estimates.

## Methods

### Study Design and Pharmacokinetic Data

This is a retrospective analysis of prospectively collected serum concentration-time data from three previous studies published by our research group (Study 3, Study 4, and Study 5) (Cheatham et al. 2008; Cheatham et al. 2011; Cheatham et al. 2014; Kays et al. 2014). The sample size was not determined a priori using power analysis, but a convenience sample using available data was used for this study. The inclusion and exclusion criteria of Study 3, Study 4, and Study 5 are listed in Table 11. As shown in Table 11, in Study 3, patients with estimated CRCL less than 50 mL/min were also enrolled because one of the study objectives was to evaluate the dosing scheme at the study sites for patients with reduced renal function. However, in Study 4 and Study 5, patients with reduced renal function (estimated CRCL less than 50 mL/min) were excluded because the study objectives were simply to determine the pharmacokinetics in obese patients with normal renal function. Creatinine clearance was estimated by the modified Cockcroft-Gault method (equation 2) using the actual serum creatinine concentration for each patient and IBW (equations 3 and 4) for patients with a BMI < 40 kg/m<sup>2</sup> and LBW (equations 19 and 20) for patients with a BMI > 40 kg/m<sup>2</sup> for the weight term (Demirovic et al. 2009):

$$\text{CRCL (mL/min)} = \frac{(140 - \text{Age}) \times \text{Weight}}{\text{SCr} \times 72} \times (0.85 \text{ if female}) \quad (2)$$

$$\text{Ideal body weight (IBW)} = 50 \text{ kg} + [2.3 \text{ kg} * (\text{height in inches} - 60)] \text{ in males} \quad (3)$$

$$\text{Ideal body weight (IBW)} = 45.5 \text{ kg} + [2.3 \text{ kg} * (\text{height in inches} - 60)] \text{ in females} \quad (4)$$

$$\text{LBW (in male, kg)} = \frac{9270 \times \text{TBW}}{6680 + 216 \times \text{BMI}} \quad (19)$$

$$\text{LBW (in female, kg)} = \frac{9270 \times \text{TBW}}{8780 + 244 \times \text{BMI}} \quad (20)$$

Table 11. Inclusion and exclusion criteria for Study 3, Study 4, and Study 5

	Study 3 (Cheatham et al. 2008)	Study 4 (Cheatham et al. 2011; Cheatham et al. 2014)	Study 5 (Kays et al. 2014)
Inclusion criteria	<ul style="list-style-type: none"> <li>- Hospitalized at Methodist Hospital or St. Francis Hospital (Indianapolis, IN)</li> <li>- Aged <math>\geq 18</math> years</li> <li>- Required antimicrobial therapy for a suspected or documented bacterial infection</li> <li>- Had central venous access</li> </ul>	<ul style="list-style-type: none"> <li>- Hospitalized at Franciscan St. Francis Health (Indianapolis, IN)</li> <li>- Body mass index <math>\geq 40 \text{ kg/m}^2</math></li> <li>- Aged <math>\geq 18</math> years</li> <li>- Required antimicrobial therapy for a suspected or documented bacterial infection</li> <li>- Had central venous access</li> <li>- Creatinine clearance<sup>a</sup> <math>\geq 50 \text{ mL/min}</math></li> </ul>	<ul style="list-style-type: none"> <li>- Hospitalized on a general medical ward at Methodist Hospital, Wishard Hospital, or Franciscan St Francis Health (Indianapolis, IN)</li> <li>- Aged <math>\geq 18</math> and <math>\leq 65</math> years</li> <li>- Body mass index <math>\geq 40 \text{ kg/m}^2</math> or total body weight <math>\geq 100</math> pounds over their ideal body weight<sup>b</sup></li> <li>- Required antimicrobial therapy for a suspected or documented bacterial infection</li> <li>- Had central venous access</li> <li>- Creatinine clearance<sup>a</sup> <math>\geq 50 \text{ mL/min}</math></li> </ul>

Table 11. Continued. Inclusion and exclusion criteria for Study 3, Study 4, and Study 5

	Study 3 (Cheatham et al. 2008)	Study 4 (Cheatham et al. 2011; Cheatham et al. 2014)	Study 5 (Kays et al. 2014)
Exclusion criteria	<ul style="list-style-type: none"> <li>- Allergy to any beta-lactam antibiotic</li> <li>- History of drug or alcohol abuse</li> <li>- Pregnancy</li> <li>- History of any seizure disorder</li> <li>- Acute or chronic renal failure</li> <li>- Renal replacement therapy of any type</li> </ul>	<ul style="list-style-type: none"> <li>- History of allergy to carbapenems</li> <li>- Pregnancy</li> <li>- Renal replacement therapy of any type</li> <li>- Hepatic dysfunction defined as serum bilirubin and alanine aminotransferase concentrations <math>\geq 2</math> and <math>\geq 4</math> times the normal upper limit, respectively</li> </ul>	<ul style="list-style-type: none"> <li>- Allergy to any beta-lactam antibiotic</li> <li>- History of drug or alcohol abuse</li> <li>- Pregnancy</li> <li>- History of any seizure disorder</li> <li>- Acute or chronic renal failure</li> <li>- Renal replacement therapy of any type</li> <li>- Hepatic dysfunction defined as serum bilirubin and alanine aminotransferase concentrations <math>\geq 2</math> and <math>\geq 4</math> times the normal upper limit, respectively</li> </ul>

<sup>a</sup> Estimated by the modified Cockcroft-Gault method (equation 22) using lean body weight (equations 19 and 20) and the actual serum creatinine concentration for each patient (Demirovic et al. 2009):

$$\text{CRCL (mL/min)} = \frac{(140 - \text{Age}) \times \text{LBW}}{\text{Scr} \times 72} \times (0.85 \text{ if female}) \quad (22)$$

$$\text{Lean body weight (LBW in male, kg)} = \frac{9270 \times \text{TBW}}{6680 + 216 \times \text{BMI}} \quad (19)$$

$$\text{Lean body weight (LBW in female, kg)} = \frac{9270 \times \text{TBW}}{8780 + 244 \times \text{BMI}} \quad (20)$$

<sup>b</sup> Calculated by equations 3 and 4:

$$\text{Ideal body weight (IBW)} = 50 \text{ kg} + [2.3 \text{ kg} * (\text{height in inches} - 60)] \text{ in males} \quad (3)$$

$$\text{Ideal body weight (IBW)} = 45.5 \text{ kg} + [2.3 \text{ kg} * (\text{height in inches} - 60)] \text{ in females} \quad (4)$$

These studies were approved by the institutional review boards at each study site, and written informed consent was obtained from each patient or a first-degree relative if the patient was unable to give informed consent due to his or her medical condition.



Patients were classified as either obese (BMI  $\geq 30$  kg/m<sup>2</sup>) or non-obese (BMI < 30 kg/m<sup>2</sup>). Table 12 shows dosing schemes in each study, which were selected to reflect the routine clinical practice at each study site at the time of each study.

Table 12. Meropenem dosing schemes for each study

	Study 3 (Cheatham et al. 2008)	Study 4 (Cheatham et al. 2011; Cheatham et al. 2014)	Study 5 (Kays et al. 2014)
Meropenem dosing regimens <sup>a</sup>	- 500 mg q6h if CRCL <sup>b</sup> > 60 mL/min - 500 mg q8h if CRCL is 40 to 60 mL/min - 500 mg q12h if CRCL is 10 to 39 mL/min	500 mg or 1000 mg q6h <sup>c</sup>	1000 mg q8h

Abbreviations: q6h, every 6 hours; CRCL, creatinine clearance; q8h, every 8 hours

<sup>a</sup> All doses were infused over 30 minutes

<sup>b</sup> Estimated by the modified Cockcroft-Gault method (equation 2) using ideal body weight (equations 3 and 4) for the weight term and the actual serum creatinine concentration for each patient:

$$\text{CRCL (mL/min)} = \frac{(140 - \text{Age}) \times \text{Weight}}{\text{SCr} \times 72} \times (0.85 \text{ if female}) \quad (2)$$

$$\text{Ideal body weight (IBW)} = 50 \text{ kg} + [2.3 \text{ kg} * (\text{height in inches} - 60)] \text{ in males} \quad (3)$$

$$\text{Ideal body weight (IBW)} = 45.5 \text{ kg} + [2.3 \text{ kg} * (\text{height in inches} - 60)] \text{ in females} \quad (4)$$

<sup>c</sup> Dosing regimens were selected upon the discretion of the treating clinician

After 2 or more days of therapy, serial blood samples were collected from an indwelling IV catheter as scheduled in each study (Table 13).

Table 13. Blood sampling scheme for meropenem studies. Boxes with X indicate the time when blood samples were collected.

Hours <sup>a</sup>	0	0.5	0.75	1	1.5	2	3	4	5	6	8	12
Study 3 (Cheatham et al. 2008)	X	X	X	X	X	X	X	X	X	X	X <sup>b</sup>	X <sup>c</sup>
Study 4 (Cheatham et al. 2011; Cheatham et al. 2014)	X	X		X		X	X	X		X		
Study 5 (Kays et al. 2014)	X	X		X	X	X	X	X	X	X	X	

<sup>a</sup> Hours after the start of the meropenem infusion.

<sup>b</sup> Only for those receiving meropenem every 8 or 12 hours.

<sup>c</sup> Only for those receiving meropenem every 12 hours.

At each time when blood sample was collected, the catheter was flushed with 10 mL of normal saline or heparin. The first 10 mL of blood draw was discarded to ensure flush solution was not mixed with the patient's blood samples. Afterwards, 10 mL blood samples were collected in non-anticoagulant (red top) tubes at each time point.

Immediately after allowing the blood to coagulate, the samples were centrifuged and serum samples were stored at -70°C. Serum samples were shipped on dry ice by overnight carrier to the Center for Anti-Infective Research and Development at Hartford Hospital (Hartford, CT) for samples obtained from Study 3 and to the University of Cincinnati Academic Health Center (Cincinnati, OH) for samples obtained from Study 4 and Study 5 for determination of meropenem concentrations.

Serum meropenem concentrations were determined by previously described analytical methods (Elkhaili et al. 1996; Kays et al. 2014). In Study 3 (Cheatham et al.

2008), meropenem serum concentrations were determined using a validated high-performance liquid chromatography assay, as previously described (Elkhaili et al. 1996). The mobile phase consisted of 5% HPLC-grade acetonitrile and 95% ammonium acetate buffer (10.53 mmol/L, pH 4.0, v/v). The flow rate was 1.0 mL/min, and chromatographic separation was performed using a reverse-phase HPLC column (Ultrasphere XL-ODS, 3 microns, 4.6 mm x 75 mm). Serum samples were allowed to thaw at room temperature, and protein precipitation was performed by adding 0.5 mL of acetonitrile to 0.5 mL of serum, vortexing for 30 seconds, and centrifuging at 2,000 x g for 10 minutes. Methylene chloride (3.2 mL) was added to the supernatant, vortexed for 30 seconds, and centrifuged at 2,000 x g for 10 minutes. The aqueous phase was then injected into the HPLC. The assay was linear over a range of 0.25-50 µg/ml ( $r = 0.999$ ), and the intraday coefficients of variation for the high (40 µg/ml) and low (2 µg/ml) quality control standards were less than 3%.

In Study 4 (Cheatham et al. 2011; Cheatham et al. 2014), meropenem serum concentrations were determined using a validated high-performance liquid chromatography assay (HPLC), as described previously (Elkhaili et al. 1996). The mobile phase consisted of 5% HPLC-grade acetonitrile and 95% ammonium acetate buffer (10.53 mmol/L, pH 4.0, v/v). The flow rate was 1.0 mL/min, and chromatographic separation was performed using a reverse-phase HPLC column (Ultrasphere XL-ODS, 3 microns, 4.6 mm x 75 mm). Serum samples were allowed to thaw at room temperature, and protein precipitation was performed by adding 0.5 mL of acetonitrile to 0.5 mL of serum, vortexing for 30 seconds, and centrifuging at 2,000 x g for 10 minutes. Methylene chloride (3.2 mL) was added to the supernatant, vortexed for 30 seconds, and

centrifuged at 2,000 x g for 10 minutes. The aqueous phase was then injected into the HPLC. The standard curve was linear over the concentration range of 0.5-50 µg/mL ( $r \geq 0.998$ ). If the assayed concentration was > 50 µg/mL, the sample was diluted with an equal volume of serum and re-assayed. For spiked serum control concentrations of 2, 20, and 40 µg/mL, the within-day coefficients of variation ranged from 0.72-9.5%, and the between-day coefficients of variation ranged from 5.6-9.7%.

In Study 5 (Kays et al. 2014), meropenem serum concentrations were determined by ultraperformance liquid chromatography with tandem mass spectrometry detection ([UPLC-MS-MS] Acquity UPLC TQD; Waters Corporation, Milford, MA). The instrument was operated with an electrospray ionization interface in multiple reaction monitoring and positive ion modes. The resolution of both quadrupoles was maintained at unit mass resolution with a peak width at half height of 0.7 atomic mass unit. Data analysis was performed with use of QuanLynx software (Waters Corporation, Milford, MA). Serum samples were thawed at room temperature, and a 200-µL aliquot was transferred into an ultrafiltration device (Nanosep 10K; Pall Corporation, Northborough, MA, USA). Then, 0.5 µL of 0.02 µg/mL of the internal standard (meropenem\_d6; Toronto Research Chemicals Inc, Ontario, Canada) was added to each device, and the samples were centrifuged for 20 minutes. The supernatant was transferred to an autosampler vial, and 10 µL was injected into the UPLC-MS-MS. Utilizing an Acquity UPLC HSS T3 1.8-µm, 2.1 x 50-mm column (Waters Corporation, Milford, MA) at 25°C, the analytes were separated using a timed gradient and a linear gradient of acetonitrile and water, each having 0.1% formic acid added. The column was eluted into the Acquity UPLC TQD, operating in a positive mode to detect meropenem at

384.17>68.05 and internal standard (meropenem\_d6) at 390.23>68.05. Secondary transitions for each analyte were also monitored for meropenem at 384.17>141.08 and internal standard (meropenem\_d6) at 390.23>147.08. The run time was 3.5 minutes per injection with baseline resolved chromatographic separation. The analytic measurement range for meropenem was 0.5–60 µg/mL. Intra-assay imprecision (coefficient of variation) was less than 9% and inter-assay coefficient of variation was less than 4% at doripenem concentrations of 1, 10, and 25 µg/mL. Intra-assay imprecision was less than 7% and inter-assay coefficient of variation was less than 5% at meropenem concentrations of 1, 10, and 25 µg/mL.

#### Population Pharmacokinetic Analysis

Serum concentration-time data for meropenem from all individual patients were analyzed simultaneously by population compartmental pharmacokinetic modeling approach using NONMEM (version VII; Globomax LLC, Ellicott, MD, USA) (Bauer et al. 2009). NONMEM software was accessed via the cluster at the Indiana Clinical and Translational Science Institution thanks to Dr. Robert R. Bies. The first-order conditional estimation (FOCE) method with interaction was used. One- and two-compartment models with zero-order input and first-order (i.e., linear) elimination were evaluated as potential structural meropenem pharmacokinetic models. Figures 3 and 4 show the diagrams describing one- and two-compartment structural models. Differential equations describing one- and two-compartment structural models are shown in equations 27 and 28-29, respectively.

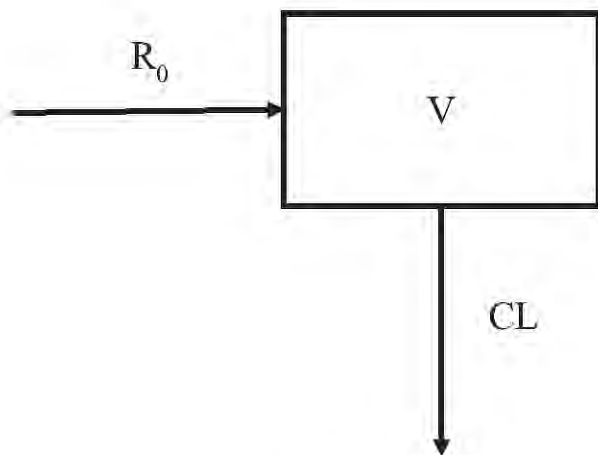

Figure 3. One-compartment structural model.  $R_0$ , the rate of drug infusion (mg/h);  $V$ , volume of distribution (L);  $CL$ , clearance (L/h).

$$\frac{dA}{dt} = R_0 - \left(\frac{CL}{V} \times A\right) \quad (23)$$

where  $\frac{dA}{dt}$  is the rate of change in the drug amount over time (mg/h),  $A$  is the amount of the drug in the body (system) (mg),  $R_0$  is the rate of drug infusion (mg/h),  $CL$  is clearance (L/h), and  $V$  is the volume of distribution (L).

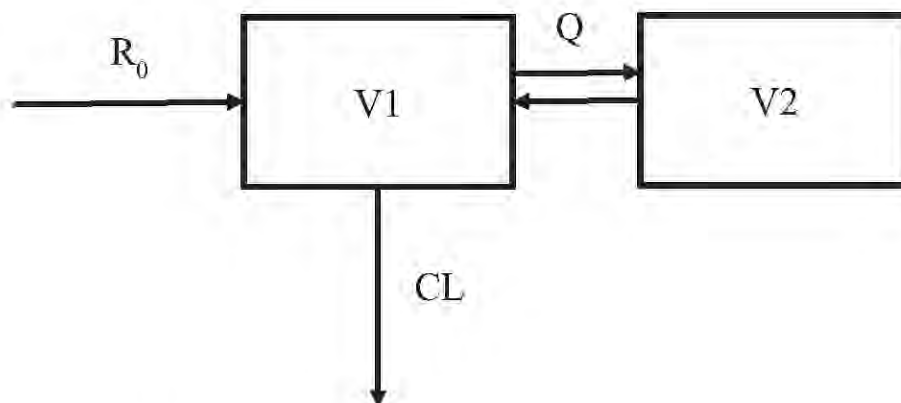

Figure 4. Two-compartment structural model.  $R_0$ , the rate of drug infusion (mg/h);  $V1$ , volume of distribution in the central compartment (L);  $V2$ , volume of distribution in the peripheral compartment (L);  $Q$ , inter-compartmental distribution clearance (L/h);  $CL$ , clearance (L/h).

$$\frac{dA_1}{dt} = R_0 + \left(\frac{Q}{V_2} \times A_2\right) - \left(\frac{Q}{V_1} \times A_1\right) - \left(\frac{CL}{V_1} \times A_1\right) \quad (24)$$

$$\frac{dA_2}{dt} = \left(\frac{Q}{V_1} \times A_1\right) - \left(\frac{Q}{V_2} \times A_2\right) \quad (25)$$

where  $\frac{dA_1}{dt}$  is the rate of change in the drug amount over time in the central compartment (mg/h),  $R_0$  is the rate of drug infusion (mg/h),  $Q$  is inter-compartmental distribution clearance (L/h),  $V_2$  is volume of distribution in the peripheral compartment (L),  $A_2$  is the amount of the drug in the peripheral compartment (mg),  $V_1$  is volume of distribution in the central compartment (L),  $A_1$  is the amount of the drug in the central compartment (mg),  $CL$  is clearance (L/h), and  $\frac{dA_2}{dt}$  is the rate of change in the drug amount over time in the peripheral compartment (mg/h). The initial estimates of  $CL$ ,  $V$ ,  $V_1$ ,  $Q$ , and  $V_2$  were the average of the parameter estimates obtained from our previous studies using non-compartmental and one-compartmental analyses (Cheatham et al. 2008; Cheatham et al. 2011; Cheatham et al. 2014; Kays et al. 2014). The initial estimate values were varied from 10-fold lower to 10-fold higher values to achieve global minima and obtain robust parameter estimates (Bauer et al. 2009). Inter-individual variability ( $\eta$ ) of population pharmacokinetic parameters was assumed to follow log-normal distribution with a mean of zero and variance of  $\omega^2$  (equation 31) (Mould and Upton, 2012). Possible correlations between the inter-individual variability for pharmacokinetic parameters in the model were examined. For residual errors ( $\varepsilon$ ) unexplained by the model, additive ( $\varepsilon_{add}$ ), proportional ( $\varepsilon_{prop}$ ), and combinational models were evaluated, and residual error was assumed to be normally distributed with a mean of zero and variance of  $\sigma^2$  (equations 32, 33, and 34) (Mould and Upton, 2012).

$$P_{ij} = TVP_j \times e^{\eta_{ij}} \quad (31)$$

$$Y_{ik} = IPRED_{ik} + \varepsilon_{add,ik} \quad (32)$$

$$Y_{ik} = IPRED_{ik} \times (1 + \varepsilon_{prop,ik}) \quad (33)$$

$$Y_{ik} = IPRED_{ik} \times (1 + \varepsilon_{prop,ik}) + \varepsilon_{add,ik} \quad (34)$$

where  $P_{ij}$  is the  $j^{\text{th}}$  pharmacokinetic parameter, such as CL and V, of the  $i^{\text{th}}$  patient,  $TVP_j$  is the typical population value of the  $j^{\text{th}}$  pharmacokinetic parameter,  $\eta_{ij}$  is a random variable for the inter-individual variability of the  $j^{\text{th}}$  pharmacokinetic parameter for the  $i^{\text{th}}$  patient,  $Y_{ik}$  is the measured drug (i.e., piperacillin and tazobactam) concentration of the  $i^{\text{th}}$  patient at the  $k^{\text{th}}$  sampling time,  $IPRED_{ik}$  is the individual model-predicted drug concentration of the  $i^{\text{th}}$  patient at the  $k^{\text{th}}$  sampling time, and  $\varepsilon_{ik}$  is residual error of the  $i^{\text{th}}$  patient at the  $k^{\text{th}}$  sampling time. The best structural pharmacokinetic model with stochastic error terms for meropenem was selected based on the visual inspection of observed concentration-time plots, goodness-of-fit plots, individual plots of observed and individual predicted concentration-time profiles, the change in the minimum objective function value ( $\Delta\text{OFV}$ ), and Akaike information criterion (AIC) (Akaike, 1974; American College of Clinical Pharmacology, 2011). In NONMEM, the objective function value (OFV) is -2 times the log of the model likelihood, and the likelihood is typically considered as a sum of squares (American College of Clinical Pharmacology, 2011). The change in the minimum objective function value ( $\Delta\text{OFV}$ ) follows a chi-square distribution and a decrease in OFV by  $> 3.84$  is considered statistically significant with 1 degree of freedom ( $df$ ) at the  $\alpha$  level of 0.05 using a chi-square test (American College of Clinical Pharmacology, 2011). Akaike information criterion (AIC) is defined in equation 35.

$$\text{AIC} = \text{OFV} + [2 \times (\text{number of parameters in the model})] \quad (35)$$



where AIC is Akaike information criterion and OFV is the model objective function value which is equal to -2 times the log of the model likelihood. Among the above listed diagnostic criteria for model selection,  $\Delta$ OFV took precedence over others.

The final pharmacokinetic model was built by evaluating the effects of covariates on the meropenem pharmacokinetic parameters using the stepwise forward inclusion followed by the backward elimination process. Tested covariates included: 1) age (years); 2) sex; 3) body size descriptor, including TBW, IBW, LBW (Janmahasatian et al. 2005), and BMI; 4) CRCL; and 5) admission to an ICU (ICU=1, general medical ward=0). Equations 3-4 and 19-20 were used to estimate IBW and LBW, respectively.

$$\text{IBW} = 50 \text{ kg} + [2.3 \text{ kg} * (\text{height in inches} - 60)] \text{ in males} \quad (3)$$

$$\text{IBW} = 45.5 \text{ kg} + [2.3 \text{ kg} * (\text{height in inches} - 60)] \text{ in females} \quad (4)$$

$$\text{LBW (in male, kg)} = \frac{9270 \times \text{TBW}}{6680 + 216 \times \text{BMI}} \quad (19)$$

$$\text{LBW (in female, kg)} = \frac{9270 \times \text{TBW}}{8780 + 244 \times \text{BMI}} \quad (20)$$

where IBW is ideal body weight (kg), LBW is lean body weight (kg), TBW is total body weight (kg), and BMI is body mass index ( $\text{kg}/\text{m}^2$ ). Creatinine clearance was estimated by the modified Cockcroft-Gault method (equation 2) using the actual serum creatinine concentration for each patient and IBW (equations 3 and 4) for patients with a BMI < 40  $\text{kg}/\text{m}^2$  and LBW (equations 19 and 20) for patients with a BMI > 40  $\text{kg}/\text{m}^2$  for the weight term (Demirovic et al. 2009):

$$\text{CRCL (mL/min)} = \frac{(140 - \text{Age}) \times \text{Weight}}{\text{SCr} \times 72} \times (0.85 \text{ if female}) \quad (2)$$

$$\text{Ideal body weight (IBW)} = 50 \text{ kg} + [2.3 \text{ kg} * (\text{height in inches} - 60)] \text{ in males} \quad (3)$$

$$\text{Ideal body weight (IBW)} = 45.5 \text{ kg} + [2.3 \text{ kg} * (\text{height in inches} - 60)] \text{ in females} \quad (4)$$

$$\text{LBW (in male, kg)} = \frac{9270 \times \text{TBW}}{6680 + 216 \times \text{BMI}} \quad (19)$$

$$\text{LBW (in female, kg)} = \frac{9270 \times \text{TBW}}{8780 + 244 \times \text{BMI}} \quad (20)$$

The admission to an intensive care unit was tested to evaluate the association between critical illness and meropenem pharmacokinetic parameters because critical illness was previously suggested to alter antibiotic pharmacokinetics (Roberts et al. 2014).

Continuous covariates (e.g., age, body size descriptors including TBW, IBW, LBW, and BMI, and CRCL) were centered at their median values. The effect of each covariate on each pharmacokinetic parameter, which is CL and V each if a one-compartment model was selected as the best structural model and CL, V1, Q, and V2 each if a two-compartment model was selected as the best structural model, was evaluated using 1) linear, power, or exponential functions for continuous covariates and 2) additive or proportional functions for categorical covariates (e.g., sex and ICU admission). Covariates that reduced the model OFV  $> 3.84$  ( $p < 0.05$ ;  $\chi^2$  distribution; 1 *df*) were considered significantly associated with the pharmacokinetic parameters in the model. In each step, among statistically significant covariates, if any, only the covariate with the greatest decrease in the model OFV was kept in the model. Afterwards, the remaining covariates were tested and added to the model in the same manner. The full model was constructed when all of the significant covariates were added to the model and there was no other remaining covariate that significantly reduced the model OFV. The final model was constructed after removing covariates that were not significantly associated with the pharmacokinetic parameters from the full model in the stepwise backward elimination process. A covariate was removed if its elimination increased the

model OFV by  $< 5.024$  ( $p > 0.025$ ;  $\chi^2$  distribution; 1 *df*). If there was more than one covariate that was not significant in the same step, the covariate with the smallest increase in the model OFV was removed, and this process was repeated until the elimination of every covariate in the model resulted in an increase in the model OFV by  $> 5.024$  ( $p < 0.025$ ;  $\chi^2$  distribution; 1 *df*).

The model fitting of the final model to the observed data was evaluated by goodness-of-fit plots. The predictive accuracy of the final pharmacokinetic model was examined by visual predictive checks (VPCs) (Byon et al. 2013). VPCs were performed by simulating serum meropenem concentration-time profiles using NONMEM (version VII; Globomax LLC, Ellicott, MD, USA) (Bauer et al. 2009). One thousand simulations were conducted using all of the study patients included to build the population pharmacokinetic model ( $n=40$ ), resulting in 40,000-virtual simulated serum meropenem concentration time profiles. Curves for the 5<sup>th</sup>, 50<sup>th</sup>, and 95<sup>th</sup> percentiles of simulated meropenem concentrations were graphed with the observed concentrations, and they were grouped by dosage regimens (500 mg q12h, 500 mg q8h, 500 mg q6h, 1000 mg q8h, or 1000 mg q6h).

Descriptive statistics were used to summarize patient demographics and each pharmacokinetic parameter. All statistical analyses were performed in SPSS (SPSS Statistics for Windows, Version 22.0; SPSS Inc. IBM Corp. Armonk, NY). For categorical variables, chi-square or Fisher's exact test was used to test the differences between non-obese and obese patients. For continuous variables, normality was tested using Kolmogorov-Smirnov test. When normality assumption was met, differences between non-obese and obese patients were tested using the 2-tailed, unpaired t-test with

either unequal or equal variances, depending on the Levene's test result for equal variance. When normality assumption was violated, Mann-Whitney U test was performed to test the differences between non-obese and obese patients. Statistical significance was defined as  $p < 0.05$ .

### Pharmacodynamic Analysis Using Monte Carlo Simulations

Pharmacodynamic exposures were modeled for the following meropenem dosing regimens: 500 mg q8h, 500 mg q6h, 1000 mg q8h, 1000 mg q6h, and 2000 mg q8h for patients with  $CRCL \geq 50$  mL/min; and 500 mg and 1000 mg q12h for patients with  $CRCL < 50$  mL/min. Each dosing regimen was simulated as 30-minute infusion, 3-hour infusion for q6h regimens, and 4-hour infusion for q8h and q12h regimens. Monte Carlo simulations were performed using NONMEM with 125 simulations of all patients included to build the population pharmacokinetic model ( $n=40$ ), so 5,000-patient steady-state serum meropenem concentration-time curves were created using the final pharmacokinetic model. In our original data set used to develop the population pharmacokinetic model ( $n=40$ ), 32 patients had  $CRCL \geq 50$  mL/min with 7 non-obese and 25 obese patients, respectively; the remaining 8 patients had  $CRCL < 50$  mL/min with 4 non-obese and 4-obese patients, respectively. All serum concentration-time curves were simulated in 0.1-hour intervals, and the unbound serum concentrations were calculated as simulated serum drug concentrations multiplied by the free fraction. The meropenem unbound fraction was assumed to be 0.98 because 1) it is considered low-protein binding drugs and 2) protein binding and/or unbound drug concentrations were not measured (Cheatham et al. 2008; Cheatham et al. 2011; Cheatham et al. 2014; Kays

et al. 2014; Merrem(R) [package insert], 2013). Based on the simulated unbound serum concentration-time profiles, the PTA for meropenem was calculated for each dosing regimen using the pharmacodynamic target of  $\geq 40\% fT > MIC$  and  $\geq 54\% fT > MIC$  at specific MICs ranging from 0.015 to 64 mg/L (Mouton et al. 2005; Lodise et al. 2006; Li et al. 2007; Baldwin et al. 2008). The dosing regimen with the PTA  $\geq 90\%$  was considered optimal (DeRyke et al. 2007).

## Results

### Patient Characteristics

Overall, a convenience sample of 40 patients (20 men and 20 women) were studied. TBW ranged from 57 kg to 305 kg, BMI from 19.2 kg/m<sup>2</sup> to 88.8 kg/m<sup>2</sup>, and estimated CRCL from 15 mL/min to 186 mL/min. Creatinine clearance was estimated by the modified Cockcroft-Gault method (equation 2) using the actual serum creatinine concentration for each patient and IBW (equations 3 and 4) for patients with a BMI < 40 kg/m<sup>2</sup> and LBW (equations 19 and 20) for patients with a BMI > 40 kg/m<sup>2</sup> for the weight term in equation 2 (Demirovic et al. 2009):

$$CRCL \text{ (mL/min)} = \frac{(140 - \text{Age}) \times \text{Weight}}{SCr \times 72} \times (0.85 \text{ if female}) \quad (2)$$

$$\text{Ideal body weight (IBW)} = 50 \text{ kg} + [2.3 \text{ kg} * (\text{height in inches} - 60)] \text{ in males} \quad (3)$$

$$\text{Ideal body weight (IBW)} = 45.5 \text{ kg} + [2.3 \text{ kg} * (\text{height in inches} - 60)] \text{ in females} \quad (4)$$

$$LBW \text{ (in male, kg)} = \frac{9270 \times TBW}{6680 + 216 \times BMI} \quad (19)$$

$$\text{LBW (in female, kg)} = \frac{9270 \times \text{TBW}}{8780 + 244 \times \text{BMI}} \quad (20) \text{No}$$

patients experienced adverse events related to meropenem therapy during the study.

Table 14 shows patient demographics for non- obese and obese patient groups.

Table 14. Patient demographics [median (range) unless otherwise stated]

Demographic characteristics	Non-obese (n=11)	Obese (n=29)	P-value
Male, no. of patients (%)	7 (63.6%)	13 (44.8%)	0.288 <sup>f</sup>
Age, years	59 (20-79)	57 (26-76)	0.782 <sup>g</sup>
Creatinine clearance, <sup>a</sup> mL/min	58 (15-182)	87 (20-186)	0.116 <sup>h</sup>
Height, cm	170 (165-183)	170 (140-193)	0.964 <sup>i</sup>
Total body weight, kg	72 (57-88)	149 (73-305)	< 0.001 <sup>i</sup>
Lean body weight, <sup>b</sup> kg	49 (40-66)	66 (38-114)	0.001 <sup>i</sup>
Ideal body weight, <sup>c</sup> kg	64 (57-78)	64 (34-87)	0.738 <sup>i</sup>
Body mass index (BMI), <sup>d</sup> kg/m <sup>2</sup>	25.0 (19.2-28.6)	53.7 (30.6-88.8)	< 0.001 <sup>i</sup>
Intensive care unit admission, no. of patients (%)	7 (63.6%)	18 (62.1%)	1.000 <sup>j</sup>
Meropenem dosage regimen, <sup>e</sup> number of patients (%)			
500 mg q12h	3 (27.3 %)	1 (3.4%)	N/A

Table 14. Continued. Patient demographics [median (range) unless otherwise stated]

Demographic characteristics	Non- obese (n=11)	Obese (n=29)	P-value
Meropenem dosage regimen, <sup>e</sup> number of patients (%)			
500 mg q8h	4 (36.4 %)	5 (17.2 %)	N/A
500 mg q6h	4 (36.4 %)	9 (31.0%)	N/A
1000 mg q8h	0	7 (24.1%)	N/A
1000 mg q6h	0	7 (24.1%)	N/A

<sup>a</sup> Creatinine clearance was estimated by the modified Cockcroft-Gault method (equation 2) using the actual serum creatinine concentration for each patient and IBW (equations 3 and 4) for patients with a BMI < 40 kg/m<sup>2</sup> and LBW (equations 19 and 20) for patients with a BMI > 40 kg/m<sup>2</sup> for the weight term in equation 2 (Demirovic et al. 2009):

$$\text{CRCL (mL/min)} = \frac{(140 - \text{Age}) \times \text{Weight}}{\text{SCr} \times 72} \times (0.85 \text{ if female}) \quad (2)$$

$$\text{Ideal body weight (IBW)} = 50 \text{ kg} + [2.3 \text{ kg} * (\text{height in inches} - 60)] \text{ in males} \quad (3)$$

$$\text{Ideal body weight (IBW)} = 45.5 \text{ kg} + [2.3 \text{ kg} * (\text{height in inches} - 60)] \text{ in females} \quad (4)$$

$$\text{LBW (in male, kg)} = \frac{9270 \times \text{TBW}}{6680 + 216 \times \text{BMI}} \quad (19)$$

$$\text{LBW (in female, kg)} = \frac{9270 \times \text{TBW}}{8780 + 244 \times \text{BMI}} \quad (20)$$

<sup>b</sup> Calculated using equations 19 in males and 20 in females, respectively:

$$\text{Lean body weight (LBW in male, kg)} = \frac{9270 \times \text{TBW}}{6680 + 216 \times \text{BMI}} \quad (19)$$

$$\text{Lean body weight (LBW in female, kg)} = \frac{9270 \times \text{TBW}}{8780 + 244 \times \text{BMI}} \quad (20)$$

<sup>c</sup> Calculated using equations 3 in males and 4 in females, respectively:

$$\text{Ideal body weight (IBW)} = 50 \text{ kg} + [2.3 \text{ kg} * (\text{height in inches} - 60)] \text{ in males} \quad (3)$$

$$\text{Ideal body weight (IBW)} = 45.5 \text{ kg} + [2.3 \text{ kg} * (\text{height in inches} - 60)] \text{ in females} \quad (4)$$

<sup>d</sup> Calculated by (total body weight in kg)/(height in m)<sup>2</sup>

<sup>e</sup> Infused over 30 minutes

<sup>f</sup> P-value from chi-square test between non-obese and obese patients

<sup>g</sup> P-value from unpaired t-test with unequal variance between non-obese and obese

<sup>h</sup> P-value from unpaired t-test with equal variance between non-obese and obese

<sup>i</sup> P-value from Mann-Whitney U test between non-obese and obese patients

<sup>j</sup> P-value from Fisher's exact test between non-obese and obese patients

N/A: Not estimated

Population Pharmacokinetic Analysis

For the population pharmacokinetic analysis, 310 meropenem concentrations from 40 patients were included. Fewer than the planned number of samples (386 samples from 40 patients) were included in the analysis because 76 samples were not collected at the planned time points. Table 15 shows the OFV and AIC of selected structural models among all tested structural models. Successfully minimized models with successfully estimated covariance structures after each NONMEM run were further evaluated for candidate models. When residual error was described in the proportional form, the model minimization was prematurely terminated, so models with proportional residual errors were not further considered for candidate models.

Table 15. Comparison of selected meropenem structural pharmacokinetic models among all tested meropenem structural pharmacokinetic models

Models	OFV <sup>a</sup>	AIC <sup>b</sup>
1-compartment model, no IIV, combinational residual error	1522.451	1530.451
1-compartment model, no IIV, additive residual error	1594.133	1600.133
1-compartment model, IIV on CL and V, combinational residual error	1220.515	1232.515
1-compartment model, IIV on CL and V, additive residual error	1292.59	1302.59
2-compartment model, no IIV, combinational residual error	1522.451	1534.451
2-compartment model, no IIV, additive residual error	1576.047	1586.047
2-compartment model; IIV on CL, V1, Q, and V2; combinational residual error	1120.859	1140.859



Table 15. Continued. Comparison of selected meropenem structural pharmacokinetic models among all tested meropenem structural pharmacokinetic models

Models	OFV <sup>a</sup>	AIC <sup>b</sup>
2-compartment model; IIV on CL, V1, Q, and V2; additive residual error	1124.949	1142.949
2-compartment model; IIV on CL, V1, Q, and V2; additive residual error; correlation estimated between CL, Q, and V2	1105.319	1129.319

Abbreviations: OFV, objective function value; AIC, Akaike information criterion; IIV, inter-individual variability; CL, clearance; V, volume of distribution; V1, volume of distribution in the central compartment; Q, inter-compartmental distribution clearance; V2, volume of distribution in the peripheral compartment

<sup>a</sup> OFV is -2 times the log of the model likelihood, and the likelihood is typically considered as a sum of squares (American College of Clinical Pharmacology, 2011). The change in the minimum objective function value ( $\Delta$ OFV) follows a chi-square distribution and a decrease in OFV by  $> 3.84$  is considered statistically significant with 1 degree of freedom (*df*) at the  $\alpha$  level of 0.05 using a chi-square test (American College of Clinical Pharmacology, 2011)

<sup>b</sup> Akaike information criterion (AIC) is defined in equation 35.

$$\text{AIC} = \text{OFV} + [2 \times (\text{number of parameters in the model})] \quad (35)$$

Based on Table 15, observed serum concentration-time profiles of meropenem were best described by a two-compartment model with zero-order input and first-order, linear elimination from the central compartment. Model-derived pharmacokinetic parameters were CL, volume of distribution in the central compartment (V1), volume of distribution in the peripheral compartment (V2), and inter-compartmental distribution clearance (Q). Equations 38 and 42 to 48 were used to calculate  $\text{AUC}_{0-\tau}$ , the micro rate constants ( $k_{10}$ ,  $k_{12}$ , and  $k_{21}$ ), macro rate constants ( $\lambda_1$  and  $\lambda_2$ ), distribution half-life (distribution  $t_{1/2}$  or  $t_{1/2,\lambda_1}$ ), and elimination half-life (elimination  $t_{1/2}$  or  $t_{1/2,\lambda_2}$ ):

$$\text{AUC}_{0-\tau}(\text{mg} \cdot \text{h} \cdot \text{L}^{-1}) = \text{Dose}/\text{CL} \quad (38)$$

$$k_{10} (\text{h}^{-1}) = \text{CL}/\text{V1} \quad (42)$$

$$k_{12} (\text{h}^{-1}) = \text{Q}/\text{V1} \quad (43)$$

$$k_{21} \text{ (h}^{-1}\text{)} = Q/V2 \quad (44)$$

$$\lambda_1 \text{ (h}^{-1}\text{)} = 0.5 * [(k_{12} + k_{21} + k_{10}) + \sqrt{(k_{12} + k_{21} + k_{10})^2 - 4k_{21}k_{10}}] \quad (45)$$

$$\lambda_2 \text{ (h}^{-1}\text{)} = 0.5 * [(k_{12} + k_{21} + k_{10}) - \sqrt{(k_{12} + k_{21} + k_{10})^2 - 4k_{21}k_{10}}] \quad (46)$$

$$t_{1/2,\lambda_1} \text{ (h)} = 0.693/\lambda_1 \quad (47)$$

$$t_{1/2,\lambda_2} \text{ (h)} = 0.693/\lambda_2 \quad (48)$$

Inter-individual variability was estimated for all pharmacokinetic parameters. The model supported the correlation between CL, V2, and Q when tested by the OMEGA BLOCK functionality in NONMEM ( $\Delta\text{OFV} = -19.630$ ). Residual error was best modeled by the additive form.

Table 16 shows different models developed in the stepwise forward addition process. Covariates that significantly decreased the model OFV and inter-individual variability in the stepwise forward process were CRCL added on to CL ( $\Delta\text{OFV}$ : -21.746), followed by LBW added on to V2 ( $\Delta\text{OFV}$ : -4.445) as shown in Table 15.

Table 16. Comparison of meropenem covariate models developed during the stepwise forward addition process

Added covariate	OFV <sup>a</sup>	$\Delta\text{OFV}^b$	AIC <sup>c</sup>
Base model	1105.319	N/A	1129.319
Univariate models (one covariate added)			
CRCL <sup>d</sup> on CL	1083.573	-21.746 <sup>h</sup>	1109.573
BMI <sup>e</sup> on CL	1105.314	-0.005 <sup>h</sup>	1131.314
TBW on CL	1105.299	-0.020 <sup>h</sup>	1131.299
LBW <sup>f</sup> on CL	1105.205	-0.114	1131.205

Table 16. Continued. Comparison of meropenem covariate models developed during the stepwise forward addition process

Added covariate	OFV <sup>a</sup>	$\Delta$ OFV <sup>b</sup>	AIC <sup>c</sup>
Base model	1105.319	N/A	1129.319
Univariate models (one covariate added)			
IBW <sup>g</sup> on CL	1105.270	-0.049	1131.270
Age on CL	1091.622	-13.697 <sup>h</sup>	1117.622
Sex on CL	1105.060	-0.259 <sup>h</sup>	1131.060
ICU on CL	1105.270	-0.049 <sup>h</sup>	1131.270
CRCL <sup>d</sup> on V1	1102.142	-3.177 <sup>h</sup>	1128.142
BMI <sup>e</sup> on V1	1105.077	-0.242 <sup>h</sup>	1131.077
TBW on V1	1105.284	-0.035 <sup>h</sup>	1131.284
LBW <sup>f</sup> on V1	1104.542	-0.777	1130.542
IBW <sup>g</sup> on V1	1103.901	-1.418	1129.901
Age on V1	1103.859	-1.460 <sup>h</sup>	1129.859
Sex on V1	1103.153	-2.166 <sup>h</sup>	1129.153
ICU on V1	1104.828	-0.491 <sup>h</sup>	1130.828
CRCL <sup>d</sup> on Q	1104.965	-0.354 <sup>h</sup>	1130.965
BMI <sup>e</sup> on Q	1104.921	-0.398 <sup>h</sup>	1130.921
TBW on Q	1104.705	-0.614 <sup>h</sup>	1130.705
LBW <sup>f</sup> on Q	1104.525	-0.794	1130.525
IBW <sup>g</sup> on Q	1104.636	-0.683	1130.636
Age on Q	1104.658	-0.661 <sup>h</sup>	1130.658
Sex on Q	1105.081	-0.238 <sup>h</sup>	1131.081

Table 16. Continued. Comparison of meropenem covariate models developed during the stepwise forward addition process

Added covariate	OFV <sup>a</sup>	$\Delta$ OFV <sup>b</sup>	AIC <sup>c</sup>
Base model	1105.319	N/A	1129.319
Univariate models (one covariate added)			
ICU on Q	1103.610	-1.709 <sup>h</sup>	1129.610
CRCL <sup>d</sup> on V2	1105.311	-0.008 <sup>h</sup>	1131.311
BMI <sup>e</sup> on V2	1104.192	-1.127 <sup>h</sup>	1130.192
TBW on V2	1103.755	-1.564 <sup>h</sup>	1129.755
LBW <sup>f</sup> on V2	1103.986	-1.333	1129.986
IBW <sup>g</sup> on V2	1105.112	-0.208	1131.112
Age on V2	1104.919	-0.400 <sup>h</sup>	1130.919
Sex on V2	1105.219	-0.100 <sup>h</sup>	1131.219
ICU on V2	1103.187	-2.132 <sup>h</sup>	1129.187
Best univariate model: CRCL on CL			
Bivariate models (two covariates added): Second covariate added on the best univariate model			
BMI <sup>e</sup> on CL	1075.228	-8.345 <sup>i</sup>	1103.228
TBW on CL	1072.769	-10.804 <sup>i</sup>	1100.769
ICU on CL	1079.402	-4.171 <sup>i</sup>	1107.402
LBW <sup>f</sup> on CL	1079.324	-4.249 <sup>i</sup>	1107.324
TBW on V2	1079.317	-4.256 <sup>i</sup>	1107.317
LBW <sup>f</sup> on V2	1079.128	-4.445 <sup>i</sup>	1107.128
ICU on Q	1079.569	-4.004 <sup>i</sup>	1107.569
Best bivariate model: CRCL <sup>d</sup> on CL + LBW on V2			

Table 16. Continued. Comparison of meropenem covariate models developed during the stepwise forward addition process

Abbreviations: OFV, objective function value;  $\Delta$ OFV, change in the minimum objective function value; AIC, Akaike information criterion; CRCL, creatinine clearance (mL/min); CL, clearance (L/h); BMI, body mass index (kg/m<sup>2</sup>); TBW, total body weight (kg); LBW, lean body weight (kg); IBW, ideal body weight (kg); ICU, admission to an intensive care unit; V1, volume of distribution in the central compartment; Q, inter-compartmental distribution clearance; V2, volume of distribution in the peripheral compartment

<sup>a</sup> OFV is -2 times the log of the model likelihood, and the likelihood is typically considered as a sum of squares (American College of Clinical Pharmacology, 2011).

<sup>b</sup> The change in the minimum objective function value ( $\Delta$ OFV) follows a chi-square distribution and a decrease in OFV by > 3.84 is considered statistically significant with 1 degree of freedom (*df*) at the  $\alpha$  level of 0.05 using a chi-square test (American College of Clinical Pharmacology, 2011)

<sup>c</sup> Akaike information criterion (AIC) is defined in equation 35.

$$\text{AIC} = \text{OFV} + [2 \times (\text{number of parameters in the model})] \quad (35)$$

<sup>d</sup> Creatinine clearance was estimated by the modified Cockcroft-Gault method (equation 2) using the actual serum creatinine concentration for each patient and IBW (equations 3 and 4) for patients with a BMI < 40 kg/m<sup>2</sup> and LBW (equations 19 and 20) for patients with a BMI > 40 kg/m<sup>2</sup> for the weight term in equation 2 (Demirovic et al. 2009):

$$\text{CRCL (mL/min)} = \frac{(140 - \text{Age}) \times \text{Weight}}{\text{SCr} \times 72} \times (0.85 \text{ if female}) \quad (2)$$

$$\text{Ideal body weight (IBW)} = 50 \text{ kg} + [2.3 \text{ kg} * (\text{height in inches} - 60)] \text{ in males} \quad (3)$$

$$\text{Ideal body weight (IBW)} = 45.5 \text{ kg} + [2.3 \text{ kg} * (\text{height in inches} - 60)] \text{ in females} \quad (4)$$

$$\text{LBW (in male, kg)} = \frac{9270 \times \text{TBW}}{6680 + 216 \times \text{BMI}} \quad (19)$$

$$\text{LBW (in female, kg)} = \frac{9270 \times \text{TBW}}{8780 + 244 \times \text{BMI}} \quad (20)$$

<sup>e</sup> Calculated by (total body weight in kg)/(height in m)<sup>2</sup>

<sup>f</sup> Calculated using equations 19 in males and 20 in females, respectively:

$$\text{Lean body weight (LBW in male, kg)} = \frac{9270 \times \text{TBW}}{6680 + 216 \times \text{BMI}} \quad (19)$$

$$\text{Lean body weight (LBW in female, kg)} = \frac{9270 \times \text{TBW}}{8780 + 244 \times \text{BMI}} \quad (20)$$

<sup>g</sup> Calculated using equations 3 in males and 4 in females, respectively:

$$\text{Ideal body weight (IBW)} = 50 \text{ kg} + [2.3 \text{ kg} * (\text{height in inches} - 60)] \text{ in males} \quad (3)$$

$$\text{Ideal body weight (IBW)} = 45.5 \text{ kg} + [2.3 \text{ kg} * (\text{height in inches} - 60)] \text{ in females} \quad (4)$$

<sup>h</sup> Difference in OFV between the corresponding model OFV and the base model OFV

<sup>i</sup> Difference in OFV between the corresponding model OFV and the best univariate model OFV

Although the model with TBW added on to CL resulted in the largest reduction in the model OFV among bivariate models, the estimated coefficient for the addition of TBW

on to CL was negative, which is not physiologically plausible, so this model was not selected as the best bivariate model. Similarly, the model with BMI added on to CL resulted in the second largest reduction in the model OFV among bivariate models, but the estimated coefficient for the addition of TBW on to CL was negative, which is not physiologically plausible, so this model was not selected as the best bivariate model either. Therefore, the selected best bivariate model to describe the observed serum meropenem concentration-time data were the model with CRCL added on to CL ( $\Delta\text{OFV}$ : -21.746) followed by LBW added on to V2 ( $\Delta\text{OFV}$ : -4.445). After the addition of LBW on to V2, no other covariates reduced the model OFV and inter-individual variability in the stepwise forward addition process. In the backward elimination step, LBW ( $\Delta\text{OFV}$ : 4.445) was removed from the meropenem model. Therefore, the final meropenem population pharmacokinetic model ( $\text{OFV}=1083.573$ ) was:

$$\text{CL (L/h)} = 8.62 * (\text{CRCL}/85)^{0.533}$$

$$\text{V1 (L)} = 13.6$$

$$\text{Q (L/h)} = 11.8$$

$$\text{V2 (L)} = 14.5$$

Table 17 summarizes the model-estimated population pharmacokinetic parameters and their associated inter-individual variability for meropenem. Figure 14 shows the goodness-of-fit plots for the final meropenem population pharmacokinetic model.

Table 17. Final population pharmacokinetic model parameters of meropenem

Parameter	Final meropenem model	
	Estimate (%SE)	Shrinkage, %
	TVCL = $\theta_1 * (\text{CRCL}/85)^{0.2}$	
$\theta_1$	8.62 (6.40)	N/A
$\theta_2$	0.533 (18.2)	N/A
V1 (L)	13.6 (10.2)	N/A
Q (L/h)	11.8 (18.6)	N/A
V2 (L)	14.5 (11.5)	N/A
Inter-individual variability ( $\omega$ )		
$\omega_{\text{CL}}$	35.1% (20.7)	2.652
$\omega_{\text{V1}}$	55.0% (35.3)	17.601
$\omega_{\text{Q}}$	103.4% (35.2)	14.454
$\omega_{\text{V2}}$	41.5% (52.4)	22.845
$\rho_{\text{CL-V2}}$	0.643	N/A
$\rho_{\text{CL-Q}}$	0.637	N/A
$\rho_{\text{Q-V2}}$	0.732	N/A
Residual error ( $\sigma$ )		
$\sigma_{\text{additive}}$	2.21 mg/L (17.0)	15.91

Abbreviations: SE: standard error; TVCL: typical value of clearance; CRCL: creatinine clearance (mL/min); V1: volume of distribution in the central compartment; Q: inter-compartmental distribution clearance; V2: volume of distribution in the peripheral compartment;  $\rho$ : correlation coefficient between inter-individual variability of specified parameters; N/A: not applicable

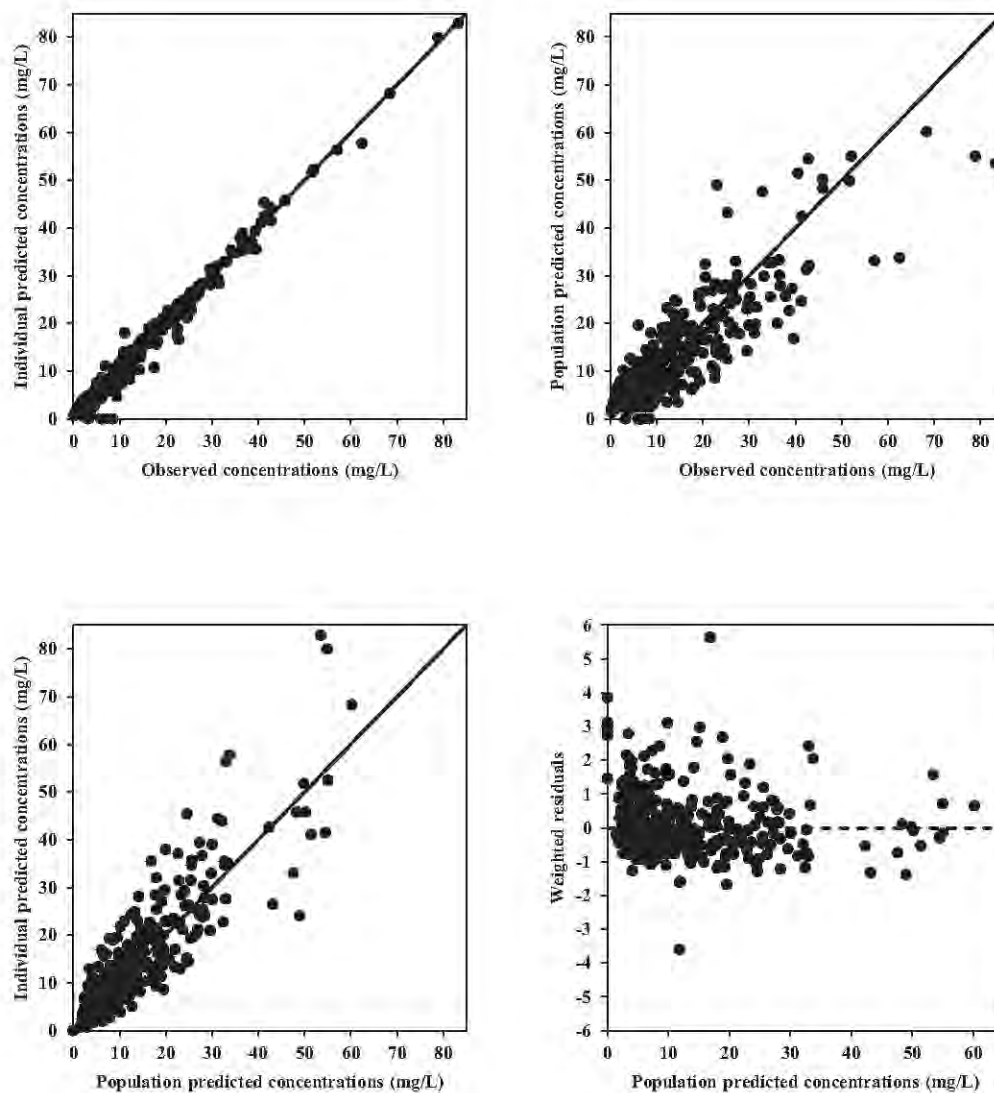

Figure 14. Goodness-of-fit plots of the final meropenem population pharmacokinetic model. The solid line represents the line of identity, and the dashed line corresponds to a residual of zero.



The distribution around the line of identity represents a rough visual estimation of residual error for the individual predicted vs. observed concentration plot, the sum of residual error and inter-individual variability for the population predicted vs. observed concentration plot, and inter-individual variability for the individual predicted vs. population predicted concentration plot. Based on the predicted vs. observed concentration and weighted residual vs population predicted concentration plots, no apparent systematic bias was observed for the final meropenem pharmacokinetic model.

Visual predictive checks with the 90% prediction intervals using the final meropenem population pharmacokinetic model, graphed with the observed concentrations, for each dosage regimen are shown in Figure 15. The predicted concentrations were obtained using Monte Carlo simulation in NONMEM, and 5<sup>th</sup>, 50<sup>th</sup> (median), and 95<sup>th</sup> percentile predicted concentrations were estimated using the percentile functions. As shown in Figure 15, most observations were within the 90% prediction interval; however, it should be noted the VPC for 500 mg q12h dosing regimen suggested some bias of the model due to under-prediction of observed concentrations in this dosing group. Based on the individual model-fit plots shown in Figure 16, the final meropenem model was able to adequately predict observed meropenem concentrations.

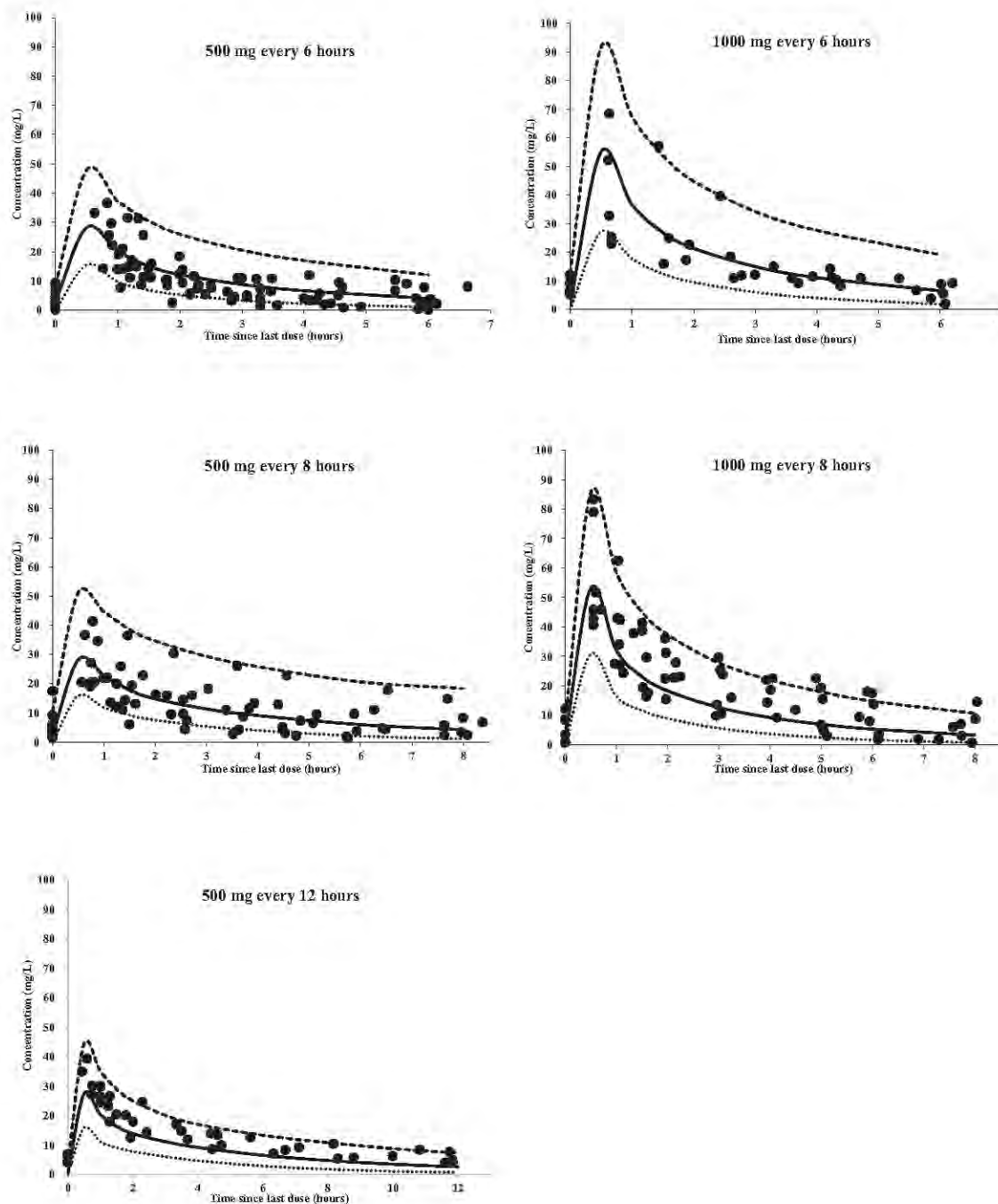

Figure 15. Visual predictive checks of the final meropenem population pharmacokinetic model for each dosage regimen. Filled circles ( $\bullet$ ), observed concentrations; square dashed lines (-----), 95<sup>th</sup> percentile predicted concentrations; solid lines, median predicted concentrations; dotted dashed lines (.....), 5<sup>th</sup> percentile predicted concentrations.

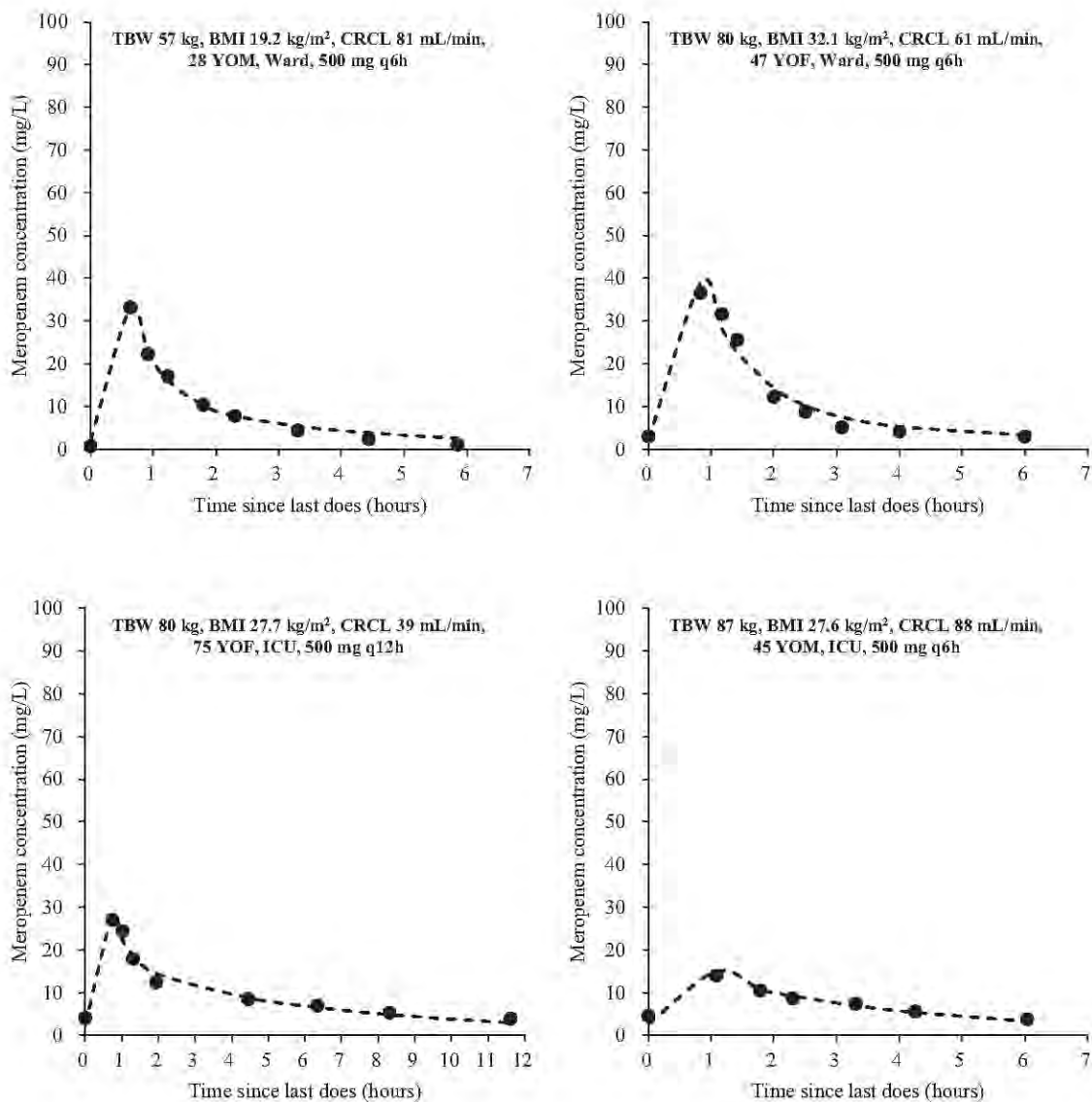

Figure 16. Observed and final model-predicted serum meropenem concentration-time profiles for all 40 patients. Filled circles represent the observed meropenem concentrations and dashed lines represent the model-predicted concentrations using the final population pharmacokinetic model.

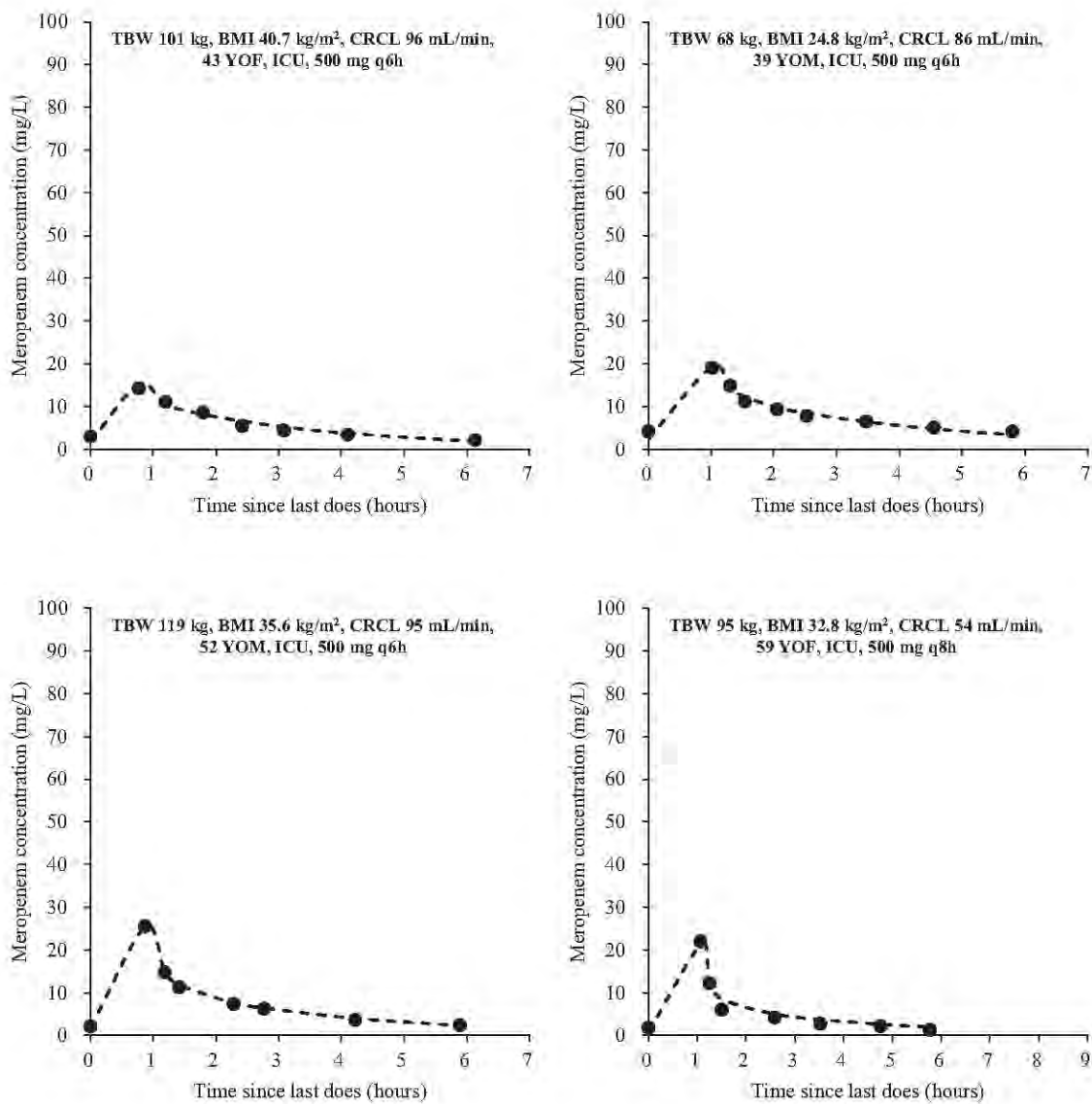

Figure 16. Continued. Observed and final model-predicted serum meropenem concentration-time profiles for all 40 patients. Filled circles represent the observed meropenem concentrations and dashed lines represent the model-predicted concentrations using the final population pharmacokinetic model.

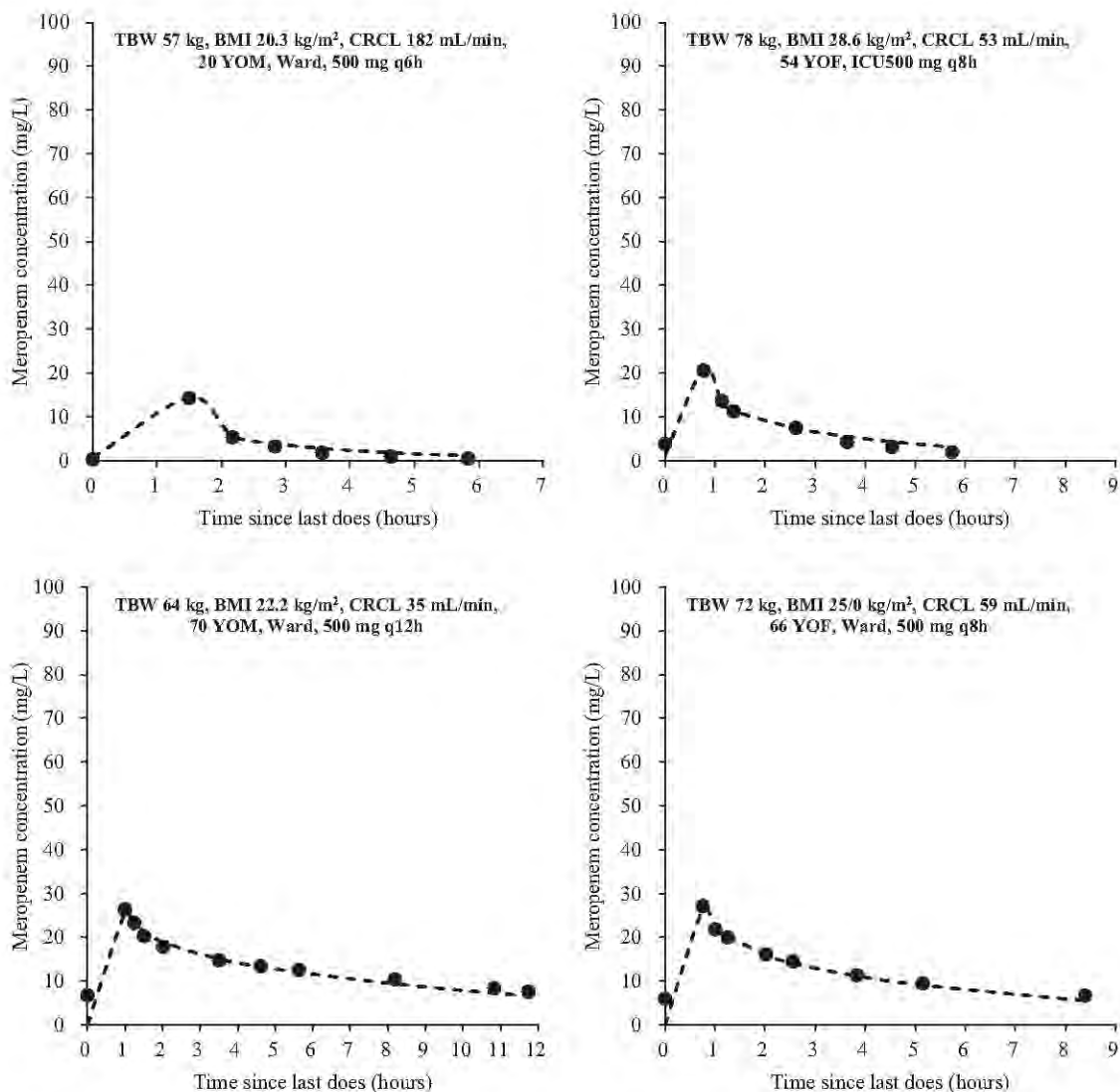

Figure 16. Continued. Observed and final model-predicted serum meropenem concentration-time profiles for all 40 patients. Filled circles represent the observed meropenem concentrations and dashed lines represent the model-predicted concentrations using the final population pharmacokinetic model.

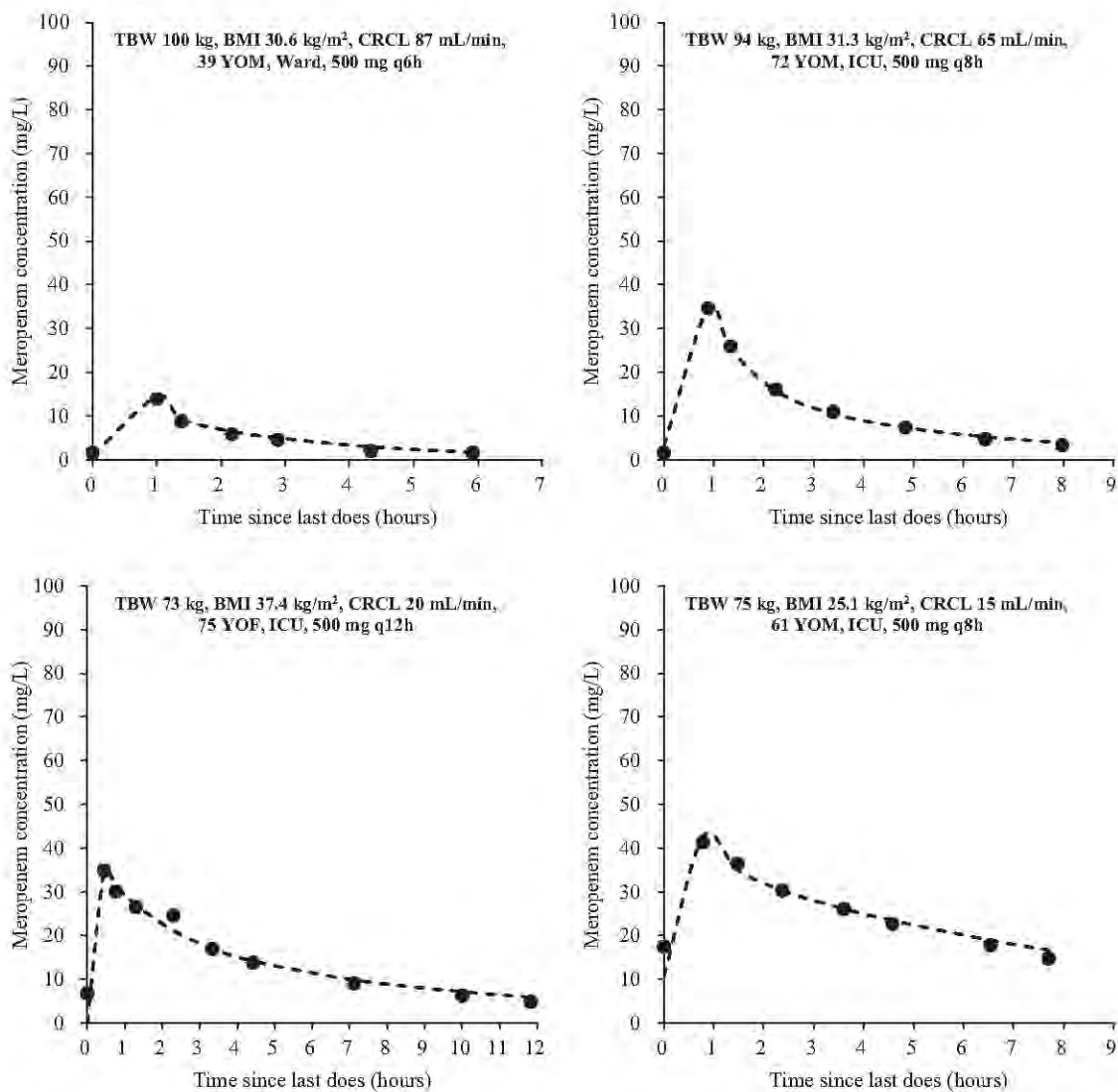

Figure 16. Continued. Observed and final model-predicted serum meropenem concentration-time profiles for all 40 patients. Filled circles represent the observed meropenem concentrations and dashed lines represent the model-predicted concentrations using the final population pharmacokinetic model.

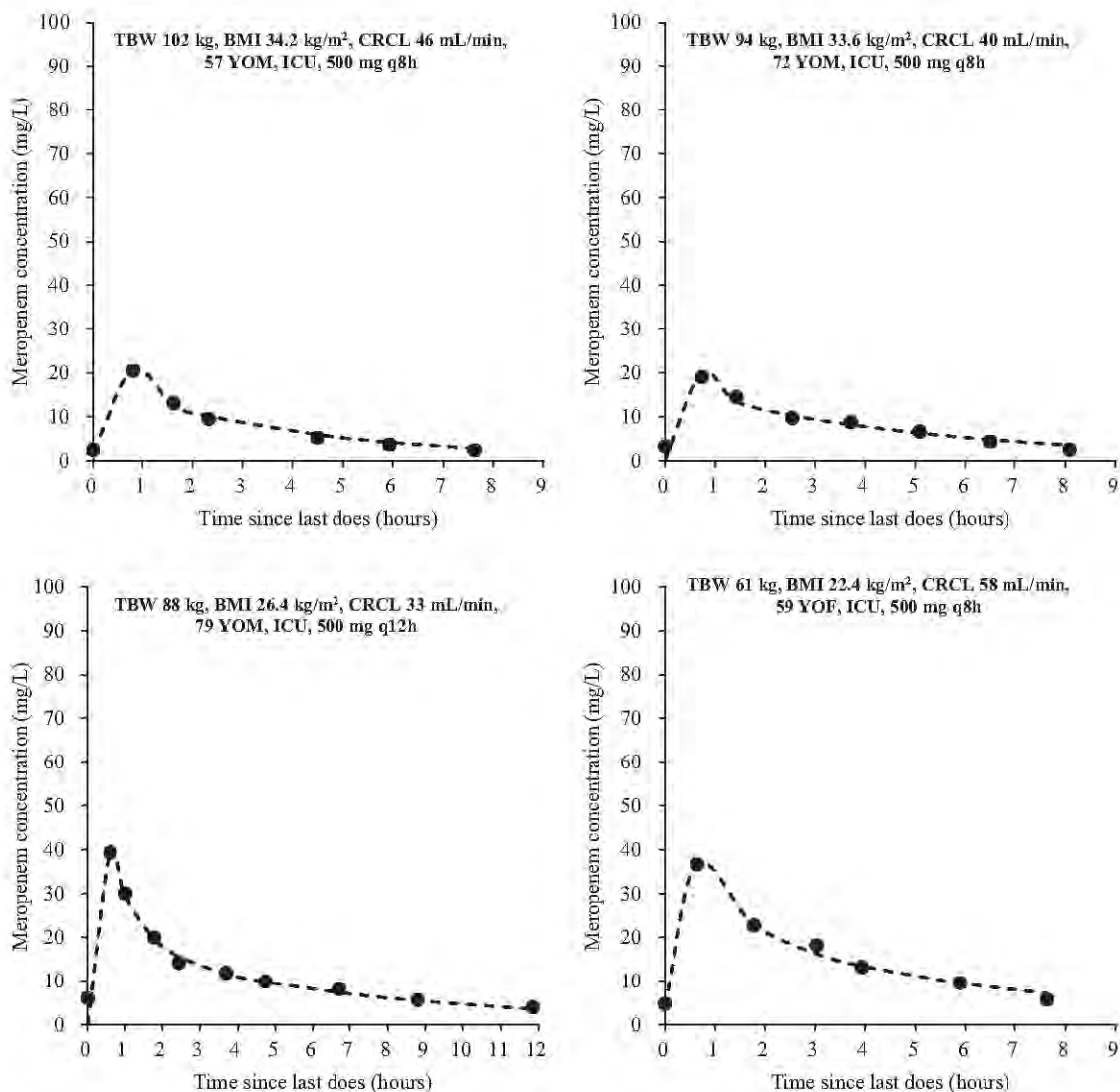

Figure 16. Continued. Observed and final model-predicted serum meropenem concentration-time profiles for all 40 patients. Filled circles represent the observed meropenem concentrations and dashed lines represent the model-predicted concentrations using the final population pharmacokinetic model.

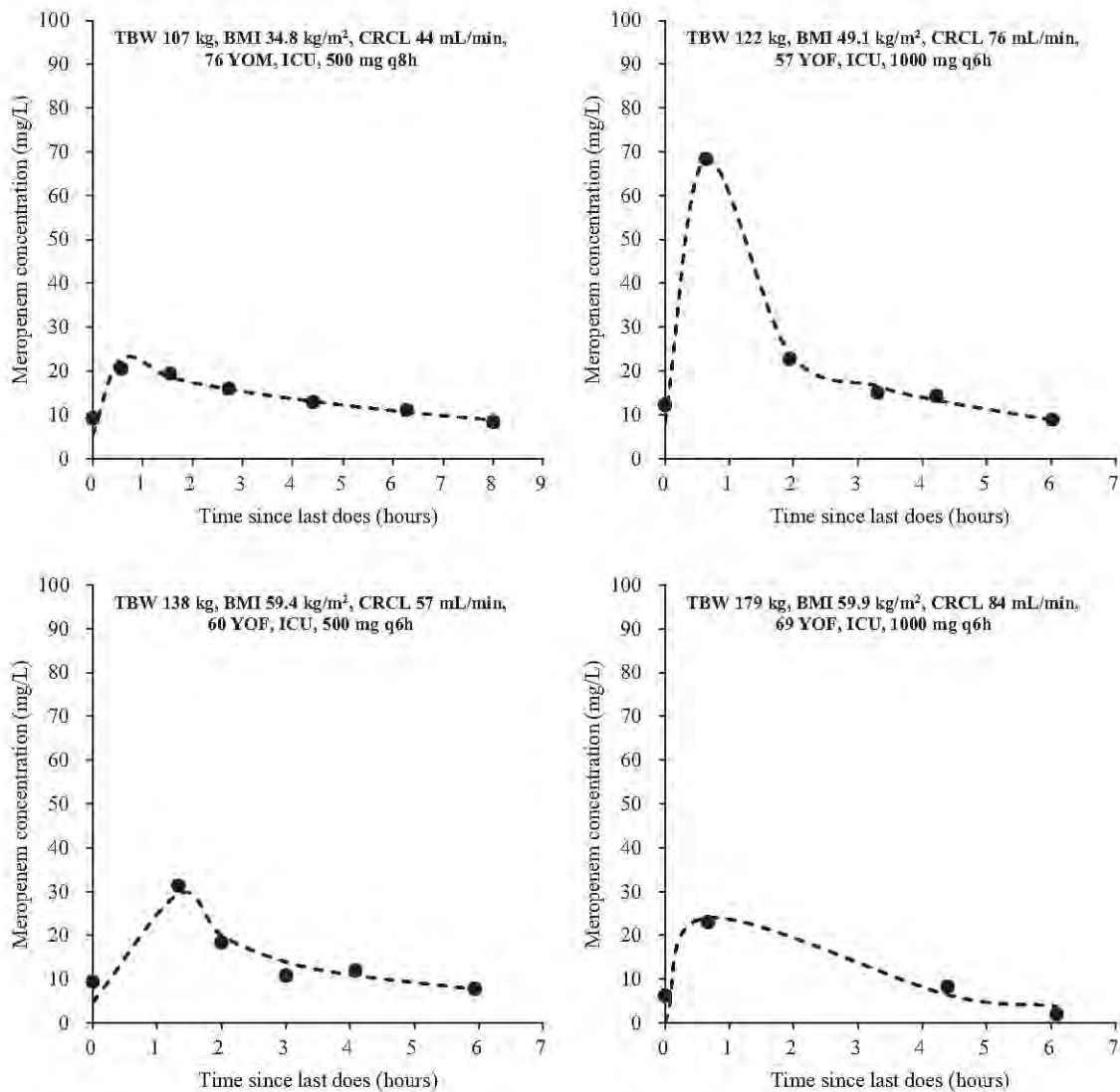

Figure 16. Continued. Observed and final model-predicted serum meropenem concentration-time profiles for all 40 patients. Filled circles represent the observed meropenem concentrations and dashed lines represent the model-predicted concentrations using the final population pharmacokinetic model.



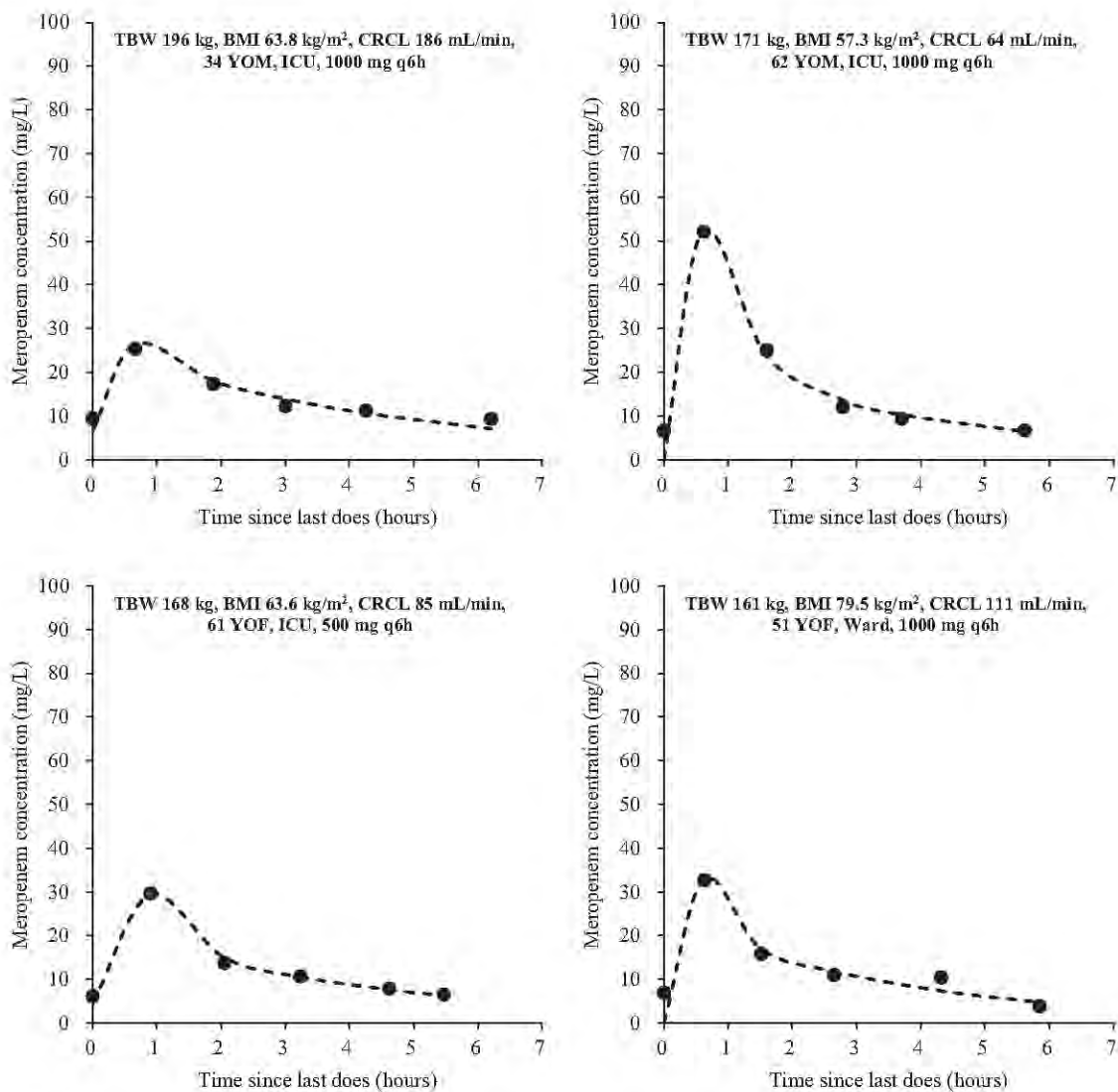

Figure 16. Continued. Observed and final model-predicted serum meropenem concentration-time profiles for all 40 patients. Filled circles represent the observed meropenem concentrations and dashed lines represent the model-predicted concentrations using the final population pharmacokinetic model.

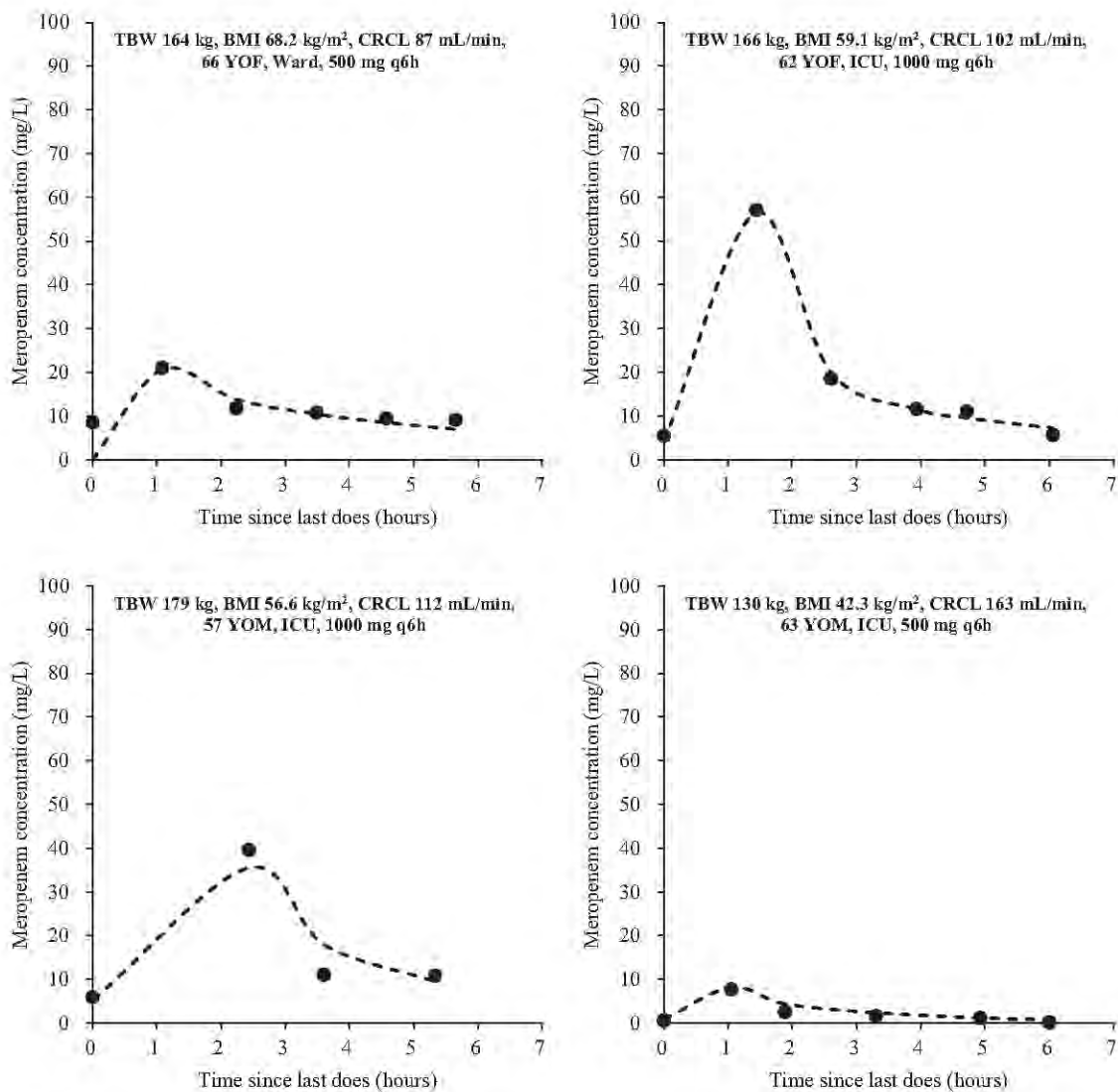

Figure 16. Continued. Observed and final model-predicted serum meropenem concentration-time profiles for all 40 patients. Filled circles represent the observed meropenem concentrations and dashed lines represent the model-predicted concentrations using the final population pharmacokinetic model.

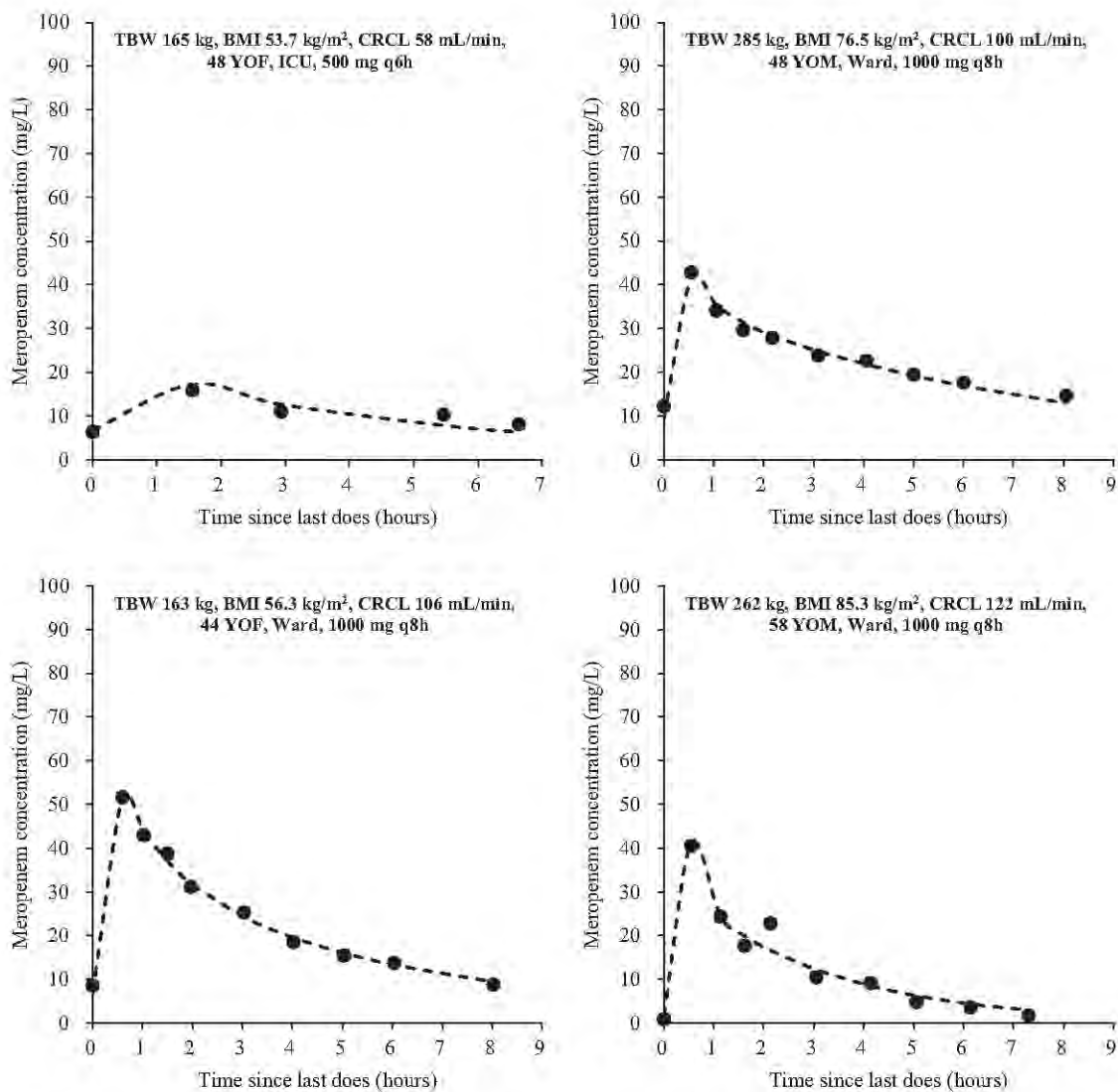

Figure 16. Continued. Observed and final model-predicted serum meropenem concentration-time profiles for all 40 patients. Filled circles represent the observed meropenem concentrations and dashed lines represent the model-predicted concentrations using the final population pharmacokinetic model.

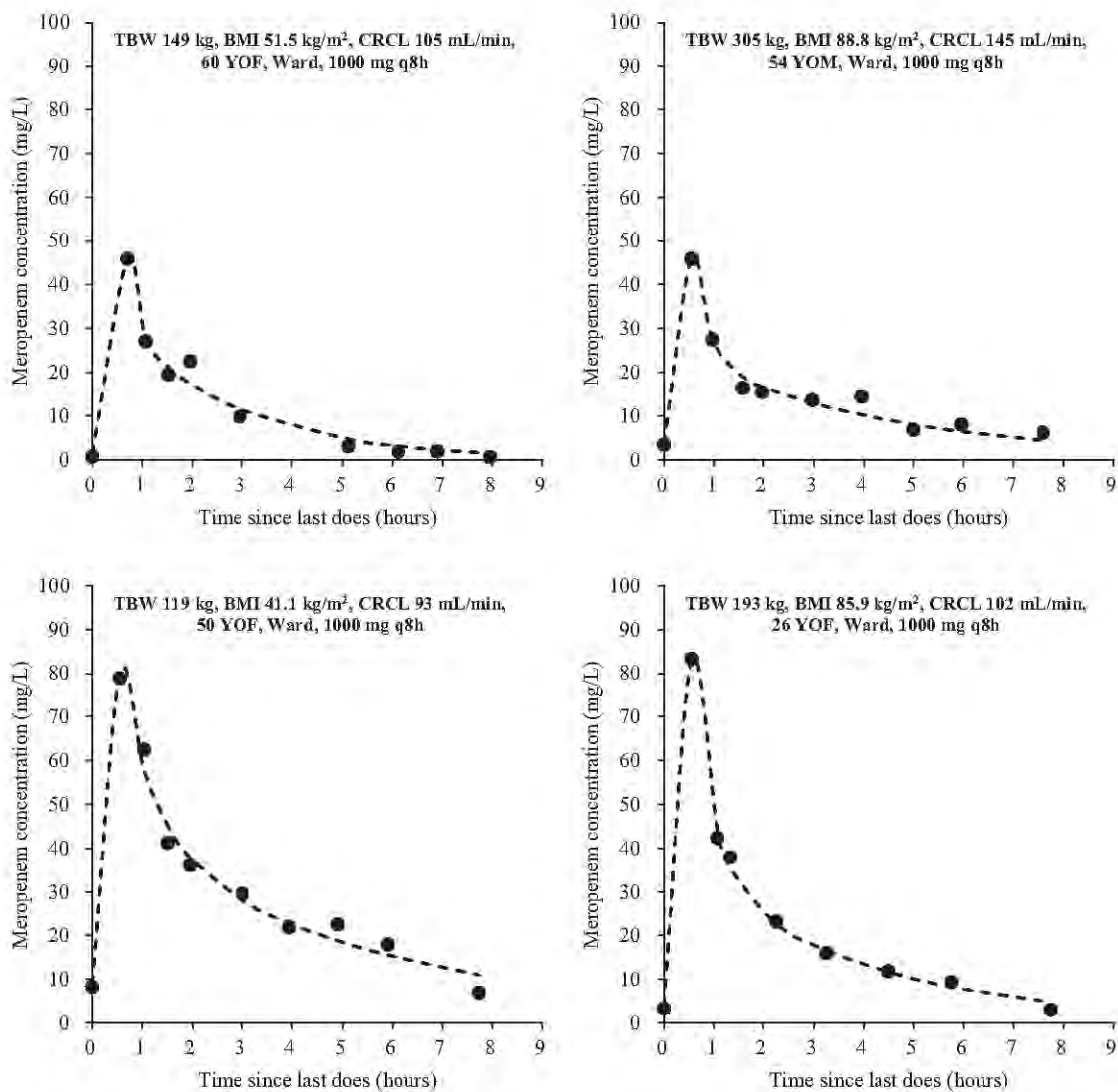

Figure 16. Continued. Observed and final model-predicted serum meropenem concentration-time profiles for all 40 patients. Filled circles represent the observed meropenem concentrations and dashed lines represent the model-predicted concentrations using the final population pharmacokinetic model.

Table 18 shows meropenem pharmacokinetic parameters estimated by the final pharmacokinetic model for non-obese and obese patients. Absolute (i.e., not-normalized for TBW) CL, V1, V2, and volume of distribution at steady-state (V<sub>ss</sub>) were not significantly different between non-obese and obese patients ( $p > 0.05$ ). However, TBW-normalized CL, V1, V2, and V<sub>ss</sub> were significantly different between non-obese and obese patients ( $p < 0.05$ ).

Table 18. Steady-state meropenem pharmacokinetic parameters [median (range)] estimated by the final population pharmacokinetic model in non-obese and obese patients

Parameter	Non-obese (n=11)	Obese (n=29)	P-value
CL (L/h)	5.5 (3.3-17.7)	8.2 (3.0-18.1)	0.383 <sup>a</sup>
CL ([L/h]/kg)	0.07 (0.04-0.31)	0.06 (0.02-0.15)	< 0.001 <sup>b</sup>
V1 (L)	14.3 (10.1-20.7)	12.3 (5.6-47.4)	0.765 <sup>a</sup>
V1 (L/kg)	0.19 (0.12-0.32)	0.10 (0.03-0.35)	< 0.001 <sup>b</sup>
Q (L/h)	10.8 (5.0-25.9)	14.6 (0.6-66.4)	0.534 <sup>a</sup>
V2 (L)	12.6 (9.7-20.1)	14.5 (5.6-27.1)	0.734 <sup>a</sup>
V2 (L/kg)	0.20 (0.13-0.29)	0.11 (0.03-0.22)	< 0.001 <sup>a</sup>
V <sub>ss</sub> (L)	30.1 (21.9-35.2)	28.6 (11.2-65.4)	0.691 <sup>a</sup>
V <sub>ss</sub> (L/kg)	0.40 (0.25-0.52)	0.22 (0.06-0.48)	< 0.001 <sup>a</sup>
t <sub>1/2,λ<sub>2</sub></sub> <sup>c</sup> (h)	4.3 (1.7-7.1)	3.1 (1.6-7.3)	0.335 <sup>a</sup>
t <sub>1/2,λ<sub>1</sub></sub> <sup>d</sup> (h)	0.4 (0.2-0.7)	0.3 (0.1-1.2)	0.994 <sup>a</sup>

Abbreviations: CL, clearance; V1, volume of distribution in the central compartment; Q, inter-compartmental distribution clearance; V2, volume of distribution in the peripheral compartment; V<sub>ss</sub>, volume of distribution at steady-state; t<sub>1/2,λ<sub>2</sub></sub>, elimination half-life; t<sub>1/2,λ<sub>1</sub></sub>, distribution half-life

<sup>a</sup> P-value from unpaired t-test with equal variance between non-morbidly obese and morbidly obese patients

<sup>b</sup> P-value from Mann-Whitney U test between non-morbidly obese and morbidly obese patients

<sup>c</sup> Calculated by equations 42 to 44, 46, and 48:

$$t_{1/2,\lambda_2} \text{ (h)} = 0.693/\lambda_2 \quad (48)$$

$$\lambda_2 \text{ (h}^{-1}\text{)} = 0.5 * [(k_{12} + k_{21} + k_{10}) - \sqrt{(k_{12} + k_{21} + k_{10})^2 - 4k_{21}k_{10}}] \quad (46)$$

$$k_{10} \text{ (h}^{-1}\text{)} = CL/V1 \quad (42)$$

$$k_{12} \text{ (h}^{-1}\text{)} = Q/V1 \quad (43)$$

$$k_{21} \text{ (h}^{-1}\text{)} = Q/V2 \quad (44)$$

<sup>d</sup> Calculated by equations 42 to 44, 45, and 47:

$$t_{1/2,\lambda_1} \text{ (h)} = 0.693/\lambda_1 \quad (47)$$

$$\lambda_1 \text{ (h}^{-1}\text{)} = 0.5 * [(k_{12} + k_{21} + k_{10}) + \sqrt{(k_{12} + k_{21} + k_{10})^2 - 4k_{21}k_{10}}] \quad (45)$$

$$k_{10} \text{ (h}^{-1}\text{)} = CL/V1 \quad (42)$$

$$k_{12} \text{ (h}^{-1}\text{)} = Q/V1 \quad (43)$$

$$k_{21} \text{ (h}^{-1}\text{)} = Q/V2 \quad (44)$$

### Monte Carlo Simulation; Pharmacodynamic Analysis

Figures 17 and 18 show PTAs for meropenem at the pharmacodynamic target of  $\geq 40\% fT > MIC$  and  $\geq 54\% fT > MIC$ , respectively, for the meropenem intermittent-infusion [Figures 17(a) and 18(a)] and prolonged-infusion [Figures 17(b) and 18(b)] dosing regimens at specific MICs in non-obese and obese patients with  $CRCL \geq 50$  mL/min. At the pharmacodynamic target of  $\geq 40\% fT > MIC$ , dosing regimens  $\geq 500$  mg q8h, infused over 30 minutes, achieved a PTA  $> 90\%$  at MICs  $\leq 2$  mg/L in both non-obese and obese patient groups with  $CRCL \geq 50$  mL/min [Figure 17(a)]. For 3- to 4-hour infusion regimens [Figure 17(b)], the PTA was  $> 90\%$  for all simulated regimens at MICs  $\leq 4$  mg/L. At the pharmacodynamic target of  $\geq 54\% fT > MIC$ , the PTA was  $> 90\%$  for all simulated 30-minute infusion dosing regimens at MICs  $\leq 2$  mg/L [Figure 18(a)]. For 3- to 4-hour infusion regimens [Figure 18(b)], the PTA was  $> 90\%$  for all regimens at MICs  $\leq 4$  mg/L. Therefore, at MICs  $\leq 2$  mg/L, which is the susceptibility breakpoint for *Pseudomonas aeruginosa* (Clinical and Laboratory Standards Institute, 2014), meropenem dosing regimens  $\geq 500$  mg q8h, infused over 30 minutes, achieved adequate pharmacodynamic exposures in both non-obese and obese patients with  $CRCL \geq 50$  mL/min.

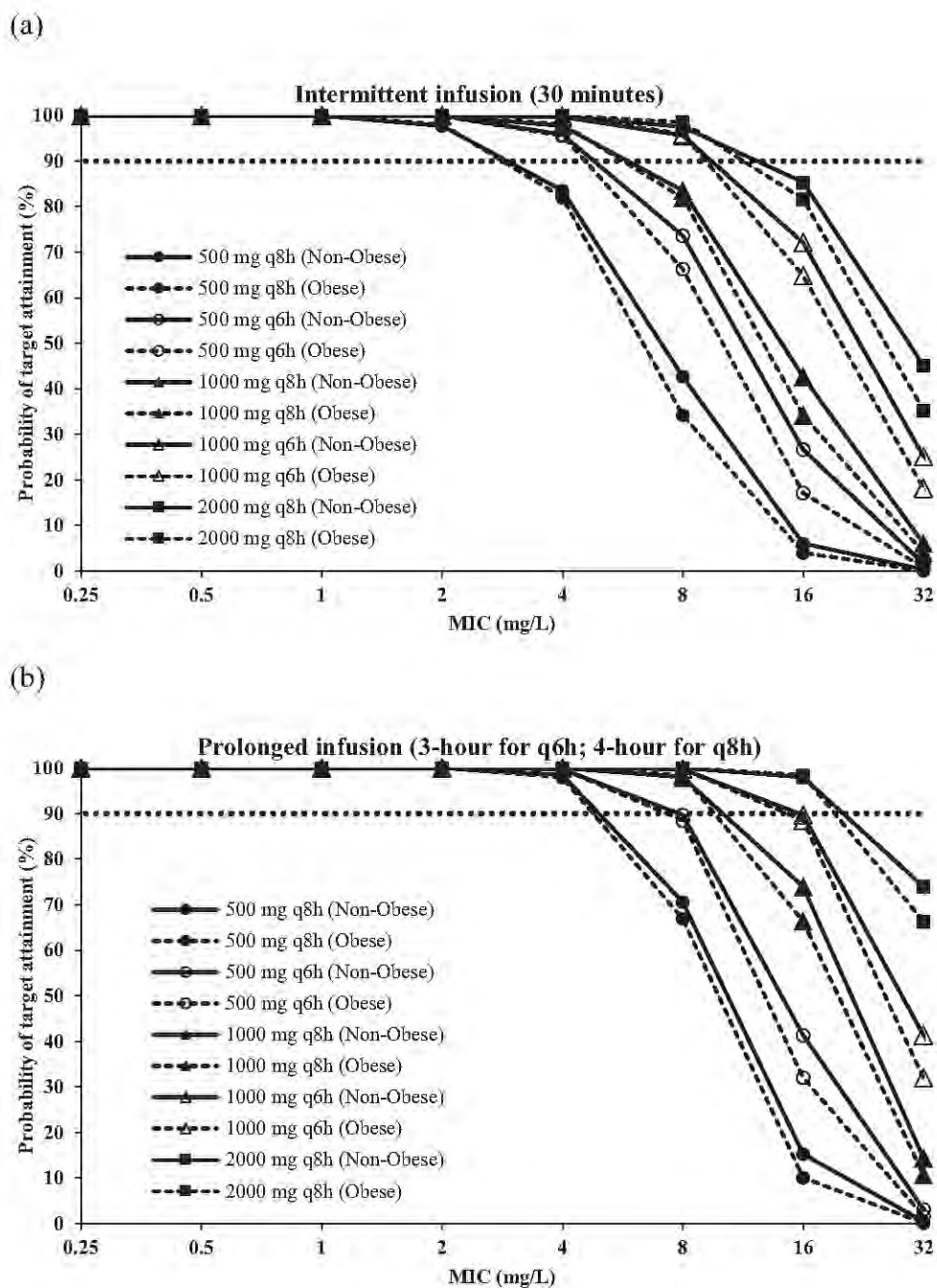
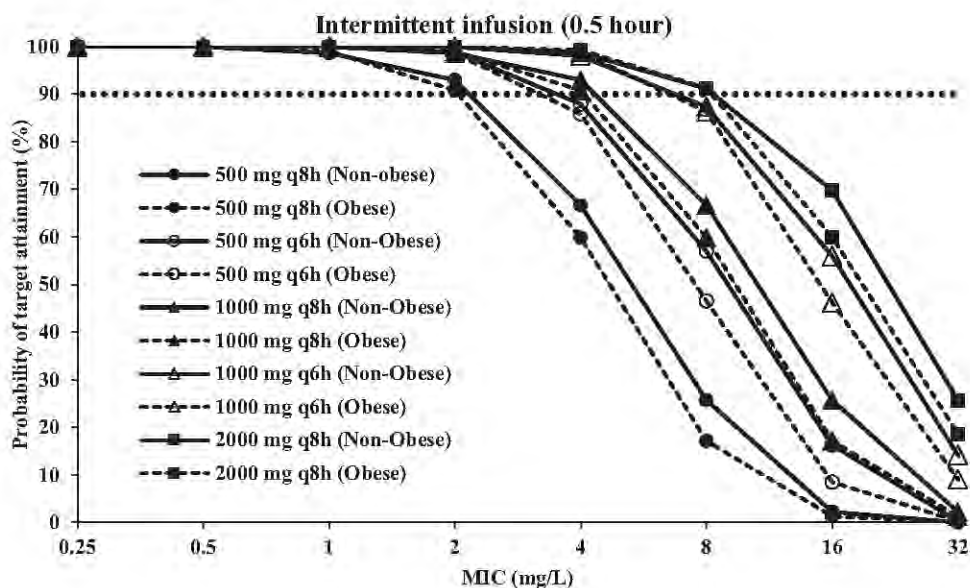

Figure 17. Probability of target attainment (PTA) for meropenem at  $\geq 40\%$   $fT > MIC$  for 5 dosing regimens, infused over (a) 30 minutes and (b) either 3 hours for q6h regimens or 4 hours for q8h regimens at specific minimum inhibitory concentrations (MICs) in non-obese and obese patients with creatinine clearance  $> 50$  mL/min. The dotted, horizontal line represents the PTA of 90%.  $fT > MIC$ , time that unbound drug concentrations remain above the MIC; q8h, every 8 hours; q6h, every 6 hours.

(a)





(b)

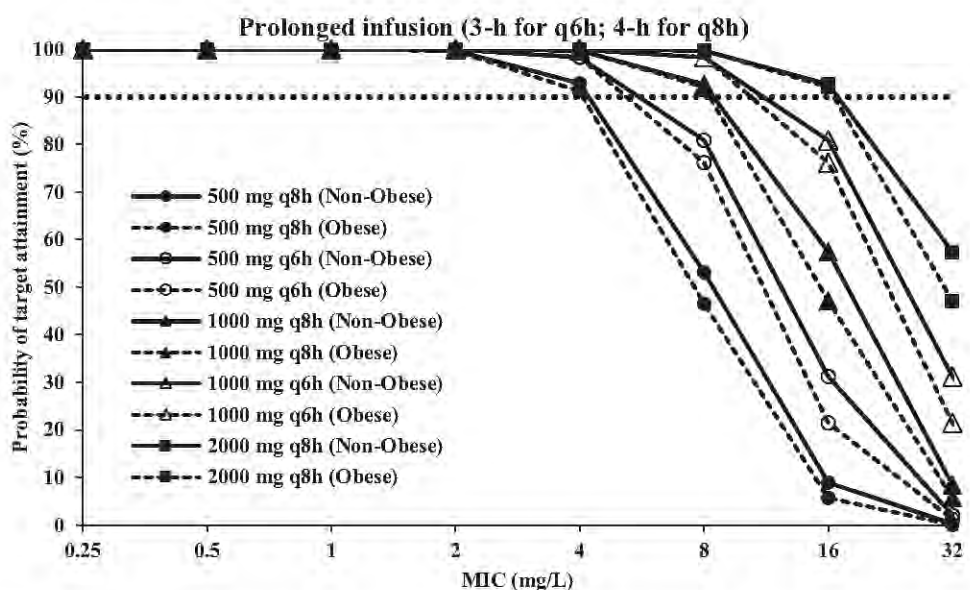

Figure 18. Probability of target attainment (PTA) for meropenem at  $\geq 54\%$   $fT > MIC$  for 5 dosing regimens, infused over (a) 30 minutes and (b) either 3 hours for q6h regimens or 4 hours for q8h regimens at specific minimum inhibitory concentrations (MICs) in non-obese and obese patients with creatinine clearance  $> 50$  mL/min. The dotted, horizontal line represents the PTA of 90%.  $fT > MIC$ , time that unbound drug concentrations remain above the MIC; q8h, every 8 hours; q6h, every 6 hours.

For patients with CRCL < 50 mL/min, at the pharmacodynamic target of  $\geq 40\%$   $fT > MIC$ , dosing regimens  $\geq 500$  mg q12h, infused over 30 minutes, achieved a PTA > 90% at MICs  $\leq 4$  mg/L in both non-obese and obese patient groups. For 3- to 4- hour infusion regimens, the PTA was > 90% for dosing regimens  $\geq 500$  mg q12h at MICs  $\leq 4$  mg/L and  $\geq 500$  mg q8h at an MIC of 8 mg/L, respectively, in both non-obese and obese patient groups. At the pharmacodynamic target of  $\geq 54\%$   $fT > MIC$ , dosing regimens  $\geq 500$  mg q12h, infused over 30 minutes, achieved a PTA > 90% at MICs  $\leq 2$  mg/L in both non-obese and obese patient groups. For 3- to 4- hour infusion regimens, the PTA was > 90% for dosing regimens  $\geq 500$  mg q12h at MICs  $\leq 4$  mg/L in both non-obese and obese patient groups. Therefore, at MICs  $\leq 2$  mg/L, which is the susceptibility breakpoint for *Pseudomonas aeruginosa* (Clinical and Laboratory Standards Institute, 2014), meropenem dosing regimens  $\geq 500$  mg q12h, infused over 30 minutes, achieved adequate pharmacodynamic exposures in patients with CRCL < 50 mL/min.

## Notes

- Akaike, Hirotugu. "A New Look at the Statistical Model Identification." *IEEE Transactions on Automatic Control* 19, no. 6 (1974): 716-23.
- American College of Clinical Pharmacology, "Pharmacometrics"  
<http://accp1.org/pharmacometrics/theory.htm> (accessed January 23 2015).
- Baldwin, Claudine M., Katherine A. Lyseng-Williamson, and Susan J. Keam. "Meropenem: A Review of Its Use in the Treatment of Serious Bacterial Infections." *Drugs* 68, no. 6 (2008): 803-38.
- Bauer, Robert J., Alison J. Boeckmann, Lewis B. Sheiner, and Stuart L. Beal. "NONMEM Users Guide." 1989-2009. Ellicott City, MD, USA: Icon Development Solutions, 2009.
- Byon, W., M. K. Smith, P. Chan, M. A. Tortorici, S. Riley, H. Dai, J. Dong, A. Ruiz-Garcia, K. Sweeney, and C. Cronenberger. "Establishing Best Practices and Guidance in Population Modeling: An Experience with an Internal Population Pharmacokinetic Analysis Guidance." *CPT: Pharmacometrics & Systems Pharmacology* 2, (2013): e51.
- Cheatham, S. Christian, Megan R. Fleming, Daniel P. Healy, Eun Kyoung Chung, Katherine M. Shea, Melissa L. Humphrey, and Michael B. Kays. "Steady-State Pharmacokinetics and Pharmacodynamics of Meropenem in Morbidly Obese Patients Hospitalized in an Intensive Care Unit." *Journal of Clinical Pharmacology* 54, no. 3 (2014): 324-30.
- Cheatham, S. Christian, Michael B. Kays, David W. Smith, Matthew F. Wack, and Kevin M. Sowinski. "Steady-State Pharmacokinetics and Pharmacodynamics of Meropenem in Hospitalized Patients." *Pharmacotherapy* 28, no. 6 (2008): 691-8.
- Cheatham, S. Christian, Megan R. Fleming, Daniel P. Healy, Christina E. K Chung, and Michael B. Kays. "Pharmacokinetics and Pharmacodynamics of Meropenem in Morbidly Obese, Hospitalized Patients." *Pharmacotherapy* 31, no. 10 (2011): 354e.
- Clinical and Laboratory Standards Institute. "Performance Standards for Antimicrobial Susceptibility Testing; Twenty-Fourth Informational Supplement." In *Document M100-S24*. Wayne, PA: CLSI, 2014.
- Cockcroft, Donald W., and M. Henry Gault. "Prediction of Creatinine Clearance from Serum Creatinine." *Nephron* 16, no. 1 (1976): 31-41.

- Demirovic, Jasmmina A., Amy Barton Pai, and Manjunath P. Pai. "Estimation of Creatinine Clearance in Morbidly Obese Patients." *American Journal of Health-System Pharmacy* 66, no. 7 (2009): 642-8.
- DeRyke, C. Andrew, Joseph L. Kutj, and David P. Nicolau. "Pharmacodynamic Target Attainment of Six Beta-Lactams and Two Fluoroquinolones against *Pseudomonas Aeruginosa*, *Acinetobacter Baumannii*, *Escherichia Coli*, and *Klebsiella* Species Collected from United States Intensive Care Units in 2004." *Pharmacotherapy* 27, no. 3 (2007): 333-42.
- Elkhaili, H., S. Niedergang, D. Pompei, L. Linger, D. Leveque, and F. Jehl. "High-Performance Liquid Chromatographic Assay for Meropenem in Serum." *Journal of Chromatography. B, Biomedical Applications* 686, no. 1 (1996): 19-26.
- Janmahasatian, Sarayut, Stephen B. Duffull, Susan Ash, Leigh C. Ward, Nuala M. Byrne, and Bruce Green. "Quantification of Lean Bodyweight." *Clinical Pharmacokinetics* 44, no. 10 (2005): 1051-65.
- Kays, Michael B., Megan R. Fleming, S. Christian Cheatham, Eun Kyoung Chung, and Joetta M. Juenke. "Comparative Pharmacokinetics and Pharmacodynamics of Doripenem and Meropenem in Obese Patients." *The Annals of Pharmacotherapy* 48, no. 2 (2014): 178-86.
- Li, Chonghua, Xiaoli Du, Joseph L. Kutj, and David P. Nicolau. "Clinical Pharmacodynamics of Meropenem in Patients with Lower Respiratory Tract Infections." *Antimicrobial Agents and Chemotherapy* 51, no. 5 (2007): 1725-30.
- Lodise, Thomas P., Ben M. Lomaestro, and George L. Drusano. "Application of Antimicrobial Pharmacodynamic Concepts into Clinical Practice: Focus on Beta-Lactam Antibiotics: Insights from the Society of Infectious Diseases Pharmacists." *Pharmacotherapy* 26, no. 9 (2006): 1320-32.
- Merrem(R) [package insert]. Wilmington, DE: AstraZeneca Pharmaceuticals LP, 2013.
- Mould, D. R., and R. N. Upton. "Basic Concepts in Population Modeling, Simulation, and Model-Based Drug Development." *CPT:Pharmacometrics & Systems Pharmacology* 1, (2012): e6.
- Mouton, Johan W., Michael N. Dudley, Otto Cars, Hartmut Derendorf, and George L. Drusano. "Standardization of Pharmacokinetic/Pharmacodynamic (PK/PD) Terminology for Anti-Infective Drugs: An Update." *The Journal of Antimicrobial Chemotherapy* 55, no. 5 (2005): 601-7.

Roberts, Jason A., Mohd H. Abdul-Aziz, Jeffrey Lipman, Johan W. Mouton, Alexander A. Vinks, Timothy W. Felton, William W. Hope, Andras Farkas, Michael N. Neely, Jerome J. Schentag, George Drusano, Otto R. Frey, Ursula Theuretzbacher, and Joseph L. Kuti. "Individualised Antibiotic Dosing for Patients Who Are Critically Ill: Challenges and Potential Solutions." *The Lancet. Infectious Diseases* 14, no. 6 (2014): 498-509.

## DETERMINATION OF OPTIMAL CEFEPIME DOSING REGIMENS IN OBESE PATIENTS COMPARED TO NON- OBESE PATIENTS

### Study Objectives

The objectives of this study were:

Objective 1: To describe the steady-state pharmacokinetics of cefepime in hospitalized obese and non-obese patients with suspected or documented infection. This objective will test the hypothesis that CL and/or V of cefepime, estimated by the nonlinear mixed-effect modeling approach, is increased in obese patients compared to non-obese patients. This objective will be achieved by comparing the cefepime pharmacokinetic parameters estimated from the population pharmacokinetic model that will be developed in this study between obese and non-obese patients.

Objective 2: To determine the appropriate cefepime dosing regimens in obesity to achieve similar pharmacodynamic targets in obese patients compared with non-obese patients with suspected or documented infection. This objective will test the hypothesis that obese patients require larger cefepime dosages compared to non-obese patients to achieve comparable drug exposures. This aim will be achieved by pharmacodynamic simulations to estimate the probability to attain the cefepime pharmacodynamic targets

over a range of MICs for various dosing regimens using the population pharmacokinetic model and the model parameter estimates.

## Methods

### Study Design and Pharmacokinetic Data

This is a retrospective analysis of prospectively collected serum concentration-time data from three previous studies published by our research group (Study 6, Study 7, and Study 8) (Hittle et al. 2003; Cheatham et al. 2011; Cheatham et al. 2013). The sample size was not determined a priori using power analysis, but a convenience sample using available data was used for this study. The inclusion and exclusion criteria of Study 6, Study 7, and Study 8 are listed in Table 19.

Table 19. Inclusion and exclusion criteria for Study 6, Study 7, and Study 8

	Study 6 (Hittle et al. 2003)	Study 7 (Cheatham et al. 2011)	Study 8 (Cheatham et al. 2013)
Inclusion criteria	<ul style="list-style-type: none"> <li>- Hospitalized at Methodist Hospital (Indianapolis, IN)</li> <li>- Aged <math>\geq 18</math> years</li> <li>- Required antimicrobial therapy for a suspected or documented bacterial infection</li> <li>- Had central venous access</li> </ul>	<ul style="list-style-type: none"> <li>- Hospitalized at Franciscan St. Francis Health (Indianapolis, IN)</li> <li>- Aged <math>\geq 18</math> years</li> <li>- Required antimicrobial therapy for a suspected or documented bacterial infection</li> <li>- Had central venous access</li> </ul>	<ul style="list-style-type: none"> <li>- Hospitalized at Franciscan St Francis Health (Indianapolis, IN)</li> <li>- Aged <math>\geq 18</math> years</li> <li>- Body mass index<sup>a</sup> <math>\geq 40</math> kg/m<sup>2</sup></li> <li>- Required antimicrobial therapy for a suspected or documented bacterial infection</li> <li>- Had central venous access</li> </ul>

Table 19. Continued. Inclusion and exclusion criteria for Study 6, Study 7, and Study 8

	Study 6 (Hittle et al. 2003)	Study 7 (Cheatham et al. 2011)	Study 8 (Cheatham et al. 2013)
Exclusion criteria	<ul style="list-style-type: none"> <li>- Allergy to any beta-lactam antibiotic</li> <li>- History of drug or alcohol abuse</li> <li>- Pregnancy</li> <li>- History of any seizure disorder</li> <li>- Acute or chronic renal failure</li> <li>- Renal replacement therapy of any type</li> </ul>	<ul style="list-style-type: none"> <li>- History of allergy to any beta-lactam antibiotic</li> <li>- History of drug or alcohol abuse</li> <li>- Pregnancy</li> <li>- History of any seizure disorder</li> <li>- Acute or chronic renal failure</li> <li>- Renal replacement therapy of any type</li> <li>- Hepatic dysfunction defined as serum bilirubin and alanine aminotransferase concentrations <math>\geq 2</math> and <math>\geq 4</math> times the normal upper limit, respectively</li> </ul>	<ul style="list-style-type: none"> <li>- Allergy to any beta-lactam antibiotic</li> <li>- History of drug or alcohol abuse</li> <li>- Pregnancy</li> <li>- History of any seizure disorder</li> <li>- Acute or chronic renal failure</li> <li>- Renal replacement therapy of any type</li> <li>- Hepatic dysfunction defined as serum bilirubin and alanine aminotransferase concentrations <math>\geq 2</math> and <math>\geq 4</math> times the normal upper limit, respectively</li> </ul>

<sup>a</sup> Calculated by (total body weight in kg)/(height in m)<sup>2</sup>

These studies were approved by the institutional review boards at each study site, and written informed consent was obtained from each patient or a first-degree relative if the patient was unable to give informed consent due to his or her medical condition.

Patients were classified as either obese (BMI  $\geq 30$  kg/m<sup>2</sup>) or non-obese (BMI  $< 30$  kg/m<sup>2</sup>). Table 20 shows dosing schemes in each study, which were selected to reflect the routine practice at each study site at the time of each study.



Table 20. Cefepime dosing schemes for each study

	Study 6 (Hittle et al. 2003) <sup>a</sup>	Study 7 (Cheatham et al. 2011)	Study 8 (Cheatham et al. 2013)
Cefepime dosing regimens	- 1 g q6h if CRCL <sup>b</sup> > 60 mL/min - 1 g q8h or q12h <sup>c</sup> if CRCL <sup>b</sup> < 60 mL/min	1g q8h, infused over 4 hours	2 g q8h, infused over 4 hours <sup>d</sup>

Abbreviations: q6h, every 6 hours; CRCL, creatinine clearance; q8h, every 8 hours; q12h, every 12 hours

<sup>a</sup> All doses were infused over 30 minutes

<sup>b</sup> Estimated by the modified Cockcroft-Gault method (equation 2) using ideal body weight (equations 3 and 4) for the weight term and the actual serum creatinine concentration for each patient:

$$\text{CRCL (mL/min)} = \frac{(140 - \text{Age}) \times \text{Weight}}{\text{SCr} \times 72} \times (0.85 \text{ if female}) \quad (2)$$

$$\text{Ideal body weight (IBW)} = 50 \text{ kg} + [2.3 \text{ kg} * (\text{height in inches} - 60)] \text{ in males} \quad (3)$$

$$\text{Ideal body weight (IBW)} = 45.5 \text{ kg} + [2.3 \text{ kg} * (\text{height in inches} - 60)] \text{ in females} \quad (4)$$

<sup>c</sup> Dosing regimens were selected upon the discretion of the treating clinician

<sup>d</sup> One patient received 3 g q8h, infused over 4 hours upon the discretion of the treating clinician (body mass index 92.5 kg/m<sup>2</sup>, total body weight 276 kg, normal renal function).

After 2 or more days of therapy, serial blood samples were collected from an indwelling IV catheter as scheduled in each study (Table 21).

Table 21. Blood sampling scheme for cefepime studies. Boxes with X indicate the time when blood samples were collected.

Hours <sup>a</sup>	0	0.5	0.75	1	1.5	2	3	4	5	6	7	8	12
Study 6 (Hittle et al. 2003)	X	X	X	X	X	X	X	X		X		X <sup>b</sup>	X <sup>c</sup>
Study 7 (Cheatham et al. 2011)	X			X		X	X	X	X	X	X	X	
Study 8 (Cheatham et al. 2013)	X			X		X	X	X	X	X	X	X	

<sup>a</sup> Hours after the start of the cefepime infusion.

<sup>b</sup> Only for those receiving cefepime every 8 hours.

<sup>c</sup> Only for those receiving cefepime every 12 hours.

At each time when blood sample was collected, the catheter was flushed with 10 mL of normal saline or heparin. The first 10 mL of blood draw was discarded to ensure flush solution was not mixed with the patient's blood samples. Afterwards, 10 mL blood samples were collected in non-anticoagulant (red top) tubes at each time point.

Immediately after allowing the blood to coagulate, the samples were centrifuged and serum samples were stored at -70°C. Serum samples were shipped on dry ice by overnight carrier to the Center for Anti-Infective Research and Development at Hartford Hospital (Hartford, CT) for samples obtained from Study 6 and to the University of Cincinnati Academic Health Center (Cincinnati, OH) for samples obtained from Study 7 and Study 8 for determination of cefepime concentrations.

In all studies (Study 6, Study 7, and Study 8), cefepime concentrations in serum were measured by reversed-phase high performance liquid chromatography with UV detection as previously described (Bonapace et al. 1999). The mobile phase consisted of 14% HPLC-grade acetonitrile and 86% 0.0023 M 1-octanesulfonic acid sodium salt in water, adjusted to pH 2.3 with 85% phosphoric acid. The flow rate was 1.0 mL/minute, and chromatographic separation was performed using two Onyx monolithic C18 analytical columns (50 x 4.6 mm) placed in series (Phenomenex, Torrance, CA). Serum samples were allowed to thaw at room temperature, and protein precipitation was performed by an equal volume of 5% trichloroacetic acid to the serum samples, vortexing for 20 seconds, and centrifuging at 3,000 x g for 10 minutes. The supernatant was then injected into the HPLC. The standard curve was linear over the concentration range of 0.78-100 µg/mL ( $r = 0.999$ ,  $n=11$ ). Concentrations > 100 µg/mL were diluted with blank pooled human plasma and reassayed. The between-day ( $n=11$ ) coefficients of variation

for spiked serum control samples of 2, 20 and 75  $\mu\text{g/mL}$  were 9.8%, 3.7% and 5.8%, respectively. The within-day coefficients of variation were less than 6.5%.

### Population Pharmacokinetic Analysis

Serum concentration-time data for cefepime from all individual patients were analyzed simultaneously by population compartmental pharmacokinetic modeling approach using NONMEM (version VII; Globomax LLC, Ellicott, MD, USA) (Bauer et al. 2009). NONMEM software was accessed via the cluster at the Indiana Clinical and Translational Science Institution thanks to Dr. Robert R. Bies. The first-order conditional estimation (FOCE) method with interaction was used. One- and two-compartment models with zero-order input and first-order (i.e., linear) elimination were evaluated as potential structural cefepime pharmacokinetic models. Figures 3 and 4 show the diagrams describing one- and two-compartment structural models. Differential equations describing one- and two-compartment structural models are shown in equations 27 and 28-29, respectively.

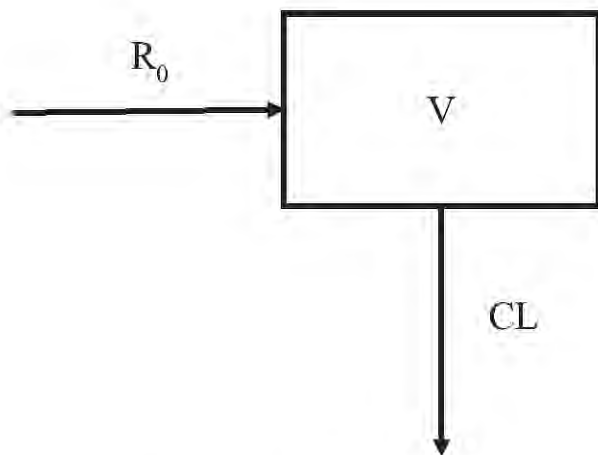

Figure 3. One-compartment structural model.  $R_0$ , the rate of drug infusion (mg/h);  $V$ , volume of distribution (L);  $CL$ , clearance (L/h).

$$\frac{dA}{dt} = R_0 - \left(\frac{CL}{V} \times A\right) \quad (23)$$

where  $\frac{dA}{dt}$  is the rate of change in the drug amount over time (mg/h),  $A$  is the amount of the drug in the body (system) (mg),  $R_0$  is the rate of drug infusion (mg/h),  $CL$  is clearance (L/h), and  $V$  is the volume of distribution (L).

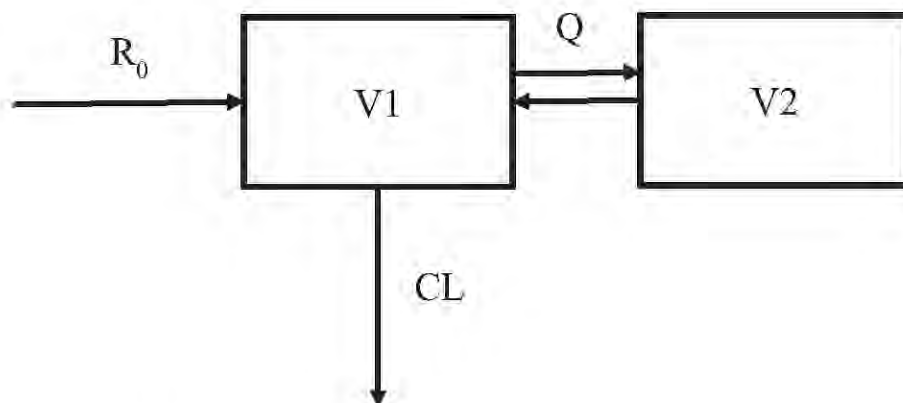

Figure 4. Two-compartment structural model.  $R_0$ , the rate of drug infusion (mg/h);  $V1$ , volume of distribution in the central compartment (L);  $V2$ , volume of distribution in the peripheral compartment (L);  $Q$ , inter-compartmental distribution clearance (L/h);  $CL$ , clearance (L/h).

$$\frac{dA_1}{dt} = R_0 + \left(\frac{Q}{V_2} \times A_2\right) - \left(\frac{Q}{V_1} \times A_1\right) - \left(\frac{CL}{V_1} \times A_1\right) \quad (24)$$

$$\frac{dA_2}{dt} = \left(\frac{Q}{V_1} \times A_1\right) - \left(\frac{Q}{V_2} \times A_2\right) \quad (25)$$

where  $\frac{dA_1}{dt}$  is the rate of change in the drug amount over time in the central compartment (mg/h),  $R_0$  is the rate of drug infusion (mg/h),  $Q$  is inter-compartmental distribution clearance (L/h),  $V_2$  is volume of distribution in the peripheral compartment (L),  $A_2$  is the amount of the drug in the peripheral compartment (mg),  $V_1$  is volume of distribution in the central compartment (L),  $A_1$  is the amount of the drug in the central compartment (mg),  $CL$  is clearance (L/h), and  $\frac{dA_2}{dt}$  is the rate of change in the drug amount over time in the peripheral compartment (mg/h). The initial estimates of  $CL$  and  $V$  were the average of the parameter estimates obtained from our previous studies using non-compartmental and one-compartmental analyses (Hittle et al. 2003; Cheatham et al. 2011; Cheatham et al. 2013). The initial estimates of parameters describing a two-compartment model ( $CL$ ,  $V_1$ ,  $Q$ , and  $V_2$ ) were the average of the parameter estimates obtained from one of our previous studies using the two-compartmental analysis (Hittle et al. 2003). The initial estimate values were varied from 10-fold lower to 10-fold higher values to achieve global minima and obtain robust parameter estimates (Bauer et al. 2009). Inter-individual variability ( $\eta$ ) of population pharmacokinetic parameters was assumed to follow log-normal distribution with a mean of zero and variance of  $\omega^2$  (equation 31) (Mould and Upton, 2012). Possible correlations between the inter-individual variability for pharmacokinetic parameters in the model were examined. For residual errors ( $\epsilon$ ) unexplained by the model, additive ( $\epsilon_{add}$ ), proportional ( $\epsilon_{prop}$ ), and combinational models

were evaluated, and residual error was assumed to be normally distributed with a mean of zero and variance of  $\sigma^2$  (equations 32, 33, and 34) (Mould and Upton, 2012).

$$P_{ij} = TVP_j \times e^{\eta_{ij}} \quad (31)$$

$$Y_{ik} = IPRED_{ik} + \varepsilon_{add,ik} \quad (32)$$

$$Y_{ik} = IPRED_{ik} \times (1 + \varepsilon_{prop,ik}) \quad (33)$$

$$Y_{ik} = IPRED_{ik} \times (1 + \varepsilon_{prop,ik}) + \varepsilon_{add,ik} \quad (34)$$

where  $P_{ij}$  is the  $j^{\text{th}}$  pharmacokinetic parameter, such as CL and V, of the  $i^{\text{th}}$  patient,  $TVP_j$  is the typical population value of the  $j^{\text{th}}$  pharmacokinetic parameter,  $\eta_{ij}$  is a random variable for the inter-individual variability of the  $j^{\text{th}}$  pharmacokinetic parameter for the  $i^{\text{th}}$  patient,  $Y_{ik}$  is the measured drug (i.e., piperacillin and tazobactam) concentration of the  $i^{\text{th}}$  patient at the  $k^{\text{th}}$  sampling time,  $IPRED_{ik}$  is the individual model-predicted drug concentration of the  $i^{\text{th}}$  patient at the  $k^{\text{th}}$  sampling time, and  $\varepsilon_{ik}$  is residual error of the  $i^{\text{th}}$  patient at the  $k^{\text{th}}$  sampling time. The best structural pharmacokinetic model with stochastic error terms for cefepime were selected based on the visual inspection of observed concentration-time plots, goodness-of-fit plots, individual plots of observed and individual predicted concentration-time profiles, the change in the minimum objective function value ( $\Delta\text{OFV}$ ), and Akaike information criterion (AIC) (Akaike, 1974; American College of Clinical Pharmacology, 2011). In NONMEM, the objective function value (OFV) is -2 times the log of the model likelihood, and the likelihood is typically considered as a sum of squares (American College of Clinical Pharmacology, 2011). The change in the minimum objective function value ( $\Delta\text{OFV}$ ) follows a chi-square distribution and a decrease in OFV by  $> 3.84$  is considered statistically significant with 1 degree of freedom ( $df$ ) at the  $\alpha$  level of 0.05 using a chi-square test (American

College of Clinical Pharmacology, 2011). Akaike information criterion (AIC) is defined in equation 35.

$$AIC = OFV + [2 \times (\text{number of parameters in the model})] \quad (35)$$

where AIC is Akaike information criterion and OFV is the model objective function value which is equal to -2 times the log of the model likelihood. Among the above listed diagnostic criteria for model selection,  $\Delta OFV$  took precedence over others.

The final pharmacokinetic model was built by evaluating the effects of covariates on the cefepime pharmacokinetic parameters using the stepwise forward inclusion followed by the backward elimination process. Tested covariates included: 1) age (years); 2) sex; 3) body size descriptor, including TBW, IBW, LBW (Janmahasatian et al. 2005), and BMI; 4) CRCL; and 5) admission to an ICU (ICU=1, general medical ward=0). Equations 3-4 and 19-20 were used to estimate IBW and LBW, respectively.

$$IBW = 50 \text{ kg} + [2.3 \text{ kg} \cdot (\text{height in inches} - 60)] \text{ in males} \quad (3)$$

$$IBW = 45.5 \text{ kg} + [2.3 \text{ kg} \cdot (\text{height in inches} - 60)] \text{ in females} \quad (4)$$

$$LBW \text{ (in male, kg)} = \frac{9270 \times TBW}{6680 + 216 \times BMI} \quad (19)$$

$$LBW \text{ (in female, kg)} = \frac{9270 \times TBW}{8780 + 244 \times BMI} \quad (20)$$

where IBW is ideal body weight (kg), LBW is lean body weight (kg), TBW is total body weight (kg), and BMI is body mass index ( $\text{kg}/\text{m}^2$ ). Creatinine clearance was estimated by the modified Cockcroft-Gault method (equation 2) using the actual serum creatinine concentration for each patient and IBW (equations 3 and 4) or TBW if  $TBW < IBW$  for patients with a  $BMI < 40 \text{ kg}/\text{m}^2$  and LBW (equations 19 and 20) for patients with a  $BMI > 40 \text{ kg}/\text{m}^2$  for the weight term (Demirovic et al. 2009):

$$\text{CRCL (mL/min)} = \frac{(140 - \text{Age}) \times \text{Weight}}{\text{SCr} \times 72} \times (0.85 \text{ if female}) \quad (2)$$

$$\text{Ideal body weight (IBW)} = 50 \text{ kg} + [2.3 \text{ kg} * (\text{height in inches} - 60)] \text{ in males} \quad (3)$$

$$\text{Ideal body weight (IBW)} = 45.5 \text{ kg} + [2.3 \text{ kg} * (\text{height in inches} - 60)] \text{ in females} \quad (4)$$

$$\text{LBW (in male, kg)} = \frac{9270 \times \text{TBW}}{6680 + 216 \times \text{BMI}} \quad (19)$$

$$\text{LBW (in female, kg)} = \frac{9270 \times \text{TBW}}{8780 + 244 \times \text{BMI}} \quad (20)$$

The admission to an intensive care unit was tested to evaluate the association between critical illness and cefepime pharmacokinetic parameters because critical illness was previously suggested to alter antibiotic pharmacokinetics (Roberts et al. 2014).

Continuous covariates (e.g., age, body size descriptors including TBW, IBW, LBW, and BMI, and CRCL) were centered at their median values. The effect of each covariate on each pharmacokinetic parameter, which is CL and V each if a one-compartment model was selected as the best structural model and CL, V1, Q, and V2 each if a two-compartment model was selected as the best structural model, was evaluated using 1) linear, power, or exponential functions for continuous covariates and 2) additive or proportional functions for categorical covariates (e.g., sex and ICU admission). Covariates that reduced the model OFV  $> 3.84$  ( $p < 0.05$ ;  $\chi^2$  distribution; 1 *df*) were considered significantly associated with the pharmacokinetic parameters in the model. In each step, among statistically significant covariates, if any, only the covariate with the greatest decrease in the model OFV was kept in the model. Afterwards, the remaining covariates were tested and added to the model in the same manner. The full model was constructed when all of the significant covariates were added to the model and there was no other remaining covariate that significantly reduced the model OFV. The



final model was constructed after removing covariates that were not significantly associated with the pharmacokinetic parameters from the full model in the stepwise backward elimination process. A covariate was removed if its elimination increased the model OFV by  $< 5.024$  ( $p > 0.025$ ;  $\chi^2$  distribution; 1 *df*). If there was more than one covariate that was not significant in the same step, the covariate with the smallest increase in the model OFV was removed, and this process was repeated until the elimination of every covariate in the model resulted in an increase in the model OFV by  $> 5.024$  ( $p < 0.025$ ;  $\chi^2$  distribution; 1 *df*).

The model fitting of the final model to the observed data was evaluated by goodness-of-fit plots. The predictive accuracy of the final pharmacokinetic model was examined by VPCs (Byon et al. 2013). VPCs were performed by simulating serum cefepime concentration-time profiles using NONMEM (version VII; Globomax LLC, Ellicott, MD, USA) (Bauer et al. 2009). One thousand simulations were conducted using all of the study patients included to build the population pharmacokinetic model ( $n=30$ ), resulting in 30,000-virtual simulated serum cefepime concentration time profiles. Curves for the 5<sup>th</sup>, 50<sup>th</sup>, and 95<sup>th</sup> percentiles of simulated cefepime concentrations were graphed with the observed concentrations, and they were grouped by dosage regimens (1 g q12h, 1 g q8h, and 1 g q6h, infused over 30 minutes; and 1 g q8h, 2 g q8h, and 3 g q8h, infused over 4 hours).

Descriptive statistics were used to summarize patient demographics and each pharmacokinetic parameter. All statistical analyses were performed in SPSS (SPSS Statistics for Windows, Version 22.0; SPSS Inc. IBM Corp. Armonk, NY). For categorical variables, chi-square or Fisher's exact test was used to test the differences

between non- obese and obese patients. For continuous variables, normality was tested using Kolmogorov-Smirnov test. When normality assumption was met, differences between non- obese and obese patients were tested using the 2-tailed, unpaired t-test with either unequal or equal variances, depending on the Levene's test result for equal variance. When normality assumption was violated, Mann-Whitney U test was performed to test the differences between non- obese and obese patients. Statistical significance was defined as  $p < 0.05$ .

#### Pharmacodynamic Analysis Using Monte Carlo Simulations

Pharmacodynamic exposures were modeled for the following cefepime dosing regimens: 1 g q12h, 1 g q8h, 1 g q6h, 2 g q12h, and 2 g q8h. Each dosing regimen was simulated to be infused over 30 minutes and either 3 hours for q6h regimen or 4 hours for q8h or q12h regimens. Monte Carlo simulations were performed using NONMEM with 200 simulations of all patients included to build the population pharmacokinetic model ( $n=30$ ), so 6,000-patient steady-state serum meropenem concentration-time curves were created using the final pharmacokinetic model. All serum concentration-time curves were simulated in 0.1-hour intervals, and the unbound serum concentrations were calculated as simulated serum drug concentrations multiplied by the free fraction. The cefepime unbound fraction was assumed to be 0.8 because 1) it is considered low-protein binding drugs and 2) protein binding and/or unbound drug concentrations were not measured (Hittle et al. 2003; Cheatham et al. 2011; Cheatham et al. 2013; Maxipime(TM) [package insert], 2012). Based on the simulated unbound serum concentration-time profiles, the PTA for cefepime was calculated for each dosing regimen using the

pharmacodynamic target of  $\geq 60\% fT > MIC$ , which was shown to be significantly associated with microbiologic improvement, at specific MICs ranging from 0.0625 to 32 mg/L (Endimiani et al. 2008; Crandon et al. 2010). The dosing regimens achieving a  $PTA \geq 90\%$  were considered optimal (DeRyke et al. 2007).

## Results

### Patient Characteristics

Overall, 30 patients (21 men and 9 women) were studied. TBW ranged from 54 kg to 276 kg, BMI from 18.5 kg/m<sup>2</sup> to 92.5 kg/m<sup>2</sup>, and estimated CRCL from 20 mL/min to 205 mL/min. Creatinine clearance was estimated by the modified Cockcroft-Gault method (equation 2) using the actual serum creatinine concentration for each patient and IBW (equations 3 and 4) for patients with a BMI < 40 kg/m<sup>2</sup> and LBW (equations 19 and 20) for patients with a BMI > 40 kg/m<sup>2</sup> for the weight term in equation 2 (Demirovic et al. 2009):

$$CRCL \text{ (mL/min)} = \frac{(140 - \text{Age}) \times \text{Weight}}{SCr \times 72} \times (0.85 \text{ if female}) \quad (2)$$

$$\text{Ideal body weight (IBW)} = 50 \text{ kg} + [2.3 \text{ kg} * (\text{height in inches} - 60)] \text{ in males} \quad (3)$$

$$\text{Ideal body weight (IBW)} = 45.5 \text{ kg} + [2.3 \text{ kg} * (\text{height in inches} - 60)] \text{ in females} \quad (4)$$

$$LBW \text{ (in male, kg)} = \frac{9270 \times TBW}{6680 + 216 \times BMI} \quad (19)$$

$$LBW \text{ (in female, kg)} = \frac{9270 \times TBW}{8780 + 244 \times BMI} \quad (20)$$

No patients experienced adverse events related to cefepime therapy during the study. Table 22 shows patient demographics for non-obese, obese, and overall patients.

Table 22. Patient demographics [median (range) unless otherwise stated]

Demographic characteristics	Non-obese (n=10)	Obese (n=20)	P-value
Male, no. of patients (%)	8 (80%)	13 (65%)	0.675 <sup>e</sup>
Age, years	44 (21-70)	59 (32-81)	0.005 <sup>f</sup>
Creatinine clearance, <sup>a</sup> mL/min	101 (56-180)	92 (20-205)	0.304 <sup>f</sup>
Height, cm	178 (147-190)	171 (147-183)	0.118 <sup>f</sup>
Total body weight, kg	74 (54-97)	110 (81-276)	< 0.001 <sup>g</sup>
Lean body weight, <sup>b</sup> kg	60 (36-71)	64 (42-96)	0.096 <sup>f</sup>
Ideal body weight, <sup>c</sup> kg	73 (41-84)	64 (41-78)	0.053 <sup>g</sup>
Body mass index (BMI), <sup>d</sup> kg/m <sup>2</sup>	22.5 (18.5-29.8)	39.2 (30.9-92.5)	< 0.001 <sup>g</sup>
Intensive care unit admission, number of patients (%)	4 (40%)	12 (60%)	0.442 <sup>e</sup>
Cefepime dosage regimen, number of patients (%)			
1 g q12h, 30-minute infusion	0	1 (5%)	N/A
1 g q8h, 30-minute infusion	0	2 (10%)	N/A
1 g q8h, 4-hour infusion	4 (40%)	5 (25%)	N/A
1 g q6h, 30-minute infusion	5 (50%)	3 (15%)	N/A
2 g q8h, 4-hour infusion	1 (10%)	8 (40%)	N/A
3 g q8h, 4-hour infusion	0	1 (5%)	N/A

<sup>a</sup> Creatinine clearance was estimated by the modified Cockcroft-Gault method (equation 2) using the actual serum creatinine concentration for each patient and IBW (equations 3 and 4) for patients with a BMI < 40 kg/m<sup>2</sup> and LBW (equations 19 and 20) for patients with a BMI > 40 kg/m<sup>2</sup> for the weight term in equation 2 (Demirovic et al. 2009):

$$\text{CRCL (mL/min)} = \frac{(140 - \text{Age}) \times \text{Weight}}{\text{SCr} \times 72} \times (0.85 \text{ if female}) \quad (2)$$

$$\text{Ideal body weight (IBW)} = 50 \text{ kg} + [2.3 \text{ kg} * (\text{height in inches} - 60)] \text{ in males} \quad (3)$$

$$\text{Ideal body weight (IBW)} = 45.5 \text{ kg} + [2.3 \text{ kg} * (\text{height in inches} - 60)] \text{ in females} \quad (4)$$

$$\text{LBW (in male, kg)} = \frac{9270 \times \text{TBW}}{6680 + 216 \times \text{BMI}} \quad (19)$$

$$\text{LBW (in female, kg)} = \frac{9270 \times \text{TBW}}{8780 + 244 \times \text{BMI}} \quad (20)$$

<sup>b</sup> Calculated using equations 19 in males and 20 in females, respectively:

$$\text{Lean body weight (LBW in male, kg)} = \frac{9270 \times \text{TBW}}{6680 + 216 \times \text{BMI}} \quad (19)$$

$$\text{Lean body weight (LBW in female, kg)} = \frac{9270 \times \text{TBW}}{8780 + 244 \times \text{BMI}} \quad (20)$$

<sup>c</sup> Calculated using equations 3 in males and 4 in females, respectively:

$$\text{Ideal body weight (IBW)} = 50 \text{ kg} + [2.3 \text{ kg} * (\text{height in inches} - 60)] \text{ in males} \quad (3)$$

$$\text{Ideal body weight (IBW)} = 45.5 \text{ kg} + [2.3 \text{ kg} * (\text{height in inches} - 60)] \text{ in females} \quad (4)$$

<sup>d</sup> Calculated by (total body weight in kg)/(height in m)<sup>2</sup>

<sup>e</sup> P-value from Fisher's exact test between non-obese and obese patients

<sup>f</sup> P-value from unpaired t-test with equal variance between non-obese and obese

<sup>g</sup> P-value from Mann-Whitney U test between non-obese and obese patients

N/A: Not estimated

Population Pharmacokinetic Analysis

For the population pharmacokinetic analysis, 216 cefepime concentrations from 30 patients were included. Fewer than the planned number of samples (273 samples from 30 patients) were included in the analysis because 57 samples were not collected at the planned time points. Table 23 shows the OFV and AIC of selected structural models among all tested structural models. Successfully minimized models with successfully estimated covariance structures after each NONMEM run were further evaluated for candidate models. When residual error was described in the additive model, the model failed to be successfully minimized, so models with additive residual errors were not further considered for candidate models.

Table 23. Comparison of selected cefepime structural pharmacokinetic models among all tested structural pharmacokinetic models

Models	OFV <sup>a</sup>	AIC <sup>b</sup>
One-compartment models		
A. No IIV, combinational residual error	1501.628	1509.628
B. No IIV, proportional residual error	1549.381	1555.381
C. IIV on CL and V, combinational residual error	1188.815	1200.815
D. IIV on CL and V, proportional residual error	1191.023	1201.023
E. IIV on CL and V, combinational residual error, correlation estimated between CL and V	1186.343	1200.343
F. IIV on CL and V, proportional residual error, correlation estimated between CL and V	1188.715	1200.715

Table 24. Continued. Comparison of selected cefepime structural pharmacokinetic models among all tested structural pharmacokinetic models

Models	OFV <sup>a</sup>	AIC <sup>b</sup>
Two-compartment models <sup>c</sup>		
G. IIV on CL, V1, and Q; proportional residual error	1181.137	1197.137
H. IIV on CL and V1, combinational residual error; correlation estimated between CL and V1	1178.572	1196.572
I. IIV on CL and V1, proportional residual error	1181.395	1195.395
J. IIV on CL and V1, proportional residual error; correlation estimated between CL and V1	1180.455	1196.455
K. IIV on CL and Q, proportional residual error	1178.243	1192.243
L. IIV on CL and V2, combinational residual error, correlation estimated between CL and V2	1182.553	1200.553

Abbreviations: OFV, objective function value; AIC, Akaike information criterion; IIV, inter-individual variability; CL, clearance; V, volume of distribution; V1, volume of distribution in the central compartment; Q, inter-compartmental distribution clearance; V2, volume of distribution in the peripheral compartment

<sup>a</sup> OFV is -2 times the log of the model likelihood, and the likelihood is typically considered as a sum of squares (American College of Clinical Pharmacology, 2011). The change in the minimum objective function value ( $\Delta$ OFV) follows a chi-square distribution and a decrease in OFV by  $> 3.84$  is considered statistically significant with 1 degree of freedom (*df*) at the  $\alpha$  level of 0.05 using a chi-square test (American College of Clinical Pharmacology, 2011)

<sup>b</sup> Akaike information criterion (AIC) is defined in equation 35.

$$\text{AIC} = \text{OFV} + [2 \times (\text{number of parameters in the model})] \quad (35)$$

<sup>c</sup> No other two-compartment models than the listed compartment models were successfully minimized

For one-compartment models, Model E in Table 23 (one-compartment model with inter-individual variability estimated for both CL and V, correlation estimated between CL and V, and residual error modeled in the combinational form) had the minimum OFV and AIC. However, the standard error associated with additive term of residual error was high at 120%, so the second best model, Model F in Table 23 (one-compartment model with inter-individual variability estimated for both CL and V, correlation estimated between CL and V, and residual error modeled in the proportional form) was selected as the best one-compartment structural model. All of the two-compartment models in Table

23 had smaller OFV and AIC compared to any one-compartment model. However, the standard errors associated with Q and V2 were high (> 60 to 80%). In addition, when comparing the individual fits of the two best two-compartment models (Figures 19 and 20) with the individual fits of the best one-compartment structural model (Figure 21), substantial improvement was not visually observed with the two-compartment models compared to the one-compartment model.

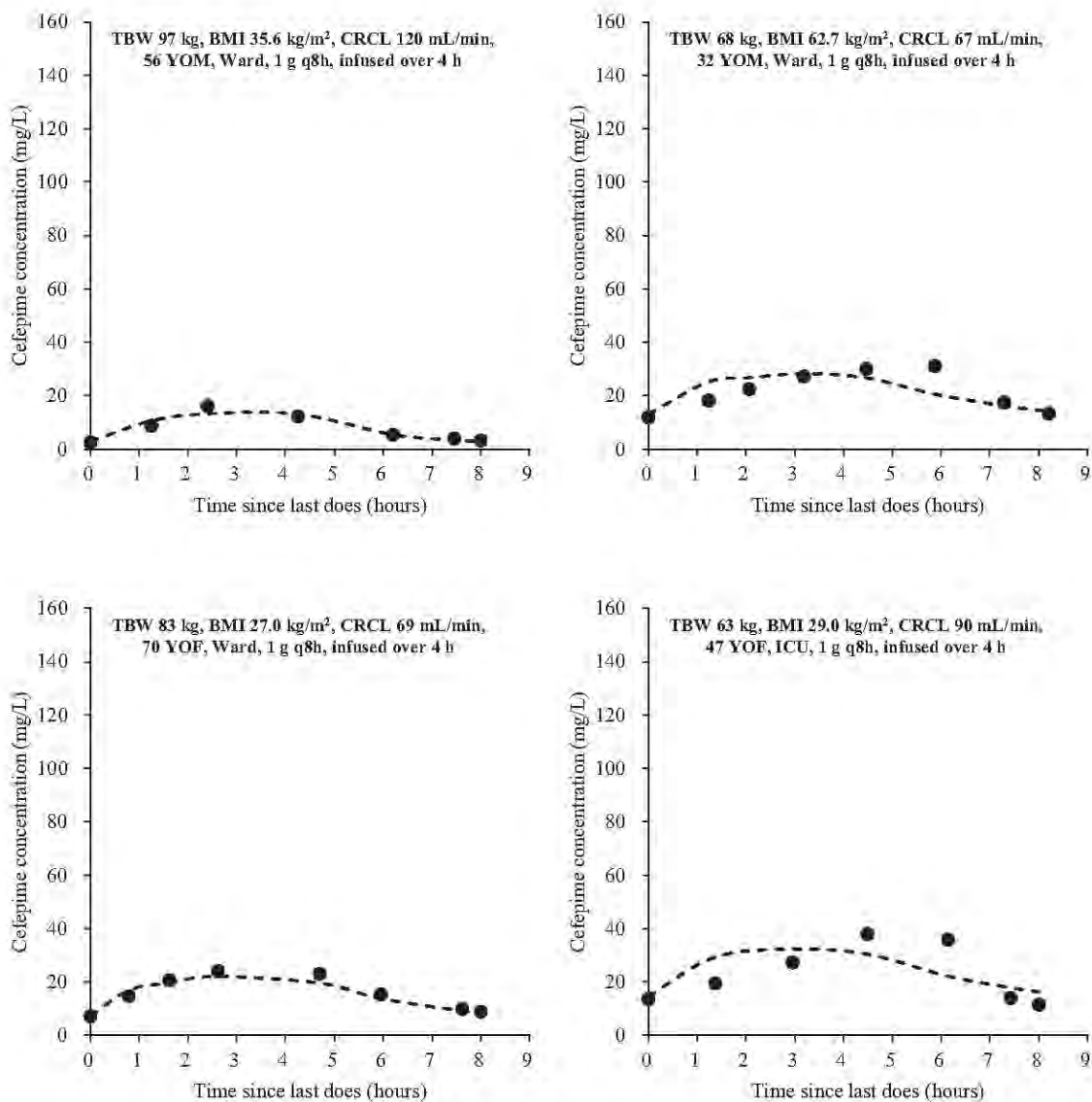

Figure 19. Observed and predicted serum cefepime concentration-time profiles for all 30 patients using Model I in Table 23 (a two-compartment model with inter-individual variability estimated for CL and V1, proportional residual error, zero-order input, and first-order, linear elimination). Filled circles represent the observed cefepime concentrations and dashed lines represent the model-predicted concentrations using Model I in Table 23 (a two-compartment model with inter-individual variability estimated for CL and V1, proportional residual error, zero-order input, and first-order, linear elimination).



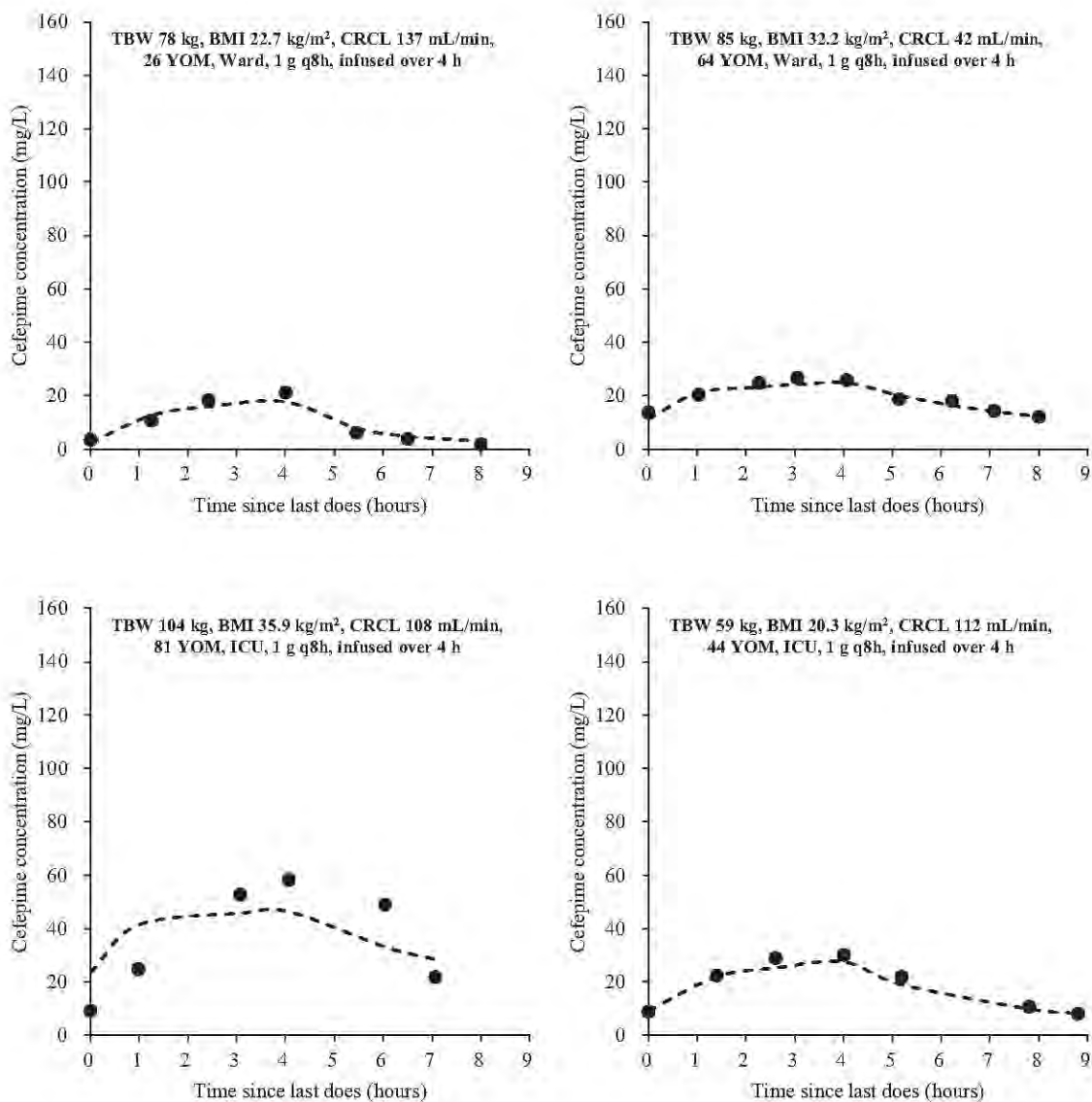

Figure 19. Continued. Observed and predicted serum cefepime concentration-time profiles for all 30 patients using Model I in Table 23 (a two-compartment model with inter-individual variability estimated for CL and V<sub>1</sub>, proportional residual error, zero-order input, and first-order, linear elimination). Filled circles represent the observed cefepime concentrations and dashed lines represent the model-predicted concentrations using Model I in Table 23 (a two-compartment model with inter-individual variability estimated for CL and V<sub>1</sub>, proportional residual error, zero-order input, and first-order, linear elimination).

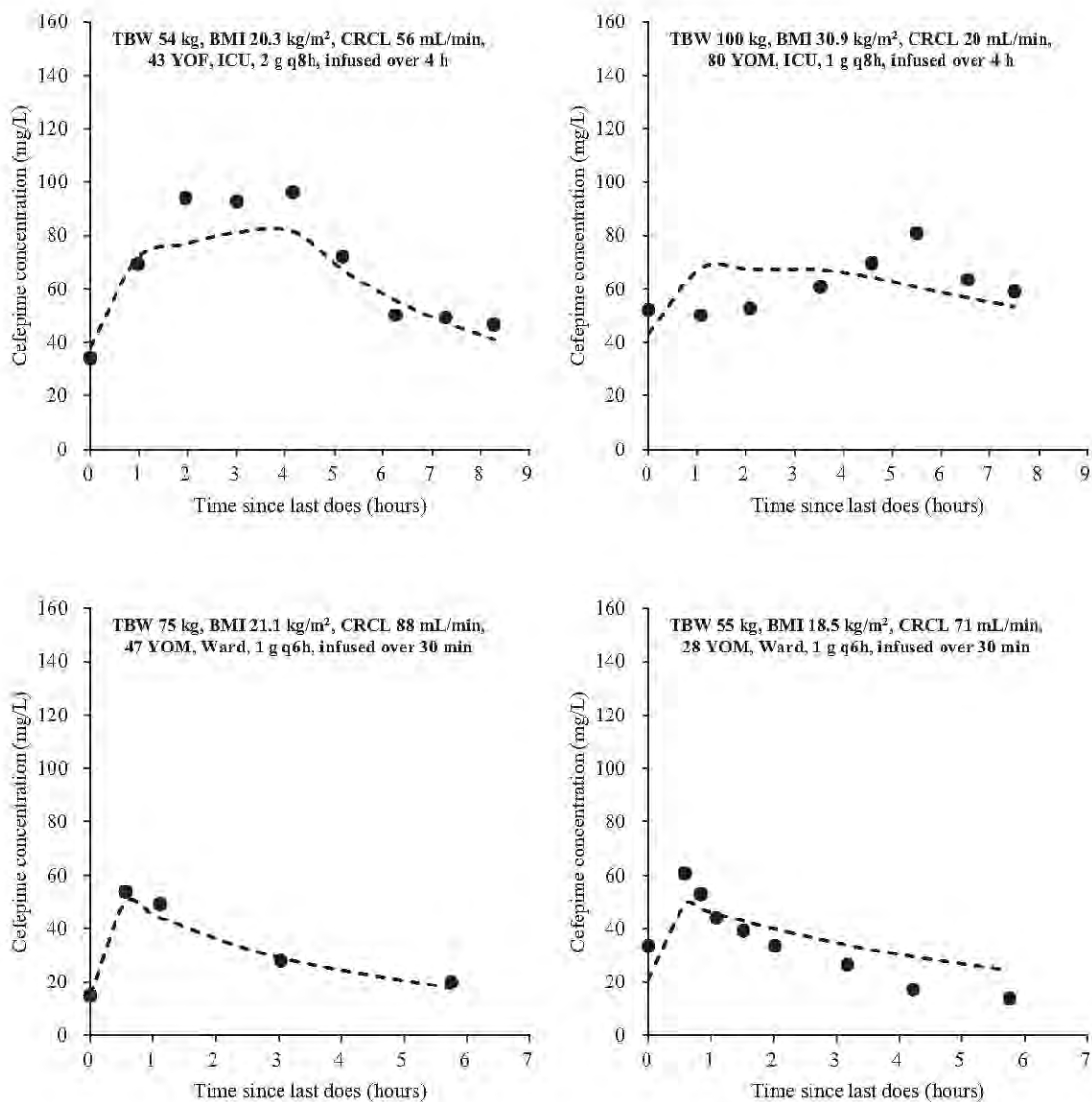

Figure 19. Continued. Observed and predicted serum cefepime concentration-time profiles for all 30 patients using Model I in Table 23 (a two-compartment model with inter-individual variability estimated for CL and V<sub>1</sub>, proportional residual error, zero-order input, and first-order, linear elimination). Filled circles represent the observed cefepime concentrations and dashed lines represent the model-predicted concentrations using Model I in Table 23 (a two-compartment model with inter-individual variability estimated for CL and V<sub>1</sub>, proportional residual error, zero-order input, and first-order, linear elimination).

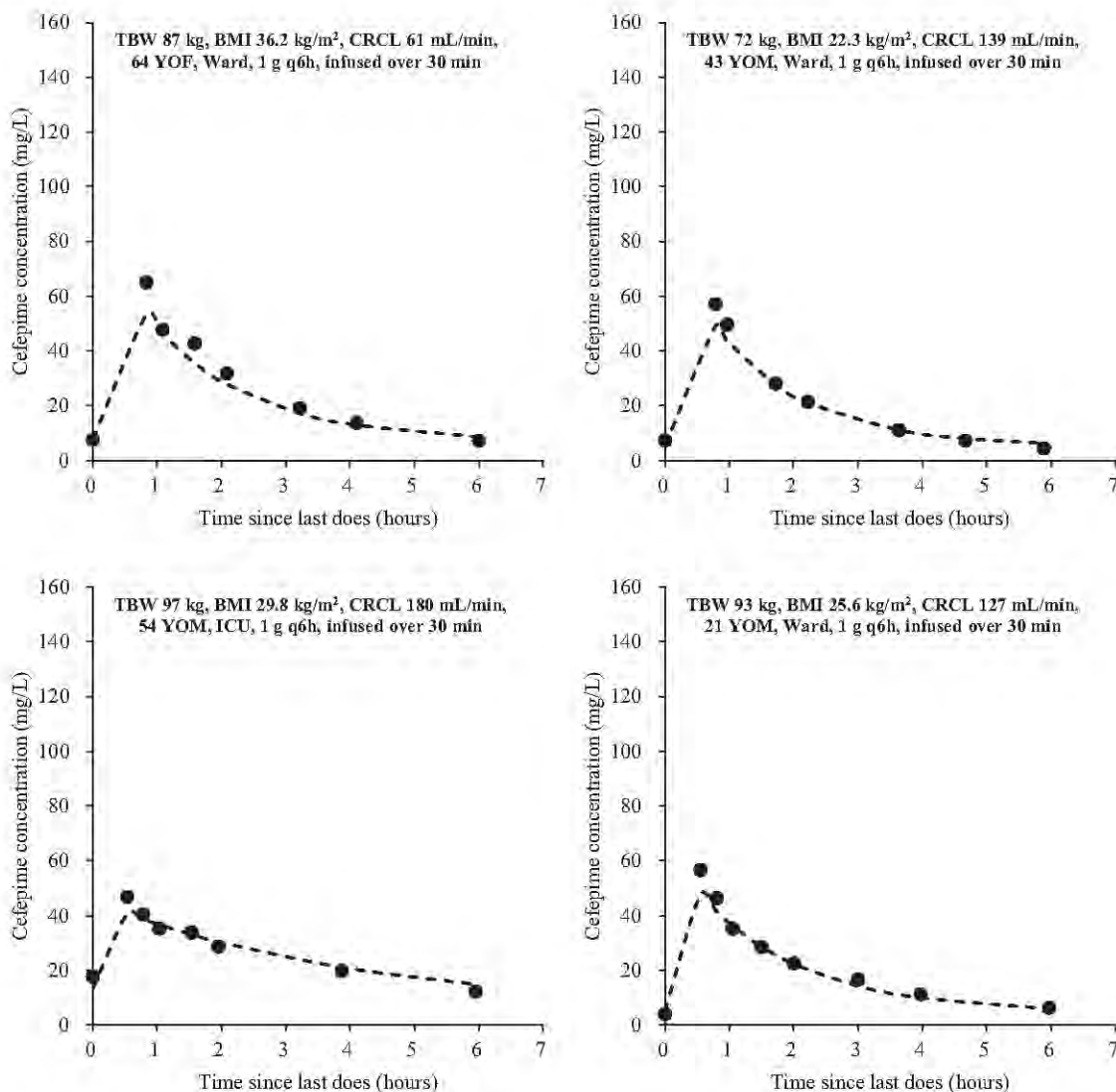

Figure 19. Continued. Observed and predicted serum cefepime concentration-time profiles for all 30 patients using Model I in Table 23 (a two-compartment model with inter-individual variability estimated for CL and V<sub>1</sub>, proportional residual error, zero-order input, and first-order, linear elimination). Filled circles represent the observed cefepime concentrations and dashed lines represent the model-predicted concentrations using Model I in Table 23 (a two-compartment model with inter-individual variability estimated for CL and V<sub>1</sub>, proportional residual error, zero-order input, and first-order, linear elimination).

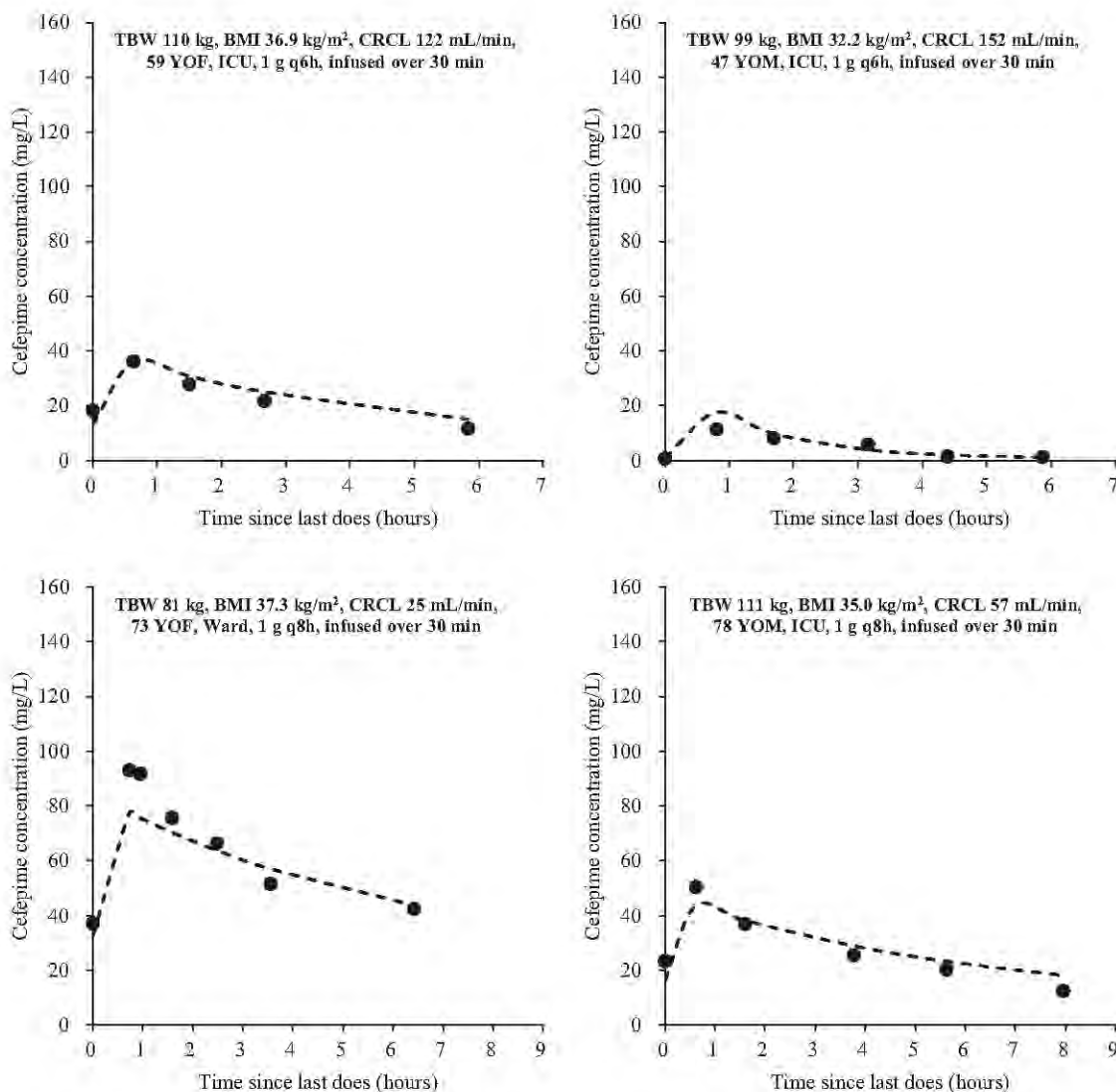

Figure 19. Continued. Observed and predicted serum cefepime concentration-time profiles for all 30 patients using Model I in Table 23 (a two-compartment model with inter-individual variability estimated for CL and V<sub>1</sub>, proportional residual error, zero-order input, and first-order, linear elimination). Filled circles represent the observed cefepime concentrations and dashed lines represent the model-predicted concentrations using Model I in Table 23 (a two-compartment model with inter-individual variability estimated for CL and V<sub>1</sub>, proportional residual error, zero-order input, and first-order, linear elimination).

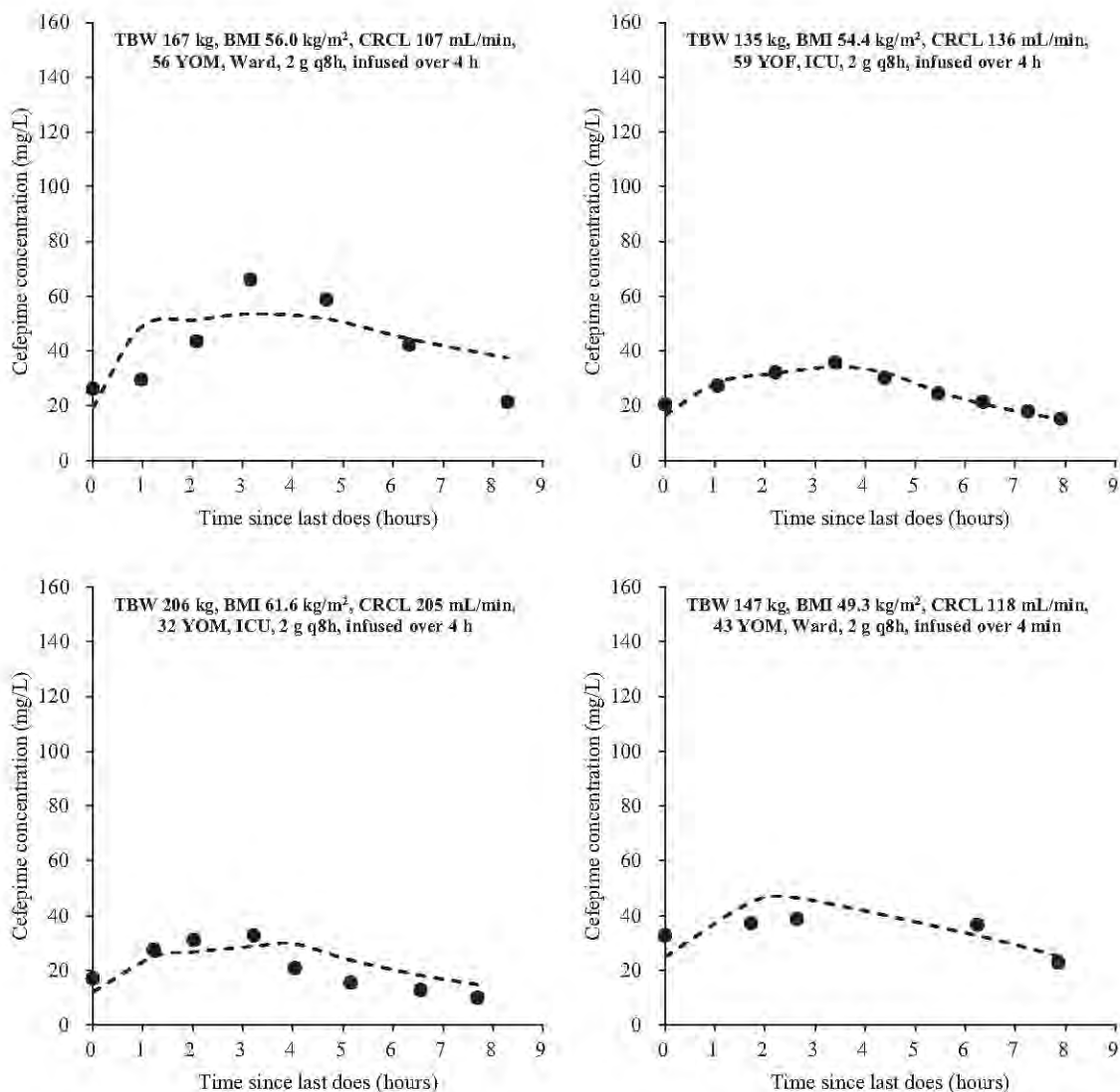

Figure 19. Continued. Observed and predicted serum cefepime concentration-time profiles for all 30 patients using Model I in Table 23 (a two-compartment model with inter-individual variability estimated for CL and V<sub>1</sub>, proportional residual error, zero-order input, and first-order, linear elimination). Filled circles represent the observed cefepime concentrations and dashed lines represent the model-predicted concentrations using Model I in Table 23 (a two-compartment model with inter-individual variability estimated for CL and V<sub>1</sub>, proportional residual error, zero-order input, and first-order, linear elimination).

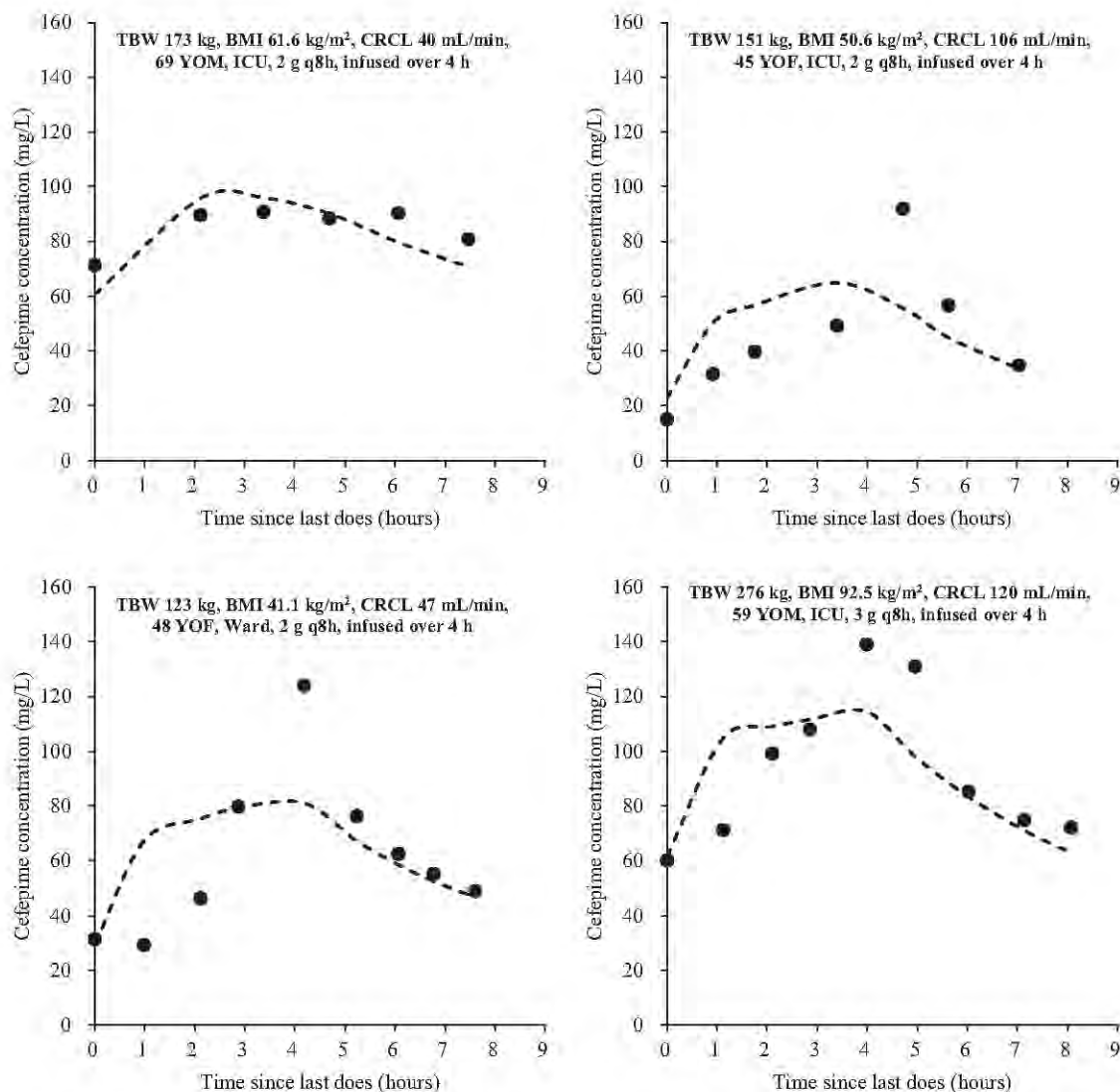

Figure 19. Continued. Observed and predicted serum cefepime concentration-time profiles for all 30 patients using Model I in Table 23 (a two-compartment model with inter-individual variability estimated for CL and V<sub>1</sub>, proportional residual error, zero-order input, and first-order, linear elimination). Filled circles represent the observed cefepime concentrations and dashed lines represent the model-predicted concentrations using Model I in Table 23 (a two-compartment model with inter-individual variability estimated for CL and V<sub>1</sub>, proportional residual error, zero-order input, and first-order, linear elimination).

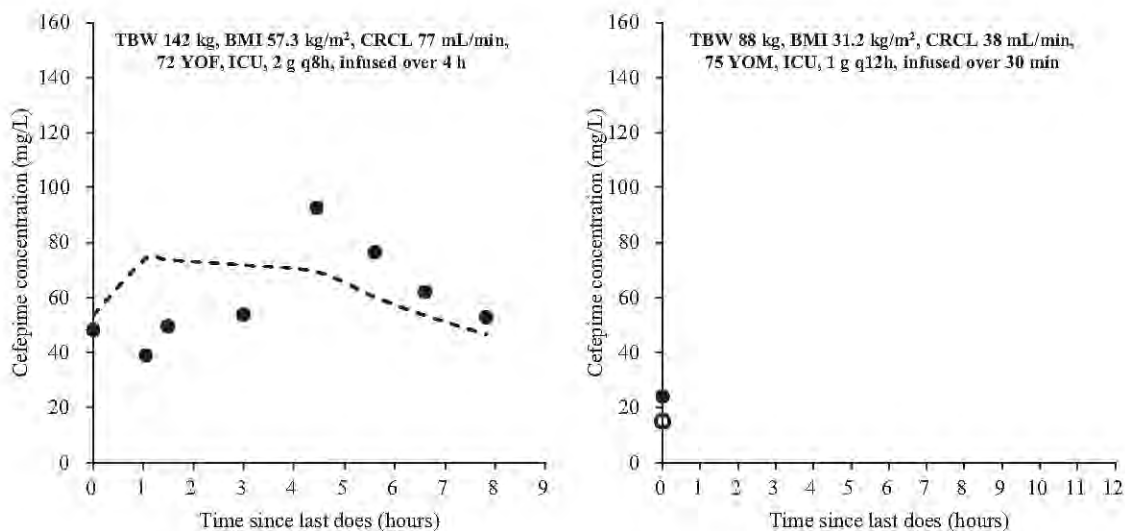

Figure 19. Continued. Observed and predicted serum cefepime concentration-time profiles for all 30 patients using Model I in Table 23 (a two-compartment model with inter-individual variability estimated for CL and V<sub>1</sub>, proportional residual error, zero-order input, and first-order, linear elimination). Filled circles represent the observed cefepime concentrations, and dashed lines an open circle represent the model-predicted concentrations using Model I in Table 23 (a two-compartment model with inter-individual variability estimated for CL and V<sub>1</sub>, proportional residual error, zero-order input, and first-order, linear elimination).

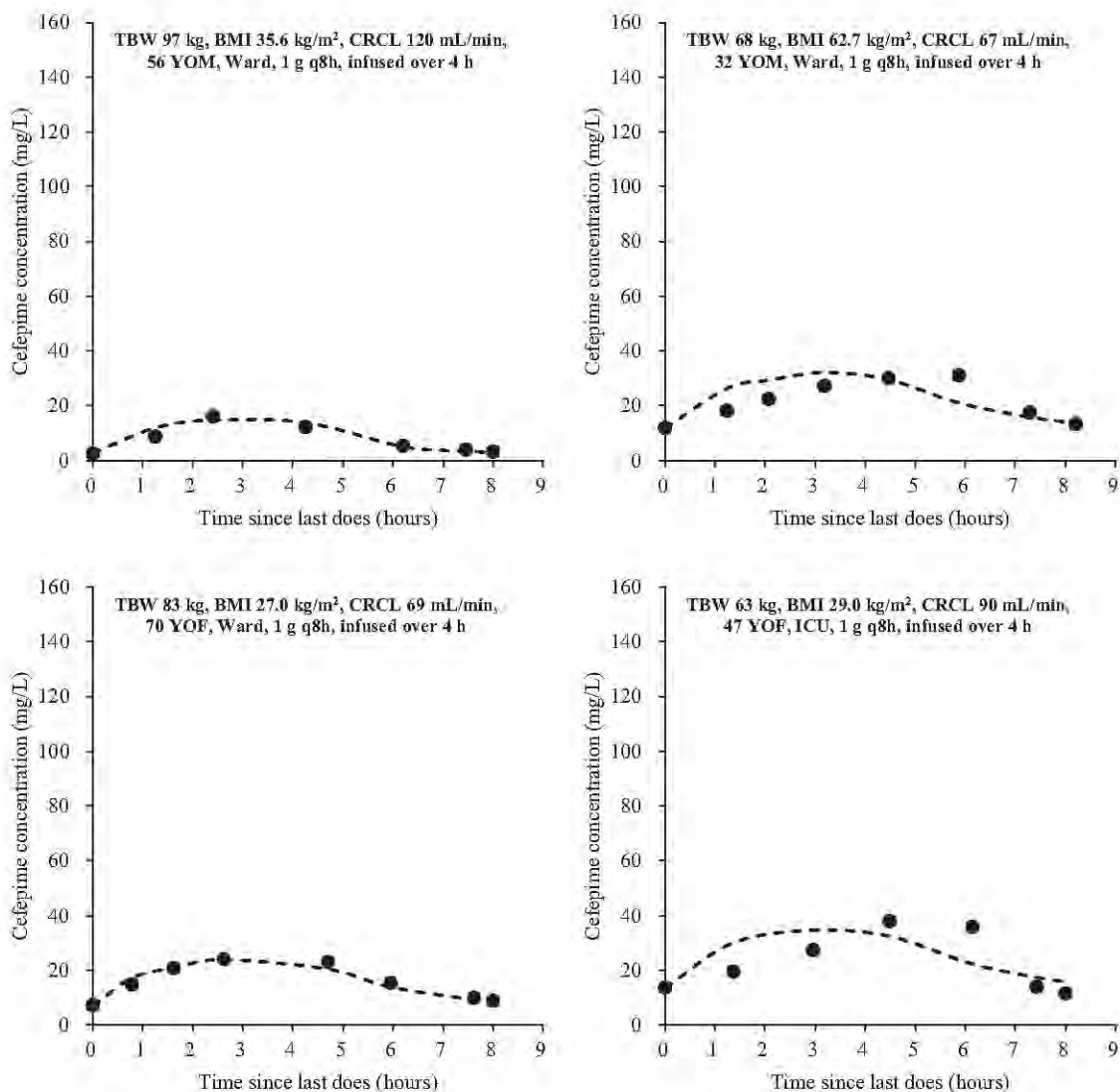

Figure 20. Observed and predicted serum cefepime concentration-time profiles for all 30 patients using Model K in Table 23 (a two-compartment model with inter-individual variability estimated for CL and Q, proportional residual error, zero-order input, and first-order, linear elimination). Filled circles represent the observed cefepime concentrations and dashed lines represent the model-predicted concentrations using Model K in Table 23 (a two-compartment model with inter-individual variability estimated for CL and Q, proportional residual error, zero-order input, and first-order, linear elimination).



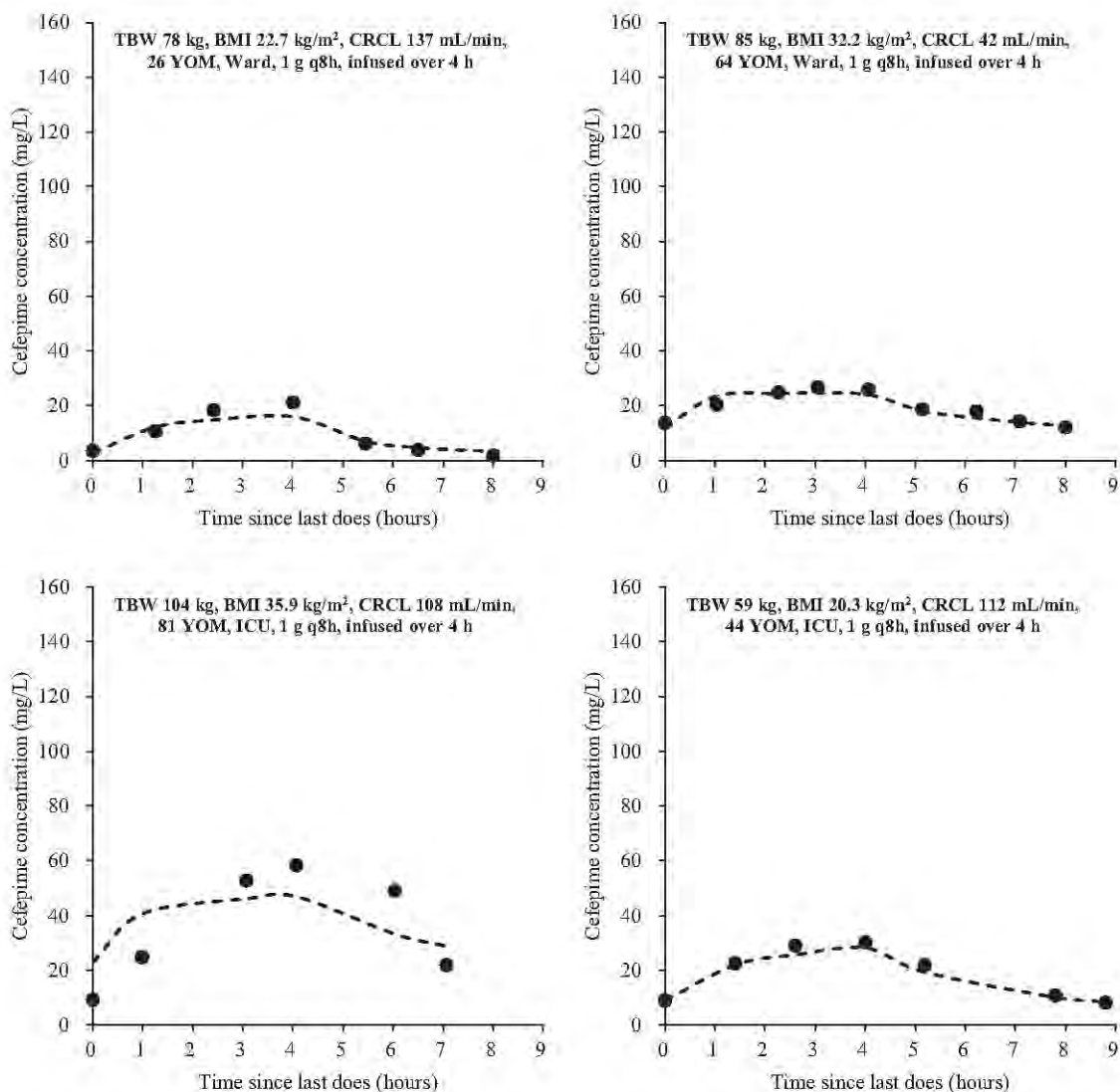

Figure 20. Continued. Observed and predicted serum cefepime concentration-time profiles for all 30 patients using Model K in Table 23 (a two-compartment model with inter-individual variability estimated for CL and Q, proportional residual error, zero-order input, and first-order, linear elimination). Filled circles represent the observed cefepime concentrations and dashed lines represent the model-predicted concentrations using Model K in Table 23 (a two-compartment model with inter-individual variability estimated for CL and Q, proportional residual error, zero-order input, and first-order, linear elimination).

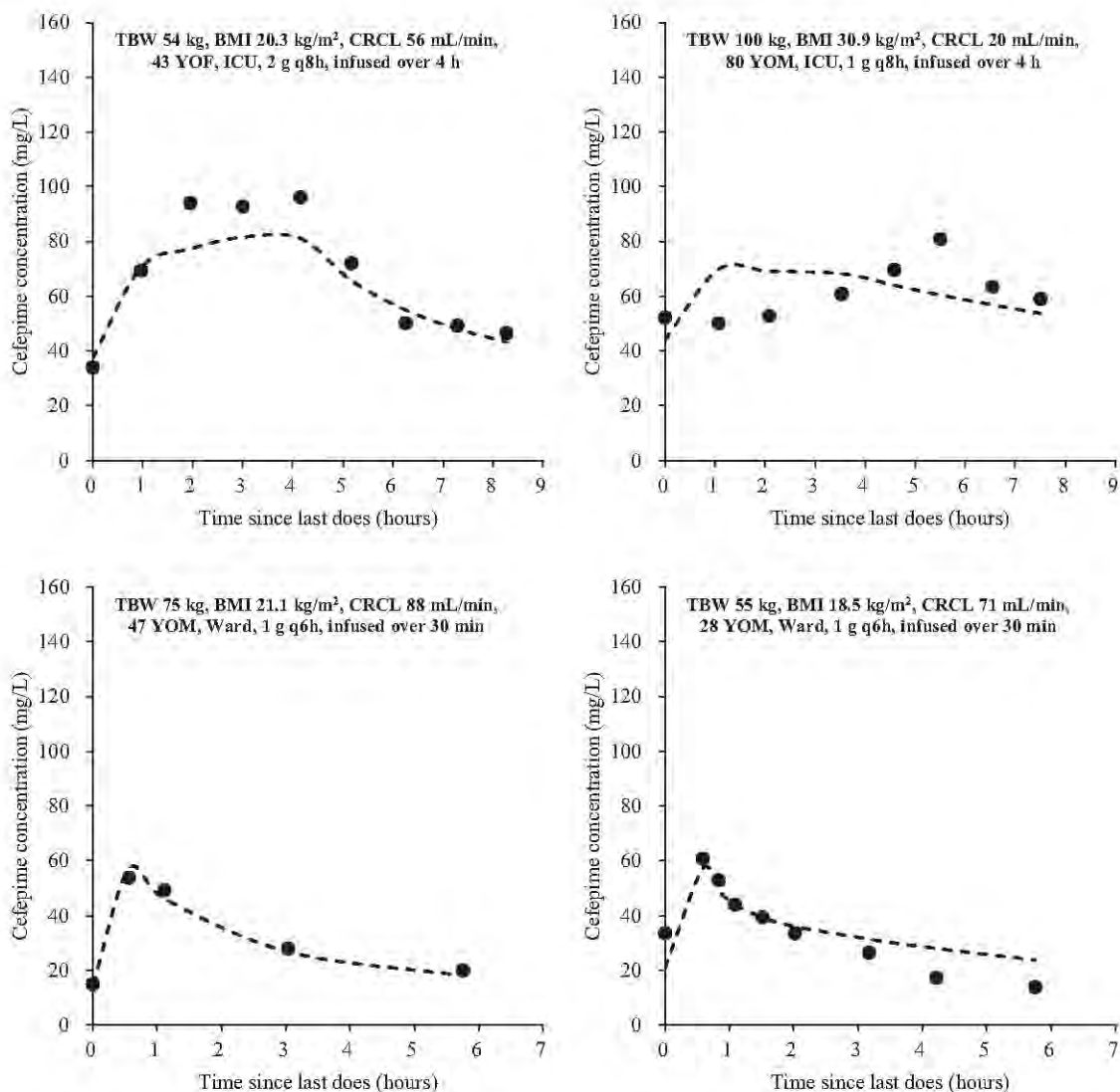

Figure 20. Continued. Observed and predicted serum cefepime concentration-time profiles for all 30 patients using Model K in Table 23 (a two-compartment model with inter-individual variability estimated for CL and Q, proportional residual error, zero-order input, and first-order, linear elimination). Filled circles represent the observed cefepime concentrations and dashed lines represent the model-predicted concentrations using Model K in Table 23 (a two-compartment model with inter-individual variability estimated for CL and Q, proportional residual error, zero-order input, and first-order, linear elimination).

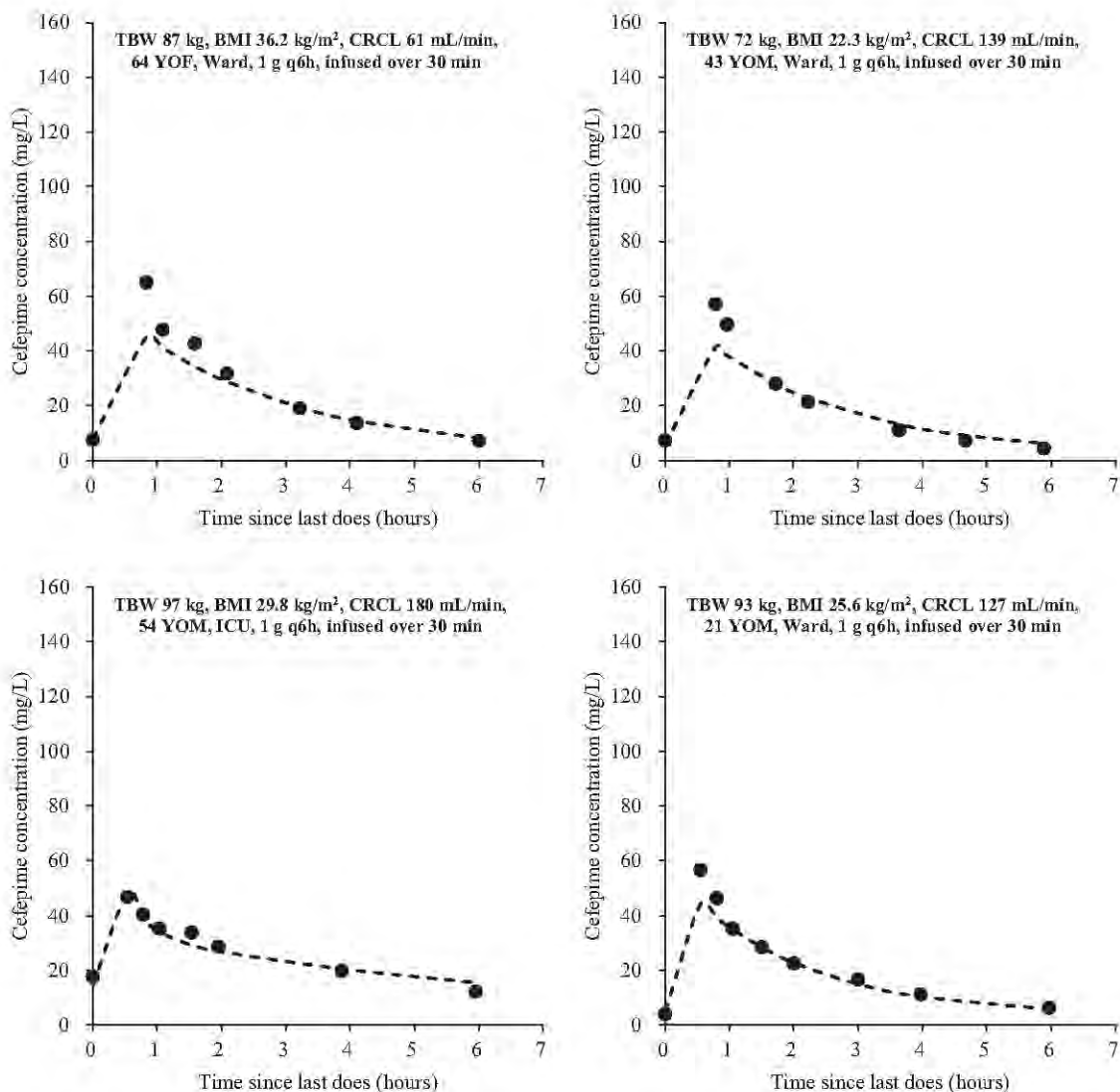

Figure 20. Continued. Observed and predicted serum cefepime concentration-time profiles for all 30 patients using Model K in Table 23 (a two-compartment model with inter-individual variability estimated for CL and Q, proportional residual error, zero-order input, and first-order, linear elimination). Filled circles represent the observed cefepime concentrations and dashed lines represent the model-predicted concentrations using Model K in Table 23 (a two-compartment model with inter-individual variability estimated for CL and Q, proportional residual error, zero-order input, and first-order, linear elimination).

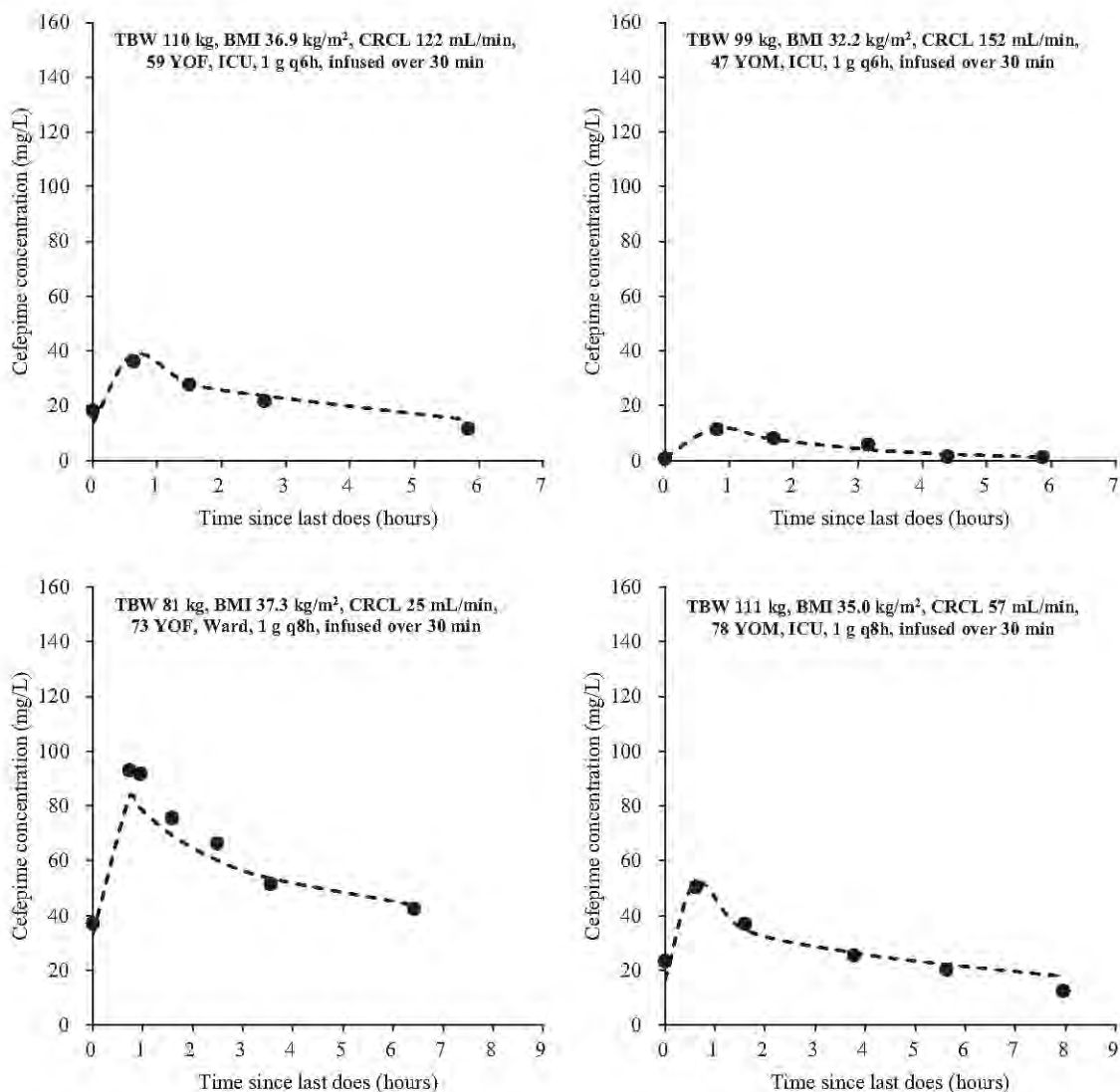

Figure 20. Continued. Observed and predicted serum cefepime concentration-time profiles for all 30 patients using Model K in Table 23 (a two-compartment model with inter-individual variability estimated for CL and Q, proportional residual error, zero-order input, and first-order, linear elimination). Filled circles represent the observed cefepime concentrations and dashed lines represent the model-predicted concentrations using Model K in Table 23 (a two-compartment model with inter-individual variability estimated for CL and Q, proportional residual error, zero-order input, and first-order, linear elimination).

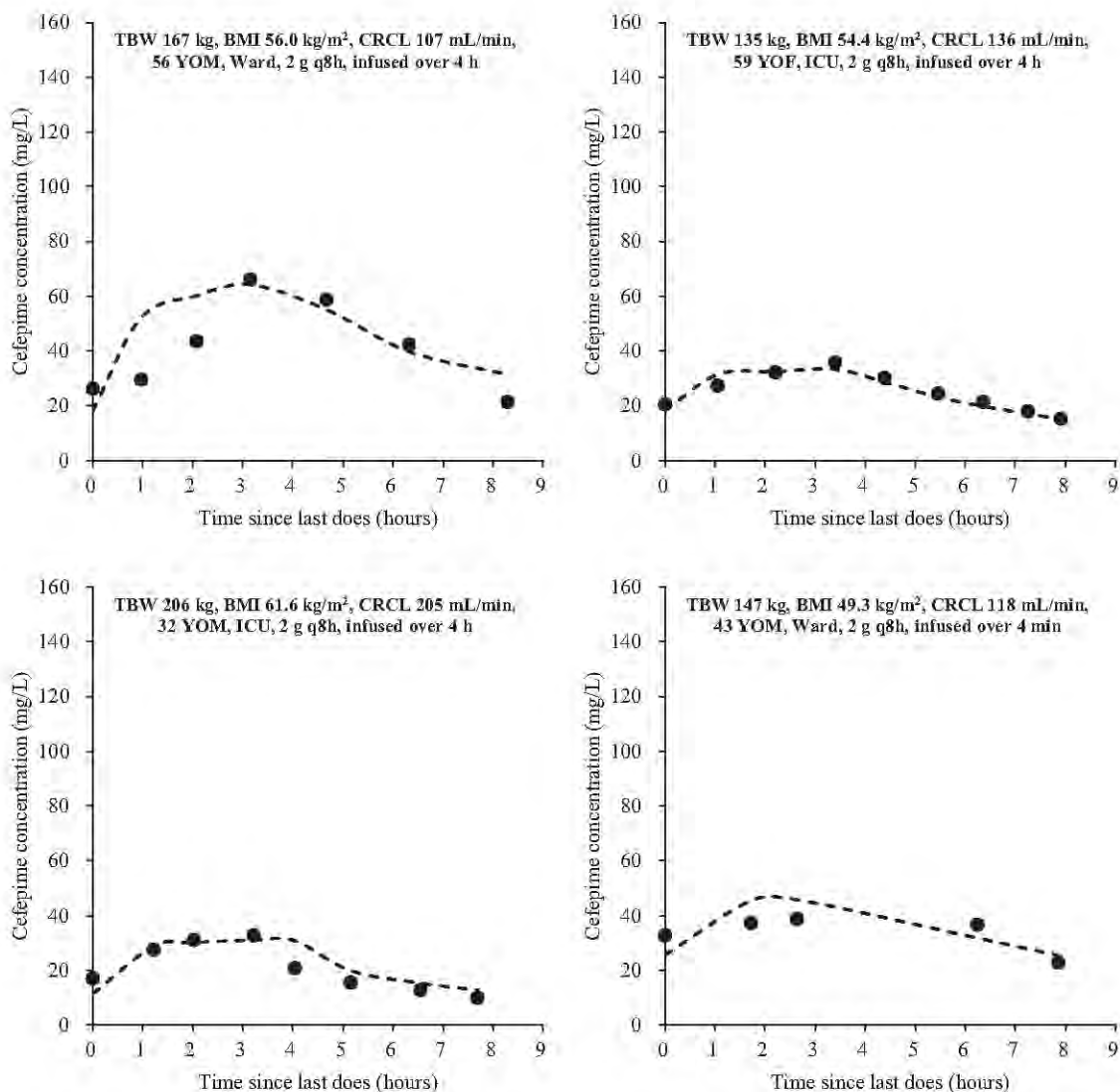

Figure 20. Continued. Observed and predicted serum cefepime concentration-time profiles for all 30 patients using Model K in Table 23 (a two-compartment model with inter-individual variability estimated for CL and Q, proportional residual error, zero-order input, and first-order, linear elimination). Filled circles represent the observed cefepime concentrations and dashed lines represent the model-predicted concentrations using Model K in Table 23 (a two-compartment model with inter-individual variability estimated for CL and Q, proportional residual error, zero-order input, and first-order, linear elimination).

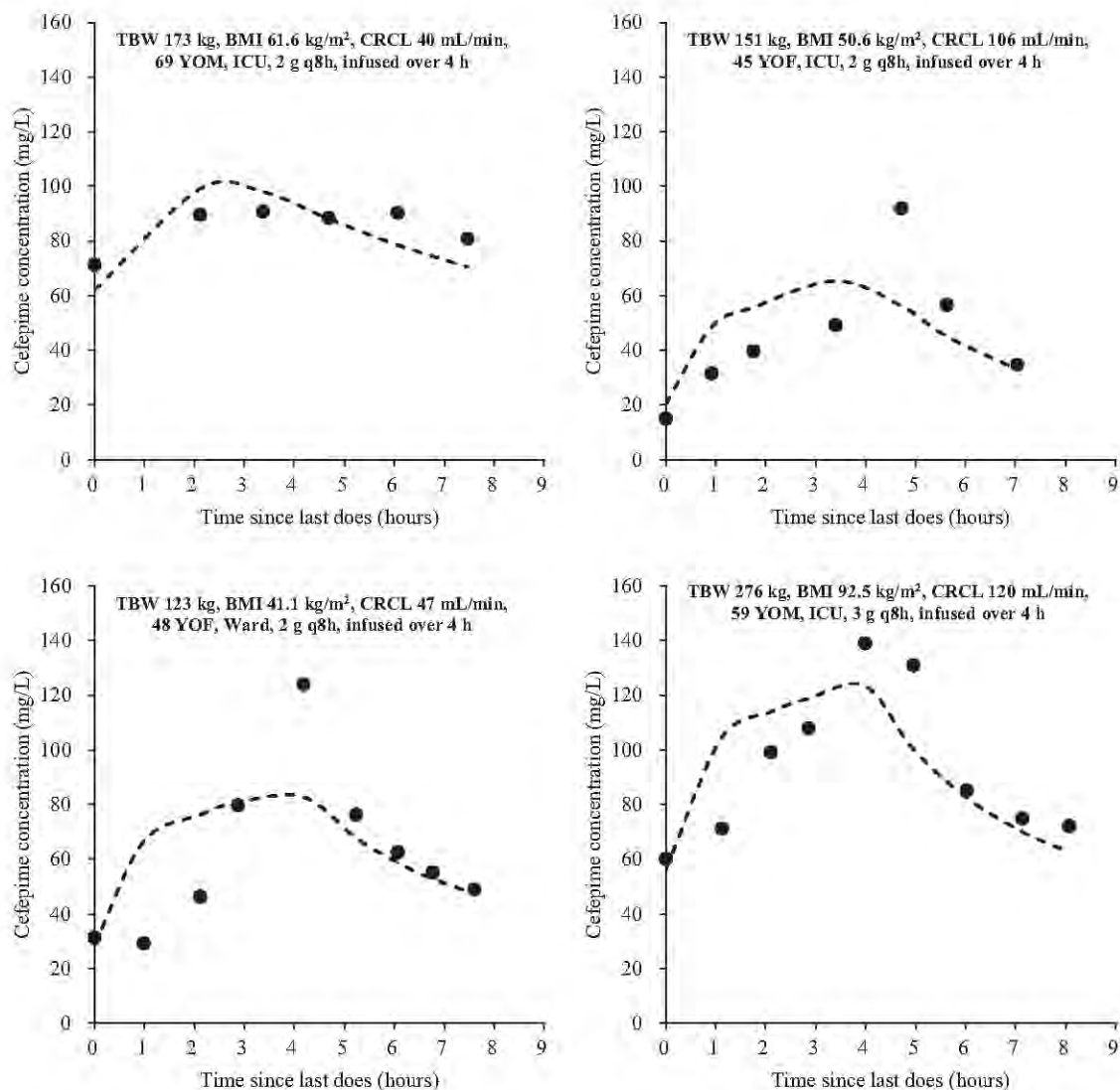

Figure 20. Continued. Observed and predicted serum cefepime concentration-time profiles for all 30 patients using Model K in Table 23 (a two-compartment model with inter-individual variability estimated for CL and Q, proportional residual error, zero-order input, and first-order, linear elimination). Filled circles represent the observed cefepime concentrations and dashed lines represent the model-predicted concentrations using Model K in Table 23 (a two-compartment model with inter-individual variability estimated for CL and Q, proportional residual error, zero-order input, and first-order, linear elimination).

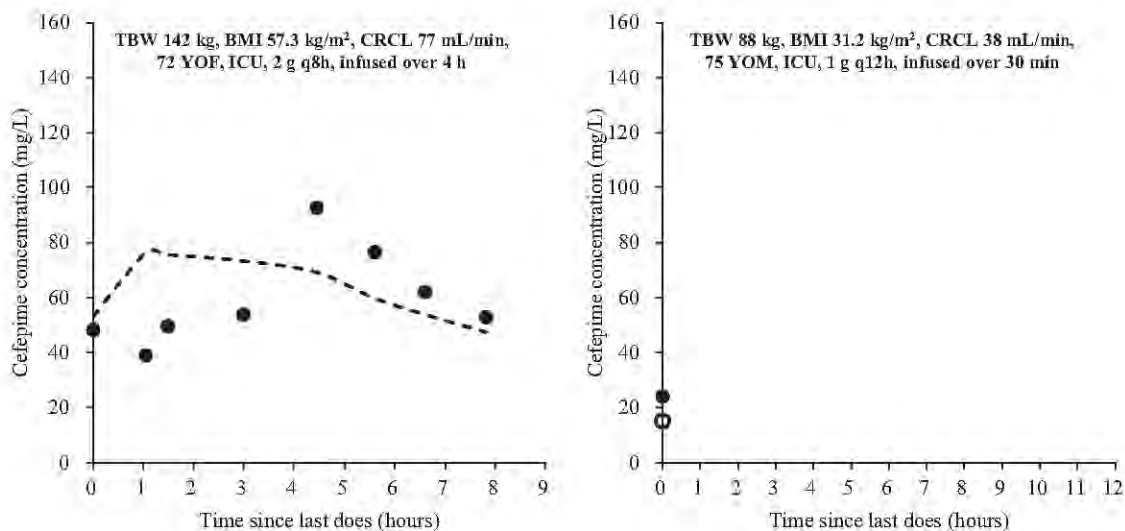

Figure 20. Continued. Observed and predicted serum cefepime concentration-time profiles for all 30 patients using Model K in Table 23 (a two-compartment model with inter-individual variability estimated for CL and Q, proportional residual error, zero-order input, and first-order, linear elimination). Filled circles represent the observed cefepime concentrations, and dashed lines and an open circle represent the model-predicted concentrations using Model K in Table 23 (a two-compartment model with inter-individual variability estimated for CL and Q, proportional residual error, zero-order input, and first-order, linear elimination).

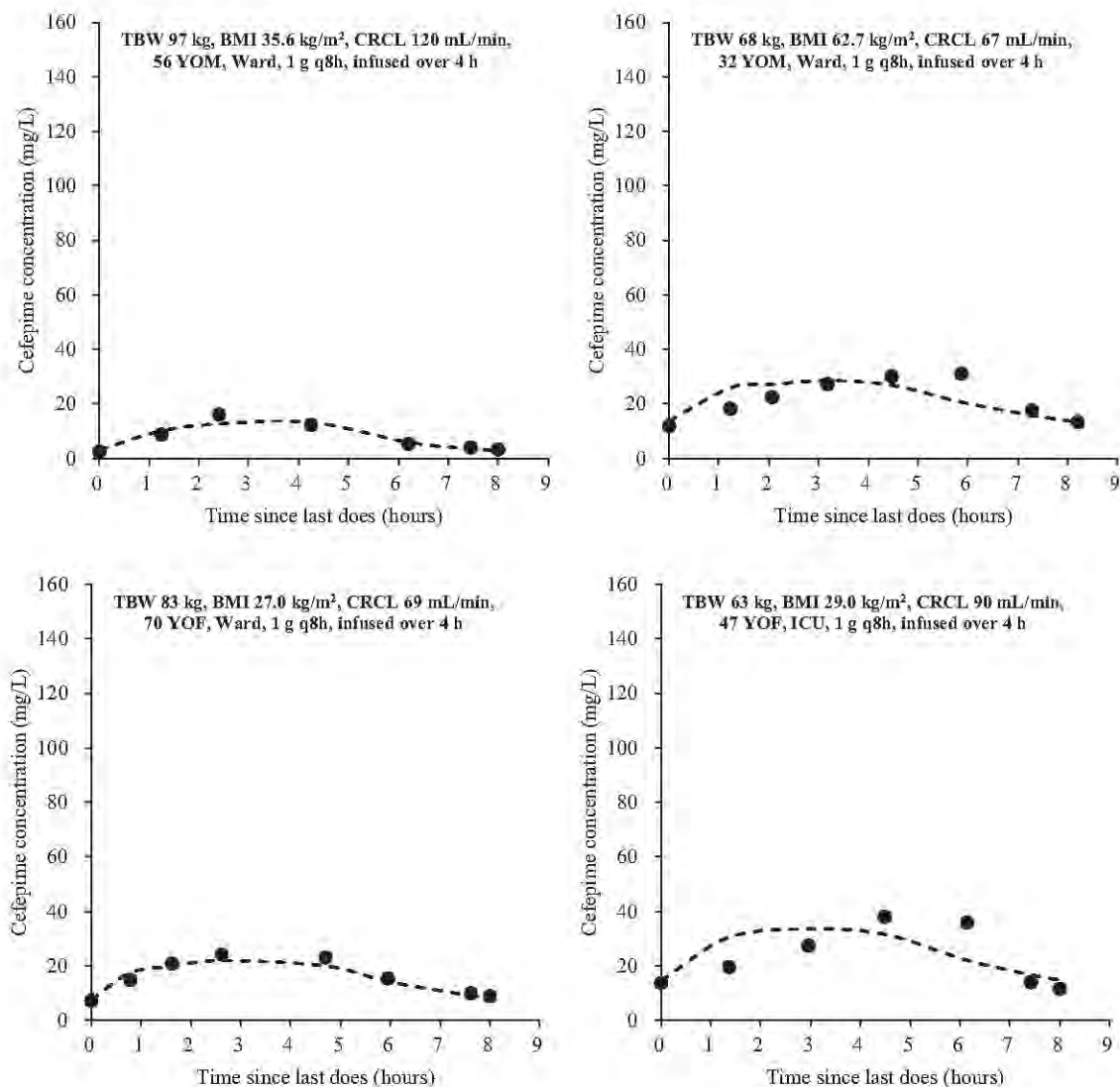

Figure 21. Observed and predicted serum cefepime concentration-time profiles for all 30 patients using Model F in Table 23 (a one-compartment model with inter-individual variability estimated for both CL and V, proportional residual error, zero-order input, and first-order, linear elimination). Filled circles represent the observed cefepime concentrations, and dashed lines represent the model-predicted concentrations using Model F in Table 23 (a one-compartment model with inter-individual variability estimated for both CL and V, proportional residual error, zero-order input, and first-order, linear elimination).



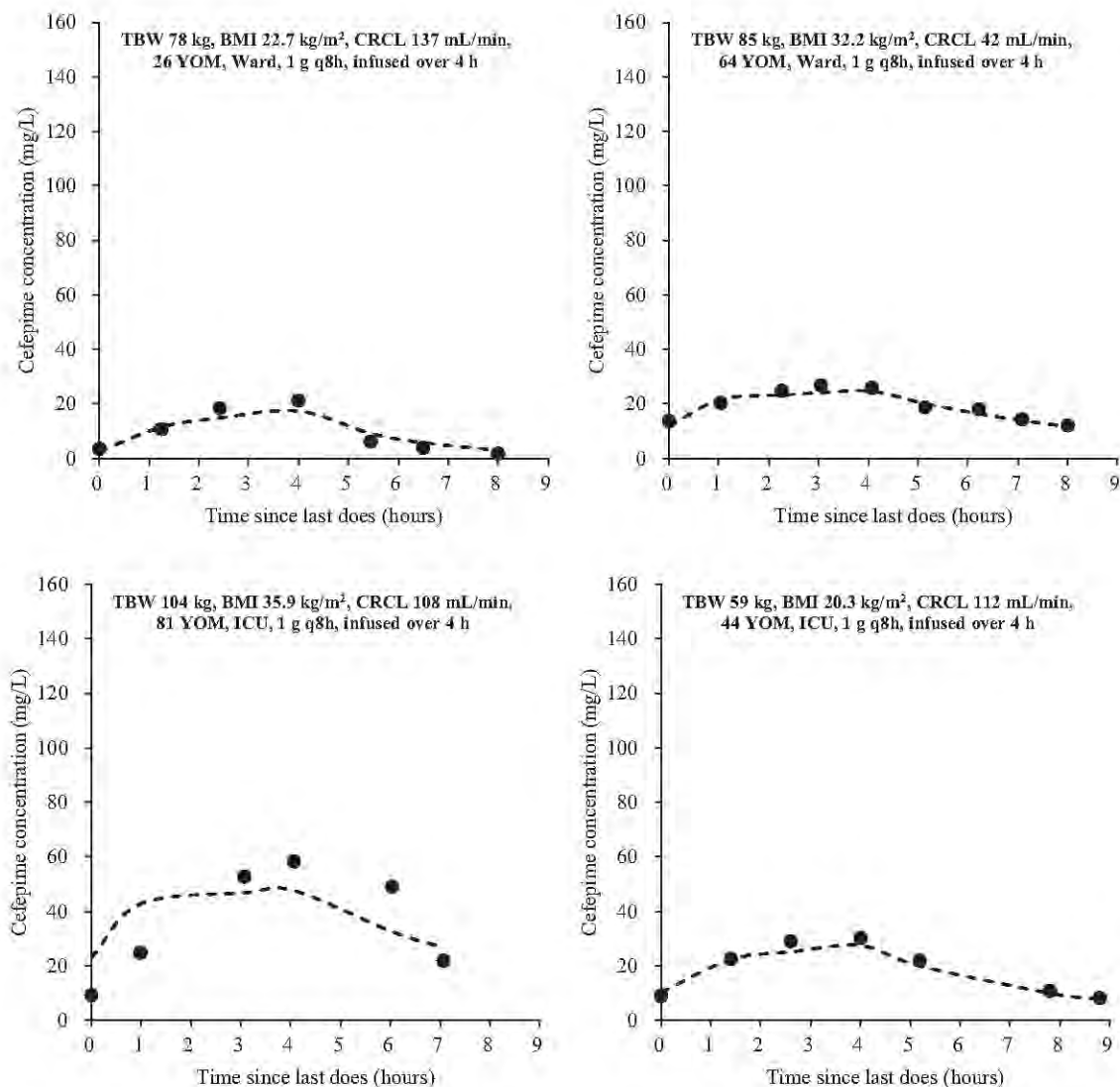

Figure 21. Continued. Observed and predicted serum cefepime concentration-time profiles for all 30 patients using Model F in Table 23 (a one-compartment model with inter-individual variability estimated for both CL and V, proportional residual error, zero-order input, and first-order, linear elimination). Filled circles represent the observed cefepime concentrations, and dashed lines represent the model-predicted concentrations using Model F in Table 23 (a one-compartment model with inter-individual variability estimated for both CL and V, proportional residual error, zero-order input, and first-order, linear elimination).

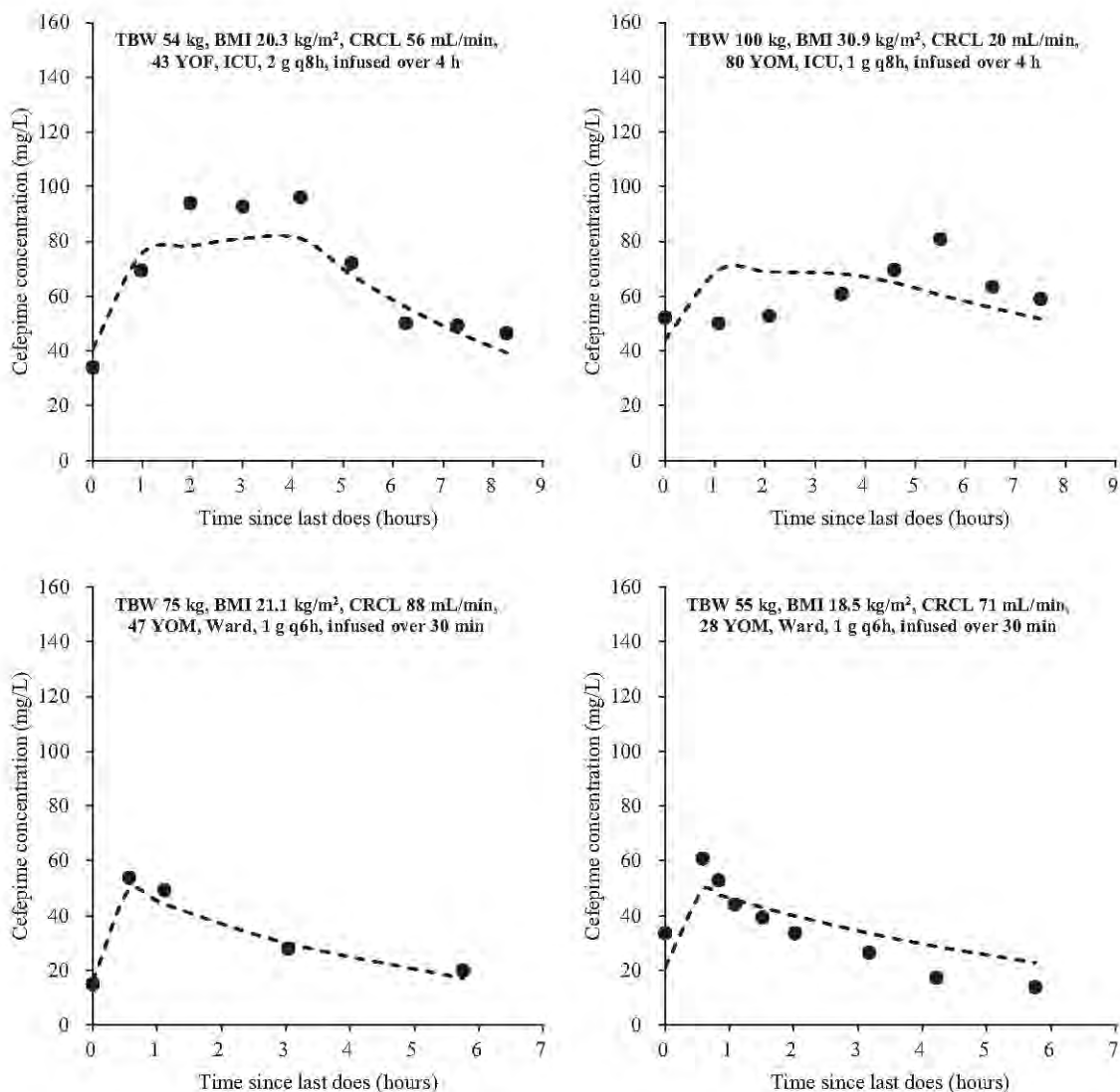

Figure 21. Continued. Observed and predicted serum cefepime concentration-time profiles for all 30 patients using Model F in Table 23 (a one-compartment model with inter-individual variability estimated for both CL and V, proportional residual error, zero-order input, and first-order, linear elimination). Filled circles represent the observed cefepime concentrations, and dashed lines represent the model-predicted concentrations using Model F in Table 23 (a one-compartment model with inter-individual variability estimated for both CL and V, proportional residual error, zero-order input, and first-order, linear elimination).

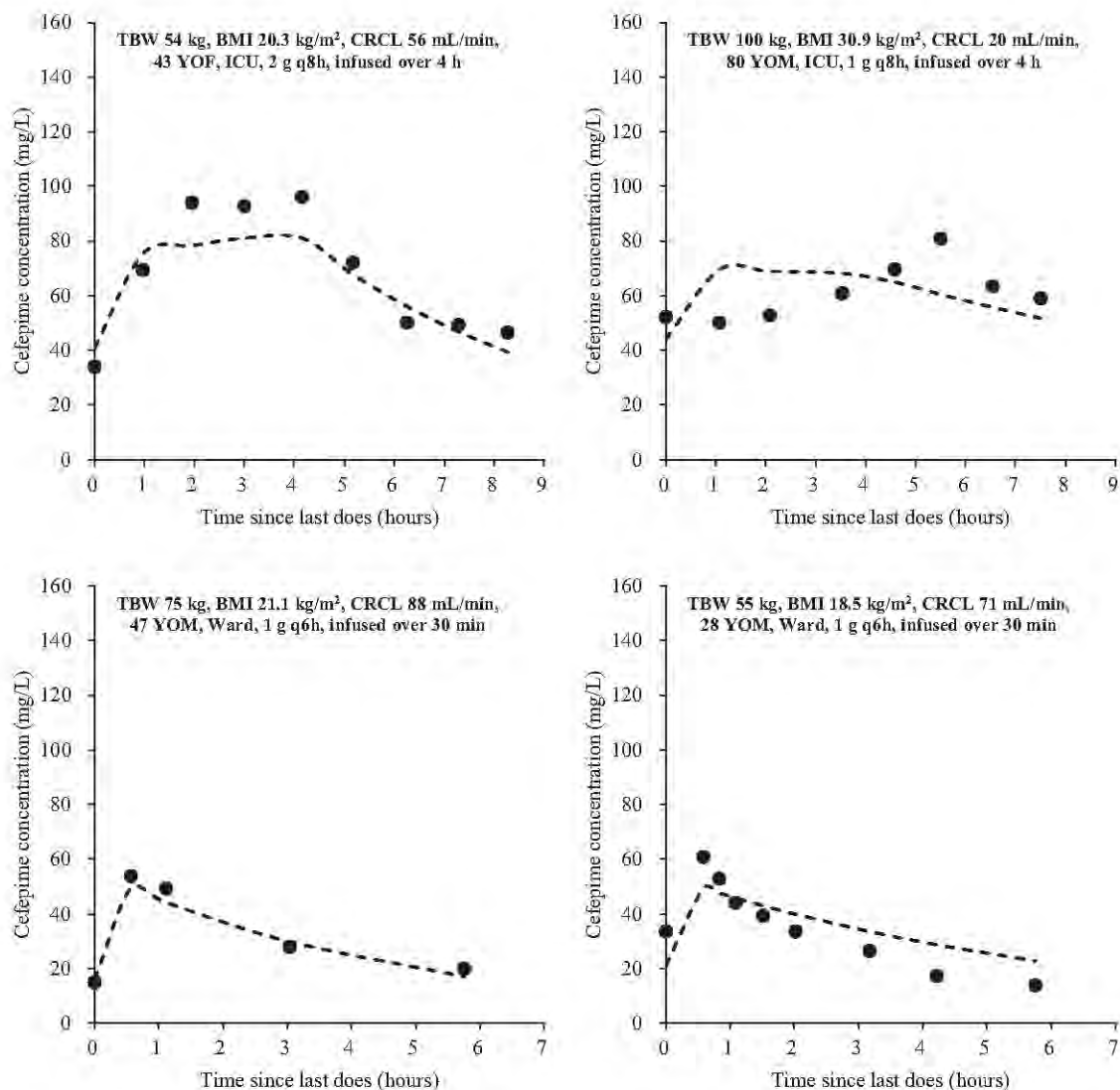

Figure 21. Continued. Observed and predicted serum cefepime concentration-time profiles for all 30 patients using Model F in Table 23 (a one-compartment model with inter-individual variability estimated for both CL and V, proportional residual error, zero-order input, and first-order, linear elimination). Filled circles represent the observed cefepime concentrations, and dashed lines represent the model-predicted concentrations using Model F in Table 23 (a one-compartment model with inter-individual variability estimated for both CL and V, proportional residual error, zero-order input, and first-order, linear elimination).

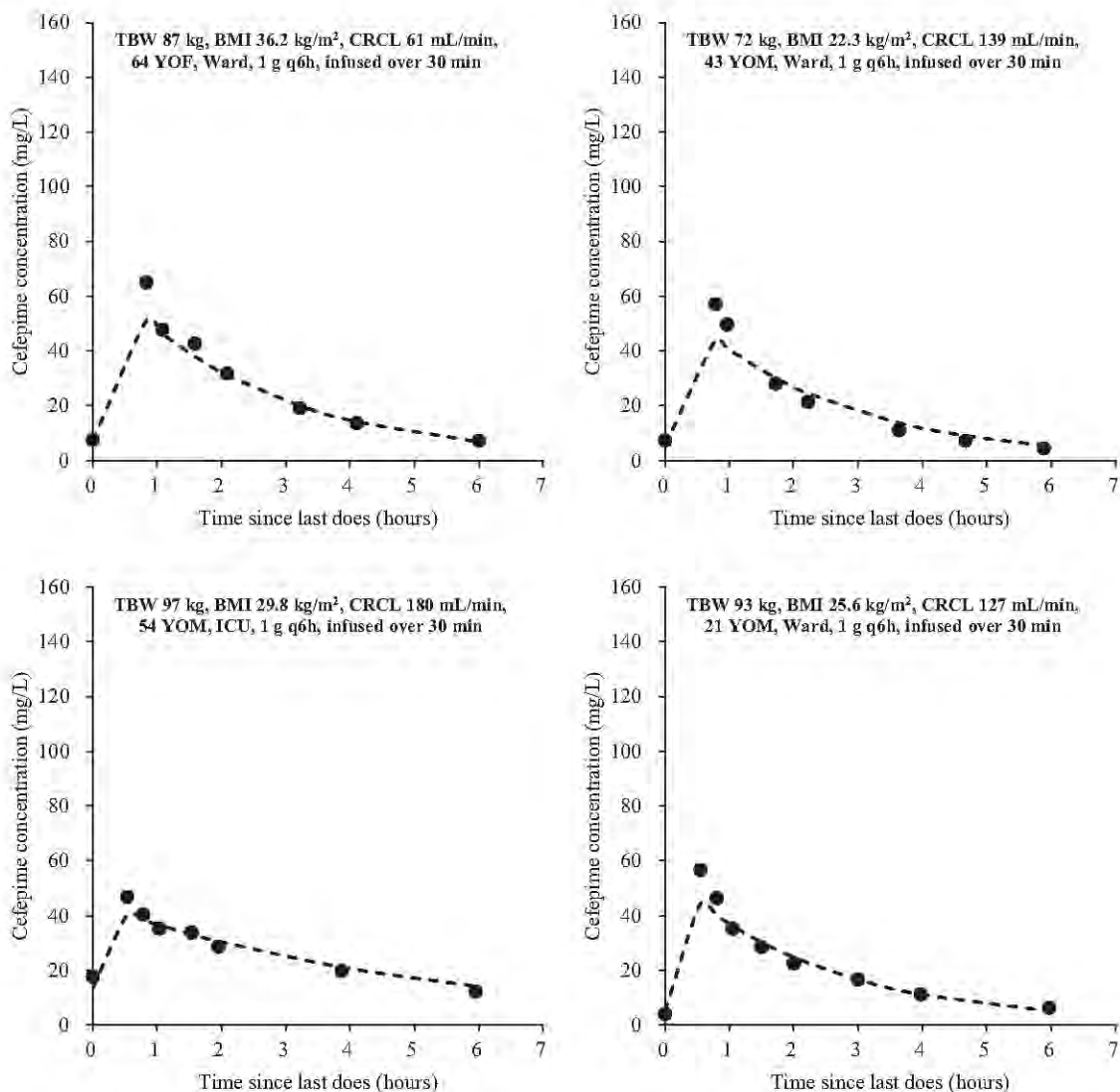

Figure 21. Continued. Observed and predicted serum cefepime concentration-time profiles for all 30 patients using Model F in Table 23 (a one-compartment model with inter-individual variability estimated for both CL and V, proportional residual error, zero-order input, and first-order, linear elimination). Filled circles represent the observed cefepime concentrations, and dashed lines represent the model-predicted concentrations using Model F in Table 23 (a one-compartment model with inter-individual variability estimated for both CL and V, proportional residual error, zero-order input, and first-order, linear elimination).

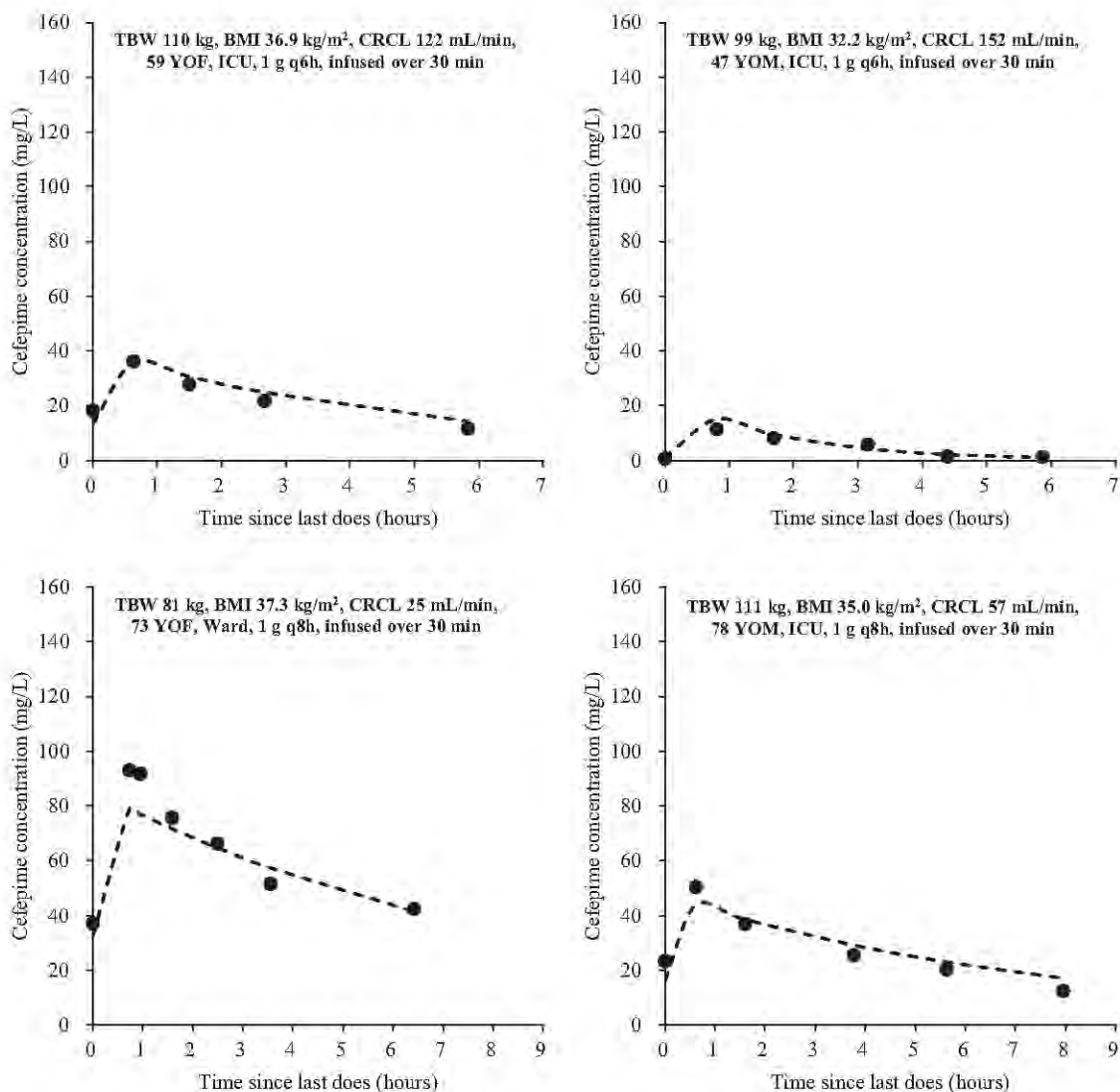

Figure 21. Continued. Observed and predicted serum cefepime concentration-time profiles for all 30 patients using Model F in Table 23 (a one-compartment model with inter-individual variability estimated for both CL and V, proportional residual error, zero-order input, and first-order, linear elimination). Filled circles represent the observed cefepime concentrations, and dashed lines represent the model-predicted concentrations using Model F in Table 23 (a one-compartment model with inter-individual variability estimated for both CL and V, proportional residual error, zero-order input, and first-order, linear elimination).

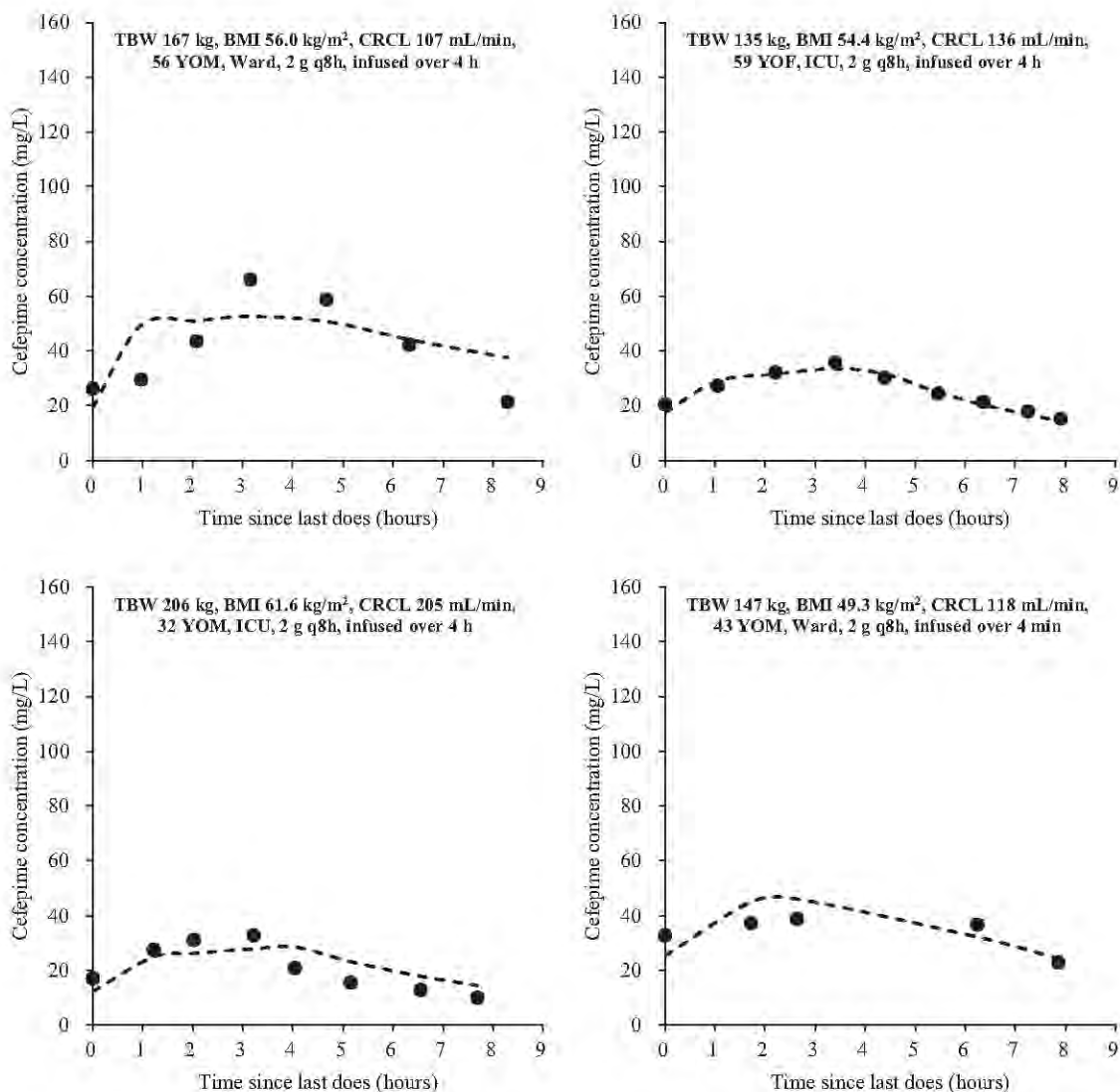

Figure 21. Continued. Observed and predicted serum cefepime concentration-time profiles for all 30 patients using Model F in Table 23 (a one-compartment model with inter-individual variability estimated for both CL and V, proportional residual error, zero-order input, and first-order, linear elimination). Filled circles represent the observed cefepime concentrations, and dashed lines represent the model-predicted concentrations using Model F in Table 23 (a one-compartment model with inter-individual variability estimated for both CL and V, proportional residual error, zero-order input, and first-order, linear elimination).

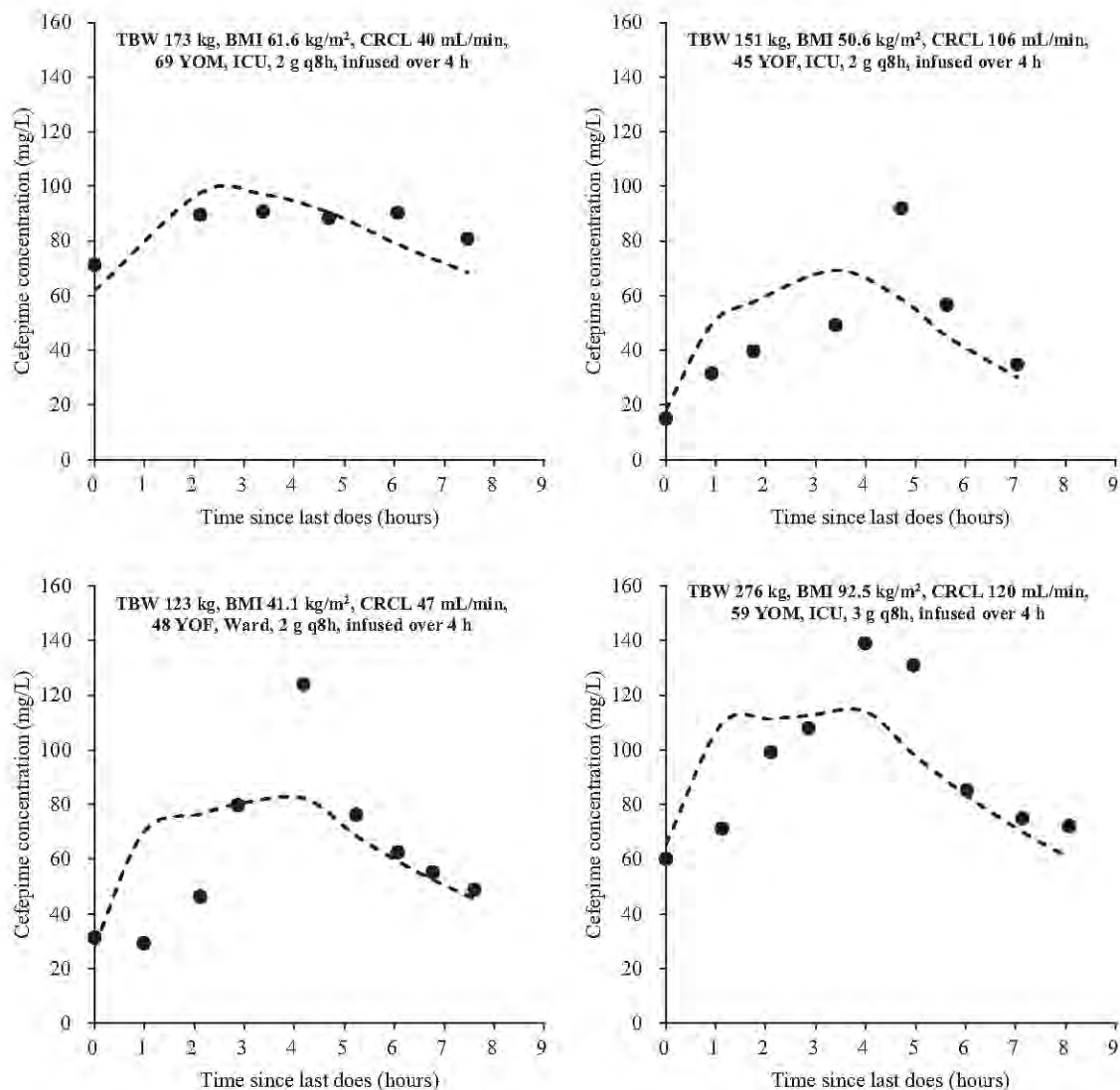

Figure 21. Continued. Observed and predicted serum cefepime concentration-time profiles for all 30 patients using Model F in Table 23 (a one-compartment model with inter-individual variability estimated for both CL and V, proportional residual error, zero-order input, and first-order, linear elimination). Filled circles represent the observed cefepime concentrations, and dashed lines represent the model-predicted concentrations using Model F in Table 23 (a one-compartment model with inter-individual variability estimated for both CL and V, proportional residual error, zero-order input, and first-order, linear elimination).

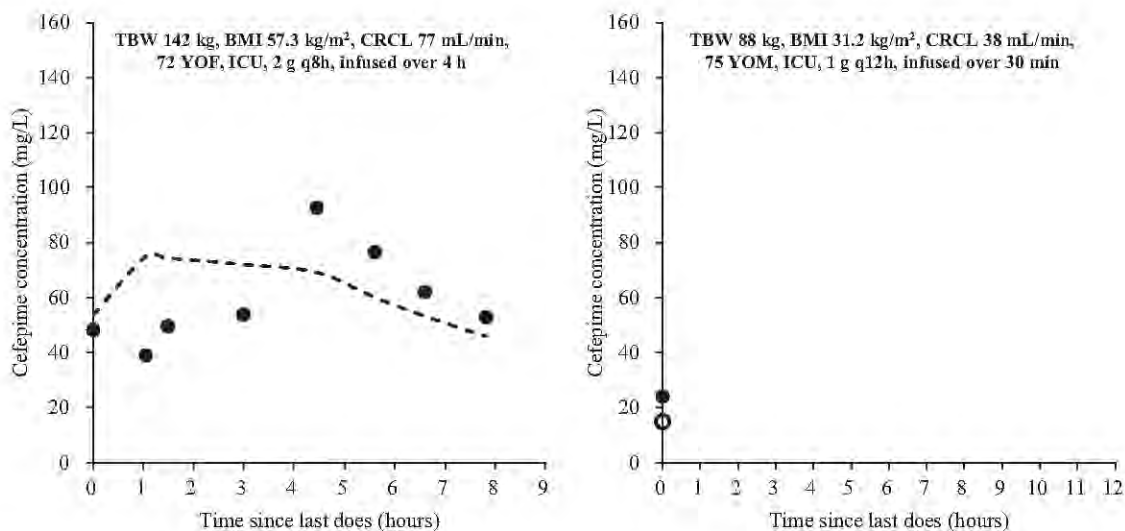

Figure 21. Continued. Observed and predicted serum cefepime concentration-time profiles for all 30 patients using Model F in Table 23 (a one-compartment model with inter-individual variability estimated for both CL and V, proportional residual error, zero-order input, and first-order, linear elimination). Filled circles represent the observed cefepime concentrations, and dashed lines represent the model-predicted concentrations using Model F in Table 23 (a one-compartment model with inter-individual variability estimated for both CL and V, proportional residual error, zero-order input, and first-order, linear elimination).



Therefore, Model F in Table 23, which is a one-compartment model with inter-individual variability estimated for both CL and V, proportional residual error, zero-order input, and first-order, linear elimination, was selected as the best structural model to describe observed serum concentration-time profiles of cefepime. Model-derived pharmacokinetic parameters were CL and V. Equations 36 to 38 were used to calculate the elimination rate constant ( $k$ ), terminal half-life ( $t_{1/2}$ ), and  $AUC_{0-\tau}$ :

$$k \text{ (h}^{-1}\text{)} = CL/V \quad (36)$$

$$t_{1/2} \text{ (h)} = 0.693/k \quad (37)$$

$$AUC_{0-\tau} \text{ (mg} \cdot \text{h} \cdot \text{L}^{-1}\text{)} = \text{Dose}/CL \quad (38)$$

Inter-individual variability was estimated for both CL and V. The correlation between inter-individual variability for CL and V was estimated by the OMEGA BLOCK functionality in NONMEM [ $\Delta OFV = -2.308$ ; correlation coefficient between CL and V ( $\rho_{CL-V}$ ) = 36.5%]; although the model OFV was not significantly decreased, the correlation coefficient was not negligible so the correlation between inter-individual variability for CL and V was kept in the model for more accurate simulation performance (Holford, 2002). According to Holford, if covariance is not modeled and the model-based simulation is planned, the simulation result based on the model may not reflect the real observations as the relationship between parameters is ignored when in reality, it actually exist. Residual error was best modeled by the proportional form.

Table 24 shows different models developed in the stepwise forward addition process. Covariates that significantly decreased the model OFV and inter-individual variability in the stepwise forward process were CRCL added on to CL ( $\Delta OFV$ : -22.558), followed by TBW added on to V ( $\Delta OFV$ : -10.834) as shown in Table 24.

Table 24. Comparison of cefepime covariate models developed during the stepwise forward addition process

Added covariate	OFV <sup>a</sup>	$\Delta$ OFV <sup>b</sup>	AIC <sup>c</sup>
Base model	1188.715	N/A	1200.715
Univariate models (one covariate added)			
CRCL <sup>d</sup> on CL	1166.157	-22.558 <sup>h</sup>	1180.157
BMI <sup>e</sup> on CL	1187.821	-0.894 <sup>h</sup>	1201.821
TBW on CL	1188.438	-0.277 <sup>h</sup>	1202.438
LBW <sup>f</sup> on CL	1188.331	-0.384	1202.331
IBW <sup>g</sup> on CL	1187.300	-1.415	1201.300
Age on CL	1178.594	-10.121 <sup>h</sup>	1192.594
Sex on CL	1187.700	-1.015 <sup>h</sup>	1201.700
ICU on CL	1187.928	-0.787 <sup>h</sup>	1201.928
CRCL <sup>d</sup> on V	1182.614	-6.101 <sup>h</sup>	1196.614
BMI <sup>e</sup> on V	1182.423	-6.292 <sup>h</sup>	1196.423
TBW on V	1182.359	-6.356 <sup>h</sup>	1196.359
LBW <sup>f</sup> on V	1184.555	-4.160	1198.555
IBW <sup>g</sup> on V	1188.667	-0.048	1202.667
Age on V	1183.279	-5.436 <sup>h</sup>	1197.279
Sex on V	1188.166	-0.549 <sup>h</sup>	1202.166
ICU on V	1185.825	-2.890 <sup>h</sup>	1199.825
Best univariate model: CRCL <sup>d</sup> on CL			
Bivariate models (two covariates added): Second covariate added on the best univariate model			
TBW on CL	1161.908	-4.249 <sup>i</sup>	1177.908
LBW <sup>f</sup> on V	1157.608	-8.549 <sup>i</sup>	1173.608
TBW on V	1155.323	-10.834 <sup>i</sup>	1171.323
BMI <sup>e</sup> on V	1157.024	-9.133 <sup>i</sup>	1173.024
ICU on V	1160.911	-5.246 <sup>i</sup>	1176.911
Best bivariate model: CRCL <sup>d</sup> on CL + TBW on V			

Abbreviations: OFV, objective function value;  $\Delta$ OFV, change in the minimum objective function value; AIC, Akaike information criterion; CRCL, creatinine clearance (mL/min); CL, clearance (L/h); BMI, body mass index (kg/m<sup>2</sup>); TBW, total body weight (kg); LBW, lean body weight (kg); IBW, ideal body weight (kg); ICU, admission to an intensive care unit; V, volume of distribution

<sup>a</sup> OFV is -2 times the log of the model likelihood, and the likelihood is typically considered as a sum of squares (American College of Clinical Pharmacology, 2011).

<sup>b</sup> The change in the minimum objective function value ( $\Delta$ OFV) follows a chi-square distribution and a decrease in OFV by > 3.84 is considered statistically significant with 1 degree of freedom (*df*) at the  $\alpha$  level of 0.05 using a chi-square test (American College of Clinical Pharmacology, 2011)

<sup>c</sup> Akaike information criterion (AIC) is defined in equation 35.

$$AIC = OFV + [2 \times (\text{number of parameters in the model})] \quad (35)$$

<sup>d</sup> Creatinine clearance was estimated by the modified Cockcroft-Gault method (equation 2) using the actual serum creatinine concentration for each patient and IBW (equations 3

and 4) for patients with a BMI < 40 kg/m<sup>2</sup> and LBW (equations 19 and 20) for patients with a BMI > 40 kg/m<sup>2</sup> for the weight term in equation 2 (Demirovic et al. 2009):

$$\text{CRCL (mL/min)} = \frac{(140 - \text{Age}) \times \text{Weight}}{\text{SCr} \times 72} \times (0.85 \text{ if female}) \quad (2)$$

$$\text{Ideal body weight (IBW)} = 50 \text{ kg} + [2.3 \text{ kg} * (\text{height in inches} - 60)] \text{ in males} \quad (3)$$

$$\text{Ideal body weight (IBW)} = 45.5 \text{ kg} + [2.3 \text{ kg} * (\text{height in inches} - 60)] \text{ in females} \quad (4)$$

$$\text{LBW (in male, kg)} = \frac{9270 \times \text{TBW}}{6680 + 216 \times \text{BMI}} \quad (19)$$

$$\text{LBW (in female, kg)} = \frac{9270 \times \text{TBW}}{8780 + 244 \times \text{BMI}} \quad (20)$$

<sup>e</sup> Calculated by (total body weight in kg)/(height in m)<sup>2</sup>

<sup>f</sup> Calculated using equations 19 in males and 20 in females, respectively:

$$\text{Lean body weight (LBW in male, kg)} = \frac{9270 \times \text{TBW}}{6680 + 216 \times \text{BMI}} \quad (19)$$

$$\text{Lean body weight (LBW in female, kg)} = \frac{9270 \times \text{TBW}}{8780 + 244 \times \text{BMI}} \quad (20)$$

<sup>g</sup> Calculated using equations 3 in males and 4 in females, respectively:

$$\text{Ideal body weight (IBW)} = 50 \text{ kg} + [2.3 \text{ kg} * (\text{height in inches} - 60)] \text{ in males} \quad (3)$$

$$\text{Ideal body weight (IBW)} = 45.5 \text{ kg} + [2.3 \text{ kg} * (\text{height in inches} - 60)] \text{ in females} \quad (4)$$

<sup>h</sup> Difference in OFV between the corresponding model OFV and the base model OFV

<sup>i</sup> Difference in OFV between the corresponding model OFV and the best univariate model OFV

After the addition of TBW on to V, no other covariates reduced the model OFV and inter-individual variability in the stepwise forward addition process. In the backward elimination step, the elimination of TBW from V and CRCL from CL increased the model OFV by 10.834 and 27.26, respectively, so both covariates were kept in the final model. Therefore, the final cefepime model (OFV=1155.323) was:

$$\text{CL (L/h)} = 8.06 + [0.0598 * (\text{CRCL} - 90)]$$

$$\text{V (L)} = 39.2 + [0.323 * (\text{TBW} - 95)]$$

Table 25 summarizes the model-estimated population pharmacokinetic parameters and their associated inter-individual variability for cefepime. Figure 22 shows the goodness-of-fit plots for the final cefepime population pharmacokinetic model.

Table 25. Final population pharmacokinetic model parameters of cefepime

Parameter	Final cefepime model	
	Estimate (%SE)	Shrinkage, %
	$TVCL = \theta_1 + [\theta_3 * (CRCL-90)]$ $TVV = \theta_2 + [\theta_4 * (TBW-95)]$	
$\theta_1$	8.06 (7.0)	N/A
$\theta_2$	39.2 (12.1)	N/A
$\theta_3$	0.0598 (17.6)	N/A
$\theta_4$	0.323 (37.5)	N/A
Inter-individual variability ( $\omega$ )		
$\omega_{CL}$	30.5% (48.6)	7.29
$\omega_{V1}$	42.2% (51.3)	27.33
$\rho_{CL-V}$	0.471	N/A
Residual error ( $\sigma$ )		
$\sigma_{proportional}$	24.5% (15.8)	9.38

Abbreviations: SE: standard error; TVCL: typical value of clearance; CRCL: creatinine clearance (mL/min); TVV: typical value of volume of distribution; TBW: total body weight (kg);  $\rho_{CL-V}$ : correlation coefficient between inter-individual variability of clearance and volume of distribution; N/A: not applicable

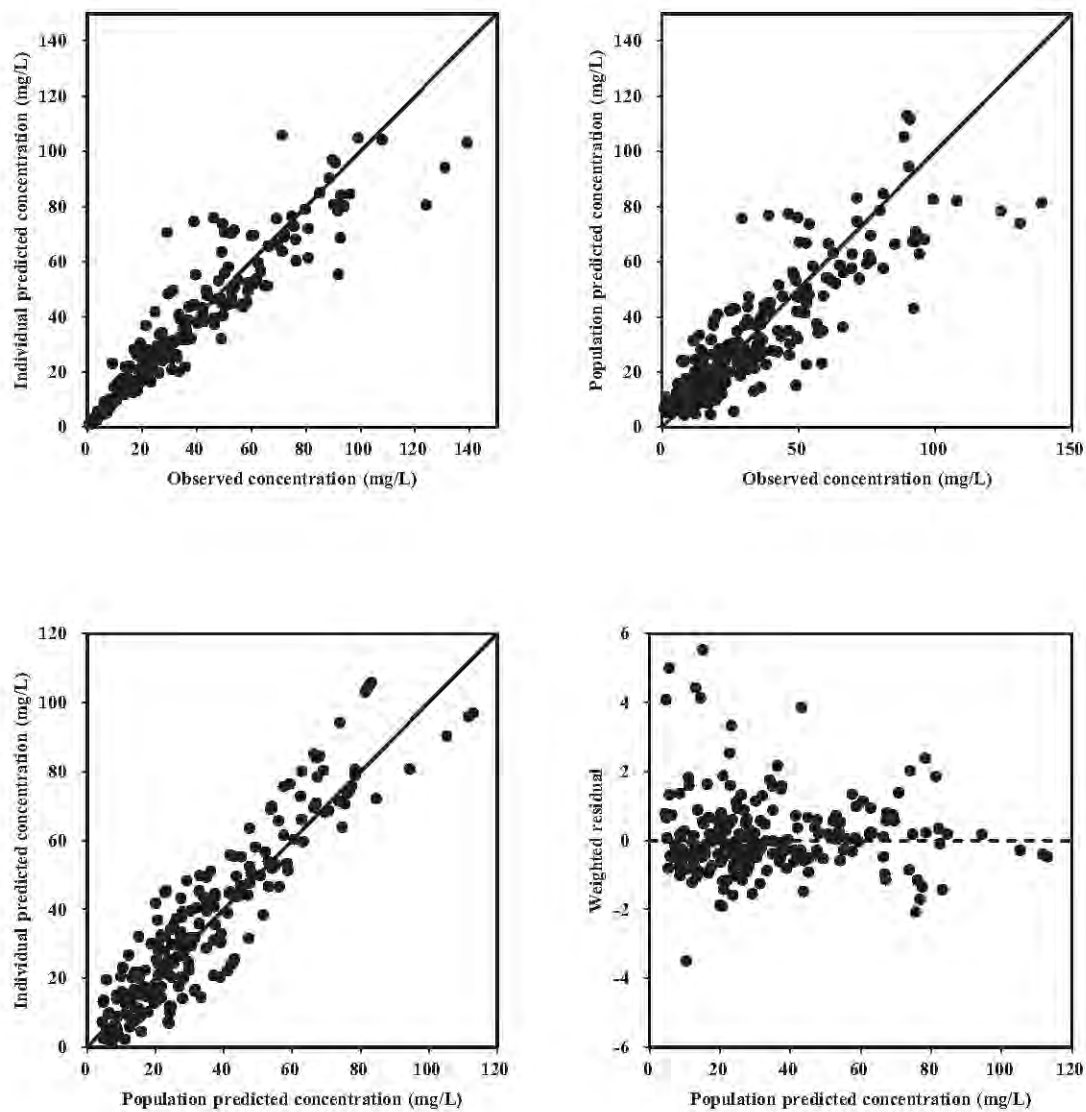

Figure 22. Goodness-of-fit plots of the final cefepime population pharmacokinetic model. The solid line represents the line of identity, and the dashed line corresponds to a residual of zero.

The distribution around the line of identity represents a rough visual estimation of residual error for the individual predicted vs. observed concentration plot, the sum of residual error and inter-individual variability for the population predicted vs. observed concentration plot, and inter-individual variability for the individual predicted vs. population predicted concentration plot. Based on the weighted residual vs population predicted concentration plots, some bias was observed at lower population predicted concentrations at  $\leq 40$  mg/L. However, overall, based on Figure 22, no apparent systematic bias was observed for the final cefepime pharmacokinetic model.

Figure 23 shows VPCs with the 90% prediction intervals using the final cefepime population pharmacokinetic model, graphed with the observed concentrations, for the following cefepime regimens: 1 g q8h, infused over 4 hours; 2 g q8h, infused over 4 hours; and 1 g q6h, infused over 30 minutes. The predicted concentrations were obtained using Monte Carlo simulation in NONMEM, and 5<sup>th</sup>, 50<sup>th</sup> (median), and 95<sup>th</sup> percentile predicted concentrations were estimated using the percentile functions. VPCs for the other dosing regimens are not shown because observed data were available from only one or two patients for these regimens. As shown in Figure 23, most observations were within the 90% prediction interval; however, for the 1 g q8h VPC, the observed concentrations near or above the 95<sup>th</sup> percentile predicted concentrations were from a single individual with the minimum value of CRCL (20 mL/min). The observed data from this individual might influence the model, resulting in broad 90% prediction interval skewed to higher concentrations. This may explain the similar concentration ranges between 1 g q8h and 1 g q6h dosing regimens in their VPCs although 1 g q8h regimen was infused over 4 hours. Also, the VPC for 1 g q6h dosing regimen shows some bias

due to under-prediction of the model at high concentrations, particularly near the maximum concentrations. Similarly, based on the individual plots of observed and model-predicted concentration-time profiles (Figure 24), the final cefepime model predicted the majority of observations, but biases were observed at higher concentrations, especially near maximum concentrations in patients receiving 30-minute infusions.

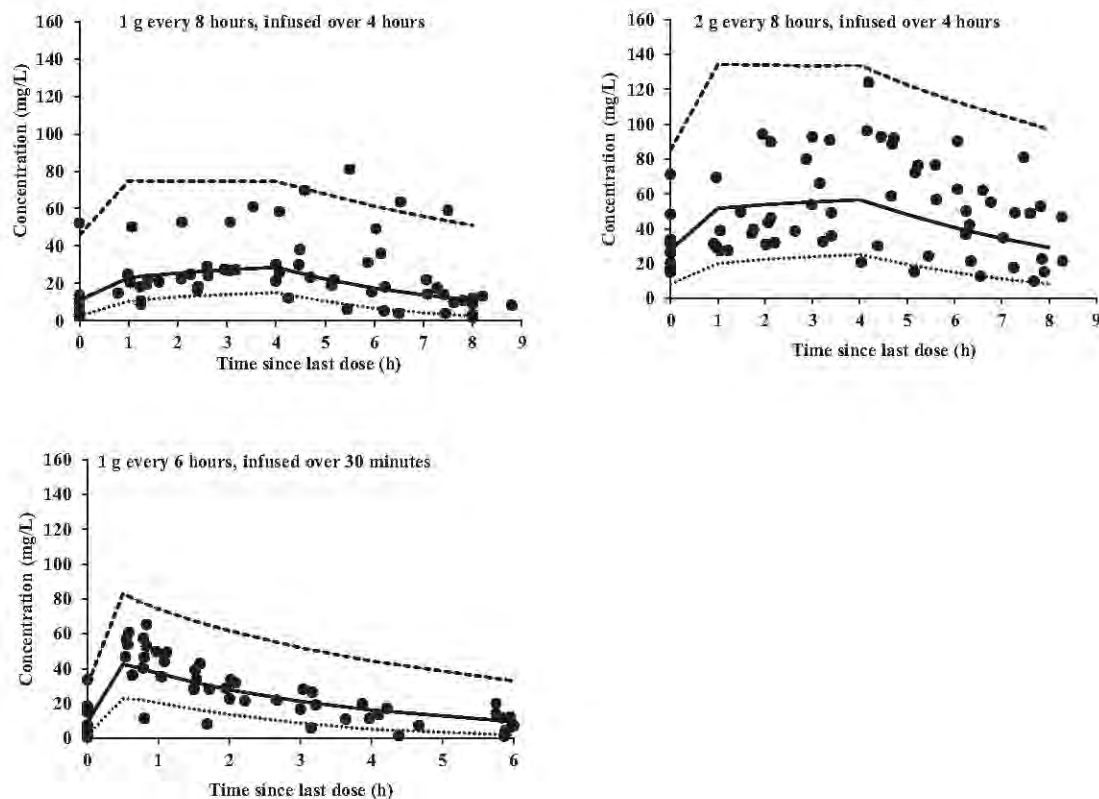

Figure 23. Visual predictive checks of the final cefepime population pharmacokinetic model for all patients receiving each of the following three dosing regimen; 1 g every 8 hours, infused over 4 hours; 2 g every 8 hours, infused over 4 hours; and 1 g every 6 hours, infused over 30 minutes. Filled circles ( $\bullet$ ), observed concentrations; square dashed lines (-----), 95<sup>th</sup> percentile predicted concentrations; solid lines, median predicted concentrations; dotted dashed lines (.....), 5<sup>th</sup> percentile predicted concentrations.



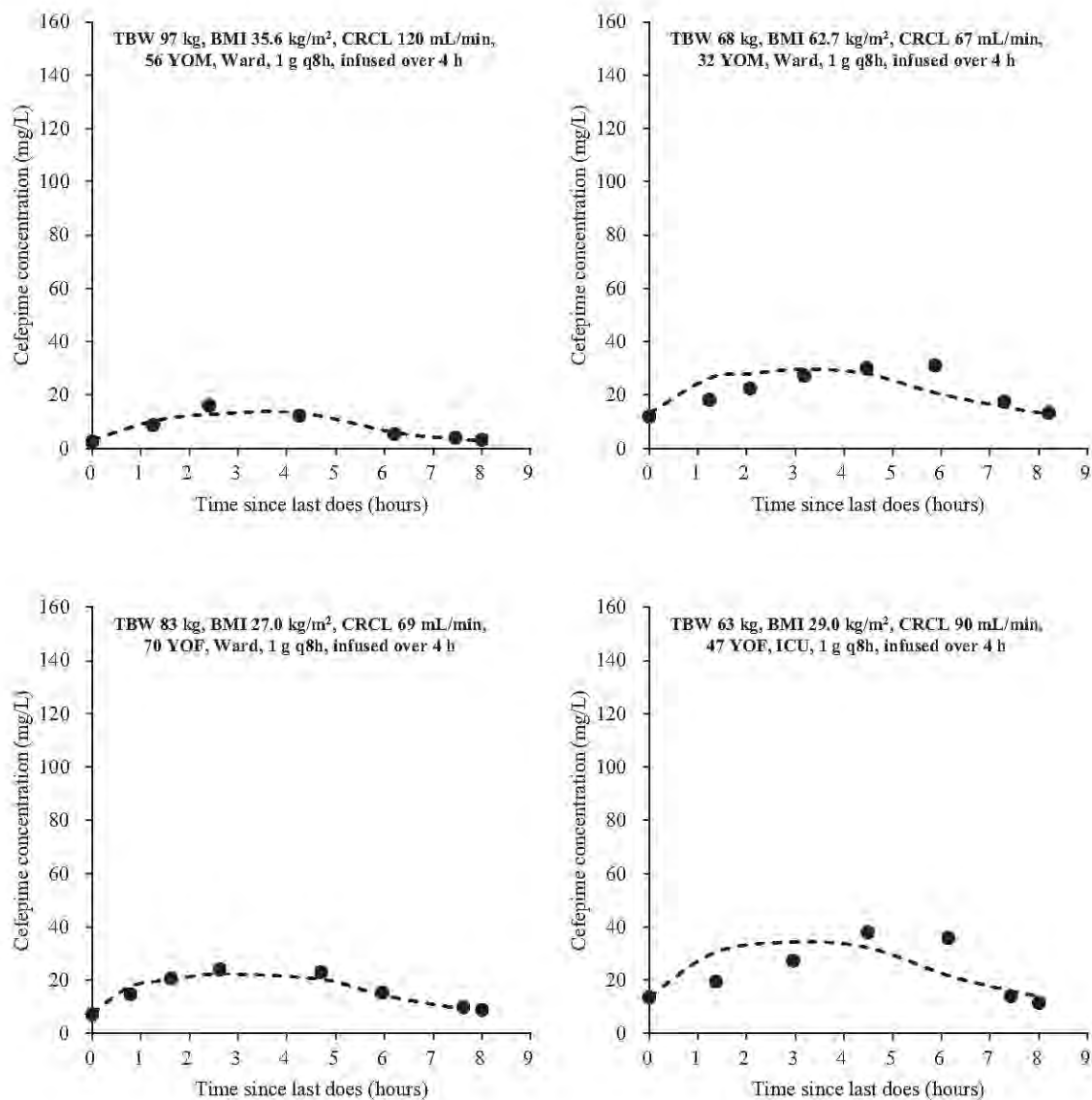

Figure 24. Observed and final model-predicted serum cefepime concentration-time profiles for all 30 patients. Filled circles represent the observed cefepime concentrations and dashed lines represent the model-predicted concentrations using the final population pharmacokinetic model.

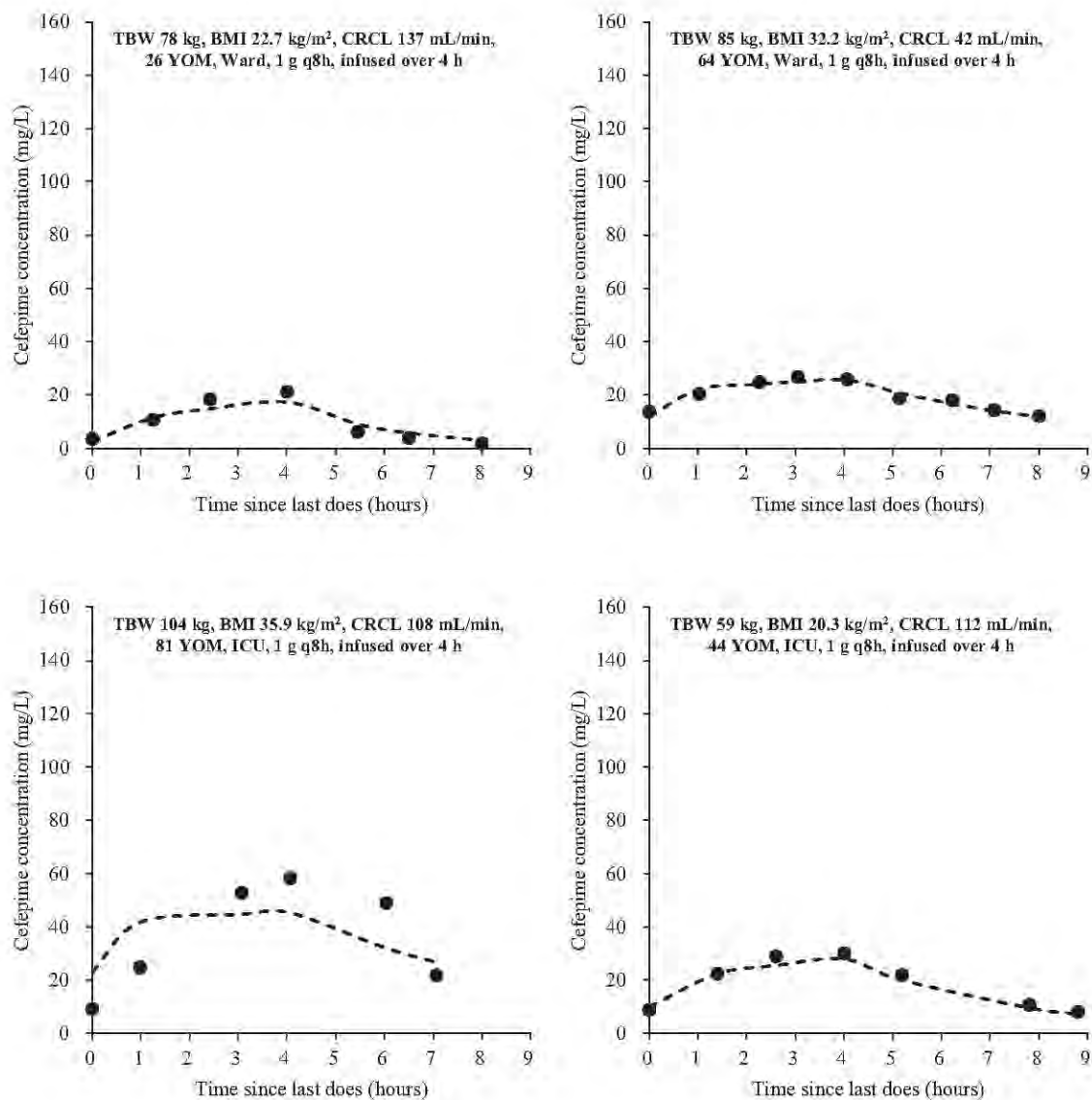

Figure 24. Continued. Observed and final model-predicted serum cefepime concentration-time profiles for all 30 patients. Filled circles represent the observed cefepime concentrations and dashed lines represent the model-predicted concentrations using the final population pharmacokinetic model.

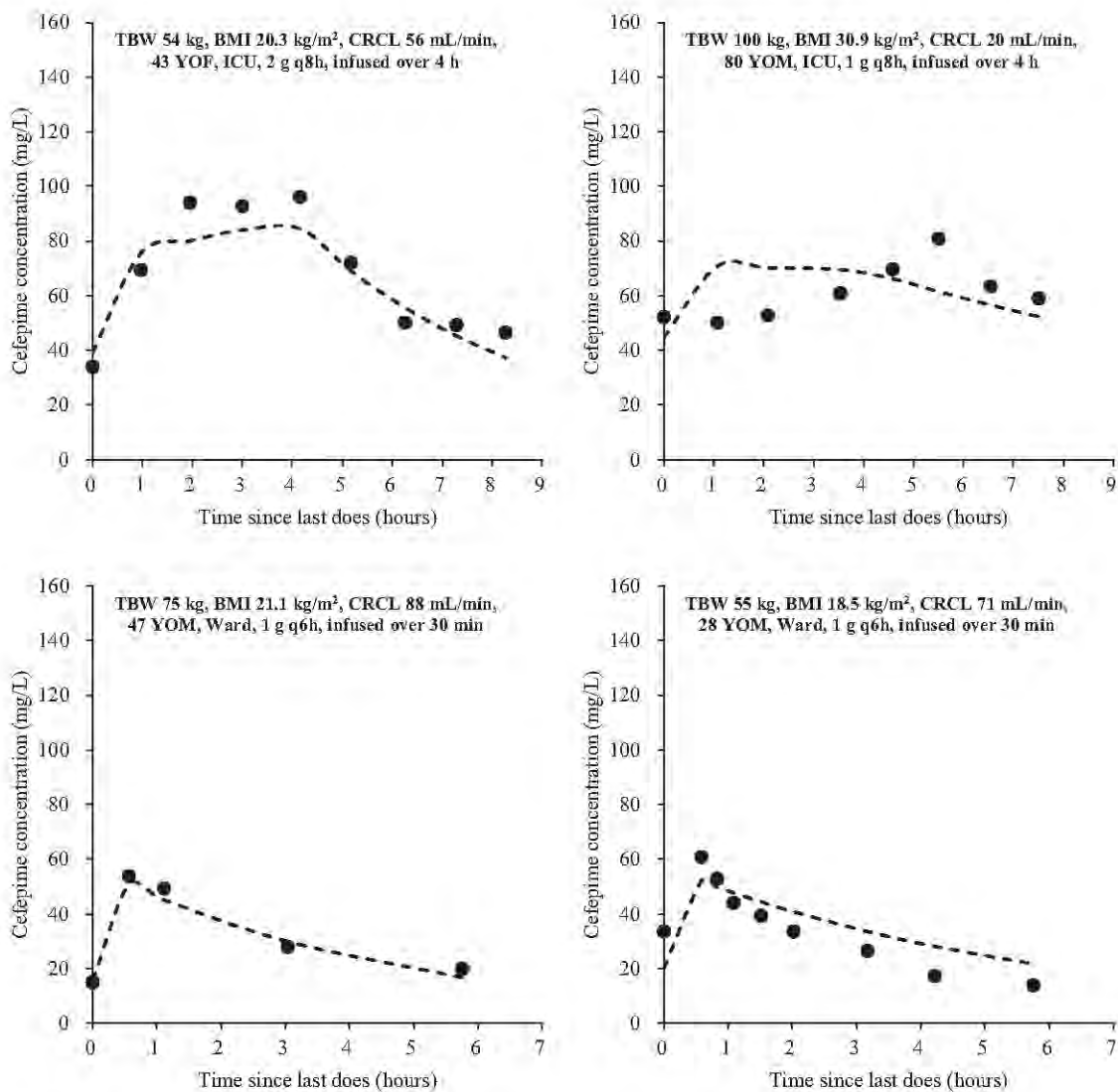

Figure 24. Continued. Observed and final model-predicted serum cefepime concentration-time profiles for all 30 patients. Filled circles represent the observed cefepime concentrations and dashed lines represent the model-predicted concentrations using the final population pharmacokinetic model.

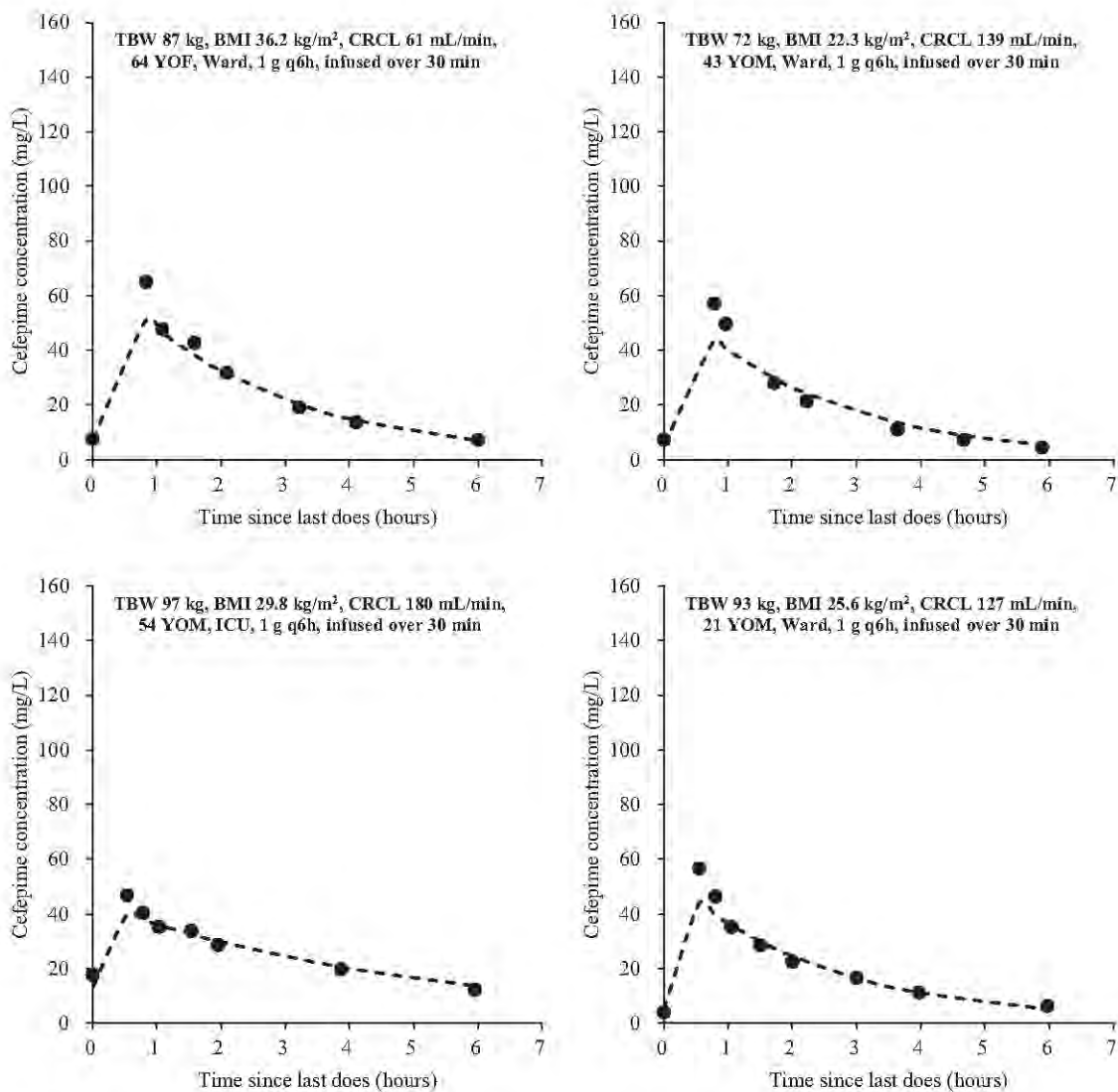

Figure 24. Continued. Observed and final model-predicted serum cefepime concentration-time profiles for all 30 patients. Filled circles represent the observed cefepime concentrations and dashed lines represent the model-predicted concentrations using the final population pharmacokinetic model.

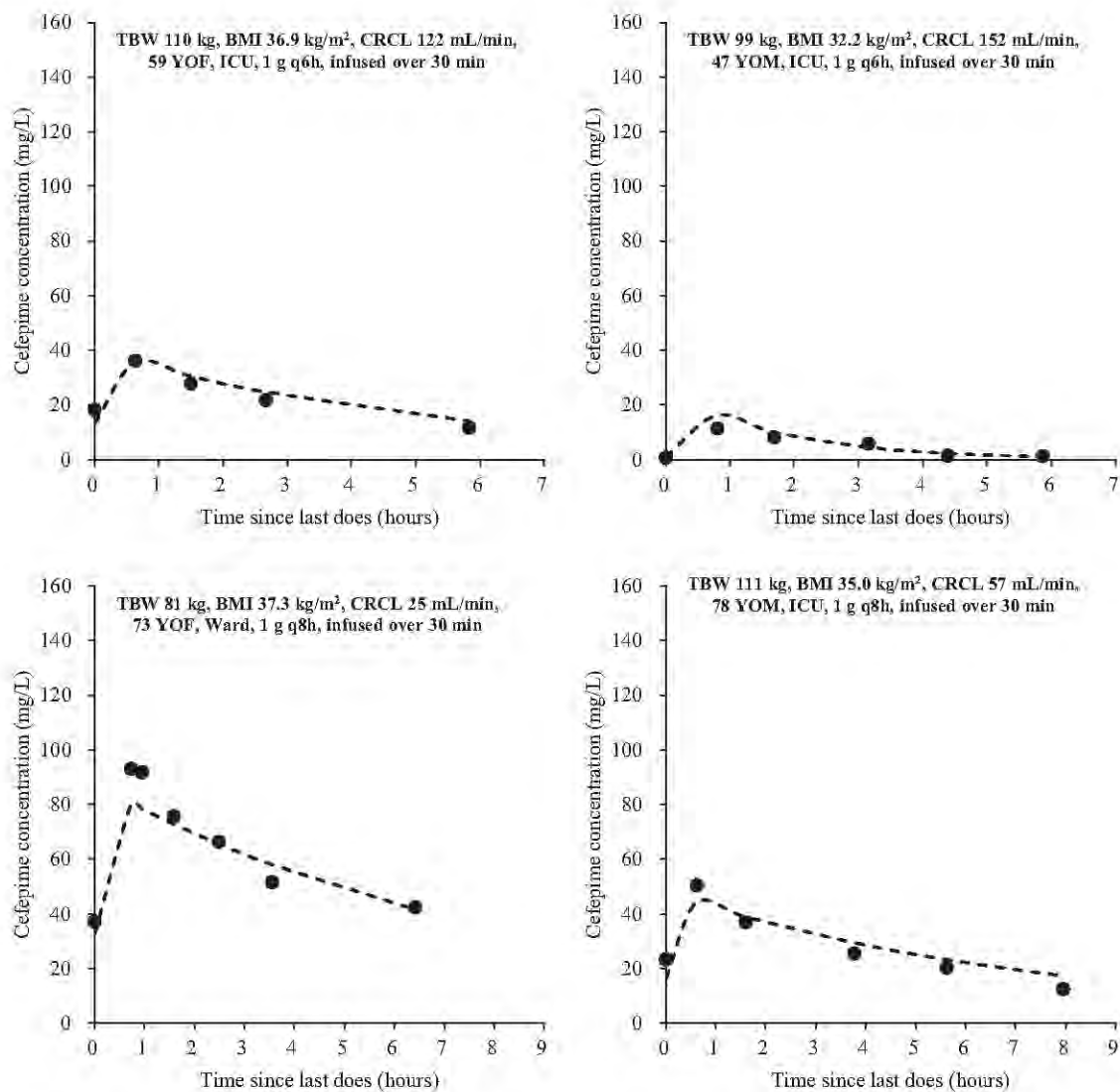

Figure 24. Continued. Observed and final model-predicted serum cefepime concentration-time profiles for all 30 patients. Filled circles represent the observed cefepime concentrations and dashed lines represent the model-predicted concentrations using the final population pharmacokinetic model.

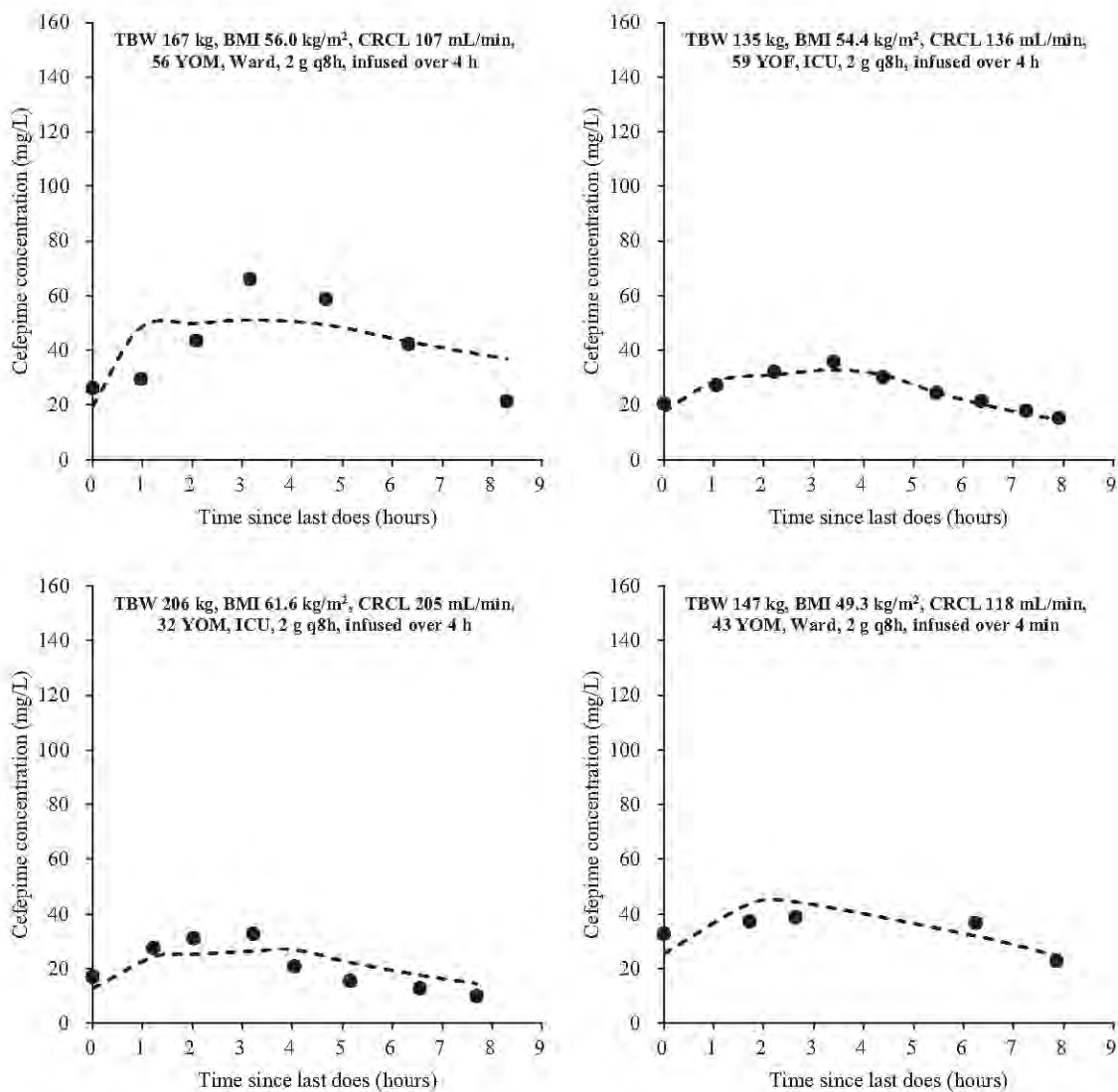

Figure 24. Continued. Observed and final model-predicted serum cefepime concentration-time profiles for all 30 patients. Filled circles represent the observed cefepime concentrations and dashed lines represent the model-predicted concentrations using the final population pharmacokinetic model.

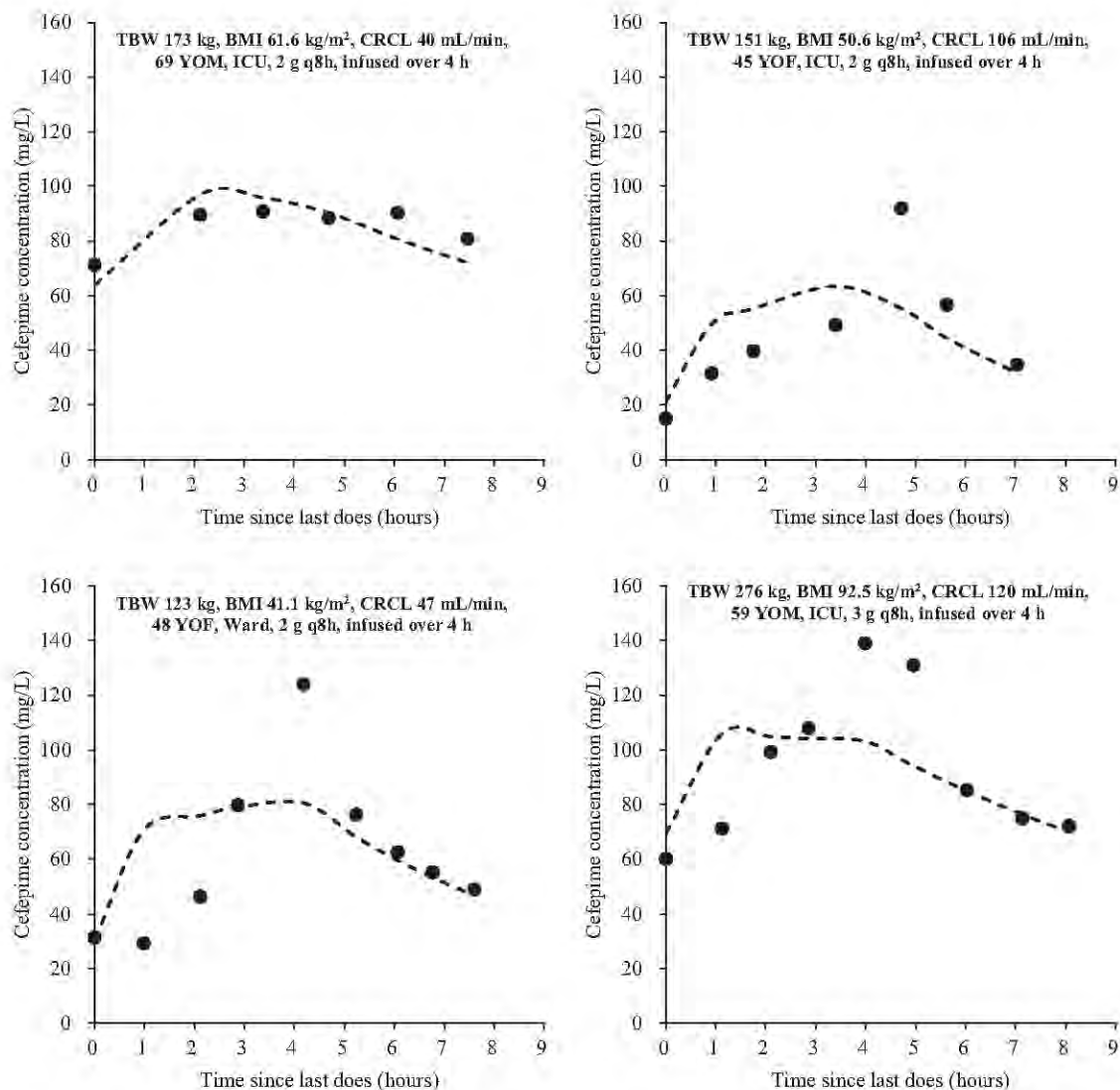

Figure 24. Continued. Observed and final model-predicted serum cefepime concentration-time profiles for all 30 patients. Filled circles represent the observed cefepime concentrations and dashed lines represent the model-predicted concentrations using the final population pharmacokinetic model.

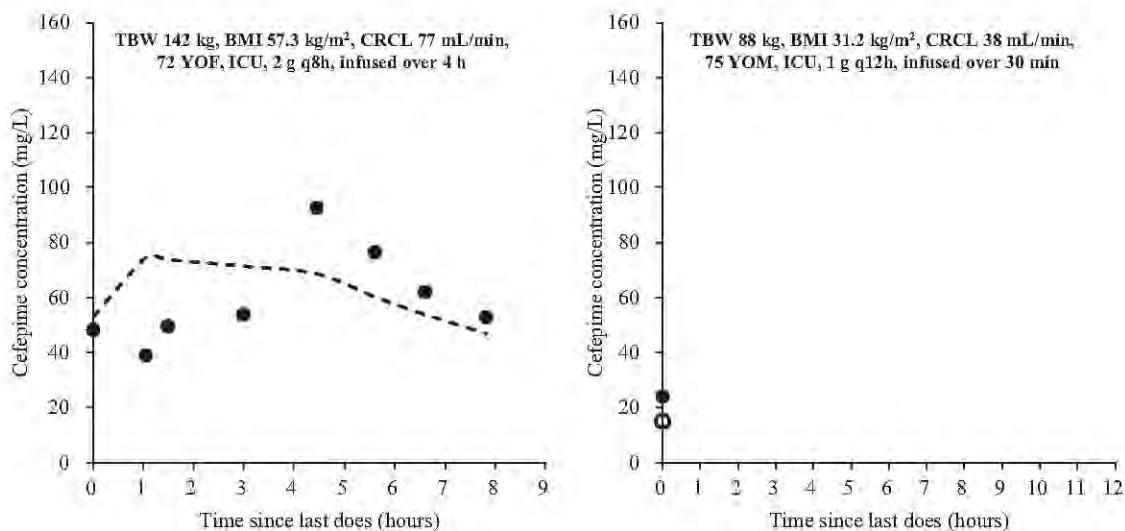

Figure 24. Continued. Observed and final model-predicted serum cefepime concentration-time profiles for all 30 patients. Filled circles represent the observed cefepime concentrations, and dashed lines and an open circle represent the model-predicted concentrations using the final population pharmacokinetic model.

Table 26 shows cefepime pharmacokinetic parameters estimated by the final pharmacokinetic model for non-obese and obese patients. Compared to non-obese patients, obese patients had similar CL, significantly smaller values for TBW-normalized CL ( $p < 0.05$ ), significantly larger  $V$  ( $p < 0.05$ ), similar TBW-normalized  $V$ , and significantly longer half-life ( $p < 0.05$ ).



Table 26. Steady-state cefepime pharmacokinetic parameters [median (range)] estimated by the final population pharmacokinetic model in non-obese and obese patients

Parameter	Non- obese (n=10)	Obese (n=20)	P-value
CL (L/h)	8.0 (5.0-12.6)	7.5 (3.6-27.9)	0.598 <sup>c</sup>
CL ([L/h]/kg) <sup>a</sup>	0.10 (0.09-0.16)	0.06 (0.03-0.28)	0.002 <sup>c</sup>
V (L)	27.6 (22.1-48.8)	50.0 (19.3-94.5)	0.006 <sup>c</sup>
V (L/kg) <sup>a</sup>	0.42 (0.26-0.78)	0.45 (0.17-0.57)	0.581 <sup>d</sup>
Terminal t <sub>1/2</sub> (h) <sup>b</sup>	2.7 (1.6-4.1)	4.2 (1.3-8.6)	0.009 <sup>c</sup>

Abbreviations: CL, clearance; V, volume of distribution; t<sub>1/2</sub>, half-life

<sup>a</sup> Normalized to total body weight

<sup>b</sup> Calculated by equations 36 to 37:

$$t_{1/2} \text{ (h)} = 0.693/k \quad (37)$$

$$k \text{ (h}^{-1}\text{)} = CL/V \quad (36)$$

<sup>c</sup> P-value from Mann-Whitney U test between non-morbidly obese and morbidly obese patients

<sup>d</sup> P-value from unpaired t-test with equal variance between non-morbidly obese and morbidly obese patients

#### Monte Carlo Simulation; Pharmacodynamic Analysis

Figures 25 and 26 show PTAs for cefepime at the pharmacodynamic target of  $\geq 60\% fT > MIC$  for the intermittent-infusion (Figure 25) and prolonged-infusion (Figure 26) dosing regimens, respectively, at specific MICs in non- obese and obese patients. At MICs  $\leq 2$  mg/L, dosing regimens  $\geq 1$  g q12h, infused over 30 minutes, achieved the PTA  $> 90\%$  in both non-obese and obese patient groups (Figure 25). At an MIC of 4 mg/L, the PTA was  $> 90\%$  for dosing regimens  $\geq 1$  g q8h in non- obese patients and  $\geq 1$  g q12h in obese patients, respectively (Figure 25). The PTA at an MIC of 8 mg/L was  $> 90\%$  for dosing regimens of 1 g q6h and 2 g q8h in non- obese patients and  $\geq 1$  g q8h in obese patients, respectively (Figure 25). For 3- to 4-hour infusion regimens, the PTA was  $>$

90% for dosing regimens  $\geq 1$  g q12h at MICs  $\leq 4$  mg/L in both non-obese and obese patient groups (Figure 26). The PTA at an MIC of 8 mg/L was  $> 90\%$  for dosing regimens  $\geq 1$  g q8h in both non-obese and obese patient groups (Figure 26).

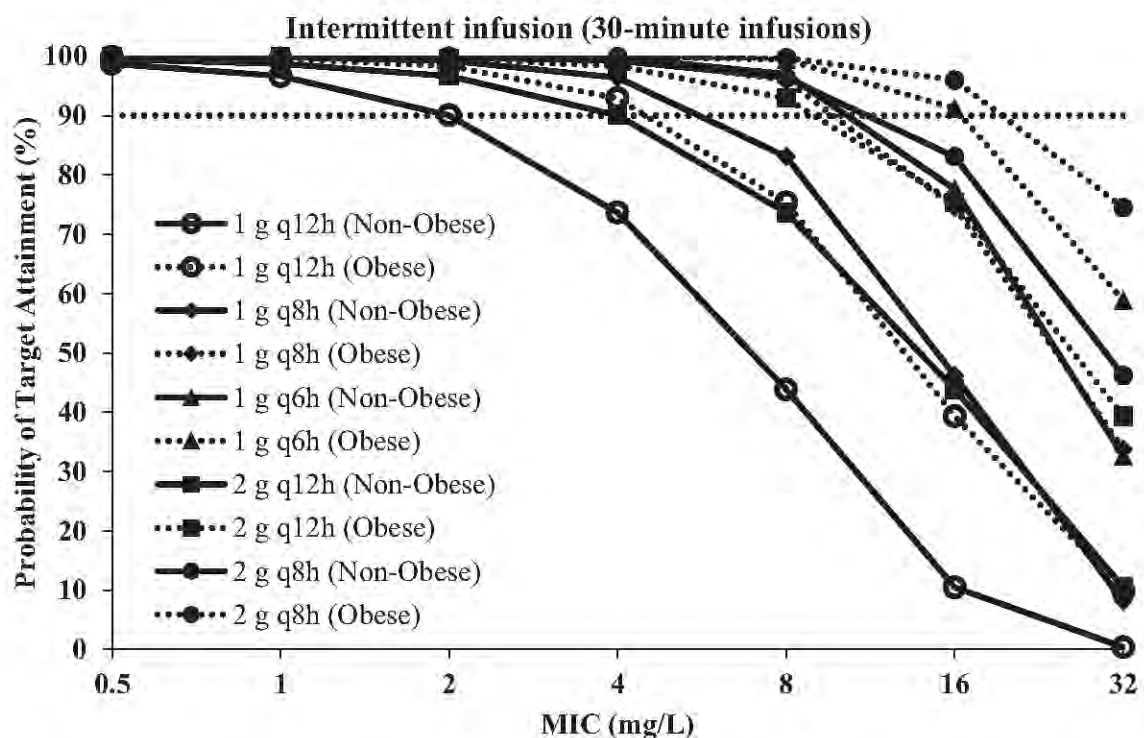

Figure 25. Probability of target attainment (PTA) for cefepime at  $\geq 60\%$   $fT > MIC$  for five intermittent-infusion (infused over 30 minutes) regimens of cefepime at specific minimum inhibitory concentrations (MICs) in non-obese and obese patients. The dotted, horizontal line represents the PTA of 90%.  $fT > MIC$ , time that unbound drug concentrations remain above the MIC; q12h, every 12 hours; q8h, every 8 hours; q6h, every 6 hours.

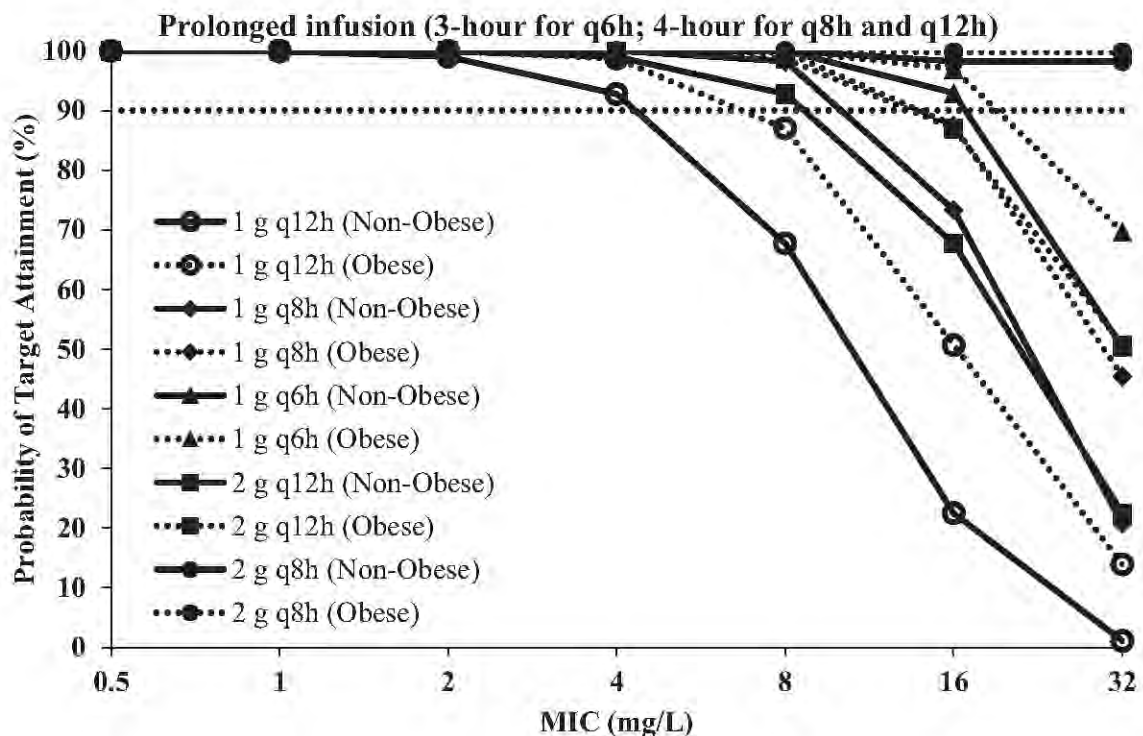

Figure 26. Probability of target attainment (PTA) for cefepime at  $\geq 60\% fT > MIC$  for five prolonged-infusion (infused over either 3 hours for q6h regimens or 4 hours for q8h and q12h regimens) regimens of cefepime at specific minimum inhibitory concentrations (MICs) in non-obese and obese patients. The dotted, horizontal line represents the PTA of 90%.  $fT > MIC$ , time that unbound drug concentrations remain above the MIC; q12h, every 12 hours; q8h, every 8 hours; q6h, every 6 hours.

## Notes

- Akaike, Hirotugu. "A New Look at the Statistical Model Identification." *IEEE Transactions on Automatic Control* 19, no. 6 (1974): 716-23.
- American College of Clinical Pharmacology, "Pharmacometrics"  
<http://accp1.org/pharmacometrics/theory.htm> (accessed January 23 2015).
- Bauer, Robert J., Alison J. Boeckmann, Lewis B. Sheiner, and Stuart L. Beal. "NONMEM Users Guide." 1989-2009. Ellicott City, MD, USA: Icon Development Solutions, 2009.
- Bonapace, Charles R., Roger L. White, Lawrence V. Friedrich, E. Douglas Norcross, and John A. Bosso. "Pharmacokinetics of Cefepime in Patients with Thermal Burn Injury." *Antimicrobial Agents and Chemotherapy* 43, no. 12 (1999): 2848-54.
- Byon, W., M. K. Smith, P. Chan, M. A. Tortorici, S. Riley, H. Dai, J. Dong, A. Ruiz-Garcia, K. Sweeney, and C. Cronenberger. "Establishing Best Practices and Guidance in Population Modeling: An Experience with an Internal Population Pharmacokinetic Analysis Guidance." *CPT: Pharmacometrics & Systems Pharmacology* 2, (2013): e51.
- Cheatham, S. Christian, Megan R. Fleming, Daniel P. Healy, and Michael B. Kays. "Steady-State Pharmacokinetics and Pharmacodynamics of Cefepime Administered by Prolonged Infusion, in Morbidly and Super-Morbidly Obese, Hospitalized Patients." Presented as a poster presentation (Abstract No. A-069) at the 53rd Interscience Conference on Antimicrobial Agents and Chemotherapy; September 10-13, 2013; Denver, Colorado.
- Cheatham, S. Christian, Katherine M. Shea, Daniel P. Healy, Melissa L. Humphrey, Megan R. Fleming, Matthew F. Wack, David W. Smith, Kevin M. Sowinski, and Michael B. Kays. "Steady-State Pharmacokinetics and Pharmacodynamics of Cefepime Administered by Prolonged Infusion in Hospitalised Patients." *International Journal of Antimicrobial Agents* 37, no. 1 (2011): 46-50.
- Cockcroft, Donald W., and M. Henry Gault. "Prediction of Creatinine Clearance from Serum Creatinine." *Nephron* 16, no. 1 (1976): 31-41.
- Crandon, Jared L., Catherine C. Bulik, Joseph L. Kuti, and David P. Nicolau. "Clinical Pharmacodynamics of Cefepime in Patients Infected with *Pseudomonas Aeruginosa*." *Antimicrobial Agents and Chemotherapy* 54, no. 3 (2010): 1111-6.

- Demirovic, Jasmmina A., Amy Barton Pai, and Manjunath P. Pai. "Estimation of Creatinine Clearance in Morbidly Obese Patients." *American Journal of Health-System Pharmacy* 66, no. 7 (2009): 642-8.
- DeRyke, C. Andrew, Joseph L. Kuti, and David P. Nicolau. "Pharmacodynamic Target Attainment of Six Beta-Lactams and Two Fluoroquinolones against *Pseudomonas Aeruginosa*, *Acinetobacter Baumannii*, *Escherichia Coli*, and *Klebsiella* Species Collected from United States Intensive Care Units in 2004." *Pharmacotherapy* 27, no. 3 (2007): 333-42.
- Endimiani, Andrea, Federico Perez, and Robert A. Bonomo. "Cefepime: A Reappraisal in an Era of Increasing Antimicrobial Resistance." *Expert Review Anti-Infective Therapy* 6, no. 6 (2008): 805-24.
- Hittle, Sarah D., David W. Smith, S. Christian Cheatham, Tate N. Trujillo, Matthew F. Wack, and Michael B. Kays. "Steady-State Pharmacokinetics and Pharmacodynamics of Cefepime Administered Every Six Hours in Critically Ill Patients." *Pharmacotherapy* 23, no. 10 (2003): 1373.
- Holford, Nicholas H. G. "Input-Output Models." In *Simulation for Designing Clinical Trials: A Pharmacokinetic-Pharmacodynamic Modeling Perspective*, edited by Hui Kimko and Stephen B. Duffull, 15-28. New York, NY, USA: Marcel Dekker, Inc., 2002.
- Janmahasatian, Sarayut, Stephen B. Duffull, Susan Ash, Leigh C. Ward, Nuala M. Byrne, and Bruce Green. "Quantification of Lean Bodyweight." *Clinical Pharmacokinetics* 44, no. 10 (2005): 1051-65.
- Maxipime(TM) [package insert]. Lake Forest, IL: Hospira, Inc., 2012.
- Roberts, Jason A., Mohd H. Abdul-Aziz, Jeffrey Lipman, Johan W. Mouton, Alexander A. Vinks, Timothy W. Felton, William W. Hope, Andras Farkas, Michael N. Neely, Jerome J. Schentag, George Drusano, Otto R. Frey, Ursula Theuretzbacher, and Joseph L. Kuti. "Individualised Antibiotic Dosing for Patients Who Are Critically Ill: Challenges and Potential Solutions." *The Lancet. Infectious Diseases* 14, no. 6 (2014): 498-509.

## DISCUSSION AND CONCLUSION

### Piperacillin/Tazobactam in Obese Patients Compared to Non-Obese Patients

In this study, we evaluated the population pharmacokinetics and pharmacodynamics of piperacillin and tazobactam administered by prolonged infusion in hospitalized patients over a wide range of TBW, BMI, and measured CRCL. The population pharmacokinetic model that best described the observed serum concentration-time data for both drugs was a one-compartment model with first-order (linear) elimination. Previous studies have described piperacillin pharmacokinetics using two- and three-compartment models, but the doses were infused over 5, 20, or 30 minutes in these studies (Auclair and Ducharme, 1999; Vinks et al. 2003; Lodise et al. 2004; Bulitta et al. 2007; Bulitta et al. 2010; Roberts et al. 2010; Landersdorfer et al. 2012; Jeon et al. 2014). Serum concentrations increase rapidly with shorter infusion times, so when piperacillin is administered by shorter infusions over 5, 20, or 30 minutes, serum concentrations may exceed the rate of the drug to distribute into peripheral compartments, resulting in discernable distribution phases. Given the inter-compartmental rate constants for piperacillin, drug distribution may be complete (or nearly complete) by the end of a 3- or 4-hour infusion so that elimination is the only discernable phase after the infusion ends (Lodise et al. 2004; Felton et al. 2012).

Therefore, a one-compartment model best described the data when piperacillin/tazobactam was administered by prolonged infusion. Another study also reported the superiority of a one-compartment model for doripenem when doses of 500 mg and 1 g were infused over 4 hours (Stein et al. 2012).

Piperacillin is renally eliminated by glomerular filtration and active tubular secretion (Sorgel and Kinzig, 1993). Glomerular filtration is a linear process, but tubular secretion is saturable with a maximum active transport rate ( $V_{max}$ ) that can be described using nonlinear (e.g., Michaelis-Menten) models. In several studies, population pharmacokinetic models incorporating Michaelis-Menten or parallel first-order with Michaelis-Menten elimination were superior to linear models in describing piperacillin pharmacokinetics (Vinks et al. 2003; Bulitta et al. 2010; Felton et al. 2012; Landersdorfer et al. 2012; Butterfield et al. 2014). However, other population pharmacokinetic studies have shown that linear models were either more accurate or comparable to nonlinear models in describing the pharmacokinetics of piperacillin (Auclair and Ducharme, 1999; Lodise et al. 2004; Bulitta et al. 2007; Roberts et al. 2010; Jeon et al. 2014). We evaluated both linear and nonlinear models in this study, and models with a Michaelis-Menten elimination component were not significantly better than the linear elimination model. Nonlinear pharmacokinetics would be expected when serum concentrations exceed the Michaelis-Menten constant,  $K_m$ , and if tubular secretion accounts for at least 20% of the total clearance (Auclair and Ducharme, 1999; Vinks et al. 2003). Reported mean  $K_m$  values in hospitalized patients have ranged from 90-245 mg/L, and standard deviations are very large (Lodise et al. 2004; Felton et al. 2012). It is possible that serum concentrations in our study patients did not exceed the  $K_m$  needed for nonlinear

elimination, even though 10 obese patients received 6.75 g doses. All serum concentrations were  $< 180$  mg/L, and only a minority (17%) of the serum concentrations were greater than the smallest reported  $K_m$  value (i.e., 90 mg/L). In addition, studies with drugs other than piperacillin have shown increased tubular secretion in obesity compared to non-obese individuals (Pai and Bearden, 2007; Hanley et al. 2010; Jain et al. 2011; Brill et al. 2012). Therefore, the  $K_m$  values for piperacillin may be higher in obese patients, so the dose administered to our obese patients (i.e., 6.75 g), which is larger than the dose approved by the Food and Drug Administration (i.e., 3.375 to 4.5 g), may not result in nonlinear elimination. Based on previous publications suggesting linear pharmacokinetics of piperacillin as well as our current study, nonlinearity may not be clinically relevant to describe piperacillin pharmacokinetics at the doses evaluated in these studies (Auclair and Ducharme, 1999; Lodise et al. 2004; Bulitta et al. 2007; Roberts et al. 2010; Jeon et al. 2014).

Piperacillin/tazobactam pharmacokinetics in obesity have been described previously (Newman et al. 2007; Deman et al. 2012; Hites et al. 2013; Sturm et al. 2014); however, only one patient was evaluated in two of these reports (Newman et al. 2007; Deman et al. 2012). Hites et al. reported piperacillin pharmacokinetics in obese and non-obese patients as part of a therapeutic drug monitoring program for  $\beta$ -lactams (Hites et al. 2013). Only two serum concentrations were obtained, and pharmacokinetic parameters were estimated using a 1-compartment model even though doses were infused over 30 minutes. Tazobactam concentrations and relationships between patient characteristics and piperacillin pharmacokinetics were not reported (Hites et al. 2013). Sturm et al. described piperacillin pharmacokinetics in nine morbidly obese patients hospitalized in a



surgical intensive care unit (Sturm et al. 2014). Piperacillin V was poorly correlated with BMI, TBW, LBW, IBW, and adjusted body weight, and CL was poorly correlated with CRCL (Sturm et al. 2014). In addition, tazobactam concentrations were not reported (Sturm et al. 2014). Unfortunately, these studies provide little assistance to clinicians who need to estimate piperacillin or tazobactam pharmacokinetic parameters to optimize drug dosing in a specific patient, which is an important component of antimicrobial stewardship (Dellit et al. 2007).

In contrast to the aforementioned studies, our study identified significant relationships between patient characteristics and pharmacokinetic parameters for piperacillin and tazobactam. Piperacillin CL was significantly associated with CRCL and BMI, and V was significantly associated with TBW. Only CRCL was significantly associated with tazobactam CL (Table 9). Compared to non-obese patients in our study, V was significantly larger and CL was significantly faster for both piperacillin and tazobactam in obese patients (Table 10). Beta-lactam antibiotics are hydrophilic drugs, but V can be larger for these agents in obesity for several reasons (Falagas and Karageorgopoulos, 2010). First, adipose tissue is approximately 30% water (Falagas and Karageorgopoulos, 2010). Second, obese patients have increased lean body weight as estimated by equations 19 and 20 (Janmahasatian et al. 2005), which was significantly larger in our obese patients than non-obese patients (Table 8).

$$\text{Lean body weight (LBW in male, kg)} = \frac{9270 \times \text{TBW}}{6680 + 216 \times \text{BMI}} \quad (19)$$

$$\text{Lean body weight (LBW in female, kg)} = \frac{9270 \times \text{TBW}}{8780 + 244 \times \text{BMI}} \quad (20)$$

Lastly, plasma volume is positively correlated with body weight (Falagas and Karageorgopoulos, 2010). As a result, piperacillin V was 40% larger and tazobactam V was over 100% larger in obese patients compared to non-obese patients (Table 10). When V was normalized to TBW, TBW-normalized piperacillin V was 36% smaller and TBW-normalized tazobactam V was similar in obesity compared to non-obese patients (Table 10). Similar to these data, previous publications have reported increased V for piperacillin (29-54 L) and tazobactam (60 L) and smaller TBW-normalized piperacillin V (0.20-0.30 L/kg) in obesity (Newman et al. 2007; Deman et al. 2012; Hites et al. 2013; Sturm et al. 2014). Faster piperacillin CL in obesity has also been reported in three publications (Newman et al. 2007; Deman et al. 2012; Hites et al. 2013). GFR may be increased in obesity due to increased glomerular planar surface area, kidney weight, and renal blood flow, resulting in increased CL of renally eliminated drugs (Pai and Bearden, 2007; Hanley et al. 2010; Jain et al. 2011). However, in a recent study by Sturm and colleagues, piperacillin CL in morbidly obese, surgical patients was less than half of the CL in our obese patients (6.0 L/h vs. 13.2 L/h) (Sturm et al. 2014). All of their study patients were admitted to an ICU, and critical illness in their patients might cause physiological alterations such as altered fluid balance resulting in increased V, hyperdynamic state leading to increased CL, and organ dysfunction including renal and/or hepatic dysfunction (Roberts et al. 2014). In the Sturm study, two-thirds of their patients were empirically treated for intraabdominal sepsis with one-third receiving vasopressors, indicating possible organ dysfunction in their patients (Sturm et al. 2014). In fact, mean CRCL was slower in their study compared to our study (75 mL/min vs. 120

ml/min), so it is likely that the differences in piperacillin CL were primarily due to differences in renal function.

Despite pharmacokinetic differences between obese and non-obese patients, the effect of obesity on piperacillin/tazobactam pharmacodynamics is dependent on the MIC of the infecting pathogen. For empiric therapy, it may be prudent to select dosing regimens that provide adequate exposures at the susceptibility breakpoint of the drug. The Clinical and Laboratory Standards Institute (CLSI) susceptibility breakpoint for Enterobacteriaceae and *Pseudomonas aeruginosa* is 16 mg/L (Clinical and Laboratory Standards Institute, 2014). The European Committee on Antimicrobial Susceptibility Testing (EUCAST) susceptibility breakpoint is 8 mg/L for Enterobacteriaceae and 16 mg/L for *Pseudomonas aeruginosa* (European Committee on Antimicrobial Susceptibility Testing, 2015a). At 16 mg/L, PTA was > 90% for 3.375 g q8h and 4.5 g q8h, infused over 4 hours, in non-obese and obese patients, respectively (Figure 12). At MICs  $\leq$  8 mg/L, all dosing regimens achieved a PTA > 90% in both patient groups. According to EUCAST MIC distributions, 81.5% of 141,606 isolates of Enterobacteriaceae and *Pseudomonas aeruginosa* are susceptible at an MIC  $\leq$  8 mg/L (European Committee on Antimicrobial Susceptibility Testing, 2015b). Therefore, 3.375 g q8h infused over 4 hours may be utilized in obese patients infected by organisms with MICs  $\leq$  8 mg/L, depending on the infection site.

Tazobactam pharmacokinetics and pharmacodynamics are important considerations as adequate exposure of the beta-lactamase inhibitor is required for the beta-lactam to exert its bactericidal effect against beta-lactamase-producing organisms. However, data are limited regarding the optimal pharmacokinetic/pharmacodynamic

target for tazobactam. Earlier studies suggested that the tazobactam AUC or maintaining tazobactam concentrations above some critical concentration were important determinants of *in vitro* activity (Strayer et al. 1994; Lister et al. 1997). Using an *in vitro* infection model, VanScoy et al. recently evaluated the pharmacodynamics of tazobactam, in combination with ceftolozane, against three isogenic strains of *Escherichia coli* with low-, moderate-, and high-level expression of a single beta-lactamase (CTX-M-15) (VanScoy et al. 2013). The initial bacterial inoculum was  $10^6$  CFU/mL, and daily tazobactam doses were fractionated into 6-, 8-, 12-, and 24-hour dosing intervals to maintain the same 24-hour AUC. The %time>threshold was the best exposure parameter correlating with tazobactam efficacy, and the threshold concentrations were 0.05 mg/L and 0.25 mg/L for low-to-moderate and high-level beta-lactamase expression, respectively (VanScoy et al. 2013). The %time>threshold needed for a 2- $\log_{10}$  reduction in CFU at 24 hours was 70%, regardless of the level of beta-lactamase production. However, it is important to note that bactericidal activity is defined as a  $\geq 3$ - $\log_{10}$  reduction in CFU at 24 hours, which may require greater exposures or higher threshold concentrations. In addition, only one beta-lactamase was studied so the optimal %time>threshold and threshold concentrations are not known for other beta-lactamase enzymes, especially those for which tazobactam is a less efficient inhibitor. Tazobactam was combined with ceftolozane, and it is not known if the optimal %time>threshold and threshold concentrations would be similar if tazobactam was combined with piperacillin. Lastly, the initial inoculum in the study was  $10^6$  CFU/mL, but the %time>threshold and threshold concentrations may be higher for infections caused by larger bacterial inocula.

Given the inherent limitations of the available data regarding tazobactam pharmacodynamics, we evaluated the PTA for %time>threshold of 70% and 100% at tazobactam concentrations ranging from 0.05 to 4 mg/L. All dosing regimens achieved a PTA > 90% for %time>threshold of 70% and 100% at concentrations  $\leq 1$  mg/L and  $\leq 0.25$  mg/L, respectively, in both patient groups (Figure 13). However, there were substantial declines in PTA with increasing concentrations. At 4 mg/L, which is the fixed concentration of tazobactam during in vitro susceptibility testing, none of the simulated dosing regimens achieved > 90% PTA for %time>threshold of 70% or 100% (Clinical and Laboratory Standards Institute, 2014). Until additional data are available, it may be prudent to increase the initial empiric doses of piperacillin/tazobactam in obese and non-obese patients to ensure adequate concentrations of tazobactam early in therapy; early in antimicrobial therapy, the infecting bacterial inoculum is large enough to contain resistant strains, so early aggressive therapy to achieve high drug concentrations may be necessary to maximize the likelihood of therapeutic success (Martinez et al. 2012). Bacterial inocula and beta-lactamase production are highest at the onset of empiric therapy, and higher tazobactam concentrations may be required to suppress beta-lactamase production and prevent amplification of resistant subpopulations.

There are some limitations that should be considered when evaluating this study. We studied a relatively small number of morbidly obese ( $\text{BMI} \geq 40 \text{ kg/m}^2$ ) patients ( $n=12$ ), and the median BMI for our obese patient population was  $50.1 \text{ kg/m}^2$  (range  $32.7$  to  $72.9 \text{ kg/m}^2$ ). Clinicians should exercise caution when applying the study findings to patients with BMIs larger than what we studied. At the time of each study, no data were collected regarding patient co-morbidities and concurrent medications. Therefore, the

effect of patient co-morbidities and concurrent medications could not be evaluated in this model. However, in our study, nonlinearity was not observed for piperacillin pharmacokinetics, so the impact of concurrent medications, especially active tubular secretion inhibitors such as ranitidine, may not be significant. Also, the information regarding primary infectious diseases being treated was not available for all patients, so the possible effect of different types or severity of infectious diseases on the pharmacokinetics of piperacillin/tazobactam could not be evaluated. However, ICU admission as a surrogate variable for critical illness such as severe sepsis was evaluated for its significant association with piperacillin/tazobactam pharmacokinetics in our study, and no significant relationship between ICU admission and piperacillin/tazobactam pharmacokinetics was observed. The effect of obesity on tissue penetration of piperacillin/tazobactam cannot be determined from this study because only serum concentrations were measured. It is not known if the observed differences in serum concentrations translate into different tissue concentrations between obese and non-obese patients. Non-obese patients received 4.5 g q8h, but 6.75 g doses were simulated in the pharmacodynamic analysis. Although piperacillin elimination was linear, it is possible that nonlinear elimination would be observed if 6.75 g doses were administered to the non-obese patients. Therefore, the pharmacodynamics of this larger dose in non-obese patients should be interpreted cautiously because our model may not be accurate to simulate concentration-time profiles in non-obese patients receiving this larger dose due to possible nonlinearity at this larger dose.

## Meropenem in Obese Patients Compared to Non-Obese Patients

In this study, we evaluated the population pharmacokinetics and pharmacodynamics of meropenem, infused over 30 minutes, in hospitalized patients over a wide range of TBW, BMI, and estimated CRCL. Based on the goodness-of-fit plots (Figure 14) and visual predictive checks (Figure 15), our final model adequately described the observed serum meropenem concentration-time data. Similar to previous meropenem pharmacokinetic studies, the population pharmacokinetic model that best described the observed serum meropenem concentration-time data was a two-compartment model with first-order, linear elimination (Wise et al. 1990; Mouton and Michel, 1991; Nilsson-Ehle et al. 1991; Chimata et al. 1993; Bedikian et al. 1994; Kelly et al. 1995; Lovering et al. 1995; Dreetz et al. 1996; Krueger et al. 1998; Tegeder et al. 1999; Giles et al. 2000; Ververs et al. 2000; Ariano et al. 2005a; Ariano et al. 2005b; Krueger et al. 2005; Lomaestro and Drusano, 2005; Novelli et al. 2005; Li et al. 2006; Isla et al. 2008; Karjagin et al. 2008; Roberts et al. 2009; Crandon et al. 2010; Ikawa et al. 2010; Lee et al. 2010; Ikawa et al. 2011; Ohata et al. 2011; Zhou et al. 2011; Binder et al. 2013; Ramon-Lopez et al. 2014). Our model supported the estimation of inter-individual variability for all pharmacokinetic parameters including CL, V1, Q, and V2 with significant correlations between inter-individual variability for CL, Q, and V2. In our study, the Q was highly variable between patients (inter-individual variability for Q, 103.4%; Table 17). Similarly, several previous studies also reported large variability in the inter-compartmental distribution rate constants (% coefficient of variation: 92 to 203%) (Bedikian et al. 1994; Krueger et al. 2005; Lomaestro and Drusano, 2005; Lee et

al. 2010). However, other previous studies reported much smaller between-subject variability for Q (22.3 to 32.8%) compared to our study (Li et al. 2006; Roberts et al. 2009; Ikawa et al. 2010). It should be noted, as shown in Table 14, we studied patients over a wider range of TBW (57 to 305 kg in our study vs. 40.6 to 127 kg vs. 75 to 85 kg vs. 38.5 to 84.6 kg) compared to previous studies (Li et al. 2006; Roberts et al. 2009; Ikawa et al. 2010). It is possible that the large inter-individual variability for Q in our study may be due to the wider range of TBW. Considering the short distribution half-life in our study patients (0.4 hours in non-obese and 0.3 hours in obese patients, Table 18), the clinical significance of large inter-individual variability for Q may be minimal.

We also tested possible correlations between inter-individual variability for CL, V1, Q, and V2 using OMEGA BLOCK functionality in NONMEM. Similar to the previous study by Doh and colleagues in burn patients, our study supported the covariance structure between meropenem pharmacokinetic parameters (Doh et al. 2010). However, the covariance structure between the pharmacokinetic parameters in their study and our study was different. According to the study by Doh and colleagues, they reported significant correlation between the inter-individual variability for CL and V1 (Doh et al. 2010). However, in our study, when testing this covariance structure, it did not significantly improve the model fitting ( $\Delta\text{OFV} = -3.032$ ). Among the various covariance structures tested in our study, the covariance structure which resulted in the largest decrease in the model OFV was the variance-covariance matrix between CL, Q, and V2 ( $\Delta\text{OFV} = -19.630$ ), resulting in a better model fitting. Therefore, our model included correlation between inter-individual variability for CL, Q, and V2.



Meropenem CL was significantly associated with CRCL only, and there were no other covariates significantly associated with any other meropenem pharmacokinetic parameters. For the pharmacokinetic parameters estimated by our final meropenem pharmacokinetic model, TBW-normalized CL, V1, V2, and Vss were significantly smaller in obese patients compared to non-obese patients (Table 18). When not normalized for TBW, none of the estimated pharmacokinetic parameters were significantly different between non-obese and obese patients (Table 18). This finding indicates meropenem is not significantly distributed into excess body weight over IBW in obese patients compared to non-obese patients (Hanley et al. 2010). Because meropenem is a relatively small, hydrophilic drug, it is mainly distributed into the extracellular space, resulting in the small, comparable V in non-obese and obese patients (Kuti et al. 2003; Falagas and Karageorgopoulos, 2010). Similar to our data, a previous publication has reported no significant difference in meropenem CL (168 vs. 102 mL/min) and V (40 vs. 27.9 L) between obese and non-obese critically ill patients (Hites et al. 2013). However, obese patients had significantly smaller TBW-normalized V compared to non-obese patients (0.3 vs. 0.5 L/kg), as reported in our study (Table 18) (Hites et al. 2013).

The comparable meropenem pharmacokinetics between non-obese and obese patients translated into comparable pharmacodynamics (Figures 17 and 18). At MICs  $\leq 1$  mg/L (the susceptibility breakpoint for Enterobacteriaceae), all simulated meropenem regimens ( $\geq 500$  mg q8h), infused over 30 minutes, achieved adequate pharmacodynamic exposures in both non-obese and obese patient groups at the pharmacodynamic target of  $\geq 40\% fT > MIC$  [Figure 17(a)] (Clinical and Laboratory Standards Institute, 2014). At an MIC of 2 mg/L (the susceptibility breakpoint for *Pseudomonas aeruginosa*), all simulated

meropenem regimens ( $\geq 500$  mg q8h) achieved adequate pharmacodynamic exposures in both non-obese and obese patient groups at  $\geq 40\%$   $fT > MIC$  [Figure 17(a)] (Clinical and Laboratory Standards Institute, 2014). If more resistant pathogens are detected, PTA at the pharmacodynamic target of  $\geq 40\%$   $fT > MIC$  was  $>90\%$  for all dosing regimens with the exception of 500 mg q8h in both non-obese and obese patient groups at an MIC of 4 mg/L [Figure 17(a)]. At an MIC of 8 mg/L, only dosing regimens  $\geq 1000$  mg q6h achieved adequate pharmacodynamic exposures in both non-obese and obese patient groups [Figure 17(a)]. Prolonged infusions improved the pharmacodynamic profile of each dosing regimen at higher MICs  $\geq 4$  mg/L [Figure 17(b)]. All dosages achieved the PTA  $> 90\%$  at MICs  $\leq 4$  mg/L [Figure 17(b)]. At an MIC of 8 mg/L, dosing regimens  $\geq 1000$  mg q8h achieved adequate pharmacodynamic exposures in both non-obese and obese patient groups [Figure 17(b)].

For patients with lower respiratory tract infections, empiric meropenem dosages to provide adequate exposures at the pharmacodynamic target of  $\geq 54\%$   $fT > MIC$  should be considered (Li et al. 2007). All simulated dosing regimens infused over 30 minutes achieved optimum pharmacodynamic exposures at MICs  $\leq 2$  mg/L [Figure 18(a)]. This higher pharmacodynamic target was more reliably attained by prolonging the infusion times to 3 or 4 hours compared to 30-minute infusions at higher MICs  $\geq 4$  mg/L [Figure 18(b)]. At MICs  $\leq 4$  mg/L, all prolonged infusion dosing regimens achieved optimum pharmacodynamic exposures in both non-obese and obese patient groups.

According to these pharmacodynamic analyses, larger meropenem dosages may not be required in obese patients. Standard dosages provide optimum pharmacodynamic exposures for susceptible organisms. Our study finding is comparable to the findings of a

previous study suggesting standard meropenem regimens achieve adequate pharmacodynamic target attainment in both non-obese and obese, critically ill patients (Hites et al. 2013). However, larger doses administered by prolonged infusions should be considered in patients with infections caused by less susceptible organisms with MICs  $\geq$  4-8 mg/L.

There are some limitations that should be considered when evaluating this study. We studied a relatively small number of morbidly obese patients (n=20), and the median BMI for our obese patient population was 53.7 kg/m<sup>2</sup> (range 30.6 to 88.8 kg/m<sup>2</sup>). Clinicians should exercise caution when applying the study findings to patients with larger BMIs. At the time of each study, no data were collected regarding patient co-morbidities and concurrent medications. Therefore, the effect of patient co-morbidities and concurrent medications on cefepime pharmacokinetics could not be evaluated in this model. However, there is no evidence suggesting nonlinear pharmacokinetics for meropenem, so the impact of concurrent medications on meropenem pharmacokinetics may not be significant. Also, the information regarding primary infectious diseases being treated was not available for all patients, so the possible effect of different types or severity of infectious diseases on the pharmacokinetics of meropenem could not be evaluated. However, ICU admission as a surrogate variable for critical illness such as severe sepsis was evaluated for its significant association with meropenem pharmacokinetics in our study, and no significant relationship between ICU admission and meropenem pharmacokinetics was observed. The effect of obesity on meropenem tissue penetration cannot be determined from this study because only serum concentrations were measured. It is not known if comparable serum meropenem

concentrations translate into similar tissue concentrations between non-morbidly obese and morbidly obese patients. In our study, CRCL was not measured, but estimated by the modified Cockcroft-Gault method using the actual serum creatinine concentrations and IBW (or TBW if TBW is smaller than IBW) in patients with a BMI < 40 kg/m<sup>2</sup> and LBW in patients with a BMI ≥ 40 kg/m<sup>2</sup>. However, Aggarwal and colleagues suggested regardless of the estimation method, estimated CRCL may not be an accurate estimate of GFR in obesity (Aggarwal et al. 2012).

### Cefepime in Obese Patients Compared to Non-Obese Patients

In this study, we evaluated the population pharmacokinetics and pharmacodynamics of cefepime, infused over 30 minutes or 4 hours, in hospitalized patients over a wide range of TBW, BMI, and estimated CRCL. Based on the goodness-of-fit plots (Figure 22) and visual predictive checks (Figure 23), our final model adequately described the majority of the observed serum cefepime concentration-time data. However, some biases were observed at higher concentrations, especially near maximum concentrations in patients receiving 30-minute infusions. The population pharmacokinetic model that best described the observed serum cefepime concentration-time data was a one-compartment model with first-order, linear elimination. Previous studies have described cefepime pharmacokinetics using two- and three-compartment models, but the doses were infused over 3, 5, 10, 15, 30, or 60 minutes in these studies (Nye et al. 1989; Bacher et al. 1992; Kalman et al. 1992; Ette and Ludden, 1995; Bonapace et al. 1999; Garrelts and Wagner, 1999; Lipman et al. 1999; Sampol et al. 2000; Lubasch et al. 2003; Tam et al. 2003; Han et al. 2006; Roos et al. 2006; Georges et

al. 2008; Higuchi et al. 2008; Ikawa et al. 2008; Delattre et al. 2012). Serum concentrations increase rapidly with shorter infusion times, so when cefepime is administered by shorter infusions over 3, 5, 10, 15, 30, or 60 minutes, serum concentrations may exceed the rate of the drug to distribute into peripheral compartments, resulting in discernable distribution phases. Given the previously reported inter-compartmental rate constants for cefepime, drug distribution may be complete (or nearly complete) by the end of a 3- or 4-hour infusion so that elimination is the only discernable phase after the infusion ends in patients who received cefepime as prolonged infusions (Tam et al. 2003; Nicasio et al. 2009). Another study also reported the superiority of a one-compartment model for doripenem when doses of 500 mg and 1 g were infused over 4 hours (Stein et al. 2012). Our study included patients receiving 30-minute infusions as well, which may explain why the two-compartment models in Table 23 had smaller OFV and AIC compared to any one-compartment model. However, the standard errors associated with Q and V2 were high (> 60 to 80%). In addition, when comparing the individual fits of the two best two-compartment models (Figures 19 and 20) with the individual fits of the best one-compartment structural model (Figure 21), substantial improvement was not visually observed with the two-compartment models compared to the one-compartment model. Therefore, a one-compartment model with inter-individual variability estimated for both CL and V, proportional residual error, zero-order input, and first-order, linear elimination, was selected as the best structural model to describe observed serum concentration-time profiles of cefepime. Actually, a relatively smaller proportion of our study patients (n=11; 37%) received cefepime as a 30-minute infusion (n=11; 37%), and the majority of patients (n=19; 63%) received cefepime as a 4-

hour infusion, so this larger proportion of patients receiving a 4-hour infusion might have driven the best structural model to be a one-compartment model. In addition, we may not have collected enough data during the distribution phase because optimal sampling programs were not used to design sampling schemes (Table 21), so our sampling scheme may not have been adequate to accurately describe the distribution phase. Therefore, in our study, a one-compartment model best described the serum cefepime concentration-time data.

In this study, we included the covariance between CL and V in our base and final model. The inclusion of the covariance between CL and V did not decrease the model OFV significantly when no covariates were added ( $\Delta\text{OFV} = -2.308$ ). Similarly, the elimination of the correlation between inter-individual variability for CL and V from the final model did not significantly increase the model OFV ( $\Delta\text{OFV} = 1.675$ ). However, the correlation coefficient between the inter-individual variability for CL and V in the final model was 47.1%. According to Holford, ignorance of parameter covariance in simulations upon its actual existence may result in very different simulation results from reality (Holford, 2002). If covariance is not modeled and consequently not included in the simulation, the simulated result may not reflect the real observations because the relationship between parameters is ignored in the model although in reality, parameters might actually be correlated. Because 47.1% of correlation was considered not negligible, we included the covariance between CL and V in our final model for more accurate and reliable simulation performance in our pharmacodynamic analysis.

According to our study, cefepime CL was significantly associated with CRCL, and V was significantly associated with TBW (Table 25). For the pharmacokinetic

parameters estimated by our final population model, obese patients had significantly larger  $V$  and significantly longer half-life compared to non-obese patients (Table 26). Beta-lactam antibiotics are typically considered hydrophilic, but  $V$  can be larger for these agents, including cefepime, in obesity for several reasons (Falagas and Karageorgopoulos, 2010). First, adipose tissue is approximately 30% water (Falagas and Karageorgopoulos, 2010). Second, obese patients have increased LBW although it was not significantly larger in our obese patients probably due to small sample size (Table 22) (Falagas and Karageorgopoulos, 2010). Last, plasma volume is positively correlated with body weight (Falagas and Karageorgopoulos, 2010). In our study, obese patients had 75% significantly larger cefepime  $V$  compared to non-obese patients, which is much larger than the approximate water composition (30%) in adipose tissue (Table 26). However, TBW-normalized  $V$  was comparable between obese and non-obese patients (Table 26). According to Hanley and colleagues, if the  $V$  of a drug is significantly increased in obese patients, but TBW-normalized  $V$  is comparable between obese and non-obese patients, it indicates substantial uptake of the drug into adipose tissue and complete (or nearly complete) distribution of the drug into excess body weight (Hanley et al. 2010). Comparing cefepime with piperacillin, tazobactam, and meropenem, it is electrically uncharged molecule at physiologic pH (vs. -1 charge for piperacillin and tazobactam) and slightly less hydrophilic compared to meropenem and tazobactam [LogP (octanol:water partition coefficient) -0.37 vs. -1.4 for tazobactam, -0.69 for meropenem, and -0.26 for piperacillin] (DrugBank, 2014; Law et al. 2014). These physicochemical properties of cefepime may explain the increased  $V$  in obesity. In fact, a recent study in obese, non-critically ill patients reported similar findings to our study. Compared to

historical non-obese, non-critically ill patient cohort, obese, non-critically ill patients in their study had larger V (33.9 L vs. 14.3-19.3 L), similar TBW-normalized V (0.3 L/kg vs. 0.2 L/kg), and longer half-life (3.1 hours vs. 1.3-2.0 hours) for cefepime/ceftazidime (Hites et al. 2014). In contrast to these data, previous publications have reported comparable cefepime V in obese, critically ill patients (24.0 L vs. 21.4L in non-obese, critically ill patients) and in morbidly obese volunteers ( $24.59 \pm 6.79$  L) (Hites et al. 2013; Rich et al. 2012). However, our study population is more heterogeneous including both ICU and medical ward patients with a wide range of BMI, TBW, and CRCL while their study populations were rather homogeneous because Hites and colleagues only included critically ill patients and Rich and colleagues only included otherwise healthy morbidly obese volunteers. Actually, Table 26 shows a wide range of estimated V in obese group (range 19.3 to 94.5 L with a median of 50.0 L), confirming a rather heterogeneous patient population in our study. This difference in the patient characteristics may explain the different study findings between our study and the previous studies.

Although cefepime pharmacokinetics were altered significantly, the impact of obesity on the cefepime pharmacodynamic profile was dependent on MICs and the infusion time (Figures 25 and 26). At MICs  $\leq 2$  mg/L (the susceptibility breakpoint for Enterobacteriaceae), all simulated cefepime regimens ( $\geq 1$  g q12h), infused over 30 minutes, achieved adequate pharmacodynamic exposures in both non-obese and obese patient groups (Figure 25) (Clinical and Laboratory Standards Institute, 2014). At the MIC of 4 mg/L (the dose-dependent susceptibility breakpoint for Enterobacteriaceae), all simulated dosages ( $\geq 1$  g q12h) achieved optimal pharmacodynamic exposures in both



non-obese and obese patient groups with the exception of 1 g q12h in non-obese patients (Figure 25) (Clinical and Laboratory Standards Institute, 2014). At the MIC of 8 mg/L (the susceptibility breakpoint for *Pseudomonas aeruginosa*), only 1 g q6h and 2 g q8h dosing regimens provided adequate pharmacodynamic exposures in non-obese patients; 30-minute infusion regimens  $\geq 1$  g q8h achieved adequate pharmacodynamic exposures in obese patients (Figure 25) (Clinical and Laboratory Standards Institute, 2014). At the MIC of 16 mg/L, no dosing regimen provided optimal pharmacodynamic exposures in non-obese patients; however, 1 g q6h and 2 g q8h dosing regimens still achieved adequate pharmacodynamic exposures in obese patients (Figure 25). Prolonged infusions improved the pharmacodynamic profile of each dosing regimen at higher MICs (Figure 26). All dosing regimens ( $\geq 1$  g q12h) achieved the PTA  $> 90\%$  in both non-obese and obese patient groups at MICs  $\leq 4$  mg/L (Figure 26). At an MIC of 8 mg/L, dosing regimens  $\geq 1$  g q8h provided optimal exposures in both non-obese and obese patient groups (Figure 26). At an MIC of 16 mg/L, PTAs were  $> 90\%$  for 1 g q6h and 2 g q8h in both non-obese and obese patient groups (Figure 26).

According to these pharmacodynamic analyses, larger cefepime doses are not required in obesity. Standard dosages provide optimum pharmacodynamic exposures for susceptible organisms in obesity. Our study finding is comparable to the findings of a previous study suggesting standard cefepime regimens achieve adequate pharmacodynamic target attainment in both non-obese and obese, critically ill patients (Hites et al. 2013). However, larger doses administered by prolonged infusions should be considered in patients with infections caused by less susceptible organisms with MICs  $\geq 4$ -8 mg/L.

There are some limitations that should be considered when evaluating this study. We studied a relatively small number of morbidly obese patients (n=10), and the mean BMI for our obese patient population was 39.2 kg/m<sup>2</sup> (range 30.9 to 92.5 kg/m<sup>2</sup>). Clinicians should exercise caution when applying the study findings to patients with larger BMIs. At the time of each study, no data were collected regarding patient co-morbidities and concurrent medications. Therefore, the effect of patient co-morbidities and concurrent medications on cefepime pharmacokinetics could not be evaluated in this model. However, there is no evidence suggesting nonlinear pharmacokinetics for cefepime, so the impact of concurrent medications on cefepime pharmacokinetics may not be significant. Also, the information regarding primary infectious diseases being treated was not available for all patients, so the possible effect of different types or severity of infectious diseases on the pharmacokinetics of cefepime could not be evaluated. However, ICU admission as a surrogate variable for critical illness such as severe sepsis was evaluated for its significant association with cefepime pharmacokinetics in our study, and no significant relationship between ICU admission and cefepime pharmacokinetics was observed. The effect of obesity on cefepime tissue penetration cannot be determined from this study because only serum concentrations were measured. It is not known if the observed differences in serum concentrations translate into different tissue concentrations in obese patients compared to non-obese patients. No clinical outcomes (e.g., clinical cure or microbiological eradication) were measured in this study. Therefore, although the same cefepime dosage appears to achieve higher pharmacodynamic exposure in obese patients compared to non-obese

patients, clinicians should be careful when interpreting and applying this study finding to patients in clinical practice.

### Conclusions and Future Directions

In conclusion, piperacillin and tazobactam pharmacokinetics are altered in obesity. Piperacillin pharmacokinetics were significantly associated with CRCL, TBW, and BMI, and tazobactam pharmacokinetics were significantly associated with CRCL. Compared to non-obese patients, CL was significantly faster and V was significantly larger for both piperacillin and tazobactam in obese patients. Based on piperacillin component, optimal pharmacodynamic exposures can be achieved with 4-hour infusions of 3.375 g q8h in non-obese patients and 4.5 g q8h in obese patients for pathogens with MICs  $\leq 16$  mg/L. However, larger empiric piperacillin/tazobactam doses may be considered to ensure adequate tazobactam concentrations early in therapy when bacterial inocula and beta-lactamase production are greatest because piperacillin/tazobactam ratio is fixed at 8:1 in the combination product. Dose adjustments may be considered after the results of culture and susceptibility testing are known.

In contrast, meropenem pharmacokinetics are comparable between non-morbidly obese patients and morbidly obese patients. Therefore, dose adjustment is not necessary to achieve adequate pharmacodynamic exposures in morbidly obese patients with infections caused by susceptible organisms. Larger doses or prolonged infusion regimens should be considered for patients with lower respiratory tract infections and infections due to more resistant bacteria.

For cefepime, the pharmacokinetics of cefepime are altered in morbid obesity. Cefepime V was significantly associated with TBW, and cefepime CL was significantly associated with CRCL. Compared to non-morbidly obese patients, V was significantly larger in morbidly obese patients, but CL was comparable between morbidly obese and non-morbidly obese patients. Despite the altered pharmacokinetics of cefepime, morbidly obese patients do not require larger empiric cefepime doses. Standard dosages provide optimum pharmacodynamic exposures for susceptible organisms in morbid obesity. However, larger doses administered by prolonged infusions should be considered in patients with infections caused by less susceptible organisms with MICs  $\geq$  4-8 mg/L.

Table 27 summarizes our study findings for piperacillin/tazobactam, meropenem, and cefepime.

Table 27. Summary of the pharmacokinetics and pharmacodynamics of piperacillin/tazobactam, meropenem, and cefepime in obesity compared to non-obese patients

	Piperacillin/Tazobactam		Meropenem	Cefepime
	Piperacillin	Tazobactam		
Model	CL (L/h) = 11.3 + [0.0646*(CRCL <sup>a</sup> -105)] + [0.0579*(BMI-35)] V (L) = 31.3 + [0.132*(TBW-120)]	CL (L/h) = 10.1 + [0.0272*(CRCL <sup>a</sup> -105)] V (L) = 34.3	CL (L/h) = 8.62*(CRCL <sup>b</sup> /85) <sup>0.533</sup> V1 (L) = 13.6 Q (L/h) = 11.8 V2 (L) = 14.5	CL (L/h) = 8.06 + [0.0598*(CRCL <sup>b</sup> -90)] V (L) = 39.2 + [0.323*(TBW-95)]
Pharmacokinetic alterations in obesity	- Significantly ↑ CL and V - Significantly ↓ TBW-normalized CL and V	- Significantly ↑ CL and V - No change in TBW-normalized CL and V	- No change in CL, Q, V1, V2, and Vss - Significantly ↓ TBW-normalized CL, V1, V2, and Vss	- No change in CL - Significantly ↑ V - Significantly ↓ TBW-normalized CL - No change in TBW-normalized V
Recommended dosing based on the simulated pharmacodynamic exposures	Doses ≥ 4.5 g q8h, infused over 4 hours, should be considered for similar pharmacodynamic exposures in obesity compared to non-obese patients receiving 3.375 g q8h, infused over 4 hours		Standard regimens (≥ 500 mg q8h) provide adequate exposures for susceptible organisms in obesity as well as non-obese patients	Standard dosages (≥ 1 g q12h) provide adequate exposures for susceptible organisms in obesity as well as in non-obese patients

Abbreviations: CL, clearance, CRCL, creatinine clearance; BMI, body mass index; V, volume of distribution TBW, total body weight; ↑, increased; ↓, decreased; q8h, every 8 hours, Q, inter-compartmental distribution clearance; V1, volume of distribution in the central compartment; V2, volume of distribution in the peripheral compartment; Vss, volume of distribution at steady state; q12h, every 12 hours

Table 27. Continued. Summary of the pharmacokinetics and pharmacodynamics of piperacillin/tazobactam, meropenem, and cefepime in obesity compared to non-obese patients

<sup>a</sup> Measured using equation 1: 
$$CRCL = \frac{(\text{Urine volume collected over 24 hours}) \times U_{Cr} \times 1000}{P_{Cr} \times (1440 \text{ min})} \quad (1)$$

where  $U_{Cr}$  represents urine creatinine concentration and  $P_{Cr}$  represents plasma creatinine concentration

<sup>b</sup> Creatinine clearance was estimated by the modified Cockcroft-Gault method (equation 2) using the actual serum creatinine concentration for each patient and IBW (equations 3 and 4) for patients with a BMI < 40 kg/m<sup>2</sup> and LBW (equations 19 and 20) for patients with a BMI > 40 kg/m<sup>2</sup> for the weight term in equation 2 (Demirovic et al. 2009):

$$CRCL \text{ (mL/min)} = \frac{(140 - \text{Age}) \times \text{Weight}}{SCr \times 72} \times (0.85 \text{ if female}) \quad (2)$$

$$\text{Ideal body weight (IBW)} = 50 \text{ kg} + [2.3 \text{ kg} \times (\text{height in inches} - 60)] \text{ in males} \quad (3)$$

$$\text{Ideal body weight (IBW)} = 45.5 \text{ kg} + [2.3 \text{ kg} \times (\text{height in inches} - 60)] \text{ in females} \quad (4)$$

$$\text{LBW (in male, kg)} = \frac{9270 \times \text{TBW}}{6680 + 216 \times \text{BMI}} \quad (19)$$

$$\text{LBW (in female, kg)} = \frac{9270 \times \text{TBW}}{8780 + 244 \times \text{BMI}} \quad (20)$$

The pharmacokinetics of beta-lactam antibiotics can be altered in obesity, but the alterations and the magnitude of alterations appear to be drug-specific. Although the pharmacokinetics of hydrophilic drugs are typically considered unchanged in obesity compared to normal-weight individuals, our study suggests the pharmacokinetics of hydrophilic drugs such as beta-lactam antibiotics can be altered in obesity due to the physiologic alterations associated with obesity as aforementioned. Furthermore, our study may highlight the complexity of predicting pharmacokinetic alterations just based on hydrophilicity. Although piperacillin/tazobactam, meropenem, and cefepime are all considered hydrophilic, the pattern of alterations in the pharmacokinetics were different for each drug in our study. This may be due to inadequate statistical power in our study as the sample size was not statistically determined a priori. However, it is also possible that other factors such as protein binding and possibly, transporter involvement may lead to the different pattern of pharmacokinetic alterations for each drug in our study. More data will be needed to confirm the role of protein binding and potential transporter involvement in the pharmacokinetic alterations of these drugs in obesity. The knowledge gained from our studies may expand our understanding of the impact of obesity on the pharmacokinetics and pharmacodynamics of drugs. Future studies evaluating the safety and efficacy of long-term treatment of these agents at model-based dosages are needed to assess if the model-based regimens derived from our study will improve patient outcomes. Although in this study, we suggested use of larger piperacillin/tazobactam doses (4.5 g q8h, infused over 4 hours) in obese patients compared to non-obese patients (3.375 g q8h, infused over 4 hours) to achieve similar exposures between obese and non-obese patients based on the pharmacodynamic simulation, caution should be exercised for

the potential increase in the risk of developing adverse drug events at these larger doses. However, the piperacillin/tazobactam dosing regimen approved by the Food and Drug Administration is 3.375 to 4.5 g q6h, infused over 30 minutes, so our recommended dosing is not really larger doses than what is used in practice. Also, more pharmacokinetic and pharmacodynamic studies are needed to evaluate the effect of obesity on the pharmacokinetics and pharmacodynamics of antimicrobials that have not been investigated so that appropriate dosing regimens may be suggested to achieve similar pharmacodynamic exposures in obese individuals compared with non-obese individuals. Individualized antimicrobial dosing regimen on the basis of pathogen susceptibility (MIC), the pharmacokinetic and pharmacodynamic characteristics of the drug, and patient characteristics such as renal function and body size will result in more reliable pharmacokinetic profiles to achieve adequate pharmacodynamic exposures to ultimately optimize patient clinical outcomes while minimizing unintended adverse consequences of antibiotic therapy as a part of antimicrobial stewardship (Dellit et al. 2007).



## Notes

- Aggarwal, Nidhi, Anna C. Porter, Ignatius Y. S. Tang, Bryan N. Becker, and Sanjeev K. Akkina. "Creatinine-Based Estimations of Kidney Function Are Unreliable in Obese Kidney Donors." *Journal of Transplant* 2012, (2012): 872894.
- Ariano, Robert E., Anna Nyhlen, J. Peter Donnelly, Daniel S. Sitar, Godfrey K. M. Harding, and Sheryl A. Zelenitsky. "Pharmacokinetics and Pharmacodynamics of Meropenem in Febrile Neutropenic Patients with Bacteremia." *The Annals of Pharmacotherapy* 39, no. 1 (2005a): 32-8.
- Ariano, Robert E., Sheryl A. Zelenitsky, Anna Nyhlen, and Daniel S. Sitar. "An Evaluation of an Optimal Sampling Strategy for Meropenem in Febrile Neutropenics." *Journal of Clinical Pharmacology* 45, no. 7 (2005b): 832-5.
- Auclair, Barbara, and Murray P. Ducharme. "Piperacillin and Tazobactam Exhibit Linear Pharmacokinetics after Multiple Standard Clinical Doses." *Antimicrobial Agents and Chemotherapy* 43, no. 6 (1999): 1465-8.
- Bacher, K., M. Schaeffer, H. Lode, C. E. Nord, K. Borner, and P. Koeppe. "Multiple Dose Pharmacokinetics, Safety, and Effects on Faecal Microflora, of Cefepime in Healthy Volunteers." *The Journal of Antimicrobial Chemotherapy* 30, no. 3 (1992): 365-75.
- Bedikian, Annet, Mark P. Okamoto, Randall K. Nakahiro, John Farino, Peter N. R. Heseltine, Maria D. Appelman, Albert E. Yellin, Thomas V. Berne, and Mark A. Gill. "Pharmacokinetics of Meropenem in Patients with Intra-Abdominal Infections." *Antimicrobial Agents and Chemotherapy* 38, no. 1 (1994): 151-4.
- Binder, Lutz, Harald Schworer, Sebastian Hoppe, Frank Streit, Silke Neumann, Annett Beckmann, Rolf Wachter, Michael Oellerich, and Philip D. Walson. "Pharmacokinetics of Meropenem in Critically Ill Patients with Severe Infections." *Therapeutic Drug Monitoring* 35, no. 1 (2013): 63-70.
- Bonapace, Charles R., Roger L. White, Lawrence V. Friedrich, E. Douglas Norcross, and John A. Bosso. "Pharmacokinetics of Cefepime in Patients with Thermal Burn Injury." *Antimicrobial Agents and Chemotherapy* 43, no. 12 (1999): 2848-54.
- Brill, Margreke J. E., Jeroen Diepstraten, Anne van Rongen, Simone van Kralingen, John N. van den Anker, and Catherijne A. Knibbe. "Impact of Obesity on Drug Metabolism and Elimination in Adults and Children." *Clinical Pharmacokinetics* 51, no. 5 (2012): 277-304.

- Bulitta, J. B., S. B. Duffull, M. Kinzig-Schippers, U. Holzgrabe, U. Stephan, G. L. Drusano, and F. Sorgel. "Systematic Comparison of the Population Pharmacokinetics and Pharmacodynamics of Piperacillin in Cystic Fibrosis Patients and Healthy Volunteers." *Antimicrobial Agents and Chemotherapy* 51, no. 7 (2007): 2497-507.
- Bulitta, Jurgen B., Martina Kinzig, Verena Jakob, Ulrike Holzgrabe, Fritz Sorgel, and Nicholas H. G. Holford. "Nonlinear Pharmacokinetics of Piperacillin in Healthy Volunteers--Implications for Optimal Dosage Regimens." *British Journal of Clinical Pharmacology* 70, no. 5 (2010): 682-93.
- Butterfield, Jill M., Thomas P. Lodise, Scott Beegle, Jonathan Rosen, Joshua Farkas, and Manjunath P. Pai. "Pharmacokinetics and Pharmacodynamics of Extended-Infusion Piperacillin/Tazobactam in Adult Patients with Cystic Fibrosis-Related Acute Pulmonary Exacerbations." *The Journal of Antimicrobial Chemotherapy* 69, no. 1 (2014): 176-9.
- Chimata, Mnoru, Mitsumasa Nagase, Yasuyuki Suzuki, Masahiko Shimomura, and Sachiko Kakuta. "Pharmacokinetics of Meropenem in Patients with Various Degrees of Renal Function, Including Patients with End-Stage Renal Disease." *Antimicrobial Agents and Chemotherapy* 37, no. 2 (1993): 229-33.
- Clinical and Laboratory Standards Institute. "Performance Standards for Antimicrobial Susceptibility Testing; Twenty-Fourth Informational Supplement." In *Document M100-S24*. Wayne, PA: CLSI, 2014.
- Crandon, Jared L., Catherine C. Bulik, Joseph L. Kuti, and David P. Nicolau. "Clinical Pharmacodynamics of Cefepime in Patients Infected with *Pseudomonas Aeruginosa*." *Antimicrobial Agents and Chemotherapy* 54, no. 3 (2010): 1111-6.
- Delattre, Isabelle K., Flora T. Musuamba, Philippe Jacqmin, Fabio S. Taccone, Pierre-Francois Laterre, Roger K. Verbeeck, Frederique Jacobs, and Pierre Wallemacq. "Population Pharmacokinetics of Four Beta-Lactams in Critically Ill Septic Patients Comedicated with Amikacin." *Clinical Biochemistry* 45, no. 10-11 (2012): 780-6.
- Dellit, Timothy H., Robert C. Owens, John E. McGowan, Jr., Dale N. Gerding, Robert A. Weinstein, John P. Burke, W. Charles Huskins, David L. Paterson, Neil O. Fishman, Christopher F. Carpenter, P. J. Brennan, Marianne Billeter, and Thomas M. Hooton. "Infectious Diseases Society of America and the Society for Healthcare Epidemiology of America Guidelines for Developing an Institutional Program to Enhance Antimicrobial Stewardship." *Clinical Infectious Diseases* 44, no. 2 (2007): 159-77.

- Deman, Hanna, Jan Verhaegen, Ludo Willems, and Isabel Spriet. "Dosing of Piperacillin/Tazobactam in a Morbidly Obese Patient." *The Journal of Antimicrobial Chemotherapy* 67, no. 3 (2012): 782-3.
- Doh, Kichan, Heungjeong Woo, Jun Hur, Hoejun Yim, Jimyon Kim, Hongseok Chae, Seunghoon Han, and Dong-Seok Yim. "Population Pharmacokinetics of Meropenem in Burn Patients." *The Journal of Antimicrobial Chemotherapy* 65, no. 11 (2010): 2428-35.
- Dreetz, Michaela, Jurg Hamacher, Jorg Eller, Klaus Borner, Peter Koeppel, Tom Schaberg, and Hartmut Lode. "Serum Bactericidal Activities and Comparative Pharmacokinetics of Meropenem and Imipenem-Cilastatin." *Antimicrobial Agents and Chemotherapy* 40, no. 1 (1996): 105-9.
- DrugBank, "Drugbank. Open Data Drug & Drug Target Database"  
<http://www.drugbank.ca/> (accessed November 6 2014).
- Ette, Ene I., and Thomas M. Ludden. "Population Pharmacokinetic Modeling: The Importance of Informative Graphics." *Pharmaceutical Research* 12, no. 12 (1995): 1845-55.
- European Committee on Antimicrobial Susceptibility Testing, "Breakpoint Tables for 489 Interpretation of MICs and Zone Diameters Version 5.0"  
<http://www.eucast.org> (accessed February 10 2015a).
- European Committee on Antimicrobial Susceptibility Testing, Data from the EUCAST 491 MIC distribution website, <http://www.eucast.org> (accessed January 22 2015b).
- Falagas, Matthew E., and Drosos E. Karageorgopoulos. "Adjustment of Dosing of Antimicrobial Agents for Bodyweight in Adults." *Lancet* 375, no. 9710 (2010): 248-51.
- Felton, T. W., W. W. Hope, B. M. Lomaestro, J. M. Butterfield, A. L. Kwa, G. L. Drusano, and T. P. Lodise. "Population Pharmacokinetics of Extended-Infusion Piperacillin-Tazobactam in Hospitalized Patients with Nosocomial Infections." *Antimicrobial Agents and Chemotherapy* 56, no. 8 (2012): 4087-94.
- Garrelts, James C., and David J. Wagner. "The Pharmacokinetics, Safety, and Tolerance of Cefepime Administered as an Intravenous Bolus or as a Rapid Infusion." *The Annals of Pharmacotherapy* 33, no. 12 (1999): 1258-61.

- Georges, B., J. M. Conil, T. Seguin, E. Dieye, P. Cougot, J. F. Decun, M. Lavit, K. Samii, G. Houin, and S. Saivin. "Cefepime in Intensive Care Unit Patients: Validation of a Population Pharmacokinetic Approach and Influence of Covariables." *International Journal of Clinical Pharmacology and Therapeutics* 46, no. 4 (2008): 157-64.
- Giles, Lucy J., Anne C. Jennings, Alison H. Thomson, Gary Creed, Richard J. Beale, and Angela McLuckie. "Pharmacokinetics of Meropenem in Intensive Care Unit Patients Receiving Continuous Veno-Venous Hemofiltration or Hemodiafiltration." *Critical Care Medicine* 28, no. 3 (2000): 632-7.
- Han, Emily E., Paul M. Beringer, Pal Falck, Stan Louie, Purush Rao, Bertrand Shapiro, and Mark Gill. "Pilot Study of Continuous Infusion Cefepime in Adult Patients with Cystic Fibrosis." *The Journal of Antimicrobial Chemotherapy* 57, no. 5 (2006): 1017-9.
- Hanley, Michael J., Darrell R. Abernethy, and David J. Greenblatt. "Effect of Obesity on the Pharmacokinetics of Drugs in Humans." *Clinical Pharmacokinetics* 49, no. 2 (2010): 71-87.
- Higuchi, Kazuko, Kazuro Ikawa, Kayo Ikeda, Hiroki Ohge, Taijiro Sueda, Hitoshi Houchi, and Norifumi Morikawa. "Peritoneal Pharmacokinetics of Cefepime in Laparotomy Patients with Inflammatory Bowel Disease, and Dosage Considerations for Surgical Intra-Abdominal Infections Based on Pharmacodynamic Assessment." *Journal of Infection and Chemotherapy* 14, no. 2 (2008): 110-6.
- Hites, Maya, Fabio Silvio Taccone, Fleur Wolff, Frederic Cotton, Marjorie Beumier, Daniel De Backer, Sandrine Roisin, Sophie Lorent, Rudy Surin, Lucie Seyler, Jean-Louis Vincent, and Frederique Jacobs. "Case-Control Study of Drug Monitoring of Beta-Lactams in Obese Critically Ill Patients." *Antimicrobial Agents and Chemotherapy* 57, no. 2 (2013): 708-15.
- Hites, M., F. S. Taccone, F. Wolff, E. Maillart, M. Beumier, R. Surin, F. Cotton, and F. Jacobs. "Broad-Spectrum Beta-Lactams in Obese Non-Critically Ill Patients." *Nutrition & Diabetes* 4, (2014): e119.
- Holford, Nicholas H. G. "Input-Output Models." In *Simulation for Designing Clinical Trials: A Pharmacokinetic-Pharmacodynamic Modeling Perspective*, edited by Hui Kimko and Stephen B. Duffull, 15-28. New York, NY, USA: Marcel Dekker, Inc., 2002.

- Ikawa, Kazuro, Norifumi Morikawa, Kayo Ikeda, Hiroki Ohge, and Taijiro Sueda. "Development of Breakpoints of Cephems for Intraabdominal Infections Based on Pharmacokinetics and Pharmacodynamics in the Peritoneal Fluid of Patients." *Journal of Infection and Chemotherapy* 14, no. 2 (2008): 141-6.
- Ikawa, Kazuro, Norifumi Morikawa, Hiroki Ohge, Kayo Ikeda, Taijiro Sueda, Masafumi Taniwaki, and Kaoru Kurisu. "Pharmacokinetic-Pharmacodynamic Target Attainment Analysis of Meropenem in Japanese Adult Patients." *Journal of Infection and Chemotherapy* 16, no. 1 (2010): 25-32.
- Ikawa, Kazuro, Akira Nakashima, Norifumi Morikawa, Kayo Ikeda, Yoshiaki Murakami, Hiroki Ohge, Hartmut Derendorf, and Taijiro Sueda. "Clinical Pharmacokinetics of Meropenem and Biapenem in Bile and Dosing Considerations for Biliary Tract Infections Based on Site-Specific Pharmacodynamic Target Attainment." *Antimicrobial Agents and Chemotherapy* 55, no. 12 (2011): 5609-15.
- Isla, Arantxazu, Alicia Rodriguez-Gascon, Inaki F. Troconiz, Lorea Bueno, Maria Angeles Solinis, Javier Maynar, Jose Angel Sanchez-Izquierdo, and Jose Luis Pedraz. "Population Pharmacokinetics of Meropenem in Critically Ill Patients Undergoing Continuous Renal Replacement Therapy." *Clinical Pharmacokinetics* 47, no. 3 (2008): 173-80.
- Jain, R., S. M. Chung, L. Jain, M. Khurana, S. W. Lau, J. E. Lee, J. Vaidyanathan, I. Zadezensky, S. Choe, and C. G. Sahajwalla. "Implications of Obesity for Drug Therapy: Limitations and Challenges." *Clinical Pharmacology and Therapeutics* 90, no. 1 (2011): 77-89.
- Janmahasatian, Sarayut, Stephen B. Duffull, Susan Ash, Leigh C. Ward, Nuala M. Byrne, and Bruce Green. "Quantification of Lean Bodyweight." *Clinical Pharmacokinetics* 44, no. 10 (2005): 1051-65.
- Jeon, Sangil, Seunghoon Han, Jongtae Lee, Taegon Hong, Jeongki Paek, Heungjeong Woo, and Dong-Seok Yim. "Population Pharmacokinetic Analysis of Piperacillin in Burn Patients." *Antimicrobial Agents and Chemotherapy* 58, no. 7 (2014): 3744-51.
- Kalman, Debra, Steven L. Barriere, and B. Lamar Johnson, Jr. "Pharmacokinetic Disposition and Bactericidal Activities of Cefepime, Ceftazidime, and Cefoperazone in Serum and Blister Fluid." *Antimicrobial Agents and Chemotherapy* 36, no. 2 (1992): 453-7.

- Karjagin, J., S. Lefevre, K. Oselin, K. Kipper, S. Marchand, A. Tikkerberi, J. Starkopf, W. Couet, and R. J. Sawchuk. "Pharmacokinetics of Meropenem Determined by Microdialysis in the Peritoneal Fluid of Patients with Severe Peritonitis Associated with Septic Shock." *Clinical Pharmacology and Therapeutics* 83, no. 3 (2008): 452-9.
- Kelly, H. C., M. Hutchison, and S. J. Haworth. "A Comparison of the Pharmacokinetics of Meropenem after Administration by Intravenous Injection over 5 min and Intravenous Infusion over 30 min." *The Journal of Antimicrobial Chemotherapy* 36 Suppl A, (1995): 35-41.
- Krueger, W. A., T. H. Schroeder, M. Hutchison, E. Hoffmann, H. J. Dieterich, A. Heininger, C. Erley, A. Wehrle, and K. Unertl. "Pharmacokinetics of Meropenem in Critically Ill Patients with Acute Renal Failure Treated by Continuous Hemodiafiltration." *Antimicrobial Agents and Chemotherapy* 42, no. 9 (1998): 2421-4.
- Krueger, Wolfgang A., Jurgen Bulitta, Martina Kinzig-Schippers, Cornelia Landersdorfer, Ulrike Holzgrabe, Kurt G. Naber, George L. Drusano, and Fritz Sorgel. "Evaluation by Monte Carlo Simulation of the Pharmacokinetics of Two Doses of Meropenem Administered Intermittently or as a Continuous Infusion in Healthy Volunteers." *Antimicrobial Agents and Chemotherapy* 49, no. 5 (2005): 1881-9.
- Kuti, Joseph L., Prachi K. Dandekar, Charles H. Nightingale, and David P. Nicolau. "Use of Monte Carlo Simulation to Design an Optimized Pharmacodynamic Dosing Strategy for Meropenem." *Journal of Clinical Pharmacology* 43, no. 10 (2003): 1116-23.
- Landersdorfer, Cornelia B., Jurgen B. Bulitta, Carl M. Kirkpatrick, Martina Kinzig, Ulrike Holzgrabe, George L. Drusano, Ulrich Stephan, and Fritz Sorgel. "Population Pharmacokinetics of Piperacillin at Two Dose Levels: Influence of Nonlinear Pharmacokinetics on the Pharmacodynamic Profile." *Antimicrobial Agents and Chemotherapy* 56, no. 11 (2012): 5715-23.
- Law, Vivian, Craig Knox, Yannick Djoumbou, Tim Jewison, An Chi Guo, Yifeng Liu, Adam Maciejewski, David Arndt, Michael Wilson, Vanessa Neveu, Alexandra Tang, Geraldine Gabriel, Carol Ly, Sakina Adamjee, Zerihun T. Dame, Beomsoo Han, You Zhou, and David S. Wishart. "Drugbank 4.0: Shedding New Light on Drug Metabolism." *Nucleic Acids Research* 42, Database issue (2014): D1091-7.

- Lee, Lois S., Martina Kinzig-Schippers, Anne N. Nafziger, Lei Ma, Fritz Sorgel, Ronald N. Jones, George L. Drusano, and Joseph S. Bertino Jr. "Comparison of 30-min and 3-h Infusion Regimens for Imipenem/Cilastatin and for Meropenem Evaluated by Monte Carlo Simulation." *Diagnostic Microbiology and Infectious Disease* 68, no. 3 (2010): 251-8.
- Li, Chonghua, Xiaoli Du, Joseph L. Kuti, and David P. Nicolau. "Clinical Pharmacodynamics of Meropenem in Patients with Lower Respiratory Tract Infections." *Antimicrobial Agents and Chemotherapy* 51, no. 5 (2007): 1725-30.
- Li, Chonghua, Joseph L. Kuti, Charles H. Nightingale, and David P. Nicolau. "Population Pharmacokinetic Analysis and Dosing Regimen Optimization of Meropenem in Adult Patients." *Journal of Clinical Pharmacology* 46, no. 10 (2006): 1171-8.
- Lipman, J., S. C. Wallis, and C. Rickard. "Low Plasma Cefepime Levels in Critically Ill Septic Patients: Pharmacokinetic Modeling Indicates Improved Troughs with Revised Dosing." *Antimicrobial Agents and Chemotherapy* 43, no. 10 (1999): 2559-61.
- Lister, Philip D., Andrea M. Prevan, and Christine C. Sanders. "Importance of Beta-Lactamase Inhibitor Pharmacokinetics in the Pharmacodynamics of Inhibitor-Drug Combinations: Studies with Piperacillin-Tazobactam and Piperacillin-Sulbactam." *Antimicrobial Agents and Chemotherapy* 41, no. 4 (1997): 721-7.
- Lodise Jr., Thomas P., Ben Lomaestro, Keith A. Rodvold, Larry H. Danziger, and George L. Drusano. "Pharmacodynamic Profiling of Piperacillin in the Presence of Tazobactam in Patients through the Use of Population Pharmacokinetic Models and Monte Carlo Simulation." *Antimicrobial Agents and Chemotherapy* 48, no. 12 (2004): 4718-24.
- Lomaestro, Ben M., and George L. Drusano. "Pharmacodynamic Evaluation of Extending the Administration Time of Meropenem Using a Monte Carlo Simulation." *Antimicrobial Agents and Chemotherapy* 49, no. 1 (2005): 461-3.
- Lovering, A. M., C. J. Vickery, D. S. Watkin, D. Leaper, C. M. McMullin, L. O. White, D. S. Reeves, and A. P. MacGowan. "The Pharmacokinetics of Meropenem in Surgical Patients with Moderate or Severe Infections." *The Journal of Antimicrobial Chemotherapy* 36, no. 1 (1995): 165-72.
- Lubasch, A., S. Ziege, B. Brodersen, K. Borner, P. Koeppe, and H. Lode. "Serum Bactericidal Activity of Trovafloxacin, in Combination with Cefepime or Amikacin, in Healthy Volunteers." *Clinical Microbiology and Infection* 9, no. 7 (2003): 670-7.

- Martinez, Marilyn N., Mark G. Papich, and George L. Drusano. "Dosing Regimen Matters: The Importance of Early Intervention and Rapid Attainment of the Pharmacokinetic/Pharmacodynamic Target." *Antimicrobial Agents and Chemotherapy* 56, no. 6 (2012): 2795-805.
- Mouton, Johan W., and Marc F. Michel. "Pharmacokinetics of Meropenem in Serum and Suction Blister Fluid During Continuous and Intermittent Infusion." *The Journal of Antimicrobial Chemotherapy* 28, no. 6 (1991): 911-8.
- Newman, Diane, Marc H. Scheetz, Oluwadamilola A. Adeyemi, Mauro Montevecchi, David P. Nicolau, Gary A. Noskin, and Michael J. Postelnick. "Serum Piperacillin/Tazobactam Pharmacokinetics in a Morbidly Obese Individual." *The Annals of Pharmacotherapy* 41, no. 10 (2007): 1734-9.
- Nicasio, Anthony M., Robert E. Ariano, Sheryl A. Zelenitsky, Aryun Kim, Jared L. Crandon, Joseph L. Kuti, and David P. Nicolau. "Population Pharmacokinetics of High-Dose, Prolonged-Infusion Cefepime in Adult Critically Ill Patients with Ventilator-Associated Pneumonia." *Antimicrobial Agents and Chemotherapy* 53, no. 4 (2009): 1476-81.
- Nilsson-Ehle, I., M. Hutchison, S. J. Haworth, and S. R. Norrby. "Pharmacokinetics of Meropenem Compared to Imipenem-Cilastatin in Young, Healthy Males." *European Journal of Clinical Microbiology & Infectious Diseases* 10, no. 2 (1991): 85-8.
- Novelli, Andrea, Chiara Adembri, Paola Livi, Stefania Fallani, Teresita Mazzei, and Angelo Raffaele De Gaudio. "Pharmacokinetic Evaluation of Meropenem and Imipenem in Critically Ill Patients with Sepsis." *Clinical Pharmacokinetics* 44, no. 5 (2005): 539-49.
- Nye, K. J., Y. G. Shi, J. M. Andrews, and R. Wise. "Pharmacokinetics and Tissue Penetration of Cefepime." *The Journal of Antimicrobial Chemotherapy* 24, no. 1 (1989): 23-8.
- Ohata, Yuka, Yoshiko Tomita, Mitsunobu Nakayama, Kazuo Tamura, and Yusuke Tanigawara. "Optimal Treatment Schedule of Meropenem for Adult Patients with Febrile Neutropenia Based on Pharmacokinetic-Pharmacodynamic Analysis." *Journal of Infection and Chemotherapy* 17, no. 6 (2011): 831-41.
- Pai, Manjunath P., and David T. Bearden. "Antimicrobial Dosing Considerations in Obese Adult Patients." *Pharmacotherapy* 27, no. 8 (2007): 1081-91.



- Ramon-Lopez, Amelia, Jane M. Allen, Alison H. Thomson, Bajlit S. Dheansa, S. Elizabeth James, Geoff W. Hanlon, Bruce Stewart, and J. Graham Davies. "Dosing Regimen of Meropenem for Adults with Severe Burns: A Population Pharmacokinetic Study with Monte Carlo Simulations." *The Journal of Antimicrobial Chemotherapy*, (2014).
- Rich, Barrie S., Rebecca Keel, Vanessa P. Ho, Harma Turbendian, Cheguevara I. Afaneh, Gregory F. Dakin, Alfons Pomp, David P. Nicolau, and Philip S. Barie. "Cefepime Dosing in the Morbidly Obese Patient Population." *Obesity Surgery* 22, no. 3 (2012): 465-71.
- Roberts, Jason A., Mohd H. Abdul-Aziz, Jeffrey Lipman, Johan W. Mouton, Alexander A. Vinks, Timothy W. Felton, William W. Hope, Andras Farkas, Michael N. Neely, Jerome J. Schentag, George Drusano, Otto R. Frey, Ursula Theuretzbacher, and Joseph L. Kuti. "Individualised Antibiotic Dosing for Patients Who Are Critically Ill: Challenges and Potential Solutions." *The Lancet. Infectious Diseases* 14, no. 6 (2014): 498-509.
- Roberts, Jason A., Carl M. J. Kirkpatrick, Michael S. Roberts, Andres J. Dalley, and Jeffrey Lipman. "First-Dose and Steady-State Population Pharmacokinetics and Pharmacodynamics of Piperacillin by Continuous or Intermittent Dosing in Critically Ill Patients with Sepsis." *International Journal of Antimicrobial Agents* 35, no. 2 (2010): 156-63.
- Roberts, Jason A., Carl M. J. Kirkpatrick, Michael S. Roberts, Thomas A. Robertson, Andrew J. Dalley, and Jeffrey Lipman. "Meropenem Dosing in Critically Ill Patients with Sepsis and without Renal Dysfunction: Intermittent Bolus Versus Continuous Administration? Monte Carlo Dosing Simulations and Subcutaneous Tissue Distribution." *The Journal of Antimicrobial Chemotherapy* 64, no. 1 (2009): 142-50.
- Roos, Juliana F., Jurgen Bulitta, Jeffrey Lipman, and Carl M. Kirkpatrick. "Pharmacokinetic-Pharmacodynamic Rationale for Cefepime Dosing Regimens in Intensive Care Units." *The Journal of Antimicrobial Chemotherapy* 58, no. 5 (2006): 987-93.
- Sampol, Emmanuelle, Alexis Jacquet, Marc Viggiano, Victor Bernini, Jean-Claude Manelli, Bruno Lacarelle, and Alain Durand. "Plasma, Urine and Skin Pharmacokinetics of Cefepime in Burns Patients." *The Journal of Antimicrobial Chemotherapy* 46, no. 2 (2000): 315-7.
- Sorgel, F., M. Kinzig. "The Chemistry, Pharmacokinetics, and Tissue Distribution of Piperacillin/Tazobactam." *The Journal of Antimicrobial Chemotherapy* 1993(Suppl A) 31 39-60

- Stein, Gary E., Grace Kulhanek, Curtis L. Smith, Joseph L. Kuti, David P. Nicolau, Amy Scharmen, Chris Farnum, MaryAnn Tran, Apoorv Kalra, and Daniel H. Havlichek. "Pharmacokinetics and Monte Carlo Simulations of Doripenem in Patients with Febrile Neutropenia." *The Annals of Pharmacotherapy* 46, no. 10 (2012): 1281-6.
- Strayer, Andy H., Deborah H. Gilbert, Phil Pivarnik, Antone A. Medeiros, Stephen H. Zinner, and Michael N. Dudley. "Pharmacodynamics of Piperacillin Alone and in Combination with Tazobactam against Piperacillin-Resistant and -Susceptible Organisms in an In Vitro Model of Infection." *Antimicrobial Agents and Chemotherapy* 38, no. 10 (1994): 2351-6.
- Sturm, Ashley W., Nichole Allen, Kelly D. Rafferty, Douglas N. Fish, Eric Toschlog, Mark Newell, and Brett Waibel. "Pharmacokinetic Analysis of Piperacillin Administered with Tazobactam in Critically Ill, Morbidly Obese Surgical Patients." *Pharmacotherapy* 34, no. 1 (2014): 28-35.
- Tam, Vincent H., Peggy S. McKinnon, Ronda L. Akins, George L. Drusano, and Michael J. Rybak. "Pharmacokinetics and Pharmacodynamics of Cefepime in Patients with Various Degrees of Renal Function." *Antimicrobial Agents and Chemotherapy* 47, no. 6 (2003): 1853-61.
- Tegeder, Irmgard, Frank Neumann, Frank Bremer, Kay Brune, Jorn Lotsch, and Gerd Geisslinger. "Pharmacokinetics of Meropenem in Critically Ill Patients with Acute Renal Failure Undergoing Continuous Venovenous Hemofiltration." *Clinical Pharmacology and Therapeutics* 65, no. 1 (1999): 50-7.
- VanScoy, Brian, Rodrigo E. Mendes, Anthony M. Nicasio, Mariana Castanheira, Catharine C. Bulik, Olanrewaju O. Okusanya, Sujuta M. Bhavnani, Alan Forrest, Ronald N. Jones, Lawrence V. Friedrich, Judith N. Steenbergen, and Paul G. Ambrose. "Pharmacokinetics-Pharmacodynamics of Tazobactam in Combination with Ceftolozane in an In Vitro Infection Model." *Antimicrobial Agents and Chemotherapy* 57, no. 6 (2013): 2809-14.
- Ververs, Tessa F. T., Aalt van Dijk, Sander A. T. M. M. Vinks, Peter J. Blankestijn, T. Jean F. Savelkoul, Jan Meulenbelt, and Frans T. J. Boereboom. "Pharmacokinetics and Dosing Regimen of Meropenem in Critically Ill Patients Receiving Continuous Venovenous Hemofiltration." *Critical Care Medicine* 28, no. 10 (2000): 3412-6.
- Vinks, Alexander A., Jan G. den Hollander, Shelley E. Overbeek, Roger W. Jelliffe, and Johan W. Mouton. "Population Pharmacokinetic Analysis of Nonlinear Behavior of Piperacillin During Intermittent or Continuous Infusion in Patients with Cystic Fibrosis." *Antimicrobial Agents and Chemotherapy* 47, no. 2 (2003): 541-7.

- Wise, R., M. Logan, M. Cooper, J. P. Ashby, and J. M. Andrews. "Meropenem Pharmacokinetics and Penetration into an Inflammatory Exudate." *Antimicrobial Agents and Chemotherapy* 34, no. 8 (1990): 1515-7.
- Zhou, Qing-Tao, Bei He, Chao Zhang, Suo-Di Zhai, Zhen-Ying Liu, and Jie Zhang. "Pharmacokinetics and Pharmacodynamics of Meropenem in Elderly Chinese with Lower Respiratory Tract Infections: Population Pharmacokinetics Analysis Using Nonlinear Mixed-Effects Modelling and Clinical Pharmacodynamics Study." *Drugs & Aging* 28, no. 11 (2011): 903-12.

## SELECTED BIBLIOGRAPHY

## SELECTED BIBLIOGRAPHY

- Abernethy, Darrell R., Marcia Divoll, David J. Greenblatt, and Barbara Ameer. "Obesity, Sex, and Acetaminophen Disposition." *Clinical Pharmacology and Therapeutics* 31, no. 6 (1982a): 783-90.
- Abernethy, Darrell R., and David J. Greenblatt. "Lidocaine Disposition in Obesity." *The American Journal of Cardiology* 53, no. 8 (1984): 1183-6.
- Abernethy, Darrell R., and David J. Greenblatt. "Ibuprofen Disposition in Obese Individuals." *Arthritis and Rheumatism* 28, no. 10 (1985a): 1117-21.
- Abernethy, Darrell R., and David J. Greenblatt. "Phenytoin Disposition in Obesity: Determination of Loading Dose." *Archives of Neurology* 42, no. 5 (1985b): 468-71.
- Abernethy, Darrell R., David J. Greenblatt, Marcia Divoll, Jerold S. Harmatz, and Richard I. Shader. "Alterations in Drug Distribution and Clearance Due to Obesity." *The Journal of Pharmacology and Experimental Therapeutics* 217, no. 3 (1981a): 681-5.
- Abernethy, Darrell R., David J. Greenblatt, Marcia Divoll, and Richard I. Shader. "Prolongation of Drug Half-Life Due to Obesity: Studies of Desmethyldiazepam (Clorazepate)." *Journal of Pharmaceutical Sciences* 71, no. 8 (1982b): 942-4.
- Abernethy, D. R., D. J. Greenblatt, M. Divoll, and R. I. Shader. "Enhanced Glucuronide Conjugation of Drugs in Obesity: Studies of Lorazepam, Oxazepam, and Acetaminophen." *The Journal of Laboratory and Clinical Medicine* 101, no. 6 (1983): 873-80.
- Abernethy, Darrell R., David J. Greenblatt, Marcia Divoll, Randall B. Smith, and Richard I. Shader. "The Influence of Obesity on the Pharmacokinetics of Oral Alprazolam and Triazolam." *Clinical Pharmacokinetics* 9, no. 2 (1984): 177-83.
- Abernethy, Darrell R., David J. Greenblatt, and Thomas W. Smith. "Digoxin Disposition in Obesity: Clinical Pharmacokinetic Investigation." *American Heart Journal* 102, no. 4 (1981b): 740-4.

- Abernethy, D. R., Elizabeth L. Todd, and Janice B. Schwartz. "Caffeine Disposition in Obesity." *British Journal of Clinical Pharmacology* 20, no. 1 (1985): 61-6.
- Adnan, Syamhanin, Janice Xuanhui Li, Steven C. Wallis, Michael Rudd, Paul Jarrett, David L. Paterson, Jeffrey Lipman, Andrew A. Udy, and Jason A. Roberts. "Pharmacokinetics of Meropenem and Piperacillin in Critically Ill Patients with Indwelling Surgical Drains." *International Journal of Antimicrobial Agents* 42, no. 1 (2013): 90-3.
- Aggarwal, Nidhi, Anna C. Porter, Ignatius Y. S. Tang, Bryan N. Becker, and Sanjeev K. Akkina. "Creatinine-Based Estimations of Kidney Function Are Unreliable in Obese Kidney Donors." *Journal of Transplant* 2012, (2012): 872894.
- Akaike, Hirotugu. "A New Look at the Statistical Model Identification." *IEEE Transactions on Automatic Control* 19, no. 6 (1974): 716-23.
- Alexander, James K. "Obesity and Cardiac Performance." *The American Journal of Cardiology* 14, (1964): 860-5.
- Alexander, J. K., E. W. Dennis, W. G. Smith, K. H. Amad, W. C. Duncan, and R. C. Austin. "Blood Volume, Cardiac Output, and Distribution of Systemic Blood Flow in Extreme obesity." *Cardiovascular Research Center Bulletin* Winter, no. 1 (1962-1963): 39-44.
- Allard, Sylvie, Martina Kinzig, Guy Boivin, Fritz Sorgel, and Marc LeBel. "Intravenous Ciprofloxacin Disposition in Obesity." *Clinical Pharmacology and Therapeutics* 54, no. 4 (1993): 368-73.
- Alpert, Martin A., and M. Wail Hashimi. "Obesity and the Heart." *The American Journal of the Medical Sciences* 306, no. 2 (1993): 117-23.
- Alvarez, Jose C., Sonia I. Cuervo, Javier R. Garzon, Julio C. Gomez, Jorge Augusto Diaz, Edelberto Silva, Ricardo Sanchez, and Jorge A. Cortes. "Pharmacokinetics of Piperacillin/Tazobactam in Cancer Patients with Hematological Malignancies and Febrile Neutropenia after Chemotherapy." *BMC Pharmacology & Toxicology* 14, (2013): 59.
- American College of Clinical Pharmacology, "Pharmacometrics"  
<http://accpl.org/pharmacometrics/theory.htm> (accessed January 23 2015).
- American Thoracic Society, and Infectious Diseases Society of America. "Guidelines for the Management of Adults with Hospital-Acquired, Ventilator-Associated, and Healthcare-Associated Pneumonia." *American Journal of Respiratory and Critical Care Medicine* 171, no. 4 (2005): 388-416.

- Amsden, Guy W., Charles H. Ballow, Joseph S. Bertino Jr., and Angela D. M. Kashuba. "Pharmacokinetics and Pharmacodynamics of Anti-Infective Agents." In *Principles and Practice of Infectious Diseases*, edited by Gerald L. Mandell, John E. Bennett and Raphael Dolin, 297-308. Philadelphia, PA: Churchill Livingstone Elsevier, 2010.
- Andes, David R., and William A. Craig. "Cephalosporins." In *Principles and Practice of Infectious Diseases*, edited by Gerald L. Mandell, John E. Bennett and Raphael Dolin, 323-340. Philadelphia, PA: Churchill Livingstone Elsevier, 2010.
- Arguedas, Adriano G., Harris R. Stutman, Margaret Zaleska, Catherine A. Knupp, Melvin I. Marks, and Eliezer Nussbaum. "Cefepime. Pharmacokinetics and Clinical Response in Patients with Cystic Fibrosis." *American Journal of Diseases of Children* 146, no. 7 (1992): 797-802.
- Ariano, Robert E., Anna Nyhlen, J. Peter Donnelly, Daniel S. Sitar, Godfrey K. M. Harding, and Sheryl A. Zelenitsky. "Pharmacokinetics and Pharmacodynamics of Meropenem in Febrile Neutropenic Patients with Bacteremia." *The Annals of Pharmacotherapy* 39, no. 1 (2005a): 32-8.
- Ariano, Robert E., Sheryl A. Zelenitsky, Anna Nyhlen, and Daniel S. Sitar. "An Evaluation of an Optimal Sampling Strategy for Meropenem in Febrile Neutropenics." *Journal of Clinical Pharmacology* 45, no. 7 (2005b): 832-5.
- Auclair, Barbara, and Murray P. Ducharme. "Piperacillin and Tazobactam Exhibit Linear Pharmacokinetics after Multiple Standard Clinical Doses." *Antimicrobial Agents and Chemotherapy* 43, no. 6 (1999): 1465-8.
- Augey, Valerie, Pierre-Yves Grosse, Gregory Albert, Michel Audran, and Françoise Bressolle. "High-Performance Liquid Chromatographic Determination of Tazobactam and Piperacillin in Human Plasma and Urine." *Journal of Chromatography. B, Biomedical Applications* 682, no. 1 (1996): 125-36.
- Bacher, K., M. Schaeffer, H. Lode, C. E. Nord, K. Borner, and P. Koeppe. "Multiple Dose Pharmacokinetics, Safety, and Effects on Faecal Microflora, of Cefepime in Healthy Volunteers." *The Journal of Antimicrobial Chemotherapy* 30, no. 3 (1992): 365-75.
- Baldwin, Claudine M., Katherine A. Lyseng-Williamson, and Susan J. Keam. "Meropenem: A Review of Its Use in the Treatment of Serious Bacterial Infections." *Drugs* 68, no. 6 (2008): 803-38.

- Barbhaiya, R. H., S. T. Fogue, C. R. Gleason, C. A. Knupp, K. A. Pittman, D. J. Weidler, and R. R. Martin. "Safety, Tolerance, and Pharmacokinetic Evaluation of Cefepime after Administration of Single Intravenous Doses." *Antimicrobial Agents and Chemotherapy* 34, no. 6 (1990): 1118-22.
- Barbhaiya, Rashimi H., S. Thomas Fogue, Carol R. Gleason, Catherine A. Knupp, Kenneth A. Pittman, Donald J. Weidler, Hassan Movahhed, James Tenney, and R. Russel Martin. "Pharmacokinetics of Cefepime after Single and Multiple Intravenous Administrations in Healthy Subjects." *Antimicrobial Agents and Chemotherapy* 36, no. 3 (1992): 552-7.
- Barbhaiya, R. H., C. A. Knupp, S. T. Fogue, G. R. Matzke, C. E. Halstenson, J. A. Opsahl, and K. A. Pittman. "Disposition of the Cephalosporin Cefepime in Normal and Renally Impaired Subjects." *Drug Metabolism and Disposition* 19, no. 1 (1991): 68-73.
- Bauer, L. A., D. J. Black, and J. S. Lill. "Vancomycin Dosing in Morbidly Obese Patients." *European Journal of Clinical Pharmacology* 54, no. 8 (1998): 621-5.
- Bauer, L. A., W. A. Drew Edwards, E. Patchen Dellinger, and D. A. Simonowitz. "Influence of Weight on Aminoglycoside Pharmacokinetics in Normal Weight and Morbidly Obese Patients." *European Journal of Clinical Pharmacology* 24, no. 5 (1983): 643-7.
- Bauer, Robert J., Alison J. Boeckmann, Lewis B. Sheiner, and Stuart L. Beal. "NONMEM Users Guide." 1989-2009. Ellicott City, MD, USA: Icon Development Solutions, 2009.
- Bax, R. P., W. Bastain, A. Featherstone, D. M. Wilkinson, M. Hutchison, and S. J. Haworth. "The Pharmacokinetics of Meropenem in Volunteers." *The Journal of Antimicrobial Chemotherapy* 24 Suppl A, (1989): 311-20.
- Bedikian, Annet, Mark P. Okamoto, Randall K. Nakahiro, John Farino, Peter N. R. Heseltine, Maria D. Appleman, Albert E. Yellin, Thomas V. Berne, and Mark A. Gill. "Pharmacokinetics of Meropenem in Patients with Intra-Abdominal Infections." *Antimicrobial Agents and Chemotherapy* 38, no. 1 (1994): 151-4.
- Benedek, I. H., W. D. Fiske, 3rd, W. O. Griffen, R. M. Bell, R. A. Blouin, and P. J. McNamara. "Serum Alpha1-Acid Glycoprotein and the Binding of Drugs in Obesity." *British Journal of Clinical Pharmacology* 16, no. 6 (1983): 751-4.
- Benedek, I. H., R. A. Blouin, and P. J. McNamara. "Serum Protein Binding and the Role of Increased Alpha1-Acid Glycoprotein in Moderately Obese Male Subjects." *British Journal of Clinical Pharmacology* 18, no. 6 (1984): 941-6.



- Bercault, Nicholas, Thierry Boulain, Kaldhoun Kuteifan, Manuel Wolf, Isabelle Runge, and Jean-Christian Fleury. "Obesity-Related Excess Mortality Rate in an Adult Intensive Care Unit: A Risk-Adjusted Matched Cohort Study." *Critical Care Medicine* 32, no. 4 (2004): 998-1003.
- Binder, Lutz, Harald Schworer, Sebastian Hoppe, Frank Streit, Silke Neumann, Annett Beckmann, Rolf Wachter, Michael Oellerich, and Philip D. Walson. "Pharmacokinetics of Meropenem in Critically Ill Patients with Severe Infections." *Therapeutic Drug Monitoring* 35, no. 1 (2013): 63-70.
- Blaser, Jurg, Benjamin B. Stone, and Stephen H. Zinner. "Two Compartment Kinetic Model with Multiple Artificial Capillary Units." *The Journal of Antimicrobial Chemotherapy* 15 Suppl A, (1985): 131-7.
- Blaser Jurg, Benjamin B. Stone, Michael C. Groner, and Stephen H. Zinner. "Comparative Study with Enoxacin and Netilmicin in a Pharmacodynamic Model to Determine Importance of Ratio of Antibiotic Peak Concentration to MIC for Bactericidal Activity and Emergence of Resistance." *Antimicrobial Agents and Chemotherapy* 31, no. 7 (1987): 1054-60.
- Blouin, Robert A., Larry A. Bauer, Delwyn D. Miller, Kenneth E. Record, and Ward O. Griffen, Jr. "Vancomycin Pharmacokinetics in Normal and Morbidly Obese Subjects." *Antimicrobial Agents and Chemotherapy* 21, no. 4 (1982): 575-80.
- Bodey, Gerald D., Steven J. Ketchel, and Victorio Rodriguez. "A Randomized Study of Carbenicillin Plus Cefamandole or Tobramycin in the Treatment of Febrile Episodes in Cancer Patients." *The American Journal of Medicine* 67, no. 4 (1979): 608-11.
- Bonapace, Charles R., Roger L. White, Lawrence V. Friedrich, E. Douglas Norcross, and John A. Bosso. "Pharmacokinetics of Cefepime in Patients with Thermal Burn Injury." *Antimicrobial Agents and Chemotherapy* 43, no. 12 (1999): 2848-54.
- Bourget, Philippe, Anne Lesne-Hulin, Robert Le Reveille, Herve Le Bever, and Herve Carsin. "Clinical Pharmacokinetics of Piperacillin-Tazobactam Combination in Patients with Major Burns and Signs of Infection." *Antimicrobial Agents and Chemotherapy* 40, no. 1 (1996): 139-45.
- Bowman, S. L., S. A. Hudson, G. Simpson, J. F. Munro, and J. A. Clements. "A Comparison of the Pharmacokinetics of Propranolol in Obese and Normal Volunteers." *British Journal of Clinical Pharmacology* 21, no. 5 (1986): 529-32.

- Brill, Margreke J. E., Jeroen Diepstraten, Anne van Rongen, Simone van Kralingen, John N. van den Anker, and Catherijne A. Knibbe. "Impact of Obesity on Drug Metabolism and Elimination in Adults and Children." *Clinical Pharmacokinetics* 51, no. 5 (2012): 277-304.
- Buck, Christine, Norbert Bertram, Thomas Ackermann, Tilman Sauerbruch, Hartmut derendorf, and Wilhem Dieter Paar. "Pharmacokinetics of Piperacillin-Tazobactam: Intermittent Dosing versus Continuous Infusion." *International Journal of Antimicrobial Agents* 25, no. 1 (2005): 62-7.
- Bui, Khanh Q., Paul G. Ambrose, David P. Nicolau, Craig D. Lapin, Charles H. Nightingale, and Richard Quintiliani. "Pharmacokinetics of High-Dose Meropenem in Adult Cystic Fibrosis Patients." *Chemotherapy* 47, no. 3 (2001): 153-86.
- Bulitta, J. B., S. B. Duffull, M. Kinzig-Schippers, U. Holzgrabe, U. Stephan, G. L. Drusano, and F. Sorgel. "Systematic Comparison of the Population Pharmacokinetics and Pharmacodynamics of Piperacillin in Cystic Fibrosis Patients and Healthy Volunteers." *Antimicrobial Agents and Chemotherapy* 51, no. 7 (2007): 2497-507.
- Bulitta, Jurgen B., Martina Kinzig, Verena Jakob, Ulrike Holzgrabe, Fritz Sorgel, and Nicholas H. G. Holford. "Nonlinear Pharmacokinetics of Piperacillin in Healthy Volunteers--Implications for Optimal Dosage Regimens." *British Journal of Clinical Pharmacology* 70, no. 5 (2010): 682-93.
- Burgess, David S., Rhonda W. Hastings, and Thomas C. Hardin. "Pharmacokinetics and Pharmacodynamics of Cefepime Administered by Intermittent and Continuous Infusion." *Clinical Therapeutics* 22, no. 1 (2000): 66-75.
- Butterfield, Jill M., Thomas P. Lodise, Scott Beegle, Jonathan Rosen, Joshua Farkas, and Manjunath P. Pai. "Pharmacokinetics and Pharmacodynamics of Extended-Infusion Piperacillin/Tazobactam in Adult Patients with Cystic Fibrosis-Related Acute Pulmonary Exacerbations." *The Journal of Antimicrobial Chemotherapy* 69, no. 1 (2014): 176-9.
- Byon, W., M. K. Smith, P. Chan, M. A. Tortorici, S. Riley, H. Dai, J. Dong, A. Ruiz-Garcia, K. Sweeney, and C. Cronenberger. "Establishing Best Practices and Guidance in Population Modeling: An Experience with an Internal Population Pharmacokinetic Analysis Guidance." *CPT: Pharmacometrics & Systems Pharmacology* 2, (2013): e51.

- Caraco, Y., E. Zylber-Katz, E. M. Berry, and M. Levy. "Antipyrine Disposition in Obesity: Evidence for Negligible Effect of Obesity on Hepatic Oxidative Metabolism." *European Journal of Clinical Pharmacology* 47, no. 6 (1995): 525-30.
- Chambers, Henry F. "Beta-Lactam & Other Cell Wall- & Membrane-Active Antibiotics." In *Basic and Clinical Pharmacology*, edited by Bertram G. Katzung, 726-744. New York: McGraw-Hill Companies, Inc., 2007.
- Chambers, Henry F. "Penicillins and Beta-Lactam Inhibitors." In *Principles and Practice of Infectious Diseases*, edited by Gerald L. Mandell, John E. Bennett and Raphael Dolin, 309-322. Philadelphia, PA: Churchill Livingstone Elsevier, 2010a.
- Chambers, Henry F. "Carbapenems and Monobactams." In *Principles and Practice of Infectious Diseases*, edited by Gerald L. Mandell, John E. Bennett and Raphael Dolin, 341-346. Philadelphia, PA: Churchill Livingstone Elsevier, 2010b.
- Cheatham, S. Christian, Megan R. Fleming, Daniel P. Healy, Christina E. K. Chung, and Michael B. Kays. "Pharmacokinetics and Pharmacodynamics of Meropenem in Morbidly Obese, Hospitalized Patients." *Pharmacotherapy* 31, no. 10 (2011): 354e.
- Cheatham, S. Christian, Megan R. Fleming, Daniel P. Healy, Christina E. K. Chung, Katherine M. Shea, Melissa L. Humphrey, and Michael B. Kays. "Steady-State Pharmacokinetics and Pharmacodynamics of Piperacillin and Tazobactam Administered by Prolonged Infusion in Obese Patients." *International Journal of Antimicrobial Agents* 41, no. 1 (2013): 52-6.
- Cheatham, S. Christian, Megan R. Fleming, Daniel P. Healy, Eun Kyoung Chung, Katherine M. Shea, Melissa L. Humphrey, and Michael B. Kays. "Steady-State Pharmacokinetics and Pharmacodynamics of Meropenem in Morbidly Obese Patients Hospitalized in an Intensive Care Unit." *Journal of Clinical Pharmacology* 54, no. 3 (2014): 324-30.
- Cheatham, S. Christian, Megan R. Fleming, Daniel P. Healy, and Michael B. Kays. "Steady-State Pharmacokinetics and Pharmacodynamics of Cefepime Administered by Prolonged Infusion, in Morbidly and Super-Morbidly Obese, Hospitalized Patients." Presented as a poster presentation (Abstract No. A-069) at the 53rd Interscience Conference on Antimicrobial Agents and Chemotherapy; September 10-13, 2013; Denver, Colorado.
- Cheatham, S. Christian, Michael B. Kays, David W. Smith, Matthew F. Wack, and Kevin M. Sowinski. "Steady-State Pharmacokinetics and Pharmacodynamics of Meropenem in Hospitalized Patients." *Pharmacotherapy* 28, no. 6 (2008): 691-8.

- Cheatham, S. Christian, Katherine M. Shea, Daniel P. Healy, Melissa L. Humphrey, Megan R. Fleming, Matthew F. Wack, David W. Smith, Kevin M. Sowinski, and Michael B. Kays. "Steady-State Pharmacokinetics and Pharmacodynamics of Cefepime Administered by Prolonged Infusion in Hospitalised Patients." *International Journal of Antimicrobial Agents* 37, no. 1 (2011): 46-50.
- Chen, M., A. N. Nafziger, G. L. Drusano, L. Ma, and J. S. Bertino, Jr. "Comparative Pharmacokinetics and Pharmacodynamic Target Attainment of Ertapenem in Normal-Weight, Obese, and Extremely Obese Adults." *Antimicrobial Agents and Chemotherapy* 50, no. 4 (2006): 1222-7.
- Cheymol, Georges, Jean-Marie Poirier, Jerome Barre, Andre Pradalier, and Jean. Dry. "Comparative Pharmacokinetics of Intravenous Propranolol in Obese and Normal Volunteers." *Journal of Clinical Pharmacology* 27, no. 11 (1987): 874-9.
- Cheymol, G., J. Weisseburger, J. M. Poirier, and C. Gellee. "The Pharmacokinetics of Dexfenfluramine in Obese and Non-Obese Subjects." *British Journal of Clinical Pharmacology* 39, no. 6 (1995): 684-87.
- Cheymol, G., R. Woestenborghs, E. Snoeck, R. Ianucci, J.-P. Le Moing, L. Naditch, J. C. Levron, and J. M. Poirier. "Pharmacokinetic Study and Cardiovascular Monitoring of Nebivolol in Normal and Obese Subjects." *European Journal of Clinical Pharmacology* 51, no. 6 (1997): 493-8.
- Chimata, Mnoru, Mitsumasa Nagase, Yasuyuki Suzuki, Masahiko Shimomura, and Sachiko Kakuta. "Pharmacokinetics of Meropenem in Patients with Various Degrees of Renal Function, Including Patients with End-Stage Renal Disease." *Antimicrobial Agents and Chemotherapy* 37, no. 2 (1993): 229-33.
- Choban, Patricia S., Rachel Heckler, Jean C. Burge, and Louis Flancbaum. "Increased Incidence of Nosocomial Infections in Obese Surgical Patients." *The American Surgeon* 61, no. 11 (1995): 1001-5.
- Christensson, B. A., B. Ljungberg, L. Eriksson, and I. Nilsson-Ehle. "Pharmacokinetics of Meropenem in Patients with Cystic Fibrosis." *European Journal of Clinical Microbiology and Infectious Diseases* 17, no. 12 (1998): 873-6.
- Christoff, P. B., D. R. Conti, C. Naylor, and W. J. Jusko. "Procainamide Disposition in Obesity." *Drug Intelligence and Clinical Pharmacy* 17, no. 7-8 (1983): 516-22.
- Clinical and Laboratory Standards Institute. "Performance Standards for Antimicrobial Susceptibility Testing; Twenty-Fourth Informational Supplement." In *Document M100-S24*. Wayne, PA: CLSI, 2014.

- Cockcroft, Donald W., and M. Henry Gault. "Prediction of Creatinine Clearance from Serum Creatinine." *Nephron* 16, no. 1 (1976): 31-41.
- Conil, J. M., B. Georges, M. Lavit, T. Seguin, I. Tack, K. Samii, G. Chabanon, G. Houin, and S. Saivin. "Pharmacokinetics of Ceftazidime and Cefepime in Burn Patients: The Importance of Age and Creatinine Clearance." *International Journal of Clinical Pharmacology and Therapeutics* 45, no. 1 (2007): 529-38.
- Cortinez L. I., B. J. Anderson, A. Penna, L. Olivares, H. R. Munoz, N. H. G. Holford, M. M. R. F. Struys, and P. Sepulveda. "Influence of Obesity on Propofol Pharmacokinetics: Derivation of a Pharmacokinetic Model." *British Journal of Anaesthesia* 105, no. 4 (2010): 448-56.
- Craig, William A. "Interrelationship Between Pharmacokinetics and Pharmacodynamics in Determining Dosage Regimens for Broad-Spectrum Cephalosporins." *Diagnostic Microbiology and Infectious Diseases* 22, no. 1-2 (1995): 89-96.
- Craig, William A. "Pharmacokinetic/Pharmacodynamic Parameters: Rationale for Antibacterial Dosing of Mice and Men." *Clinical Infectious Diseases* 26, no. 1 (1998): 1-10; quiz 11-2.
- Craig, William A. "Basic Pharmacodynamics of Antibacterials with Clinical Applications to the Use of Beta-Lactams, Glycopeptides, and Linezolid." *Infectious Disease Clinics of North America* 17, no. 3 (2003): 479-501.
- Craig, William A., and David Andes. "Pharmacokinetics and Pharmacodynamics of Antibiotics in Otitis Media." *The Pediatric Infectious Disease Journal* 15, no. 3 (1996): 255-9.
- Craig, W. A., and S. C. Ebert. "Killing and Regrowth of Bacteria In Vitro: A Review." *Scandinavian Journal of Infectious Diseases. Supplementum* 74, (1990): 63-70.
- Craig, W. A., S. Ebert, and Y. Watanabe. "Differences in Time above MIC Required for Efficacy of Beta-Lactams in Animal Infection Models." Presented as a poster presentation (Abstract No. 86) at the 33<sup>rd</sup> Interscience Conference on Antimicrobial Agents and Chemotherapy; 1993; San Francisco, California.
- Crandon, Jared L., Robert E. Ariano, Sheryl A. Zelenitsky, Anthony M. Nicasio, Joseph L. Kuti, and David P. Nicolau. "Optimization of Meropenem Dosage in the Critically Ill Population Based on Renal Function." *Intensive Care Medicine* 37, no. 4 (2011): 632-8.
- Crandon, Jared L., Catherine C. Bulik, Joseph L. Kuti, and David P. Nicolau. "Clinical Pharmacodynamics of Cefepime in Patients Infected with *Pseudomonas Aeruginosa*." *Antimicrobial Agents and Chemotherapy* 54, no. 3 (2010): 1111-6.

- Delattre, Isabelle K., Flora T. Musuamba, Philippe Jacqmin, Fabio S. Taccone, Pierre-Francois Laterre, Roger K. Verbeeck, Frederique Jacobs, and Pierre Wallemacq. "Population Pharmacokinetics of Four Beta-Lactams in Critically Ill Septic Patients Comedicated with Amikacin." *Clinical Biochemistry* 45, no. 10-11 (2012): 780-6.
- Dellinger, R. Phillip, Mitchell M. Levy, Andrew Rhodes, Djillali Amrane, Herwig Gerlach, Steven M. Opal, Jonathan E. Sevransky, Charles L. Sprung, Ivor S. Douglas, Roman Jaeschke, Tiffany M. Osborn, Mark E. Nunnally, Sean R. Townsend, Konrad Reinhart, Ruth M. Kleinpell, Derek C. Angus, Clifford S. Deutschman, Flavia R. Machado, Gordon D. Rubenfeld, Steven A. Webb, Richard J. Beale, Jean-Louis Vincent, and Rui Moreno. "Surviving Sepsis Campaign: International Guidelines for Management of Severe Sepsis and Septic Shock: 2012." *Critical Care Medicine* 41, no. 2 (2013): 580-637.
- Dellit, Timothy H., Robert C. Owens, John E. McGowan, Jr., Dale N. Gerding, Robert A. Weinstein, John P. Burke, W. Charles Huskins, David L. Paterson, Neil O. Fishman, Christopher F. Carpenter, P. J. Brennan, Marianne Billeter, and Thomas M. Hooton. "Infectious Diseases Society of America and the Society for Healthcare Epidemiology of America Guidelines for Developing an Institutional Program to Enhance Antimicrobial Stewardship." *Clinical Infectious Diseases* 44, no. 2 (2007): 159-77.
- Deman, Hanna, Jan Verhaegen, Ludo Willems, and Isabel Spriet. "Dosing of Piperacillin/Tazobactam in a Morbidly Obese Patient." *The Journal of Antimicrobial Chemotherapy* 67, no. 3 (2012): 782-3.
- Demirovic, Jasmmina A., Amy Barton Pai, and Manjunath P. Pai. "Estimation of Creatinine Clearance in Morbidly Obese Patients." *American Journal of Health-System Pharmacy* 66, no. 7 (2009): 642-8.
- DeRyke, C. Andrew, Joseph L. Kuti, and David P. Nicolau. "Pharmacodynamic Target Attainment of Six Beta-Lactams and Two Fluoroquinolones against *Pseudomonas Aeruginosa*, *Acinetobacter Baumannii*, *Escherichia Coli*, and *Klebsiella* Species Collected from United States Intensive Care Units in 2004." *Pharmacotherapy* 27, no. 3 (2007): 333-42.
- Devine, Ben J. "Gentamicin Therapy." *Drug Intelligence and Clinical Pharmacology* 8, (1974): 650-5.
- Dionne, R. E., L. A. Bauer, G. A. Gibson, W. O. Griffen, Jr., and R. A. Blouin. "Estimating Creatinine Clearance in Morbidly Obese Patients." *American Journal of Hospital Pharmacy* 38, no. 6 (1981): 641-4.

- Doh, Kichan, Heungjeong Woo, Jun Hur, Hoejun Yim, Jimyon Kim, Hongseok Chae, Seunghoon Han, and Dong-Seok Yim. "Population Pharmacokinetics of Meropenem in Burn Patients." *The Journal of Antimicrobial Chemotherapy* 65, no. 11 (2010): 2428-35.
- Donato, M. Teresa, Agustin Lahoz, Nuria Jimenez, Gabriela Perez, Alfonso Serralta, Jose Mir, Jose V. Castell, and M. Jose Gomez-Lechon. "Potential Impact of Steatosis on Cytochrome P450 Enzymes of Human Hepatocytes Isolated from Fatty Liver Grafts." *Drug Metabolism and Disposition* 34, no. 9 (2006): 1556-62.
- Dreetz, Michaela, Jurg Hamacher, Jorg Eller, Klaus Borner, Peter Koeppel, Tom Schaberg, and Hartmut Lode. "Serum Bactericidal Activities and Comparative Pharmacokinetics of Meropenem and Imipenem-Cilastatin." *Antimicrobial Agents and Chemotherapy* 40, no. 1 (1996): 105-9.
- DrugBank, "Drugbank. Open Data Drug & Drug Target Database" <http://www.drugbank.ca/> (accessed November 6 2014).
- Drusano, George L. "Antimicrobial Pharmacodynamics: Critical Interactions of 'Bug and Drug'." *Nature Reviews. Microbiology* 2, no. 4 (2004): 289-300.
- Drusano, George L., Sandra L. Preston, Cynthia Fowler, Michael Corrado, Barbara Weisinger, and James Kahn. "Relationship Between Fluoroquinolone Area under the Curve: Minimum Inhibitory Concentration Ratio and the Probability of Eradication of the Infecting Pathogen, in Patients with Nosocomial Pneumonia." *The Journal of Infectious Diseases* 189, no. 9 (2004): 1590-7.
- Dvorchik, Barry H., and David Damphousse. "The Pharmacokinetics of Daptomycin in Moderately Obese, Morbidly Obese, and Matched Nonobese Subjects." *Journal of Clinical Pharmacology* 45, no. 1 (2005): 48-56.
- Elkhaili, H., S. Niedergang, D. Pompei, L. Linger, D. Leveque, and F. Jehl. "High-Performance Liquid Chromatographic Assay for Meropenem in Serum." *Journal of Chromatography. B, Biomedical Applications* 686, no. 1 (1996): 19-26.
- Emery, Maurice G., Jeannine M. Fisher, Jenny Y. Chien, Eva D. Kharasch, E. Patchen Dellinger, Kris V. Kowdley, and Kenneth E. Thummel. "CYP2E1 Activity Before and After Weight Loss in Morbidly Obese Subjects with Nonalcoholic Fatty Liver Disease." *Hepatology* 38, no. 2 (2003): 428-35.
- Endimiani, Andrea, Federico Perez, and Robert A. Bonomo. "Cefepime: A Reappraisal in an Era of Increasing Antimicrobial Resistance." *Expert Review Anti-Infective Therapy* 6, no. 6 (2008): 805-24.

- Engel, Georg, Ute Hofman, Hugo Heidemann, Jose Cosme, and Michel Eichelbaum. "Antipyrine as a Probe for Human Oxidative Drug Metabolism: Identification of the Cytochrome P450 Enzymes Catalyzing 4-Hydroxyantipyrine, 3-Hydroxymethylantipyrine, and Norantipyrine Formation." *Clinical Pharmacology and Therapeutics* 59, no. 6 (1996): 613-23.
- Ette, Ene I., and Thomas M. Ludden. "Population Pharmacokinetic Modeling: The Importance of Informative Graphics." *Pharmaceutical Research* 12, no. 12 (1995): 1845-55.
- European Committee on Antimicrobial Susceptibility Testing, "Breakpoint Tables for 489 Interpretation of MICs and Zone Diameters Version 5.0" <http://www.eucast.org> (accessed February 10 2015a).
- European Committee on Antimicrobial Susceptibility Testing, Data from the EUCAST 491 MIC distribution website, <http://www.eucast.org> (accessed January 22 2015b).
- Falagas, Matthew E., and Drosos E. Karageorgopoulos. "Adjustment of Dosing of Antimicrobial Agents for Bodyweight in Adults." *Lancet* 375, no. 9710 (2010): 248-51.
- Falagas, Matthew E., and Maria Kompoti. "Obesity and Infection." *The Lancet. Infectious Diseases* 6, no. 7 (2006): 438-46.
- Farrell, Geoff C., N. C. Teoh, and R. S. McCuskey. "Hepatic Microcirculation in Fatty Liver Disease." *The Anatomical Record* 291, no. 6 (2008): 684-92.
- Felton, T. W., W. W. Hope, B. M. Lomaestro, J. M. Butterfield, A. L. Kwa, G. L. Drusano, and T. P. Lodise. "Population Pharmacokinetics of Extended-Infusion Piperacillin-Tazobactam in Hospitalized Patients with Nosocomial Infections." *Antimicrobial Agents and Chemotherapy* 56, no. 8 (2012): 4087-94.
- Felton, T. W., K. McCalman, I. Malagon, B. Isalska, S. Whalley, J. Goodwin, A. M. Bentley, and W. W. Hope. "Pulmonary Penetration of Piperacillin and Tazobactam in Critically Ill Patients." *Clinical Pharmacology and Therapeutics* 96, no. 4 (2014): 438-48.
- Flechner, Stuart M., Magnus E. Colbeinsson, Janice Tam, and Burton Lum. "The Impact of Body Weight on Cyclosporine Pharmacokinetics in Renal Transplant Recipients." *Transplantation* 47, no. 5 (1989): 806-10.



- Food and Agriculture Organization of the United Nations, "The State of Food and Agriculture: Food Systems for Better Nutrition"  
<http://www.fao.org/docrep/018/i3300e/i3300e.pdf> (accessed October 7 2014).
- Food and Drug Administration, "Guidance for Industry, Population Pharmacokinetics"  
<http://www.fda.gov/downloads/Drugs/Guidances/UCM072137.pdf> (accessed October 15 2014).
- Forse, R. A., B. Karam, L. D. MacLean, and N. V. Christou. "Antibiotic Prophylaxis for Surgery in Morbidly Obese Patients." *Surgery* 106, no. 4 (1989): 750-7.
- Fox, Caroline S., Martin G. Larson, Eric P. Leip, Bruce Culleton, Peter W. F. Wilson, and Daniel Levy. "Predictor of New-Onset Kidney Disease in a Community-Based Population." *JAMA* 291, no. 7 (2004): 844-50.
- Garrelts, James C., and David J. Wagner. "The Pharmacokinetics, Safety, and Tolerance of Cefepime Administered as an Intravenous Bolus or as a Rapid Infusion." *The Annals of Pharmacotherapy* 33, no. 12 (1999): 1258-61.
- Georges, B., J. M. Conil, T. Seguin, E. Dieye, P. Cougot, J. F. Decun, M. Lavit, K. Samii, G. Houin, and S. Saivin. "Cefepime in Intensive Care Unit Patients: Validation of a Population Pharmacokinetic Approach and Influence of Covariables." *International Journal of Clinical Pharmacology and Therapeutics* 46, no. 4 (2008): 157-64.
- Gibbs, John P., Ted Gooley, Bruce Corneau, Georgia Murray, Patricia Stewart, Frederick R. Appelbaum, and John T. Slattery. "The Impact of Obesity and Disease on Busulfan Oral Clearance in Adults." *Blood* 93, no. 12 (1999): 4436-40.
- Giles, Lucy J., Anne C. Jennings, Alison H. Thomson, Gary Creed, Richard J. Beale, and Angela McLuckie. "Pharmacokinetics of Meropenem in Intensive Care Unit Patients Receiving Continuous Veno-Venous Hemofiltration or Hemodiafiltration." *Critical Care Medicine* 28, no. 3 (2000): 632-7.
- Giron, Jose A., Burt R. Meyers, and Shalom Z. Hirschman. "Biliary Concentrations of Piperacillin in Patients Undergoing Cholecystectomy." *Antimicrobial Agents and Chemotherapy* 19, no. 2 (1981): 309-11.
- Gray, David S., George A. Bray, Nabil Gemayel, and Karl Kaplan. "Effect of Obesity on Bioelectrical Impedance." *The American Journal of Clinical Nutrition* 50, no. 2 (1989): 255-60.
- Greenblatt, David J., Darrell R. Abernethy, Ann Locniskar, Jerold S. Harmatz, Raul A. Limjuco, and Richard I. Shader. "Effect of Age, Gender, and Obesity on Midazolam Kinetics." *Anesthesiology* 61, no. 1 (1984): 27-35.

- Greenblatt, David J., H. Friedman, Ethan S. Burstein, Joseph M. Scavone, Gershwin T. Blyden, Herman R. Ochs, Lawrence G. Miller, Jerold S. Harmatz, and Richard I. Shader. "Trazodone Kinetics: Effect of Age, Gender, and Obesity." *Clinical Pharmacology and Therapeutics* 42, no. 2 (1987): 193-200.
- Hamilton, Rhonda, Xia C. Thai, Darius Ameri, and Manjunath P. Pai. "Oral Bioavailability of Linezolid Before and After Roux-en-Y Gastric Bypass Surgery: Is Dose Modification Necessary in Obese Subject?" *The Journal of Antimicrobial Chemotherapy* 68, no. 3 (2013): 666-73.
- Han, Emily E., Paul M. Beringer, Pal Falck, Stan Louie, Purush Rao, Bertrand Shapiro, and Mark Gill. "Pilot Study of Continuous Infusion Cefepime in Adult Patients with Cystic Fibrosis." *The Journal of Antimicrobial Chemotherapy* 57, no. 5 (2006): 1017-9.
- Hanley, Michael J., Darrell R. Abernethy, and David J. Greenblatt. "Effect of Obesity on the Pharmacokinetics of Drugs in Humans." *Clinical Pharmacokinetics* 49, no. 2 (2010): 71-87.
- Henegar, Jeffrey R., Steven A. Bigler, Lisa K. Henegar, Suresh C. Tyagi, and John E. Hall. "Functional and Structural Changes in the Kidney in the Early Stages of Obesity." *Journal of the American Society of Nephrology* 12, no. 6 (2001): 1211-7.
- Higuchi, Kazuko, Kazuro Ikawa, Kayo Ikeda, Hiroki Ohge, Taijiro Sueda, Hitoshi Houchi, and Norifumi Morikawa. "Peritoneal Pharmacokinetics of Cefepime in Laparotomy Patients with Inflammatory Bowel Disease, and Dosage Considerations for Surgical Intra-Abdominal Infections Based on Pharmacodynamic Assessment." *Journal of Infection and Chemotherapy* 14, no. 2 (2008): 110-6.
- Hites, Maya, Fabio Silvio Taccone, Fleur Wolff, Frederic Cotton, Marjorie Beumier, Daniel De Backer, Sandrine Roisin, Sophie Lorent, Rudy Surin, Lucie Seyler, Jean-Louis Vincent, and Frederique Jacobs. "Case-Control Study of Drug Monitoring of Beta-Lactams in Obese Critically Ill Patients." *Antimicrobial Agents and Chemotherapy* 57, no. 2 (2013): 708-15.
- Hites, M., F. S. Taccone, F. Wolff, E. Maillart, M. Beumier, R. Surin, F. Cotton, and F. Jacobs. "Broad-Spectrum Beta-Lactams in Obese Non-Critically Ill Patients." *Nutrition & Diabetes* 4, (2014): e119.
- Hittle, Sarah D., David W. Smith, S. Christian Cheatham, Tate N. Trujillo, Matthew F. Wack, and Michael B. Kays. "Steady-State Pharmacokinetics and Pharmacodynamics of Cefepime Administered Every Six Hours in Critically Ill Patients." *Pharmacotherapy* 23, no. 10 (2003): 1373.

- Holford, Nicholas H. G. "Input-Output Models." In *Simulation for Designing Clinical Trials: A Pharmacokinetic-Pharmacodynamic Modeling Perspective*, edited by Hui Kimko and Stephen B. Duffull, 15-28. New York, NY, USA: Marcel Dekker, Inc., 2002.
- Huls, Christine E., Randall A. Prince, Dan K. Seilhemier, and John A. Bosso. "Pharmacokinetics of Cefepime in Cystic Fibrosis Patients." *Antimicrobial Agents and Chemotherapy* 37, no. 7 (1993): 1414-6.
- Huttunen, R., M. Karppelin, and J. Syrjanen. "Obesity and Nosocomial Infections." *The Journal of Hospital Infection* 85, no. 1 (2013): 8-16.
- Ikawa, Kazuro, Norifumi Morikawa, Kayo Ikeda, Hiroki Ohge, and Taijiro Sueda. "Development of Breakpoints of Cephems for Intraabdominal Infections Based on Pharmacokinetics and Pharmacodynamics in the Peritoneal Fluid of Patients." *Journal of Infection and Chemotherapy* 14, no. 2 (2008): 141-6.
- Ikawa, Kazuro, Norifumi Morikawa, Hiroki Ohge, Kayo Ikeda, Taijiro Sueda, Masafumi Taniwaki, and Kaoru Kurisu. "Pharmacokinetic-Pharmacodynamic Target Attainment Analysis of Meropenem in Japanese Adult Patients." *Journal of Infection and Chemotherapy* 16, no. 1 (2010): 25-32.
- Ikawa, Kazuro, Akira Nakashima, Norifumi Morikawa, Kayo Ikeda, Yoshiaki Murakami, Hiroki Ohge, Hartmut Derendorf, and Taijiro Sueda. "Clinical Pharmacokinetics of Meropenem and Biapenem in Bile and Dosing Considerations for Biliary Tract Infections Based on Site-Specific Pharmacodynamic Target Attainment." *Antimicrobial Agents and Chemotherapy* 55, no. 12 (2011): 5609-15.
- Iseki, Kunitoshi, Yoshiharu Ikemiya, Kozen Kinjo, Taku Inoue, Chiho Iseki, and Shuichi Takishita. "Body Mass Index and the Risk of Development of End-Stage Disease in a Screened Cohort." *Kidney International* 65, no. 5 (2004): 1870-6.
- Isla, Arantxazu, Alicia Rodriguez-Gascon, Inaki F. Troconiz, Lorea Bueno, Maria Angeles Solinis, Javier Maynar, Jose Angel Sanchez-Izquierdo, and Jose Luis Pedraz. "Population Pharmacokinetics of Meropenem in Critically Ill Patients Undergoing Continuous Renal Replacement Therapy." *Clinical Pharmacokinetics* 47, no. 3 (2008): 173-80.
- Jackson, S. J., F. E. Leahy, A. A. McGowan, L. J. C. Bluck, W. A. Coward, and S. A. Jebb. "Delayed Gastric Emptying in the Obese: An Assessment Using the Non-Invasive (13)C-Octanoic Acid Breath Test." *Diabetes, Obesity & Metabolism* 6, no. 4 (2004): 264-70.

- Jain, R., S. M. Chung, L. Jain, M. Khurana, S. W. Lau, J. E. Lee, J. Vaidyanathan, I. Zadezensky, S. Choe, and C. G. Sahajwalla. "Implications of Obesity for Drug Therapy: Limitations and Challenges." *Clinical Pharmacology and Therapeutics* 90, no. 1 (2011): 77-89.
- Janmahasatian, Sarayut, Stephen B. Duffull, Susan Ash, Leigh C. Ward, Nuala M. Byrne, and Bruce Green. "Quantification of Lean Bodyweight." *Clinical Pharmacokinetics* 44, no. 10 (2005): 1051-65.
- Janson, Brett, and Karin Thursky. "Dosing of Antibiotics in Obesity." *Current Opinion in Infectious Diseases* 25, no. 6 (2012): 634-49.
- Jeon, Sangil, Seunghoon Han, Jongtae Lee, Taegon Hong, Jeongki Paek, Heungjeong Woo, and Dong-Seok Yim. "Population Pharmacokinetic Analysis of Piperacillin in Burn Patients." *Antimicrobial Agents and Chemotherapy* 58, no. 7 (2014): 3744-51.
- Jhee, Stanford S., Jack W. Kern, Jin-Pil Burm, Albert E. Yellin, and Mark A. Gill. "Piperacillin-Tazobactam Pharmacokinetics in Patients with Intraabdominal Infections." *Pharmacotherapy* 15, no. 4 (1995): 472-8.
- Kalman, Debra, Steven L. Barriere, and B. Lamar Johnson, Jr. "Pharmacokinetic Disposition and Bactericidal Activities of Cefepime, Ceftazidime, and Cefoperazone in Serum and Blister Fluid." *Antimicrobial Agents and Chemotherapy* 36, no. 2 (1992): 453-7.
- Kamimori, G. H., S. M. Somani, R. G. Knowlton, and R. M. Perkins. "The Effects of Obesity and Exercise on the Pharmacokinetics of Caffeine in Lean and Obese Volunteers." *European Journal of Clinical Pharmacology* 31, no. 5 (1987): 595-600.
- Karjagin, J., S. Lefeuvre, K. Oselin, K. Kipper, S. Marchand, A. Tikkerberi, J. Starkopf, W. Couet, and R. J. Sawchuk. "Pharmacokinetics of Meropenem Determined by Microdialysis in the Peritoneal Fluid of Patients with Severe Peritonitis Associated with Septic Shock." *Clinical Pharmacology and Therapeutics* 83, no. 3 (2008): 452-9.
- Kashuba, Angela D. M., Anne N. Nafziger, George L. Drusano, and Joseph S. Bertino, Jr. "Optimizing Aminoglycoside Therapy for Nosocomial Pneumonia Caused by Gram-Negative Bacteria." *Antimicrobial Agents and Chemotherapy* 43, no. 3 (1999): 623-9.

- Kays, Michael B., Megan R. Fleming, S. Christian Cheatham, Eun Kyoung Chung, and Joetta M. Juenke. "Comparative Pharmacokinetics and Pharmacodynamics of Doripenem and Meropenem in Obese Patients." *The Annals of Pharmacotherapy* 48, no. 2 (2014): 178-86.
- Kelly, H. C., M. Hutchison, and S. J. Haworth. "A Comparison of the Pharmacokinetics of Meropenem after Administration by Intravenous Injection over 5 min and Intravenous Infusion over 30 min." *The Journal of Antimicrobial Chemotherapy* 36 Suppl A, (1995): 35-41.
- Kieft, H., A. I. M. Hoepelman, C. A. Knupp, A. van Dijk, J. M. Branger, A. Struyvenberg, and J. Verhoef. "Pharmacokinetics of Cefepime in Patients with the Sepsis Syndrome." *The Journal of Antimicrobial Chemotherapy* 32 Suppl B, (1993): 117-22.
- Kim, Myo-Kyoung, Blair Capitano, Holly M. Mattoes, Dawei Xuan, Richard Quintiliani, Charles H. Nightingale, and David P. Nicolau. "Pharmacokinetic and Pharmacodynamic Evaluation of Two Dosing Regimens for Piperacillin-Tazobactam." *Pharmacotherapy* 22, no. 5 (2002): 569-77.
- Komuro, Masahito, Toshimatsu Maeda, Hiroyoshi Hayakawa, Katherine L. Allen, and Carol E. Green. "The Formation of Desethyl-Piperacillin from Piperacillin by Human Liver S9 In Vitro." *Biopharmaceutics & Drug Disposition* 18, no. 3 (1997): 185-90.
- Kovarik, J. M., J. C. ter Maaten, C. M. A. Rademaker, M. Deenstra, I. M. Hoepelman, H.C. Hart, G. R. Matzke, and J. Verhoef. "Pharmacokinetics of Cefepime in Patients with Respiratory Infections." *Antimicrobial Agents and Chemotherapy* 34, no. 10 (1990): 1885-8.
- Krueger, W. A., T. H. Schroeder, M. Hutchison, E. Hoffmann, H. J. Dieterich, A. Heininger, C. Erley, A. Wehrle, and K. Unertl. "Pharmacokinetics of Meropenem in Critically Ill Patients with Acute Renal Failure Treated by Continuous Hemodiafiltration." *Antimicrobial Agents and Chemotherapy* 42, no. 9 (1998): 2421-4.
- Krueger, Wolfgang A., Jurgen Bulitta, Martina Kinzig-Schippers, Cornelia Landersdorfer, Ulrike Holzgrabe, Kurt G. Naber, George L. Drusano, and Fritz Sorgel. "Evaluation by Monte Carlo Simulation of the Pharmacokinetics of Two Doses of Meropenem Administered Intermittently or as a Continuous Infusion in Healthy Volunteers." *Antimicrobial Agents and Chemotherapy* 49, no. 5 (2005): 1881-9.

- Kuti, Joseph L., Prachi K. Dandekar, Charles H. Nightingale, and David P. Nicolau. "Use of Monte Carlo Simulation to Design an Optimized Pharmacodynamic Dosing Strategy for Meropenem." *Journal of Clinical Pharmacology* 43, no. 10 (2003): 1116-23.
- Kuti, Joseph L., Sheryl Horowitz, Charles H. Nightingale, and David P. Nicolau. "Comparison of Pharmacodynamic Target Attainment between Healthy Subjects and Patients for Ceftazidime and Meropenem." *Pharmacotherapy* 25, no. 7 (2005): 935-41.
- Kuti, Joseph L., Charles H. Nightingale, R. Frederic Knauff, and David P. Nicolau. "Pharmacokinetic Properties and Stability of Continuous-Infusion Meropenem in Adults with Cystic Fibrosis." *Clinical Therapeutics* 26, no. 4 (2004): 493-501.
- Landersdorfer, Cornelia B., Jurgen B. Bulitta, Carl M. Kirkpatrick, Martina Kinzig, Ulrike Holzgrabe, George L. Drusano, Ulrich Stephan, and Fritz Sorgel. "Population Pharmacokinetics of Piperacillin at Two Dose Levels: Influence of Nonlinear Pharmacokinetics on the Pharmacodynamic Profile." *Antimicrobial Agents and Chemotherapy* 56, no. 11 (2012): 5715-23.
- Lau, A., M. Lee, and R. Sharifi. "Pharmacokinetics of Piperacillin in Hospitalized Patients." *International Journal of Clinical Pharmacology, Therapeutics, and Toxicology* 23, no. 8 (1985): 391-4.
- Law, Vivian, Craig Knox, Yannick Djoumbou, Tim Jewison, An Chi Guo, Yifeng Liu, Adam Maciejewski, David Arndt, Michael Wilson, Vanessa Neveu, Alexandra Tang, Geraldine Gabriel, Carol Ly, Sakina Adamjee, Zerihun T. Dame, Beomsoo Han, You Zhou, and David S. Wishart. "Drugbank 4.0: Shedding New Light on Drug Metabolism." *Nucleic Acids Research* 42, Database issue (2014): D1091-7.
- Leclercq, Isabelle, Yves Horsmans, Jean-Pierre Desager, Nathalie Delzenne, and Andre-Pierre Geubel. "Reduction in Hepatic Cytochrome P-450 is Correlated to the Degree of Liver Fat Content in Animal Models of Steatosis in the Absence of Inflammation." *Journal of Hepatology* 28, no. 3 (1998): 410-16.
- Lee, Lois S., Martina Kinzig-Schippers, Anne N. Nafziger, Lei Ma, Fritz Sorgel, Ronald N. Jones, George L. Drusano, and Joseph S. Bertino Jr. "Comparison of 30-min and 3-h Infusion Regimens for Imipenem/Cilastatin and for Meropenem Evaluated by Monte Carlo Simulation." *Diagnostic Microbiology and Infectious Disease* 68, no. 3 (2010): 251-8.
- Leroy, A., J. P. Fillastre, F. Borsa-Lebas, I. Etienne, and G. Humbert. "Pharmacokinetics of Meropenem (ICI 194,660) and Its Metabolite (ICI 213,689) in Healthy Subjects and in Patients with Renal Impairment." *Antimicrobial Agents and Chemotherapy* 36, no. 12 (1992): 2794-8.

- Levey, Andrew S., Tom Greene, John W. Kusek, and Gerald J. Beck. "A Simplified Equation to Predict Glomerular Filtration Rate from Serum Creatinine." *Journal of the American Society of Nephrology* 11, (2000): 155A.
- Levey, Andrew S., Lesley A. Stevens, Christopher H. Schmid, Yaping (Lucy) Zhang, Alejandro F. Castro, 3rd, Harold I. Feldman, John W. Kusek, Paul Eggers, Frederick Van Lente, Tom Greene, and Josef Coresh. "A New Equation to Estimate Glomerular Filtration Rate." *Annals of Internal Medicine* 150, no. 9 (2009): 604-12.
- Li, Chonghua, Xiaoli Du, Joseph L. Kuti, and David P. Nicolau. "Clinical Pharmacodynamics of Meropenem in Patients with Lower Respiratory Tract Infections." *Antimicrobial Agents and Chemotherapy* 51, no. 5 (2007): 1725-30.
- Li, Chonghua, Joseph L. Kuti, Charles H. Nightingale, Debra L. Mansfield, Adrian Dana, and David P. Nicolau. "Population Pharmacokinetics and Pharmacodynamics of Piperacillin/Tazobactam in Patients with Complicated Intra-abdominal Infection." *The Journal of Antimicrobial Chemotherapy* 56, no. 2 (2005): 388-95.
- Li, Chonghua, Joseph L. Kuti, Charles H. Nightingale, and David P. Nicolau. "Population Pharmacokinetic Analysis and Dosing Regimen Optimization of Meropenem in Adult Patients." *Journal of Clinical Pharmacology* 46, no. 10 (2006): 1171-8.
- Lipman, J., S. C. Wallis, and C. Rickard. "Low Plasma Cefepime Levels in Critically Ill Septic Patients: Pharmacokinetic Modeling Indicates Improved Troughs with Revised Dosing." *Antimicrobial Agents and Chemotherapy* 43, no. 10 (1999): 2559-61.
- Lister, Philip D., Andrea M. Prevan, and Christine C. Sanders. "Importance of Beta-Lactamase Inhibitor Pharmacokinetics in the Pharmacodynamics of Inhibitor-Drug Combinations: Studies with Piperacillin-Tazobactam and Piperacillin-Sulbactam." *Antimicrobial Agents and Chemotherapy* 41, no. 4 (1997): 721-7.
- Lodise Jr., Thomas P., Ben Lomaestro, Keith A. Rodvold, Larry H. Danziger, and George L. Drusano. "Pharmacodynamic Profiling of Piperacillin in the Presence of Tazobactam in Patients through the Use of Population Pharmacokinetic Models and Monte Carlo Simulation." *Antimicrobial Agents and Chemotherapy* 48, no. 12 (2004): 4718-24.
- Lodise, Thomas P., Ben M. Lomaestro, and George L. Drusano. "Application of Antimicrobial Pharmacodynamic Concepts into Clinical Practice: Focus on Beta-Lactam Antibiotics: Insights from the Society of Infectious Diseases Pharmacists." *Pharmacotherapy* 26, no. 9 (2006): 1320-32.

- Lomaestro, Ben M., and George L. Drusano. "Pharmacodynamic Evaluation of Extending the Administration Time of Meropenem Using a Monte Carlo Simulation." *Antimicrobial Agents and Chemotherapy* 49, no. 1 (2005): 461-3.
- Longo, Cristina, Gillian Bartlett, Brenda Macgibbon, Nancy Mayo, Ellen Rosenberg, Lyne Nadeau, and Stella S. Daskalopoulou. "The Effect of Obesity on Antibiotic Treatment Failure: A Historical Cohort Study." *Pharmacoepidemiology and Drug Safety* 22, no. 9 (2013): 970-6.
- Lovering, A. M., C. J. Vickery, D. S. Watkin, D. Leaper, C. M. McMullin, L. O. White, D. S. Reeves, and A. P. MacGowan. "The Pharmacokinetics of Meropenem in Surgical Patients with Moderate or Severe Infections." *The Journal of Antimicrobial Chemotherapy* 36, no. 1 (1995): 165-72.
- Lubasch, A., S. Ziege, B. Brodersen, K. Borner, P. Koeppe, and H. Lode. "Serum Bactericidal Activity of Trovafloxacin, in Combination with Cefepime or Amikacin, in Healthy Volunteers." *Clinical Microbiology and Infection* 9, no. 7 (2003): 670-7.
- Martinez, Marilyn N., Mark G. Papich, and George L. Drusano. "Dosing Regimen Matters: The Importance of Early Intervention and Rapid Attainment of the Pharmacokinetic/Pharmacodynamic Target." *Antimicrobial Agents and Chemotherapy* 56, no. 6 (2012): 2795-805.
- Maxipime(TM) [package insert]. Lake Forest, IL: Hospira, Inc., 2012.
- McKinnon, Peggy S., Joseph A. Paladino, and Jerome J. Shentag. "Evaluation of Area under the Inhibitory Curve (AUC) and Time above the Minimum Inhibitory Concentration (T>MIC) as Predictors of Outcome for Cefepime and Ceftazidime in Serious Bacterial Infections." *International Journal of Antimicrobial Agents* 31, no. 4 (2008): 345-51.
- McWhinney, Brett C., Steven C. Wallis, Tara Hillister, Jason A. Roberts, Jeffrey Lipman, and Jacobus P. J. Ungerer. "Analysis of 12 Beta-Lactam Antibiotics in Human Plasma by HPLC with Ultraviolet Detection." *Journal of Chromatography. B, Analytical Technologies in the Biomedical and Life Sciences* 878, no. 22 (2010): 2039-43.
- Merrem(R) [package insert]. Wilmington, DE: AstraZeneca Pharmaceuticals LP, 2013.
- Minami, Yoshinori, Masahito Komuro, Kumiko Sakawa, and Naobumi Ishida. "Desethyl Piperacillin, a New Active Metabolite of Piperacillin in Human." *The Journal of Antibiotics* 44, no. 2 (1991): 256-8.



- Mitscher, Lester A. "Antibiotics and Antimicrobial Agents." In *Foye's Principles of Medicinal Chemistry*, edited by David A. Williams and Thomas L. Lemke, 819-866. Philadelphia, PA: Lippincott Williams and Wilkins, 2002.
- Moon, Yong S. K., Karen C. Chung, and Mark A. Gill. "Pharmacokinetics of Meropenem in Animals, Healthy Volunteers, and Patients." *Clinical Infectious Diseases* 24 Suppl 2, (1997): S249-55.
- Mould, D. R., and R. N. Upton. "Basic Concepts in Population Modeling, Simulation, and Model-Based Drug Development." *CPT:Pharmacometrics & Systems Pharmacology* 1, (2012): e6.
- Mouton, Johan W. "Impact of Pharmacodynamics on Breakpoint Selection for Susceptibility Testing." *Infectious Disease Clinics of North America* 17, no. 3 (2003): 579-98.
- Mouton, Johan W., Michael N. Dudley, Otto Cars, Hartmut Derendorf, and George L. Drusano. "Standardization of Pharmacokinetic/Pharmacodynamic (PK/PD) Terminology for Anti-Infective Drugs: An Update." *The Journal of Antimicrobial Chemotherapy* 55, no. 5 (2005): 601-7.
- Mouton, Johan W., and Marc F. Michel. "Pharmacokinetics of Meropenem in Serum and Suction Blister Fluid During Continuous and Intermittent Infusion." *The Journal of Antimicrobial Chemotherapy* 28, no. 6 (1991): 911-8.
- Navarro-Diaz, Maruja, Auumpta Serra, Ramon Romero, Josep Bonet, Beatriu Bayes, Merce Homs, Noelia Perez, and Jordi Bonal. "Effect of Drastic Weight Loss after Bariatric Surgery on Renal Parameters in Extremely Obese Patients: Long-Term Follow-Up." *Journal of the American Society of Nephrology* 17, no. 12 Suppl 3 (2006): S213-7.
- Newman, Diane, Marc H. Scheetz, Oluwadamilola A. Adeyemi, Mauro Montevecchi, David P. Nicolau, Gary A. Noskin, and Michael J. Postelnick. "Serum Piperacillin/Tazobactam Pharmacokinetics in a Morbidly Obese Individual." *The Annals of Pharmacotherapy* 41, no. 10 (2007): 1734-9.
- Nicasio, Anthony M., Robert E. Ariano, Sheryl A. Zelenitsky, Arjun Kim, Jared L. Crandon, Joseph L. Kutti, and David P. Nicolau. "Population Pharmacokinetics of High-Dose, Prolonged-Infusion Cefepime in Adult Critically Ill Patients with Ventilator-Associated Pneumonia." *Antimicrobial Agents and Chemotherapy* 53, no. 4 (2009): 1476-81.
- Nilsson-Ehle, I., M. Hutchison, S. J. Haworth, and S. R. Norrby. "Pharmacokinetics of Meropenem Compared to Imipenem-Cilastatin in Young, Healthy Males." *European Journal of Clinical Microbiology & Infectious Diseases* 10, no. 2 (1991): 85-8.

- Novelli, Andrea, Chiara Adembri, Paola Livi, Stefania Fallani, Teresita Mazzei, and Angelo Raffaele De Gaudio. "Pharmacokinetic Evaluation of Meropenem and Imipenem in Critically Ill Patients with Sepsis." *Clinical Pharmacokinetics* 44, no. 5 (2005): 539-49.
- Nye, K. J., Y. G. Shi, J. M. Andrews, and R. Wise. "Pharmacokinetics and Tissue Penetration of Cefepime." *The Journal of Antimicrobial Chemotherapy* 24, no. 1 (1989): 23-8.
- Occhipinti, Donna J., Susan L. Pendland, Lori L. Schoonover, Eric B. Rypins, Larry H. Danziger, and Keith A. Rodvold. "Pharmacokinetics and Pharmacodynamics of Two Multiple-Dose Piperacillin-Tazobactam Regimens." *Antimicrobial Agents and Chemotherapy* 41, no. 11 (1997): 2511-7.
- Ogden, Cynthia L., Margaret D. Carroll, Brian K. Kit, and Katherine M. Flegal. "Prevalence of Childhood and Adult Obesity in the United States, 2011-2012." *JAMA* 311, no. 8 (2014): 806-14.
- Ohata, Yuka, Yoshiko Tomita, Mitsunobu Nakayama, Kazuo Tamura, and Yusuke Tanigawara. "Optimal Treatment Schedule of Meropenem for Adult Patients with Febrile Neutropenia Based on Pharmacokinetic-Pharmacodynamic Analysis." *Journal of Infection and Chemotherapy* 17, no. 6 (2011): 831-41.
- Pai, Manjunath P. "Drug Dosing Based on Weight and Body Surface Area: Mathematical Assumptions and Limitations in Obese Adults." *Pharmacotherapy* 32, no. 9 (2012): 856-68.
- Pai, Manjunath P., and David T. Bearden. "Antimicrobial Dosing Considerations in Obese Adult Patients." *Pharmacotherapy* 27, no. 8 (2007): 1081-91.
- Pearson, T. C., D. L. Guthrie, J. Simpson, S. Chinn, G. Barosi, A. Ferrant, S. M. Lewis, and Y. Najean. "Interpretation of Measured Red Cell Mass and Plasma Volume in Adults: Expert Panel on Radionuclides of the International Council for Standardization in Haematology." *British Journal of Haematology* 89, no. 4 (1995): 748-56.
- Perry, Caroline M., and Anthony Markham. "Piperacillin/Tazobactam: An Updated Review of Its Use in the Treatment of Bacterial Infections." *Drugs* 57, no. 5 (1999): 805-43.
- Preston, Sandra L., George L. Drusano, Adam L. Berman, Cynthia L. Fowler, Andrew T. Chow, Bruce Dornseif, Veronica Reichl, Jaya Natarajan, and Michael Corrado. "Pharmacodynamics of Levofloxacin: A New Paradigm for Early Clinical Trials." *JAMA* 279, no. 2 (1998): 125-9.

- Public Health England, "Severe Obesity"  
[http://www.noo.org.uk/NOO\\_about\\_obesity/morbid\\_obesity](http://www.noo.org.uk/NOO_about_obesity/morbid_obesity) (accessed October 7 2014).
- Ramon-Lopez, Amelia, Jane M. Allen, Alison H. Thomson, Bajlit S. Dheansa, S. Elizabeth James, Geoff W. Hanlon, Bruce Stewart, and J. Graham Davies. "Dosing Regimen of Meropenem for Adults with Severe Burns: A Population Pharmacokinetic Study with Monte Carlo Simulations." *The Journal of Antimicrobial Chemotherapy*, (2014).
- Rea, D. J., J. K. Heimbach, J. P. Grande, S. C. Textor, S. J. Taler, M. Prieto, T. S. Larson, F. G. Cosio, and M. D. Stegall. "Glomerular Volume and Renal Histology in Obese and Non-Obese Living Kidney Donors." *Kidney International* 70, no. 9 (2006): 1636-41.
- Reiss, Robert A., Curtis E. Haas, Shyam D. Karki, Barry Gumbiner, Stephen L. Welle, and Stanley W. Carson. "Lithium Pharmacokinetics in the Obese." *Clinical Pharmacology and Therapeutics* 55, no. 4 (1994): 392-8.
- Rich, Barrie S., Rebecca Keel, Vanessa P. Ho, Harma Turbendian, Cheguevara I. Afaneh, Gregory F. Dakin, Alfons Pomp, David P. Nicolau, and Philip S. Barie. "Cefepime Dosing in the Morbidly Obese Patient Population." *Obesity Surgery* 22, no. 3 (2012): 465-71.
- Roberts, Jason A., Mohd H. Abdul-Aziz, Jeffrey Lipman, Johan W. Mouton, Alexander A. Vinks, Timothy W. Felton, William W. Hope, Andras Farkas, Michael N. Neely, Jerome J. Schentag, George Drusano, Otto R. Frey, Ursula Theuretzbacher, and Joseph L. Kuti. "Individualised Antibiotic Dosing for Patients Who Are Critically Ill: Challenges and Potential Solutions." *The Lancet Infectious Diseases* 14, no. 6 (2014): 498-509.
- Roberts, Jason A., Carl M. J. Kirkpatrick, Michael S. Roberts, Andres J. Dalley, and Jeffrey Lipman. "First-Dose and Steady-State Population Pharmacokinetics and Pharmacodynamics of Piperacillin by Continuous or Intermittent Dosing in Critically Ill Patients with Sepsis." *International Journal of Antimicrobial Agents* 35, no. 2 (2010): 156-63.
- Roberts, Jason A., Carl M. J. Kirkpatrick, Michael S. Roberts, Thomas A. Robertson, Andrew J. Dalley, and Jeffrey Lipman. "Meropenem Dosing in Critically Ill Patients with Sepsis and without Renal Dysfunction: Intermittent Bolus Versus Continuous Administration? Monte Carlo Dosing Simulations and Subcutaneous Tissue Distribution." *The Journal of Antimicrobial Chemotherapy* 64, no. 1 (2009): 142-50.

- Roberts, Jason A., Michael S. Roberts, Thomas A. Robertson, Andrew J. Dalley, and Jeffrey Lipman. "Piperacillin Penetration into Tissue of Critically Ill Patients with Sepsis -- Bolus Versus Continuous Administration." *Critical Care Medicine* 37, no. 3 (2009): 926-33.
- Roe, Jada L., Joseph M. Fuentes, and Michael E. Mullins. "Underdosing of Common Antibiotics for Obese Patients in the ED." *The American Journal of Emergency Medicine* 30, no. 7 (2012): 1212-4.
- Roos, Juliana F., Jurgen Bulitta, Jeffrey Lipman, and Carl M. Kirkpatrick. "Pharmacokinetic-Pharmacodynamic Rationale for Cefepime Dosing Regimens in Intensive Care Units." *The Journal of Antimicrobial Chemotherapy* 58, no. 5 (2006): 987-93.
- Rowland, Malcolm, and Thomas N. Tozer. "Absorption." In *Clinical Pharmacokinetics and Pharmacodynamics*, 183-216. Philadelphia, PA: Lippincott Williams and Wilkins, 2011a.
- Rowland, Malcolm, and Thomas N. Tozer. "Elimination." In *Clinical Pharmacokinetics and Pharmacodynamics*, 111-158. Philadelphia, PA: Lippincott Williams and Wilkins, 2011b.
- Salazar, Daniel E., and George B. Corcoran. "Predicting Creatinine Clearance and Renal Drug Clearance in Obese Patients from Estimated Fat-Free Body Mass." *The American Journal of Medicine* 84, no. 6 (1988): 1053-60.
- Sampol, Emmanuelle, Alexis Jacquet, Marc Viggiano, Victor Bernini, Jean-Claude Manelli, Bruno Lacarelle, and Alain Durand. "Plasma, Urine and Skin Pharmacokinetics of Cefepime in Burns Patients." *The Journal of Antimicrobial Chemotherapy* 46, no. 2 (2000): 315-7.
- Schentag, Jerome J., Ian L. Smith, Douglas J. Swanson, Carlo DeAngelis, Joseph E. Fracasso, Andras Vari, and John W. Vance. "Role for Dual Individualization with Cefmenoxime." *The American Journal of Medicine* 77, no. 6A (1984): 43-50.
- Shea, Katherine M., S. Christian Cheatham, Matthew F. Wack, David W. Smith, Kevin M. Sowinski, and Michael B. Kays. "Steady-State Pharmacokinetics and Pharmacodynamics of Piperacillin/Tazobactam Administered by Prolonged Infusion in Hospitalised Patients." *International Journal of Antimicrobial Agents* 34, no. 5 (2009): 429-33.
- Shikuma, Lois R., Bruce H. Ackerman, Ross H. Weaver, Lynn D. Solem, Richard G. Strate, Frank B. Cerra, and Darwin E. Zaske. "Thermal Injury Effects on Drug Disposition: A Prospective Study with Piperacillin." *Journal of Clinical Pharmacology* 30, no. 7 (1990): 632-7.

- Sime, Fekade Bruck, Michael S. Roberts, Morgyn S. Warner, Uwe Hahn, Thomas A. Robertson, Sue Yeend, Andy Phay, Sheila Lehman, Jeffrey Lipman, Sandra L. Peake, and Jason A. Roberts. "Altered Pharmacokinetics of Piperacillin in Febrile Neutropenic Patients with Hematological Malignancy." *Antimicrobial Agents and Chemotherapy* 58, no. 6 (2014): 3533-7.
- Sorgel, F., and M. Kinzig. "The Chemistry, Pharmacokinetics, and Tissue Distribution of Piperacillin/Tazobactam." *The Journal of Antimicrobial Chemotherapy* 31 Suppl A, (1993): 39-60.
- Stein, Gary E., Grace Kulhanek, Curtis L. Smith, Joseph L. Kuti, David P. Nicolau, Amy Scharmen, Chris Farnum, MaryAnn Tran, Apoorv Kalra, and Daniel H. Havlichek. "Pharmacokinetics and Monte Carlo Simulations of Doripenem in Patients with Febrile Neutropenia." *The Annals of Pharmacotherapy* 46, no. 10 (2012): 1281-6.
- Stevens, Gretchen A., Gitanjali M. Singh, Yuan Lu, Goodarz Danaei, John K. Lin, Mariel M. Finucane, Adil N. Bahalim, Russel K. McIntire, Hialy R. Gutierrez, Melanie Cowan, Christopher J. Paciorek, Farshad Farzadfar, Leanne Riley, and Majid Ezzati. "National, Regional, and Global Trends in Adult Overweight and Obesity Prevalences." *Population Health Metrics* 10, no. 1 (2012): 22.
- Stokholm, K. H., J. Brochner-Mortensen, and P. F. Hoilund-Carlsen. "Increased Glomerular Filtration Rate and Adrenocortical Function in Obese Women." *International Journal of Obesity* 4, no. 1 (1980): 57-63.
- Strayer, Andy H., Deborah H. Gilbert, Phil Pivarnik, Antone A. Medeiros, Stephen H. Zinner, and Michael N. Dudley. "Pharmacodynamics of Piperacillin Alone and in Combination with Tazobactam against Piperacillin-Resistant and -Susceptible Organisms in an In Vitro Model of Infection." *Antimicrobial Agents and Chemotherapy* 38, no. 10 (1994): 2351-6.
- Sturm, Ashley W., Nichole Allen, Kelly D. Rafferty, Douglas N. Fish, Eric Toschlog, Mark Newell, and Brett Waibel. "Pharmacokinetic Analysis of Piperacillin Administered with Tazobactam in Critically Ill, Morbidly Obese Surgical Patients." *Pharmacotherapy* 34, no. 1 (2014): 28-35.
- Tam, Vincent H., Peggy S. McKinnon, Ronda L. Akins, George L. Drusano, and Michael J. Rybak. "Pharmacokinetics and Pharmacodynamics of Cefepime in Patients with Various Degrees of Renal Function." *Antimicrobial Agents and Chemotherapy* 47, no. 6 (2003): 1853-61.
- Tam, Vincent H., Peggy S. McKinnon, Ronda L. Akins, Michael J. Rybak, and George L. Drusano. "Pharmacodynamics of Cefepime in Patients with Gram-Negative Infections." *The Journal of Antimicrobial Chemotherapy* 50, no. 3 (2002): 425-8.

- Tegeder, Irmgard, Frank Neumann, Frank Bremer, Kay Brune, Jorn Lotsch, and Gerd Geisslinger. "Pharmacokinetics of Meropenem in Critically Ill Patients with Acute Renal Failure Undergoing Continuous Venovenous Hemofiltration." *Clinical Pharmacology and Therapeutics* 65, no. 1 (1999): 50-7.
- Turnidge, J. D. "The Pharmacodynamics of Beta-Lactams." *Clinical Infectious Diseases* 27, no. 1 (1998): 10-22.
- Uchino, H., T. Inaba, and W. Kalow. "Human Metabolism of Antipyrine Labelled with <sup>14</sup>C in the Pyrazolone Ring or in the N-Methyl Group." *Xenobiotica* 13, no. 3 (1983): 155-62.
- Vance-Bryan, Kyle, David R. P. Guay, Susan S. Gilliland, Keith A. Rodvold, and John C. Rotschafer. "Effect of Obesity on Vancomycin Pharmacokinetic Parameters as Determined by Using a Bayesian Forecasting Technique." *Antimicrobial Agents and Chemotherapy* 37, no. 3 (1993): 436-40.
- Van der Auwera, P., and P. J. Santella. "Pharmacokinetics of Cefepime: A Review." *The Journal of Antimicrobial Chemotherapy* 32 Suppl B, (1993): 103-15.
- VanScoy, Brian, Rodrigo E. Mendes, Anthony M. Nicasio, Mariana Castanheira, Catharine C. Bulik, Olanrewaju O. Okusanya, Sujuta M. Bhavnani, Alan Forrest, Ronald N. Jones, Lawrence V. Friedrich, Judith N. Steenbergen, and Paul G. Ambrose. "Pharmacokinetics-Pharmacodynamics of Tazobactam in Combination with Ceftolozane in an In Vitro Infection Model." *Antimicrobial Agents and Chemotherapy* 57, no. 6 (2013): 2809-14.
- Van Wart, Scott, Luann Phillips, Elizabeth A. Ludwig, Rene Russo, Diptee A. Gajjar, Akintunde Bello, Paul G. Ambrose, Christopher Costanzo, Thaddeus H. Grasela, Roger Echols, and Dennis M. Grasela. "Population Pharmacokinetics and Pharmacodynamics of Garenoxacin in Patients with Community-Acquired Respiratory Tract Infections." *Antimicrobial Agents and Chemotherapy* 48, no. 12 (2004): 4766-77.
- Varin, France, Julie Ducharme, Yves Theoret, Jean-Guy Besner, David R. Bevan, and Francois Donati. "Influence of Extreme Obesity on the Body Disposition and Neuromuscular Blocking Effect of Atracurium." *Clinical Pharmacology and Therapeutics* 48, no. 1 (1990): 18-25.
- Ververs, Tessa F. T., Aalt van Dijk, Sander A. T. M. M. Vinks, Peter J. Blankestijn, T. Jean F. Savelkoul, Jan Meulenbelt, and Frans T. J. Boereboom. "Pharmacokinetics and Dosing Regimen of Meropenem in Critically Ill Patients Receiving Continuous Venovenous Hemofiltration." *Critical Care Medicine* 28, no. 10 (2000): 3412-6.

- Vinks, Alexander A., Jan G. den Hollander, Shelley E. Overbeek, Roger W. Jelliffe, and Johan W. Mouton. "Population Pharmacokinetic Analysis of Nonlinear Behavior of Piperacillin During Intermittent or Continuous Infusion in Patients with Cystic Fibrosis." *Antimicrobial Agents and Chemotherapy* 47, no. 2 (2003): 541-7.
- Vinks, Alexander A., Ronald N. van Rossem, Ron A. Mathot, Harry G. Heijerman, and Johan W. Mouton. "Pharmacokinetics of Aztreonam in Healthy Subjects and Patients with Cystic Fibrosis and Evaluation of Dose-Exposure Relationships Using Monte Carlo Simulation." *Antimicrobial Agents and Chemotherapy* 51, no. 9 (2007): 3049-55.
- Vogelman, B., S. Gudmundsson, J. Leggett, J. Turnidge, S. Ebert, and W. A. Craig. "Correlation of Antimicrobial Pharmacokinetic Parameters with Therapeutic Efficacy in an Animal Model." *The Journal of Infectious Diseases* 158, no. 4 (1988): 831-47.
- Weltman, Martin D., Geoffrey C. Farrell, Pauline Hall, Magnus Ingelman-Sundberg, and Christopher Liddle. "Hepatic Cytochrome P450 2E1 is Increased in Patients with Nonalcoholic Steatohepatitis." *Hepatology* 27, no. 1 (1998):128-33.
- Weltman, Martin D., Geoffrey C. Farrell, and Christopher Liddle. "Increased Hepatocyte CYP2E1 Expression in a Rat Nutritional Model of Hepatic Steatosis with Inflammation." *Gastroenterology* 111, no. 6 (1996):1645-53.
- Wise, R., M. Logan, M. Cooper, J. P. Ashby, and J. M. Andrews. "Meropenem Pharmacokinetics and Penetration into an Inflammatory Exudate." *Antimicrobial Agents and Chemotherapy* 34, no. 8 (1990): 1515-7.
- World Health Organization, "Global Health Observatory Data Repository: Obesity (Body Mass Index  $\geq$  30) Data by Country"  
<http://apps.who.int/gho/data/node.main.A900?lang=en> (accessed October 7 2014).
- World Health Organization, "Obesity and Overweight"  
<http://www.who.int/mediacentre/factsheets/fs311/en/> (accessed October 7 2014).
- Yee, J. Y. V., and S. B. Duffull. "The Effect of Body Weight on Dalteparin Pharmacokinetics: A Preliminary Study." *European Journal of Clinical Pharmacology* 56, no. 4 (2000): 293-7.
- Zakrison, Tanya L., Darcy A. Hille, and Nicholas Namias. "Effect of Body Mass Index on Treatment of Complicated Intra-Abdominal Infections in Hospitalized Adults: Comparison of Ertapenem with Piperacillin-Tazobactam." *Surgical Infections* 13, no. 1 (2012): 38-42.

Zhou, Qing-Tao, Bei He, Chao Zhang, Suo-Di Zhai, Zhen-Ying Liu, and Jie Zhang.  
"Pharmacokinetics and Pharmacodynamics of Meropenem in Elderly Chinese  
with Lower Respiratory Tract Infections: Population Pharmacokinetics Analysis  
Using Nonlinear Mixed-Effects Modelling and Clinical Pharmacodynamics  
Study." *Drugs & Aging* 28, no. 11 (2011): 903-12.

Zosyn(R) [package insert]. Philadelphia, PA: Pfizer Injectables, 2013.



VITA

## VITA

**Eun Kyoung (Christina) Chung****Education and Training:**

- |                         |   |
|-------------------------|---|
| Anticipated<br>May 2015 | Doctor of Philosophy in Pharmacy Practice, specializing in Clinical Pharmaceutical Sciences (Infectious Diseases Pharmacotherapy), Department of Pharmacy Practice, College of Pharmacy, Purdue University, West Lafayette, IN. Primary Advisor: Michael B. Kays, PharmD; Dissertation: Beta-Lactam Antimicrobial Dosing Optimization in Obese Patients Compared to Non-Obese Patients Using Population Pharmacokinetic/Pharmacodynamic Approach. |
| May 2010                | Doctor of Pharmacy, College of Pharmacy, Purdue University, West Lafayette, IN.<br>GPA 4.0  |
| February 2004           | Bachelor of Science in Pharmacy, School of Pharmacy, Sungkyunkwan University, Suwon, Gyeong-gi, South Korea. GPA 3.7  |

**Research Experience:**

- 2013-Present Population Pharmacokinetics (PK) and Pharmacodynamics (PD) of Cefazolin in Hospitalized Obese Patients Compared to Non-Obese Patients. Mentor: Michael B. Kays, PharmD
- 2013-Present Alternative Requirements of Obese Patients in Model-Based Linezolid Dosing Regimens for Optimal Therapy in Comparison to Non-Obese Patients. Mentor: Michael B. Kays, PharmD
- 2012 - Present Population Pharmacokinetics (PK) and Pharmacodynamics (PD) of Piperacillin/Tazobactam, Administered by Prolonged Infusion, in Hospitalized Pediatric Patients. Mentor: Michael B. Kays, PharmD
- 2012- Present Population Pharmacokinetics (PK) and Pharmacodynamics (PD) of Cefepime in Hospitalized, Morbidly Obese and Non-Morbidly obese Patients. Mentor: Michael B. Kays, PharmD
- 2012- Present Pharmacokinetics and Pharmacodynamics of Doripenem in Hospitalized, Morbidly Obese Patients. Mentor: Michael B. Kays, PharmD
- 2011-Present Development and Implementation of a Pharmacist-Managed Outpatient Parenteral Antimicrobial Therapy (OPAT) Program in a County Teaching Hospital: Evaluation of Clinical Outcome from Patients Followed by the OPAT Program. Mentor: Sharon Erdman, PharmD
- 2010-2013 Pharmacokinetics (PK) and Pharmacodynamics (PD) of Meropenem in Hospitalized, Obese and Non-Obese Patients. Mentor: Michael B. Kays, PharmD
- 2010-2012 Pharmacokinetics (PK) and Pharmacodynamics (PD) of Piperacillin/Tazobactam, Administered by Prolonged Infusion, in Hospitalized Obese and Non-Obese Patients. Mentor: Michael B. Kays, PharmD

- 2009 Development of a Pharmacokinetic Model of Codeine in CYP2D6 Extensive and Poor Metabolizers. Mentor: Brian R. Overholser, PharmD
- 2008 Pharmacokinetics and Pharmacodynamics of Ibutilide in Patients with Heart Failure due to Left Ventricular Systolic Dysfunction. Mentor: Kevin M. Sowinski, PharmD
- 2007 Effect of Different Mutations of DJ-1 Protein on the Selective Death of Dopaminergic Neurons. Mentor: Fang Liu; Jean-Christopher Rochet, PhD
- 2004 Roles of Heme Oxygenase and Carbon Monoxide as New Neuroregulators in Neurodegenerative Diseases. Mentor: Sang-In Yang; Seok-Yong Lee, PhD
- 2004 Effect of CYP variants on Pharmacokinetics and Pharmacodynamics of drugs in Korean Population. Mentor: Jung-Woo Bae; Sang-In Yang; Seok-Yong Lee, PhD

**Teaching Experience:**

- August 2013- Co-Preceptor/Graduate teaching assistant  
Present Clerkship in Ambulatory Care, CLPH 88500, Purdue University.
- January 2012- Course co-coordinator/Course Instructor/Graduate teaching  
Present assistant  
Advanced Primary Literature Evaluation, CLPH 45300, Purdue University
- August 2010- Co-Preceptor/Graduate teaching assistant  
Present Clerkship in Infectious Diseases, CLPH 88500, Purdue University.
- August 2010- Co-Preceptor/Graduate teaching assistant  
Present Clerkship in Critical Care, CLPH 88500, Purdue University.

August 2010- Present	<u>Graduate teaching assistant</u> Principles Of Drug Information And Literature Evaluation, CLPH 86700, Purdue University.
January 2011-May 2014	<u>Graduate teaching assistant</u> Integrated Laboratory VI: Case Discussions for Pathophysiology and Therapeutics III, PHRM 40400, Purdue University.
January-May 2014	<u>Graduate teaching assistant</u> Health Care Systems, PHRM 83100, Purdue University.
January 2011-May 2014	<u>Graduate teaching assistant</u> Pathophysiology and Therapeutics II/III, CLPH 87200/87300, Purdue University.
January 2011-May 2012	<u>Graduate mentor</u> Graduate Mentoring Program, Purdue University.
January-May 2009	<u>Professional teaching assistant</u> Biopharmaceutics and Pharmacokinetics, IPPH 47500, Purdue University.
August 2008-May 2009	<u>Professional teaching assistant</u> Medicinal Chemistry and Molecular Pharmacology, MCMP 407/408, Purdue University.
August-December 2008	<u>Professional teaching assistant</u> Organic Chemistry, MCMP 204, Purdue University.
January-May 2008	<u>Student course coordinator</u> Nature of Cancer, MCMP 401, Purdue University.
August 2006-May 2008	<u>Professional teaching assistant</u> Organic Chemistry Lab, MCMP 204L/205L, Purdue University.

**Professional Experience:**

August 2010-Present	<u>Clinical Pharmacist</u> Infectious Diseases, Eskenazi Health (Wishard Health Services until December 2013), Indianapolis, IN Adult Medicine, Eskenazi Health (Wishard Health Services until December 2013), Indianapolis, IN
May 2009-April 2010	<u>Advanced Pharmacy Practice Experiences</u> College of Pharmacy, Purdue University
January-May 2009	<u>Pharmacy Intern</u> Purdue University Pharmacy, West Lafayette, IN
August-December 2007	<u>Pharmacy Intern</u> CVS Pharmacy, Lafayette, IN
August 2007	<u>Pharmacy Intern</u> CVS Pharmacy, Frankfort, IN
March 2004-July 2005	<u>Part-time Pharmacist</u> Medical Pharmacy, Busan, South Korea
July-August 2003	<u>Pharmacy Intern</u> Medical Pharmacy, Busan, South Korea

**Grant Support:****Funded grant support:**

**Title:** Alternative Requirements of Obese Patients in Model-Based Linezolid Dosing Regimens for Optimal Therapy in Comparison to Non-Obese Patients

**Award:** Young Investigator Award

**Sponsor:** American Society for Clinical Pharmacology and Therapeutics

**Amount:** \$35,000

**Date:** July 1, 2013 – December 31, 2014

**Role:** Principal Investigator

**Publications:**

1. **Chung EK**, Muloma E, Osterholzer D, Atkinson K, Erdman SM. development and implementation of a pharmacist-managed outpatient parenteral antimicrobial therapy (OPAT) program in a county teaching hospital. Manuscript under internal review.
2. **Chung EK**, Cheatham SC, Fleming MR, Healy DP, Kays MB. Population pharmacokinetics and pharmacodynamics of piperacillin and tazobactam administered by prolonged infusion in morbidly obese and non-obese patients. Manuscript under internal review.
3. Cheatham SC, Fleming MR, Healy DP, **Chung EK**, Shea KM, Humphrey ML, Kays MB. Steady-state pharmacokinetics and pharmacodynamics of meropenem in morbidly obese, hospitalized patients. *J Clin Pharmacol* 2014;54:324-330
4. Kays MB, Fleming MR, Cheatham SC, **Chung EK**, Juenke JM. Comparative pharmacokinetics and pharmacodynamics of doripenem and meropenem in obese patients. *Ann Pharmacother* 2014;48:178-186
5. Cheatham SC, Fleming MR, Healy DP, **Chung EK**, Shea KM, Humphrey ML, Kays MB. Steady-State pharmacokinetics and pharmacodynamics of piperacillin and tazobactam administered by prolonged infusion in obese patients. *Int J Antimicrob Agents* 2013;41:52-6
6. Choi CI, Kim MJ, **Chung EK**, Lee HI, Jang CG, Bae JW, and Lee SY. CYP2C9\*3 and \*13 alleles significantly affect the pharmacokinetics of irbesartan in healthy Korean subjects. *Eur J Clin Pharmacol* 2012;68:149-54

**Abstracts:**

1. Nichols KR, **Chung EK**, Knoderer CA, Buenger LE, Crumby AS, Speicher R, Healy DP, Kays MB. Population pharmacokinetics (PK) and pharmacodynamics (PD) of extended-infusion piperacillin, administered with tazobactam, in critically ill children. 54<sup>th</sup> Interscience Conference on Antimicrobial Agents and Chemotherapy, September 5-9, 2014, Washington, DC (Accepted).
2. **Chung EK**, Cheatham SC, Fleming MR, Healy DP, Kays MB. Population Pharmacokinetics and Pharmacodynamics of Cefepime in Hospitalized Obese and Non-Obese Patients. 2014 Annual Meeting, American Society for Clinical Pharmacology and Therapeutics, March 18-22, 2014, Atlanta, Georgia (Abstract #PI-021)
3. **Chung EK**, Cheatham SC, Fleming MR, Kays MB. Population Pharmacokinetics and Pharmacodynamics of Doripenem in Obese Patients. 2013

- Annual Meeting, American College of Clinical Pharmacy, October 13-16, 2013, Albuquerque, New Mexico (Abstract #125)
4. **Chung CEK**, Cheatham SC, Fleming MR, Kays MB. Population Pharmacokinetics and Pharmacodynamics of Meropenem, Administered by 30-Minute Infusion, in Hospitalized Obese and Non-Obese Patients. 2013 Annual Meeting, American Society for Clinical Pharmacology and Therapeutics, March 6-9, 2013, Indianapolis, Indiana (Abstract #PI-23)
  5. **Chung CEK**, Cheatham SC, Fleming MR, Kays MB. Population Pharmacokinetics and Pharmacodynamics of Piperacillin, Administered with Tazobactam by Prolonged Infusion, in Morbidly Obese and Non-Obese Patients. 2012 Annual Meeting, American College of Clinical Pharmacy, October 21-24, 2012, Hollywood, Florida (Abstract #134).
  6. Kays MB, Fleming MR, Cheatham SC, **Chung CEK**, Juenke JM. Doripenem Pharmacokinetics and Pharmacodynamics in Obese Patients Hospitalized in an Intensive Care Unit. 2012 Annual Meeting, American College of Clinical Pharmacy, October 21-24, 2012, Hollywood, Florida (Abstract #132).
  7. Kays MB, Fleming MR, Cheatham SC, **Chung CEK**, Juenke JM. Comparative Pharmacokinetics and Pharmacodynamics of Doripenem and Meropenem in Obese Patients. 2012 Annual Meeting, American College of Clinical Pharmacy, October 21-24, 2012, Hollywood, Florida (Abstract #133).
  8. Beeler C, **Chung CEK**, Osterholzer D, Erdman S. Incidence of Adverse Events in Outpatient Parenteral Antimicrobial Therapy. 2012 IDWeek, A Joint Meeting of Infectious Diseases Society of America, Society of Healthcare Epidemiology of America, HIV Medicine Association, and Pediatric Infectious Diseases Society, October 17-21, 2012, San Diego, California (Abstract #799).
  9. Kays MB, Cheatham SC, Fleming MR, Juenke JM, **Chung CEK**. Pharmacokinetics and Pharmacodynamics of Doripenem in Obese, Hospitalized Patients. 52<sup>nd</sup> Interscience Conference on Antimicrobial Agents and Chemotherapy, September 9-12, 2012, San Francisco, California (Abstract #A-017).
  10. Whited L, Cole J, Stewart E, **Chung CEK**, Erdman S. Incidence of PICC line-associated complications in outpatient parenteral antimicrobial therapy (OPAT). 46<sup>th</sup> Annual American Society of Health-System Pharmacists Midyear Clinical Meeting, December 4-8, 2011, New Orleans, Louisiana (Abstract #4-114).
  11. Cheatham SC, Fleming MR, Healy DP, **Chung CEK**, Shea KM, Humphrey ML, Kays MB. Pharmacokinetics and pharmacodynamics of piperacillin/tazobactam administered by prolonged infusion in morbidly obese, hospitalized patients. 2011 Annual Meeting, American College of Clinical Pharmacy, October 16-19, 2011, Pittsburgh, Pennsylvania (Abstract #143)



12. Cheatham SC, Fleming MR, Healy DP, **Chung CEK**, Kays MB. Pharmacokinetics and pharmacodynamics of meropenem in morbidly obese, hospitalized patients. 2011 Annual Meeting, American College of Clinical Pharmacy, October 16-19, 2011, Pittsburgh, Pennsylvania (Abstract #154)-selected as the Great Eight finalist (2011 Annual Meeting Best Paper Presentations)
13. Cheatham SC, Fleming MR, Healy DP, **Chung CEK**, Shea KM, Humphrey ML, Kays MB. Pharmacokinetics and pharmacodynamics of piperacillin, administered with tazobactam by prolonged infusion, in hospitalized obese patients. 51<sup>st</sup> Interscience Conference on Antimicrobial Agents and Chemotherapy Annual Meeting, September 17-20, 2011, Chicago, Illinois (Abstract #A1-1155)

### **Presentations:**

1. Haas D, Schwartz A, **Chung CEK**. "Determination of vancomycin pharmacokinetics in neonates to develop practical initial dosing recommendations", presented at Journal Club Meeting, Division of Clinical Pharmacology, School of Medicine, Indiana University, Indianapolis, IN, May 16, 2014
2. **Chung CEK**. "Antimicrobial dosing optimization in obesity: Use of population PK/PD approach for antimicrobial stewardship program", presented at Personalized Therapeutics Seminar, Division of Clinical Pharmacology, School of Medicine, Indiana University, Indianapolis, IN, March 4, 2014
3. **Chung CEK**, Quinney S, Li C. "Population pharmacokinetics of piperacillin and tazobactam in critically ill patients undergoing continuous renal replacement therapy: application to pharmacokinetic/pharmacodynamic analysis", presented at Journal Club Meeting, Division of Clinical Pharmacology, School of Medicine, Indiana University, Indianapolis, IN, January 31, 2014
4. **Chung CEK**. "Population pharmacokinetics and pharmacodynamics of meropenem in obese and non-obese hospitalized patients", presented at Graduate Student Awards Symposium – Jenkins/Knevel Awards, College of Pharmacy, Purdue University, West Lafayette, IN, November 7, 2013
5. **Chung EK**. "Antimicrobial dosing optimization in obese patients: Application of population pharmacokinetic studies to antimicrobial stewardship program", presented at Inje University, School of Medicine, Pharmacogenomics Research Center, Busan, South Korea, May 29, 2013
6. **Chung CEK**. "Population pharmacokinetics and pharmacodynamics of meropenem in obese and non-obese hospitalized patients", presented at Infectious

- Diseases Section Meeting, American Society for Clinical Pharmacology and Therapeutics, Indianapolis, IN, March 7, 2013
7. **Chung CEK**, Lu D, Li L. “Benefit of early statin therapy in patients with acute myocardial infarction who have extremely low low-density lipoprotein cholesterol”, presented at Journal Club Meeting, Division of Clinical Pharmacology, School of Medicine, Indiana University, Indianapolis, IN, December 9, 2011
  8. **Chung CEK**. “What is going on behind the counter?”, presented at Good Pharm Seminar, Korean Pharmacists Association, Seoul, South Korea, August 15, 2011
  9. **Chung CEK**. “Development of a predictive model of CYP3A inhibition effects on codeine metabolism”, presented at Purdue Pharmacy Graduate Seminar, Purdue University, West Lafayette, IN, October 28, 2010
  10. **Chung CEK**. “Development of a Pharmacokinetic Model of Codeine in CYP2D6 Extensive Metabolizers and Poor Metabolizers”, presented at Purdue PharmD Poster Session, Purdue University, West Lafayette, IN, April 30, 2010
  11. **Chung CEK**. “Apriso™ Monograph”, Drug Information clerkship rotation, Methodist Hospital, Indianapolis, IN, April 2010
  12. **Chung CEK**. “Does choice of combination antiretroviral therapy (cART) alter changes in cerebral function testing after 48 weeks in treatment-naïve, HIV-1-infected individuals commencing cART? A randomized, controlled study”, Drug Information clerkship rotation, Methodist Hospital, Indianapolis, IN, April 2010
  13. **Chung CEK**. “Telavancin”, Hospital Operation clerkship rotation, Indiana University Hospital, Indianapolis, IN, March 2010
  14. **Chung CEK**. “Switch to a raltegravir-based regimen versus continuation of a lopinavir-ritonavir-based regimen in stable HIV-infected patients with suppressed viraemia (SWITCHMRK 1 and 2): Two multicenter, double-blind, randomized controlled trials”, Hospital Pharmacy Operation clerkship rotation, Indiana University Hospital, Indianapolis, IN, March 2010
  15. **Chung CEK**. “Surgical antibiotic prophylaxis”, Hospital Pharmacy Operation clerkship rotation, Indiana University Hospital, Indianapolis, IN, February 2010
  16. **Chung CEK**. “Antiretroviral therapy in HIV-infected patients – Roles of pharmacists in outpatient setting”, Ambulatory Care clerkship rotation, Wishard Memorial Hospital, Indianapolis, IN, January 2010
  17. **Chung CEK**. “Intravenous diltiazem is superior to intravenous amiodarone or digoxin for achieving ventricular rate control in patients with acute uncomplicated atrial fibrillation”, Surgical ICU clerkship rotation, Indiana University Hospital, Indianapolis, IN, November 2009
  18. **Chung CEK**. “Inhaled nitric oxide”, Surgical ICU rotation, Indiana University Hospital, Indianapolis, IN, November 2009

19. **Chung CEK.** “Efficacy and safety of fondaparinux versus enoxaparin in patients with acute coronary syndromes treated with glycoprotein IIb/IIIa inhibitors or thienopyridines”, Adult Medicine clerkship rotation, Wishard Memorial Hospital, Indianapolis, IN, August 2009
20. **Chung CEK.** “Prasugrel versus clopidogrel”, Adult Medicine clerkship rotation, Wishard Memorial Hospital, Indianapolis, IN, August 2009
21. **Chung CEK.** “Third-party pharmacy audit analysis”, Community Pharmacy Operation clerkship rotation, IU Prescription Center, Indianapolis, IN, June 2009

**Professional Affiliations:**

Society of Infectious Diseases Pharmacists  
 American Society for Clinical Pharmacology and Therapeutics  
 Infectious Diseases Society of America  
 American Society of Microbiology  
 American College of Clinical Pharmacy  
 American Society of Health-System Pharmacists  
 American Pharmacists Association  
 Pharmaceutical Society of Korea

**Awards and Honors:**

November 2013	The Jenkins-Knevel Awards for Excellence in Research, College of Pharmacy, Purdue University
June 2013	Young Investigator Award, American Society for Clinical Pharmacology and Therapeutics
November 2012	Logan Travel Award, College of Pharmacy, Purdue University
May 2011	Graduate Summer Research Award, Purdue University
May 2010	Doctor of Pharmacy Degree with Highest Distinction, Purdue University
May 2010	College of Pharmacy Academic Excellence Award, Purdue University

March 2009	Rho Chi Academic Achievement Award, College of Pharmacy, Purdue University
December 2008- Present	Golden Key International Honor's Society
January 2008- Present	Rho Chi National Pharmacy Honor's Society
May-August 2008	Dean's Summer Undergraduate Research Fellowship Recipient, College of Pharmacy, Purdue University
October 2006	Rho Chi Achievement Award, College of Pharmacy, Purdue University
Multiple Semesters	Pharmacy merit-based scholarships, College of Pharmacy, Purdue University
Multiple Semesters	Dean's list and Semester honors, Purdue University

## PUBLICATIONS

## PUBLICATIONS

1. Chung EK, Muloma E, Osterholzer D, Atkinson K, Erdman SM. Development and implementation of a pharmacist-managed outpatient parenteral antimicrobial therapy (OPAT) program in a county teaching hospital. Manuscript under review.
2. Chung EK, Cheatham SC, Fleming MR, Healy DP, Kays MB. Population pharmacokinetics and pharmacodynamics of piperacillin and tazobactam administered by prolonged infusion in morbidly obese and non-obese patients. Manuscript submitted.
3. Cheatham SC, Fleming MR, Healy DP, Chung EK, Shea KM, Humphrey ML, Kays MB. Steady-state pharmacokinetics and pharmacokinetics of meropenem in morbidly obese, hospitalized patients. *J Clin Pharmacol* 2014;54:324-330
4. Kays MB, Fleming MR, Cheatham SC, Chung EK, Juenke JM. Comparative pharmacokinetics and pharmacodynamics of doripenem and meropenem in obese patients. *Ann Pharmacother* 2014;48:178-186
5. Cheatham SC, Fleming MR, Healy DP, Chung CEK, Shea KM, Humphrey ML, Kays MB. Steady-State pharmacokinetics and pharmacodynamics of piperacillin and tazobactam administered by prolonged infusion in obese patients. *Int J Antimicrob Agents* 2013;41:52-6

6. Choi CI, Kim MJ, Chung EK, Lee HI, Jang CG, Bae JW, and Lee SY.  
CYP2C9\*3 and \*13 alleles significantly affect the pharmacokinetics of irbesartan  
in healthy Korean subjects. *Eur J Clin Pharmacol* 2012;68:149-54