

6-2010

Offset Right-Turn Lanes for Improved Intersection Sight Distance

Karen Schurr

University of Nebraska-Lincoln, kschurr1@unl.edu

Timothy J. Foss Jr.

University of Nebraska- Lincoln

Follow this and additional works at: <http://digitalcommons.unl.edu/ndor>



Part of the [Transportation Engineering Commons](#)

Schurr, Karen and Foss, Timothy J. Jr., "Offset Right-Turn Lanes for Improved Intersection Sight Distance" (2010). *Nebraska Department of Transportation Research Reports*. 63.
<http://digitalcommons.unl.edu/ndor/63>

This Article is brought to you for free and open access by the Nebraska LTAP at DigitalCommons@University of Nebraska - Lincoln. It has been accepted for inclusion in Nebraska Department of Transportation Research Reports by an authorized administrator of DigitalCommons@University of Nebraska - Lincoln.

*NDOR Research Project Number SPR-P1(06) P592
Transportation Research Studies*

OFFSET RIGHT-TURN LANES FOR IMPROVED INTERSECTION SIGHT DISTANCE

Final Report

Karen S. Schurr
Timothy J. Foss Jr.

**Nebraska Transportation Center
Department of Civil Engineering
College of Engineering
University of Nebraska-Lincoln**

330 Whittier Research Center
Lincoln, Nebraska 68588
Telephone (402) 472-1974
FAX (402) 472-0859

Sponsored by the
Nebraska Department of Roads
1500 Nebraska Highway 2
Lincoln, Nebraska 68509-4567
Telephone (402) 479-4337
FAX (402) 479-3975

June 2010

Technical Report Documentation Page

1. Report No SPR-P1(06) P592	2. Government Accession No.	3. Recipient's Catalog No.	
4. Title and Subtitle Offset Right-Turn Lanes for Improved Intersection Sight Distance		5. Report Date June 2010	
		6. Performing Organization Code SPR-P1(06) P592	
7. Author/s Karen S. Schurr, Timothy J. Foss Jr.		8. Performing Organization Report No.	
9. Performing Organization Name and Address Nebraska Transportation Center, Dept of Civil Engineering University of Nebraska-Lincoln 262 Whittier Research Center Lincoln, NE 68583-0855		10. Work Unit No. (TRAIS)	
		11. Contract or Grant No. SPR-P1(06) P592	
12. Sponsoring Organization Name and Address U.S. Department of Transportation Research and Special Programs Administration 400 7th Street, SW Washington, DC 20590-0001		13. Type of Report and Period Covered Final Report June 2010	
15. Supplementary Notes			
16. Abstract <p>Many transportation agencies have started using offset right-turn lanes (ORTLs) at two-way stop-controlled intersections in the hope of improving driver safety by providing intersection departure sight distance triangles that eliminate through roadway right-turning vehicle obstructions. Currently, there are no specific geometric guidelines for key three-dimensional characteristics to allow drivers the optimal use of laterally-shifted right-turn lanes.</p> <p>Results of driver behavior studies at existing locations of offset right-turns lanes indicate that drivers are not performing as expected at parallel-type ORTLs, rendering its presence useless. Tapered-type ORTLs appear to be much more intuitive to driver expectancy and appropriate for the three-dimensional characteristics of all vehicle types.</p> <p>This research project identifies specific negative driver behaviors and recommends appropriate traffic control devices that meet current MUTCD guidelines to mitigate misleading visual cues and accentuate elements that reinforce the intended positive behavior at ORTL intersections for successful use of the laterally-offset right-turn auxiliary lane.</p>			
17. Key Words Offset right-turn lane, right-turn lane, intersection departure sight triangle	18. Distribution Statement		
19. Security Classification (of this report) Unclassified	20. Security Classification (of this page) Unclassified	21. No. Of Pages	22. Price

Form DOT F 1700.7 (8-72) Reproduction of form and completed page is authorized

ACKNOWLEDGEMENTS

This is the final report of Nebraska Department of Roads (NDOR) Research Project Number Project No. SPR-P1(06) P592 *Offset Right-Turn Lanes for Improved Intersection Sight Distance*. The research was performed for NDOR by the Nebraska Transportation Center in the Civil Engineering Department at the University of Nebraska-Lincoln.

The project monitor was Laura Lenzen, Assistant Traffic Engineer in the Traffic Division at NDOR. She and NDOR engineers Mohinder Makker, Donald Turek, Daniel Waddle, James Knott and Matt Neemann provided oversight and guidance to the research team. Their excellent cooperation contributed to the successful completion of the research.

DISCLAIMER

The contents of this report reflect the views of the authors who are responsible for the facts and accuracy of the data presented herein. The contents do not necessarily reflect the official views or policies of NDOR, the Federal Highway Administration, or the University of Nebraska-Lincoln. This report does not constitute a standard, specification, or regulation. Trade or manufacturers' names, which may appear in this report, are cited only because they are considered essential to the objectives of this report. The U.S. government and the State of Nebraska do not endorse products or manufacturers.

TABLE OF CONTENTS

	Page
ABSTRACT	i
ACKNOWLEDGMENTS	ii
DISCLAIMER	ii
TABLE OF CONTENTS	iii
LIST OF FIGURES	v
LIST OF TABLES	vii
Chapter 1 INTRODUCTION	1
Increasing Use of Offset Right-Turn Lanes.....	1
Objective.....	4
Chapter 2 PRELIMINARY BEHAVIOR STUDIES	5
Identification of Existing ORTL Intersections in Nebraska	5
Identification of Existing Guidelines for ORTL Intersection Geometry and Operations	8
Daytime/Nighttime Driver Behavior Study.....	10
Results and Inferences from Preliminary Study at Site 1	20
Limitations of Preliminary Study at Site 1.....	22
Chapter 3 LITERATURE REVIEW	25
Is There a Problem with SRTLs at Two-Way Stop-controlled Intersections?	25
Before and After Studies.....	28
Study Time Period	29
Sign Effectiveness and Motorist Compliance.....	29
Intersection Sight Distance	29
Stopping Guidance	31
Previous Offset Left-Turn Lane (OLTL) Research	31
Design Standards	32
Background on Driver Expectancy.....	32
Research Project Objectives Modified Due to Site 1 Preliminary Behavior Study Findings and Review of Previous Research	33

Chapter 4 AMELIORATION OF STOPPED DRIVER POSITIONING ISSUE	35
Background.....	35
Chapter 5 “STOP AT LINE” SIGN STUDY DESIGN.....	37
Study Objectives	37
Study Outline	37
Hypotheses Testing	38
Chapter 6 SITE SELECTION AND DATA COLLECTION	40
Sample Size.....	42
Recording of Vehicle Stopping Position	43
Study Periods	43
Equipment.....	44
Spreadsheet Formatting	45
Variables Collected	46
Stopping Distance from the Through Lane	47
Study Period	48
Day of the Week	48
Weather Conditions	48
Light Conditions	48
Minor Approach Vehicle Type	48
Stop Duration	48
Major Approach Vehicle Speed	49
ORTL Present.....	49
ORTL Vehicle Count.....	49
ORTL Vehicle Type Count.....	49
Chapter 7 ANALYSIS AND RESULTS.....	51
Analysis Method.....	51
Software Used	52
Results.....	52
Site 1: 148 th Street and Hwy N-2 Results and Descriptive Statistics.....	52
Linearity	55
Homoscedasticity.....	55

Independence of Errors	56
Normality of Errors	56
Site 8: Hwy US-77 and East Junction Hwy N-41 Descriptive Statistics.....	59
Linearity	61
Homoscedasticity	61
Independence of Errors	62
Normality of Errors	62
Comparison of ORTL and SRTL Behavior.....	65
Other Important Statistics from the Datasets	65
Chapter 8 DRIVER BEHAVIOR STUDIES OF RIGHT-TURNING AND THROUGH DRIVERS ALONG THE MAJOR ROADWAY OF PARALLEL-TYPE RIGHT-TURN LANES	67
Right-Turning Driver Speed Choices and Repercussions.....	67
Study Method.....	67
Chapter 9 DRIVER BEHAVIOR STUDY AT TAPERED-TYPE ORTL, SITE 7..75	
Chapter 10 RECOMMENDATIONS FOR AN ECONOMICAL OFFSET RIGHT- TURN LANE THAT MEETS DRIVER EXPECTATIONS FOR ALL VEHICULAR USERS	87
Review of Project Objectives	87
Future Research Suggestions	94
REFERENCES	95
APPENDIX 1 RECORDING EVENTS, BATTERY SPECIFICATIONS AND RECORDING APPARATUS SETUP INSTRUCTIONS	99
APPENDIX 2 SPSS OUTPUT	101
APPENDIX 3 DATA TRANSFORMATIONS	113

LIST OF FIGURES

	Page
1 Typical Parallel-Type ORTL.....	2
2 Typical Tapered-Type ORTL	2
3 Intersection Departure Sight Distance: SRTL	3
4 Intersection Departure Sight Distance: ORTL	3
5 Preliminary Driver Behavior Study Sites with ORTL Intersection Approaches in or near Lincoln, NE	5
6 Site 7, Tapered-Type ORTL at the Intersection of Hwys US-26 & US30 in Ogallala, NE	7
7 Site 7, Portion of Pavement Striping Plan Sheet for Hwys US-26 & US-30 Intersection, West of Ogallala, NE.....	7
8 Priority of Vehicle and Pedestrian Movements at a Two-Way Stop- Controlled Intersection.....	8
9 Comparison of Physical and Functional Areas of an Intersection	9
10 Site 7 Plan View Showing Potential Conflict Point Between Major Road Left-Turn and Major Road Right-Turn Movements	10
11 Site 1 Construction Barrel Video Camera Locations for Light/Dark Driver Behavior Study.....	11
12 Barrel Camera Assembly	11
13 Barrel Camera View Looking East at Site 1, 148 th Street & N-2 Intersection in Light Conditions (A) and Dark Conditions (B)	12
14 Vehicle Positioning Zones for Categorizing Right-Turn Driver Lateral Lane Position Behavior at Site 1	14
15 Lateral Vehicle Positioning within ORTL at Site 1	14
16 Lateral Vehicle Positioning within ORTL at Site 1, Entire Time Period.	15
17 Semi-trailer Truck Driver Infringing Upon Painted Offset Median	16
18 Lateral Dimensions to Key Cues for Driver Positioning at Southbound Minor Road Stop-Controlled Approach of Sit 1, 148 th Street & Hwy N-2.....	17

19 Mean Vehicle Bumper Position from Near Edge of Major Road Through Lane by Vehicle Type at SB Stop-Controlled Approach, Site 1	18
20 Standard Deviation of Vehicle Bumper Position from Near Edge of Major Road Through Lane by Vehicle Type at SB Stop-Controlled Approach, Site 1.....	19
21 85th-Percentile Vehicle Bumper Position from Near Edge of Major Road Through Lane by Vehicle Type at SB Stop-Controlled Approach, Site 1.....	19
22 95th-Percentile Vehicle Bumper Position from Near Edge of Major Road Through Lane by Vehicle Type at SB Stop-Controlled Approach, Site 1.....	20
23 Painted Stop Bar for Both Left-Straight and Right-Turning Drivers at Site 1.....	21
24 Adjacent Approach Vehicle Causing Intersection Sight Distance Obstruction at Site 1	22
25 Site B, ORTL at West Junction of US-18 and US-218, Floyd, IA	27
26 Minimum-Decision-Point Vertex Dimensions for Intersection Departure Sight Triangle	30
27 Comparison of ISD Triangles at OLTs and ORTLs	32
28 Preliminary Suggestions to Improve Stopped Driver Location Choice on Southbound Stopped Approach at 148th Street	36
29 Aerial Views of Sites 1 and 8.....	41
30 Painted Stop Bar at Desirable Location for Optimal Intersection Sight Distance for Stopped Driver at Sites 1 and 8.....	42
31 Field Assembly at Site 1 During Installation.....	45
32 Homogeneity of Errors Test for Site 1	56
33 Normality of Errors Graph for Site 1, 148th Street and Hwy N-2.....	57
34 Reproduction of Figure 2B-14 of the MUTCD	62
35 Homogeneity of Errors Test for Site 8, Hwy US-77 and East Junction Hwy N-41.....	62
36 Normality of Errors Histogram for Site 8, Hwy US-77 and East Junction Hwy N-41.....	63

37 Normality of Errors Histogram for Site 8, Hwy US-77 and East Junction Hwy N-41 with Outliers Greater than Two Standard Deviations Removed ..	64
38 Research Vehicle Positioned to Collect Through and Right-Turn Driver Speeds in Right-most Through Lane of Westbound Hwy N-2 at Site 1.....	67
39 Speed Distribution of Free Flow Right-Turning Vehicles in Right-most Through Lane at the Entry Taper into the ORTL at Site 1	69
40 Speed Distribution of Free Flow Through Vehicles in Right-most Through Lane at the Entry Taper into the ORTL at Site 1	69
41 Free Flow Right-Turning Driver Speed Statistics by Vehicle Type at Site 1.....	70
42 Free Flow Through Traffic in Right-most Through Lane Driver Speed Statistics by Vehicle Type at Site 1	70
43 Speed Distribution of Free Flow Right-Turning Vehicles in Right-most Through Lane at the Entry Taper into the SRTL at Site 8.....	71
44 Speed Distribution of Free Flow Through Vehicles in Right-most Through Lane at the Entry Taper into the SRTL at Site 8.....	71
45 Free Flow Right-Turning Driver Speed Statistics by Vehicle Type at Site 8.....	72
46 Free Flow Through Driver in Right-most Through Lane Speed Statistics by Vehicle Type at Site 8	72
47 Site 7, Hwys US-26 and US-30 West of Ogallala, NE.....	75
48 Key Dimensions of Tapered ORTL at Site 7	76
49 Hwy US-26 Stop-Controlled Approach to Hwy US-30.....	76
50 Number of Stopped Driver Occurrences During Site 7 Study Period	77
51 Mean of Driver Stopping Distance from Near Through Lane Edge by Vehicle Type at Site 7	78
52 Standard Deviation of Driver Stopping Distance from Near Through Lane Edge by Vehicle Type at Site 7	78
53 Median or 50 th -Percentile Cumulative Driver Stopping Distance from Near Through Lane Edge by Vehicle Type at Site 7.....	79

54 85th-Percentile Cumulative Driver Stopping Distance from Near Through Lane Edge by Vehicle Type at Site 7	79
55 95th-Percentile Cumulative Driver Stopping Distance from Near Through Lane Edge by Vehicle Type at Site 7	79
56 Horizontal Geometric Details of Site 7	82
57 Striping Plan for Site 7 Intersection	83
58 View of Computer Rendering of Site 7 from Northwest Quadrant.....	84
59 View of Computer Rendering of Site 7 from Southeast Quadrant.....	84
60 View of Computer Rendering of Site 7 from Northwest Quadrant.....	85
61 Computer Rendering of Westbound Hwy US-30 Driver’s Eye View at Beginning of ORTL Taper	85
62 Counter-productive Visual Cue Issues at Site 1.....	88
63 Improvements of Visual Cues at Site 1	89
64 Plan View of Proposed Staggered Stop Bar Pavement Marking to Better Fit Driver Behavior at MLA-Type Intersections	91
65 Computer Rendering of Recommendations for Optimal ORTL Design ..	92
66 Computer Rendering of Passenger Car Driver Viewpoint from Vehicle 1..	92
67 Computer Rendering of Passenger Car Driver Viewpoint from Vehicle 2..	93
68 Computer Rendering of Recommendations for Optimal ORTL Design ..	93
69 Computer Rendering of Passenger Car Driver Viewpoint from Vehicle 3 with Front Bumper 20 ft from Near Edge of Through Driving Lane.....	94

LIST OF TABLES

	Page
1 Geometric Characteristics of Preliminary Study Sites 1 through 6.....	6
2 Study Time Blocks of Dark/Light Data Collection Periods.....	13
3 Number of Stopped Drivers in Light/Dark Study Conditions by Vehicle Type	18
4 Summary of Potentially Negative Behaviors Identified at Site 1	23
5 Intersection Characteristics from Hochstein Study.....	25
6 ORTL Safety Effectiveness Summary	26
7 Possible Variable Affecting Driver’s Choice of Vehicle Positioning on the Minor Approach of a High-Speed Two-Way Stop-Controlled Intersection ..	38
8 Hypothesis Decision Rules	38
9 List of Independent Variables Collected	47
10 Site 1, 148th Street and Hwy N-2 Descriptive Statistics Related to Stop Distance.....	53
11 Site 1, 148th and Hwy N-2 t-test Results	53
12 Linear Regression Results for Site 1, 148th Street and Hwy N-2.....	54
13 Normality of Errors Test for Site 1, 148th Street and Hwy N-2.....	56
14 Normality of Errors Test for Site 1, 148th Street and Hwy N-2, Outliers Removed.....	58
15 Site 8, Hwy US-77 and East Junction Hwy N-41 Descriptive Statistics ...	59
16 Site 8, Hwy US-77 and East Junction Hwy N-41 t-test Results	59
17 Linear Regression Results for Site 8, Hwy US-77 and East Junction Hwy N-41	60
18 Normality of Errors Test for Site 8, Hwy US-77 and East Junction Hwy N- 41	63
19 Normality of Errors Test for Site 8, Hwy US-77 and East Junction Hwy N- 41 with Outliers Greater than Two Standard Deviations Removed	64
20 Cumulative Stopping Distance Percentages at Site 1 and Site 8 Combining All Before, After and Extended Study Period Data.....	66

21 Site Comparisons of Key Statistical Speeds 73
22 Cumulative Statistics for Stopped Vehicle Front Bumper Positions When Drivers' View Obstructed by Vehicles Within Right-Turn Lane at Sites 1 and 7..... 80
23 Summary of Visual Cues and Recommendations for Improvements 90

Chapter 1 INTRODUCTION

Increasing Use of Offset Right-Turn Lanes

Transportation agencies have started to use offset right-turn lanes (ORTLs) at two-way stop-controlled intersections in the hope of improving driver safety. An ORTL is similar to a standard right-turn lane except it has a painted or raised channelizing island that separates the right-turn lane from the through lanes (FIGURES 1 and 2). A standard right-turn lane as described in the 2004 AASHTO publication *A Policy on Geometric Design of Highways and Streets* (1), commonly known as the Green Book, is a lane that is at minimum 10 ft wide and consists of three components: an entering taper, deceleration length, and storage length. While meeting or exceeding the minimum standards, an ORTL provides additional intersection departure sight distance to drivers in vehicles that are stopped on an intersection's minor road approach wishing to enter or cross the major uncontrolled through traffic. Two types of sight triangles considered in intersection geometric design are approach and departure sight triangles. These triangles encompass areas along intersection approach legs that should be clear of obstructions that might block a driver's view of potentially conflicting vehicles. Dimensions of the sight triangles depend upon the design speed of the major roadway and the type of traffic control used at the intersection.

FIGURES 1 and 2 depict two geometric design types of ORTLs that are currently in use at Nebraska state highway intersections. FIGURE 1 shows a parallel-type design with a painted island between the major road through lane and the right-turn lane FIGURE 2 shows the tapered design, which also has a painted island adjacent to the right-turn lane. Currently on state roadways in Nebraska, the parallel ORTL-type design is much more common. The tapered offset configuration matches the minimum-sight-line hypotenuse of the intersection departure sight triangle, providing an elongated triangular offset rather than a constant width offset.

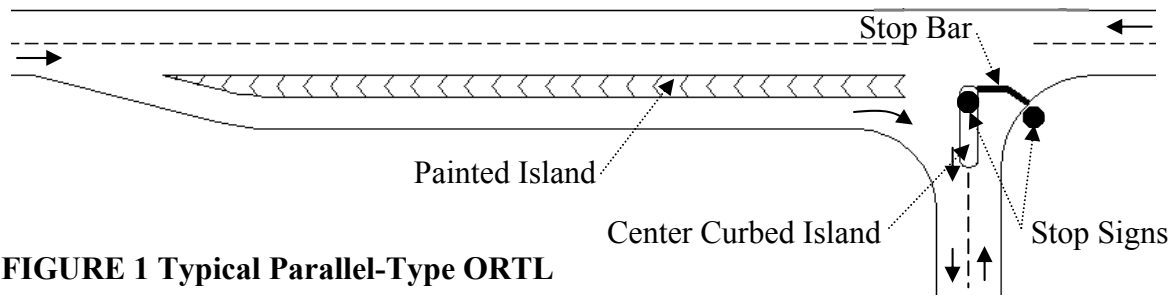

FIGURE 1 Typical Parallel-Type ORTL

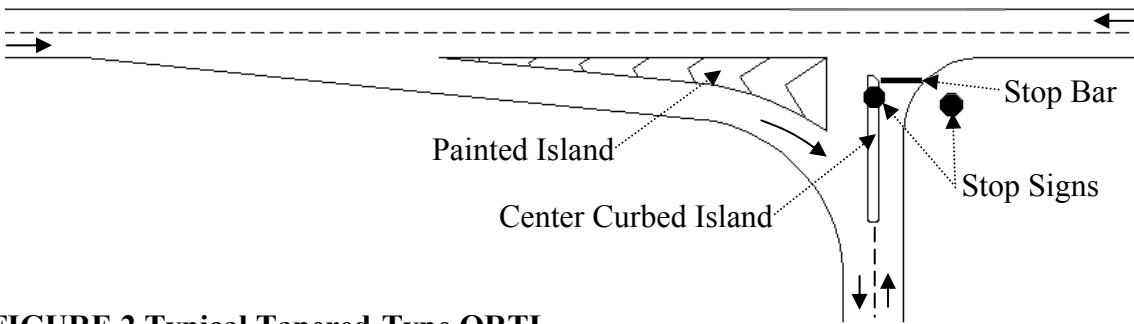

FIGURE 2 Typical Tapered-Type ORTL

FIGURES 3 and 4 illustrate the advantage of a clear intersection departure sight triangle afforded by an ORTL compared to an SRTL. The geometric features in these two figures are identified in the same manner as in FIGURES 1 and 2. Offsetting of the right-turn lane as shown in FIGURE 4 results in an unobstructed departure sight triangle for a driver stopped on the minor approach with an intent to enter the intersection.

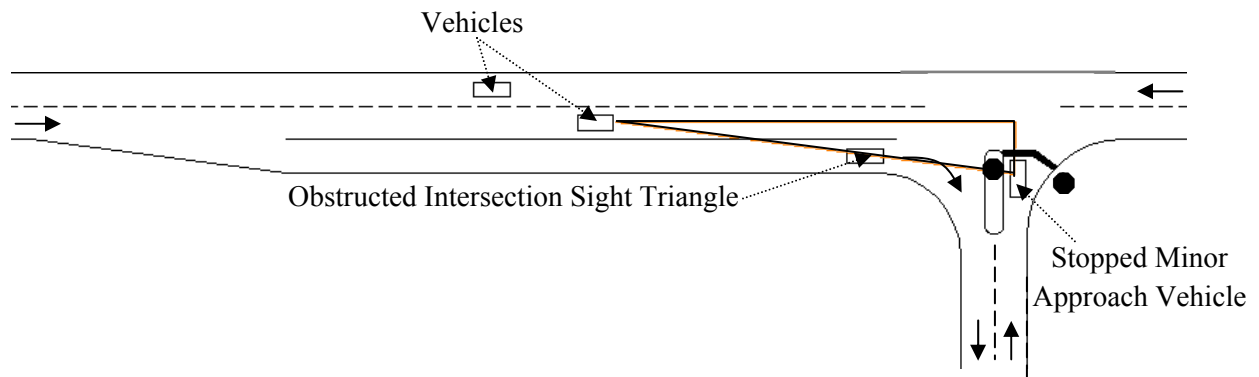

FIGURE 3 Intersection Departure Sight Distance: Standard Right-Turn Lane (SRTL)

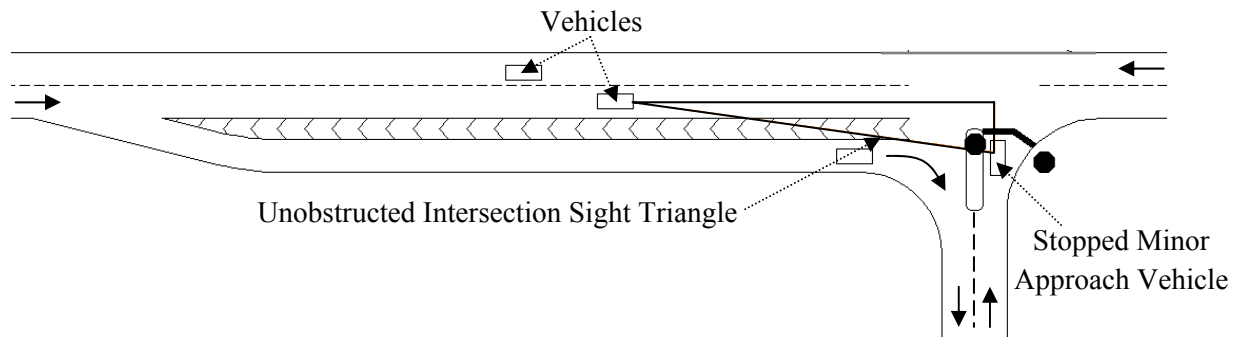

FIGURE 4 Intersection Departure Sight Distance: Offset Right-Turn Lane (ORTL)

Since ORTLs are a fairly new response from roadway design engineers to improve intersection safety, conditions under which they should be selected as the lane- geometry of choice are fairly vague. An example of such indistinct circumstances is shown below in an excerpt from the Missouri Department of Transportation Engineering Policy Guide (2):

“Consideration is to be given to offset right-turn lanes in locations with high mainline operating speeds, a large percentage of [mainline right-] turning trucks, unique sight distance issues or crash experience where investigation of crash diagrams indicates a safety benefit may be obtained from an offset turn lane.”(2)

An obvious solution for the minor road stopped driver is to wait until an appropriate departure sight triangle is clear of vehicles before attempting a turning or through movement. However, anecdotal evidence suggests drivers may become impatient or not realize that right-turning vehicles are significantly obstructing their vision. They may enter the major road without an appropriate gap in the through traffic stream resulting in a right-angle impact with an oncoming through vehicle which can cause severe injury to the vehicle occupants. The obstructed intersection departure sight triangle can also prevent the approaching major-road

through-vehicle driver from reacting defensively to an entering minor road driver accepting an unsuitable gap.

Obviously, an ORTL design requires more public right-of-way, more pavement, and more maintenance than an SRTL that is adjacent to the through traffic lanes. Research is needed to determine when construction of an offset auxiliary lane is most cost effective. If an ORTL is the style of choice, design guidelines should be established that

1. Meet the goal of removing right-turning major road vehicles from the intersection sight distance (ISD) triangle, and
2. Meet driver expectations at these types of intersections.

It is essential that the three-dimensional geometry of the intersection as a whole provide an environment that drivers approaching from any direction will thoroughly understand. All drivers should be able to rely upon their past successfully-executed driving experiences to operate their vehicles correctly and safely through a two-way stop-controlled intersection where ORTLs are provided.

Objective

The Nebraska Department of Roads (NDOR) Materials and Research Division selected staff members with considerable roadway design and traffic engineering background and expertise for a Technical Advisory Committee (TAC) to guide the focus of this research project.

The primary research objective was originally focused upon whether an SRTL or ORTL is the optimal choice at a given location where a right-turn lane is warranted along the major roadway of a two-way stopped-controlled intersection. NDOR's key concern was the use of ORTLs on major high-speed roadways. "High speed" was defined as a 50 mph or greater major road design speed. This definition is that used by the Green Book (1) to separate various design criteria into high and low speed circumstances.

Behavior studies were performed to assess the pros and cons of standard and offset intersections with the intent of developing guidelines for which type is optimal in a given circumstance. Since there are no standard guidelines used by NDOR for the appropriate three-dimensional intersection geometry to be used in creating an offset design, this research project also provides recommendations for characteristics that should optimize function, operations and safety at such intersections.

Chapter 2 PRELIMINARY BEHAVIOR STUDIES

Identification of Existing ORTL Intersections in Nebraska

Before a literature search of existing research on the topic of offset right-turn lanes was initiated, the state highway system in Nebraska was reviewed for high-speed two-way stop-controlled intersections that were designed with such features. Very few locations were found on the state system. This was expected since the installation of this type of turn lane is fairly recent.

The following locations were used for preliminary behavior studies to get some background on potential issues for a research literature review. FIGURE 5 shows six two-way stop-controlled intersections that were observed in or near Lincoln, NE to get a broad sense of operational, safety and conflict issues at intersection approaches with ORTLs. All six sites exhibited the parallel style of ORTL. Geometric characteristics of each site are shown in TABLE 1. All six sites exhibited intersecting roadways that were very close to zero degree skew angles which is typical of most intersections along Nebraska State highways.

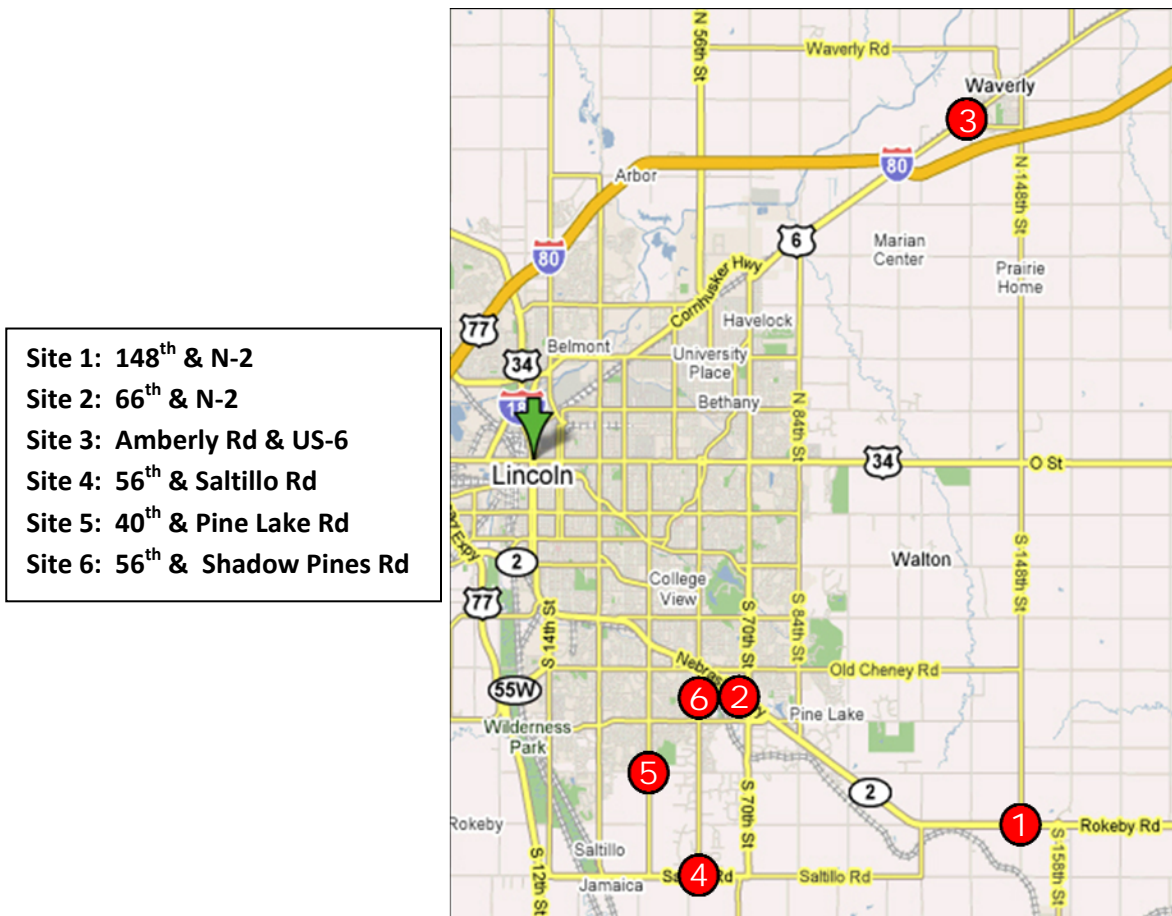

FIGURE 5 Preliminary Driver Behavior Study Sites with ORTL Intersection Approaches in or near Lincoln, NE

TABLE 1 Geometric Characteristics of Preliminary Study Sites 1 though 6

Site	Major Road Characteristics				ORTL Characteristics					Minor Stopped Approach Characteristics				
	Major Rd Lanes	Speed Limit (mph)	Median Width (ft)	Int Legs	Taper Rate	Lane Wdth (ft)	Parallel Lane Length (ft)	Shldr Wdth (ft)	Offset Wdth (ft)	Dist. to Raised Median * (ft)	Dist to Stop Bar* (ft)	Dist to Stop Sign * (ft)	Room for MLA **	MLA Ops ***
1	4	65	40	4	10:1	13	527	4	12	9	8	14	Y	N
2	4	55	18	3	11:1	12	316	4	18	11	none	18	Y	N
3	4	55	16	3	20:1	12	300	4	8	5	5	10	N	Y
4	2	55	12	3	29:1	12	163	10	6	18	none	25	Y	Y
5	3	45	29	4	8:1	12	220	curb	13	62	none	68	Y	N
6	3	45	29	4	8:1	12	132	curb	14	none	none	47	Y	Y

*Perpendicular distance from near edge of through major road driving lane.

**The stopped intersection approach is wide enough for two passenger cars to be adjacent to each other near the through lane edge of pavement (option to function as Multiple-Lane Approach, MLA).

***The stopped intersection approach is striped to indicate that two vehicles may queue adjacent to each other near the through lane edge of the pavement (encouragement to function as MLA).

As can be seen from TABLE 1, the geometric characteristics of all six sites varied greatly with the exception of Sites 5 and 6, shown shaded gray in TABLE 1, which were constructed at about the same point in time (summer of 2007). Both of these locations were in newly-built suburban areas along the edge of Lincoln, NE and since the posted speed limit was less than 50 mph, the sites were just used for preliminary conflict study purposes.

Site 4 was an intersection between two county roads which were not under the jurisdiction of NDOR. The minor approach of Site 3 was an outlet to Hwy N-2 from a residential subdivision that was just beginning to be developed and therefore had very little inbound or outbound traffic at the time this study was conducted. Site 2 was an intersection which had been altered from an SRTL to an ORTL. Geometric features of Site 2 were not optimal due to narrow right-of-way and low budget constraints.

Site 1 was a good candidate for ultimate operational field studies since it exhibited fairly reasonable geometry and a high volume of right-turning vehicles on the intersection approach with the ORTL.

Only one tapered-type ORTL, Site 7 was discovered at the intersection of Hwys US 26 and US-30 near the airport on the west side of Ogallala, Nebraska. FIGURE 6 shows a view of the Site 7 intersection from a view point within the offset right-turn lane. FIGURE 7 shows a portion of a paint striping plan sheet from the design construction plans of Site 7.



FIGURE 6 Site 7, Tapered-Type ORTL at the Intersection of Hwys US-26 & US-30 in Ogallala, NE

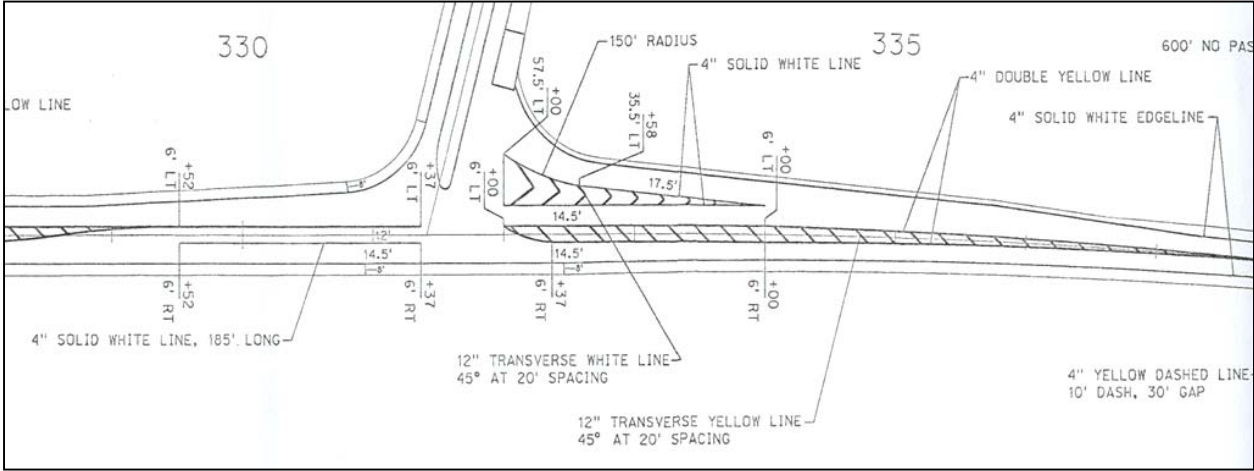

FIGURE 7 Site 7, Portion of Pavement Striping Plan Sheet for Hwys US-26 & US-30 Intersection West of Ogallala, NE.

The parallel-type of ORTL may be the geometric design of choice for the following reasons:

- Retains all elements of a typical intersection by keeping the ORTL within close proximity of the intersection proper maintaining driver expectancy with respect to the proper hierarchy of traffic streams. Tapered-type ORTL connects the right-turn movement farther from the intersection proper possibly resulting in a speed differential between left-turners from the major and right-turners from the major road.
- Requires less right-of-way for construction
- Requires less pavement, fill, and other associated paving items relative to driving lane construction, and
- Requires less public right-of-way.

Identification of Existing Guidelines for ORTL Intersection Geometry and Operations

Primary guidebooks for roadway design and traffic engineering practitioners were consulted to determine

- 1) Warrants for when ORTLs should be constructed instead of SRTLs,
- 2) The appropriate traffic stream hierarchy of movements at two-way stop-controlled intersections to enhance driver expectancy features which is shown in the latest edition of the Highway Capacity Manual (HCM) (3), and
- 3) Standards for the geometry of the offset right-lane (and other approaches to the intersection) for optimal driver understanding and usage of such facilities which would be expected to be found in the latest edition of the Green Book (1).

No specific warrants or geometric dimensions for ORTLs were listed in the Green Book.

Guidelines for key features of auxiliary lanes are likely used by geometric design engineers under the assumption that an ORTL displaying such dimensions would operate successfully.

FIGURE 8 shows the hierarchy of movements at a two-way stop-controlled intersection from the HCM (3). Traffic streams 13, 14, 15 and 16 refer to pedestrians, if they are a consideration. This study will not include consideration of pedestrians since intersections with design speeds of 50 mph or greater in Nebraska do not generally exhibit significant, if any pedestrian usage. According to these guidelines, the right-turning traffic streams along the major road (Streams 3 and 6) have priority over the left-turning traffic streams along the major road (Streams 1 and 4 at a 4-legged intersection and Stream 4 at a 3-legged intersection) and the right-turning traffic streams on the stop-controlled minor road approach (Streams 9 and 12 at a 4-legged intersection and Stream 9 at a 3-legged intersection).

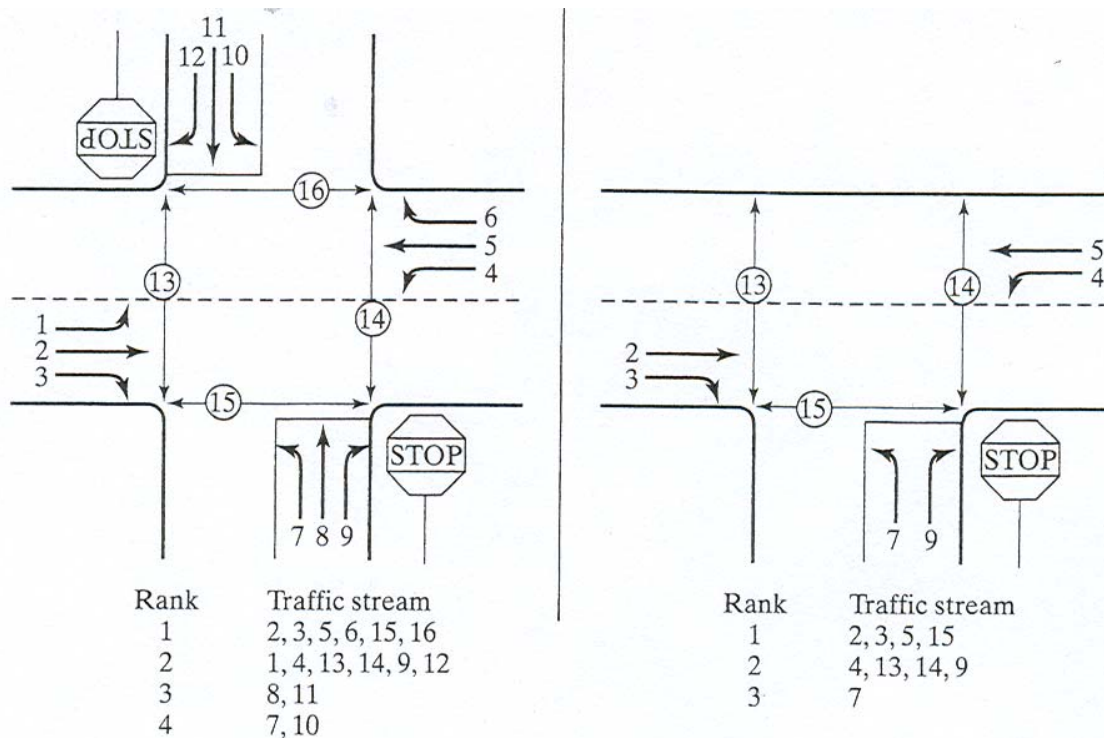

FIGURE 8 Priority of Vehicle and Pedestrian Movements at a Two-Way Stop-Controlled Intersection (3, Highway Capacity Manual, Exhibit 17-3, pg. 17-4)

Drivers can rely upon their *a priori* expectancy of the hierarchy of traffic movements to perform successfully at two-way stop-controlled intersections as long as the pavement geometry of Traffic Streams 3 and 6 are near the physical area of the intersection. FIGURE 9 shows the physical and functional part of an intersection.

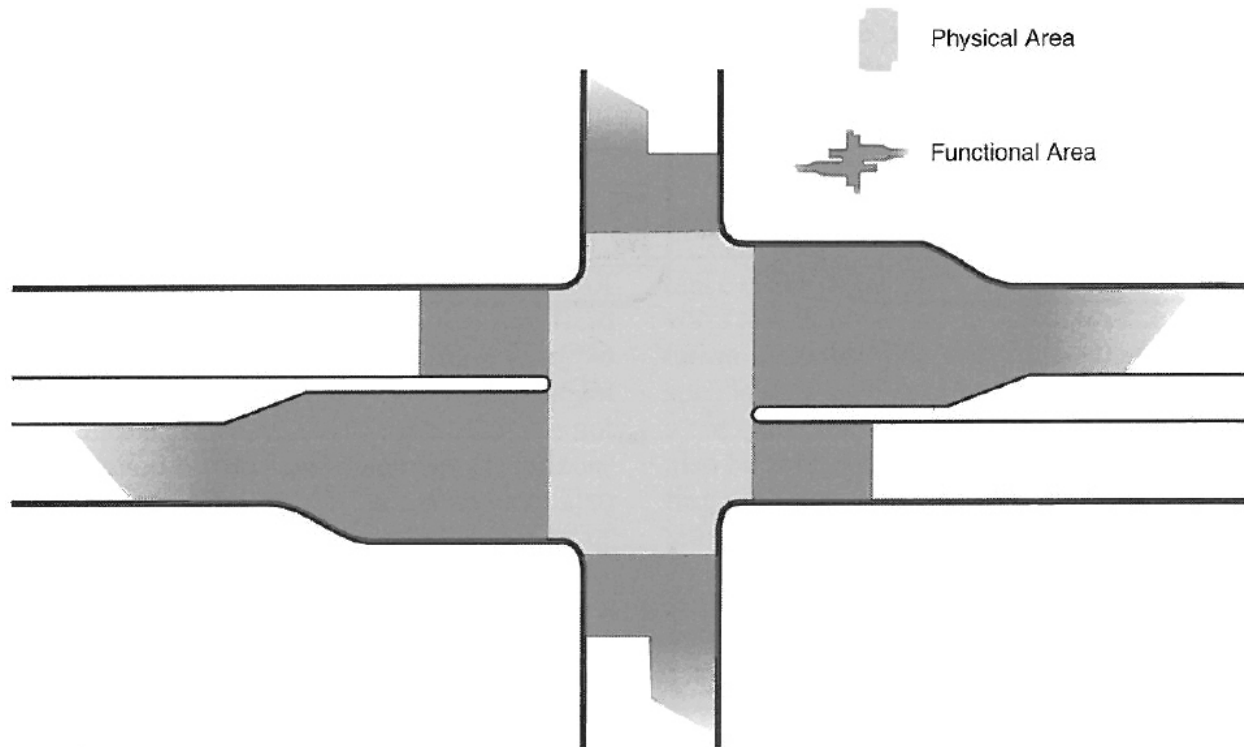

FIGURE 9 Comparison of Physical and Functional Areas of an Intersection (4)

Lateral placement of the ORTL has an effect on traffic stream priority. The physical connection point of the ORTL with the minor road departure lane should be near enough laterally to the major road so that a left-turning driver from the major road understands that the right-turning driver is still within the intersection proper and not on a merging higher-speed right-turn ramp. FIGURE 10 shows Site 7 with dashed arrows representing the potential conflict point between the major road left-turn movement and major road right-turn movement along the departure lane of the minor roadway. If the offset island is too wide laterally and the right-turning curve radius too large, the drivers of both vehicles may be confused about which has the turning priority, violating driver expectancy. The major road median width, if present, may also have an adverse effect on driver expectancy. Desirably, the relative operating speeds of the two movements shown below should be similar, reducing accident severity if one should occur. If the median of the major road were wide, the left-turn driver would have an opportunity to attain a higher speed by the time he/she reached the conflict point with the right-turning driver.

According to the Green Book (1), there are three typical types of right-turning roadways at intersections:

- 1) A minimum edge-of-traveled way design,
- 2) A design with a corner triangular island, and
- 3) A free-flow design using a simple radius or compound radii.

It is highly recommended that the first design type be used in combination with ORTL geometry to reinforce a driver's expectation that the right-turn movement is part of the intersection proper and not a free-flow right-turn lane. Geometry of the right-turn lane should relay this perceptually to both left-turning drivers from the major road as well as right-turning drivers from the major road. Encouraging high speed right-turn movements may cause safety problems at the conflict point shown in FIGURE 10.

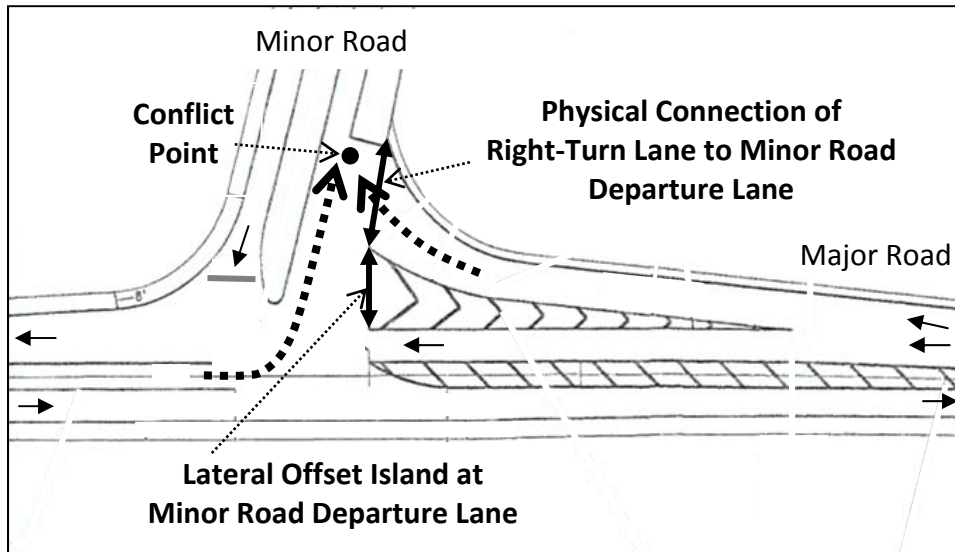

FIGURE 10 Site 7 Plan View Showing Potential Conflict Point Between Major Road Left-Turn and Major Road Right-Turn Movements

Daytime/Nighttime Driver Behavior Study

In addition to the potential issues identified above, there was an interest from the project TAC at NDOR to learn if daytime and nighttime driver behaviors were significantly different at ORTL sites. A short review of driver behavior in light and dark driving environments was undertaken to determine if further in-depth studies should collect data under both conditions.

The timing of the study was such that the review data could be collected when the time change from Central Daylight Time (CDT) to Central Standard Time (CST) occurred. The first data collection event was completed between 6 am and 8 am CDT on Wednesday, October 25th and the second data collection event was conducted between 6 am and 8 am CST on Friday, November 3rd. Site 1, 148th and N-2 was selected as an appropriate location for the study since it had relatively high right-turn volumes and a fairly large percentage of trucks in the right-turn traffic stream.

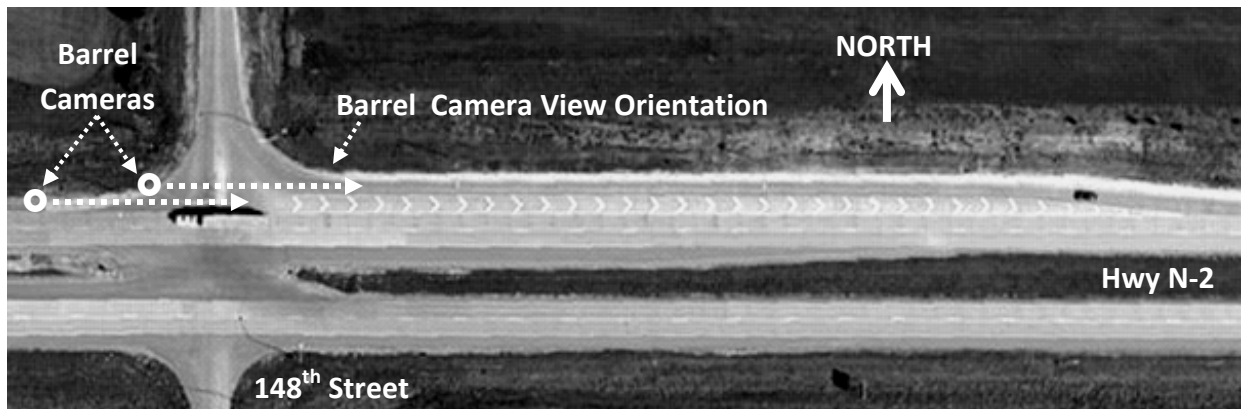

FIGURE 11 Site 1 Construction Barrel Video Camera Locations for Light/Dark Driver Behavior Study

FIGURE 11 shows an aerial view of the location of construction barrels that had been modified with an opening to allow a small video camera to be inserted. Once barrel was aligned with the ORTL and one was aligned with the painted offset median to allow the view of drivers’ lateral placement choices both within the right-turn lane and the view of stopped approach vehicles on southbound 148th Street. FIGURE 12 shows the barrel camera assembly from the point of view of a passing driver. The intent of the barrel camera assembly was to capture the actions of drivers without affecting their behaviors.



FIGURE 12 Barrel Camera Assembly

FIGURE 13 shows the view of the camera aligned with the painted offset median in daylight conditions.



FIGURE 13 Barrel Camera View Looking East at Site 1, 148th Street & N-2 Intersection in Light Conditions (A) and Dark Conditions (B)

Since the route was one which is used by daily commuters, it was an opportune time to provide behavior data for some similar system users during both light and dark conditions during a peak traffic period. With sunrise occurring an hour earlier due to the return of CST, the same commuters may be using the intersection in different lighting conditions. Since Site 1 had

roadside lighting, the “light” period was considered to be when the roadside lighting was off and the “dark” period was considered when roadside lighting was on. TABLE 2 shows 15-minute time increments and the resulting light/dark conditions. During the second data collection event, clouds prevented the roadside lights from shutting off for an overlap time of exactly an hour so collected data that was analyzed represents about a 30-minute period.

TABLE 2 Study Time Blocks of Dark/Light Data Collection Periods

Time	6:00 to 6:15 am	6:15 to 6:30 am	6:30 to 6:45 am	6:45 to 7:00 am	7:00 to 7:15 am	7:15 to 7:30 am	7:30 to 7:45 am	7:45 to 8:00 am
CDT, Oct 25								
CST Nov 3								

Dark = Rdwy Lights On
Light = Rdwy Light Off

The video was reviewed to observe driver behaviors related to two key concerns felt to be critical for optimal intersection departure sight distance:

- 1) Where did right-turning drivers along Hwy N-2 choose to orient their vehicles within the right-turn lane with respect to the painted median, and
- 2) Where did stopped drivers on the minor road approach position themselves to optimize their view of approaching vehicles on the major roadway?

The NDOR TAC was particularly interested in determining if large trucks were using the available pavement of the painted island to increase their turning radius in order to make a higher speed right-turn. A vehicle infringing on the area above the painted island would theoretically be reducing the available intersection sight distance of a driver on the stopped minor approach.

FIGURE 14 shows 4 locations of right-turn driver vehicle positioning that were collected from the 30-minute video. If the vehicle center was closer to the line marked as “C” it was counted as a “centered” position. If the vehicle center was closer to the line marked as “N”, it was counted as a north position. An “M” vehicle position was one in which the body of the vehicle was above the painted offset median area.

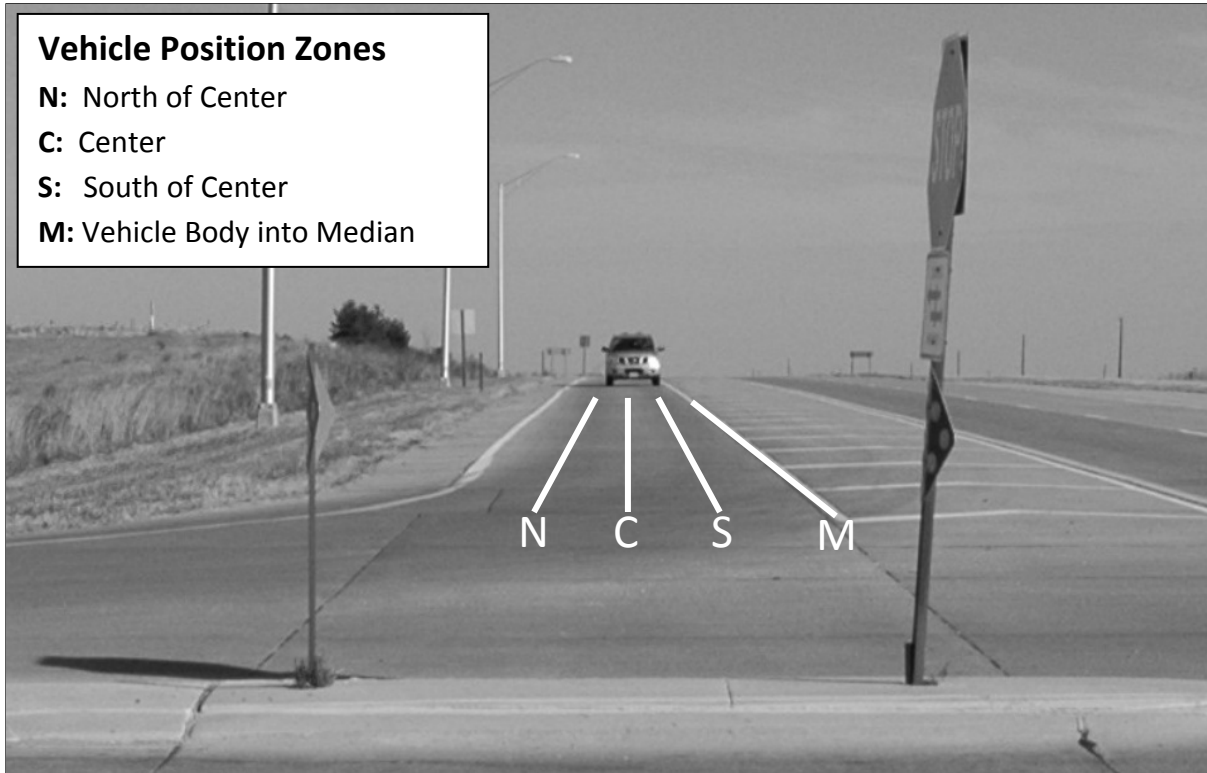

FIGURE 14 Vehicle Positioning Zones for Categorizing Right-Turn Driver Lateral Lane Position Behavior at Site 1

There were a total of 105 right-turning vehicles that used the ORTL within the 30-minute data collection period, 47 in light conditions and 68 in dark conditions. FIGURE 15 shows the outcome of how vehicles were positioned by their drivers during that time period.

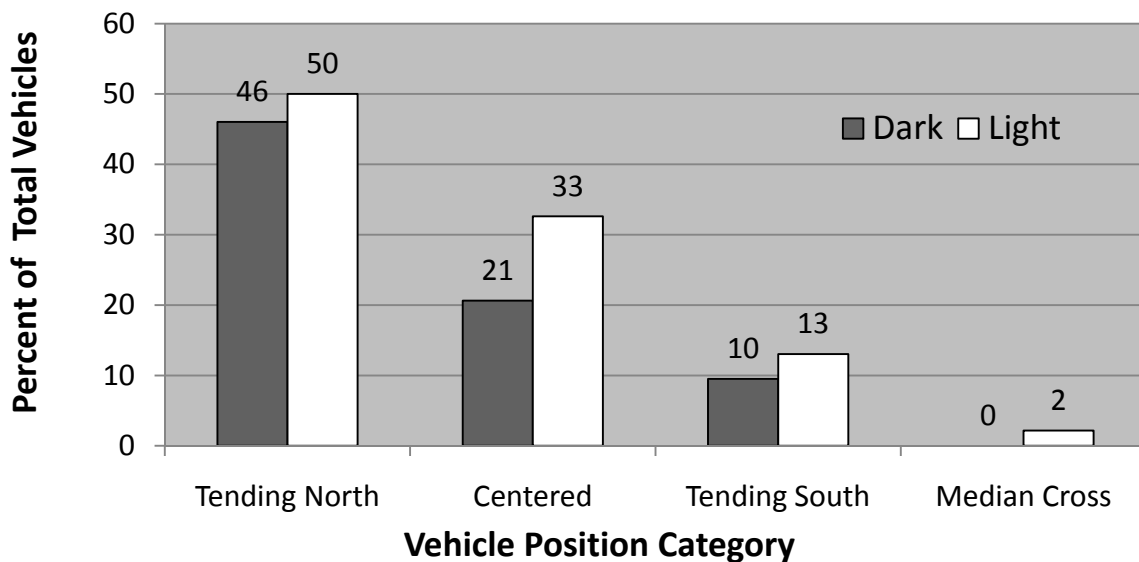

FIGURE 15 Lateral Vehicle Positioning within ORTL at Site 1

During the entire two-hour study period, there were a total of 369 drivers that used the ORTL: 130 in light conditions and 239 in dark conditions. FIGURE 16 shows the outcome of the entire time period.

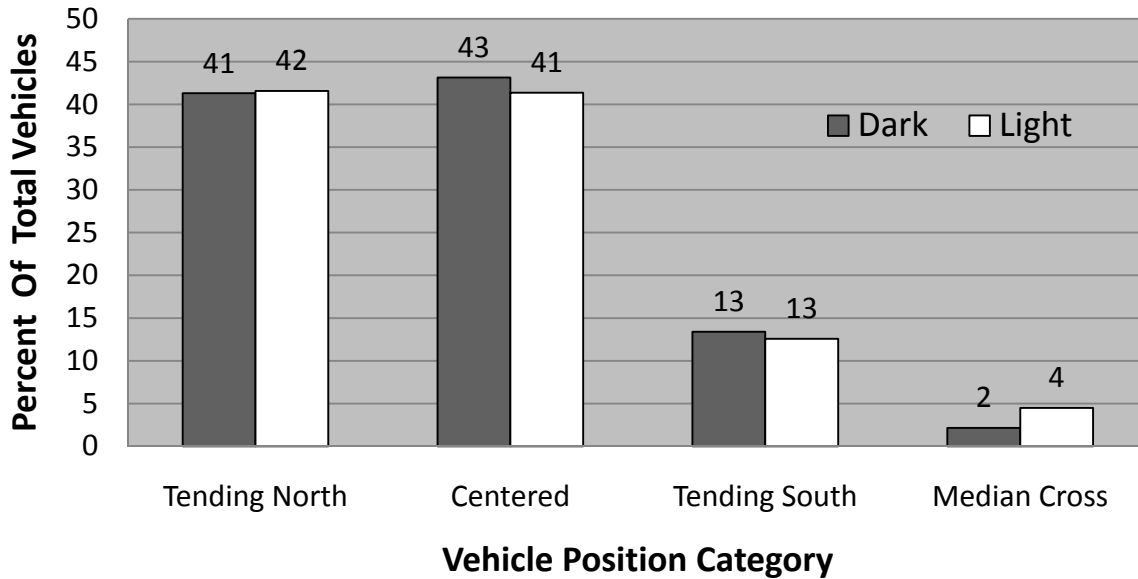

FIGURE 16 Lateral Vehicle Positioning within ORTL at Site 1, Entire Time Period

Ten drivers (about 3 percent of all collected) positioned their vehicles partially over the painted median. Three were driving passenger cars, 2 were driving pickup trucks and 5 were driving semi tractor trailers. FIGURE 17 shows an example of a semi tractor trailer infringing upon the painted island area.

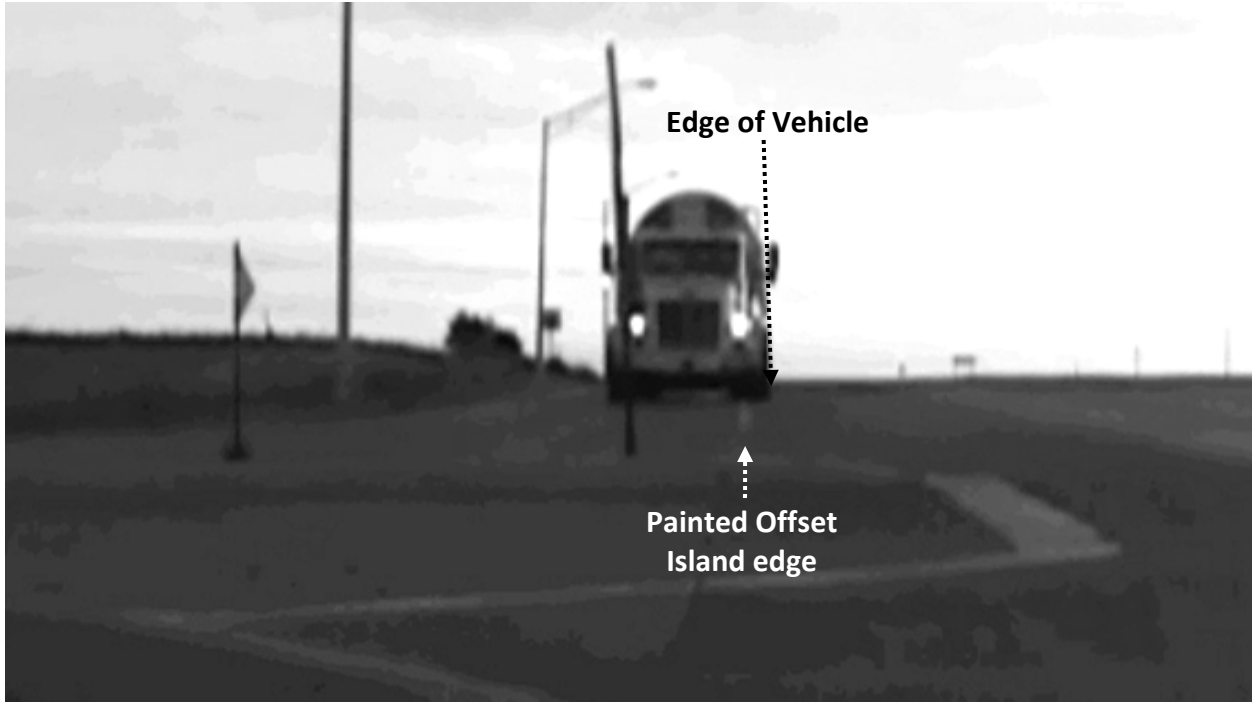

FIGURE 17 Semi-trailer Truck Driver Infringing Upon Painted Offset Median

In general, it appears that a high majority of drivers position their vehicles well within the designated right-turn lane.

The second point of concern for this preliminary study was to determine where stopped drivers on the minor road approach position themselves to optimize their view of approaching vehicles on the major roadway in order to choose an appropriate gap to safely enter the major road. FIGURE 18 shows measurements from the nearest edge of the major-road through driving lane to visible cues on the stop-controlled approach that indicate appropriate choices for a driver to position the front bumper of his/her vehicle. All of the video captured in the 2-hour period of both days was reviewed to collect positioning data of all vehicles stopping on the approach

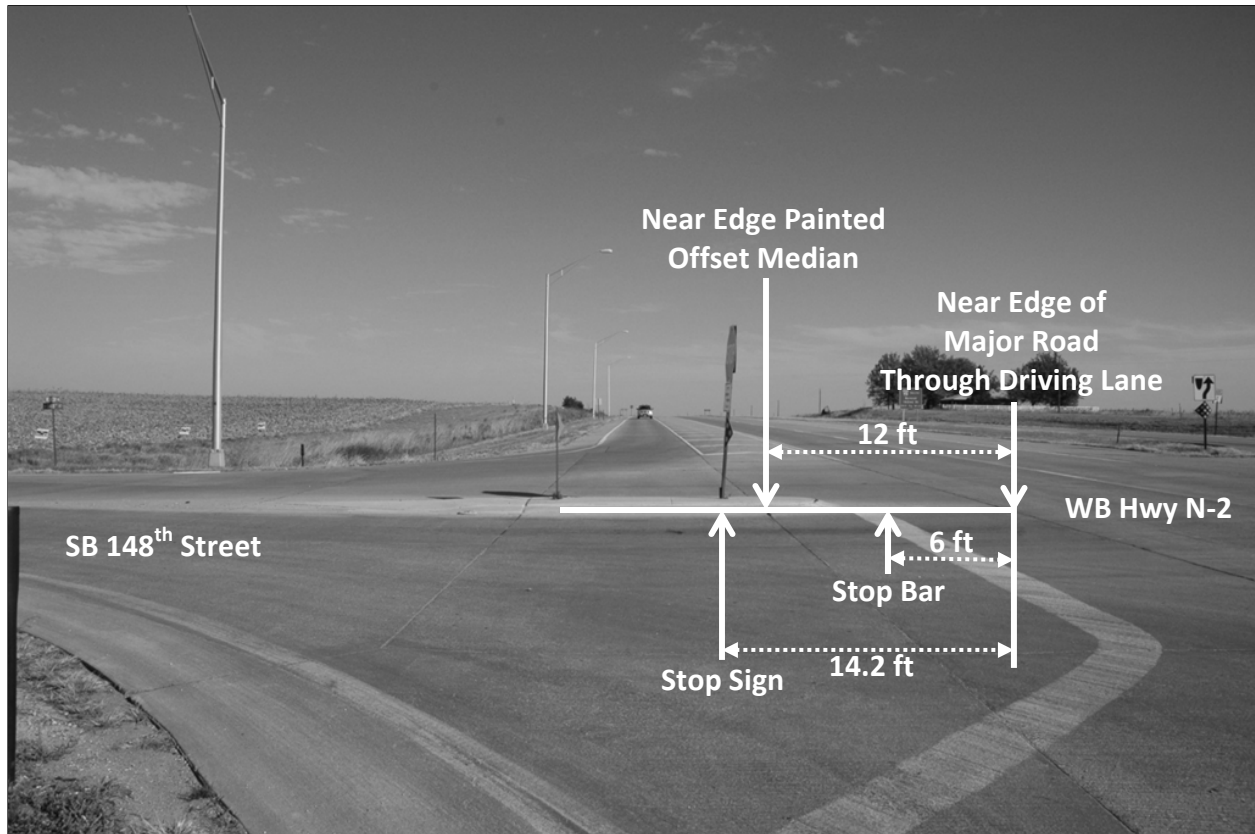

FIGURE 18 Lateral Dimensions to Key Cues for Driver Positioning at Southbound Minor Road Stop-Controlled Approach of Site 1, 148th Street & Hwy N-2

FIGURES 19 through 22 show pertinent statistical information about stopped driver vehicle positioning behavior at Site 1 for the left-turning/through movement. According to the Green Book intersection departure sight distance triangle guidelines, the minimum distance from the vehicle front bumper to the near edge of the through driving lane is 6.5 ft (1). Desirably, intersection sight triangles should be designed for a distance of 10 ft for this dimension to provide a more conservative area to be clear of sight obstructions (1). Data from the video was separated into three vehicle types: passenger cars (PC), pickup trucks (Truck), and semi tractor trailers (Semi). Front bumper positioning locations were determined for all vehicles stopping at the southbound stop-controlled approach of 148th Street to determine the following statistical data:

- Mean Front Bumper Position(ft),
- Standard Deviation (ft),
- 85th-Percentile Front Bumper Position (ft), and
- 95th-Percentile Front Bumper Position (ft).

Vehicle positioning data was separated into two conditions:

- 1) Vehicle occupying the ORTL, and
- 2) No vehicle occupying the ORTL.

TABLE 3 shows the number of stopped drivers in light/dark conditions by vehicle type and whether the ORTL was occupied or unoccupied. Statistics for both data sets are shown for light and dark conditions on FIGURES 19 through 22.

TABLE 3 Number of Stopped Drivers in Light/Dark Study Conditions by Vehicle Type

Light Condition	Passenger Cars (PC)	Pickup Trucks (Truck)	Semi-Trailer Trucks (Semi)	Unoccupied ORTL	Total Approach Vehicles	Total Approach Vehicles with Occupied ORTL
Light	9	10	4	22	45	23
Dark	14	10	3	19	46	27
Totals	23	20	7	41	91	50

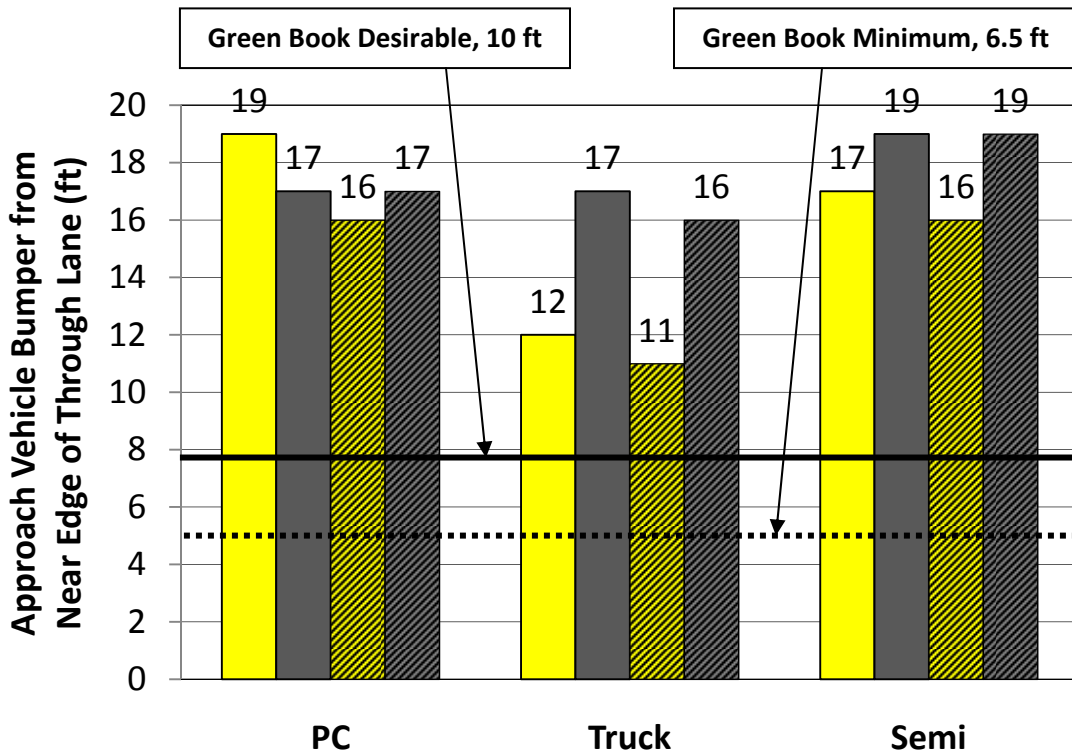

FIGURE 19 Mean Vehicle Bumper Position from Near Edge of Major Road Through Lane by Vehicle Type at SB Stop-Controlled Approach, Site 1

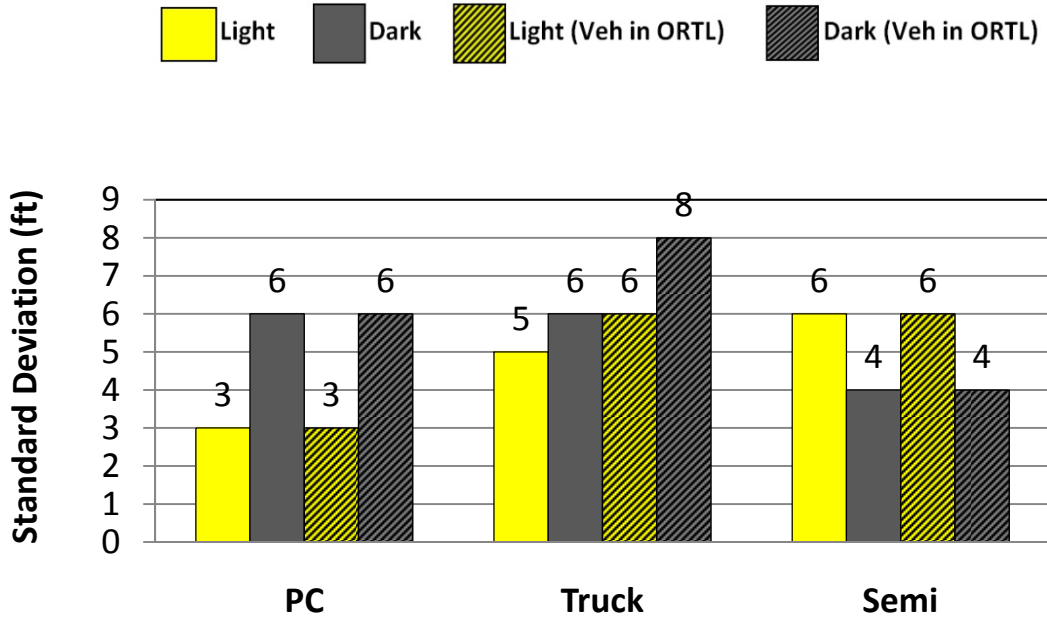

FIGURE 20 Standard Deviation of Vehicle Bumper Position from Near Edge of Major Road Through Lane by Vehicle Type at SB Stop-Controlled Approach, Site 1

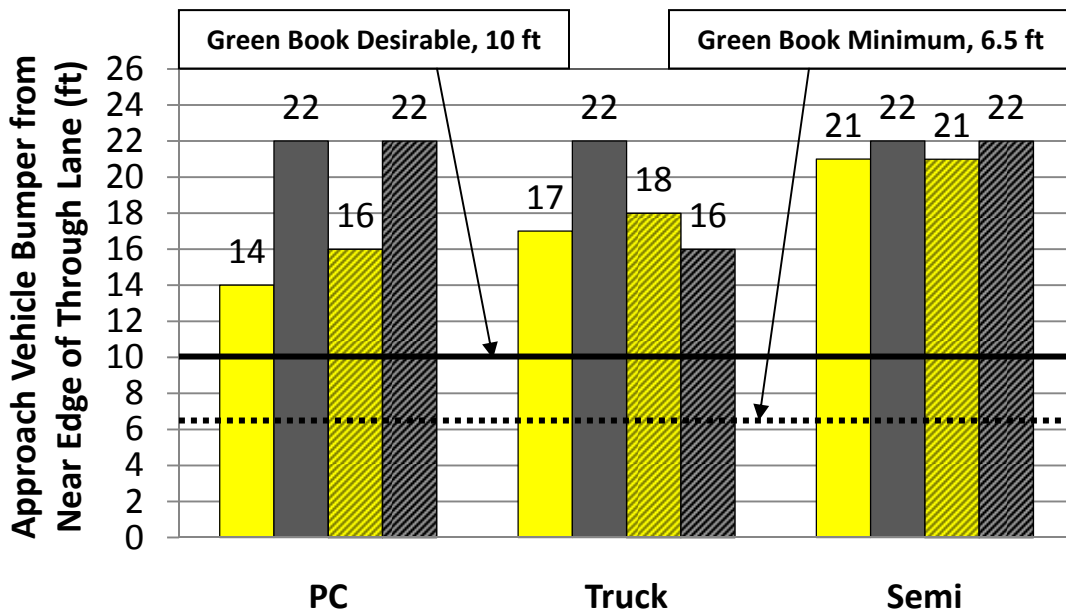
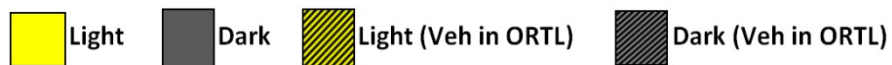

FIGURE 21 85th-Percentile Vehicle Bumper Position from Near Edge of Major Road Through Lane by Vehicle Type at SB Stop-Controlled Approach, Site 1



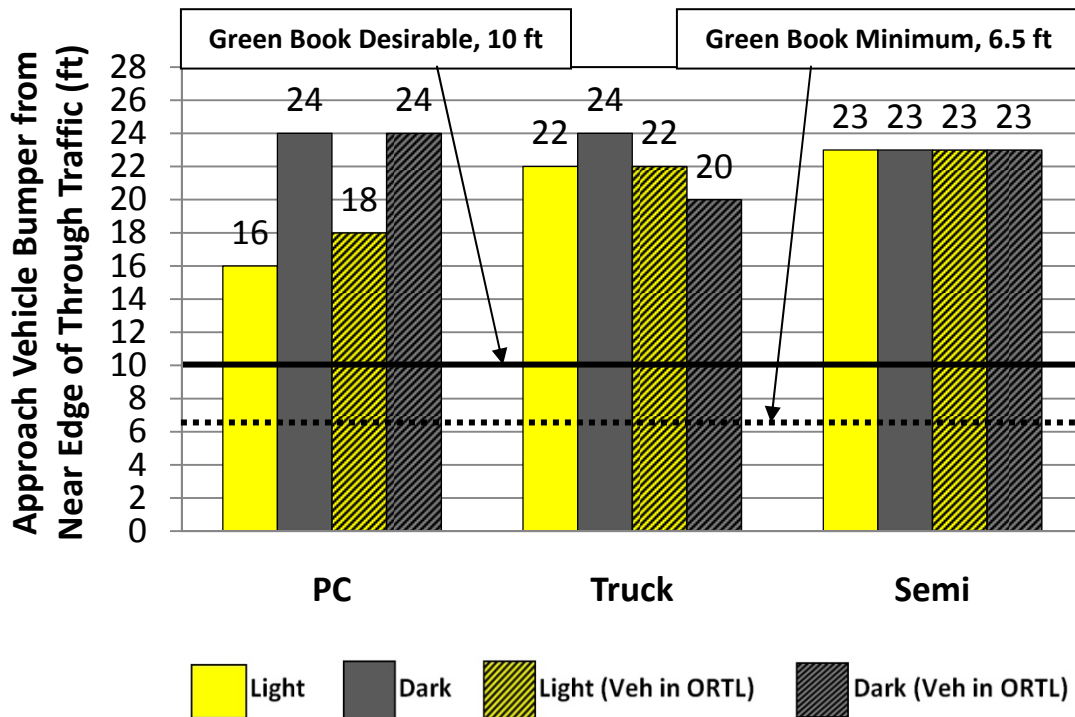

FIGURE 22 95th-Percentile Vehicle Bumper Position from Near Edge of Major Road Through Lane by Vehicle Type at SB Stop-Controlled Approach, Site 1

Results and Inferences from Preliminary Study at Site 1

Site 1 was selected for the Light/Dark study primarily because it was the ORTL intersection location with the highest volume of traffic with the most feasible geometric design of the 6 parallel type ORTL sites available. Even though the study collected data for 4 hours during peak hour periods, the number of drivers stopped at the southbound 148th Street approach was only 91, 50 of which were obstructed at some point in time by a vehicle in the ORTL.

Results and Inferences: Light vs Dark Environments

Statistical analyses at the 95 percent level of confidence were conducted of all three stopped vehicle types with or without obstructions in the ORTL to see if there was a significant difference in positioning from the near edge of the through major-road driving lane. In all three cases of PC, Truck and Semi, there were no significant differences in position relative to light and dark environments. Due to these results, further data collected for the research project would not be separated due to environmental lighting conditions.

Driver Choice of Positioning: Mean

Generally, the mean driver choice of positioning distance from the near edge of the through major road driving lane is from 16 to 19 ft regardless of vehicle type. This is significantly larger than the 6.5 ft minimum to 10 ft desirable range given in the Green Book (1).

Only 2 of 25 PC drivers (8 percent) in light conditions and 2 of 27 drivers (7 percent) in dark conditions positioned themselves to properly use the advantages afforded by the ORTL. Two of 23 Truck drivers (9 percent) in light conditions, none of 25 Truck drivers in dark conditions (0 percent) and none of 11 Semi drivers in light or dark conditions positioned themselves appropriately to take advantage of the ORTL.

Driver Choice of Positioning: Standard Deviation

The general standard deviation of all vehicle types is about ± 5 ft which indicates that drivers are not necessarily encouraged to position their vehicles at a specific location along the stopped approach.

Driver Choice of Positioning: 85th- and 95th-Percentile Values

A bumper position of 22 ft from the near driving lane would include 85 percent of all drivers studied and a bumper position of 24 ft would include 95 percent of drivers studied. This is again significantly larger than the 6.5 ft minimum to 10 ft desirable range given in the Green Book (1).

Driver Choice of Positioning: Presence of Right-Turning Vehicle on the Stopped Approach

The pavement surface on the southbound stop-controlled approach of 148th Street is designed to accommodate large vehicles such as semi tractor trailers to turn right. The resulting expanse of surfacing allows two smaller vehicles to position themselves adjacent to each other given that one driver is turning left/straight and the second is turning right. FIGURE 23 shows that the painted stop bar is angled at the right side of the approach, encouraging those drivers turning right to begin their turn and stop at the angled bar location to select an appropriate traffic gap. Unfortunately, this situation results in the intersection sight distance of both drivers to be obstructed by each other's vehicle. FIGURE 24 shows such a situation.



FIGURE 23 Painted Stop Bar for Both Left-Straight and Right Turning Drivers at Site 1

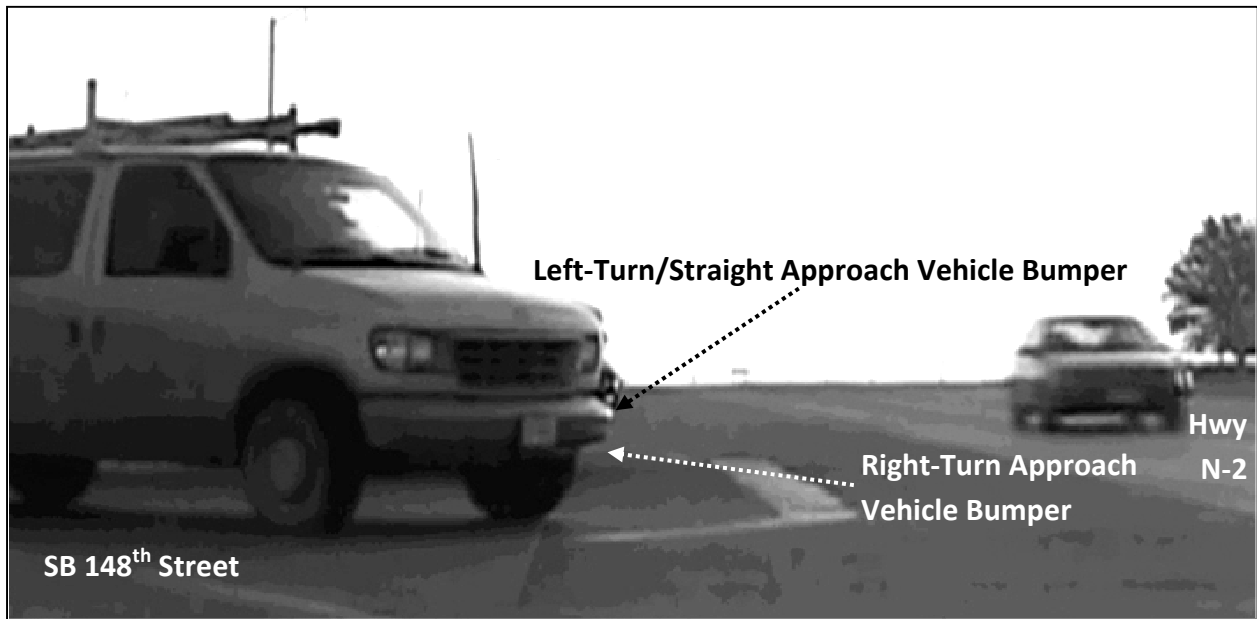

FIGURE 24 Adjacent Approach Vehicle Causing Intersection Sight Distance Obstruction at Site 1

Intersection legs with ORTLs in the departure direction and multiple-lane stop-controlled approaches in the entering direction compound the challenges facing drivers to make a confident and safe entry into the through traffic stream.

Limitations of Preliminary Study at Site 1

The study undertaken at Site 1 was intended to gain insight into driver behavior at ORTLs. Due to the small sample size, results should not be considered to be representative of driver behavior that may be divulged by a longer time period of data collection. However, the study did identify several points to be investigated further in the research project. TABLE 4 lists behaviors that have a potentially negative safety effect at ORTL intersections.

With a reasonable understanding of potential negative operational behavior issues to assess at ORTL intersections, a literature review was conducted to determine if previous research had been performed at similar intersection locations and if so, how those studies may assist with the initial objectives of this project.

TABLE 4 Summary of Potentially Negative Behaviors Identified at Site 1

Traffic Stream Hierarchy Details (3)													
<table border="1"> <thead> <tr> <th>Hierarchy Ranking</th> <th>Traffic Stream</th> </tr> </thead> <tbody> <tr> <td>1</td> <td>2, 3, 5, 6</td> </tr> <tr> <td>2</td> <td>1, 4, 9, 12</td> </tr> <tr> <td>3</td> <td>8, 11</td> </tr> <tr> <td>4</td> <td>7, 10</td> </tr> </tbody> </table>		Hierarchy Ranking	Traffic Stream	1	2, 3, 5, 6	2	1, 4, 9, 12	3	8, 11	4	7, 10		
Hierarchy Ranking	Traffic Stream												
1	2, 3, 5, 6												
2	1, 4, 9, 12												
3	8, 11												
4	7, 10												
Traffic Mvmt	Hierarchy Ranking	Driver Behavior	Potential Negative Effects										
6	1	Drivers infringe upon painted island near right turn to increase turning radius of vehicle for faster right turn	Obstacle in intersection sight triangle for Mvmts 10, 11, and 12 Potential right-angle crashes for failure of Mvmts 10, 11, and 12 to yield to Mvmt 5										
1	2	Drivers may believe they have the right-of-way over Mvmt 6 if right-turn lane connection is too far away from the intersection proper	Potential for sideswipe crashes for failure of Mvmt 1 to yield to Mvmt 6										
12	2	Approach pavement surfacing is designed for large vehicles that off-track therefore allowing Mvmt 12 drivers to align adjacent to Mvmts 10-11 drivers	Mvmt 12 driver's ISD may be limited on the left to approaching through drivers. Potential for rear-end crashes between Mvmt 12 and 5.										
12	2	Angled stop bar at intersection 1. Encourages Mvmt 12 to stop with Mvmt 10-11 (if present) as obstacle within intersection sight triangle 2. Angled stop bar encourages Mvmt 12 driver to stop at a skewed angle with respect to the intersection	1. Mvmt 12 driver's ISD is limited to the left. Potential for right-angle or rear-end accidents between Mvmt 12 and 5. 2. Mvmt 12 driver must look over shoulder to view Mvmt 5. Potential for rear-end accidents between Mvmt 12 and 5.										
10-11	4-3 respectively	Drivers unsure of where to stop for best ISD view.	Geometry of intersection is designed based upon minimum guidelines in Green Book (1) that don't match driver behavior. Potential for Mvmt 10 right-angle crashes with Mvmts 1, 2, 4, 5 and Mvmt 11 right-angle crashes with Mvmts 1, 2, 3, 4, 5										

Chapter 3 LITERATURE REVIEW

NDOR considers construction of ORTLs at intersections when there is evidence that right-turning vehicles are blocking sight lines of drivers stopped on the minor approach. The National Cooperative Highway Research Program (NCHRP) Report 500 (1) identifies blockage of sight lines as an unsafe roadway feature. While an ORTL provides a clearer intersection departure sight triangle to the drivers stopped on the minor approach compared to the SRTL, construction of an ORTL might be questionable if drivers are not benefiting from them. That is, why build ORTLs if drivers stopped on the minor approach do not use the offset to their benefit? Where ORTLs are already built, it may be useful to look at ways of increasing the beneficial usage of the offset by locating stop bars at appropriate positions and encouraging drivers to stop as close to the stop bar as possible.

Is There a Problem with SRTLs at Two-way Stop-controlled Intersections?

It is generally accepted by transportation geometric design experts that the presence of an exclusive right-turn lane for high volumes of right-turn traffic at divided highway intersections improves intersection safety by reducing speed differentials between right-turning and through drivers and therefore resulting rear-end collisions. However, research undertaken by Maze, Hawkins and Burchett (5) as well as Van Maren (6) of right-turn lanes at rural divided highway intersections indicated that SRTLs may actually increase crashes. Speculation by Maze, et al., was that higher crash rates were not due directly to SRTL presence but were due to their installation at high crash locations. An alternate explanation would be that vehicle-occupied SRTLs are creating obstacles with a stop-controlled approach driver's departure sight triangle, creating a more dangerous intersection environment.

A survey of state transportation agencies conducted by Maze, Hawkins and Burchett (5) indicated that only 5 of 28 responding agencies had utilized ORTLs as a safety improvement measure at rural expressway intersections. Since ORTLs are a relatively new element of high-speed roadway intersection geometry, there are no guidelines on use or design in the Green Book (1) and few studies conducted to determine the potential safety effectiveness of ORTLs.

Hochstein, et al. (7) performed a naïve before-after study of two intersections in Iowa and Site 1 (148th Street and Hwy N-2 in Nebraska) in 2007. All intersections were two-way stop-controlled locations on rural expressways. TABLE 5 shows pertinent information about each intersection.

TABLE 5 Intersection Characteristics from Hochstein Study

Site Identifier	Location, State	ORTL Type	Rt-Turn Lane History	Before Period	After Period
1	148 th and Hwy N-2, near Lincoln, Nebraska	Parallel	1997-2003, no rt-turn lane 2003-2010, ORTL	Jan 1998 – June 2003	July 2003 – Dec 2005
A	US-61 and Hershey Rd, Muscatine, Iowa	Tapered	1984-2003, no rt-turn lane 2003-2005, ORTL 2005- Present, signalized	Jan 2000 – June 2003	Aug 2003 – Oct 2005
B	US-18 and US 218, Floyd, Iowa	Tapered	1990s-2003, std rt-turn lane 2003-2005, ORTL	Jan 2000 – Sept 2003	Oct 2003 – Dec 2005

A logical assumption about relative safety after the installation of an ORTL is that there should be a reduction in right-angle crash frequency or more specifically, near-side right-angle crash frequency. The Hochstein study (7) yielded the following results shown in TABLE 6.

TABLE 6 ORTL Safety Effectiveness Summary

Crash Frequency Type	Percent Change		
	Site 1	Site A	Site B
Total	+267	+14	+1
Right-Angle	+10	+8	-58
Near-Side Right-Angle	-100	+56	-44

Site 1, subject of the preliminary ORTL behavior study, had a slight increase in right-angle accidents but did not experience a near-side right-angle crash in the 2.5 year after period. The Hochstein study (7) is quoted directly below.

“Of the 3 crashes that occurred during the before period, only 1 was a near-side right-angle collision involving a vehicle on southbound 148th Street colliding with a westbound vehicle on N-2 (the approach where the offset right-turn lane was eventually installed), giving a near-side right-angle crash frequency of 0.18 crashes per year. It was noted in the crash report that the southbound driver’s sight distance was obstructed by an uninvolved right-turning vehicle on N-2; therefore, this collision may have been prevented had the ORTL been in place at that time. In the after period, even though the overall crash frequency dramatically increased, no near-side right-angle crashes occurred at the intersection, giving a 100 percent reduction for this crash type. Therefore, it appears that the ORTL was a safety improvement in terms of preventing near-side right-angle collisions. However, it should be mentioned that a collision classified as “other” in the after period was a single-vehicle, run-off-road, PDO crash under daylight and dry conditions in which a westbound vehicle on N-2 took evasive actions to prevent a near-side right-angle collision with a southbound vehicle on 148th Street, which had pulled out in front of the westbound vehicle. It was not stated whether a right-turning vehicle was present at the time of this collision.”

Site A also had a slight increase in right-angle accidents in the after period as well as a 56 percent increase in the near-side right-angle crash frequency. The three-dimensional geometry of Site A includes a horizontal curve, relatively steep grade and 14-16 ft dividing median (too narrow to store a crossing vehicle) which may have contributed to the crash frequency increase.

Site B showed a reduction in both right-angle crashes (58 percent reduction) and near-side right-angle crashes (44 percent). FIGURE 25 shows photographs that are reproduced from the Hochstein study (7).



FIGURE 25 Site B, ORTL at West Junction of US-18 and US-218, Floyd, IA (6)

Although dimensions of a minimum departure sight triangle were used to determine the offset of the ORTL, pavement markings were placed such that the offset was reduced from 14 ft to 12 ft.

A district office official indicated that when funds were available, the ORTL design would be offset by another 3 to 4 feet and rumble strips would be used within the gore area to encourage right-turning drivers to shift the full lateral offset width. The Hochstein report (7) is quoted again directly below.

“Another means of increasing the offset at this location may also include moving the stop bar, stop sign, and divisional island on southwest-bound US-218 closer to the mainline. Currently, they are positioned too far back (as shown in FIGURE [25B]), and as a result, minor road drivers stopped at the stop bar do not get the full sight distance advantage provided by the ORTL.”

The Hochstein study had limitations such as:

- A limited number of study sites,
- Less than 3 years of study data at each site,
- No adjustment for increasing traffic volumes over the 5.5 year period, and
- A naïve before-after analysis which does not take regression to the mean into account.

Due to these limitations, the safety change rates may not be transferable to other expressway intersections but they do relate to the driver behavior evidence discovered in the preliminary Site 1 study.

The previous research literature review was focused to provide information on before-and-after studies, and length of study period. Other considerations were sign effectiveness and driver compliance, intersection sight distance, and stopping guidance.

A review of the mechanics of a before-and-after study is presented since it is used for this research. The length of a study is determined by a combination of resources available, the amount of time the behavior can be observed and the required amount of data to study a given phenomenon. The before and after section reviews the precedent set by other studies in the past. The AASHTO Intersection Sight Distance model defines recommended minimum ISD values and explains how it applies to this study. The stopping guidance section looks into the existing laws and definitions of a stop at a stop-controlled intersection. The design standards section reviews design standards currently in place for ORTLs as well as design standards for deceleration lanes.

Before and After Studies

Before and after (B/A) studies have commonly been used to study the effect of a change introduced by an analyst on some phenomenon of interest (8, 9, 10, 11). The mechanics of the B/A studies as applied to highway crashes is well-illustrated by Hauer (12). The idea behind B/A studies is to observe the phenomenon of interest for some duration of time, introduce the change (treatment) while keeping other factors unchanged, and observe the change in the phenomenon, if any. Any change in the phenomenon of interest is then attributed to the treatment introduced by the analyst. This is referred to as a naïve B/A study (12). The naïve B/A study attributes any observed change in studied phenomenon was due to the treatment and not any other factors present during the study (12). The phenomenon of interest is usually called the dependent variable while other factors that may affect it including the treatment are called independent variables.

Study Time Period

B/A studies historically require a period of time to elapse after a change is made to discern the “true” effect of a treatment on the dependent variable. Often the effect of a treatment may not become evident until the treatment has been in place for a protracted period of time. Alternatively, it may be possible to observe the effect of a treatment in a relatively short period of time. Because of this fact, it may be wise to begin the study immediately after a treatment is implemented. This will avoid loss of potentially valuable behavior data. A decision to include or exclude the data can be made at a later date. There may also be concerns regarding cost of data collection, which usually is higher with a longer study period. Based on the reviewed literature, it seems that there is no standard waiting period between stages of a B/A study when studying driver behavior. An investigation of similar B/A research showed that the waiting period before a study resumes after a change is implemented is between the time immediately after implementation to eight months after the change was implemented (10, 13, 14). A review of several studies that deal with changes in traffic signs found that the studies started immediately or used a waiting period of one to two weeks after implementation of the treatment (8, 9, 11, 15).

Sign Effectiveness and Motorist Compliance

This section presents the results from several studies concerning signs at stop-controlled intersections. One study focused on increasing motorist compliance at stop signs, another focused on decreasing motorist speeds, and yet another study researched the effect of signs on motorist behavior on several different roadway geometric designs.

The study that focused on increasing motorist compliance at stop signs used a Light Emitting Diode (LED) sign (16). The sign consisted of animated eyes that looked to left then to the right. It was found that at intersections where the sign was installed there was an increase in percentage of motorists that came to a complete stop.

The study that focused on the effectiveness of Dynamic Speed Display Signs (DSDS) on motorist speeds used a sign that had a white background with black legend reading “YOUR SPEED”. Below the legend was a LED screen that would display the current speed of motorists (17). This study found that at sites where the sign was installed, there was a 1 to 4 mph decrease in the 85th-percentile speed and a decrease in the percentage of motorists exceeding the posted speed limit.

The study that researched the effect of signs on motorist behavior included behavior at stop-controlled intersections (8). The treatments used were fluorescent stop and stop-ahead signs and a stop sign with flashing LED lights at each of the eight corners of the sign. It was determined by the researchers that the fluorescent stop ahead sign reduced nighttime speeds. At intersections where the fluorescent stop sign appeared, a 24 percent increase in vehicles coming to a complete stop occurred. At intersections where the stop sign had LED lights on each corner there was a 29 percent increase in vehicles coming to a complete stop. Blow-throughs were also reduced by 50 percent (the term “blow-through” was used to describe situations where drivers failed to stop at a stop sign).

Intersection Sight Distance

The 2004 AASHTO Green Book (1) separates intersection sight distance (ISD) triangles based on type of movement and intersection control. The Green Book (1) states that:

*“The vertex (decision point) of the departure sight triangle on the minor road should be 14.5 ft from the edge of the major-road traveled way. This represents the typical position of the minor-road driver’s eye when a vehicle is stopped relatively close to the major road. Field observations of vehicle stopping positions found that, **where necessary**, drivers will stop with the front of their vehicle 6.5 ft or less from the edge of the major-road traveled way. Measurements of passenger cars indicate that the distance from the front of the vehicle to the driver’s eye for the current US passenger car population is nearly always 8 ft or less. Where practical, it is desirable to increase the distance from the edge of the major-road traveled way to the vertex of the clear sight triangle from 14.5 to 18 ft. This increase allows 10 ft from the edge of the major-road traveled way to the front of the stopped vehicle, providing a larger sight triangle.”*

A key phrase, highlighted in bold print above, indicates that a driver’s final bumper position on a stop-controlled approach may be 6.5 ft if a driver determines it was **necessary** for an appropriate view of the intersection. The necessity to be so near the through major-road lane would most likely arise from typical obstructions found at intersections (vegetation, structures, parked cars, etc). It is unlikely that a driver would recognize the potential of a moving right-turning vehicle as an obstruction within the traveled roadway environment and therefore may not distinguish the necessity to be especially vigilant for through traffic that may be shadowed by right-turners. FIGURE 26 shows the minimum dimensions for the short leg (decision point vertex) of the intersection departure sight triangle described by the Green Book (1).

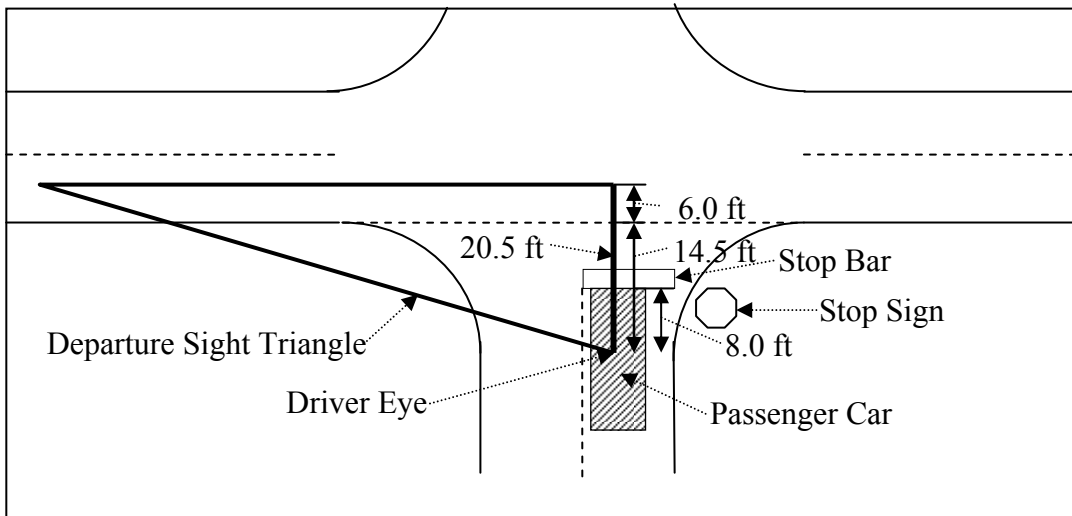

FIGURE 26 Minimum-Decision-Point Vertex Dimensions for Intersection Departure Sight Triangle (1)

The research that provided the basis for the ISD requirements for the 2004 Green Book was presented in the NCHRP Report 383 (18). The guidelines defined the critical gap for vehicle maneuvers to be the 50th-percentile accepted gap length (18). This means that 50 percent of the driver population would reject the design gap for a particular maneuver due to safety concerns. Conversely this means that 50 percent of the driver population would execute the maneuver assuming that they had sufficient time to complete it without problems. It was stated that these design criteria for intersections were higher than those required by operational criteria because it is desirable to incorporate in safety factors to account for unconsidered variables (18).

Stopping Guidance

The Nebraska Driver's Manual (19) and the Manual on Uniform Traffic Control Devices (MUTCD, 20) state that in the presence of a stop sign a driver must come to a complete stop before entering an intersection. If there is a painted stop line present, the driver is to stop at the line. The legal definition of a stop is provided by the City of Lincoln Nebraska Municipal Code, which reads "Stop, when such an act is required, shall mean complete cessation of movement." (21). Regulations governing a vehicle entering a stop-controlled intersection are as follows (22):

"(a) Except when directed to proceed by a police officer or traffic-control signal, every driver of a vehicle approaching a stop intersection indicated by a stop sign shall stop before entering the crosswalk on the near side of the intersection, or in the event there is no crosswalk, shall stop at a clearly marked stop line, but if none, then at the point nearest the intersecting street where the driver has a view of approaching traffic on the intersecting street before entering the intersection.

(b) Such driver, after having stopped shall yield the right-of-way to any vehicle which has entered the intersection from another street or which is approaching so closely on said street as to constitute an immediate hazard, but said driver having so yielded may proceed and the drivers of all other vehicles approaching the intersection shall yield the right-of-way to the vehicle so proceeding."

This issue was reviewed due to concerns that guiding drivers to stop at a stop bar closer to the conflicting lanes of traffic than the accompanying stop sign might conflict with the regulating law.

Previous Offset Left-Turn Lane (OLTL) Research

OLTLs have been studied to a much greater level than ORTLs. They are designed to eliminate ISD problems that stem from opposed left turns at intersections with permissive left turns. However, the ISD problem is in this case different from that of the ORTL as it stems from the lateral positioning of the opposing left-turning traffic (23, 24, 25). FIGURE 27 shows a graphical interpretation of the difference. The controlling offsets are not the same. In the case of ORTL, if Vehicle B remains in its lane, it will not affect Vehicle A's ISD as long as Vehicle A is offset properly from the through roadway. However, the theory of using painted islands to offset traffic to improve safety and ISD has been shown in research on OLTLs (23, 24, 25, 26). Therefore, providing offset right-turn lanes might be expected to improve ISD and safety; this however has yet to be proven by research.

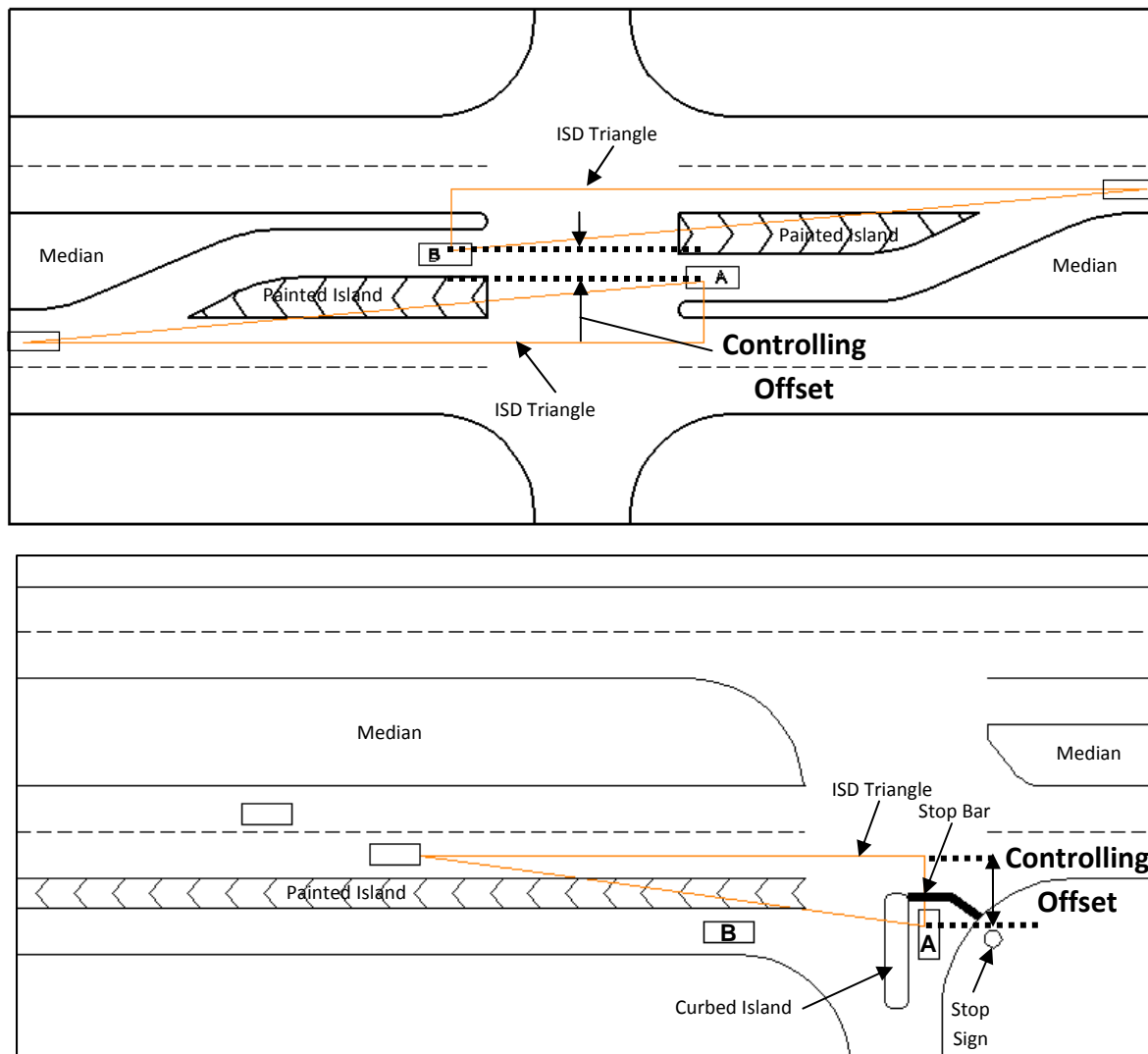

FIGURE 27 Comparison of ISD Triangles at OLTLs and ORTLs

Design Standards

There are no specific design guidelines for an ORTL-type intersection in the current Green Book (2) or the NDOR Roadway Design Manual (27). Most geometric design engineers likely use general guidance available on auxiliary lane geometry for taper ratios, deceleration lengths and storage lengths. It is critical that drivers be able to use their a priori and ad hoc driver expectancy skills to evaluate the driving environment for cues to perform safely and consistently on the roadway system.

Background on Driver Expectancy

According to the Green Book (1), there are two ways in which drivers gain experience and retain it for future use.

1. **A priori** driver expectancy results from the body of knowledge, skills and abilities a driver brings to the driving task from previous training or the successful completion of safe control of the vehicle in similar situations. This has a direct affect on how a driver perceives and reacts to a given situation.
Example: A driver familiar with driving multi-lane freeways in the United States expects to exit the freeway from the right-most lane of any number of through driving lanes in his/her direction of traffic. An appropriate driver behavior would be to gradually maneuver the vehicle to the right-most lane in advance of the exit location, choosing acceptable gaps in traffic to do so.
2. **Ad hoc** driver expectancy is driver behavior that is modified in real time due to knowledge gained immediately from a given situation.
Example: A driver approaches a series of speed bumps within his/her traffic lane and approaches the first one at what is believed to be a reasonable speed for the perceived 3-dimensional characteristics of the traffic control device. If the driver crosses the first speed bump too fast, the result will be a negative driver comfort experience (abrupt jolt in vehicle's suspension system), resulting in a modification of speed (braking) before crossing the next speed bump.

Any geometric recommendations resulting from driver behaviors identified in this research project must conform to these types of driver expectancy in order to have the opportunity to be successful.

Research Project Objectives Modified Due to Site 1 Preliminary Behavior Study Findings and Review of Previous Research

Initially, the primary objective of this research project was to focus upon whether an SRTL or ORTL is the optimal choice at a given location where a right-turn lane is warranted along the major roadway of a two-way stopped-controlled intersection.

A review of previous research on the subject yielded one safety effectiveness study (7) with mixed results and limited application due to a small number of sites (3 including Site 1), a short time period of ORTL operation, no adjustment for traffic volume changes over the 5.5 year study period, and a naïve study approach with inherent bias.

A statewide search for ORTL locations along rural major road state highways with a high design speed (50 mph or greater) resulted in 2 parallel-type installations near Lincoln, NE and 1 tapered-type location near Ogallala, NE. ORTLs are currently experimental in nature because their practical use is so limited. Some of the available ORTL sites have been implemented with new construction rather than evolving from SRTLs due to high near-side right-angle crashes making before-after safety effectiveness studies using the Empirical Bayes approach impossible. Finding enough local sites to appropriately conduct an operational or safety analysis with any statistical merit to provide ORTL warrants is in the future and an impossible goal at the time this research was commissioned.

Due to the preliminary study at Site 1, many issues were discovered that need to be addressed in order to allow the geometric features of a two-way stop-controlled intersection with an ORTL to function as intended. Once locations are constructed with geometry that best fits driver behavior at the stop-controlled intersection approach as well as the ORTL, studies can be undertaken to assess the pros and cons of SRTLs and ORTLs with the intent of developing guidelines for which type is optimal in a given circumstance. Driver experience with ORTLs is

an issue due to limited installations over which to develop *a priori* driver expectancy.

Since there are no standard guidelines used by NDOR for the appropriate three-dimensional intersection geometry to be used in creating an offset design, this research project focused on conducting behavior studies to provide initial recommendations for characteristics that should optimize function, operations and safety at such intersections.

Chapter 4

AMELIORATION OF STOPPED DRIVER POSITIONING ISSUE

Background

The results of the preliminary study at Site 1 documented the following behaviors of all drivers on the stopped approach of the minor road (with or without a vehicle in the ORTL) that were negating the installation value of the ORTL:

- Less than 10 percent of stopping drivers positioned their front bumpers at the stop bar (6 ft from the near edge of the through major road lane) which was the appropriate location with respect to the minimum ISD triangle defined by the Green Book (1) at Site 1 given the design speed of 70 mph on Hwy N-2.
- The standard deviation of the PC, Truck and Semi subgroups was between 3 to 8 ft, indicating that all drivers were not exactly sure of the appropriate location to position themselves with respect to the near edge of the through major-road lane.
- A front bumper position of 22 ft from the near major-road edge would be an appropriate decision point vertex of the ISD triangle covering 85 percent of all drivers during the study period.
- A front bumper position of 24 ft from the near major road edge would be an appropriate decision point vertex for 95 percent of all drivers during the study period.

Given the limited funding of the research project, the research team in conjunction with the TAC brainstormed possible low-cost methods to improve the conditions at Site 1. Preliminary suggestions included the following:

- 1) Provide a new semi-permanent stop bar at 6 ft from the near edge of the through major-road lane.
- 2) Move the central-island stop sign toward Hwy N-2, following any clearance regulations for snow plows with side mirrors which may be plowing the surfaced shoulders or regular major-road through-traffic clearance issues.
- 3) Mount a sign reading “STOP AT LINE” (Nebraska sign supplement R1-5C-24) below the current stop sign in the center island and below the current stop sign on the right side of the stopped approach.
- 4) Temporarily put a changeable message sign (CMS) at the stopped approach at Site 1 with the message “STOP AT LINE”,

FIGURE 28 shows a simulation of what the proposed suggestions would look like on a photograph of the Site 1 southbound stop-controlled approach at 148th Street.



FIGURE 28 Preliminary Suggestions to Improve Stopped Driver Location Choice on Southbound Stopped Approach at 148th Street.

Items 1 and 3 were considered the most practical permanent low-cost alternatives. The TAC also recommended just installing the “STOP AT LINE” sign only under the stop sign on the right side of the approach, the general opinion being that adding another sign to a post that already had a stop sign, a divided highway sign and a diamond button delineator would be too many signs at one installation and confusing to the driver on the stop-controlled approach. Although it was expected that making these minor changes would not provide the necessary change driver positioning required to make the ORTL meet minimum ISD design criteria from the Green Book (essentially move the mean stopping position from about 17 ft to 6 ft), these two suggestions were used in a study described in the following chapter.

Chapter 5

“STOP AT LINE” SIGN STUDY DESIGN

Preliminary evidence of driver behavior in Nebraska indicates that drivers are not taking advantage of the ISD triangle afforded by an ORTL because they are stopping well short of the appropriate minimum decision point vertex. The primary study issue is to persuade drivers to stop closer to the painted stop bar which is placed at the appropriate location to provide the minimum unobstructed ISD. An associated research issue is to find the durability of the effect that an employed method might have on drivers' stopping position with reference to the stop bar.

Study Objectives

The objective of this portion of the research was to determine the effectiveness of the R1-5C “STOP AT LINE” sign, which is available for use on Nebraska highways in the 2005 Nebraska Supplement to the MUTCD (9). This sign was used to persuade drivers to stop closer to the painted stop bar when installed on the minor approach of a two-way stop-controlled intersection. Given that the effectiveness of many traffic signs diminishes with time, this research also investigated the durability of R1-5C effect over time.

The effectiveness of R1-5C sign in getting drivers to stop closer to the stop bar at two-way stop-controlled intersections was tested at two intersections with similar geometric design elements except that one was a standard right-turn lane (SRTL) while the other was equipped with an ORTL. Effectiveness of the sign at both intersections was determined by comparing vehicle positioning relative to the stop bar before and after installation of the sign. Durability of the sign's effectiveness was measured by comparing vehicle positioning data collected one week after installation of the sign to data collected three weeks after installation of the sign.

Study Outline

Both study sites (described later) had poor reflective sheeting on signs and worn pavement markings that were replaced before any data collection. Doing so reduced the number of confounding factors that may have effect on results of the study. Replacement of old signs or worn pavement markings before data collection is not unusual; other researchers have undertaken similar measures before collecting data. For example, in a study of operational effects of different reflective sheeting on regulatory and warning signs, Gates et al., (10) replaced worn signs with new signs to limit differences between study sites. As such, all data at the two study sites was collected after renewal of reflective sheeting on the traffic signs and painting of fresh pavement markings.

The primary variable of interest in this study was the driver's stopped position choice of his/her vehicle's front bumper edge on the minor stop-controlled approach. TABLE 7 provides a list of some possible variables that might affect a driver's choice of vehicle positioning on the minor approach.

TABLE 7 Possible Variable Affecting Driver’s Choice of Vehicle Positioning on the Minor Approach of a High-Speed Two-Way Stop-Controlled Intersection

Variable Category	Variable Type
Traffic Characteristics	Major Road Through Traffic Volumes/Speeds Major Road Turning Traffic Volumes/Speeds Major Road Through Truck Traffic Volumes/Speeds Major Road Turning Truck Traffic Volumes/Speeds
Traffic Control Devices	Stop Bar Marking Location Stop Sign Locations Other Roadside Sign Locations
Roadway Characteristics	Horizontal Curvature Vertical Curvature Vertical Grade Major Road Through Traffic Design Speed Major Road Turning Traffic Design Speed Multiple Lanes on the Major Road Multiple Lanes on the Minor Road Approach Width of Painted Offset Median for ORTL
Vehicle Types	Passenger Cars Light Trucks and Pickups Semi Tractor Trailers Recreational Vehicles Motorcycles
Stopped Approach Driver Characteristics	Age Gender Level of distraction (cell phone users, etc) Perceptual Differences
Environmental Characteristics	Light/Dark Rain/Snow/Ice Overcast/Bright Sun

Hypotheses Testing

The null hypothesis in this study was that the installation of the R1-5C sign would cause no significant change in vehicle stopping position relative to the painted stop bar. The alternate hypothesis was that the mean stopping distance between the stopped vehicle and stop bar decreased with the sign in place. TABLE 7 displayed previously has an extensive list of variables that could possibly affect vehicle stopping position on the minor approach controlled by a stop sign. The variables that were tested in this study are provided later in this chapter. TABLE 8 represents the null and alternative hypothesis and decision rules using the Tukey’s t-test (a common statistical test to evaluate differences in means of two groups):

TABLE 8 Hypothesis Decision Rules

Alternatives	Decision Rule
$H_0: \mu_0 \leq \mu_a$	If $t^* \geq t(\alpha; n - 1)$, conclude H_0
$H_a: \mu_0 > \mu_a$	If $t^* < t(\alpha; n - 1)$, conclude H_a

$$t^* = \frac{\bar{Y} - \mu_0}{s\{\bar{Y}\}}$$

where μ_0 is the mean distance vehicles stop from the through roadway before a treatment is implemented, μ_a is the mean distance vehicles stop from the through roadway after the R1-5C “STOP AT LINE” sign was installed. The variable t^* is the sample Tukey’s statistic, n is sample size, α is the user-chosen risk of making a Type 1 error (rejecting the null hypothesis when it is true), \bar{Y} is the sample mean and $s\{\bar{Y}\}$ is the variance of the sample mean. A value of $\alpha = 0.05$ representing a 95 percent level of confidence is used in this study.

The effects of other variables that might affect vehicle positioning will be controlled for by collecting data on those variables and accounting for those variables in the data analysis (e.g. variables such as nighttime, daytime, type of vehicle, etc.).

Chapter 6

SITE SELECTION AND DATA COLLECTION

Site Selection

Two sites in Nebraska were selected for this study to assess the impact of the R1-5C “STOP AT LINE” sign: Site 1, the ORTL intersection of 148th Street and Hwy N-2 and the SRTL intersection of Hwy 77 and the East Junction of Hwy N-41. Both intersections are similar in geometric design features except for right-turn lane geometry and traffic volumes, which reduced confounding factors. Other ORTL intersections were available in Nebraska but were rejected for a variety of reasons. Specifically, the intersection of Hwy 2 and 66th St. in Lincoln, the intersection of Hwy 6 and Amberly Road in Waverly, and the intersection of 56th and Saltillo Road in Lincoln were considered and rejected. The intersection of Hwy 2 and 66th St. was not selected for this study because of low traffic volume and location near signalized intersections that would result in through traffic arriving in platoons rather than random arrivals. The intersections at Hwy 6 and Amberly Road and 56th St. and Saltillo Road were rejected because the study requirements conflicted with MUTCD safety requirements. The conflict was that the available geometry did not allow clear sight triangles for minor approach traffic when vehicles were present in the ORTL. To gain clear ISD when vehicles were present in the ORTL, drivers needed to stop closer than 6 ft to the through roadway near edge. This violated the requirements outlined in the MUTCD (20), according to which a stop bar shall not be placed closer than 4 ft from the edge of the intersecting travelled way. Aerial photographs of the study intersections are presented in FIGURE 29.



Site 1 Intersection, 148th Street and Hwy N-2



Site 8 Intersection, Hwy 77 and East Junction with Hwy N-41

FIGURE 29 Aerial Views of Sites 1 and 8

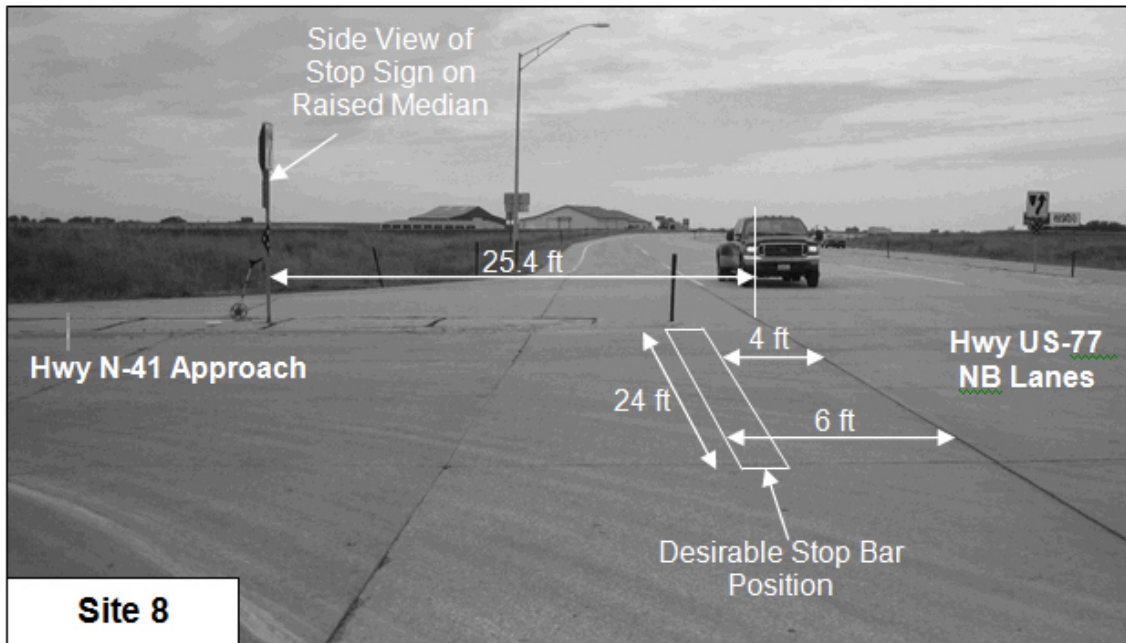
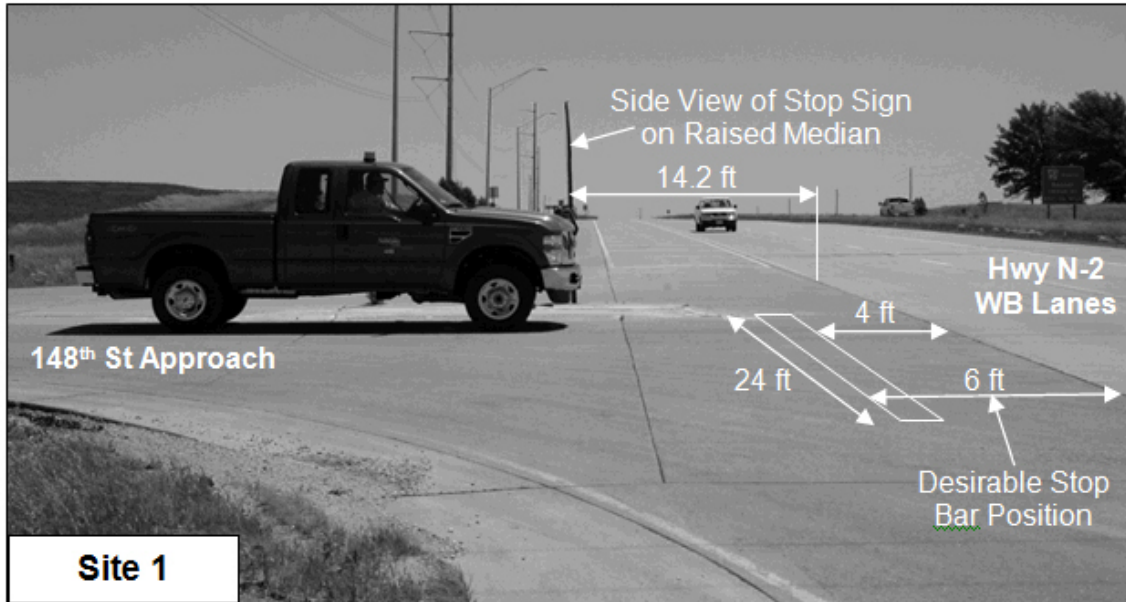

FIGURE 30 Painted Stop Bar at Desirable Location for Optimal Intersection Sight Distance for Stopped Driver at Sites 1 and 8

Sample Size

The Manual of Transportation Engineering (28) provides an equation to estimate the sample size required to obtain a given accuracy to a specified confidence and margin of error shown below.

$$N = \left(\frac{SK}{E} \right)^2$$

where N is the calculated sample size, S is the estimated standard deviation, K is the corresponding constant applicable to the level of confidence for the study and E is the allowable error in the estimation of the sample mean.

To estimate the sample size for this study, an allowable error (E) of 0.5 ft was used along with a K value of 1.96 representing a 95 percent confidence level. For an estimated standard deviation a value of 5.0 ft was used in the sample size calculations which was calculated from the preliminary light/dark study of Site 1. The calculated minimum sample size was 384 observations.

Recording of Vehicle Stopping Position

The method to record the vehicle stopping position involved noting two stopping positions for each minor approach vehicle, the first being the point at which the vehicle first comes to a stop and the second being the final position of the vehicle before visible acceleration into the intersection could be seen. This method accounts for drivers that stop and then creep forward to obtain a better view of the roadway before entering and is similar to the method described in NCHRP Report 383 (29). The second stopping point was assumed as the location where the driver decided that it was safe to execute the desired turning or through maneuver. Vehicles that did not stop had no stopping point recorded for them. This resulted in the exclusion of rolling stops from the collected data, similar to the study described in NCHRP Report 383 (29). The stopping point for each vehicle was defined as the location that coincided with the front edge of the front bumper of a stopped vehicle. A stop was defined in the same manner as described in the Stopping Guidance section of the literature review in Chapter 3.

Two methods were considered to measure the minor approach vehicle stopping distance from the near edge of the through lane. The first method involved the overlay of a clear sheet of plastic with a marked scale based on field measurements onto a computer monitor displaying a stopped vehicle. This overlay with scale allowed a user to approximate the stopping distances of the vehicles by video inspection. The second method considered was to use Autoscope software (30) to determine stopping positions. This involved setting up a grid within the software based on field measured distances. After the grid was calibrated, the software provided a set of grid coordinates from which distances could be calculated (30). These calculated distances provided the stopping position of the vehicles on the stop-controlled minor approach.

The method using the Autoscope software was chosen for this study because the video quality was not sufficient to accurately measure half-foot increments using the first method. However, the video quality was sufficient for Autoscope to calculate vehicle positioning. During the study, Autoscope would not always detect vehicles that stopped on the minor approach. This issue may have been caused by sun glare in the camera lens, windy conditions, or an unknown issue with the software.

Study Periods

Data was collected at each study site for a minimum of one twelve-hour period during which morning, noon and evening peak traffic information was gathered. A modification was then made to each intersection (i.e. the R1-5C sign was added to the intersection). The study provided a minimum period of one week for drivers to familiarize themselves with the change in intersection control. This precedent was set in previous Before-After studies (10, 16). To record the information, a Digital Video Recorder (DVR) was used with a minimum capacity of 50

hours. This DVR had the capability for a time stamp. This was important because the videos needed to be synchronized for the review of data.

The data collection effort was divided into three periods: Before, After, and Extended periods with a waiting period between each period. The Before period consisted of five days (Monday-Friday) of data collection. The R1-5C sign was then installed and a seven-day period was allowed to lapse before data for the After period was collected; again using five days (Monday-Friday). The Extended study period began four weeks after installation of the R1-5C sign. Data was collected in the Extended period as in the two other periods.

Equipment

Data collection at each intersection required two cameras to record video. One camera recorded the vehicle stopping positions of the two-way stop-controlled minor-road approach traffic while the other camera recorded traffic on the major approaches of the intersection. Video from this camera (after processing) provided gap time, vehicle speeds, and traffic turning counts for analysis.

The cameras were mounted on light poles to record video from an elevated position. Mounting of cameras atop the light poles reduced any effects on driver behavior compared to ground-based cameras. Cooperation from the relevant roadway jurisdictions was needed to mount the cameras at the two study sites. This process is described later in this section.

A twelve-hour period was chosen to observe the morning, noon, and evening peak traffic and to insure that sufficient (384 or more) observations were collected for data analysis. This twelve-hour period consisted of the hours between 6:00 am and 6:00 pm. A DVR for the cameras and a portable video display were needed to record the video information. A monitor with video inputs was used for the video display in the field. A direct current to alternating current inverter in conjunction with a surge protector was used to transfer power from the batteries to the recording equipment. A waterproof container was needed to safeguard the recording equipment, which was chained to the light pole to prevent theft. Marine deep-cycle batteries were used to power the recording apparatus. Tests showed that the batteries provided sufficient power for the apparatus to record video for approximately 18 hours continuously. These tests occurred in a climate-controlled environment instead of in-field conditions. Cold and hot field recording conditions along with aging batteries caused the apparatus to operate at a lower efficiency and record less than the desired 12 hours on some occasions. Appendix 1 includes a list of all recording events, details of the battery and camera specifications, and a description of the recording apparatus assembly process. Field-testing of the apparatus indicated the need for four batteries: two for fieldwork and two spares for unforeseen circumstances.

This study required cooperation with NDOR Traffic Division and state district personnel for the relocation and/or repainting of stop bars and the installation of the R1-5C sign. It also required the usage of a vehicle to transport personnel and materials to the study site. Daily trips were required to replace the discharged battery with one that was charged and to ensure that the recording equipment was functioning properly.

FIGURE 31 shows the field equipment assembly with the cameras mounted on the light pole and monitoring equipment on the ground.



FIGURE 31 Field Assembly at Site 1 During Installation

Spreadsheet Formatting

A computer software spreadsheet was developed for the collected data using the Autoscope detector output files and Microsoft Excel 2007. The Autoscope output was gathered using the software data collection program found within the Autoscope software package. This program collected data either during live video feed or while a recording was played back through a DVR. The data collector compiled information into a text file that was later converted into an Excel spreadsheet.

This spreadsheet provided information related to the various sensors that were in the Autoscope detector file including sensor activation and deactivation times. The speed detectors, in addition to activation and deactivation times, provided speeds for both when a vehicle activated a sensor and when the vehicle left the sensor zone.

Information derived from activation and deactivation events was manually entered into another spreadsheet. This second spreadsheet contained information such as vehicle arrival and departure time, duration of stop, average through lane vehicle speed, and ORTL vehicle presence information. Time of day, vehicle type and stop distance were calculated by reviewing the synchronized video. All of this information was recorded and coded into variables that were later used in the analysis.

Variables Collected

The variables previously displayed in TABLE 7 were an effort to list as many variables that could possibly have an effect on the distance that drivers stop from the near edge of the through roadway. Only a subset of the variables shown in TABLE 7 were collected, which are described below in TABLE 9.

TABLE 9 List of Independent Variables Collected

Driver Positioning	Stopping Distance, ft = perpendicular distance from near edge of major-road through-traffic lane to front bumper of stopped vehicle
Traffic Characteristics	Average Through Lane Speed, mph = Numerical average of speeds of vehicles that pass through the main approach section of the intersection while a vehicle is stopped at the minor approach. Only speeds between 45 and 85 mph were considered Stop Duration, sec = time minor road vehicle was stopped waiting for acceptable gap ORTL Vehicle Presence = Indication if any vehicles used the ORTL while a vehicle was stopped on the minor approach
Vehicle Types	Total ORTL Vehicle Count = number of vehicles of a particular type that passed through the ORTL while a vehicle was stopped on the minor approach ORTL Type 1 Vehicle = PC or Minivan ORTL Type 2 Vehicle = Pickup, Full-Size SUV, or Van ORTL Type 3 Vehicle = Semi, RV, or Bus ORTL Type 4 Vehicle = Motorcycle Minor Rd Type 1 Vehicle = PC or Minivan Minor Rd Type 2 Vehicle = Pickup, Full-size SUV, or Van Minor Rd Type 3 Vehicle = Semi, RV, or Bus Minor Rd Type 4 Vehicle = Motorcycle
Day of the Week	Monday Tuesday Wednesday Thursday Friday
Light Conditions	Daylight Dusk Night (roadside lighting on) Dawn
Environmental Conditions	Dry Wet
Study Periods	Before “STOP AT LINE” sign added After “STOP AT LINE” sign added Extended

Stopping Distance from the Through Lane

This was the primary variable of interest in the study and the dependent variable in the data analysis. This variable was the calculated distance obtained from the grid coordinates from Autoscope. For example a particular data point, say 15.89 ft, implies that a vehicles’ final stopping point was 15.89 ft from the near edge of the through roadway. In subsequent analysis this variable is labeled as STDTL.

Study Period

This variable represents the data collection time period: Before, After, and Extended. When this variable is coded for study it is broken down into three dummy (indicator) variables – one each for the three study periods and labeled Before, After, and Extended. For each variable, a value of 1 indicates that the observation was collected in that period; 0 otherwise (e.g. a value of 0 for the Before variable implies that it was collected either in the After or Extended period). In subsequent analysis, the labels for these three dummy variables are BS, AS and ES for the Before, After, and Extended periods, respectively.

Day of the Week

This variable has five possible responses: Monday, Tuesday, Wednesday, Thursday, and Friday. This variable is divided into five dummy variables, one for each day. A code of a 1 for any day implies the observation was collected on that day; 0 otherwise.

Weather Conditions

A rainy condition was the only weather condition taken into account in this study. This variable took the form of a dummy variable; a value of 1 indicating rainy conditions and 0 otherwise. This variable is labeled WC in subsequent analysis.

Light Conditions

This variable pertains to light condition at the time of data collection. It was divided into four dummy variables: Dawn, Daylight, Dusk, and Nighttime (roadside lighting on). The dawn period began when the roadside lighting shut off and ended when solar glare from the rising sun could no longer be seen in the camera. The daylight period started when no solar glare could be seen in the camera and ended when glare from the setting sun could be seen in the camera in the evening. The dusk period began when the setting sun provided glare in the camera and ended when the streetlights turned on, which was considered the start of the nighttime (lighted) period. These dummy variables were coded in a similar manner to the previous variables. That is, when a data point was collected, say during daylight, the value of daylight variable would be 1 and 0 for the other dummy variables. In subsequent analysis these four dummy variables are labeled Dwn, Dylght, Dsk, and Ngghtm.

Minor Approach Vehicle Type

This variable was divided into four dummy variables: Type 1, Type 2, Type 3, and Type 4. Passenger cars and minivans were defined as Type 1 vehicles. Type 2 vehicles were defined as pickups, full size SUVs, and vans while Type 3 vehicles were defined as semi tractor trailers, recreational vehicles (RVs), and busses. Type 4 vehicles were motorcycles. These dummy variables were coded in a similar manner as the previous dummy variables and are labeled MVT1, MVT2, MVT3, and MVT4 in subsequent analysis.

Stop Duration

This variable was defined as the time (in seconds) when a vehicle first stopped until it entered the through roadway. Time was noted when a vehicle stopped on the minor approach and again when it departed by entering the through roadway. The difference between these two periods was the stop duration. For example, if a vehicle came to a stop on the minor approach at 9:15:45 AM and the same vehicle then left its final stopping position to enter the through roadway at 9:16:38

AM, then a value of 53 seconds was noted as the stop duration. This information was recorded automatically by Autoscope and a calculation was performed in Excel to find the stop duration time. This variable is labeled SD in subsequent analysis.

Major Approach Vehicle Speed

Autoscope software was used to gather an average speed of vehicles on the major approach while a vehicle was stopped on the minor approach. The major approach vehicle speed was calculated as the arithmetic mean of the speeds of vehicles passing on the major approach while a vehicle on the minor approach was stopped. For example, four vehicles pass on the major approach while a vehicle is stopped on the minor approach. Their recorded speeds were: 60, 65, 60, 65 mph. This would give a major approach vehicle speed of 62.5 mph. This variable is labeled MAVS in subsequent analysis.

ORTL Present

This variable was used to indicate the presence of a vehicle in the ORTL when a vehicle was stopped on the minor approach. This variable was coded as a 1 if one or more vehicles were present in the ORTL while a vehicle was stopped on the minor approach; conversely it was coded 0 if no vehicles were present in the ORTL. This variable is labeled ORTLVP in subsequent analysis.

ORTL Vehicle Count

This variable is the total count of vehicles present in the ORTL (including those that traversed the ORTL) while a vehicle was stopped on the minor approach and was labeled as ORTLVC.

ORTL Vehicle Type Count

This variable is the count of different types of vehicles present in the ORTL (including those that traversed the ORTL) while a vehicle was stopped on the minor approach. Since four different types of vehicles were taken into consideration, there are four variables that represent the counts of Type 1, Type 2, Type 3 and Type 4 vehicles. They are labeled as ORTLVC1, ORTLVC2, ORTLVC3, and ORTLVC4, respectively.

Chapter 7 ANALYSIS AND RESULTS

The collected data was analyzed to assess the change in vehicle positioning relative to the near through lane edge after installation of the R1-5C sign. The data collected before installation of the R1-5C sign (Before period) served as a control for assessing changes in vehicle positioning.

Analysis Method

The study utilized simple t-tests and linear regression to compare vehicle positioning during the three periods. Use of analysis of variance (ANOVA) was precluded by the presence of one continuous independent variable and due to the relatively large number of independent variables, which makes it difficult to separate interaction effects between the independent variables.

The dependent variable in this analysis was the stopping distance from the through lane (STDTL), which was the distance between the near edge of the through roadway and the front bumper of a vehicle stopped on the minor approach. Other distances of interest such as from bumper to stop bar or from bumper to the stop sign are easily considered but were not included in this study because any reduction in stopping distance to the through roadway from the treatment will be the same when the stopping position is related to the position of the stop bar or sign.

Simple t-tests were first used to compare the mean values of STDTL during the three data collection period. Specifically, any differences in means between the Before and After periods, the Before and Extended period, and the After and Extended period were investigated for the two study sites. This method of testing is rather simplistic, as it does not account for any factors that may have changed besides the installation of the R1-5C sign during the three time periods. To overcome this naiveté, the data needs to be analyzed to control for as many variables as collected that might impact STDTL. This was achieved by performing a multiple linear regression.

Multiple linear regression was used to create a linear equation that predicts the value of a dependent variable based on known values of a collection of independent variables (31). The regression provides coefficients for each independent variable used in the linear equation that represent the change in the dependent variable due to a unit change in the independent variable. The independent variables can be a mix of nominal, interval, ordinal, or ratio variables. Below is a generalized linear regression equation.

$$y = \beta_0 + \beta_1x_1 + \dots + \beta_nx_n + e_i$$

The quantity y represents a predicted value gained from entering known data into the equation. Each β value is a coefficient that when multiplied by the corresponding independent variable value provides the magnitude of change in y . β_0 is a coefficient that represents the intercept of y . β_1 is a coefficient that represents the change in value of y based on the presence of the first independent variable and x_1 represents the value of the first variable. β_n is a coefficient that represents the change in value of y based on the presence of the n^{th} independent variable and x_n represents the value of the n^{th} independent variable. The value e_i is an error term that captures all other factors which influence the dependent variable y other than the regressors, x_i (32).

Linear regression models are estimated using the method of least squares (32).

When estimating a linear regression model, it is useful to know how well the regression line fits the data. This is accomplished by obtaining the R^2 value (called the coefficient of determination) for the regression model. The R^2 value is a measure of the proportional reduction of total variation associated with the use of the independent variables. The range of R^2 is between 0 and 1; values closer to 0 indicate a poor fit while values closer to 1 indicate an excellent fit.

In the linear regression model estimation, independent variables are tested for statistical significance using the Tukey's t-test. In this research, a confidence value of 95 percent was used implying an α value of 0.05. During model building if an independent variable is found to be statistically significant it was retained in model specification, conversely if an independent variable was found not to be statistically significant it was removed from the model specification.

Certain assumptions are made when linear regression is used to establish a relationship between a dependent variable and a set of independent variables; these are the assumptions of linearity, homoscedasticity, independence, and normality. The linearity assumption implies that the relationship between the dependent variable and the set of independent variables is linear. The homoscedasticity assumption is that the errors or observed instances of divergence from the predicted values have the same variance. The independence assumption is that the errors are independent of each other. Normality is the assumption that the errors are normally distributed (32). These assumptions were tested after model estimation with diagnostic routines available in the statistical software package used for analysis.

Software Used

Statistical Package for Social Sciences (SPSS), Version 17.0 was used for linear regression while Microsoft Excel 2007 was used to organize the variables.

In SPSS, independent variables were entered into a linear regression model specification (with STDTL as the dependent variable) and checked for statistical significance. The SPSS software package then output relevant linear regression statistics such as R^2 , and t-test values. The SPSS output also included coefficient, and coefficient standard variation values for each significant independent variable.

The Enter method, used in the model estimation, involved automatically adding and removing variables from the regression model by SPSS. In this method, a variable added is tested for significance and it is removed if found to not have a statistically significant effect on the dependent variable. If a variable is found to have a statistically significant effect on the dependent variable it is retained in the regression model (32).

Results

All of the collected independent variables were investigated to discern their effects on the dependent variable. The following sections describe the analysis of the data collected at the two study sites. Descriptive statistics are presented before model estimation results are discussed for data collected at each site.

Site 1: 148th Street and Hwy N-2 Results and Descriptive Statistics

TABLE 10 displays the descriptive statistics for the data collected at Site 1 intersection. It displays the information for 3 categories: the Before, After, and Extended periods separately as well as statistics for the dependent and independent variables. These values include the number

of observations, the minimum, maximum, and mean values for stopping distance, the standard deviation, and sample size.

TABLE 10 Site 1, 148th Street and Hwy N-2 Descriptive Statistics Related to Stop Distance

Study Period	Number of Observations	Minimum	Maximum	Mean	Standard Deviation
Before	1059	0	40.3	16.2	6.5
After	732	1.5	37.8	16.4	6.7
Extended	916	0.9	37.3	15.4	6.2

Results of the simple t-tests comparing the means of STDTL during the three periods are shown in TABLE 11. Upon examination of the t-test results it can be observed that mean STDTL decreased by 0.8 ft between the Before and Extended periods. The t-statistic for the Before versus Extended test is greater than the critical t-value of 1.96 thus the inference can be made that installation of the R1-5C sign had an effect on STDTL after it had been in place for 28 days. This however does not appear to be the case for the After period. This is because the t-statistic is less than the critical t-value for the Before versus After test. More than the required 384 observations were used in the analysis because the data was available and it made the study more robust. All of these inferences were further tested statistically for validity with multiple linear regressions.

TABLE 11 Site 1, 148th and Hwy N-2 t-test Results

Study Period	Number of Observations	Mean SDFTL	t-statistic	df	Standard Deviation
Before vs After	1057 vs 734	16.2 vs 16.4	0.63	1789	6.5 vs 6.7
Before vs Extended	1057 vs 916	16.2 vs 15.4	-2.74	1971	6.5 vs 6.2
After vs Extended	734 vs 916	16.4 vs 15.4	-3.10	1648	6.7 vs 6.2

TABLE 12 presents the estimated model for STDTL based on data collected at the Hwy N-2 and 148th St. intersection. The entirety of the output is displayed in Appendix 2.

TABLE 12 Linear Regression Results for Site 1, 148th Street and Hwy N-2

Model 1	Coefficients ^a		t Statistic	α-Value (significance)
	Regression Coefficients	Standard Error		
(Constant)	17.12	0.24	68.76	0.000
Extended vs Before and After (ES)	-0.80	0.26	-3.06	0.002
Minor Vehicle Type 1 (MVT1)	-0.87	0.28	-3.12	0.002
Minor Vehicle Type 3 (MVT3)	0.80	0.34	2.39	0.017
Stop Duration (SD)	-0.04	0.01	-4.04	0.000
ORTL Vehicle Present (ORTLVP)	-0.70	0.31	-2.25	0.025

^aDependent Variable: Stop Distance from Through Lane, STDTL, ft

The R² value for the model was 0.02, which indicates that the model is not a good fit to the data. The f statistic for the regression is 11.7, which is greater than the critical value of 2.2 (both values provided from Appendix 3). The linear regression output in TABLE 11 shows the estimated intercept and estimated coefficients for each independent variable in the model accompanied by their respective t-statistics. The estimated coefficients can be tested similar to the hypothesis testing shown in TABLE 8 to statistically determine if they are different than 0 by comparing their respective t-statistics to the critical t-value at 95 percent confidence (1.96). An absolute value of t-statistic greater than 1.96 is indicative of statistical significance at the 95 percent confidence level. All of the independent variables in the estimated model are statistically significant. The estimated regression equation for STDTL is:

$$STDTL = 17.12 - 0.80 * ES - 0.87 * MVT1 + 0.80 * MVT3 - 0.04 * SD - 0.70 * ORTLVP$$

The estimated model shows that there was a statistically significant change in drivers' stopping distance during the Extended period compared to the Before and After periods. According to the estimated coefficient in the model, drivers stopped 0.80 ft closer to the through lane during the Extended period compared to the Before and After periods. While this is a statistically significant change, functionally it is not very useful as this decrease in distance from the through roadway does not provide a meaningful increase in ISD.

The type of minor approach vehicle had a statistically significant effect on STDTL. The estimated model shows Minor Vehicle Type 1 (passenger car or minivan) stopped 0.87 ft closer to the edge of the through roadway than other types of vehicles. Minor vehicle Type 3 (commercial or semi truck) had a positive estimated coefficient, which implies that these vehicles stopped 0.80 ft further away from the through roadway compared to other types of vehicles.

The estimated model indicated that the time spent by a vehicle stopped on the minor approach was statistically significant. The estimated coefficient of -0.04 indicates that as time passed vehicles stopped on the minor approach moved closer to the edge of the through roadway.

A significant difference was found between stopping distance when a vehicle was present in the ORTL compared to no vehicle in the ORTL. On average, drivers stopped 0.70 ft closer to the through lane when a vehicle was present in the ORTL. While this difference is not large, it shows that drivers moved closer to the through roadway when a vehicle was present in the ORTL.

Several other independent variables were tried in the model specification but were found to be statistically insignificant. These included through roadway speed, ORTL vehicle type, day of the week, light conditions, and rainy conditions. Through roadway speed was shown not to have a significant effect on stopping distance. This means that no evidence was found that the stopping distance is dependent on how fast cross traffic is moving. The ORTL vehicle type was found not to have a significant effect on distance from the through roadway at which a vehicle stops. That means that evidence was not found that shows that the type of vehicle in the ORTL is important. Evidence was not found to show that the day on which the data was collected had a significant effect upon stopping distance. Evidence was not found to show that light conditions had a significant effect on stopping distance. This means that data gathered during the day will not differ significantly from data gathered during the night which was indicated in the preliminary study at Site 1. There was no difference found in stopping distance between dry and rainy conditions.

Linear regression assumptions for the model estimated for Site 1 were checked. These included the assumptions of linearity, homoscedasticity, independence of errors, and normality of errors. Each assumption check is described in the next sections.

Linearity

The assumption that the relationship between the dependent variable and the set of independent variables is linear can be satisfied by a lack of fitness test. This test determines if a linear or higher power regression is needed to describe the relationship between the dependent variable and the set of independent variables. SPSS provides a routine based on the null hypothesis that a linear trend line accurately describes the relationship. The alternate hypothesis is that a linear trend line does not accurately describe the relationship.

The test reported a Fisher's F-statistic of 1.075, which is less than the critical value of 1.114 needed for 95 percent confidence level. Thus, the null hypothesis is not rejected and the linearity assumption is assumed satisfied.

Homoscedasticity

Homoscedasticity is also referred to as homogeneity of variance of the errors or residuals in the regression model. To check this assumption, an investigation of the spread of values on a chart are compared to the average residual. To satisfy the assumption there must be a homogeneous spread of points on both sides of the average residual line. FIGURE 32 displays residuals versus predicted values. It shows that the data points are fairly equally spread about the horizontal line along the average residual line of zero. As such, it appears that the estimated model does not suffer from heteroscedasticity.

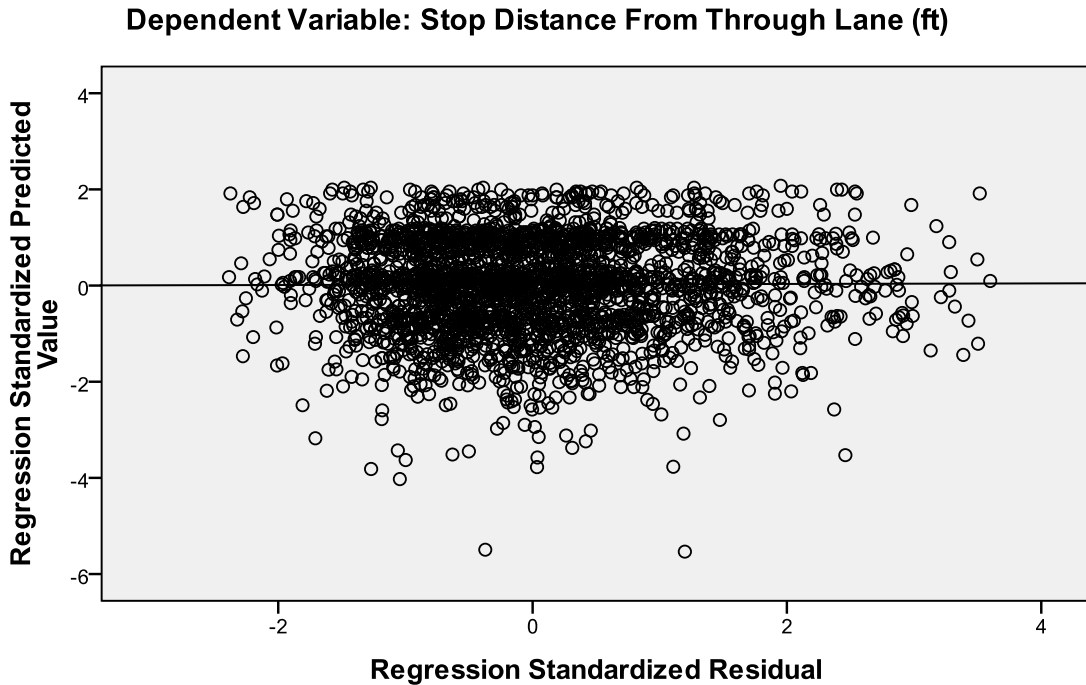

FIGURE 32 Homogeneity of Errors Test for Site 1

Independence of Errors

The independence of errors assumption requires that the errors do not display any serial correlation. This is checked by the Durbin-Watson test statistic, which yields a value of 2.0 when no serial correlation is present. Values greater than 2.0 indicate presence of serial correlation. The null hypothesis for this test is that the errors are independent. The alternative hypothesis is that the errors are not independent and are serially correlated. Generally, errors are considered independent if the Durbin-Watson statistic is within the range of 1.5-2.5. The Durbin-Watson test for the model estimated for Site 1 was 1.891 which indicates that the errors in the estimated model can be considered independent.

Normality of Errors

The Normality of Errors assumption requires that the errors in a regression model be normally distributed. As part of linear regression, SPSS can perform two normality tests. The first is the Kolmogorov-Smirnov and the other is the Shapiro-Wilk test. For both tests, the null hypothesis is that the errors are normally distributed and the alternate hypothesis is that the errors are not normally distributed. TABLE 13 displays the results of these two tests for the model estimated for Site 1.

TABLE 13 Normality of Errors Test for Site 1, 148th Street and Hwy N-2

	Kolmogorov-Smirnov			Shapiro-Wilk		
	Statistic	df	Sig.	Statistic	df	Sig.
Studentized Residual	0.053	2707	0.000	0.975	2707	0.000

The results for both tests imply a rejection of the null hypothesis in favor of the alternate, i.e. the errors are not normally distributed. This results when the data has excessive skew or kurtosis (32). These two issues can be detected by examining a normality probability plot. FIGURE 33 provides a normality probability plot for Site 1.

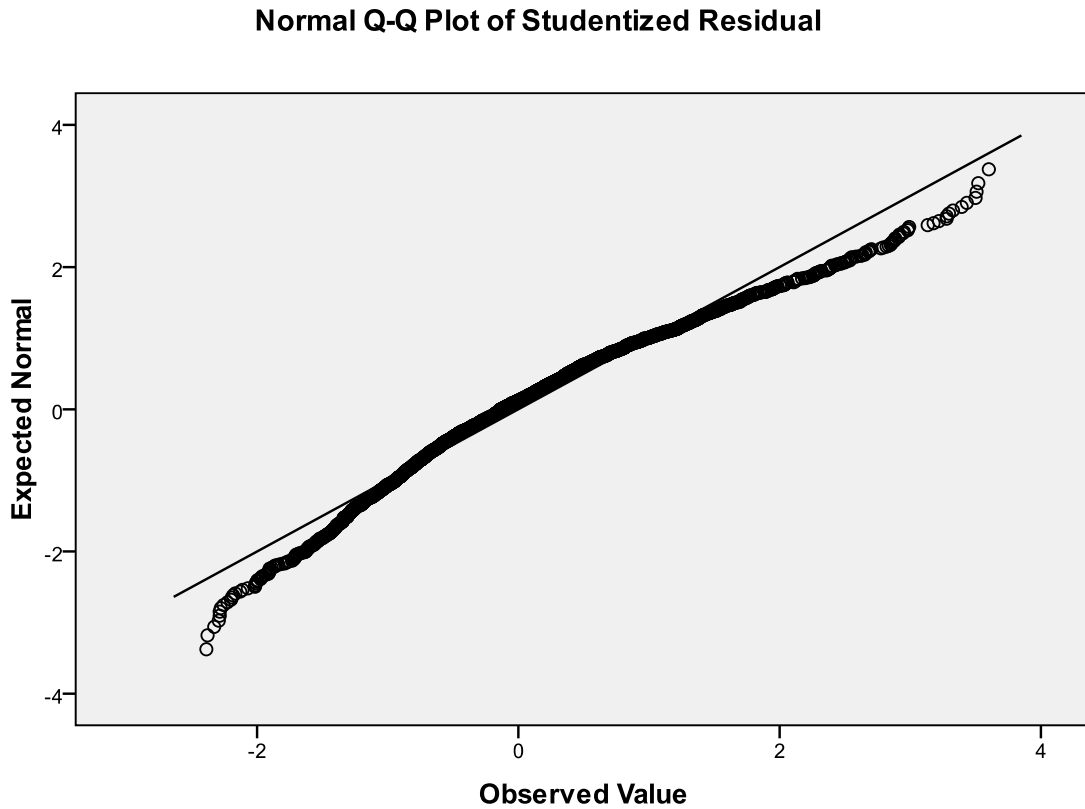

FIGURE 33 Normality of Errors Graph for Site 1, 148th Street and Hwy N-2

To be considered normal, the error values must fall along the diagonal line in FIGURE 323. When the plotted values form a bow shaped line, the data exhibits excessive skew. When the data forms an S shape, the data shows excessive kurtosis (32). Skew occurs when the errors are too large and numerous in one direction, or one tail of the probability distribution is too large. Kurtosis occurs when both tails of the probability distribution are too large, or when the errors are too large and numerous in both directions (32).

In FIGURE 33 the plotted values form a slightly S shape. This means that the data suffers from kurtosis. A remedy to this issue is to remove outliers to reduce the size and number of errors occurring at the tails of the normality distribution. TABLE 14 and FIGURE 34 display the Shapiro-Wilk test and normality of errors plot with outliers beyond 2 standard deviations removed. The outliers that were identified to lie outside of 2 standard deviations are presented in Appendix 2. Note that this will include the outliers outside of 3 standard deviations as well. Previous to removing outliers beyond 2 standard deviations, outliers for 3 standard deviations were identified and removed. The analysis was re-run with outliers outside 3 standard deviations removed.

TABLE 14 Normality of Errors Test for Site 1, 148th Street and Hwy N-2, Outliers More than Two Standard Deviations Removed

	Kolmogorov-Smirnov			Shapiro-Wilk		
	Statistic	df	Sig.	Statistic	df	Sig.
Studentized Residual	0.046	2539	0.000	0.983	2539	0.000

Normal Q-Q Plot of Studentized Residual

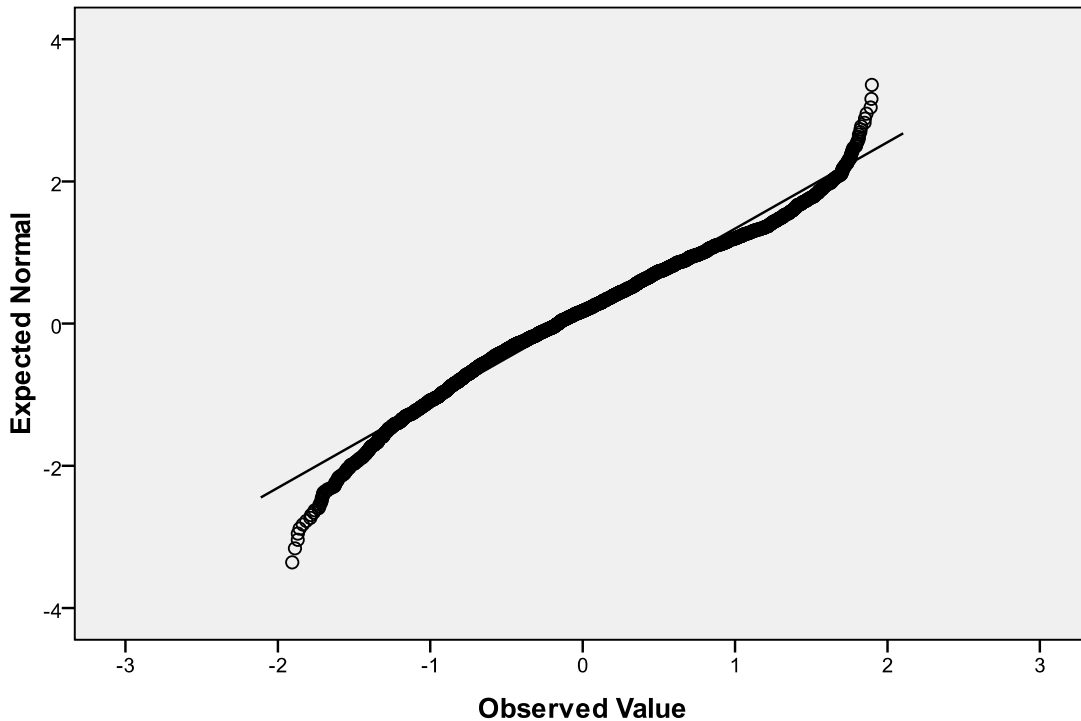

FIGURE 34 Normality of Errors Histogram with Outliers Greater than Two Standard Deviations from the Mean Removed at Site 1, 148th Street and Hwy N-2

It can be seen in TABLE 14 and FIGURE 34 that removing outliers more than 2 standard deviations from the mean did not resolve the issue of normality. Removing outliers outside of 3 standard deviations also did not resolve the normality issue. The scale FIGURES 33 and 34 chart are different. This accounts for the misleading apparent increase in divergence from the normal line. A possible reason that errors are not normally distributed may be that either the dependent or one of the independent variables is not normally distributed. The dependent variable and stop duration independent variables were found not to be normally distributed. This issue can sometimes be resolved by applying a transformation to the data. Several transformations including square root, log, and inverse were tested but attempts to make the data conform to a normal distribution failed. The results of these transformations are presented in Appendix 3.

Since the errors are not normally distributed for the estimated model, the results from multiple linear regression are suspect as it relies on data to be normally distributed to obtain dependable confidence intervals and perform meaningful t-tests. Since the errors are not normally distributed, the confidence intervals could be too large or too small. Hypothesis testing based on the t-tests regarding significance of independent variables is suspect. Another possible cause for the errors not being normally distributed is that there is some unknown independent variable that would assist in the prediction STDTL. If this variable was determined and studied it might resolve the normality of errors issue.

Site 8: Hwy US-77 and East Junction Hwy N-41 Descriptive Statistics

TABLE 15 displays the descriptive statistics for the study at Site 8. The values displayed are the descriptive statistics for the stopping distance dependent variable.

TABLE 15 Site 8, Hwy US-77 and East Junction Hwy N-41 Descriptive Statistics

Study Period	Number of Observations	Minimum	Maximum	Mean	Standard Deviation
Before	430	0.1	43.2	17.5	8.7
After	278	1.1	42.2	17.3	8.3
Extended	187	0.9	37.3	15.4	9.6

TABLE 16 Site 8, Hwy US-77 and East Junction Hwy N-41 t-test Results

Study Period	Number of Observations	Mean SDFTL	t-statistic	df	Standard Deviation
Before vs After	430 vs 254	17.5 vs 17.4	-0.1	682	8.7 vs 8.4
Before vs Extended	430 vs 187	17.5 vs 18.0	0.6	615	8.7 vs 9.6
After vs Extended	254 vs 187	17.4 vs 18.0	0.6	439	8.4 vs 9.6

Upon examination of the simple t-test results it can be observed that the mean stopping distance increased by 0.5 ft between the before and extended study period as shown in TABLE 16. Less than the required 384 observations were used in the analysis because sufficient data was not gathered during the prescribed study periods. The t-statistic for the Before versus Extended test is less than the critical t value of 1.96 thus the inference can be made that the sign had no effect on the driver behavior after it had been in place for 28 days. This also appears to be the case for the 7-day After period once the sign was installed. This is because the t-statistic was less than the critical t value for the Before versus After test. All of these inferences will be further tested statistically for validity with multiple linear regression.

Figure 23 presents the estimated model for stopping position based on data collected at the Hwy 77 and Hwy 41 intersection. The entirety of the output is displayed in Appendix 3.

TABLE 17 Linear Regression Results for Site 8, Hwy US-77 and East Junction Hwy N-41

Model 2	Coefficients ^a		t Statistic	α-Value (significance)
	Regression Coefficients	Standard Error		
(Constant)	18.01	0.49	36.60	0.000
Monday (Mon)	1.53	0.77	1.99	0.047
Minor Vehicle Type 2 (MVT2)	1.89	0.67	2.82	0.005
Stop Duration (SD)	-0.090	0.02	-4.11	0.000

The R² value for the model is 0.04, which indicates that the model is not a good fit to the data. The F statistic for the regression is 11.274, which is greater than the critical value of 2.615 (both values provided from Appendix 3). This means that the regression model is meaningful. The linear regression output shows the estimated intercept and estimated coefficients for each independent variable in the model accompanied by their respective t-statistics. The estimated coefficients can be tested similar to the hypothesis testing shown in TABLE 8 to statistically determine if they are different than 0 by comparing their respective t-statistics to the critical t value at 95 percent confidence (1.96). An absolute value of t-statistic greater than 1.96 is indicative of statistical significance at the 95 percent confidence level. All of the independent variables in the estimated model are statistically significant. The estimated regression equation for STDTL is:

$$STDTL = 18.01 + 1.53 * Mon + 1.89 * MVT2 - 0.09 * SD$$

The estimated model shows that there was no significant difference in drivers' stopping distance between the Before, After, and Extended study periods.

Driver behavior was found to be statistically significantly different on Monday when compared to behavior on Tuesday, Wednesday, Thursday and Friday. This difference was shown in TABLE 17 to be an increase in distance of 1.53 ft.. The type of minor approach vehicle had a statistically significant effect on the dependent variable. Minor Vehicle Type 2 had a positive coefficient. This means if a vehicle was a Pickup or Full-size SUV it is more likely to stop further away from the edge of the through roadway than a vehicle of another type. The estimated model indicated that the time spent by a vehicle stopped on the minor approach had a statistically significant impact on the dependent variable. The estimated coefficient of -0.04 indicates that as time passed vehicles stopped on the minor approach moved closer to the edge of the through roadway.

Several other independent variables were tried in the model specification but were found to be statistically insignificant. These included through major-road speed, ORTL vehicle type, study period, light conditions, and rainy conditions. Through roadway speed was shown not to have a significant effect on stopping distance. This means that no evidence was discovered to show that the stopping distance is dependent on how fast cross traffic is moving. The ORTL vehicle type and ORTL present variables are misnomers at Site 8 since there is no offset on the SRTL. The RTL variable designations were noted as ORTL to simplify the analysis. No data was found to suggest that the ORTL vehicle type has a significant effect on distance from the through way at which a vehicle stops. That means that the data shows that the type of vehicle in the ORTL is not important. No evidence was discovered to suggest that a vehicle being in the

ORTL was important. No evidence was found to suggest that light conditions have a significant effect on stopping distance. There was no difference found in stopping distance between dry and rainy conditions.

Linear regression assumptions for the model estimated for Site 8 were checked. These include a section on the assumption of linearity, homoscedasticity, independence of errors, and normality of errors.

Linearity

The assumption that the data is linear can be satisfied by a lack of fitness test. This test will determine if a linear or higher power regression is needed to describe the behavior of the data. SPSS provides a program that will perform this test. It uses a null hypothesis that a linear trend line will accurately describe the data. The alternate hypothesis is that a linear trend line will not accurately describe the data. If the null hypothesis is not rejected than the assumption of linearity is satisfied. FIGURE 35 displays the results of the linearity check.

The test reported a Fisher's F-statistic of 1.075, which is less than the critical value of 1.207 needed for 95 percent confidence level. Thus, the null hypothesis is not rejected and the linearity assumption is assumed satisfied.

Homoscedasticity

Homoscedasticity is also referred to as homogeneity of variance of the errors or residuals in the regression model. To satisfy the assumption there must be a homogeneous spread of points on both sides of the average residual line. FIGURE 35 displays a graph of residuals versus predicted values. It shows that the data points are fairly equally spread about the horizontal line along the average residual line of zero. As such, it appears that the estimated model does not suffer from heteroscedasticity.

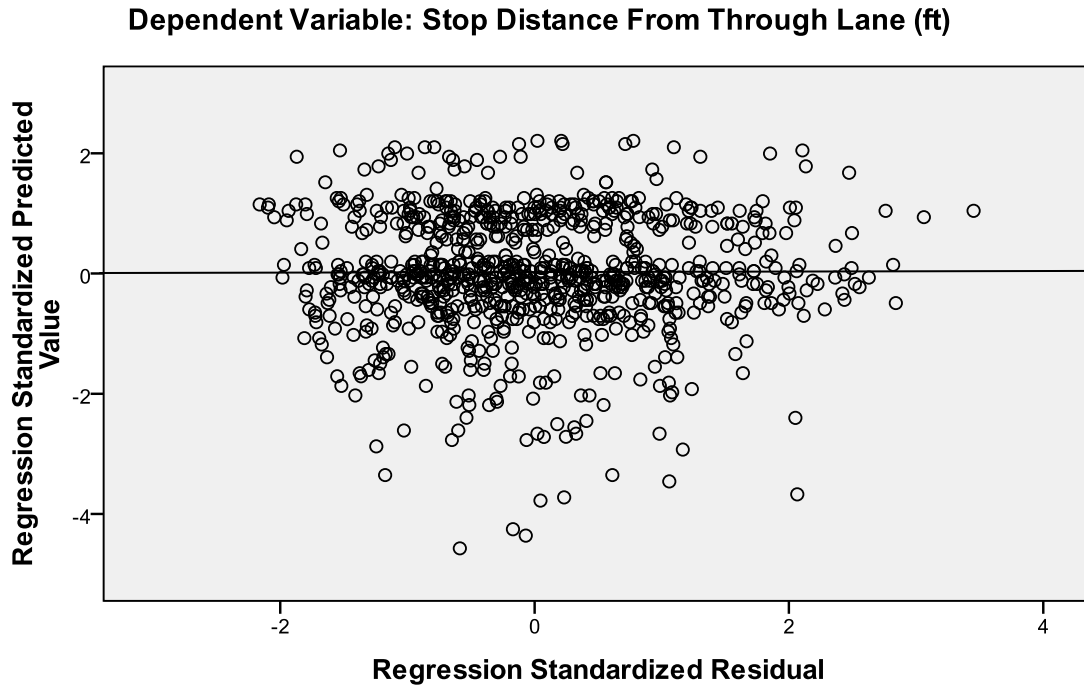

FIGURE 35 Homogeneity of Errors Test for Site 8, Hwy US-77 and East Junction Hwy N-41

Independence of Errors

The independence of errors assumption requires that the errors do not display any serial correlation. This is checked by the Durbin-Watson test statistic, which yields a value of 2.0 when no serial correlation is present and values farther away from 2.0 indicate presence of serial correlation. The null hypothesis for this test is that the errors are independent. The alternative hypothesis is that the errors are not independent and are serially correlated. Generally, errors are considered independent if the Durbin-Watson statistic is within the range of 1.5-2.5. The results of the Durbin-Watson test for the model estimated for Site 8 is 2.10 which indicates that the errors in the estimated model can be considered independent.

Normality of Errors

The Normality of Errors assumption requires that the errors for a study are normally distributed. The Kolmogorov-Smirnov and the Shapiro-Wilk tests check this. For these tests, the null hypothesis is that the errors are normally distributed. The alternate hypothesis is that the errors are not normally distributed. TABLE 18 displays the results of these two tests for the model estimated for Hwy 77 and Hwy 41 site.

TABLE 18 Normality of Errors Test for Site 8, Hwy US-77 and East Junction Hwy N-41

	Kolmogorov-Smirnov			Shapiro-Wilk		
	Statistic	df	Sig.	Statistic	df	Sig.
Studentized Residual	0.044	871	0.000	0.986	871	0.000

The result for both tests is that the null hypothesis is rejected and the conclusion is made that the errors are not normally distributed. This happens when the data has excessive skewness or kurtosis (32). FIGURE 36 provides a normality probability plot for Site 8.

Normal Q-Q Plot of Studentized Residual

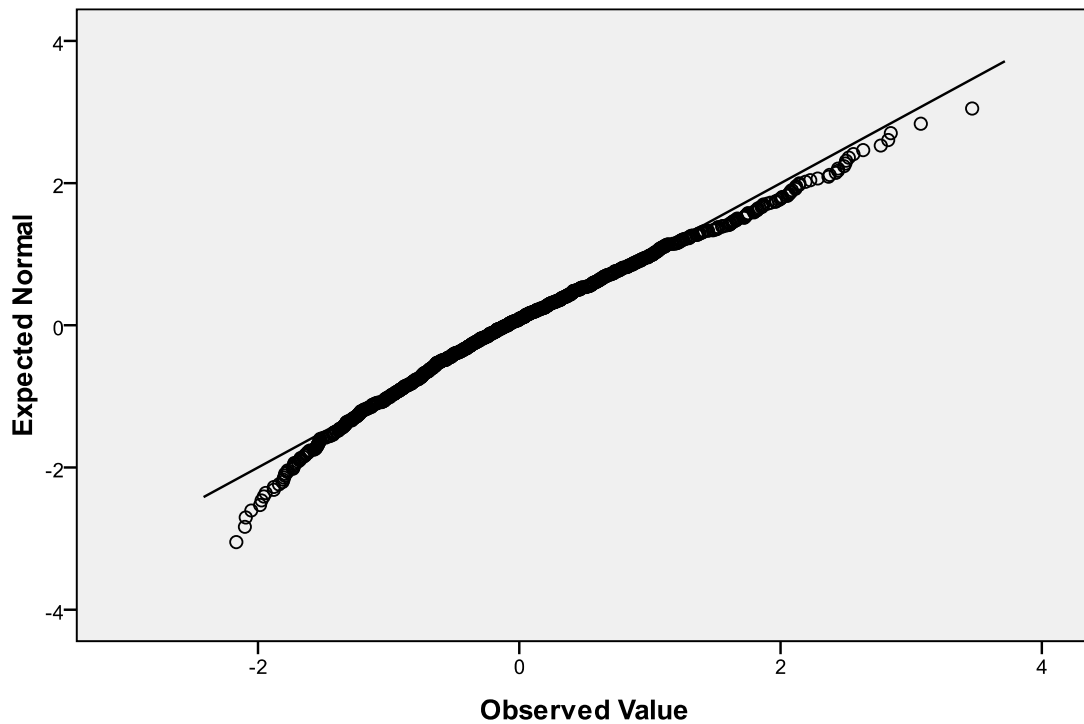

FIGURE 36 Normality of Errors Histogram for Site 8, Hwy US-77 and East Junction Hwy N-41

To be considered normal, the error values must fall along the diagonal line in FIGURE 36. When the plotted values form a bow shaped line, the data exhibits excessive skew. When the data forms an S shape, the data shows excessive kurtosis (32). Skew occurs when the errors are too large and numerous in one direction, or one tail of the probability distribution is too large. Kurtosis occurs when both tails of the probability distribution are too large, or when the errors are too large and numerous in both directions (32).

In FIGURE 36, the plotted values form a slight S shape. This means that the data suffers from kurtosis. A remedy to this issue is to remove outliers to reduce the size and number of

errors occurring at the tails of the normality distribution. TABLE 19 and FIGURE 37 display the Normality of Errors test and plot with outliers beyond 2 standard deviations removed. The outliers that were identified to lie outside of 2 standard deviations are presented in Appendix 3. Note that this will include the outliers outside of 3 standard deviations as well.

TABLE 19 Normality of Errors Test for Site 8, Hwy US-77 and East Junction Hwy N-41 with Outliers Greater than Two Standard Deviations Removed

	Kolmogorov-Smirnov			Shapiro-Wilk		
	Statistic	df	Sig.	Statistic	df	Sig.
Studentized Residual	0.040	827	0.004	0.987	827	0.000

Normal Q-Q Plot of Studentized Residual

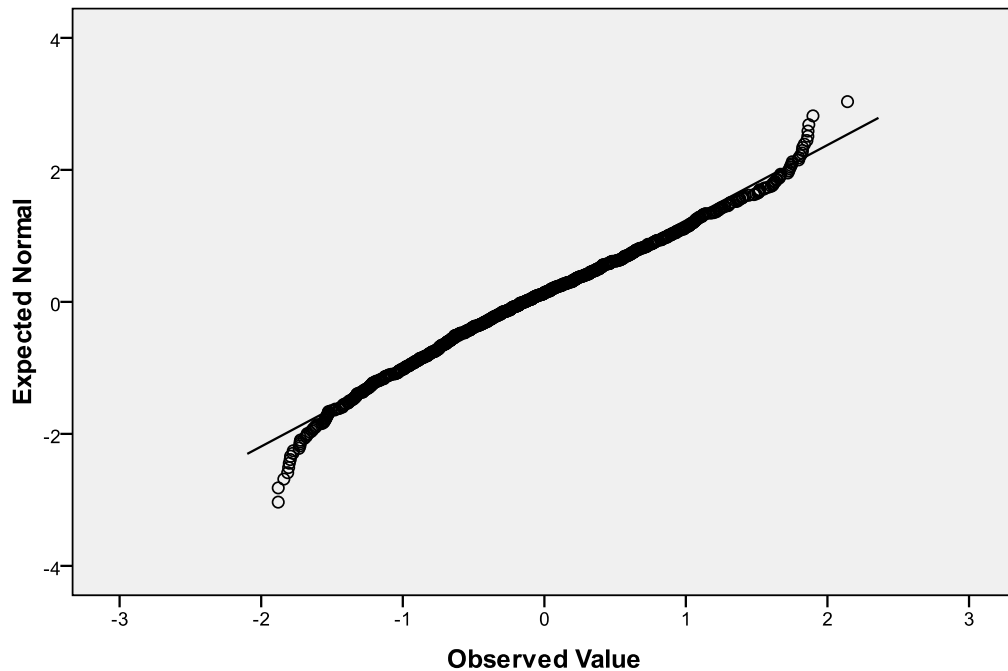

FIGURE 37 Normality of Errors Histogram for Site 8, Hwy US-77 and East Junction Hwy N-41 with Outliers Greater than Two Standard Deviations Removed

It can be seen in TABLE 19 and FIGURE 37 that removing outliers more than 2 or 3 standard deviations out did not resolve the issue of normality. Note also that the scales of FIGURES 36 and 37 are different which accounts for the misleading apparent increase in divergence from the normal line.

Another possible reason that errors are not normally distributed is that either the dependent or one of the independent variables is not normally distributed. The dependent variable and stop duration independent variables were found not to be normally distributed. This

issue can be resolved by applying a transformation to the data. Several transformations including square root, log, and inverse were tested but attempts to make the data conform to a normal distribution failed. The results of these transformations are provided in Appendix 3.

Since the errors are not normally distributed for the estimated model, the results from multiple linear regression are suspect as it relies on data to be normally distributed to obtain dependable confidence intervals and perform meaningful t-tests. Since the errors are not normally distributed, the confidence intervals could be too large or too small. Hypothesis testing based on the t-tests regarding significance of independent variables is suspect. Another possible cause for the errors not being normally distributed is that there is some unknown independent variable that would assist in the prediction STDTL. If this variable was determined and studied it might resolve the normality of errors issue.

Comparison of ORTL and SRTL Behavior

One of the similarities in behavior at the two sites was that vehicles on average stopped well in advance of the provided stop bar. It was shown that the treatment caused a statistically significant decrease in stopping distance from the through approach at ORTL Site 1. At SRTL Site 8 no such difference was shown in the data. This shows that the treatment was generally ignored at the Hwy 77 and Hwy 41 site. One possible explanation for this could be that when a vehicle is in the SRTL, stopping at the bar will not provide the needed sight distance to execute a turn. This would mean that the sight lines would be blocked until the SRTL was clear of vehicles. This might cause drivers to not pull forward since they know their view of upcoming traffic will be blocked until the RTL is clear. Another explanation could be that there was a smaller turning volume onto the minor approach from the major approach. This would leave the SRTL open to provide adequate sight distance from a point further in advance of the stop bar for a greater proportion of the data.

Decreasing the stopping distance at SRTL intersections does not inherently translate into better sight distance. If the ISD is blocked by a vehicle in the SRTL the only two options are to 1) wait until the SRTL is clear or 2) move into the main approach to see around the SRTL. This is likely the reason that no benefit was seen from the treatment at the SRTL study site.

It was shown at both study sites that after a period of one month the treatment had little or no effect. At ORTL Site 1, there was an improvement of 0.8 ft. This improvement was statistically significant however, it is functionally irrelevant. The average stopping distance for the before period was 16.2 ft from the through roadway. The required stopping distance to gain full benefit of the offset was 6 ft from the roadway. This means that the treatment improved the stopping sight distance by less than a tenth of the required distance to gain unobstructed ISD.

Should the treatment be used to improve stopping distance behavior at ORTL type intersections? Since the treatment was only marginally effective, it becomes a question of engineering judgment. The cost of installing a sign at an intersection is relatively inexpensive compared to the cost of a crash or the total cost of a project. This means that even small safety benefits from installing the sign are worth the cost of the installation. If sign clutter is a concern, than the marginal benefit by installing the sign may not be warranted.

Other Important Statistics from the Datasets

TABLE 20 show cumulative stopping distance locations combining all Before, After, and Extended study periods.

TABLE 20 Cumulative Stopping Distance Percentages at Site1 and Site 8 Combining All Before, After and Extended Study Period Data

Vehicle Category WITH or WITHOUT Obstruction in RTL (Site Number)	50 th - Percentile Stopping Distance	85 th - Percentile Stopping Distance	95 th - Percentile Stopping Distance	Sample Size
Non-Trucks WITH Vehicle in ORTL (1)	14.1	21.0	26.7	444
Non-Trucks WITH Vehicle in SRTL (8)	17.8	26.8	35.3	70
Trucks WITH Vehicle in ORTL(1)	14.3	22.2	28.3	150
Trucks WITH Vehicle in SRTL(8)	15.6	25.0	31.4	66
Non-Trucks WITHOUT Vehicle in ORTL (1)	15.2	22.7	27.3	1682
Non-Trucks WITHOUT Vehicle in SRTL(8)	17.2	26.8	32.6	381
Trucks WITHOUT Vehicle in ORTL(1)	16.2	24.8	30.4	428
Trucks WITHOUT Vehicles in SRTL(8)	15.8	26.1	33.7	377
Mean of ALL Vehicles WITH Obstruction	15.5	23.8	30.4	730
Mean of ALL Vehicles WITHOUT Obstruction	16.1	25.1	31.0	2868
Mean of ALL ORTLs WITH Obstruction	14.2	21.6	27.5	594

One key concern of this research is to determine a stopping distance location that will capture a large percentage of drivers to enable the geometric design of an offset-right turn lane to provide drivers with a clear ISD triangle at two-way stop-controlled intersections with right-turn lanes. It appears that a stopping distance of 14 ft would capture 50 percent of those drivers who had vehicles in the ORTL, a distance of 22 ft would capture 85 percent of such drivers and a distance of 28 ft would capture 95 percent.

Chapter 8

DRIVER BEHAVIOR STUDIES OF RIGHT-TURNING AND THROUGH DRIVERS ALONG THE MAJOR ROADWAY OF PARALLEL-TYPE RIGHT-TURN LANES

Right-Turning Driver Speed Choices and Repercussions

Right-turn lanes are designed to decrease the risk of rear-end collisions between vehicles performing a right turn at an intersection and through traffic. This part of the research study was designed to determine the driver behaviors in advance of the ORTL and SRTL right-turn deceleration lanes by comparing and contrasting driver speed choices. The study was performed at Site 1, 148th Street and Hwy N-2 for the ORTL type and Site 8, Hwy US 77 and the East Junction of Hwy N-41 for the SRTL type. It was found that right-turning drivers slow down before entering the right-turn tapers (which develops into the full right-turn lane width) at both sites. Regardless of the right-turn lane type, drivers are inclined to slow before entering the taper potentially causing following through-traffic drivers to slow as well.

Study Method

Driver operating speeds were collected along the right-most through lane of the major road approaches with right-turn lanes using a LIDAR gun operated by a research assistant from a research pick-up truck pulled to the side of the paved shoulder 300 ft in advance of the beginning of the entrance taper of the ORTL and SRTL of both sites. FIGURE 38 shows the position of the research vehicle at Site 1. This location was deemed distant enough to prevent excessive driver behavior interference and positioned appropriately to minimize the angle of incidence of the radar beam with respect to the taillights of the study vehicle.



FIGURE 38 Research Vehicle Positioned to Collect Through and Right-Turn Driver Speeds in Right-most Through Lane of Westbound Hwy N-2 at Site 1

The sample size chosen for this study was based on the total number of vehicle speeds needed to achieve a 1.5 mph margin of error. To determine this number, the following equation (28) was used:

$$N = \frac{S^2 K^2 (2 + U^2)}{2E^2}$$

where,

N = Number of measured speeds,

S = Estimated sample standard deviation, mph (estimated as 7 mph),

K = Constant corresponding to the desired confidence level (1.96 for 95 percent level of confidence),

U = Constant corresponding to the desired percentile speed (1.64 for 95th-percentile speed), and

E = permitted error in the average speed estimate, mph (1.5 mph margin of error).

The estimated number of speeds required for this study was found to be 221 occurrences for both right-turning vehicles and through vehicles in the right-most through lane at each site location. Vehicle speeds classified as “free flow” were those having 5 seconds or more between the study vehicle and a vehicle ahead or behind. Vehicle types of passenger cars (PC), pickups and SUVs (LT), and semi tractor trailers and busses (TB) were logged as speeds were collected. FIGURES 39 and 40 display the free flow speed distribution of both right-turning drivers and through drivers travelling in the right-most through lane of the roadway at the point where the taper begins to develop the full lane width of the right-turn lane.

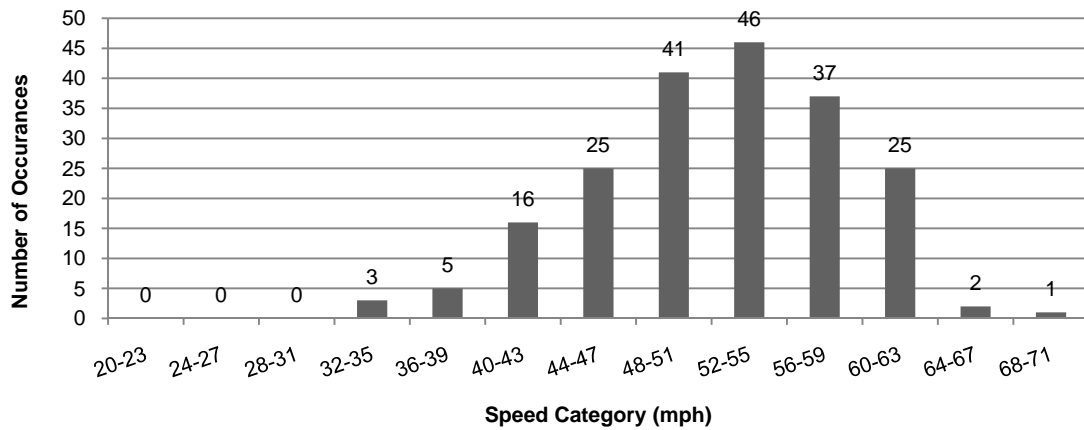

FIGURE 39 Speed Distribution of Free Flow Right-Turning Vehicles in Right-most Through Lane at the Entry Taper into the ORTL at Site 1

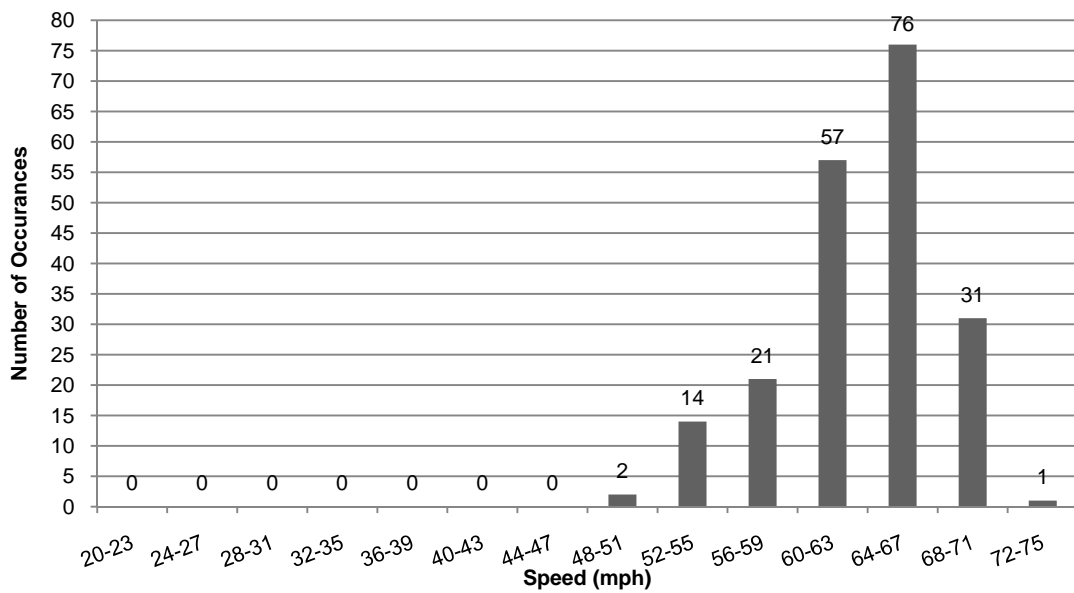

FIGURE 40 Speed Distribution of Free Flow Through Vehicles in Right-most Through Lane at the Entry Taper into the ORTL at Site 1

The mean, median, mode, 5th-, 15th-, 85th-, 95th-percentile speeds were also calculated for both right-turning and through drivers. These statistics are outlined in FIGURES 41 and 42, separated by vehicle type. The data shows that all types of vehicles regardless of vehicle size are performing in a similar fashion as they approach the right-turn taper.

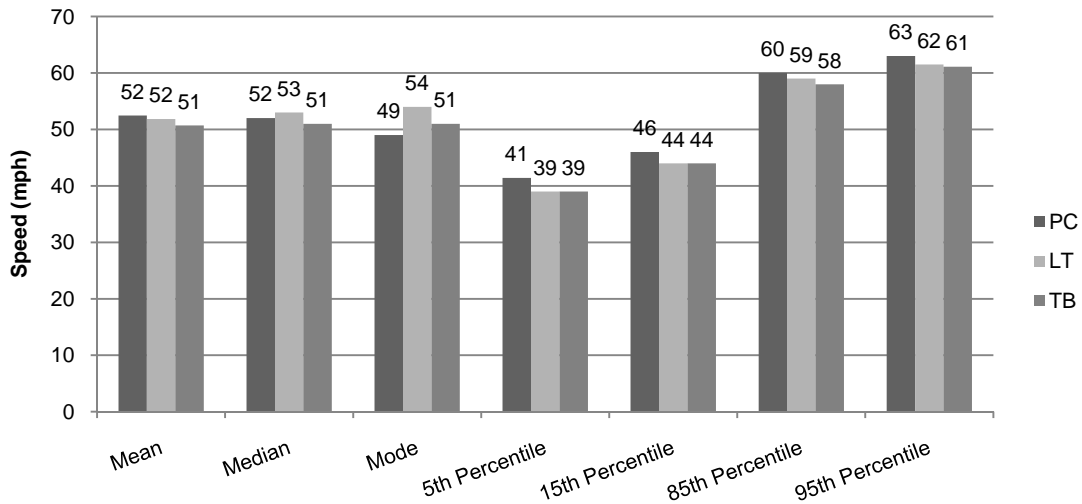

FIGURE 41 Free Flow Right-Turning Driver Speed Statistics by Vehicle Type at Site 1

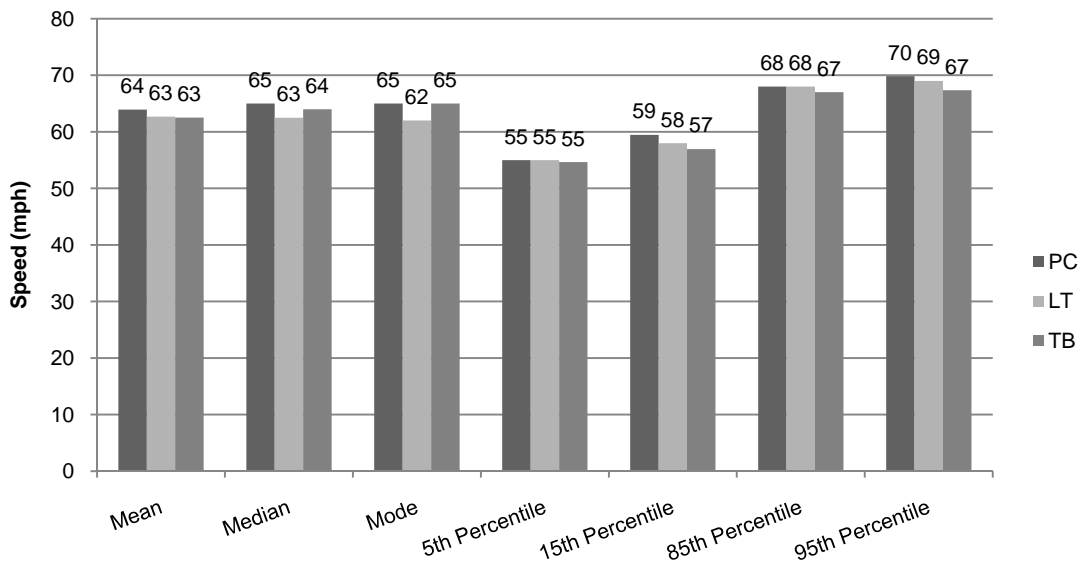

FIGURE 42 Free Flow Through Traffic in Right-most Through Lane Driver Speed Statistics by Vehicle Type at Site 1

Similar driver speed choice distributions and driver speed statistics are shown in FIGURES 43 through 46 from data collected at Site 8 with the SRTL.

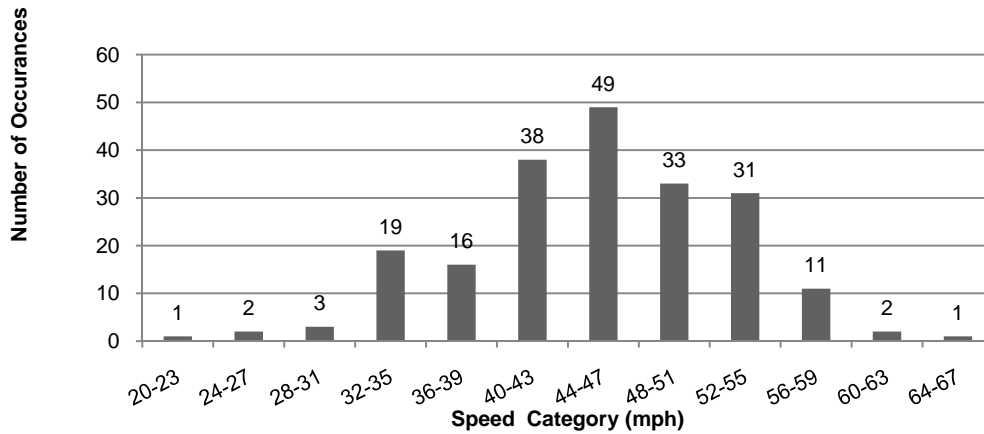

FIGURE 43 Speed Distribution of Free Flow Right-Turning Vehicles in Right-most Through Lane at the Entry Taper into the SRTL at Site 8

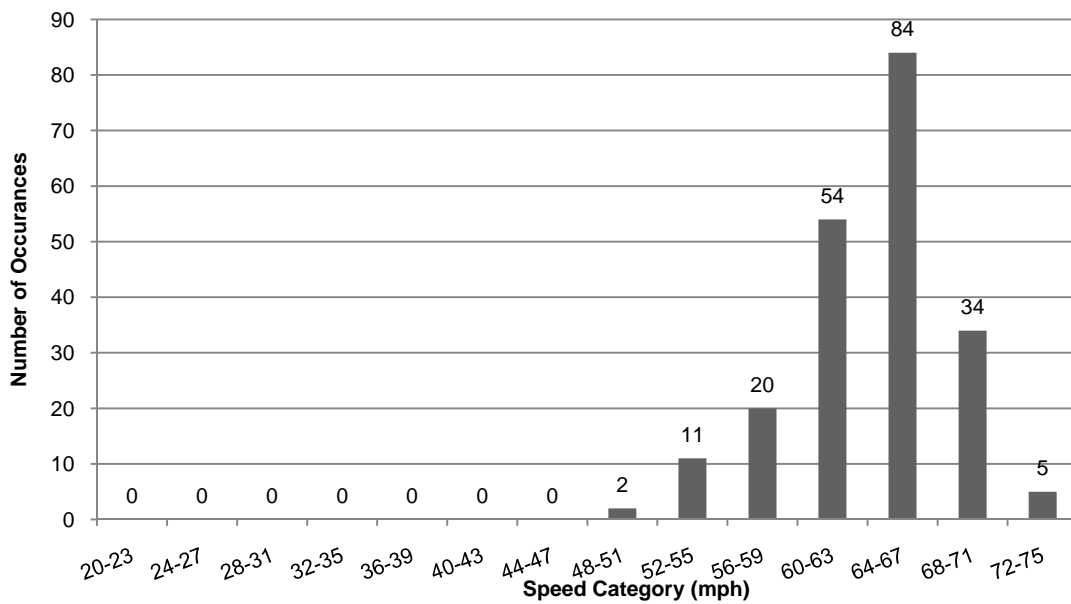

FIGURE 44 Speed Distribution of Free Flow Through Vehicles in Right-most Through Lane at the Entry Taper into the SRTL at Site 8

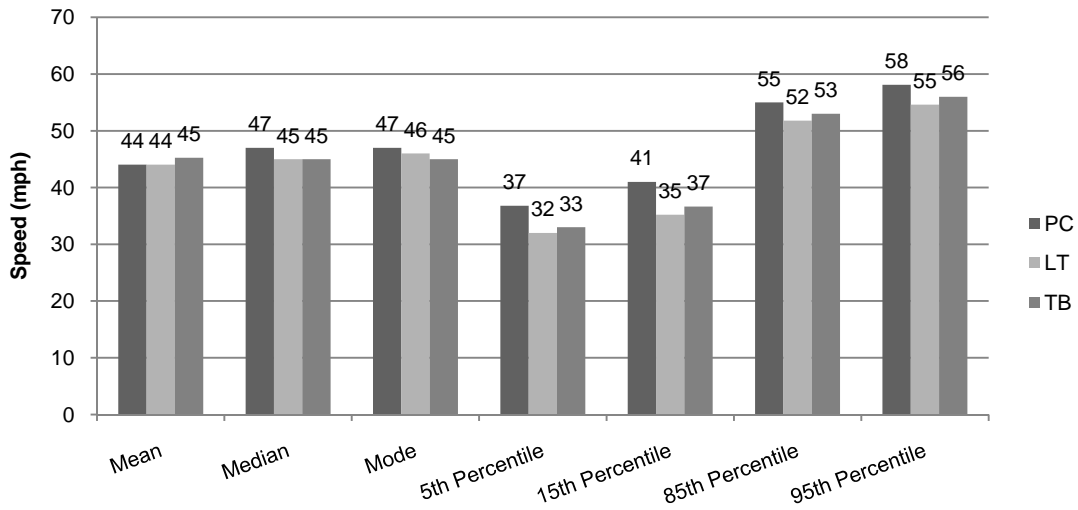

FIGURE 45 Free Flow Right-Turning Driver Speed Statistics by Vehicle Type at Site 8

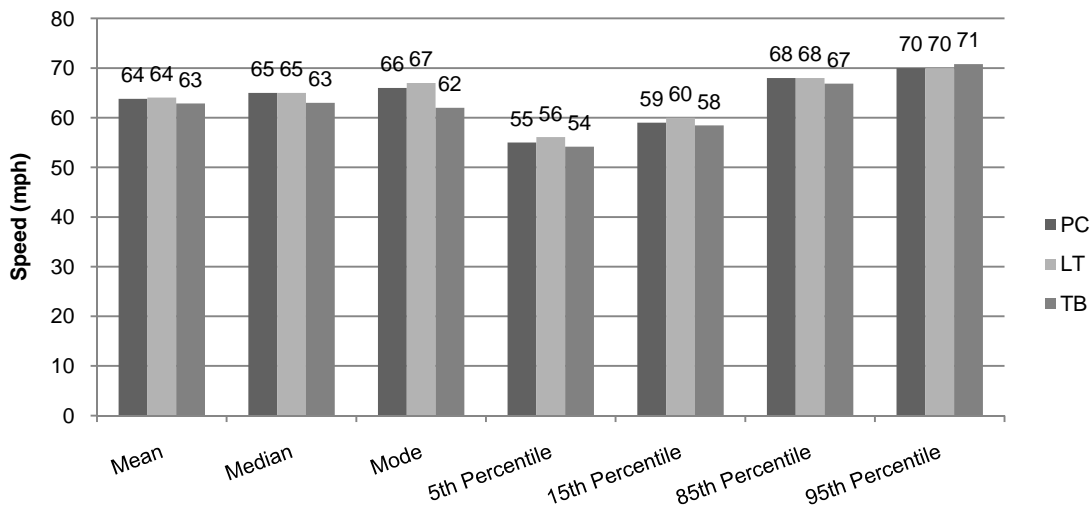

FIGURE 46 Free Flow Through Driver in Right-most Through Lane Speed Statistics by Vehicle Type at Site 8

The individual speed statistics were very similar when comparing PCs, LTs and TBs at each site location, so for further analysis, the PC (passenger car) type is focused upon since it represents the largest portion of the vehicle traffic volume at both locations.

TABLE 21 compares the mean, mode, 15th- and 85th-percentile values of driver speed choices at both locations.

TABLE 21 Site Comparisons of Key Statistical Speeds

Site	Mean Speed			Mode Speed			15 th -Percentile Speed			85 th -Percentile Speed		
	Rt-Trn	Thru	Rt minus Thru	Rt-Trn	Thru	Rt minus Thru	Rt-Trn	Thru	Rt minus Thru	Rt-Trn	Thru	Rt minus Thru
1	52	64	-12	49	65	-16	46	59	-13	60	68	-8
8	44	64	-20	47	66	-19	41	59	-18	55	68	-13

All key speed statistics for through drivers at both Sites 1 and 8 were virtually identical which is expected since both through roadways are expressways and have identical cross-sectional geometry. However, the overall speed differential between through and right-turning drivers is about 12 mph at Site 1 and about 18 mph at Site 8. The SRTL at Site 8 has a parallel lane length of about 250 ft as opposed to about 500 ft at Site 1 and it is likely that the greater speed differential at Site 8 is due to the overall shorter available deceleration length encouraging Site 8 drivers to reduce their speed more in the through lane than at Site 1.

A notable result from this study is that although there is a separate right-turning lane for drivers to leave the through roadway and decelerate upon to make their right-turn movement, they are still slowing their driving speed by 12 to 18 mph in the through lane. It is possible that a flatter taper rate than 10:1 at Site 1 and 15:1 at Site 8 may encourage drivers to do all of their deceleration once within the right-turn lane proper. However, the taper should not be so flat as to make the right-turning auxiliary lane appear as an added through lane. The combination of horizontal, vertical and cross-sectional elements of the through roadway geometric design should be checked for any perceptual illusions that may confuse approaching drivers at high speeds.

Chapter 9

DRIVER BEHAVIOR STUDY AT TAPERED-TYPE ORTL AT SITE 7

As mentioned earlier, in the search for existing ORTLs in Nebraska, it was found that the parallel type of ORTL is much more prevalent. Reasons for the choice of geometric designs were listed previously as the following:

- Retains all elements of a typical intersection by keeping the ORTL within close proximity of the intersection proper maintaining driver expectancy with respect to the proper hierarchy of traffic streams,
- Requires less right-of-way for construction,
- Requires less pavement, fill, and other associated paving items relative to driving lane construction, and
- Requires less public right-of-way.

It is logical to deduct that the parallel-type of ORTL would be a more economical installation than a tapered-type style and therefore be the design of choice.

Site 7, the intersection between Hwys US-26 and US-30 on the west edge of Ogallala, Nebraska was the only tapered-type ORTL found on the Nebraska State highway system. A two-day data collection effort was undertaken at Site 7 to provide some insight as to the benefits and detriments of a tapered-type installation. FIGURES 47 show details of Site 7.



FIGURE 47 Site 7, Hwys US-26 and US-30 west of Ogallala, Nebraska

FIGURE 48 shows that the tapered ORTL was designed according to the Green Book guidelines for a major road speed of 60 mph and a decision point vertex of about 28 ft.

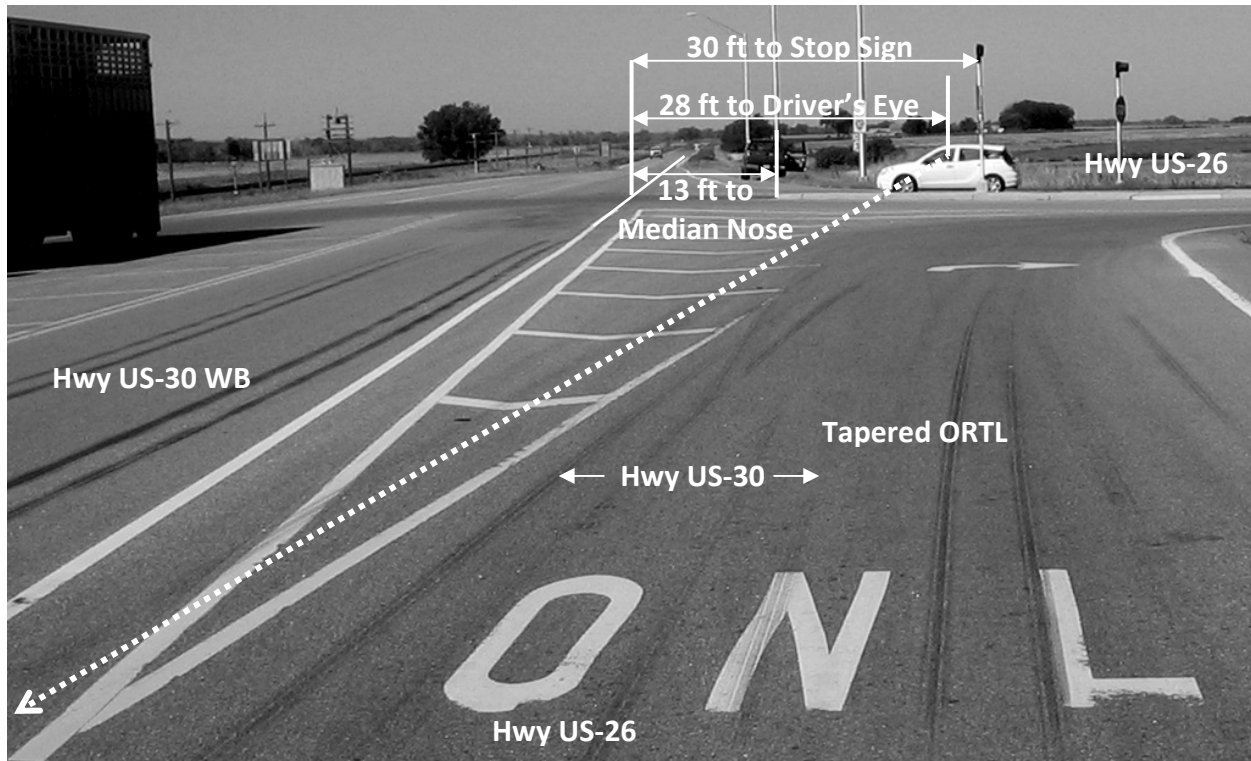

FIGURE 48 Key Dimensions of Tapered ORTL at Site 7

FIGURE 49 shows the stop-controlled approach for the southbound Hwy US-26 driver. It also shows one of two barrel video cameras that was used to collect driver behaviors along the ORTL as well at the stop-controlled approach, similar to the preliminary study at Site 1. This approach did not have a painted stop bar on the pavement.



FIGURE 49 Hwy US-26 Stop-Controlled Approach to Hwy US-30

Data was collected during peak traffic times on August 11th and 12th, 2008. There were very few occurrences of stopped drivers that were obstructed by vehicles in the ORTL as can be

seen from FIGURE 50. Both unobstructed and obstructed occurrences were collected and separated into the following vehicle types:

- Passenger Car, PC,
- Sport Utility Vehicle, SUV,
- Mini Van, MV,
- Semi Tractor Trailer, SM,
- Single Unit Truck, SU,
- Pickup Truck, PU, and
- Motorcycle, MC

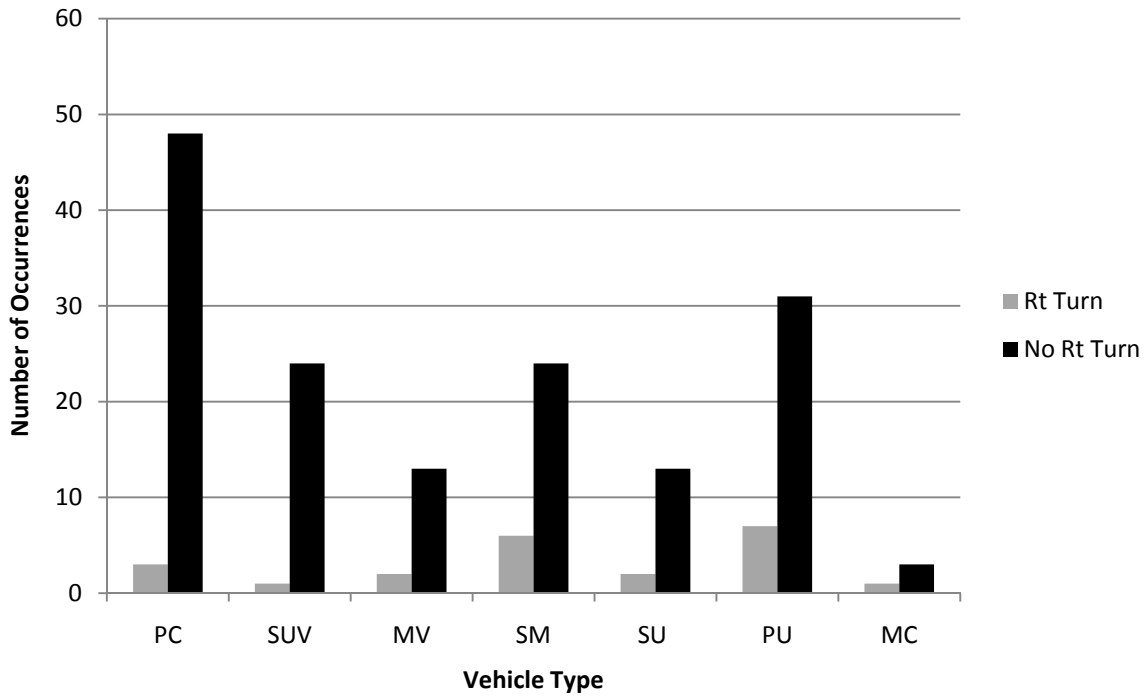

FIGURE 50 Number of Stopped Driver Occurrences During Site 7 Study Period

FIGURES 51 through 55 show key statistical values for mean, standard deviation, 50th-, 85th- and 95th-percentile stop positions for all vehicle types encountered.

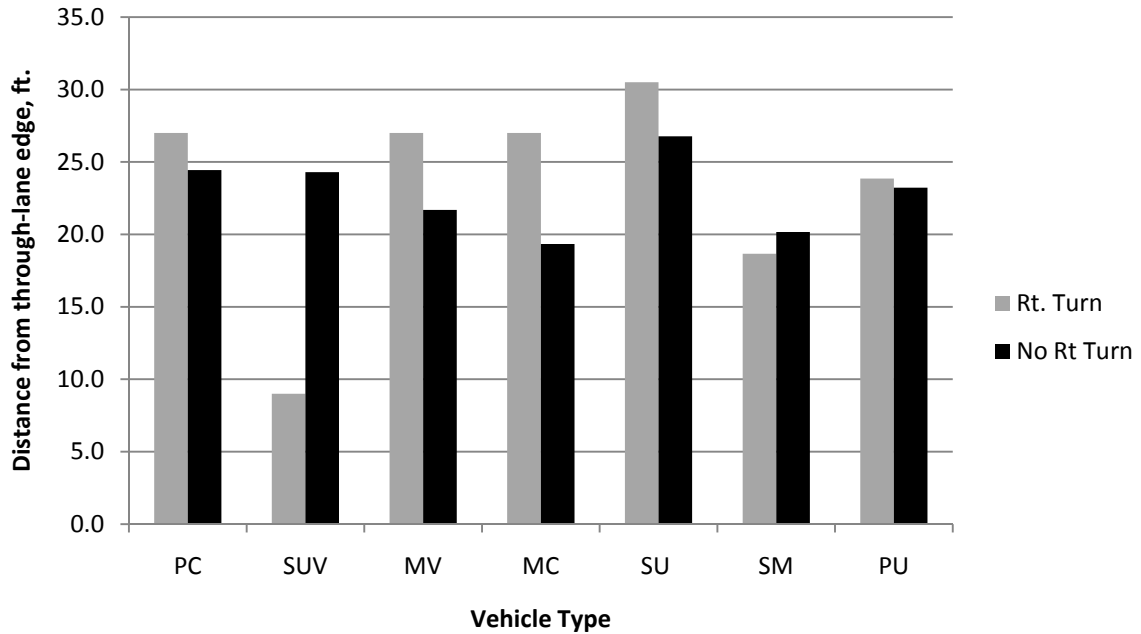

FIGURE 51 Mean of Driver Stopping Distance from Near Through Lane Edge by Vehicle Type at Site 7

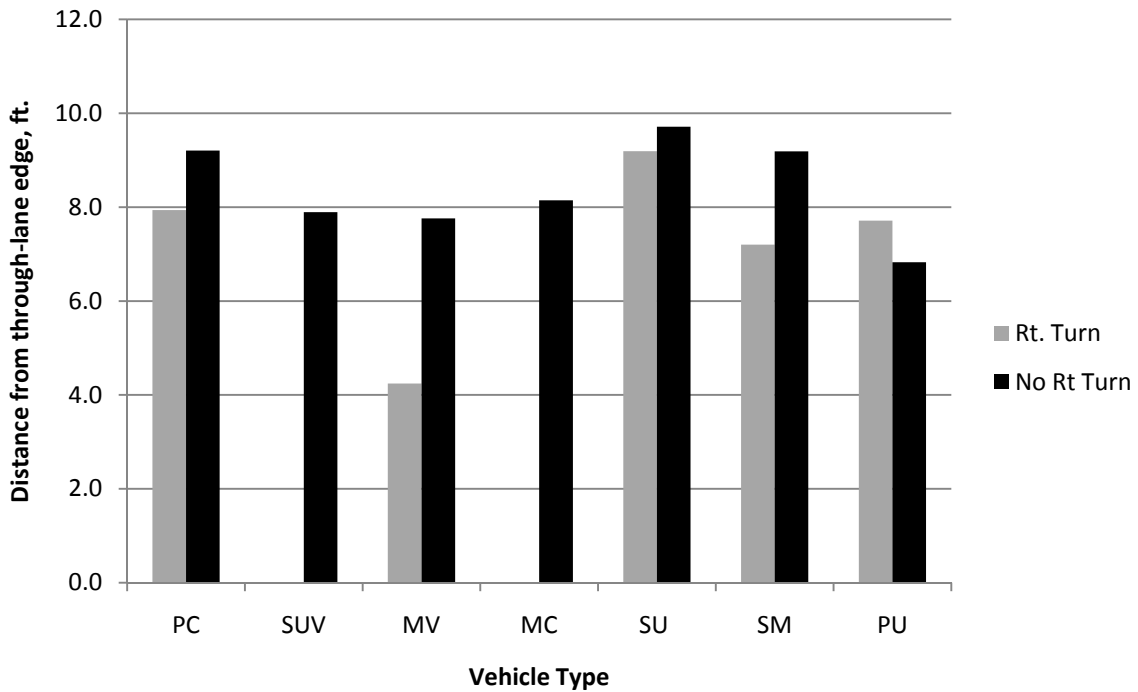

FIGURE 52 Standard Deviation of Driver Stopping Distance from Near Through Lane Edge by Vehicle Type at Site 7

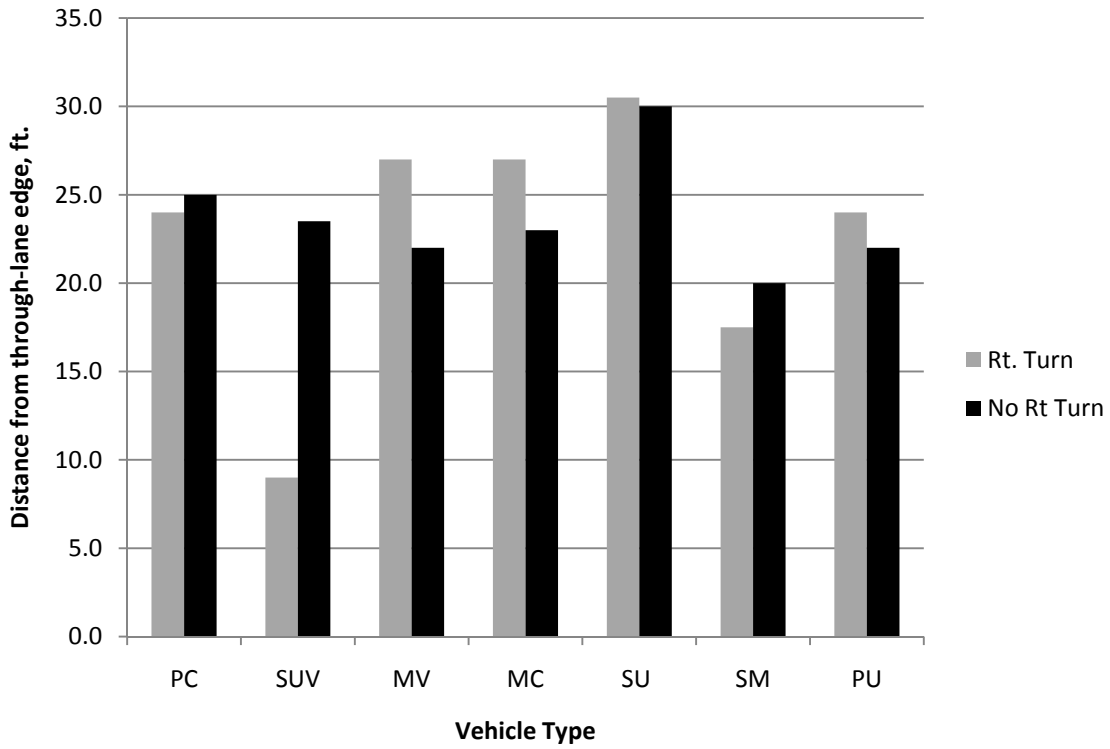

FIGURE 53 Median or 50th-Percentile Cumulative Driver Stopping Distance from Near Through Lane Edge by Vehicle Type at Site 7

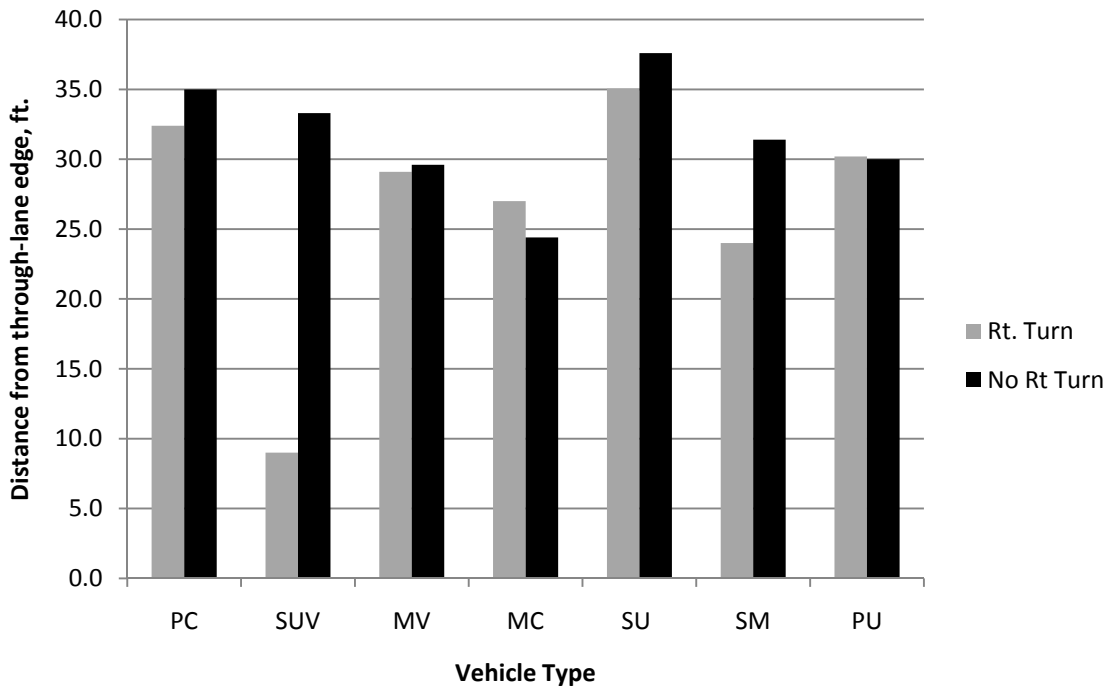

FIGURE 54 85th-Percentile Cumulative Driver Stopping Distance from Near Through Lane Edge by Vehicle Type at Site 7

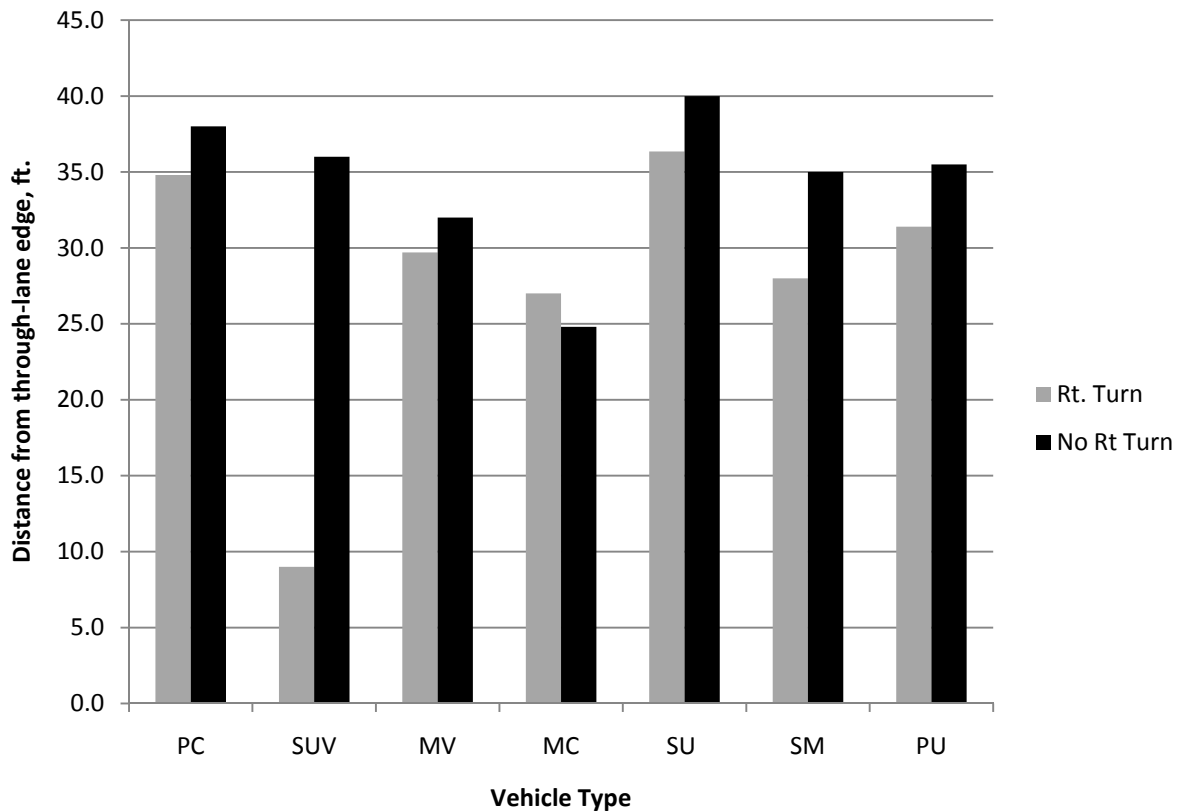

FIGURE 55 95th-Percentile Cumulative Driver Stopping Distance from Near Through Lane Edge by Vehicle Type at Site 7

As with parallel ORTLs, one key concern of this research is to determine a stopping distance location that will capture a large percentage of drivers to enable the geometric design of an offset-right turn lane to provide them with a clear ISD triangle at two-way stop-controlled intersections with right-turn lanes. TABLE 22 compares cumulative percentage values of stopped vehicle front bumper locations from the two largest subsets of vehicle types with both the largest proportion of vehicles within the dataset and the longest stopping distance values:

- Passenger cars, PCs, and
- Pickup Trucks, PUs.

TABLE 22 Cumulative Statistics for Stopped Vehicle Front Bumper Positions When Drivers' View Obstructed by Vehicles Within Right-Turn Lane at Sites 1 and 7

Site	Cumulative Statistics for Stopped Front Bumper Position		
	50 th -Percentile	85 th -Percentile	95 th -Percentile
Site 7 PCs	24	32	35
Site 7 PUs	24	30	31
Site 1	14	22	28

Site 7's cumulative values are larger than those of Site 1, but the location of Site 7's center island stop sign is about 30 ft from the near through driving lane edge as opposed to 14.2

ft at Site 1. Site 1 also had the painted stop bar to assist drivers with another cue as to where they should position their vehicles with respect to the near edge of the through lane. Site 7 drivers had about ± 8 ft standard deviation from the mean, indicating that positioning was variable.

Overall, the existing pavement geometry of Site 7 served drivers of all vehicles well during the study period. Though the traffic volumes at Site 7 were very low compared to Sites 1 and 8, there were many large trucks which were able to keep all wheels on the paved surface while making all turning movements. The ORTL even succeeded keeping the wheels of an overloaded flatbed truck with a segment of wind turbine support pole on the paved surfacing. FIGURE 56 shows the horizontal geometric details of the pavement construction at Site 7 and FIGURE 57 shows the striping plan details (which may differ slightly from the striping that was actually painted on the roadway surface). FIGURES 58 through 61 show a three-dimensional rendering of Site 7 used to help understand viewpoints of all drivers using the intersection.

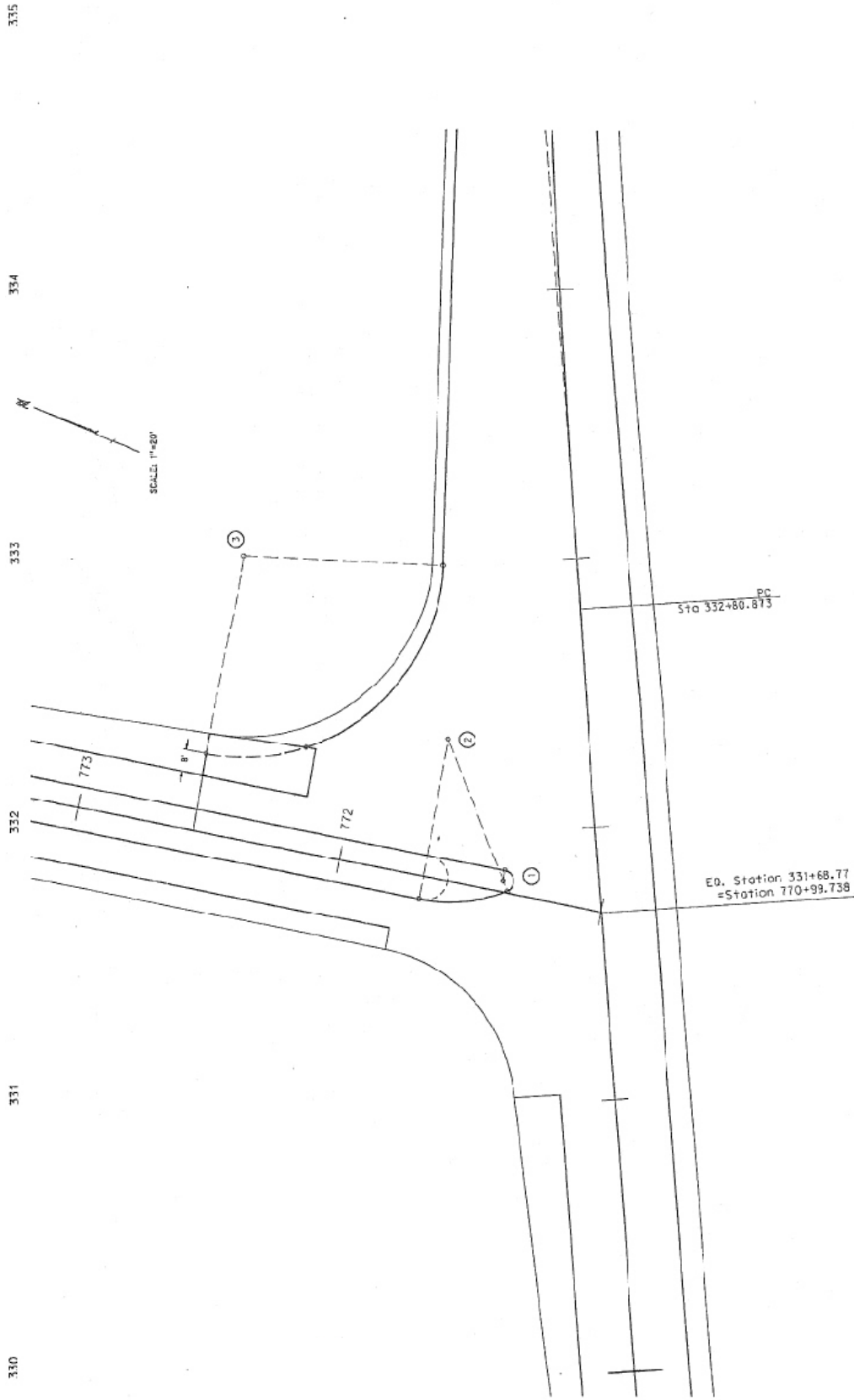

- ① 4.00' R.P. 35.50' LT. STA. 331+82.66 = 3.93' RT. STA. 771+38.78
P.C. 35.32' LT. STA. 331+70.84
P.T. 35.49' LT. STA. 331+86.53
- ② 60.00' R.P. 10.00' R. STA. 332+36.16 = 52' RT. STA. 771+85.74
P.C. 68.18' LT. STA. 331+70.16
P.T. 35.32' LT. STA. 331+70.84
- ③ 75.00' R.P. 25.00' LT. STA. 333+00.36 = 103.70' RT. STA. 772+56.1
P.C. 143.89' LT. STA. 332+86.42 = 88.7' RT. STA. 772+56.1
P.T. 50.30' LT. STA. 333+00.36

FIGURE 56 Horizontal Geometric Details of Site 7

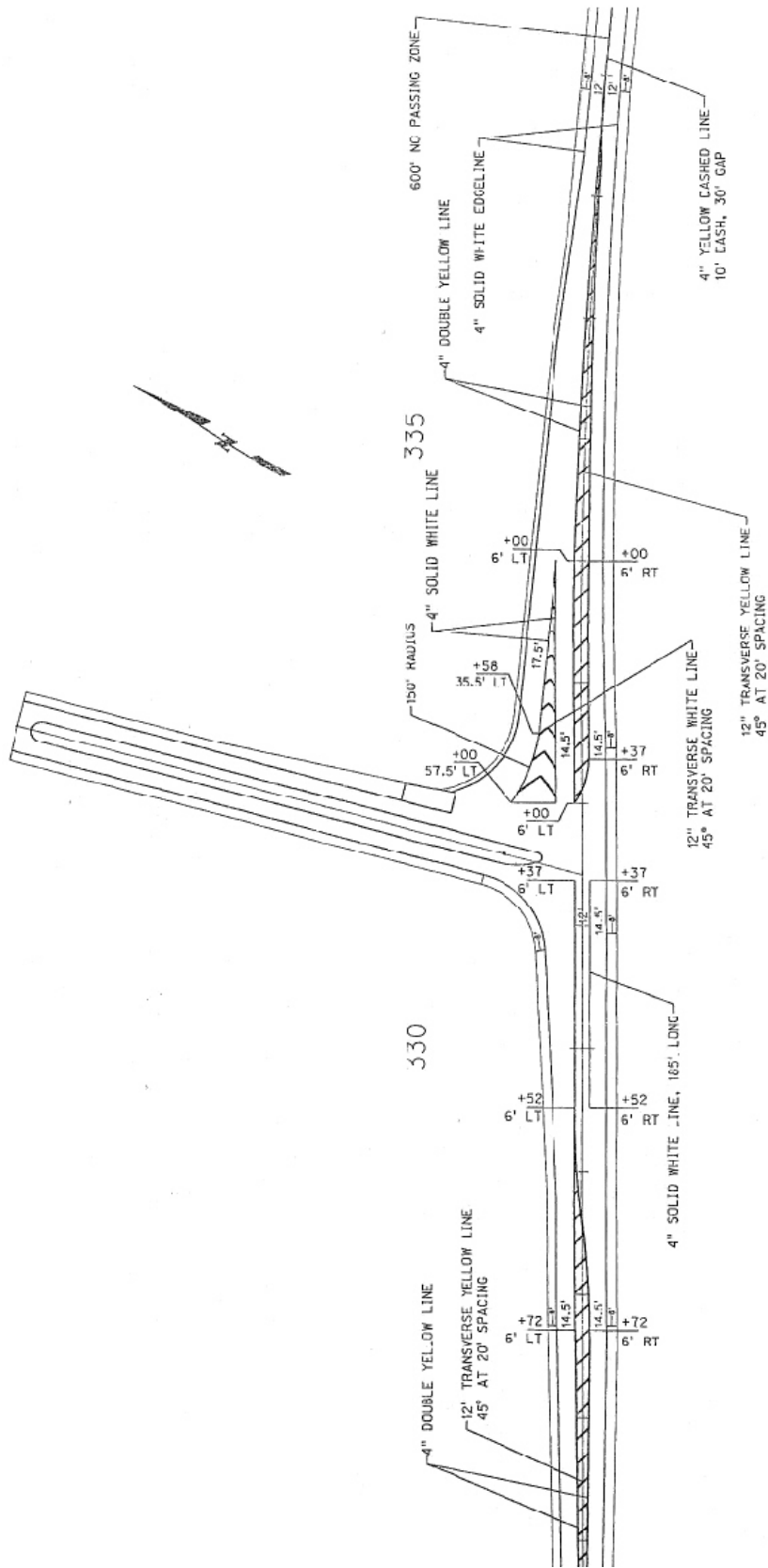

NOTES

1. ALL SOLID AND DASHED LINES ON CONCRETE SHALL BE PERFORMED PAVEMENT MARKING, TYPE 4, BROOVED.
2. ALL SOLID AND DASHED LINES ON ASPHALT SHALL BE PERFORMED PAVEMENT MARKING, TYPE 4.

FIGURE 57 Striping Plan for Site 7 Intersection

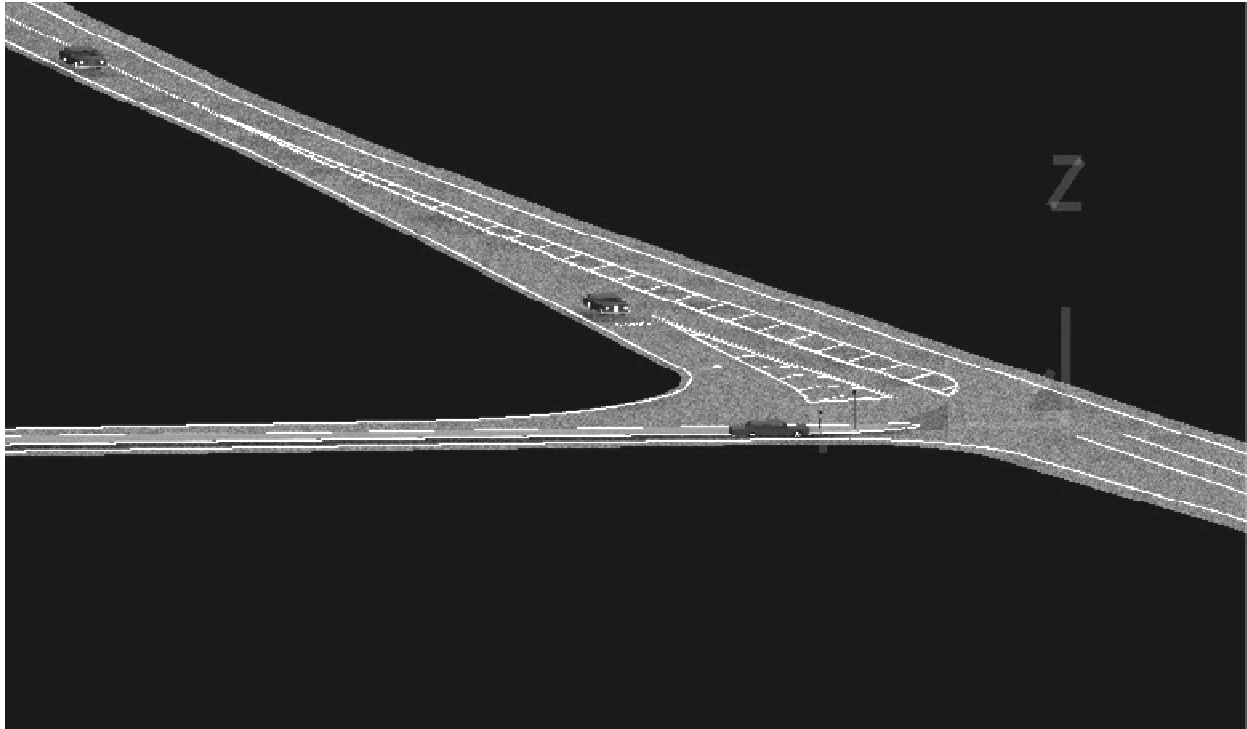

FIGURE 58 View of Computer Rendering of Site 7 from Northwest Quadrant

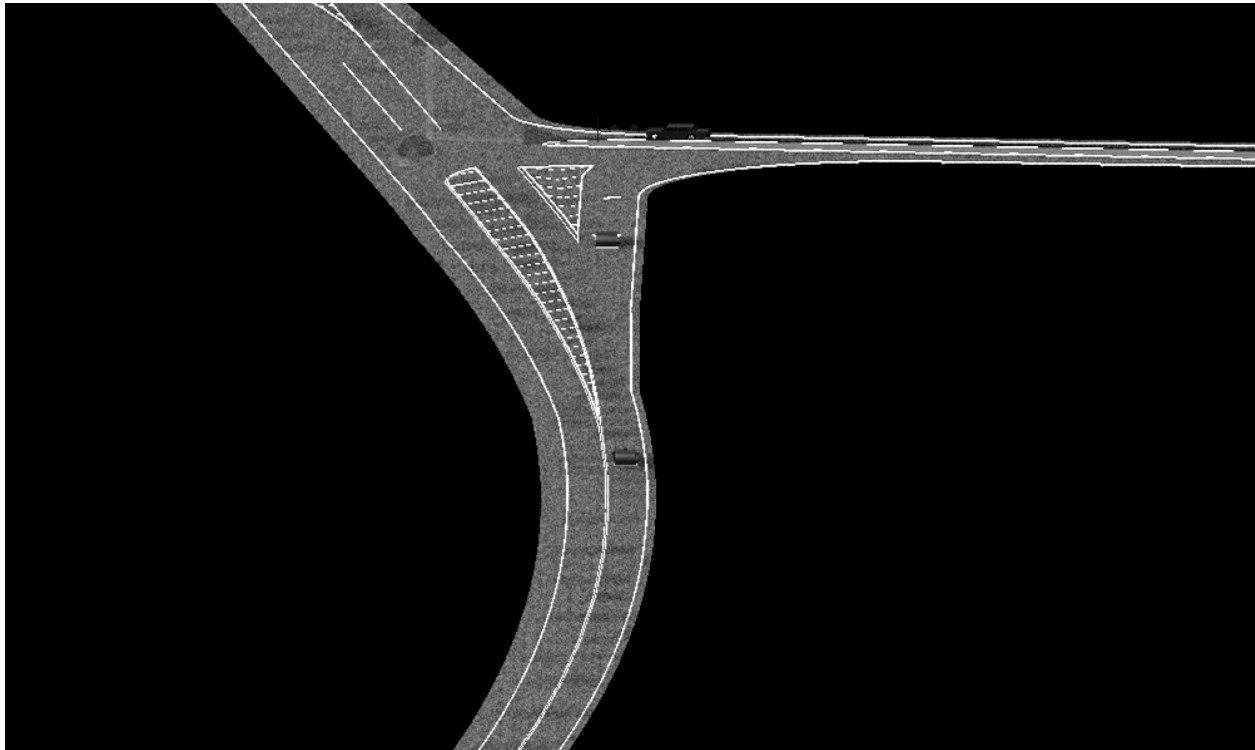

FIGURE 59 View of Computer Rendering of Site 7 from Southeast Quadrant

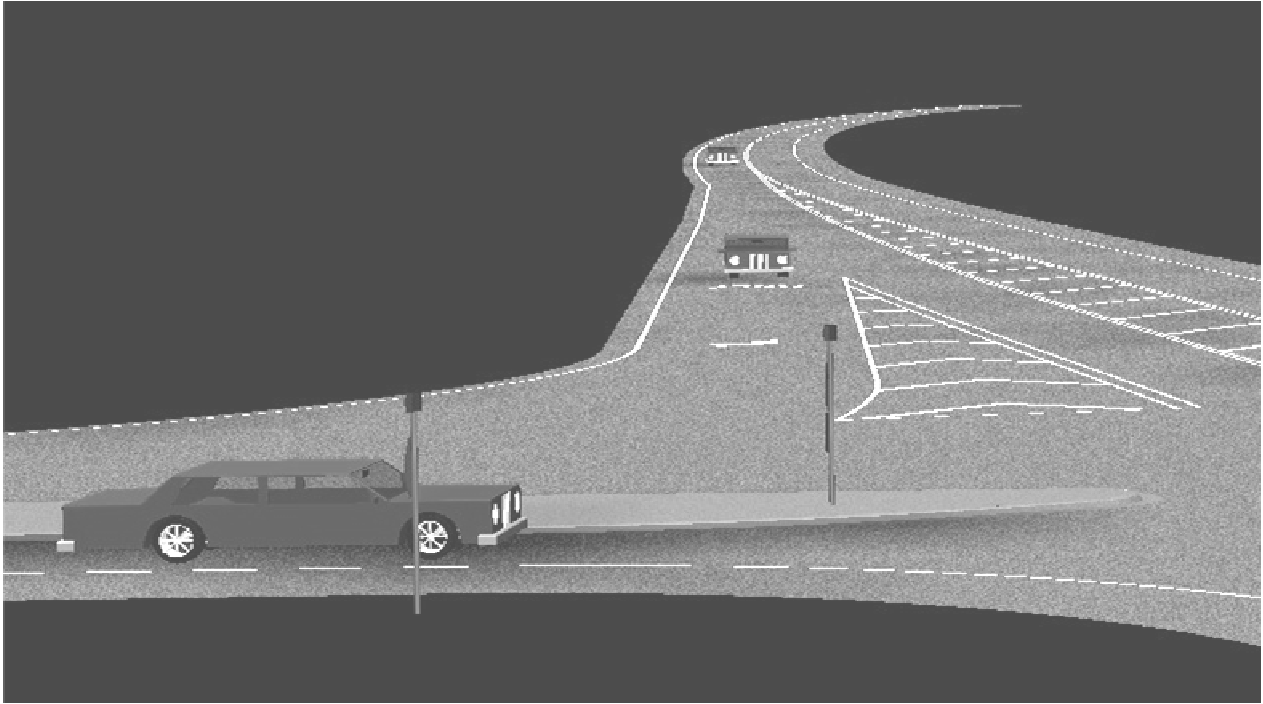

FIGURE 60 View of Computer Rendering of Site 7 from Northwest Quadrant

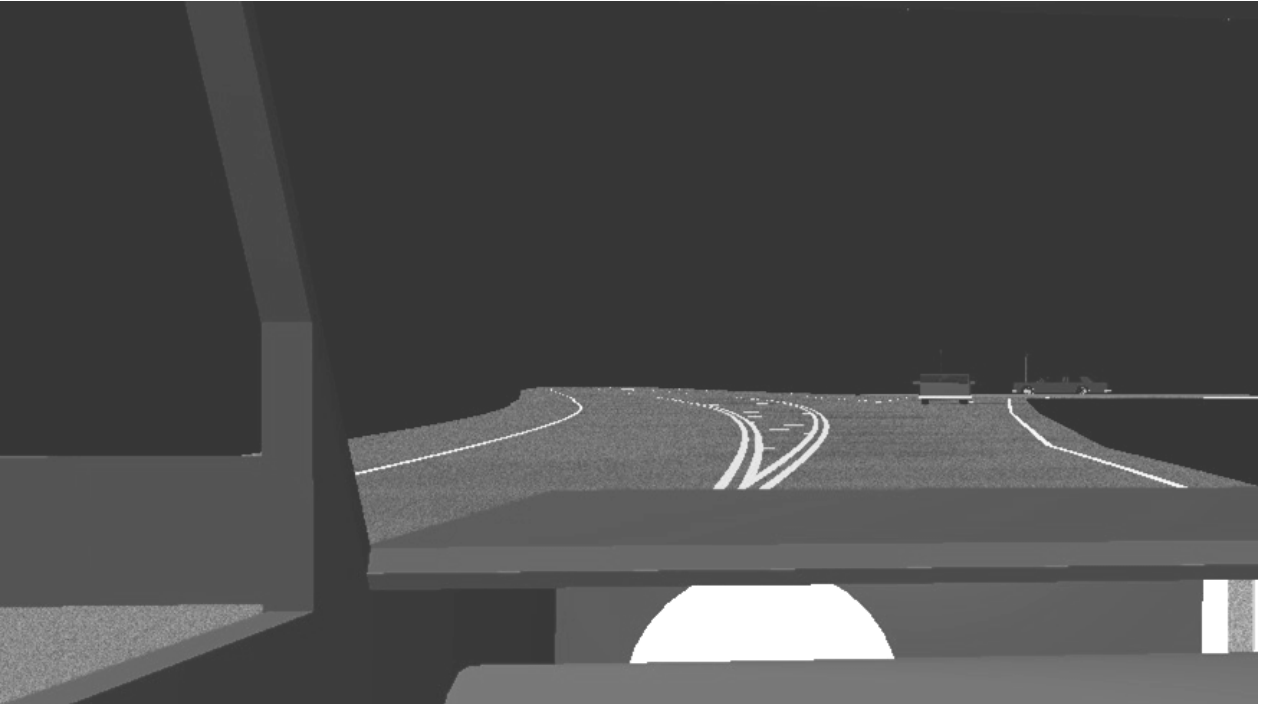

FIGURE 61 Computer Rendering of Westbound Hwy US-30 Driver's Eye View at Beginning of ORTL Taper

Chapter 10

RECOMMENDATIONS FOR AN ECONOMICAL OFFSET RIGHT-TURN LANE THAT MEETS DRIVER EXPECTATIONS FOR ALL VEHICULAR USERS

Review of Project Objectives

Initially, the primary objective of this research project was to focus upon whether an SRTL or ORTL is the optimal choice at a given location where a right-turn lane is warranted along the major roadway of a two-way stopped-controlled intersection.

A review of previous research on the subject yielded one safety effectiveness study (7) with mixed results and limited application due to a small number of sites (three sites, including Site 1), a short time period of ORTL operation (5.5 years instead of the standard 6 years), no adjustment for traffic volume changes over the study period, and a naïve study approach with inherent bias.

A statewide search for ORTL locations along rural major road state highways with a high design speed (50 mph or greater) resulted in 2 parallel-type installations near Lincoln, NE and 1 tapered-type location near Ogallala, NE. ORTLs are currently experimental in nature because their practical use is so limited. Some of the available ORTL sites have been implemented with new construction rather than evolving from SRTLs due to high near-side right-angle crashes making before-after safety effectiveness studies using the Empirical Bayes approach impossible. Finding enough local sites to appropriately conduct an operational or safety analysis with any statistical merit to provide ORTL warrants is in the future and an impossible goal at the time this research was commissioned.

Due to the preliminary study at Site 1, many issues were discovered that needed to be addressed in order to allow the geometric features of a two-way stop-controlled intersection with an ORTL to function as intended. Once locations are constructed with geometry that best fits driver behavior at the stop-controlled intersection approach as well as the ORTL, studies can be undertaken to assess the pros and cons of SRTLs and ORTLs with the intent of developing guidelines for which type is optimal in a given circumstance. Driver experience with ORTLs is an issue due to limited installations over which to develop *a priori* driver expectancy.

Since there are no standard guidelines used by NDOR for the appropriate three-dimensional intersection geometry to be used in creating an offset design, this research project focused on conducting behavior studies to provide initial recommendations for characteristics that should optimize function, operations and safety at such intersections.

Results of the driver behavior studies indicate that drivers are not performing as expected at parallel-type ORTLs with pavement geometry similar to Site 1 rendering its presence useless. The geometry of Site 7 appears to be much more appropriate and intuitive to driver expectancy and the three-dimensional characteristics of all vehicle types.

The NDOR research project *Number SPR-P1(05) P574, Multiple Lane Approaches to Stop-Controlled Intersections* developed recommendations for appropriate traffic control devices that meet MUTCD guidelines from negative driver behaviors that occurred at Site 1. FIGURE 63 shows examples of visual cues the minor road approach driver may be receiving from the three-dimensional features and traffic control devices at the Site 1 intersection which may be resulting in inappropriate choices for optimal safety. Recommendations for improving the misleading visual cues are shown in FIGURE 64. Each visual cue issue, recommendation for improvement, explanation of recommendation and official guideline resource is summarized

following FIGURES 62 and 63 in TABLE 23. FIGURE 64 shows a plan view of the proposed recommendations at a typical Nebraska 4-lane expressway-type 3-legged intersection.

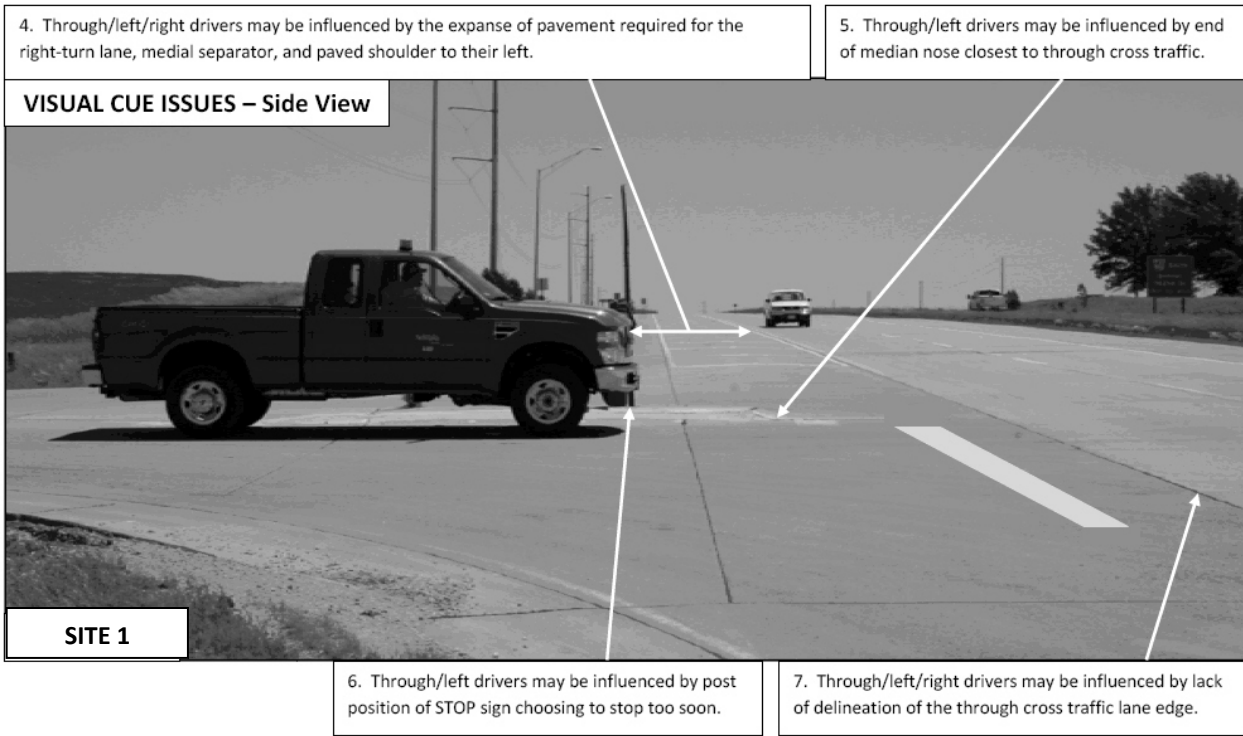
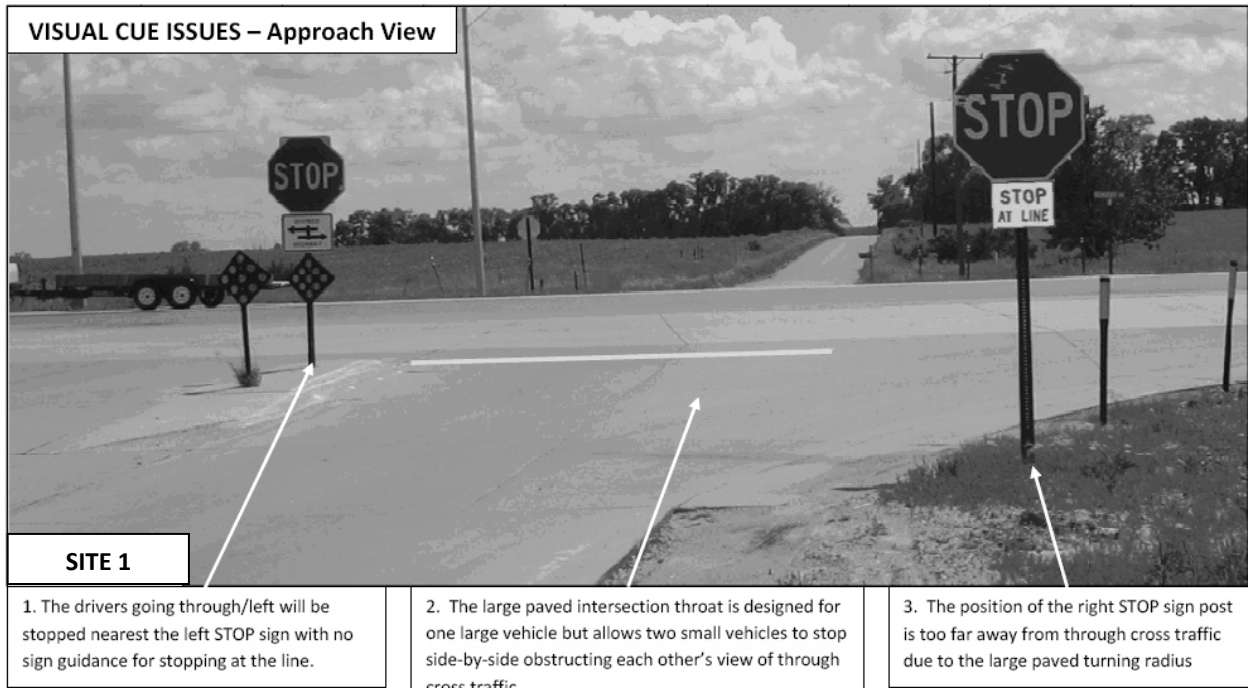
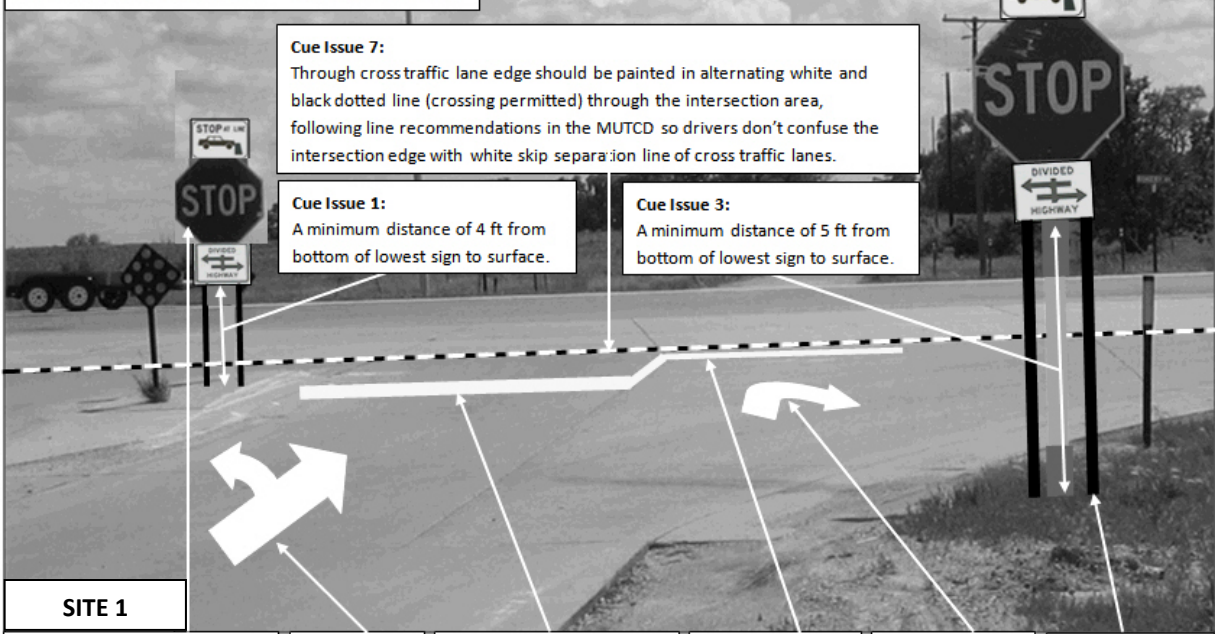

FIGURE 62 Counter-productive Visual Cue Issues at Site 1

RECOMMENDATIONS – Approach View



SITE 1

<p>Cue Issue 1: Left STOP sign with dual posts will be placed 20 ft from the through cross traffic lane edge. Through/left drivers should stop nearest the left STOP sign with redundant STOP messages and iconic guidance.</p>	<p>Cue Issue 1: Through/left turn arrows will be placed in the through/left lane before the stop bar.</p>	<p>Cue Issue 1: Stop bar for through/left movement should be placed 20 ft from through cross traffic lane edge and the transverse width shall match full lane width of the through/left lane only.</p>	<p>Cue Issue 2: Stop bar for right movement should be placed 6 ft from through cross traffic and be 12 ft in length.</p>	<p>Cue Issue 2: Right turn arrow should be placed in excess pavement area used by small right-turning vehicles.</p>	<p>Cue Issue 3: Right STOP sign with dual posts should be placed between 30-40 ft from the through cross traffic lane edge.</p>
--	--	---	---	--	--

Cue Issue 4:
If the non-stopping crossroad has a separate right-turn lane, delineate it with a right-turn pavement arrow.

Cue Issue 5 & 6:
Median nose end should be 2 ft beyond the position of the STOP sign and the STOP bar.

Cue Issue 7:
Through cross traffic lane edge should alternate black/white for concrete pavement.

RECOMMENDATIONS – Side View

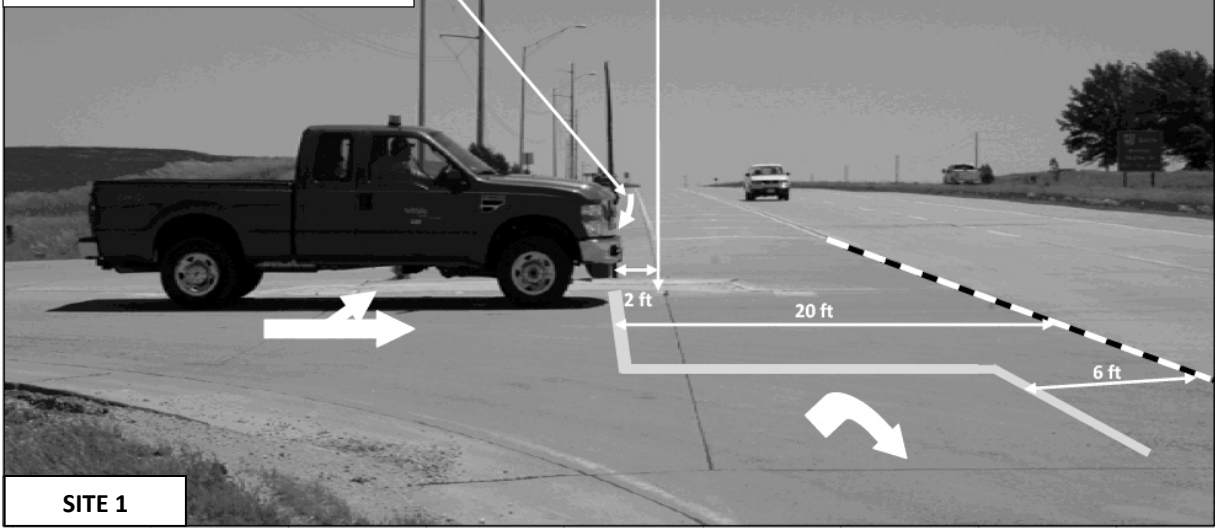

SITE 1

FIGURE 63 Improvements of Visual Cues at Site 1

TABLE 23 Summary of Visual Cues and Recommendations for Improvements

Issue No.	Inappropriate Visual Cue	Recommendation for Improvement	Explanation	Applicable Guidelines
1	Through/left drivers on the minor road approach may stop at the left-side stop sign with no indication that the desirable position is actually closer to the through cross traffic lane edge.	Place left STOP sign (dual posts) 20 ft from the through cross traffic lane edge. Include text-icon version of STOP AT LINE sign above STOP sign and if the major cross road is a divided highway, include DIVIDED HIGHWAY sign below STOP sign. Ensure that the bottom of the lowest sign is no closer than 4 ft to the surface below the sign. Add stop bar 20 ft from through cross traffic lane edge for the width of the through/left approach lane. Include through/left arrow on pavement of through/left approach lane.	Multiple signs at a single installation are allowed if the signs supplement each other. Through/left minor road approach traffic position will allow good ISD for right-turn driver. View of T/L driver will be minimally blocked by right-turn vehicle. It is nearly impossible for a through/left vehicle to be struck by cross traffic from the right that may be visually blocked by a right-turning vehicle.	MUTCD Section 2A.16.A, C MUTCD Figure 2A-1, page 2A-9 MUTCD Section 3B.16
2	Approach pavement throat must be constructed for large vehicle turning paths. Two small vehicles can fit side-by-side inhibiting each others' view of cross traffic gaps.	Add a second stop line 6 ft from the through cross traffic lane edge for a 12 ft width. Connect both stop bars with a single white solid line. A right-turn pavement arrow should be added before the right stop bar.	If the paved intersection throat area is large, it is possible for two small vehicles to be side-by-side. It is likely that a right-turning driver would angle the small vehicle toward the right in the paved area available according to a priori expectancy and minimally restrict a through /left driver's view of approaching major road vehicles from the right.	2004 AASHTO Green Book, pages 583-621
3	Position of right-side STOP sign is not adjacent to desirable stopping position of right-turning drivers due to the large paved turning radius.	Place right stop sign (dual posts) 12 ft minimum to 50 ft maximum from the through cross traffic lane edge. Include text-icon version of STOP AT LINE sign above STOP sign and if the cross road is a divided highway, include DIVIDED HIGHWAY sign below the STOP sign. Ensure that the bottom of the lowest sign is not less than 5 ft higher than the elevation of the paved edge of the approach lane closest to the post.	A paved intersection designed for a large vehicle exhibits a large turning radius that prevents the STOP sign on the right side from being close to the through cross traffic lane edge.	MUTCD Section 2A.16.A, C MUTCD Section 2A.18
4	Extra width for right-turn lanes, medial separators, and paved shoulders may confuse minor road approach drivers' idea of where the through cross traffic lane edge is located	If there is separate right turn lane on the major road to the left of the driver stopped on the approach, include a right-turn painted arrow in the right-turn lane in clear view of the stopped driver to enable recognition of the purpose for extra paved lanes. Minimize paved shoulder width on the right-turn lane.	It is necessary for the driver of a stopped vehicle on the minor road approach to appropriately judge the position of the major road through cross traffic lane edge to feel safe when the vehicle is at rest. Concrete pavement on a sunny day reflects light which diminishes the ability to discern lane lines, added lanes, medial separators and shoulders. Any acceptable method to better delineate these features for what they are is recommended.	MUTCD Section 3B-19
5	The raised median nose must be at least a shoulder's width from the through cross traffic edge of pavement and therefore may indicate that moving closer to the lane edge is inappropriate.	The end of the median nose closest to the major road should be 2 ft beyond the dual posts of the STOP sign (18 ft from the through cross traffic lane edge).	It is important that the left STOP sign posts, median nose end and stop bar are all in the same position to redundantly remind the driver to stop where it is desirable for the given situation. Locating a raised median nose 18 ft from the through cross traffic lane edge should not violate AASHTO guidelines for clear shoulder widths along roadways.	2004 AASHTO Green Book, pages 312-315
6	Desirable stopping position is not adjacent to left-side STOP sign post position on approach.	The left STOP sign should be positioned exactly where the desirable vehicle stopping position is located since the sign itself will be readily visible on the driver's side of the vehicle, at the driver's eye height and above. This position is 20 ft from the through cross traffic lane edge.	It is most critical that the driver in the through/left lane position the vehicle properly, since this particular movement is of the lowest priority in the intersection traffic movement hierarchy. The right-turning driver will likely angle the vehicle slightly and roll forward while assessing traffic gaps from the left.	2000 HCM Page 17-4 MUTCD Figure 2A-2, page 2A-10
7	Through/left/right drivers on the minor road may be influenced by confusion of the exact location of the through cross traffic lane edge since the pavement surfacing is all one color.	The through cross traffic lane edge should be delineated by an alternate white/black dotted line. The black dot alternate is for situations with concrete pavement and added auxiliary lanes where it is difficult to judge the lane edge.	As mentioned in Issue 4, it is necessary for the driver of a stopped vehicle on the minor road approach to appropriately judge the position of the major road through cross traffic lane edge to feel safe when the vehicle is at rest. Adding the pavement marking delineation is intended to avoid confusion of visualizing the lane edge correctly.	MUTCD Section 3B.06, 3B.008, pages 3B-16 to 3B-19

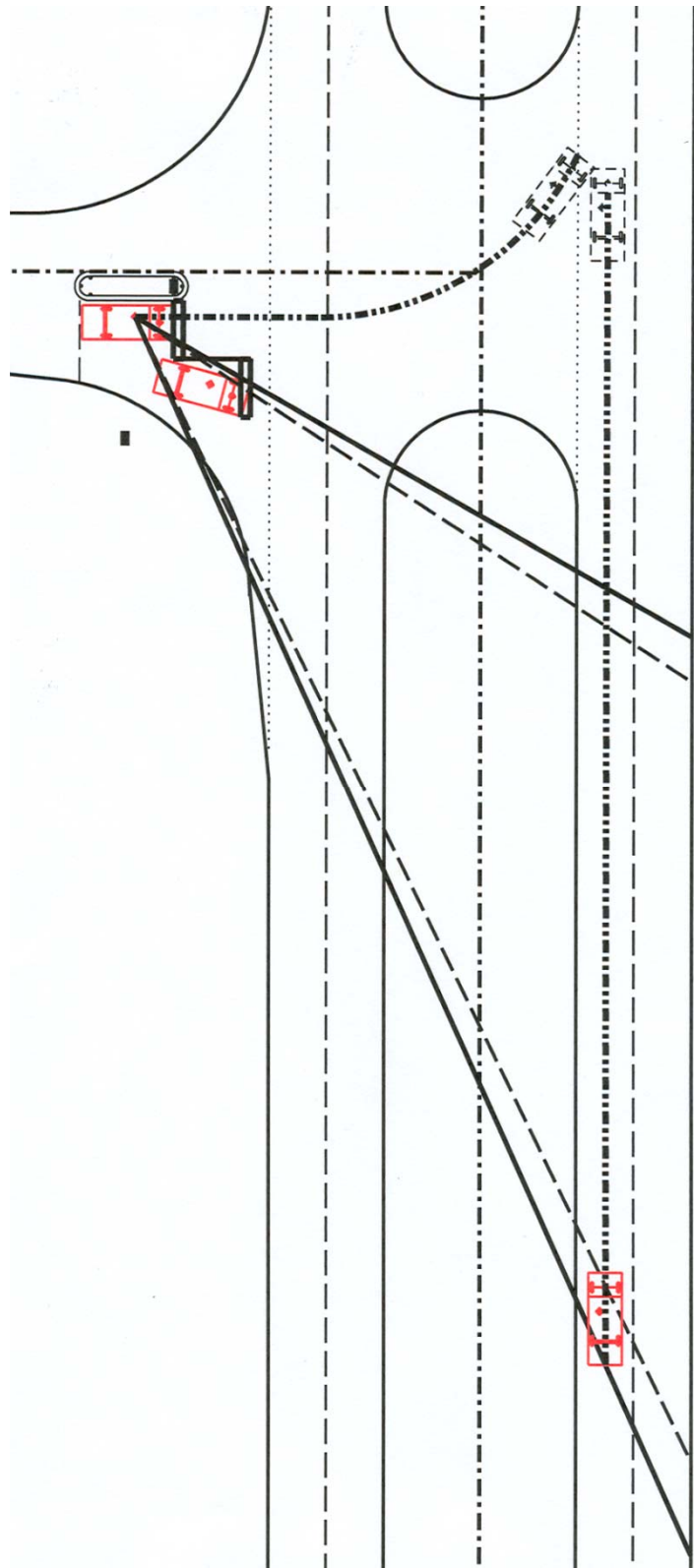

FIGURE 64 Plan View of Proposed Staggered Stop Bar Pavement Marking to Better Fit Driver Behavior at MLA-Type Intersections

The recommendations from FIGURE 64 have been combined with the inference from this project's findings that the taper-type ORTL is a more functional, intuitive geometric design to produce a computer rendering of an optimal model. FIGURES 65-69 show optimal design.

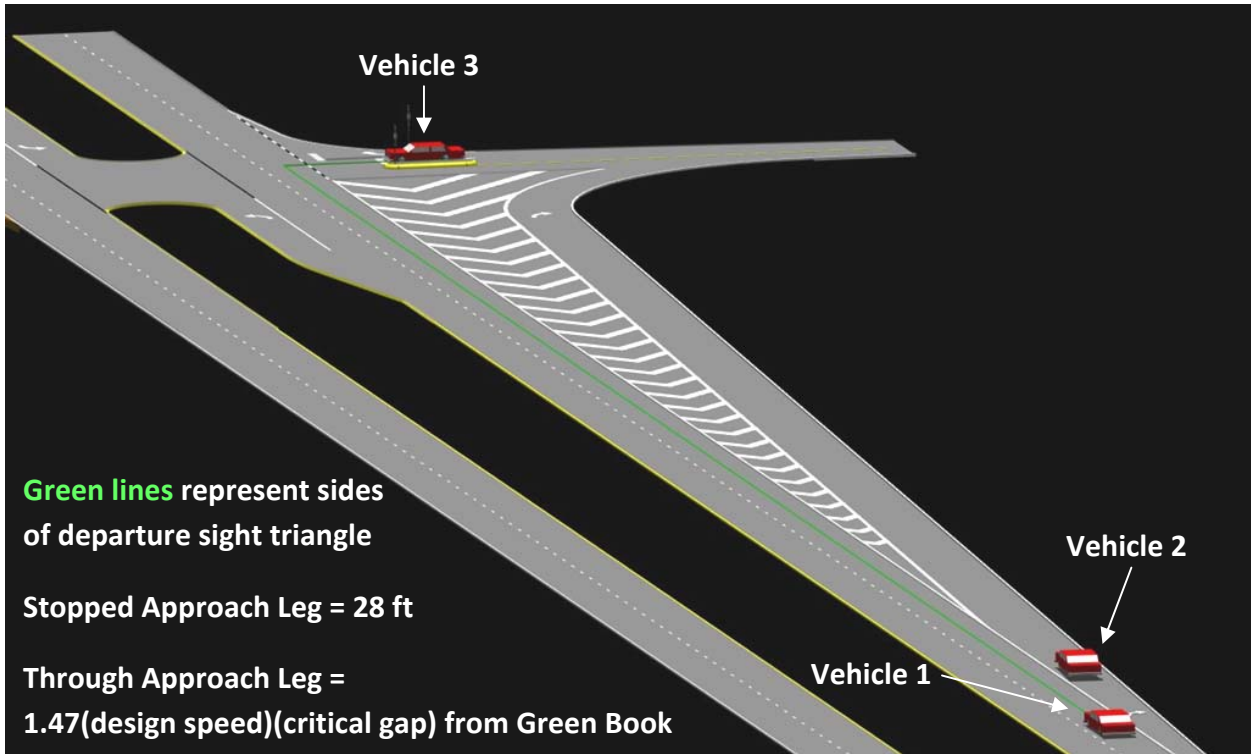

FIGURE 65 Computer Rendering of Recommendations for Optimal ORTL Design

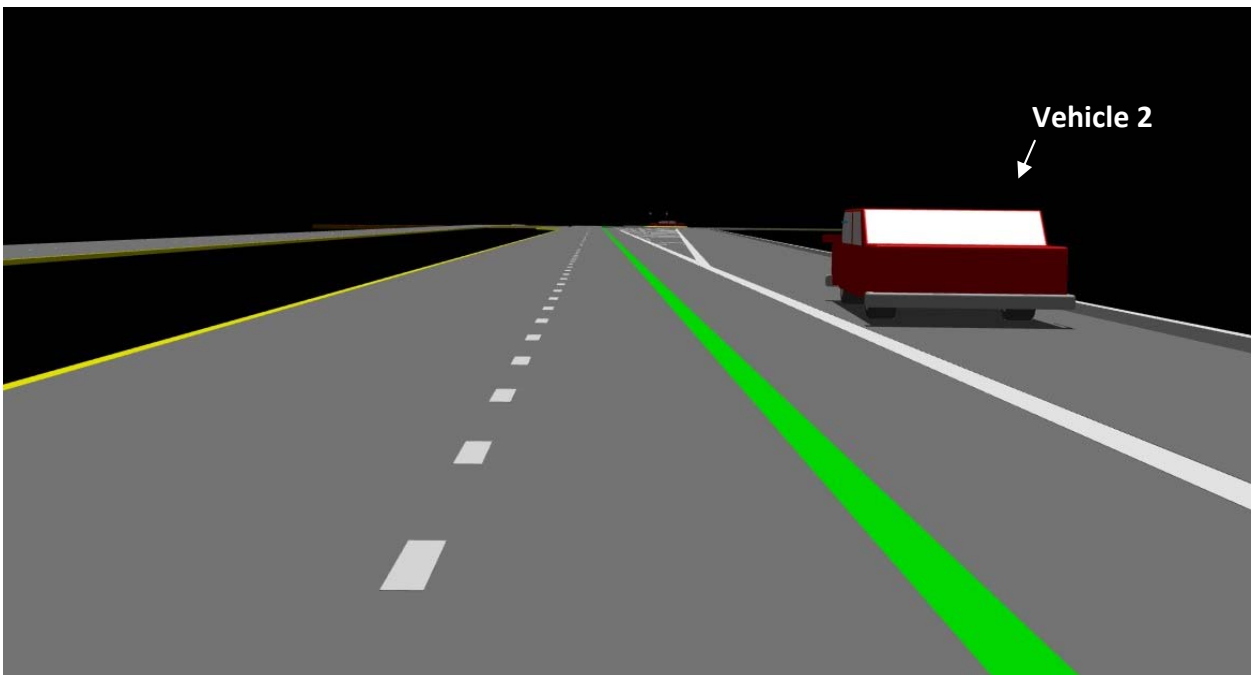

FIGURE 66 Computer Rendering of Passenger Car Driver Viewpoint from Vehicle 1

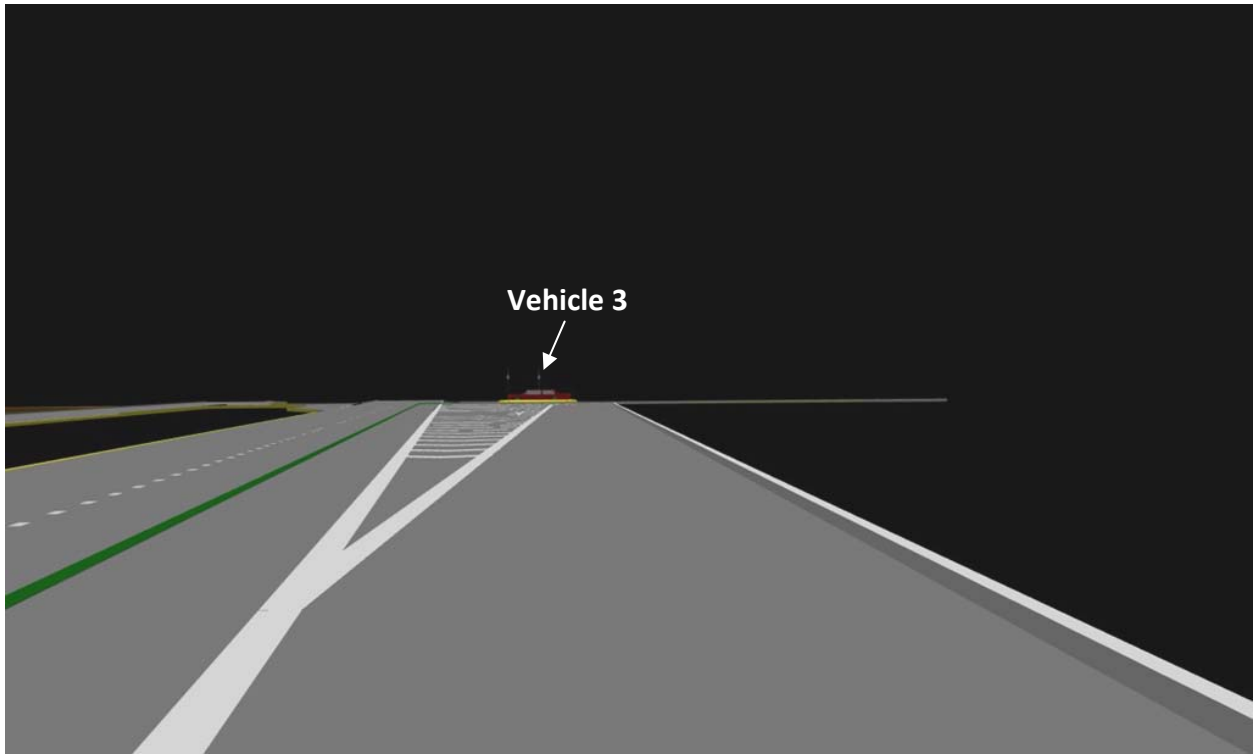

FIGURE 67 Computer Rendering of Passenger Car Driver Viewpoint from Vehicle 2

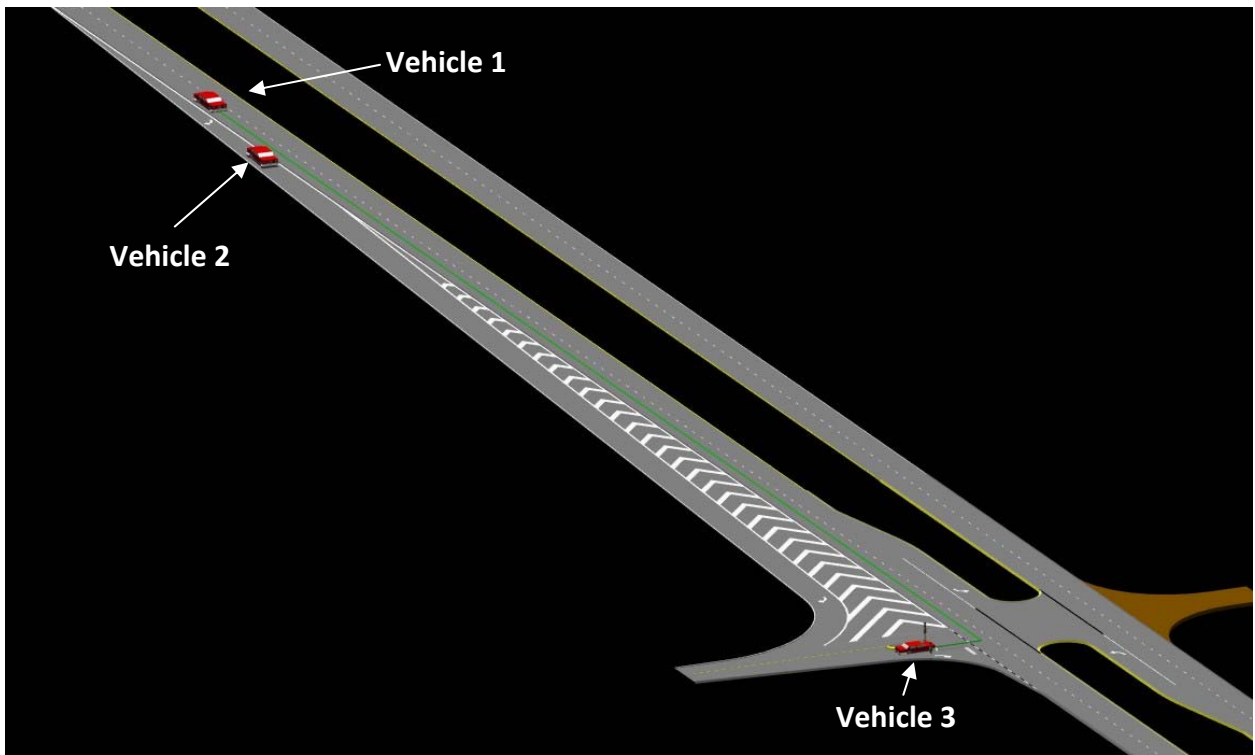

FIGURE 68 Computer Rendering of Recommendations for Optimal ORTL Design

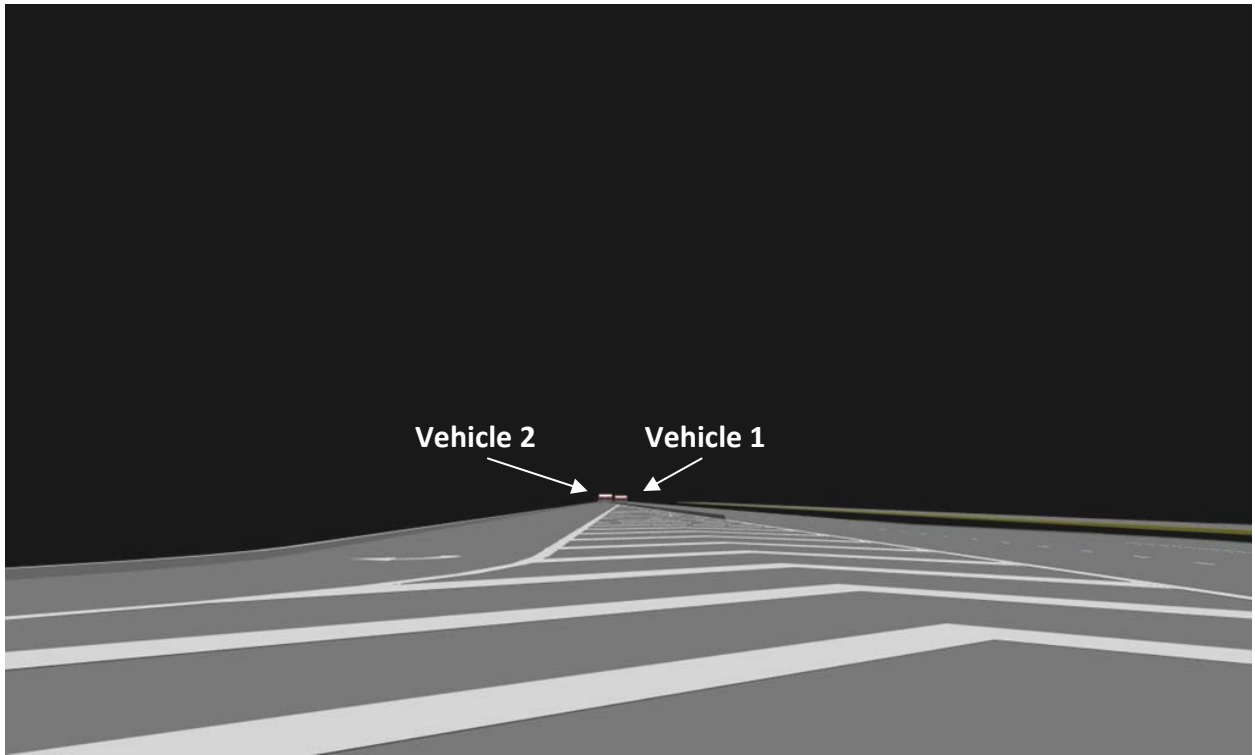

FIGURE 69 Computer Rendering of Passenger Car Driver Viewpoint from Vehicle 3 with Front Bumper 20 ft from Near Edge of Through Driving Lane

The triangular-shaped island geometry is based on the hypotenuse of the minimum departure sight distance triangle for a given major road design speed proscribed by the Green Book (1) and a decision point vertex front bumper position of 20 ft from the near edge of the through driving lane. Given the improvements of visual cues shown in FIGURE 64 supported by the content in TABLE 18, all drivers should have enough reinforcing traffic control devices to correctly position themselves for optimal departure sight distance.

Future Research Suggestions

It is clear that many questions still exist about ORTLs, largely due to the following facts:

- There are too few installations to allow safety studies.
- There are no geometric guidelines for designers to use when deciding key elements of three-dimensional features of the offset right-turn lane that can generate poor choices by through, right-turning, and left-turning drivers on major roads and stopped drivers at minor road approaches of two-way stop controlled intersections exhibiting ORTLs.
- Guidelines for typical auxiliary lanes don't appear to be transferrable to ORTLs.
- Optimal guidelines for three-dimensional geometric roadway features evolve over time after having studied behaviors generated by drivers given unfamiliar features in an iterative manner.

Ideally, this subject would be a good topic for an NCHRP study since these are generally large budget projects that can use multiple study sites across the nation to collect a large amount of data for a robust statistical analysis.

REFERENCES

1. A Policy on Geometric Design of Highways and Streets. American Association of State and Highway Transportation Officials, Washington D.C. 2004.
2. Missouri Department of Transportation Engineering Policy Guide, Missouri DOT. Available http://epg.modot.mo.gov/index.php?title=940.9_Auxiliary_Acceleration_and_Turning_Lanes#940.9.7_Right_Turn_Lanes Accessed 17 June 2010.
3. Highway Capacity Manual, 2000
4. Access Management Manual, Transportation Research Board, Washington, D.C., 2003
5. Maze, T.H., N.R. Hawkins, and G. Burchett. 2004. *Rural Expressway Intersection Synthesis of Practice and Crash Analysis*. Final Report. CTRE Project 03-157. Ames, IA: Center for Transportation Research and Education. <http://www.ctre.iastate.edu/reports/expressway.pdf>
6. Van Maren, P.A. 1980. *Correlation of Design and Control Characteristics with Accidents at Rural Multi-Lane Highway Intersections in Indiana*. Interim Report. FHWA-IN-JHRP-77-20. Purdue University and Indiana State Highway Commission Joint Highway Research Project.
7. Hochstein, J. L., T.H. Maze, H. Preston, R. Storm, T.M. Welch. 2007. *Safety Effects of Offset Right-Turn Lanes at Rural Expressway Intersections*. Ames, IA: Center for Transportation Research and Education.
8. Neuman R. T., R. Pfefer, K. L. Slack, K. K. Hardy, D. W. Harwood, I. B. Potts, D. J. Torbic, E. R. K. Rabbani. *Strategy 17.1 B8 Provide Offset Right-Turn Lanes at Intersections* In *NCHRP Report 500 Guidance for Implementation of the AASHTO Strategic Highway Safety Plan, Volume 5: A Guide for Addressing Unsignalized Intersection Collisions*, Transportation Research Board. Washington D.C. 2003 pg. v30-v33.
9. *NDOR Supplement to the MUTCD*. Nebraska Department of Roads. [PDF online]. Available <http://www.dor.state.ne.us/traffeng/mutcd/r1-11signs.pdf> Accessed 14 November 2009.
10. Gates, T. J., P. J. Carlson and G. Hawkins, Jr. *Field Evaluations of Warning and Regulatory Signs with Enhanced Conspicuity Properties in Transportation Research Record 1862*, Transportation Research Board. Washinton D.C. 2004, pp. 64-76.

11. Ullman, G. L. and E. R. Rose. *Evaluation of Dynamic Speed Display Signs*. In *Transportation Research Record 1918*, Transportation Research Board. Washington D.C. 2005, pp. 92-97.
12. Pesti, G. and P. T. McCoy. *Long-Term Effectiveness of Speed Monitoring Displays in Work Zones on Rural Interstate Highways*. In *Transportation Research Record 1754*, Transportation Research Board. Washington D.C. 2001, pp. 21-30.
13. Pant P. D., Y. Park, S. V. Neti and A. B. Hossain. *Comparative Study of Rural Stop-Controlled and Beacon-Controlled Intersections* In *Transportation Research Record 1692*, Transportation Research Board. Washington D.C. 1999, pp. 164-172.
14. Hauer, E. *Observational Before-After Studies in Road Safety Estimating the Effects of Highway and Traffic Engineering Measures on Road Safety*, Elsevier Science Inc. 660 White Plains Road, Tarrytown, New York. 1997.
15. Schultz, G. G., R. Peterson., C. Bradley, D. L. Eggett . *Evaluation of Advance Warning Signal Installation*. Brigham Young University, Utah Department of Transportation. 2006 Available <http://www.udot.utah.gov/main/f?p=100:p:g:10202603580464244683:::1:T,V:1566>, Accessed 23 November 2007.
16. Rose, E. R., G. L. Ullman. *Evaluation of Dynamic Speed Display Signs (DSDS)*. Texas Transportation Institute, Texas Department of Transportation, Federal Highway Administration. 2003. Available <ftp://ftp.dot.state.tx.us/pub/txdot-info/rli/psr/0-4475-s.pdf> Accessed 25 November 2007.
17. Houten, R. V., R. A. Retting. *Increasing Motorist Compliance and Caution A Stop Signs*, Journal Of A LIED Behavior Analysis. 2001 [PDF online]. Available <http://seab.envmed.rochester.edu/jaba/articles/2001/jaba-34-02-0185.pdf> Accessed April 2008.
18. Harwood, D. W., J. M. Mason, R. E. Brydia, M.T. Pietrucha and G. L. Gittings. *Report 383, Intersection Sight Distance*, National Cooperative Highway Research Program. National Academy Press. Washington D.C. 1996, pp. 38-59.
19. Nebraska Drivers Manual, 2007 [PDF online] www.dmv.state.ne.us pp. 29 Accessed May 2007.
20. Manual on Uniform Traffic Control Devices. 2003 edition with revisions 1 and 2 incorporated. Federal Highway Administration. [PDF online] http://mutcd.fhwa.dot.gov/kno_2003r1r2.htm Accessed May 2008.
21. Lincoln Municipal Code Chapter 10.02.380 Definitions, 2008 [PDF online] <http://www.lincoln.ne.gov/city/attorn/lmc/ti10/ch1002.pdf> pp. 8 Accessed May 2008.

22. Lincoln Municipal Code Chapter 10.14.010 Rules Of The Road, 2008 [PDF online] <http://www.lincoln.ne.gov/city/attorn/lmc/ti10/ch1014.pdf> pp. 2 Accessed May 2008.
23. Tarawneh, M. S., P.T. McCoy. *Guidelines for Offsetting Opposing Left-Turn Lanes on Divided Roadways* In *Transportation Research Record 1579*, Transportation Research Board. Washington D.C. 1997, pp. 43-53.
24. Tarawneh, M. S., P.T. McCoy. *Effect of Offset Between Opposing Left-Turn Lanes on Driver Performance* In *Transportation Research Record 1523*, Transportation Research Board. Washington D.C. 1996, pp. 61-72.
25. Khattak A. J., B. Naik, V. Kannan. *Safety Evaluation of Left-Turn Lane Line Width at Intersections With Opposing Left-Turn Lanes*. NDOR Research Project Number SPR-P1(03)P554, Nebraska Department of Roads. Lincoln NE. 2004.
26. Naik,B., J. Appiah, A.J. Khattak and L.R. Rilett.. *Safety effectiveness of offsetting opposing left-turn lanes: A case study*. Journal of the Transportation Research Forum, Vol 48 No. 2, 2009.
27. *NDOR Roadway Design Manual*. Nebraska Department of Roads. [PDF online]. July 2006 . Available <http://www.dor.state.ne.us/roadway-design/pdfs/rwydesignman.pdf> Accessed 10 October 2007
28. *Manual of Transportation Engineering Studies*. Institute of Transportation Engineers, Washington D.C. 2000.
29. Harwood, D. W., J. M. Mason, R. E. Brydia, M.T. Pietrucha and G. L. Gittings. *Report 383, Intersection Sight Distance*, National Cooperative Highway Research Program. National Academy Press. Washington D.C. 1996, Appendix H.
30. *Autoscope User's Guide*, P/N 200-0905-002 revision NC. Econolite Control Products, Inc. 3360 E La Palma Avenue, Anaheim, CA. Available as part of the software package.
31. *SPSS Users Manual*. SPSS, Inc. 233 S. Wacker Drive 11th floor , Chicago, IL. Available as part of the software package.
32. Dowdy, S., S. Wearden, D. Chilko. *Statistics for Research third edition*, John Wiley and Sons Inc.. Hoboken, NJ. 2004.
33. Schurr, Karen S., D. Sitorius, *Multiple-Lane Approaches to Stop-Controlled Intersections*, Research Project Number SPR-P1(05) P574, Nebraska Department of Roads, Lincoln, NE. May 2010

APPENDIX 1: Recording Events, Battery Specifications and Recording Apparatus Setup Instructions

Recording Events

Table 8: Hwy 2 and 148th St. Before

Date:	Times:
July 31:	7:15:00-10:30:00
July 31:	11:00:00-18:00:00
AUG 01:	6:00:00-7:00:44
AUG 01:	11:41:53-18:00:00
AUG 04:	12:08:54-18:00:00
AUG 05:	6:00:00-9:50:39
AUG 05:	12:16:28-18:00:00
AUG 06:	11:12:58-18:00:00
AUG 07:	11:00:00-18:00:00

Table 9: Hwy 2 and 148th St. After

Date:	Times:
AUG 25:	6:00:00-10:30:00
AUG 25:	11:00:00-16:49:17
AUG 26:	6:00:01-10:30:00
AUG 26:	11:00:00-14:49:56
AUG 27:	6:00:01-10:30:00
AUG 27:	11:00:00-18:00:00
AUG 28:	6:00:00-10:30:00
AUG 28:	11:00:00-18:00:00
AUG 29:	6:00:00-10:30:00
AUG 29:	11:00:00-16:21:18

Table 10: Hwy 2 and 148th St. Extended Study

Date:	Times:
Sept 15:	6:00:01 – 18:00:00
Sept 16:	6:00:01 – 15:21:12
Sept 16:	16:09:47 – 16:21:17
Sept 16:	17:37:14 – 17:45:40
Sept 17:	6:00:01 – 17:32:59
Sept 18:	6:00:00-12:28:54
Sept 18:	14:08:18 – 14:22:00
Sept 18:	14:40:40 – 18:00:00
Sept 19:	6:27:03 – 6:39:41

Sept 19:	7:27:50 – 7:37:21
Sept 19:	8:47:58 – 18:00:00

Table 11: Hwy 77 and Hwy 41 Before

Date:	Times:
OCT 28:	6:00:00-18:00:00
OCT 29:	6:00:00-18:00:00
OCT 30:	6:00:01-18:00:00
OCT 31:	6:00:01-17:59:59
NOV 03:	6:00:00-17:59:59

Table 12: Hwy 77 and Hwy 41 After

Date:	Times:
NOV 17:	10:28:38-18:00:00
NOV 18:	10:53:33-18:00:00
NOV 19:	6:00:00-10:11:16
NOV 20:	6:00:01-18:00:00
NOV 21:	9:39:44-18:00:00

Table 13: Hwy 77 and Hwy 41 Extended Study

Date:	Times:
Dec 04:	10:46:11-18:00:00
Dec 05:	10:51:10-18:00:00
Dec 08:	9:00:53-18:00:00
Dec 09:	11:45:43-18:00:00
Dec 10:	9:22:55-18:00:00

APPENDIX 2: SPSS Output

Hwy 2 and 148th St. Output

Regression

Variables Entered/Removed

Model	Variables Entered	Variables Removed	Method
1	ORTL vehicle present, Minor vehicle type 1, Extended Study, Stop Duration (sec), Minor vehicle type 3 ^a		Enter

a. All requested variables entered.

Model Summary

Model	R	R Square	Std. Error of the Estimate
1	.145 ^a	.021	6.4028937

a. Predictors: (Constant), ORTL vehicle present, Minor vehicle type 1, Extended Study, Stop Duration (sec), Minor vehicle type 3

ANOVA^b

Model		Sum of Squares	df	Mean Square	F	Sig.
1	Regression	2391.728	5	478.346	11.668	.000 ^a
	Residual	110733.027	2701	40.997	Fcrit	
	Total	113124.754	2706		2.217	

a. Predictors: (Constant), ORTL vehicle present, Minor vehicle type 1, Extended Study, Stop Duration (sec), Minor vehicle type 3

b. Dependent Variable: Stop Distance From Through Lane (ft)

Coefficients^a

Model				t	Sig.
		B	Std. Error		
1	(Constant)	17.115	.249	68.759	.000
	Extended Study	-.797	.261	-3.055	.002
	Minor vehicle type 1	-.871	.279	-3.122	.002
	Minor vehicle type 3	.802	.335	2.390	.017
	Stop Duration (sec)	-.038	.009	-4.044	.000
	ORTL vehicle present	-.702	.312	-2.249	.025

Variables Entered/Removed

Model	Variables Entered	Variables Removed	Method
1	ORTL vehicle present, Minor vehicle type 1, Extended Study, Stop Duration (sec), Minor vehicle type 3 ^a		. Enter

a. Dependent Variable: Stop Distance From Through Lane (ft)

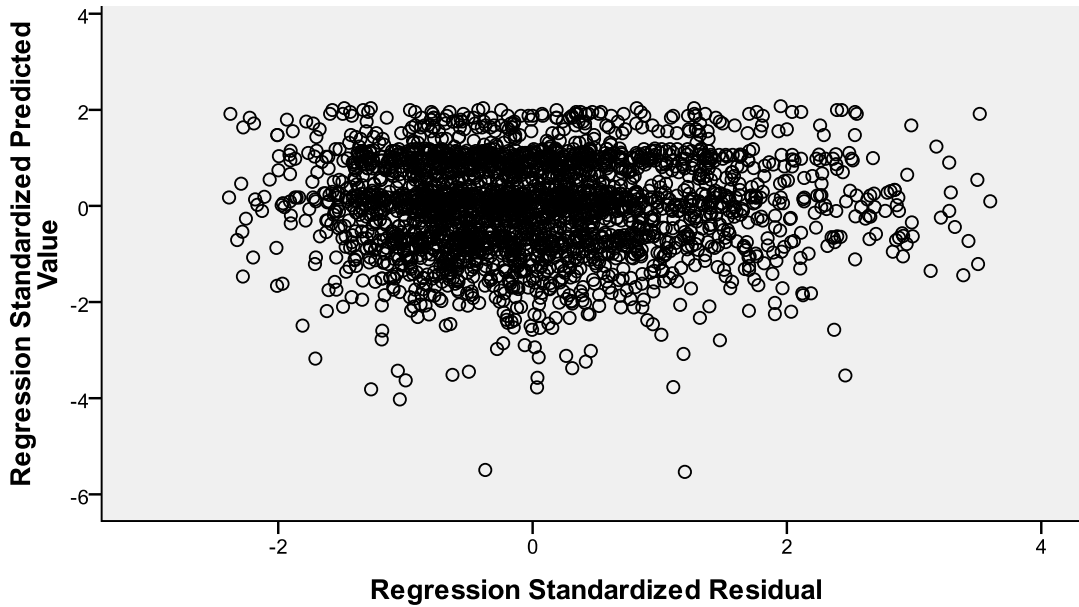

Tests of Normality

	Kolmogorov-Smirnov			Shapiro-Wilk		
	Statistic	df	Sig.	Statistic	df	Sig.
Studentized Residual	.053	2707	.000	.975	2707	.000

Normal Q-Q Plot of Studentized Residual

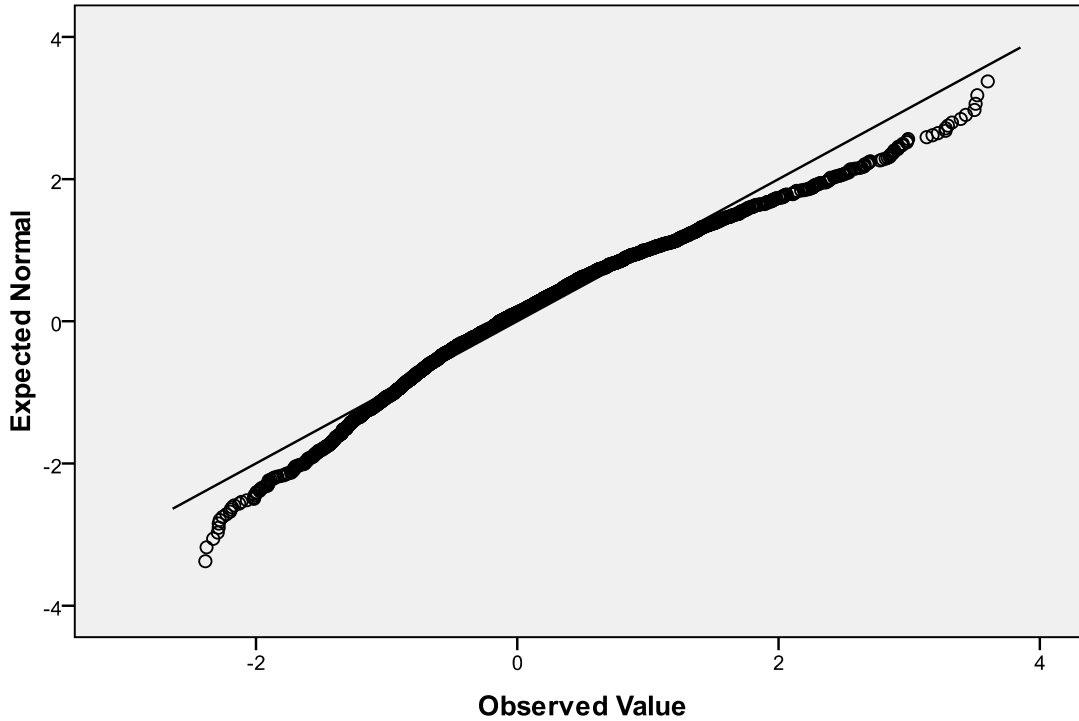

Lack of Fit Tests

Dependent Variable: Stop Distance From Through Lane (ft)

Source	Sum of Squares	df	Mean Square	F	Sig.
Lack of Fit	23326.925	537	43.439	1.075	.138

Model Summary^b

Model	R	R Square	Std. Error of the Estimate	Durbin-Watson
1	.145 ^a	.021	6.4028937	1.891

a. Predictors: (Constant), Extended Study, Minor vehicle type 3, ORTL vehicle present, Stop Duration (sec), Minor vehicle type 1

b. Dependent Variable: Stop Distance From Through Lane (ft)

Hwy 2 and 148th St. Outliers Removed Output

Casewise Diagnostics^a

Case Number	Std. Residual	Stop Distance From Through Lane (ft)	Predicted Value	Residual
13	-2.007	4.5007	17.353190	-12.8524789
37	2.024	28.6700	15.712674	12.9573417
53	-2.323	.4258	15.299517	-14.8737240
56	3.387	36.3001	14.610303	21.6897645
57	2.394	33.1701	17.841466	15.3286305
64	2.774	33.6303	15.868214	17.7621206
71	2.291	32.0201	17.353190	14.6669365
81	2.547	32.4800	16.168692	16.3113146
83	2.385	32.2500	16.977593	15.2724458
92	2.655	33.1701	16.168692	17.0014049
101	2.000	30.2712	17.465869	12.8053351
120	2.882	34.3209	15.868214	18.4526966
122	2.042	30.0410	16.964453	13.0765056
143	2.685	33.4002	16.206251	17.1939643
148	2.042	29.8107	16.739095	13.0715759
150	2.034	26.9200	13.896669	13.0233331
205	2.273	30.9522	16.401058	14.5511539
228	2.645	32.7100	15.775683	16.9343188
238	2.368	30.5016	15.342378	15.1591972
273	-2.224	3.4509	17.691227	-14.2402998
274	-2.165	2.1258	15.987901	-13.8621306
279	2.232	31.1827	16.889334	14.2933618
305	2.618	32.4800	15.717975	16.7620310
411	2.497	32.2500	16.262930	15.9871091
413	3.428	37.2300	15.279370	21.9506788
435	2.701	32.7100	15.417498	17.2925039
438	2.550	34.0907	17.766347	16.3243633
443	2.690	33.1701	15.943333	17.2267631
444	2.219	30.0410	15.830654	14.2103044
451	2.539	32.0201	15.762543	16.2575836
498	2.877	34.5512	16.131132	18.4200852
499	3.211	36.3001	15.738123	20.5619445
598	2.304	31.6436	16.889334	14.7543070
601	2.055	28.4400	15.279370	13.1606305
650	2.272	30.7219	16.175700	14.5461819
666	3.517	40.2832	17.766347	22.5168819
687	3.175	37.4601	17.127832	20.3323017
712	3.599	39.1015	16.056012	23.0454658
751	-2.007	4.5007	17.353190	-12.8524789
764	2.060	30.0410	16.851774	13.1891847
806	2.913	33.6303	14.978892	18.6514426
823	-2.278	.0000	14.585883	-14.5858831
872	3.498	38.8712	16.476177	22.3949806

903	-2.376	2.5515	17.766347	-15.2147981
908	2.239	30.5016	16.168692	14.3328838
915	-2.282	.8500	15.462065	-14.6120653
922	2.105	28.2200	14.741423	13.4785929
932	2.790	34.0907	16.225370	17.8653399
946	2.277	31.1827	16.601996	14.5806995
955	2.864	34.3209	15.980893	18.3400175
972	2.883	33.8005	15.342378	18.4581011
998	-2.181	2.1258	16.093572	-13.9678017
1024	-2.387	.8500	16.131132	-15.2811318
1044	2.107	28.4400	14.948340	13.4916597
1054	2.649	32.2809	15.316929	16.9639289
1056	3.504	37.2615	14.828653	22.4328135
1058	3.277	36.8500	15.868214	20.9817983
1065	2.260	30.6409	16.168692	14.4721717
1070	2.584	32.4900	15.943333	16.5466728
1090	2.440	32.2500	16.626416	15.6235857
1103	2.136	29.7321	16.056012	13.6760477
1158	2.432	33.4103	17.841466	15.5688273
1170	3.276	37.7903	16.814214	20.9761244
1179	-2.276	2.9333	17.503429	-14.5700859
1189	-2.292	1.7280	16.401058	-14.6730241
1208	2.261	31.3303	16.851774	14.4785387
1224	2.633	32.9501	16.093572	16.8565250
1238	2.907	34.0417	15.429608	18.6120896
1272	2.200	30.6409	16.551296	14.0895668
1277	2.112	30.4111	16.889334	13.5217777
1280	2.394	32.0200	16.689226	15.3307988
1294	2.978	36.6100	17.540988	19.0690116
1311	2.129	29.7321	16.100580	13.6314800
1358	2.536	34.0417	17.803906	16.2377916
1396	2.422	30.8706	15.361497	15.5091510
1422	2.491	32.9501	17.002013	15.9480843
1444	2.352	30.4111	15.354489	15.0566225
1457	2.113	31.3303	17.803906	13.5264065
1466	2.044	29.9617	16.877025	13.0846843
1489	2.946	35.4403	16.576547	18.8637704
1506	2.261	32.0200	17.540988	14.4790365
1583	2.460	28.4000	12.650191	15.7498374
1588	2.363	32.0200	16.889334	15.1306912
1616	2.915	34.0417	15.379938	18.6617601
1648	2.983	34.7410	15.642856	19.0981934
1653	2.041	30.8706	17.803906	13.0667416
1707	2.535	33.5824	17.353190	16.2291923
1715	-2.009	1.5381	14.403386	-12.8653351
1717	2.136	30.1914	16.513737	13.6776560
1757	2.677	34.0417	16.902474	17.1392244
1770	2.008	29.3204	16.463868	12.8565686

1773	2.508	32.9501	16.889334	16.0607634
1782	-2.191	3.5504	17.578548	-14.0281960
1797	2.252	31.3902	16.969482	14.4206776
1824	2.170	28.9304	15.033789	13.8966531
1832	2.121	27.8400	14.257146	13.5828698
1857	2.377	30.4809	15.259147	15.2217203
1860	2.396	30.7107	15.371827	15.3388247
1872	-2.015	2.2475	15.146468	-12.8989587
1958	2.388	31.1603	15.867111	15.2931606
1966	3.289	37.2902	16.230398	21.0598282
1974	2.833	33.2103	15.071349	18.1389461
1976	2.372	28.7302	13.543512	15.1866619
1978	2.111	28.9603	15.441645	13.5186470
2009	2.034	28.2800	15.259147	13.0208808
2070	2.301	30.7107	15.979790	14.7308615
2078	2.190	28.2800	14.257146	14.0228819
2197	-2.068	3.2430	16.481206	-13.2381823
2201	2.656	32.7601	15.754432	17.0056662
2260	2.989	34.5109	15.371827	19.1390790
2266	2.312	30.7107	15.904670	14.8059809
2283	2.518	32.9802	16.856803	16.1233809
2286	3.131	34.7406	14.695752	20.0448827
2294	-2.109	2.6400	16.143168	-13.5031305
2301	2.815	34.2811	16.255847	18.0252961
2371	2.127	27.8400	14.219587	13.6204295
2392	-2.254	1.2827	15.716872	-14.4342183
2445	2.271	30.4809	15.942230	14.5386378
2465	2.137	29.8117	16.130028	13.6816890
2476	2.942	34.0601	15.221588	18.8384841
2482	2.030	28.7302	15.730012	13.0001624
2487	-2.197	.8884	14.958670	-14.0702443
2502	2.319	30.0314	15.184028	14.8473721
2506	3.321	36.8201	15.554324	21.2657426
2507	2.859	33.6020	15.296707	18.3053300
2534	2.388	32.0700	16.781683	15.2883184
2535	2.465	31.8402	16.054909	15.7852479
2544	2.229	29.8117	15.541184	14.2705334
2554	2.847	34.5101	16.280267	18.2298776
2558	2.536	31.1603	14.921110	16.2391610
2585	2.847	34.5109	16.280267	18.2306383
2697	-2.127	2.2475	15.867111	-13.6196009

a. Dependent Variable: Stop Distance From Through Lane (ft)

Tests of Normality

	Kolmogorov-Smirnov			Shapiro-Wilk		
	Statistic	df	Sig.	Statistic	df	Sig.
Studentized Residual	.046	2539	.000	.983	2539	.000

Normal Q-Q Plot of Studentized Residual

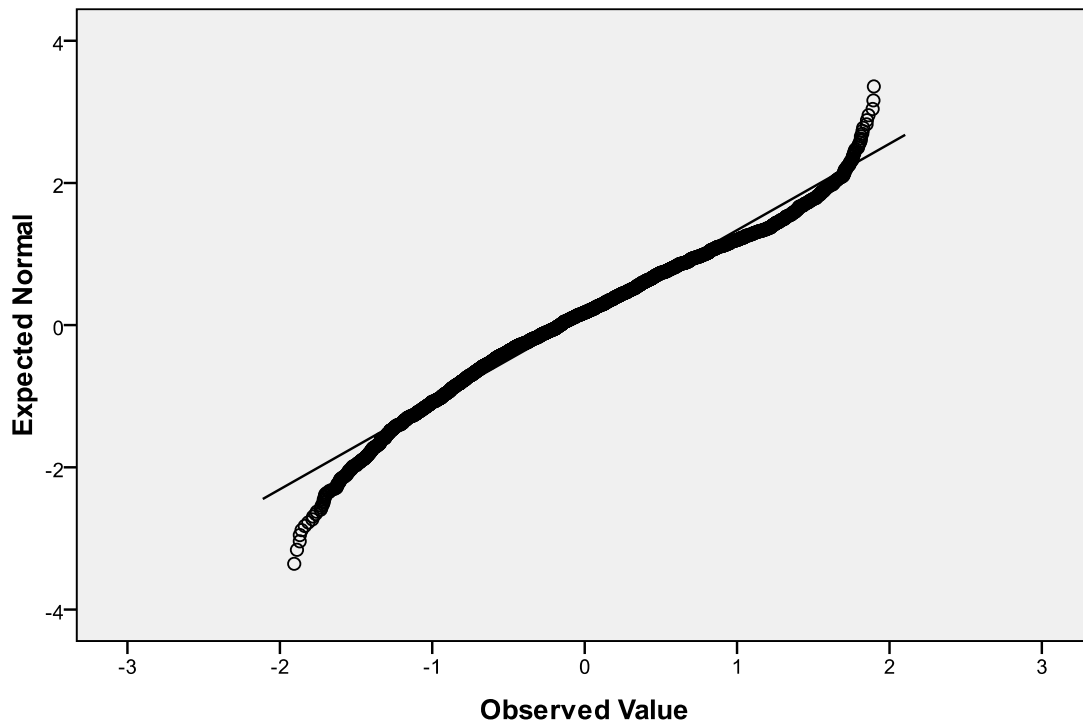

Hwy 77 and Hwy 41 Output

Regression

Variables Entered/Removed

Model	Variables Entered	Variables Removed	Method
1	Stop Duration (sec), Monday, Minor vehicle type 2 ^a		Enter

a. All requested variables entered.

Model Summary

Model	R	R Square	Std. Error of the Estimate
1	.194 ^a	.038	8.6416650

ANOVA^b

Model		Sum of Squares	df	Mean Square	F	Sig.
1	Regression	2525.762	3	841.921	11.274	.000 ^a
	Residual	64746.151	867	74.678	Fcrit	
	Total	67271.913	870		2.615	

a. Predictors: (Constant), Stop Duration (sec), Monday, Minor vehicle type 2

b. Dependent Variable: Stop Distance From Through Lane (ft)

Coefficients^a

Model				t	Sig.
		B	Std. Error		
1	(Constant)	18.013	.492	36.597	.000
	Monday	1.532	.772	1.985	.047
	Minor vehicle type 2	1.892	.672	2.817	.005
	Stop Duration (sec)	-.090	.022	-4.108	.000

a. Dependent Variable: Stop Distance From Through Lane (ft)

Normal Q-Q Plot of Studentized Residual

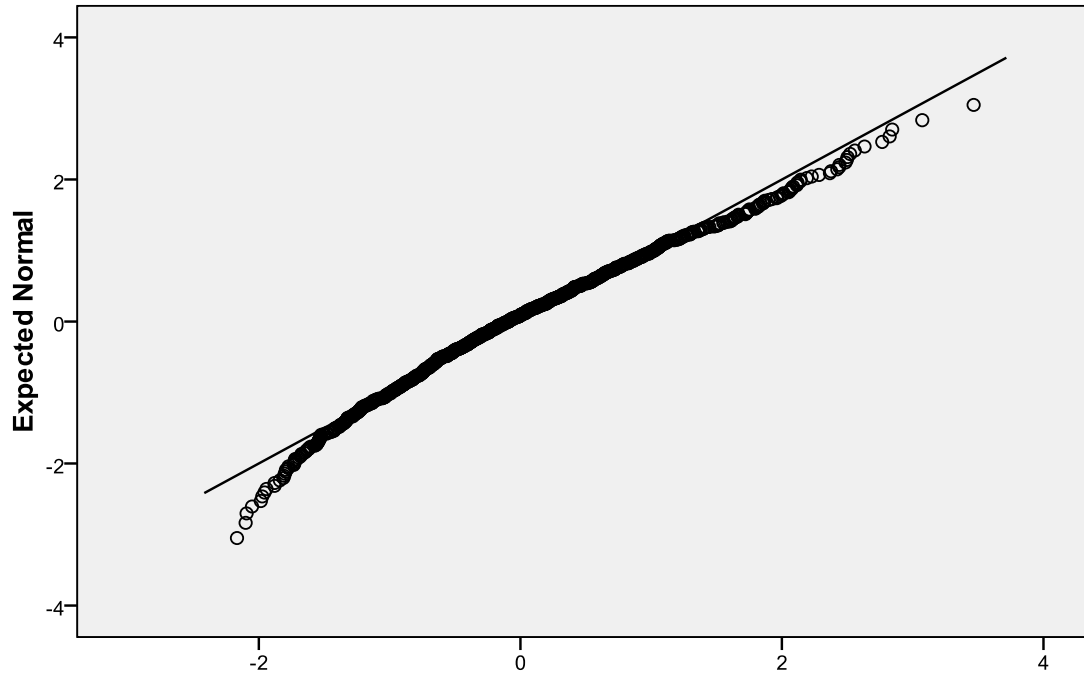

Tests of Normality

	Kolmogorov-Smirnov			Shapiro-Wilk		
	Statistic	df	Sig.	Statistic	df	Sig.
Studentized Residual	.044	871	.000	.986	871	.000

Scatterplot

Dependent Variable: Stop Distance From Through Lane (ft)

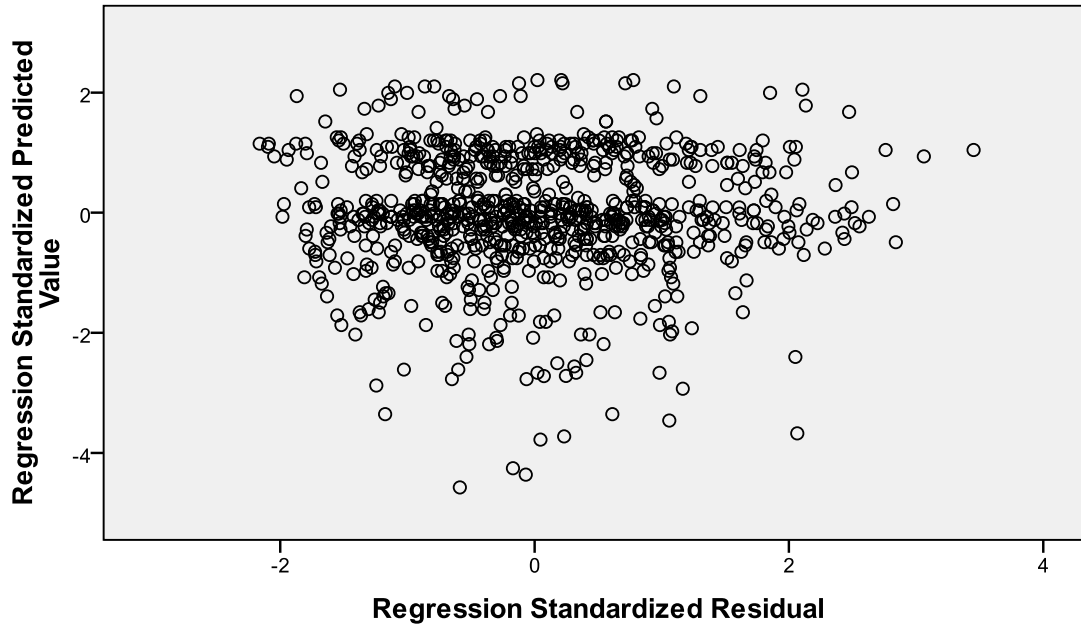

Model Summary^b

Model	R	R Square	Adjusted R Square	Std. Error of the Estimate	Durbin-Watson
1	.194 ^a	.038	.034	8.6416650	2.104

a. Predictors: (Constant), Stop Duration (sec), Monday, Minor vehicle type 2

b. Dependent Variable: Stop Distance From Through Lane (ft)

Lack of Fit Tests

Dependent Variable: Stop Distance From Through Lane (ft)

Source	Sum of Squares	df	Mean Square	F	Sig.
Lack of Fit	8509.827	146	58.286	.747	.985

Hwy 77 and Hwy 41 Outliers Removed Output

Casewise Diagnostics^a

Case Number	Std. Residual	Stop Distance From Through Lane (ft)	Predicted Value	Residual
18	2.364	37.9000	17.470912	20.4290898
98	2.188	36.2900	17.380617	18.9093845
103	2.117	34.6800	16.387376	18.2926254
112	-2.047	1.4900	19.182789	-17.6927556
131	2.437	37.9000	16.838849	21.0611522
144	2.140	35.6000	17.109733	18.4902684
168	-2.089	1.4900	19.543968	-18.0539340
211	2.225	36.5200	17.290322	19.2296791
270	2.075	34.6800	16.748555	17.9314469
284	2.083	35.8300	17.832090	17.9979114
293	2.055	37.2100	19.453673	17.7563284
319	2.282	36.2900	16.567965	19.7220361
330	2.519	39.0600	17.290322	21.7696790
376	2.761	43.2200	19.363378	23.8566228
386	2.474	41.8200	20.443560	21.3764416
390	2.043	36.7500	19.092860	17.6571409
397	2.051	31.2200	13.494594	17.7254078
437	2.133	39.0600	20.624149	18.4358512
447	2.368	38.8300	18.370503	20.4594965
450	2.066	29.1800	11.327523	17.8524772
500	2.436	38.6100	17.561206	21.0487939
506	2.008	36.8100	19.453673	17.3563270
513	2.004	34.3400	17.019438	17.3205616
600	2.421	37.9400	17.019438	20.9205616
611	2.841	41.3000	16.748555	24.5514455
625	2.629	40.1900	17.470912	22.7190885
669	-2.096	1.3400	19.453673	-18.1136730
681	2.820	42.2000	17.832090	24.3679100
702	2.555	39.2801	17.200028	22.0800347
721	2.061	35.4601	17.651501	17.8085683
740	2.496	40.3001	18.731316	21.5687448
768	2.107	39.2801	21.075622	18.2044404
798	3.062	45.6401	19.183155	26.4568986
806	3.453	49.2000	19.363744	29.8363054
825	2.492	39.2801	17.741795	21.5382670
849	-2.162	.8628	19.543968	-18.6811235

a. Dependent Variable: Stop Distance From Through Lane (ft)

Tests of Normality

	Kolmogorov-Smirnov			Shapiro-Wilk		
	Statistic	df	Sig.	Statistic	df	Sig.
Studentized Residual	.040	827	.004	.987	827	.000

Normal Q-Q Plot of Studentized Residual

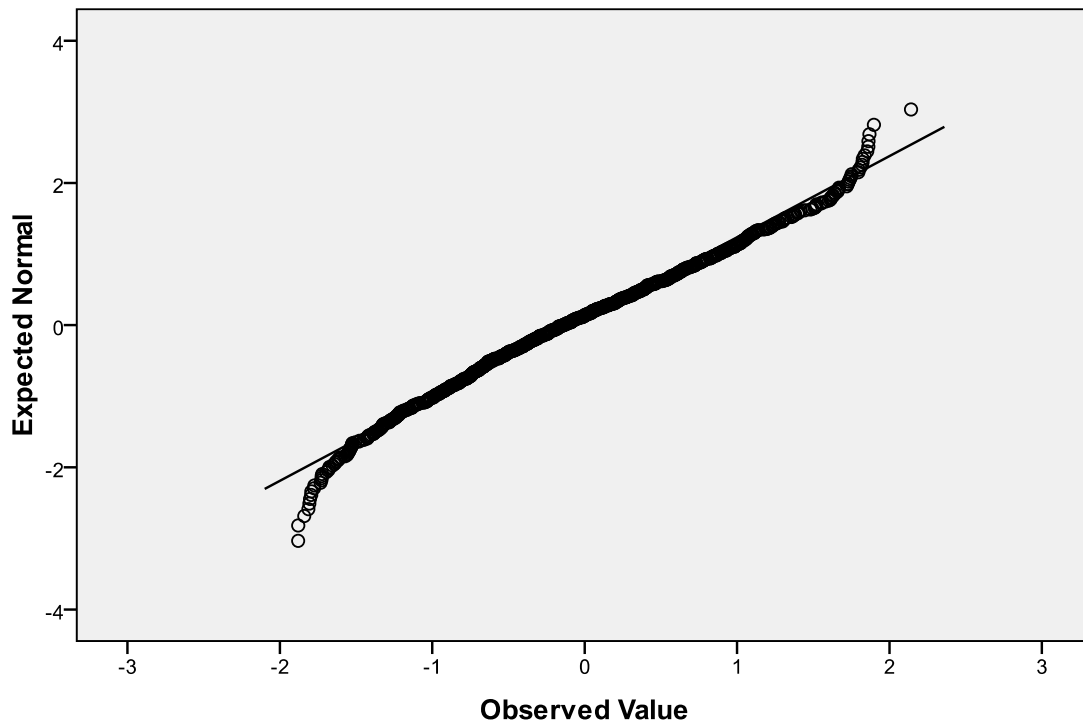

APPENDIX 3: Data Transformations
148th and Hwy 2
Square Root Transform

Tests of Normality

	Kolmogorov-Smirnov			Shapiro-Wilk		
	Statistic	df	Sig.	Statistic	df	Sig.
Studentized Residual	.018	2707	.046	.997	2707	.000

Normal Q-Q Plot of Studentized Residual

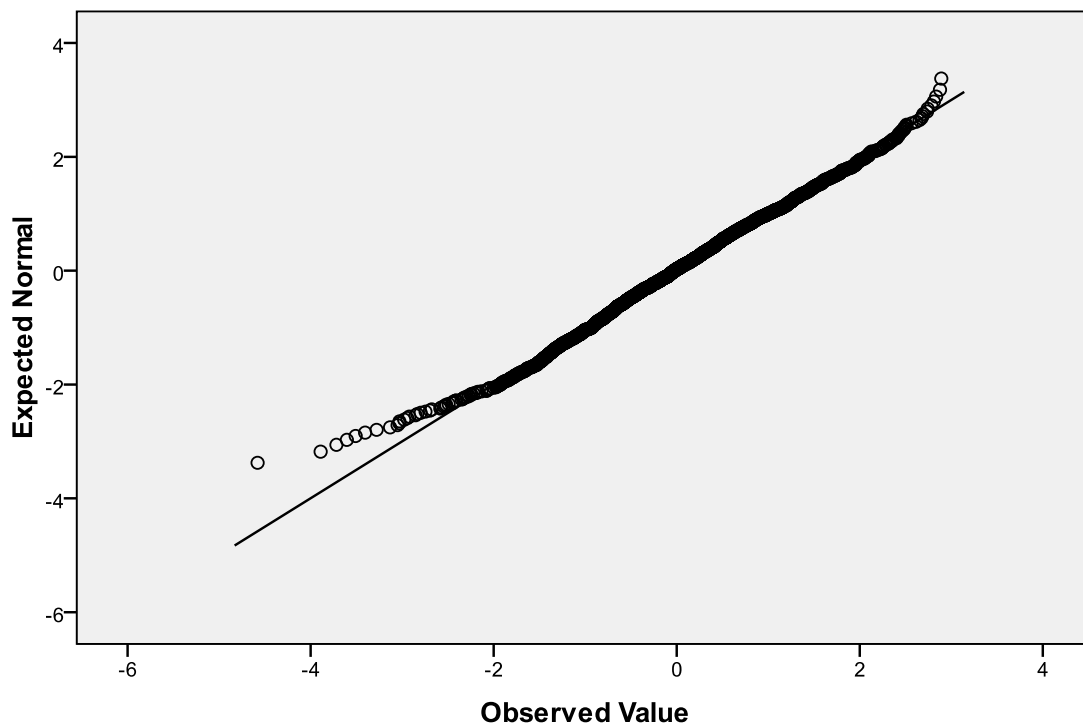

Natural Log Transform

Tests of Normality

	Kolmogorov-Smirnov			Shapiro-Wilk		
	Statistic	df	Sig.	Statistic	df	Sig.
Studentized Residual	.037	2707	.000	.969	2707	.000

Normal Q-Q Plot of Studentized Residual

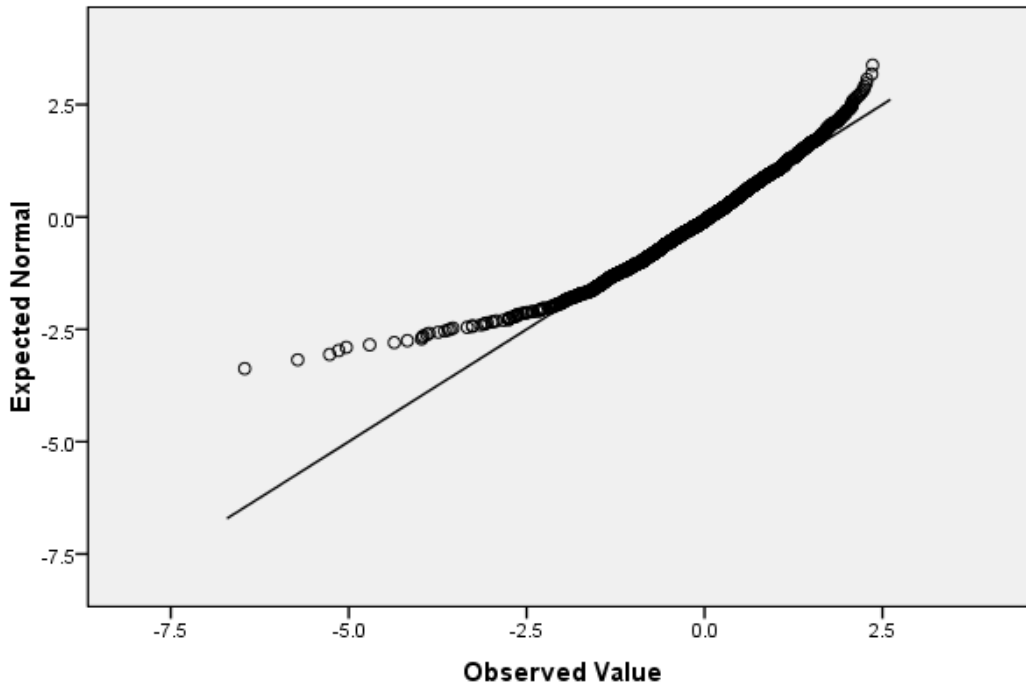

Log base 10 Transform

Tests of Normality

	Kolmogorov-Smirnov			Shapiro-Wilk		
	Statistic	df	Sig.	Statistic	df	Sig.
Studentized Residual	.043	2706	.000	.951	2706	.000

Normal Q-Q Plot of Studentized Residual

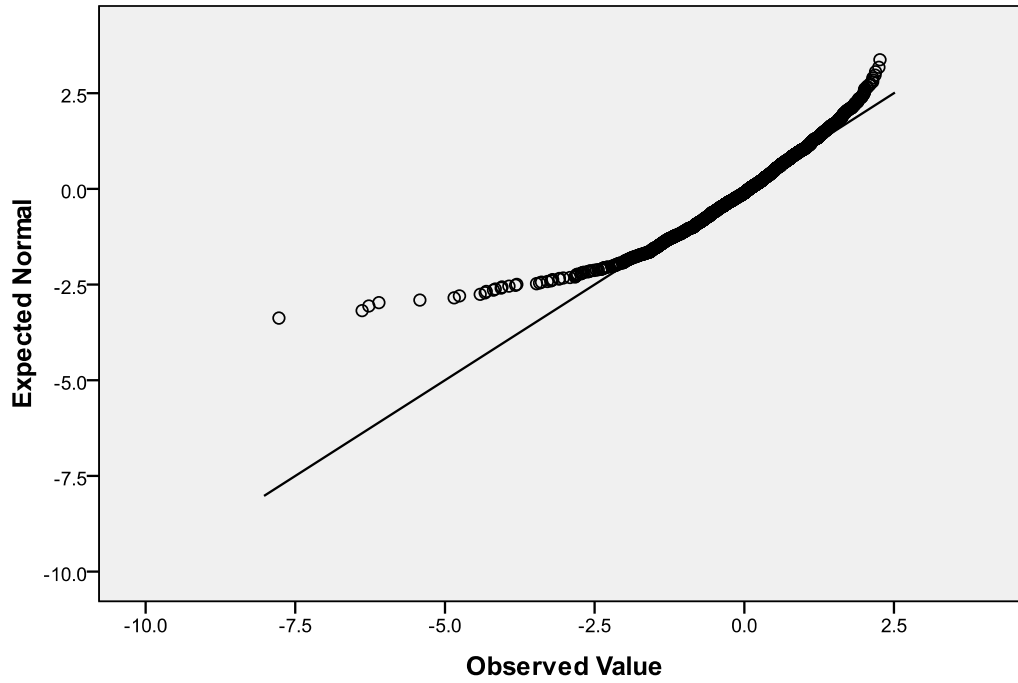

Inverse Transform

Tests of Normality

	Kolmogorov-Smirnov			Shapiro-Wilk		
	Statistic	df	Sig.	Statistic	df	Sig.
Studentized Residual	.229	2706	.000	.358	2706	.000

Normal Q-Q Plot of Studentized Residual

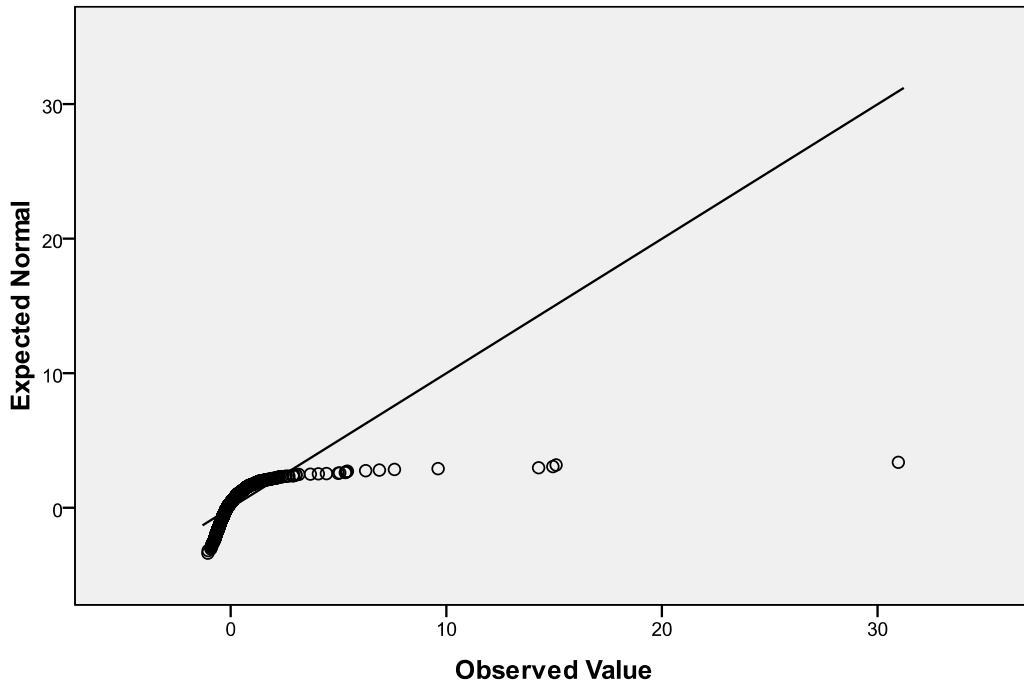

**Hwy 77 and Hwy 41
Square Root Transform**

Tests of Normality

	Kolmogorov-Smirnov			Shapiro-Wilk		
	Statistic	df	Sig.	Statistic	df	Sig.
Studentized Residual	.234	871	.000	.699	871	.000

Normal Q-Q Plot of Studentized Residual

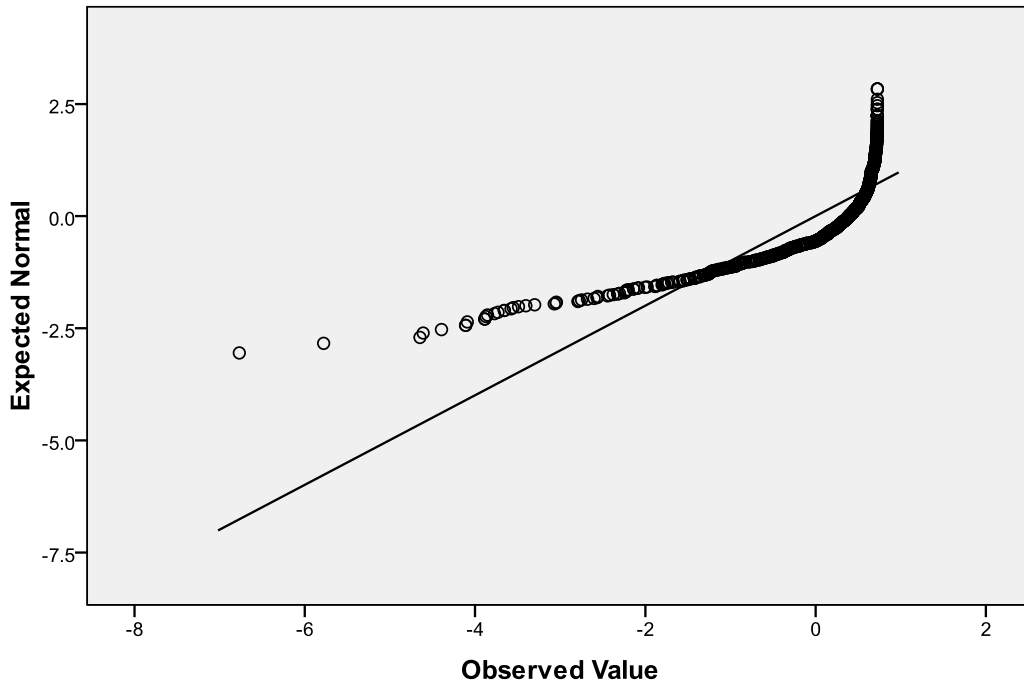

Natural Log Transform

Tests of Normality

	Kolmogorov-Smirnov			Shapiro-Wilk		
	Statistic	df	Sig.	Statistic	df	Sig.
Studentized Residual	.262	871	.000	.601	871	.000

Normal Q-Q Plot of Studentized Residual

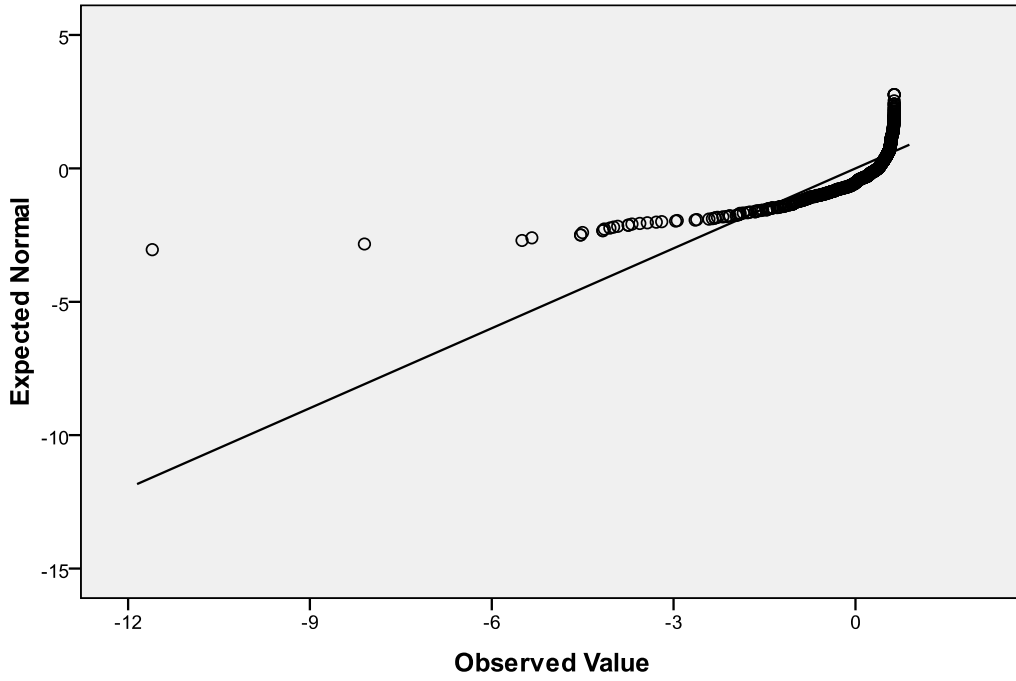

Log Base 10 Transform

Tests of Normality

	Kolmogorov-Smirnov			Shapiro-Wilk		
	Statistic	df	Sig.	Statistic	df	Sig.
Studentized Residual	.262	871	.000	.601	871	.000

Normal Q-Q Plot of Studentized Residual

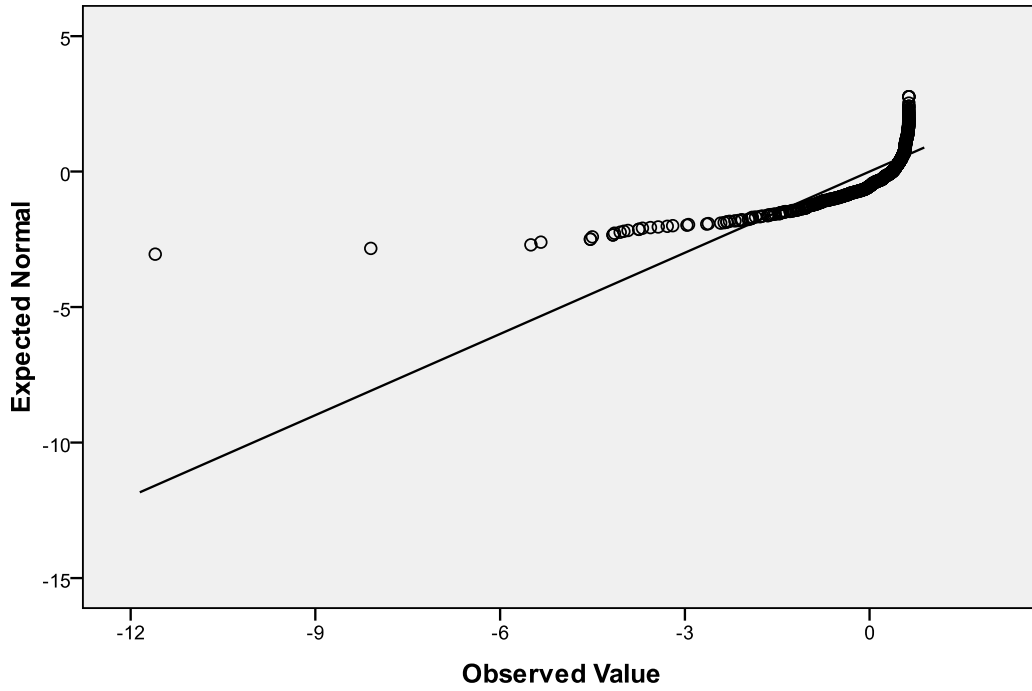

Inverse Transform

Tests of Normality

	Kolmogorov-Smirnov			Shapiro-Wilk		
	Statistic	df	Sig.	Statistic	df	Sig.
Studentized Residual	.388	871	.000	.142	871	.000

Normal Q-Q Plot of Studentized Residual

