

Embedded supervisory control and output reporting for the oscillating ultrasonic temperature sensors

HASHMI, Anas, MALAKOUTIKHAH, Maryam, LIGHT, Roger and KALASHNIKOV, Alexander

Available from Sheffield Hallam University Research Archive (SHURA) at:

<http://shura.shu.ac.uk/13508/>

This document is the author deposited version. You are advised to consult the publisher's version if you wish to cite from it.

Published version

HASHMI, Anas, MALAKOUTIKHAH, Maryam, LIGHT, Roger and KALASHNIKOV, Alexander (2015). Embedded supervisory control and output reporting for the oscillating ultrasonic temperature sensors. In: SILHAVY, R., SENKERIK, R., OPLATKOVA, Z.K., PROKOPOVA, Z. and SILHAVY, P., (eds.) Intelligent Systems in Cybernetics and Automation Theory. Springer, 139-150.

Repository use policy

Copyright © and Moral Rights for the papers on this site are retained by the individual authors and/or other copyright owners. Users may download and/or print one copy of any article(s) in SHURA to facilitate their private study or for non-commercial research. You may not engage in further distribution of the material or use it for any profit-making activities or any commercial gain.

Embedded supervisory control and output reporting for the oscillating ultrasonic temperature sensors

A.Hashmi, M.Malakoutikhah, R.A.Light, A.N.Kalashnikov

Abstract. Ultrasonic temperature sensors can potentially outperform conventional sensors because they are capable of very fast sensing across the complete ultrasound pathway, whilst conventional sensors only sense temperature at a single point and have substantial thermal inertia. We report recent developments in electronic instrumentation for oscillating ultrasonic temperature sensors with the aim of achieving high accuracy and low scatter at a low cost.

Keywords: temperature sensor, ultrasonic instrumentation, ultrasonic NDE

1 Introduction to ultrasonic NDE sensors

Ultrasonic sensors utilise ultrasonic waves for non-destructive or non-invasive probing of media or objects of interest. These sensors consist of at least one ultrasonic transducer to transmit and receive ultrasonic waves (or two separate transducers, one for reception and one for transmission) and supporting electronics [1]. Most applications of ultrasonic sensors are concerned with finding the voids or discontinuities from which the waves reflect in opaque objects or media. Examples include underwater sensors for locating fish and marine navigation; air sonars for range finding in construction and used as parking sensors; medical ultrasonic imaging and some other non-destructive testing, detection of obstacles, proximity sensing and imaging applications (e.g. [2]).

Another group of ultrasonic sensors is used to evaluate changes in the object or medium where the ultrasonic waves propagate; for example, non-destructive evaluation (NDE) for quality control or online process monitoring. In those types of sensors, changes in the ultrasound propagation parameters (amplitude and/or time of flight - TOF), sometimes across a range of frequencies for ultrasonic spectroscopy, are measured in order to evaluate the state of the wave propagation environment.

Compared to the majority of sensors that operate based on other physical principles, NDE ultrasonic sensors can sense the environment across the complete ultrasonic pathway instead of only a single point. This feature allows one to obtain “averaged” or “integrated” estimates using only one or two ultrasonic transducers without the need to install a number of conventional sensors, such as thermistors, to find the average temperature in a process vessel.

Another advantage of NDE ultrasonic sensors relates to the fact that the environment of interest is employed as part of the sensor itself without the need for any intermediation. Correct reading of most temperature sensors requires the sensor to

first attain thermal equilibrium with the environment and that can take up to several seconds or even tens of seconds depending on the conventional sensor's thermal inertia. In contrast, ultrasonic waves propagate hundreds of metres in gases and thousands of metres in liquids and solids in just one second, enabling faster response to changing process conditions or potential thermal runaways.

Ultrasonic measurements frequently involve balancing between two contradictory requirements. On one hand, increasing the operating frequency of the transducer(s) decreases both the ultrasound wavelength and the time period, thus improving both the spatial and temporal resolutions. On the other hand, increasing the operating frequency leads to a rapid increase in the ultrasonic wave's attenuation, which reduces the signal-to-noise ratio (SNR) at the output of the ultrasonic receiver. Insufficient SNR could lead to substantial uncertainty of the measurement results [3]. In those cases, the ultrasonic pathway may need to be reduced in order to restore the SNR to an acceptable level. The cost of the transducer(s) is another important consideration that affects the selection of the operating frequency of an ultrasonic sensor. High frequency ultrasonic transducers (operating at tens of MHz and above) can cost over one-thousand dollars each, whilst mass produced devices operating at 25 or 32 or 40 kHz can be bought for a few dollars in large quantities.

Our research group aims to develop inexpensive ultrasonic sensors that can outperform their traditional counterparts (e.g. [4-7]). Cost requirements force the utilization of mass produced transducers operating in the 20 to 50 kHz frequency range. Section 2 discusses several electronic architectures for these sensors of which we believe the oscillating sensor architecture is most advantageous. In addition to the circuitry that is required to sustain the oscillations and keep the sensor within the desired operating conditions, oscillating ultrasonic sensors should be equipped with a microcontroller that provides supervisory control of electronics, measurement of the output frequency and the ability to communicate that measured frequency or the related process parameter to the data consumer. The output frequency should be measured with high resolution and accuracy (e.g. 100 ppm uncertainty may not be sufficient for some temperature measurements) using one out of several approaches discussed in Section 3. Section 4 summarises our experiences with various implementations for band pass filters (BPFs) that are required to keep the operating frequency of an oscillating sensor within a particular range. Section 5 presents recent developments for the amplifier, required to compensate for the energy losses in the sensor loop, related to the addition of the automatic gain control that enables scatter reduction of the output frequency of a sensor. The recent design of the phase shifter, needed to tune the output frequency of the sensor to the required value at the particular calibration point, is presented in Section 6. Section 7 concludes this paper.

2 Comparison of electronic architectures for ultrasonic NDE sensors

Ultrasonic NDE sensors can be used to measure and monitor various physical quantities using several arrangements of ultrasonic transducers [1,8]. More specific-

ly, we focus our discussion on ultrasonic temperature measurements of water using two separate ultrasonic transducers fixed against each other at the boundaries of the water containing vessel (through transmission arrangement). Ultrasonic sensing utilises the ultrasound velocity that is dependent upon the temperature; for example, for water that dependency varies from 1482.36 m/s at 20°C to 1509.14 m/s at 30°C with a quoted measurement uncertainty of less than 0.02 m/s [9]. In order to measure temperature with an uncertainty and/or resolution of 0.1°C, one needs to achieve the relative uncertainty/resolution of measured TOF that can be estimated using the following equation:

$$\frac{(1509\text{m/s} - 1482\text{m/s}) / (30^\circ\text{C} - 20^\circ\text{C})}{(1509\text{m/s} + 1482\text{m/s}) / 2} \times 0.1^\circ\text{C} \approx 1.8 \times 10^{-4}. \quad (1)$$

Let us consider several electronic architectures for the measurement of ultrasound TOF with the aim of determining how the above uncertainty can be achieved at low cost, assuming that we are interested in measurements for a typical process pipe with a 10 cm diameter where the expected TOF is around:

$$0.1\text{m} / 1500\text{ m/s} \approx 60\ \mu\text{s}. \quad (2)$$

The first option relates to direct measurement of the TOF using the setup presented in Fig.1 (here, and thereafter, the amplifier is used to compensate for the propagation and energy conversion losses).

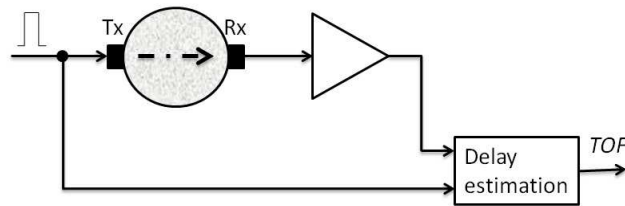

Fig. 1. Direct TOF measurement architecture

The delay estimation block measures the time interval between the instants of detection of the excitation pulse at input A and detection of the propagated pulse at input B. The time reference is provided by the clock oscillator. The delay estimator can be built to provide time resolution better than the period of the clock pulses. Examples of sub-sample delay estimation include cross-correlation processing (the shape of the pulse should not change much during its propagation, which holds in the being considered case), using the centre of gravity instants of both pulses to estimate the TOF ([10]) or by linearly interpolating samples of different signs to find the first zero crossing points for both pulses [11]. All these methods require considerable computing power, which would increase the cost of the sensor. A more affordable solution would simply involve counting the clock pulses between the detection of the two above mentioned pulses. In this case, the period of the clock oscillator should be smaller than the measured time interval by the inverse of the required resolution, i.e. the number of clock pulses counted during the measured time interval should be

greater or equal to the inverse of the required resolution. In the considered case, this requirement translates to the clock oscillator period of:

$$\text{appr. } 60 \mu\text{s} \times 10^{-4} \approx 6 \text{ ns}, \quad (3)$$

hence, the reference clock frequency needs to be around 150 MHz. Such a high frequency is difficult to use in low cost instrumentation; thus, this approach will only become feasible for pipes with larger diameters. Another potential problem with this approach is the potential jitter and uncertainty related to the pulse detections due to the additive noise presence.

TOF measurement can also be implemented by re-circulating a pulse (sending a pulse into water as soon as a pulse is detected at the receiver). The block diagram for an instrument implementing this “sing-around” architecture is presented in Fig. 2.

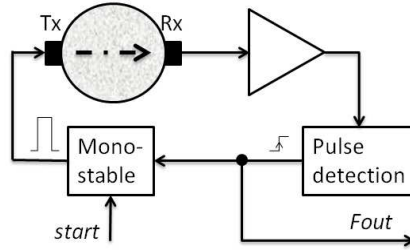

Fig. 2. Sing-around architecture

This arrangement enables one to measure the number of pulses that re-circulate over a known time interval and estimate the TOF as the ratio between the known measurement interval and the number of the re-circulated pulses. In order to achieve the required resolution, the number of pulses should be greater than the inverse of the required resolution. Consequently, the measurement time required to complete the measurement will be around:

$$\text{appr. } 60 \mu\text{s} / 10^{-4} \approx 0.6 \text{ s}. \quad (4)$$

Although, in many cases, this measurement time is not prohibitive, consistent jitter-free detection of the received pulses may be complicated by the inevitable presence of additive noise.

Measuring the phase shift between the continuous sine wave supplied to the transmitter and the output wave at the receiver $\Delta\phi$ (Fig. 3) could also be used to evaluate the TOF τ from the following equation:

$$\Delta\phi = 2\pi f\tau \Rightarrow \tau = \Delta\phi / (2\pi f), \quad (5)$$

where f is the frequency of the sine wave that is kept the same as the resonant frequency of the transducers in order to increase the SNR. For ultrasonic frequencies ($f > 20 \text{ kHz}$) the phase shift in the considered case would be greater than 2π ($20 \text{ kHz} \times 60 \mu\text{s} > 1$) and the phase shift estimator could only evaluate the fractional part.

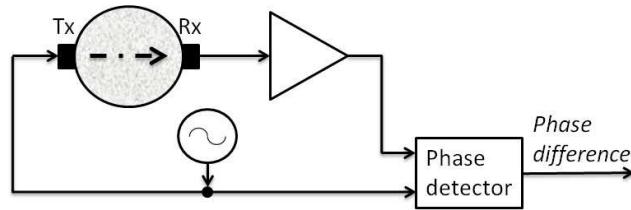

Fig. 3. Phase shift measurement architecture

Inexpensive phase shift estimators count reference pulses gated at the instants when the sine waves of interest cross the same amplitude level (e.g. zero crossing). To achieve the required resolution, the number of reference pulses for the complete period of the sine wave should be greater than the inverse of the resolution. For the lowest 20 kHz ultrasonic frequency, the period of the sine wave is 50 μ s, which is even smaller than the TOF in the considered case. Therefore the frequency of the reference pulses should be even higher than that in the case of direct TOF measurement architecture.

The oscillating ultrasonic sensors are attractive by their potential simplicity (only a single amplifier is required to make the sensor work, Fig. 4) and their

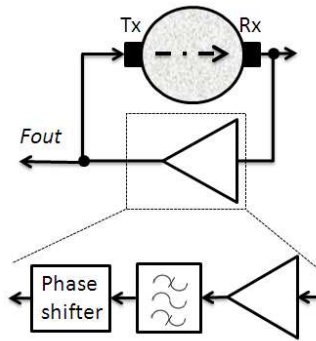

Fig. 4. Oscillating architecture

potentially shorter measurement time as compared to the sing-around ultrasonic sensors. The oscillating ultrasonic sensors, which have been developed in our group to date, oscillate at frequencies in the range 30-200 kHz, requiring less than

$$1 / (30 \text{ kHz} \times 10^{-4}) < 0.3 \text{ s} \quad (6)$$

in order to measure the sensor's output frequency to the required accuracy. In this case, a single amplifier does enable sustained oscillations, but very little control over the sensor's operation is possible. Moreover, most inexpensive ultrasonic transducers feature several resonances and they can start oscillations at different frequencies depending on, for example, the gain of the amplifier at start up, and some other factors,

in a somewhat unpredictable fashion. Therefore, a robust design must include an electronic filter that reliably enables operation only within a particular frequency range. Inclusion of a tuneable phase shifter is desirable in order to obtain a specific output frequency at a specific calibration temperature, allowing electronic compensation of the technological tolerances that inevitably occur during the manufacture and mounting of the transducers.

3 Provision of inexpensive but accurate measurements of the oscillating sensor's output frequency

Inexpensive but accurate frequency measurements can be achieved by using a digital counter and a reference clock oscillator with the frequency f_r . If the frequency of the reference oscillator is much higher than the frequency that is to be measured f_x , the counter is gated by a single period of the signal of interest counting N reference pulses. Then f_x is calculated as follows

$$f_x = f_r / N. \quad (7)$$

If the frequency of the reference oscillator is much lower than that is to be measured, the counter is gated by a single period of the reference oscillator and the input pulses are counted. The following expression becomes applicable for the frequency estimation:

$$f_x = f_r \times N. \quad (8)$$

The counter's output is accurate to a single pulse; thus, it can be inaccurate up to one count. Consequently, achieving the relative 10^{-4} resolution is possible if the number of pulses counted is no less than 10,000.

Sometimes the ratio between the frequencies is lower than the pulse count that ensures the required relative resolution. In this case, the counter needs to be gated not during a single period but over several periods of either f_x ($f_x < f_r$) or f_r ($f_x > f_r$) as appropriate [12]. In practice, frequency measurements with the required resolution can be achieved by employing two separate counters for the reference and input pulses; every time the lower frequency pulse counter increments, the value of the other counter is compared to the inverse of the required resolution. If the value of the counted high frequency pulses is higher, then the required resolution has already been achieved, the output frequency can be calculated and communicated and a new frequency measurement can be started by clearing both of the counters.

Another important factor in achieving the required resolution is the frequency stability and/or tolerance of the reference clock oscillator. Relatively inexpensive crystals, which cost a fraction of a dollar, can provide ± 30 – 50 ppm or 0.3 – 0.5×10^{-4} frequency tolerances in 1–10 MHz range when connected to appropriate pins of a microcontroller, which could be just about enough for the considered application. A crystal oscillator with similar tolerances costs more (around a dollar), but does not require a microcontroller to be capable of using a wide range of crystals and can gen-

erate waveforms with low jitter. Temperature compensated crystal oscillators (TCXO) are a more accurate (a few ppms only) but more expensive (a few dollars) option for the reference oscillator. Higher accuracy oven controlled crystal oscillators (OCXO) are prohibitive for low cost instrumentation because they typically cost around one-hundred dollars or more.

4 Implementing BPFs for oscillating ultrasonic sensors

Inclusion of a BPF into the signal loop of an oscillating ultrasonic sensor is essential if the sensor's ultrasonic transducers feature multiple resonances. This is frequently the case for low-cost, mass-produced transducers when they are securely attached to some supporting frame and/or are being submersed.

Dr Alzebda implemented a variable BPF using an LT1568 integrated circuit and digital potentiometers set by the supervisory microcontroller for ultrasonic oscillating temperature sensors operated above 300 kHz [4]. This relatively high operating frequency resulted in obtaining over 30 output frequency readings per second with the relative resolution of 10^{-4} , but the sensor could only operate at ultrasonic pathways of no more than about 30 mm—which is insufficient for the considered case.

Dr Popejoy developed an ultrasonic oscillating tilt sensor that operated with ultrasonic pathways of up to 500 mm at frequencies around 30 kHz [6]. As the operating frequency was well below the specified lowest operating frequency for the LT1568 parts, the variable BPF was built using two operating amplifiers and three digital potentiometers using the fliege BPF configuration [6,13].

Although the cost of the bill of materials (BOM) for this design was not too high, the adoption of specialised mixed-signal integrated circuits provides an opportunity to further reduce that cost. That approach consists of using programmable analogue and digital blocks, provided in addition to a fully featured microcontroller, in PSoC1 mixed signal microcontrollers manufactured by Cypress [14]. These devices include switched capacitor blocks that can be configured as various filters; additionally, they allow for adjustments of the filter properties at the run time by changing the values of the variable capacitors and/or changing the frequency at which the capacitors switch. There was a concern that using the switched capacitor principle would break the signal loop continuity, thereby disabling the sustained oscillations. However, PSoC1 band pass filters have been experimentally proven to be a viable low-cost option for implementing oscillating ultrasonic sensors, which on numerous occasions reliably operated for over fifty hours [15].

5 PSoC1-based amplifier combining both the discrete and continuous gain control

An oscillating ultrasonic sensor can function if and only if the energy conversion and propagation losses in the signal loop are fully compensated by an amplifier. The oscillations became sustained when the overall gain in the signal loop is greater

or equal to unity; but, if it exceeds unity even slightly, then the output signal of the amplifier quickly saturates at the rail voltages.

Earlier oscillating sensor designs included a fixed gain amplifier built using one or two operating amplifiers with digital potentiometers at the input and output, which allowed for variation of the overall gain [4, 6].

PSoC1 devices can contain up to four programmable gain amplifiers (PGAs) with quite a wide range of available discrete gain settings. The PGAs can be cascaded and used for the loss compensation and adjustment of the signal loop gain. Fig. 5 presents the experimental results for the output frequency of an ultrasonic temperature sensor with ultrasonic pathway of around 50 mm. An amplifier that featured two cascaded PGAs and a band pass filter. The gain of the first stage G_1 was fixed to the value shown in the figure legend, and the gain of the second stage G_2 was varied to obtain all of the curves presented in Fig. 5.

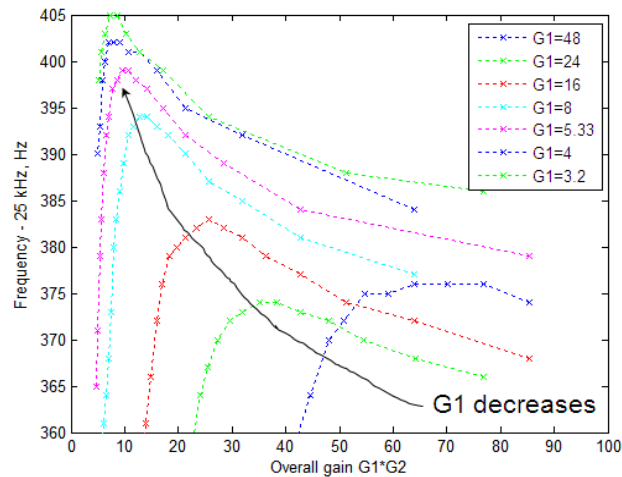

Fig. 5. Output frequency of an oscillating ultrasonic sensor, which was held at a constant temperature, depending on the overall gain in the signal loop and its composition

The results show that, even for the same overall gain, the output frequency could differ considerably depending on the gain composition, by around ± 10 Hz for the higher overall gains or even more for the lower overall gains. For every curve there was a maximum point at which variations of the gain of the second stage affected the gain of the sensor output frequency to a lesser extent. For this reason, the gain for the amplifiers was selected at one of the maximum points that featured maximum flatness ($G_1=24$ and overall gain of around 36 for the data presented in Fig. 5). It is important to note that this behaviour was observed without any involvement of the switched capacitor blocks present in PSoC; thus, it could not be attributed to the intermittent nature of their operation.

However, this selection could only be done once and at a single operating frequency. Temperature changes would affect both the ultrasound velocity and the gain of the amplifiers, to some extent, causing unwanted output frequency changes. Additionally, ultrasonic transducers would age, thereby becoming less efficient in

energy conversion, and in many situations the absorption of ultrasonic waves within the medium of interest could vary. These concerns called for the development of an amplifier that automatically adjusts its gain according to the changes of the signal losses in the signal loop.

The first design of the amplifier with supervisory gain control utilised PSoC1 comparators to detect whether the output voltage exceeded certain levels. If the upper level is exceeded by the output signal of the amplifier, then the gain of some of the PGAs is decreased. If the lower level is not exceeded, then the gain is increased. In practice, the output signal of the sensor was driven to saturation because digital control could not keep the overall gain exactly at unity because it was required to produce undistorted sine waveforms.

The first design of the amplifier with the analogue automatic gain control (AGC) included using an incandescent light bulb to set the gain of an operating amplifier, similar to [16]. Unfortunately, that design did not control the gain at the ultrasonic frequencies of interest (the reason for this remains unclear), despite the fact that the bulb itself featured nonlinear resistance and the operating amplifier provided enough current at a valid operating point. After examining, simulating and prototyping several other AGC circuits developed for audio processing, the best results overall were achieved using the circuit described in [17].

The final design of the amplifier featured both the supervisory and automatic gain controls and, in addition to a PSoC, it required one extra operating amplifier and one field effect transistor. The block diagram of this design is presented in Fig. 6. The first amplification stage (between points A and B) is implemented using a supervisory gain control to achieve the level of output voltage sufficient for the effective operation of the second amplifier with the AGC connected between points B and C. The circuitry between points C and D provides final amplification, frequency filtering and frequency measurement using another PSoC.

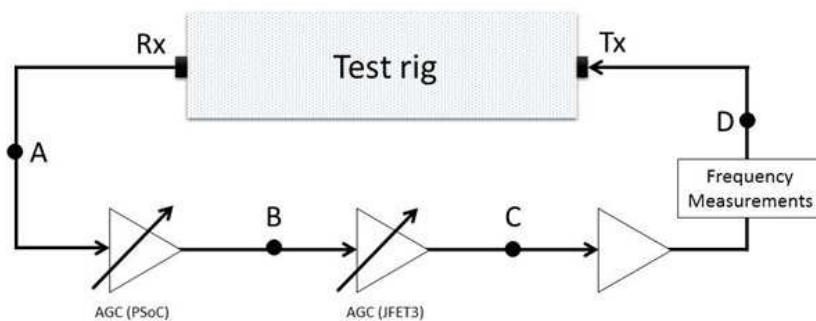

Fig. 6. Block diagram of the ultrasonic oscillating temperature sensor with supervisory and automatic gain controls

Experiments showed that this arrangement ensured the lowest scatter of the sensor output frequency at a constant temperature as compared to the previous designs. The downside of this arrangement is the increased BOM cost.

6 PSoC1-based tuneable phase shifter

Phase shifts at frequencies up to 1 MHz can be achieved at a low cost by employing RC circuits; the phase shift adjustment can be most conveniently implemented by controlling resistances in these circuits. In order to be deployed for an ultrasonic oscillating sensor, the phase shifter should operate across a range of frequencies and it should enable the setting of arbitrary phase shifts for flexibility.

Such a device can consist of several cascaded RC stages because a single RC stage cannot provide phase shifts of more than 90° . These stages would require buffering to reduce their influence on each other; compensation of the gain changes when tuning the phase; and quite an elaborated calibration to operate across a range of frequencies.

For this reason, we believe that a more robust approach is to create the required phase shift using the phasor diagram by adding in the phase and 90° shifted components with appropriate weights. The phase shifter that was previously developed utilised four digital potentiometers that set the required weights [13]. In the latest design, presented in Fig. 7 [18], these weights were set by altering gains of the programmable gain amplifiers (PGA1 and PGA2) and the values of the gain setting switched capacitors (SC) in SCBLOCK1. As the sign of the SCBLOCK1 input signal, coming from PGA1, can be altered programmatically, the output signal of this block can have a phase shift in the range from almost -90° to $+90^\circ$, which may be sufficient in practice. The other components in the design were employed to extend this range to the full range of 360 angular degrees by outputting either the output signal of the SCBLOCK1 or its copy inverted by the low pass filter.

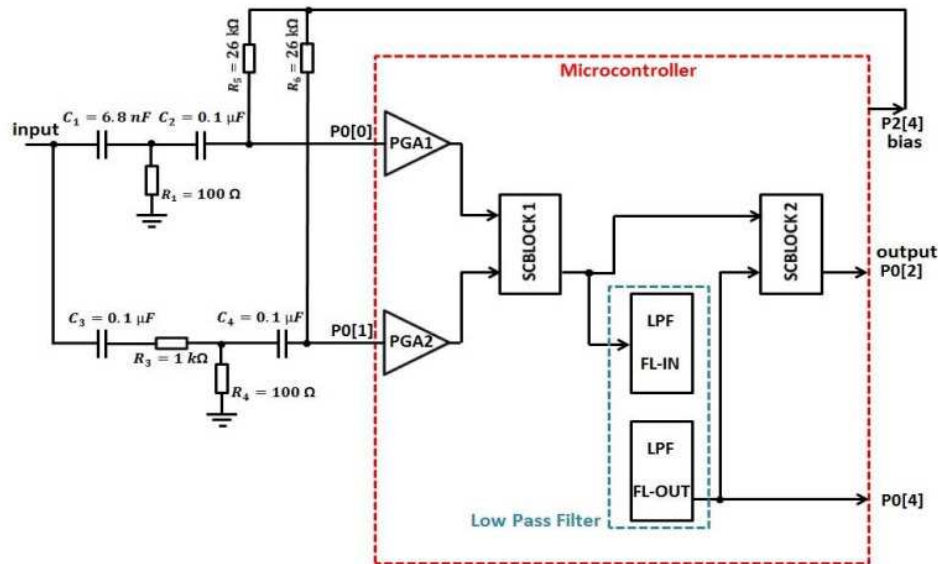

Fig. 7. Block diagram of the PSoC1 based tuneable phase shifter [18]

MATLAB simulation of the developed phase shifter showed that, by setting the correct values of the SCBLOCK1 capacitors, the resulting phase shift errors did not exceed $\pm 1.5^\circ$, whilst the variation of the output amplitude (that should ideally stay the same) did not exceed $\pm 1\%$ [18]. In practice, some larger deviations were observed that depended upon the method of the phase shift measurement. These deviations occurred because the output signal was modulated by the switching frequency of the capacitors, which complicated the situation, resulting in somehow ambiguous readings. An example of an experimental measurement is presented in Fig. 8 [18].

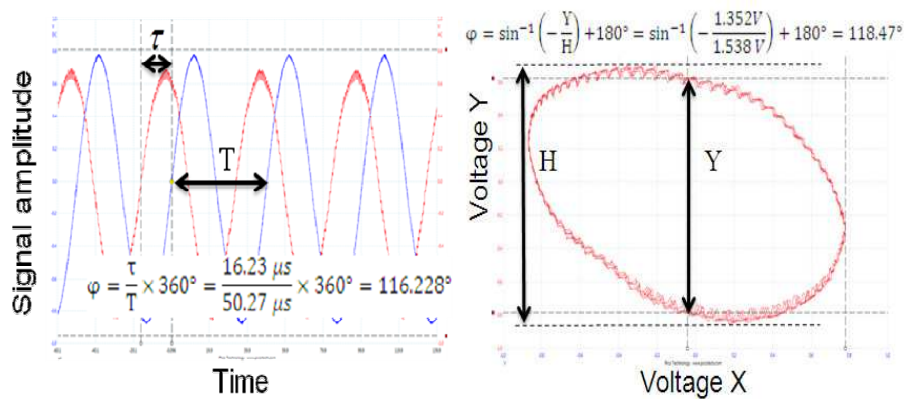

Fig. 8. Measurement of the actual phase shift using the direct oscilloscope method (left) and Lissajous figures (right) when the desired phase shift was set to 120° [18]

7 Conclusions

Although some industrial applications of ultrasonic thermometers have been reported a long time ago (e.g. [19]), development of a reliable high accuracy ultrasonic sensor for cost-sensitive applications still remains an engineering challenge. Our development of oscillating ultrasonic sensors show that even though it can be simple to make a sensor oscillate, getting it to perform reliably to the required specification is not easy. In this paper, we reported our recent development that enabled better control of the sensor's operation and behaviour; this was achieved using a limited number of low-cost electronic components that were evaluated on their own and which showed notable improvements over previous designs. The experimental assessment of the developed module together will be carried out soon.

8 References

1. R.C.Asher, Ultrasonic Sensors for Chemical and Process Plant (Sensors Series), Taylor and Francis, 1997, 496 p.

2. O.Sonbul and A.N.Kalashnikov, "Electronic Architecture for Air Coupled Ultrasonic Pulse-Echo Range Finding with Application to Security and Surface Profile Imaging", *Universal J. of Electrical and Electronic Eng.*, vol.2(3), 2014, pp. 105-111 (open access).
3. A.N.Kalashnikov and R.E.Challis, 2005. "Errors and uncertainties in the measurement of ultrasonic wave attenuation and phase velocity", *IEEE Trans. Ultrason., Ferroel. Freq. Control*, vol. 52, 2005, no.2, pp.1754-1768.
4. S.Alzebda, Low-cost oscillating sensing for ultrasonic testing and monitoring of liquids, PhD thesis, Nottingham University, 2011.
5. S. Alzebda and A. N. Kalashnikov, "Ultrasonic sensing of temperature of liquids using inexpensive narrowband piezoelectric transducers," *IEEE Trans Ultrasonics, Ferroel., Freq.Contr.*, vol. 57, 2010, no.12, pp. 2704-2711.
6. P.Popejoy, Development of an ultrasonic tilt sensor, PhD thesis, Nottingham University, 2014.
7. P.Popejoy, S.Alzebda, O.Sonbul and A.N.Kalshnikov, "Linear angle measurement using continuous wave ultrasonic oscillator", *Proc. 2012 IEEE Int. Instrumentation and Measurement Technol. Conf.*, 13-16 May 2012, Graz, Austria, pp.733-736.
8. A.Afaneh, S.Alzebda, V.Ivchenko and A.N.Kalashnikov, "Ultrasonic measurements of temperature in aqueous solutions: why and how", *Physics Research International*, 2011, 156396 (open access).
9. G.W.C.Kaye and T.H.Laby, Tables of Physical and chemical constants, Longman, 16th edition, sect. 2.4.1 "The speed and attenuation of sound".
10. A.N.Kalashnikov, K.L.Shafran, R.E.Challis, C.C.Perry, M.E.Unwin, A.K.Holmes, and V.Ivchenko, "Super-resolution in situ ultrasonic monitoring of chemical reactions", *Proc. 2004 IEEE Ultrasonics Symp.*, pp.549-552.
11. A.Afaneh and A.N.Kalashnikov, "Embedded processing of acquired ultrasonic waveforms for online monitoring of fast chemical reactions in aqueous solutions", in V.Haasz, ed., *Advanced distributed measuring systems: exhibits of application*, River Publishers, 2012, pp.67-93.
12. D.Van Ess, "Measuring frequency", application note AN2283, available online on <http://www.cypress.com/?rID=2671>, accessed Jan 2015.
13. P.Popejoy, S.Alzebda, A.Hashmi, M.Harriott, O.Sonbul, A.N.Kalashnikov and B.R.Hayes-Gill, "Comparison of implementations of driving electronics for ultrasonic oscillating sensors", *Proc. 2012 IEEE Ultrasonics Symp.*, pp.2427 – 2430.
14. PSoC® 1 product page, available online on <http://www.cypress.com/?id=1573>, accessed Jan 2015.
15. A.Hashmi, PSoC1-based data logging instrumentation for overnight measurement of the output frequency of ultrasonic oscillating sensors versus the ambient temperature, MSc thesis, Nottingham, 2013.
16. Wein bridge oscillator, available online on en.wikipedia.org/wiki/Wien_bridge_oscillator, accessed Jan 2015.
17. Effective AGC amplifier can be built at a nominal cost, available online on tinyurl.com/mqhz7rh, accessed Jan 2015.
18. M.Malakoutikhah, Optimisation of the oscillating temperature sensor cell for differential calorimeter use, MSc thesis, Nottingham, 2014.
19. L.C.Lynnworth, "Industrial Applications of Ultrasound - A Review: II. Measurements, Tests, and Process Control Using Low-Intensity Ultrasound", *IEEE Trans.Sonics Ultrason.*, vol.SU-22, 1975, no. 2, pp.71-101.