

A Low Power Single-stage LED Driver Operating between Discontinuous Conduction Mode and Critical Conduction Mode

AL-NAEMI, Faris, YANG, Jianbo and ZHANG, Weiping

Available from Sheffield Hallam University Research Archive (SHURA) at:

<http://shura.shu.ac.uk/13078/>

This document is the author deposited version. You are advised to consult the publisher's version if you wish to cite from it.

Published version

AL-NAEMI, Faris, YANG, Jianbo and ZHANG, Weiping (2015). A Low Power Single-stage LED Driver Operating between Discontinuous Conduction Mode and Critical Conduction Mode. *Energy Procedia*, 74, 817-825.

Repository use policy

Copyright © and Moral Rights for the papers on this site are retained by the individual authors and/or other copyright owners. Users may download and/or print one copy of any article(s) in SHURA to facilitate their private study or for non-commercial research. You may not engage in further distribution of the material or use it for any profit-making activities or any commercial gain.



International Conference on Technologies and Materials for Renewable Energy, Environment and Sustainability, TMREES15

A Low Power Single-Stage LED Driver Operating between Discontinuous Conduction Mode and Critical Conduction Mode

Faris Al-Naemi^a, Jianbo Yang^a, Weiping Zhang^b

^aSheffield Hallam University, 153 Arundel St, Sheffield, S1 2NU, United Kingdom

^bNorth China University of Technology, 5 Jianyuanzhuang St, Beijing, 100144, China

Abstract

A novel single-stage single-switch (S^4) LED driver is proposed in this paper. The paper focuses on the operation principles of the power stage circuit with an operation switched between Critical Conduction Mode (CRM) and Discontinuous Conduction Mode (DCM), including steady state analysis, simulation and backed up by experimental results. The results verify that this proposed LED driver can obtain a high power factor (PF) and the dc output is relatively stable.

© 2015 Published by Elsevier Ltd. This is an open access article under the CC BY-NC-ND license

(<http://creativecommons.org/licenses/by-nc-nd/4.0/>).

Peer-review under responsibility of the Euro-Mediterranean Institute for Sustainable Development (EUMISD)

Keywords: CRM; DCM; PFC; Single-stage

1. Introduction

Light-Emitting-Diode (LED) has become a commonly used solid-state light source in general lighting applications [1, 2]. It has longer lifetime and has no poison mercury content compared with the conventional fluorescent lamp [3]. So LEDs now have been drawing attention as a state-of-the-art illuminator and the driver of LEDs in the markets also keeps up with the progress in this promising field [4]. The active PFC converters can be implemented using either the “two-stage” approach or the “single-stage” approach. The most commonly used approach in ac/dc conversion that meets high power quality requirements is the “two-stage” approach [5]. The “two-stage” approach includes two power-conversion processes. The first stage is a PFC (power factor correction) stage like a boost converter, and the second stage normally is a dc/dc converter to regulate the output voltage. This approach has good performances for power factor (PF) and output-voltage regulation. The main disadvantage is the high cost due to an increase in the device count. This “two-stage” PFC ac/dc converter usually increases the cost by about 15%, compared with that of an ac/dc converter without PFC [6-9].

In order to reduce the cost, the single-stage approach, which integrates the PFC stage with a dc/dc converter into one stage, has been presented in this paper. These integrated single-stage PFC converters usually use a boost converter to achieve PFC in discontinuous conduction mode (DCM) operation and constant on-time control, which is known as the voltage-follower approach. This approach is simpler to be implemented than the multiplier approach (usually for continuous conduction mode (CCM) operation); however, it requires an input filter to obtain a good input current waveform. In this paper, the proposed converter operates between the DCM and critical conduction mode (CRM). The input current falls to zero without dwelling at zero in part of the half-line frequency cycle. Therefore, for a given throughput power, the proposed operation involves lower peak input current than the pure DCM operation and requires smaller input filter. Furthermore, the dc bus voltage is controlled directly, which solves the high voltage stress problem existed in the single-stage PFC converter.

2. Operation Principle

2.1. Power stage

The proposed single-stage PFC converter is briefly illustrated in Fig.1. Although the power stage circuit has only one switch, two conversion stages can be identified. In fact, input inductor L_1 , rectifier D_1, D_2 , switch Q_1 and internal energy-storage capacitor C_p form a DCM boost power stage, while switch Q_1 , the transformer T_1 , freewheeling diode D_3 , output rectifier D_4 and output-filter capacitor C_2 make up a forward power stage. Referring to Fig.1, the operating principle of the proposed converter can be explained as follows;

When Q_1 is turned on, L_1 is energized by the rectified input voltage and inductor current i_{in} increases. At the same time, the primary of the transformer T_1 is energized by C_p . D_4 is forward biased. Thus, the energy is being transferred to the output.

When Q_1 is turned off, energy stored in L_1 is being transferred to C_p and i_{in} is decreasing to zero. D_3 is forward biased and C_p is energized by the demagnetization winding of T_1 to restore the transformer core. As a result, i_{D3} is also decreasing to zero. D_4 is reverse biased and output is supplied by C_2 .

To achieve low harmonic distortions in i_{in} , L_1 is usually operated in the DCM [10]. The proposed converter operates in a mode switching between DCM and BCM. This obviously further reduces the input current distortion. The control scheme will be discussed in the following section.

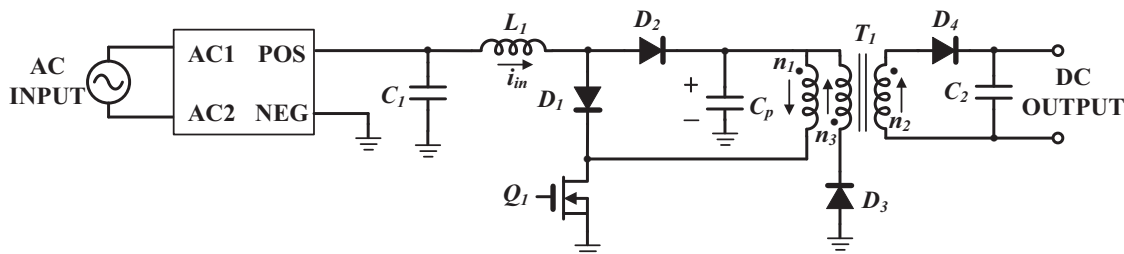

Fig.1 proposed single-stage converter

2.2. CRM & DCM

Converters in critical conduction mode operation are generally accepted for low-power PFC applications. At CRM, such as Boost, a turn-on switching process is initiated when the output diode current falls to zero, while a turn-off switching process is established when the peak transistor current reaches the threshold level set by the controller output. This ensures the converter operating at the boundary of Continuous Conduction Mode (CCM) and Discontinuous Conduction Mode (DCM) at the expense of variable switching frequency over the AC line period.

Referring to Fig.2, the proposed converter operates in a different way from the conventional CRM and DCM. The turn-on switching signal is set out when the current through C_p rather than the output diode current falls to zero. This makes sure that the core returned to its initial state during every switching cycle. A turn-off switching process is also established when the peak transistor current reaches the threshold level set by the controller output.

The operation principle is determined by which current falls to zero first, the current through L_l or the current through D_3 . If the current through L_l falls to zero firstly, Q_1 will not be turned on until the current through D_3 becomes zero. Therefore, the converter operates in DCM. On the contrary, when current through D_3 decreases to zero first, the turning-on of Q_1 is activated when the current through L_l falls to zero. Thus, the converter operates in CRM. As a result, as depicted in Fig.3, the operation of the proposed converter switches between DCM and CRM during a half-line period. In Fig.3, v_i is the rectified input voltage and i_{in} is the current through L_l . It is obvious that the current through L_l stays at zero in part of the half-line cycle, while it drops to zero but without dwelling at zero in the rest, which indicates that the operation of the converter switches between DCM and CRM.

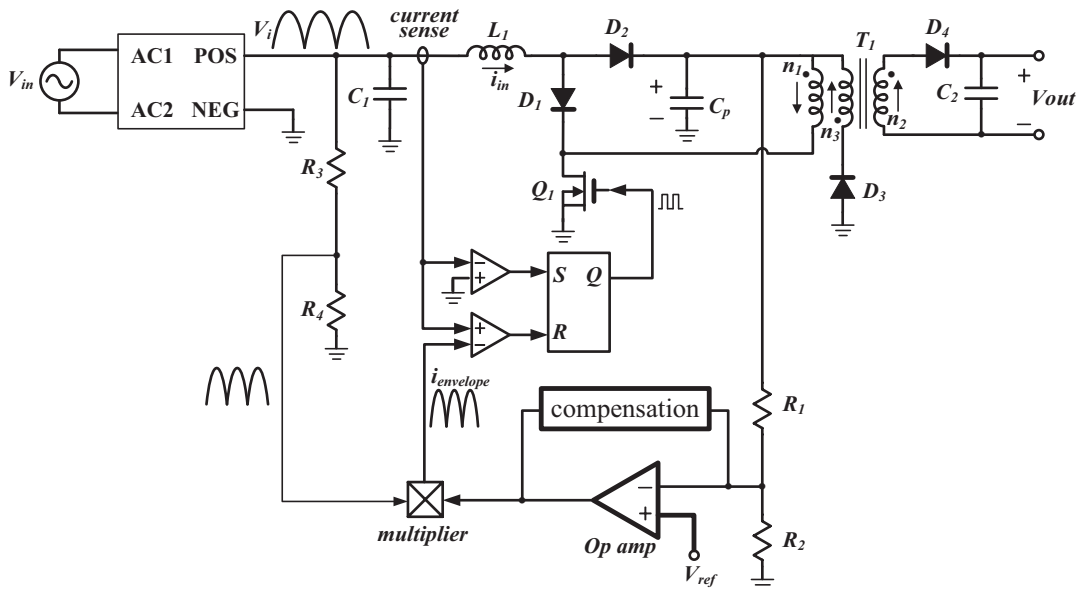

Fig.2 control of the proposed converter with L6561

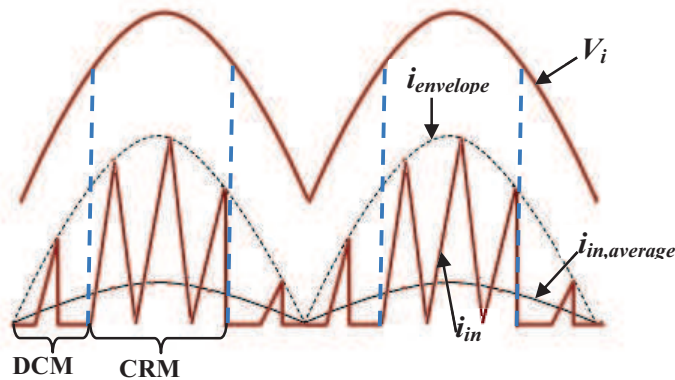

Fig.3 current through L_l

3. Steady-state analysis

As plotted in Fig.3, the input voltage is $V_m|\sin\omega t|$. The peak inductor current is enveloped by rectified sinusoid

$$i_{pk}(t) = I_{pk}|\sin\omega t| \quad (1)$$

$$I_{pk} \approx 4 \frac{P_{in}}{V_m} \quad (2)$$

P_{in} is input power. When the transistor is conducting, the peak transistor current can be expressed as:

$$i_{pk}(t) = \frac{1}{L_1} t_{on}(t)V_m|\sin\omega t| \quad (3)$$

The transistor “on” time can be obtained by substituting (1) into (3).

$$t_{on}(t) = \frac{L_1 I_{pk}}{V_m} = T_{on} \quad (4)$$

This equation shows that the transistor “on” time of CRM is constant. When the discharging time of L_l is equal to the demagnetizing time of the demagnetization winding of T_l , the converter comes to the boundary of the DCM and CRM.

The discharging time of L_l is:

$$t_{ds} = \frac{L_1 I_{pk}|\sin\omega t|}{V_{cp} - V_m|\sin\omega t|} \quad (5)$$

According to Faraday law, when Q_l is turned on, the change of the flux, $\Delta\Phi$ in the transformer is:

$$\Delta\Phi = \frac{V_{cp} t_{on}}{n_1} \quad (6)$$

n_1 is the number of turns of the transformer primary winding. When Q_l turns off, the core of T_l should be restored. Then, the demagnetizing time can be obtained as:

$$\frac{V_{cp} t_{dm}}{n_3} = \frac{V_{cp} t_{on}}{n_1} \quad (7)$$

n_3 the number of turns of the transformer auxiliary winding. Substituting of (4) into (7), the demagnetization time t_{dm} is:

$$t_{dm} = \frac{n_3 L_1 I_{pk}}{n_1 V_m} \quad (8)$$

When $t_{dm} = t_{ds}$, the converter is in the boundary of DCM and CRM. When $t_{dm} > t_{ds}$, the converter operates in DCM. When $t_{dm} < t_{ds}$, the converter operates in CRM.

When $t_{dm} = t_{ds}$, The boundary condition is:

$$\frac{n_3 L_1 I_{pk}}{n_1 V_m} = \frac{L_1 I_{pk} |\sin \omega t|}{V_{Cp} - V_m |\sin \omega t|} \quad (9)$$

Further simplification yield:

$$\frac{n_3}{n_1} = \frac{V_m |\sin \omega t|}{V_{Cp} - V_m |\sin \omega t|} \quad (10)$$

According to the discussion above, the working conditions of the converter are:

DCM:

$$\frac{n_1}{n_3} < \frac{V_{Cp}}{V_m |\sin \omega t|} - 1 \quad (11)$$

CRM:

$$\frac{n_1}{n_3} > \frac{V_{Cp}}{V_m |\sin \omega t|} - 1 \quad (12)$$

As shown in (11) and (12), the proposed converter will operate in DCM when:

$$V_m |\sin \omega t| < \frac{V_{Cp}}{1 + \frac{n_1}{n_3}} \quad (13)$$

And it will operate in CRM when:

$$V_m |\sin \omega t| > \frac{V_{Cp}}{1 + \frac{n_1}{n_3}} \quad (14)$$

This conclusion is in accordance with the waveforms shown in Fig.3. When the rectified input voltage is in the vicinity of zero, the converter is in DCM. When the input rectified voltage rises from 0 to its peak value the converter enters into the CRM operation mode.

4. Simulation and experiments

The proposed scheme has been tested with simulation and experiment. The simulation was carried out by Psim9.0 and was designed to have a 220v input and 40V/1A output. The results of a closed loop simulation are illustrated in Fig. 4 to 7.

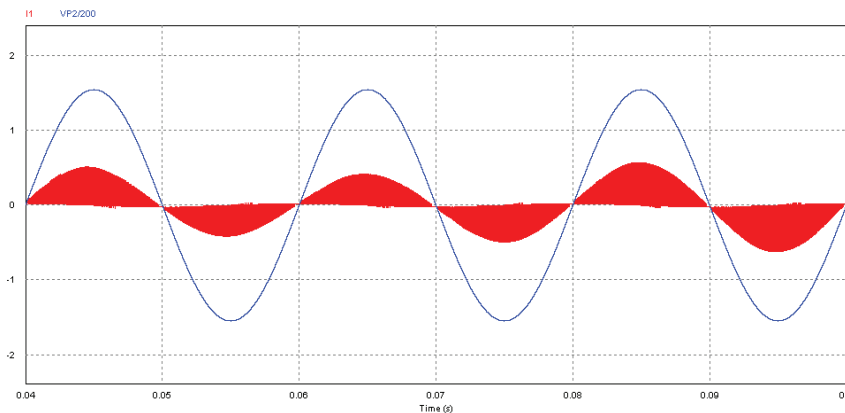

Fig. 4 input voltage (220Vac) and input current (560mA peak)

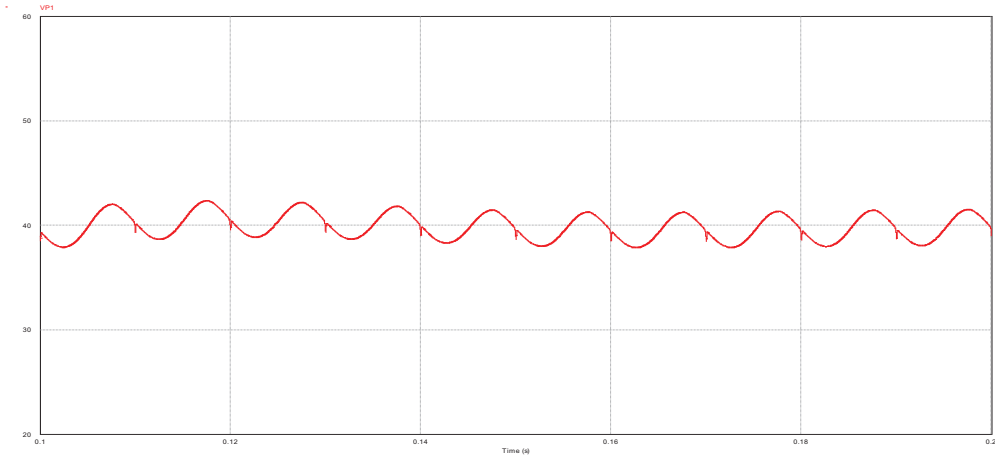

Fig. 5 output voltage 40v (Ripple: 3v)

The simulation is implemented in a single closed loop control. The compensation is a capacitor. The power stage circuit is imitated to be controlled by L6561 which is usually used for the CRM PFC applications.

Fig. 4 shows that the input current is sinusoidal and is in phase with the input voltage. This proves that the proposed converter can have a high power factor switching between the CRM and DCM operation modes.

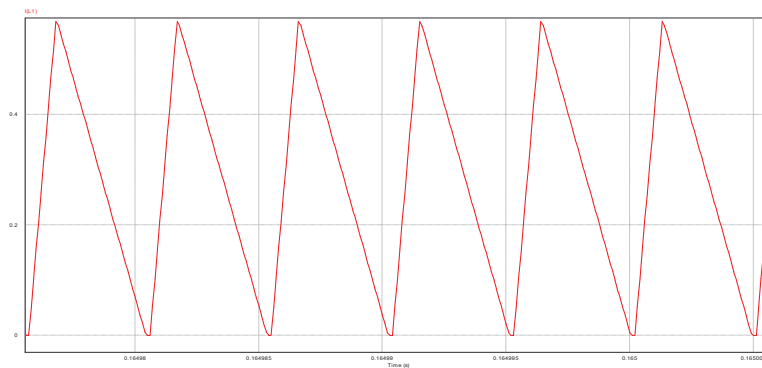

Fig. 6 input inductor (L_1 in Fig.1) CRM

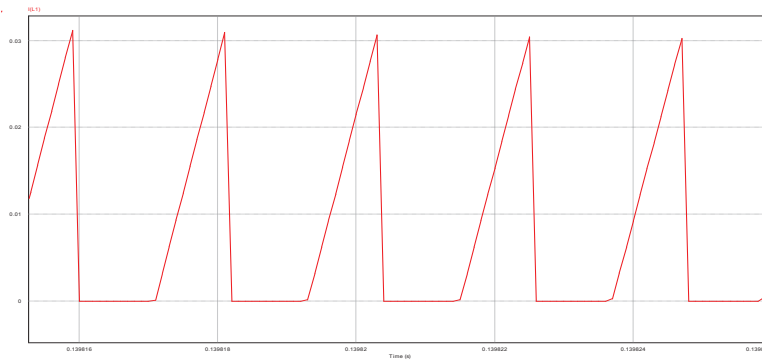

Fig. 7 input inductor (L_1 in Fig.1) DCM

The output voltage is shown in Fig.5. The output voltage is a stable dc output. Fig.6 and Fig.7 depict the details of the input inductor (L_I in Fig.1) current. They prove that the converter operate differently. During partial of the operation, the inductor L_I current falls to zero and the converter operates in DCM. In the other part of the operation, the inductor current (L_I) falls to zero without dwelling at zero. This shows that the converter operates in CRM. This is the same as waveforms in Fig.3.

A laboratory prototype for the proposed converter at 8W output was built to verify the control strategy and evaluate the circuit performance while the output voltage is kept to 23V. The circuit diagram is given in Fig. 2. The MOSFET IRFPES0, diode MUR480 and PFC Controller L6561 are used in the prototype. The inductors ($L_I=1\text{mH}$) and transformer (T_I) are realized in an EFD core. Experimental waveforms are shown in Fig. 8 to 10.

Fig. 8 shows that the input current is well regulated and is in phase with the input voltage. The output voltage shown in Fig.9 is stabilized at 23V with a ripple of 1V. The efficiency is almost 82%. Fig. 10 proves that the all the harmonics of the input current can meet the IEC61000-3-2 requirements for class C. The power factor is 0.98

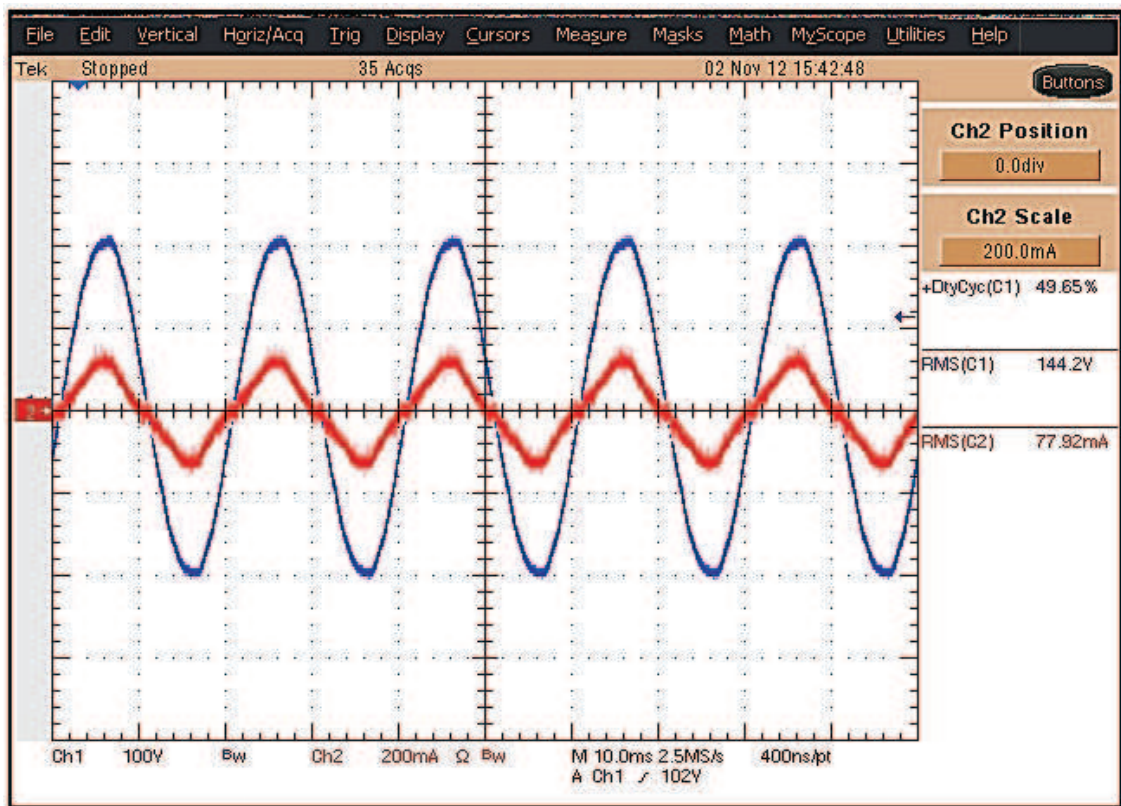

Fig. 8 input voltage (140Vac) and input current (77mA rms)

5. Conclusion

In this paper, a single-stage and single-switch converter operating in DCM and CRM for power factor correction application is proposed and analyzed. This converter integrates the conventional two-stage into one. It greatly reduces the component count and cost for the ac/dc driver used in off-line applications. The front end PFC stage operates switching between CRM and DCM mode. This driver scheme is especially suitable for low power level off-line driver applications, such as LED lighting driver.

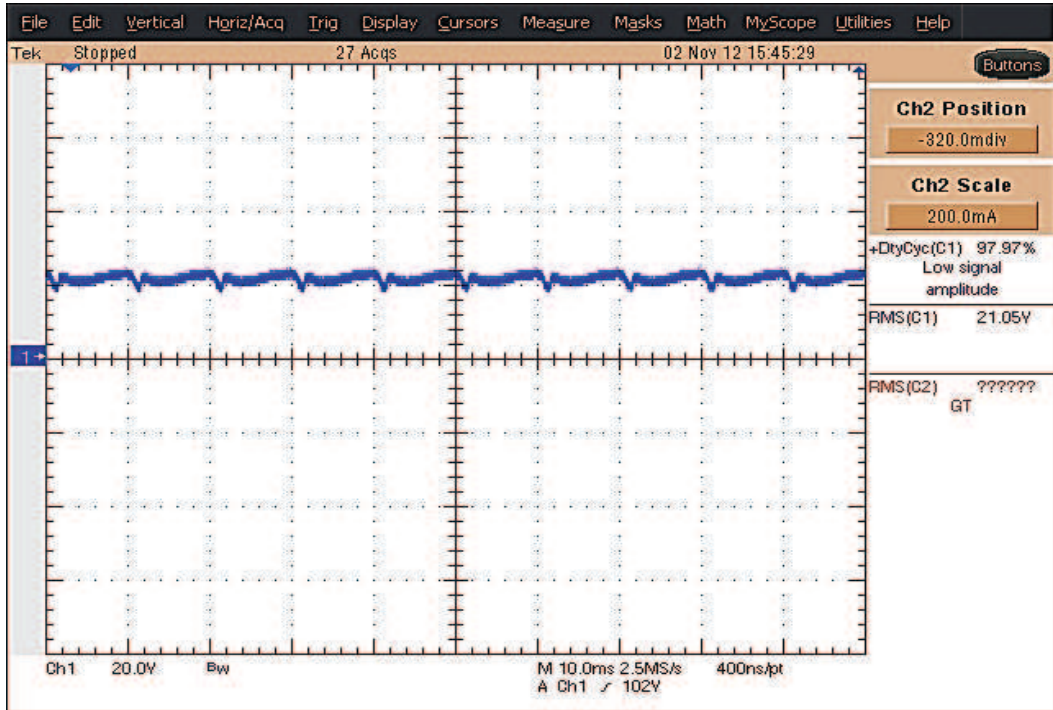

Fig. 9 output voltage (23v) ripple 1v

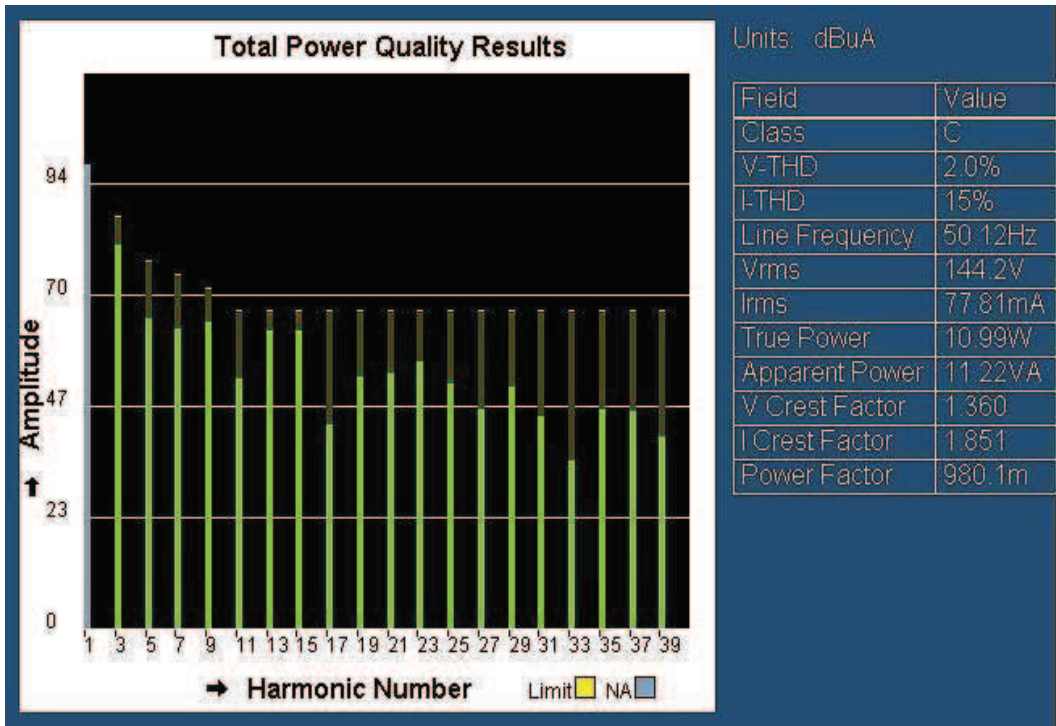

Fig.10 input current harmonics

References

- [1] Maxim-Dallas Semiconductor, “Why drive white LEDs with constant current,” Jun. 2004
- [2] C. Y. Wu, T. F. Wu, J. R. Tsai, Y. M. Chen, and C. C. Chen, “Multistring LED backlight driving system for LCD panels with colour sequential display and area control,” *IEEE Trans. Ind. Electron.*, vol. 55, no. 10, pp. 3791–3800, 2008
- [3] S. K. Kim, H. S. Han, Y. J. Woo, and G. H. Cho, “Detection and regulation of CCFL current and open-lamp voltage while keeping floating condition of the lamp,” *IEEE Trans. Ind. Electron.*, vol. 53, no. 2, pp. 707–709, 2006
- [4] Xunwei Zhou, Mauro Donati, Luca Amoroso, and Fred C. Lee, “Improved Light-Load Efficiency for Synchronous Rectifier Voltage Regulator Module,” *IEEE Transactions on Power Electronics*, vol. 15, no. 5, pp. 826–834, 2000
- [5] El Aroudi A., Haroun R., Cid-Pastor A., Martinez-Salamero L.: 'Suppression of Line Frequency Instabilities in PFC AC-DC Power Supplies by Feedback Notch Filtering the Pre-Regulator Output Voltage', *IEEE Trans. Circuit and systems I*, vol.60, no.3, pp. 796-809, 2013
- [6] J. Qian, Q. Zhao and F. C. Lee, “Single stage single-switch power factor correction AC/DC converters with DC-bus voltage feedback for universal line applications,” *IEEE Trans. on Power Electronics*, vol.13, no.6, pp. 1079–1088, 1998
- [7] Pritam Das., Majid Pahlevaninezhad., Gerry Moschopoulos.: 'Analysis and Design of a New AC–DC Single-Stage Full-Bridge PWM Converter With Two Controllers'. *IEEE Trans. Ind. Electron.*, vol.60, no.11, pp. 4930-4946, 2013
- [8] M. Arias., D. G. Lamar., J. Sebastian., D. Balocco., A. A. Diallo.: 'High efficiency LED driver without electrolytic capacitor for street lighting', *IEEE Trans. Ind. Appl.*, vol. 49, no.1, pp. 127–137, 2013
- [9] Hugo Santos Ribeiro., Beatriz Vieira Borges, “Solving Technical Problems on the Full-Bridge Single-Stage PFCs,” *IEEE Trans. Ind. Electron.*, vol.61, no.5, pp.2264-2277, 2014
- [10] M. Madigan, R. Erickson, E. Ismail, “Integrated high-quality rectifier-regulators,” *IEEE Power Electronics Specialists Conf. (PESC) Record*, pp. 1043-1051, 1992.