

DIRECTED ENERGY FOR RELATIVISTIC PROPULSION AND INTERSTELLAR COMMUNICATIONS

PHILIP LUBIN¹, GARY B. HUGHES², JOHANNA BIBLE¹ AND ISABELLA JOHANSSON¹

1. *Physics Department, University of California, Santa Barbara, CA 93106-9530, USA.*

2. *Statistics Department, California Polytechnic State University, San Luis Obispo, CA 93407-0405, USA.*

An orbital planetary defense system that is also capable of beamed power propulsion allows mildly relativistic spacecraft speeds using existing technologies. While designed to heat the surface of potentially hazardous objects to the evaporation point to mitigate asteroid threats the system is inherently multi-functional with one mode being relativistic beamed spacecraft propulsion. The system is called DE-STAR for Directed Energy Solar Targeting of Asteroids and exploRation. DE-STAR is a proposed orbital platform that is a modular phased array of lasers, powered by the sun. Modular design allows for incremental development, test and initial deployment, lowering cost, minimizing risk and allowing for technological co-development, leading eventually to an orbiting structure that could be erected in stages. The main objective of DE-STAR would be to use the focused directed energy to raise the surface spot temperature of an asteroid to $\sim 3,000$ K, allowing direct evaporation of all known substances. The same system is also capable of propelling spacecraft to relativistic speeds, allowing rapid interplanetary travel and relativistic interstellar probes. Our baseline system is a DE-STAR 4, which is a 10 km square array that is capable of producing a 30 m diameter spot at a distance of 1 AU from the array. Such a system allows for engaging an asteroid that is beyond 1 AU from the DE-STAR 4. When used in its “photon rail gun mode”, a DE-STAR 4 would be capable of propelling a 1, 10, 10^2 , 10^3 , 10^4 kg spacecraft that is equipped with a 30 m diameter reflector to 1 AU in approximately 0.3, 1, 3, 10, 30 days, respectively, with speeds of about 4%, 1.2%, 0.4%, 0.15%, 0.05% the speed of light at 1 AU. With continued illumination to 3 AU the spacecraft, with a 30 m diameter reflector, would reach speeds $\sqrt{2}$ faster. A DE-STAR 4 could propel a 10^2 kg probe with 900 m diameter reflector to 2% the speed of light with continued illumination out to 30 AU, and ultimately to 3% the speed of light after which the spacecraft will coast. Such speeds far exceed the galactic escape velocity. Smaller systems are also extremely useful and can be built now. For example, a DE-STAR 1 (10 m size array) would be capable of evaporating space debris at 10^4 km (\sim diam. of Earth) while a DE-STAR 2 could divert volatile-laden asteroids 100 m in diameter by initiating engagement at ~ 0.01 -0.5 AU. All sized systems can be used to propel varying sized systems for both testing and for interplanetary use. An extreme case is a wafer scale spacecraft (WaferSat) with a 1 m reflector that can achieve $>25\%$ in about 15 minutes. The phased array configuration is capable of creating multiple beams, so a single DE-STAR of sufficient size could engage several threats simultaneously or propelling several spacecraft. A DE-STAR could also provide power to ion propulsion systems, providing both a means of acceleration on the outbound leg, and deceleration for orbit insertion by rotating the spacecraft “ping-ponging” between two systems in either a photon rail gun mode or power ion engines. There are a number of other applications as well including SPS for down linking power to the Earth via millimeter or microwave. A larger system such as a DE-STAR 6 system could propel a 10^4 kg spacecraft to near the speed of light allowing for true interstellar travel. The same technology can also be used for extremely long range communications with continuous communication between Earth and the interstellar spacecraft. This technology also has direct implications for interstellar and intergalactic beaming allowing for SETI across the universe for civilizations that have mastered this technology. There are a number of other applications for the system. While decidedly futuristic in its outlook many of the core technologies now exist and small systems can be built to test the basic concepts as the technology improves. While there are enormous challenges to fully implementing this technology the opportunities enabled are truly revolutionary.

Keywords: relativistic propulsion, interstellar communications

1. INTRODUCTION

Scientists and the public have long been interested and fascinated with methods for relativistic travel to allow interstellar and intergalactic travel. A few of the projects that have studied it are Project Orion, a nuclear pulse propulsion spacecraft studied in the early 1950s (Bussard, 1958 [1]); Project Daedalus, a two-stage spacecraft utilizing fusion rockets capable of traveling 6 light years in 50 years (Bond and Martin, 1978 [2]); and Project Longshot, a US Naval Academy and NASA proposed nuclear fission spacecraft (Beals *et al.*, 1988 [3]). While these areas of

This paper was presented at the Icarus Interstellar Starship Congress 15th - 18th August 2013, Dallas, Texas, USA.

thought have been around for decades, our current abilities in space travel are meager at best compared to our dreams. For example, the maximum spacecraft speed obtained to date is by the Voyager 1 spacecraft, at about 17 km/s (relative to the sun) and while new technologies such as ion engines promise more efficient use of propellant none of our current technologies are practical for travel to even the nearest stars in a human lifetime.

Using a laser as a photon drive is not a new idea. For example, Marx (1966 [4]) proposed an Interstellar vehicle propelled by terrestrial laser beam. In the 1980s R.L. Forward proposed a solar pumped laser [5]. Forward proposed using a 1,000 km diameter

Fresnel lens to focus the laser on a spacecraft composed of a 1,000 kg mirror system. What is new is that recent and very rapid developments with photonics allow new laser technologies capable of very high efficiency and the ability to phase lock to synthesize a narrow beam. In the case of planetary defense, using a phased array of lasers allows vaporization of all known asteroid types and thus both direct vaporization as well as plume thrust deflection. This method is proposed as a feasible system for a future standoff directed energy system (Lubin *et al.*, 2013 [6], 2014 [7]; Hughes *et al.*, 2013 [8]). This system is known as **DE-STAR** for **D**irected **E**nergy System for **T**argeting of Asteroids and **e**xplo**R**ation. DE-STAR consists of an array of phase-locked modest power laser (kW class) amplifiers driven by a common seed laser. The lasers are powered by solar photovoltaics with no other power source required. Conveniently, the size of the solar array is roughly the same as the size of the laser array. While the system was designed to vaporize and deflect asteroids, it has many other uses including direct photon propulsion which is the primary purpose of this paper.

DE-STAR is a modular and replicated array of identical elements and lends itself to mass production and extensibility. DE-STAR arrays are numbered by the log of the linear size in meters. For example a 100 m by 100 m sized array is a DE-STAR 2, while a 10 km by 10 km array is a DE-STAR 4. Systems from very small (hand-sized) to planet size are all self-similar. Sizes from meter class to kilometer class are discussed in our other papers. As an example relevant to full planetary defense and modest relativistic travel is a Utilizing current technology, a DE-STAR 4 system with sides of 10^4 m outputs an average of 70 GW assuming modest evolution of current technology. For relativistic robotic probes a DE-STAR 4 system when used as a photon driver would propel a 100 kg spacecraft equipped with a current technology 30 m diameter thin film reflector can obtain a velocity of 0.4% the speed of light at a distance of 1 AU (approx. distance to Mars for example) and 0.6% the speed of light at the edge of the solar system. If we assume that the reflector receives full illumination at the edge of the solar system, requiring a 900 m diameter reflector (this requires a future nano technology reflector), then the velocity is increased from 0.6% to 3%. Such a probe could enable the first interstellar probes. If we use a modest laser communications link, as discussed in detail below, with the same technology we can get live streaming video back along the entire length of the voyage out to the nearest stars.

2. CONTEXT

DE-STAR is a standoff system composed of phased array

technology designed to primarily defend the earth from asteroids and secondarily provide many other uses including photon propulsion, communications, and mining. The phased array is powered completely by solar technology. The system is inherently designed to be a multi-tasking system capable of many different uses when not in use defending Earth. DE-STAR can be used as a LIDAR system to detect asteroids, as a photon drive to propel spacecraft, as a mining system to analyze the compositions of various asteroids and celestial bodies, and as a communications array to name a few. This is illustrated in Fig. 1.

Current levels of technology allow DE-STAR to be a realistic option to be considered with many near term and long term benefits. Converting solar power to electricity is relatively efficient, with current state of the art technology approaching 50% efficiency for space based cells in concentration and approaching near 40% without concentration. Converting electricity to long coherence length laser light is also currently approaching 50% efficiency. We make modest assumptions that over the next 1-2 decades both of these efficiencies approach 70% though none of the qualitative conclusions for our program depend on this improved efficiency. However, based on the trends for both solar to electrical and electrical to laser efficiency this assumption is not unreasonable.

3. SPOT SIZE VERSUS REFLECTOR SIZE

The initial case for spot size smaller than the reflector has been discussed but is covered again below (Bible *et al.*, 2013 [9]). As the spacecraft travels away from DE-STAR the laser spot size continues to grow and eventually overwhelms the reflector located on the spacecraft.

While the spot size is smaller than the reflector, it is straightforward to solve for time as a function of velocity. We know that the force due to the radiation pressure of the reflected laser beam is

$$F = \frac{P\varepsilon}{c} \quad (1)$$

where P is the power at the spacecraft, and $\varepsilon = 1 + \varepsilon_r$, where ε_r is the reflector reflection coefficient, $\varepsilon_r = 0$ for no reflection (absorption) and $\varepsilon_r = 1$ for complete reflection. Note that $\varepsilon = 2$ for an ideal reflector. Real reflectors with multi-layer

Fig. 1 Artist conception of DE-STAR propelling a small spacecraft via direct photon drive (proton pressure).

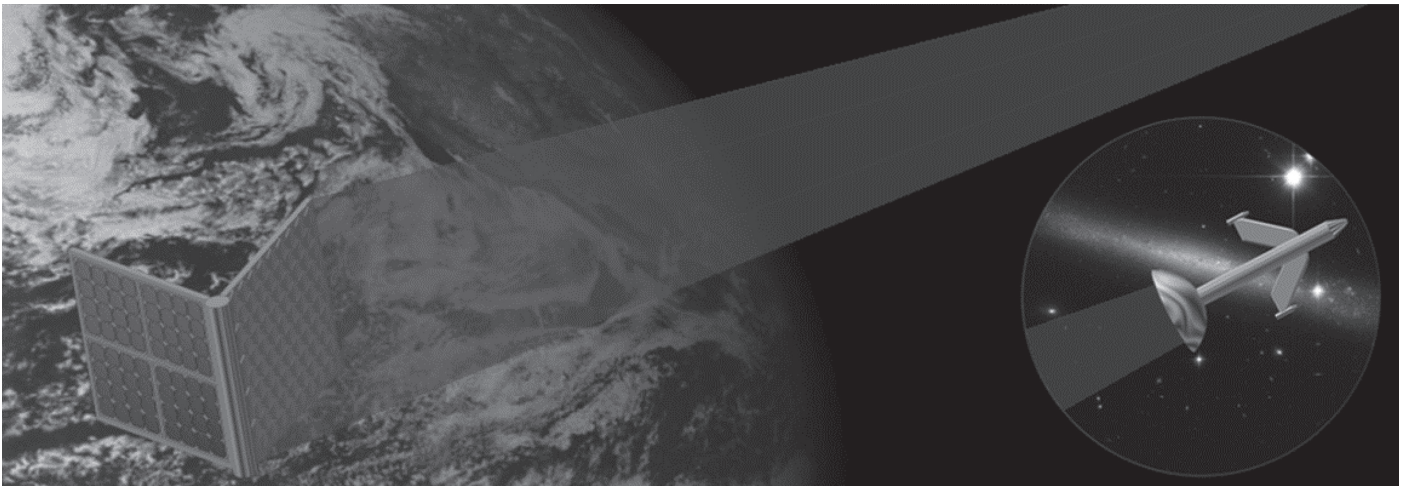

reflection coatings will be very close to ideal. We note that given an initial power, P_0 , from DE-STAR, relativistic effects must be taken into account. That is:

$$F = \frac{P_0 \varepsilon}{\gamma c} \quad (2)$$

Since the force is the derivative of the momentum, $\rho = m_0 \gamma v$, where m_0 is the rest mass.

$$\frac{P_0 \varepsilon}{\gamma c} = \frac{d\rho}{dt} \quad (3)$$

$$\frac{P_0 \varepsilon}{\gamma c} = m_0 \left(\frac{d\gamma}{dv} v + \gamma \right) \frac{dv}{dt} \quad (4)$$

Further simplifying, we obtain t in terms of the relativistic speed $\beta = v/c$

$$\frac{m c}{(1 - \beta^2)^2} \int \quad (5)$$

Which then solves to the analytical form for t vs β :

$$t = \frac{m_0 c^2}{2P_0 \varepsilon} \left(\frac{\beta}{1 - \beta^2} + \frac{1}{2} \ln \left| \frac{1 + \beta}{1 - \beta} \right| \right) \quad (6)$$

$$t = \frac{m_0 c^2}{2P_0 \varepsilon} \left(\frac{\beta}{1 - \beta^2} + \tanh^{-1}(\beta) \right) \quad (7)$$

A plot determines proper behaviour while $D_s < D$ (see Figure 2 for definitions). The problem evolves as the DE-STAR laser spot size becomes larger than the reflector and the resultant propellant force decreases. We will consider the case of a DE-STAR 4 which nominally has 70 GW of laser power for a 470 N drive assuming near perfect reflection. Below we de-rate this to 50 GW or 333 N of thrust. See Figure 3.

Fig. 2 Diagram depicting relevant variables. L is the distance to the spacecraft and L_0 denotes the distance of the spacecraft when the beam spot equals the reflector size. As the spacecraft moves outward, the laser spot size (D_s) increases in proportion to the distance L to the spacecraft and ultimately, D_s becomes larger than D at which point the photon force begins to decrease proportional to the ratio of the spot to reflector area or $(D_s/D)^2$.

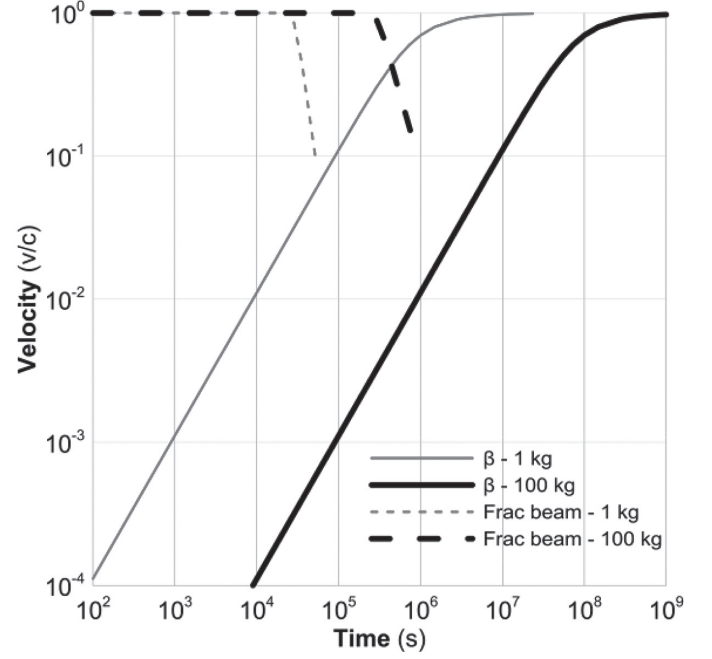
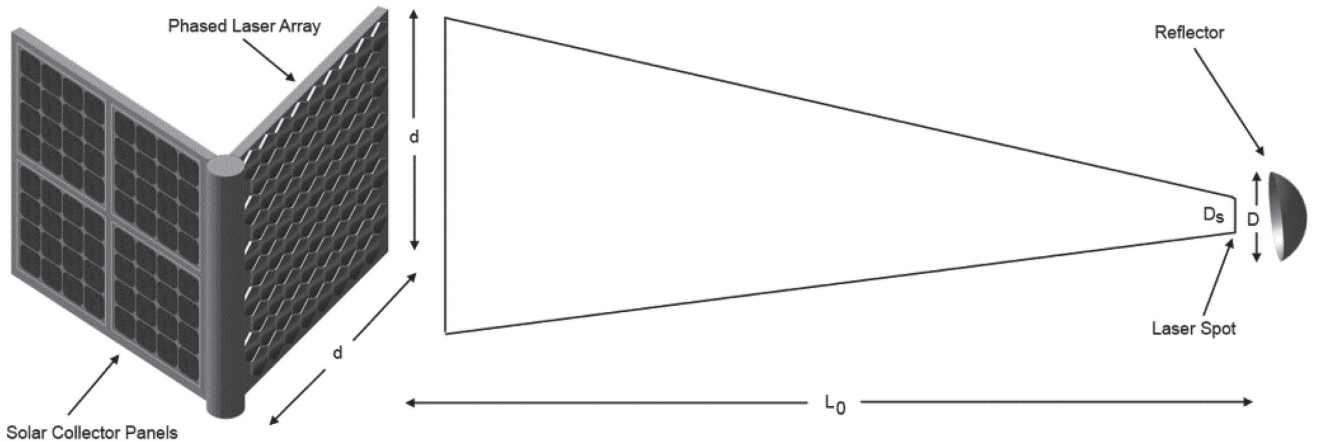

Fig. 3 Speed versus time using the inverted equation for time (7), for both a $m_0 = 1$ and 100 kg spacecraft+sail, $P_0 = 50$ GW (DE-STAR 4) with $\varepsilon_r = 1$. The speed assumes the reflector is large enough to accommodate the beam divergence but the beam fraction refers to a 30 m diameter sail. The 100 mg case assumes a 10 micron thick sail that has a mass of 9 kg while the 1 kg case assume a 1 micron thick sail that has a mass of about 1 kg. As the speed increases, the spacecraft begins to display relativistic effects as is readily seen. The 1 kg system achieves about 5% c in about 10 hours while the 100 kg system achieves about 0.6% c in about 6 days again both with a 30 m sail.

We can confirm the non-relativistic limit for $\beta \ll 1$

$$\ln \left| \frac{1 + \beta}{1 - \beta} \right| = \sum_{n=1}^{\infty} \frac{2}{2n-1} \beta^{2n-1} \rightarrow 2\beta, \beta \ll 1 \quad (8)$$

$$t \rightarrow \frac{m_0 c^2}{2P_0 \varepsilon} (\beta + \beta) = \frac{m_0 v c}{P_0 \varepsilon} = \frac{\rho}{F} \quad (9)$$

This is precisely what is expected in the non-relativistic limit. For heavy spacecraft (large m_0) the time to relativistic speeds are longer. In the instance of a 10^4 kg spacecraft the speed remains non-relativistic even after illumination for 30 years, as shown in Fig. 4.

The DE-STAR 4 spot size grows with time for a 100 kg craft with 30 m diameter reflector as shown in Fig. 5 so that after approximately 3×10^5 s, the beam exceeds the reflector size.

The next logical step is to question what occurs when $D_s > D$. As the spot size becomes larger than the size of the reflector the amount of force on the reflector decreases. A rudimentary solution for the non-relativistic case determines velocity as a function of reflector distance. In order to solve the non-relativistic case we must first define L_0 to be the distance at which $D_s = D$ (see Fig. 6 for the different situations). Below we assume a perfect reflector.

Now let L be the distance to the reflector. We solve for the kinetic energy from $L = 0 \rightarrow L_0$ ($D_s < D$) (see Fig. 7)

$$KE_1 = FL_0 \quad (10)$$

Given that

$$L_0 = \frac{dD}{2\lambda} \quad \text{and} \quad F = \frac{2P_0}{c}$$

we rewrite our kinetic energy to a more reasonable form

$$KE_1 = \frac{P_0 dD}{c\lambda} \quad (12)$$

Fig. 4 Plot of velocity versus illumination time for $m_0 = 10^2$ kg (black line) and $m_0 = 10^4$ kg (red line) with $P_0 = 50$ GW and $\epsilon_r = 2$ with 9% of the mass in each case allocated for the reflector. As expected the heavier mass is non-relativistic for a longer period of time. With 9% of the mass budget allocated for the sail the 100 kg system uses a 30 m sail while the 10,000 kg system uses a 300 m sail both assuming a relatively thick 10 micron thick sail. Using a 1 micron thick sail allows for a sail about 3 times larger. 1 micron is about the current limit in sail material but nano engineered sails may allow for much larger sails and thus even higher speeds.

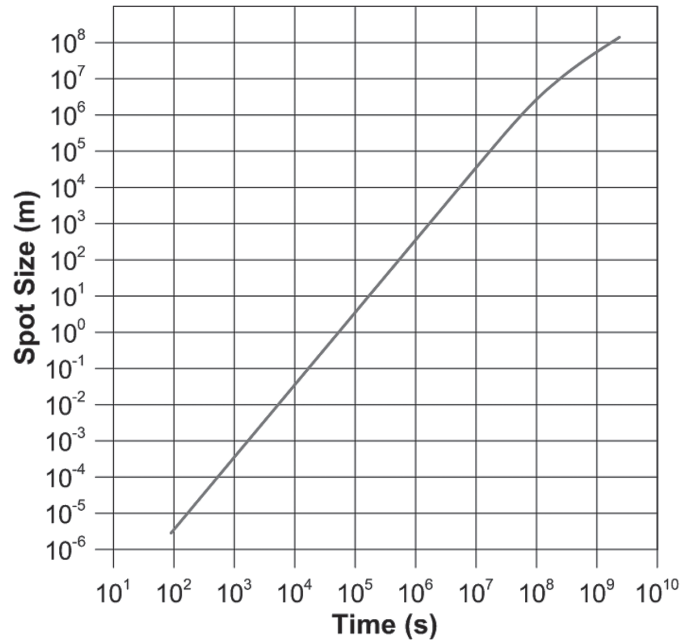
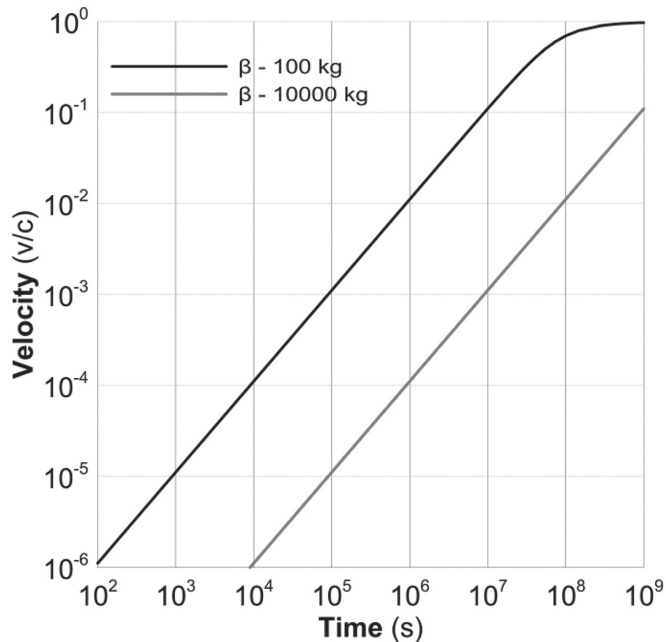

Fig. 5 Plot of DE-STAR spot size (reflector size required) with respect to time for the 100 kg craft case. This assumes the reflector is illuminated fully the entire time.

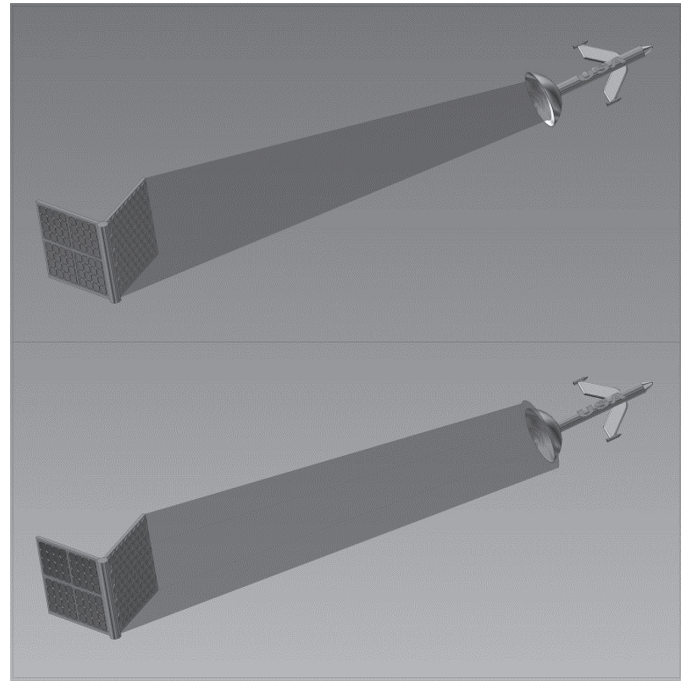

Fig. 6 Artist conception of DE-STAR propelling a spacecraft. The top image depicts the situation $D_s < D$ while the bottom depicts $D_s > D$.

We can further solve for the kinetic energy from $L = L_0 \rightarrow \infty$,

$$KE_2 = \int_{L_0}^{\infty} F dL \quad (13)$$

For $D_s > D$, we know that the force is given by

$$F = \frac{2P_0}{c} \left(\frac{L_0}{L} \right)^2 \quad (14)$$

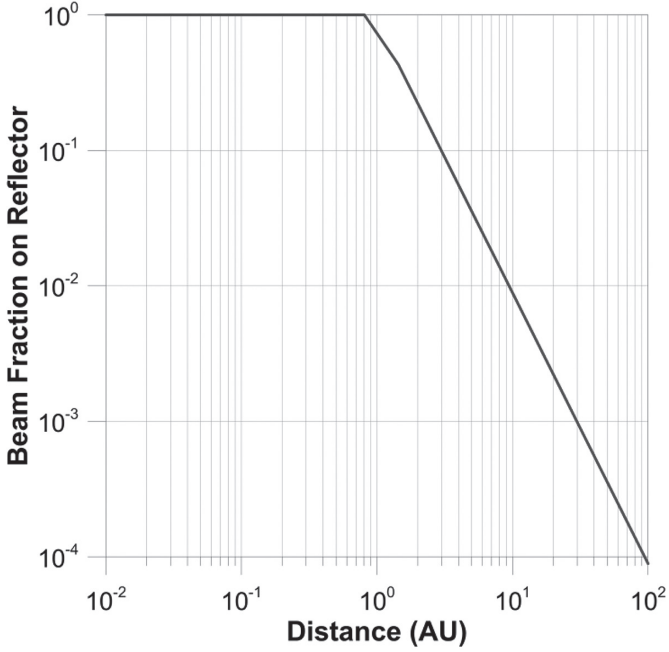

Fig. 7 Plot of beam fraction on reflector $(D_s/D)^2$ versus distance for the case of a craft with a 30 m reflector being illuminated by a DE-STAR 4 array. $(D_s/D)^2$ is the fraction of laser power intercepted by the reflector. After approximately 1 AU (or ~ 3 days for the case of a 100 kg craft) the laser spot size exceeds the size of the reflector at which point the fraction of the beam intercepted by the reflector decreases. This plot is the same independent of the mass of the craft but the time to a given distance changes.

By using equations (13) and (14) we can then solve for our kinetic energy

$$KE_2 = \frac{P_0 d^2 D^2}{2c\lambda^2} \left(\frac{1}{L_0} - \frac{1}{L} \right) \quad (15)$$

We now want to find the total kinetic energy by adding (15) and (12).

$$KE_{total} = \frac{2P_0}{c\lambda} L_0 \left(2 - \frac{L}{L_0} \right) \quad (16)$$

which we can then solve for $v(L)$

$$v(L) = \sqrt{\frac{4P_0}{mc} L_0 \left(2 - \frac{L}{L_0} \right)} \quad (17)$$

As this calculation does not take into account relativistic effects it will only be accurate for $v \ll c$. Let v_0 be the speed for which the distance to the spacecraft is $L = L_0$ (i.e., $D_s = D$ - the beam spreads to the diameter of the reflector at distance L_0) then

$$v_0 = \sqrt{\frac{4P_0}{mc} L_0} \quad (18)$$

For any subsequent distance the speed is given by:

$$v(L) = v_0 \sqrt{2 - \frac{L_0}{L}} \quad (19)$$

and L_0 is again the distance at which $D_s = D$. As we approach infinite distances the velocity limit will be $\sqrt{2}v_0$. **Thus, if we keep the reflector illuminated after the beam spreads to a larger diameter than the reflector we gain a factor of $\sqrt{2}$ in final speed.**

Because the transverse dimension is not contracted at relativistic speeds we can easily compute the effective reflector and spot size. Using recursive methods we can calculate the position, velocity, and spot size for a given amount of power.

It is apparent that the percentage of the power that is on the reflector becomes negligible after a long period of time. For example after about 3 AU, the percentage of power on the reflector is down to 10% of the initial power for a 100 kg craft with a 30 m reflector due to beam spread. For reference in the next figure we summarize many of the parameters associated with the relativistic solution. For future nano material reflectors or larger De-STAR units relativistic speeds become possible.

4. CURRENT AND FUTURE REFLECTOR DESIGNS

In order to make use of a photon drive the reflector design is critical. Unlike a solar sail that has very low flux from the sun (1.4 kW/m² at 1 AU), the reflector here must be able to withstand a much larger flux from the laser. However, since the laser line is extremely narrow a highly resonant multi-layer dielectric coating is feasible. As a result of weight constraints and the potential for heat buildup on the associated spacecraft the reflector must have near perfect reflection with extremely low mass. Currently, 99.999% reflectivity has been achieved on dielectric thin films over glass substrates at the appropriate wavelength and it is theoretically possible to achieve 99.99% or greater with plastics. A thin film "roll to roll" manufacturing method using multi-layer thin films has been designed as shown in Fig. 8 and can achieve the required low areal mass and high reflectivity. Using current reflector designs (Bible *et al.*, 2013 [9]) with a reflectivity of 99.995% and density of ~ 10 g/m² a 30 m diameter reflector that is 10 μ m thick has a mass of about 9 kg. In order to not apply excess flux at close distances it is assume the laser spot is defocused to the full reflector size. This is easily done with the phased array arrangement. See Tables 1 and 2.

As a realistic option, this satisfies our basic requirements of minimal mass addition to the spacecraft and the reflectivity necessary to minimize heating (Bible 2013 [9]). As the reflectivity decreases the loss increases and the temperature rises. We need to keep the temperature low enough to be consistent with the thin film reflectors.

Future reflector possibilities - In the future it may be possible to use nano-technology to produce ultra-thin reflectors. Assuming in the future that we have a 1 nm thick graphene reflector that is optimized for our laser, the reflector mass (currently assumed to be 10 μ m thick plastic with multi-layer dielectric) will decrease by 10^4 leading to a 100 times increase in velocity for a probe dominated by reflector mass. Correspondingly we could increase the reflector size by a factor of 100 for the same mass reflector as our baseline 10 μ m thick plastic. This would lead to a 100 fold increase in illumination distance L_0 (Eq 17 or 19) which would lead to a factor of 10 increase in speed for the same mass as for the baseline reflector (10 μ m thick plastic film). This is true in the non-relativistic limit and clearly has implications for pushing towards relativistic probes.

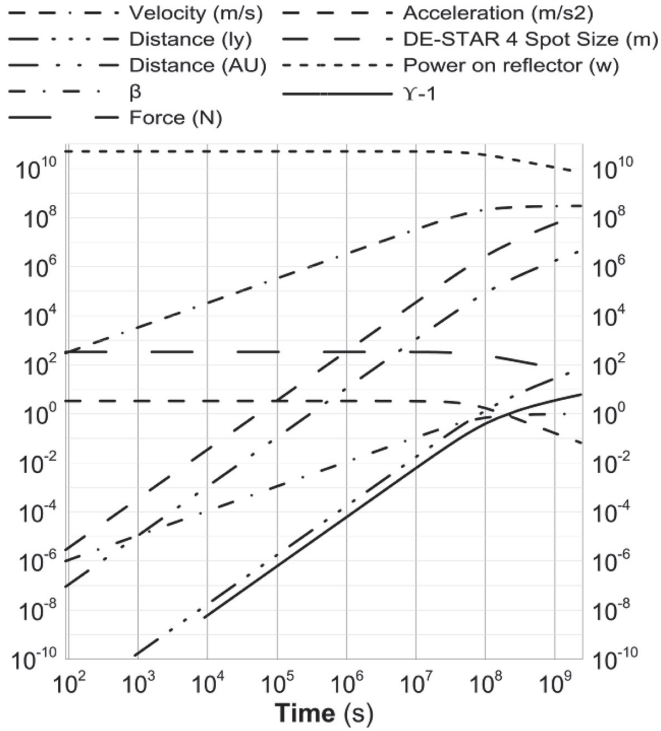

Fig. 8 Numerical solution to relativistic equation of motion for 100 kg rest mass with a reflector that is assumed to grow as large as is needed to intercept the full beam and a DE-STAR 4 - 50 GW drive. As discussed the case of a fixed reflector of 30 m diameter that is reasonable for a 100 kg craft will only reach about 3% the speed of light and then coast. The decrease of power on the reflector is from relativistic effects. See Fig. 9.

Future Possibilities - This technology will only improve with time and while large structures in space are difficult to build current if we look into the future it is not hard to imagine we will master the ability to build vastly larger structures someday. It is interesting to look at scaling.

We have used a DE-STAR 4 needed for planetary defense but a future society may master building much larger arrays. The ability to convert broadband incoherent sunlight into narrow band nearly coherent laser light radically transforms our ability to deliver power to spacecraft and other targets. In the non-relativistic limit the speed to the point L_0 of the beam no longer filling the reflector is

$$v_0 = \sqrt{\frac{4P_0}{mc}} L_0 \quad (20)$$

TABLE 1: Table Depicts the Reflector Temperature due to Heat Dissipation for Three Different Reflectivities for a Power of 50 GW (DE-STAR 4) on a 30 m Diameter Thin Film Reflector. Calculations are Done for Both one Side and two Side Emission in the IR to Dissipate the Heat. One Side is Pessimistic as Both Sides can Emit if Tuned Properly. These Temperature Elevations are Practical for Possible Reflector Materials but for the Baseline Thin Film Plastic $T < 140^\circ\text{C}$ is Desired Corresponding to a Reflectivity of 99.995% if Both Sides Radiate Efficiently.

Reflectivity	Heat Dissipation	Temperature (1 side rad)	Temperature (2 side rad)
99.999%	700 W/m ²	333 K (60°C)	280 K (7°C)
99.995%	3.5 kW/m ²	500 K (227°C)	416 K (143°C)
99.99%	7 kW/m ²	593 K (320°C)	500 K (227°C)

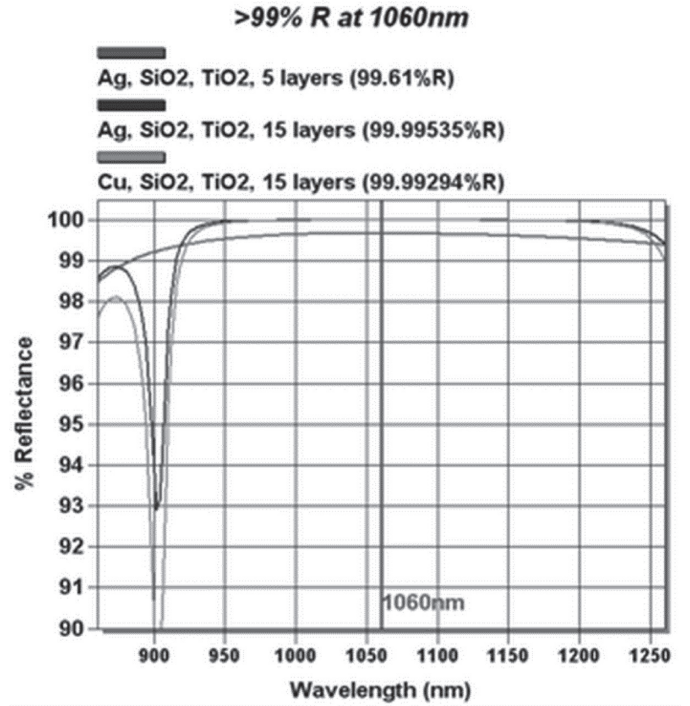

Fig. 9 Graph of the percent reflectance for a practical thin film roll to roll reflector design. The green line of 1,060 nm corresponds to DE-STAR’s laser wavelength. (Source: figure and data from Surface Optics - private communications (2013)). Reflectivities in excess of 99.995% are achievable now on thin film plastics and with further refinements 99.999% looks feasible.

Note that the power P_0 scales as d^2 where d is the DE-STAR array size and the distance to beam filling L_0 scales as d (divergence angle scales as $1/d$) and thus the speed to L_0 scales as $d^{3/2}$ for a given reflector size. Hence a scale up to a DE-STAR 5 or 6 would increase the speed by $10^{3/2} \sim 32$ and $100^{3/2} \sim 1000$ respectively in the non-relativistic limit. These are clearly large factors to consider. In the relativistic limit from the equation we derived above. We can compute the time to a given speed is given by

$$t = \frac{m_0 c^2}{2P_0 \epsilon} \left(\frac{\beta}{1-\beta^2} + \frac{1}{2} \ln \left| \frac{1+\beta}{1-\beta} \right| \right) \quad (21)$$

Thus the time to a speed scales as $1/P_0$ or d^{-2} . Hence a DE-STAR 5 or 6 would shorten the time to a given speed by a factor of 10^2 and 10^4 respectively or alternatively allow mass increases of the same factor. These are clearly dramatic changes.

TABLE 2: The Mass of a Reflector with Density 1 g/cm³ is Shown for Various Thicknesses (t) and Diameters (D) Assuming a Square Reflector Shape.

	D = 1 m	D = 10 m	D = 10 ² m	D = 10 ³ m	D = 10 ⁴ m	D = 10 ⁵ m	D = 10 ⁶ m
t = 1 nm	10 ⁻⁶ kg	10 ⁻⁴ kg	10 ⁻² kg	10 ⁰ kg	10 ² kg	10 ⁴ kg	10 ⁶ kg
t = 10 nm	10 ⁻⁵ kg	10 ⁻³ kg	10 ⁻¹ kg	10 ¹ kg	10 ³ kg	10 ⁵ kg	10 ⁷ kg
t = 10 ² nm	10 ⁻⁴ kg	10 ⁻² kg	10 ⁰ kg	10 ² kg	10 ⁴ kg	10 ⁶ kg	10 ⁸ kg
t = 10 ³ nm	10 ⁻³ kg	10 ⁻¹ kg	10 ¹ kg	10 ³ kg	10 ⁵ kg	10 ⁷ kg	10 ⁹ kg
t = 10 ⁴ nm	10 ⁻² kg	10 ⁰ kg	10 ² kg	10 ⁴ kg	10 ⁶ kg	10 ⁸ kg	10 ¹⁰ kg

5. COMMUNICATIONS

Another use of the DE-STAR system would be for long range interstellar communications to and from the spacecraft. This is a critical issue for long range interstellar probes in the future. Can we get high speed data back?

DE-STAR to spacecraft data rate - Consider an optical link calculation with DE-STAR 4 which emits about 50 GW at 1.06 μm or about 3×10^{29} γ/s, with a divergence half angle of

$$\theta \approx \frac{\lambda}{D} \approx 10^{-10} \text{ rad} \quad (22)$$

At a distance of $L = 1$ light year (ly) ($\sim 10^{16}$ m) the spot size (diameter) is about $D_s \sim 2 \times 10^6$ m. For the case of the 100 kg robotic craft and with a 30 m diameter reflector this gives a **spacecraft** received photon rate of $3 \times 10^{29} \times (30/2 \times 10^6)^2 \sim 7 \times 10^{19}$ γ/s. If we assume it takes 40 photons per bit (which is very conservative) this yields data rate of about 2×10^{18} bits/s, clearly an enormous rate.

Spacecraft to DE-STAR data rate - Assume the spacecraft has a very modest 10 W transmitter on the spacecraft (an RTG for example) for an optical link at the same basic wavelength ~ 1.06 μm (slightly different to allow full duplex communications if needed) and that it uses the same 30 m reflector as for the photon drive but this time it uses it as the communications transmitter antenna (mirror). We do the same basic analysis as above. 10 W at 1.06 μm or about 5×10^{19} γ/s, with a divergence half angle of

$$\theta \approx \frac{\lambda}{D} \approx 3.5 \times 10^{-8} \text{ rad}$$

At a distance of $L = 1$ ly ($\sim 10^{16}$ m) the spot size (diameter) is about $D_s \sim 3.5 \times 10^8$ m. For the case of the 100 kg robotic craft and with a 30 m diameter reflector transmitting BACK to a DE-STAR 4 which acts as the receiver this gives a received (by the DE-STAR) photon rate of $5 \times 10^{19} \times (10^4 / 3.5 \times 10^8)^2 \sim 4 \times 10^{10}$ γ/s. If we assume it takes the same 40 photons per bit this yields a **received (at Earth** or wherever the DE-STAR system is located) data rate of about 1×10^9 bits/s or 1 Gbps. At the nearest star (Proxima Centauri) at a distance of about 4 ly the data rate at Earth from the spacecraft is about 70 Mbps. **Live streaming >HD video looks feasible all the way to our nearby interstellar neighbors.** This is summarized in Fig. 10.

Conclusion - very high bandwidth data rates are feasible at interstellar distances modulo the time of flight of course.

Interstellar SETI Implications - It is worthwhile considering the implications that this technology has on SETI (Search for

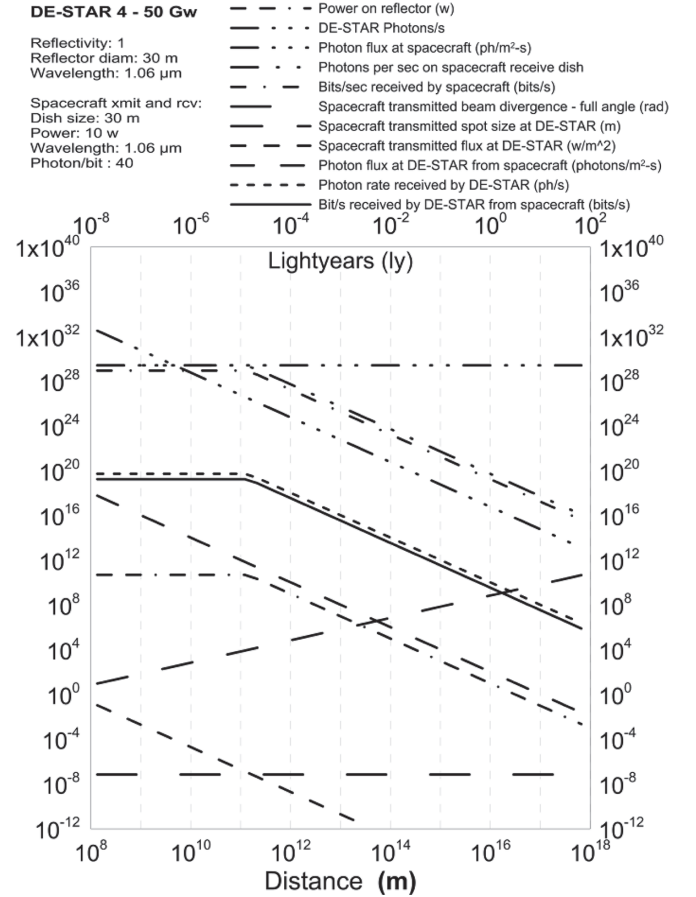

Fig. 10 Communications parameters between a DE-STAR 4 and a small robotic spacecraft vs. distance to spacecraft. The spacecraft is assumed to have a 10 watt burst mode (hibernates most of the time) IR transmitter and uses a 30 m reflector as both the drive and the transmit/receive reflector. Both uplink (DE-STAR to spacecraft) and downlink (spacecraft to DE-STAR) are shown.

Extraterrestrial Intelligence). As an example consider the recent exoplanets discovered by the Kepler mission. The “sweet spot” for Kepler detections is about 1,000 ly away. Imagine pointing a DE-STAR 4 at each of the several thousand Kepler exoplanet systems. At 1,000 ly ($\sim 10^{19}$ m) distance the DE-STAR 4 beam size is about 10^9 m or about 100 times the size of the Earth or about the diameter of the sun. Given a spot size of 10^9 m, this gives a photon flux at the exoplanet of about 3×10^{11} γ/m² s. For comparison, a magnitude 0 star is roughly 3×10^{10} γ/m² s in 1 band. **This implies that a DE-STAR 4 pointed at a planet 1,000 ly from Earth would appear as bright or brighter than the brightest star in our night time sky (assuming we could “see” at 1 μm).** This is truly remarkable. At the moment we do not know the location of these exoplanets precisely enough to point the beam so a raster scan of the entire exoplanetary system would be needed. To raster scan an exo solar system

is complex due to the long time-of-flight and the dynamic nature of the system (i.e., the planets are moving). As a simple example assume a 10^{12} m “raster box” at the exo solar system (this is about 6 AU in our solar system) or a reasonable size for “earth like planets in habitable zones” around sun like stars with some additional size added. Since the beam size at 1,000 ly is 10^9 m this is a 1000 by 1000 beam box or 10^6 beams. We now enter the slippery realm of when are they looking at “us” while we are “looking - transmitting” to them or vice versa. Assume for now they have a small 1 m class telescope (like Kepler) doing broad sky surveys. Since our flux is so high at 1,000 ly ($\sim 3 \times 10^{11} \gamma/m^2 s$) detection is extremely rapid. Assume we scan the entire 1,000 by 1,000 beam box in 1 s giving 10^{-6} s per beam or $3 \times 10^5 \gamma/m^2$ or $3 \times 10^5 \gamma$ in a 1 m aperture. This is easily detectable by our current generation of detectors and this is for an extremely modest 1 m aperture.

Conclusion - If we are looking for life forms of similar advancement to us then are we looking in the “right” way? This is partly a philosophical discussion now. Note however we do not need to assume they look in a narrow bandwidth (i.e., they do not need to know of transmission frequency) as we show up as a bright signal in a typical “photometric” band. Have we searched properly for this? Have they?

According to the latest Kepler statistics 1 in 5 sun-like stars may harbor habitable zone planets like the earth. This means roughly 10-40 billion earth like planets in our galaxy alone. We only went out to 1,000 ly with our analysis. Below we go to inter-galactic distances but before we do so let’s explore our galaxy further. Let’s go out to 10^5 ly, about the “size” of our entire galaxy. The same analysis, for 100 times the distance, gives a flux at 10^5 ly of about $3 \times 10^7 \gamma/m^2 s$ with a beam size of 10^{11} m or nearly 1 AU. Thus to “scan” a exo solar system at 10^5 ly we have a beam size which is 100 times larger and thus need 100^2 less “beams” to scan the same physically sized solar system. For the same time allocated per solar system we spend 10^4 times more time per beam on the solar system beam at 10^5 ly vs. one at 10^3 ly but have a flux of 10^4 times less $\gamma/m^2 s$ and thus we conclude we get the same detection for the same size aperture telescope at a solar system at 10^5 ly as one at 10^3 ly. Here we are assuming solar systems are like our own for searching for “earth like” planets around “sun like” stars with planetary distances of order of a few AU from the star. While dust in our galaxy does have a K correction at $1 \mu m$ wavelength it looks feasible to scan the entire galaxy for such signals.

Communication between two DE-STAR units - Now suppose that we have a link between two DE-STAR 4 units located 1,000 ly apart. Such a case could either be from a future scenario where we would ultimately colonize exo planets or in the case of SETI as a case between two comparably advanced civilizations. This would give approximately $3 \times 10^{19} \gamma/s$ received at each end since the flux from each at the other is $3 \times 10^{11} \gamma/m^2 s$ and the receiving area is $10^8 m^2$. This would clearly be an ultra-high speed link over a major part of the galaxy and extending it to the “edge of the galaxy” at 10^5 ly would drop the signal by 10^4 to $3 \times 10^{15} \gamma/s$ still an enormous rate. However, live streaming would of course be severely delayed by time of flight. To do a full analysis we would fold in the number of potential habitable planets (we assume habitable means “they” are like us of course) of some 10-40 billion habitable planets.

Intergalactic SETI implications - We can carry this further and ask what are the limits of this technology for searches for advanced civilizations at intergalactic distances. We start by

enlarging the distance to 1 Gly ($10^9 ly \sim 10^{25} m$) or 10^6 times the distance to the Kepler planets at 1,000 ly. The flux drops to 10^{-12} of what it was at 1,000 ly or to about $1 \gamma/m^2 s$. However this is in a very narrow laser line and hence is still quite large per unit bandwidth. The equivalent photometric magnitude (assuming a standard I/J broadband filter) is also shown in Fig. 11 at a distance of 1 Gly. For reference we note the photometric limit of the Hubble Space Telescope is close to 30th magnitude and this is a modest 2.4 m diameter telescope. **The conclusion is that even at 1 Gly the equivalent photometric magnitude is visible in a meter class space telescope.** See Fig. 12.

Laser linewidths - The lasers we baseline have line widths of between <1 kHz and 10 GHz depending on the configuration or between 10^{-12} and $10^{-5} \mu m$. Background are discussed below and we will see the background in these narrow bands are extremely small. Returning to distances between the two civilizations of 1 Gly and fluxes of $1 \gamma/m^2 s$ we get received rates of $10^8 \gamma/s$ at each end IF they are pointing at “each other”. If we go to 10 Gly the flux drop by 100 and the rate at each end to $10^6 \gamma/s$. The signals would be modulated in some way to imply non-natural sources and imply intelligence. At such distances redshifts become quite significant and the ability for life to form so quickly is completely unknown since the number of known intelligent species is between 0 and 1. In this number we include Earth. Gravitational lensing effects may also become relevant at these extreme distances and a full general relativistic transport simulation is needed. For reference, we will assume the number

Fig. 11 Communications or searches between two civilizations with DE-STAR 4 units at each civilization vs distance out to 1 Gly. The conclusion is that we would get an equivalent bit rate at 1 Gly of about 2 Mbps. This implies that this “modest” technology that we have now advanced to envisioning implies that civilizations across the entire universe could send high speed information to each other modulo the time of flight. The implications for SETI searches are profound.

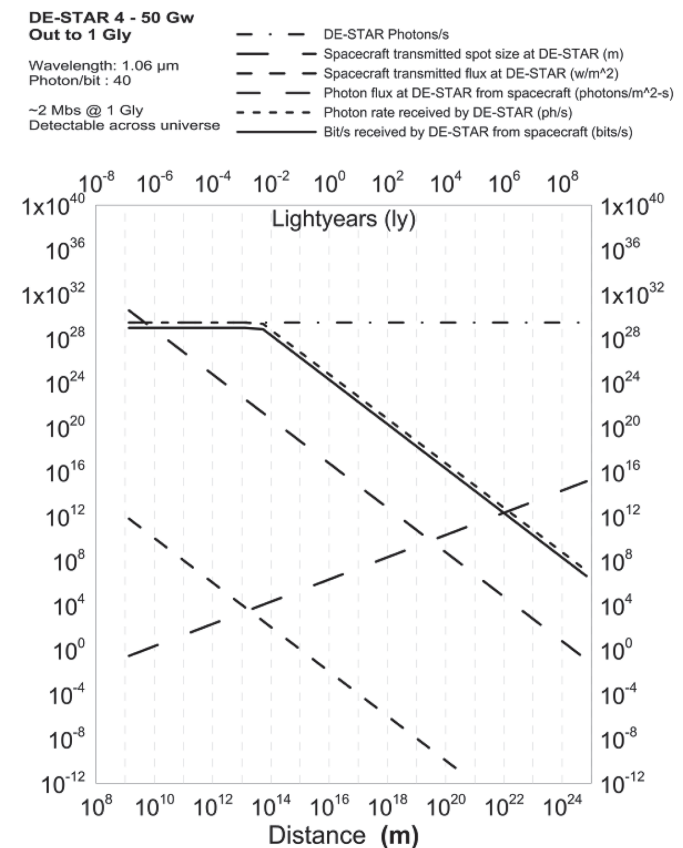

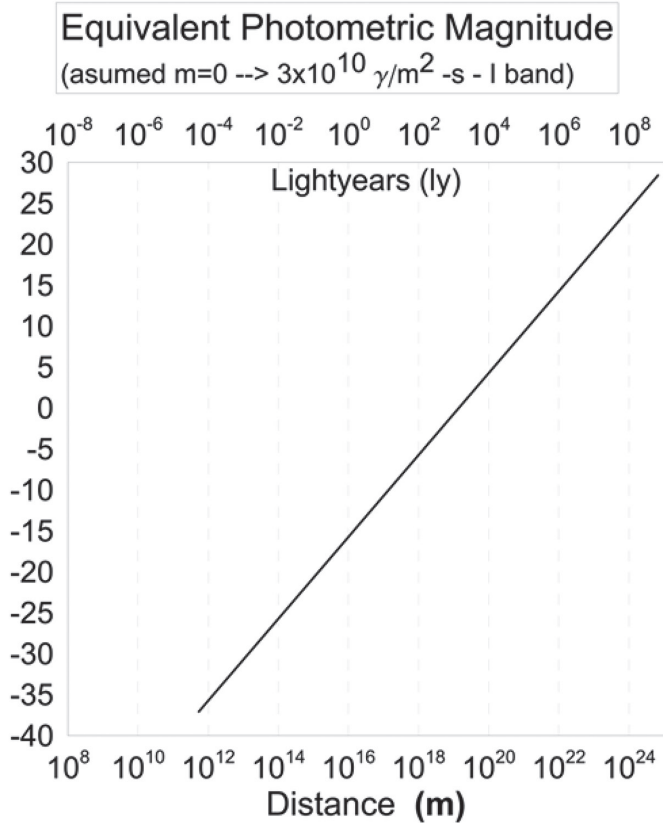

Fig. 12 Photometric (broad band equivalent) magnitude vs distance for a DE-STAR 4 out to 1 Gly. The I band equivalent photometric magnitude at 1 Gly from a DE-STAR 4 is approximate $m = 30$ or roughly the limit of the HST.

density of planets per galaxy is like our own and the number of galaxies (estimated to be) 100 to 500 billion. Assuming the same density of planets as in our galaxy (a BIG assumption) we would conclude there are of order 10^{21} planets that may be habitable if planet formation is similar at modest redshifts. This is completely unknown at present so we can only speculate.

Backgrounds - The relevant background at $1 \mu\text{m}$ wavelengths are optical emission from the telescope/ array, zodiacal emission from our solar system dust both scattering sunlight and emitting thermal radiation (Zodi) and the Cosmic Infrared Background (CIB). It is assumed that the latter is the sum of all unresolved galaxies in the universe in the field of view. The Cosmic Microwave Background (CMB) is not relevant and light from our galaxy is relatively small unless looking directly at a star. If searches/ communications are done inside our atmosphere then the situation is more complex due to emission from our atmosphere. For communications and for SETI programs we are looking at intelligently modulated signals not just random noise.

The Zodiacal light is highly anisotropic and also time dependent and location of the Earth in the orbit around the sun dependent. We treat this from data collected from the DIRBE instrument on COBE. The CIB is far more isotropic on modest angular scales and becomes largely point like on very small scales. Again we model this from the DIRBE data on COBE and subsequent measurements. We also model the optics at various temperatures and the Earths atmospheric emission for inside the atmosphere measurement but will focus here on orbital programs. The Zodi and CIB are shown in Figs. 13 & 14.

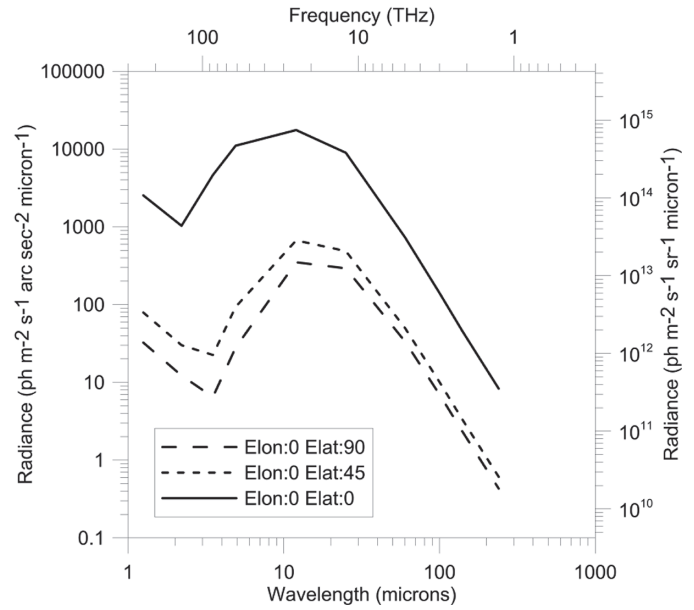

Fig. 13 Zodiacal emission from the COBE DIRBE measurements showing day 100 of the COBE mission at observation from the along the ecliptic plane to 45° to 90° (ecliptic pole). William Reach private communication (2012). Note the radiated peak from solar system dust around $15 \mu\text{m}$ due to the dust temperature being about 200 K and the scattered rise near $1 \mu\text{m}$ due to the zodi dust scattered sunlight.

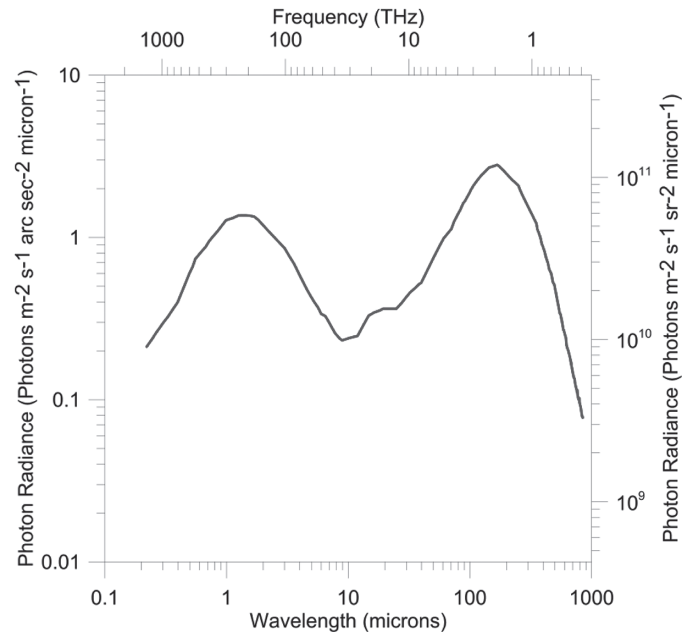

Fig. 14 Cosmic Infrared Background (CIB) radiation from COBE DIRBE and subsequent measurements.

Conclusion - The dominant background comparing the Zodi and CIB is the Zodi with worst case being observations in the ecliptic plane. Note the left hand vertical axes units are $\gamma/\text{m}^2 \text{ arcsec}^2 \mu\text{m}$. It is the extremely narrow laser line that dramatically reduces the backgrounds. As mentioned the laser linewidths we use are between 10^{-12} and $10^{-5} \mu\text{m}$ with $10^{-12} \mu\text{m}$ being the goal but even at the upper limit of $10^{-5} \mu\text{m}$ the background are very small. Note the two peaks near $1 \mu\text{m}$ and $200 \mu\text{m}$ due the fusion component (stars) and the reradiated interstellar dust component respectively.

Optics and Atmospheric Emission - The emission from the optics tends to be quite small (though not negligible

compared to the CIB for example) at $1 \mu\text{m}$ as we are usually running the optics near room temperature or below and thus we are on the Wien side of the curve and steeply suppressed. For observations inside the Earth atmosphere it is much more complex and “seeing” effects become quite serious depending on the system. At present we do not know how to use adaptive optics to the levels required for anything like the DE-STAR 4 (0.1 nrad synthesized beam). Perhaps we will master this someday. There are also time varying emission lines from a variety of species such as OH. These are extremely narrow in general with very deep minimum so this does help reduce the OH background. Other lines are broader however.

For comparison we have modeled the optics, atmosphere for various sites, including airborne and the CIB and Zodi on one plot as shown in Fig. 13. The optics are shown as the worst case black body emission where in general the emission is much less with typical emissivity's from 1-10% rather than unity as plotted. Compared to the Zodi and CIB the optical emission is sub dominant at $1 \mu\text{m}$. This is NOT true at longer wavelengths as is seen in Fig. 15.

Stopping and Ping Pong Systems - The current photon drive systems work since they do not carry any significant propellant and thus the mass is greatly reduced. In a scenario where stopping or orbital insertion is desired a ping pong approach is possible IF a second system can be built at the destination. Clearly this is a complex maneuver and an ion engine powered by the DE-STAR may be extremely useful but adds mass. Another possibility is to eject a reflective shield and use it as a reverse thrust system. Clearly this issue (stopping) is a serious one to contend with for orbital insertion systems. Braking against the magnetic field or solar wind of a star might be possible as well. These are all highly speculative. See Fig. 16.

Long Range power beaming - An off shoot of long range communications would be long range power transmission. Again considering the DE-STAR 4 which projects 50 GW into a 0.2 nrad beam. At 1 AU the flux would about 50 MW/m² for a 30 m spot size. This large amount of power being transmitted

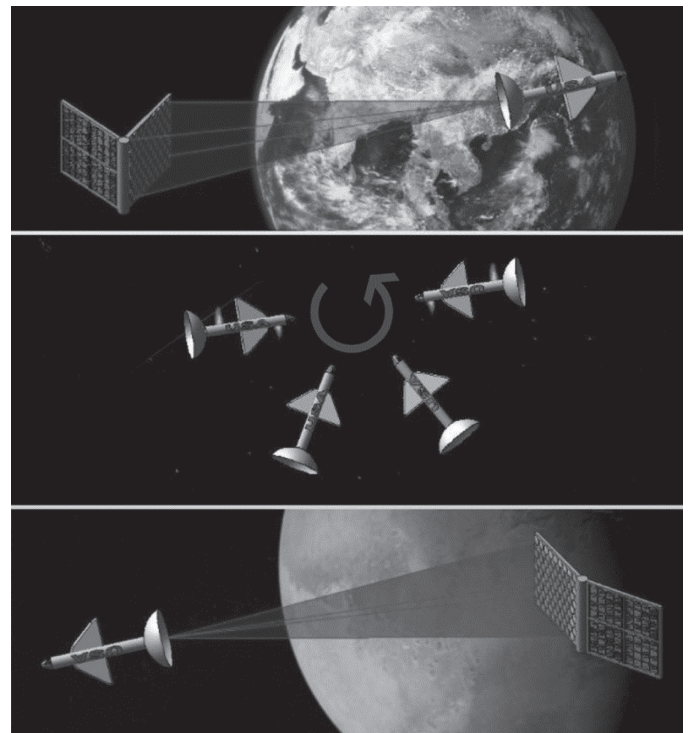
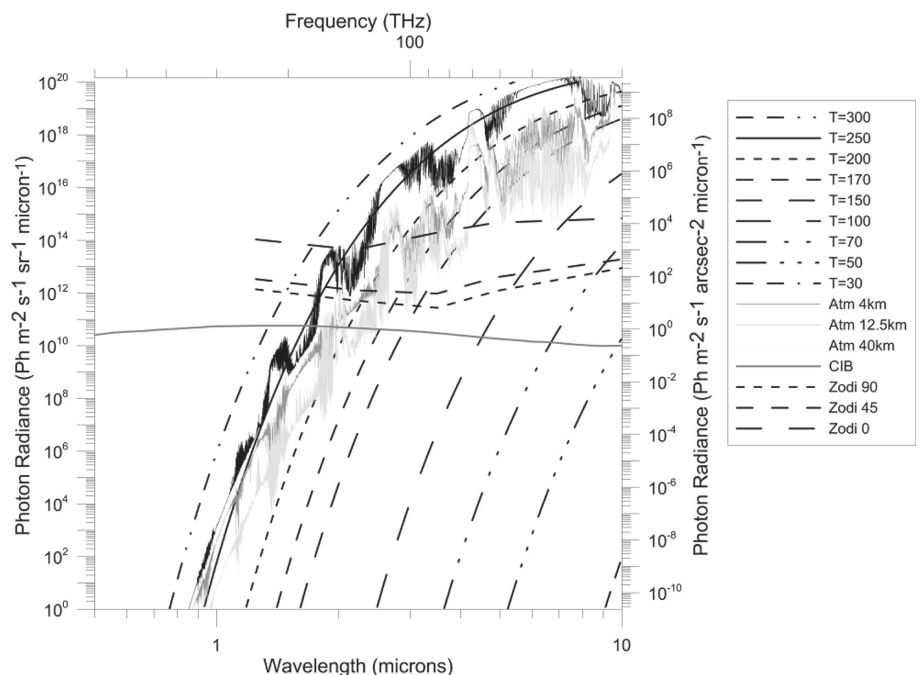

Fig. 16 A second DE-STAR photon drive at the mission destination can decelerated the spacecraft under controlled conditions. This deceleration is achieved by a “ping-pong” method where the spacecraft rotates and first one DE-STAR and then the second provide opposing forces to the reflector.

is how DE-STAR functions as a planetary defense system. It is possible to send significant power over the entire solar system using the DE-STAR allowing for very deep interplanetary probes to be recharged as well as to facilitate extremely high bidirectional data rates for communications and for power transfer to distant outposts if needed. This is discussed further in our other papers.

Nano and Wafer scale spacecraft - A unique possibility our group is exploring is to place an entire spacecraft on a wafer

Fig. 15 Comparison of optical emission vs optics temperature assuming emissivity is unity, atmospheric emission for various altitudes, Cosmic Infrared Background and Zodiacal light at various ecliptic inclinations (day 100 from COBE) vs wavelength for 0.5 to $10 \mu\text{m}$. Note the left hand and right hand vertical axes are reversed compared to Figs. 13 and 14. The bottom line is that at $1 \mu\text{m}$; the optical emission is small compared to the Zodi and CIB.



(we call it WaferSat) that includes a small burst mode phased array laser communications link, cameras and other sensors, guidance including star cameras and a MEMS INU, photon thrusters for fine scale pointing and small course corrections and an embedded RTG or beta converter along with narrow bandwidth PV for beam power conversion at vast distances to power it. Combined with a 1 meter reflector this system would achieve $>25\% c$ in about 15 minutes and would reach the nearest star (Promixa Centauri) in about 15 years. With **current densities** allowing about 10 million transistors per mm^2 , a 10 cm wafer could accommodate close to 1 trillion devices. Redundancy, low temperature operation, ultra low power burst mode operation, radiation hardening, high “g” load capability and fault tolerant architecture will be key. Such a system would allow about 100 “launches” per day or about 40,000 probes sent per year. The first interstellar probes may well be semiconductor wafers sent out this way. Such a system would also have vast uses inside our solar system. Silicon may be suitable but other materials may be preferred, especially III-V compounds that allow integrated photonics and electronics.

We know how to accelerate sub atomic scale particles to 99.999...% the speed of light. We know how to accelerate massive system like the Space Shuttle to 0.01% (ish) the speed of light. What is needed is a way to bridge the particle level and macroscopic level and accelerate micro scale (g and mg) level systems to modestly relativistic speeds. Putting a spacecraft **on a wafer that has a mass less than 1 g is feasible**. Photon driven propulsion offers this possibility. One key technology will be to engineer nano-scale reflectors that are ultra-low mass. A $1 \mu\text{m}$ thick glass or plastic all dielectric ultra-low absorption reflector

is our current baseline. The same beam that accelerates the system can also power it initially (chip level PV or IR rectennas for example) but even this will only go so far. We are exploring embedded microscopic RTG’s might as an option. This requires a future concerted effort to bring these technologies together to microscopic relativistic spacecraft. This will be discussed in detail in another paper.

6. CONCLUSIONS

Recent advances in photonics allow us to begin a serious program of beamed energy with a wide variety of implications for wide variety of purposes including planetary defense, direct photonic propulsion with interstellar capability and profound implications for SETI. Using current and rapidly evolving technologies we could enable the first generation of photon driven robotic interstellar probes that achieve mildly relativistic speeds using current reflector designs and significant relativistic speeds if we can master nano technology reflectors. The multiple uses would justify the cost for such a system. It uses forward looking technology with long term prospects to greatly expand our ability to explore. Further uses of the technology would enable long range communications with the photon propelled probe as well as extremely high data rates between DE-STAR and spacecraft and two DE-STAR units. We show that such systems have significant implications for SETI with detection across essentially the entire universe. While the challenges to perfecting this technology are very significant, so too are the revolutionary possibilities that are enabled by it. The philosophical and scientific implications of this technology are truly profound.

REFERENCES

1. R. Bussard, “Concepts for Future Nuclear Rocket Propulsion”, *Journal of Jet Propulsion*, **28**, pp.223-227, 1958.
2. A. Bond and A.R. Martin, “Project Daedalus - Final Report”, *Journal of the British Interplanetary Society Supplement*, pp.5-7, 1978.
3. K.A. Beals, M. Beaulieu, F.J. Dembia, J. Kerstiens, D.L. Kramer, J.R. West and J.A. Zito, “Project Longshot: An Unmanned Probe to Alpha Centauri”, US Naval Academy, NASA-CR-184718, 1988.
4. G. Marx, “Interstellar vehicle propelled by terrestrial laser beam”, *Nature*, **211**, pp.22-23, 1966.
5. R.L. Forward, “Roundtrip interstellar travel using laser-pushed lightsails”, *Journal of Spacecraft and Rockets*, **21**, pp.187-195, 1984.
6. P.M. Lubin, G.B. Hughes, J. Bible, J. Bublitz, J. Arriola, C. Motta, J. Suen, I. Johansson, J. Wu, A. Milich, M. Oleson and M. Pryor, “Directed Energy Planetary Defense”, in *Proc. of SPIE, Optics & Photonics*, **Vol 8876**, 2013.
7. P. Lubin, G.B. Hughes, J. Bible, J. Bublitz, J. Arriola, C. Motta, J. Suen, I. Johansson, J. Riley, N. Sarvian, D. Clayton-Warwick, J. Wu, A. Milich, M. Oleson, M. Pryor, P. Krogen, M. Kangas and H. O’Neill, “Toward directed energy planetary defense”, *Optical Engineering*, **53**, pp.025103-1 to 025103-18, doi: 10.1117/1.OE.53.2.025103, 2014.
8. G.B. Hughes, P. Lubin, J. Bible, J. Bublitz, J. Arriola, C. Motta, J. Suen, I. Johansson, J. Riley, N. Sarvian, J. Wu, A. Milich, M. Oleson and M. Pryor, “DE-STAR: phased-array laser technology for planetary defense and other scientific purposes”, in *Proc. of SPIE Nanophotonics and Macrophotonics for Space Environments VII*, eds. Edward W. Taylor, David A. Cardimona, **Vol. 8876**, 88760J, 2013.
9. J. Bible, J. Bublitz, I. Johansson, G.B. Hughes and P. Lubin, “Relativistic Propulsion Using Directed Energy”, in *Proc. of SPIE Nanophotonics and Macrophotonics for Space Environments VII*, eds. Edward W. Taylor, David A. Cardimona, **Vol. 8876**, 887605, 2013.

(Received 29 April 2014; Revised 7 October 2014; Accepted 28 August 2015)

* * *