

μ LED-Based Single-Wavelength Bi-directional POF Link With 10 Gb/s Aggregate Data Rate

Xin Li, Nikolaos Bamiedakis, Jinlong Wei, Jonathan J. D. McKendry, Enyuan Xie, Ricardo Ferreira, Erdan Gu, Martin D. Dawson, Richard V. Penty, and Ian H. White

Abstract—We report record 10 Gb/s bi-directional data transmission over a single 10 m SI-POF, by employing blue microlight-emitting diodes (μ LEDs) at a single wavelength, APD receivers, and a PAM-32 modulation scheme. The implementation of 10 Gb/s LED-POF links takes advantage of the bi-directional configuration, which doubles the overall channel capacity, and APDs, which provide an enhanced link power budget owing to their improved sensitivity compared with conventional p-i-n photodiodes. Moreover, the high spectral efficiency of the PAM-32 modulation scheme employed, together with equalization techniques, enable the full utilization of the link bandwidth and the transmission of data rates higher than those obtained with conventional on-off keying. Simulation and experimental results demonstrate the feasibility of such a bi-directional link, and simultaneous 5 Gb/s data transmission is realized in each direction, achieving an aggregate data rate of 10 Gb/s with a BER $< 10^{-3}$. The crosstalk penalty between the two directions of the link is measured to be less than 0.5 dB.

Index Terms—APD, bi-directional communication, micro-LED, plastic optical fiber (POF), pulse amplitude modulation (PAM).

I. INTRODUCTION

IN recent years, there has been much research interest in the deployment of step-index plastic optical fiber (SI-POF) in low-cost short-reach communication links, such as those employed in in-home and automotive networks. These applications can fully exploit the mechanical and cost advantages provided by SI-POF, namely, ease of installation, high flexibility, resilience to bending, shock and vibration, and cost-efficiency [1], [2]. Moreover, it has been shown that POF links, apart from higher interconnection data rates, can also provide cost and power advantages over common copper-based technologies [3], [4]. Light-emitting diodes (LEDs) appear to be especially attractive for use in such low cost SI-POF links as they are compatible with the large core diameter of POF, eye-safe, and cost- and energy-efficient. However, the increasing

network traffic foreseen in such environments (e.g., the interconnected house, 3-DTV, HDTV, multi-sensor automotive data networks) will require high transmission data rates of >1 Gb/s over such optical links [5]. The high speed performance of LED-POF links is typically limited by the low bandwidth of the POF (200 MHz \times 50 m), the RCLEDs typically employed (~ 100 MHz), and the relatively high attenuation coefficient of SI-POF (e.g., 0.16 dB/m at 650 nm) [5]. As a result, various schemes which enable an improvement in the achievable data rates over LED-POF links, such as advanced modulation formats, multiplexing techniques, such as wavelength-division multiplexing (WDM) and bi-directional (BiDi) transmission, and the use of avalanche photodiodes (APDs) have attracted considerable research interest. The use of spectrally efficient modulation formats, such as multi-level and multi-carrier modulation, has been proposed and demonstrated in such links. A 5 Gb/s data transmission rate over 25 m of a RCLED-POF link has been realised using 32-level pulse amplitude modulation (PAM-32) with a bit-error ratio (BER) $< 10^{-12}$ [6]. A 5.5 Gb/s transmission over 1 m SI-POF is achieved employing GaN LEDs and a PAM-4 modulation scheme [7]. Discrete multi-tone modulation has also been demonstrated using an LED transmitter, achieving 1.5 Gb/s over 50 m of POF with a BER $< 10^{-3}$ [8]. Moreover, WDM has been implemented over SI-POF links using six laser diodes and achieving an aggregate data rate of 21.4 Gb/s [9]. A 1 Gb/s real-time BiDi transmission over a single SI-POF is achieved using red lasers and a passive 1×2 POF splitter [10]. Finally, recent studies have demonstrated that APDs can offer improved sensitivity in such links enabling higher data rates or longer reaches [6].

In this work, we propose the use of BiDi transmission over LED-POF links in order to double the channel capacity and we report record single-wavelength 10 Gb/s BiDi data transmission. The link employs 20 μ m-diameter, 450 nm μ LEDs, 800 μ m-diameter APDs and PAM-32 modulation in order to achieve 5 Gb/s in each link direction. Such μ LEDs, with diameters ≤ 100 μ m, can demonstrate higher modulation bandwidths [11]. Moreover, μ LEDs emitting in the blue wavelength range match very well the low attenuation window of POF and the attenuation coefficient is lower than that for red wavelength. It also offers high coupling efficiency owing to their small dimension in comparison to the POF core size (1 mm in diameter). 6.25 Gb/s data transmission over 10 m of POF using 4 μ LEDs and a PAM-16 modulation has been experimentally demonstrated with a BER $< 10^{-3}$ [12]. Simulation studies on the BiDi μ LED-POF link are presented indicating the feasibility of such link and highlighting the importance of the use of APD-based receivers. The BiDi optical link is implemented and data transmission

Manuscript received March 16, 2015; revised May 8, 2015; accepted May 13, 2015. Date of publication June 16, 2015; date of current version August 3, 2015. This work was supported by the UK EPSRC via the Ultra Parallel Visible Light Communication Project. Additional data related to this publication is available at the data repository <https://www.repository.cam.ac.uk/handle/1810/247990>.

X. Li, N. Bamiedakis, J. Wei, R. V. Penty, and I. H. White are with the Centre for Photonic Systems, Electrical Engineering Division, Department of Engineering, University of Cambridge, Cambridge CB2 1TN, U.K. (e-mail: xl336@cam.ac.uk; nb301@cam.ac.uk; jw748@cam.ac.uk; rvp11@cam.ac.uk; ihw3@cam.ac.uk).

J. J. D. McKendry, E. Xie, R. Ferreira, E. Gu, and M. D. Dawson are with the Institute of Photonics, University of Strathclyde, Glasgow G1 1XQ, U.K. (e-mail: jonathan.mckendry@strath.ac.uk; enyuan.xie@strath.ac.uk; ricardo.ferreira@strath.ac.uk; erdan.gu@strath.ac.uk; m.dawson@strath.ac.uk).

Color versions of one or more of the figures in this paper are available online at <http://ieeexplore.ieee.org>.

Digital Object Identifier 10.1109/JLT.2015.2443984

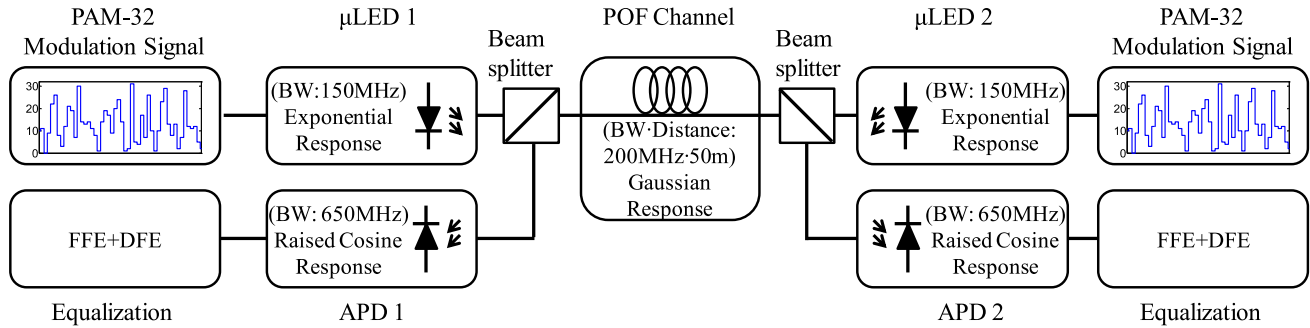

Fig. 1. BiDi link model with noted bandwidth (BW) for the optoelectronic components.

TABLE I
SIMULATION MODELS AND SPECIFICATION

Component	Response	Parameter
μ LEDs	Exponential	Bandwidth: 150 MHz Emission Power: 0 dBm Wavelength: 450 nm
POF	Gaussian	Bandwidth distance product: 200 MHz \times 50 m Attenuation: 0.2 dB/m at 450 nm
APD	Raised-Cosine	Responsivity: 0.275 A/W Bandwidth: 650 MHz

experiments are carried out to investigate the link performance. A gross aggregate data rate of 10 Gb/s is achieved over 10 m of POF with a BER $< 10^{-3}$ for both directions, which is within forward-error correction (FEC) limits. The 10 Gb/s gross data rate includes the required FEC overhead. The crosstalk penalty for each link direction is measured to be less than 0.5 dB. The reported results constitute, to the best of our knowledge, a record aggregate data rate performance for LED-POF links at a single wavelength and demonstrate the potential to achieve relatively large capacity in short-reach optical links using such low-cost components.

The remainder of the paper is organized as follows. Section II describes the link model used for the simulation studies and presents the obtained results. The link implementation and data transmission experiments are reported in Section III, while Section IV provides the conclusions.

II. SYSTEM MODEL AND SIMULATION RESULTS

A link model is developed to study the performance of the BiDi LED-POF link (see Fig. 1). The characteristics of the components employed in the simulations are based on the actual components used in the link demonstration. Table I summarises the important parameters and the type of response assumed for the different components in the link. Separate component studies have been carried out to determine some of the μ LED, POF and APD characteristics, while the value of the remaining parameters required are based on their datasheets. The impulse response of LEDs in fiber optic systems has been studied [13] and an exponential response is proposed. Moreover, the light-voltage (L - V) characteristic of the μ LEDs is measured and is incorporated in the model in order to take into account the effect of their non-linear behaviour on the link performance. The

frequency response of a SI-POF can be accurately modelled using a Gaussian filter [13]. The employed value for the POF loss coefficient at 450 nm (0.2 dB/m) is based on the measured value of the particular SI-POF (Eska-Mega) used in the experimental demonstration. The obtained loss value is larger than the 0.12 dB/m value used in the datasheet, as this includes bending losses and facets imperfections. The APD receiver is modelled as having a raised cosine frequency response [13] with a bandwidth of 650 MHz, as found by related measurements on the receivers used in the link implementation. The value for the APD responsivity used in the simulations is based on the datasheet of the APD employed in the experiments (First Sensor AD800-11). The value used is 0.275 A/W for $M = 1$. The receiver noise performance and APD avalanche gain (M) used in the simulation model are based on experimentally-determined values. The beam splitter is assumed to introduce a 3 dB coupling loss in each link direction.

In order to evaluate the effect of the use of the APD in the link, a similar link model is setup using a p-i-n-based receiver instead of the APD. The p-i-n receiver is modelled to have similar bandwidth and noise performance as the APD but with a unity avalanche gain ($M = 1$). The responsivity used for the p-i-n detector is chosen to be the same as the APD receiver without any gain (0.275 A/W) in order to provide a like-for-like comparison for the link power budget. The typical responsivity for a p-i-n detector at this wavelength range is of similar range (e.g. the commercially-available p-i-n receiver (Femto HAS-X-S-1G4-SI) has a responsivity of 0.19 A/W at 450 nm).

The PAM-32 signal is generated using a 2^9-1 pseudo random binary sequence (PRBS), emulating the short run length codes used in data communications (e.g., 8B10). Every 5 bits of the binary data sequence are combined to form the corresponding PAM-32 symbol. A 1 Gsample/s PAM-32 modulating signal is employed, giving rise to a gross data rate of 5 Gb/s in each direction. Due to the limited bandwidth of the link, the received PAM-32 waveform is severely distorted [see Fig. 2(a)] and the corresponding eye diagram is completely closed [see Fig. 2(b)]. As a result, feed-forward (FFE) and decision-feedback equalization (DFE) are used at the receiver to overcome the link bandwidth limitation and fully recover the transmitted signals [see Fig. 2(c)]. The obtained equalised eye diagrams are open and the 32 levels are clearly distinguishable, indicating that the transmitted data can be successfully recovered at the receiver.

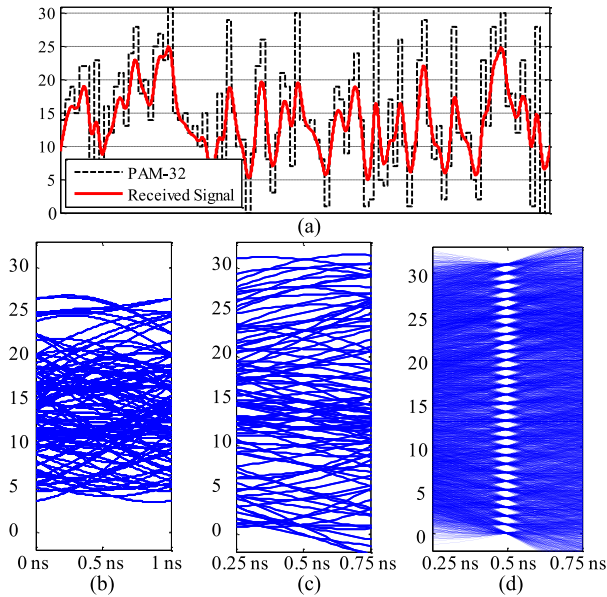

Fig. 2. Simulation results for (a) the transmitted ideal PAM-32 signal and received 5 Gb/s PAM-32 waveform after transmission over 25 m of POF, (b) received eye diagram in one link direction, (c) respective eye-diagram after equalization and (d) equalized eye-diagram generated using a $2^{15}-1$ PRBS sequence at 5 Gb/s.

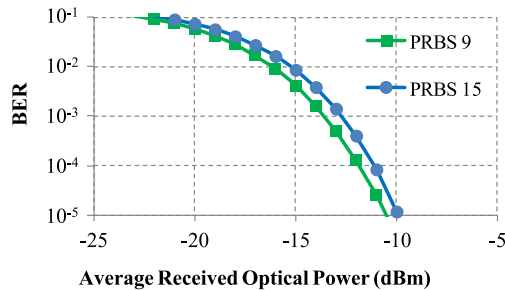

Fig. 3. Simulated BER results for the 5 Gb/s PAM-32 link using $2^{15}-1$ PRBS and 2^9-1 PRBS pattern.

It should be noted that the use of the relatively short pattern length (2^9-1 PRBS) results in the absence of some amplitude transitions in the transmitted PAM signal. In order to assess the link performance for a longer pattern which would generate more transitions, a longer $2^{15}-1$ PRBS is also studied using the same link model. The simulated received eye diagram after equalization for a $2^{15}-1$ PRBS pattern is obtained [see Fig. 2(d)] and the respective BER performance is calculated (see Fig. 3). The obtained eye diagrams are open and the levels are clearly distinguishable. The comparison of the BER curves obtained for a $2^{15}-1$ PRBS and a 2^9-1 PRBS pattern indicates a small power penalty <0.5 dB at $\text{BER} = 10^{-3}$.

A power budget analysis is used to evaluate the link performance and compare the APD- and p-i-n-based link configurations. The APD exhibits higher sensitivity than the p-i-n and therefore provides a larger power budget. Fig. 4 shows the additional power budget obtained as a function of the APD avalanche gain M . The additional power budget increases as

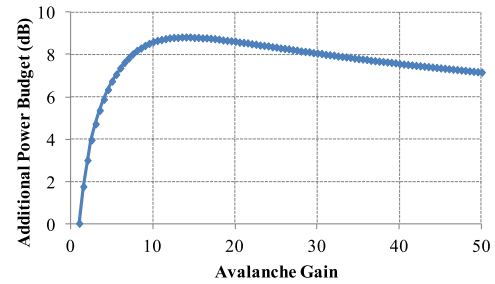

Fig. 4. Additional power budget in the μ LED-POF link obtained with the APD receiver as a function of the APD avalanche gain.

M increases due to the larger APD sensitivity until it reaches an optimum value M_{opt} . Further increase in the gain M results in a performance deterioration due to the excess noise factor of the APD. For this particular device, the optimum APD avalanche gain M_{opt} is found to be 12 while the resulting power budget improvement over the p-i-n is ~ 9 dB. For the simulations, the μ LED emitted power is assumed to be 0 dBm while the APD is assumed to operate at the optimum avalanche gain ($M_{\text{opt}} = 12$), yielding a sensitivity of -33.7 dBm for a BER of 10^{-3} at 100 Mb/s. For comparison, the sensitivity of the respective p-i-n receiver is -24.5 dBm for the same 10^{-3} BER at 100 Mb/s.

The power penalties considered in the link budget analysis include the multilevel, noise enhancement, residual inter-symbol interference (ISI), extinction ratio, non-linearity, attenuation and beamsplitter loss penalties. The multilevel penalty is introduced by the multilevel modulation scheme due to the reduction in the amplitude between two adjacent levels of the PAM signal [14]. The higher the order of the PAM scheme, the larger is the multilevel penalty. For the PAM-32 scheme, the multilevel penalty is found to be 14.9 dB. The noise enhancement penalty is introduced by the FFE process as, apart from the received signal, the noise is also amplified. Its magnitude depends on the values of the tap coefficients used in FFE process. The residual ISI penalty represents the signal degradation due to the limited link bandwidth that cannot be mitigated through the equalization process. The extinction ratio power penalty is caused by the non-zero power level for the symbol “0,” while the non-linearity penalty is due to the signal distortion induced by the non-linear response of the μ LED. The non-linearity penalty is obtained by comparing the BER performance of a link using a μ LED with a linear and a non-linear $L-V$ characteristic. For different POF lengths, the link bandwidth is different and therefore different tap coefficients are employed in the equalizers to optimise the link performance. As a result, the “linear” and “non-linear” links exhibit different eye closure for the different link lengths and therefore, different values for the respective non-linearity power penalty. The attenuation penalty represents the optical loss in the system due to the transmission over the POF and depends on the link length. To enable BiDi transmission in the link two beam splitters are used in the optical path resulting in additional optical loss in the system. For the simulations, each beamsplitter is assumed to introduce a loss of 3 dB in the link. Finally, a

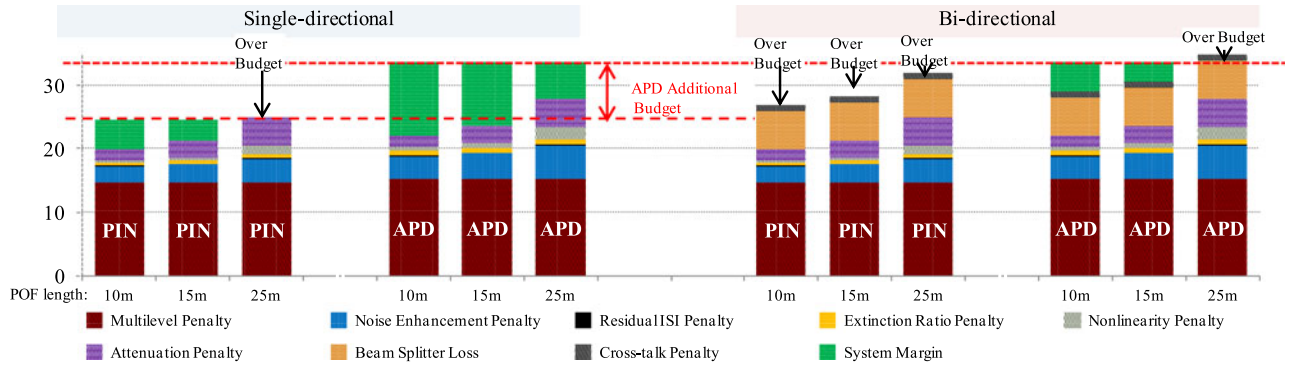

Fig. 5. Simulation results of power budget analysis.

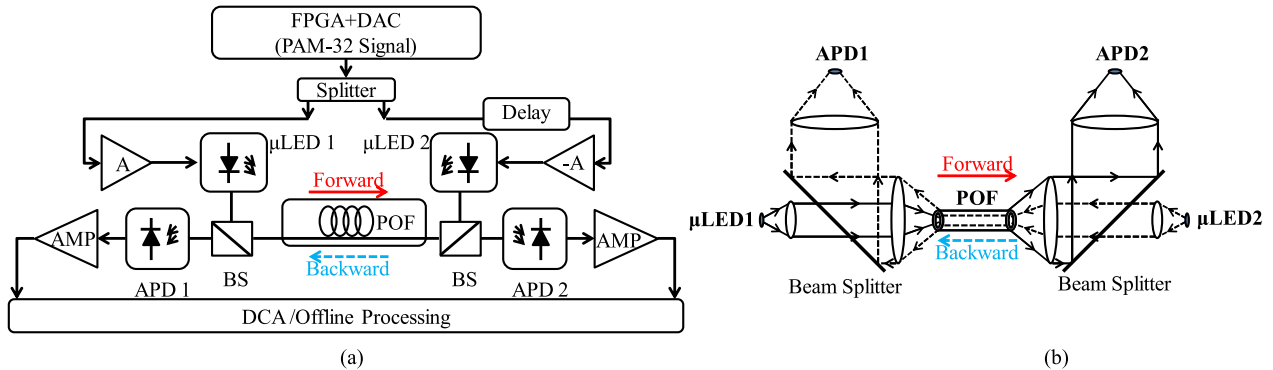

Fig. 6. (a) Experimental setup for implementing the BiDi SI-POF link; (b) optical coupling scheme at each POF end.

crosstalk penalty of 1 dB is assumed in the BiDi link simulations to account for the effect of the use of the second μ LED.

Fig. 5 shows in detail the link power budget of the single-directional (SiDi) and BiDi μ LED-POF links implemented with both p-i-n and APD receivers for different POF lengths: 10, 15 and 25 m. The simulation results show that there is no system margin available for the p-i-n-based link to support 10 Gb/s BiDi data transmission for any of the POF lengths studied. However, the APD-based link is able to support 10 Gb/s BiDi transmission up to 15 m of SI-POF due to the larger power budget provided by the APD. The link power margins are found to be 5.7 dB and 4.5 dB for 10 and 15 m of POF, respectively. The simulation results clearly demonstrate the advantage of using APDs in SI-POF links and indicate the feasibility of achieving a 10 Gb/s BiDi link over SI-POF using μ LEDs and a PAM-32 modulation scheme.

The link reach is limited by the optical losses in the system: POF attenuation, optical coupling loss at the μ LEDs-POF and POF-APD interfaces and the 6 dB optical loss due to the use of the two beamsplitters in the optical path. Longer POF lengths therefore could be potentially supported by employing higher efficiency optical coupling schemes, such as in [15], where a monolithically-integrated transceiver chip is fabricated consisting of p-i-n PDs and top-emitting vertical cavity surface-emitting lasers.

III. EXPERIMENTAL SETUP AND RESULTS

An APD-based 10 Gb/s BiDi LED-POF link is implemented [see Fig. 6(a)]. Two 450 μ m GaN μ LEDs, each with a 20 μ m diameter, are used as the transmitters and two 800 μ m-diameter APD as the receivers. For the purposes of this demonstration, discrete optical coupling components are used to combine and split the two optical streams at the input and output of the POF respectively. The emitted light from the μ LED is coupled into the POF using a pair of aspheric lenses while a beam splitter is introduced in the optical path at each POF end to enable BiDi link transmission [see Fig. 6(b)]. The light transmitted over the POF is focused on the APD using a pair of aspherical lenses. The input coupling loss (μ LED-POF coupling) is measured to be \sim 2.8 dB, while the output coupling loss (POF-APD coupling) is found to be \sim 2.4 dB. A slight difference in the obtained coupling loss values is observed in each link direction due to the alignment of the coupling elements. The BiDi coupling scheme can be implemented with miniaturized components integrated with the source and receiver. Work towards this is currently underway to demonstrate a similar POF-link that could find application in real-world low-cost optical systems.

The 5 Gb/s PAM-32 modulation signal is generated using an FPGA and a 16-bit 1 GSamples/s DAC. The modulation signal is split into two PAM-32 signals, which are subsequently delayed

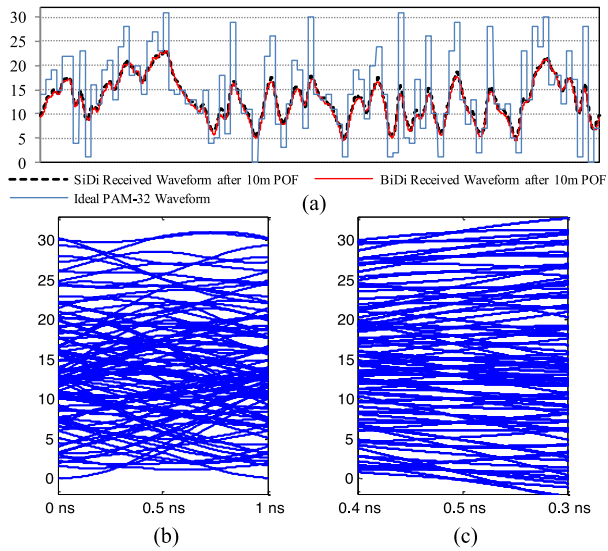

Fig. 7. (a) Received waveforms for SiDi and BiDi transmission; (b) received 5 Gb/s eye-diagram in one link direction after transmission over 10 m of POF and (c) respective eye-diagram after equalization.

with respect to each other to generate two quasi-decorrelated data streams and which are then amplified (SHF-826 H, BW: 70 kHz–25 GHz) in order to drive the two μ LEDs. At the APD receiver end, the received electrical signals are amplified using a low noise amplifier (LNA, ZFL-1000L N+, BW: 0.1–1000 MHz, noise figure: 2.9 dB) and are captured using a digital communication analyzer for offline processing. The performance of the SiDi link is obtained using the same setup but by operating one μ LED at a time.

The received electrical PAM-32 waveforms for the SiDi and BiDi link operation are shown in Fig. 7(a). The received waveform in the BiDi link is slightly more distorted than the one obtained from the SiDi link operation due to optical crosstalk induced by the operation of the second link channel. This optical crosstalk can be mainly attributed to reflections from the optical interfaces in the link (surfaces of the optical lenses, beam splitters, POF facets as well as APD and μ LED dies). After equalization, the transmitted signals are successfully recovered in BiDi link operation and 32 clear signal levels can be observed in the equalised eye-diagram [see Fig. 7(c)]. The BER performance of the link is calculated using the equalised waveforms and the measured APD receiver noise.

In order to optimise the BiDi link performance, the optimum APD gain is investigated for this link configuration. Fig. 8 shows the obtained BER for the optical back-to-back (B2B, short POF patch cord) link under different APD gains. The optimum APD gain is found to be $M = 14$. The excess noise factor of the APD with $M = 14$ is 1.49. This yields a sensitivity of -16.8 dBm for a BER of 10^{-3} .

The BER performance of the BiDi link in each direction (forward and backward) is obtained for the optimum APD operating point [see Fig. 9(a) and (b)]. The BER curves obtained for SiDi data transmission over the same setup are also plotted for comparison. The plots demonstrate that BiDi 10 Gb/s transmission

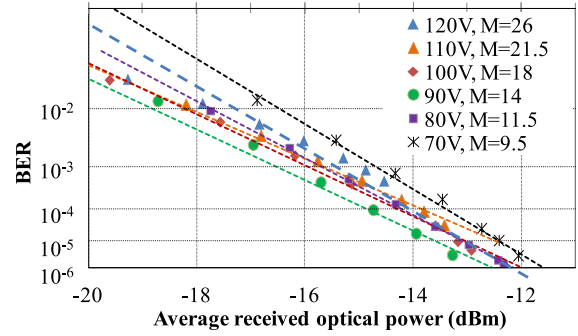

Fig. 8. Experimental BER results for the optical B2B link for different APD gains (M).

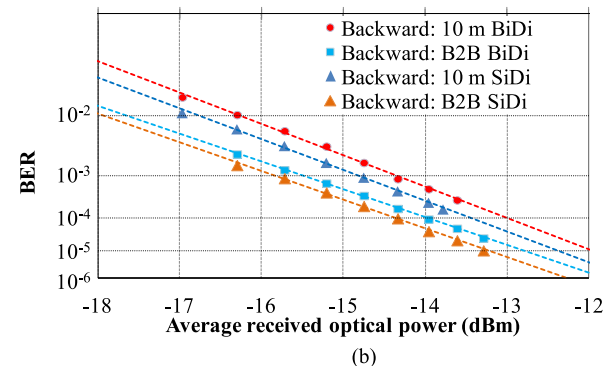
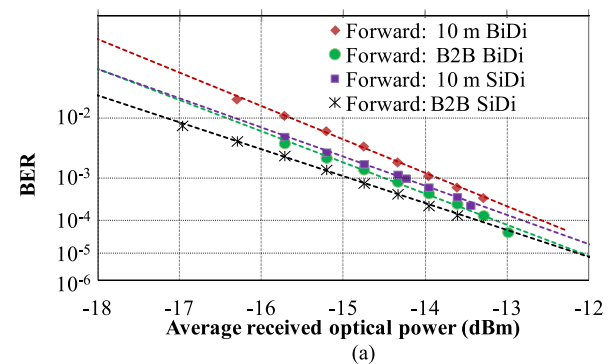

Fig. 9. Experimental BER results for (a) the forward and (b) backward channels in the BiDi link.

can be achieved over 10 m of POF with a BER $< 10^{-3}$. The average optical power required at the receiver end to achieve an aggregate 10 Gb/s over 10 m of SI-POF is -13.8 and -14.4 dBm for the forward and backward direction, respectively. The reverse link direction exhibits slightly improved performance over the forward link by ~ 0.7 dB, owing to the slightly larger bandwidth of the μ LED used in this direction. The power penalty due to optical crosstalk can be found by comparing the BER curves for the SiDi and BiDi links. This is found to be 0.5 and 0.3 dB for the forward and backward channel respectively. The obtained value is small indicating that the BiDi link, and therefore link capacity doubling, is feasible with very small degradation in the performance of each link direction.

IV. CONCLUSION

In this work, we have proposed the use of a BiDi μ LED-based single wavelength optical link over SI-POF in conjunction with PAM-32 modulation and APD receivers in order to achieve a record high aggregate SI-POF link capacity. Simulation and experimental studies are presented on a 10 Gb/s BiDi SI-POF link employing 450 nm μ LEDs and APDs indicating the feasibility of such links and demonstrating their potential for use in low-cost communication links such as in-home and automotive environments.

The presented simulation studies based on power budget analysis highlight the importance of the use of APD in such links and indicate that a 10 Gb/s BiDi PAM-32 transmission is feasible over 10 m of POF with an 5.3 dB power margin. Longer reaches can be realised by improving the employed optical coupling scheme. A proof-of-principle demonstration is implemented using discrete free-space optical components (lenses, beamsplitters), two 20 μ m-diameter μ LEDs and two APD receivers. 10 Gb/s BiDi data transmission is achieved over 10 m of SI-POF with a BER $< 10^{-3}$. The receiver sensitivity is found to be -13.8 and -14.4 dBm for the forward and backward link direction respectively, while a small power penalty (≤ 0.5 dB) is observed in the link due to optical crosstalk. The reported results constitute, to the best of our knowledge, record data rate transmission in LED-based POF links.

REFERENCES

- [1] O. Ziemann, J. Krauser, P. E. Zamzow, and W. Daum, *POF Handbook: Optical Short Range Transmission Systems*. New York, NY, USA: Springer-Verlag, 2008.
- [2] M. Atef, R. Swoboda, and H. Zimmermann, "A gigabit fully integrated plastic optical fiber receiver for a RC-LED source," in *Proc. IEEE 15th Des. Diagn. Electro. Circuits Syst. Int. Symp.*, Apr. 18–20, 2012, pp. 74–78.
- [3] A. M. J. Koonen, H. P. A. Van Den Boom, E. O. Martinez, P. Guignard, and E. Tangdiongga, "Cost optimization of optical in-building networks," presented at the Eur. Conf. Exhib. Opt. Commun., Geneva, Switzerland, Sep. 18–22, 2011.
- [4] A. M. J. Koonen and E. Tangdiongga, "Photonic home area networks," *J. Lightw. Technol.*, vol. 32, no. 4, pp. 591–604, Feb. 15, 2014.
- [5] Y. Dong and K. W. Martin, "Gigabit communications over plastic optical fiber," *IEEE Solid-State Circuits Mag.*, vol. 3, no. 1, pp. 60–69, Winter 2011.
- [6] X. Li, J. L. Wei, N. Bamiedakis, R. V. Penty, and I. H. White, "Avalanche photodiode enhanced PAM-32 5 Gb/s LED-POF link," presented at the Eur. Conf. Opt. Commun., Cannes, France, Sep. 21–25, 2014.
- [7] J. Vinogradov, R. Kruglov, K. L. Chi, J. W. Shi, M. Bloos, S. Loquai, and O. Ziemann, "GaN light-emitting diodes for up to 5.5-Gb/s short-reach data transmission over SI-POF," *IEEE Photon. Technol. Lett.*, vol. 26, no. 24, pp. 2473–2475, Dec. 15, 2014.
- [8] L. Peng, M. Helard, S. Haese, M. Liu, and J. F. Helard, "Hybrid PN-ZP-DMT scheme for spectrum-efficient optical communications and its application to SI-POF," *J. Lightw. Technol.*, vol. 32, no. 18, pp. 3149–3160, Sep. 15, 2014.
- [9] R. Kruglov, J. Vinogradov, S. Loquai, O. Ziemann, C. A. Bunge, T. Hager, and U. Strauss, "21.4 Gb/s discrete multitone transmission over 50-m SI-POF employing 6-channel WDM," presented at the Opt. Fiber Commun. Conf. Exhib., San Francisco, CA, USA, Mar. 9–13, 2014.
- [10] A. Antonino, S. Straullu, S. Abrate, A. Nespolo, P. Savio, D. Zeolla, J. R. Molina, R. Gaudino, S. Loquai, and J. Vinogradov, "Real-time gigabit ethernet bidirectional transmission over a single SI-POF up to 75 meters," presented at the Opt. Fiber Commun. Conf/Nat. Fiber Opt. Eng. Conf., Los Angeles, CA, USA, Mar. 6–10, 2011.
- [11] J. J. D. McKendry, D. Massoubre, S. Zhang, B. R. Rae, R. P. Green, E. Gu, R. K. Henderson, A. E. Kelly, and M. D. Dawson, "Visible-light communications using a CMOS-controlled micro-light-emitting-diode array," *J. Lightw. Technol.*, vol. 30, no. 1, pp. 61–67, Jan. 1, 2012.
- [12] X. Li, N. Bamiedakis, J. L. Wei, J. J. D. McKendry, E. Xie, R. Ferreira, E. Gu, M. D. Dawson, R. V. Penty, and I. H. White, "6.25 Gb/s POF link using GaN μ LED arrays and optically generated pulse amplitude modulation," presented at the Conf. Lasers Electro.-Opt., San Jose, CA, USA, May 10–15, 2015.
- [13] G. D. Brown, "Bandwidth and rise time calculations for digital multimode fiber-optic data links," *J. Lightw. Technol.*, vol. 10, no. 5, pp. 672–678, May 1992.
- [14] L. Geng, J. L. Wei, R. V. Penty, I. H. White, and D. G. Cunningham, "3 Gbit/s LED-based step index plastic optical fiber link using multilevel pulse amplitude modulation," presented at the Opt. Fiber Commun. Conf. Expo./Nat. Fiber Opt. Eng. Conf., Anaheim, CA, USA, Mar. 17–21, 2013.
- [15] A. Kern, A. Al-Samaneh, D. Wahl, and R. Michalzick, "Monolithic VCSEL—PIN photodiode integration for bi-directional optical data transmission," *IEEE J. Sel. Topics Quantum Electron.*, vol. 19, no. 4, pp. 1–13, Jul./Aug. 2013.

Authors' biographies not available at the time of publication.