

Combining sensor monitoring and fault tolerant control to maintain flight control system functionalities

D. Ossmann* H.-D. Joos**

* Department of Aerospace Engineering & Mechanics
University of Minnesota, Minneapolis, MN, 55455, USA
(e-mail: dossmann@umn.edu)¹

** Institute of System Dynamics and Control, DLR Oberpfaffenhofen
82234 Weßling, Germany, (e-mail: dieter.joos@dlr.de)

Abstract: To maintain nominal flight control system functionalities during fault scenarios, enhancements of the state-of-practise angle of attack and airspeed sensor fault accommodation strategies are presented. The strategy combines a fault detection and diagnosis (FDD) system with a robust fault tolerant control law. The FDD system allows to maintain the nominal flight control law as long as at least one angle of attack and airspeed sensor are available. The FDD system is designed using advanced nullspace computation, optimization, and signal processing techniques. For the scenario of a total airspeed measurement loss, an airspeed independent longitudinal backup control law is designed using global optimization techniques. Using this law avoids the state-of-practise switch to a direct law in which the pilot must control the elevator positions directly. The results from an extensive industrial validation and verification campaign are reported.

Keywords: Fault tolerant flight control, fault detection & isolation, verification and validation.

1. INTRODUCTION

Fault detection and diagnosis (FDD) as well as fault tolerant control (FTC) approaches were pragmatically pursued to establish a maximum degree of safety and reliability. For the new generation of aircraft this pragmatic design paradigm has been raised to a performance-oriented one which can be termed as full-time and all-event availability of performance-optimized guidance, navigation and control (GNC) functions Goupil et al. (2015). Such a robust provision of GNC functions can be translated in the desire to assist the pilot in all possible scenarios to keep the flight safe, making the flight task itself easier and the mission optimal. A high level description of this idea is given in Figure 1. In fault scenarios, which are indicated by the red dots in the figure, it may be necessary to downgrade to a control law with less GNC functionality. This can be, for example, due to the unavailability of a certain sensor signal or actuator. Such a degradation is referred to moving from the *normal law*, i.e. nominal functionality, to an *alternate law*, providing limited functionality. In the worst case scenario, the pilot will fly the so called *direct law*, where the pilot directly controls the control surface of the aircraft. The flight in the direct law shall be avoided, as in this law the pilot has to focus most of the attention on the piloting task. Thus, current FDD/FTC research is focused on the situational extension of the nominal GNC functionality level in case of faults. This is illustrated by

moving the purple line (current situation) of degradation to the right (desired situation).

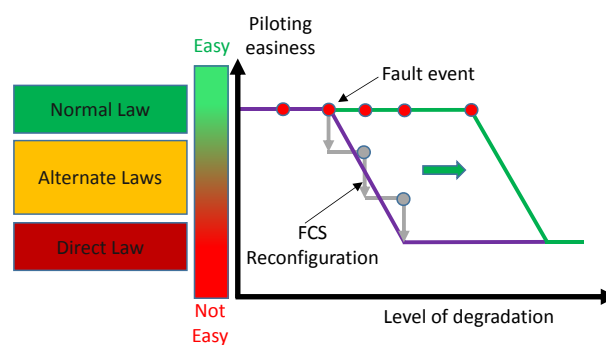

Fig. 1. Illustration of GNC functionality extension idea

To achieve high GNC functionality in case of faults, the key enablers have been identified to be advanced FDD and FTC, which can contribute to the future more sustainable aircraft Goupil et al. (2015). Early and robust detection of incipient faults thanks to advanced FDD is required to extend the availability of key flight parameters and thereby *maintain* the nominal GNC functionality level. In case of a loss of key flight parameters FTC allows to *improve* the flight control system (FCS) functionality to get closer to its nominal level. Two key flight parameters required to ensure the highest possible FCS functionality level is the aircraft's angle of attack (AoA) and its calibrated airspeed (VCAS). While the latter is used to schedule the

¹ The research of this paper was performed by the author when affiliated with the German Aerospace Center, DLR Oberpfaffenhofen.

control gains and thus highly influences the performance and stability of the aircraft, the first is used to protect the aircraft from reaching stall conditions. Due to their importance for the FCS, we propose two main algorithms to enhance the state-of-practice VCAS and AoA sensor fault accommodation strategy: an advanced FDD system to monitor the triplex redundant VCAS and AoA measurements as well as an alternate longitudinal control law, a so-called backup law, independent of the two measurements.

The advanced FDD system enhances current state-of-practice to be able to isolate multiple sensor faults. The state-of-practice monitoring scheme is able to cope with a single fault scenario in the triplex redundant measurement system Berdjag et al. (2013) and switches to an alternate or even direct law in case of more than one fault. The presented FDD system allows maintaining the normal law, i.e. the nominal longitudinal control law and all protections, as long as one sensor in each of the two triplex redundant measurements is still working. In case of a total loss of the VCAS measurements the state-of-practice fault accommodation strategy initiates a switch to the direct law, where the pilot directly controls the elevators via his stick actions. For this scenario a newly developed backup law is presented. This backup law operates the aircraft without using VCAS for scheduling and keeps the stability and performance level close to the normal law.

The tackled problem is part of the EU-FP7 RECONFIGURE project on FDD/FTC techniques for modern civil aircraft. Valuable contributions dealing with the same or parts of the defined problem can be found in literature: In Rosa et al. (2015) a mixed- μ FDD/FTC approach is proposed, in Hardier et al. (2015) an online parameter estimation algorithm to recover lost measurements is applied, in Wan et al. (2016) a moving horizon estimation techniques for the FDD problem is used, in Chen et al. (2015) sliding mode observers to tackle the sensor FDD problem are developed, and in Hartley and Maciejowski (2015) a fault tolerant longitudinal law based on model predictive control is presented. In the approach in this paper the combined FDD/FTC problem is tackled. The use of signal together with model based fault detection techniques as well as the use of global optimization techniques differentiates the presented approach from the mentioned contributions. These techniques allow the design of an FDD/FTC system with increased performance. To show this, the final part of the paper deals with the reporting of the latest results of an extensive industrial validation and verification campaign set up in the RECONFIGURE project.

2. FAULT ACCOMMODATION STRATEGY

Up to three AoA and three VCAS faults result in various different fault scenarios to be dealt with. In this section a summary of the strategy coping with these scenarios is given. In Table 1 possible fault scenarios and its accommodation strategies are listed. As long as one of the AoA and VCAS sensors are properly working, the nominal control law together with its full protection functionality can be maintained. This extends the state of practice capability, which can only deal with a single sensor in every triplex redundant measurement.

In case of a total loss of the AoA sensors, an alternate law, namely the nominal control law without direct AoA protections is activated. This alternate law is state of practice and should not be confused with the herein developed backup law. The backup law, independent of VCAS, is activated in case of a total loss of the VCAS sensors. It provides satisfactory handling qualities and avoids the switch to the direct control law, but does not include direct AoA protections. This fault accommodation strategy is also coherent with another main design constraints, namely to keep the nominal control law and protections in operation as long as possible.

Scenario	Running algorithms
fault free	nominal control law and protections
1 or 2 AoA sensors fail	fault isolation and use of remaining AoA sensor to maintain nominal control law and protections
1 or 2 VCAS sensors fail	fault isolation and use of remaining VCAS sensor to maintain nominal control law and protections
3 AoA sensors fail	switch to alternate law which includes nominal control law but without direct AoA protections
3 VCAS sensors fail or all 6 sensors fail	switch to a VCAS independent longitudinal backup law

Table 1. Fault accommodation strategy

Note, in case of further or other failures, as for example the loss of the inertial measurement unit or the loss of flight control computers, it might still be necessary to activate the direct law. However, the presented approach helps to extend the provision of high GNC functionality levels during VCAS and AoA faults.

3. FAULT DETECTION AND ISOLATION SYSTEM FOR ROBUSTLY MONITORING AOA AND VCAS

As the FDD system needs to be able to detect and isolate the faulty sensors, i.e. locate which sensors are faulty, each of the six air data sensors (three for AoA and three for VCAS) are monitored without the use of the other five sensors. In this way it is possible to avoid a coupling between the faults and directly solve the fault isolation problem. This is schematically shown for a triplex redundant sensor system in Fig. 2. Each of the

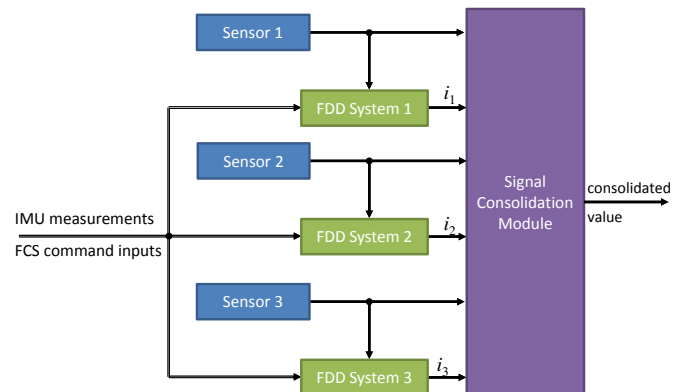

Fig. 2. FDD system monitoring a triplex sensor system
six fault detection subsystems consist of a model based

and a signal based component as depicted in Fig. 3. By signal based methods we refer to methods which process only the measurement signal. By model based methods we refer to methods which make use of a mathematical description of the underlying system. The combination of signal and model based methods enables to reliably detect and isolate the faulty sensors. Each of the FDD subsystems generates a decision variable i for each sensor, which indicates if the sensor is working correctly ($i_{s,k} = 1$) or not ($i_{s,k} = 0$), where $s \in \{\alpha, VCAS\}$ and $k = 1, 2, 3$. With this knowledge available, the state-of-practice signal consolidation scheme, which provides a weighted median in case of no fault, a mean based calculation in case of two faults, and a constant value in case of more than one fault, can be enhanced to

$$\alpha_c = \begin{cases} g_1 \tilde{\alpha} + g_2 (\min(\underline{\alpha}) + \max(\underline{\alpha})) & \text{if } S_i = 3 \\ \frac{1}{S_i} \sum_{k=1}^3 \alpha_k i_{\alpha,k} & \text{if } 3 > S_i \geq 1 \\ c & \text{otherwise.} \end{cases} \quad (1)$$

In (1) α_c is the consolidate AoA value, $\underline{\alpha}$ is a vector containing the three AoA measurement signals α_1 , α_2 and α_3 , $\tilde{\alpha}$ is the median value of three measurements, $S_i = i_{\alpha,1} + i_{\alpha,2} + i_{\alpha,3}$ indicates how many sensors work correctly, and c is a constant value which is propagated in case of a total loss. The weights g_1 and g_2 are selected to weight the median value against the two remaining sensors, while $g_1 + 2g_2 = 1$ needs to be fulfilled. This consolidation scheme enhances the state-of-practice by providing a correct value in case of two faults. Note, it maintains the state-of-practice functionality in fault free and single fault scenarios.

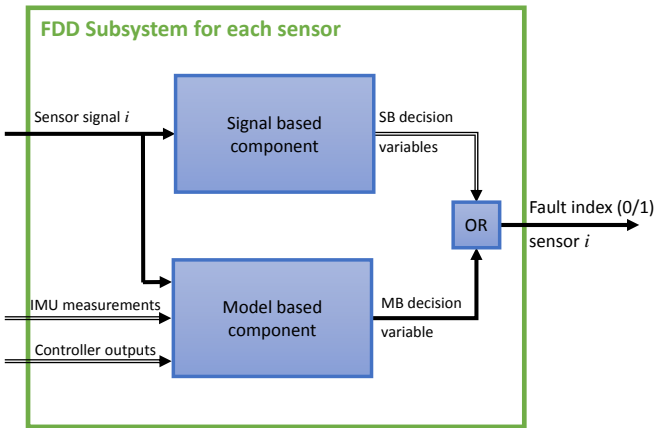

Fig. 3. FDD system to monitor one AoA sensor based on signals and model based components

3.1 Signal based component

Signal based fault detection approaches assume that the available signals contain information which directly indicates the presence of faults. The main advantage of such a signal processing based methods is their reduced complexity. One implemented methods is simple limit checking on the absolute measurement value as well as its derivative. Further, plausibility checks, checking if in presence of a changing input signal a changing output signal is present,

are used. Finally, a recursive version of discrete Fourier transformation has been developed to be able to detect unwanted oscillations in the signals. A detailed description of all these algorithms can be found in Ossmann and Joos (2016), where they are applied for the AoA measurement signals. For the VCAS and the AoA monitoring the same algorithms are used, however, with an adapted parameter setting.

3.2 Model based component

The model based component uses linear filters to generate a so called residual signal, which shall be zero (or sufficiently small) in all fault free cases, while it needs to be nonzero in case of faults. For the generation of these linear filters a two step approach is used: The first step uses linear model of the underlying dynamics to determine an adequate structure of the residual filter based on nullspace computations tailored for FDD purposes. Theoretical details about this approach can be found in Varga (2003) with an extension on how to select the nullspace basis vectors to increase robustness against uncertainties in Ossmann and Joos (2016). The second step is an update of the filter parameters based on non-convex optimization techniques and generated simulation data using the non-linear high fidelity model. The optimization approach is based on the theoretical descriptions in Ossmann (2014).

Due to the fact that this paper focuses on combining the FDD and FTC algorithms as well as the validation and verification results the description of FDD system is only summarized briefly here. Readers interested in the FDD part can find more details about its background and its development in Ossmann and Joos (2016).

4. AN ALTERNATE BACKUP CONTROL LAW TO RETAIN PILOTING EASINESS

For the design of a backup robust longitudinal controller to be used in the case of failure of all velocity sensors, we use an optimization based multi-objective tuning approach of the controller parameters as described in Joos (1999). The controller structure must be rich enough to allow the required performance and robustness.

Important features of the chosen methodology are that various kinds of design objectives can be taken into account in their most natural form via appropriately formulated mathematical criteria (e.g., initial response, overshoot, settling time). The main appeal of the multi-objective optimization, as a computer aided design technique, is its ability to handle several (potentially) conflicting design goals simultaneously, and finding the best compromising solution. This technique can also serve for robustness assessment purposes, by finding “worst-case” parameter combinations to decide whether a design is robust or not.

Robustness of the controller to be designed can be achieved in several ways by appropriately mapping of the robustness requirements onto design criteria. The *local* robustness of the controller in the vicinity of a design point can be enforced by defining suited robustness criteria, which directly address robustness to not-modeled parametric variations

(e.g., ensuring sufficient gain/phase margins). *Global* robustness against parametric variations (e.g., weight and/or center of gravity position) can be addressed using multiple models representing different operating conditions. This automatically leads to multiple-model multi-criteria design problem formulations. The design criteria (or constraints) are evaluated as the worst-case value over the whole range of a selected representative model set. Herein robustness is covered using such a multi-model approach. Further, stability is enforced by a specific time response constraint.

For a mathematical description of the optimization, let $c_i(\theta, \rho)$, $i \in \mathcal{I}$ (e.g., $\mathcal{I} = \{1, \dots, N_c\}$) be a set of criteria depending on the tuning parameters $\theta \in \Theta$ and uncertain parameters $\rho \in \Pi$. The admissible tuning parameter space is defined by Θ and Π is the set of uncertain parameter values. For example, a discrete-set as $\Pi = \{\rho^{(1)}, \dots, \rho^{(N)}\}$ may account for a multiple-model based problem formulation. The problem of finding satisfactory compromise solutions for the tuning variable θ in presence of uncertainties in ρ , we can solve a scalar weighted min-max optimisation problem of the form

$$\begin{aligned} \min_{\theta \in \Theta} \max_{i \in \mathcal{I}_s, \rho \in \Pi} \left\{ \frac{c_i(\theta, \rho)}{d_i} \right\}, \\ \text{subject to } \max_{\rho \in \Pi} c_i(\theta, \rho) \leq d_i \text{ for } i \in \mathcal{I} \setminus \mathcal{I}_s, \end{aligned} \quad (2)$$

where for the i -th criterion, the weighting factors $d_i > 0$ can be interpreted either as demand (or *soft constraint*) for $i \in \mathcal{I}_s$ or a *hard constraint* for $i \in \mathcal{I} \setminus \mathcal{I}_s$. The above min-max multi-criteria optimisation problem has been reformulated as a smooth *nonlinear programming problem* (NLP) with inequalities and simple bounds constraints and solved by using available solvers as those presented in Joos et al. (2002).

For the structure of the longitudinal controller we rely on proven approaches like the C^* -control law as described in Brockhaus et al. (2011). It was augmented by constant pitch rate and pitch acceleration feedback yielding a common *command and stability augmentation system* CAS/SAS. The challenge was to find proper constant controller gains, without scheduling, to make it robust against operational variations. The according control law equations are given by

$$\begin{aligned} \dot{x} &= [\theta_1 \ \theta_2 \ 0 \ \theta_3] u \\ \eta &= x + [\theta_4 \ \theta_5 \ \theta_6 \ 0] u, \end{aligned} \quad (3)$$

where the input vector u consists of pitch rate q , load factor n_z , pitch acceleration \dot{q} , and the commanded load factor $n_{z,\text{ref}}$. η is the generated elevator deflection command. The free tuning parameters of this control law structure are the elements of θ_1 to θ_6 . For tuning of the controller parameters a multi-objective, multi-model optimization, as briefly described above, has been set up with the full non-linear benchmark model in order to fully cover the overall operational range of the aircraft, including non-clear configurations.

The complete set of criteria used for design is described in Table 2, q_0 is the pitch rate trim value, n_{z_0} the load factor trim value, Θ the pitch angle of the aircraft, and t_{end} the simulation time.

Description	Type	Basic formula
pitch rate overshoot	minimized	$\max_t (q(t) - q_0)$
load factor overshoot		$\max_t (n_z(t) - n_{z_0})$
load factor rise time		$\arg \min_t (n_z(t) \geq 0.95 \max_t n_z(t))$
load factor set-point deviation		$\int_{t_{\text{end}-3}}^{t_{\text{end}}} (n_z(t) - n_{z,\text{ref}})^2 d\tau$
load factor steady state		$\max_{t > t_{\text{end}-3}} dn_z(t)/dt $
pitch steady state	constraint	$\max_{t > t_{\text{end}-3}} d^2\Theta(t)/dt^2 $
state (stability)		

Table 2. Applied design criteria.

The command performance is illustrated in Fig. 4. Here for more than 220 points in the operational range, including non-clear configurations, the load factor response due to a doublet stick input with small amplitude (13% of maximum stick deflection) is depicted, showing a reasonable homogeneity of the responses with sufficiently good rise time and stationarity. The achieved results of the backup controller are comparable to the one of the baseline controller depicted in Fig. 5. To point out again this is achieved without the use of any scheduling variables.

To check robustness and stability of the controller, which was designed using non-linear simulations only, gain and phase margins at 214 trim cases have been computed. The open loop transfer functions of the aircraft, sensor actuator dynamics together with the backup law were generated on these points to be able to determine the stability margins. The results are shown in Fig. 6. Gain margins not less than 6dB and phase margins of at least 60° could be achieved indicating satisfactory robustness to uncertainties. Note again, that no criteria based on gain and phase margins have been applied during the design, making the margin tests reasonable verification criteria.

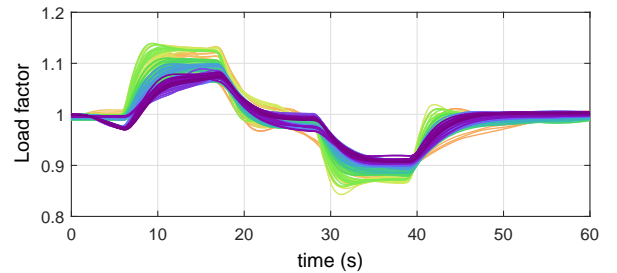

Fig. 4. Backup controller n_z responses to stick doublet

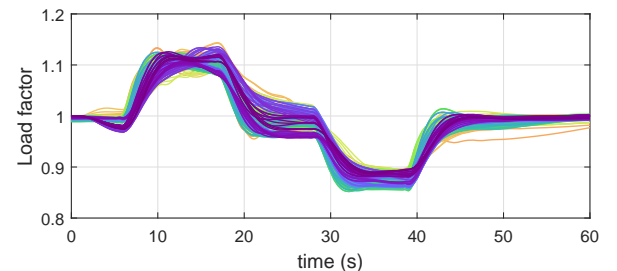

Fig. 5. Baseline controller n_z responses to stick doublet.

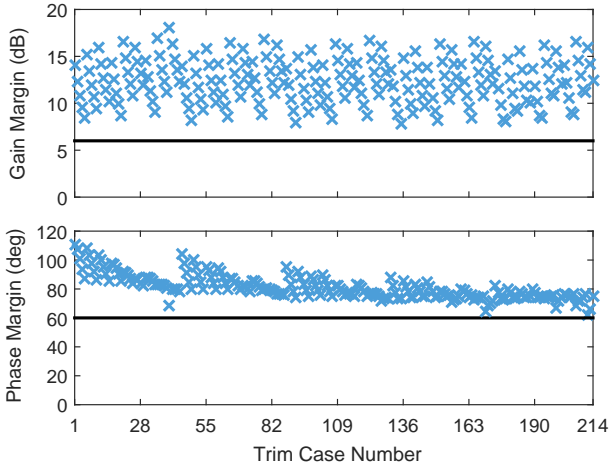

Fig. 6. Open loop gain and phase margins.

5. INDUSTRIAL VALIDATION AND VERIFICATION RESULTS

The subsequently performed industrial V&V activities are part of a typical aircraft industrial development process. An important prerequisite is the implementation of the developed algorithms on the flight control computer of the fly-by-wire aircraft system environment. A graphical tool has been used to specify the block diagram structure of the algorithms. In contrast to the equivalent Matlab/Simulink-based block diagram modeling, only a limited set of certified elementary blocks is available. However, this limited set represents a set of certifiable code, which can be used on a flight control computer.

5.1 Test procedure

Various test scenarios have been defined to assess FDI performance and controller performance in case of loss of at least 2 sensors of AoA or VCAS including:

- Full forward and back stick input, also in combination with max or min thrust to test performance for extreme values of N_z or AoA.
- Responses to vertical gusts as well as head and tail shear winds.
- Fault detection performance in typical cruise maneuvering conditions including very long flights.
- Auto pilot modes, like flight path angle or vertical speed step commands.
- Random pilot input for stick and thrust command.

For all scenarios a Monte-Carlo like parameter study was performed for a prescribed set of flight conditions and randomly chosen sensor fault events. The flight envelope is defined between 5000 ft to 41000 ft, from minimum selectable speed to maximum speed and weight, and a center of gravity position between 28% and 44%. The fault occurrence time is selected between 5 s and 90% of the overall simulation time.

All simulations have been performed twice: a first campaign without sensor faults validates the robustness of the FDD-system against false alarms; a second campaign with sensor faults validates the detection performance and

controller performance after fault events. Most of the test scenarios are related to flight envelope protection tests not suitable to test the backup law. The auto pilot scenario however can serve as a test scenario for a piloted flight allowing to validate the performance of our backup law.

5.2 FDD results

The robustness validation is performed without any faults injected, thus validating if false alarms may appear. The performance analysis deals with fault scenarios, thus calculating the rate of missed detection and the detection time. Various maneuvers, including pilot inputs with different amplitudes, wind inputs with different wind velocities and gradients, turbulence inputs, wind shear as well as auto-pilot maneuvers are tested. No false alarms were encountered in around 3000 simulations runs. The validation step of the detectability performance of the FDD system includes various fault scenarios. Not a single missed detection has been encountered in the repeated 3000 runs with faults. The detection time performance resulted in a mean detection value of 0.87 s, a minimum of 0.04 s and a maximum of 11.04 s. These results allow a satisfactory fast adaptation of the FCS.

5.3 FTC results

To illustrate that safe flight could be continued after detected loss of all velocity sensors by means of the backup law, an auto pilot scenario is selected (alternative to a piloted flight after detection). The auto pilot is in flight path angle mode. Wind gusts and turbulence are also applied in this scenario (after 100 s). Note that protections are irrelevant for these scenarios. However, the activation due to undetected faults still has to be avoided. All sensor faults are detected within 3.04 s with a mean detection time of 0.85 s.

Fig. 7 illustrates how the commanded flight path angle is recovered after the fault events, which occur between 19 s and 47 s. Due to the fast detection and reconfiguration, the maximum error in the flight path over all 10 simulations is below 2 deg. For comparison, the time responses without sensor faults are depicted in Fig. 8. The comparison illustrates the strong influence of the faulty signal until detection and clearly demonstrates the necessity of a fast and reliable fault detection. Table 3 lists the types and numbers of faulty sensors applied during the auto piloted simulations. In 3 of the 10 simulations plotted the controller has been reconfigured to the backup law. The AoA and VCAS sensors are totally lost in 3 cases each. At most 2 sensors of AoA or VCAS are faulty in 5 cases, showing that the proposed signal consolidation is sufficient to continue the flight with the original baseline controller.

Similar results could be achieved for vertical speed mode of the auto pilot, demonstrating again the possibility to proceed auto pilot flight or to continue piloted flight at an augmented level. In Fig. 9 the vertical speed responses are compared for a nominal flight and a flight where all AoA and VCAS sensors are lost. A bias is applied on all sensors (about 20° on AoA, 160 kts on VCAS) at time 41 s. The faults are detected immediately after 0.08 s (2 sampling

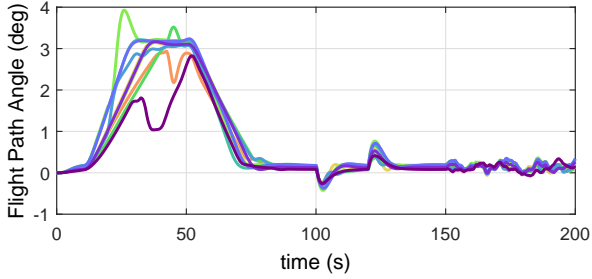

Fig. 7. Auto pilot flight in flight path angle mode, at least 2 AoA or VCAS sensors are lost during flight.

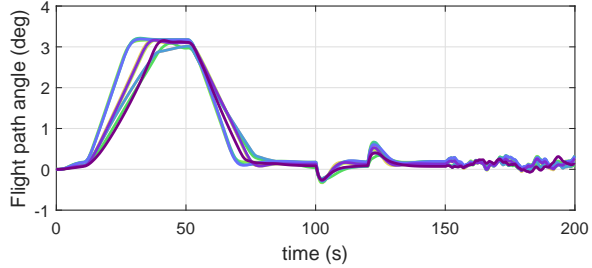

Fig. 8. Fault free Auto pilot flight (flight path angle mode).

Fault type	No. of faults	
	AoA	VCAS
Noise	2	2
Oscillation	3	2
Freeze	3	3
Bias	2/2	2/3
Runaway	3/2/2	0/2/0
Non-return to zero	2/2	2/3

Table 3. Simulated fault types

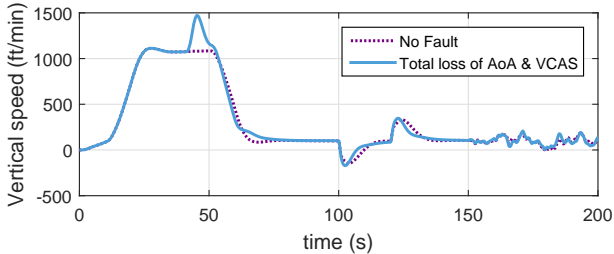

Fig. 9. Auto pilot flight with all sensors lost compared to nominal flight (vertical speed mode).

times) the controller is reconfigured and the flight can be continued. The results of Fig. 9 also illustrate how severe the disturbance in vertical speed can be even though the reconfiguration starts already after 0.08 s.

6. CONCLUSION

Two main enhancement of the state-of-practice fault accommodation strategies in modern civil aircraft for the case of angle of attack and airspeed sensor faults have been presented. The sensor fault diagnosis capabilities are enhanced to multiple fault scenarios. The presented backup control law independent of the velocity measurements providing satisfactory handling qualities in case of a total velocity measurement loss. According results of an extensive verification and validation campaign have been

reported. The presented approach supports to achieve the goal of full-time and all-event availability of performance-optimized guidance, navigation and control functions.

ACKNOWLEDGMENT

This work was performed in the framework of the European FP7 RECONFIGURE Project: Grant agreement AAT-2012-RTD-2314544.

REFERENCES

- Berdjag, D., Cieslak, J., and Zolghadri, A. (2013). *Fault Detection and Isolation of aircraft air data/inertial system*, chapter Fault Detection and Isolation of aircraft air data/inertial system, 317–332. Torus Press.
- Brockhaus, R., Alles, W., and Luckner, R. (2011). *Flugregelung*. Springer Verlag Berlin Heidelberg, 3 edition.
- Chen, L., Edwards, C., and Alwi, H. (2015). LPV sliding mode observers for sensor fault reconstruction with erroneous scheduling parameter measurements. *54th IEEE Conference on Decision and Control*. Osaka, Japan.
- Goupil, P., Boada-Bauxell, J., Marcos, A., Rosa, P., Kerr, M., and Dalbies, L. (2015). An overview of the FP7 RECONFIGURE project: industrial, scientific and technological objectives. In *Proc. of 9th IFAC Safeprocess*. Paris, France.
- Hardier, G., Seren, C., and Ezerzere, P. (2015). Model-based techniques for virtual sensing of longitudinal flight parameters. *International Journal of Applied Mathematics and Computer Sciences*, 25(1), 23–38.
- Hartley, E.N. and Maciejowski, J. (2015). A longitudinal flight control law based on robust MPC and H2 methods to accommodate sensor loss in the RECONFIGURE benchmark. In *Proc. of 9th IFAC Safeprocess*. Paris, France.
- Joos, H.D. (1999). A methodology for multi-objective design assessment and flight control synthesis tuning. *Aerospace Science and Technology*, 3(3), 161–176.
- Joos, H.D., Bals, J., Looye, G., Schnepfer, K., and Varga, A. (2002). A multi-objective optimisation-based software environment for control systems design. In *Proc. of IEEE International Conference on Control Applications and International Symposium on Computer Aided Control Systems Design*, 7–14. Glasgow, Scotland.
- Ossmann, D. (2014). Optimization based tuning of fault detection and diagnosis systems for safety critical systems. In *Proc. of 19th IFAC World Congress*. Capetown, South Africa.
- Ossmann, D. and Joos, H.D. (2016). Enhanced detection and isolation of angle of attack sensor faults. In *Proc. of AIAA Guidance, Navigation, and Control Conference*. San Diego, USA.
- Rosa, P., Vasconcelos, J., and Kerr, M. (2015). A mixed- μ approach to the integrated design of an FDI/FTC system applied to a high-fidelity industrial airbus non-linear simulator. In *Proc. of 9th IFAC Safeprocess*. Paris, France.
- Varga, A. (2003). On computing least order fault detection filters using rational nullspace bases. In *Proc. of 5th IFAC Safeprocess*. Washington D.C., USA.
- Wan, Y., Keviczky, T., and Verhaegen, M. (2016). Robust air data sensor fault diagnosis with enhanced fault sensitivity using moving horizon estimation. In *Proc. American Control Conference 2016*. Boston, USA.