

TRANSITION INTO HIGHER EDUCATION: IS THE DEVELOPMENT OF AN  
ACADEMIC SOCIAL IDENTITY IN PSYCHOLOGY STUDENTS IMPORTANT TO  
ACHIEVEMENT?

*JULIENNE MCGEOUGH*

TRANSITION INTO HIGHER EDUCATION: IS THE DEVELOPMENT OF AN  
ACADEMIC SOCIAL IDENTITY IN PSYCHOLOGY STUDENTS IMPORTANT TO  
ACHIEVEMENT?

JULIENNE MARY MCGEOUGH

A thesis submitted in partial fulfilment of the  
requirements of Liverpool John Moores University  
for the degree of Doctor of Philosophy

January 2017

## **Dedication**

This thesis is dedicated to

Libby, Ellie, Isaac.

My mum.

Sharon.

“Shine on you crazy diamond.”

## Contents

Dedication .....	iii
Contents .....	iv
List of Tables .....	ix
List of Figures .....	x
Abstract .....	xi
Acknowledgements .....	xii
List of abbreviations.....	xiii
1 Introduction and thesis overview.....	1
1.1 Introduction.....	1
1.2 Statement of Research purpose.....	1
1.2 Higher Education in the UK - the cultural landscape.....	2
1.3 Research aim.....	3
1.4 Linking the studies together.....	3
2 Literature Review .....	7
2.1 Introduction.....	7
2.2 Early research linking processes of identification within student populations .....	8
2.3 Models of identity within Higher Education Research .....	10
2.3.1 Classification of Identity models within Higher Education.....	11
2.3.2 Defining Academic Identity .....	12
2.3.3 Academic Identity and undergraduates.....	14
2.4 Social Identity Theory and the Academic Journey .....	15
2.4.1 Beyond simple belonging: I am the groups I belong to. ....	15
2.5 Attainment within Higher Education and its relationship to Identity .....	17
2.6 Summary.....	17
3 Transition into Higher Education. ....	19
3.1 Introduction.....	19
3.2 Transition experiences within the research literature.....	19
3.3 What are the challenges to be faced? .....	20

3.3.1	The lead up to university .....	21
3.3.2	The reality of the First Year Experience: comparisons of internal images to reality .....	22
3.3.2.1	Transition and attrition: .....	22
3.4	Defining transition .....	26
3.4.1	Gale and Parker's Three Typologies of Transition (2014) .....	26
3.4.1.3	Transition as a lifelong process of “Becoming”: .....	30
3.4.1.4	Review of Gale & Porter's Three Typologies of Transition (2014): .....	31
3.5	Current models of the experience of transition .....	35
3.5.1	Maunder, Gingham & Rogers (2010) Experience of transition .....	35
3.5.2	Briggs, Clark & Hall - interaction of institution and individual on development of learner identity 38	
3.6	Research questions .....	39
3.7	Summary .....	41
4	The Experiences of Transition: A meta-ethnographical approach .....	42
4.1	Introduction .....	42
4.2	The Status of a Meta-ethnography .....	42
4.2.1	Meta-analysis in Psychology studies .....	42
4.2.2	Meta-ethnography vs meta-analysis: Similarities and differences? .....	44
4.2.3	Philosophy of Meta-ethnography philosophy .....	45
4.3	Process - Lines of argument synthesis .....	47
4.3.1	Translation Process .....	47
4.4	Results and Discussion .....	48
4.4.1	Final Thematic Map .....	49
4.4.2	Identity processes: Do I want to be a student? .....	51
4.4.2.2	Us and them: am I student?: .....	54
4.4.3	Filters of experience .....	61
4.4.4	Resolution .....	67
4.4.4.1	Initial period vs ongoing comparison: .....	67
4.4.4.2	Self-growth: .....	69
4.5	Summary .....	72
5	Understanding Identity Processes within Undergraduate Psychology Students .....	75
5.1	Introduction .....	75
5.2	Social Identity: definition and clarification .....	75
5.2.1	Need to affiliate .....	76
5.2.2	Multiple Social Identities and the effects of others .....	79

5.2.3 Academic Identity influence .....	81
5.3 Study Aims .....	82
5.4 Methodology .....	82
5.4.1 Analysis .....	83
5.4.2 Participants .....	85
5.7 Results.....	86
5.7.1 Focus group overviews .....	86
5.7.1.2 Focus group 2: .....	87
5.7.1.3 Focus group 3: .....	88
5.7.2 Themes .....	88
5.8 Summary .....	99
5.9 Integrating the Transition Phases and Social Identity .....	101
6 Measures of Academic Social Identity .....	103
6.1 Introduction.....	103
6.2 Theoretical Basis for a Measure of Academic Identity .....	103
6.2.1 Domains of Identity for inclusion.....	103
6.2.2 Social Identity structure and measurement.....	104
6.3 Current measures of Social Identity .....	104
6.3.1. Global measures .....	105
6.3.2. Multidimensional measures .....	105
6.3.2.4. Cameron’s “Three Factor” model of social identity (2004). .....	106
6.4 Psychometrics .....	106
6.4.1 Early roots of Psychometrics .....	107
6.4.2 The Debate of Psychometrics as Pathological .....	108
6.5 Addressing the issues of Psychometrics .....	108
6.5.1 Reliability .....	108
6.5.2 Validity.....	109
6.6 Generating Items - Qualitative methodology .....	109
6.6.1 Scale structure .....	110
6.7 Pilot Study .....	113
6.7.1 Methodology .....	113
6.7.2 Results .....	114
6.7.2.1. Content Validity Index. ....	114
6.7.2.3. Reliability and Validity (Pilot data).....	114

6.7.2.3.1	Descriptive Statistics .....	114
6.7.2.3.1	Reliability: .....	115
6.7.2.3.2	Factor Analysis Assumptions. ....	118
6.7.3	Discussion .....	122
Factor 1:	Cognitive evaluations of subject and department .....	122
Factor 2:	Normative Comparison .....	122
6.7.4	Summary: .....	124
6.8	Pilot Study II – test of new measure .....	125
6.8.1	Participants .....	125
6.8.2	Descriptive Statistics .....	125
6.8.3	Reliability .....	125
6.8.4	Confirmatory Factor Analysis Descriptive Analysis .....	129
6.8.5	Confirmatory Factor Analysis Assumptions.....	129
6.8.6	Confirmatory Factor Analysis Results.....	129
6.9	Summary .....	133
7	The relationship between Academic Social Identity and Academic attainment .....	135
7.1	Introduction.....	135
7.1.1	Psychological correlates of attainment .....	135
7.1.2	Academic Social Identity and Attainment .....	137
7.1.3	Social identity within undergraduates .....	137
7.1.4	Hypotheses .....	138
7.2	Method.....	138
7.2.1	Participants .....	138
7.2.2	Design.....	138
7.2.3	Measures.....	139
7.2.4	Procedure.....	139
7.3	Results.....	140
7.3.1	Descriptive statistics .....	140
7.3.2	Assumption Testing.....	141
7.3.3	Multiple regression .....	142
7.4	Discussion.....	145
8	Thesis summary.....	147
8.1	Introduction.....	147
8.2	Main Findings .....	147

8.2.1	Research questions and findings.....	148
8.3.	Synthesis of findings.....	155
8.3.1	Identity needs within students .....	155
8.3.2	Transition periods.....	156
8.3.3	Measuring Academic Identity .....	156
8.3.4	The relationship between Academic Social Identity and Engagement .....	157
8.4	Theoretical implications of the study.....	157
8.5	Practical implications.....	161
8.5.1	Reflective account .....	162
8.6	Policy implications .....	165
8.7	Limitations of the current study .....	166
8.8	Summary.....	166
9	References .....	168
10	Appendices.....	186



## List of Tables

Table 1: Focus group Participants .....	86
Table 6:2: Descriptive Statistics of Sub-constructs in the Initial Scale .....	115
Table 6:3: Reliability Statistics for each item on the initial Academic Identity Scale .....	116
Table 6:4: Correlation Matrix for each sub-construct on the Initial Scale .....	119
Table 6:5: Summary of exploratory factor analysis results for the Academic Identity Scale.....	121
Table 6:6: Descriptive statistics showing means, sd, range, Cronbach Alpha's for total scale and each subset	126
Table 6:7: Rotated Factor Matrix with new labels for items and factor .....	128
Table 6:8 Means, s.d. and range of Academic Social Identity Scale version 2 .....	129
Table 6:9: Confirmatory Factor Analysis ASI (Psychology):Standardized Regression Weights for each item	131
Table 6:10: Comparison of the initial and final solution fit statistics of the ASI (Psychology) Scale. ....	133
Table 7:11: Descriptive statistics of ASI, Self-efficacy and Conscientiousness .....	140
Table 7:12: Multicollinearity statistics for each variable .....	141
Table 7:13: Correlation matrix .....	142
Table 7:14: Descriptive statistics for each sub-construct of the ASI.....	143
Table 7:15: Multicollinearity statistics for each sub-construct on the ASI .....	144
Table A:16 Inclusion and Exclusion Criteria for searching .....	188
Table A:17 Initial search results.....	190
Table A:18 Relevant titles from initial search.....	191
Table A:19 Intial search details with decision information.....	194
Table B:20 Final articles with brief summary .....	199
Table C:21 Table of codes with labels and paper reference .....	216

## List of Figures

Figure 3-1: Maunder, Cunliffe, and Mjali’s thematic map of transitional experiences into HE (2010).....	37
Figure 4-1: Themes of the final papers merged.....	50
Figure 4-2 Proposed new model of transition phases and SIT .....	74
Figure 5-1: Integrating the Transition Phases and Social Identity .....	102
Figure 6-1: CFA, indicating Three Factor Model Construct of Academic Social Identity .....	132
Figure C-1-1 Concept map derived from synthesis of papers 1-3.....	214
Figure C-1-2 Concept map derived from papers 1-4.....	214
Figure C-1-3 Concept map derived from papers 1-5.....	215
Figure C-10-4 Concept maps derived from papers 1-6 .....	215
Figure H-10-1: Scree plot.....	256
Figure 1-2: Plot of regression.....	259
Figure 1-3: Plot of normal histogram .....	260

## **Abstract**

Identity has been recognised as a possible influence within education research and a student's ability to achieve their full potential (Bluic, Ellis, Goodyear & Hendres, 2011). The current thesis explores identity in undergraduate Psychology students, in particular it provides a theoretical framework based on Social Identity Theory (Abrams & Hogg, 1990) for understanding how identity is developed. Transition is a time when identity is in flux (Gale & Parker, 2014) and therefore allows for a study identity change, development and the impact of this on attainment.

The study took a mixed methods approach starting with two qualitative studies which explored identity processes in undergraduate students. It used a unique approach in Psychology by adopting a meta-ethnographical design (n=8) and an adapted form of Grounded Theory which allows for theory development through the integration of the original researcher's analysis of the participant's narratives across the eight papers (Noblit & Hare, 1988). A concept map provides an understanding of how transition and Social Identity Theory is integrated to facilitate identity change. A further qualitative study which uses a traditional focus group design and thematic analysis (n=18). Four themes emerged which present evidence for the importance of transition and identity for students.

The qualitative studies also informed the development of a tool to measure Academic Social Identity. Validity and reliability was established through a number of iterations of Exploratory and Confirmatory factor analysis (n=205). The final psychometric scale includes items designed to measure normative processes, evaluation and emotion and reflect the theoretical framework of Social Identity Theory. The final study used a multiple regression analysis with ASI predicting GPA (n=71). The results indicated that the construct ASI had a strong relationship with academic achievement. The thesis discusses policy implications for institutional arrangements of student support services, transition and subject areas and a focus on attrition and student well-being.

## **Acknowledgements**

To everyone, thank you.

## **List of abbreviations**

FYE	First-year Experience
UG	Undergraduate
PG	Postgraduate
SIT	Social Identity Theory
SCT	Self-Categorisation Theory
ASI	Academic Social Identity
HEI	Higher Education Institutor
HEA	Higher Education Academy

## **1 Introduction and thesis overview**

*“This is a time of immense change in the higher education system. The government is aiming to use student choice as a major driver in shaping HE provision, and some commentators anticipate that increased student fees will lead to higher expectations and, some argue, a stronger ‘consumer’ mindset amongst students. In this context, the need for institutions to understand how they can most effectively translate their strategic intentions to improve student retention and success into activities that will most effectively impact on student, department and institutional-level outcomes, is clearly paramount.”*  
**HEA Academy (2014)**

### **1.1 Introduction**

Within the UK there has been increasing numbers of students attending university at Undergraduate level with the 2013-2014 official figure given by HESA as 386,960 1st year students. This was an 8% increase on 2012-13 figures with home students (those from the UK studying at a UK university) showing similar trends. Transferring the cost of a degree from the government to the student has not been the deterrent it had feared it would be. Indeed, 2015 was a record for the number of students applying for a university place with 592,290 applications to UCAS (Gurney-Read, 2015). The number of pupils who had stayed in tertiary education inched over the 50% line with 52% going onto Higher Education (BBC, 2012). Correspondingly the National Student Satisfaction Survey results has also shown an overall increase in satisfaction from when it was started in 2003 (HEFCE, 2015). Furthermore, student’s class of degree is also on an upward trend with 20% achieving a first in 2014 compared to 10% in 2004 (Weale, 2015). It can be concluded from these trends that Higher Education in the UK is thriving both at the start of university and at the end as students leave.

### **1.2 Statement of Research purpose**

With a particular focus on Psychology students this thesis explores the journey of identity and Higher Education. The main theoretical premises behind the research are Social Identity and Social Categorisation Theories with the intention that these would describe the processes involved in success at university. It does this through a mix of qualitative and quantitative

methods through which it will examine the early days of degree level study and determine if students develop a specific identity with peers, departments or institutions. Furthermore, it sought to develop a reliable and valid measure of identity amongst Psychology undergraduates and used this to establish whether a strong academic identity is a requirement of achievement at university.

## **1.2 Higher Education in the UK - the cultural landscape**

There is little doubt that the implementation of Higher Education student fees, along with the government strategy of reducing caps numbers with the best 'A' Level grades, are forcing changes throughout the sector with the result of greater competition for students by institutions (Ratcliffe, 2015). Furthermore, the increase in access to Higher Education has made graduating with a good degree essential to students who now are responsible for paying for their own education. Coupled with a downturn in the economy and a decrease in graduate jobs there is a further focus on what value a degree offers a graduate. These pressures have developed alongside a rise in publicly available league tables and NSS scores which have opened institutions to greater scrutiny. Locke (2014), in a paper that explores the relationship between marketisation and rankings, states that universities are increasingly seeking to place themselves as attractive to potential customers (students). Institutions are now publicly accountable in ways that in previous decades was not possible with national media league tables (e.g. Guardian) and Government backed surveys such as the National Student Survey making it seem easier for students and families to assess universities. Furthermore, the UK operates within a global ranking system in which the placement of UK institutions can be measured internationally. Indeed, the driving force behind the Browne report (2010), at least in part, was the need for UK institutions to compete in this global market of Higher Education. The accumulation of these factors ensure that student satisfaction and progress is important to students and institutions alike.

An increasingly important question then for all stakeholders is what are the predictors of a student's success at university? Of course, this is not only something that has been of recent interest to students, institutions and policy makers but is particularly pressing in the current climate. While it can be assumed that ability and skills along with motivation and

determination are likely to be involved, is there another factor that has so far not been considered? A possible variable that has received some attention within educational research has been that of identity (e.g. Krogan, 2003). The literature review in Chapter two will outline how identity within Higher Education research has been explored and developed, it will establish that the main body of this research has been underpinned by Sociological theories and only recently has Psychological theories such as Social Identity Theory been suggested as a theoretical explanation. This study will propose that it is plausible to use this as an explanation of the identification processes within the undergraduates.

### **1.3 Research aim**

To investigate the experiences of transition of students into Higher Education and how Social Identity and Categorisation may inform their sense of Academic Identity and impact on attainment.

Research questions are listed below with the chapter summaries, this should allow the reader to develop an overview of the studies and how they linked together to meet the stated aim.

### **1.4 Linking the studies together**

The thesis is laid out so that allows the reader to follow undergraduate students through the university experience. The studies build to allow the research aim to be examined in depth and breadth. Each of the chapters are summarised below and links between the research chapters will be made for the reader.

Chapter two presents models of identity found within Higher Education and includes a broad discussion of the processes involved in social identity amongst students prior to the Tajfel and Turner's development of Social Identity Theory in the 1970s. For the purposes of clarity, the relationship between these processes and SIT will be discussed briefly with the key propositions highlighted. Additionally, each of the chapters has a focused literature review which provides support for the specific research questions. The following provides the reader with signposts of the purpose of each chapter.



Chapters three and four presents a meta-ethnography of qualitative research on the transition experiences in 1st year undergraduates at UK Higher Education institutions. The chapter starts with an extensive literature review that examines the transition research currently informing Higher Education practice. Additionally, it discusses the relationship between transition and identity formation and shifts and the importance of this to students and the possible impact on attainment. This literature review is informed by the threads started in Chapter two and builds a framework which will be the foundation for the rest of the thesis. The study aims to answer a number of questions (please note, the number at the start of the Research Question Refers to the chapter it is tested):

**4RQ1:** Is identity development evident in the narratives of the participants and researchers included in the research?

**4RQ1a:** - What are the processes involved in identity development?

**4RQ2:** Is there evidence of a transition typology in the research data and the narratives of the participants?

**4RQ2a:** Which of the transition typologies best explain the experience and processes involved in the transition?

**4RQ3:** What is the experience of transition in the first year of university with a focus on those studies that explore transition prior to drop-out?

**4RQ3a:** Are stresses inevitable part of the transition process

**4RQ3b:** Can stress be alleviated by the structures of the university?

**4RQ5:** Are the experiences and outcomes of transition universal across students?

Chapter five is qualitative research from focus group interviews and explored the meaning of identity to students from Psychology students in the first and third years. This builds on the previous study by exploring the processes of identity that emerged and applying them systematically to multiple identity issues. Therefore, while primarily the aim of the study was to ensure that the language for a psychometric measure would be informed by the population group it was aimed at this chapter also is centred on the importance of belonging as voiced by the participants. The chapter includes a literature review that explores Social Identity in depth with a particular focus on the importance to social identities to students.

The interviews explored student, subject and institutional identity from a Social Identity perspective and therefore included questions that would allow data to emerge on multiple identities, self-esteem effects of belonging and self-categorisation of groups. In addition, this study allows for issues of identity beyond the initial first year transition experience. The study in Chapter 5 had the following research questions:

**5RQ1** What are the influences of identity processes during transition periods?

**5RQ2** How do Social Identity and Self-Categorisation theories inform different aspects of identity during Undergraduate study?

**5RQ3** Do the development of academic identities change student behaviour?

**5RQ4** Do undergraduates construct identities and display language that evidences this?

Chapter six presents the development of a psychometric measure of Academic Identity incorporating the conclusions from chapters four and five. The literature review presents research on best practice of psychometric development and gives a rationale for the methodology used to develop the scale. It also pulls on the main findings of the literature review and focus group data to ensure that the measure is reliable and valid and easily understood by the target population. Within this chapter there is also quantitative data analysing the reliability and validity of the scale amongst students from two universities and across cohorts.

**6RQ1** Is the structure of the Academic Social Identity derived from Social Identity Theory?

**6RQ1a** Does the structure of Academic Social Identity reflect the three components of Social Identity?

The final research chapter (chapter seven) utilises the Academic Identity Scale developed in Chapter seven to establish possible relationships between Academic Identity and academic outcomes. Success was measured by accessing university recorded GPA. The following research questions were developed at this point:

**7RQ1** Does Academic Social Identity correlate with attainment?

**7RQ2** Does it correlate with ASI to a lesser or greater degree than Academic self-efficacy and conscientiousness?

**7RQ3** Does the relationship between Academic social identity and attainment increase with progress through degree levels?

Chapter eight is the concluding chapter of the thesis and summarises for the reader the key findings while also outlining further avenues for research. The findings show that there is a relationship between Academic Social Identity and grade outcomes at all stages of degree study.

## 2 Literature Review

### 2.1 Introduction

The process of arriving at university to start your journey towards graduating as a member of an academic community has been explored in literature (e.g. Peel, 2000; Chow & Healey, 2008; Moogan, Baron & Harris, 1999). A key element of this journey is that of internalising the rules and behaviour of your chosen subject. Mead (1934) defines identity as characteristics that are salient and which the student attributes to his or herself. The individual characteristics will emerge through social interactions thus grounding the identity in the acceptance of the shared rules, knowledge and expectations of the community. The community found within university subjects and departments has been coined “academic tribes” by Becher and Trowler (2001). As with any tribe there are unspoken rules and codes that individuals who want to belong will be expected to display. However, Becher and Trowler’s work has not been tested empirically and while it is an interesting concept it lacks, from a Psychologist's point of view, a theoretical underpinning that explains fully how identity is developed. The Academic Tribe idea sits closely with the theoretical framework of Social Identity Theory, a process by which social groupings, and affiliations with them, affects your view of yourself and others. SIT argues that an individual's social identity is shaped by their membership of any number of groups (Abrams & Hogg, 1990). Their behaviour, it is claimed, is shaped by their acceptance that they belong to certain groups within society and accept assigned social categories. This last concept is expanded on by Turner (1982) and Turner, Hogg, Oakes, Reicher and Wetherell (1987) in self-categorisation theory which separates social identity from personal identity and states that individuals are more likely to focus on the similarities they have with a salient group than any differences.

This chapter will set out the aims and purposes of this thesis, giving cultural and theoretical contexts. It will first outline the issues facing Higher Education in the UK including recent changes to funding and government policy thereby highlighting the reasons that make this current research relevant and important. It will then move onto propose that the theoretical frameworks within Social Identity Theory can help explain some of the individual differences in student experience and outcomes. Additionally, I will present the central

questions that this thesis attempts to answer and the broad methods used through the various studies. As Social Identity Theory has only recently been explored within Higher Education (10-15 years) the literature review draws on a broad base of research from a number of academic subjects and provides support for the research questions from the direct study of identity and those studies in which the processes of identification are studied.

## **2.2 Early research linking processes of identification within student populations**

While Social Identity Theory was first forwarded by Tajfel in 1978 it was not until the 1980s that this was explored in terms of student identity. By 2011 it was recognised by some researchers that ignoring student's strength of identification as a learner had been to the detriment of research in how students learn and achieve (e.g. Bluic, Ellis, Goodyear & Hendres, 2011). The first group of articles considered are those that look at the processes of social identity, such as belonging and categorisation.

Belonging is a central concept within Social Identity Theory and Self Categorisation Theory and explains how people perceive themselves in terms of the groups around them and how these perceptions shape their aspirations to belong to them (Hogg & Abrams, 1998). Furthermore, it is proposed that it is a key concept which explains the drive to belong to an Academic Tribe at university and is important to academic success. Furthermore, as students seek to belong to a group they will engage in academic behaviours which will further increase this identity. The link between a student's status with their peers and their engagement and subsequent attainment was explored by Spady (1970) which was an early study looking at a student's subjective own sense of identity and integration and whether these elements were enough to overcome any pre-existing negative resources, such as family income. The author argued that belonging to a number of extracurricular groups brought status and recognition and thereby encouraged students to progress further in education. However, the relationship is not straightforward as shown by Hurtado and Carter (1997) who criticised the subjective measures Spady used stating that they failed to take into account whether the groups the students chose to belong to did indeed enhance their sense of belonging to the wider academic community. Hurtado and Carter explored how students transitioned from High School to college (university) and the effect of ethnic minority status

to their sense of belonging to the institution. They used a broader measure of engagement and belonging and included behaviours such as discussing their subject outside of class as a proxy of academic engagement. Two-hundred and seventy-two students took part in a questionnaire based study, all of the participants had started college the semester before taking part and had a fair gender split (58% female and 42% male). As they were considering the impact of ethnic status on their belonging they also analysed the data from 4 minority groups from 127 colleges. Interestingly, they did not include a comparison of belonging between Caucasians and other groups. The authors state they use “The Sense of Belonging Scale” but do not state whether this was developed for the study or not, additionally reliability and validity of the scale was not reported. Nonetheless this paper is interesting in that it establishes the clashes that may occur between identities prior to arriving at college and the subsequent ability to develop a deep sense of belonging and the effect this may have on outcomes such as students’ academic behaviours such as peer interactions and seeking academic support. Further research has shown that a sense of belonging is important to attainment and low dropout rates at school, college and university (e.g. Anderman & Anderman, 1999; Hausmann, Schofield, Woods, 2007; Hoffman, Richmond, Morrow & Salomone, 2003).

As intimated, the need to belong is not indiscriminate within SIT, with some groups seen as more attractive and more desirable than others. Once a group is deemed important members become involved in a process of identification. This dynamic will be explored further as Social Identity Theory fully is outlined in chapter four, however again it is worth considering it in the context of Higher Education prior to SIT. Vreeland and Bidwell (1966) summarise research emerging at the time as “evidence is accumulating that college socialize students to characteristic values and attitudes”. It was their hypothesis that the nature of college departments was such that it had a long term effect on personality and values of the students attending them. By using college departments, we can see a link with Academic Tribes proposed by Becher and Trowler (2001) whose concept was neatly defined by Krishnan (2009) as:

One would then arrive at the conclusion that disciplines are a form of social segmentation that resists an overarching authority. Their practitioners belong to

different ‘academic tribes’ inhabiting and defending different ‘knowledge territories’, distinguishing themselves through self-created cultural practices and specific values itself in the existence of disciplinary academic departments and (national) disciplinary associations. (pp.21-22).

Why should departments (or tribes of knowledge) be the driving force for change amongst student’s attitudes and characteristics? Vreeland and Bidwell (1966) propose a number of reasons why departmental influence is important however they suggested that the strongest factor is that of the “professor-as-role-model”. While the findings of the paper are unfocused they do explore a number of dynamics that are of interest for this literature review. First, the paper attempted to identify and measure goals students developed during their time within the departments which the authors grouped into technical and moral (unspoken rules around academic behaviours, for example commitment). Their findings suggest that departments were interested in their students developing more than just technical or subject knowledge and did this through modelling behaviour for them. Specifically, they identify departments in which student-staff dynamics could be labelled as “disciple-master” which generated more than just subject knowledge transfer but acted as a conduit for learning wider academic behaviours. Social Identity Theory accommodates and explains this behaviour through the process of depersonalisation (Turner, 1982). While this can be seen as negative in which people lose a sense of self it was not intended to have these negative overtones and a theoretical level is a description of a behaviour. For our purposes here a student loses a sense of their own self, possibly only temporarily, in order to become a member of the academic tribe. This behaviour is even more likely to occur with groups that are deemed to be of high status to the individual. This again will be explored further in the outline of Social Identity.

### **2.3 Models of identity within Higher Education Research**

As stated previously the role of identity has emerged within Higher Education Research as a potential factor in student success. It is not unusual for constructs to be conceptualised differently across academic subjects and this has been the case with “identity”. One of the aims of this literature review is to give the reader a brief classification of identity models found within Higher Education research outside of Social Identity Theory. Furthermore,

early theories of student identity development often describe similar processes to those found within Social Identity Theory or Social Categorisation Theory and these similarities will be discussed. As the literature review progresses I will argue that a strong advantage of using SIT or SCT lies within their ability to not only describe patterns or trends of behaviour within student population but also offers an explanation for its development that is missing from non-psychological theories.

### *2.3.1 Classification of Identity models within Higher Education*

*“Identity is where I come from.”* This group of research within Higher Education frames identity as a possible variable which may have an impact on a student's ability to succeed at university. Within this group of research are studies that include looking at ethnic identity of a student or their socio-economic status. In this sense it is derived from a sociological stance which has proposed that identity is derived from the cultural or collective experiences and norms (e.g. Nagel 1995). While these studies may give a broad indication of the relationship between existing identity and education outcomes it fails to examine individual differences and the structures within the individual that forms identity, for example, cognition or motivation (Stets & Burke, 2000). A subtle difference within this research are studies which consider the impact of university on a student's existing identity. I propose that this is distinct from the model put forward by this thesis, in that it does not discuss the development of a student or academic identity but how only how study at university shapes existing ethnic or socio-economic identity.

*“Identity equals what I do.”* An early model of identity can be seen within discussions of what a graduate program should include in order to develop the student to become a competent member of a professional group (e.g Wyatt, 1954; Robertson, 1959). In this case to become a psychologist (for example) is to develop a set of skills and a way of thinking that ensures the student is sufficiently competent in order to undertake further training at higher levels or specialisms. This definition of identity as directly linked to careers and professional bodies and is expanded on in more theoretical detail in the next classification



*“Identity as part of an academic community.”* As stated this is an expansion of the previous classification and includes work on “communities of practice” or similar. The theories proposed incorporate Becher and Trowler’s seminal text on *“Academic Tribes”* (2001). As with the *“Identity equals what I do”* classification this is closely aligned with identity being a part of the skills developed during a training period (academic study in this case) but also includes elements of the theories that underpin *“Identity is where I come from”*.

Additionally, this classification argues that not only is there a relationship between study and cultural identities but that the student also develops a distinct academic identity which takes its cultural norms from the academic community. However, for a Psychologist the same difficulties suggested in previous classifications can also be forwarded here. Individual differences are not taken account of, nor is there a solid theoretical framework built on empirical research. An important model of socialisation into the academic community can also be included within this classification (Weidman, 1989). This model argues that socialisation and therefore student identity occurs over a number of stages and processes from that as a “freshman” with certain values and goals which through social relationships, both peer and staff, are maintained or changed depending on their assessment of the goal. Importantly Weidman argues that non-college reference groups are also important in shaping a student’s perception of themselves as they move away from non-college ideals.

### *2.3.2 Defining Academic Identity*

Quigley (2011), in a paper solely discussing the subject, struggles to define Academic Identity precisely. He argues that the phrase has been poorly articulated in research that seeks to explore this construct. However, he does state the following:

However, this is not to say that there are not commonalities; there are and I would argue that these commonalities may be set within a particular framework, which can help to situate an academic in terms of personal standing both within and without their particular institution and their personal and professional networks. (p.21).

It can be concluded, that for Quigley, Academic Identity is very firmly entrenched in terms of “Identity is what I do”, with the academic functioning within a community that recognises the identity and closely aligned to professionalism. Rightly within his paper he does pose the issue of where this leaves those who are training and in the earlier stages of an academic

career. I would argue further that this very limited approach to Academic Identity rejects the notion of undergraduate study as an important part of the Higher Education community. He proposes that studies can be split into two strands of Academic Identity research (trait and functionalist). A trait approaches to Academic Identity, Quigley argues, is too narrow and does not give an explanation for the development of identity within the developing Academic. However, Quigley also finds that structuralists rely too heavily on broad professional practices as its measure of whether an individual identifies with an academic community or not. Furthermore, and of particular interest, Quigley reviews and critiques what he states are two key papers within the field of Academic Identity (Henkel, 2005; Archer, 2008). Henkel's paper explores the relationship of Academic Identity in the changing world of Higher Education as outlined in Chapter one of this thesis. Henkel firmly places identity formation within communities, stating that without a strong community which allows for social processes to develop, thereby giving rise to members who identify with it. The strong social requirement in this paper for the development of an identity closely aligns with the current thesis which argues that social identity provides a deeper understanding of how Academic Identity is formed than that of Quigley's structural identity approach. Indeed, Social Identity and Categorization theories enhance and expand Henkel's understanding of the processes involved in developing an identity, academic or otherwise, drawing on research from Mead (1935) as do Social Identity researchers to establish that the self needs to integrate into community attitudes and values in order to fully develop. Henkel's paper is driven by the changing nature of Higher Education in the UK as government pressures steer research and funding in a way that is unprecedented. For Henkel this causes a tension between the academic values of independent research driven only by scientific interest and the need to adhere to new policies. In this aspect then Henkel's paper, other than the broad discussion of how identity is formed within a community, has limited interest to the current study. Furthermore, it explores identity only within postgraduate researchers and academic staff which as previously stated is a narrow understanding of Academic Identity. Archer's later paper again positions Academic Identity within post-doctoral academic study and research. Again the paper also has a discussion that revolves around the changing nature of the academic profession in the UK. However, her research question is to explore the nature of authenticity and success within the participants chosen

fields of research. For Archer, young academics who are starting in their research career perceive themselves as not yet full members and this is shown in their narratives around inauthenticity even while actively involved in research communities. Interestingly, Archer argues that the following themes emerge as part of developing an identity; ‘being’, ‘having’ and ‘doing’ which neatly reflect concepts that will be seen in chapter three’s literature review on transition. Additionally, her focus is on those members of the community that do not yet feel full members and furthermore those that feel that due to individual differences such as age, race or gender is impossible for them to fully integrate. Possible social identities (those identities not yet internalised) are explored further in Chapter five amongst undergraduates.

### *2.3.3 Academic Identity and undergraduates*

When reading the literature outlined above it is worth asking the question when the label Academic Identity should apply? The research put forward in this thesis argues that the academic journey starts with the transition into Higher Education with undergraduates very much part of this community and seeking to be a part of it. Tapp (2014) describes undergraduates as “knower and learner” and that the development of an academic identity is crucial to their engagement as students. Furthermore, this paper argues those students who develop a strong sense of belonging and internalisation of academic behaviours as important in shifting the sense of self from non-learner to one of accepting an academic identity. Additionally, many more studies explore academic identity amongst undergraduates (e.g. Chorba, Was & Isaacson, 2012, Kensington-Miller, Sneddon & Stewart, 2014, Walker & Syed, 2013). A number of similarities exist across such research such as the argument put forward that development of an academic identity is important to success at university. Additionally, the research at an undergraduate level positions identity at a very early development stage, though it must be noted the term is also used with secondary school research. Furthermore, the term in Higher Education UG research is seen as a facet of existing identity and self, in this sense Social Identity as outlined in Chapter five will be seen to accommodate multiple and possible social identities.

This brief overview was intended to give the reader an understanding of existing research outside of Psychology, for those who would like to read further a comprehensive view of identity theory within sociology can be found in Stets and Burke's text "*A Sociological Approach to Self and Identity*". However, more importantly it is my proposition that Social Identity incorporates all of the above definitions of identity. Indeed, SIT does not refute any of them, however instead it draws them together not only giving the research cohesion but also depth of explanation. I will now outline early research which includes the processes of SIT if not the language.

## **2.4 Social Identity Theory and the Academic Journey**

While Social Identity was developed to explain negative inter-group behaviours such as discrimination against members of other groups it has since become a major theory to describe how groups form and the effect of membership on individuals (Ferguson, 2012, Tajfel, 1978). It is generally considered to be a comprehensive theory that utilises cognition and motivation to explain behaviour, which gives depth of explanation as well as explaining intergroup behaviour. It is not surprising therefore, that Social Identity Theory has eventually been applied to the transition period of higher education given that starting university is a time when students are faced with joining new social groups in a strange situation. The relationship between identity and transition will be developed in Chapter three. The following section will outline Social Identity Theory and Social Categorisation Theory, applying the theories to Higher Education with supporting literature.

### *2.4.1 Beyond simple belonging: I am the groups I belong to.*

The need to belong was previously discussed and was shown to have been considered important within Higher Education however the research is disparate and although this is not unusual when a concept is theorised across different disciplines it nevertheless lacks depth and cohesion. By applying Social Identity Theory and Social Categorization theory this will allow a better understanding of the processes and dynamics in transitioning into higher education and development a student identity, including individual differences in cognition and motivation. Social Identity Theory is a well-tested and established theory which has a wealth of research which explores the structure of identity (eg. Hogg, 1992; Hogg and

Abrams, 1988; Haslam & Turner, 1992). Soon after the emergence of Social Identity theory further models which expand its explanations developed particularly within the field of social cognition and self-categorisation. A notable example of this was Turner (1985) who by employing cognition theory posited that categorisation of people into groups is a cognitive process similar to that used in categorising physical items. Social Identity Theory and Social Categorisation Theory additionally outline the effects of categorisation on the thoughts, feelings and behaviours of the individual and crucially establish a relationship between the need to belong and the motivation to categorise. It is this fundamental aspect of social interaction which underlies this thesis. I propose that on arriving at university students have a high need to belong and therefore are driven to categorise and themselves with groups. It is likely that as with many psychologically processes identification and categorising are mostly hidden to the individual.

Belonging as defined in early studies of identity and higher education incorporates only one aspect of self-categorisation (affective). It does not explain the initial drive nor the actual processes of categorisation and therefore is unable to expand on individual differences that may increase or decrease the motivation to belong. Furthermore, categorisation of oneself and others into out-groups and in-groups explains behaviour modification; for example, if I perceive a group is important and I class myself as moderately like them I am likely to adapt my behaviour to further fit in with the group. Depersonalisation, as this process is known is not a loss of identity but a shifting of individual identity (self) to group identity. Should new students who are watching staff members and other students identify this group as high status and one they want to belong to will moderate their behaviour to be seen to belong. This gives an explanatory framework to the research outlined previously by Vreeland and Bidwell (1966) who argued that students are shaped by academics within their department. Following this line of reasoning it can be argued that Social Categorisation gives a plausible argument for becoming a member of the Academic Tribe and therefore a framework for the present study to explore the identification process. It is likely that the various domains such as affective, cognitive and behaviours will need to be explored in order to avoid the same criticisms as I have laid out with early research of identity in Higher Education. A full explanation of Social Identity Theory and Social Categorisation Theory and critical

evaluation of the key concepts is outlined in chapters four and five when exploring the concepts of identity within a student population.

### **2.5 Attainment within Higher Education and its relationship to Identity**

A pertinent question for any research in Education is the potential effect the processes in question has on the potential outcomes for the student. If it is the case that Academic Identity exists and is important to engagement, it can be expected that students will show difference in outcomes. Previous research has shown that there are a number of factors that contribute to academic success such as motivation and self-efficacy (Richardson, Abram & Bond, 2012) and these will be included in the research. Chapter eight will fully examine the relationship between these variables with a discussion of the definition of outcomes and attainment.

### **2.6 Summary**

In summary this chapter explored the literature within Higher Education literature which explores identity as a possible important variable in student's success. While early research had considered identity development in undergraduate study the chapter argued that this had been disparate and under developed. In particular, the classifications of various strands showed that the research had predominantly framed identity as an issue of a student's background (e.g. race) or of that as a role taken on by students (e.g. medical training), or finally as that as a part of the academic community they wish to join. It was argued that Becher and Trowler's (2001) concept of Academic Tribes which suggests that subject areas within Higher Education act as tribes with unspoken rules and behaviours. Each of the strands of research overlap and build on each other but as this chapter suggests lack a theoretical framework in which identity can be sufficiently studied to the point of measurement and explanation of how important it is for achievement. It was proposed that Social Identity Theory (Tajfel, 1978) would be able to provide the theoretical framework and underlying construct to understanding how identity may develop in undergraduates. Once a construct, in this case Academic Identity, has a basis grounded in theory then it is possible to develop a measure that can later be used in research as a tool to measure it and correlate it with outcomes such as attainment.



### **3 Transition into Higher Education.**

#### **3.1 Introduction**

Transition at any stage of life can be challenging and this is no different when faced with a transition within education. By the time students arrive at university it is likely they will have already been through a number of transitional periods throughout their academic career, such as moving from primary to secondary school or from GCSE level work to A Level work. However, it could be argued that transition into university holds a number of unique challenges. There is the requirement to socialise with an entirely new group of people and unlike previous moves through the education system in which for most they moved on with a group of friends this may need to be done alone. Add to this a new level of academic study and an encouragement to be more independent in their studies it is likely that most students will feel nervous about starting university. Additionally, for a number of students it is the first time that they will have lived away from home and this can be a daunting prospect. As the chapter develops it will be seen that transition, of course, is not applicable only to those first few months.

#### **3.2 Transition experiences within the research literature**

As already indicated the literature review will start by looking at transition experiences in the existing research. Specifically, it will put forward evidence that the transition into Higher Education is unique and that the challenges faced by students increase the likelihood of starting university as a stressful period. As can be expected transition does not just start on the day of arrival, although this is an obvious focus and therefore the chapter will look at the cultural ideals of higher education their interactions prior to starting at university. Furthermore, literature that classifies the typologies of transition models and therefore defines and shapes the practice within HE institutions will be presented. Moreover, the effect of these practices on the individuals will also be considered with a particular focus on attribution. Finally, the literature review will look at how identity is currently framed within the transitional literature of Higher Education.



### **3.3 What are the challenges to be faced?**

It is plausible to expect that individual differences of experience and background will lead to varying expectations and levels of preparedness for university level study. When considering research on transition into university the societal context and government policy is also important. For example, part time attendance is currently on the decline as a result to the changes in student financial support (Butcher, 2015). However, there are enough similarities within this population that an attempt can be made to outline the main challenges that students will face on transferring from school to university.

The majority of students (either at home or living on campus) take on new financial responsibilities, not least large fees and maintenance loans. Additionally, many students will become responsible for living costs. Alongside these challenges is the requirement of a new level of academic study with a greater emphasis on independent learning. Furthermore, students are faced with making new relationships and forming social groups. Research has focused on the impact of these pressures on the well-being of students (Peat, Dalziel & Grant, 2010) with other research arguing that students today are exposed to greater stressors than 20 or 30 years previously (Cooke, Bewick, Barkham, Bradley & Audin, 2006). Universities have developed induction programmes in response to these issues and yet even with these in place there are higher rates of anxiety and depression amongst students than the general population (Stallman, 2010). The cost of not addressing these problems at an institutional level impacts on finance and costs for the university involved as attrition rates rise. However, arguably more importantly it is the impact on the individuals who do not make the transition smoothly with reports of lower self-esteem and confidence within this group (Longden, 2004). Understandably the research has concentrated on why attrition rates are high and therefore there has been a focus on the negative experiences of university. However, poor transition also has an impact on those students who fail to integrate easily into higher education who have been shown to have poorer academic outcomes than those who do (Feldman, 2005; Reason, Terenzini, & Domingo, 2006; Shim & Ryan, 2012). For this reason, it is crucial that we fully understand transition and how to help individuals adapt and cope with this stage in their lives. By exploring a wide range of research this study will be able to explore issues of transition from a broad base of students.

### *3.3.1 The lead up to university*

Research has shown that in the lead up to university there is difficulty imagining a future life as a student (Peel, 2000). In this study pupils voiced the assumption that the transformation from a year 12 pupil to a university student would happen automatically. The authors argue that this attitude towards transition displays a high level of naivety and leads to low level of active preparation activities prior to university. Contradictorily, the pupils in year 12 expected that adapting to university would be difficult, traumatic and that there would be low support from the university staff. In this they expected to move from a setting in which teachers would monitor their attendance and engagement into a setting in which they would be expected to be independent learners with immediate effect. Understandably students are concerned with the prospect and worry that they will not be able to excel without external motivation they are used to. However, there is an element of excitement which accompanies a move to “freedom” (Peel, 2000). While mixed with worries and concerns there is an element of understanding the opportunities that lie ahead, the chance to take on new identities and the move away from home in a structured and supported way (Chow & Healey, 2008). Students expectations of the social side of university, while peppered with some elements of anxiety about making friends, are also positive with expectations of a social life that is better than the one they lead at home (Moogan, Baron & Harris, 1999)

Alongside this are the concerns about the risks involved in undertaking a university degree, not only financially but also how anxieties about being able to undertake a new level of work and making new friends (Tognoli, 2003). Furthermore, research has shown that students start university with expectations of the outcomes of degree level education, for example their increased value in the job market and their own ability to achieve a good degree classification (Byrne, Flood, Hassall et al, 2011). However, the authors did not explore the relationship of individual expectations between ability and degree value and the impact on their transition experience. Self-efficacy refers to a person’s belief in their ability to complete a task (Bandura, 1977) and has been shown to relate to adjustment at university and subsequent academic performance (Brady-Amoon & Fuertes, 2011). In research using a concept map to develop themes from qualitative data within student satisfaction surveys

Zaitseva, Milsom and Stewart (2013) found that concerns about both social integration and academic progress were evident throughout the first year and this research at least reflected the worries students had prior to starting university.

### *3.3.2 The reality of the First Year Experience: comparisons of internal images to reality*

The first year experience while universal across the sector (that is all students were first years at some point) is under researched with mostly small scale studies giving little coherence. As already mentioned earlier in the chapter, the bulk of research is concerned with how to best reduce attrition and therefore the focus is on exploring experiences that lead to dropout. While outside the scope of this research it is worth establishing what is understood about why students leave before we can consider successful transition.

*3.3.2.1 Transition and attrition:* Closely related to transition is the issue of attrition and what leads students to consider dropping out of university, either long term or temporarily. It has already been pointed out that such students are more likely to suffer from lack of confidence and low self-esteem. Research has tried to identify which students are at risk of dropping out from a demographic basis, for example family background or individual traits (Tinto, 1975) and there has been some predictive value in this method (Kelly, Kendrick, Newgent & Lucas, 2007). However, it has been generally accepted that this has limited value and a more useful way forward is to consider interactions of the environment on individuals. The model of attrition most widely accepted in the field is that of Tinto's Interaction Model (1982). This interaction model incorporates a number of aspects that we have seen in the transition models so far. The attrition models which are focused on understanding why students leave rather than the experience of the majority (that is, students who stay) are useful to consider as they could be argued as more comprehensive than either the Maunders model of transition or the Briggs Model of University influence on learner identity (these transition models will be presented later in the chapter, p.35). Tinto proposes that as well as individual differences that correlate with attrition there are a number of other variables that should be considered. As Brigg's identified the support systems within the university are important and Tinto includes these within his model, additionally he argues that these systems should be separated into two parts; that of support systems as well as academic systems. Furthermore,

Tinto includes academic and social integration, both of which he considered as important if attrition was to be understood. That social integration is important in reducing drop out has been supported by Pascarella, and Terenzini (1980) who showed a strong correlation between successful socialisation and commitment to study with students less inclined to leave regardless of their academic background. Furthermore, Pascarella and Terenzini suggest that the success of socialisation is the dominating factor in whether a student will drop out. This has been further supported by Bean (1985) who incorporated socialisation as a key element of his model on attrition. However, this model lacks a theoretical approach to help explain how the individual integrates and the processes involved.

There are some notable research projects through the HEA that have considered the first year experience in UK higher education institutions. Furthermore, there is some research that can be used from the American experience that can inform our understanding. The research presented below does not address identity issues, the link with identity will be made as the literature review progresses. However, it is worth looking at the practical factors that face first year students.

One such study that needs to be acknowledged is that by Harvey and Drew (2006) funded by the HEA. Described as a meta-analytical review of the first year experience it includes research from 1986 to 2006, plus significant material prior to this with further analysis of grey material. The search for literature was guided by the following themes:

1. Performance and retention, including predicting success, assessing performance and withdrawal and retention.
2. Factors impacting on performance and persistence, including institutional, personal and external factors
3. Support for the first-year, including induction, adjustment and skill support.
4. Learning and teaching, including new techniques for first-year groups and first-year learning behaviour.

While this article is broad and summarises a wide range of literature concerning first year experience it must be noted that it lacks analysis or theory building and therefore it has limited use in being able to add to our understanding of this area. However, it does give a

very detailed overview of the literature and is useful for the reader who wants further descriptive information on the subject.

A further study, also funded by the HEA, is of more interest. Undertaken by Longden and Yorke (2008, 2007) it sought to expand Yorke et al's 1997 research which had looked at the experience of the first year prior to the introduction of top up fees in the UK. The conclusions of the first part of the study (Longden & Yorke, 2007) showed that students who leave higher education often cited stress, poor programme choice and finance as their main reasons for leaving. The second part (Longden & Yorke, 2008) was extensive and surveyed a wider number of subject areas and was conducted in two phases. The first phase in 2007 was conducted at 6 months into degree study and received 7000 responses from 51 institutions and includes short and long answer analysis. Generally, this large scale study found that students were positive about university however there were some specific trends that emerged and are worth noting. Positive experience was correlated with making friends and high quality teaching while negative experiences clustered around feedback which was reported as not being either useful or prompt and this caused anxiety. Both of these findings support the research that had explored students concerns prior to coming to university regarding social and academic progress but also anxiety over the level of work expected. Feedback and assessment has been a consistent concern expressed by students within the literature and relates to lack of knowledge about HEI (Surgenor, 2013). Understanding what is expected in an assessment is a worry voiced by many students with complaints that the criteria is unclear. Students on arrival at university and starting their first assessment have no frame of reference; A Levels having prepared them only for one style of learning which does not require higher cognitive skills of critical evaluation and the integration of material (Wingate, 2007). Furthermore, this supports the research by Peel (2000) with year 12 students presented in the previous section and is again reflected in 1st years participants stating that they had very little real knowledge of Higher Education standards (Haggis & Pouget, 2002, Bryne et al, 2011). Prior to university images of education to date would be formed by school experiences and while individuals may express concerns as to the higher standards that will be expected they have few concrete ideas as to what the differences will be specifically (Gamache, 2002).

Further findings from Longden and Yorke (2008) showed that students were confident a degree would lead to graduate jobs but were concerned about their current ability to handle finances, workload and living away from family. Homesickness is an additional theme that is found in the FYE research, with students struggling to adapt to life away from home (Tognoli, 2003; Thurber & Walton, 2012). Close attachments to family, distance from home and frequency of contact was found to be associated with higher levels of homesickness and depression along with lower levels of self-esteem and attainment. There is some indication that developing new friendships acts as a buffer to feelings of missing home with an increase in persistence with those students who most successfully integrate socially (Tinto, 1997; Maunders, Gingham & Rogers, 2010). Indeed, Tinto argues that social integration at university precedes intellectual development and is vital if students are to adapt to university. Support networks cited in research by Astin (1984) also include staff during the second year but in the first year this relationship was weak and was not found to be a source of support for students. This echoes the concerns students had before attending university and it is not clearly understood why staff are not part of the support system. Whether this is due to the assumptions by students that prevent dependency on staff in the first year or another process has not yet been explored within the research on FYE. Additionally, stress is a common theme in much of the research with finances being a particularly issue. While it is too soon to fully assess students under the latest system of funding (that is, the burden of paying for university resting with the student) there is research that evaluates the concerns of students who had some level of responsibility for fees and maintenance through loans. Callender and Wilkinson's (2003) research showed that the burden of debt within this cohort is too great and that drop-out was directly related to this with a greater impact on lower economic groups of students. Additionally, lack of money was the second most common reason given by students who were leaving university (Davies and Elias, 2003). A study by Unite (2006) estimates that over 40% of students report they have to work, with the majority of them stating it was for essential living expenses. Callender (2008) in a large scale study which included 1000 students from six UK universities found a relationship between part time work and attainment, with students who reported the highest levels of part time work

gaining the lowest grades. Work and study balance has been shown to cause a high degree of anxiety and stress within student populations (Moreau & Leathwood, 2006).

The literature presented above showed how students moved from a naive understanding of what it is to be a student at a Higher Education Institution to the reality of the difficulties of first year study and beyond which included stressors of study, finance and social factors. It is this transition from naivety to reality that this chapter is exploring.

### **3.4 Defining transition**

It is worth considering what is meant by transition and whether there is something inherently stressful in the process itself. While at a basic lay understanding transition is as simple as a period of change from one state to another, in fact as with many human processes it is more complex than this. This understanding of transition looks only at the external factors that change without considering the process within the person. Gale and Parker (2014) define transition from the perspective of the person experiencing change and states “we define transition as the capability to navigate change” (p.737). In this short statement it is the individual's ability to adapt to external changes that is important to understanding transition. Transition typologies have been developed to help describe practice within Higher Education institutions and which theories underlying it may be responsible for these programmes. While there are a number of models for transition Gale and Parker’s Three typology of transition will be critiqued as this is directly applicable to Higher Education and allows for a range of student experiences.

#### *3.4.1 Gale and Parker's Three Typologies of Transition (2014)*

Gale and Parker’s article aims to review research that explores transition practices and theories and suggests that transition has been conceptualised in three distinct ways within University induction programmes, each of which are in turn based on three broad theoretical understandings of transition. The first is to consider transition as a fixed turning point (e.g. Palmer, O’Kane & Owens, 2009) and could be labelled as an “induction” view of transition. A second label is that of “development” which is that of developing a new identity. Lastly transition can be seen as a flexible period and status which Gale and Parker labelled as

“becoming” (e.g. Dismore, 2014). Gale and Parker (2014) propose that while Higher Education institutes have focused on providing support within the model of “induction” transition and furthermore some have even provided a framework that allows the students to develop into their new identity very few show evidence of providing space for students to “become” their new identities. These three distinct ways of viewing transition reflect Archer’s research in Chapter two of authentic Academic Identity within postdoctoral researchers as ‘being’, ‘having’ and ‘doing’ (Archer, 2008).

*3.4.1.1. Transition as “Induction”:* This is a traditional approach, which is underlined by a definition of transition as “sequentially defined periods of adjustment involving pathways of inculcation, from institutional and/or disciplinary context to another.” (Gale & Parker, 2014, p.737). Transition is viewed as a stage to move through and induction programmes will be focused on students adapting to their new environment and learning the “rules” of the institutions they have signed up to, with the aim of ensuring students fit in with the university. The onus here is on the student to engage with the programmes offered. Gale and Parker propose that programmes within this grouping will use words such as “journey” or “pathway” to conceptualise that the student is moving through this period. Another indication of a programme of this type would be that of a focus on experience at the start of university, typically first year experiences (FYE) and will not consider experiences prior to this. Kift (2009) suggests that these can be divided into two broad approaches known as 1st and 2nd generational approaches, with co-curricular activities such as orientation programmes, student decision making support labelled as 1st generation and 2nd generation including curricula activities such as assessment and curriculum development. Historically these have been developed in a response to criticisms of a lack of support for students moving into Higher Education, particular those from a non-traditional background (Laurence, 2005; Reay, Davies, David, & Ball. 2002). Proponents of the “transition as induction” view argue that by using first and second generational programmes combined together students are given a holistic and joined up approach to the first year experience offering personal and academic support and advice. Kift explains that the best approach is to ensure that this is not addressed only at a subject level:



when first generation co-curricular and second generation curricular approaches are brought together in a comprehensive, integrated, and coordinated strategy that delivers a seamless FYE [first year experience] across an entire institution and all of its disciplines, programs, and services. (Kift 2009, p.1)

Indeed, combined approaches have been coined as third generation by Kift (2009) and Kift, Nelson and Clarke (2010) who argue that combining information giving support as well as curricula support enables students to move through this transition period smoothly. It is suggested that a well-developed first year curriculum which scaffolds and supports first year learning will ensure that students are able to achieve and adapt to university academia. However, Gale and Parker argue that they fail to take into account that widening participation has meant that students who need a different approach are not offered one, and while it is a comprehensive and rigorous programme in its scope and delivery it is in fact a rigid system of one size fits all and are designed only to induct the student into the dominant norms of the university (Thomas, 2002). This has been nicely phrased by Quinn (2010) “the terms of transition are set by others”. When one considers this phrase it highlights the weak spot of these induction programmes; that is a lack of insight within this theoretical framework of transitions as unique and individual experiences which is about change within the person. Furthermore, Quinn (2012) argue that there are very few institutions who offer this 3rd generation level of induction, with most giving only 1st or 2nd generation.

*3.4.1.2 “Development” transition programmes:* The second theory and practice grouping are those inductions that define transition within terms of identity, with individuals shifting “from one identity to another’ (Ecclestone, Biesta & Hughes 2010). It is immediately obvious that within this paradigm transition is seen as something that happens within the person, who develops or changes into someone different and is therefore perceived as transformational. Higher Education institutions which follow this line for inducting students will likely have programmes that look similar to those who follow a traditional T1 support. However, they are likely to talk about stages (as would a developmental Psychologist about growth) and not periods as would a T1 theory. In this case time is seen as important but in a different way from the first typology. With “transition as induction” time is allotted to students to access all the information they need to progress to the next step in their studies,

in most instances the first year. However, for those that prescribe to a development model may acknowledge that a student may not have developed enough within themselves to move onto the next stage by the end of the first year. Does this then mean these programmes, unlike T1 models of induction, are likely to move into the second year, allowing longer for students to develop if required? There is no evidence that this is the case and indeed research indicates that T1 and T2 informed induction programmes differ only in the support offered not the time span. There may be more focus on first-year students shadowing student mentors (Heirdsfield, Walker, Walsh & Wilss, 2008; Keup & Barefoot 2005) or “service learning” element (Jamelske, 2009) within those programmes that derive from a developmental model of transition. As with T1 theorists, it is likely that developmental type research will highlight the difficulties that students face, acknowledging that it can be a difficult stage of development, however as can be expected this is not seen as an external change in the environment but an internal developmental change that the student need to jump through.

One of the reasons students find transition to university so tumultuous is that it often challenges existing views of self and one’s place in the world. Many students from disadvantaged backgrounds, for example, experience significant culture shock on entering an institution whose practices and traditions are alien to them. Transition is a time of identity re-shaping and coming to terms with whether expectations about university life have been met, or need to be revised, or, in fact, if the mismatch between expectation and reality is too great to warrant persistence. (Krause and Coates 2008, p. 500)

However, Margolis and Romero (2001) argue that institutions which use mentoring and other forms of identity development strategies do so to maintain and reproduce the existing hierarchy. Additionally, Gale and Parker (2014) refute this developmental perspective of transition do so because of the values that are held at the core of its theories. For example, Brownlee, Walker, Lennox, Exley and Pearce (2009) describes the FYE as ‘a valuable time for promoting changes in thinking, particularly in relation to beliefs about learning and knowing’” in order to ‘awaken intellectual curiosity’ (Jamelske 2009, p377). Gale and Parker propose this alienates students from working class background as the curriculum does

not “reflect and affirm working-class students by ensuring that working-class histories and perspectives are presented with respect rather than marginalised and ignored’ (Quinn 2010, 125–26). Indeed, Krause (2006) argues that the HE curriculum is ‘a challenge to one’s identity and a threat to familiar ways of knowing and doing’ (Krause 2006,p.5). If we refer to Wilson’s description of 1st to 3rd generation induction programmes we can see that he suggests that there is no obvious aim to answer these issues by current models offered by institutions.

*3.4.1.3 Transition as a lifelong process of “Becoming”*: This final view rejects transition as a concept that can be defined terms of stages or periods of life that individuals move through but more of an everyday experience. Gale and Parker quote Quinn (2012) who defines transition-as-becoming (T3) as “we need to change the terms of the discussion and recognise that the concept of transition itself does not fully capture the fluidity of our learning or our lives”. T3 does not see transition as linear as the previous definitions do and theorists from this approach would strongly reject that all students go through a period of anxiety and stress when moving into university. While they may acknowledge that some students may experience stress and for some this can lead to lower productivity they do not accept that this is universal. Furthermore, the authors state that for some students, transition can lead to “*profound change and be an impetus for new learning*” (Ecclestone, Biesta, and Hughes 2010, 3). It is possible that for some students’ transitions are not periods of crisis with intervening periods of stable life experiences and that some individuals’ difficulties are important factors in success at university. A further issue that Gale and Parker have with T1 and T2 transition programmes is a what they state is a disconnect with life transition research, particularly that of how young people approach and manage transition within other areas of life. They further state that this is common across many occupational and social areas with few links between practice and theory. Furthermore, this approach rejects the notion that we are situated within fixed identities or roles and that situations or events force us into new ones. They argue that students do not work and study in the linear way that T1 and T2 theories would require them to, nor is it a sequential pathway from school to university to work (Cohen & Ainley, 2000). Gale and Parker (2014) argue therefore that programmes that are tailored to help students down this pathway will fail some students

whose life experiences are not represented. Furthermore, they cite research that describes non normative experiences as deviant or deficient (Colley, 2007), ‘unruly’ and ‘inadequate’ (Quinn 2010, p.126). The resulting programs leave students without a voice, having to adapt to the institutions on the university's terms. We have then a definition of T3 and also how Gale and Parker propose it is different from T1 and T2 however a deeper understanding of “transition-as-becoming” is required. Rather than isolated (T1) or stilted movements (T2), T3 is fluid and encapsulates more than just the university experience which they state is only part of everyday transitions that students are making. T3 theorists argue that transition must be understood as: “a series of flows, energies, movements and capacities, a series of fragments or segments capable of being linked together in ways other than those that congeal it into an identity” (Grosz, 1994, p.52).

‘Becoming’ allows individuals to escape the categories that are provided for them within the identities as students and to explore the multiplicity of life. While acknowledging that universities need processes and support for students these need to be more flexible, accepting that for some student’s withdrawal is right for them at this moment or that course change is required with a deeper understanding of the need for information to be provided in order that students can make choices themselves about their future. The authors argue that not only should an individual approach to support and information planning be given universities should also promote flexible longer term learning, including possibilities of breaks from study or part time learning for a section of the course. Rather than the aim of induction to be one of assimilation and integration programmes should offer a curriculum that affirms students “cultural capital” through an “emergent discourse of adaptation” Zepke and Leach (2005) allowing students the space within the curriculum to contribute from “who they are and what they know” (Gale 2012, p.252), this gives the room for a dialogue that is transformational for the student but also for the university which is challenged to consider their knowledge base. “For T3 scholars, the appropriate response is to adjust HE systems and practices, including their knowledge systems and practices, to make them more open and flexible.” (Gale and Parker, 2014, p.33).

*3.4.1.4 Review of Gale & Porter's Three Typologies of Transition (2014):* Gale and Parker's paper gives a comprehensive review in which they argue there are three main theoretical

bases that underpin induction strategies at Higher Education. They look at what is common within institutions for students during the initial period of transition and also discuss in-depth the theories and biases behind each of the types of programmes. Gale and Parker reject the first two types of induction as sufficient in their scope and understanding of students needs and propose that students need a more flexible approach to support during university that allows them transform as individuals. While it is not suggested that we reject outright these categories there are a number of concerns about the typology in general and specifically the final transition as becoming approach which will be discussed.

The authors argue that T1 and T2 strategies are disconnected from the research literature on young people, identity and transition, however it also fails itself to put forward a theoretical explanation and framework for how “becoming” (T3) occurs drawing only on Sociological and Cultural Studies research to define their concept of transition. However, this link it at a societal level, such as class issues around working class students having a different narrative to traditional students which is not respected by institutions and therefore this group of students are alienated. Throughout the paper the focus of their disagreement with the previous two types of induction is that of a class struggle with an image of working class students as a voiceless entity unable to have their story heard. Yet there is research that shows students from non-traditional backgrounds with the adequate supports systems do succeed at university within the normal curriculum and expectations (Thomas, 2002). Furthermore, if universities are to produce students who are well equipped to succeed in the workplace they need do so for all students irrespective of family situations.

Additionally, its basis is that transition is a lifelong lived experience and refutes the image of transitions to university as always negative. However, this goes in the face of much of the research that shows university for many students is a stressful period, especially for the non-traditional students they focus on whose experiences so far have not been that of the learner that most institutions would have normally attracted. While they acknowledge that there can be difficulties these are downplayed in favour of a larger story as transition throughout life. Furthermore, they state that for some students’ difficulties are transformative. It would seem an issue here is one of linguistics or understanding of stress, indeed they refer to the period

of stress used by T1 and T2 theorists as a “crisis”. It is interesting to note here that none of the papers they used as evidence of stress from a T1 and/or T2 approach use the word “crisis” to describe students’ experiences of transition in the First Year of University. This is Gale and Parkers own interpretation of the T1 and T2 research findings. This language allows Gale and Parker to extrapolate that induction into university is disjointed in the T1 and T2 researcher’s framework from other areas of life and allows them to argue that practice has not been underpinned by the latest research developments about transition. Furthermore, while they acknowledge there does need to be systems in place for support they are not clear in what form this should take and neither do they deal with what is a thorny issue for their stance, that induction programmes have been successful in helping many students adjust to university life. However, they do recommend a more flexible approach to university courses (i.e. FT/PT courses or easier study breaks) than currently UK degree programmes allow. This would follow a more American University system of study in which credits are earned over a long period of time in necessary with some universities offering short fat courses which allows students to graduate after only 2 years. However, a higher retention rate is not evident in US Institutions, with students from a lower economic background reporting lower rates than other students (Ishitani, 2006). Additionally, researchers at American Universities are also looking for ways to support students to reduce their attrition figures (e.g. Perna & Thomas 2006). Transition was defined by Gale and Parker in various ways depending on the theoretical basis it was referring to. The first definition within induction literature was “sequentially defined periods of adjustment involving pathways of inculcation, from institutional and/or disciplinary context to another.” (Gale & Parker, 2014, pg, 737). Wilson (2009) argued that institutions do this relatively well with 1st and 2nd generation induction courses offering curricula and co-curricular support throughout the first year however they fail to engage with students on an individual basis as Gale and Parker argue they should, adapting their processes to suit the narrative of the student and their background.

Gale and Parker suggest that the following points are not considered by student support systems at university:

- a longer transition period than the initial year

- the experiences of students prior to coming to university
- young people, identity and transition theories which then place transitions as a lifelong experience which doesn't stop at university
- how transition is perceived by individuals rather than a mass
- transitions are not dynamic and do not interact at an individual level

Gale and Parker with other T3 researchers (e.g. Quinn, 2010) suggest that institutions should engage with students on a more individual level rather than en masse however, they do not utilise literature that would allow them to develop a model that institutions could use to develop a personalised response to transition. The current study proposes that Psychological literature around transition and Social Identity Theory (as outlined in chapter two) allows for a greater understanding of the processes involved in the first year of university and also answers some of the issues that Gale and Parker have with T1 and T2. There is an obvious link between transitions and Social Identity Theory as the SIT seeks to explain how identities are formed and the processes by which individuals categorise and compare themselves to groups around them, clearly transition periods bring this need to the forefront as people adapt to new social groups. Broadly speaking Social Identity Theory states that part of how we understand ourselves comes from the social groups that we belong to (e.g. Tajfel & Turner, 1979). While this theory was developed to understand inter-group conflict it has developed further to explain how individuals process information about groups around them, including those they belong to as well as ones they are outside of. This current study proposes that by ignoring Social Identity Theory Gale and Parker's (2014) perception of transition and identity is flawed. Social Identity Theory is not an optional process that students can ignore if they choose, it is inevitable that anyone moving into a new social arena will use the processes of SIT to adapt to the potential social groups. Social Categorisation Theory, a development of the SIT states that individuals categorise themselves similar to other group members, over time this categorisation is internalised and they accept this is now a part of their image of self.

### **3.5 Current models of the experience of transition**

A number of researchers have attempted to conceptualise and model the processes involved in transition into university and how students experience their first months of university life. These models come from a range of academic disciplines and reflect various theoretical biases.

#### *3.5.1 Maunders, Gingham & Rogers (2010) Experience of transition*

This model is based on the experiences of undergraduate Psychology students as they transitioned into Higher Education. Maunders et al interviewed 7 first and second year students and is based on early research findings, the full project interviewed 19 students in total. Maunders et al postulates development of personal and social identities as central in the transition process. Maunders in doing this reflects a Psychological understanding of transition based on Social Identity Theory. Within Gale and Parker's (2012) typology it fits as a T2, that is Maunders uses developmental explanations of growth of identity and self. Participants voiced the importance of belonging to social groups with a need to develop similar identities to those studying the same course. Anxiety about the need to make friends was eased with increased contact time. Furthermore, as their sense of belonging to the subject group grew so they felt they themselves had changed, growing within themselves to become more like "students". During this process the students talked about making outgroup comparisons with their friends at home, concluding that they were now different from then and different from who they were before. However, the thematic model also includes "need for preparedness". This reflects research cited earlier in the introduction by Peel (2000) in which students only had vague ideas of what university was like and were therefore poorly prepared. Participants reflected that they would have liked to be mentally ready for the move to Higher Education. The authors noted that this was repeated by 2nd years about the step up from first to second year university study. Uncertainty reduction Hogg and Grieve (1999) argue is a prime motivator in Social Identification and Categorisation processes. From the earliest days of Social Identity Theory research, self-esteem had been recognised as an important drive in the need to belong to groups (e.g., Tajfel & Turner, 1979; Turner, 1982), with research showing that those people with lower self-esteem would have a greater need for group identification. However, Hogg and Grieve argue that in fact it is the need for



certainty which drives our need to categorise individuals and groups. Once a person has what they feel is a “working” understanding of the social world around them then they can decide how to behave and thus grow in confidence. It is understandable that students prior to coming to university are high in anxiety which is driven by a lack of ability to know fully what to expect and with unrealistic ideas based on preconceptions of what it will be like Maunders et al (2010) state therefore that only when we include this drive to reduce uncertainty can we fully understand transition experiences into Higher Education. The work undertaken by Maunders et al is presented by a thematic map 3.1, p. 37. While this thematic concept map includes what seems to be two essential dynamics within transition (development and preparedness) and additionally gives a place for comparison and categorisation it does not fully explore how these two dynamics relate to each other. The current study will seek to explore the relationship between social identity development and processes with the need to reduce uncertainty during the move to university.

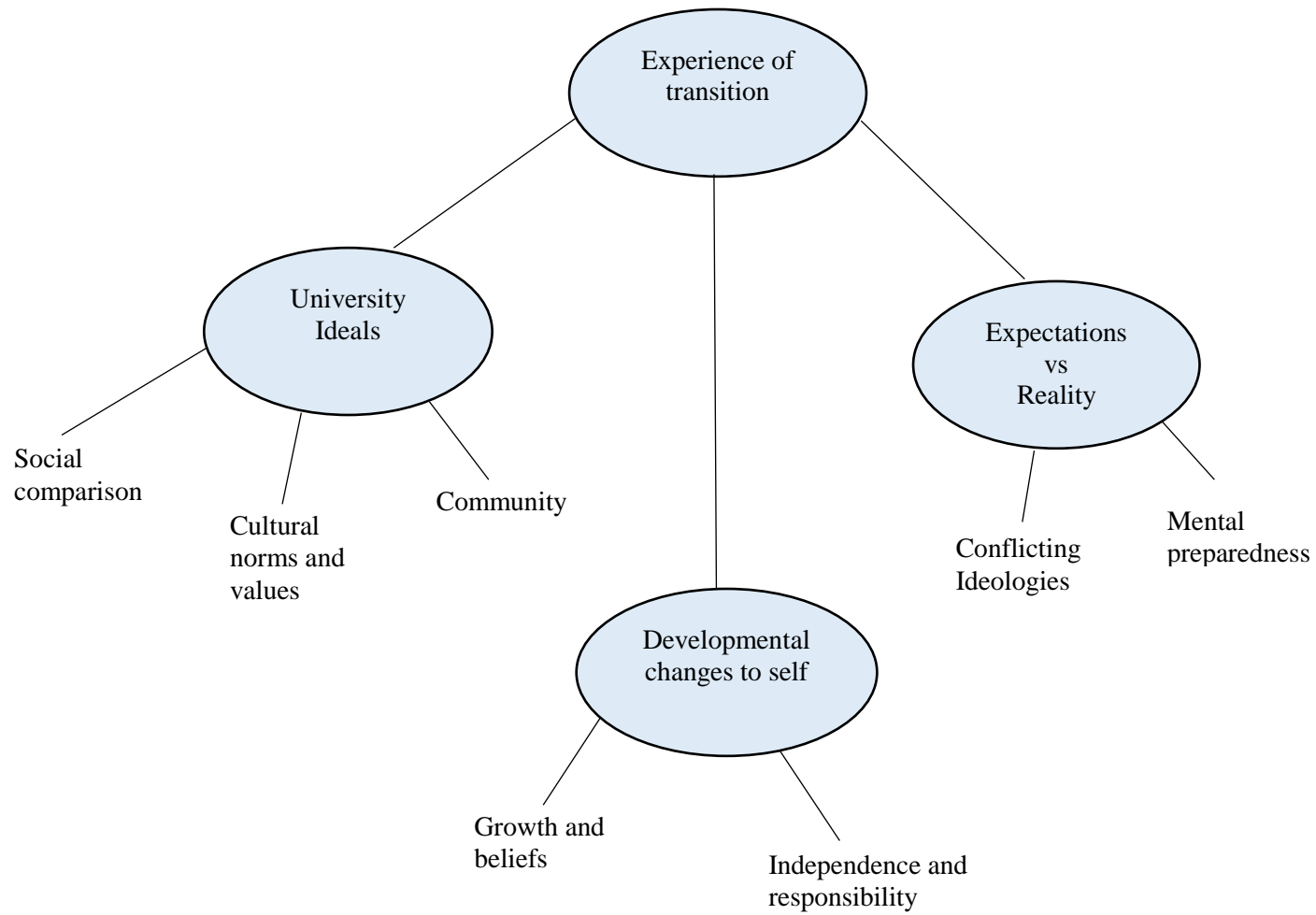

Figure 3-1: Maunder, Cunliffe, and Mjali's thematic map of transitional experiences into HE (2010)

### *3.5.2 Briggs, Clark & Hall - interaction of institution and individual on development of learner identity*

Briggs, Clark and Hall (2012) have developed a schema that reflects how a student develops a learner identity and the role the institution may play in this. The aim of the paper was to develop a model of organisational influence which facilitates student engagement and reduces dropout rates. The research used data from two primary studies which included surveys, focus groups and interviews with staff and students and from this proposes a model of process of transition and the formation of higher education “learner identity”. Learner identity is not clearly defined within this paper but is associated with a sense of autonomy over their own learning journey. It is based on the premise that when students start at university they are required to reorganise their ideas of who they are, both socially and as learners. Briggs et al proposes that the institution itself also plays a role in helping students to develop this identity. The paper explores the relationship between student expectations, support systems and learning and teaching practices within higher education. Furthermore, it looks at experiences before university and the impact these had on students once they were involved in Higher Education. The data from primary and secondary sources were integrated to develop the final model of transition. However, it is unclear what analysis was used for any of the data included in the study or the integration method. Nonetheless it is useful to understand the flow of formation of identity and how this may inform the current study. Biggs proposes two models; the first is a broad overview and the second shows the relationship between the concepts. Model 1 shows that learner identity is developed through two stages which are informed by two strands of influence. The first stage ends when the student has committed to university and has accepted a place of study following A Levels. It involves the student imaging themselves as a student of a higher education institution and includes aspirations and expectations. The school influence during this stage involves encouragement to take up HE along with preparation in moving students to a more independent mode of study and living. Alongside this perspective, students also have contact with HE institutions through open days and further information and opportunities for contact that the university may supply. The next stage is over when their identity as a “higher education learner” is secure. This process involves adjusting to the demands of higher education, growing in confidence academically and socially and gaining autonomy. The

schools only role is celebrating the student's identity when the student returns to visit schools or colleges, however the university's influence at this point is heavily involved with induction and support.

The authors use Yorke and Thomas's (2003) research on transition to strongly suggest that institutions need to be friendly and approachable in order that a supportive influence is developed and allows to the student to grow in their identity as a learner. However, there are a number of issues with the model. With reference to Gale and Parker's typology of transition, this model is a T1 and T2 with elements of induction (universities influence) and development of a learner identity. Furthermore, it does acknowledge the need for institutions to engage with individuals and suggests that universities do this in a way that handles the changing pattern of student engagement since recent changes in funding. While the model is useful in terms of understanding the role of schools and universities and it does acknowledge that there is some circular dynamics in supporting the decision to go to university which the model does not fully explore. Additionally, the processes within the individual for developing a learner identity are not acknowledged nor does it explore the relationships between peers, institution and individual or the ongoing nature of this process. It is the current study's premise that there would will be ongoing comparison and categorisation processes throughout the transition period and only by teasing out this relationship can we fully explain how students arrive at an identity they are comfortable with. Additionally, as suggested by Maunders et al (2010) it is necessary to consider socialisation and preparedness.

### **3.6 Research questions**

The present study aims to answer a number of questions regarding the transition period to university:

**4RQ1:** Is identity development evident in the narratives of the participants and researchers included in the research?

**4RQ1a:** - What are the processes involved in identity development?

**4RQ2:** Is there evidence of a transition typology in the research data and the narratives of the participants?

**4RQ2a:** Which of the transition typologies best explain the experience and processes involved in the transition?

**4RQ3:** What is the experience of transition in the first year of university with a focus on those studies that explore transition prior to drop-out?

**4RQ3a:** Are stresses inevitable part of the transition process

**4RQ3b:** Can stress be alleviated by the structures of the university?

**4RQ5:** Are the experiences and outcomes of transition universal across students?

### **3.7 Summary**

To fully understand the development of Academic Identity in undergraduate students it is important to explore the transition into Higher Education and the First Year Experience as the period of time when this identity will be emerging. As this chapter elucidates this time in a student's life is often accompanied by a number of stressors, not least of which is the need for the individual to seek acceptance and a sense of belonging amongst a new social group. It can be concluded that successful transition, including socialisation processes (Pascarella & Terenzini, 1980) leads to lower drop-out rates and higher commitment levels to study. Additionally, transition programmes by HEI do not always allow for a long enough period of adjustment or consider the individual students needs and requirements (Gale & Parker, 2014). Through an extensive review of the transition literature it was concluded that experiences of transition are important for students to develop a state of preparedness in which socialisation can occur, this included understanding their place within their cohort. Briggs, Clark and Hall (2012) argued that students need to develop a sense of themselves as learners, however the current study argues that this is not a sufficient model to understand the development of Academic Identity and that students need to be able to evaluate their chosen subject, their place within that group and develop a sense of belonging.

## **4 The Experiences of Transition: A meta-ethnographical approach**

### **4.1 Introduction**

Chapter three posed a number of research questions addressing issues of transition and identity within undergraduate studies. Chapter four outlines the methodology used, giving a rationale for the use of a meta-ethnography. Additionally, it presents the analysis from the meta-ethnography and how these findings relate to previous research presented in chapters two and three.

### **4.2 The Status of a Meta-ethnography**

A meta-ethnography can be considered an empirical study which systematically analyses data obtained using qualitative research methods (Noblit & Hare, 1988). It can be regarded as similar to meta-analysis, which is a systematic analysis of outcome of studies employing quantitative research methods. In comparison to a traditional review of literature, a meta-ethnography allows for extracting new interpretations. These are used to answer research questions and therefore a meta-ethnography can, at least in this respect be compared to an empirical research study.

As a way of introducing the meta-ethnographic approach, the following section will first present a very brief overview of the methodology of meta-analysis, its underlying philosophy and its possible applications. It is beyond the scope of this work to give an in-depth discussion of meta-analysis and therefore the focus will be on drawing out the benefits of meta-analytical techniques. Presenting the philosophy behind meta-ethnography will help to establish its rigour before finally focusing on the methodology employed in the present study.

#### *4.2.1 Meta-analysis in Psychology studies*

It is argued by a number of researchers that single studies have limited use in developing theories and advising policy within education and medicine (e.g. Dixon-Woods, Agarwal, Jones, Young, & Sutton, 2005; Schmidt, 1992). A meta-analysis potentially overcomes this limitation by keeping its status as an empirical study but with the benefit of combining many

studies and findings. Although in effect a review, it is in fact a primary study in that it uses the original data from individual research papers as units of analysis entries (Denson & Seltzer, 2011). The aim is to go beyond simple comparing and contrasting findings and includes a specific research question which is based on a wider scope of empirically obtained evidence. Importantly the interpretation of data is central to a meta-analysis that is not possible in a conventional literature review (Denson & Seltzer, 2011). Methods of meta-analysis are based on effect sizes calculated according to the principles of Hedges and Olkin (1985). Schmidt (1992, p. 1173) makes the following three statements that build up to arguments of advantages for applying meta-analysis in psychology studies:

1. traditional data analysis and interpretations procedures based on statistical significance tests militate against the discovery of the underlying regularities and relationships that are the foundation for scientific progress;
2. meta-analysis methods can solve this problem - and they have already begun to do so in some areas;
3. meta-analysis is not merely a new way of doing literature reviews. (p.1173).

The first point of Schmidt's argument relates to a larger discussion within Psychology and addresses its reliance on null hypothesis testing with its potential for measurement errors in individual studies. In the next two points he suggests that a meta-analysis is useful in overcoming the individual research bias but only if meta-analysis is not another type of literature review. Guzzo, Jackson and Katzell (1986) posit that meta-analysis allows for a quantitative interpretation of existing data that is not possible within a literature review. Furthermore, the use of systematic searching and statistical techniques alongside its accumulative approach overcomes issues with potential measurement error. Additionally, another advantage of meta-analysis lies in its ability to develop theories based on its outcomes. As argued by Schmidt (1992), Psychology as a discipline has not progressed as fast as some would have liked, due to of a lack of cohesive theories and/or contradictory findings reported from one in a certain research paper to another. Meta-analysis, advocates argue, can propose, and more importantly fill this gap by providing causal explanations via path analysis.



However, while meta-analysis in the last thirty years has developed into a sound research and statistical methodology, there was no equivalent method within qualitative research counterpart until Noblit and Hare in 1988. In order for qualitative research to emulate the development of meta-analysis within quantitative research, there needs to be the capacity for findings not only to be combined but, more importantly, to allow for theoretical development via a synthesised research paper that is both (i) a primary research and (ii) testing its own research question.

#### *4.2.2 Meta-ethnography vs meta-analysis: Similarities and differences?*

While it is apparent that there would be a difference in how qualitative and quantitative data is synthesised in the two “meta”-methodologies (meta-ethnography and meta-analysis) this is not the only variation between the two approaches. For example, Campbell (2002) argues that even at the very early stage of literature searching stage it is not possible to rely on the same methods. Qualitative papers are easier to miss due to the way many potentially relevant studies are presented in paper titles and abstracts. Additionally, as Britten, Campbell, Pope, Donovan, Morgan and Pill (2002) suggest the criteria for judging the quality of the research would need to be substantially different. Jones (2004) argues that meta-ethnography needs its own research methods distinct from those of meta-analysis and that a too close emulation of quantitative synthesis methods may produce “mission drift”. He proposes that, instead of the inflexible methodologies of statistical research and its underlying philosophies it is important to keep in mind that qualitative research is more adaptive and intuitive. Without this ability of adapting the research to the context it would not be able to achieve its aims of retaining the narrative of the participants at the centre of its interpretation. Therefore, the translations – which forms the basis of its results and findings of qualitative research, would also be lost. Jones’s view echoes that of Popay, Rogers, and Williams in (1998, p. 341) who posited that “the hallmark of good qualitative methodology is its flexibility rather than its standardisation”. However, this required flexibility may lead to issues of methodological rigour and scientific validity. It is therefore worth exploring the validity of the synthesis methodology when applied to qualitative research.

#### *4.2.3 Philosophy of Meta-ethnography philosophy*

The key to understanding the philosophy of meta-ethnography and also its validity is closely intertwined with that of the qualitative approach to research. Noblit and Hare (1988) reiterate that the qualitative research is hermeneutic, i.e. interpretive in nature, translating the narrative of its participants into themes and concepts which link to broader psychological theories. In this view it is essential, therefore, that any systematic review and synthesis of qualitative work needs also to be interpretative at its core and to be grounded in the narrative of the study participants who take part in the study. To lose the narrative nature of qualitative research is to lose its very essence, which is one of storytelling involving the everyday lives of people. With regards to systematic reviews, Dixon-Woods, Fitzpatrick and Roberts, (2001) emphasise that it is the themes and concepts that emerge from these stories that form the analytical devices used by qualitative researchers.

Interpretative research interprets the social and cultural perspectives through the words they use when talking or writing about their own experiences. This phenomenological approach ensures that the words themselves describe the situations for a unique personal position within a context driven translation of the data into possible theories. The aim of interpretation may take one of three forms as outlined by (Schlechty & Noblit, 1982):

1. making the obvious obvious
2. making the obvious dubious
3. making the hidden obvious.

One key aspect that comes out within many researchers who employ meta-ethnography is their assertion that meta-ethnography does not just draw generalisations of comparing and contrasting results but that the findings translate into one another. Turner (1980) posits that all explanation is comparative and translative and that meta-ethnography is an extension of this in that it uses the terms of the original studies to translate into one another.

Meta-synthesis of qualitative research has not been uniformly welcomed or approved of. As previously mentioned proponents of meta-ethnography argued that any method for synthesising qualitative research should not lose the essence of its nature. Walsh and Downe

(2004) argue that some critics have been concerned that not only does the analysis need careful attention but also the underlying philosophy of interpretive research approaches. They suggest that some researchers who adopt this approach will have a different attitude to knowledge generation than those from a quantitative approach. For some qualitative researchers it is impossible to fully explain experience as experience is unique to the individual and it is therefore not possible to generalise findings and that it is foolish to develop a coherent theory to explain phenomena (Sandelowski, Docherty, & Emden, 1997, Campbell et al. 2003). This of course is what meta-ethnography intends to achieve in using selective studies that represent the whole (Noblit & Hare, 1988). This inference of what can we comprehend of an experience from a smaller sample gives power to the argument that meta-ethnography is an empirical study in its own right but pulls at the definition of qualitative knowledge production forwarded by Sandelowski et al (1997). The author's evaluation of meta-ethnography is that it reduces the original thick data into shallow summaries and risks destroying the integrity of the individual projects by losing the voices of the individuals involved and their experiences. In fact, this stance is in danger of leaving Psychology with isolated islands of knowledge that cannot be developed into cohesive theoretical frameworks. Within qualitative research there has been disquiet over this issue with numerous critical and evaluative review and discussion papers arguing that qualitative research needs to develop cohesive theories using more than narrative literature reviews (eg. Britten et al, 2002; Jones, 2004; Barnett-Page & Thomas, 2009).

The aim of literature reviews is to allow authors and readers an informed judgement about the current knowledge base within a particular field. A systematic review will allow the reader to assess the quality of all the research available and also give an indicator of the scope. In this sense qualitative research has begun to develop rigour within its own paradigm. However, if the qualitative research community is to develop a reputation as robust as that of the quantitative community then it additionally needs a methodology for synthesis like that of meta-analysis which goes beyond the comparing and contrasting stage but also tests a unified question and theory.

### **4.3 Process - Lines of argument synthesis**

The following section outlines the process and steps used through the meta-ethnography. It is not intended to be an analysis of the data though examples of the analysis used will be given for clarification purposes. It is intended that a line of argument synthesis would emerge through the process. As previously stated this allows for inference of the chosen population (in this case University Institutions) from the sample of papers that represent the whole. A line of argument synthesis is made up of two broad stages which are:

1. Reciprocal translations through which we synthesise all of the studies, translating each into one another.
2. Clinical inference in which we develop a “whole” line of argument.

The above steps feed into a Grounded Theory framework in which data are coded and translated into each other to develop concepts that form into a cohesive theory. A more detailed outline of how the current study accomplished this follows. A number of worked examples of both meta-ethnography and grounded theory research were used along with key articles and books in both fields to ensure that each step was clear and transparent.

#### *4.3.1 Translation Process*

**1st reading.** A summary of the articles was written on the first read through of each article and this acted as a type “memo writing” that is normally undertaken after interviews within a Grounded Theory study. These memos/summaries contain initial reactions to the study and allowed for an initial comparison between the papers.

**2nd reading.** Noblit and Hare (1988) suggest that idiomatic translations should be the final aim of the analysis of a reciprocal argument. However, it was decided that earlier steps in the process should allow a more literal translation and therefore at the second read through phrases using the original words were listed. While idiomatic translations seek to discover the meaning of the original text it was felt that using the original words at this early stage would allow the researchers to stay as close to the voices of the participants and the original researchers as possible. Indeed, this is a closer adherence to Grounded Theory than the steps suggested by Noblit and Hare, who while recommending a Grounded Theory approach for reciprocal arguments do not specifically explain how this is to be done.

The methodological thrust of grounded theory is toward the development of theory, without any particular commitment to specific kinds of data, lines of research, or theoretical interests . . . Rather it is a style of doing qualitative analysis that includes a number of distinct features . . . and the use of a coding paradigm to ensure conceptual development and density' (Strauss, 1987, p1)

Open coding of 1st and 2nd order data was done during the second reading of each of the selected papers. This was as important to ensure that coding is thorough, essential to the development of a grounded theory and at this initial stage the aim was to generate as many ideas possible from the data (Sbaraini, Carter, Evans & Blinkhorn, 2011). An example of some these codings can be seen below and all of them are listed in appendix C.2.

**3rd reading.** At this stage there were a number of aims;

- i. to test the codes developed in the first two readings across all of the papers papers, checking that there was sufficient evidence for each one and applying to sections that had previously been missed.
- ii. Once it was sure that codes had been developed fully they were grouped into themes with subthemes also emerging. The quotes and research that supports each theme are listed in appendix C.4.

**Building a line of argument.** As already outlined above it is important to translate the papers into each other and this was done in the current study via a series of mind maps. During the third reading the researcher would summarise the data derived from it textually and with mind-maps. The mind maps were modified as the metaphors and processes of transition emerged from each article, the themes that had been developed in the previous stages were used to label the elements on the mind maps. The final map is below in section 4.4.1; the evolution of the map is shown in appendix C.3.

#### **4.4 Results and Discussion**

The main aim of the meta-ethnography was to explore the processes of identity development during the initial days of transition into higher education. A secondary objective was that by understanding the student's point of view and their experience of the early days of university

it would be possible to information induction practice. Unlike normal qualitative papers, a meta-ethnography sets out to show evidence from not only the original participants but also the researcher's analysis. The results are not solely based on frequency of quotes from participants on a particular topic but also uses the authors and researchers' conclusions. As the papers selected were considered to be of good quality and sound it can be concluded that the analyses in each of the papers is a synthesis of the original data given by participants. Therefore, as a line of argument these conclusions will fit together and put forward a working theoretical model for future research.

The themes will be presented in order of the centrality of theme in the final model and therefore I will start by looking at the identity processes that emerged throughout the papers. It must be noted that some papers did not have identity as a main theme, however even within these papers the processes of Social Identity could be found both in primary and secondary data. From there I will move onto explore the prior cognitive and emotional precepts that inform the individual student's identification process. Furthermore, I will present the effects of identification and show evidence for its cyclical nature.

#### *4.4.1 Final Thematic Map*

The figure on the page 50, (figure 4.1) presents the final merging of all the papers and indicates a cyclical nature to Categorisation and Comparison processes. This is similar to many instances of developing a Social Identity category as discussed in chapter two. There is a reiterative element to the figure with the individuals understanding of themselves adapting and incorporating a new self-concept. However, unlike Festinger's Social Comparison theory SIT allows for deindividuation as the individual redefines themselves in order to be a typical group and seek acceptance into the group. The various papers called this process by different labels, for example paper 6 called it "threshold of induction" in which students have cognitive variables (images) of what it is to be a student. The start of university, as the figure shows, brings reality to the vague images that Peel (200) refers to in chapter three and present in the participants of the current study. With the influence of risk, aspirations and the need to belong participant's social identity as students are shaped

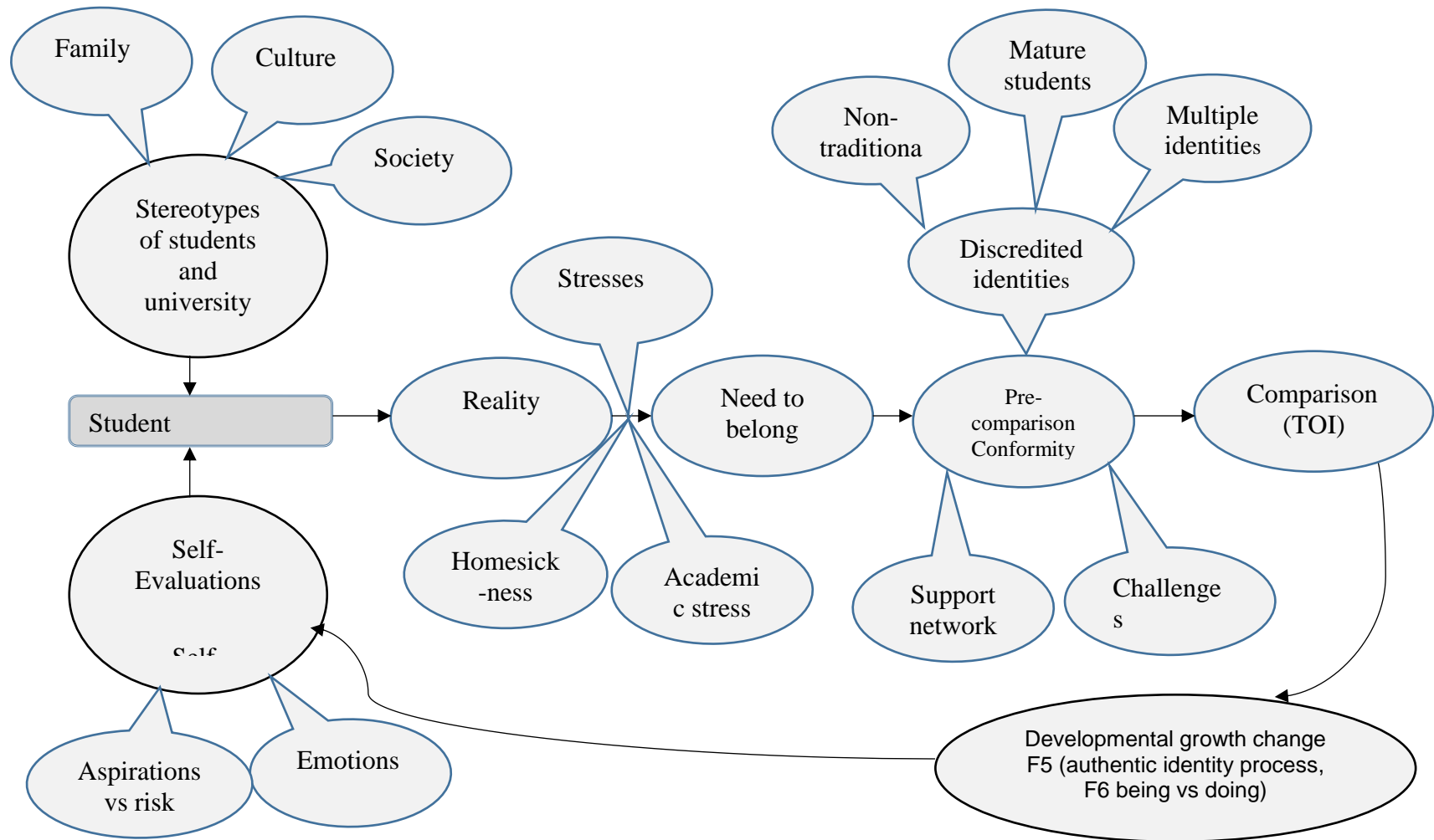

Figure 4-1: Themes of the final papers merged

#### *4.4.2 Identity processes: Do I want to be a student?*

Integral to the process of Social Identification is that of Social-Categorisation Theory. This theory suggests that categorisation of groups and a person's desire to belong to a group happens continually. It was my argument that this would be particularly prevalent during a transition period, especially one with as many changes as starting at a higher education institution. Categorisation processes occurred prior to starting at university as students used their preconceptions of university to compare themselves against societal images of university.

*4.4.2.1 Categorisation of university: what is university and do I want to belong?:* A theme that emerged early on in the research was around the preconceptions that students held about university study and life. As this is drawing on comments and quotes about their understanding of university prior to coming and the literature included was primarily about transition there are fewer references, nonetheless this is a consistent finding. A number of students had expectations of university as difficult and challenging academically which led to anxiety prior to arrival. For example, in what is the first of many comparisons made throughout the papers, students made forward looking contrasts of how university would be different from that of their previous learning experiences. In paper 1 we see one participant explaining her images of university:

I was just really scared about that fact...that it's such a step up. Everyone used to say A-levels are...a certain level and then like Uni was literally like 10,20 levels above that so i was just really scared about that the work and I was expecting the quality and just the step up.

However, some students felt that because their ideas of university were based on students partying and drinking with a focus on the social aspect that academically it would be easy. Paper 1 has a number of students who stated this:

I thought (university) would be all about partying and stuff and I suppose that's what the stereotype is about students, that they don't actually work but that the big thing that struck me about the discrepancy about my expectation and about what's happened here. (paper 1, code 52)



Participants cited a number of sources of internalised images of university including family friends and school. Some of these were positive and lead to an expectation of university as the norm, a rite of passage almost and what was expected of them as individuals. The following student who was in her second year illustrates this, “It just seemed like the natural route to go really...you’ve done sixth form, now to Uni” (paper 1, code 6)

However, linked with this was the images of university as a high status educational establishment, with direct comparison of themselves against this ideal. The quotes of the original participants and the analysis of the authors is worth expanding on here so that it can be established where such images may originate from: “I thought it was going to be ...extra extra difficult...like if you want to increase your earning potential by x amount you’re going to have to be really really intelligent in order to do that” (paper 1, code 46)

Maunder et al also suggested that students had internalised cultural and societal ideas of university being elitist (paper 1, code 11) and that these images spoke to students in different ways depending on their experience of university as part of the norm for them. Furthermore, Christie (paper 6) suggests these differences in how the narrative speaks to different groups of young people in society is changing (paper 6, code 72). As widening participation of Higher Education has grown the discourse that would normally be considered middle class has widened to non-traditional students. The images and concerns shown thus far sits alongside the literature presented in the introduction by Peel (2000) whose participants had a vague idea of what they expected university to be. Furthermore, prior research by Zaitseva, Milsom and Stewart (2013) indicates that expectations impact on the ability to successfully transition into university. The literature presented in the first year did not look at individual differences in the background of the students, however the analysis of the current study shows that this is important. For example, Christie (paper 6) uses a quote by Eleanor, a student who had come to university at 21 as a mature student and a single parent as a “natural progression” (paper 6, code 1). However, another of the quotes she chose to support this argument tells, at the very least, a more complicated message and is discussed by

Christie in codes 6-9 of the sixth paper. Heather, another of Christie's participants Christie argues goes against the cultural stereotypes about who could become a student:

My brother was always the intelligent one [...]. I failed a couple of exams when I was younger. The rest of my family thought I was going to drop out of school at 16 and get pregnant. Part of me wanted to to to uni to prove a point to say "I'm not like you think just because I'm a bit crazy. (Paper 6, code 6)

Risk was mentioned more often by non-traditional students, not just financially but also by stepping out of the identity that would normally be taken up at 16 amongst their communities. One student said this explicitly; "going to university was a risk but I wanted to change my life. I'd been rejected by the army and wanted a complete change [...]" (paper 6, code 20)

I propose that the image of elitism is a key component of the processes of Social Identity which drives Self-Categorisation, furthermore the narrative of risk supports this further. It is unlikely that people would take risks for something that they did not consider of value. SCT occurs when a person is not yet a member of a desired and valued group, indeed this is a more complex idea of risk than that discussed in the introduction and supports SCT by suggesting that for some students it is more than just social integration at risk but also the value of the degree itself. The analysis presents evidence that cognitively students still saw a degree as worth having; even with widening participation students still valued the opportunities degree level education brings. This is seen by Matt in paper 6 who talked about "the money!" and "the extra opportunities" that come from gaining a degree (paper 6, code 11). His aspiration was that of doing something other than "a normal wee job" and it was his expectation that becoming part of an elite group at a good university would help him achieve this goal. The authors of this paper called the theme "Trust in transitions infrastructure" (paper 6, code 82) and argues strongly that students within the study valued the degree for its end results. This was seen across many of the student groups within the sample. Furthermore, other less obvious value statements were seen. For example, mature students expressed how doing a degree was important to their self-worth, re-addressing missed educational chances and talked about how proud they were with their achievements so far

(paper 3, code 6) while younger students had narratives around the chance to grow and develop. This is seen in paper 4 by Katy:

I think that going to university is about moving onto another stage of your life, you're not in school anymore, you're not not a child anymore. You are on your own now. I think university is a good way of making that step. I think moving away from home is what makes your more independent, and adult. (paper 4, code 17)

Additionally, students expressed views such as “outgrowing” home and their previous identities and that university is the next step to make in terms of growing up and a chance to explore who would become (paper 4, codes 14-16). This suggestion of the need to move away and find yourself is coined dislocation by Chow in the fourth paper which explores a sense of home and how this changes with a move to university. Chow et al suggest that dislocation is needed in order for students to question their self-image and develop a new one.

To summarise, many of the students held preconceived ideas of university and these were informed by peers but also societal ideas of university education still being elitist. Of course, the participants were all students at the time of taking part so to some extent cognitively they would be reasoning their choices for having taken the university route. Nonetheless, there is evidence here of students seeking to be part of something they considered valuable.

*4.4.2.2 Us and them: am I student?:* Furthermore, not only do participants have stereotypes of university they also held ideas about being a student which they had internalised, this was hinted at in the quote above about partying and socialising (paper 1, code 52). As this is not at an institutional level but individual level it is proposed that this will be more directly linked to their idea of self and it was seen that this was the case. Throughout the papers there were many instances in which students would talk about whether they were a student and if so what type of student they were. Their internalised images of “student identity” set the stage for comparing and contrasting themselves between this image and their self-image. As will be established this is only the beginning of an ongoing dynamic of comparison

between internalised images which are constantly modified through the reality of being a student and then used to compare with their self-image and how they meet the new internalised image. Prior to university however, the images do not have the benefit of reality and again are shaped by their peers, family and societal ideas of student identity. While this is a relatively minor theme at this stage in the process it is necessary to discuss here so that we can establish the images students arrive at university with. The following female 1st year student is drawing on a cultural idea of being a “student”:

I was expecting a ...lazy kind of laid back life...I’m not a lazy person but I did expect there to be ... times when you can just kind of like chill out and not really do anything...I think a lot of the time university and university work is slightly underestimated ...and that people don’t actually think there is this amount of work to do. (Paper 1, code 54).

Maunder (paper 1, code 55) expands on the contradiction seen in her own paper but also across the sample of papers selected for the meta-ethnography. Participants reflected on the value of holding a degree and voiced descriptions of university as elitist however, there were expectations of students being lazy and focused on laziness. It is my thesis that this contradiction in fact works together to increase Self-Categorisation. It holds up graduates valuable and therefore a worthwhile group to want to become a part of however, how does that happen? It happens by being a “student” and it accepted that students have a particularly way of behaving. Once students are behaving as other students do then they can own this label and become part of the elite. Indeed, paper 3 explores this complex set of identity markers through a theory called “threshold-of-induction model.” Blair, Cline and Wallis (2010) argue that this study explores this idea of attaining student identity by looking at students who are not the norm. In this paper they propose that individual participants hold a unique set of variables that all need to be met until they accept a student identity, crossing this threshold allows them to accept label. This brings out the implicit cognitive measures used with Social Categorisation Theory, which argues that individuals measure themselves against a group, in this case of course students. However, Blair, Cline and Wallis (2010) expand on what these images may include for the non-traditional students. We begin to see here greater individual differences in comparisons between groups of students. For example,

a student in paper 1 did not have the narrative of students for whom university was expected as their family members had already attended. We can see this from the following quotes:

because there wasn't really anyone that I knew what was at university at the point in time so obviously i had no reference point...so it was using..whatever limited experience I had to sort of make up this of what would be expected. (paper 1, FT6)

I come from a family of academics and Uni was always going to happen...it's just in the family that we all go (paper 1, FT7)

Similarly, this contrast of preparation is seen again in paper 6 in which the authors argue that students from a non-traditional background enter a world that is non familiar to them without the familiar cultural capital that traditional students begin with (6, FT9). Paper 7 explored the impact of poor preparation for university however, the authors did not fully explore why some students are motivated to prepare and others are not. However, it can be concluded from the above quotes and the papers as a whole that students overwhelmingly rely on peers for their understanding of university life while cultural norms and societal ideas of university play a role in some of their assumptions of university as a high status institution.

Furthermore, for those students from a non-traditional background this is likely to lead to higher levels of anxiety as unlike those from traditional university backgrounds they do not have the stabilising effect of family narratives of university life as argued by Blair in paper three.

Once the move to university happens and the initial induction period has started the focus of categorisation moves from the level of school versus university or level of the individual versus institution to that of a more complex categorisation of others into types of students and individual comparison of self against these groups and working out where one wants to fit or currently fits. In paper three a mature student is seen as making shifts to what is seen as this normative student identity with her choice of clothes, such markers are seen as part of the social identification processes:

I get teased by the other girls at college because I have changed my hair, I've changed my way of dress and they said: 'Is there a man in your life?' Someone asked me; 'Well what what sort of clothes are you wearing now?' and I said: 'More casual'. He said: 'Oh, more studenty'. (K, paper 3, code 34)

Interestingly there is also a growing set of comparisons made between their new student life and previous home life. Participants identified themselves as students, contrasting their previous life as boring or their friends at home as different. This clear sense of ownership with the student identity and growing sense of pride and internalisation shows a shift in identity. Furthermore, there is evidence of the "variables" that people may hold within their "student identity image" and these are sought and used within the first few weeks, showing a filtering of potential friends for those that best fit your own image of being student. As paper 5 clearly shows participants took on student behaviour and "symbols" to increase the likelihood of social success. For example, Alex (paper 5, code 92) uses a beer can to show he was one of the lads and indeed he uses this as a marker when seeking out other people he would be happy mixing with.

Well I was on a mixed floor [in residential block], I was the first to arrive on my floor. I knocked on people's doors on my floor and they were either foreigners or third years... Mum and Dad were in my room, and I said 'right, you stay there I'm gonna go round'. I went downstairs, knocked on two people's doors ... they ...a big pile of beer and stuff that, you know, that's the association. Then I thought 'alright I'll chat to these'. I had a good chat with 'em, made me a bit more confident for the evening. It was sort of like 'Right, I'm shit-scared here, but we've got tonight to look forward to'. (Alex, paper 5, code 8)

In another example of categorisation of student groups, we see a participant categorising some people as slackers or workers (paper 1, code 29) in a clear demonstration of ingroup and outgroup language with words such as "them" to identify people outside of their own grouping. A male student talked about this very issue:

I think the biggest problem I have is that I don't want to be with people that aren't going to be arsed doing the reading outside of lectures and as soon as I'm stuck with them then I'm not going to want anything to do with them (paper 1, code 29)

Maunder argues that the construction of "normal" students was seen as those who are living on campus, 18 years old and full time with those who fall outside of this experience as "other" or "traditional" or "non-traditional". Halls was a particular focus of identity processes and supported students in their move to university but was also a polarisation for ingroups and outgroups. In paper 4 the authors talked about halls as having an elite status (paper 4, code 26) and this was shown by Erica who had lived off campus since her arrival.

I thought I would meet more people but that's what not living in halls does. People in halls seem to stick together, I mean we do stick together as well but I don't think we try to on purpose. We don't go let's not go talk to her and walk off and go home. I didn't think would make more friends on my course but they all seem a bit weird and all too old. (paper 4, code 27)

So far I have argued that students not only have images of university as an institution but also that of the "normal" student experience. Additionally, we can see that they engage in categorising people into groups or types of students. Furthermore, it is proposed that they measure themselves against this image to see if they are yet themselves a student, as discussed by "threshold of induction model". The male students in paper 5 had a distinct idea of being a male university student and they used their laddish behaviour as a currency to gain admittance to the group, for example John talked about being one of the boys as basis for friendship:

Groups of guys... basically drinking, being out on the pull...I suppose it goes back to the sort of fitting in-establishing yourself within a group. If you can all share that sort of similar interest then it's weak-but a basis for – friendship (John, paper 5, code 19).

Again with mature students, talking about younger students we see a categorisation of how they behave and their goals and aims, Maunder summarised this as a student who is "other" talking about normal students.

they're trying to...make the most of the few years they've got at university - they're not going to get that experience again...it's like the first time they've been away from home so they wanna enjoy the partying side of it whereas I don't feel that I need to do that (female, second year, paper 1, code 23)

We can also see here that the authors of paper 3 showed that non-traditional students positioned themselves out of the group “student” not yet accepting the label (paper 3, code 32) and talked about “real” students as something they had not yet become. This feeling is similar to the phenomenon called “Imposter Syndrome” which originally assumed to be a female issue especially in the professions and academia (Clance & Imes, 1978). However, there has been more recent research that explored correlates of Imposter Syndrome amongst undergraduates of both sex (Hutchison, Follman & Antoine, 2006) and its relation to self-efficacy. While the study used a small sample, they nonetheless found that gender was not implicated in Imposter Syndrome. However, it did relate to self-efficacy beliefs regarding the ability to complete the programme. Of particular relevance to the current study is recent research that sought to explore whether the assessment process could overcome Imposter Syndrome amongst mature students (Chapman, 2015). Importantly this study focused on the first year transition experiences for mature students and concluded that while writing was “scary” it was important step in their journey of find a place to belong within academia. This relates strongly to the types of transition already focused on within this study and suggests that transition is both a moment in time and an ongoing process particularly for non-traditional students. It must be noted that the participants in the current study within paper three were non-traditional students who had talked about their “academic” behaviour so were engaged in doing student learning behaviours but they could not yet adopt the label as student for themselves. It can be concluded that “becoming” a student is more than just “doing” academic behaviours such as reading, lectures and writing. Indeed, if we look above there is very little mention of academic behaviours by any of the participants, although it was not entirely missing from the dataset. For students in paper six they saw the university experiences as the whole thing and therefore their contact as “day” students excluded them from the identity student, Christie argues that these students showed emotional disorder and insecurity around internalising the label student. In fact, the participants stated they were doing not being students, they did not accept that they were becoming a new person or



developing a new identity, that the degree was only a means to an end (paper 6, codes 37-43). Conversely these students valued their degree highly and entered a different narrative about student behaviour, that of entitlement and hard work. Heather spoke about students who were affluent as being very “studenty” while others in the interviews talked about such students as being inferior in their attitudes to study.

Heather: “The people who roll out of halls in the really really typical student clothes, and the girls who come in their pretty little pointed boots with their hair done and their make-up done every day for university” (paper 6, code 48)

and:

Matt: “they’re the one who’re out all the whole time and they don’t seem to care as much [...] you never see them with a book, or revising [...] they’ve got their overdraft and their credit cards that are like sky high, [...] I don’t understand how people can get themselves into that position.” (paper 6, 55)

It would seem that non-traditional students as stated in the first section would conclude that they are taking higher risks through being at university, both socially and financially and indeed they valued the degree highly for its ability to offer them a better life and yet here they seem to be alienated strongly from the label student. However, this was not a situation that they were entirely complacent about as you can see from the quotes above, their language is not neutral. This could be argued to be a facet of SIT theory in which minority groups feel frustration and anger at the majority (Hoggs & Abram, 1988).

A minor theme to emerge that is worth noting here was that students hope there would be a chance to take on a new identity, to move on from their existing self-identity which is linked to home. In paper 2 this was summarised by one student:

You’re sort of free to make a new start, even if you were fine back home you have an opportunity just to be new here ... because when you first come to university your identity from home isn’t fixed any more, you sort of have to create a new identity

whether that's the same as the one you had at home or a different one. (paper 2, code 3).

This sub-theme is however, a desire that is grounded in naivety as will be seen by the following sections, however at this stage it is interesting to see a quote given in paper five by a Cameron, a male in his first year:

In my experience ... I could understand, to some extent people wanting to try and make out they're someone that they're not, It seems, er I don't, it's quite contradictory, my view on that; I think I've got a bit of both in that I don't see the point in being someone you're not, but equally I can understand why somebody might want to do that. But from actually seeing with my own eyes, I didn't really see it happen. Erm, from the people that I still know now, that I've known since year, the people they are today is pretty much exactly the same they were in first year, so I wouldn't think that I'd see much of that. (paper 5, code 50).

The dynamics around the label "student" very much indicates that the processes involved in Social Identity Theory and Social Categorisation Theory are evident. Social identity is driven by the need to belong and we will next look at the emotions involved in the transition process and other factors that may mediate the effects.

#### *4.4.3 Filters of experience*

There has already been mention of some individual differences even with the stereotypes that students may have about university and student life, for example "threshold of induction" is built on the notion of individual differences within the variables that students may hold that builds up their image of becoming a student. Likewise, psychological processes such as motivation and stress will add to these differences. This section of the results will include the individual psychological "filters" within the student. For example, in paper 3 mature students talked about their lack of attainment at school and how this still influenced their attitudes to their own ability but this was not seen in other papers. The figure below outlines these "filters" which bridges the preconceptions of university and student life and the start of the transition period. Filters are important to understand at this

stage as it is likely that how people transition and adapt will differ based on these. Some filters seemed to be universal however not all were and this will be indicated as they are discussed.

A theme not considered prior to the research but arose within a number of the papers was that of their existing identities and the possible clashes for some students with the student culture and images outlined already. One paper that was particularly focused on this aspect and can add to the argument about individual identity clashes aimed to understand how Christians who attend sports university with a distinct focus on partying as part of its identity manage to integrate these two identities (paper 2). Generalising out such findings to the general population of students is always difficult to do when using qualitative research, however, as discussed in the methodology, Doyle (2003) proposes that a meta-ethnography should develop theories around commonalities amongst the papers. In this case the difficulty is increased as not the identities involved in paper two could be considered extreme and therefore is not common across the papers. However, I will aim to show that subtle clashes of identity do occur throughout the sample. In paper two the author proposes that students begin university with “discreditable identities” which are defined as those who appear to be “normal” while hiding an identity that is different from the majority culture around them. (paper 2, code 6). The tension between two identities coupled with the need to belong and integrate increased anxiety amongst this group before starting university as evidence by the following quotes:

Male student: “I was anxious about how I might change negatively ... I didn’t want to become something that I didn’t want to be ... I was scared that might happen just from peer pressure” (paper 2, code 10)

“I wasn’t really into that whole drinking, clubbing lifestyle, I thought I’d just sort of stick out, not make any friends.” (paper 2, code 14).

Discreditable identities, a sociological term, can be proposed to be similar to low status minority groups within social identity theory in which we see tensions between possible identities theorised and explained. Further evidence of identity tensions is seen in some of the other papers also which lends support to this being an issue for first year students. An

example that is easy to draw on is between that of mature students and their lives away from university and this is shown in paper three (code 18) and the students responses to conflicts between the roles they were expected to play. The authors outlined a dual role that caused tension and stress between university and home life with K stating that she imagined a world in which, “I would be able to have two lives, I would be able to have a whole life and a student life”. The authors after these set of interviews concluded that this group of non-traditional students struggled with embracing university life fully and therefore were not yet able to internalise the identity of student due to this. In the transition typology put forward by Gale and Parker (2014) it was suggested that non-traditional students found that university failed to hold their own life stories as valuable, instead superimposing a middle class narrative and mode of being a student. This did not emerge as a finding within the literature however pre-conceptions of university were found to be based on the student's access to images of university. For students who came from a traditional university background these were readily available, however for other students there were less. This was discussed in “us and them” (p.51) however it's impact is likely to act as a filter during the transition period of university.

A further struggle was that of gender and academic behaviour. In paper five male students were able to use their “laddish” behaviour as easy currency into an easily marked identity role, however this was not without complications as students found after the initial transition period. The struggle portrayed centres around a narrative of performed and authentic identities, which has shifted from a minority group versus a majority group dilemma to an intrapersonal one. Unlike the previous struggle which was about in-group and out-group envy and desire to belong to the majority group, that of mature students wanting the full student experience we see now male students dealing with which identity they want to be salient. Whereas Christian identity potentially is stigmatised and therefore forces the identity to be hidden, nor is there envy as with a minority group, in this paper there is a different identity dilemma very much to do with the desire to belong, but also the avoidance of loneliness alongside the underlying motivation to get a good degree. For these participants the attraction of constructing a laddish identity meant that they had access to a group which they risked losing should they to adhere to the male group rules. The following quotes show

first the need to belong followed by the potential group result on individuality. They are both by the same student and shows a pull and an attraction to an identity as well as an awareness of the potential implications:

People think it's easier for them to be accepted if, erm, you know they're definitely one of the lads rather, than you, know, a less masculine male.(paper 5, code 51)

Rugby ... it's a team thing. That's why you see them singing around campus together, drinking together, they always go out together...a sort, sort of community ... I think again going back to what I said about certain lads...sort of taking on this persona with which they're perhaps, which is different to them normally, I think it's a similar thing. People, I think, change when they're in a group. There's a shared sort of, well if not a lack of responsibility, there's a kind of "you can hide behind this body of people" and probably act in quite a different way than they would do otherwise. (paper 5. code 39)

Deindividuation is discussed widely within Social Identity Theory (e.g. Brewer, 1991; Lear & Spears, 1991; Rees, Haslam, Coffee & Lavalley, 2015) and generally arises through group membership when the individual has a high motivation to belong to a group; the main premise of this theory is that the process leads to a shifting of self. As can be drawn out so far from this analysis there is a strong need to belong, which heightened during the transition into university and will be discussed in the next paragraph. Couple this with the stereotypes people hold about student life and university and it is hardly surprising we see such observations being made.

This leads to a further filter of the emotions involved on starting university. As may be easily predicted many students talked about anxiety and this was expressed by participants throughout the studies. Paper eight coded 146 references to stress in the journals written by their participants (paper 8, code 15). While this referred to organisation and time management other papers showed other stresses such as social and day to day living, for example halls and the dynamics of flat sharing (paper 8). Academic concerns have been referred to briefly in the first section as students talked about their images of university and

the differences between HE and school. However, it is felt that this is distinct from the first theme as this focuses on emotions that overflow into the first few weeks of university. The words used to describe how they felt about socialising and needing to make friends was summarised by Maunder et al (2013) as “desperation” (paper 1, code 35). One participant suggested she was “latching on” in the early days (paper 1, code 12). This fear of isolation was also talked about in papers two and five in which participants struggled with aspects of identity driven by this need to avoid loneliness. Paper two’s aim was to explore how students with Christian identity on arrival managed integration into a culture of drinking and partying which may be at odds with their Christian faith. Mature students however, were less concerned about these issues (paper 3) and were more likely to express concerns about academic progress. This is further illustrated by one student in paper three; M as she is called by the authors, who felt that her experiences of school had led her to view the start of university as difficult and showed low confidence and low self-esteem in her ability to meet the challenge.

Goals and aspirations was a further theme that emerged and showed individual differences across the sample. These relate to the motivations that led to them to apply for university and undertake a degree and was one of the clear indicators shown in the sample that was more likely to lead to questions about dropping out. Paper seven, whose focus was on stress and coping in first year graduates placed goal focus as important in helping individuals overcome the difficulties of the transition period of higher education and mitigated against negative emotions (codes 32-38). Jane gives evidence of this:

I can see my goal and the end of it so I’m going towards it so I know that I’m going to get it so it actually makes me closer you know to my goal and my dreams so I try not to see it as a very stressful thing to do, instead I see it as a very beneficial and very interesting thing to do, so I try to concentrate on the positive side of it not the negative (paper, 7 code 33)

Conversely another student in the same paper felt he lacked goals and a clear motivation for doing the degree and this led to lower commitment levels:

David: "As the time come closer I was getting stressed out and that and erm sort of realised that I sort of didn't want to go. When I was here I made a really good effort but I don't know, I realised up the time that maybe I wasn't doing the right thing, which of like I probably set myself up for failure."(paper 7, code 36,37)

The authors concluded that goal orientations are equivalent to positive thinking and hope which they propose is important to completing the degree. The importance of achieving was a stressor for students, paper 8 drew this out in quite some detail. This was partly due to the methodology used in this paper in which students journaled throughout their first year and therefore were more instantaneous responses to situations. The following quote was from a student who having read the journal back reflected on their first year experience:

Looking back ... I guess it was a fairly stressful time ... the main source of stress for me personally was not knowing what was expected of you (i.e. not being familiar with the standard requirements on essays, presentations, etc). Through the first semester I remember constantly stressing over my results; would I ever pass my modules!? ... Needless to say, the days leading up to the date when the results came out were absolutely nerve-wracking... (paper 8, code 25).

I have already concluded that the group of students who seemed to show greater risk taking along with higher valuations of the degree were less likely to take on the label of student. I further argue that the build-up of these filters would also lead to greater levels of stress. One could argue that students who value the outcomes of a degree highly for the opportunities it gives should be less likely to drop out, however it is known that non-traditional students are more at risk of doing this than traditional students and why this may be the case will be considered in the discussion. However, it was also seen that motivations were not always linked to academic outcomes as was seen in the first section there was the desire to move away, to develop and mature with a chance to become a different person.

University is a time when you really, it's probably the first time you're given the freedom to be yourself. I think that has positive and negative connotations. I think lots of people are extremely malleable when they arrive at university, anxious to fit in...If it means they have to take on a different persona to do this, then I think lots of people from what I've seen are willing to do that. (paper 5 code, 49)

In this sense the goals and aspirations are harder to define and it can be proposed much harder for institutions to meet. The wider aspect of personal motivation and goals about growth and development will be considered further in the section on resolution. The dynamic between risk, goals motivation and the non-traditional student will also be further considered.

#### *4.4.4 Resolution*

Resolution as a theme was not identified by any of the original researchers however it was something that emerged as a strong narrative within the meta-ethnography. Resolution within the current study covers a range of domains, however it wasn't always the case that all students reached a form of resolution nor does resolution mean that that there wasn't an element of ongoing categorising and comparing. It was decided to include it as a distinct theme as it would seem that there is a tension between the researchers who themselves held an image of students moving towards resolution of some kind while also insisting that transition was ongoing. In contrast however, there was a view held consistently by participants in a number of the papers that the initial period is distinct from the rest of the first year experience. I will start by showing the evidence of the first months of university as a distinct period by participants before showing further evidence that there was some resolution at the end of this time, though this is inconsistent. Furthermore, there will be analysis to show that for some there is a definite ongoing identity struggle along with identifying issues that continues to be pressing for the majority of students. To conclude, while there is evidence of an ongoing comparison beyond the initial transition period there was also support for students seeing this time as unique accompanied with its own set of behaviours and experiences.

*4.4.4.1 Initial period vs ongoing comparison:* Maunders in paper one argues that her interpretation of the interview data pointed to transition being on going throughout degree programmes (paper 1, code 39 & code 63), however some of her quotes do not support this view entirely. It is my suggestion, already put forward in the previous paragraph, that the initial period at least is unique, while also acknowledging that there is an element of ongoing categorising and comparisons throughout higher education, similar to many other transitions.



I further suggest that this is due to the social identity processes that are involved when attempting to mix with a new social group. The following analysis will show that this is particularly the case for students who have moved away from home, however even students who travel in daily are possibly open to such processes to a degree, possible differences between these groups however will be discussed later.

I have already presented quotes and references to the original analysis that points to my proposition of the uniqueness of the initial period however further quotes will be given to extrapolate this conclusion further still. Maunders et al (2013) (paper 1, code 35) concluded that socialising in the first few months of the initiation into higher education was used to avoid isolation with one student using the word “clingy” to describe her relational style. Additionally, this is further supported by a quote in which a student who talks about being “reliant” on people while also observing that this reduces over the first year. During the focused stage of searching other evidence for this initial period being unique became apparent. Indeed, the premise of paper 4 is that identity is partly wrapped up in a sense of place and home and that the move to university forces a sense of dislocation which the authors suggest is resolved, eventually, for the majority of students in their sample. In this paper Chow and Healey (2008) use their interview data to conclude that the move from home brought about dislocation which “undermined participants’ social psychological processes” (paper 4 code 16; IFT 1, 2). It is to be stressed that this is not necessarily negative but that the move from one place to another prompts a cut in existing social relationships and a need to develop new ones. Within this study growing familiarity with the new place encouraged a sense of attachment, this was particularly associated with the opportunities and goal fulfilment that this new “home” could give them as outline above (paper 4, code IFT3). Furthermore, while this paper gives evidence of an ongoing process with questions about what the meaning of home and how this links to who they are now there is also a resolution of identity which is reached over the period of the research. It can be concluded that this paper suggests that something is distinctive about the initial transition period while acknowledging that there is also some element of ongoing identity process. Additionally, a quote already provided in paper eight (quote 25) showed that semester one in particular was a time of stress during which students needed to adapt to a new living situation and higher

academic standards. Furthermore, feelings of homesickness associated with a new place and as discussed in paper seven (code 62) is likely to heighten this particular time in the process of identification. Denovan and Macaskill (2013) (paper 7) suggest that homesickness can be interpreted as students grieving for their home and family. This makes sense of the need to “cling” when one considers students are seeking for a “replacement” home. The authors provide a quote from one student (Michelle, paper 7, code 62) who talks of “weaning” herself off contact with family over time with Gemma giving the following quote:

I speak to them every day so I’m always in contact with them [family]. Since I’ve been at uni I’ve always missed people, but I suppose everybody does, but I think it gets easier with time. Last semester I went home every weekend, but now if I leave it on the weekend I’m not as bad as what I was last year, so I suppose that’s it really getting used to being away from people. (paper 7, code 81)

This quote was coded as “adapting” on my first reading of it and I propose that this is key to understanding both the uniqueness of the initial transition period but also the ongoing nature of the comparisons. Each change at university (new year, new seminar group, new assignment) brings about the need for categorisation another group and comparing oneself against the new image of what being a student is, however the unique circumstances of the disjuncture of images versus reality along with the drive to socialise and make friends will never be so pressing. Furthermore, I propose that not only is there a distinction in the levels and intensity of comparison during this stage in contrast to subsequent stages but that there is also a difference in the nature of the comparisons that occur during this initial period and the ongoing comparative processes that the authors refer to. Prior to university, as already discussed in the first section, participants are comparing themselves against an image of Higher Education. Once university has begun however we see a gradual shift from this broad categorisation to a focus at the personal level, as outlined above when we consider students developing in-groups and out-groups. Furthermore, the results of this leads to the next sub-theme, that of self-growth.

*4.4.4.2 Self-growth:* I propose that the dynamics and stressors outlined above forced change and indeed many of the participants reported benefits. However, that while this was not a

universal narrative, students nonetheless talked about personal growth having derived from academic challenges. The focus of change seemed that of personal development with the growth in academic ability a drive for redefining who they were and further comparing and contrasting of themselves within the Higher Education setting. Many students made this connection as central to changes of self during degree education.

I just think that...it changes you as a person...it's just an amazing life experience cos it just changes you so much and although it's difficult and hard I've learnt so much about myself that I didn't know a few years ago (paper 1, code 89)

Rather than negative experiences being seen as something to be avoided in the case of transition into university these experiences seemed to be a necessary part of the experience. The authors of paper three positioned undertaking a degree for the mature, non-traditional students as part of a life transition experience (paper 3, code 10). For these students it was a major shift in terms of their images of self. B showed this with the following quote: "I have realised I am not a useless piece of furniture, I can do things" with a further quote "I can do things for myself" (paper 4, code 15) when talking about the impact of the course and how it had transformed her image of herself. This is in stark contrast to the other paper which had included non-traditional students. As mentioned above there are differences between those students who live on campus and those commuting daily in terms of experiences and stressors but also some similarities. Students seemed to fall into three groups for this theme and each grouping will be dealt with in turn, additionally I will explore why such differences occur.

1. Traditional students, generally these talked about personal growth
2. Students who positioned themselves outside of the traditional experience and therefore more likely to refute the label "student" but did have a narrative of self-growth.
3. The final group of students rejected that they were "students" and were younger non-traditional students (approximately 18-24 years old) and generally did not speak about personal growth.

For students who were living on campus and able to take part in the full university experience as outlined above personal growth was a central part of the description of their experience. The following quote shows one such student had an internalised idea of university as elite, moreover her place within Higher Education as “little”, however it can be seen that the central narrative here was one of personal growth:

I see (university) as like an elite thing...I would never to go Uni...this year's been really tough it has made aware that I can do things...and get really good grades even though it's stressful and hard work...I think my biggest fear with starting Uni was like oh my god uni's all the way up there like this massive thing and here's little me coming into it (paper 1, code 82 & 83)

Additionally, the authors reported that this participant over time had adapted to the new environment as her identity had “assimilated” some of the ideas she had of being a student (paper 1, code 84). Moreover, these authors concluded that their participants as a whole still held a constructed idealised image about being “student” in which they themselves had not yet achieved and still talked about “becoming” (paper 1, code 88). This echoes three previous points that have been made in the opening section of “resolution” theme and touches on the other groups I have identified. The first echo is that of the ongoing nature of identity formation and acceptance, secondly “threshold of induction” model proposed by authors of paper 3 in which students felt that they could not call themselves student (mature students, non-traditional) and thirdly that of the stance held by the non-traditional younger students of paper 6 who had spoken of “doing” rather than “being” (group type 3). However, it has to be noted that the first group of students unlike the other two groups seemed more comfortable moving toward an identity of student. Paper six brings out an anomaly from the rest of the papers within this narrative of self-growth. These participants who placed themselves outside the normal student experience (paper 6) and rejected a narrative around personal growth. For them university was a means in an end and this shows in their high level of trust in the outcomes of the degree and its usefulness in terms of career, however they did not see it has transformational nor did they seem to desire it to be so. Why non-traditional students who fall within the normal age range for university do not hold a narrative of growth is a pressing need for further exploration if this is a possible process that holds them back from achieving their full potential.

## 4.5 Summary

The analysis showed that transition during the first few months of university life can be understood through the processes of Social Identity Theory of Self Categorisation and Social Comparison. The final thematic map (p.74, figure 4.2) and the quotes showed that students were keen to find a place to belong with comparisons of in-groups and out-groups which involved categorisation of groups. This was found to be the case across a number of domains, for example day time students categorising full time students as an out-group to traditional students categorising non-traditional students. Additionally, these processes were not seen only in the first year but students in the 2<sup>nd</sup> and 3<sup>rd</sup> year, though this needs to be explored further as the focus of many of the papers were those first months. Furthermore, students reported stress during the early transition period as the norm, however this was not found to be a strong theme as others in the analysis. Furthermore, stress (in particular academic challenges and stress) and often facilitated growth and increased the social identity as students. While the research focused on the first year it can be seen that students themselves talked about transition as development although not all accepted that education at Higher Education had changed them. Additionally, it can be seen that students sought to “be students” and in this case it was an Identity that they felt was achievable and highly sought by the majority of participants. It is suggested that to classify identity transition as either “induction”, “developmental” or “becoming” as proposed by Gale and Parker is too simplistic. Figure 4.2 on page (74) proposes a new model which incorporates the findings from the present study and the different typologies of transition reviewed in the introduction to this chapter. It was expected that transition would look more like T1 and T2 types however it was found that the process is ongoing, possibly beyond graduation and into early careers. Nonetheless the present study strongly suggests that to ignore the uniqueness of induction period leads to students not being integrated into university life. Furthermore, the evidence of the meta-ethnography suggests that while indeed the university system is not as accepting of narratives of non-traditional students as it is of traditional students and additionally that while there were differences across these groups in terms of their goals and agenda’s nonetheless this was not a major element of the analysis. The induction period, indicates a unique period in which students seek support from new peers, however

institutional support was a weak theme throughout the analysis. This was unexpected as previous research such as that by York and Longden report (2008) found that support from the University enabled students to adapt to degree level education and campus life. Furthermore, Astin (1984) indicated that staff were important within the transition process, indeed a proposal of the current thesis is that staff are part of the possible future identity that students seek to categorise and seek to belong to. It also possible that non-traditional students do not find it difficult to fit into the “university” process to quite the extent that Gale and Parker propose. Indeed, these students were the only ones that cited staff as important to their academic progression. It may be that the focus of the present study, that of identity, had precluded papers that had explored staff and student dynamics. As few papers looked at Social Identity Theory and therefore possible comparison groups, including staff, this may be one reason this theme did not emerge. Further work needs to consider how students view their subject in order to elicit whether their lecturers, or the perception of their lecturers are important. Additionally, as suggested by the literature review in Chapter two there is likely to be different domains of identity, the current chapter’s research was unable to consider this as the papers selected were not able to explore this in any depth. It is intended that this will be explored in Chapter five.

Figure 4-2 Proposed new model of transition phases and SIT

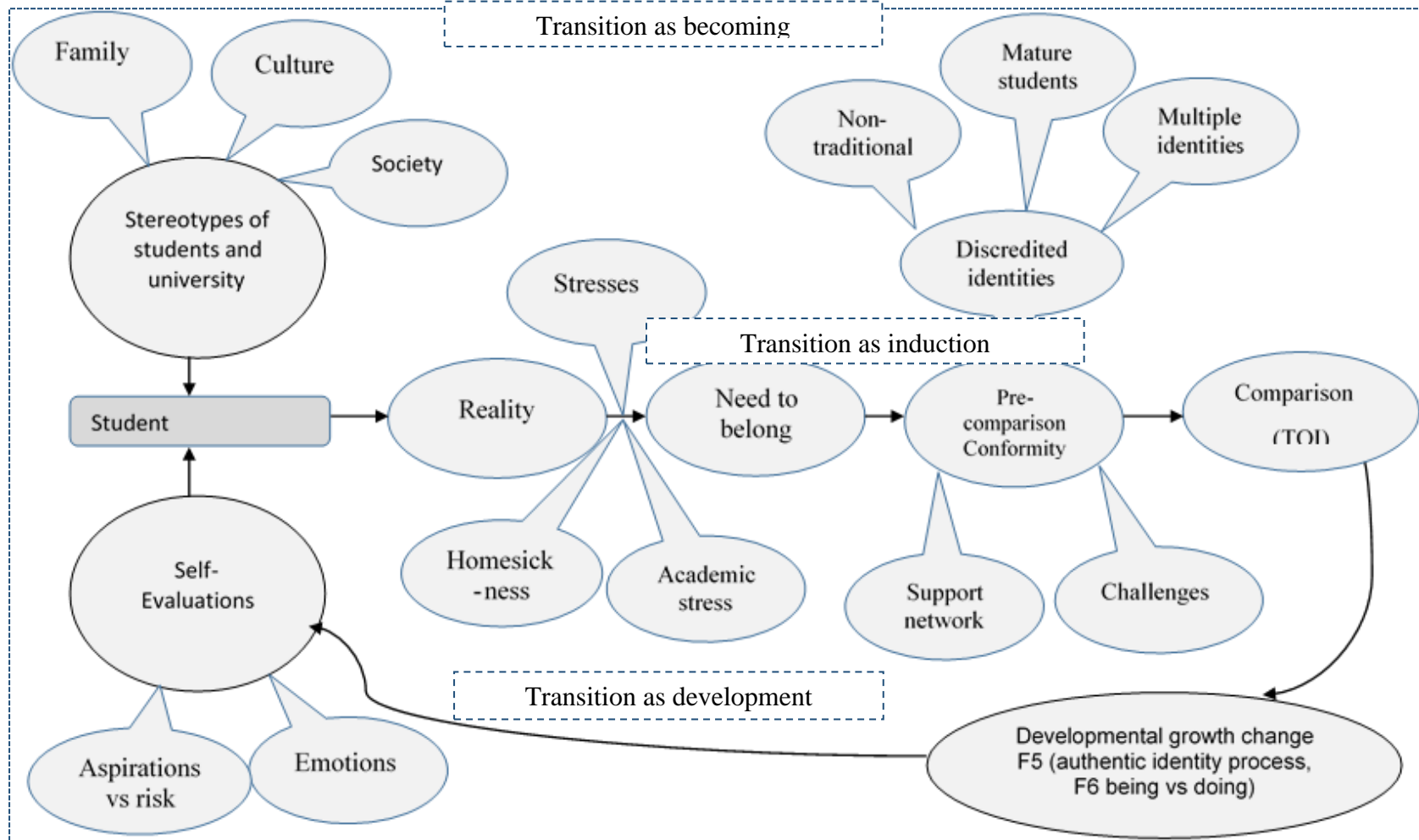

## **5 Understanding Identity Processes within Undergraduate Psychology Students**

### **5.1 Introduction**

Social Identity Theory attempts to understand how people perceive themselves based on their social groups and has a number of key concepts that are relevant to the study of students within a Higher Education setting. The previous chapter established identity formation as a process that was ongoing beyond initial transition. Additionally, it showed that generally the experience of becoming a student could be understood within the framework of Social Identity and Categorisation. However, it was not able to explore this beyond the initial transition period. Furthermore, it did not delve further into the different possible social identities available to students. For example, it was not able to gain an understanding of how students related to their subjects or institutions. It is the aim of the current study to establish whether students equally seek to identify with these domains alongside integrating with the student population.

Chapter five will demonstrate that students seek to belong to the category student and to integrate socially. The introduction will briefly outline the main tenets of the theories of Social Identity Self Categorisation as they relate to the student experience. Additionally, the acceptance of this label was not universally accepted as the literature analysed in Chapter four indicated and this will be discussed with reference to research. Furthermore, expressions of identity were displayed by students but categories of student or subject or institution was not explored in depth therefore multiple identities will be discussed.

### **5.2 Social Identity: definition and clarification**

Tajfel's (1969) original work on Social Identity had theorised on the development of prejudice across groups and its focus therefore was not on the "self" or on individual identities but rather intergroup dynamics. Nonetheless, it does put forward an outline of how individuals become members of a group and how this process forms our "social identity" and is therefore a theoretical framework suitable to help us understand transition into



university from a social perspective. Hogg and Turner (1987) argue that over the decade since Social Identity first emerged, with its intention to explain the effects of categorization on intergroup behaviour, the theory has grown in strength and depth as research based on SIT has been tested outside of its original hypothesis. Additionally, Hogg and Turner argue that Social Identity Theory had developed in two distinct strands with a common theme, outlined below:

The fundamental hypothesis shared by both theories is that individuals define themselves in terms of their social group memberships and that group-defined self-perception produces psychologically distinctive effects in social behaviour. (Turner, Hoggs and Abrams, 1998, pg vii)

The original theory of intergroup behaviour provides an understanding of intergroup conflict and social change. This work provides an explanation of why individuals are motivated to maintain and enhance the status of their groups compared to other groups (in-group and out-group) with the intention of achieving within themselves a positive social identity (Tajfel 1974, 1978; Tajfel and Turner 1979, 1986; Turner 1975). Later self-categorization theory was developed by Turner in the 1980s (Turner 1982, 1985; Turner et al. 1987). This second set of theories is more general and is focused on the deindividuation processes that occur when an individual becomes a group member. For the purposes of this thesis both theories will be used and as it has become common to use the term Social Identity Theory when referring to either strand or as an umbrella term for the combination this will be indicated.

### *5.2.1 Need to affiliate*

Hoggs and Abrams (1988) in a key text on intergroup relations and processes give a good summary of the societal behaviours observed by Tajfel which led to SIT:

...while a society is made up of individuals, it is patterned into relatively distinct social groups and categories, and people's views, opinions, and practices are acquired from those groups to which they belong. These groups can be considered to have an objective existence to the extent that members of different groups believe different things, dress in different ways, hold different values, speak different

languages, live in different places, and generally behave differently (Hoggs and Abram, 1988, p2)

Furthermore, Ellemers, de Gilder and Haslam (2004) argue that the original theory had three key components; social categorization, social comparison, and social identification. However, the idea that the self is a product of the society a person belongs to is not new and was first proposed in Mead's work on "symbolic interactionism" (1934) but it was Turner (1982) that promoted the importance of category based thinking as the basis for our social groupings. By doing so he offered an explanation at an individual cognitive level for the impact of society on the self. The importance of the group on the behaviour of the individual has been shown by research in his minimal group paradigm experiments (Tajfel, 1982). In this work participants with no affiliation to each other were placed in "high estimator" or "low estimator" groups. As the title of the groups suggest there was minimal affiliation to the group and yet members displayed bias towards their in-group. This effect has been explored further in existing groups (Brown, 2000) who found that decisions were made to ensure that out-groups had a lower rewards even if this meant the amount available to the in-group was less than if shared equally. While this has been of research interest in understanding prejudice it is also important to the current research as it shows that individuals affiliate quickly with a potential social group and that is likely to be seen with students at the start of university. Furthermore, it is proposed that obvious out-groups will be available to students, for example those studying a different subject or nearby Higher Education Institutions.

It is theorised within Social Identity Theory that underlying the behaviour to enhance their own groups is the motivation to improve and protect self-esteem. Indeed, this process is crucial to understanding SIT, without this as a central feature to the theory it is hard to explain social comparison and categorization along with in-group bias. It was proposed that increasing the status of an in-group has the effect on increasing the self-esteem of its individual members (e.g. Tajfel and Turner, 1979, Turner, 1982). Self-esteem is a concept that has been explored widely within Psychological research (e.g. Cast & Burke, 2002) and includes not only the effects of low self-esteem but also the conclusion that it is an important

driver of people's behaviours (Judge & Bono, 2001; Swann, Chang-Schneider & Larsen McClarty, 2007). Additionally, avoiding lowering esteem triggers has been discussed and adds to the overall evidence that intergroup behaviour is motivated by self-esteem (Aberson, Healy & Romero, 2000). However, less discussed is that the choice of joining a prospective high status group may also be a self-esteem motivator. Possible social identities are a concept that is under-reported in the literature (though not completely ignored in the early development of the theory) and the current study argues that it is of direct relevance to not only transition in the first days of higher education but also the ongoing identity issues of students. Looking in at a group from the outside a number of issues are considered, for example how like the group is to the self but also the status and desire to join (Cinnirella, 1998). Furthermore, Cinnirella argues that the possible social group also has:

1. a perceived source (that is if their origin is from an in-group or out-group)
2. associated perception of their likelihood of being realized.
3. an affect associated with it
4. level of salience

(Cinnirella, 1998, pg 231)

It is proposed that during transition into university there are multiple possible social identities and the above criteria will be identifiable through the narratives of the participants involved in this study. Within the literature explored in Chapter 3's meta-ethnography we saw for example that the credibility of information was improved if the source was students, particularly those further into their studies. However, the current study proposes that students additionally seek to become a part of their own subject group but it is unclear whether this is a higher priority to that of the more general identity "student". The findings in chapter three suggested that there are societal pressures during degree study that increases the perceived value of degrees and therefore increases the stresses involved for some groups. The current study proposes that this will influence identification with the subject social identity. Hence, a further research question will be about the domains that students will seek to identify with.

### *5.2.2 Multiple Social Identities and the effects of others*

The concept of multiple identities is not only applicable to the category of students. We belong to many social groups, for example we have nationalities as well as gender (Hopkins, 2001). Some categories are not related to each other at all and do not cause any conflict while others may have a cross over. When coming to university new students find themselves with new labels. As already stated they are now classed as “students” to other members of society, additionally within their institution they are also categorised by academic subject and finally outside of the institution itself when mixing with students from other universities they will likely lose their subject identity and take on institutional identity (e.g. Liverpool Hope University). There is a scarcity of research that looks at this hierarchical student identity, partly this is due to the lack of interest within social psychology generally for looking at identities adopted by the individual compared to the interest in studying inter-group conflict. However, there has been some interest in this as in terms of nationality, for example local, regional, national (Rutland, Cinnirella, & Simpson, 2008). In a paper covering two studies Rutland et al measured how Scottish participants (university students) compared themselves against the identity “Scottish” “British” or European”. This is a similar hierarchy to the present study (student, subject and institution) and therefore the methodology and results are of a particular interest. Study 1 was a pilot study and included 45 Scottish students who were asked to classify 5 national categories on similarities (Germany, Scotland, Britain, Europe and America). Interestingly the students located Britain and Scotland nearer America than Europe, though they classified Germany as similar to Europe. This now introduces the idea of salience and contexts. Salience states that one identity will be prominent and Turner proposes only one identity within the same category can be salient at once. Additionally, context here is also considered and the authors argued that context was important, that is the knowledge of each group; Britain is seen as closer to American due to shared language and shared military alliances. However, in the second study the need for context became unclear. In this study 104 students were assigned to one of three conditions:

- Condition 1: Scottish only (no mention of any other nationality)
- Condition 2: German first (rated Germans First)
- Condition 3: Americans first (rated Americans First)

At a European level, contexts were important but not evident at the Scottish level, for example European identification lowered when there were comparison groups, this occurred in both test conditions. For the current study this is a crucial point as comparison of other groups changes self-identification. As the authors identified, by bringing in a group they considered themselves dissimilar to (German) they were then less likely to accept a shared identity (European) but were happy to accept the European label when there was no comparison. Furthermore, other Social Identity studies have found that using comparisons has other effects. A member of a minority group who is also a member of a superordinate group, for example a Black student (minority group member who is also a member of another social group, that of student). Research has suggested in this case the individual will seek upward in-group comparisons (Festinger, 1954; Blanton, Crocker and Miller, 2000; Mackie, 1984) possibly increasing negative self-evaluations. Another dynamic that further lowers self-esteem is when an out-group is categorised as higher status, this effect has been studied early on in Social Identity Theory development (Crocker, Major and Sciacchitano, 1993; Ellemers, Kortekaas, & Ouwerkerk, 1999; Rubin & Hewstone, 1998) and has been brought up to date more recently with virtual research and online identities (Frischlich, Rieger and Rutkowski, 2014). This is not agreed on by all researchers, for example Crocker and Miller (2000) propose the effects of comparison by a lower status group with a higher social group is buffeted by members also identifying with successful groups in another arena; a member of a minority ethnic group supporting a successful sporting team. Interestingly, Rutland and Cinnirella (2000) suggests that salience does not necessarily infer a strong identity. Lasticova (2006) cautions against looking at such interrelated categories in a pure hierarchical order given they are likely to share a number of common behaviours, thoughts and emotions. Reviewing the research Lasticova argues that there are three broad groupings of arguments against the hierarchy of identities:

These are, of course, mutually interrelated and concern: (1) the thematic presence of particular social categories in public discourse and their subsequent accessibility for self-definition; (2) the structural relations between social groups including their relative status; (3) the representations of the “superordinate” categories. Lasticova, 2006, p550

For the current study the concept of multiple identities is important as not only do the proposed population belong to a number of interrelated and subordinate and superordinate groups they are also likely to compare themselves against other groups; Psychology vs Geography and Liverpool Hope vs John Moores University, for example. The qualitative interviews will allow for a full exploration of which of the domains are important to students that is which one they identify with the most.

### *5.2.3 Academic Identity influence*

Additionally, as argued by Academic Identity literature (in Chapter 2) there are codes and languages unique to a subject area (Becher & Trowler, 2001). A further key tenet in Social Identity Theory is the influence groups have on the behaviour of its members. It is proposed by the current study that the subject identity group, comprised of academics and of other psychology students will be a source of group attributes (Vreeland & Bidwell, 1966; Krishnan, 2009). Hogg (1996) argues that prototypes are cognitive representations which define the group and these are used by individuals to compare themselves as similar or different to these images. Hogg himself argues that intra-group differentiation has been under researched but theorised that group members will perceive themselves as similar due to the process of deindividuation. This loss of self is often seen as a negative outcome of group membership with the consequence of reduced individual responsibility for behaviour (see Goodman, Price & Veneables, 2014 for a discussion on anti-social behaviour and deindividuation of members within groups). However, research has shown that there are also positive effects on behaviour from this process (eg. Platow, Durante, Williams, Garrett, Walshe, Cincotta, Lianos, and & Barutchu, 1999). Deindividuation has been defined by Reicher, Spears and Postmes (1995) as conformity to categorical norms and reframed within the Social Identity Theory to form SIDE (Social Identity Model of Deindividuation). As SIDE conceptualises the self as multi-faceted rather than unitary (as does Social Identity Theory) this suggests that the individual faced with a possible social group which they consider as high status will shift from their focus from the individual to what is required to become a member of this group. In this instance a new student decides to focus on what are the categories involved in being a Psychology student. It was demonstrated in chapter four that

students had naïve ideas of what it was to be a student (also known as Threshold of Induction by Blair, Cline and Wallis (2010, paper 6) but it is unclear from the meta-ethnography whether this also occurs at the level of academic subject.

As discussed in Chapter two prior to the development of Social Identity theory, Vreeland and Bidwell (1966) proposed that lecturers have a unique place of influence shaping students' attitudes. Furthermore, Trapp (2014) as argued in chapter two suggests that all students begin with a sense of "otherness" but through the writing and reading practices internalise their subject values and behaviour codes thereby taking on a subject academic social identity. It is proposed that students will seek to identify strongly with their subject group.

### **5.3 Study Aims**

This chapter had a number of research questions:

**RQ1** What are the influences of identity processes during transition periods?

**RQ2** How do Social Identity and Self-Categorisation theories inform different aspects of identity during Undergraduate study?

**RQ3** Do the development of academic identities change student behaviour?

**RQ4** Do undergraduates construct identities and display language that evidences this?

### **5.4 Methodology**

A theory led thematic analytical approach utilising focus groups was developed focused around questions of identity and categorisation. A focus group approach, over that of individual interviews, was selected for a number of reasons not least that they generally allow for a broader sample than individual interviews (Krueger, 1994). While some researchers consider that group dynamics reduce the purity of the data collected there are ways to deal with this during the focus group stage and analysis (Nassar-McMillan and Borders, 2002; Kidd and Parshall, 2000). Indeed, others argue that focus groups add to the quality of the data (Gorodzeisky, 2011) by shared experiences (Vaughn, Schumm and Sinagub, 1996). Furthermore, McEwan, Espie, Metcalfe, Brodie and Wilson (2004) argue

that focus group particular suit adolescents and while students are not within this age range nonetheless they are used to discussing issues with peer groups and educational settings. Ethically the study topic is relatively benign and can therefore be considered appropriate to discuss within a group setting.

Hayes (1997) outlines a theory led thematic analytical approach which allows for researchers to be directed by prior theoretical framework. The interviews were guided by use of an agenda and previous identity measure (Karasawa, 1991), this method is recommended by Nassar-Mcmillan and Borders and is used by a number of researchers (Gucciardi and Gordon, 2009). The interviews started with a general discussion of the attitudes and behaviours they thought belonged to the identity “student”. The items from the existing questionnaire were presented to the group and they were asked to consider first how they felt they applied to them as “students”, then as Psychology students and then as Liverpool Hope students. It was decided to use Karasawa’s two-component measure (1991) as the basis of the focus groups which is closely aligned to Social Identity Theory and in particular includes items that assesses Self-Categorization as well as a sense of emotional attachment towards the group. A typical question was “would you think it was accurate if you were described as a member of (group)?” A list of these questions can be found in appendix D. Additionally open-ended questions which allowed students to discuss their understanding of identity.

#### *5.4.1 Analysis*

Thematic analysis has a degree of flexibility that means that not only can the data be used to reflect the reality on the surface of the data but also be used to dissect this surface (Braun & Clarke, 2006) looking underneath at themes and patterns that emerge. The analysis will take both a deductive theoretical approach as well as inductive which will allow the data to be analysed within Social Identity and Self-Categorisation Theories (Yukhymenko, Brown, Lawless, Brodowinska, & Mullin, 2014; Fereday, & Muir-Cochrane, 2008). Grounded theory was discounted as a new theory of identity is not being sought, which is the primary reason that this approach is used (Holloway and Todres, 2003), in fact the research is being explored from within a tight theoretical framework. Some researchers (e.g. Boyatzis, 1998) state that thematic analysis is suitable only when used within other qualitative approaches,



however this is disputed strongly by others, such as Braun and Clarke (2006). Additionally, it's use as a specific analysis is supported in a recent critical review by Alhojailan (2012). Both these papers propose that Thematic Analysis critics based their arguments on reviewing research in which elements of TA have been used by researchers who have not fully understood the processes or its theoretical basis. The analysis will take a theoretical rather than an inductive approach and this will allow the data to be analysed within Social Identity and Self-Categorisation Theories and is supported by Hayes (1997) in her paper on theory led thematic analysis. As is normal with theoretical approaches the data will be coded at a semantic level, the interpretation of the phenomenological sought when previous research is discussed.

There are a number of stages that are need to be gone through to ensure a rigorous qualitative analysis of focus group data, the method set out by Braun and Clarke (2006) was followed:

1. Familiarisation of the data: As I conducted the interviews and typed up the data I became very familiar with the data. This step was crucial as I could easily recall comments made in the separate interviews. It was this stage I felt an overview of the individual focus groups would help, acting as a narrative of the group dynamic. These have been included at the start of the analysis stage and I hoped they would give the reader a snapshot of how each interview differed or were similar (section below 5.7.1).
2. Template analysis as described by a number of researchers allows for a mixed inductive and deductive approach to thematic analysis (Yukhymenko, Brown, Lawless, Brodowinska, & Mullin, 2014; Fereday, & Muir-Cochrane, 2008). This approach allows for the analysis to test the theoretical basis of the research while also allowing for open coding and the text to speak for itself. There are a number of stages to this approach which are outlined below:
  - a. Step one and two revolve around a codebook development. Codes taken from the literature review of Social Identity and Self-Categorisation were developed a priori to the analysis. The codebook includes not only samples but definitions of the code. As a participant's narrative was deemed to fit a

particular code it was added as evidence. However, within this system it is also possible to develop further codes from the data itself.

- b. The code book was applied to a further reading of the each of the interviews.
- c. Once the coding of the data is complete the next stage is to analyse across the full set of data, identifying codes and themes that emerged, drawing out possible interconnections or those that are disjointed and different to that which was expected.
- d. Finally, the codes are examined by reviewing the previous stages and includes a series of reiterations from text to codes and corroboration on existing themes and to ensure that themes are fully represented within the coding table. Clustering is also a crucial part of this final stage with a final set of core themes emerged.

During analysis I looked for topics that were independent or had been prompted by more vocal group members and identified these on the transcripts, additionally I particularly focused on direct answers (Kidd & Parshall, 2000)

#### *5.4.2 Participants*

Participants were recruited via email at Liverpool Hope University, the first years receiving a course credit for attending. The groups ranged from 4-8 in number and were composed of first and 3rd years who all were taking Psychology as either a single or joint honours. Table 5.1 on page 86 gives details of the year of study, gender and code names for each participant. The sampling procedure was opportunistic and while a number of emails were sent to students in all years only first and third years responded.

## 5.7 Results

### 5.7.1 Focus group overviews

To give an overview and general view of the dynamics within each of the focus groups a brief summary is given first based on field notes soon after each session ended. The second half of this analysis will look at patterns that emerged across the data. Both of these sections will then be discussed within the framework of previous literature before exploring items for the proposed measure.

#### 5.7.1.1 Focus group 1: Clear Social Identity Theory and Self-Categorisation Theory

processes were evident within the first transcript, for example a number of students showed comparisons both inter and intra group. Additionally, as will be shown in the analysis a sense of self-esteem was derived from the groups. Furthermore, this changed depending on their own assessment of the value of the category. Generally, the students showed most attachment to the subject identity level. This occurred even when discussing a part of the subject they disliked (RMS) and they displayed pride that it gave the subject a validity as a science. However, the group as a whole expressed both positive and negative feelings towards the student identity, for example acknowledging that it had negative stereotypes

Table 1: Focus group Participants

<b>Focus group 1</b>			
Carl	3rd year	Psychology	Male
Abigail	3rd year	Psychology & Health	Female
Sheena	1st year	Psychology & Criminology	Female
Bella	1st year	Psychology & Criminology	Female
Steve	1st year	Sports Psychology	Male
Timothy	1st year	Sports Psychology	Male
Katy	1st year	Psychology and Health	Female
Kevin	1st year	Sports Psychology	Male

<b>Focus group 2</b>			
Tom	1st year	Psychology & Fine art	Male
Ruth	1 <sup>st</sup> year,	Psychology	Female
Tammy	1 <sup>st</sup> year	Psychology & Biology	Female
Julie	3 <sup>rd</sup> year	Psychology & Music	Female
<b>Focus group 3</b>			
Alex (A)	1st year	Psychology & Criminology	Male
Mikel (M)	3rd year	Sport Psychology	Male
Susan (S)	1st year	Psychology	Female
Mark (Ma)	1st year,	Psychology	Male
Angela (An)	1st year,	Sport Psychology	Female
Joshua (Ja)	1st year	Psychology,	Male

from out-groups but also talking about a sense of loss as they were moving onto graduation. The group expressed a low level identification with institution category. This seemed to be influenced by negative stereotypes from outsiders but also low self-categorisation with certain aspects of the institutions, for example the Christian input at Hope. Identity as a student and subject student grew from shaky starts during the transition period from high school to university to a high level of identity in the third year.

*5.7.1.2 Focus group 2:* A number of interesting themes emerged in focus group 2, these are in contrast to the other two. This group had a number of students from the Creative Campus, which is a small Liverpool Hope inner city campus. Comparison between institutional groups emerged, with a sense of pride as members of a minor community within a larger community. This seemed to help buffer the negative attitudes from outside the institution when socialising with students at other universities. They were seen as different for a reason

other than that of being a Liverpool Hope Student. This group also had members who expressed a greater sense of loss on moving on from their student days and therefore a higher level of attachment due to this threat to their identity.

*5.7.1.3 Focus group 3:* This group was quieter and found it difficult to express their understanding of the word identity, though they did suggest that it came from appearance and social groups. The student identity again was quite mixed, with negative stereotypes causing conflict, however participants did acknowledge enjoying the lifestyle being a student could offer. In this group, there were more students who lived off campus with parents or in their own home while other students lived in halls. As expected, these subgroups had very different levels of identification with the label “student”. The campus group displayed a deep immersion in university life, while with the non-campus only displayed student identity as salient occasionally. In this group a number of students expressed higher levels of negative comments of psychology as a subject reporting lower levels of attachment and identification with psychology. Nonetheless, this still seemed higher than that of “student” or institution. At the institutional level this group had some participants who would accept the Liverpool Hope identity though all members had friends, family or other students negatively stereotype Hope as a university. Again, there was an expression of growth of identity, this time from the start of the year to the end as they engaged in academic work and discussion.

## *5.7.2 Themes*

*5.7.2.1 The Journey: Highs and Lows.* The analysis starts with a broad look at the experience of starting university to the final weeks before the end of degree. It will also discuss whether students found it easy to arrive at university and what situations or processes may help these early weeks. During this part of the discussion, the analysis will incorporate student, subject and institution identities.

*5.7.2.2 The transition.* A number of participants reflected on the first few months at university and expressed how initially they had found it hard to leave behind their previous friendship group and develop a new identity, added to this a few mentioned “pressure from work”, “fear of not fitting in” and “having felt uncomfortable” before coming. This reflects

the findings of Peel (2000) in Chapter 3's literature review. Naive images of university prior to coming with the result of increased anxiety amongst prospective students (Tognoli, 2003, section 3.3.1, page 21) A few students who did not live on campus or had returned home frequently felt that had not yet integrated, this was especially true for Abigail:

...like I wouldn't say I'd come here and - like I go home every weekend um, and I have done since I've been here 'cause I don't feel - it's not that I don't feel comfortable, I just...would rather spend time with people at home than here yeah.

However, this was not universal and while almost all had mentioned struggles the majority had settled and were enjoying student life. For some students they felt that university had allowed them to find "their identity". This reflects the findings of the meta-ethnography in the previous chapter which shows that for some students, university was a chance to develop a new sense of self. Indeed, the concept of possible social identities is described by Cinerella (1998) who outlined the processes involved when individuals consider which social identity to assume and the social cognition processes involved. Past and possible social identity struggles are seen in the quote below by Katy who struggled with balancing old friends and her new life but also mentioned that being independent had been important. She talks of her life prior to university as "you were yourself" and how at university "everything changed"

no I think um I think just before un like you were conformable with the friends you had and you were them and like you were yourself kind of but before you came to uni like think everything changed and I was a more independent when I came here because I wasn't relying on anybody

As can be seen for Katy things were thrown into flux at the changes but for one student the contrast between her previous life and student life had been underpinned by having to reflect on life choices (Tom):

yeah especially when you're just before uni because that's when you want to decide what you want to do for the rest of your life so it's like when you've got to make a decision on who you are...that's like when you make your decision

This supports the discussion of the findings in chapter three in which students talked about the tension between past identities and the desire to immerse themselves into their new identity. It was further enhanced by the need and importance of undertaking degree study, as we can see with Tom. Once a cognitive decision had been made to study at degree level then it was important that you made a success of it. Therefore, esteem enhancement of their student identity can be evidenced by not only comparison of “self” prior to university but also of peers who had chosen not to attend Higher Education. Mikel displayed cognitive dissonance with non-university friends and his own student identity. In the first quote Mikel highlights exposure to negative influences. However, it can also be seen later in the interview he strongly identified as being a student he and had internalized the negativity to show that it he fitted into the category student:

“Mikel: yeah, not so much from family but sometimes from friends back home who like went straight into work sometimes like y’know just like a bit like, give you a bit of stick for it sort of thing

Interviewer: in what way give you stick?

Mikel: like just saying like ‘our taxes are paying for you’ and all that sort of thing like”

“Mikel: er.. well some people say they’re like, lazy and you know that they should get a job and all that sort of thing

Mikel: I um, I’d probably say I fit the stereotype quite a lot like

Interviewer: in what way?

M: um just constantly like perhaps, I blew me money on something like stupid or and err just going out a lot that sort of thing”

Comparison between student and non-student (either of “self” prior to university or of current out-groups) was a consistent finding both in chapter four and the current study. It was of particular importance to students who were from non-traditional backgrounds. Social Categorisation and Social Identity Theories allows for an understanding of the cognitive processes involved as Social Comparison occurs. The first stage of any categorisation is to develop an understanding of the social group, to do this it is necessary to establish cognitive

images, as can be seen above students have images of being a student that they have internalised. The next stage is to decide how close they themselves compare to the group. Comparison of self to a group can occur by distancing themselves from the out-group (non-students) while also engaging in deindividuation to establish they themselves are in fact a typical member for the social group in question. Deindividuation is a loss of self in order to merge with a larger group, as outlined in the earlier part of this chapter.

“Susan: yeah I get the same of um, my fiancée doesn’t like students

Interviewer: oh doesn’t like students?

Susan: yeah,

Interviewer: you do get that actually, can you explain that a bit more?

Susan: ‘cause they’re all like, they all go out and erm, they’re all like big groups of people and he thinks that he’s paying for them ‘cause he works and stuff

Interviewer: Ok

Susan: he’s jealous

Interviewer: he’s jealous?

Susan: yeah (laughs)

Interviewer: so you think people who stereotype students and are negative are jealous?

Susan: they were lazy in school and they just didn’t get to university”

While feeling ambivalent at times about the student status the participants, as seen above, engaged in esteem enhancements to protect the student identity label.

Students differed in their identifications according to transition period (first or third year). As it was proposed the early stage of movement into higher education is characterised by categorisation and comparison, however within the third years there was evidence of a more complex social identity. This can be seen in the words used by Alex who was a male third year student:

I think um RMS is very important and um it’s uh you know it’s this idea, psychology’s domain um, you know promoting um like critical thinking and scepticism and you know the concept of hypothesis testing rather than just going with your feelings or something um these these values um because I assimilate these



values because you know it's part of psychology so I guess I am assimilating a typical psychology student because of this I I identify with these values

Alex's identity was a more complex identity than those of the first years and as can be seen in the quote above this identity focus was on the codes and behaviours he thought typical of a typical psychology student. In his own words he was "assimilating" what he saw as Psychological values, internalising them and then accepting this identity. As discussed in the literature review social identity deindividuation and depersonalisation is important to categorisation and while it occurs in minimal groups is known to have a stronger effect in well-established groups (Reicher, Spears & Postmes, 1995). Furthermore, Tom's words confirm the proposition that Academic Tribes have codes and behaviours as theorised by Becher and Trowler (2001) and is an important part of the academic journey. By incorporating Academic Identity, development as seen in the final figure of chapter four it can be seen that through various stages of transition students internalise the codes of their academic journey, developing and becoming a student. This will be explored further on in this chapter but at this initial stage, tentative conclusions can be drawn that students indeed integrate into the subject and that Academic Tribes works at an undergraduate level.

A number of students cited a departmental off-campus trip as an example of institutional support during the transition period. This had not only helped them make new friends but also to deepen existing ones. The trip for one student was seen as pivotal to fitting in, "...that's when it changed for me" and explained that after this trip his trips home reduced.

Timothy "I used to home every weekend, 'cause I live in a shared house with people I don't know so I didn't really get on with anyone and then I went to Caerdeon and that changed"

This comment was supported by others in the same focus group who said that knowing more people made him feel comfortable around town.

Timothy..."on that trip, and then you see thirty and forty more faces around

you that you know anyway so it just feels more comfortable.”

Not surprisingly sporting clubs helped students who took part to settle in quicker, and some talked about the sport uniform (which carries the Liverpool Hope logo and name) as reinforcing their identity, this supports Spady’s (1970) research who cited social groups as important element in increasing a sense of belonging amongst students. Certainly in terms of transition and finding a place in their new environment, these participants had found social groups useful, hinting at such identity markers as wearing uniforms reinforcing this process. Wearing the same clothes has been fully discussed in the social identity literature and therefore it was not surprising that playing a sport together (an in-group vs an out-group) and increased their in-group identification (Haslam, Jetten, Postmes & Haslam, 2009).

*5.7.2.3 Identity Threats.* An unexpected finding was how insecure the students were about their institutional identity. While the majority of students seemed to have had a positive progression a number of issues reduced their levels of identity. This occurred particularly within the domain of institution however, it had the effect of also reducing their levels of identity across all of domains (student, subject, institution). In contrast to the work and study examples stated in the above paragraphs, some participants thought that low-level work and lectures that were unchallenging reduced their identification as students and with the subject. It is interesting to ask whether this is because it led to reduced attendance or it reduced the status of the group thereby lowering the need or desire to identify with the identity domain in question. Matthew who had previously acknowledged having a high student identity but a low subject identity replied to a question about whether he did preparation before class as follows:

“I did once or twice at the start and then I just realised like it was kind of pointless so...”

(interviewer “why pointless)

“well not so much pointless but there wasn’t as much of a need for it, you’d still understand even if went without doing the prep sort of thing.”

A number of students had previously suggested that it was when they were working on assignments they specifically felt they were students or Psychology students; this was even the case with students who reported low identity generally. This would be supported by the cognitive theories forwarded by Turner (1970) within SCT, which argue that salience is important for accessing identity and only one identity at a time is conscious. Thus if behaviours affirm an identity, by disengaging and reducing the number of study activities and further reduce their student identity and a sense of incongruence lowering self-categorisation with Liverpool Hope as students.

A further threat to identification with the institution was that of some traditions within Liverpool Hope, particular those that centered on Christianity. Tom who would identify as a student over Liverpool Hope student suggested this was due to the religious aspects, particularly when forced to take part, for example having “to stand up during grace”, he explains his reaction to this below:

“...made me incredibly angry so...um because of the religious part of it I find that quite annoying as being part of that type of uni I don't want to be associated with being at a religious uni but as a general course type I think it's really good.”

Not only did the religious aspect lower identification with the university as seen above for some it threatened the internalized image of what it was to be a student. This is further evidence that the student identity, even if sometimes negative, had been internalised.

Ruth “yeah, I went to like an all girls catholic school so it didn't bother me like, as much, but I still thought it was like, really strange that it's univeristy like, everyone's meant to be moving to becoming an adult and everything it was just really strange, it was kind of forced upon everyone.”

Tammy “yeah, that's the thing it's like when they're act - they're actually still you know, making you do that sort of thing at this point you're meant to be adults, you're’

meant to be able to make your own decisions about it and they would still sort of really really front own you”

The two students above actively engage in first categorising the institutional behaviours and beliefs in order to develop an image of what being a member of this group identity entails. Secondly comparison of themselves and evaluating their desire to belong.

A surprising sub theme from the interviews that emerged was the low self-esteem when asked about the institution identity. A possible number of reasons were identified; the external evaluation of the group, the students own value of the group and low attachment to the group. A number of students cited that being a small university in a city with larger universities and the impression that the institution was not as academic was spoken about on social events amongst other students. In contrast to the sense of pride and attachment felt when speaking about the subject they now expressed a low sense of belonging and uncertainty about their status amongst other students as can be seen by Ruth who had previously attended York University:

“yeah, so many like all my friends in York are like oh my God I can’t believe you go to Hope but like, your never do anything with your life...”

When asked if they would feel it was accurate if they were described as a typical Liverpool Hope student distancing from the in-group was found. This is in contrast to that of general student identity as discussed in the transition section when students distanced the out-group. This distancing from their in-group indicates low attachment:

Matthew: “..um in some way yeah probably but in ways probably not ‘cause it tends to get looked down a bit from like the other two unis”

Anna showed the same distancing when asked if she would introduce herself as a Liverpool Hope student:

“...um yeah, I don’t think I’d really that I was a Liverpool Hope student unless asked and also if they say where do you study I would usually say in Liverpool, not

Liverpool Hope.”

It could be argued that a smaller university within a city that has two larger ones can be classified as a minority group. Distancing is not unusual amongst minority groups, who often report ambivalence about their status and identity (Tajfel & Turner, 1986).

*5.7.2.4 Identity Protection Engagement.* It was interesting to note that there was one dynamic which buffered the interaction between self-esteem and membership of the institution group. The art students who lived at a small campus known as the Creative Campus and located nearer to the large city centre universities. The students talked of the culture of “being different” amongst students from Liverpool University and JMU, that they “were known to party”. When asked if they would describe themselves as a typical Liverpool Hope Student, Tom replied with a statement showing his self-categorisation of belong to the in-group using “us” and “they” language.

“I think not as a Liverpool Hope student, more as like the creative campus, I’m a lot more patriotic about being from the creative campus than anything else um, it seems that be more the way that I am defined, at least when you're out and stuff, ‘cause the stereotypes I’ve heard about it, heard other peop- other students at other universities have about Liverpool Hope is stereotypes of the creative campus not Liverpool Hope because it, they don't’ like us because we're artsy and creative.”

Brewer (1991) proposed that this dynamic between a minority group and larger groups “optimal distinctiveness” which postulates that individuals need to attain a balances between how distinctive their group from others while not risking exclusion. It further states that minority groups, contrary to previous research, can be a source of well-being and high self-esteem resulting in greater satisfaction. Furthermore, a number of researches have explored how members of minority groups show higher identification than majority group members (Ellemers & van Rijswijk, 1997; Simon & Hamilton, 1994). The quote above is particular interesting as Tom later went onto say that he disliked his art subject as opposed to his

psychology subject “disliking how they [arts theorists] think”, it can only be assumed that his high attachment was to the Creative Campus not the art subject. Additionally, it is interesting to note that students were very attached to their subject identity while downplaying their institution label.

Hurtado and Carter (1997) measured conditions that could increase a student's sense of belonging and identification, such as academic behaviours. This was confirmed by a number of students who discussed at the subject identity level that working in groups, being with other students and work that challenged them increased their identification with their subject. A few students expressed how group-work in particular increased their identity:

Matthew “I didn’t mind too much the poster side of things it was the start and you got to know people a bit more because of that.”

Angela “I quite the first year it was a diff - getting into groups, talking over it like going over your own experiments that sat doing an essay, doing your own individual research and the fact that you were sharing with with other people and I met more new people in that group as well so I like that assignment with the poster.”

The students showed a degree of pride about their chosen subject, especially with the image they felt it portrayed to others outside of the subject. This was one of the few themes that was constant across the interviews. Anna (quoted previously) would willingly identify as a Psychology student but would distance herself from the institutional label. Research by Branton and Jones (2005) indicated that minority groups can increase self-esteem by showing the strong attachment to one aspect of their social identities as discussed above. They further propose that the effects of comparison by a lower status group to a perceived higher status group is buffeted by members also identifying with successful groups in another arena. For example, a member of a minority ethnic group supporting a successful sporting team. While this research included ethnic groups, it is proposed that the participants (members of a perceived lower status institution) identified strongly with their perceived high status subject group to buffer the effects of low status membership.

Internal self-evaluations of the subject re-confirmed their identity and this internalisation of the identity was apparent even in part of the course they disliked. Alex above had previously stated that he did not like RMS but in the quote below shows his how it had encouraged his identification with Psychology:

“I think um RMS is very important um it’s uh you know it’s this idea, psychology’s domain, um you know promoting um like critical thinking and scepticism an you know the concept of hypothesis testing rather than just going with your feelings or something um these values um because I assimilate these values you know know it’s part of psychology, so I guess I am assimilating a typical psychology because of this, I identity with these values.”

This can be explored on another level, that of the journey as a student. Cathy is a third year student and the quote is a far more developed than quotes about identity with first year students. This was generally the case across all interviews with 3rd year students expressing a high level of identity with the subject, though this was mirrored by one student in the first year who explained she had grown into the subject from semester one to the end of semester two. Angela:

“I’d say I acknowledge more that I’m a psychology student now at the of the year also at the beginning of the year as I going in and like introducing myself to everyone and finding my lectures, when in the middle I would maybe not acknowledge it as much”

In summary a number of views could be expressed under the phrase “we are like this...” and supports Self Categorisation Theory (Turner, 1985) and the importance of this categorisation in becoming a member of the Academic Tribe of Psychology. Of course it is important to establish the link between the participants list of behaviours which they perceive fits the category “student” and how they compare themselves against it.

Tammy “....yeah. Well I, would say like you - you are a typical student ways because I have, a couple times I have sitting down going ‘yes this is

studenty'. Yes, yeah by living in halls, living in campus and sort of there's things you do, well I do come from the tiniest little place in the middle of nowhere which has absolutely nothing to do so even going to like a cafe and sitting down and reading books or doing sketches is being a study for me...and being quite different from how most people are back home"

The quote by Tammy is an example not only of social comparison in terms of categorising himself as a student but also social comparison with an out-group, the people back home in this case.

### **5.8 Summary**

The data indicated that while students had negative external influences about two of the possible social identity groups, that of student and institution. The impact of these external influences had different effects on the student's categorisation and comparison behaviour. With student identity they engaged in distancing themselves from the out-group (non-students), however from the social group of institution they actively distanced themselves from the in-group. This is made even more interesting when we consider that the participants readily accepted the negative comments of the out-group about the student identity, acknowledging this typified them as students themselves. However, the institution label, while distancing themselves from it was less obviously internalized. Indeed, students were found to hide behind their subject identity, enhancing that identity to overcome what they saw as deficiencies in the broader institution.

A further possible explanation for the difference in acceptance of student or institutional identity is the external information regarding each of these social groups. For example, the cultural information for institutions is that of quantitative ratings as discussed in the introduction (i.e. NSS and league tables). However, student identity has a cultural narrative, which talks about a rite of passage for young adults into adulthood. This narrative allows for the student behaviour identified in this article such as drinking and laziness as a period of testing boundaries. Additionally, as understood in Chapter four participants could use these behaviours to integrate socially. However, the institutional identity is that of worth bound up



in future objectives and expectations. Further research should consider whether differences in transitional groups could further explore the role of cultural norms attached to possible student identities.

Perceived low status institutions should acknowledge that students may be exposed to external negative evaluations. However, this study indicated that it is possible to overcome these by strong subject identities in which students were given opportunities to engage academically with each other. Furthermore, it is possible for smaller sub-groups of students who felt that they had a unique identity to rebuff the external negative influences and comparisons of the larger institutions. In order to fully understand the dynamics, further research is required which explores the identity patterns of students attending traditional and large universities. Future research should also consider the impact of identity patterns on attainment levels. This is especially the case when it can be concluded that the relationship between identity and behaviour change was weak. While some students did verbalise that they felt most identifiable as a student when either doing work they found challenging, engaging in study or in group work this was not a consistent finding. It is unsure whether this was due to an uncertain identification with the label student or whether identity doesn't have a surface behaviour change.

The qualitative research presented in the thesis thus far supports the proposition that Social Identity Theory and Social Categorization Theory explains a student's journey through academia. Throughout the interviews, students would talk of social comparisons between themselves and the category groups in question. This worked both negatively and positively on self-esteem depending on their evaluation of the group. Further Self-Categorisation processes will be discussed in the next chapters as each domain is discussed in more detail.

The journey of becoming a student was a clear theme that emerged throughout the interviews from shaky starts to those who were moving on and expressing a sense of loss as they were due to graduate. Additionally, this theme included topics which helped to increase identity and those which decreased or threatened identification with the various domains.

## **5.9 Integrating the Transition Phases and Social Identity**

Unlike the previous chapter, which had focused on the transition phase into university this study considered also, moving on from university. The findings in Chapter 4 indicated that students had a sense of becoming “a student” through the processes of Social Identity and Self-Categorisation. This chapter sought to understand how these processes enable the students develop a social identity within various domains of student, subject and institution. The thematic map that the was presented at the end chapter 4 shows how transition is an ongoing process though the institution certainly had an initial role in helping students adjust successfully. Within the current study, the processes in the map were evident. However, what had not been apparent in the previous chapter was the role of external influences on identity once the student had arrived at university. This was particularly the case with institutional identity, and while the processes outlined in the transitional figure still apply instead of it leading to higher affiliation with Liverpool Hope the circular comparison led to a further disengagement. While it had not been fully spelt out it was an underlying assumption that generally the processes would lead to increased identification. If identities fluctuate and change based on the strengths and threats identified within this chapter, then it is necessary to develop an ability measure identity within students. This will be addressed in chapter seven.

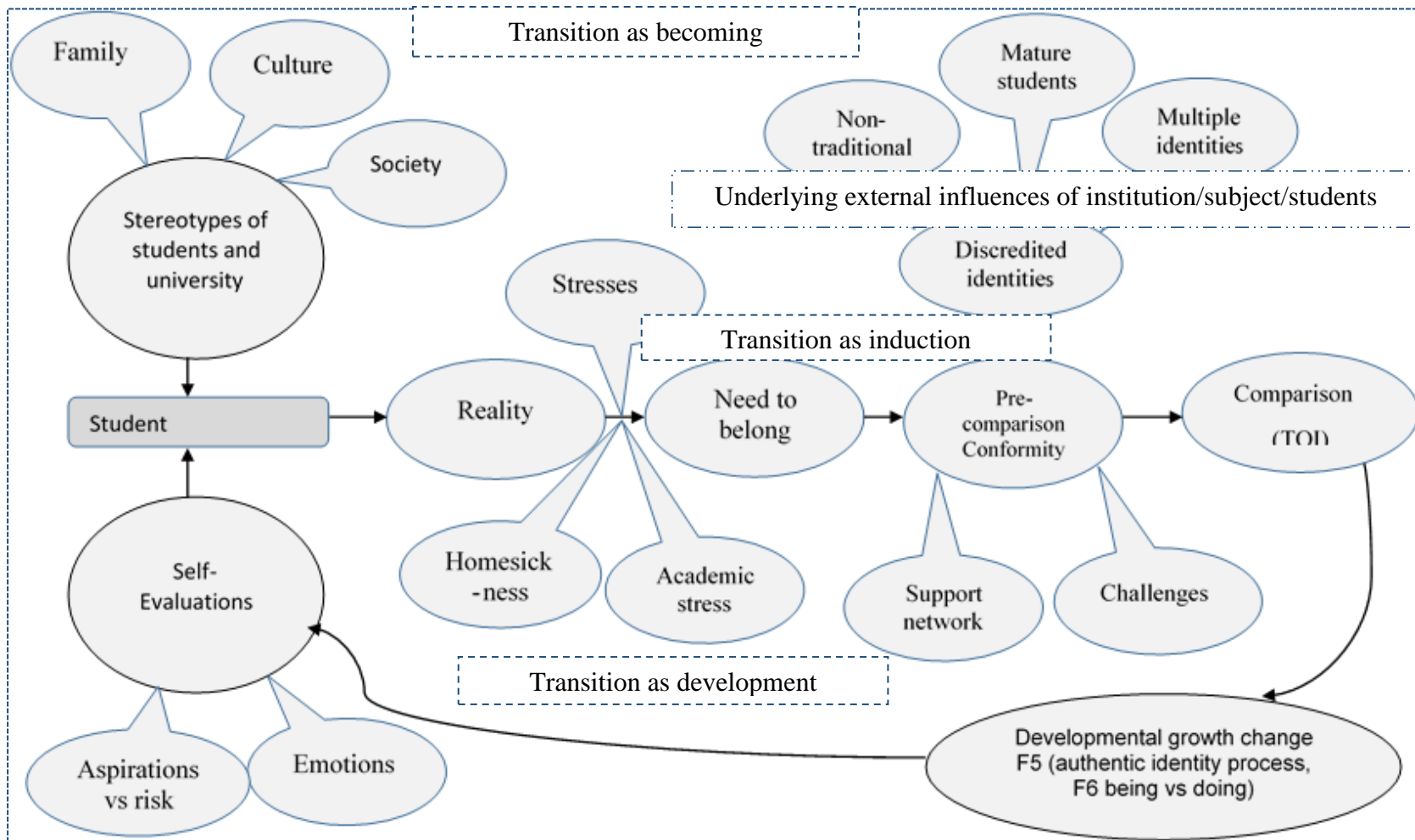

Figure 5-1: Integrating the Transition Phases and Social Identity

## **6 Measures of Academic Social Identity**

### **6.1 Introduction**

The previous chapters have established that identity development occurs within transition periods and beyond. Furthermore, identity based on academic social groups was variable across domains, years and vulnerable to external and internal influences. The stereotypes and cultural norms worked both negatively and positively on self-esteem depending on their evaluation of the group. However, whether the development of identity as an undergraduate is important to attainment has not been answered. Additionally, identity as described in the past chapters would need to be measurable if this is to be answered. This chapter will address the first of these two issues. The need to develop a reliable and valid measure of a construct is necessary in order to find out its effects on behaviour; in this case attainment.

### **6.2 Theoretical Basis for a Measure of Academic Identity**

#### *6.2.1 Domains of Identity for inclusion*

It has so far been established that identity at university occurs at student, subject and institutional level. Furthermore, processes of cognitive judgements of the group, emotional attachment and value of group status was consistently a part of the narrative. The domain of “student” was highly variable with however it consistently reported low self-esteem with high attachment. However, “institution” returned low levels of identity, attachment and self-esteem. Psychology, the “subject” label, conversely had high levels of attachment, self-esteem and identity. Comparisons at an institution level will need to be avoided as this domain did not seem to relate in the qualitative stage to academic behaviour. This will allow for exploration of academic identity journey to be explored as it can be seen throughout the focus groups that the students were most consistent when talking about the subject. At this domain level all three dimensions of affect, behaviour and cognition was evidenced. This is supported by the Becher and Trowler’s (2001) Academic Tribes stance that individual subject areas have distinct boundaries and is further supported by earlier research that show students identify with their academic subject area (Vreeland & Bidwell, 1966; Krishnan, 2009). It is concluded that the scale will need to include the subject label. With regards to the student identity this was clear for some but less for others and most importantly did not

relate with any academic behaviours. Again, there were some opportunities offered by the university for students to increase their sense of identity, however this was not universal and is more vulnerable to external influences such as living off campus. Nonetheless as previous research has indicated that student identity is important (Spady, 1970) and therefore some items will be included that measure this.

### *6.2.2 Social Identity structure and measurement*

Social identity is not a unitary global structure but is made up of three dimensions; affect, behavioural, cognitive (perception) (Ellemers, Spears, & Doosje, 2002). Social identity has a strong emotional component to it (e.g. Ellemers, Kortekaas & Ouwerkerk. 1999) and this needs to be reflected in any scale that seeks to measure identification with a brand or organisation. Additionally, there is a behavioural aspect with students stating that they identified as a student when they were doing things they categorised as “studenty”. This description of what they see as normative behaviour for the category of student also indicates that participants see themselves as students and seek to emulate such behaviours reinforcing the social identity. Finally, in chapter 5 there was evidence of a cognitive component and this also reflects social identity research (Turner, 1985). Furthermore, Festinger (1954) and later Turner and Oakes (1986) describe how individuals are motivated to compare themselves against individuals and groups. These are based on prototypical ideas of members of the social group in question. The thesis in chapters four and five established that students engaged in Social Comparison (Festinger, 1954) and Self-Categorisation processes. It will be necessary, therefore to include the items of cognition which is of particular importance to self-categorisation.

## **6.3 Current measures of Social Identity**

There are a number of measures of Social Identity and these are summarised in Appendix G but can be categorised as follows:

1. Global measures
2. Multidimensional measures
  - a. Measures which manipulate social identity

### *6.3.1. Global measures*

Global measures allow for ease of data collection and analysis. However, they treat Social Identity as a single united construct. By using such measures, it is not possible to explore mechanisms that may help the researcher differentiate how people differ in the domains that make up their identity. These are not considered suitable for the current study as identity is central to research question. Multidimensional scales allow for Social Identity to be measured within a number of facets and therefore reflect the findings of chapter five.

### *6.3.2. Multidimensional measures*

#### *6.3.2.1. Hinkle, Taylor, Fox-Cardamone & Crook (1989) "Three-component measure":*

Designed to extend an earlier global measure of identity by Brown, Condor, Matthews & Williams (1986). It consists of 7 questions with a scale of 1-9 and has 3 sub-groups of emotional identification, individual/group opposition and cognitive aspects of identification. The scale only allows for sub-scales to be used and cannot be used a global measure of identity, however the complete scale yielded a Cronbach alpha of 0.85. The shortness of the questionnaire would not allow measurement of the three identity levels of subject, student or identity and was originally only designed for lab experiments. In addition, it does not include a priming condition and was for general samples not for specific situations such as a student group or organisation.

*6.3.2.2. Karasawa's (1991) "Two-component measure".* This measure was designed to differentiate between different domains, that of High School as a whole and that of the student peer group. Additionally, it included affective and cognitive components within the items that measured for identification of the school as a whole. The author did not report the original alpha score. The identification with the school included 5 items, measured from minus 3 to plus 3. There were 2 items that were included to identify with group members and also on a scale of minus 3 to plus 3. The scale does not include components of cognition and affective for the second subscale and therefore not suitable to test the current research question.

6.3.2.3. *Ellemers, Kortekaas & Ouwerkerk (1994) "Three-component measure"*. This was the first questionnaire that measured fully the three components included in Tajfel's (1974) social identity theory as:

"the individual's knowledge that he belongs to certain groups together with emotional and value significance to of the group members" (p31)

It therefore included the subscales of cognition which is of particular importance to self-categorisation, it also included items to measure of participant's attachment to a group. Furthermore, it measures the respondent's evaluation of the groups status. Ellemers at al (1994) proposes that each of these components need not be equal. This is the measure that is closest to the current research question however unlike Karaswa's measure it does accommodate for different identity groups or categories.

6.3.2.4. *Cameron's "Three Factor" model of social identity (2004)*. This measure was designed to test Cameron's hypothesis that social identity is constructed of three correlated dimensions: centrality, in-group affect and in-group ties. Centrality is similar to the cognitive based components of Ellmers and measures how frequently a group comes to one mind. In-group affect measures self-esteem effects of belonging to a particular group and uses comparisons with other groups to do this. This dimension is interesting in that it does not presuppose what emotions may arise from belonging to the group, however it is based on comparison of one group to another. In-group ties assess how close a person feels emotionally to a group.

Both of these final measures have merit for the current research as they allow for a multidimensional approach across cognition, attachment and group esteem, however neither allow for measurement across the two domains and therefore are not fully suitable for the current study.

## **6.4 Psychometrics**

It has long been debated whether psychological unseen constructs can be measured adequately by Psychologists, particularly via the means of Psychometrics (see Johnson,

1936, Michell 1997a, 1997b, 1999, 2000, 2008; Barrett, 2003). This debate has now focused around Michell's assertion that Psychometrics is a "Pathology of Science" with equally strong counter arguments (Borsboom & Mellenbergh, 2004). It is imperative to understand the nature of the debate to ensure that any tool, which is developed, is reliable and valid. Michell's arguments cannot be entirely dismissed but careful use and a good understanding of what Psychologists hope to achieve is crucial to avoid criticism. This section will give a very brief history of the field of psychometrics. It will discuss the suitability of Psychometrics exploring the concepts of validity and reliability. The aim of modern day Psychometrics has been summarised by Jones and Thissen (2007) as:

"the disciplinary home of a set of statistical models and methods that have been developed primarily to summarize, describe, and draw inferences from empirical data collected in psychological research." (p.21).

#### *6.4.1 Early roots of Psychometrics*

Psychometrics grew out of two distinct fields of Psychology (Jones & Thissen, 2007);

- i, individual differences
- ii. psychophysics

Each of these branches of early Psychology were interested in developing methods to measure human ability. The branch of individual differences grew from an interest by Astronomers in the difference it took observers to spot stellar events, which Psychophysics was concerned with the relationship between the mind and the subsequent movement within the body. Furthermore, alongside this work as the development of statistics that would allow for analysis of the data from experiments. These two branches along with Thurstone's (1927, work in statistics (Thurstone & Jones, 1957) provide the basis of modern Psychometrics in which today we see constructs such as IQ or attitudes being measured, or in the case of the current study Academic Identity.



#### *6.4.2 The Debate of Psychometrics as Pathological*

Mitchell (1997, 2000, 2008) initially argued that psychometrics was a pathology of science in 1997 and this phrase has since been hotly defended by him as counter-arguments have built to defend the field and methodology (Borsboom & Mellenbergh, 2004). Mitchell argues that Psychologists involved in the field of Psychometrics are so deceived as to not even be able to notice there is an error in their reasoning surrounding the methodology. While Mitchell has, an issue with the ability to measure unseen hypothetical constructs the greater issue he argues is to do with how numbers are used for measurements purposes in Psychological research. These issues have caused others to also question the methods used within Psychology such as Barrett (2003) who expands on Mitchell's paper to further evaluate the use of numbers and their use in scales. Furthermore, while the debate is currently of particular interest and pursued through journals by Mitchell there had been questions about the use of number in psychology as far back as 1936 through to modern day Psychometrics (Johnson, 1936, Wittgenstein, 1958; Rust & Golombok, 2009). It is not possible to fully explore the debate in this thesis other than to acknowledge there has been criticism of the methodology. The focus of the next section will be to ensure that the method used in the current study takes the best practice of this research area, ensuring each step of the development of the Psychometric measure is thorough and precise.

### **6.5 Addressing the issues of Psychometrics**

Psychometrics is now a highly developed branch of methodology within psychology and other areas. A definition of modern day psychometrics could be the “science of assessment” (Rust & Golombok, 2008). The tools developed are interchangeably called “scales” measures” or “instruments”. The concepts of reliability and validity have been central to the history of these tools and will be discussed in an attempt to address some of the concerns outlined above.

#### *6.5.1 Reliability*

Reliability is the ability to measure a construct consistently or that it has a low error rate. It is relatively easy to establish reliability within physical sciences, for example measuring height with a ruler (the tool) can be verified against other scales. Even some level of error

can be acceptable. However, dealing with Psychological constructs is much harder; how can reliability be ensured and what level of error is acceptable?

It must be noted that reliability is independent of validity in that a tool can be reliable with being valid. However, reliability underpins validity and therefore is established first (Tavakol & Dennick, 2011). There are a number of statistical procedures that can establish reliability, for example Internal Consistency using a test such as Cronbach's alpha or a test-retest procedure for temporal stability (Cook & Beckman, 2006). Each of the tests will be used to establish validity later in the chapter.

### *6.5.2 Validity*

An inter-related concept is validity, which can be defined as the instruments ability to measure the intended construct. Validity is broader than reliability and starts prior to the development of the measure with a clear identification of the domain to be measure and item generation procedures. Finally, a number of statistical tests establish its validity as a complete scale.

## **6.6 Generating Items - Qualitative methodology**

Social identity is a complex construct and deciding what needs to be measured is invariably a complicated process. As already identified, the measurement needs to include dimensions of affect, behavioural and cognition but also student and subject domains. Existing literature indicates how social identity is constructed and possible multiple identity issues. However, not only do the previous chapters establish that elements of identity revolve around the academic journey of an undergraduate student it in addition gives an insight into identity from a student's perspective. Furthermore, the research presented in chapters 4 and 5 also explores how the language of identity is used by the intended population. This methodology is supported by Nassar-McMillan and Borders (2002) who advocate the use of focus groups to generate item development.

### 6.6.1 Scale structure

Each of the items were to be short clear sentences in the first person (Bowling, 1997).

Questions would be developed under the following sub-scales:

1. Student Self-categorisation: It is intended that first subscale should be kept to a couple of items only to keep the overall scale brief.
2. Subject Self-categorisation: As this is a major sub-scale in the questionnaire it was decided these should have a number of items.
3. Subject Evaluation: Another major sub-scale and therefore will include a number of items.
4. Engagement: This was shown to be important to student's sense of identity and therefore will be an important sub-scale of the questionnaire and show the outward behaviours of an academic identity.
5. Academic community: The participants mentioned tutor importance a number of times but more importantly this is part of the academic tribe theory, the language for this will be drawn from the QAA descriptors of psychology. It is argued that participants who have understood their subject will also be aware of the academic community they are becoming part of.
6. Subject attachment: this will measure the strength of emotional attachment.
7. Self: finally, there is will be one question that assess how strong a sense of self is, it is expected this will be negatively correlated with the total questionnaire.

Hogg and Turner (1987) argues that only one identity can be salient and as the scale may be used in a wide variety of setting and not in the confines of a controlled laboratory, it is necessary to evoke the relevant identity with a prime. The measure will be focused mostly on one dimension, that of subject identity, and therefore a prime that evoked this identity would be valid and necessary. It was decided to use a normative prime rather than a comparative manipulation prime in order that self-esteem was not lowered. The QAA benchmark statement about Psychology was used and participants were then required to write one short statement; "Tell me a little about what you think Psychology is..." A scale of 1-7 with 1 strongly disagree and 7 strongly agree was also used.

*6.6.1.2 Self-categorisation.* Self-category statements within identity questionnaires ask the respondents to consider if they are close to what they consider the ideal of a member of the chosen category. The items will focus on comparing self against the target group. Language such as “typical” “few differences” “agree” will be used. Karawasa (1991) measure of social identity amongst school pupils had high validity and used similar language. Ashmore, Deaux and McLaughlin-Volpe (2004) argue that individual’s perception of their fit within a possible future social group as such requires language that allows the participant to judge how near they are to a prototypical member. It was decided to use similar language to Karawasa’s “Two-Component Measure” (1991). In this group then the items will be:

**Student Self-categorisation:**

1. Generally, I would agree if someone described me as a typical student.
2. I see myself as independent from the other students I mix with (negatively worded).

**Subject Self-categorisation:**

1. Generally, I would agree if someone described me as a typical psychology student.
2. I see myself as independent from the psychology students I mix with (negatively worded).
3. Overall I would say there are few differences between me and psychology students.
4. I have found that I often disagree with psychology students (negatively worded).
5. I view myself as similar to most students in my subject area.
6. I feel I fit well within the psychology group of students.
7. I view myself as similar to most psychology students.

*6.6.1.2 Subject Evaluation.* In this sub-scale the items will measure the status of the target group, in this case Psychology student and is similar to Ellmers et al (1994) value significance or Cameron’s (2004) in-group ties, it does include also an element of affect as it taps into a sense of pride in belonging to the group.

1. It is easy to be excited about Psychology as a subject.
2. Psychology is a unique subject.

3. Psychology has an important role to play within society.
4. Psychology students have a lot to be proud about with their academic subject.

*6.6.1.3. Group Attachment.* This subgroup will assess attachment to the group, how important to a participant's well-being it is to belong to it.

1. I feel attachment to my psychology department.
2. Overall I am glad to belong to the psychology department.
3. I would be sorry if I couldn't spend time with Psychology students.

*6.6.1.4 Academic Community.* This sub-scale is not currently measured on any identity measure but is considered important in a model of social identity underpinning academic identity. It is intended to assess the students understanding of the community they belong to as well as assessing the perceived status of their tutors. The questions are derived from the QAA Psychology benchmarks.

1. My Psychology lecturers understand the scientific underpinning of psychology as a discipline.
2. My lecturers show good understanding of Psychological theory
3. I would agree that my Psychology lecturers are active researchers.
4. I find the lecturers in psychology interesting and enthusiastic

*6.6.1.5 Engagement.* This variable was identified by Hurtado and Carter (1997) as important to a student's sense of belonging and was confirmed in the focus group interviews. As they mention that they feel most like students when doing work this includes engagement out of classes as well as attendance. Furthermore, a few students talked about being motivated and so an item has been included about this.

1. Overall, I do little preparation for my classes (negatively worded)
2. I am motivated to achieve good results in my academic subject.
3. I ensure that I attend as many classes as possible.

*6.6.1.6 Self.* One item was designed to measure independence of the group:

1. My academic achievements are independent of support from my subject area

#### *6.6.1.7 Demographic questions:*

1. Mode of study (full time or part time)
2. Single or Joint honours
3. Subjects
5. Year of study.

### **6.7 Pilot Study**

A pilot study of the test measure was conducted to establish the validity of the questionnaire and was completed in two parts:

1. A panel of experts
2. Participants completing an initial version of the test

#### *6.7.1 Methodology*

*6.7.1.1. Participants.* The panel experts consisted of seven Psychology lecturers or PhD students who are active researchers. Only one was a Personality researcher and had previous experience of working with psychometric development. The other six experts have a good understanding of social psychology. Lynn (1986) recommends between 3 to 10 experts on a panel. One hundred and twenty-three participants took part in the initial testing of the questionnaire; all were Psychology students at Liverpool Hope. Four of the participants declined to take part in the demographic questions, the remaining 119 were all full time students. A number of students had failed to complete the measure however, as a factor analysis is sensitive to such issues these were removed leaving 101 cases.

Fifty-seven students were first years, 12 were second years and 28 were in their final year. Sixty-two participants were single honours; the remaining took a variety of secondary subjects. First years were given one course credit for their participation. Recruitment of all students took place via email.

*6.7.1.2. Procedure.* The experts were asked to rate on a scale of 1-4 the relevance of the items in measuring identity within students. Comments were sought.

Students were invited via email to take part in a short survey style questionnaire. If they were interested they followed a link in the email and were first presented with a number of statements about their participation and once these had been agreed they proceeded to the demographic questions and then the initial questionnaire of 24 questions.

### *6.7.2 Results*

*6.7.2.1. Content Validity Index.* The Academic Identity Scale was rated relevant by the majority of the raters across the items of the scale (S-CVI=0.94). Polit and Beck (2006) recommend using S-CVI/Ave to calculate the final S-CVI as this is identical to Average Congruency Percentage. The CPA (Waltz, Strickland & Lenz, 2005) recommend above .90; Polit and Beck argue that this should be the case with S-CVI/Ave. It can be concluded that the scale initially meets validity requirements by 7 raters on scale-content. However, there was an issue with two items:

1. My academic achievements are independent of support from my subject area
2. I find the lecturers in psychology interesting and enthusiastic

The first of these questions was expected to receive low relevance scores as it is outside of the construct of identity and therefore this item will not be included. The second item is part of the Community sub-set of questions. While it did receive a low overall grade, the majority still rated this item as relevant or highly relevant and therefore it will be included.

*6.7.2.3. Reliability and Validity (Pilot data).* To test the reliability and validity of the Academic Identity Scale an exploratory factor analysis was used for each dimension. Reliability data, means and standard deviation for the scale as globally is presented first.

*6.7.2.3.1 Descriptive Statistics.* The Academic Identity Scale has a range from 7-168. The total scale returned a mean score of 119.32 (s.d. 14.67). The lowest score was 60, with the highest score coming in 156; a high score indicating a stronger Academic Identity.

Table 6.2: Descriptive Statistics of Sub-constructs in the Initial Scale

	Potential Range	Minimum	Maximum	Mean	s.d.
Total	24-168	62.00	155.00	118.56	15.68
Student Self-Categorisation	2-14	3.00	14.00	8.65	2.32
Subject Self-Categorisation	7-49	17.00	43.00	29.32	4.55
Engagement	3-21	5.00	21.00	15.63	2.65
Academic Community	4-28	7.00	28.00	17.144	3.02
Subject Evaluation	4-28	8.00	28.00	23.28	4.25
Subject Attachment	3-21	2.00	21.00	14.52	3.31
Self	1-7	2.00	7.00	4.1	1.27

6.7.2.3.1 *Reliability*: Internal consistency allows us to measure the relatedness of items on a scale, for this analysis Cronbach’s Alpha was used, a standard statistical test used for this purpose. The internal consistency reliability of the 24 items reported was 0.88, Field (2009) proposes that a scale with a Cronbach’s  $\alpha$  above 0.8 can be considered robust. The item-total statistics table is shown below and while it can be agreed that the scale is reliable as a whole; item 9 report negative Item-Total Correlations. This would suggest the patterns of responses were different on these. Question 9 was an item about “self-identity”

- My academic achievements are independent of support from my subject area.



Table 6:3: Reliability Statistics for each item on the initial Academic Identity Scale

	r	r <sup>2</sup>	$\alpha$ if deleted
Engagement 1 (reverse) Overall, I do little preparation for my classes.	.19	.43	.89
Engagement 2 I am motivated to achieve good results in my academic subject.	.54	.70	.88
Engagement 3 I ensure that I attend as many classes as possible.	.39	.55	.88
Student Categorisation 1 Generally, I would agree if someone described me as a typical student.	.29	.49	.89
Student Categorisation 2 (reverse) I see myself as independent from the other students I mix with	.24	.74	.89
Subject Evaluation 1 It is easy to be excited about Psychology as a subject.	.54	.71	.87
Subject Evaluation 2 Psychology is a unique subject.	.44	.62	.88
Subject Evaluation 3 Psychology has an important role to play within society.	.54	.66	.88
Subject Evaluation 4 Psychology students have a lot to be proud about with their academic subject.	.73	.72	.87
Subject Categorisation 1 Generally, I would agree if someone described me as a typical psychology student.	.43	.42	.88
Subject Categorisation 2 (reverse) I see myself as independent from the psychology students I mix with (negatively worded).	.40	.76	.88
Subject Categorisation 3 Overall I would say there are few differences between me and psychology students.	.43	.55	.88
Subject Categorisation 4 (reverse). I have found that I often disagree with psychology students (negatively worded).	.36	.51	.88

Subject Categorisation 5 I view myself as similar to most students in my subject area.	.56	.79	.88
Subject Categorisation 6 I feel I fit well within the psychology group of students.	.68	.77	.87
Subject Categorisation 7 I view myself as similar to most psychology students.	.57	.79	.88
Academic Community 1 My Psychology lecturers understand the scientific underpinnings of psychology as a discipline	.59	.86	.88
Academic Community 2 My lecturers show good knowledge of Psychological theory	.59	.86	.88
Academic Community 3 I find the lecturers in psychology interesting and enthusiastic	.52	.63	.88
Academic Community 4 I would agree that my Psychology lectures are active researchers.	.64	.78	.88
Emotion 1 I feel attachment to my subject department	.52	.58	.88
Emotion 2 I would be sorry if I couldn't spend time with Psychology Students	.36	.53	.88
Emotion 3 Overall I am glad to belong to the Psychology department	.76	.83	.87
Self: My academic achievements are independent of support from my subject area	.10	.28	.89

As table 6.2 shows there are a number of items reporting low correlations but removing them would do little to improve the Cronbach Alpha score. It is generally accepted that the higher the Alpha the better for reliability, however there are a number of issues with this assumption. First, a high Alpha would indicate that a scale has uni-dimensionality, which would be problematic in the current study. Cortina (1993) suggests that this is not necessarily the case and that communalities with high loadings on a number of factors can result in high Cronbach Alpha's. Therefore, relying solely on reliability statistics is not recommended. Additionally, and more interesting and relevant to the current study is the pattern of low correlations but high Alpha scores. Panayides (2013) argues that a high Alpha

may not only indicate inter-item correlation but also that there are redundant items, given the pattern so far the current study will look closely at this issue during the factor analysis. However, Panayides additionally suggests that high loadings on factors paired with low items correlations should be used in order to maximise the breadth of the construct.

A Hotelling's T-square, undertaken as the sample size is smaller than normal, reports distribution properties across the items. This analysis reported a significant finding and we can assume that the items have a similar distribution around the means ( $F(23,78) = 22.47$ ,  $p > 0.001$ ). Given the number of items per subset it was decided not to run individual Cronbach Alpha's on each one.

*6.7.2.3.2 Factor Analysis Assumptions.* While the final sample size was only 101 and generally larger samples are used in factor analysis Mundfrom and Shaw (2005) argued that smaller sample sizes in certain conditions does not reduce the reliability of the analysis. Using their guidelines, the sample size is suitable for the number of factors and level of communality; the communalities for each of the dimensions were either high or moderate as will be seen in the results below. There were no extreme univariate outliers as indicated on standardised z-scores. Additionally, a Mahalanobis D<sup>2</sup> calculation of probability showed two slight outliers, to accommodate for this a Principal Axis Factor Analysis will be used as this can handle data violation at this level. Squared Multiple Correlations indicate that there are no issues with multi-collinearity or singularity within the dataset; see table 2 above, (Tabachnick & Fidell, 2007). Therefore, it is possible to continue with the Factor Analysis.

A principal axis factor analysis was conducted on the 24 item Academic Identity measure with direct oblimin oblique rotation. The KMO reported at 0.78 and Bartlett's test of Sphericity  $X^2(276) = 1520.73$ ,  $p < 0.001$ . Field (2009) states that KMO above 0.7 and additionally the significant Bartlett results indicates that correlations between items exist and therefore the data is suitable for Factor Analysis. The determinant score (5.98) was above the recommend score of 0. Communalities statistics indicate issues with some of the items which reported low scores. Item 9 (My academic achievements are independent of support

from my subject area) was particularly low ( $R=0.28$ ). Additionally, items 1 ( $R=0.49$ ) and 2 ( $R=0.44$ ) are also an issue.

- Item 1: Generally, I would agree if someone described me as a typical student.
- Item 2: Overall, I do little preparation for my classes.

Item 1 is not directly related to the Academic Identity and is expected to load as a separate factor of identity bound up in student rather than subject. Item 2 is more concerning as this item relates to engagement which was important to the proposed construct of Academic Identity. While Field (2009) states that communalities should be above 0.6, this is refuted by Foster, Barkus and Yavorsky (2006) who argue that communalities as low as 0.4 are acceptable. The number of factors returned was 6, explaining a combined 61% of the variance, however the scree plot (shown below) indicates that 3 or 4 factors should be retained. The pattern rotated matrix indicated that all of the items at this stage should be kept with high as each of the factors had items with loadings above 0.6. However, of concern was the low correlations between the factors as reported in table 6.3. Additionally, a number of items loaded on 2 or more factors.

*Table 6:4: Correlation Matrix for each sub-construct on the Initial Scale*

<i>Factor</i>	<i>1</i>	<i>2</i>	<i>3</i>	<i>4</i>	<i>5</i>	<i>6</i>
<i>1</i>	<i>1.00</i>	<i>-.01</i>	<i>.31</i>	<i>-.10</i>	<i>-.29</i>	<i>.36</i>
<i>2</i>	<i>-.01</i>	<i>1.00</i>	<i>-.30</i>	<i>-.01</i>	<i>.12</i>	<i>.05</i>
<i>3</i>	<i>.31</i>	<i>-.30</i>	<i>1.00</i>	<i>-.11</i>	<i>-.22</i>	<i>.32</i>
<i>4</i>	<i>-.10</i>	<i>-.01</i>	<i>-.11</i>	<i>1.00</i>	<i>.01</i>	<i>-.19</i>
<i>5</i>	<i>-.29</i>	<i>.12</i>	<i>-.22</i>	<i>.01</i>	<i>1.00</i>	<i>-.20</i>
<i>6</i>	<i>.36</i>	<i>.05</i>	<i>.32</i>	<i>-.19</i>	<i>-.20</i>	<i>1.00</i>

*Extraction Method: Principal Axis Factoring. Rotation Method: Oblimin with Kaiser Normalization.*

A further factor analysis was run, this time removing the items that had seemed to be exceptionally low on correlations, these included:

1. Engagement question 1
2. Student Categorisation 1 & 2
3. Self
4. Subject Categorisation 1
5. Attachment question 2

The initial Factor Analysis now showed that Engagement questions 2 and 3 were problematic with low communalities. It was decided to exclude these from the factor analysis. The final Factor Analysis was finally composed of 16 items, which showed a reliability of  $\alpha=0.89$ . The sampling adequacy for the analysis was again very good (KMO=0.84) and Bartlett's test of Sphericity reported at  $X^2(120) = 1062.88, p < 0.001$ . Three components with attributed to 61% of the variance. The scree plot (in Appendix H.2) was unambiguous and showed 3 components should be retained. Table 6.4 shows the factor loadings after rotations.

The Rotated Factor Matrix, at first glance looks confusing with some items loading on two factors. The proposed answer to this structure will be discussed with reference to Social Identity Theory in the discussion. However, briefly it would seem that a reasonable assumption is that Factor 1 reflects cognitive evaluations of Psychology as a subject and their subject Department. The second is self-categorisation in which the students feeling of how close they perceive themselves as similar to other psychology students is measured. The final factor is that of affect around the identity of Psychology student.

Table 6:5: Summary of exploratory factor analysis results for the Academic Identity Scale.

	Cognitive Evaluation of Psychology	Normative Categorisation	Affective response
My Psychology lecturers understand the scientific underpinnings of psychology as a discipline	.92		
My lecturers show good knowledge of Psychological theory	.87		
Psychology has an important role to play within society	.76		
I would agree that my Psychology lectures are active researchers.	.68		.46
Psychology is a unique subject.	.63		
It is easy to be excited about Psychology as an academic subject.	.63		.45
I find the lecturers in psychology interesting and enthusiastic	.57		
I view myself as similar to most students in my subject area		.81	
I see myself as independent from the psychology students I mix with.		.73	
I feel I fit well within the psychology group of students		.72	
I find the lecturers in psychology interesting and enthusiastic		.59	
I have found that I often disagree with psychology students		.56	
I view myself as similar to most students in my subject area		.43	.68
I feel attachment to my subject department			.68
I would be sorry if I couldn't spend time with Psychology Students	.53		.67
Psychology students have a lot to be proud about with their academic subject	.48		.60

Eigenvalues	4.41	2.75	2.54
% of variance	27.55	17.16	17.16
Cronbach alpha	0.90	0.77	0.83

### *6.7.3 Discussion*

The factor analysis returned three factors with robust loadings on each one and can be summarised as cognitive, categorisation and affect. Importantly each factor was correlated with each other and while some items loaded on a two factors this may be seen as supporting Academic Identity as a Social Identity and Self-Categorisation construct. A correlation exists between evaluating a social identity as high status (in this case subject evaluation) and the sense of pride (affect) that comes from this. In fact, this essential to Social Identity and its suggestion that members derive self-esteem from membership of perceived high status groups.

#### *Factor 1: Cognitive evaluations of subject and department*

This factor returned the highest validity and included items that assessed the students understanding of how important and unique psychology is to society coupled with their understanding of how the Psychology Department reflected these values. Turner (1975) proposes that Self-Categorisation Theory begins with assessing the value of the group; the higher the individual the status of a group the more likely they will seek to become part of the in-group. These items are similar to the items included in the subscales of Cameron's (2004) "group ties" and Ellmers et al (2004) "evaluation" factors.

#### *Factor 2: Normative Comparison*

Normative comparison is the next stage in Self-Categorisation after evaluation. At this point, the individual compares themselves to the in-group members, looking at a typical member and measuring themselves against the group and its members. Social comparison and self-categorisation was considered in the introduction through research that explored multiple identities, Rutland et al (2008) showed that participants compare themselves against groups they perceive as most like them and also has a high status. Social comparison is looking at how typical "I am" to the rest of the group. Interestingly the students were given an

opportunity to categorise themselves as students generally, however, they chose to categorise themselves by their subject area.

*Factor 3: Emotional dimension of Academic Identity*

From the start of this chapter we have been looking at how students feel they belong to the subject they have chosen, this cluster of items supports research that indicates that emotion is a crucial part of identity as outlined by Ellmer (1994). This cluster is not just about a sense of belonging but also other emotions such as feeling excitement or pride about the subject. There is one item that should fit here but was included in the cluster on factor 1 about evaluation, however this item is negatively reversed and such items are often confusing to read.

*Factor 4: Behavioural*

This factor returned a low Cronbach's alpha below that which is considered the minimum for reliability and reading on the surface also indicates that the items are not a good fit although the final validity does analysis supports this cluster as a construct. It is uncertain at this stage if the items are an issue, for example not unclearly written or if is that the theoretical basis of the construct which doesn't support this cluster. Nevertheless, there is scope within Social Identity Theory to support a behavioural measure of social categorisation on the Academic Identity.

The final clusters and factors are listed below:

*Factor 1: Cognitive evaluation of Psychology and Department*

Psychology is a unique subject

I would agree that my Psychology lecturers are active researchers

My lecturers show good knowledge of psychological theory

My psychology lecturers understand the scientific underpinnings of psychology as a discipline

Psychology has an important role to play within society



*Factor 2(role comparison - normative)*

I view myself as similar to most students in my subject area

I feel I fit well within the psychology group of students

I see myself as independent from the psychology students I mix with

I view myself as similar to most Psychology students

*Factor 3 Emotions*

I feel attachment to my subject department

Overall, I am glad to belong to the Psychology department

It is easy to be excited about psychology as a subject

Psychology students have a lot to be excited about with their academic subject

*Factor 4 Categorisation (role comparison - behavioural)*

I have found that I often disagree with psychology students

Overall, I would say there are few differences between me and psychology students

Generally, I would agree if someone described me as a typical psychology student

I find the lecturers in psychology interesting and enthusiastic

*6.7.4 Summary:*

While the groupings of the research have changed the items themselves seem to be valid and the scale as a whole is reliable. Leaving behind the groupings that emerged from the qualitative research was difficult as I had become so involved in the research process. First, the current questionnaire is now very different to other identity measures and also to see groups that mirror even if they do not match the groups originally shown from the interviews it is evidence that the language and the research was solid. These clusters show a level of objectivity and confirms the process so far. While the sample size is an issue and while there is research presented to show that the minimum number was met nonetheless more participants would have increased the validity.

## **6.8 Pilot Study II – test of new measure**

### *6.8.1 Participants*

An Exploratory and Confirmatory Factor Analysis will be undertaken to further confirm the structure of the scale. The final data set included 205 participants, all of whom studied Psychology and were full time. One hundred and forty-one students attended Liverpool Hope, with a further 64 attending Liverpool John Moores University. There was a 50% split between those students who only studied Psychology compared to those were joint hours; the second subjects had a wide variety. The majority of the students were first years (n=150) with 35 second years and 20 third years. The questionnaire was available through Survey Monkey, with the addition of demographic questions regarding attendance, subjects and university.

### *6.8.2 Descriptive Statistics*

The Academic Identity Scale had the 16 items suggested from the first pilot study and has a range from 7-112. The total scale returned a maximum score of 83.15 (mean = 83.16, s.d. = 15.68). Table 6:6: Descriptive statistics showing means, sd, range and Cronbach Alpha's for total scale and each subsetp126, includes descriptive statistics for each of the subsets.

### *6.8.3 Reliability*

The internal consistency reliability of the 16 items reported was 0.81 however the subset of behavioural items (Factor 4 from Pilot Study 1) is very low ( $\alpha=0.35$ ). However, a look at the item-total statistics in table 6.2 (p.86) report that they correlate well with the scale globally, indicating that there is not a problem with the items themselves but with the subset. Additionally, the subset seemed to have a particular low factorability in the pilot study. The questions included in the subset are the least well delineated.

Table 6:6: Descriptive statistics showing means, sd, range and Cronbach Alpha's for total scale and each subset

	Potential range	Minimum	Maximum	Mean	s.d.	$\alpha$
Total	7-112	26	103	118.56	15.68	0.81
Subject Evaluation	5-35	5	35	7.70	3.5	0.80
Normative Comparison	4-28	6.00	27.00	17.92	7.08	0.75
Emotional	3-21	4.00	21.00	16.48	3.49	0.83
Behavioural	4-28	8.00	25.00	17.37	3.28	0.35

The aim of this stage was to complete a Confirmatory Factor Analysis, however as there was an initial concern about one of the factors in the Cronbach Alpha an Exploratory Factor Analysis was used first. A Component-Axis EFA was used as this is considered to be a more robust Factor Analysis. The Determinant=0.001 and The KMO was above 0.7 and therefore adequate and Barlett's test of Sphericity >0.01. Again, these preliminary statistics indicated that the subsequent factor analysis was acceptable. There were some low extracted communalities which would indicate an issue with some of the items, notably item 1 and items 15 and 16, however all of these items returned high correlations in the reliability statistics. Additionally, factor 1 (which explained 20% of the scale variance) included item 1 and was loaded at 0.53. Generally, the component axis factor analysis reflected the same set of factors as the pilot study, also all of the items were loaded onto the same factors. Nevertheless, as the fourth factor was still seemingly problematic it was decided to run the analysis again coding within SPSS a maximum of four factors to extract to establish if this would be a better solution. As all of the initial items returned eigenvalues above 1 and were highly correlated it was decided to include all of these variables.

The evidence so far with both Pilot studies indicates that the fourth factor should be removed, leaving a reduced scale of only 12 items. However, these remaining three factors

of Subject Evaluation, Normative Comparison and Affect (Emotion) equate to factors identified by a number of researchers (Ellemers, Kortekaas & Ouwerkerk, 1994; Cameron, 2004) within Social Identity and Self-Categorisation Research and therefore reflect the research to date. A further EFA was conducted with only these three loadings and table 6.6 shows the pattern matrix.

Table 6:7: Rotated Factor Matrix with new labels for items and factor

	1*	2**	3***
Evaluation1: My Psychology lecturers understand the scientific underpinnings of psychology as a discipline	.920		
Evaluation2: My lecturers show good knowledge of Psychological theory	.869		
Evaluation3: Psychology has an important role to play within society	.760		
Evaluation4: I would agree that my Psychology lectures are active researchers.	.684		.461
Evaluation5: Psychology is a unique subject.	.633		
Evaluation6: It is easy to be excited about Psychology as an academic subject.	.628		.449
Evaluation7: I find the lecturers in psychology interesting and enthusiastic	.573		
Normative1: I view myself as similar to most students in my subject area		.809	
Normative 2*: I see myself as independent from the psychology students I mix with.		.729	
Normative 3: I view myself as similar to most Psychology students		.715	
Normative 4: Overall, I would say there are few differences between me and psychology students		.593	
Normative 5*: I have found that I often disagree with psychology students		.561	
Normative 6: I feel I fit well within the psychology group of students		.429	.682
Emotion1: I feel attachment to my subject department			.677
Emotion2: Overall I am glad to belong to the Psychology department	.531		.673
Emotion3: Psychology students have a lot to be proud about with their academic subject.	.478		.601

\*Factor 1: Evaluation\*\*Factor 2: Normative Categorisation\*\*\*Factor 3: Emotion

#### 6.8.4 Confirmatory Factor Analysis Descriptive Analysis

As with the previous test of the scale there were three subscales, the descriptive statistics for these are in table 6.8 below.

Table 6:8 Means, s.d. and range of Academic Social Identity Scale version 2

	Potential Range	Minimum	Maximum	Mean	s.d.	$\alpha$
Total	16-112	71	108	93.56	7.36	0.80
Evaluation	7-49	34	49	44.14	3.39	0.79
Normative	6-36	10.00	40.00	30.27	4.7	0.77
Emotion	3-21	12.00	21.00	19.19	1.72	0.74

#### 6.8.5 Confirmatory Factor Analysis Assumptions

In preparation for a structured equation modelling approach to CFA the data was tested for assumptions. Univariate outliers were excluded from 8 cells. Univariate normality (via z-scores) was found to be within acceptable limits with no item being outside of -2 and 2. Multivariate outliers were identified using Mahalanobis Distances chi-square critical value of 34.52 (13 variables and  $p=0.001$ ). However, there were a number of variables that proved to be above this value and these were removed. The majority of the relationships were sufficiently linear for SEM, however a few relationships were more quadratic and inverse. However, this limitation will be addressed during the SEM. Additionally Emotion 3 and Emotion 4 showed moderate levels of multicollinearity ( $<10$ ) and will be accounted for in the SEM.

#### 6.8.6 Confirmatory Factor Analysis Results

A confirmatory factor analysis of the items was conducted using AMOS 23 with a Maximum Likelihood Estimates used as default. The first model reported a significant chi-square ( $>.01$ ) and poor model fit. This was likely due to low correlations on 2 items in the sub scale of Evaluation (evaluation 6 & 7). Evaluation 7 had not been an issue in the EFA

stage, however it was possibly measuring two constructs (interesting AND enthusiastic) and it was decided to remove this item. Additionally, Evaluation 6 had previously loaded on two factors (Evaluation and Emotion). However, it is theoretically acceptable for item 6 to be included in the subscale of Emotion, when this model was tested, item 6 returned a correlation of only  $r=0.24$  with factor 3, therefore this item is deleted also. Furthermore, too many modifications required to achieve a good fit. The CFA results are reported in appendix H.3.

The final model (AMOS MLE), initially reported a significant chi-square ( $\chi^2 = 418.93$ ,  $df = 74$ ,  $p > 0.001$ ). All items loaded significantly on the subscales of Evaluation (factor 1), Normative (factor 2) and Emotion (factor 3), the Confirmatory Factor Analysis results for each item is presented in the table 6.8. The final analysis and model reported a non-significant chi-square ( $\chi^2 = 70.72$ ,  $df = 59$ ,  $p = .141$ ). Other model fit statistics indicate that the model was acceptable. Table 6.9 compares the initial and final goodness-of-fit statistics and indicates that the final model was superior. Incremental and absolute indices (0.96-0.99) were above the threshold of GFI (.90) was and the RMSEA (0.03) coefficients were within the desired confidence intervals (0.0–0.05).

Table 6:9: Confirmatory Factor Analysis of the ASI (Psychology): Standardized Regression Weights for each item

Item Description	Standardised Regression Weights
Factor 1: Evaluation	
My Psychology lecturers understand the scientific underpinnings of psychology as a discipline	.98
My lecturers show good knowledge of Psychological theory	.69
Psychology has an important role to play within society	.49
I would agree that my Psychology lectures are active researchers.	.55
Psychology is a unique subject.	.63
Factor 2: Normative	
I view myself as similar to most students in my subject area	.70
I see myself as independent from the psychology students I mix with.	.51
I view myself as similar to most Psychology students	.71
Overall, I would say there are few differences between me and psychology students	.51
I have found that I often disagree with psychology students	.50
I feel I fit well within the psychology group of students	.69
Factor 3: Emotion	
Emotion1: I feel attachment to my subject department	.99
Emotion2: Overall I am glad to belong to the Psychology department	.60
Emotion3: Psychology students have a lot to be proud about with their academic subject.	.45

The MI indicated a number of error's had correlations and would improve the model fit and were theoretically meaningful and therefore they were included in the model. The correlated error terms are indicated in figure 7.1 below.



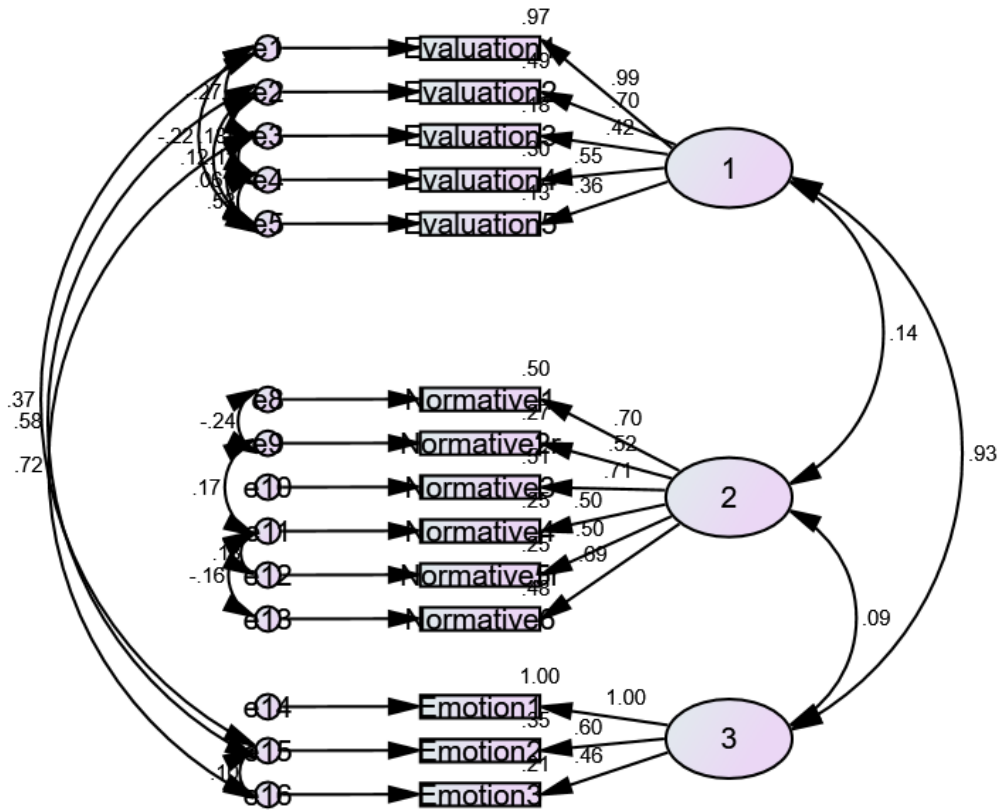

Figure 6-1: CFA, indicating Three Factor Model Construct of Academic Social Identity

Table 6:10: Comparison of the initial and final solution fit statistics of the ASI (Psychology) Scale.

Solution	Initial	Final
$\chi^2$ goodness of fit	418.93	70.72
Df	74	59
Probability level	0.00	0.141
CMIN/DF	5.66	1.20
RMSEA	1.51	0.03
(90% confidence interval)	(1.36-1.87)	(0.0-0.05)
SRMR	0.59	0.00
Incremental Fit Indices		
NFI	.71	.96
CFI	.75	.99
Predictive fit indices		
AIC		
Hypothesised	480.93	162.72
Saturated	210.00	210.00
Independence	1493.80	1493.78
Absolute fit indices		
GFI	0.79	.95

## 6.9 Summary

The analysis of the final scale shows a good degree of validity of reliability though the structure of Academic Social Identity that has emerged is different from the that which had been originally proposed in the opening chapter of the thesis. The scale only measures one domain (that of subject) which supports the findings of chapters 4 and 5. However, importantly the final scale of 12 items reflects the factors of Subject Evaluation, Normative Comparison and Affect (Emotion) which equate to factors identified by a number of researchers (Ellemers, Kortekaas & Ouwerkerk, 1994; Cameron, 2004) within Social Identity and Self-Categorisation Research and therefore reflect the research to date. The confirmatory factor analysis confirms this structure, though it is recognised that possibly two factors would be sufficient to measure the construct of Academic Social Identity. However,

the theory behind the 2 factor solution is less secure and therefore it has been decided to keep Evaluation (factor 1), Normative (factor 2) and Emotion (factor 3).

## **7 The relationship between Academic Social Identity and Academic attainment**

### **7.1 Introduction**

The thesis so far has shown that students seek to identify with each other and with their subject area. Furthermore, through qualitative studies, a sense of belonging was shown to exist at both the student and subject level. However, chapter five suggested that the student domain showed more variance and students derived lower levels of self-esteem from membership of this group. This was further supported in the previous chapter as items related to student identification reported highly variable results. Additionally, transition periods, especially in the first year, are phases in which students adapt behaviour to become a member of the group. However, literature indicates that this not only happens with their immediate peers but also within the subject area, displaying academic behaviours as they saw were appropriate to Psychology students (Vreeland & Bidwell, 1966, McGeough, McIlroy & Palmer-Conn 2016). Again, the need to identify with the subject area was present in the participants in chapter seven, however subject identification did not manifest itself in behaviours as was expected. While it can be stated that following the results of the psychometric development of the Academic Social Identity that such a construct exists, it is not yet apparent whether this is linked to a set of behaviours. Therefore, in this chapter the aim will be to explore the relationship between Academic Social Identity and attainment levels. To ensure that the study can fully consider the variance that can be explained by Academic Social Identity on attainment the literature review will also discuss other variables, such as Academic Self-efficacy, that have previously been found to have a strong correlation with academic grades.

#### *7.1.1 Psychological correlates of attainment*

The relationship between academic ability and academic attainment has been supported by a broad range of literature (e.g. Bridgeman, Pollack and Burton, 2004; Ramist, Lewis, & McCamley-Jenkins, 2001). However, other research has indicated that there is far more to academic success than a simple relationship between IQ and grades. In a recent study which included not only intelligence but also conscientiousness and autonomous motivation (Di Domeni & Fournie, 2015), results indicated that conscientiousness was a strong predictor of GPA amongst already able students. Furthermore, conscientiousness was found to

compensate amongst participants with low levels of autonomous motivation. Additionally, research which focuses on personality and university success found that trait conscientiousness demonstrated the strongest predictive quality ( $r = .23$ ) compared to other FFM traits (McAbee & Oswald, 2013). Trait conscientiousness has been defined as the characteristic within a person to set goals, delaying gratification while following norms and rules to achieve them (Roberts, Jackson, Fayard, Edmonds, and Meints, 2009). Students high in conscientiousness are likely to reflect five facets identified in research as industriousness, orderliness, impulse control, reliability and formality (Greenidge, 2013). In particular, when each of these facets are correlated to GPA it is industriousness and reliability which are predictive of achievement orientation in university (Paunonen & Ashton, 2013). These findings have also been used to explain why females, who tend to be higher in conscientiousness, achieve higher grades at university compared to males (Farsides & Woodfield, 2006). The present study will therefore include a measure of conscientiousness when exploring correlates of attainment amongst university students.

However, this research does not include another variable that has been implicated in research around success at university, that of self-efficacy. Richardson, Abraham and Bond (2012) undertook a large meta-analysis of University students' grade point average scores (GPA) resulting in a conceptual map which gives a comprehensive picture of the variables which relate to success. While motivation was identified as an antecedent to success along with personality factors and learning strategies it was self-efficacy that was shown to be most significant in terms of attainment levels. This variable along with goal setting and effort regulation were described by the authors as non-intellective variables for learning and were found to have greater predictive qualities than demographic or psychosocial factors which returned generally low correlations with GPA. General self-efficacy has been defined by Bandura (1994) as a person's belief in their ability and influences motivation, feelings and thoughts about themselves and events. Self-efficacy will also be included in the present study as a possible predictive variable of academic achievement.

### *7.1.2 Academic Social Identity and Attainment*

The thesis has not yet established the possible relationship between Academic Social Identity and attainment, however previous research has looked at identity (as discussed in chapter 3 and 4) and transition, and possible future attainment. However, the research is non-specific and as argued strongly throughout the thesis is not clearly defined. For example, Leong, Gibson, Lounsbury and Huffstetler (2005) reported that compared to the FFM traits (including conscientiousness, which has already been identified as important factor) identity was found to be important and authors employ a working definition of “sense of identity” which is built on Erikson’s (1968) stages of identity theory. Furthermore, the authors argue that this sense of identity during the early years of college influences an increase in identity processes as students “try out” which identity they wish to develop and maintain. This is supported by the analysis in chapter five in which students in the third year had a stronger sense of identity in comparison to first or second years. Interestingly Leong et al (2005) see identity on a continuum rather than a categorical “yes or no” identification with a subject area or group. This view is shared by the present study and therefore participants will be measured on a scale from strong to low identification.

### *7.1.3 Social identity within undergraduates*

Identity within this thesis has further been defined within that of a Social Identity Theoretical framework. Chapter seven through a process of factor analysis developed a model of the theoretical structure of Academic Social Identity, including its observable factors of evaluation of Psychology, normative categorisation of self against psychology students and affect (emotional). It has been argued that a combination of these factors represents Academic Social Identity and students who are high in this will have a high evaluation of Psychology as a subject. This will further drive their feelings of belonging and pride in the subject, leading to a student adopting a student identity. Furthermore, it was argued that behaviours will change to conform their idea of a Psychology student. This categorisation is seen not only in the factor analysis results of chapter seven but also in the meta-ethnography in chapter three and four and in the focus group research in chapter five.

#### *7.1.4 Hypotheses*

It is predicted that Academic Social Identity, Academic self-efficacy and conscientiousness will predict attainment as measured by GPA. Additionally, the relationship between Academic social identity and attainment will increase with progress through degree levels.

## **7.2 Method**

### *7.2.1 Participants*

Seventy-one participants were included in the final analysis with four participants removed as they had not indicated their permission to access grades. Three students had also attempted to complete the study twice, as it was not possible to ascertain which was their intended answer they were also removed. All of the students were full time with the majority studying Psychology as single honours (n=47). Again, more first year students took part (n=34), this is possibly due to course credits which were awarded for completion of this study. The remaining students were 2<sup>nd</sup> (n= 17) and 3<sup>rd</sup> (n=20). Fifty-seven students were female with only four male participants. This is not unusual for Psychology studies and while of some concern, sex is not a predictor in this study and therefore will not have an impact on the final analysis. It can be noted that only 4 male students responded to the emails to take part in the research. While this may be a concern for Academic Conscientiousness, a trait in which girls generally score higher, gender is not considered to be an issue for the development of Academic Social Identity which is the variable that is of importance for the current study.

### *7.2.2 Design*

Predictor variables were Academic Social Identity, Academic Self-Efficacy and Academic Conscientiousness. Additionally, year and mode (full time or part) of study. An outcome variable of GPA grade at the end of the year shortly after the completion of the survey was recorded from student records with permission of the participants.

### *7.2.3 Measures*

Richardson, Abraham and Bond (2102) argue that the best proxy of academic achievement is best obtained using cumulative grades rather than a single assignment. In this study GPA was retrieved no more than 3 weeks after completion of the online survey and was an end of semester grade.

The Academic Social Identity Scale has 14 items and 3 sub-factors of Subject-Evaluation, Normative and Emotion. The measure has a range of 14 – 98 and utilises a Likert scale of 1-7 with high scores indicate higher levels of Academic Social Identity. Academic Conscientiousness (McIlroy, 2000) measures academic behaviours such as promptness, organisation, study strategy, discipline, consistency and diligence. In further research McIlroy and Bunting (2002) found this measure to have a relationship of .58 with GPA grades. Higher grades in this scale equal higher level of Academic Conscientiousness and were answered by a Likert scale of 1-7.

Academic-efficacy was also a ten-item self-report scale developed to measure Bandura's theory of efficacy (1986, 1994). It therefore includes items designed to reflect the construct of the individual's self-belief of success and action based on this belief including the ability to overcome obstacles. Previous research indicated that the scale has a Cronbach's alpha's of 0.87 for self-efficacy. Again higher scores on this measure correlate with higher levels of self-efficacy with a Likert scale of 1-7.

### *7.2.4 Procedure*

Self-report measures were completed online via Survey Monkey, generally these should only take 10 minutes to complete. The students were contacted via email and online research participation databases. First years were given one course credit for taking part. The research was undertaken during the summer term. This period was selected as exams were approaching and all students it was thought would be engaged in higher levels of study. As previously explained in chapters 5 and 6, Academic Social Identity fluctuates depending on "student" type behaviour. Some students are naturally more conscientious than others, thus it was decided that to control for this variable exam period would ensure that all students



were likely to be engaged in “student” behaviour. Examination results were obtained one month after the examinations were completed and average GPA was used to record their Psychology grade. Additionally, students were entered into a small prize draw (£25 Amazon voucher) for taking part.

### 7.3 Results

A multiple regression was undertaken to explore whether the outcome variable of Psychology grade (as measured by end of year GPA) could be predicted by Academic Social Identity, Academic Self-Efficacy and Academic Conscientiousness. Additionally, mode and year of study as dummy variables were included in the model.

#### 7.3.1 Descriptive statistics

The outcome variable of GPA grade had normal distribution with no significant skew (0.40) or kurtosis (0.00). The range was 52 with a low grade of 29 and a high of 81 (mean = 59.35 (SD = 11.09). These are in line with normal grades for the end of year GPA for each of the cohorts included. However, third years had an average grade of 62.25, with first and second years reported average grades of 58.38 and 57.82, indicating that grades increased as students progressed through their degree. However, this should be treated with caution as 1<sup>st</sup> year students were given a course credit and therefore a broader range of ability may have been encouraged to take part, though it is hoped this is offset by the prize draw.

Academic Social Identity Scale, Academic Self-Efficacy and Academic Conscientiousness had a normal distribution, the range, mean and standard deviations are reported in table 7.1

Table 7:11: Descriptive statistics of ASI, Self-efficacy and Conscientiousness

	Mean	SD	Range	Skewness	Confidence intervals		$\alpha$
					Low	High	
ASI-Total	71.92	15.25	56 (38-94)	-1.07	68.31	75.52	0.96
Academic Self-efficacy	48.83	11.61	53 (17-70)	-0.18	46.08	51.58	0.87
Academic Conscientiousness	42.82	11.67	53 (17-70)	0.29	40.06	45.58	0.88

Academic Conscientiousness and Self-Efficacy also had normal distributions and the reported means and standard deviations are summarised in table 7.1. The mean for Academic Self-Efficacy was higher than Academic Conscientiousness. With further exploration of this particular predictor variable it is seen that single honour students (41.79) were lower than joint (44.83), this is an unexpected difference in conscientiousness. Year of study did show more predictable trends with first and third year students (mean = 43.26, mean = 44.87) having higher conscientiousness levels than 2<sup>nd</sup> years (mean = 39.52). Males (mean = 38.93) had lower levels of conscientiousness than females (mean = 43.78). A deeper exploration of the frequencies within the data show that slightly more males take single honours, however given that numbers of males were low this should be treated with caution. Nonetheless previous research has shown that males are lower in conscientiousness and this may indicate why the difference between single and joint honour students in this research occurred.

### 7.3.2. Assumption Testing

Standard residuals analysis indicated that there were no extreme outliers (Std. residual min = -2.35, Std. residual max = 3.09). An analysis of collinearity statistics showed that multicollinearity was not a concern as shown in table 7.2 below.

Table 7:12: Multicollinearity statistics for each variable

	Collinearity Statistics	
	Tolerance	VIF
ASI-Total	0.72	1.40
Academic Self Efficacy	0.54	1.85
Academic Conscientiousness	0.54	1.86
Year of study	0.78	1.27
Mode of study	0.85	1.18

The data met the assumption of independent errors (Durbin-Watson value = 1.03). Both the histogram of standardised residuals and the normal *P-P* plot of standardised residuals indicate that errors are normally distributed, both charts are shown in figure appendix I. Additionally, the scatterplot of standardised predicted values indicate that the data met

assumptions of homogeneity of variance and linearity. Non zero variances of each of the predictor and output variables were met, included in table 7.2, above.

### 7.3.3 Multiple regression

Correlations for each of the variables are reported below in table 7.3. It can be concluded at this stage that simple large correlations exist between Academic Social Identity and Academic Self-Efficacy and Conscientiousness and the outcome variable of Psychology grade (GPA). It would seem that mode of study and year of study was not significant, however these are dummy variables and the multiple regression model will be used to fully explore these variables.

Table 7:13: Correlation matrix

	1	2	3	4	5	6
1. Psychology Grade	-	<b>0.79</b>	<b>0.52</b>	<b>0.61</b>	0.15	0.07
2. ASI-Total	<b>0.79</b>	-	<b>0.45</b>	<b>0.44</b>	<b>0.25</b>	0.00
3. Academic Conscientiousness	<b>0.52</b>	<b>0.45</b>	-	<b>0.63</b>	0.04	0.11
4. Academic Self-Efficacy	<b>0.61</b>	<b>0.44</b>	<b>0.63</b>	-	0.17	0.07
5. Year of study	0.15	<b>0.25</b>	0.04	0.17	-	<b>-0.36</b>
6. Mode of study	0.07	0.00	0.11	.065	<b>-0.36</b>	-

Numbers given in bold are significant at  $p > 0.05$

A more useful exploration at this stage for these variables would be tests of difference. As such a t-test was used with Mode of study as the IV and psychology grade, ASI-Total, Academic Conscientiousness and Academic Self-Efficacy. Furthermore, a one-way ANOVA indicated that year of study also was not significant with GPA as the DV ( $F = 1.16$ ,  $df = 2,68$ ,  $p = 0.32$ ). Nonetheless each of these variables will be included in the regression model in a block with stepwise entry.

A stepwise multiple regression was used in order to establish the strength of each predictor variable in the model. The first model generated included only the variable ASI-Total ( $R = 0.79$ ,  $R^2 = 0.62$ ) and reported a significant ANOVA ( $F = 113.99$ ,  $df = 1,69$ ,  $p > .001$ ). A

second model included the variable of Academic Self-Efficacy which slightly improved the overall prediction of GPA ( $R = 0.82$ ,  $R^2 = 0.71$ ;  $F = 83.11$ ,  $df = 2,68$ ,  $p > .001$ ). Standardised beta coefficients for the two predictors included in the best fitting model are ASI-Total,  $\beta = 0.43$ ,  $t = 8.82$ ,  $p < .001$ ; Academic Self-Efficacy,  $\beta = 0.29$ ,  $t = 4.51$ ,  $p < .001$ .

The variables of Academic Conscientiousness and year and mode of study were excluded from the model. Therefore, it can be concluded that the results of the regression analysis provide partial confirmation of the research hypothesis with only ASI-Total and Academic Self-Efficacy being included in the model as predictors of GPA

As the focus of the thesis has been the role of Identity within undergraduates a further multiple regression which included the sub-constructs of the ASI was undertaken. Descriptive statistics are included in table 7.4 and indicate that each of the sub-constructs were normally distributed.

*Table 7:14: Descriptive statistics for each sub-construct of the ASI*

	Mean	SD	Range	Skewness	Confidence intervals	
					Low	High
ASI-Evaluation	27.60	6.83	23.00 (12.00-35.00)	-0.89	26.00	29.22
ASI-Normative	28.77	6.04	24.00 (-16-40.00)	-0.60	27.34	30.21
ASI-Emotion	15.54	3.68	14.00 (7-21)	-0.54	14.67	16.41

Standard residuals analysis indicated that there were no extreme outliers (Std. residual min = -2.34, Std. residual max = 2.32). An analysis of collinearity statistics showed that multicollinearity was not a concern as shown in table 7.5 below.

Table 7:15: Multicollinearity statistics for each sub-construct on the ASI

	Collinearity Statistics	
	Tolerance	VIF
ASI-Evaluation	0.23	4.38
ASI-Normative	0.42	2.36
ASI-Emotion	0.25	4.01

The data also met the assumption of independent errors (Durbin-Watson value = 1.21). Both the histogram of standardised residuals and the normal *P-P* plot of standardised residuals indicate that errors are normally distributed, both charts are shown in figure appendix I. Additionally, the scatterplot of standardised predicted values indicate that the data met assumptions of homogeneity of variance and linearity. As all assumptions were met the three sub-constructs of the ASI were included along with Academic Self-Efficacy in a forced entry multiple regression which proved to be significant ( $R = 0.86$ ,  $R^2 = 0.74$ ,  $F(4,66) = 46.64$ ,  $p < .001$ ). The beta coefficients for the four predictors were ASI-Evaluation ( $\beta = 0.17$ ,  $t = 0.85$ ,  $p = 0.40$ ), ASI-Normative ( $\beta = 0.85$ ,  $t = 5.21$ ,  $p < .001$ ), ASI-Emotion ( $\beta = 0.25$ ,  $t = 0.71$ ,  $p = 0.48$ ), Academic Self-Efficacy ( $\beta = 0.30$ ,  $t = 4.76$ ,  $p < .001$ ).

Thus far it can be concluded that while ASI-Total was significant in the first multiple regression and with Academic Self-Efficacy would suggest a strong relationship with GPA and therefore good predictive ability. However, the second model would seem to question the Academic Social Identity construct with subject evaluation, normative and emotion aspects. Indeed, only the normative sub-construct showing to be significant in the second multiple regression. The discussion in chapter seven indicated the possibility of a two factor solution was also a plausible structure for ASI. Therefore, a multiple regression with ASI-Evaluation and ASI-Emotion as a combined variable (ASI-Evaluation with emotion), with Academic Self-Efficacy and ASI-Normative was performed this gave the following as best fit. Forced entry multiple regression, which proved to be significant ( $R = 0.86$ ,  $R^2 = 0.73$ ,  $F(3,67) = 63.10$ ,  $p < .001$ ). The beta coefficients for the four predictors were ASI-Normative ( $\beta = 0.85$ ,  $t = 5.27$ ,  $p < .001$ ), Academic Self-Efficacy ( $\beta = 0.30$ ,  $t = 4.76$ ,  $p < .001$ ), ASI-Evaluation with emotion ( $\beta = 0.20$ ,  $t = 1.97$ ,  $p = 0.05$ ).

#### **7.4 Discussion**

Following a number of multiple regression analyses the variables of ASI-Total and Academic Self-Efficacy were found to be predictive of GPA, with ASI-Total showing an increased correlation compared to Academic Self-Efficacy. Further data analysis shows that only the sub-construct of normative was significant with emotion and subject evaluation not included unless these were combined. Therefore, it can be concluded that while ASI-Total is related to academic attainment, the sub-constructs that relate to GPA are ASI-Normative and ASI-Evaluation with emotion. Academic Conscientiousness and year and mode of study were not found to be significant.

First the discussion will briefly consider the ability of Academic Social Identity to predict GPA before exploration of the other variables. A fuller discussion of ASI and grade outcome will be discussed in the final chapter of the thesis (chapter 9). In chapter 7 it had been proposed that a two factor model of Academic Social Identity was a possible solution, however it was argued that this ASI-Emotion was a unique variable that was important to the model as a separate construct to that of Evaluation and Normative dynamics. It is possible that this was incorrect and that indeed a better model would be to subsume Emotion construct into Evaluation and Normative. As discussed in chapter 7 it is accepted that there would be a strong relationship between high evaluation of subject and a sense of pride. It is therefore likely that this ASI-Emotion construct is an outcome of ASI-Evaluation. A solution to this was identified and a further multiple regression undertaken with ASI Evaluation and Emotion combined and the other two significant variables still included (Academic Self-Efficacy and ASI-Normative). This model was accepted as significant with a strong predictive ability. A fuller explanation with a fuller discussion of the implications of this will be discussed in chapter 9 as the thesis is brought to a conclusion.

A further surprise had been the rejection of Academic Conscientiousness as a predictor of GPA. This contradicts previous research which found that it had a strong relationship (Richardson, Abraham & Bond, 2012, McIlroy, 2000) independent of intelligence. The items included in the scale included such questions as “I always plan my study time as a top

priority” and “I seldom work as hard at my studies” which should represent good study habits. However it is possible that the timing of this study (approaching exam period) meant that students were applying themselves generally. This may also explain why mode of study and year of study was also insignificant. Additionally, it may be that by the end of the year students had established better study habits and these were reflected in their answers. Furthermore, it is possible that the recruitment technique meant only students with a good level of conscientiousness completed the questionnaire. Further study would require improvement to answer these questions. Most importantly a longitudinal design would elucidate the changes of conscientiousness over the course of the year, this would also allow for a better understanding of the relationship between GPA, conscientiousness, mode of study and level (1<sup>st</sup>, 2<sup>nd</sup>, 3<sup>rd</sup> year).

The inclusion of Academic Self-efficacy in the model supports previous research (Richardson, Abraham & Bond, 2012; Zimmerman, 2000; Schunk & Pajares, 2002; McIlroy, 2000) which is increasingly showing that a student’s belief in their ability and their subsequent motivation to study leads to increased GPA. The present study found a stronger relationship between Academic self-efficacy and their achievement than some of the other studies. For example, Richardson, Abraham and Bond (2012) found that self-efficacy had a moderate relationship to GPA of  $r = 0.31$  whereas the present study reported  $r = 0.61$ . This increase may be due to the differences between performance efficacy and academic efficacy (Zimmerman, Bandura, & Martinez-Pons, 1992). Performance efficacy draws on a person’s recent experiences to evaluate their ability to achieve in the next situation. Academic self-efficacy better reflects Bandura’s (1986) definition of self-efficacy which is based on the person’s general ability to achieve, in this case in the specific situation of academia. Academic self-efficacy is more robust to immediate situations and therefore a better measure of outcome. Nonetheless, this variable should be studied over the year to better understand how self-efficacy develops as a student progresses through a new level of study.

## **8 Thesis summary**

### **8.1 Introduction**

Broadly this thesis had the aim of exploring the journey of Higher Education from the perspective of the identity processes of the undergraduates involved. The study sought to do this using Social Identity Theory and Social Categorisation theories as a framework. It also sought to understand how identity developed and was maintained with the intention of being able to relate this to university success and achievement. The general research literature of the area does not give a theoretical framework in which to understand the development of identity. Neither is there currently a specific tool for measuring identity amongst students. It was the aim of the study to fill these gaps in knowledge. Alongside these two broad objectives there were a number of research questions to offer further focus:

1. What are the experiences of student transition into Higher Education?
2. Is Social Identity or Categorisation Theory able to explain the dynamics of starting a new phase of education on student's ability to integrate?
3. How is identity understood by students themselves?
4. Do they develop equally a student, subject or institutional identity or are there differences amongst these possible domains?
5. Is the identity developed at University unique and if so can it be adequately measured and quantified?
6. Does a strong Academic Identity impact on student success at University?

This final chapter will first discuss the main findings that emerged from each of the chapters. It will next report the implications of these results. Additionally, it will discuss recommendations for future research and limitations of the current study.

### **8.2 Main Findings**

The main findings of the study were chapter related and a summary of each one will be given here. More importantly this section will then move on to showing how the chapters integrate to provide a synthesis of these findings.



### 8.2.1 *Research questions and findings*

**4RQ1:** Is identity development evident in the narratives of the participants and researchers included in the research?

**4RQ1a:** - What are the processes involved in identity development?

**4RQ2:** Is there evidence of a transition typology in the research data and the narratives of the participants?

**4RQ2a:** Which of the transition typologies best explain the experience and processes involved in the transition?

**4RQ3:** What is the experience of transition in the first year of university with a focus on those studies that explore transition prior to drop-out?

**4RQ3a:** Are stresses inevitable part of the transition process

**4RQ3b:** Can stress be alleviated by the structures of the university?

**4RQ5:** Are the experiences and outcomes of transition universal across students?

The analysis showed that transition during the first few months of university life can be understood through the processes of Social Identity Theory of Self Categorisation and Social Comparison. The main findings of this chapter, presented textually and in the final thematic map answer the questions posed in the introduction about identity development and the processes involved (4RQ1/4RQ1a). The final thematic map (p.74, figure 4.2) and the quotes showed that students were keen to find a place to belong with comparisons of in-groups and out-groups which involved categorisation of groups. This was found to be the case across a number of domains, for example day time students categorising full time students as an out-group to traditional students categorising non-traditional students. Additionally, these processes were not seen only in the first year but students in the 2<sup>nd</sup> and 3<sup>rd</sup> year, though this needs to be explored further as the focus of many of the papers were those first months. Furthermore, students reported stress during the early transition period as the norm, however this was not found to be a strong a theme as others in the analysis. Furthermore, stress (in particular academic challenges and stress) and often facilitated growth and increased the social identity as students. Importantly this finding answers 4RQ4 regarding stress which was a weak universal finding but interestingly was not necessarily a negative factor. While the research focused on the first year it can be seen that students themselves talked about

transition as development although not all accepted that education at Higher Education had changed them. Additionally, it can be seen that students sought to “be students” and in this case it was an Identity that they felt was achievable and highly sought by the majority of participants. It is suggested that to classify identity transition as either “induction”, “developmental” or “becoming” as proposed by Gale and Parker is too simplistic (4RQ2). Figure 4.2 (p.74) proposes a new model which incorporates the findings from the present study and the different typologies of transition reviewed in the introduction to this chapter. It was expected that transition would look more like T1 and T2 types however it was found that the process is ongoing, possibly beyond graduation and into early careers. As posed by 4RQ5, transition and the challenges that brings is universal but there were some participants that adapted better than others and some students who found university life more difficult even after the initial stages. Therefore, the present study strongly suggests that to ignore the uniqueness of induction period leads to students not being integrated into university life. Furthermore, the evidence of the meta-ethnography suggests that while indeed the university system is not as accepting of narratives of non-traditional students as it is of traditional students and additionally that while there were differences across these groups in terms of their goals and agenda’s nonetheless this was not a major element of the analysis. The induction period, indicates a unique period in which students seek support from new peers, however institutional support was a weak theme throughout the analysis. This was unexpected as previous research such as that by York and Longden report (2008) found that support from the University enabled students to adapt to degree level education and campus life. Furthermore, Astin (1984) indicated that staff were important within the transition process, indeed a proposal of the current thesis is that staff are part of the possible future identity that students seek to categorise and seek to belong to. It also possible that non-traditional students do not find it difficult to fit into the “university” process to quite the extent that Gale and Parker propose. Indeed, these students were the only ones that cited staff as important to their academic progression. It may be that the focus of the present study, that of identity, had precluded papers that had explored staff and student dynamics. As few papers looked at Social Identity Theory and therefore possible comparison groups, including staff, this may be one reason this theme did not emerge.

**5RQ1** What are the influences of identity processes during transition periods?

**5RQ2** How do Social Identity and Self-Categorisation theories inform different aspects of identity during Undergraduate study?

**5RQ3** Do the development of academic identities change student behaviour?

**5RQ4** Do undergraduates construct identities and display language that evidences this?

Directly addressing 5RQ1, 5RQ2 and 5RQ4, the data indicated that while students had negative external influences about two of the possible social identity groups, that of student and institution, the impact of these external influences had different effects on the student's categorisation and comparison behaviour. With student identity they engaged in distancing themselves from the out-group (non-students), however from the social group of institution they actively distanced themselves from the in-group. This is made even more interesting when we consider that the participants readily accepted the negative comments of the out-group about the student identity, acknowledging this typified them as students themselves. However, the institution label, while distancing themselves from it was less obviously internalized. Indeed, students were found to hide behind their subject identity, enhancing that identity to overcome what they saw as deficiencies in the broader institution. A further possible explanation for the difference in acceptance of student or institutional identity is the external information regarding each of these social groups. For example, the cultural information for institutions is that of quantitative ratings as discussed in the introduction (i.e. NSS and league tables). However, student identity has a cultural narrative, which talks about a rite of passage for young adults into adulthood. This narrative allows for the student behaviour identified in this article such as drinking and laziness as a period of testing boundaries. Additionally, as understood in Chapter four participants could use these behaviours to integrate socially. However, the institutional identity is that of worth bound up in future objectives and expectations. Further research should consider whether differences in transitional groups could further explore the role of cultural norms attached to possible student identities.

Perceived low status institutions should acknowledge that students may be exposed to external negative evaluations. However, this study indicated that it is possible to overcome these by strong subject identities in which students were given opportunities to engage academically with each other. Furthermore, it is possible for smaller sub-groups of students who felt that they had a unique identity to rebuff the external negative influences and comparisons of the larger institutions. In order to fully understand the dynamics, further research is required which explores the identity patterns of students attending traditional and large universities. Future research should also consider the impact of identity patterns on attainment levels. This is especially the case when it can be concluded that the relationship between identity and behaviour change was weak (5RQ3). While some students did verbalise that they felt most identifiable as a student when either doing work they found challenging, engaging in study or in group work this was not a consistent finding. It is unsure whether this was due to an uncertain identification with the label student or whether identity doesn't have a surface behaviour change.

The qualitative research presented in the thesis thus far supports the proposition that Social Identity Theory and Social Categorization Theory explains a student's journey through academia. Throughout the interviews, students would talk of social comparisons between themselves and the category groups in question. This worked both negatively and positively on self-esteem depending on their evaluation of the group. Further Self-Categorisation processes will be discussed in the next chapters as each domain is discussed in more detail.

The journey of becoming a student was a clear theme that emerged throughout the interviews from shaky starts to those who were moving on and expressing a sense of loss as they were due to graduate. Additionally, this theme included topics which helped to increase identity and those which decreased or threatened identification with the various domains. Unlike the previous chapter, which had focused on the transition phase into university this study considered also, moving on from university. The findings in Chapter 4 indicated that students had a sense of becoming “a student” through the processes of Social Identity and Self-Categorisation. This chapter sought to understand how these processes enable the students develop a social identity within various domains of student, subject and institution.

The thematic map that was presented at the end of chapter 4 shows how transition is an ongoing process though the institution certainly had an initial role in helping students adjust successfully. Within the current study, the processes in the map were evident. However, what had not been apparent in the previous chapter was the role of external influences on identity once the student had arrived at university. This was particularly the case with institutional identity, and while the processes outlined in the transitional figure still apply instead of it leading to higher affiliation with Liverpool Hope the circular comparison led to a further disengagement. While it had not been fully spelt out it was an underlying assumption that generally the processes would lead to increased identification. If identities fluctuate and change based on the strengths and threats identified within this chapter, then it is necessary to develop an ability measure identity within students. This will be addressed in chapter seven.

**6RQ1** Is the structure of the Academic Social Identity derived from Social Identity Theory?

**6RQ1a** Does the structure of Academic Social Identity reflect the three components of Social Identity?

The analysis of the final scale shows a good degree of validity of reliability though the structure of Academic Social Identity that has emerged is different from the that which had been originally proposed in the opening chapter of the thesis. The scale only measures one domain (that of subject) which supports the findings of chapters 4 and 5. However, importantly the final scale of 12 items reflects the factors of Subject Evaluation, Normative Comparison and Affect (Emotion) which equate to factors identified by a number of researchers (Ellemers, Kortekaas & Ouwerkerk, 1994; Cameron, 2004) within Social Identity and Self-Categorisation Research and therefore reflect the research to date. The confirmatory factor analysis confirms this structure, though it is recognised that possibly two factors would be sufficient to measure the construct of Academic Social Identity. However, the theory behind the 2 factor solution is less secure and therefore it has been decided to keep Evaluation (factor 1), Normative (factor 2) and Emotion (factor 3).

**7RQ1** Does Academic Social Identity correlate with attainment?

**7RQ2** Does attainment correlate with ASI to a lesser or greater degree than Academic self-efficacy and conscientiousness?

**7RQ3** Does the relationship between Academic social identity and attainment increase with progress through degree levels?

The results presented in chapter indicate that variables of ASI-Total and Academic Self-Efficacy were found to be predictive of GPA (7RQ1). ASI-Total showed an increased correlation compared to Academic Self-Efficacy (7RQ2). Further data analysis shows that only the sub-construct of normative was significant. The sub-factors of emotion and subject evaluation were not included unless these were combined. Therefore, it can be concluded that while ASI-Total is related to academic attainment, the sub-constructs that relate to GPA are ASI-Normative and ASI-Evaluation with emotion. Academic Conscientiousness and year and mode of study were not found to be significant. This answers 7RQ3, which had suggested that results would indicate that the relationship between ASI and attainment would strengthen over the course of the degree. A fuller discussion of ASI and grade outcome will be discussed in the final chapter of the thesis (chapter 8). In chapter 6 it had been proposed that a two factor model of Academic Social Identity was a possible solution, however it was argued that this ASI-Emotion was a unique variable that was important to the model as a separate construct to that of Evaluation and Normative dynamics. It is possible that this was incorrect and that indeed a better model would be to subsume Emotion construct into Evaluation and Normative. As discussed in chapter 6 it is accepted that there would be a strong relationship between high evaluation of subject and a sense of pride. It is therefore likely that this ASI-Emotion construct is an outcome of ASI-Evaluation. A solution to this was identified and a further multiple regression undertaken with ASI Evaluation and Emotion combined and the other two significant variables still included (Academic Self-Efficacy and ASI-Normative). This model was accepted as significant with a strong predictive ability. A fuller explanation with a fuller discussion of the implications of this will be discussed in chapter 8 as the thesis is brought to a conclusion.

A further surprise had been the rejection of Academic Conscientiousness as a predictor of GPA. This contradicts previous research which found that it had a strong relationship (Richardson, Abraham & Bond, 2012, McIlroy, 2000) independent of intelligence. The items included in the scale included such questions as “I always plan my study time as a top priority” and “I seldom work as hard at my studies” which should represent good study habits. However, it is possible that the timing of this study (approaching exam period) meant that students were applying themselves generally. This may also explain why mode of study and year of study was also insignificant. Additionally, it may be that by the end of the year students had established better study habits and these were reflected in their answers. Furthermore, it is possible that the recruitment technique meant only students with a good level of conscientiousness completed the questionnaire. Further study would require improvement to answer these questions. Most importantly a longitudinal design would elucidate the changes of conscientiousness over the course of the year, this would also allow for a better understanding of the relationship between GPA, conscientiousness, mode of study and level (1<sup>st</sup>, 2<sup>nd</sup>, 3<sup>rd</sup> year).

The inclusion of Academic Self-efficacy in the model supports previous research (Richardson, Abraham & Bond, 2012; Zimmerman, 2000; Schunk & Pajares, 2002; McIlroy, 2000) which is increasingly showing that a student’s belief in their ability and their subsequent motivation to study leads to increased GPA. The present study found a stronger relationship between Academic self-efficacy and their achievement than some of the other studies. For example, Richardson, Abraham and Bond (2012) found that self-efficacy had a moderate relationship to GPA of  $r = 0.31$  whereas the present study reported  $r = 0.61$ . This increase may be due to the differences between performance efficacy and academic efficacy (Zimmerman, Bandura, & Martinez-Pons, 1992). Performance efficacy draws on a person’s recent experiences to evaluate their ability to achieve in the next situation. Academic self-efficacy better reflects Bandura’s (1986) definition of self-efficacy which is based on the person’s general ability to achieve, in this case in the specific situation of academia. Academic self-efficacy is more robust to immediate situations and therefore a better measure

of outcome. Nonetheless, this variable should be studied over the year to better understand how academic self-efficacy develops as a student progresses through a new level of study.

### **8.3. Synthesis of findings**

#### *8.3.1 Identity needs within students*

The main finding to emerge was that students have a strong need to develop an identity. This finding was supported by chapters four, five and seven all of which explored how identity is developed and conceptualised. Each of these chapters built a picture of the majority of students, who particularly during periods of transition, sought to identify with other students and their subject areas. However, chapter four did conclude that not all students want to identify with the label of “student”. It was unexpected that students would feel so strongly about “other groups” around them and the in-groups that were identified were not expected, for example the out-group denigration of traditional students by non-traditional students. Nonetheless even this shows that students are engaging in Social Identity Processes, and this was further seen in chapter four when students talked about identification with their subject. Here however, the negative aspect of the “student” identity was even more apparent and participants, while happy to accept the label, also voiced negative narratives surrounding the label, for example students party and are lazy. More importantly by this stage in the research it was obvious that students do not seek to identify with their institutions while feeling strong affiliation with their subjects. This was further supported by chapter seven’s factor analysis of the construct of Academic Social Identity which showed student label extremely variable. It therefore can be concluded that students display social identity processes during the time at university with the majority of the participants involved in the study showing their need for some level of identification with student and especially subject area. It can further be concluded that Social Identity and Social Categorisation are acceptable theories in which to understand these processes. The theoretical implications of this will be discussed further into this section. Additionally, it was expected that students would change their behaviour based on their identity with their subject, taking on the unspoken rules of their academic tribe. This was not found to be part of the construct of Academic Social Identity and instead it was argued that this better be seen as an outcome, this will be discussed in section 9.1.4. It can be concluded however, at this stage that the research questions about



identity processes and their link to SIT and SCT can generally be accepted.

### *8.3.2 Transition periods*

Another finding that emerged was that of the importance of transition periods for triggering identity processes. It was expected that the start of university would instigate students need for identity, this is not unique to university and it was therefore reasonable to conclude this would also occur when starting Higher Education. Again this finding can be seen through chapters five and seven with students showing increased levels of identity as they progressed through university, with participants in the focus group study of chapter 5 showing a more complex identity at third year. Identity processes, however, were not just seen at the transition into Higher Education but also during and even at the end as seen in chapter 5 with students who were about to leave. Furthermore, there was an issue in chapter 8 in which students did not display differentiation between various levels of study and identification with their subject area. Nevertheless, the initial move into Higher Education saw noticeable Social Identity and Social Categorisation dynamics and therefore it is reasonable to accept that the first year experience is important and this will be discussed in policy implications.

### *8.3.3 Measuring Academic Identity*

While chapter seven deals with this in an empirical study it was the findings of chapters four and five that helped develop an understanding of identity as not only displayed by students during their undergraduate journey but also their understanding of identity and whether it had a purpose for them. The conclusions of these explorations informed the development of the first scale, as well as helping when reviewing each of the subsequent drafts. As already discussed there were different levels of identification with the various labels of student, subject and institution with subject the most secure, positive and most likely to lead to greater engagement. Chapter seven supported this and items that measured “student” identity as opposed to “subject” identity were highly variable and therefore discarded. Subject identity was more consistent and a structure of the construct Academic Social Identity was developed through factor analysis. This supported the theory that identity during undergraduate study can be explained by Social Identity and Categorisation Theories. However, chapter eight brought into question some of the conclusions of Chapter seven. It

had been argued that the construct was better understood as a three-factor solution. However, when it was measured against actual achievement this was not the case and it would seem a better solution would be to model the construct as a two factor solution with Evaluation and Emotion combined. Again, theoretical implications will be discussed shortly.

#### *8.3.4 The relationship between Academic Social Identity and Engagement*

The final finding is discussed in chapter 8 and broadly speaking supports the hypothesis that a strong academic identity is correlated with academic achievement can be supported. It had previously been thought earlier in the thesis that the behavioural aspect of identity would be a sub-construct of Academic Social Identity. As chapter seven's initial factor analysis showed however, this was not the case and behaviour was not included in the final solution. Chapter 8 therefore was important to explore this relationship and its main finding was that Academic Social Identity when measured by the two factors of ASI (Evaluation and Emotion) and ASI (Normative identity) has a strong correlation with GPA.

### **8.4 Theoretical implications of the study**

It was the main premise of the study that previous research, while referring to identity within undergraduates, had not fully defined, explained or measured it adequately enough. It was the aim of this thesis to fill this gap and the findings summarised above shows that this has been met. It is therefore important to outline how it has managed to achieve this.

The literature presented in the early chapters of the thesis (chapters 2 and 3) conceptualised identity in a number of ways as outlined in the models listed in chapter 2 (p.10). Furthermore, the work on transition in chapter three also focused on what it was to become a student. These two strands are important to the final understanding of Identity as developed through this thesis. In summary it is proposed that identity for undergraduates is more than simply belonging but that of internalisation of their subject identity and that this is most likely to occur during transition periods, particularly in the early months of entry into Higher Education.

Gale and Parker (2014) strongly argued that transition has to be more than simply belonging or developing into a student but needs to be viewed as becoming and seen in the context of the person's previous experiences. This was confirmed by the final model which is presented in chapter 4 and shows a complex picture of transition and how it can be understood through the framework of Social Identity and Categorisation theories. What has not been brought out previously in this thesis is how the typologies of transitions outlined in chapter three (p.26) can be incorporated into the research about the different models of identity in chapter 2. To summarise Gale and Parker argue that transitions are conceptualised in a number of ways in the literature which influence policy in quite distinct ways. These typologies were as follows:

- i. Transition as a fixed turning point (e.g. Palmer, O'Kane, & Owens, 2009) and could be labelled as an "induction" view of transition.
- ii. A second label is that of "development" which is that of developing a new identity.
- iii. Lastly transition can be seen as a flexible period and status which Gale and Parker labelled as "becoming".

It was only the final typology that Gale and Parker (2014) argue is truly able to accommodate the student's previous experiences and narratives and therefore offer an adequate transition policy in which all students could be catered for. Certainly the research in chapter 4 shows that non-traditional students struggle to see themselves as able to fully participate or identify with higher education labels in a way that was not identified amongst traditional students. However, of more interest here is the possibility that these links with the classifications of the research identified in chapter two.

Identity within Higher Education research historically was presented as a background variable such as ethnicity and socio-economic status (Nagel, 1995). Such research argued that students may begin university with a cultural gap that needs to be made up. As will be seen when this argument develops, and in line with Gale and Parkers "becoming" typology, background of the student cannot be ignored. Indeed, Gale and Parker place such background variables as central to their issue with higher education induction programmes which ignore such nuances. Furthermore, the model that was presented at the end of the

chapter 4 and represented in chapter 5 with updated findings incorporated research that proposes that some students start their undergraduate career with what has been called discreditable identities (paper 2) and they therefore have a greater drive to undertake self-categorisation and comparison of themselves to other students and the ideals of the university system. While the identity research presented within this classification is incomplete it is nonetheless important to understand and incorporate into future research.

Later research emerged that explored identity as an aspect of what a person does, for example professional development through undergraduate and post-graduate study. This classification has been well researched with plenty of literature surrounding the development of professional identity (Wyatt, 1954; Roberston, 1959). Additionally, this thesis actively excluded such research from its literature and meta-ethnography. However, this classification emerges in the findings of chapter 4 during the meta-ethnography when a minority of students stated that they saw a degree only in terms of “doing” (paper 6) and how it could help them develop their career. It could be argued that this is not an issue, however as proposed by Gale and Parker this fails to encourage the non-traditional student to “become” in quite the same way as the more traditional middle class participants. Furthermore, the thesis argues strongly that all students display identity processes including those students for whom undertaking a degree is seen as a means to an end. For example, their categorisation of themselves as students who were more serious about their studies as opposed to those who were not, a classic in-group and out-group dynamic. Again, it will be outlined further why this aspect of induction, transition and identity cannot be ignored.

The final classification of “identity as part of a community” was originally framed as the closest to the research premise of the current study and argued that it drew on aspect of “identity is where I come from” and “identity is what I am”. It can also be seen that this is the closest to Gale and Parkers typology of “becoming”. It is proposed that the development of Academic Social Identity theory as outlined in the thesis is a plausible way of merging the transition and identity research into a more comprehensive framework. Furthermore, it gives a depth to both strands that was previously not identifiable in the literature. Quigley (2011) identified the origins of academic identity as:

“However, this is not to say that there are not commonalities; there are and I would argue that these commonalities may be set within a particular framework, which can help to situate an academic in terms of personal standing both within and without their particular institution and their personal and professional networks.” (p.21).

Of course, an issue here is that Quigley is talking about established academics who have developed a career in academia. Nonetheless this definition attempts to explain the origins of academic identity as derived from the “commonalities...within a particular framework.” This of course, is not dissimilar to the ideas of Becher and Trowler (2001) who argued that subjects have “academic tribes” in which there are shared unspoken rules, language and goals. The current set of studies in this thesis gives a framework for understanding how students develop this identity. From the conclusions made thus far a better definition that Academic Social Identity is proposed by this thesis as follows:

“a social identity that is derived from belonging to an academic subject at university, incorporating the process of the individual categorising themselves as similar to others with the same identity and based on a positive evaluation of the subject leading positive emotions.” (authors words).

It is what underlies this definition that is the strength of this thesis lies within the examination of the processes by which individuals develop an Academic Social Identity. A culmination of the literature presented in the thesis and the findings in each of the studies has been able to expose that students develop and identity at university in similar ways that they develop identities elsewhere. Crucially the definition is not only about those that have moved through their initial stages of entry into higher education but allows for new students at the start of their studies. Additionally, it includes the processes of Social Identity and Categorisation as identified by a number of researcher (Tafjel and Turner, 1979, Turner, 1985). However, the structure is not the same as that identified in the literature in chapter two or chapter seven. It was originally thought that the construct would be composed of three unique elements as outlined by Social Identity theorists, that is cognitive, emotion and behavioural (Ellemers, Kortekaas & Ouwerkerk. 1999). While some measures did follow

this structure (e.g. Karasawa's (1991) "Two Component measure of Identity") the majority did (Hinkle, Taylor, Fox-Cardamone & Crook, 1989; Ellemers, Kortekaas & Ouwerkerk, 1994; Cameron, 2004) and it was hypothesised that Academic Social Identity would be similar to these. However, the final construct reported a robust factor analysis with three components which differed from the previous measures. For example, Ellemers et al (1994) scale incorporated subscales of cognition, attachment to the group and evaluation of the status of the group. The current scale presented in chapter 7 does not include items which directly measure cognitive elements of identity, however normative identification relies on elements of cognition. Furthermore, this could be argued as being similar to Cameron's theory of centrality (1994). Additionally, evaluation and attachment are present but as a combined construct.

### **8.5 Practical implications**

The start of the thesis outlined the increased importance for institutions and their individual students in ensuring that Higher Education is as pedagogically effective as possible. Chapter one started with a picture of the UK university in a state of flux with increasing accountability to the public via league tables and NSS publication. This, with the increase in student fees, has impressed on institutions the need to improve the "student experience." The thesis that went onto outline the impact to the individual student who fails to transition into Higher Education successfully. Longden and Yorke (2008) cited stress and poor programme choice for as the reasons for most students leaving higher education however, alongside this was research by Tinto (1997) and Maunders, Gingham and Rogers (2010) who also highlighted the need to integrate socially during the first few months of university. Additionally, Astin (1984) identified the need for new students to have accessible support networks, this was supported by the model presented in the current research in chapters four and five. The present study found that support networks were a crucial buffering dynamic during the process of transition when students are comparing themselves against socially generated and internalised images of what it is to be a student. In answer to these issues the new definition of Academic Social Identity presented by the current study may be able to inform policy at an institutional level. It is recommended that institutions reflect on how identity is encouraged through the curriculum and developed through each of the years of

study. The literature around transition rightly identifies that induction must not be just about how students learn the initial rules of higher education but also how they develop and become “students”. It is the conclusion of the current study that institutions would be best encouraging this identity at subject level. However, positive institutional identity is possible as seen in chapter five when students were part of a smaller internal community within the larger institution. If, as the current study proposes, developing Academic Social Identity is related to academic success and achievement at university then ignoring this aspect of student development is detrimental to their progress. With universities increasingly under scrutiny by potential students and parents this should not be ignored. Increasingly graduates compete in a competitive job market and those with good degree awards are likely to succeed above those with lower awards. Further research needs to be undertaken that explores how identity can be encouraged amongst students who are not living on campus or are part time.

#### *8.5.1 Reflective account*

This section will include a reflexivity account of both the meta-ethnography and the focus group studies. While they held different challenges for me as a researcher there are some similarities that will be discussed. The aim of this account is not to be a critique of the research methodologies but rather to show how I placed myself within the narratives of the participants and researchers involved. Day (2012) states that “Reflexivity has emerged as a central and critical concept in the methodology of qualitative social research” (p.61). However, she also goes onto argue that reflexivity as a term means many things to authors, especially when we consider the varied academic fields that will engage in reflexivity. This variety of disciplines means that an author needs to ensure that their interpretation of reflexivity is obvious to the reader (Pillow, 2003).

*8.5.1.1 My journey* I am of course on a similar journey to many of the participants that are included in the research, albeit I am further along than they are. I was once where they are and have succumbed to the ideals of academia and embraced education as a transformative process. I have pursued an identification with my subject area and currently teach undergraduates through all levels of the curriculum. I think it is fair to say the subject area of

Psychology is one of my “social identities” and that I feel a strong level of belonging. Furthermore, I was a non-traditional student, the first of my family to undertake a degree which I did as a mother of two young children. Reading some of the interviews within the literature included in the meta-ethnography reminded me of my own struggle to accept that the world of academia was as much my right to belong to as students who were 18 and from traditional university families. Additionally, I recognised the risk that non-traditional students took when stepping out of the narrative they had grown up with. However, I struggled to accept that such students needed a special kind of curriculum as detailed by Gale and Parker (2014) in their review of induction programmes. Indeed, it was hard during the meta-ethnography to stay objective and not purposely reject evidence that supported this view. It is not an overstatement to say that I found this view offensive. However, during the course of the research my view on this has shifted as I forced myself to read objectively the findings of the literature.

*8.5.1.2 Dual role* I am not a peer for students but one of the faculty members that I had been arguing may shape their social identity and understanding of what it is to be a Psychology student. This is of course my status for both studies (meta-ethnography and focus groups) though with the interviews I was present and representing the departmental staff for the student who participated. This dynamic was difficult at times, not least when students spoke about how the institution is seen by others in the local area. I was careful to stay as neutral as possible during these interviews, keeping reactions to their evaluations under control.

*8.5.1.2 My personal experience* Coincidentally, during the time I was exploring issues of transitions, I had a daughter also starting her undergraduate programme. While I do not feel this had an impact on how I viewed the research that emerged it nonetheless gave a poignancy to the process that may have been absent. I would argue that this gave me a level of extra sympathy for the struggles that first years undertaken during their initial months at university. Indeed, I think my own daughter moving on to university and the current research has fed back into my role as personal tutor to first year students. It would be difficult to see



how undertaking the research outline in this thesis would allow an academic not to appreciate the importance they have in shaping a student's academic career. While this is most obvious in small groups the research throughout the thesis argues that the importance lies in the community which shapes a subject area.

### **8.3 Future research**

The scale of the field within which this thesis is placed is extensive and multifaceted. The current study has left numerous questions unanswered and outside the immediate scope of this research and would address gaps in theory and policy. Exploring the following will add to the current body of knowledge and inform practice.

1. Can identity be manipulated or encouraged in students who have low identification with their subject area? A further study that explored interventions designed to increase identity with a pre and post measure of ASI included in this may answer this question. It is also worth noting that if this was done with a broad range of students and took a longitudinal approach then grades could be tracked alongside identity fluctuations.
2. Furthermore, identity fluctuations themselves have not been answered by the current study. Again a longitudinal piece of research would be able to examine whether these fluctuations are a normal part of the identity process or whether such dips are can be used to identify risk of drop out.
3. While not discussed in the current study online education is a growing area within Higher Education with increased use of blended learning. It is possible that identity processes are different to face to face study. Research has indicated that online learning can be a variable experiences with higher rates of drop out due to feelings of isolation (Tyler-Smith, 2006). A possible explanation for this may be the lack of identity that students develop online.
4. Also not discussed is the changing face of current Higher Education with an increase in size of cohorts. The current study identified that belonging to a smaller community within a large institution can increase a sense of belonging. A further

exploration must be that of how students within in large institutions differ in their identity, if at all.

5. Additional scales which measure Academic Social Identity within other subject areas should be developed.

## **8.6 Policy implications**

The thesis started with a broad look at the current state of Higher Education within the UK by outlining the growth in student numbers as well as the increase in fees and the demands placed on Universities to maintain a high place within league tables based on student satisfaction. Further research presented showed that it was important for students well-being to successfully transition into Higher Education and achieve once they had started on a degree programme. The cost of not addressing these problems at an institutional level impacts on finance and costs for the university involved as attrition rates rise. However, arguably more importantly it is the impact on the individuals who do not make the transition smoothly with reports of lower self-esteem and confidence within this group (Longden, 2004). It is therefore, important that Universities address the issues presented in this thesis.

Currently it is the norm across the sector to centralise university support for students (Balmer, 2014; Temmerman, 2016). It is likely that while this is more cost-efficient, the findings within this thesis suggest that this may be counterproductive to students' outcomes and also hinder their need to fully identify with their chosen subject. At the very least institutions need to consider how they foster a sense of identity within smaller cohorts than currently is the norm. It was shown in chapter 1 that student numbers have grown (Gurney-Read, 2015) it is therefore questionable how easy it is for a student to identify with academics that they have difficulty accessing or only see from a distance (Temmerman, 2016). Again, while large intakes ensure lower costs per head this may be to the detriment of a student's socialisation with the faculty and subject areas, leading to lower attainment and satisfaction levels. The thesis presented findings that this may be even more of an issue for students from non-traditional backgrounds though further research needs to be undertaken to fully explore this issue.

### **8.7 Limitations of the current study**

The findings of the current study are restricted by the students that were included in the study. Two of the studies included students from one institution, another included participants from an additional institution. Additionally, all students who actively took part in the research were from one subject only; Psychology. The final scale in its current format can only be used to measure identity in Psychology students. However, chapter three and four presented a meta-ethnography which included students from a broad range of institutions and subjects. The findings of this study were generally supported by research undertaken in subsequent chapters. It can be concluded therefore that although the focus group and empirical research projects were limited to students from two North West universities their findings can be accepted as generalisable to other students. However, to be certain of this further research should be undertaken which includes students from a broader range of institutions and subjects.

Furthermore, the final study took part during the exam period, and on reflection this may have impacted on the participants' sense of ASI, Academic Self-Efficacy and Academic Conscientiousness. Furthermore, while it was recommended that GPA should be taken as an average of the years accumulated grades this may also have included grades that were taken during a low point of identity. This was addressed to some extent by only including scores from assignments during the current semester many of which will have been submitted shortly before participation in the study.

Ideally this current study would have included background information about the participants, particularly with the findings that emerged with the studies in chapters four and five. However, it was outside the scope of the current study to include this. Again, further research is recommended to complete this gap, along with exploration of individual differences in sex, age and personality.

### **8.8 Summary**

It can be concluded that the thesis was successful in understanding the process of identity through the undergraduate journey and has developed a tool for measuring this. The

measuring instrument was developed with reference to a range of sound psychometric properties. Its initial robustness suggests potential for continued use in filling a gap in an important research and pedagogical area. Furthermore, the study not only considered the implications of identity development in terms of concrete outcomes measured by GPA but also addressed theoretical gaps and informed policy. While there are a number of limitations to the study these are not so great that the findings are in doubt.

## 9 References

- Aberson, C. L., Healy, M., & Romero, V. (2000). Ingroup bias and self-esteem: A meta-analysis. *Personality and social psychology review*, 4(2), 157-173.
- Abrams, D & Michael A. H. (1990). *Social Identity Theory: Constructive and Critical Advances*. London: Harvester-Wheatsheaf.
- Alhojailan, M. I. (2012). Thematic analysis: A critical review of its process and evaluation. *West East Journal of Social Sciences*, 1(1), 39-47.
- Anderman, L.H., & Anderman, E.M. (1999). Social predictors of changes in students' achievement goal orientations. *Contemporary Educational Psychology*, 25, 21-37
- Archer, L. (2008). Younger academics' constructions of 'authenticity', 'success' and professional identity. *Studies in Higher Education*, 33(4), 385-403.
- Ashmore, R. D., Deaux, K., & McLaughlin-Volpe, T. (2004). An organizing framework for collective identity: articulation and significance of multidimensionality. *Psychological bulletin*, 130(1), 80.
- Astin, A. W. (1984). Student involvement: A developmental theory for higher education. *Journal of college student personnel*, 25(4), 297-308.
- Ball, S. J., Davies, J., David, M., & Reay, D. (2002). 'Classification' and 'Judgement': social class and the 'cognitive structures' of choice of Higher Education. *British journal of sociology of education*, 23(1), 51-72.
- Balmer, R. (2015, March 6) Centralisation puts collegiate system at risk? Retrieved from <http://www.tcs.cam.ac.uk/news/0032021-centralisation-puts-collegiate-system-at-risk.html>
- Bandura, A. (1977). Self-efficacy: toward a unifying theory of behavioral change. *Psychological review*, 84(2), 191.
- Bandura, A. (1986). *Social foundations of thought and action: A social cognitive theory*. Prentice-Hall, Inc.
- Barnett-Page, E., & Thomas, J. (2009). Methods for the synthesis of qualitative research: a critical review. *BMC medical research methodology*, 9(1), 59.
- Barrett, P. (2003). Beyond psychometrics: Measurement, non-quantitative structure, and applied numerics. *Journal of Managerial Psychology*, 18(5), 421-439.
- Bean, J. P. (1985). Interaction effects based on class level in an explanatory model of college student dropout syndrome. *American educational research journal*, 22(1), 35-64.

- Becher, T. & Trowler, R. (2001). *Academic Tribes and Territories: Intellectual enquiry and the culture of disciplines*. Buckingham: The Society for Research into Higher Education & Open University Press
- Blanton, H., Crocker, J., & Miller, D.T. (2000). The effects of in-group versus out-group social comparison on self-esteem in the context of a negative stereotype. *Journal of Experimental Social Psychology*, 36(5), 519-530.
- Blair, E., Cline, T., & Wallis, J. (2010). When do adults entering higher education begin to identify themselves as students? The threshold-of-induction model. *Studies in Continuing Education*, 32(2), 133-146.
- Bluic, A-M., Ellis, R., Goodyear, P., & Hendres, D.M. (2011). The role of social identification as university student in learning: Relationships between students' social identity, approaches to learning, and academic achievement. *Educational Psychology*, 31(5), 599-574
- Borsboom, D., & Mellenbergh, G. J. (2004). Why Psychometrics is Not Pathological A Comment on Michell. *Theory & Psychology*, 14(1), 105-120.
- Bowling A. (2003) *Measuring social networks and social suport*.In: *Bowling A. Measuring health. A review of quality of life measurement scales*. 2<sup>a</sup> ed. Philadelphia: Open University Press.
- Boyatzis, R. (1998). *Transforming qualitative information: Thematic analysis and code development*. Thousand Oaks, CA: Sage.
- Brady-Amoon, P., & Fuertes, J. N. (2011). Self-efficacy, self-rated abilities, adjustment, and academic performance. *Journal of Counseling & Development*, 89(4), 431–438. <http://dx.doi.org/10.1002/j.1556-6676.2011.tb02840.x>
- Branton, R.P. and Jones, B.S. (2005). 'Re---examining Racial Attitudes: The Conditional Relationship between Diversity and Socioeconomic Environment.' *American Journal of Political Science*, 49: 359–72.
- Braun, V., & Clarke, V. (2006). Using thematic analysis in psychology. *Qualitative Research in Psychology*, 3, 77-101. doi: 10.1191/1478088706qp063oa
- Brewer, M. B. (1991). The Social Self: On Being the Same and Different at the Same Time. *Personality and Social Psychology Bulletin*, 17, 475-482. doi: 10.1177/0146167291175001
- Bridgeman, B., Pollack, J., & Burton, N. (2004). Understanding what SAT Reasoning Test™ scores add to high school grades: A straightforward approach. *ETS Research Report Series*, 2004(2), i-20.

- Briggs, A. R. J., Clark, J., & Hall, I. (2012). Building bridges: understanding student transition to university. *Quality in Higher Education*, 18(1), 3-21.
- Britten, N., Campbell, R., Pope, C., Donovan, J., Morgan, M., & Pill, R. (2002). Using meta ethnography to synthesise qualitative research: a worked example. *Journal of Health Services Research & Policy*, 7(4), 209-215.
- Brown, R. (2000). Social identity theory: Past achievements, current problems and future challenges. *European journal of social psychology*, 30(6), 745-778.
- Brown, R., Condor, S., Mathews, A., Wade, G., & Williams, J. (1986). Explaining intergroup differentiation in an industrial organization. *Journal of Occupational psychology*, 59(4), 273-286.
- Browne, J. (2010). Securing a sustainable future for higher education: an independent review of higher education funding and student finance.
- Brownlee, J., Walker, S., Lennox, S., Exley, B., & Pearce, S. (2009). The first year university experience: using personal epistemology to understand effective learning and teaching in higher education. *Higher Education*, 58(5), 599-618.
- Butcher, J. (2015). Financial risk and inflexibility: part-time HE in decline. *Widening Participation and Lifelong Learning*, 17(4), 89-104.
- Byrne, M., Flood, B., Hassall, T., Joyce, J., Montaña, J. L. A., González, J. M. G., & Tourna-Germanou, E. (2012, June). Motivations, expectations and preparedness for higher education: A study of accounting students in Ireland, the UK, Spain and Greece. In *Accounting Forum* (Vol. 36, No. 2, pp. 134-144). Elsevier.
- Callender, C., & Wilkinson, D. (2003). *Student income and expenditure survey 2002/3* (No. 487). DfES Research Report.
- Callender, C. (2008). The impact of term-time employment on higher education students' academic attainment and achievement. *Journal of Education Policy*, 23(4), 359-377.
- Cameron, J. E. (2004). A three-factor model of social identity. *Self and identity*, 3(3), 239-262.
- Cast, A. D., & Burke, P. J. (2002). A theory of self-esteem. *Social forces*, 80(3), 1041-1068.
- Chapman, A. (2015). Using the assessment process to overcome Imposter Syndrome in mature students. *Journal of Further and Higher Education*, 1-8.
- Chorba, K., Was, C. A., & Isaacson, R. M. (2012). Individual Differences in Academic Identity and Self-Handicapping in Undergraduate College Students. *Individual Differences Research*, 10(2).

- Chow, K., & Healey, M. (2008). Place attachment and place identity: First-year undergraduates making the transition from home to university. *Journal of Environmental Psychology, 28*(4), 362-372.
- Cinnirella, M. (1998). Exploring temporal aspects of social identity: the concept of possible social identities. *European Journal of Social Psychology, 28*(2), 227-248.
- Clance, P. R., & Imes, S. A. (1978). The imposter phenomenon in high achieving women: Dynamics and therapeutic intervention. *Psychotherapy: Theory, Research & Practice, 15*(3), 241.
- Cohen, P., & Ainley, P. (2000). In the country of the blind?: Youth studies and cultural studies in Britain. *Journal of Youth Studies, 3*(1), 79-95.
- Colley, H. (2007). Understanding time in learning transitions through the lifecourse. *International Studies in Sociology of Education, 17*(4), 427-443.
- Cook, D. A., & Beckman, T. J. (2006). Current concepts in validity and reliability for psychometric instruments: theory and application. *The American journal of medicine, 119*(2), 166-e7.
- Cooke, R., Bewick, B. M., Barkham, M., Bradley, M., & Audin, K. (2006). Measuring, monitoring and managing the psychological well-being of first year university students. *British Journal of Guidance & Counselling, 34*(4), 505-517.
- Cortina, J. M. (1993). What is coefficient alpha? An examination of theory and applications. *Journal of applied psychology, 78*(1), 98.
- Crocker, J, Major, B., Sciacchitano, A.M., & . (1993). Ingroup versus outgroup comparisons and self-esteem. *Personality and Social Psychology Bulletin, 19*, 711-721
- Davies, R., & Elias, P. (2003). *Dropping out: A study of early leavers from higher education*. London: Department for Education and Skills.
- Day, S. (2012). A reflexive lens: Exploring dilemmas of qualitative methodology through the concept of reflexivity. *Qualitative Sociology Review, 8*(1).
- Denovan, A., & Macaskill, A. (2013). An interpretative phenomenological analysis of stress and coping in first year undergraduates. *British Educational Research Journal, 39*(6), 1002-1024.
- Denson, N., & Seltzer, M. H. (2011). Meta-analysis in higher education: An illustrative example using hierarchical linear modeling. *Research in Higher Education, 52*(3), 215-244.
- Di Domenico, S. I., & Fournier, M. A. (2015). Able, ready, and willing: Examining the additive and interactive effects of intelligence, conscientiousness, and autonomous



- motivation on undergraduate academic performance. *Learning and Individual Differences*, 40, 156-162.
- Dismore, H. (2014). Experiencing the transition from an apprenticeship to higher education. *Journal of Education and Work*, 27(6), 585-607.
- Dixon-Woods, M., Agarwal, S., Jones, D., Young, B., & Sutton, A. (2005). Synthesising qualitative and quantitative evidence: a review of possible methods. *Journal of health services research & policy*, 10(1), 45-53B.
- Dixon-Woods, M., Fitzpatrick, R., & Roberts, K. (2001). Including qualitative research in systematic reviews: opportunities and problems. *Journal of evaluation in clinical practice*, 7(2), 125-133.
- Doyle, L. H. (2003). Synthesis through meta-ethnography: paradoxes, enhancements, and possibilities. *Qualitative Research*, 3(3), 321-344.
- Duque, C. L. (2014), A framework for analysing higher education performance: students' satisfaction, perceived learning outcomes, and dropout intentions. *Total Quality Management & Business Excellence*, 25(1-2), 1-21.
- Ecclestone, K. (2010). Managing and supporting the vulnerable self. *Transitions and Learning through the Lifecourse*. London and New York: Routledge.
- Ecclestone, K., G. Biesta & M. Hughes. 2010. 'Transitions in the lifecourse: the role of identity, agency and structure', in K. Ecclestone, G. Biesta and M. Hughes (eds), *Transitions and learning through the lifecourse*. London: Routledge (1-15).
- Ellemers, N., De Gilder, D., & Haslam, S. A. (2004). Motivating individuals and groups at work: A social identity perspective on leadership and group performance. *Academy of Management Review*, 29(3), 459-478.
- Ellemers, N., Kortekaas, P., & Ouwerkerk, J. (1999). Self-categorization, commitment to the group and social self-esteem as related but distinct aspects of social identity. *European Journal of Social Psychology*, 29, 371-389.
- Ellemers, N., & Van Rijswijk, W. (1997). Identity needs versus social opportunities: The use of group-level and individual-level identity management strategies. *Social Psychology Quarterly*, 60, 52-65.
- Erikson, E. H. (1968). *Identity*. Norton.
- Field, A. (2009). *Discovering statistics using SPSS*. Sage publications.
- Feldman, R. S. (Ed.). (2005). *Improving the first year of college: Research and practice*. Psychology Press.

- Ferguson, N. (2011). Social Identity Theory. In D. Christie (Ed.), *Encyclopedia of Peace Psychology*. Chichester, England: Wiley
- Fereday, J., & Muir-Cochrane, E. (2008). Demonstrating rigor using thematic analysis: A hybrid approach of inductive and deductive coding and theme development. *International journal of qualitative methods*, 5(1), 80-92.
- Festinger, L. (1954). A theory of social comparison processes. *Human relations*, 7(2), 117-140.
- Frischlich, L., Rieger, D., & Rutkowski, O. (2014, June). I'd rather die than be with you: The effects of mortality salience and negative social identity on identification with a virtual group. In *International Conference on Social Computing and Social Media* (pp. 440-451). Springer International Publishing.
- Gale, T., & Parker, S. (2014). Navigating change: a typology of student transition in higher education. *Studies in Higher Education*, 39(5), 734-753.
- Gamache, P. (2002). University students as creators of personal knowledge: An alternative epistemological view. *Teaching in Higher Education*, 7(3), 277-294.
- Goodman, S., Price, S. A., & Venables, C. (2014). How members of the public account for the England Riots of summer 2011. *Applied Psychological Research Journal*, 1(1), 34-49.
- Gorodzeisky, A. 2011. "Focus Groups as a Tool in the Construction of Questionnaires: The Case of Discriminatory Attitudes", *Quantity and Quality: International Journal of Methodology Quality & Quantity*, 45, 1217-1231.
- Greenidge, D. D. (2013). *An empirical analysis of the representation of lower-order facets of the big five personality dimensions* (Doctoral dissertation, University of Nottingham).
- Grosz, E. A. (1994). *Volatile bodies: Toward a corporeal feminism*. Indiana University Press.
- Gucciardi, D. F., & Gordon, S. (2009). Development and preliminary validation of the Cricket Mental Toughness Inventory (CMTI). *Journal of sports sciences*, 27, 1293-1310. doi: 10.1080/02640410903242306
- Gurney-Read, J. (2015, January 30). Record number of students applying to university. *The Telegraph*. Retrieved from <http://www.telegraph.co.uk/education/universityeducation/11377594/Record-number-of-students-applying-to-university.html>
- Guzzo, R. A., Jackson, S. E., & Katzell, R. A. (1986) Meta-analysis analysis. In L. L. Cummings & B. M. Staw (Eds.), *Research in organizational behaviour* Vol. 9. Greenwich, CT: JAI Press. Pp. 407-442.

- Haggis, T., & Pouget, M. (2002). Trying to be motivated: perspectives on learning from younger students accessing higher education. *Teaching in higher education*, 7(3), 323-336.
- Harvey, L. and Drew, S., 2006. The first year experience: briefing on induction. *The Higher Education Academy*, Retrieved from [http://www.heacademy.ac.uk/assets/documents/archive/web0575\\_the\\_first\\_year\\_experience\\_briefing\\_on\\_induction.pdf](http://www.heacademy.ac.uk/assets/documents/archive/web0575_the_first_year_experience_briefing_on_induction.pdf) (accessed: 24 September, 2011).
- Haslam, S. A. (2004). *Psychology in organizations*. Sage.
- Haslam, S. A., & Turner, J. C. (1992). Context dependent variation in social stereotyping 2: The relationship between frame of reference, self categorisation and accentuation. *European Journal of Social Psychology*, 22,251–278.
- Haslam, S. A., Jetten, J., Postmes, T., & Haslam, C. (2009). Social identity, health and well-being: an emerging agenda for applied psychology. *Applied Psychology*, 58(1), 1-23.
- Hausmann, L. R.M., Schofield, J. W., Woods, R. L. (2007). Sense of belonging as a predictor of intentions to persist among African American and White first-year college students. *Research in Higher Education*, 48(7), 803-839.
- Hayes, N. (1997). Theory-led thematic analysis: Social identification in small companies.
- Hedges, L.V., & Olkin, I. (1985). *Statistical method for meta-analysis*. Orlando, FL: Academic Press.
- HEFCE (2015). *UK review of the provision of information about higher education: National Student Survey results and trends analysis 2005-2013*. UK: London. Retrieved from <http://www.hefce.ac.uk/pubs/year/2014/201413/>
- Heirdsfield, A. M., Walker, S., Walsh, K., & Wilss, L. (2008). Peer mentoring for first-year teacher education students: The mentors' experience. *Mentoring & Tutoring: partnership in learning*, 16(2), 109-124.
- Henkel, M. (2005). Academic identity and autonomy in a changing policy environment. *Higher education*, 49(1-2), 155-176.
- Hinkle, S., Taylor, L. A., Fox-Cardamone, D. L., & Crook, K. F. (1989). Intragroup identification and intergroup differentiation: A multicomponent approach. *British Journal of Social Psychology*, 28, 305-317. doi: 10.1111/j.2044-8309.1989.tb00874.x
- Hoffman, M., Richmond, J., Morrow, J., & Salomone, K. (2002). Investigating sense of belonging in first-year college students. *Journal of College Student Retention: Research, Theory & Practice*, 4(3), 227-256.
- Hogg MA. (1992). *The Social Psychology of Group Cohesiveness*. New York: New York

Univ. Press

- Hogg, M. A., & Abrams, D. (1988). *Social Identifications: A Social Psychology of Intergroup Relations and Group Processes*. London: Routledge
- Hogg, M. A., & Grieve, P. (1999). Social identity theory and the crisis of confidence in social psychology: A commentary, and some research on uncertainty reduction. *Asian Journal of Social Psychology*, 2, 79-93.
- Hogg, M. A., & Turner, J. C. (1987). Social identity and conformity: A theory of referent informational influence. *Current issues in European social psychology*, 2, 139-182.
- Holloway, I., & Todres, L. (2003). The Status of Method: Flexibility, Consistency and Coherence. *Qualitative Research*, 3, 345-357. doi: 10.1177/1468794103033004
- Hopkins, N (2001). "National identity: Pride and Prejudice?" *British Journal of Social Psychology*. 40 (2), 183–186. DOI: 10.1348/014466601164795
- Huon, G. & Sankey, M. (2002). The transition to university: Understanding differences in success. Paper presented at 6th Pacific Rim Conference on First Year in Higher Education, Christchurch NZ, July.
- Hurtado, S. & Carter, D. F. (1997, October). Effects of college transition and perceptions of the campus racial climate on Latino college students' sense of belonging. *Sociology of Education*, 70(4), 324-345.
- Hutchison, M. A., Follman, D., & Antoine, D. J. (2006). The Undergraduate Research Experience As It Relates To Research Efficacy Beliefs And The Imposter Phenomenon.
- Ibrahim, A.I. (2012) Thematic analysis: A critical review of its process and evaluation. *West East Journal of Social Sciences-December 2012; 1 (1)*
- Ishitani, T. T. (2006). Studying attrition and degree completion behavior among first-generation college students in the United States. *Journal of Higher Education*, 861-885.
- Jamelske, E. (2009). Measuring the impact of a university first-year experience program on student GPA and retention. *Higher Education*, 57(3), 373-391.
- Johnson, H. M. (1936). Pseudo-mathematics in the mental and social sciences. *The American Journal of Psychology*, 342-351.
- Jones, K. (2004). Mission drift in qualitative research, or moving toward a systematic review of qualitative studies, moving back to a more systematic narrative review. *Qualitative Report*, 9(1), 95-112.
- Jones, L. V., & Thissen, D. (2007). A history and overview of psychometrics. *Handbook of statistics*, 26, 1-28.

- Judge, T. A., & Bono, J. E. (2001). Relationship of core self-evaluations traits—self-esteem, generalized self-efficacy, locus of control, and emotional stability—with job satisfaction and job performance: A meta-analysis. *Journal of applied Psychology*, *86*(1), 80.
- Karasawa, M. (1991). Toward an assessment of social identity: The structure of group identification and its effects on in-group evaluations. *British Journal of Social Psychology*, *30*, 293-307. doi: 10.1111/j.2044-8309.1991.tb00947.x
- Kelly, J. T., Kendrick, M. M., Newgent, R. A., & Lucas, C. J. (2007). Strategies for student transition to college: A proactive approach. *College Student Journal*, *41*(4), 1021.
- Kensington-Miller, B., Sneddon, J., & Stewart, S. (2014). Crossing new uncharted territory: shifts in academic identity as a result of modifying teaching practice in undergraduate mathematics. *International Journal of Mathematical Education in Science and Technology*, *45*(6), 827-838.
- Keup, J., & Barefoot, B. (2005). Learning how to be a successful student: Exploring the impact of first-year seminars on student outcomes. *Journal of The First-Year Experience & Students in Transition*, *17*(1), 11-47.
- Kidd, P. S., & Parshall, M. B. (2000). Getting the focus and the group: Enhancing analytical rigor in focus group research. *Qualitative Health Research*, *10*(3), 293-308.
- Kift, S. (2009). *Articulating a transition pedagogy to scaffold and to enhance the first year student learning experience in Australian higher education: Final report for ALTC senior fellowship program*. Strawberry Hills, NSW: Australian Learning and Teaching Council.
- Kift, S. M., Nelson, K. J., & Clarke, J. A. (2010). Transition pedagogy: a third generation approach to FYE: a case study of policy and practice for the higher education sector. *The International Journal of the First Year in Higher Education*, *1*(1), 1-20.
- Krause, Kerri-Lee (2006) 'On being Strategic About the first year', Queensland University of Technology First Year Forum, 5 October, Keynote Paper.
- Krause, K. L., & Coates, H. (2008). Students' engagement in first-year university. *Assessment & Evaluation in Higher Education*, *33*(5), 493-505.
- Krishnan, A. (2009). What are Academic Disciplines? Some observations on the Disciplinarity vs. Interdisciplinarity debate. *ESRC National Centre for Research Methods NCRM Working Paper Series*
- Krogan, M (2003). Higher Education Communities and Academic Identity. *Higher Education Quarterly* *54* (3) 207-216
- Krueger, R. A. (1994). *Focus groups. A practical guide for applied research (2nd ed.)*. London: Sage.

- Lášticová, B. (2006). Identification with large scale social categories: A social psychology perspective. *Sociológia-Slovak Sociological Review*, 38(6), 546-561.
- Lawrence, J 2005, 'Re-conceptualising attrition and retention: integrating theoretical, research and student perspectives', *Studies in Learning, Evaluation Innovation and Development*, 2(3) pp.16-33.
- Lea, M., & Spears, R. (1991). Computer-mediated communication, de-individuation and group decision-making. *International Journal of Man-Machine Studies*, 34(2), 283-301.
- Leach, C. W., Van Zomeren, M., Zebel, S., Vliek, M. L., Pennekamp, S. F., Doosje, B., ... & Spears, R. (2008). Group-level self-definition and self-investment: a hierarchical (multicomponent) model of in-group identification. *Journal of personality and social psychology*, 95(1), 144.
- Leong, F. T., Gibson, L. W., Lounsbury, J. W., & Huffstetler, B. C. (2005). Sense of identity and collegiate academic achievement. *Journal of College Student Development*, 46(5), 501-514.
- Locke, W. (2014). The intensification of rankings logic in an increasingly marketised higher education environment. *European Journal of Education*, 49(1), 77-90.
- Longden, B. (2004). Interpreting student early departure from higher education through the lens of cultural capital. *Tertiary Education & Management*, 10(2), 121-138.
- Lynn, M. R. (1986). Determination and quantification of content validity. *Nursing research*, 35(6), 382-386.
- Mackie, D., & Cooper, J. (1984) Attitude polarization: Effects of group membership. *Journal of Personality and Social Psychology*, Vol 46(3) 575-585. doi:10.1037/0022-3514.46.3.575
- Margolis, E., & Romero, M. (2001). In the image and likeness.... *How mentoring functions in the hidden curriculum. In The hidden curriculum in higher education, ed. E. Margolis*, 79-96.
- Maunder, R. E., Cunliffe, M., Galvin, J., Mjali, S., & Rogers, J. (2013). Listening to student voices: student researchers exploring undergraduate experiences of university transition. *Higher Education*, 66(2), 139-152.
- Maunder, R., Cunliffe, M. and Mjali, S. (2010) Transitions in higher education: what we think, what we expect and what we get. Poster presented to: *The University of Northampton Learning and Teaching Conference: Learning Dialogues, University of Northampton, England, 13 May 2010.*

- McAbee, S. T., & Oswald, F. L. (2013). The criterion-related validity of personality measures for predicting GPA: A meta-analytic validity competition. *Psychological Assessment, 25*(2), 532.
- McEwan, M. J., Espie, C. A., Metcalfe, J., Brodie, M. J., & Wilson, M. T. (2004). Quality of life and psychosocial development in adolescents with epilepsy: a qualitative investigation using focus group methods. *Seizure : The Journal of the British Epilepsy Association, 13*, 15-31.
- McGeough, J., McIlroy, D. & Palmer-Conn, S. (2016). Protecting Social Identities: Institutional Self-Comparison by Undergraduates. Paper presented at Ireland International Conference on Education (IICE-2016), Dublin , April.
- McIlroy, D. (2000). An evaluation of the factor structure and predictive utility of a test anxiety scale with reference to students' past performance and personality indices. *British Journal of Educational Psychology, 70*(1), 17-32.
- McIlroy, D., & Bunting, B. (2002). Personality, behavior, and academic achievement: Principles for educators to inculcate and students to model. *Contemporary Educational Psychology, 27*(2), 326-337.
- Mead, G. H. (1934) *Mind, Self, and Society*. University of Chicago
- Michell, J. (1997a). Quantitative science and the definition of measurement in psychology. *British Journal of Psychology, 88*, 355–383.
- Michell, J. (1997b). Reply to Kline, Laming, Lovie, Luce and Morgan. *British Journal of Psychology, 88*, 401–406.
- Michell, J. (1999). *Measurement in psychology: Critical history of a methodological concept*. Cambridge: Cambridge University Press
- Michell, J. (2000). Normal science, pathological science and psychometrics. *Theory & Psychology, 10*(5), 639-667.
- Michell, J. (2008). Is psychometrics pathological science?. *Measurement, 6*(1-2), 7-24.
- Moogan, Y. J., Baron, S., & Harris, K. (1999). Decision-making behaviour of potential higher education students. *Higher Education Quarterly, 53*(3), 211-228.
- Moreau, M. P., & Leathwood, C. (2006). Balancing paid work and studies: Working (-class) students in higher education. *Studies in Higher Education, 31*(1), 23-42.
- Mundfrom, D.J., Shaw, D.G. & Tian, L.K. (2005) Minimum sample size recommendations for conducting factor analysis. *International Journal of Testing 5* (2); 159-168

- Nagel, J. (1995). American Indian ethnic renewal: Politics and the resurgence of identity. *American Sociological Review*, 947-965.
- Nassar-McMillan, S.C. & Borders, L. D. (2002). Use of Focus Groups in Survey Item Development , *The Qualitative Report*, Volume 7, (1)
- Noblit, G. W., & Hare, R. D. (1988). *Meta-ethnography: Synthesizing qualitative studies* (Vol. 11). Sage.
- Okuyama, T., Akechi, T., Kugaya, A., Okamura, H., Shima, Y., Maruguchi, M., Uchitomi, Y. (2000). Development and validation of the cancer fatigue scale: a brief, three-dimensional, self-rating scale for assessment of fatigue in cancer patients. *Journal of pain and symptom management*, 19, 5-14.
- Pajares, F., & Schunk, D. H. (2002). Self and self-belief in psychology and education: A historical perspective. *Improving academic achievement: Impact of psychological factors on education*, 3-21.
- Palmer, M., O'Kane, P., & Owens, M. (2009). Betwixt spaces: Student accounts of turning point experiences in the first-year transition. *Studies in Higher education*, 34(1), 37-54.
- Panayides, P. (2013). Coefficient alpha: interpret with caution. *Europe's Journal of Psychology*, 9(4), 687-696.
- Pascarella, E. T., & Terenzini, P. T. (1980). Predicting freshman persistence and voluntary dropout decisions from a theoretical model. *The Journal of Higher Education*, 60-75.
- Paunonen, S. V., & Ashton, M. C. (2013). On the prediction of academic performance with personality traits: A replication study. *Journal of Research in Personality*, 47(6), 778-781.
- Peat, M., Dalziel, J., & Grant, A. M. (2001). Enhancing the first year student experience by facilitating the development of peer networks through a one-day workshop. *Higher Education Research and Development*, 20(2), 199-215.
- Peel, M. (2000). 'Nobody cares': The challenge of isolation in school to university transition. *Journal of Institutional Research*, 9(1). Retrieved from <http://www.aair.org.au/jir/May00/Peel.pdf>
- Perna, L. W., & Thomas, S. L. (2006). A framework for reducing the college success gap and promoting success for all.
- Pillow, W. (2003). Confession, catharsis, or cure? Rethinking the uses of reflexivity as methodological power in qualitative research. *International journal of qualitative studies in education*, 16(2), 175-196.



- Platow, M. J., Durante, M., Williams, N., Garrett, M., Walshe, J., Cincotta, S. & Barutchu, A. (1999). The contribution of sport fan social identity to the production of prosocial behavior. *Group Dynamics: Theory, Research, and Practice*, 3(2), 161.
- Polit, D. F., & Beck, C. T. (2006). The content validity index: are you sure you know what's being reported? Critique and recommendations. *Research in nursing & health*, 29(5), 489-497.
- Popay, J., Rogers, A., & Williams, G. (1998). Rationale and standards for the systematic review of qualitative literature in health services research. *Qualitative health research*, 8(3), 341-351.
- Postmes, T., Haslam, S. A., & Jans, L. (2013). A single-item measure of social identification: Reliability, validity, and utility. *British Journal of Social Psychology*, 52(4), 597-617.
- Potter, J., & Wetherell, M. (1987). *Discourse and social psychology: Beyond attitudes and behaviour*. Sage.
- Quigley, S. A. (2011). Academic identity: a modern perspective. *Educate*, 11(1), 20-30.
- Quinn, J. (2010). Rethinking 'failed transitions' to higher education. *Transitions and learning through the lifecourse*, 118-129.
- Ramist, L., Lewis, C., & McCamley-Jenkins, L. (2001). Using Achievement Tests/SAT® II: Subject Tests to Demonstrate Achievement and Predict College Grades: Sex, Language, Ethnic, and Parental Education Groups. Research Report No. 2001-5. *College Entrance Examination Board*.
- Ratcliffe, R. (2015, August 8). Universities fight to woo students in run-up to A-level results. *The Guardian*. Retrieved from <https://www.theguardian.com/education/2015/aug/08/universities-fight-for-students-before-a-level-results>
- Reason, R. D., Terenzini, P. T., & Domingo, R. J. (2006). First things first: Developing academic competence in the first year of college. *Research in Higher Education*, 47(2), 149-175.
- Rees, T., Haslam, S. A., Coffee, P., & Lavalley, D. (2015). A social identity approach to sport psychology: Principles, practice, and prospects. *Sports Medicine*, 45(8), 1083-1096.
- Reicher, S., & Hopkins, N. (1996). Seeking influence through characterizing self-categories: An analysis of anti-abortionist rhetoric. *British Journal of Social Psychology*, 35(2), 297-311
- Reicher, S. D., Spears, R., & Postmes, T. (1995). A social identity model of deindividuation phenomena. *European review of social psychology*, 6(1), 161-198.

- Richardson, M., Abraham, C., & Bond, R. (2012). Psychological correlates of university students' academic performance: a systematic review and meta-analysis. *Psychological bulletin*, 138(2), 353.
- Roberts, B. W., Jackson, J. J., Fayard, J. V., Edmonds, G., & Meints, J. (2009). Conscientiousness.
- Robertson, M. H. (1959). A search for Identity. *American Psychologist*. 193-194
- Rubin, M., & Hewstone, M. (1998). Social identity theory's self-esteem hypothesis: A review and some suggestions for clarification. *Personality and Social Psychology Review*, 2, 40-62
- Rust, J. & Golombok, S. (1989). Modern psychometrics: The science of psychological assessment. London: Routledge.
- Rutland, A., & Cinnirella, M. (2000). Context effects on Scottish national and European self-categorization: The importance of category accessibility, fragility and relations. *British Journal of Social Psychology*, 39(4), 495-519.
- Rutland, A., Cinnirella, M. & Simpson, R. (2008). Stability and variability in national and European self-identification. *European Psychologist*. 13, (4), 267-276
- Sbaraini, A., Carter, S. M., Evans, R. W., & Blinkhorn, A. (2011). How to do a grounded theory study: a worked example of a study of dental practices. *BMC medical research methodology*, 11(1), 1.
- Sandelowski, M., Docherty, S., & Emden, C. (1997). Focus on qualitative methods Qualitative metasynthesis: issues and techniques. *Research in nursing and health*, 20, 365-372.
- Schlechty, P., & Noblit, G. (1982). Some uses of sociological theory in educational evaluation. *Policy Research*. Greenwich, CT: JAI.
- Schmidt, F. L. (1992). What do data really mean? Research findings, meta-analysis, and cumulative knowledge in psychology. *American Psychologist*, 47(10), 1173.
- Shim, S. S., & Ryan, A. M. (2012). What do students want socially when they arrive at college? Implications of social achievement goals for social behaviors and adjustment during the first semester of college. *Motivation and Emotion*, 36(4), 504-515.
- Simon, B., & Hamilton, D. L. (1994) Self-stereotyping and social context: The effects of relative in-group size and in-group status. *Journal of Personality and Social Psychology*. 66(4):699-711

- Stallman, H. M. (2010). Psychological distress in university students: A comparison with general population data. *Australian Psychologist*, 45(4), 249-257.
- Surgenor, P. W. G. (2013). Measuring up: comparing first year students' and tutors' expectations of assessment. *Assessment & Evaluation in Higher Education*, 38(3), 288-302.
- Spady, W. G. (1970). Lament for the letterman: Effects of peer status and extracurricular activities on goals and achievement. *The American Journal of Sociology*, 75(4), 680-702.
- Spears, R. (2008). Group-level self-definition and self-investment: a hierarchical (multicomponent) model of in-group identification. *Journal of personality and social psychology*, 95(1), 144.
- Strauss, A. L. (1987). *Qualitative analysis for social scientists*. Cambridge University Press.
- Stets, J. E., & Burke, P. J. (2000). Identity theory and social identity theory. *Social psychology quarterly*, 224-237.
- Swann Jr, W. B., Chang-Schneider, C., & Larsen McClarty, K. (2007). Do people's self-views matter? Self-concept and self-esteem in everyday life. *American Psychologist*, 62(2), 84.
- Tabachnick, B.G. and Fidell, L.S. (2007), *Using Multivariate Statistics* (5th ed.). New York: Allyn and Bacon.
- Tajfel, H. (1974). Social identity and intergroup behaviour. *Social Science Information*, 13, 65-93.
- Tajfel, H. (Ed.) (1978). *Differentiation Between Social Groups: Studies in the Social Psychology of Intergroup Relations*. London: Academic Press.
- Tajfel, H., & Turner, J. C. (1979). An integrative theory of intergroup conflict. *The social psychology of intergroup relations*, 33(47), 74.
- Tajfel, H., & Turner, J. C. (1986). The social identity theory of intergroup behaviour. In S. Worchel & W. G. Austin (Eds.), *Psychology of Intergroup Relations* (pp. 7-24). Chicago, IL: Nelson-Hall.
- Tapp, J. (2014). 'I actually listened, I'm proud of myself.' The effects of a participatory pedagogy on students' constructions of academic identities. *Teaching in Higher Education*, 19(4), 323-335.
- Tavakol, M., & Dennick, R. (2011). Making sense of Cronbach's alpha. *International journal of medical education*, 2, 53.

- Temmerman, N. (2016, February 19). Governance should support student learning. Retrieved from <http://www.universityworldnews.com/article.php?story=20160215212257686>
- Thomas, L. (2002). Student retention in higher education: the role of institutional habitus. *Journal of Education Policy*, 17(4), 423-442.
- Thomas, L. (2012). Building student engagement and belonging in Higher Education at a time of change. *Paul Hamlyn Foundation*, 100.
- Thurber, C. A., & Walton, E. A. (2012). Homesickness and adjustment in university students. *Journal of American College Health*, 60(5), 415-419.
- Thurstone, L. L. (1927) A law of comparative judgment, *Psychological Reviews* 34, 273–286
- Thurstone, L.L. & Jones, L.V. (1957) The rational origin for measuring subjective values, *Journal of the American Statistical Association* 52, 458–471.
- Tinto, V. (1975). Dropout from higher education: A theoretical synthesis of recent research. *Review of educational research*, 45(1), 89-125.
- Tinto, V. (1982). Limits of theory and practice in student attrition. *The journal of higher education*, 687-700.
- Tinto, V. (1997). Classrooms as communities: Exploring the educational character of student persistence. *Journal of higher education*, 599-623.
- Tognoli, J. (2003). Leaving home: Homesickness, place attachment, and transition among residential college students. *Journal of College Student Psychotherapy*, 18(1), 35-48.
- Turner, J. C. (1975). Social comparison and social identity: Some prospects for intergroup behaviour. *European journal of social psychology*, 5(1), 1-34.
- Turner, J.C. (1982). "Toward a cognitive redefinition of the social group". In Tajfel, H. *Social identity and intergroup relations* (Cambridge, UK: Cambridge university press): 15–40.
- Turner, J C. (1985). "Social Categorization and the Self-Concept: A Social Cognitive Theory of Group Behavior." *Advances in Group Processes*, ed by Edward J. Lawler. Greenwich, CT: JAI.Pp. 77-121
- Turner, S. P., (1980) *Sociological Explanation as Translation*. New York: Cambridge University Press.

- Turner, J. C., Hogg, M. A., Oakes, P. J., Reicher, S. D. & Wetherell, M. S. (1987). *Rediscovering the social group: A self-categorization theory*. Oxford: Blackwell
- Turner, J. & Oakes, P. (1986). "The significance of the social identity concept for social psychology with reference to individualism, interactionism and social influence". *British Journal of Social Psychology* **25** (3): 237–252. doi:10.1111/j.2044-8309.1986.tb00732.x.
- Tyler-Smith, K. (2006). Early attrition among first time eLearners: A review of factors that contribute to drop-out, withdrawal and non-completion rates of adult learners undertaking eLearning programmes. *Journal of Online learning and Teaching*, 2(2), 73-85.
- UNITE (2006). The Student Experience Report 2006. Retrieved from <http://www.unite-group.co.uk/binaries/722/100/the-student-experience-report-2006.pdf>
- Vaughn, S. & Schumm, J. S. & Sinagub, J. M. (1996). *Focus group interviews in education and psychology*. London: Sage.
- Verkuyten M, Hagendoorn L. 1998. Prejudice and self-categorization: the variable role of authoritarianism and in-group stereotypes. *Personality and Social Psychology Bulletin* **24**: 99-110
- Vreeland, R. S. & Bidwell, C. E. (1966) Classifying University Departments: An approach to the analysis of their effects upon undergraduates' values and attitudes
- Walker, L. M., & Syed, M. (2013). Integrating Identities: Ethnic and Academic Identities Among Diverse College Students. *Teachers College Record*, *115*(8), 1-24.
- Walsh, D., & Downe, S. (2006). Appraising the quality of qualitative research. *Midwifery*, *22*(2), 108-119.
- Was, C. A., & Isaacson, R. M. (2008). The development of a measure of academic identity status. *Journal of Research in Education*, *18*, 94-105.
- Weale, S (2015, July 1). Degree classifications must change to stop students 'coasting', says minister. *The Guardian*. Retrieved from <https://www.theguardian.com/education/2015/jul/01/too-many-students-getting-21-degrees-says-universities-minister>
- Weidman, J. Undergraduate Socialization: A Conceptual Approach. In J. Smart (ed.), *Higher Education: Handbook of Theory and Research* (Vol. 5). New York: Agathon, 1989
- Wingate, U. (2007). A framework for transition: supporting 'learning to learn' in higher education. *Higher Education Quarterly*, *61*(3), 391-405.
- Wittgenstein, L. (1958). *The blue and brown books*.

- Wyatt. (1954). A search for Identity. *American Psychologist*. 193-194
- Yorke, M., & Longden, B. (2007). The first-year experience in higher education in the UK: Report on Phase 1 of a project funded by the Higher Education Academy.
- Yorke, M., & Longden, B. (2008). The first-year experience of higher education in the UK. *Higher Education Academy*. Available at <http://www.heacademy.ac.uk/assets/York/documents/resources/publications/FYEFinalReport.pdf> [accesses on 2 September 2010] *THE INTERNATIONAL JOURNAL OF INTERDISCIPLINARY SOCIAL SCIENCES*.
- Yorke, M., & Thomas, L. (2003). Improving the retention of students from lower socio-economic groups. *Journal of higher education policy and management*, 25(1), 63-74.
- Yukhymenko, M., Brown, S. W., Lawless, K., Brodowinska, K., & Mullin, G. (2014). Thematic Analysis of Teacher Instructional Practices and Student Responses in Middle School Classrooms with Problem-Based Learning Environment. *Global Education Review*, 1(3).
- Zaitseva, E., Milsom, C., & Stewart, M. (2013). Connecting the dots: using concept maps for interpreting student satisfaction. *Quality in Higher Education*, 19(2), 225-247.
- Zepke, N., & Leach, L. (2005). Integration and adaptation Approaches to the student retention and achievement puzzle. *Active Learning in higher education*, 6(1), 46-59.
- Zepke, N., Leach, L., & Prebble, T. (2006). Being learner centred: one way to improve student retention?. *Studies in Higher Education*, 31(5), 587-600.
- Zimmerman, B. J. (2000). Self-efficacy: An essential motive to learn. *Contemporary educational psychology*, 25(1), 82-91.
- Zimmerman, B. J., Bandura, A., & Martinez-Pons, M. (1992). Self-motivation for academic attainment: The role of self-efficacy beliefs and personal goal setting. *American educational research journal*, 29(3), 663-676.

## 10 Appendices

Appendix A – Meta-ethnography .....	188
Appendix A.1: Database limiters.....	188
Appendix A.2: List of databases .....	189
Appendix A.3 Initial search results.....	190
Appendix A.4 List of initial relevant titles .....	191
Appendix A.5 Initial search details with rejection decisions.....	194
Appendix B: Meta-ethnography analysis.....	199
Appendix B.2 Article overview .....	201
Appendix C: Meta-ethnography results .....	208
Appendix C.1 Sample memos .....	208
Appendix C.2 coding sample .....	210
Appendix C.3 Concept maps .....	214
Appendix C.4 Table of codes.....	216
Appendix D: Focus group interview schedule .....	219
D.1 Interview schedule .....	219
Appendix E: focus group analysis.....	220
Appendix E.1 Focus group example transcript .....	220
Appendix E.2 Sample individual script edit.....	233
Appendix E.3 Student Identity extraction.....	241
Appendix F: focus group analysis and results .....	246
Appendix F.2. Sample of open coding .....	246
Appendix F.3 Codebook .....	252
Appendix G: Social Identity measures.....	254
Appendix G.1.....	254

Appendix H: Scale analysis .....	255
Appendix H.1 Content Validity index results .....	255
Appendix H.2 Scree plot.....	256
Appendix H.3 CFA results.....	257
Appendix I: Regression analysis.....	259
Appendix I.1 P.P. Plot.....	259
Appendix I.2 Normal histogram .....	260
Appendix J: Presentations and Publications .....	261



## Appendix A – Meta-ethnography

This appendix contains the search strategies and results for the meta-ethnography written up in chapters three and four. The following subsections list each of the items:

Appendix A.1: Database limiters

Appendix A.2: List of databases

Appendix A.3 Initial search results

Appendix A.4 List of initial relevant titles and authors

Appendix A.5 Initial search details with rejection decisions

### Appendix A.1: Database limiters

The following limiters were used during the searches of each of the databases and are summarised in the table below.

Journals. uk, english, post 1998, (EXCLUDE ( SUBJAREA , "MEDI" ) OR EXCLUDE ( SUBJAREA , "HEAL" ) OR EXCLUDE ( SUBJAREA , "BIOC" ) OR EXCLUDE ( SUBJAREA , "ENGI" ) OR EXCLUDE ( SUBJAREA , "NURS" ) OR EXCLUDE ( SUBJAREA , "CENG" ) OR EXCLUDE ( SUBJAREA , "PHAR" ) )

*Table A:16 Inclusion and Exclusion Criteria for searching*

<b>inclusion</b>	<b>exclusion</b>
qualitative only	focus on one demographic only (eg only females etc)
British institutions	post-graduates
general degree	medical
open to general students	nursing
higher education	teaching
	career or vocational

## **Appendix A.2: List of databases**

The following databases were accessed;

Scopus, Ebsco, Science Direct, Web of Science, PsycARTICLES, PsycINFO, academic onefile.

The above searches included the following resources

academic search complete

art full text

ebook collection

education research complete

ERIC

globalhealth

greenFILE

Humanities International Complete

Library, Information Science and Technology Abstracts

Sportsdiscus

British Education

Education Administration abstracts

Education Abstracts

Child Development and Adolescent Studies

### Appendix A.3 Initial search results

Table A:17 Initial search results

Date	time	database	terms used	number of results	relevant studies	search code
11/3/2015	13.30	scopus	( transition OR induction OR adjustment OR progress ) AND ( student* OR undergrad* OR learners OR freshman OR freshmen OR first-years ) AND ( college OR university ) AND identity AND ( qualitative OR interview OR thematic OR semi-structured OR ipa OR content analysis )	981	32	1
11/3/2015	15.30	ebsco	(( transition OR induction OR adjustment ) ) AND ( ( student* OR undergrad* OR learners OR first-years ) ) AND ( ( college OR university ) ) AND identity AND ( ( qualitative OR interview OR thematic OR semi-structured OR ipa OR content analysis ) )	442	10 (4)	2
12/3/2015	10.00	science direct	pub-date > 1997 and ( transition OR induction OR adjustment OR progress ) AND ( student* OR undergrad* OR learners OR freshman OR freshmen OR first-years ) AND ( college OR university ) AND identity AND ( qualitative OR interview OR thematic OR semi-structured OR ipa OR content analysis )	15	0	3
12/3/2015	13.30	web of science	(( transition OR induction OR adjustment OR progress ) AND ( student* OR undergrad* OR learners OR freshman OR freshmen OR first-years ) AND ( college OR university ) AND identity AND ( qualitative OR interview OR thematic OR semi-structured OR ipa OR content analysis )	99	1(4)	4
12/3/2015	15.00	psyarticles	AB ( ( student OR undergraduate OR first year ) ) AND AB transition AND AB ( ( university OR college ) )	46	0	5
13/3/2015	10.00	psyinfo & child development and adolescent studies	( AB ( ( student OR undergraduate OR first year ) ) AND AB transition AND AB ( ( university OR college ) ) ) AND ( ( UK OR england OR scotland OR Ireland ) )	55	3 (1)	6
13/3/2015	13.00	academic onefile	( student OR undergraduate ) AND identity AND transition AND ( university OR college )	112	2 (1)	7
				1750		

Brackets indicate the number of unique titles returned in each search

## Appendix A.4 List of initial relevant titles

The team read each of the abstracts of the titles from the initial searches and only those that were relevant were listed below.

Table A:18 Relevant titles from initial search

1	Lowe	Lessening sensitivity: student experiences of teaching and learning sensitive issues
1	Martin, Spolander, Maas	The evolution of student identity: A case of caveat emptor
1	Holton & riley	Talking on the move: Place-based interviewing with undergraduate students
1	anderson, Johnston & macdonald	Patterns of learning in a sample of adult returners to higher education
1	dismore	Experiencing the transition from an apprenticeship to higher education
1	francis, burke and read	The submergence and re-emergence of gender in undergraduate accounts of university experience
1	bardi, buchanan, goodwin slabu robinson	Value stability and change during self-chosen life transitions: Self-selection versus socialization effects
1	conroy and de visser	Man up!': Discursive constructions of non-drinkers among UK undergraduates
1	owuamalam & zagefka	We'll never get past the glass ceiling! Meta-stereotyping, world-views and perceived relative group-worth
1	busse	Why do first-year students of German lose motivation during their first year at university?
1 (2)	Maunder, R., Cunliffe, Galvin, Mjali	Listening to student voices: student researchers exploring undergraduate experiences of universitytransition.
1	O'Boyle	Valuing the talk of young people: are we nearly there yet?
1	Zaitseva Milson Stewart	Connecting the dots: Using concept maps for interpreting student satisfaction
1	perkins	Learning cultures and the conservatoire: An ethnographically-informed case study
1	stokoe, benwell, attenbrough	University students managing engagement, preparation, knowledge and achievement: Interactional evidence from institutional, domestic and virtual settings
1	hodgson harris	It is hard to know what you are being asked to do.' deciphering codes, constructing schemas
1	humberstone beard clayton	Performativity and enjoyable learning
1	sharma guest	Navigating religion between university and home: Christian students' experiences in English universities
1 (2, 4)	finn	Young, free and single? Theorising partner relationships during the first year of university
1	baxter	Who am i and what keeps me going? profiling the distance learning student in higher education
1 (2, 4)	Allen-Collinson, Jacquelyn; Brown, Rebecca	I'm a Reddie and a Christian! Identity negotiations amongst first-year university students.

1	byrne, flood, hassall,	Motivations, expectations and preparedness for higher education: A study of accounting students in Ireland, the UK, Spain and Greece
1 (2)	Briggs, A.R.J.1 Clark, J.2 jill.clark@newcastle.ac.uk Hall, I.	Building bridges: understanding student transition to university.
1	stevenson	Possible selves: Students orientating themselves towards the future through extracurricular activity
1	hopkins	Towards critical geographies of the university campus: Understanding the contested experiences of Muslim students
1	wainwright marandel	Parents in higher education: Impacts of university learning on the self and the family
1 (2, 6)	MacNamara, Áine Collins, Dave	The role of psychological characteristics in managing the transition to university
1	blair, cline, wallis	When do adults entering higher education begin to identify themselves as students? The threshold-of-induction model
1	leese	Bridging the gap: Supporting student transitions into higher education
1	dempster	Having the balls, having it all? Sport and constructions of undergraduate laddishness
1 (2, 4, 7)	chow healey	Place attachment and place identity: First-year undergraduates making the transition from home to university
1 (2)	O'Donnell, Victoria, Tobbell	THE TRANSITION OF ADULT STUDENTS TO HIGHER EDUCATION: LEGITIMATE PERIPHERAL PARTICIPATION IN A COMMUNITY OF PRACTICE?
1	jackson	Transitions into Higher Education: Gendered implications for academic self-concept
2	o'shea	Transitions and Turning Points: Exploring How First-in-Family Female Students Story Their Transition to University and Student Identity Formation
2	warin & dempster	The salience of gender during the transition to higher education: male students' accounts of performed and authentic identities.
2	Hernandez-Martinez, Paul P.A.Hernandez-Martinez@lboro.ac.uk Williams, Julian2 Black, Laura2 Davis, Pauline2 Pampaka, Maria2 Wake, Geoff3	Students' views on their transition from school to college mathematics: rethinking 'transition' as an issue of identity.
2 (4)	Maunder	Undergraduate peer mentoring: An investigation into processes, activities and outcomes. emotional Journeys: young people and transitions to university
2	hill and reddy	Undergraduate peer mentoring: An investigation into processes, activities and outcomes.
2	taylor & house	An exploration of identity, motivations and concerns of non-traditional students at different stages of higher education.
2	stuart, lido, morgan, solomon, may	The impact of engagement with extracurricular activities on the student experience and graduate outcomes for widening participation populations.

4	Jessen & Jetten	Bridging and bonding interactions in higher education: social capital and students' academic and professional identity formation
6	Andrew Denovan* and Ann Macaskill	An interpretative phenomenological analysis of stress and coping in first year undergraduates
6	sheridan & dunne	The bigger picture: undergraduate voices reflecting on academic transition in an Irish university
6	<b>Risquez, Angelica, Moore, S. &amp; Morley, M.</b>	<b>Welcome to college? Developing a richer understanding of the transition process for adult first year students using reflective written Journals.</b>
7	Margarita Azmitia, Moin Syed and Kimberley Radmacher	Finding Your Niche: Identity and Emotional Support in Emerging Adults' Adjustment to the Transition to College
7	Clare Cassidy and Karen Trew	Identity change in Northern Ireland: a longitudinal study of students' transition to university
7	Maunder, R., Gingham, browne	Transition in Higher Education: Exploring the experiences of first and second year psychology undergraduate students.
1	Scanlon, Lesley Rowling, Louise Weber, Zita,	You don't have like an identity ... you are just lost in a crowd': Forming a Student Identity in the First-year Transition to University.

## Appendix A.5 Initial search details with rejection decisions

The table below gives author, title and year of publication. The table indicates those that have been rejected (greyed out) with reasons why this was the case. Each paper at this stage was given a number starting with “is” for initial stage. Papers that were accepted were also given a “q” number to indicate that they had passed initial screening and through to quality stage.

Table A:19 Initial search details with decision information

is1	Lowe, P. (2015). Lessening sensitivity: student experiences of teaching and learning sensitive issues. <i>Teaching in Higher Education</i> , 20 (1), 119-129.	rejected	no first years included in the research	
is2	Martin, L., Spolander, G., Ali, I. & Maas B. (2014). The evolution of student identity: A case of caveat emptor. <i>Journal of Further and Higher Education</i> , 38 (2). 200-210	rejected	no clear qualitative data included	
is3	Holton, M. & Riley, M. Talking on the move: place based interviewing with undergraduate students. <i>Area</i> 46, (1). 59-65	rejected	not clear first year data available	
is4	Anderson, A., Johnston, B. & McDonald, A. (2014). Patterns of learning in a sample of adult returners to Higher Education. <i>Journal of Further and Higher Education</i> , 38 (4), 536-552	rejected	is not about typical entry routes	
is5	Dismore, H. (2014). Experiencing the transition from an apprenticeship to higher education. <i>Journal of education and work</i> , 27 (6), 585-607.	rejected	exploring Level 3 NVQ's and foundation degrees	
is6	Francis, B., Burke, P. & Read, B. (2014). The submergence and re-emergence of gender in undergraduate accounts of university experience. <i>Gender and Education</i> , 26 (1), 1-17	rejected	not about transition issues, gender discussed but across all years.	
is7	Bardi, A., Buchanan, K.E., Goodwin, R., Slabu, K. & Robinson, M. (2014). Value stability and change during self-chosen life transitions: Self-selection versus socialization effects. <i>Journal of Personality and Social Psychology</i> , 106 (1) 131-147	Rejected	Not qualitative	
is8	Conroy, D. & De Visser, R (2012). 'Man up!': Discursive constructions of non-drinkers among UK undergraduates. <i>Journal of Health Psychology</i> 18(11), 1432-1444	rejected	did not address alcohol culture as part of transition but as gender issue	

is9	We'll never get past the glass ceiling! Meta-stereotyping, world-views and perceived relative group-worth. <i>British Journal of Psychology</i> , 104, 543-562	rejected	international students at uk universities	
<b>is10</b>	<b>Busse, V. W. (2013). Why do first-year students of German lose motivation during their first year at university? <i>Studies in Higher Education</i> 38 (7), 951-971</b>	<b>included</b>		<b>q1</b>
<b>is11</b>	<b>Maunder, R. E., Cunliffe, M., Galvin, J., Mjali, S. &amp; Rogers, J. (2013). Listening to student voices: student researchers exploring undergraduate experiences of university transition. <i>Higher Education</i>, 66, 139-152</b>	<b>included</b>		<b>q2</b>
is12	O'Boyle, A. (2013). Valuing the talk of young people: are we nearly there yet? <i>London Review of Education</i> , 11 (2). 127-139.	rejected	about 14-19 year olds (fe and schools)	
<b>is13</b>	<b>Zaitseva, E., Milson, C., &amp; Stewart, M. (2013). Connecting the dots: Using concept maps for interpreting student satisfaction. <i>Quality in Higher Education</i>, 19 (2), 225-247.</b>	<b>included</b>		<b>q3</b>
is14	Perkins, R (2013). Learning cultures and the conservatoire: An ethnographically-informed case study. <i>Music Education Research</i> , 15 (2), 196-213	rejected	music students, vocational courses.	
is15	Stokoe, E., Benwell, B. & Attenborough, F. (2013). University students managing engagement, preparation, knowledge and achievement: Interactional evidence from institutional, domestic and virtual settings. <i>Learning, Culture and Social Interaction</i> , 2, 25-90.	rejected	observation not text based	
is16	Hodgson, J. & Harris, A. (2013). It is hard to know what you are being asked to do.' deciphering codes, constructing schemas. <i>English in Education</i> , 47 (1), 6-17.	rejected	no transition detail	
is17	Humberstone, B., Beard, C. & Clayton, B. (2013). Performativity and enjoyable learning. <i>Journal of Further and Higher Education</i> , 37 (2), 280-295.	rejected	vocational students	
is18	Sharma, S. & Guest, M. Navigating religion between university and home: Christian students' experience in English Universities. <i>Social &amp; Cultural Geography</i> , 14 (1), 59-79	rejected	focus on how faith is changed	
is19	Finn, K. (2013). Young, free and single? Theorising partner relationships during the first year of university. <i>British Journal of Sociology of Education</i> , 34 (1), 94-111	rejected	doesn't look at one university	
is20	Baxter, J. (2012). Who am i and what keeps me going? profiling the distance learning student in higher education. <i>The International Journal Review of Research in Open and Distance Learning</i> , 13 (4), 107-129.	rejected	online students	



<b>IS21</b>	<b>Allen-Collinson, J &amp; Brown, R (2012). I'm a Reddie and a Christian! Identity negotiations amongst first-year university students. <i>Studies in Higher Education</i>, 37 (4), 497-511</b>	<b>Included</b>		<b>q4</b>
is22	Byrne, M., Flood, B., Hassall, T., Joyce, J., Montano, J., Gonzalez, J. & Germanou, E. (2012). Motivations, expectations and preparedness for higher education: A study of accounting students in Ireland, the UK, Spain and Greece. <i>Accounting Forum</i> , 36, 134-144.	rejected	quantitative, vocational students	
<b>IS23</b>	<b>Briggs, A., Clark, J. &amp; Hall, I. (2012). Building bridges: Understanding student transition to university. <i>Quality in Higher Education</i>, 18 (1), 3-21</b>	<b>included</b>		<b>q5</b>
IS24	Stevenson, J & Clegg, S. (2011). Possible selves: students orientating themselves towards the future through extracurricular activity. <i>British Educational Research Journal</i> , 37 (2), 231-246.	rejected	explores end of degree issues, not start	
is25	Hopkins, P. Towards critical geographies of the university campus: Understanding the contested experiences of Muslim students. <i>Transactions of the British Institute of Geographers</i> , 36, 157-169	rejected	didn't focus on issues of transition	
IS26	Wainwright, E & Marandet, E. (2010). Parents in higher education: impacts of university learning on the self and the family. <i>Educational Review</i> , 62 (4), 449-465.	rejected	transition issues focus on parenting and studying not	
is27	MacNamara, A. & Collins, D. (2010). The role of psychological characteristics in managing the transition to university. <i>Psychology of Sport and Exercise</i> , 11, 353-362.	rejected	elite sports students	
<b>is28</b>	<b>Blair, E., Cline, T. &amp; Wallis, J. (2010). When do adults entering higher education begin to identify themselves as students? The threshold-of-induction model. <i>Studies in Continuing Education</i>, 32 (2), 133-146</b>	<b>included</b>	<b>it does look at early transition into university</b>	<b>q6</b>
is29	Dempster, S. (2009). Having the balls, having it all? Sport and constructions of undergraduate laddishness. <i>Gender and Education</i> , 21 (5), 481-500.	rejected	transition themes not included	
<b>is30</b>	<b>Chow, K &amp; Healey, M. (2008). Place attachment and place identity: First-year undergraduates making the transition from home to university. <i>Journal of Environmental Psychology</i>, 28, 362-372.</b>	<b>included</b>		<b>q7</b>
<b>is31</b>	<b>Jackson, C. (2003). Transitions into Higher Education: gendered implications for academic self-concept. <i>Oxford Review of Education</i>. 29 (3), 331-346.</b>	<b>included</b>		<b>q8</b>
<b>is32</b>	<b>Warin, J. &amp; Dempster, S. (2007). The salience of gender during the transition to higher education: male students'</b>	<b>included</b>		<b>q9</b>

	<b>accounts of performed and authentic identities. <i>British Educational Research Journal</i>, 33 (6), 887-903.</b>			
Is33	Hernandez-Martinez, P., Williams, J., Black, L., Davis, P., Pampaka, M. & Wake, G. (2011). Students' views on their transition from school to college mathematics: rethinking 'transition' as an issue of identity. <i>Research in Mathematics Education</i> , 13 (2), 119-130.	rejected	sixth formers.	
<b>is34</b>	<b>Christie, H. (2009). Emotional Journeys: young people and transitions to university. <i>British Journal of Sociology of Education</i>, 30 (2), 123-136.</b>	<b>included</b>		<b>q10</b>
<b>is35</b>	<b>Hill, R. &amp; Reddy, P. (2007). Undergraduate peer mentoring: An investigation into processes, activities and outcomes. <i>Psychology Learning and Teaching</i>, 6 (2), 98-103.</b>	<b>included</b>		<b>q11</b>
<b>is36</b>	<b>Taylor, J &amp; House, B. (2010). An exploration of identity, motivations and concerns of non-traditional students at different stages of higher education. <i>Psychology Teaching Review</i>, 16 (1), 46-57</b>	<b>included</b>		<b>q12</b>
is37	The impact of engagement with extracurricular activities on the student experience and graduate outcomes for widening participation populations.	rejected	qualitative only retrospective from post graduation	
is38	Bridging and bonding interactions in higher education: social capital and students' academic and professional identity formation	rejected	non uk students	
<b>is39</b>	<b>An interpretative phenomenological analysis of stress and coping in first year undergraduates</b>	<b>included</b>		<b>q13</b>
<b>is40</b>	<b>The bigger picture: undergraduate voices reflecting on academic transition in an Irish university</b>	<b>included</b>		<b>q14</b>
is41	Welcome to college? Developing a richer understanding of the transition process for adult first year students using reflective written Journals.	rejected	mature students only	
is42	Finding Your Niche: Identity and Emotional Support in Emerging Adults' Adjustment to the Transition to College	rejected	quantitative	
is43	Identity change in Northern Ireland: a longitudinal study of students' transition to university	rejected	quantitative	
<b>is44</b>	<b>Transition in Higher Education: Exploring the experiences of first and second year psychology undergraduate students.</b>	<b>included</b>		<b>q15</b>
<b>is45</b>	<b>Scanlon, L., Rowling, L. &amp; Weber, Z. (2007). 'You don't have like an identity ... you are just lost in a crowd':</b>	<b>included</b>		<b>q16</b>

	<b>Forming a Student Identity in the First-year Transition to University. <i>Journal of Youth Studies</i>, 10 (2), 223-24A.</b>			
<b>is46</b>	<b>Bridging the gap: supporting students transition into higher education</b>	<b>included</b>		<b>q17</b>
is47	Transitions and turning points:exploring how first-in-family female students story their transition to university and student identity formation	rejected	non UK student	

## Appendix B: Meta-ethnography analysis

This appendix provides a full list of the final articles that were selected for the meta-ethnography. Exclusion during the quality screening stages articles were rejected for a variety of reasons, for example if not enough information about their methods were given.

Appendix B.1 Final articles with summary information

Appendix B.2 Article overview

### Appendix B.1 Final articles with summary information

Articles were designated with “F” and a number

*Table B:20 Final articles with brief summary*

<b>Methods &amp; concepts</b>	<b>Maunder et al F1</b>	<b>Allen-Collinson &amp; Brown F2</b>	<b>Blair, Cline &amp; Wallis F3</b>	<b>Chow &amp; Healey F4</b>	<b>Warin &amp; Dempster F5</b>	<b>Christie F6</b>	<b>Denovan &amp; Macaskill F7</b>	<b>Sheridan &amp; Dunne F8</b>
<b>Sample</b>	nineteen 1st & 2nd year UG Psy students	5 full time first year christian students	9 first years progressing to 2nd	10 first year UG	24 1st, 2nd & 3rd year	12 2nd & 3rd year students	10 1st year UG's	36 first year
<b>Setting</b>	Uni of Northampton	Uni of Bath	Uni of Bedfordshire	Uni of Glouc	Uni of Winchester	Two Scottish Uni's	Teeside & Sheffield Hallam	Dublin City Uni
<b>Data collection</b>	9 individual interviews & 4 focus groups	semi-structured interviews	in depth interviews, retrospective	in depth semi structured interviews	single interviews	retrospective semi-structured interviews	semistructured interviews	reflective Journal
<b>Analysis</b>	Thematic	Thematic	Coding strategy based on Grounded Theory	Thematic	Analysis of themes (pre-decided)	Computer assisted analysis	IPA	Grounded theory
<b>Transition as “..”</b>	“reality check”	“conflict and resolution”	“threshold...”	“changing place identity”	performed and authentic	being rather than doing	“stressful”	a lived experience

<b>key descriptors</b>								
----------------------------	--	--	--	--	--	--	--	--

## **Appendix B.2 Article overview**

Eight articles were included in the final analysis and all dealt with issues of transition to university. A brief discussion follows that will look at similarities between the selected articles at a sampling and methodological level before each article is briefly summarised.

### **Articles overview**

As this is a meta-ethnography the focus of the analysis will be to explore the culture of universities and in particular the first few months and how students adapt to their new identities, expectations and surroundings of university life. While many of these may be practical a good number are also psycho-social and involve personal and social growth within the individual and the studies included reflect this aspect. As can be seen in table below the studies are generally inclusive of students attending only one institution, however there are a small number of articles that do include students from a number of universities. It is likely that this focus on one university in each study is likely to be due to issues of recruitment however it is also useful in that each university will have a different culture and ethos which students will become to identify with. This can be seen very clearly in the article which looks at students at Bath University (Allen-Collinson & Brown, 2012), in which the authors clearly show a “Reddie” identity which may conflict with existing identities. However, it was decided to keep the multiple institution studies as these look at the broader development of “student” identity from a non-traditional student background.

The majority of the studies interviewed students at the time of transition with only 2 including students later in their university careers and asking them to retrospectively talk about their experiences as new Undergraduates. While there are obvious issues about retrospective studies these articles were included as they directly address issues of transition and it was thought that these would help understand the students Journey from start to end in a way that would not be understood if they were not included. All but one of the articles interviewed students individually or in focus groups, the one study that did not do this employed a reflective diary of the initial months, this was considered especially interesting and would help again to understand the picture of transition from a different perspective.

As meta-ethnography is an inscription of the researchers original translations of their participants words it is important that studies including in this type of synthesis ensure that participants are central to the research and that a true honest analysis of their words shape the conclusions that authors draw. Each of the articles included were felt to meet this criteria, how they do that will be explored in their individual summaries. The aim at this point is twofold; the first is to paint a broad brush picture of each article and secondly to make some initial comparisons between them. It will not during this iteration try to do this within a theoretical framework.

### **Study 1: Listening to student voices: student researchers exploring undergraduate experiences of university transition.**

The first study by Maunder, Cunliffe, Galvin, Mjali & Rogers, 2013 was part of a larger ongoing qualitative research project that employed students as researchers to interview their peers with the focus in this study on the transition period. The study strongly puts the participants voices at the centre of the research and it is their experiences and words that are translated into the final analysis. Three main themes that emerged were internalised images about university, expectations versus reality and developmental changes to self. It was this “reality checking” drive that challenged the new students and shaped developmental growth. The students did not arrive at university in a neutral emotional and cognitive state, that is they had preconceived images about university life and their place within it. Questioning these images was integral to their development of self and therefore their shift in identity during the transition process.

### **Study 2: I’m a Reddie and a Christian! Identity negotiations amongst first-year university students**

The second study by Allen-Collinson & Brown (2012) was undertaken by a staff member and a student who wanted to explore the concepts of identity construction at university when students arrive with a strong social identity that may be at odds with some aspects of university culture. The University campus is relatively small and the participants describe it as a “little community”, it has a history both within the campus and in the local town as maintaining a “Jock culture” with “Reddies” (a nickname for students attending Redwich

University) imparting their traditions to new students. Five participants who identified as committed and practising Christians at the start of their University careers were interviewed. The themes that emerged were commitment to existing identity (in this case Christian), identity tensions, disclosures and negotiations, and finally acceptance, confirmation and affirmation. The authors would place identity change as something of a Journey that is progressive for the participants who spoke about their experiences. As in the previous study experiences prior to university are crucial but not as “images” of university life but the social identities that students bring with them to university. The analogy used here is one of conflict and conflict resolution and it is within this resolution that identity change takes place.

**Study 3: When do adults entering higher education begin to identify themselves as students? The threshold-of-induction model.**

The next study (Blair, Cline & Wallis, 2010) was one of the few aimed at non-traditional students, in this case adults or students who felt university were atypical for their social background. The methodology employed a retrospective approach to interviews, asking 2nd years to reflect on their first year of undergraduate study. While all the students hoped to gain entry onto a teacher training course at this point they are second years on a degree course that was not specifically vocational and therefore suitable for inclusion. The authors used a “Chain of Reaction” model of induction to analyse the interviews, this model argues that movement is from the individual (self-evaluation) to the general (information). COR is a model that explains adults transition in Higher Education and develops a new stage, that of “threshold-of-induction”. Transition in this study is seen again as a one direction Journey, a similar to study 2, however the authors suggested that adults students move towards a threshold of acceptance with the label “university student”. The findings did not support this metaphor of transition, and in fact the participants. Additionally, their previous identities were considered central to their ability to fully integrate as a student within an HE setting. Unlike the first study however, in this one the authors did not position identity within personal growth and development, nor did they argue that this growth alone could challenge pre-existing notions though this that the images being challenged were on of “self” informed by feedback from previous experiences. The metaphor in this study therefore is that of



transition being a threshold that once crossed the individual is free to develop within the new identity.

**Study 4: Place attachment and place identity: First year undergraduates making the transition from home to university.**

The fourth study (Chow & Healey, 2008) looks at transition from a very different position than the others that have been included, in that the authors propose that moving to university and identifying as a student involves gaining a sense of attachment to the place, and it is through this attachment that students gain a sense of identity. The authors propose that everyone has places that hold deep emotional meanings for them and they have attachment to and call “home” which the authors suggests is more than a house and that while it does have a geographical location it is also located socially and is vested with emotion and deep feelings. It is an obvious question therefore to consider place as key to our understanding of transition for university students, especially for those who move away from home. For the meta-ethnography we need to consider whether the present study sits answers the questions of transitions and identity change that are undertaken during that first year of university life. While it is theoretically a different understanding of identity from the other studies nonetheless it does attempt to explore such how the change of place affects social relationships, adjustments and identity change; indeed the authors argument of place as important is persuasive enough that to ignore this would lead to the meta-ethnography missing a crucial part of the overall analogy. The metaphor then is one of transition as a “change of place identity”.

**Study 5: The salience of gender during the transition to higher education: male students’ accounts of performed and authentic identities.**

Study 5 (Warin & Dempster, 2005) was the only research project to position gender as a central issue of identity during the early period of university and while it only includes males it was felt that this would be able to contribute to the overall picture of the relationship of

gender and transition. The authors' own decisions for exploring male students experiences are sound and grounded within social identity theory. It is argued that males in particular have a strong identity within the student culture and "laddish" behaviour is overt and that gender identity becomes salient during these first few months as a way of gaining entry into an obvious "in-group" and seeking acceptance as a member. It is suggested that the new students would take on "laddish" behaviour as a form of social currency but that these persona's were performed and not authentic. Identity change within this paper is the growth from one type of persona to another, however it was also concluded this new construction of authentic selves or the voicing of disquiet around performed selves would only be possible as students become more confident of their place at university and their social group. Therefore transition in this paper is seen as challenging growth of self and authenticity.

#### **Study 6: Emotional Journeys: young people and transitions to university**

The next study is another that uses multiple sites of Higher Institutions, though both are pre-1992 Universities in Scotland and the students involved had all taken part in a widening access course. Though all were below 25 years of age at the time of taking part in the study they did not come to university via traditional route of school exams. Again this study is part of an ongoing research project and the current paper includes only younger students and their experiences of transition. It is a retrospective study in which 2nd and 3rd year students were asked to reflect back to their first year transition period. As the title indicates the author see's the transition into university as a journey, this of course has been voiced in previous research above such as study 4 & 5. However, the paper positions this Journey as an emotional process. Interestingly this is one of the few papers to consider the structure of the university and explores how students feel a sense of trust with the institution with a particular focus on students from non-traditional backgrounds. There were two themes that emerge are that of "becoming" a student and how infrastructure surrounding transition could help or hinder this and "being versus doing" While title posits identity change as a Journey, this paper could better be understood as seeing transition within the emotions of trusting and belonging that leads to an internalisation (or indeed fails to lead) of the label identity, its majority theme of "doing rather than being" summarises how the author interprets the students descriptions of their idea of identity.

### **Study 7: An interpretative phenomenological analysis of stress and coping in first year undergraduates**

This study (Denovan & Macaskill, 2013) directly address the difficult issues that students face on transfer to university. The participants reflect typical range of younger students and have a mix of those living at home, on campus and those working part time and not. The questioning in the study was more concrete than other studies in the meta-ethnographic sample in that it asks the students what advice they would give friends starting university the next year, this immediately focused answers that would be more practical than psychosocial. Nonetheless both are explored and therefore this study will allow for similarities and differences from others in the sample to be explored. Five main themes were extrapolated and it is immediately obvious that some similar to previous themes. The changes that are undertaken is the first theme, and while some of these are not previously discussed such as independent living however that of homesickness picks up the theme of “place and home”. The next theme of expectations shadows the metaphors of transition in the first paper but is broader in its scope. The further themes are that of academic focus, support network and difficulties. The authors clearly position transition as stressful and explores further coping mechanisms to address these issues.

### **Study 8: The bigger picture: undergraduate voices reflecting on academic transition into an Irish University.**

The eighth study (Sheridan & Dunne, 2012) employed a Journal methodology, and it was these methodologies that form the basis of the data exploration. The students were asked to keep a Journal over the first of the semester of the first year at university. While such studies may be open to criticisms of the quality of Journal keeping over a long period of time as well as the students ability to reflect at such an early part of their degree career there are benefits to employing this type of data collection. It provides in the moment reflections of the students during the day and outside of research environment such as an interview and focus groups. Indeed the authors argue that it allows a further exploration of the writing and reflexivity development of the students involved and aware of how difficult some students may find the process the researchers provided a template for the students to use. This

included some summaries that the students were expected to report, such as goals and learning activities, additionally they recorded any issues they had encountered with research and asked to reflect on how these differed from previous learning experiences and settings. Finally, they were asked to reflect on their general experiences as well as the process of reflection. The authors report that they found reading the Journals quite an intimate and personal process and that they felt that the transition could be described as a “lived experience” The discussion of findings starts with describing identity as a transformation, this is repeated in other studies and is a majority theme that is emerging within this iteration. Understandably given the methodology academic issues are central and in this aspect it mirrors the study on stresses and coping however unlike that paper it highlights group work as a majority source of stress. Again like the previous study it explores the stress of transition as well as the emotions involved in this period, however unlike study 6 it does this in relation to the stress of coping rather than exploring emotions related to the institution.

## **Appendix C: Meta-ethnography results**

This appendix provides information about the analysis, including samples of the memo's written after a paper was written, initial coding and each of the concept maps that will show how the final one was arrived at and how each paper fed into it. The previous appendix (appendix 2) gave initial thoughts, the following provides a more focused analysis with thoughts on codes as they emerged and will allow the reader to understand how the author ensured saturation.

Appendix C.1 Sample memos

Appendix C.2 Sample of codes derived from a paper.

Appendix C.3 Conceptual maps

Appendix C.4 Table of codes

### **Appendix C.1 Sample memos**

#### **F1, 3 (18/06/16)**

this final section of the analysis looked at developmental changes in the student's self since university. Students talked about changes on a personal level both academically and with practical aspects. The authors interpreted difficulties and challenges by students as an opportunity for growth as they achieved with university life. There are words that showed students "assimilation" into university life - adapting to the university environment.

DO STUDENTS NEED TO EXPERIENCE ALL STAGES TO BE ABLE TO GROW  
IDENTITY AS A STUDENT?? DO STUDENTS NEED TO IDENTIFY AS A STUDENT?

#### **F1, 2 (16/06/16)**

Comparisons continue to be a theme here but now between expectations and reality. we see here for the first time in the paper images of university as hard or easy emerging and reality countering that.

Internal images = university is easy/university is hard

?? they do not fully explore why people have these different images however seems to have a different about "students identity" and the institution of university as different

Evidence of cognitive dissonance is seen about images of university being a place they could be lazy but that while there were times this could be the case it was also that it was hard work (52) These contradictions were very apparent in this section and the authors accredited these to ideas about students v ideas about university. These prior images allowed the participants to control their anxiety by being able to prep! = this is a positive idea of anxiety, it is motivating = HOWEVER what is left is that it may allow students to prepare in a wrong way. The authors called this “uncertainty reduction”.

GROUP identity developing: when students start seeing other students as authentic voices of the student experiences this is seen by the authors as the participants positioning themselves within the group (or is it that they were seen as experienced and experts?? - my note))

### **F1,1 (15/06/2015)**

The authors of the paper call this section internalised images about university; this seems to me a clear and precise title for the section which reflects the words of the participants, translating them into a theme regarding their thoughts about university prior to arrival. The section can be seen in a number of stages of time (this links into transition as induction) but also about hints about growth also within the individual (this links into transition as developmental).

Prior: students arrive with ideas about university and students. These come from a number of family and society expectations about university and the importance of higher education for the participants. These images feed into anxiety about the work that may be involved and also their ability to achieve this standard, this came from images about university academic standards being a step up from A level/school work.

Arrival: students were seen to be involved in comparison of themselves against others shortly after arriving. This was apparent in a number of arenas:

1. non traditional students comparing themselves against traditional students

- a. on campus
  - b. straight from school
2. studious vs slackers

These were fed by the internalised images they arrived with

Students referred to anxiety about these initial days, particularly around making friends and avoiding isolation

Moving on: as students became more secure about their surroundings and their identity friendships evolved and changed and more honest and meaningful relationships emerged.

Generally while the MT (main title) sums up the experience prior I am not sure it reflects that there is also identity development, anxiety and categorisation about groups of students and their own setting within this

### **Appendix C.2 coding sample**

The coding sample was from the same paper as the memo above. The codes are differentiated between codes that derived from first person quotes (1stq) and those that are sourced from the paper's author (2<sup>nd</sup>). Links were made with the memo as indicated below.

Main Titles: Internalised images about university: Expectations v Reality: Developmental changes to self.

MT: Internalised images about university (memo F1,1 (15/06/2015))

- (1) 1 2nd internalised images about university life
- (1) 2 2nd internalised images about "normal students"
- (1) 3 2nd internalised images used to compare and interpret their own transition experiences
- (1) 4 2nd images held about university which influenced expectations
- (1) 5 2nd cultural practices about participation in higher education underline choices
- (1) 6 1stq natural progression - societal norms
- (1) 6 1stq natural progression - family values
- (1) 7 2nd predicted life course with participation in university being a cultural norm
- (1) 8 2ndMT Student identity of self is imposed by family
- (1) 9 2nd Cultural values evident in internalised images as university as a high status institution
- (1) 10 1stq "For people with more money, superior intelligence and stuff"
- (1) 11 2nd Elite university images still evident
- (1) 12 2nd Images of university life could act as a barrier depending on cultural background

- (1) 12 2nd Barriers such as anxiety over ability
- (1) 13 1stq Step up from A Level to degree
- (1) 14 2nd internalised “what other people said” and became their own
- (1) 15 2nd images are benchmarks for their expectations
- (1) 16 2nd “normal” students and “normal university life”
- (1) 17 2nd traditional students of living away from home and straight from school were “normal” and “traditional”
- (1) 18 1stq The whole university is living away from home
- (1) 19 2nd those who didn’t have this whole university experience are seen as “others”
- (1) 20 2nd movement from elite to mass *my note: yet this is not yet internalised though?*
- (1) 21 2ndLT pathologised “others” Leathwood & O’Connel 2003
- (1) 22 2nd consistent comparisons between “normal” “traditional students” and “others”
- (1) 23 1stq “other” students also compare themselves to the “traditional students”
- (1) 24 2nd drawing on cultural norms meant that “them” as normal students were seen by “others”
- (1) 25 2nd social groups formed around these ideas of “normal” and “others”
- 
- (1) 26 2nd on arrival at university students would compare and categorise themselves
- (1) 27 2nd formed allegiances with those alike them and avoided others
- (1) 28 2nd other categorisations were taking their work seriously/working hard - formed working groups
- (1) 29 1stq “I don’t want to be with people that aren’t going to be arsed doing the reading....”
- (1) 30 2nd “slackers” versus “studious”
- (1) 31 2nd frustration when both groups had to mix in group work with tension
- (1) 32 2nd gave him a specific identity within the student identity
- (1) 33 2nd transitions can be ongoing and shown by the need to position identities
- (1) 34 2nd making friends causes anxiety and fear of being isolated this would be in contrast to the image they have of uni
- (1) 35 2nd friendships made in first days to avoid loneliness
- (1) 36 1stq less reliance to need friends meant real friendships could grow
- (1) 37 2nd selective about friendships as confidence grew
- (1) 38 2nd transitions are progressive through university
- (1) 39 2nd move from reliance and need to selection and control
- (1) 40 2nd being part of a group allowed identity and security
- (1) 41 2nds images students held about university created attitudes and beliefs about uni and students
- (1) 42 2nds anxiety about social bonds and comparison with groups for identification purposes
- (1) 43 2nds development of social groups which shifted and changed through ongoing comparison and transition

MT: Expectations vs Reality (memo F1,2 (16/06/2015))

- (1) 44 2nd Comparisons made by students between prior expectations and arrival
- (1) 45 2nd Conflicts evident between expectations and reality
- (1) 46 1stq Intelligence vs hard work, hard work is enough to make the grade
- (1) 47 1stq expectations of it being too difficult not met



- (1) 48 2nd link to ideas about internalised images, cultural expectations of university as higher status
- (1) 49 2nd some students thought university was going to be sociable, was in fact harder than expected
- (1) 50 1stq school ideas about university as easy was not true
- (1) 51 2nd school stereotypes about "students"
- (1) 52 1stq social ideas about "students" stereotypes - lazy, parties and no work vs reality
- (1) 53 2nd conflicting views of university held by the same people - evidence of cognitive dissonance?
- (1) 54 1stq quote supporting above
- (1) 55 2nd building images allowed them to control for anxiety by developing ideas of how they could prepare for the unknown
- (1) 56 1stq school life the basis for expectations, that it would be the same as school, school as a "template"
- (1) 57 1stq non traditional students had little reference points for university
- (1) 58 1stq their limited experience had to be made up by guesses of what to expect
- (1) 59 2nd other students were seen as authentic voices that could be believed
- (1) 60 2nd these were seen as more able to reduce uncertainty and increase confidence
- (1) 61 1stq students compared to tutors and parents
- (1) 62 1st students further ahead seen as someone to be trusted
- (1) 63 2nd transition not seen as static but dynamic
- (1) 64 2nd strong group identity - insiders (other students) believed
- (1) 65 1stq transition at other periods also hard (1st - 2nd) but maybe with other students to help more realistic
- (1) 66 1stq high expectations means reality is easier
- (1) 67 2nds other students helped participants prepare mentally
- (1) 68 2nds collective group identity emerging through sharing with fellow students

MT: Developmental changes to self (F1, 3 (16/06/16))

- (1) 69 2nd personal change noticed since starting university - self changed and developed
- (1) 70 2nd personal change noticed since starting university - identity
- (1) 71 2nd participants put changes down to transition experiences
- (1) 72 2ndLT sustained changes, dynamic through university
- (1) 73 2nd changes brought about by the practical aspects of being independent
- (1) 74 2nd also as a more abstract change from passive to active study approach
- (1) 75 1stq "but you've also got...to do a bit of outside work"
- (1) 76 1stq motivation...commitment
- (1) 77 2nd success linked to having to do work, self-responsibility
- (1) 78 2nd forced to change and develop independence to adapt to the demands of the new environment
- (1) 79 2nd growth as a person since starting university and how self-beliefs and goals develop during time
- (1) 80 2nd personal growth in skills and capabilities in touch with themselves
- (1) 81 2nd able to express strengths and weaknesses
- (1) 82 1stq university is elite, nearly not attainable
- (1) 83 1stq "massive thing and here's little me coming into it"
- (1) 84 2nd negotiating demands led to assimilation of her identity with environment and developed self-belief
- (1) 85 1stq change in personality - university had "made me more extraverted"

- (1) 86 2nd growing aspirations
- (1) 87 2nd "becoming" shows transition was incomplete
- (1) 88 2nd developments ongoing through the degree
- (1) 89 1stq "learnt so much about myself that I didn't know a few years ago"
- (1) 90 2nds students aware of changes that had occurred to them personally

**Appendix C.3 Concept maps**  
**conceptual map f1, f2, f3**

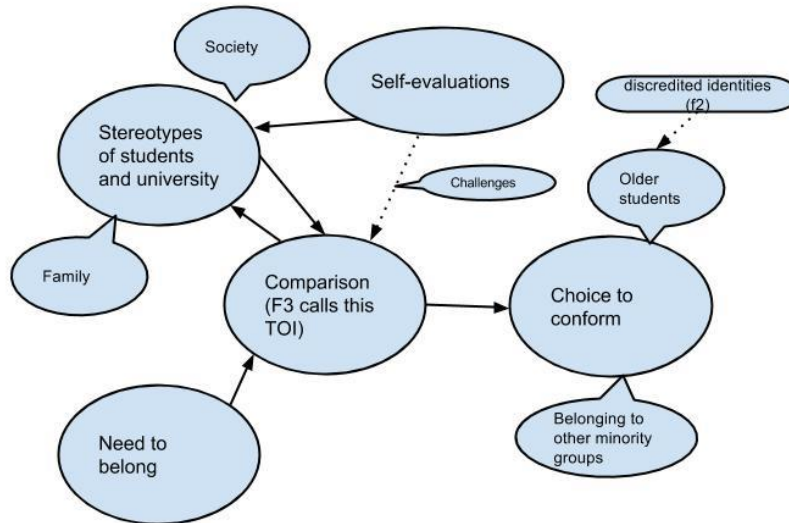

Figure C-1-1 Concept map derived from synthesis of papers 1-3

**Team conversation**  
**23/06/2015 - f1, f2, f3,**  
**f4**

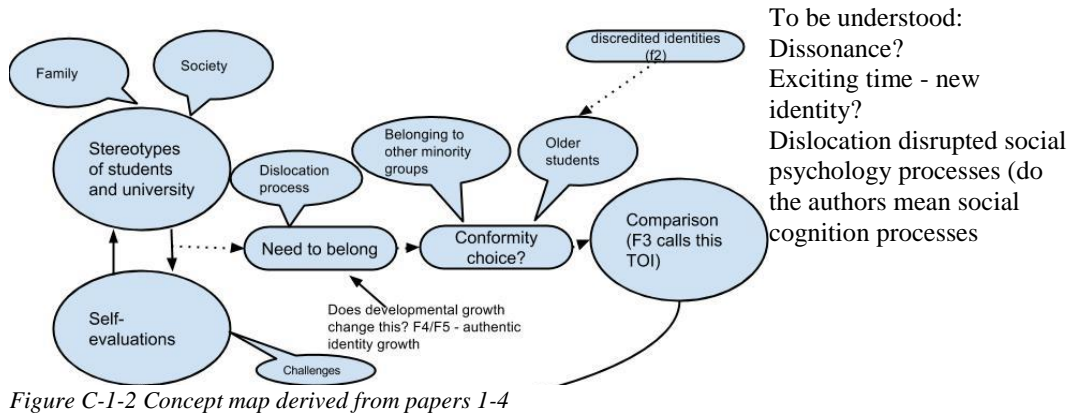
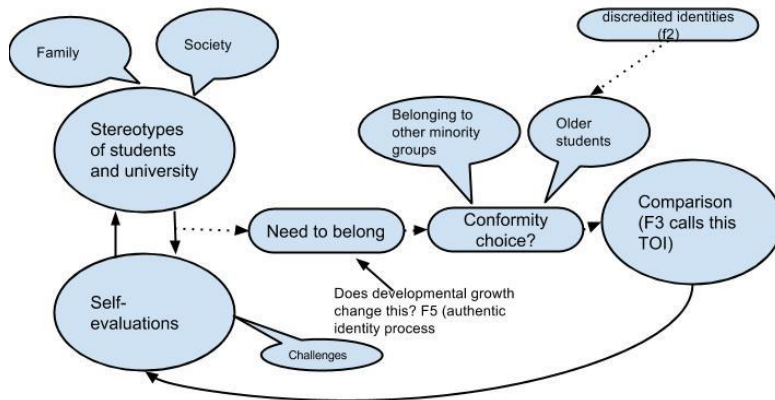

Figure C-1-2 Concept map derived from papers 1-4

23/06/15 - f1, f2, f3, f4, F5



27/06/15 - f1, f2, f3, f4, F5, F6

Figure C-1-3 Concept map derived from papers 1-5

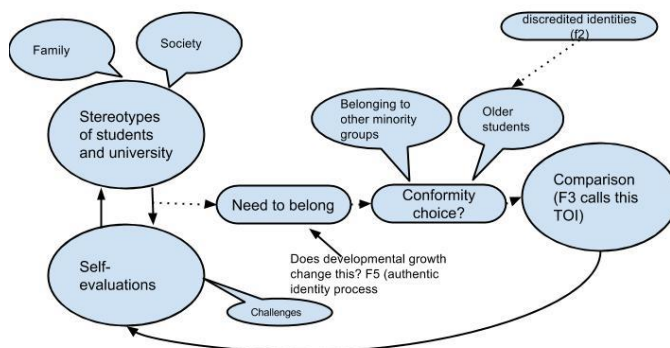

Figure C-10-4 Concept maps derived from papers 1-6

## Appendix C.4 Table of codes

Table C:21 Table of codes with labels and paper reference

Sub Theme headings	Original codes	Additional Focus Code	related to
University level * Cultural * Societal  * Family * Friends Preconceptions of students New identity	(1,2) (1,11) (1,5) (1,9) (1,10) (1,48) (1,49) (1,82) (1,6) (1,7) (1,20) (1,58)(4, 40) (6,1) (6,2) (6,3) (6,4) (6,7) (6,15) (1,6ii) (1,8) (1,50) (1,2) (1,16) (1,17) (1,24) (1,51) (1,51) (2,13) (2,16) (3,32) (6,34) (2, 5-7) (4, 15&16)  <b>Barriers</b> * Anxieties (1,12) (1,12ii) (3,21) (5,33) (7,74) * Groupwork (1,31) (8,9+10+11+12+13) * Presentations (7,78) (7,79) * Loneliness (1,34) (1,35) (1,49) (1,15) (2,16) (4,13) (5,31) (5,32) (5,36) (7,10) (7,50) * Or Racism (2,19) (2,20) (6,54) * Previous experiences (3,3) (3,5) (3,7) (3,11) (7,79) (7,80) (7,81) * Homesickness (4,11) (7,6) (7,9) (7,12)  Uni V school (3,7) (5,52) (8,5) (8,6) (8,7) (8,8) (8,20) * Harder (1,13) (1,56) (1,74) (1,75q+76) (7,17) * Changes (1,69)  Changes to identity (1,70) (4,18)  <b>Confidence</b> * Social Changes (1,36) (1,37) (1,39) (2,29) (2,30) (2,32) (2,39)	A (1, FT1, 2, 3, 4, 5) (2, FT7) (6, FT8) (6, FT9) (7, FT10, 11, 12, 13) (4, FT15)  B (1, FT1) C (2, FT1) (4, FT2) (5, FT3)	expectations of uni academically sources of university inequality in images of university impact of university images on preparation student identity

Identity processes	<p>Emotions (6,28)</p> <ul style="list-style-type: none"> <li>* Positive (2,2) (4,14) (6,38)</li> <li>* Negative (2,14) (3,24) (3,21) (5,34) (5,35) (6,25) (6,25)</li> <li>* Mixed (4,7) (4,9)</li> </ul> <p>Goals (3,13) (3,14) (6,8) (6,9) (7,33) (7,38)</p> <ul style="list-style-type: none"> <li>* value (6,8) (6,9) (6,10) (6,11) (6,29) (6,31) (6,46)</li> <li>* low goals (7,35) (7,36) (7,37)</li> </ul> <p>Comparisons (1,3)</p> <ul style="list-style-type: none"> <li>* Colouring transitions (1,3) (1,14) (1,26) (1,58) (7,22) (7,23)</li> <li>* Impact expectations (1,4) (1,49) (1,66) (1,84) (1,86) (6,14)</li> <li>* Benchmarks (1,15)</li> <li>* Normal v nonnormal (1,16) (1,17) (1,18) (1,19) (1,21) (1,22) (1,23) (3,1)</li> <li>* Evidence (SIT) (1,26) (1,27) (1,40) (1,41) (1,42) (2,17) (2,36) (4,27) (5,5) (5,6) (5,7) (5,9) (5,11) (5,12) (5,26) (5,28) (5,40) (5,46) (6,48) (6,49) (6,50)</li> </ul> <p>Us/them</p> <ul style="list-style-type: none"> <li>* uni for them (1,10) (1,12) (1,83q) (3,1) (3,9) (3,11) (3,24) (3,25) (3,26) (3,27) (6,34) (6,35) (6,47)</li> <li>* Do I fit the norm (1,14) (1,16) (1,17) (1,23) (2,35) (2,37) (3,9) (3,11) (3,26) (3,29) (3,31) (3,33) (5,13) (6,39)</li> <li>* Social ingroups <ul style="list-style-type: none"> <li>* trad v non (1,25) (3,32) (3,34) (6,54) (6,55)</li> <li>* Slackers v studious (1,29+30+31) (1,32)</li> <li>* "Discredited" (2,16) (2,28) (2,34) (2,38)</li> <li>* Subcultures (2,22)</li> </ul> </li> <li>* Difficulties <ul style="list-style-type: none"> <li>* No reference (1,57) (1,58)</li> </ul> </li> <li>* Gender (5,6+7+8) (5,9) (5,10) (5,19) (5,27) (5,28)</li> <li>* Home Students (6,22+23) (6,25+26) (6,38) (6,51) (6,52) (7,50)</li> </ul>	D (1, FT1) (3, FT2)	filters of experience *goals/risk/aspirations, anxieties/emotions, impact (colouring transition, impact of expectations) identity groupings *ingroups/outgroups, comparisons
Resolution	<p>Opportunities</p> <ul style="list-style-type: none"> <li>*Initial period</li> <li>Ongoing throughout (1,33) (1,38) (1,43) (1,63) (1,65) (1,72) (1,88)</li> <li>* incomplete (1,87)</li> <li>* cyclical nature (21,21)</li> <li>*ongoing</li> </ul>	G (1, FT1, 2, 3)  H (1, FT1, 2; 4 FT3)	growth struggles/barriers opportunities

	<p>*induction as unique</p> <p>* Growth of self (1,69) (1,79) (1,80) (1,81) (1,89q) (1,90) (3,4) (3,8) (3,10) (3,12) (3,5) (3,16) (3,38) (4,17) (5,38) (6,18) (7,5) (7,7) (7,8) (7,13)</p> <p>* Other students voices (1,59) (1,60) (1,61) (1,62) (1,64) (1,67) (2,18) (expert) (3,20) (7,60)</p> <p>* Identity (1,70) (1,84)</p> <p>* Lack of Change (6,38+39)</p> <p>* “How?” (1,73) (1,74) (1,78) (3,22) (4,24) (4,26) (4,35) (5,42) (5,43) (5,45) (7,14) (7,32) (7,47) (7,71)</p> <p>* “How?” (1,73) (1,74) (1,78) (3,22) (4,24) (4,26) (4,35) (5,42) (5,43) (5,45) (7,14) (7,32) (7,47) (7,71)</p> <p>* Challenges</p> <p>* Overcome (1,77) (1,79) (1,80) (4,16)</p>	<p>I (4, FT1, 2, 3)</p>	
--	---	-----------------------------	--

## Appendix D: Focus group interview schedule

### D.1 Interview schedule

1. First of all can you please start by each starting your name, your year of study and your subjects?

We will start with some simple questions that will help frame the discussion. These are from an existing questionnaire and I need to know if they make sense to you. Whether they need to be changed in anyway.

2. To what extent do you see yourself as a student/psychology/hope student?
3. Would you think it was accurate if you were described typical student/psychology/hope student?
4. How often do you acknowledge the fact that you are a student/psychology/hope student?
5. Would you feel good if you were described as a typical student/psychology/hope student?
6. How often do you refer to yourself as being a student/psychology/hope student when you introduce yourself?
7. To what extent do you feel attachment to the identity of student/psychology/hope student?

-----

8. Who of the three groups influences your behaviours, thoughts and attitudes?
9. Where do most of your best friends come from?

-----



## Appendix E: focus group analysis

This appendix contains samples of focus group interviews and further examples of how the transcripts were edited to get individual responses of each participant and how different domains were also grouped together. The sample individual script was chosen not for its length but for the ease of identifying it in the student identity extraction

Appendix D.1 Focus group 2 example transcript

Appendix D.2 Sample individual script

Appendix D.3 Student identity extraction

### Appendix E.1 Focus group example transcript

---

**J:** great thank you very much everybody, and your eyes kept flicking to the recorder, just- we'll try to ignore it, as time goes on you will do. OK, erm, right, when you st- when I give you- when you're, when you hear the word 'student' what does that kind of conjure up, are there any kind of ideas that come with the word 'student'.

**A:** young, that's, that's what I

**J:** young?

**A:** young

**J:** yep ok, anything else?

**A:** um.. poor

**J:** poor, young and poor, yeah that's kind of a given isn't it really? Um, Michael

**M:** Um, again, like just young, skint um and err going out, like, drinking, that sort of thing

**J:** Ok, and you...

**M:** stereotypes and that

**J:** Ok, so when we talk about stereotypes, which are some of the stereotypes do you think that most people say about students?

**M:** er... well some people say they're like, lazy and you know that they should get a job and all that sort of thing

**J:** ok and what about you Steph, would you agree or...

**S:** yeah, just like drunk and

**J:** drunk

**S:** and lazy

**J:** drunk and lazy

**S:** that's... it I think

**J:** ok, ok, and Matt?

**Ma:** err, same that has already been said really, just kind of skint and out of work

**J:** ok

**An:** um... don't know, like students it's like the new found freedom so everyone goes a bit crazy and wild, going out socialising all the time but also like the educational side of it as well, like social identities like you're saying like groups and cliques and stuff like that

**J:** ok, ok so you see a few more positive things, 'cause you were quite neutral to begin with, 'young', but it did get progressively, like, slightly more negative, but you see a few more positive things?

**An:** yeah, there's like groups and societies and things you know sports groups, 'cause I do sport, I'm part of sports groups here and met new different groups of friends; course friends, hall friends, sports friends, like different groups within university

**J:** is anybody else part of any societies?

**Ma:** psychology society

**J:** you're in the psychology society, did you go out at Christmas?

**Ma:** I didn't, no

**J:** with them, no apparently it's a good one, I always... that was the staff, I'm not sure about the students... um, anybody else in any kind of societies or clubs? Ok, so you, but you're in the sport ones

**An:** yep

**J:** yeah, ok and Joshua, what about you?

**Ja:** um I'd say the same to be fair, at first as soon as I think of student I think of University

**J:** yeah

**Ja:** more than the other, at school and out of school funding, same with new friends and you've got more freedom

**J:** ok, ok, have you all enjoyed being students so far?

**An:** yep

**J:** would you say it's been a fairly enjoyable experience?

**Ja:** yeah

**Ma:** yeah

**J:** any negatives?

**Ma:** being poor

**An:** yeah

**J:** being poor, that comes up quite a lot actually, we've had quite a few groups saying 'poor' ok, erm, so you've talked about your aspect of it, what about your families, when they talk about you being students, do you get any kind of jibes about it from family and friends who are not students?

**A:** family, um they always kind of pushed me in that direction so I think they're quite happy I'm at university

**J:** ok

**M:** yeah, not so much from family but sometimes from friends back home who like went straight into work sometimes like y'know just like a bit like, give you a bit of stick for it sort of thing

**J:** in what way give you stick?

**M:** like just saying like 'our taxes are paying for you' and all that sort of thing like

**J:** ok no that's quite common

**S:** yeah I get the same of um, my fiancée doesn't like students

**J:** oh doesn't like students?

**S:** yeah,

**J:** you do get that actually, can you explain that a bit more?

**S:** 'cause they're all like, they all go out and erm, they're all like big groups of people and he thinks that he's paying for them 'cause he works and stuff

**J:** Ok

**A:** he's jealous

**J:** he's jealous?

**S:** yeah (laughs)

**J:** so you think people who stereotype students and are negative are jealous?

**A:** they were lazy in school and they just didn't get to university

**J:** well there is that, there is that ok

**S:** he is jealous 'cause he wanted to go into university but he's in the army so he can't and he doesn't want to go into work

**J:** ok

**S:** so he is jealous Adrian

**J:** ok, ok we'll pick up on that theme later 'cause actually I think it's really interesting in the way... yeah, we'll pick up on again, Math

**Ma:** um yeah I do get a bit of stick for it back home, I mean with all the debts and stuff

**J:** ok

**Ma:** they're sort of just trying to make me worried by the end of it

**J:** ok, ok

**An:** um, I think my family's quite positive about it but I've got a few friends who are like, still in college and they're like the year below me who will have to pay the extra fees so like we were the last year to get the lower fees so I get stick about that but other that all my friends do want to go to university

**J:** so they want to go to university anyway

**An:** yeah, but then I'm just a bit gutted that they missed out on the lower fees

**J:** yeah, that's going to be a bit of a bummer for them

**Ja:** I guess they were saying, they were positive about it wanting me to go uni and stuff but I guess as time went on they realised they were getting- I was spending more and more money so they was giving me more stick

**J:** ok, that's your family?

**Ja:** aye

**J:** yeah, ok um, what about the, the academic side of student life, how have you all found that?

**Ja:** in terms of like...

**J:** in terms of managing the academic side?

**Ja:** 's not really that hard for me

**J:** it's a bit hard?

**Ja:** no, it hasn't

**J:** it hasn't been hard? That's 'cause we're great tutors

**Ja:** yeah, it's not really that hard, it's just like everything seems to like pile up on the last minute sort of thing

**[murmurs of agreement]**

**S:** yeah, I find at times I think a bit difficult but works ok

**Ma:** um well I came straight in from sixth form so I find the way you sort of learn is a bit different less kind of like spoon fed in a way like you have to do a lot, a lot more yourself than just like the classes and stuff

**J:** ok

**An:** yeah our first year so far I think has been ok but getting to this stage I've had like deadlines and exams and it's all kind of piled up at the end so it's a bit harder now but throughout the year it's been ok

**Ma:** I'd say the same, leaving work to the last minute is...

**J:** it's just, first year does, it kind of eases you in and then it comes a bit of a shock towards the end of the year when you suddenly realise how much you haven't done and you still need to do. Um those students who are dual honours, do you, do you feel a pull or are those quite easily matched at the moment, so Adrian do you, how do you manage between the mixture?

**A:** what was the question sorry?

**J:** um the dual honours, um so you're doing psychology and criminology so you meet two different teams, how do you feel about that?

**A:** um psychology applies to criminology a lot

**J:** ok So you feel they marry up quite well?

**A:** yeah they do

**J:** yep ok, Michael what about you?

**M:** erm yeah with doing like sports psychology like, tends to cross over a little bit as well so

**J:** ok, ok, so you're happy with the situation as it is

**M:** yeah

**J:** I'm not expecting you to be on out here, I'm just probing you a little bit it's ok Math? You're... oh, you're single honours sorry, Anna?

**An:** um well I'm sports psychology too, I did both sport and psychology at A-level, so this first year's kind of been going over that sort of thing and they both interlink quite, and I chose both subjects 'cause I like them so they're both the same speed

**J:** ok and Joshua? You're singles honours aren't you? Ok right um, when I say the word 'Identity', what comes to mind? That's a bit of a harder question probably, but what comes to mind when I say what is identity?

**Ja:** who you are, where you come from

**J:** ok, so who you are and where you come from, could anybody add anything to that?

**Ma:** what makes you you basically, so like individuality

**J:** ok, so what makes you you, your um, ok, anybody else?

**Ja:** I'd say what you look like

**J:** who you look- what you look like so the clothes that you choose?

**Ja:** yeah

**J:** how do you choose your clothes though, if that's going to be an identity marker

**Ja:** it depends like what kind of crowd you're hanging out with

**J:** ok, ok anybody else add anything?... Ok, what we're going to move into then is, we're going to start- we've explored a bit about being a student, um what I'm really looking at is the way that your different identities as a Liverpool Hope psychology student fits together or doesn't fit together ok, so what I'm actually going to do is go down a list of questions and they'll apply first of all to being a student ok, hi, sorry

**Mystery voice:** yeah can I come in?

**J:** we've actually already started I'm sorry and it's quite... no I'm afraid not sorry. Ok um, so what extent do you see yourself as a student? So as a-yeah to what extent do you see yourself as a student.

**A:** could you specify more?

**J:** specify more than that, can anybody else, what do you think of that question, to what extend do you see yourself as a student?

**Ma:** fit the stereotype basically

**J:** yeah, how do- would you

**A:** I would agree

**J:** yep, ok, do you mean you fit in with the stereotype?

**A:** oh no, I don't, no.

**J:** you don't fit in with the stereotype, ok that's fine, um what about you Michael, to what extent do you see yourself as a student?

**M:** I um, I'd probably say I fit the stereotype quite a lot like

**J:** in what way?

**M:** um just constantly like perhaps, I blew me money on something like stupid or and err just going out a lot that sort of thing

**J:** so you've learnt a lot of lessons since coming, life lessons?

**M:** yeah, you could say that

**J:** that's all part of being a student, what about you Steph?

**S:** erm.. I don't think I do fit it but

**J:** you live off campus don't you?

**S:** yeah,

**J:** ok

**Ma:** yeah, that's the main thing really living on campus, you just get to be a student more don't you, someone who does those things

**J:** ok,, explain to me 'you get to be a student more' explain to me what you mean by that

**Ma:** you experience more the student life more than someone who doesn't live in halls

**J:** ok, and the student life is... I know I keep probing here but I really need to pull this out, the student life is...

**Ma:** getting together, going out drinking

**J:** ok, ok and you think being off campus...

**Ma:** that's off campus life they don't do that..

**J:** as easily ok, ok, and you would agree Steph?

**S:** yeah

**J:** ok, ok, what about you Math, what do you thing?

**Ma:** um

**J:** would you, to what extent do you see yourself as a student?

**Ma:** quite a lot, probably like, it's like you erm, you kinda learn how to take care of yourself in a way

**J:** ok

**Ma:** like it's like that step between sort of living at home with parents, and getting to the real world

**J:** ok, ok and Anna?

**A:** yeah I think I'm quite a stereotypical student um, go out quite a lot social gathering quite a lot, like what we've just said also like learning to be independent and organising, you've got to push yourself to be more organised in a routine that's your own individual routine rather than what you would have at home.. but I think I'm a typical student yeah

**J:** good, and what about you Joshua?

**Ja:** yeah it's pretty much the same pretty much the stereotypical student although student as well

**J:** but you live off campus don't you?

**Ja:** ah but I live in halls outside

**J:** ah right ok, so you live in a halls but not.

**Ja:** yeah

**J:** ok, does anybody else live in a kind of halls but not on campus no, ok just you Joshua. Ok, um, would you think it was accurate if you were described as a



typical student, some of these are repetitive but we just got to go with them, so would you think it was accurate if you were described as a typical student?

**Ja:** no

**J:** no, ok that's fine

**M:** yeah, I'd probably say that so

**Ma:** yeah definitely

**J:** ok

**S:** yeah I think [laughs]

**J:** ok good ok How often do you acknowledge the fact that you are a student? Adrian]

**A:** whenever I have, um an assignment to do

**J:** whenever you have an assignment to do, so you acknowledge it to yourself?

**A:** yep

**J:** yep, ok, what about to other people?

**A:** um... I don't, I don't think anybody really cares

**J:** ok, ok, what about you Michael, how often do you acknowledge the fact you're a student?

**M:** um, probably quite a bit like you do realise like um just like, like when you're doing all the typical student stuff you know what I mean?

**J:** ok, yeah ok, Steph?

**S:** um only when people ask what I work as

**J:** ok, and does that often happen outside, obviously outside of university

**S:** not that often, it's only been like, the loan because I've got my own house, like I have to do a lot of stuff for it and then people ask what your employment status is yeah

**J:** ok, ok

**Ma:** um, quite a lot 'cause like I'm constantly around people that are something to do with the university, like the only time I'll ever be with somebody who isn't a student or a tutor will be when I'm back home

**J:** ok, and what about you Anna?

**An:** yeah, constantly I'd say I remember being a student like living in halls and I'm always asked, you in university? like job applications which I've been doing y'like student, even shopping student discounts stuff like that I'm always aware I'm a student

**J:** ok good

**Ja:** I'd say like, I acknowledge I'm a student but I kind of take it for granted at the same time

**J:** ok, so it's not always in your head, obviously but it's, it's something, it's there

**Ja:** yeah

**J:** ok good thank you Joshua. Would you feel good if you were described as a typical student? This is about feelings rather than about whether you know or not, would you feel good if you were described as a typical student? Adrian?

**A:** it wouldn't matter to be quite honest

**J:** you wouldn't mind ok

**M:** err, i wouldn't feel like, really good but it wouldn't really bother us too much to be honest

**S:** I don't know, I think because of the negative comments I would like, I'd probably be a bit embarrassed but it's not like, I don't think badly of students, it's just people who I'm around, 'cause none of them go to uni erm, they think negatively of it, so to be classed as a typical student I don't know, I'd feel quite...

**J:** ok, I know that I would- that came out quite a lot yesterday, you feel fine about it but would you say that um, worried about what the connotations that people might have of that?

**S:** hmm, yeah

**J:** ok, what about you Math?

**Ma:** um, I'm fine with it, like I've not really encountered any sort of negativity towards like being a student

**J:** ok, ok, and Anna

**An:** um, I think it depends on who would be calling you a typical student, like if it was my friends I don't think I'd mind but I don't know maybe, someone in my family would describe me as a typical student it's generally got negative connotations and that's something I don't think I'd appreciate as much from them

**J:** ok, and onto you Joshua

**Ja:** um, I'd say the same, I wouldn't really mind what people...

**J:** ok, ok good. Um how often do you refer yourself, refer to yourself as being a student when you introduce yourself?

**A:** I don't really mention it to be honest

**J:** you don't. Say, you're in a

**A:** I mean if someone asks what do I do I say yeah I'm a psychology student

**J:** ok, ok, and you put the words psychology student in fairly regularly? Or after you've been asked what you do?

**A:** um not really, because, else weird conversations start

**J:** we'll get on to the psychology student idea in a minute, ok, what about you Michael?

**M:** um yeah I wouldn't really do it like when I was getting introduced, but if someone asked I'd just say I'm a student

**J:** oh, ok, and you Steph?

**S:** I'm the same, wouldn't point out to someone, but if they asked me

**J:** ok, and what about you

**Ma:** urm, well I've not really met anyone who wasn't a student since being here because I- even if you go out and stuff you go to the student nights so everybody's kind of the same

**J:** ok

**An:** yeah I don't really say unless someone's asked me

**J:** ok Anna, and you Joshua

**Ja:** I'd pretty much say the same as well

**J:** ok, ok and um to what extent do you feel attachment to the identity 'student'

**M:** I don't have an answer to that actually, could you repeat the question?

**J:** yeah, that's fine, to what extent do you feel attachment to the identity of student?

**A:** not really attached

**J:** not really attached, ok that's fine

**M:** I wouldn't say I was that attached to an identity like

**J:** and you would agree with that really Adrian?

**A:** yeah

**J:** ok, what about you Steph?

**S:** not really attached

**J:** not, ok

**Ma:** um, I love it [laughingly]

**J:** you love it!

**Ma:** I want to stay at university forever

[laughter] **J:** [laughs] ok, so you like the idea of being a student

**Ma:** yeah

**J:** and you actually ok could you explain a bit more about that

**Ma:** um, I dunno, it's just like it's a great lifestyle like not that- too much work to be worried about in the first year and plenty of time to socialise and like make new friends

**J:** ok, ok on the back of what Math said, would you add anything to that at all?

**A:** i don't dislike it I just...

**J:** ok, ok Anna?

**An:** yeah I'm the same that I really enjoy being a student especially going into the first year it's all new and I'd say I'm quite attached to being a student, as far as it goes, but it may change second, third year as the work piles on.

**J:** it does get a bit harder in the second year I have to say, Joshua?

**Ja:** um, I'd say since I said that I'm I stereotypical student I'd say that I do have a sense of attachment to being a student so yeah, I kinda do enjoy it and stuff]

**J:** ok I forgot to ask who works by the way, does anybody work?

**Ja:** I don't

**J:** you don't

**A:** no

**J:** so you're all full time students without jobs, ok um... ok, now we're going to go on to looking at the identity as a Liverpool Hope student ok, so what I want to think about is the times when that may be more of a- more obvious than at other times,um.. so we're going to go through the questions again, ok, but this time we're talking about being a Liverpool Hope student rather than a student generic student ok, so, to what extent do you see yourself as a Liverpool Hope student? Adrian?

**A:** just when I really go to lectures

**J:** just when you really go to lectures

**A:** and seminars, that's the only..

**J:** that's the only time?

**M:** pretty much all the time really 'cause living like here so

**J:** ok, ok

**S:** I'm the same, only when I go to it, doing my work on assignments

**J:** ok, ok

**Ma:** um, most of the time probably 'cause I'm in like the halls that Hope owns as well so everyone's the same really

**J:** so you're living in campuses that are owned by Liverpool Hope,

**Ma:** yeah

**J:** so that makes... halls I should say

=====

## Appendix E.2 Sample individual script edit

=====

Transcript from focus group 1, recording 080512

**Julie:** uh xxxx first year Psychology and music student

**Julie:** yeah but- sorry I was just going to say because I have- I have known 'cause like yeah 'cause I go back and forth from campuses quite a lot and yeah, there is, it's kind of I mean it feels sort of like a sort of a stereotype of the different students

**Julie:** who knows... well 'cause the the guys that go to the creative campus are always the ones like you know with the bright hair and the bright clothes and all kind of out there and and they just- they seem generally more um... more like outspoken? And and things? You know, whereas over here I suppose is more like is more stereotypical of what a, what you know what people outside university would call students

**Julie:** um, well I think over here, obviously because there are so many more students than the creative campus, I reckon it does tend to get much louder it does tend to get a bit a bit crazy like that like a- around night time

**Julie:** you know that sort of thing whereas yeah the creative campus, even though it's got fewer students they, like individually they seem very different

**Julie:** yeah

**Julie:** um, well for me I actually, because I'm a bit older, so I actually did live on my own for a couple of years and stuff before I came to university so I suppose for me it doesn't really feel too different in that way you know, but I don't know really, you might be....

**Julie:** actually, you know thinking about it, when I was, when I was back at home, I was always the one having more parties and no- and none of my friends are really so, so much into like music and stuff as I am

**Julie:** you know they- they're all far more um far quieter that way, so I, I would always be the one having parties whereas the minute that I came over here and I was with er with the creative campus it was everybody else that was having the parties

**Julie:** I just find the stereotype quite entertaining so, so I don't really mind

**Julie:** and I think, I think if students get actually properly blamed for things then that kind of irritates me

**Julie:** y'know 'cause they, it seems to be that a lot of the time there's the stereotype of young people in general, a lot of the time that does kind of creep in to the student stereotype you know and so when something negative has happened and it immediately gets blamed on students then that kind of irritates me

**Julie:** because the general stereotype that we're all just kind of crazy and party all the time doesn't really bother me at all

**Julie:** yeah

**Julie:** um well to be honest I mean- 'cause I'd never even been to Liverpool before, I came to uni so I had no idea that there was some kind of social divide between universities until I got here you know, and then I actually just started- I mean it was, again, I just found it quite entertaining I quite enjoyed the fact that there was this kind of- 'cause it's, 'cause it's nothing it's nothing malicious it's just, it's just sort of a bit joking around

**Julie:** y'know, I mean I never actually feel as if I say to someone oh I'm a Hope student and they look down on me...

**Julie:**... Particularly, I mean we just kind of joke about it so it's ok

**Julie:** y'know and, and as far as I'm concerned I mean I came to uni just because I wanted to come to uni, I haven't come here for any particular career in mind... so for me y'know any degree is fine just for the experience of it and yeah... so that was the reason I came

**Julie:** um I actually think when I first- when I when I started first year I felt very very much like a student because it had taken me a couple of years to get to that stage again you know so um, so at first I was like 'yeah I'm a student again' and that was kind of the main thoughts that go- were going on in my head but then as the years have gone on it sort of eased off and now I sort of only actually remember that I have student status when I fill out a form and I have it saying student instead of unemployed [laughter] so that's kind of the only time I really remember it now because um yeah just because there's so much more going on now that I've been in Liverpool for a few years

**Julie:** no

**Julie:** no

**Julie:** I think the funny thing is that in this context when we're saying typical it means stereotypical anyway...

**Julie:** yeah, it yeah 'cause um I just think it's interesting y'know because obviously a typical student... you know traditionally you would say the kind of person yeah, like works a lot and that you know get- actually gets the stuff done whereas you know really, like for example I mean here the typical student during freshers week is the one that goes out all the time to meet new friends and just like you know and goes along to that bar crawl and stuff like that and to be honest I mean my freshers week wasn't like that, I literally, I actually had a very quiet freshers week and then went on a bar crawl but everyone else I knew went out every single night and I got no idea how you do that [laughter]

**Julie:** but um, but no I wouldn't say... actually no, to be honest maybe I would say I'm a typical student because like, because I tend to like I tend to get my work done but then at the same time I, I wouldn't say that it's, that it's everything I do you know I just, it's just that when I, when I actually eventually feel motivated to do it then I will just do it and get it done so... but yeah I mean it depends which way you're looking at the typical aspect

**Julie:** yeah, I think, I think with um with older people, like older family members it comes up a lot because you know, because that's, I guess that's because all they definitely know that you do now [laughter] so they go like 'oh how's uni?' yeah but um I guess with me I do sometimes use it kind of, kind of as an excuse just for general behaviour you know like it- for example like I um if I leave work 'til very late and I just go out and buy like loads and loads of snacks you know and someone'll be like 'oh your insane' I'd be like 'no, I'm a student' [laughter] that's what we do

**Julie:** yeah being a... once again it's always in a very sort of light-hearted..

**Julie:**.. way

**Julie:** yeah, um

**Julie:** this Friday [nervous laughter] and then it's completely done, I mean...

**Julie:** I'm sure it will be, I don't know how I'm going to feel, but like, well for me it's not really... it's not really saying, i-it's not really like me leaving the student role that I would find, you know, a bit of a shock, I think, I mean, 'cause obviously being in



Liverpool for three years, being at this university for three years, spending time with all these new people for the last three years, I think that's going to be the main thing um.. but um, but I wouldn't say that it's the role of a student that I'm attached to, I think it's just everything that comes with it

**Julie:** um I think, I think I remember when I first came here, I think I felt very similar to the way that you did Trim, actually

**Julie:** y'know 'cause um, 'cause I'm not religious so when I, when I first came here and then realised it was a Christian university, 'cause I kind of feel like that, that wasn't really that obvious before you come here whereas when you get here it's very obvious [laughter]

**Julie:** you know and I don't, the thing is, I mean I don't mind that at all, but yeah it's just when you sort of feel as if, that then should become a majority part of your life here then I think that is quite daunting, you know so um... and then, but to be honest I mean for me the majority of the time it was, it was then realising that Liverpool Hope was the one that was kind of looked down upon, you know, out of the universities over here so, and then I remember for a little while that kind of bothered me just because I wasn't even aware of it until I came here but then I remembered that, you know the reason that I'm coming to university is, is just for the experience of university and just because I wanted to so, then I wasn't really so bothered any more

**Julie:** um, no I feel, I feel more detached from typical Hope student than just typical student

**Julie:** yeah, I-I can't, I can't imagine anyone describing me as a typical Liverpool Hope student, that feels strange to me

**Julie:** um just when people ask me where I'm going I suppose is the only time I really say it you know, 'cause if, 'cause if someone, if someone- actually no, when someone first asks me where are you going I tend to say I go to uni in Liverpool, just, just 'cause it's just a general thing, and then you know, yeah if someone asks me specifically then I'll say but other than that I don't really tend to mention it

**Julie:** I've never actually been- faced anything like that luckily, it seems like, 'cause I think over on this campus... it- even, even though it is obviously a very um a very big thing you know having the Christianity part over here, 'cause you really, you know,

here we have the chapel and everything else, but then, at the chaplaincy, like the- I find that they are very very open minded you know, and you can go there and have discussions about anything and they will approach it from a very...

**Julie:** yeah. No, I I I wouldn't, I wouldn't feel particularly good as such, I mean I guess it would bother me a little bit because I don't really feel like I am, I don't really associate myself to be, you know, a typical Liverpool Hope student

**Julie:** that's not, that's not really what I think about, but then, then it wouldn't bother me as such I would just be... I don't know, I feel... I feel a little bit off about it but I wouldn't, I wouldn't say that it would actually have any kind of negative affect on me  
yeah

**Julie:** same

**Julie:** um, I guess I have attachment in terms of like the tutors and that because I feel like the hope tutors are really really good

**Julie:** [laughs] yeah, so I've gotten to know quite, quite a few of the different members of staff here and I find that, I find that the fact that they do actually remember you, you know and they do actually wan- they are actually interested in how you're doing and that sort of thing, and I think that that, that side of it is really nice to be, to be associated with, to be attached to, but you know, just the general title of Liverpool Hope student I wouldn't say I'm attached to

**Julie:** yeah, so I don't, I mean... I guess in a way I kind of like see myself as a music student just because I, I sort of like being um, like ideas that people have about music students, 'cause I think it's quite nice, you know but then um for psychology students like, I I quite often feel a bit out of my depth in psychological conversations [laughing] you know because a lot of the time if I'm like, if I'm with a few of my friends that also take psychology, because I'm friends with the psychology students, and you know, if we're having these discussions about things then I will sometimes actually end up feeling quite nervous because I'll feel like I'll need to know about certain things that they're talking about and then I'll, then I'll feel quite self conscious if I don't quite remember a certain theory or you know, that sort of thing, so um...

**Julie:** that'll be my wild card in future

**Julie:** and people suddenly get really nervous around you

**Julie:** um to be honest no, I mean i-err I wouldn't say.. I wouldn't say it's accurate ma- mainly just because I mean you know once again that's going back to the whole stereotype idea, like I wouldn't say, 'cause music students tend to have this like stereotype of being very kind of very lazy and very just sort of, oh, it's looked upon as sort of a doss subject, really you know and and to be honest I mean, I don't really mind that 'cause I think a lot of the time people just take music because they really enjoy music you know in the same way that I'd imagine people take fine art because they really

**Julie:** enjoy it that's you know so I mean that was one of the main reasons why I wanted to take psychology with music so that I could do psychology as sort of you know my more academic side of things and music because it's just the more creative

**Julie:** so I like that mix

**Julie:** um I tend to associate myself psychology student more often than music student um.. ma-mainly like once again because I think of music as more of a hobby to me and psychology is like is more of what I would say is my study you know, so erm

**Julie:** well yeah, I mean I feel like um, 'cause with psychology I mean to be honest with you I'll take, I'll take a bit of an example which would be like.. the essays and stuff like when you're writing an essay you have a statement, you have to always back that up with, with evidence every single time whereas with music it's quite a bit more relaxed you know and you can, you can say something you don't necessarily have to, have to have done you know loads of reading in order to have said something so in that way I sort of feel as if yeah that would be more of the um, it feels more casual to me I suppose, my music course than the psychology one does. So I suppose in that way I would say psychology student or if someone asked me what I do I'd always say psychology and music I would never just say music

**Julie:** I, I actually quite enjoy it when someone says I'm a typical psychology student or a typical music student I think it's quite, it's quite fun because like, 'cause of the, I think the cool thing is that obviously a psychologist, like someone psychology particularly on like, when you see psychologists on T.V like or or in sitcoms or something like that, they're always the one that's really sort of, just quite crazy yeah  
[laughter]

**Julie:** um, I sometimes bring it up, or really no, if I'm just surrounded by students you know, 'cause then I'll say well I'm a psychology student you know, because then if there's a lot of psychology students there it makes things more interesting

**Julie:** yeah, just because, I-I guess it's um I guess it's one of those things where if you say you study a certain topic and then someone else says they also study that then you sort of feel as if you, I think particularly in psychology you kind of feel like you've already got a bond with that person you know, and that, that will get...

**Julie:** I actually do feel quite attached to it, but mainly because I'm not planning on going into psychology in any sort of like you know, or at least anytime soon as like as a career so I think I'm really going to miss it when I'm, when I'm finished with it you know so... so I guess in that way I'm very attached to, to being a psychology student just because I'm, this is just part of my life I'm never really going to have again

**Julie:** yeah, subject

**Julie:** uh all subjects, um now that I've thinking about it actually the majorityity come from creative campus just, just because at the creative campus it seems that when you know one person they're going to know like ten other people [laughter]

**Julie:** yeah, I mean particularly seeing as the creative subjects have far fewer students in, in the classes you know like for example in music everyone knows each other, in in psychology there are still some people that I'm seeing now that they're saying oh I've been here since first year and I'm like I've never seen you before in my life

**Julie:** yeah. It's a very big subject you know, but but yeah so I guess that just because it's more intimate over there... yeah

**Julie:** I'd say the same with me actually yeah

**Julie:** um well I actually I personally know quite a lot of people that would associate themselves with one particular focus in their like they make that their identity like, like for example I mean a few of my friends that um, in fact another um another person I know who also did psychology and music, and um, and she's got, you know she's got like music tattoos and things like that and I think, actually I've noticed quite a few people over at creative campus they do have you know music tattoos of some kind and it kind of seems as if they- they do associate themselves with music and and ye-and you know there are other things as well but music is like their life I would say you

know, or um or I suppose with other people it would be their religion that would be their life so um but I don't know I mean with me I think it is just the way that I am with people I'd say with me it's more just a case of socially like that would be my identity

### Appendix E.3 Student Identity extraction

**Julie:** y'know and, and as far as I'm concerned I mean I came to uni just because I wanted to come to uni, I haven't come here for any particular career in mind.. so for me y'know any degree is fine just for the experience of it and yeah.. so that was the reason I cam

**T:** I'd say quite a high degree really

**T:**yeah

**T:** well I never thought I was defining my identity now

**T:** is in..but I did one year psychology in Norway and in Norway all psychology course has to be in philosophy and history of science

**T:** and had we- it's like logic and that's like created quite a strong frame of mind as a scientific part because you learn about. the history like going from positivism to like empirical relativism all that type of thing

**T:** which sort of creates quite a strong frame of mind which I sort of define a lot how I think what I do from

**T:** yeah I'm happy about that

**T:** yeah

**R:** err yeah I'd say I'm a student I've got a lot of friends who don't go to university and um I live a very different lifestyle than a lot of them obviously because I do go to university like most times a week, so...

**Ta:** um well it's my job during term time and I've got y'know two other jobs during the holiday time I mean it's just... what I do like, I pay to come here and that is like a big part of my life but it's not me

**Julie:** um I actually think when I first- when I when I started first year I felt very very much like a student because it had taken me a couple of years to get to that stage again you know so um, so at first I was like 'yeah I'm a student again' and that was kind of the main thoughts that go- were going on in my head but then as the years have gone on it sort of eased off and now I sort of only actually remember that I have student status when I fill out a form and I have it saying student instead of unemployed [laughter] so that's kind of the only time I really remember it now because um yeah

just because there's so much more going on now that I've been in Liverpool for a few years

**Julie:** no

**R:** um yeah I have a part time job just as a waitress

**Ta:** two part time jobs

**Ta:** uh, no

**T:** only when at home

**Julie:** no

**T:** yeah. Well I, I would say like you- you are a typical student in some ways because I have been, a couple of times I have been sitting down and going 'yes this is studenty' [laughter]

**T:** yes, yeah by living in halls, living in campus and sort of there's things you do, well I do come from the tiniest little place in the middle of nowhere which has absolutely nothing to do so even going to like a café and sitting down and reading books or doing sketches is being a student for me... and being quite different from how most people are back home

**T:** yes, yes probably would be that

**R:** yeah

**R:** um, in some ways yeah, and in others no like still do what normal students do like you'll miss a lecture every now and again at nine o'clock in the morning 'cause you can't get out of bed

**R:** yeah, oh good... um no, um I don't really go out much, like I don't really party much or anything I just- what I do I don't feel any different now from what I did when I was in school

**R:** yeah I know

**Ta:** I don't really feel that that's accurate, I don't... I mean I party but not a lot and I don't drink and I feel like I work a bit harder than most people that I know of in my course um.. so I wouldn't really say that I'm a typical student um... No

**Julie:** I think the funny thing is that in this context when we're saying typical it means stereotypical anyway..

**Julie:** yeah, it yeah 'cause um I just think it's interesting y'know because obviously a typical student... you know traditionally you would say the kind of person yeah, like works a lot and that you know get- actually gets the stuff done whereas you know really, like for example I mean here the typical student during freshers week is the one that goes out all the time to meet new friends and just like you know and goes along to that bar crawl and stuff like that and to be honest I mean my freshers week wasn't like that, I literally, I actually had a very quiet freshers week and then went on a bar crawl but everyone else I knew went out every single night and I got no idea how you do that [laughter]

**Julie:** but um, but no I wouldn't say... actually no, to be honest maybe I would say I'm a typical student because like, because I tend to like I tend to get my work done but then at the same time I, I wouldn't say that it's, that it's everything I do you know I just, it's just that when I, when I actually eventually feel motivated to do it then I will just do it and get it done so... but yeah I mean it depends which way you're looking at the typical aspect

**T:** I don't think that often now, it was more last year, like first year, y'know..

**T:** well I mean I was more of a stereotypical student in a way because I was part of the students newspaper... I worked at a student house.. um we like because I worked at a student house, we'd always go down to the student house and you'd get cheaper beer there... [laughter]... and do no work

**T:** I never introduce myself as a student, no but I do say that I go to uni

**T:** so sort of yeah

**R:** err, no, as you said before, like when you're filling in forms, oh you say oh yeah I'm a student or I use it a lot as an excuse in work I say oh I can't work this weekend I've got work to do for uni, but apart from that no not really

**Ta:** um only to get off work during term time [laughter] and when I'm filling in a form and when my grandparents ask me every single time how uni's going

**Julie:** yeah, I think, I think with um with older people, like older family members it comes up a lot because you know, because that's, I guess that's because all they definitely know that you do now [laughter] so they go like 'oh how's uni?' yeah but um I guess with me I do sometimes use it kind of, kind of as an excuse just for general



behaviour you know like it- for example like I um if I leave work 'til very late and I just go out and buy like loads and loads of snacks you know and someone'll be like 'oh your insane' I'd be like 'no, I'm a student' [laughter] that's what we do

**Julie:** yeah being a... once again it's always in a very sort of light-hearted..

**Julie:**.. way

**T:** yeah I wouldn't mind that at all

**R:** um, I wouldn't feel good or bad about it yeah

**R:** yeah

**Ta:** I don't know, I might feel a little bit insulted considering I'm not [laughter] but I wouldn't really care, I mean just, I'm sure no one would actually mean it in a bad way so.. [laughter] it doesn't really bother me either way to be honest

**T:** attachment. I'm not sure to like degrees, or not much... it's.... I'm not sure really. I do like.. have.. quite attached to the idea of like psychology and just knowing stuff in general, I do read a lot of psychology... outside of the course

**T:** but... and neuroscience... and science in general really, but these are not as being a student and more just a general interest

**R:** yeah, um... same really i..yeah I'm not quite sure how to answer that one

**R:** oh yeah

**R:** definitely something to be proud of

**T:** yeah I think so to

**R:** it was hard to get here

**T:** it's definitely something to be proud of, I mean it is called like higher education, so I do feel it's quite cool in that way and I don't want to leave, I want to work in university for the rest of my life really

**T:** work with research

**R:** yeah I, like you work really hard for you're a-levels again, so it's definitely something to be proud of and then you've paid so much money to come here then why on earth would you ever want to throw it away is beyond me

**Ta:** yeah, like they said it's really hard to get here and you are paying, so you may as well do your hardest and feel proud of it um... yeah

**Julie:** yeah, um

**Julie:** this Friday [nervous laughter] and then it's completely done, I mean...

**Julie:** I'm sure it will be, I don't know how I'm going to feel, but like, well for me it's not really... it's not really saying, i-it's not really like me leaving the student role that I would find, you know, a bit of a shock, I think, I mean, 'cause obviously being in Liverpool for three years, being at this university for three years, spending time with all these new people for the last three years, I think that's going to be the main thing um.. but um, but I wouldn't say that it's the role of a student that I'm attached to, I think it's just everything that comes with it

## Appendix F: focus group analysis and results

Appendix F provides a sample of the open coding of the section of the transcript provided in appendix E. Initial coding was done on printed transcripts, the following are the second and third stages of analysis which was compiled using QDA MinerLite, v 1.4.6.

### Appendix F.2. Sample of open coding

Table F.1: Sample of open coding

Text	Codes
we do have differences like the creative	Identity differences
T: because we've got a bad reputation round town and because like, I talk to other people and I said they have no flat parties, we have flat parties every single week	External evaluation (within emotion) (includes member of group)
T: because we've got a bad reputation round town and because like, I talk to other people and I said they have no flat parties, we have flat parties every single week T: flat parties	(overlaps External evaluation) emotion (includes member of group)
we've got	(within External evaluation) (within emotion) member of group
J: yeah but- sorry I was just going to say because I have- I have known 'cause like yeah 'cause I go back and forth from campuses quite a lot and yeah, there is, it's kind of I mean it feels sort of like a sort of a stereotype of the different students	External evaluation (includes Identity differences) (includes External evaluation)
quite a lot and yeah, there i	(within External evaluation) Identity differences
kind of I mean it feels sort of like a sort of a stereotype of the different students	External evaluation
J: who knows... well 'cause the the guys that go to the creative campus are always the ones like you know with the bright hair and the bright clothes and all kind of out there and and they just- they seem generally more um... more like outspoken? And and things? You know, whereas over here I suppose is more like is more stereotypical of what a, what you know what people outside university would call students	Distancing (includes Identity differences)
they just- they seem generally more um... more like outspoken?	(within Distancing) Identity differences
well I think over here, obviously because there are so many more students than the creative campus	Minority group

I reckon it does tend to get much louder it does tend to get a bit a bit crazy like that like a- around night time	Identity differences
even though it's got fewer students they, like individually they seem very different	Identity differences (overlaps Distancing)
even though it's got fewer students they, like individually they seem very different	(within Identity differences) Distancing
and we've got, haven't we got like twenty eight red cards the first two weeks?	member of group
T: we got twenty eight red cards	emotion (includes member of group)
: we got twenty eight red cards	(within emotion) member of group
T: yeah, we had the most red cards of all the campus	member of group (overlaps emotion)
yeah, we had the most red cards of all the campus Ta: yeah um we have the red card thing but I don't really know... of anyone that's got more than one	(overlaps member of group) emotion (includes Identity differences)
Ta: yeah um we have the red card thing but I don't really know... of anyone that's got more than one	Identity differences
I felt a lot more like a stereotypical student when I lived away than I do now I live at home	rejection
R: yeah it was all parties, it was a lot more social and um like people with, the people on our courses and things like that so it was a lot different than living at home with the parents now	external (includes internalisation)
yeah it was all parties, it was a lot more social and um like people with, the people on our courses and things like that so it was a lot different than living at home with the parents now	internalisation
well for me I actually, because I'm a bit older, so I actually did live on my own for a couple of years and stuff before I came to university so I suppose for me it doesn't really feel too different in that way you know, but I don't know really, you might be...	rejection
like the same stereotype as the creative campus are um T: might specifically go exactly with...	external
yeah but it's hard to tell though because I've not found the same type of people anywhere else and I've been quite a lo- a lot around	rejection
J: actually, you know thinking about it, when I was, when I was back at home, I was always the one having more parties and no- and none of my friends are really so, so much into like music and stuff as I am	internalisation (includes acceptance)
actually, you know thinking about it, when I was, when I was back at home, I was always the one having more parties and no- and none of my friends are really so, so much into like music and stuff as I am	acceptance

I worked so hard to get here I'm not going to waste my time going to all the parties and...	rejection
I work really hard, I mean I do go to parties and all of that but...	value
because anyone that actually knows a student is probably not going to believe that because you can't just say that we're all the same person, all the same type, I mean obviously we wouldn't have stereotypes if it weren't a bit true but... they're not completely true	rejection
and I know they're not true of me, so it doesn't really bother me	rejection
for a lot of students its genuinely true	external
it's one of them things that it does- things do happen – can't really try and sugar coat it	external
I just find the stereotype quite entertaining so, so I don't really mind	external
J: and I think, I think if students get actually properly blamed for things then that kind of irritates me	rejection (includes external)
and I think, I think if students get actually properly blamed for things then that kind of irritates me	(within rejection) external
for some reason people don't like Hope students though	External hope External evaluation
for some reason people don't like Hope students though	External evaluation
yeah, I don't- I don't I've talked to some people, I asked a girl that- she was at our campus and I was like 'why don't people like Hope students	External hope
think that's why the, like, creative campus has got a bad reputation because they just think we're so like creative and we don't like,	Identity protection engagement
it has actually been described as 'fine art, the most useless course in the world' – lowest employment rates and everything... um	Low value
R: um from my own personal experiences I worked really hard at my A-levels and I went to um University of York and it took me everything to get into that university and um like I went there through clearance as well but um, so I just took a course that like,, I was doing history of art and I absolutely hated it and my mum was like 'oh well if you really want to give it up, like come back' and I was like ' but where am I going to go?' and she's like 'well you can go to Liverpool' and I was like ' I really just don't want to, I might go to Hope' and she was like 'you can't go to Hope ' [laughter] she was like 'you can't go from going to the university of York to Hope' and I was like 'well at the end of the day like it's still a degree like it's not that much of a difference and I've enjoyed myself like so much more doing my course here than I could have ever done there especially in terms of like the tutors and things like they were very up themselves er, at York and um they didn't really care much about their students and it was very much their own research interests and that was just how it was.	Pride hope External hope Identity protection engagement (includes value) (includes External hope) (includes Acceptance Hope)

um from my own personal experiences I worked really hard at my A-levels	(within Pride hope) (within External hope) (within Identity protection engagement) value
and I was like ' but where am I going to go?' and she's like 'well you can go to Liverpool' and I was like ' I really just don't want to, I might go to Hope' and she was like 'you can't go to Hope ' [laughter] she was like 'you can't go from going to the university of York to Hope'	(within Pride hope) (within External hope) (within Identity protection engagement) External hope
well at the end of the day like it's still a degree like it's not that much of a difference and I've enjoyed myself like so much more doing my course here than I could have ever done there especially in terms of like the tutors and things like they were very up themselves er, at York and um they didn't really care much about their students and it was very much their own research interests and that was just how it was.	Acceptance Hope
T: yeah a lot of the te- the tutors in psychology are incredible	Pride hope Identity protection engagement (includes psychology accepted)
yeah a lot of the te- the tutors in psychology are incredible	psychology accepted
R: yeah, so many like all my friends in York are like oh my God I can't believe you go to Hope but like, you're never going to do anything with your life...	Rejection hope (includes External evaluation)
so many like all my friends in York are like oh my God I can't believe you go to Hope but like, you're never going to do anything with your life...	External evaluation
um well to be honest I mean- 'cause I'd never even been to Liverpool before, I came to uni so I had no idea that there was some kind of social divide between universities until I got here you know, and then I actually just started- I mean it was, again, I just found it quite entertaining I quite enjoyed the fact that there was this kind of- 'cause it's, 'cause it's nothing it's nothing malicious it's just, it's just sort of a bit joking around	External hope (includes External hope)
ause I'd never even been to Liverpool before, I came to uni so I had no idea that there was some kind of social divide between universities until I got here you know, and then I actually just started	(within External hope) External hope
I'd say quite a high degree really	Hopes
well I never thought I was defining my identity now	rejection
but I did one year psychology in Norway and in Norway all psychology course has to be in philosophy and history of science T: and had we- it's like logic and that's like created quite a strong frame of mind as a scientific part because you learn about... the history like going from positivism to like empirical relativism all that type of thing	psychology accepted (overlaps valued)

and had we- it's like logic and that's like created quite a strong frame of mind as a scientific part because you learn about... the history like going from positivism to like empirical relativism all that type of thing T: which sort of creates quite a strong frame of mind which I sort of define a lot how I think what I do from	(overlaps psychology accepted) valued (includes psychology accepted)
T: which sort of creates quite a strong frame of mind which I sort of define a lot how I think what I do from	psychology accepted
actually think when I first- when I when I started first year I felt very very much like a student because it had taken me a couple of years to get to that stage again you know so um, so at first I was like 'yeah I'm a student again'	acceptance
that was kind of the main thoughts that go- were going on in my head but then as the years have gone on it sort of eased off	Transition into HE
now I sort of only actually remember that I have student status when I fill out a form	external
saying student instead of unemployed [laughter] so that's kind of the only time I really remember it now because um yeah just because there's so much more going on now that I've been in Liverpool for a few years	internalisation (overlaps external) (includes widening)
saying student instead of unemployed [laughter] so that's kind of the only time I really remember it	(within internalisation) external (overlaps widening)
remember it now because um yeah just because there's so much more going on now that I've been in Liverpool for a few years	(overlaps external) widening
um yeah I have a part time job just as a waitress	complex
Well I, I would say like you- you are a typical student in some ways because I have been, a couple of times I have been sitting down and going 'yes this is studenty' [laughter]	internalisation
J: yeah, it yeah 'cause um I just think it's interesting y'know because obviously a typical student... you know traditionally you would say the kind of person yeah, like works a lot and that you know get- actually gets the stuff done whereas you know really, like for example I mean here the typical student during freshers week is the one that goes out all the time to meet new friends and just like you know and goes along to that bar crawl and stuff like that and to be honest I mean my freshers week wasn't like that, I literally, I actually had a very quiet freshers week and then went on a bar crawl but everyone else I knew went out every single night and I got no idea how you do that [laughter]	External evaluation external (includes acceptance) (includes Identity differences) (includes Markers) (includes rejection)
yeah, it yeah 'cause um I just think it's interesting y'know because obviously a typical student... you know traditionally you would say the kind of person yeah, like works a lot and that you know get- actually gets the stuff done whereas you know really, like for example I mean here the typical student during freshers week is the one that goes out all the time to meet new friends and just like you know and goes along to that bar crawl and stuff like that and to be honest I mean my freshers week wasn't like that, I literally, I actually had a very quiet freshers week and then went on a bar crawl but everyone else I knew went out every single night and I got no idea how you do that [laughter]	acceptance (includes Identity differences) (includes Markers) (includes rejection)

actually gets the stuff done whereas you know really, like for example I mean here the typical student during freshers week is the one that goes out all the time to meet new friends and just like you know and goes along to that bar crawl and stuff like that and to be honest I mean my freshers week wasn't like that	(within External evaluation) (within external) (within acceptance) Identity differences (includes Markers) (overlaps rejection)
like for example I mean here the typical student during freshers week is the one that goes out all the time to meet new friends and just like you know	(within External evaluation) (within external) (within acceptance) (within Identity differences) Markers (overlaps rejection)
during freshers week is the one that goes out all the time to meet new friends and just like you know and goes along to that bar crawl and stuff like that and to be honest I mean my freshers week wasn't like that, I literally, I actually had a very quiet freshers week and then went on a bar crawl but everyone else I knew went out every single night and I got no idea how you do that [laughter]	(overlaps Identity differences) (overlaps Markers) rejection
but um, but no I wouldn't say... actually no, to be honest maybe I would say I'm a typical student because like, because I tend to like I tend to get my work done	internalisation
I wouldn't say that it's, that it's everything I do you know I just, it's just that when I, when I actually eventually feel motivated to do it then I will just do it and get it done so.. but yeah I mean it depends which way you're looking at the	Positive behaviour
I don't think that often now, it was more last year, like first year, y'know...	Transition into HE
well I mean I was more of a stereotypical student in a way because I was part of the students newspaper...	Markers
I worked at a student house... um we like because I worked at a student house, we'd always go down to the student house and you'd get cheaper beer there	Markers (overlaps Markers) (overlaps Negative behaviours)
we'd always go down to the student house and you'd get cheaper beer there... [laughter]... and do no work	(overlaps Markers) Markers Negative behaviours
T: I never introduce myself as a student, no but I do say that I go to uni	rejection
err, no, as you said before, like when you're filling in forms, oh you say oh yeah I'm a student or I use it a lot as an excuse in work I say oh I can't work this weekend I've got work to do for uni, but apart from that no not really	rejection
um only to get off work during term time [laughter] and when I'm filling in a form and when my grandparents ask me every single time how uni's going	rejection



J: yeah, I think, I think with um with older people, like older family members it comes up a lot because you know, because that's, I guess that's because all they definitely know that you do now [laughter] so they go like 'oh how's uni?' yeah but um I guess with me I do sometimes use it kind of, kind of as an excuse just for general behaviour you know like it- for example like I um if I leave work 'til very late and I just go out and buy like loads and loads of snacks you know and someone'll be like 'oh your insane' I'd be like 'no, I'm a student' [laughter] that's what we do	Negative behaviours rejection (includes external)
yeah, I think, I think with um with older people, like older family members it comes up a lot because you know, because that's, I guess that's because all they definitely know that you do now [laughter] so they go like 'oh how's uni?' yeah but um I guess with me I do sometimes use it kind of, kind of as an excuse just for general behaviour you know like it- for example like I um if I leave work 'til very late and I just go out and buy like loads and loads of snacks you know and someone'll be like 'oh your insane' I'd be like 'no, I'm a student' [laughter] that's what we do	external

### Appendix F.3 Codebook

The following is a sample of the code book that was developed during the open coding reading of the transcripts and then applied to a further reading of each one.

Table F.2 Codebook sample

Category	Code	Description
Identity processes	Identity differences	Acknowledges or narrates differences between them and an outgroup
Identity processes	External evaluation	Identity influenced by external agencies, such as family friends but also a wider influence from society or community
Identity processes	emotion	Emotions about being a member of the group, possibly pride
Identity processes	member of group	identifies as a member of the group
Identity processes	Distancing	uses words to show a distance from the group
Identity processes	widening	less reliant on university and student identity as individual settled into the degree
Identity processes	complex	identity included outside of student and complex
Identity processes	Markers	behaviours or signs that the participants proposes is part of the group
Identity processes	comparison of groups	participant identifies differences between one group and another, their own groups, - intra identity dynamics, not inter
Identity processes	Identity protection engagement	individuals showed processes that protected their identity

Identity processes	Minority group	participants acknowledge they are part of a minority group
Student domain	acceptance	acceptance of student identity label
Student domain	rejection	outright statement that they do not want to be identified as a student
Student domain	pride	emotion of pride that they are part of the student group
Student domain	external	evaluations from outside the group
Student domain	internalisation	Internalisation of the values and evaluations given by external influences. May or may not have emotions attached but the individual accepts that the group in question behaves in a certain way.
Student domain	Positive behaviour	
Student domain	Negative behaviours	Identification of a negative behaviour as a symbol of the group
Degree	value	value of degree evidence
Degree	reasons for	Includes reasons why students may have undertaken a degree, general, not specific to a domain or identity
Degree	Hopes	
Degree	positive experiences	narrative could be perceived as a journey moments were the process through identity was high. It includes all three domains
Degree	Low Journey	moments were the process through the degree was hard, incorporates challenges but more than that. It was moments when the identity was most at risk. It includes all three domains
Degree	Transition into HE	Issues to do with experiences prior to starting the degree and the first year experience
Institution identity	Acceptance Hope	
Institution identity	Rejection hope	
Institution identity	Pride hope	
Institution identity	External hope	
Institution identity	Internalisation hope	statements that show that the perceived evaluations of psychology students are accepted and internalised, that is they feel they have become this
Subject art	Low value	
psychology	psychology accepted	acceptance of psychology label
psychology	valued	positive value statements for psychology as a subject

## Appendix G: Social Identity measures

### Appendix G

*Table G.1 Comparison of Social Identity Measures*

Feature	Global Measures				Multi-component Measures			
	Brown et al (1986)	Mael & Ashforth (1988)	Doosje et al (1995)	Haslam et al (1999)	Hinkle et al (1989)	Karasawa (1991)	Ellemers et al (1999)	Cameron (2004)
Number of items	10	6	4	1				
High inter-item reliability		✓	✓	n/a	Within subscales	Within subscales	Within subscales	Within subscales
Multiple components of identity	✓		✓		✓	✓	✓	✓
Differentiates between subcomponents					✓	✓	✓	✓
Suitable for real groups	✓	✓	✓	✓		✓	✓	✓
Suitable for ad hoc groups			✓	✓	✓		✓	
Social identity salience measure			✓	✓				

The above table was adapted from Haslam (2004)

## Appendix H: Scale analysis

Appendix H.1 Content Validity Index

Appendix H.2 Scree Plot

Appendix H.3 CFA results

### Appendix H.1 Content Validity index results

Table H.1 Content validity index table

Asi STS C1	Asi ENG 1r	AsiS UBEV AL1	AsiS UBEV AL2	Asi STS C2r	Asi SUB SC1	As iC C1	AsiS UBEV AL3	S E L F	AsiS UBSC 2r	Asi SUB SC3	As iC C2	AsiS UBSC 4r	As iC C4	Asi SUB SC5	As iG A2	AsiS UBEV AL4	As iC C3	Asi SUB SC6	As iG A3	As iG A1	As iE ng 2	As iE ng 3	Asi SUB SC7	
4.0 0	4.0 0	4.00	3.00	4.0 0	2.0 0	3.00	4.00	2 . 0 0	3.00	4.0 0	4.00	4.00	1.00	4.0 0	3.00	4.00	4.00	4.0 0	4.00	4.00	3.00	4.00	4.0 0	
4.0 0	4.0 0	4.00	4.00	4.0 0	3.0 0	4.00	4.00	2 . 0 0	4.00	4.0 0	4.00	3.00	2.00	4.0 0	4.00	4.00	4.00	4.0 0	4.00	4.00	2.00	4.00	4.0 0	
4.0 0	4.0 0	4.00	4.00	4.0 0	4.0 0	4.00	3.00	1 . 0 0	4.00	4.0 0	4.00	3.00	1.00	4.0 0	4.00	4.00	4.00	3.0 0	4.00	3.00	4.00	4.00	4.0 0	
4.0 0	3.0 0	4.00	4.00	4.0 0	4.0 0	4.00	4.00	3 . 0 0	4.00	4.0 0	4.00	4.00	3.00	4.0 0	4.00	4.00	3.00	4.0 0	3.00	4.00	4.00	4.00	3.00	4.0 0
4.0 0	4.0 0	4.00	3.00	4.0 0	4.0 0	4.00	4.00	2 . 0 0	4.00	4.0 0	3.00	4.00	3.00	4.0 0	3.00	4.00	4.00	3.0 0	4.00	4.00	4.00	4.00	4.00	4.0 0
4.0 0	4.0 0	4.00	4.00	3.0 0	4.0 0	4.00	4.00	4 . 0 0	3.00	4.0 0	4.00	3.00	3.00	4.0 0	4.00	4.00	4.00	4.0 0	4.00	4.00	4.00	4.00	4.00	4.0 0
4.0 0	3.0 0	4.00	4.00	4.0 0	4.0 0	4.00	3.00	4 . 0 0	4.00	4.0 0	4.00	2.00	1.00	4.0 0	3.00	4.00	4.00	4.0 0	3.00	4.00	4.00	4.00	4.00	3.0 0

1.0	1.0			1.0	1.			.4	1.0	1.		.4	1.0	1.		1.	1.0	1.	1.	.8	1.	1.0
0	0	1.00	1.00	0	.86	00	1.00	3	0	00	.86	3	0	00	1.00	00	0	00	00	6	00	0

## Appendix H.2 Scree plot

Figure H-10-1: Scree plot

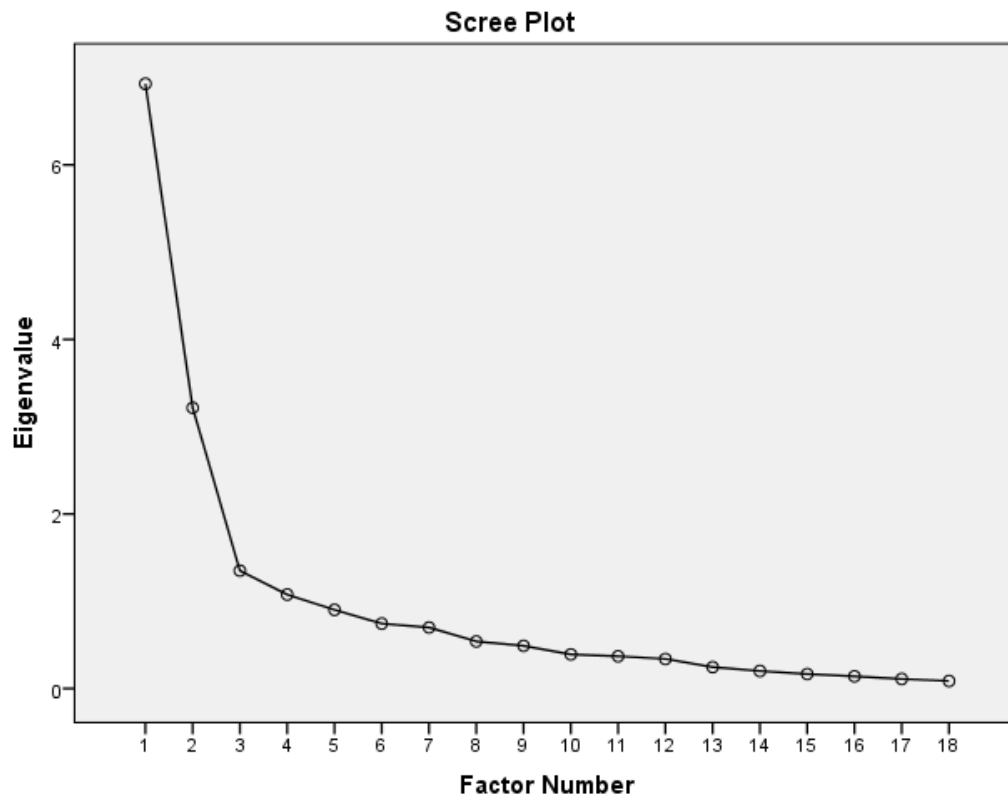

## Appendix H.3 CFA results

### Model Fit Summary

#### CMIN

Table H:1 Model Fit Summary Tables

Model	NPAR	CMIN	DF	P	CMIN/DF
Default model	46	70.716	59	.141	1.199
Saturated model	105	.000	0		
Independence model	14	1465.799	91	.000	16.108

#### RMR, GFI

Model	RMR	GFI	AGFI	PGFI
Default model	.041	.954	.918	.536
Saturated model	.000	1.000		
Independence model	.232	.425	.336	.368

#### Baseline Comparisons

Model	NFI Delta1	RFI rho1	IFI Delta2	TLI rho2	CFI
Default model	.952	.926	.992	.987	.991
Saturated model	1.000		1.000		1.000
Independence model	.000	.000	.000	.000	.000

#### Parsimony-Adjusted Measures

Model	PRATIO	PNFI	PCFI
Default model	.648	.617	.643
Saturated model	.000	.000	.000
Independence model	1.000	.000	.000

#### NCP

Model	NCP	LO 90	HI 90
Default model	11.716	.000	37.015
Saturated model	.000	.000	.000
Independence model	1374.799	1254.482	1502.520

**FMIN**

Model	FMIN	F0	LO 90	HI 90
Default model	.347	.057	.000	.181
Saturated model	.000	.000	.000	.000
Independence model	7.185	6.739	6.149	7.365

**RMSEA**

Model	RMSEA	LO 90	HI 90	PCLOSE
Default model	.031	.000	.055	.889
Independence model	.272	.260	.284	.000

**AIC**

Model	AIC	BCC	BIC	CAIC
Default model	162.716	170.018	315.575	361.575
Saturated model	210.000	226.667	558.916	663.916
Independence model	1493.799	1496.021	1540.321	1554.321

**ECVI**

Model	ECVI	LO 90	HI 90	MECVI
Default model	.798	.740	.922	.833
Saturated model	1.029	1.029	1.029	1.111
Independence model	7.323	6.733	7.949	7.333

**HOELTER**

Model	HOELTER	HOELTER
	.05	.01
Default model	225	252
Independence model	16	18

Minimization: .082

Miscellaneous: 4.709

Bootstrap: .000

Total: 4.791

## Appendix I: Regression analysis

### Appendix I.1 P.P. Plot

Figure 1-2: Plot of regression

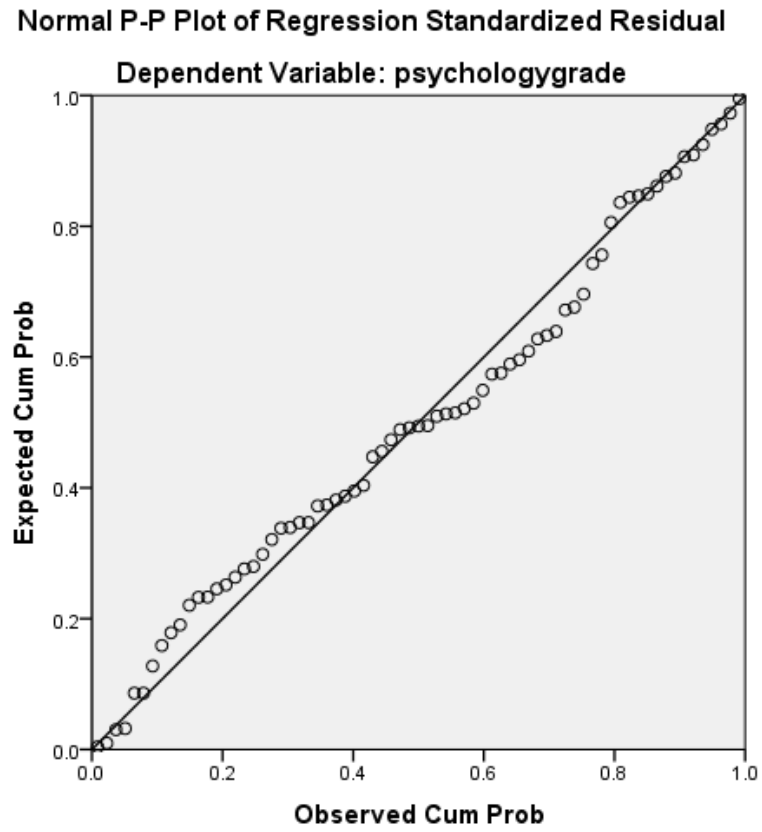
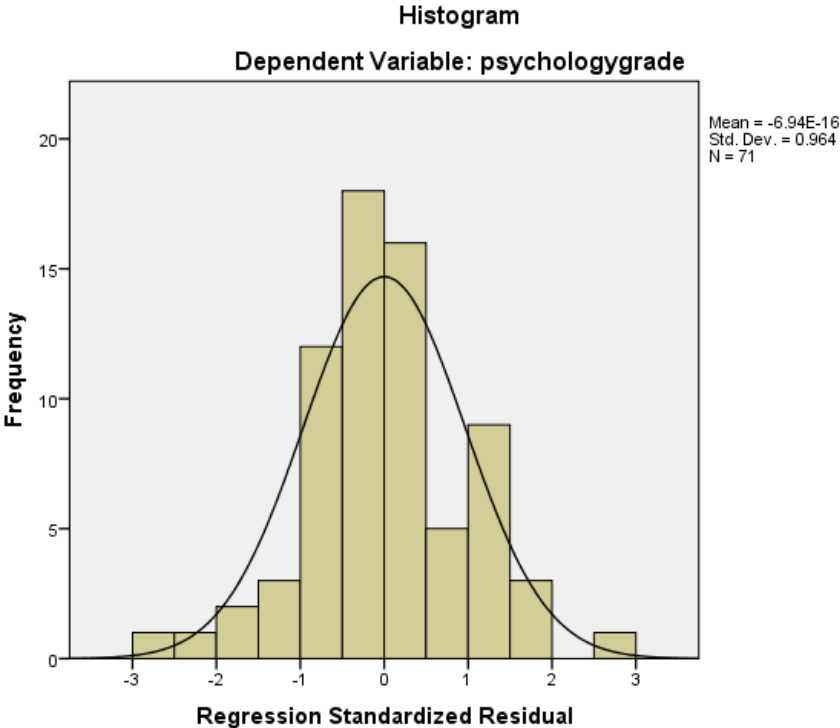



Figure 1-3: Plot of normal histogram

**Appendix I.2**  
**Normal**

**histogram**



## **Appendix J: Presentations and Publications**

The studies in the current study have been presented and published through the following:

1. Liverpool University: silence in literature, education, and psychology (July 1-3 2015)

Invited key note.

### **Meta-ethnography: Silencing the participants?**

Meta-ethnography is a methodology for synthesising qualitative research. Established by Noblit & Hare (1998), it has been employed mostly within education and medical research where it has focused on questions of identity or quality of life. Meta-ethnography has not had the same level of interest as its counterpart in quantitative research; meta-synthesis.

This talk will consider whether meta-ethnography is a sound methodology before looking at the stages involved during the process. Finally, it will question the place the participants have within it and whether meta-ethnography betrays its interpretive roots, silencing the participants and instead only allowing the researchers a voice.

2. Ireland International Conference on Education (April 2016)

### **Protecting Social Identities: Institutional Self-Comparison by Undergraduates**

Conference paper published in conference proceedings

Widening participation has led to a growth in university places across the Higher Education Sector. Alongside this, there is greater public scrutiny of the quality of both degrees and institutions. Additionally, students have a greater awareness of the potential quality of the institution they are attending via league tables and the annual NSS. While research has been undertaken exploring how students make choices there has been less focus on the experience of students at “lower status” universities. Three focus groups of  $N = 19$  Psychology students from a North-West university were conducted to discuss issues of identity. Thematic Analysis was used to explore issues of Social comparisons and Identity processes. The main themes to emerge were transitional issues, threats to identity and identity protection as students developed narratives around their perceptions of status of student and institution. These findings are discussed in relation to enabling students to develop a stronger identity.

3. Ireland International Conference on Education (April 2016)

Presentation and extended abstract

**Development, Reliability and Validity of an Academic Social Identity Scale  
(Psychology)**

4. LJMU Learning and Teaching Conference (June 2016)

Presentation

**“Am I a student?” A meta-ethnography of students experiences of Transition into  
Higher Education.**