



Strathprints Institutional Repository

Yu, Fangzhu and Booth, Campbell and Dyśko, Adam (2016) Backup protection requirements in future low-inertia power systems. In: 51st International Universities' Power Engineering Conference, 2016-09-06 - 2016-09-09, Coimbra Institute of Engineering. ,

This version is available at <http://strathprints.strath.ac.uk/59387/>

Strathprints is designed to allow users to access the research output of the University of Strathclyde. Unless otherwise explicitly stated on the manuscript, Copyright © and Moral Rights for the papers on this site are retained by the individual authors and/or other copyright owners. Please check the manuscript for details of any other licences that may have been applied. You may not engage in further distribution of the material for any profitmaking activities or any commercial gain. You may freely distribute both the url (<http://strathprints.strath.ac.uk/>) and the content of this paper for research or private study, educational, or not-for-profit purposes without prior permission or charge.

Any correspondence concerning this service should be sent to Strathprints administrator: strathprints@strath.ac.uk

Backup Protection Requirements in Future Low-Inertia Power Systems

Fangzhu Yu¹

Campbell Booth¹

Adam Dyśko¹

fangzhu.yu@strath.ac.uk

campbell.d.booth@strath.ac.uk

a.dysko@strath.ac.uk

¹-Department of Electronic and Electrical Engineering, University of Strathclyde, Glasgow, G1 1XW, UK

Abstract— The content of this paper will illustrate how, in the future, the power transmission system in Great Britain (GB) may be much “weaker” than it is at present, and will describe the potential impact that this could have on the voltage profiles during faults, and how the operation of backup protection system operation, if required, needs to be considered carefully to ensure system integrity in the future. The potential for future problems associated with generators’, converter-interfaced infeeds’, and HVDC interconnectors’ potential inability to “ride through” during slow/backup protection operations, and the consequent risk of complete system collapse, will also be highlighted. The paper also contains a description of ongoing and future work concerned with investigation of the use of wide-area communications systems, which may already be in existence and used for other purposes, to enhance backup protection performance and possibly offer an alternative and improved solution compared with existing schemes. It is shown how such a system could potentially be “settings-free” and establish and maintain an image of the connectivity of the network from either SCADA data and/or analysing current flows during normal operation. Example results of simulations are included to demonstrate the concept of identifying fault locations and protection failures using measured voltages from phasor measurement units (PMUs). This may act as a foundation for a future backup protection scheme and this is discussed in the conclusions and future work sections.

Index Terms— Backup, Communications, IP/MPLS, Phasor measurement, Protection, System strength

I. INTRODUCTION

One view of the concept of “system strength” could be the general ability of the entire power system network to remain stable following disturbances. Fault level is one of the most important indicators of system strength. With increasing amounts of converter-interfaced generation (particularly non-synchronous generation), individual source fault infeeds and consequently, overall system fault levels, may decrease significantly in future, potentially compromising system strength. The reduction of short circuit level will also lead to wider and deeper voltage depressions during and after faults, possibly compromising the operation of certain types of system protection and increasing challenges associated with low voltage ride through capability for all generators, HVDC interconnectors and embedded HVDC links.

As shown in Fig. 1, it is anticipated that the fault levels in GB will decline significantly, even for the “No Progression” scenario [1]. For the “Gone Green” scenario, reductions in short circuit level range from 35% to 70% reductions from present values, largely as a result of decommissioning of synchronous machines and introduction of converter-interfaced sources and infeeds.

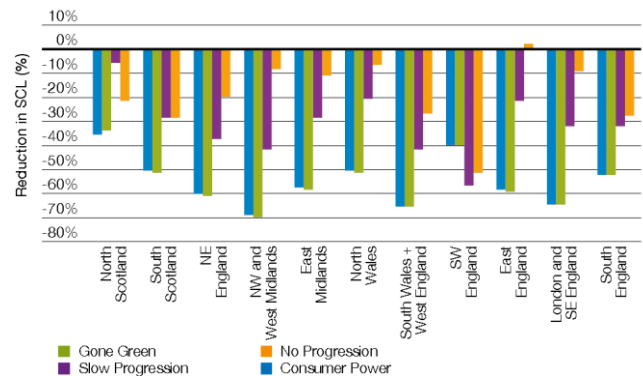

Fig. 1. Short circuit decline 2025/26 vs 2015/16 levels [1]

According to Fig. 2, for a three-phase fault at Walpole 400 kV substation cleared in 140 ms (the slowest assumed main protection clearance time), the voltage depression is much wider for 2025 than that for 2015 – it is clear that almost the entire countries of England and Wales would see the impact of this transmission system fault.

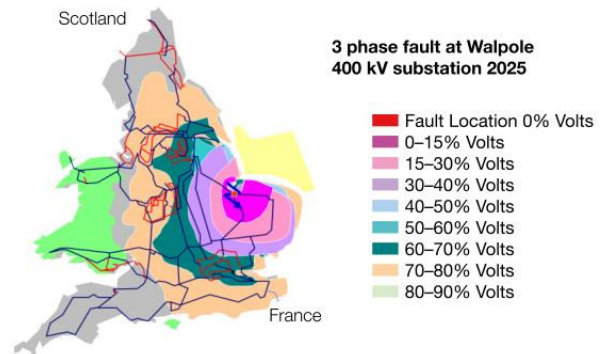

Fig. 2. Voltage map for fault at 400 kV Walpole substation in 2025 [1]

If, under a future “weaker system” scenario, the main protection was to fail, then existing backup protection, which operates with approximately 500 ms time delay (although circuit breaker fail may operate faster than this), could clearly lead to ride through problems for generators and HVDC links. Ride-through for HVDC systems and all transmission-connected generation is usually only stipulated with respect to assumed 140 ms to 250 ms main protection clearance times [2]). This could be even more challenging in the future due to more severe and widespread voltage depressions in a weaker system (as shown in Fig. 2). In such a scenario, although highly unlikely to occur in the first place, the risk of complete system collapse cannot be discounted. In the European context, codes and recommendations for generators and HVDC interfaces have recently been issued [2] to define how generators should behave during faults and in terms of their ride through capability – although specific codes must be defined for each national system operator to meet their own system’s requirements.

The remainder of the paper is structured as follows: existing backup protection arrangements are reviewed briefly in section II; section III reviews PMUs and selected applications; simulation results and analysis relating to the proposed PMU-based scheme for fault identification/location are presented in section IV; and IP/MPLS, a potential communications mechanism for the proposed scheme, is introduced in Section V. Conclusions and future are summarised at the end of the paper.

II. EXISTING TRANSMISSION SYSTEM BACKUP PROTECTION

A. Distance protection

Distance protection is used to provide both primary and remote backup protection in transmission networks. It operates by calculating the apparent impedance from measurements of voltage and current and uses this data to identify faults and their approximate locations [3] and subsequently take tripping action (with various time delays dependent on the fault location) [4].

Normally, distance protection consists of an instantaneous (Zone 1) and several time-delayed zones (Zone 2, Zone 3...) to provide remote backup protection [5]. A diagram illustrating typical zones of protection is shown in Fig. 3.

In actual applications, distance protection may have up to six zones (such as reverse zone 3 to provide backup for busbar faults “behind” the relaying location).

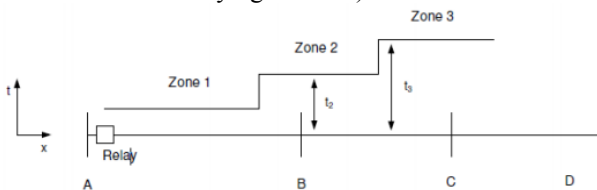

Fig. 3. Diagram of zones and elements of the system protected [5]

The advantage of backup distance protection is that coverage of the protected line section is independent of internal

impedance of the source (i.e. it is theoretically independent of fault level) and no communication system is required (although sometimes communications is used to enhance performance).

The disadvantages of distance backup protection are the potential nuisance tripping of zone 3, which could (and has in the past) cause cascading outages, and the relatively slow operation (typically 400-500ms) of zone 2 which may challenge low voltage ride through capability of generators, particularly in the future if during-fault voltage depressions are more severe and widespread as shown earlier in this paper.

B. Overcurrent protection

Overcurrent protection is normally used to provide remote backup protection for transmission networks. For 400 kV and 275 kV transmission lines, with maximum fault levels of 63 kA (per phase) at 400 kV and 40 kA at 275 kV, the backup overcurrent protection operation time is at least 1 s for a three phase fault at the remote end of the protected section [6].

The advantage of overcurrent protection as backup protection in transmission level is cheap and again does not require communication systems to function. The main disadvantage is that it may be influenced by changes in fault levels (e.g. in very weak systems it may not operate, or operate more slowly than it should) and it is relatively slow-acting.

C. Circuit breaker fail protection

Circuit breaker fail (CBF) protection is extensively used as a local backup protection scheme which provides a relatively faster and more secure means of backup protection than alternative network protection-based methods. If a circuit breaker does not operate in a predetermined period of time after receiving a tripping signal from relay, the CBF will detect the flow of current (indicating that the main breaker has not operated) and trip all adjacent circuit breakers required to effect clearance of the persisting fault [7]. Lockout relays are used to prevent reclosing of circuit breakers tripped by CBF.

For transmission networks in GB, the clearance time of CBF is typically 300 ms [6]. The advantage of CBF is that it is faster and more secure than network protection backup schemes. However, this comes at a cost associated with additional hardware, wiring, in some cases communications, complexity and requirements to maintain the schemes – and modify them if the network is extended or changed in the future.

III. PHASOR MEASUREMENT UNITS (PMUS)

A. Principles

PMU provides real-time measurements of magnitude and phase of voltage and current. PMU data (or derived data from PMUs) may include positive sequence voltages and currents, individual phase voltage and currents, local frequency and ROCOF (rate of change of frequency) and many other quantities which can be used in wide area monitoring, control and protection schemes. Using accurate time synchronisation at the point of measurement from the GPS (global positioning system) clock, signals from geographically-separate locations

can be compared accurately using PMUs and wide-area communication systems [8].

B. Overview of PMU applications

Wide area measuring system (WAMS) is one of the most common applications of PMUs in power systems. WAMS can be used to improve the speed of measurement and accuracy of information provided for functions such as state estimation [9]. A typical WAMS structure is shown in Fig. 4. Typically, many PMUs are connected to PDCs (phasor data concentrators) via communication networks. The PDCs collect, analyse and sort the incoming data from PMUs. The processed data from PDCs can be exchanged between PDCs and then sent to local applications or higher level control system for further concentration or analysis of the data [10].

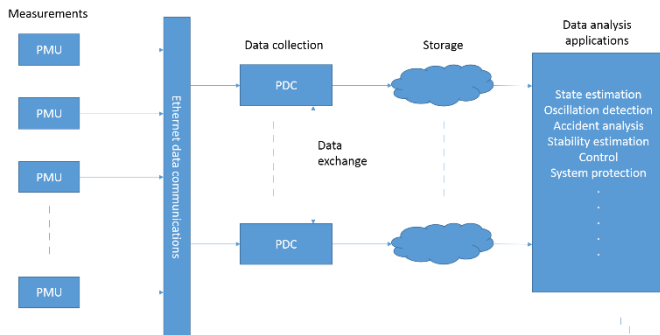

Fig. 4. A schema of PMU/ WAMS

As already mentioned, PMUs can potentially improve the speed and accuracy of state estimation functions, as proposed in [11], where a system to monitor the voltage security in distribution systems is described. An application of PMU-based wide area monitoring and control in the Chinese 110 kV distribution networks is presented in [12].

Wide area protection and control schemes based on WAMS and communication systems have been proposed. For example, a wide area differential backup protection is studied in [13]. A novel architecture for integrated wide area protection and control is proposed in [14]. The number of applications of PMUs is expected to grow in the future as confidence in and adoption of the technology grows.

IV. INTERNET PROTOCOL / MULTIPROTOCOL LABEL SWITCHING (IP/MPLS)

In order to include PMU data from a wide area as part of a fast and cost-effective backup protection scheme, it is critical that a high-performance communication system is used, ideally with high bandwidth, high security, low latency and low levels of jitter. Time Division Multiplexing (TDM) over Synchronous Digital Hierarchy (SDH) or Synchronous Optical Network (SONET) has traditionally been used in transmission network control and protection applications [15]. The

advantage of TDM is primarily through its inherent high levels of reliability and availability – it can switch upon failure to alternative communications paths in less than 50ms. However, the disadvantage is inflexibility and inefficiency as bandwidth is reserved for specific functions [15].

IP/MPLS is a relatively new option for transmission networks. It can potentially support both existing TDM and new IP and Ethernet applications such as wide area protection. The security and reliability levels are not compromised using IP/MPLS: the fast reroute feature (FRR) provides recovery times for link or node failures of less than 50ms. IP/MPLS solutions are relatively cheap. It is promising as an enabler for wide area protection schemes.

V. PMU-BASED, VOLTAGE-ONLY METHOD OF FAULT LOCATION

A. Overview

The proposed backup protection scheme is assumed to operate using an image of the network connectivity, which can be maintained at a central/regional level using SCADA or potentially observed current flows gathered from SCADA or PMUs. Using this network model, when a fault is detected (using detected voltage dips and “steps” from PMUs as outlined later), then the location (in terms of the faulted line) of the fault can be detected. If, following a time delay, the measured voltages indicate that the fault has not been cleared and that a main protection scheme (or circuit breaker) has failed, then tripping commands to the appropriate circuit breakers (using the aforementioned image of network connectivity to determine which breakers must be tripped) could be sent. This is still at the concept stage – the following sections of the paper focus on demonstrating the feasibility of using PMUs to identify the faulted feeder (and the protection that has failed).

B. Power system model

A single-line diagram of the power system model used in this study is shown in Fig. 5. The 3-bus system is based on an actual section of the 400 kV transmission network in GB and the fault levels have been set to minimum levels in accordance with [16] to represent a relatively weak system of the future. The model has been created using Simpowersystems. The fault locations are shown in Fig. 5. All faults are three phase to earth faults.

The voltage magnitude at each busbar is measured by a P class, 10 kHz PMU model, which reports output every 20 ms (once per cycle). This reporting rate is why the results in the figures later in the paper seems to suggest step changes in voltage, as opposed to ramped changes (which are the case in reality), but due to the once-per-cycle PMU reporting rate, they appear as step changes. The PMU model was created by researchers at the University of Strathclyde [17].

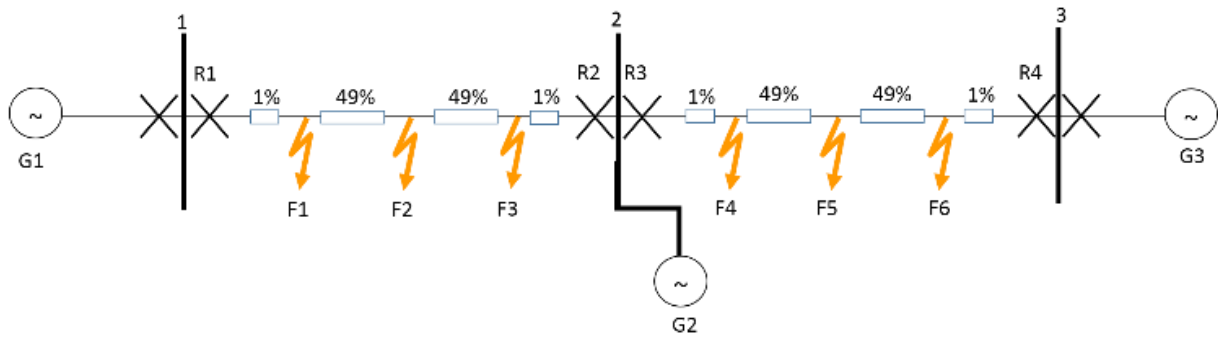

Fig. 5. Single line diagram of the model

C. Simulation results for faults at various locations

Each type of fault simulated has two groups of results. The first is under the assumption of no operation of any of the main protections at both end lines (case A). This is of course extremely unlikely but should be considered. The second scenario is perhaps more realistic (although still relatively unlikely) and assumes operation of only one of the line-end main protections and failure of the other (case B). All faults are applied at 0.5 s within the simulation and, in cases where one of the main protections is assumed to operate correctly, the correctly-operating relay and circuit breaker act to clear the fault 80 ms after the initial fault occurrence.

a) Faults close up to single connection busbar (F_1 and F_6)

The simulation results of case A for F_1 is shown in Fig. 6. The black, red and blue traces show the voltage magnitudes measured at busbars 1, 2 and 3 (V_1 , V_2 and V_3). It can be seen from the graph that the magnitudes of V_1 and V_2 are much smaller than that of V_3 (both are less than 60% of nominal) which can be used to deduce that the location of the fault is definitely between busbar 1 and busbar 2. The results of case A for F_6 is similar.

It is clear that the voltage remains depressed at all locations as it is assumed in this case that both line-end main protections have failed (subsequent backup operation is not simulated).

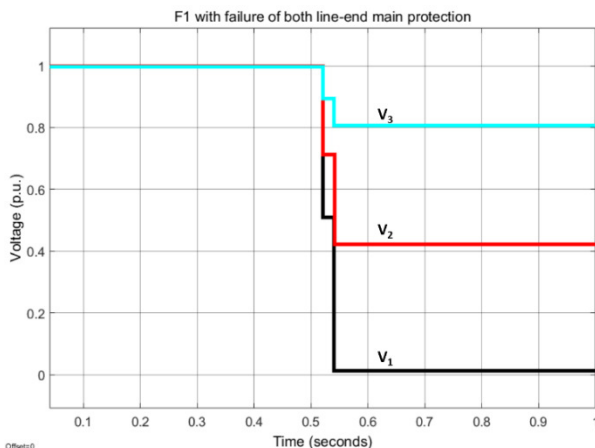

Fig. 6. Simulation results of case A for F_1 – both line-end main protection fail

The simulation results for case B are summarised in Table 1 for F_1 and F_6 . In these cases, the voltage at one end of the faulted line will “step” up when the main protection at that line-end operates correctly, with the other end assumed failed. For operation of relays protecting circuits at busbar 2, two voltages will step up upon circuit breaker opening; e.g. for F_4 , if the circuit breaker controlled by R_3 opens, both V_1 and V_2 will step up. For operation of relays remote from busbar 2 (e.g. at busbars 1 and 3), only one voltage will step up; e.g. for F_4 , if the circuit breaker controlled by R_4 opens, only V_3 will “step up”.

It can be observed that, for all fault positions, the voltage measured at one busbar will always behave differently from the others, and therefore, when only one protection/circuit breaker fails to operate, the measured voltages and subsequent step ups can always be used to identify the faulted feeder (and, by implication, the failed protection).

Table 1. Summary of case B

Fault location	Relay operation				V_1 Step	V_2 Step	V_3 Step	Identified fault location
	R_1	R_2	R_3	R_4				
F_1	✓	×	–	–	✓	×	×	$R_1 - R_2$
	×	✓	–	–	×	✓	✓	$R_1 - R_2$
F_6	–	–	✓	×	✓	✓	×	$R_3 - R_4$
	–	–	×	✓	×	×	✓	$R_3 - R_4$

b) Faults in the middle of transmission line (F_2 and F_5)

As the simultaneous failure of all main protection schemes at both line ends is deemed virtually impossible in practice, the remaining simulations focus only on situations where the main protections at one line end have failed, with the other line end protection operating correctly. Fig. 7 shows one simulation result of case B for F_2 as an example.

The simulation results of case B be are summarised in Table 2. As before, similar patterns of voltage and subsequent step ups can be used to determine the faulted feeder and failed protection system(s). This information would then be used (in the backup protection system that will be developed in future) to send trip signals to the appropriate circuit breakers to clear the fault.

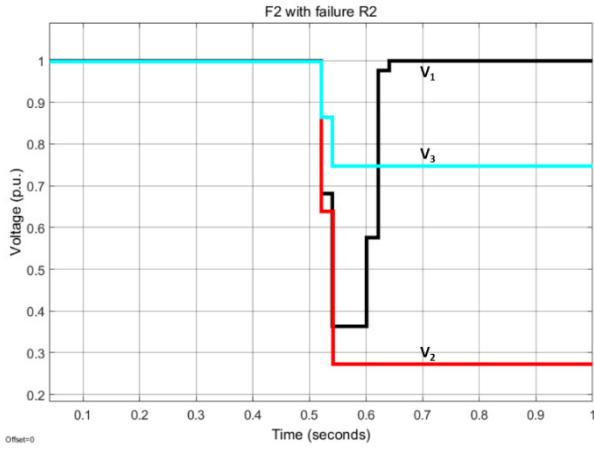

Fig. 7. Simulation results of case B for F₂ – only R₂ fails

Table 2. Summary of case B

Fault location	Relay operation				V ₁ Step	V ₂ Step	V ₃ Step	Identified fault location
	R ₁	R ₂	R ₃	R ₄				
F ₂	✓	×	-	-	✓	×	×	R ₁ –R ₂
	×	✓	-	-	×	✓	✓	R ₁ –R ₂
F ₅	-	-	✓	×	✓	✓	×	R ₃ –R ₄
	-	-	×	✓	×	×	✓	R ₃ –R ₄

c) Faults close up to multiple connection busbar (F₃ and F₄)

The simulation results of case B for F₃ and F₄ are shown in Fig. 8 and Fig. 9 respectively, with main protection at one line end assumed to have failed. As these fault locations are very close to each other, located 1% from the end of different lines connected to the same busbar, then the initial magnitude of all measured voltages in these two scenarios are almost identical. V₂ collapses to a value close to 0 for both faults, as they are very close to busbar 2. V₁ and V₃ have values of approximately 0.5 p.u. during the fault (before any circuit breakers open), which makes it very difficult to determine whether the fault is on one line or the other in this case from initial examination of voltages. However, when one of the main protections operates, then, as for the previous cases, the fault location (F₃ or F₄) can be known as the protection at the one end of the line will have tripped the breaker and the voltage at this location will step up.

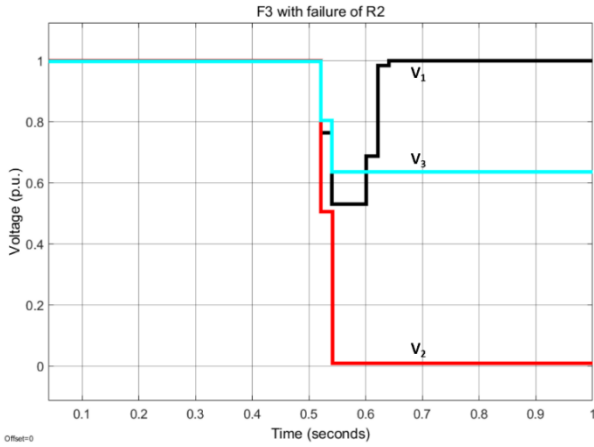

Fig. 8. Simulation results of case B for F₃ – only R₂ fails

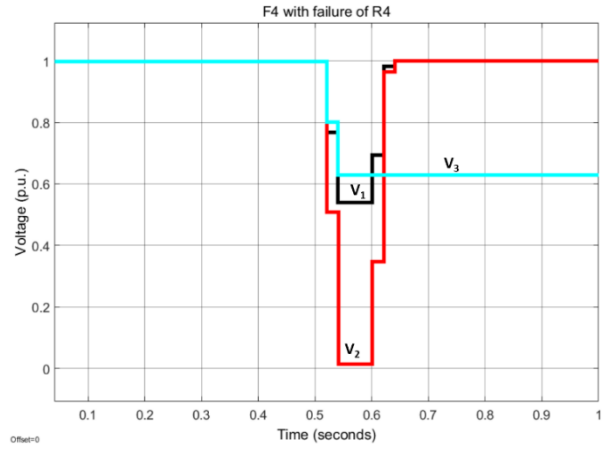

Fig. 9. Simulation results of case B for F₄ - only R₄ fails

The simulation results of case B be can summarised in Table 3. Similar to the results shown in sections A and B, for operation of relays at busbar 2, two voltages will step up when one of the line-end main protections operates and for operation of relays remote from busbar 2, only one voltage will step up.

Table 3. Summary of case B

Fault location	Relay operation				V ₁ Step	V ₂ Step	V ₃ Step	Identified fault location
	R ₁	R ₂	R ₃	R ₄				
F ₃	✓	×	-	-	✓	×	×	R ₁ –R ₂
	×	✓	-	-	×	✓	✓	R ₁ –R ₂
F ₄	-	-	✓	×	✓	✓	×	R ₃ –R ₄
	-	-	×	✓	×	×	✓	R ₃ –R ₄

VI. CONCLUSION AND FUTURE WORK

This paper has demonstrated the concept of a new method for identification of fault location for the purposes of backup protection. The method is based solely on analysis of distributed voltage magnitude measurements from PMUs. It has been shown how, using said measurements, the position of faults can always be determined from observations of voltage depressions and the subsequent voltage step ups at specific location(s). The case where there are multiple failures of protection systems or circuit breakers at several locations may be more difficult for faults at certain locations (e.g. very close to line ends), but the authors believe such scenarios to be highly unlikely, although these scenarios will still be investigated.

In order to move forward to the implementation and full investigation of the efficacy of the scheme, a number of further investigations and developments are needed: the method of gathering PMU data, including the associated communications infrastructure, must be determined; a software-based implementation of the fault identification methods must be developed and tested; simulations of more complex and realistic power systems must be conducting, including testing the operation of the system with resistive faults and when the fault levels in the system vary; implementation and testing using RTDS and other hardware in the laboratory. All of this

represents future work that the authors will be undertaking as this project progresses.

REFERENCES

- [1] National Grid, 2015, "System Operability Framework", available from: <http://www2.nationalgrid.com/UK/Industry-information/Future-of-Energy/System-Operability-Framework/>
- [2] National Grid, "Fault Ride Through ENTSO-E Requirements for Generators - Interpretation", available from: <http://www2.nationalgrid.com/WorkArea/DownloadAsset.aspx?id=17270>
- [3] R. Leelaruij and L. Vanfretti, "Power system protective relaying: basic concepts, industrial-grade devices, and communication mechanism", Internal Report. Stockholm: KTH Royal Institute of Technology, July 2011, available from: <http://www.vanfretti.com>
- [4] Alstom Grid and Alstom Grid Worldwide Contact Center, Network protection & automation guide, May, 2011.
- [5] K.Yumak, Distribution of electrical energy lab. Notes v1.0, 2013, available from: http://web.itu.edu.tr/yumakk/downloads/Lab_Notes_Distance_Protection_v1.pdf
- [6] National Grid, 2011, "Application and Protection Setting Policy for the National Grid UK Transmission System" *National Grid internal policy* document.
- [7] "Review of the Breaker Failure Protection practices in Utilities," Protective Relay Engineers, 2012 65th Annual Conference for, College Station, TX, 2012, pp. 260-268, available from: <http://ieeexplore.ieee.org/stamp/stamp.jsp?tp=&arnumber=6201237&isnumber=6201216>
- [8] S. Urooj and V. Sood, "Phasor measurement unit (PMU) based wide area protection system," Computing for Sustainable Global Development (INDIACom), 2015 2nd International Conference on, New Delhi, 2015, pp. 597-599, available from: <http://ieeexplore.ieee.org/stamp/stamp.jsp?tp=&arnumber=7100319&isnumber=7100186>
- [9] D. Karlsson, M. Hemmingsson and S. Lindahl, "Wide Area System Monitoring and Control – terminology, phenomena, and solution implementation strategies", in IEEE Power and Energy Magazine, vol.2, no.5, pp.68-76, Sept.-Oct.2004, available from: <http://ieeexplore.ieee.org/stamp/stamp.jsp?tp=&arnumber=1338124&isnumber=29514>
- [10] H. Bevrani, M. Watanabe, Y. Mitani, "An Introduction on Power System Monitoring," in Power System Monitoring and Control , 1, Wiley-IEEE Press, 2014, pp.288, available from: <http://ieeexplore.ieee.org/xpl/articleDetails.jsp?arnumber=6836739&queryText=an%20introduction%20on%20power%20system%20monitoring&newsearch=true>
- [11] X. Liu, X. Zhang and V. Venkatasubramanian, "Distributed Voltage Security Monitoring in Large Power Systems Using Synchrophasors," in IEEE Transactions on Smart Grid, vol. 7, no. 2, pp. 982-991, March 2016, available from: <http://ieeexplore.ieee.org/stamp/stamp.jsp?tp=&arnumber=7065224&isnumber=7410169>
- [12] W.An et al., "Application of Wide Area Monitoring Protection and Control in an electricity distribution network," Developments in Power System Protection (DPSP 2014), 12th IET International Conference on, Copenhagen, 2014, pp. 1-5, available from: <http://ieeexplore.ieee.org/stamp/stamp.jsp?tp=&arnumber=6822862&isnumber=6809516>
- [13] Y. Lv et al, "Study on wide-area backup protection system for the smart grid," Electric Utility Deregulation and Restructuring and Power Technologies (DRPT), 2011 4th International Conference on, Weihai, Shandong, 2011, pp. 218-224, available from: <http://ieeexplore.ieee.org/stamp/stamp.jsp?tp=&arnumber=5993892&isnumber=5993852>
- [14] Z. Q. Bo et al., "Novel architecture for integrated wide area protection and control," Power Engineering Conference (UPEC), 2015 50th International Universities, Stoke on Trent, 2015, pp. 1-4, available from: <http://ieeexplore.ieee.org/stamp/stamp.jsp?tp=&arnumber=7339962&isnumber=7339753>
- [15] Alcatel. Lucent, "Deploying IP/MPLS Communications Networks for Smart Grids," available from: www.tmcnet.com/redirect/?u=1006563
- [16] National Grid, 2015, "Electricity Ten Year Statement (ETYS)", available from: <http://www2.nationalgrid.com/UK/Industry-information/Future-of-Energy/Electricity-ten-year-statement/>
- [17] A. J. Roscoe, "Exploring the Relative Performance of Frequency-Tracking and Fixed-Filter Phasor Measurement Unit Algorithms Under C37.118 Test Procedures, the Effects of Interharmonics, and Initial Attempts at Merging P-Class Response With M-Class Filtering," in IEEE Transactions on Instrumentation and Measurement, vol. 62, no. 8, pp. 2140-2153, Aug. 2013, available from: <http://ieeexplore.ieee.org/stamp/stamp.jsp?tp=&arnumber=6547743&isnumber=6556973>