



Oi, Daniel K.L. and Ling, Alex and Grieve, James A. and Jennewein, Thomas and Dinkelaker, Aline N. and Krutzik, Markus (2016) Nanosatellites for quantum science and technology. Contemporary Physics. pp. 1-32. ISSN 0010-7514 , DOI:10.1080/00107514.2016.1235150

This version is available at <https://strathprints.strath.ac.uk/57818/>

Strathprints is designed to allow users to access the research output of the University of Strathclyde. Unless otherwise explicitly stated on the manuscript, Copyright © and Moral Rights for the papers on this site are retained by the individual authors and/or other copyright owners. Please check the manuscript for details of any other licences that may have been applied. You may not engage in further distribution of the material for any profitmaking activities or any commercial gain. You may freely distribute both the url (<https://strathprints.strath.ac.uk/>) and the content of this paper for research or private study, educational, or not-for-profit purposes without prior permission or charge.

Any correspondence concerning this service should be sent to the Strathprints administrator: strathprints@strath.ac.uk

To appear in *Contemporary Physics*
 Vol. 00, No. 00, Month 20XX, 1–32

REVIEW ARTICLE

Nanosatellites for Quantum Science and Technology

Daniel K. L. Oi^{a*}, Alex Ling^b, James A. Grieve^b, Thomas Jennewein^c, Aline N. Dinkelaker^d, Markus Krutzik^d

^a*SUPA Department of Physics, University of Strathclyde, Glasgow G4 0NG, United Kingdom,* ^b*Centre for Quantum Technologies, National University of Singapore, Block S15, 3 Science Drive 2, Singapore 117543,*

^c*Institute for Quantum Computing and Department of Physics and Astronomy, University of Waterloo, Canada and the Quantum Information Science Program, Canadian Institute for Advanced Research, Toronto, Canada* ^d*Institute of Physics, Humboldt-Universität zu Berlin.*

(May 2016)

Bringing quantum science and technology to the space frontier offers exciting prospects for both fundamental physics and applications such as long-range secure communication and space-borne quantum probes for inertial sensing with enhanced accuracy and sensitivity. But despite important terrestrial pathfinding precursors on common microgravity platforms and promising proposals to exploit the significant advantages of space quantum missions, large-scale quantum testbeds in space are yet to be realized due to the high costs and leadtimes of traditional “Big Space” satellite development. But the “small space” revolution, spearheaded by the rise of nanosatellites such as CubeSats, is an opportunity to greatly accelerate the progress of quantum space missions by providing easy and affordable access to space and encouraging agile development. We review space quantum science and technology, CubeSats and their rapidly developing capabilities, and how they can be used to advance quantum satellite systems.

Keywords: CubeSats, Quantum, Space, Science, Fundamental Physics, Technology, NanoSatellites, Communications

1. Introduction

The development of quantum science and technology is gradually revolutionizing many different areas such as computation, communication, timing, navigation, and sensing, as well as allowing us to probe foundational aspects of physics in ever expanding regimes. There is considerable investment by companies and governments into quantum computation and related technologies, and the first wave of terrestrial applications in quantum communication are coming to fruition with deployment of commercial quantum key distribution systems. In order to reach global communication distances, one important step is to exploit the advantages of taking quantum science into space [1]. Moreover, space-based quantum science experiments are important avenues for exploring quantum physics at length and velocity scales impossible on the Earth [2], probing the foundation of General Relativity (GR) in unique regimes of space-time. The Holy Grail of unifying GR with quantum mechanics will require experimental insights gained from measurements of predicted violations of current theory by new ones [3–5].

While many promising research programs aim at bringing quantum systems into space [6–13], the high costs, development risk and long development times of traditional satellite programmes has slowed down experimental progress and requires major long term state support. Conventional space missions are typified by large and high performance satellites with multiple redundant and

*Email: daniel.oi@strath.ac.uk



Figure 1. Set of NanoRacks CubeSats Deployed From International Space Station. The Small Satellite Orbital Deployer (SSOD), in the grasp of the Kibo laboratory robotic arm, is photographed by an Expedition 38 crew member on the International Space Station as it deploys a set of NanoRacks 3U CubeSats. This image shows the difference in scale between nanosatellites and the largest man-made structure in space. Credit: NASA

tested components. With high launch costs¹, the usual development strategy has been to maximize the capability and reliability of each satellite, though this leads to increased mass and complexity, and spiralling costs. This poses a high barrier and limits the number of groups that can compete in this “Big Space” environment, hence slowing the development of space quantum technologies.

1.1. *Small Space Revolution*

In recent years, the “small space” revolution has provided a paradigm shift that is better suited to more modestly funded groups, especially in the education and research sector. The pioneering concept has been the CubeSat nanosatellite standard that is based on a 1U (unit) of a cube 10 cm in linear dimension, and nominally 1 kg mass, that can function as a fully operational satellite². By stacking several units together to form 2U, 3U or even larger box-like shapes, larger spacecraft can be constructed. Originally developed as an aerospace educational tool to allow students hands-on experience in building, launching, and operating real satellites [15], the CubeSat standard has seen a tremendous expansion both in its application and capability. The establishment of CubeSat standards has enabled a thriving commercial market in commodity parts, often based on commercial off the shelf (COTS) components, leading to economies of scale and dramatically lowering the hardware cost over their space-rated counterparts.

Building low-cost spacecraft is only half of the equation, getting them into orbit in a cost-effective manner is the other. CubeSats have traditionally relied on ridesharing; large commercial launches have spare mass capacity that can be purchased on the secondary launch market for a fraction of the full cost of the launch. A popular option has been carriage to the International Space Station (ISS) on a cargo supply vehicle from where they can be deployed from the “CubeSat Cannon” (JEM Small Satellite Orbital Deployer [16] or Nanoracks CubeSat deployer) as shown in Fig. 1. Some space agencies have CubeSat programs that include a free launch opportunity, such as NASA’s ELaNa programme [17] or through ESA [18].

Together with miniaturized hardware and affordable access to space, CubeSats are at the forefront of the movement to democratize space. Instead of being the domain of large countries and corporations, small institutions or individuals have the opportunity to send satellites into space for the cost of a nice car. This places space-based quantum technology and quantum science demonstra-

¹An Ariane 5 launch (20t) to low-Earth orbit costs EUR 150 – 170M [14].

²Conventionally, spacecraft between 1 – 10 kg are called nanosatellites, CubeSats are the most common variety. Throughout this review, we will use the terms nanosatellite and CubeSat interchangeably.

tions into the reach of a modestly well-funded research group or centre, rather than just large-scale organizations.

1.2. *The Quantum Revolution*

Quantum mechanics is a highly successful scientific theory which describes the microscopic physics of matter and energy with very high precision. It dramatically differs from the notion of “classical physics”, i.e. the physics of Newton and Einstein. Not all properties of quantum systems have simultaneously well defined values, performing measurements will disturb them ³, and quantum systems can be correlated by so-called quantum entanglement, which is stronger than can exist in classical physics [19]. Since the 1980s, it was realized that these characteristics of quantum theory could be advantageously employed for information processing, the development of a quantum computer is just one example. Beside information processing, quantum effects can be used to enhance other applications such as timekeeping or sensing. Scientifically, it is also important to probe the limits of quantum theory in previously unexplored regimes in order to increase our understanding and give directions towards new physics. Bringing quantum science experiments to space is one avenue to achieve this.

What makes CubeSats particularly suited to space based quantum science and technology is the parallel effort to miniaturize and ruggedize quantum systems. In order to take quantum science out of the laboratory and into the real world, systems will need to be compact, low power, tolerant of various environmental conditions, and be able to be operated autonomously or unattended, the sort of qualities that are ideal for a nanosatellite payload. The successful development of pathfinder instruments operating on Earth-based microgravity platforms such as drop towers [9, 20], airplanes [21] and sounding rockets [10] indicate that technology for space-borne quantum payloads can be compactified and ruggedized. As quantum systems further shrink and the capabilities of CubeSats increase, the feasible range of missions expands. Whereas current experimental quantum CubeSat technology is focussed on testing and validating experimental subsystems, in the not too distant future we should see full missions being conducted with CubeSats including quantum communications between orbit and ground.

2. Space Quantum Science and Technology Applications

There are several important reasons to deploy quantum systems to space. Orbiting satellites bring the same advantages to quantum communications as it does for conventional classical communications. This enables long range and wide area coverage, the ability to connect non-stationary users, and the ability to create large interconnected constellations for networked access. Long line-of-sight distances are also advantageous for experiments that test the behaviour of quantum entanglement, or else using quantum signals to probe new physics. High velocities are also easier to achieve in space compared with the Earth, orbital speed in low-Earth orbit is about $7800 \text{ m}\cdot\text{s}^{-1}$, much faster than a quantum instrument could be moved on the Earth. Furthermore, testing quantum correlations between particles measured at different gravitational potentials could provide insights in alternative theories of quantized light fields [22].

Quantum metrology and sensing can be performed using cold atoms or Bose-Einstein condensates (BECs). The free-fall conditions in orbit eliminate the need to support the atoms against gravity, especially useful for matter-wave interferometry where the detection sensitivity can be improved by increasing the time that atoms can travel freely, this being limited on the Earth as the atoms fall towards the floor. Moreover, the unique environment of microgravity enables the realization of ultra-

³The existence of non-commuting observables and measurement-disturbance relations are both commonly referred to as Heisenberg’s Uncertainty Principle.

shallow traps, in which the atoms can adiabatically expand to reach unprecedented temperatures in the pico-Kelvin regime. Mass-dependent effects on the trapped atoms are negligible, thus enabling improved miscibility of different species and isotopes in quantum gas mixtures. Orbits can be chosen where the quantum sensor is subjected to large spatial variations of velocity and the gravitational potential, significant for precision tests of GR. Future generations of the Global Positioning System (GPS) may also use quantum enhanced clocks based on trapped cold atoms.

2.1. *Quantum Key Distribution*

One of the leading candidates for space quantum technology is quantum key distribution (QKD) for secure communication. QKD involves sending single photon signals encoding a cryptographic key in its quantum state. The laws of quantum physics prevents an eavesdropper from tapping into the signal without detection. Terrestrial QKD systems commonly use single photon signals sent through optical fibres and can only link sites that have pre-existing fibre cables. Furthermore, absorption losses in fibre limits the practical range to a few hundred kilometres [23]. Free-space optical transmission is a well studied alternative method of transmitting QKD signals but atmospheric absorption, scattering, and beam wander severely limits the horizontal range, not even taking into account the curvature of the Earth preventing line-of-sight. Without the advent of long-term quantum technologies like quantum memories and repeaters, QKD is currently limited at best to intra-continental range on Earth.

Satellite based systems offer the best established technology to extend the range of QKD to global distances (Fig. 2). The effective atmospheric optical density when looking straight up is only equivalent to one or two kilometres horizontally at sea level. When a photon is beyond the Earth's atmosphere, it can travel for extremely long distances without absorption or distortion. Two points on the Earth separated by thousands of km can “see” a single satellite at the same time, thus providing a mechanism by which to establish secure links over a long distance. A satellite can also be used as a trusted courier for keys, as it passes over various ground stations it establishes different quantum keys with each of them. The payload computer transmits a bit-wise sum of keys to the two respective ground stations using classical communications, and this enables the ground sites to generate a secure key between them, regardless of their distance.

There are two main types of QKD systems: prepare-send-measure protocols of the Bennett-Brassard protocol (BB84) type [26], and protocols based on utilizing the quantum correlations in entangled states (E91-type protocols) [27, 28]. A third type of protocol is based on continuous variable (CV) quantum states and exploit the Heisenberg uncertainty principle but is currently less suitable for long-range QKD due to its sensitivity to signal losses [29].

2.1.1. *BB84-type Protocols*

In BB84-type protocols, a sender (typically called Alice) prepares a quantum state in one of a set of pre-agreed states randomly. This is sent to a receiver (called Bob) who then measures the state in a randomly selected basis independently of Alice. By publicly sharing a subset of their preparation and measurement records, Alice and Bob can check that the correlations they obtain are consistent with there being no eavesdropper (called Eve) tapping or manipulating their signal. Alice and Bob estimate the noise on the channel using a subset of transmitted signals, i.e. the correlations are not perfect for certain preparation-measurement combinations. They should conservatively assume that this noise was due to the action of an Eve, who is prevented by the laws of physics from discovering what Alice has sent without introducing a disturbance to what Bob detects. If the noise level is below a certain threshold (11% for the BB84 protocol), Alice and Bob must use error correction and privacy amplification, a classical information cryptographic processing technique, to condense their remaining unannounced preparation and measurement records into a smaller cryptographic key that is guaranteed to be uncorrelated to an arbitrary degree with any

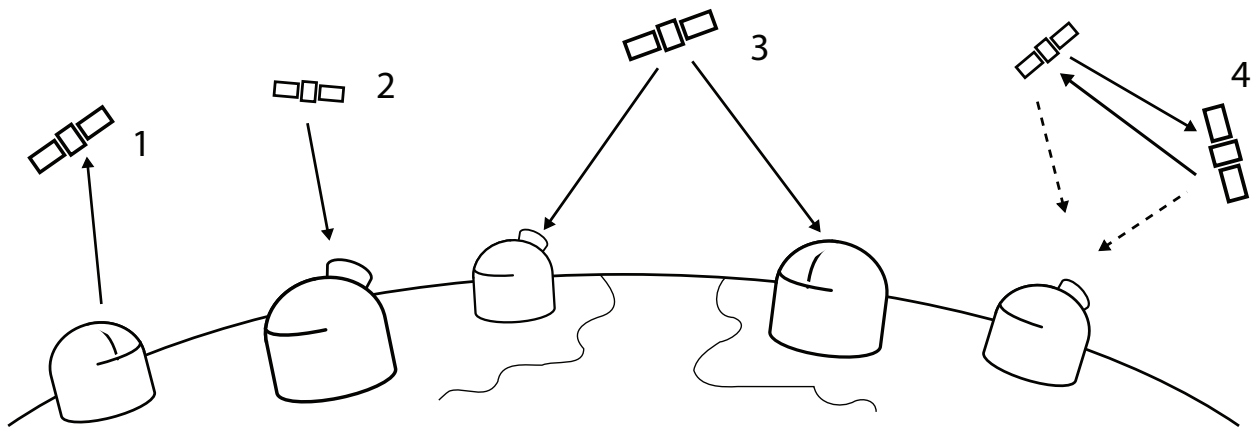

Figure 2. Satellite quantum communication topologies. (1) An optical ground station transmits quantum signal states to an orbiting satellite where it is measured. (2) The satellite carries the quantum source and sends signals down to the Earth. (3) A satellite sends each half of an entangled photon pair to a separate ground station. (4) Satellite to satellite quantum communication with classical command and control from a ground station. There is considerable flexibility in planning satellite quantum communication missions. A single photon (or weak coherent pulse) source can be used in schemes 1, 2, and 4 to create secure quantum communication links. An entangled pair source can be used in all 4 schemes to distribute entanglement for both secure communication and fundamental tests of physics. In 3, instead of an entangled source on the satellite, the ground stations could each transmit quantum signals to the satellite which would then perform a Bell measurement, allowing entanglement swapping or measurement-device-independent QKD [24]. Figure from [25]

information Eve may have gained by tapping into the signals that Alice had originally sent. In this way, Alice and Bob can generate a perfectly random and secret sequence, called a one-time-pad, that can be used to encrypt communications between them. Unlike public key cryptography that is based upon unproven assumptions about the difficulty of certain mathematical problems and limits on the computational power of Eve, the information theoretic security of the one-time-pad has been proven.

In order to guarantee security of this protocol, *ideally* Alice should transmit single photon signals to Bob. True single photon sources are still under development and real-world BB84-type QKD systems use so-called weak-coherent-pulse (WCP) sources, i.e. a very weak laser pulse. Due to the photon statistics of the output of a laser pulse, if the signal is very weak most of the time there are no photons in the pulse at all. A small fraction of the time there is one photon and Alice can encode her quantum signal into it, usually its polarization degree freedom. But inevitably, there is a small fraction of the time when two or more photons are emitted in the pulse, these are then prepared as multiple copies of the same state that Eve can siphon off and use to destroy the security of the protocol. Practically, to circumvent the problem of multiple photons within a pulse giving away information to Eve, modified decoy-state protocols transmit pulses of various strengths to reveal the presence of an Eve hoping to siphon off extra photons [30]. This allows the use of WCP sources but at the overhead of a less efficient protocol and added complication.

For BB84-type QKD protocols, a single photon or WCP source can be located either on the ground [31] or on the satellite with the receiver positioned at the other end. This allows a secure link to be created between Earth and space and a secure cryptographic key generated that the satellite then acts couriers as described earlier. This results in what is known as a trusted-node system, where the satellite is trusted to keep the cryptographic keys secure. Since it generates and stores the key for both ground parties, its security is intrinsic to the security of the entire system. Operationally, the difficulty of intercepting and interfering with a satellite in orbit without detection can be considered a practical deterrent to an eavesdropper. However, Alice and Bob has to trust the people who design, build and operate the satellite, analogous to trusting GoogleTM to keep your data safe.

2.1.2. Entanglement-Based Protocols

A more flexible system can be built using entanglement-based protocols of the Ekert (E91) type. This scheme uses pairs of entangled photons, each half of the pair sent to Alice and Bob who measure their half of the photon pair in a randomly and independently chosen basis and again publicly compare a subset of their results. They can use the observed correlations to establish that the photon pairs were in fact entangled and had not been tampered with by an eavesdropper. In fact, they can assume that it was Eve who controls the source of photon pairs because if the correlations between Alice and Bob are strong enough, they will be able to distil a secure private key based on their unannounced measurement results in a similar way to that described previously.

At a basic level, entanglement-based QKD relies on the fact that it is impossible for a local and realistic hidden variable model to replicate the strong correlation of quantum entangled particles. Quantum mechanical entangled states cannot be described by a local realistic model whereby the outcomes of measurements are pre-determined prior to the actual measurement itself, assuming that no influence can travel faster than the speed of light ⁴. If Eve had interfered with, or tapped into the entangled particle pairs before Alice and Bob measured them, she would have “collapsed” the state and Alice and Bob would not observe violations of Bell’s inequality. In this way, Alice and Bob can verify the security of the entangled pair source without having to trust it.

By placing an entanglement source in orbit and transmitting photon pairs down to Earth along separate paths, two distant parties could be securely linked. This method is called untrusted node satellite QKD as the two Earth parties can certify the presence of quantum correlations that allow secure communication without trusting whoever built, launched, or operated the satellite ⁵. However the simultaneous transmission of entangled photon pairs from an orbiting satellite to separate ground receivers is a challenging task, even for a large satellite.

Space-based entanglement distribution has also been proposed to create a network for highly accurate time synchronization [33]. This requires that entangled links be set up amongst different orbiting satellite nodes that would use the quantum correlations to improve the accuracy of local clocks. Entanglement also allows the system to be robust against malicious action or eavesdropping on the timing signals. Such a distributed synchronized timing network would have important application in various fields such as Earth science, navigation, and fundamental tests of physics.

2.2. Fundamental tests of quantum entanglement

Quantum mechanics theory does not impose any fundamental limits on the separation distances for entanglement. Space-based quantum platforms will enable entanglement tests with separation distances and relative velocities between the photons extended drastically beyond what can be achieved on the ground [34]. Quantum satellite systems will enable tests of quantum entanglement in new regimes that have the potential to solidify (or disrupt) current theories. For instance, it is of scientific interest to study the impact on quantum entanglement when the measurements on the entangled photons are performed at different gravitational potentials and different velocities, regimes only provided by space platforms [2]. Similarly, entanglement between two Bose-Einstein condensates (BECs) may be modified by differential accelerations [35]. Therefore, performing quantum entanglement tests that include a space platform will deepen our knowledge on the interplay of quantum physics with relativistic space-time. These results will also be crucial in confirming the validity of applications such as Quantum Key Distribution, where the proofs of security are based on the assumption that the underlying physics is correct in the relevant regime.

⁴Einstein famously declared that he did not believe in such “spooky action at a distance” in his argument against the completeness of quantum mechanics. The theoretical work by John Bell and subsequent experiments showing violations of his inequality have contradicted Einstein’s contention.

⁵We should also note that Alice and Bob do still have to trust the manufacturer of their own equipment. As their receivers are under their direct control, it is possible for them to monitor and verify their operation [32]. This is not the case for a trusted node satellite however.

2.3. Atom interferometers and atomic clocks

Ultra-cold dilute atomic gases deployed in space are ideal quantum probes for precision measurements. In recent years, quantum technology for atomic clocks and atom interferometers has matured rapidly but current performance of ground-based quantum sensors has reached levels where Earth's gravity itself is a limiting factor to the intrinsic resolution, systematic analysis of perturbations at the parts per billion level have to be carefully considered. Operating in space is one way to overcome these restrictions by allowing longer observation and interaction times of the quantum probes, and thus achieve their ultimate potential. The projected resolution enhancement of quantum sensors has vital application for Earth observation and highly accurate gravity field mapping [36], navigation [37], measurement of fundamental constants [38], precision timekeeping [39], and will also enable fundamental questions of modern physics questions to be addressed with unprecedented precision [11, 40, 41].

2.3.1. Fundamental tests of gravity

General relativity (GR), developed by Albert Einstein over one hundred years, has passed many crucial tests, most recently the observation of gravitational waves [42]. However, quantum theory and gravity have not yet been successfully combined into a single theory implying that we may need to extend or modify their theoretical bases [5]. Experiments that measure gravitational effects with increasing precision can restrict possible extensions to GR, such as the standard model extension, either by confirming theoretical predictions at a given level, or by measuring a divergence. So far, no such violations of the underlying principles of Einsteins Equivalence principle (EEP) have been found. Cold atomic systems can test all three principles of the EEP [43]: the weak equivalence principle (WEP) also known as Universality of Free Fall (UFF), Local Position Invariance (LPI), and Local Lorentz Invariance (LLI). These experiments employ atom interferometry (AI) where different atomic species constitute ideal test masses whose relative acceleration due to gravity can be compared (WEP), or use atoms as clocks where the ticking rate of different clocks can be compared with each other in changing gravitational potentials and reference frames (LLI, LPI).

The successful development of pathfinder instruments operating on Earth-based microgravity platforms such as drop towers [9, 20], airplanes [21] and sounding rockets [10] indicate that space-borne atom interferometer missions are a promising avenue to probe the interplay between quantum physics and gravity. AI based on ultracold gases – cooled down to only a billionth of a degree above absolute zero – exhibit unique capabilities for fundamental physics in the microgravity environment of space. Clouds of atoms at pico-Kelvin temperatures can act as freely falling test masses whose motion due to gravity is read out via the interaction with appropriately designed laser waves (Fig. 3). These waves can be thought of as a nano-scale ruler with which to precisely monitor the position of the atoms [45]. The measured phaseshift in such an interferometer, and therefore the reachable sensitivity of a single measurement, scales quadratically with the interrogation time, an indefinitely long and periodic free fall in space is ideal for high-precision measurements of the WEP [11, 46]⁶. The WEP states that different test bodies will have the same free-fall acceleration in an external gravitational field with trajectories that depend only on the initial position and velocity. In a dual-atomic-species AI, the prepared matter wave samples of two atomic species with different effective masses is simultaneously interrogated by the same interferometer sequence. By using dilute samples of non-interacting atoms or isotopes, the centre-of-mass (COM) positions of the test objects can be independently measured with high precision and subsequently brought to coincidence [46]. Future space-borne quantum tests of the WEP with two-component matter waves composed of alkali gases aim to reach accuracies in Eötvös ratio measurements of better than one part in 10^{14} [11, 12], improving the best classical tests using laser ranging [47] and torsion balances [48] by at least two orders of magnitude.

⁶Drop towers and parabolic aircraft flight only allow seconds of continuous freefall whilst sounding rockets allow several minutes.

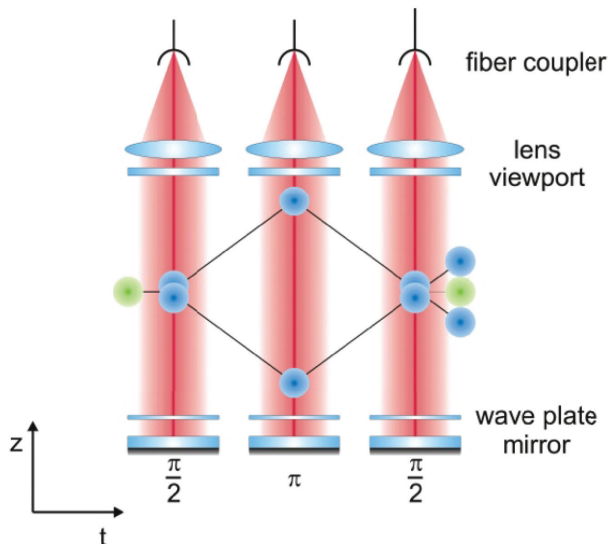

Figure 3. Schematic of a space-based atom interferometer. The sequence of operations progresses left to right. A cloud of cold atoms is put into a quantum superposition of moving up and down by a first $\pi/2$ laser pulse and are left to freely propagate as matter waves. These opposite travelling waves are then reflected by a π laser pulse so that they become coincident and are recombined by a second $\pi/2$ laser pulse. The final state of the atoms is read out through fluorescence and measures the effect of external perturbations (such as acceleration) that induce a relative phase during the time the atoms were in superposition. The sensitivity of the measurement increases the longer the atoms can propagate in superposition, this is restricted on Earth to the time it takes for the atoms to fall. Figure from [44]

Moreover, operating microscopic quantum interferometers at macroscopic displacements in space-time will enable us to study unexplored regimes of low energy quantum phenomena [3, 49]. The availability of long distances and low noise environments would allow the construction of long baseline interferometers (LBI) with matter waves in space as the next generation of low frequency gravitational wave detectors [50, 51]. Several facilities based on ultracold atom interferometers have been studied and proposed as potential payloads for space-borne instruments [11, 51–53].

2.3.2. Atomic clocks and frequency standards

Atomic clock experiments are also extensively developed for space deployment. Most prominently, the ACES mission is scheduled for launch in 2016 and aims to test the LPI with improved precision by comparing a cold caesium fountain clock (PHARAO) and a space hydrogen maser (SHM) aboard the ISS with a network of ground-based clocks on Earth [39]. A space-borne mission with modern atomic clocks in combination with ground-based clocks has two major advantages: the accuracy and stability of cold atom based clocks can be improved when operated in microgravity, due to longer interrogation times, and the potential difference between space-borne clocks and the ground network increases the strength of a possible violation signature [54]. Besides testing LPI, atomic clocks or frequency references in combination with a length reference (e.g., optical cavity) can also be used to test the constancy of the speed of light in a Kennedy-Thorndike-type test [55]. Here, a precise comparison of two (or more) frequency standards is performed in reference frames with varying velocity with respect to the cosmic microwave background. The two frequency references could also be laser oscillators stabilized to an optical hyperfine transition in molecular iodine and to an optical resonator laser [40]. The reference system is a satellite, hosting both optical standards, whose speed and direction varies relative to the preferred frame of reference due to its orbital motion. Moreover, stable absolute frequency standards can be used in different ways to obtain a position measurement, such as time-of-flight measurements of transmitted signals that is measured with clocks on satellites [39]. Clocks are proposed for space craft navigation [37] for deep space

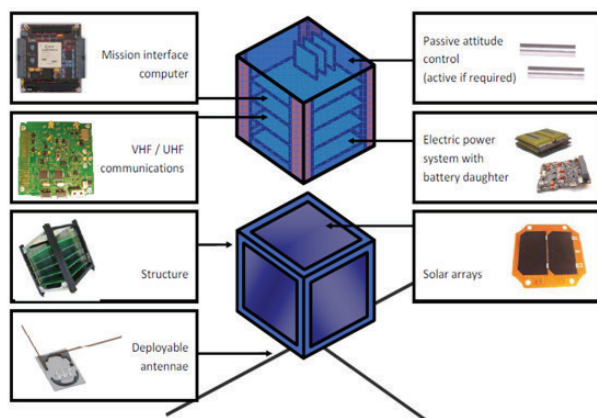

Figure 4. A 1U CubeSat schematic of internal and external parts. The basic building block of a CubeSat is a 10 cm cube with a mass of 1 kg. It contains all the necessary functions of an independent spacecraft, namely power generation and storage, communications, attitude control, and an onboard computer to control the spacecraft. A structure securely holds all the components and serves as the mechanical interface to the canister and deployment mechanism (not shown), e.g. Poly-Picosat Orbital Deployer or P-POD for short. Credit: Steve Greenland (Clyde Space Plc)

missions to allow for precise navigation in an environment without access to GPS systems ⁷.

3. Space 101

Space is hard, or so the saying goes, but CubeSats are making it easier. This is achieved through a combination of reducing the cost and complexity of hardware, reducing the cost to launch, and building up community knowledge of how to develop and operate space vehicles. These characteristics have major implications for the type of space quantum science and technology missions suitable for CubeSats and the structure of the associated development programme. We review the basic elements of CubeSats and how they operate.

3.1. *CubeSat Basics*

A CubeSat is a class of nanosatellites typically massing 1 to 10 kg and with a volume of a few litres (Fig. 4) compared with a conventional satellite of 1000 kg mass and size of a car ⁸. This results in a correspondingly smaller size, weight, and power (SWaP) envelope into which to fit mission capability, though at a much lower cost. CubeSats are fully self-contained spacecraft able to operate in space, usually low-Earth orbit. The CubeSat can be divided into platform systems and its payload. The platform systems provide the necessary functions of a spacecraft and support the operations of the payload, these functions include power generation and storage, communications, an onboard computer, and some form of attitude control. Additionally, propulsion systems are under development to support certain missions.

⁷Global navigation satellite systems (GNSS) such as GPS, GLONASS, BeiDu, and Galileo, employ the same basic principle. Atomic clocks on each satellite transmits a radio timing signal that a ground receiver can compare and using the time-of-flight difference, together with the accurately known orbits of the transmitting satellites, to obtain a position solution. The main source of error is due to distortion of the radio signals as they propagate through the ionosphere, not the intrinsic accuracy of the onboard clocks themselves. A low altitude constellation of CubeSats with atomic clocks could provide local ionospheric correction and improve GPS accuracy for terrestrial applications.

⁸There are even smaller satellite classes such as picosats (0.1 – 1 kg) and femtosats (< 0.1 kg). An example of a picosat is the Pocketcube [56]. Advances in miniaturization of systems for these satellites can feed into CubeSats but it is unlikely that quantum technology and science missions will be able to use these sub-nanosatellites directly in the near-term.

3.1.1. Structure

The CubeSat is named after the fundamental building block, a 1-unit (1U) cube of dimensions 10 cm a side and with a mass of 1 kg⁹. Fully functional satellites have been flown in such a configuration but to expand mission capability, several 1U blocks can be combined to form larger spacecraft, e.g. linear structures 1.5U, 2U, 3U, or 6U (2x3), or 8U (2x2x2) are the most commonly considered.

The majority of mass and volume of a 1U CubeSat will be devoted to platform systems leaving a small amount left for payload. A 2U configuration can give more than 1U of payload, and with 3U CubeSats proving to be a popular choice for the expanded payload capabilities whilst still keeping launch costs relatively low. Commercially available structures for different configurations include Pumpkin Inc. [57], Innovative Solutions in Space [58], GomSpace [59] and Clyde Space [60]. These are usually made of aluminium though some research CubeSats have been designed with composites [61] or using additive manufacture (3D printing) [62].

A key function of the structure is to provide a mechanical interface with the deployment mechanism that ejects the CubeSat from the launcher. In the case of a 1-3U CubeSat, this consists of a set of four rails that contact the inner support structure of the deployer pod. For 6U CubeSats, this may consist of a set of two tabs on one large side that are clamped by the deployer [63].

3.1.2. Power

Electrical power is generated by solar panels that supplies an electrical power system (EPS) and stored in lithium ion batteries. As most orbits in LEO take the CubeSat in an out of sunlight, sufficient electrical energy must be stored for use during eclipse. Thus the solar panels need to be large enough not only to run the CubeSat when sunlit but should also develop a surplus for storage. Body mounted panels are restricted in the the amount of power that can be generated. The solar constant (1.35 kW/m² at the orbital radius of the Earth), together with triple junction solar cells of 28 – 30% efficiency gives a maximum of 4 W per 1U (10 cm × 10 cm) surface area but packing efficiency reduces this by a factor of 2. Deployable solar cell arrays (or wings) are used to greatly increase the projected surface area available to capture the energy of the Sun. Higher power needs is a driver to larger CubeSats as this allows larger solar arrays to be carried. For example, a 3U CubeSat with double-sided double-deployed solar arrays can generate 30 W.

An orbital period in LEO is 90 minutes, or 16 orbits per day. During eclipse, the satellite relies on stored power in a lithium ion battery. The rapid charge-discharge cycle reduces battery lifetime, this is mitigated by restricting depth of discharge (DoD) to 10%¹⁰. This means that battery capacity is oversized compared with the energy actually needed per orbit.

An EPS performs several functions. The power that can be generated by a solar cell depends on the incident sunlight, the temperature, and the current-voltage, an EPS will track each panel to operate at the maximum power point. This electrical power needs to be conditioned and distributed to the rest of the spacecraft via a power bus or else stored or retrieved from the battery. Additionally, a watchdog timer can be used to reset (turning it off and on again) the entire spacecraft should an error cause the satellite to become inoperable.

3.1.3. Control, Communication, and Command

An onboard computer (OBC) controls the operation of the satellite. It interfaces with the EPS to control how power is delivered, the communication system to receive commands and transmit data, ADCS to control the satellite attitude, or operate the payload. Low power processors are typically used considering the restricted power available and flash memory storage with robust

⁹The exact mass limit is not usually strict, the trend has been towards CubeSats of density 1.5 kg per 1U. Volume usually is the main constraint rather than mass for CubeSat designs.

¹⁰For 100% DoD, 1000 charge discharge cycles would only last 2 months in LEO.

error correction is used to store programs and data.

Radio is used to communicate with CubeSats, usually with amateur VHF frequencies for low bandwidth applications, but increasingly UHF communications is being used to allow higher bit rate, especially for downlink of data such as imagery. An advantage of VHF/UHF is that the radiation pattern of the simple antennas used on CubeSats are not very directional hence the CubeSat does not need to point very well. For even higher bandwidth, S-band or even X-band transceivers and patch antennas are now available that can achieve 100 kbit/s to 100 mbits/s data rates respectively [64]. However, the spacecraft must be point towards and track the ground station requiring active attitude control.

The Ground Segment consists of the Earth-based communication system and control centre used to track and control the spacecraft. A minimal setup consists of a single radio station that periodically contacts the CubeSat as its ground path passes sufficiently close to the station. Commands can be uploaded and telemetry and data can be downloaded during the few minutes of contact per pass. There have been efforts to organize a network of ground stations, each of which can communicate with a participating CubeSats, this would have the advantage of multiple or near-continuous contact with a CubeSat as well as the potential for greater data download capability.

3.1.4. *ADCS/Propulsion*

A satellite should have control over its attitude and not tumble uncontrollably. In particular, precise attitude control is mission critical if the payload is to establish a long distance quantum communication link, for example with a quantum ground station. A stable platform is also crucial for precision measurement. The attitude determination and control system (ADCS) both monitors the orientation of the CubeSat and controls its attitude. The simplest form of attitude control is passive and uses permanent magnets to provide an aligning torque through their interaction with the Earth's magnetic field [65]. As the Earth's magnetic field direction changes during the orbit, the orientation of the CubeSat will also follow. To dampen any initial rotation or oscillations, this is combined with hysteresis rods, magnetically susceptible material that dissipates energy as its magnetization changes. This is especially important when the satellite is initially deployed into orbit as it can be left with significant rotation. The first action of a CubeSat after ejection from the deployer is detumbling, or bringing the angular rate close to zero. Alternatively, by extending a boom a CubeSat could exploit the gravity gradient (tidal force) to stabilize the attitude of the craft along the local "vertical", again hysteresis rods are used for dampening.

Active ADCS uses both sensors and actuators to control the orientation of a spacecraft. Orientation information can be gathered using many different types of sensors including magnetometers, Earth horizon sensors, Sun sensors, or star trackers. High precision pointing is achieved using a star tracker, this effectively consists of a telescope and a digital camera that images the star field and matches it with known positions using a star map. Sub-pixel determination of star locations can be achieved through centroiding. Up until recently, commercially available star trackers have been large but high performance star trackers have now become available for CubeSat use¹¹. Rotation rates can be determined using rate sensing gyroscopes, typically based on micro electromechanical systems (MEMS) technology such as piezo tuning forks. These are small, lightweight and low power, especially compared with a ring laser gyroscope.

The sensor information is fed into the ADCS control loop that uses a combination of (active) actuators to orient the spacecraft. Instead of a permanent magnet, a spacecraft can use a magnetic torque actuator, also known as a magnetorquer (MTQ), that passes electrical current through wire coils to generate a controllable magnetic dipole moment. With knowledge of the local magnetic field direction (using a magnetometer mounted on a small boom, to locate it away from perturbations

¹¹High precision pointing determination requires that each pixel subtend a small angle and traditionally larger pixels have used long focal length telescopes. Commercial trends in digital imaging have been towards smaller and lower noise pixel sensors allowing miniaturization of the optical assembly including bulky light baffles to prevent flare from the Sun, Earth, and Moon.

due to the satellite itself), the rotation of the spacecraft can be controlled using a so-called B dot control law.

Fine angular displacements are achieved through changing the angular momentum of control wheels, aka reaction wheels. Varying the individual rotation rate of three wheels with orthogonal rotation axes provides full control of the orientation of the craft. Alternatively, a control moment gyro (CMG) works by changing the axis of rotation of a momentum wheel. In both these cases the angular momentum vector of the rest of the spacecraft changes through angular momentum conservation. Angular momentum can build up through residual torque arising from gravity gradient, interaction of remnant dipole moment of the spacecraft with the Earth's magnetic field, or aerodynamic forces from the atmosphere in LEO. Reaction wheels have a maximum amount of angular momentum they can absorb so it is necessary to bleed off (dump) the excess periodically using the MTQs.

On larger craft, thrusters are sometimes used for attitude control. On CubeSats, the primary interest is their use for propulsion especially for the purposes of orbit maintenance or de-orbiting after end-of-life (EOL). But propulsion systems may be useful for orbital manoeuvring to control the relative displacement of swarms or constellations of CubeSats. Various types of thrusters are under development including compressed gases, MEMS solid propellant, water-based propellant, ion and plasma thrusters. The overall change of velocity (ΔV) achievable is small but still useful for fine orbital manoeuvres. Solar sails are a possibility for long duration interplanetary missions.

3.2. *Development Philosophy*

The differences between nanosatellites and conventional satellites are not just the size and cost, but also crucially the developmental ethos. Traditional space development is more aligned to large and costly engineering projects that are risk averse and prioritize reliability and standard practice over rapid innovation. Given that the individual cost of a nanosatellite and ride-shared launch is much smaller than for a conventional satellite, the lowered cost of failure allows a shift to a more aggressive development path. It permits a rapid iterated development schedule whereby a series of launches builds up capability and flight heritage for components and systems before more advanced missions are performed. This has been exploited commercially by companies such as Planet Labs whose “flocks” of “doves” 3U CubeSats for Earth Observation are constantly revised¹². So-called technology demonstration flights are increasingly common even in “Big Space”, the LISA Pathfinder mission is one such example [67].

The more focussed missions and smaller part count of CubeSats mitigates one of the reservations against nanosatellites, reliability. Large conventional spacecraft use space-qualified parts (often with redundancy), these are components with flight heritage and are highly specified for environmental tolerance such as radiation hardness. But this comes at greatly increased cost and the associated conservative design practice leads to component performance much lower than conventional commercial counterparts. For example, radiation hardened space-qualified processors are much larger and slower than a modern smart phone¹³. As typical CubeSat missions last only a few months to a year, conventional off-the-shelf components may be sufficient to survive long enough to accomplish mission success. Fewer parts in a small satellite means that even though each component may be less reliable than the high specification space-rated parts on a large satellite, the overall system

¹²“... I think one of the fun things about our iteration approach is every time weve added a new feature, we have a little bit of empty space, and we put some new component in there like the reaction wheels, then in the next generation we re-factor the design and improve its manufacturability. Then magically I get the space back again. Generation 10 has as many free cavities in it as Generation 1 did. Theres still as much free space, and I can still put more stuff in. Generation 12, somehow, is about double the free space as Generation 10 because we did a nice job repackaging things. Were very far from the end of the road, from what I think we can do with a CubeSat.”, Planet Labs CTO Chris Boshuizen [66]

¹³NASA built and successfully launched CubeSats that were little more than smart phones with solar cells [68]. This demonstrates the immense capability that rapid commercial electronics development can offer to the small space revolution.

reliability may be similar¹⁴.

The characteristics of CubeSats lends themselves to different types of mission to conventional satellites. Often, the aim is not to supplant large and highly capable satellites with CubeSats but to provide complementary capability where it is not practical to use a larger platform. Single use missions, component demonstrations and establishing flight heritage and reliability, and distributed constellations of satellites are prime examples where the smaller, faster, cheaper aspects of nanosats can be most usefully employed. It is not simply a case of “Building tiny version of big satellites” but “new satellites for new missions”. CubeSats lend themselves to High Risk, High Reward missions. [70]. But ultimately, the advances in miniaturized components means that missions once thought to be the domain of large satellites are increasingly being considered for smaller spacecraft with the advantages of reduced cost and development effort. It may not be too long until CubeSats carry end-user quantum technology or scientific payloads.

3.3. *Getting into Space*

The rapid development of CubeSats and other nanosatellites has occurred in conjunction with the rise of a secondary space launch industry capitalizing on their popularity. CubeSats typically are launched as secondary or tertiary payloads with large conventional satellites. In this way, the cost of placing a functioning spacecraft into orbit can be as low as USD50K for a 1U CubeSat by ridesharing¹⁵. Commercial launch brokers such as Spaceflight Industries [71] arrange launch opportunities for all comers, in 2016 they offer rides on 8 launches into a variety of orbits. The total number of CubeSats launched has risen dramatically recently with more than 400 since 2000 when the CubeSat standard was defined, three quarters of which were in the last 3 years (Fig. 5).

It can be argued that the great development of CubeSats is not the CubeSats themselves, but the way that satellites are carried into space [63, 72]. A major difference between a large conventional satellite and a CubeSat is that the latter is canisterized¹⁶. Large satellites are bespoke creations and of unique shape, this requires close co-operation between the launch provider and the satellite builder in order to make sure that they can be assembled and integrated. This development complication is a barrier to small satellite developers hence defining a standard physical and electrical interface for nanosatellites considerably simplifies the process of launching a CubeSat. The CubeSat developer can design to a specified standard, and the launch provider only needs to cater to a standard deployer configuration. A CubeSat developer can finish building their satellite even before finding a launch opportunity, something not possible for a conventional satellite. The further commoditization of space access, particularly with increased competition in commercial launch capability, will further ease the ability for small satellite makers to launch their spacecraft.

As CubeSats are usually secondary (or tertiary) payloads, the prime concern of the launch provider is that they do not endanger the success of the primary satellite getting into orbit. This means that the CubeSat builder must demonstrate that their craft is safe to attach and launch with the primary payload. A series of acceptance tests are used to ensure that the CubeSat will not pose a hazard by causing mass instabilities (e.g. vibrating excessively and breaking under launch conditions and creating loose pieces), electromagnetic interference, outgassing, explosive or corrosive materials, or electrical incompatibilities. Once the CubeSat is accepted, it and its deployer are integrated with the launch vehicle.

¹⁴In [69], the analysis of recent CubeSat missions indicates that it was mainly the experience of the developers that determined the probability of mission success, rather than inherent unreliability of the CubeSat platform itself. More experienced builders achieved good success rates once they reached orbit, some notable launch failures destroying many CubeSats notwithstanding.

¹⁵The total cost usually includes pre-flight engineering and handling to mate the CubeSat in its dispenser with the deployer launch vehicle. These costs do not scale directly with mass so the cost for small satellites on a per kg basis is higher than for large satellites. However, the cost to launch a 1kg nanosatellite is still at least 2 orders of magnitude lower than for a 1000 kg conventional satellite.

¹⁶The original CubeSat standard used the P-POD, a spring-loaded box containing the CubeSat. Different types of CubeSat deployers are now available.

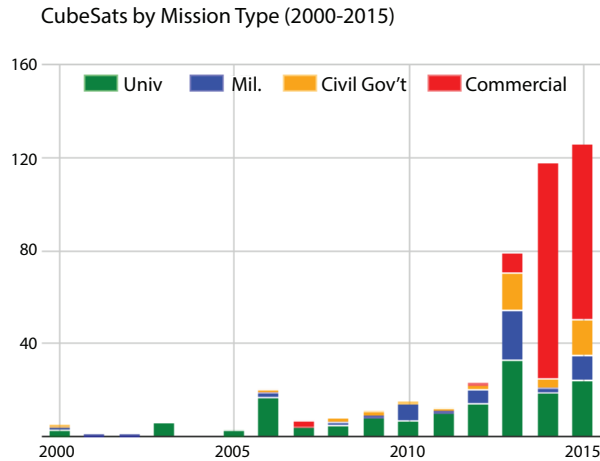

Figure 5. Historical CubeSat Launch Numbers. Since 2000, at least 435 CubeSats have been launched. There have been a few notable launch failures including the loss of 14 CubeSats on a Dnepr-1 vehicle in 2007, and 28 CubeSats on an Antares vehicle in 2014, overall just over a quarter never made it into space. Commercial CubeSat launches have seen a dramatic rise in recent years, mainly driven by Planet Labs who have been building up their constellation of Earth observing platforms, 147 up till the end of 2015. The demand for nanosatellite access to space has developed in conjunction with commercial launch brokers who offer standardized terms and conditions for obtaining launch opportunities on scheduled launches of either large satellites or ISS resupply missions. Dedicated CubeSat launches are less common but the development of small satellite launch vehicles will see these types of orbital deployment increase. Edited chart created on April 27 2016 using data from M. Swartwout.

3.3.1. Orbits

Nanosatellites are commonly launched as rideshare opportunities on scheduled large satellite launches. This means that the orbit is pre-determined by the “prime” satellite. But a market in rideshare opportunities means that the CubeSat developer can choose different orbits depending on the launch. Dedicated CubeSat launches are another possibility but this relies on several different CubeSat groups to agree on a common orbit. A launch of 190 nanosatellites is planned for the end of 2016 on the Dnepr vehicle.

The simplest orbit is the equatorial orbit that circles the Earth above its equator. An example is the geostationary orbit where the orbital period is exactly the same length of the rotation of the Earth or 24 hours. This means that the satellite maintains its position over a particular longitude on the Earth, useful for telecommunications. This allows nearly half of the Earth to be visible though the high altitude (35,786 km) results in long transmission distances.

A common orbit for CubeSats is that of the ISS as it is a convenient platform from which to deploy into LEO. The ISS orbits at an altitude of approximately 400km and is inclined at 51.65° to the equator¹⁷ where it covers 75% of the Earth and 95% of the population. The ISS orbit has proven popular for LEO deployment as it is comparatively easy to access due to regular supply missions.

For Earth observation, a Sun synchronous orbit (SSO) is often chosen. These 600 – 800 km altitude orbits pass near the poles and is inclined at 98° to the equator (slightly retrograde) and whose orbital plane is at a fixed angle to the Sun. This means that it always passes over a particular point of the Earth at the same local time ensuring consistent Sun illumination angles. A dawn-dusk orbit (one whose orbital axis is along the Earth-Sun direction) will be in perpetual daylight hence does not experience large temperature swings or solar power fluctuation.

A variety of other orbits are used for providing constellations for GPS, mobile satellite communications (Iridium), or asset tracking (Orbcomm). CubeSats, due to their small size, lend themselves

¹⁷Practical considerations for the launch profile of the Soyuz spacecraft that transport astronauts and supplies to the ISS dictated this inclination.

to distributed satellite systems and missions that benefit from a constellation configuration.

3.3.2. *And Down Again (Debris Mitigation)*

Nanosatellites, especially the proliferation of CubeSats, has highlighted the particular issue of space debris and the danger that they pose to continued space operations. An attitude in traditional space development is that nanosats are little more than space junk cluttering up Earth orbit, hence view their popularity as a threat¹⁸. The number of nanosatellites being launched and planned in the near future has raised several concerns, that they are typically launched into already crowded LEO altitudes¹⁹, they could be difficult to track, they often lack any means to control their orbit so cannot make evasive manoeuvres, or often deployed in clusters, and their operators may have little or no experience in satellite operations. Potential nanosatellite developers should be aware of these issues as they may have important ramifications for mission design.

The problem of space debris and collisions has resulted in an international guidelines to limit the orbital lifetime of satellites to 25 years or less [75]. The aim is ensure than satellites are removed from orbit after they have completed their operational life so that they do not pose a collision hazard. Large satellites typically have propulsion systems that allow them to control their orbit, either for station keeping, collision avoidance, or for de-orbiting at the end of its life. Nanosatellites have to rely on passive mechanisms by which they can de-orbit within the 25 year guideline. Satellite orbits decay due to drag from residual atmospheric density in LEO²⁰. For a typical nanosatellite, the natural orbital lifetime is less than 25 years for altitudes below 650km. Above this, active means are required to comply with the 25 year guideline.

A popular deployment route for CubeSats is ejection from the ISS at a 400 km altitude with a lifetime of a year. Other popular orbits include polar or sun-synchronous orbits that pass over the pole, these are typically 600 km altitude. These altitudes are marginal in terms of orbital lifetime and due to these orbits all crossing the poles, this leads to a greater chance of collision²¹. CubeSat de-orbit mechanisms are being developed but they reduce mission payload and their reliability has yet to be established [76].

As nanosatellite missions become more ambitious and sent to higher orbits, the issue of decommissioning becomes a significant mission driver and may lead to important design choices, especially at the early stages of design. It may involve increased platform mass budgets to accommodate de-orbiting devices, propulsion for orbital changes, or reliance of other active (third party) debris removal methods.

4. Technology Roadmap

Though it may not be currently feasible to perform most final missions with nanosatellites due to SWaP limitations, the continued advance in miniaturization of both satellite systems and physics payloads are grounds for optimism. A main priority is increasing the technology readiness level (TRL) of different systems [77], both on the platform and payload to bring enhanced capability for more challenging missions. Irrespective of their employment for end-use applications, nanosatellites can definitely play a vital role in accelerating component and subsystem development vital for space

¹⁸“There’s been a lot of concern the last couple of years about small satellites and their proliferation. There are those in the industry who derisively refer to cubesats as ‘debris sats’” [73]

¹⁹About half of all active satellites (≈ 1200) are in LEO (200 – 2000 km) [74]

²⁰The atmospheric density near the edge of space drops off exponentially with altitude but can still cause significant drag, especially for small objects having low ballistic coefficients. The effective height of the atmosphere also depends on solar activity, during a sunspot maximum the increased insolation heats up the atmosphere leading it to grow and causing more rapid de-orbiting of satellites in lower orbits

²¹Iridium 33 and Cosmos 2251 collided on February 10, 2009, 16:56 UTC over Siberia. Though not in polar orbits, they were both in highly inclined orbits that meet close to the poles.

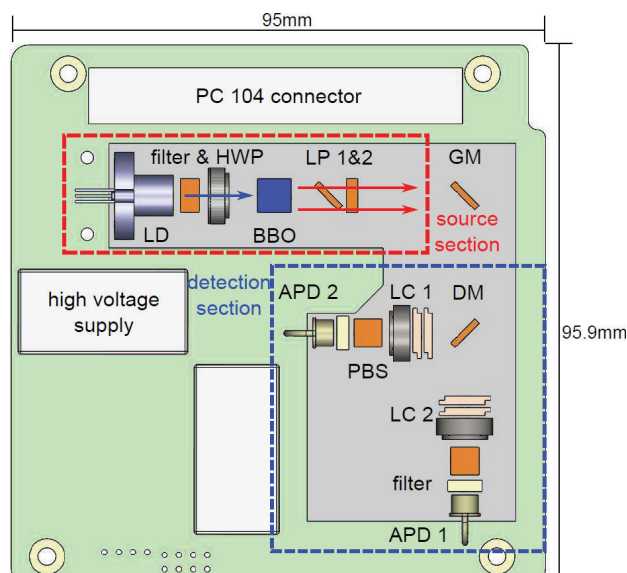

Figure 6. Schematic of the correlated photon source currently flying as a hosted payload on the Galassia satellite. The payload has been developed to contain a non-degenerate source of photon pairs (red box) and the necessary optoelectronics to measure high quality polarization correlations (blue box). The optical parts are mounted on a printed circuit board (green) that provides and interface to the spacecraft. Power and communications is performed through a set of PC104 connector pins. LD: laser diode, HWP: half-wave plate, LP: long-pass filters, GM: gold mirror, DM: dichroic mirror, LC: liquid-crystal polarization rotators, PBS: polarizing beamsplitter, APD: avalanche photodiodes.

quantum technology. We identify several areas in particular.

4.1. Payload Sub-Systems

Quantum payloads may be developed to take advantage of the growing platform capability. The implementation of key technologies on CubeSats can progress in small steps, gaining experience every time while keeping the cost relatively low. Starting on the level of testing key components individually, complexity can then be increased with each Cubesat mission while the tested technology can be optimized for volume and weight.

4.1.1. Quantum photon sources

Correlated pairs of photons generated in a spontaneous parametric process (either by down conversion or four-wave mixing) have interesting properties that can be exploited for applications or fundamental physics. For example, photon pairs generated in parametric down conversion are very strongly correlated in time. Each photon in a pair is born within a few hundred femtoseconds of its twin. In contrast, the best single photon detectors have a timing jitter of tens of picoseconds, and more practical detectors (such as commercial off-the-shelf Geiger-mode avalanche photodiodes) have typical timing jitters that are about half a nanosecond. This makes it possible to use time-stamping techniques to synchronize widely separated atomic clocks. Alternatively, this means it is possible to achieve timing synchronization from simple crystal oscillators, a timing accuracy to within half a nanosecond *without* reference to a GPS-type system [78].

The other notable use of correlated photon pairs is for the generation of quantum entanglement, the current workhorse technique being spontaneous parametric down conversion (SPDC). While SPDC sources have extremely high performance in the laboratory, they are often fragile, bulky and require precise temperature control. One of the authors (A. Ling) has been developing compact and rugged SPDC sources for nanosatellites (Fig. 6) with the aim of deploying polarization-entangled photon pairs from CubeSats for space quantum networks.

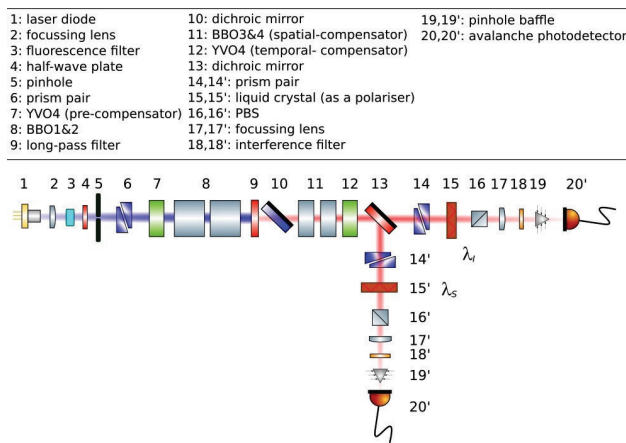

Figure 7. Proposed geometry for a high brightness, high efficiency entangled photon source suitable for spac-based QKD experiments. Although the number of components appears large, they can be arranged to fit into a dedicated CubeSat of at least 2U size.

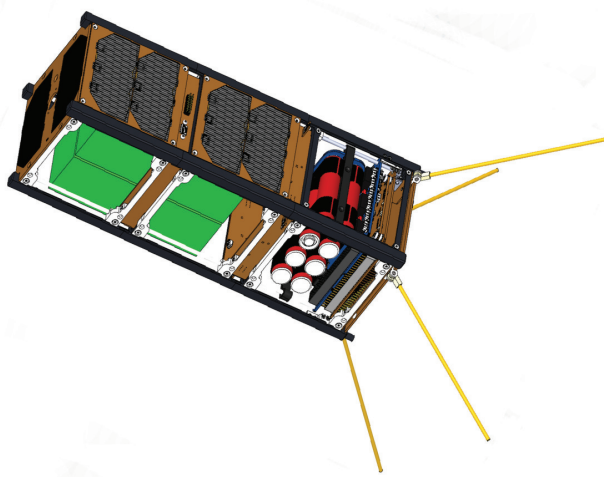

Figure 8. A 3U CubeSat cut-out model. The available payload volume for a compact photon pair source is shown (green region). Also shown are the batteries (red), spring-loaded antennas (yellow), and solar cells (grey). Platform systems are located at the antenna end with components mounted on PC104 standard sized boards.

The first step in this programme is to carry out a pathfinding mission to establish space heritage of critical components that are commonly used in entanglement experiments. The pathfinder mission serves two objectives: the first is to develop the techniques for assembling the optics necessary for a space-capable photon pair source that could, in the future, be rapidly converted to produce polarization-entangled photon pairs; the second is to use the generated photon pairs for metrology to establish the space worthiness of the apparatus used to detect and measure the polarization correlations. This has recently been achieved [79] with a mission on the CubeSat Galassia (currently in an orbit with an altitude of 550 km, and an inclination of 15 degrees) [80].

The next iteration to produce a bright entangled photon pair source is currently under development (Fig. 7). To deal with the expected link loss from a satellite at zenith to ground (estimated at -40 dB) [81], the photon pair source should produce at least 1 million detectable pairs of photons per second and could be hosted on a 3U CubeSat platform (Fig. 8) for in-orbit validation of its performance.

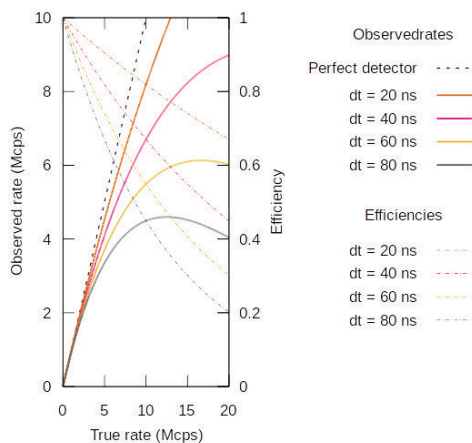

Figure 9. A model of rate-dependent efficiency, in which photons with exponentially distributed inter-arrival times are detected by detectors with a sharply defined, non-extending dead time (dt) and unit efficiency outside this region. Even in such a simple model, it is clear that high detection efficiencies are only possible at comparatively low rates.

4.1.2. Quantum photon detectors

To enable quantum key distribution either with BB84-type protocols or entangled photons requires single photon detectors. The state-of-the-art in fast and high-efficiency single photon detectors currently require superconducting materials and for the immediate future we do not expect these to become accessible to the common CubeSat-sized spacecraft.

At present, the most mature practical technology for single photon detection is the Geiger-mode avalanche photodiode (GM-APD). These small, rugged devices operate at relatively low voltages (below 300 V typically, reducing worries about destructive arcing in space) with relatively high efficiencies (typical detection efficiency of about 50%). However, such devices are known to suffer radiation damage [82, 83] leading to eventual loss of performance. This can be mitigated by using high-Z material shielding (such as tantalum) or accepting a trade-off against lifetime. Previous missions employing GM-APDs within large spacecraft (and better effective shielding) have been successful (e.g. [84]). The Galassia mission is currently flying unshielded GM-APDs on a nanosatellite, and measurements are ongoing to understand the effects of radiation in low Earth orbit.

A key challenge to the in-orbit detection of high single photon rates may turn out to be familiar to Earth-bound photonics researchers. The approximately Poissonian statistics of quantum light sources results in exponentially distributed inter-arrival times (see Fig. 9). At increasing rates, an exponentially increasing fraction of photons will arrive within the finite recovery time inherent to all single-photon detectors. This rate-dependent efficiency [85] may be improved by reducing the recovery time of the detectors, such as using very fast active quenching circuits, but this comes with tradeoffs. For the typical high quantum-efficiency detectors discussed above, relatively high voltages need to be switched in order to achieve quenching [86], resulting in increased power requirements. Within the relative confines of a nanosatellite, this power consumption (and associated thermal management) may prove to be the practical bottleneck in the quest for higher rates. Fast quenching with GM-APDs built using CMOS-technology is possible, but this results in reduced detection efficiency as the CMOS-type detectors have much shorter absorption regions for light.

4.1.3. Photonic quantum encodings

In many free-space quantum communications experiments, the polarization of a photon is used as the quantum encoding, because for optical wavelengths it is highly robust in atmosphere, even under turbulence [87, 88]. An important issue with a system based on polarisation is that the

reference frame between a transmitter and receiver polarisations must be actively controlled, and any optical elements in the optical path must be calibrated. The transmitter and sender must align their respective axes defining vertical and horizontal polarization and as the satellite traverses the sky, its local axis may rotate with respect with that of the ground receiver requiring additional system complexity to track and compensate.

Recently it has also been shown that phase-encodings are compatible with the wave-front distortions introduced by turbulence as well as pointing errors [89, 90]. Phase encoding could be a very appealing technology because it has a lot of commonality with laser systems used in conventional optical communication systems. In addition, phase-encoding is less susceptible to polarization errors from telescopes, optics or beam-steering systems. This would, in particular, be interesting for utilizing spatial-light-modulators as the active optical elements, such as in HYPERION project [91, 92].

An alternative encoding that avoids the need for a shared reference frame is by combining polarization with orbital angular momentum (OAM) [93]. A photon can carry angular momentum in the spatial modes of its wavefunction, in addition to the familiar photon spin. This orbital angular momentum is also quantized and can take on values $\dots, -3, -2, -1, 0, +1, +2, \dots$ corresponding to various Laguerre-Gaussian modes. By encoding quantum information into hybrid polarization-OAM states, relative rotations of the transmitter and receiver cancel out so that the information can be obtained without sharing a common reference frame.

Another important type of encoding for quantum communication is continuous variables. Rather than single-photons, these protocols use the quadratures of the optical field. The benefit is that the required hardware can be very similar to classical communication devices, including laser sources, modulators and photo diodes, and a first feasibility study with a satellite laser communication terminal is under way [94].

4.1.4. Pointing and tracking

Pointing and tracking of the quantum optical beams is one of the most demanding requirements for a quantum payload. The pointing requirement is on the order of $1 \mu\text{rad}$ for a transmitter, and $50 - 500 \mu\text{rad}$ with a quantum receiver [81]. In addition, the speed of the space platform causes so-called velocity aberration that results in a variable point-ahead offset between incoming and outgoing optical beams up to $\sim 50\mu$ that must be taken into account.

The beam steering unit will typically use a reference signal, such as a beacon laser, sent from the distant communication node and received by a beacon tracker (similar to a star tracker) to provide the feedback to the steering actuator. The closed-loop control system needs to compensate for gross pointing errors (alignment offsets) of the satellite body as well as high frequency noise, e.g. due to ADCS control wheel jitter or vibration. The former can be controlled by a feedback control loop with the ADCS. The latter can be addressed with high bandwidth inertial measurement units to stabilize the beam in between frame updates of the beacon tracker [95].

Beam steering can be performed using fast steering mirrors, such as utilized in [96]. However, tip-tilt mirrors may introduce polarization errors because of the complex reflectivity due to Fresnel-equations. Therefore, as a tip-tilt mirror is angled, it will introduce variable birefringence, which can lead to a depolarization unless special optical coatings are used, or active compensation is implemented [97]. MEMS steering mirrors are promising for reduced mass and power consumption, these are being actively developed for CubeSat optical communications [98].

For a low-cost COTS approach to beam steering, consumer image stabilization assemblies (as in some photographic lenses) could be used. These employ a lens group that can be decentred from the optical axis to provide beam deflection. Such units are easily obtained, are small, and already have inbuilt driving electronics. Being a refractive element, care needs to be taken in multi-wavelength operation, e.g. different beacon and signal photon wavelengths. The motion of the steering lens also needs to be taken into account as this could perturb the orientation of the CubeSat, though this is solvable in principle by including a feedback loop to the ADCS.

Another interesting approach for beam-steering is the use of spatial light modulators (SLM), which can implement an electronically tunable diffraction grating, as was recently demonstrated for laser communication [91, 92]. However, typically, SLM devices are polarizing and therefore will require additional efforts to compensate polarization effects, or the use of photon encodings other than polarization.

4.1.5. (Ultra)cold atom systems

Applications of atom interferometers and atomic clocks are widespread, covering deep space navigation to important questions of modern physics such as the Einstein Equivalence principle [11, 36, 37, 39, 51]. Several space related missions with cold atom sensors have been proposed and pathfinder experiments in Earth-bound microgravity environments (drop tower, zero-g airplane, sounding rockets) have demonstrated the maturity of their underlying principal technologies [9, 20, 21, 99–101]. These platforms constitute a relevant testbed for demonstrator experiments ultimately to be performed in orbit and already impose challenging requirements on the payload key technologies in terms of mechanical and thermal robustness, long-term reliability, remote control capability and miniaturization. However, cold atom systems for space operation have to fulfil an even more demanding set of requirements, not only stretching development heritage in terms of dimensions, mass and power consumption, but also introducing new challenges like radiation hardness.

Typically, the experimental setup for ultracold atoms (e.g., Bose-Einstein condensates) and AI includes the following three subsystems: Physics package, laser system, and control electronics [44]. Each of these functional units contains a number of further sub-systems and has to fulfil several functions. The physics package consists of compact atomic source (this could be, for instance, an atom chip, an optical dipole trap, or a combination of both) hosted in an ultra-high vacuum (UHV) science chamber operated at around 10^{-11} mbar level ²², the detection unit for imaging of the atomic clouds, the vacuum pump system and a multilayer magnetic shield. It provides the environment for high-flux laser cooling and trapping processes in a 2D/3D Magneto-optical trap configuration, in which the atoms are captured from the background gas and cooled to micro-Kelvin temperatures. In a next step, the atoms are transferred into a conservative trapping potential (magnetic, optical or hybrid) and subsequently cooled down by means of evaporative cooling to eventually condense into a Bose-Einstein condensate (BEC). The expansion rate of a BEC is typically less than $1 \text{ mm}\cdot\text{s}^{-1}$, corresponding to nano-Kelvin temperatures, and constitutes a highly coherent matter wave packet for interferometric measurement to precisely determine (differential) accelerations.

CubeSat missions allow qualification of principal quantum sensor technologies in compact sub-system assemblies. Major milestones in a potential CubeSat program for future quantum sensors would be operation of single laser sources stabilized to an atomic or optical transition, miniaturized vacuum systems with compactified magneto-optical assemblies for laser cooling (for example diffraction grating that creates the formation of trapping beams from a single laser beam), and finally, one could envision a BEC-based instrument using atom chips in combination with diffraction gratings [103], ultimately to be used to build a physics package with a drastically reduced volume for future CubeSat application ²³.

²²Even though the satellite is in space, in LEO the residual atmospheric pressure is greater than that required for these experiments. The wake shield concept has been proposed to generate a region of extremely low pressure in the wind shadow of the rapidly travelling satellite [102], providing extremely high pumping speed without dedicated vacuum pumps.

²³In comparison, the STEP mission was proposed to test the WEP using a 820 kg satellite in LEO. It would compare the acceleration of 8 pairs of \sim kg metal test masses. The MICROSCOPE mission, to be launched in 2016, is a scaled-down version of STEP and uses fewer but similarly sized test masses on a 330 kg satellite. The payload mass is dominated by the cryogenic systems necessary to keep cool the large masses. A cold atom instrument dedicated to test EEP in space was designed in [44], with an overall mass of 221 kg, an average power consumption of 608 W (819 W peak), and a volume of 470 liter. Even though there is still a long way to go, future payloads could potentially be much smaller and eventually fit into CubeSats - given a continuous support through development programs specifically for cold atom technology.

4.1.6. *Laser systems for atomic physics in space*

Laser systems are one of the main sub-systems in a cold atom experiment, for atomic clocks and other quantum physics experiments in space. Future space missions require complex but robust and compact laser systems. Semiconductor lasers are a promising candidate for deployment in space - they are small, cost-effective and subject to a rapid performance increase. For example, a precise measurement of differential acceleration of a degenerate quantum gas mixture in a dual-species AI requires a laser system which is capable for (i) laser cooling and trapping of the atoms before evaporation as well as internal state preparation, (ii) matter wave manipulation by means of two-photon Raman transitions during the interferometer phase and (iii) the detection of the output states of the two interferometers [11].

A laser system basically consists of a low power reference laser which provides an absolute frequency reference via spectroscopy stabilization, and high power, low linewidth laser sources used for cooling, coherent manipulation and detection of the atoms. The switching of the laser beams, frequency shifts, power monitoring and dynamic intensity control (e.g. laser pulse generation) for the specified experimental sequence are performed by switching- and distribution modules. Both physics package and laser system require control and driving electronics, operated by a digital management unit (DMU) which has to be linked to the space platforms DMU via electronic interfaces for data and power [44]

To ensure reliable operation during space missions, it is therefore important to increase the TRL [77] of different types of diode laser sources (depending on their anticipated function) as well as complete laser systems step by step. Testing laser systems and individual components in space is thus the next crucial step to enable more complex space-borne science missions. However, big satellite missions might be too expensive and time consuming for component and subsystem tests. Instead, sounding rockets, zero-g flights and of course CubeSats can provide suitable and more effective test environments for laser technologies and other subsystems.

As the mass, weight and power budgets are the main driving forces, a laser system for space applications has to be compact, light and energy efficient. Additionally, the whole payload has to be mechanically stable to survive the rocket launch and reliable to ensure functionality over the mission duration without any external intervention. Large variations in temperature, the vacuum environment and the effect of radiation might have to be shielded, depending on the specific space-platform.

Both extended cavity diode lasers (ECDL) and distributed feedback (DFB) lasers at different atomic transition frequencies have been developed for space applications [104–106]. Apart from the lasers themselves, the challenge will be to miniaturize the supporting equipment such as power supplies, frequency stabilization, and thermal management. Development and tests of complete space-borne laser systems for atom interferometry or clock operation are ongoing or yet to be demonstrated in space, e.g. in the context of ACES [107] and MAIUS [100]. Dedicated tests of laser subsystem technology for atomic physics experiments in space have recently been performed on sounding rockets or will be launched soon: the FOKUS [99, 108] and the KALEXUS experiments [101] (see also Fig. 10) are mission qualified (TRL 9) and tested laser frequency stabilization to atomic transitions on a sounding rocket, JOKARUS will be the first high-performance frequency reference based on molecular iodine (see Fig. 10).

Sounding rockets are commonly used to provide an excellent microgravity testbed to scientific payloads and constitute the next step towards space. But to exploit the reduced gravity duration of about a few minutes during a free fall parabola in the thermosphere, the payload has to get there first. During the burning phase of the sounding rocket motors, high accelerations and vibrations, DC shocks and thermal loads will affect the experiment [109]. Thus, every component and subsystem has to withstand a certain vibration spectrum, caused by the specific motors and the given mechanical assembly. Another aspect of qualification are temperature gradients (air friction heat up the outer hull to $\sim 200^\circ\text{C}$), which strongly depend on the thermal design of the whole payload,

DLR funded laser system payloads for sounding rocket applications *

	KALEXUS	FOKUS (Rb ref.)	MAIUS-A LS	JOKARUS
Set-up	2 Lasers, spectroscopy (potassium), optical switch, control electronics	1 Laser, spectroscopy (rubidium)	8 Lasers, spectroscopy (rubidium), distribution and switching module	1 Laser, spectroscopy (molecular iodine), control electronics
Power budget	50 W	20 W	80 W	< 50 W (t.b.c)
Dimensions (L x B x H)	345 x 210 x 185 mm ³	215 x 170 x 50 mm ³	300 x 260 x 210 mm ³	t.b.d.
Mass	16 kg	2.1 kg	22 kg	< 15 kg (t.b.c)
	Launched (TEXUS)	Launched (TEXUS)	Scheduled 2016	Scheduled 2017

*Consortium heritage : HU Berlin, FBH Berlin, U Bremen (ZARM), U Hannover, U Hamburg, And U Mainz

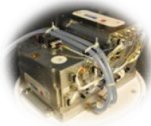

Figure 10. DLR funded laser system heritage for precision measurements with cold atoms and optical frequency standards aboard sounding rockets. DFB: Distributed Feedback Laser, ECDL: Extended Cavity Diode Laser, MOPA: Master Oscillator Power Amplifier. Pictures adapted from [100, 101], Copyright Humboldt-Universität zu Berlin.

which together with the mechanical loads have to be simulated for the entire payload prior launch.

The results and technologies of these pathfinder missions can be used to prepare laser system experiments on small satellites and CubeSats. While the KALEXUS payload is a complete system with two lasers, spectroscopy setup and control electronics, the SWaP budget is still too high for direct application on CubeSats without further developments ($L \times W \times H = 345 \times 210 \times 185 \text{ mm}^3$, $m = 16 \text{ kg}$, $P \approx 45 \text{ W}$). However, the ongoing miniaturization and tests in a space environment are steps towards final laser system designs for small satellite missions. Additionally, current plans for fully developed scientific cold atom experiments in space will see more technological advancement: MAIUS will fly an atom interferometer on a sounding rocket [10] (MAIUS laser system shown in Fig. 10). All of these science and technology missions include laser systems that could be adjusted for small satellite applications.

A first CubeSat mission design (COALAS: COmpact, Autonomous LAser payload for Satellite operation) could be a reduced complexity laser system from this heritage [100], e.g. a single microintegrated laser source with monitoring hardware and control electronics. A suitable, hermetically sealed and rugged laser housing for vacuum environment is already in development. Such a laser technology demonstrator could be realized for a nanosatellite on a relatively short timescale of 2-3 years. To reduce costs, the use of COTS, existing and standardized parts should be preferred. The effect of radiation and thermal cycling on COTS parts will need to be assessed. Precursor flights can be used to provide vital in-orbit data on their performance, especially for long-duration applications.

For the first CubeSat based laser system technology demonstrator, one could envision a 3U CubeSat, of which 2U might be used for the payload (including experimental control). This allows for roughly 3 kg of mass, $20 \times 10 \times 10 \text{ cm}^3$ of volume and up to 30 W of power, depending on the solar panels. With electronics based on the PC104 format ($L \times B = 95 \text{ mm} \times 95.9 \text{ mm}$, variable height) and the hermetically sealed laser housing with a footprint of $128 \times 78.2 \times 22.5 \text{ mm}^3$ as described in [44], one could fit a diode laser, spectroscopy unit, control electronics (current control, temperature control, frequency control) plus OBC (incl. data storage) inside the two units, as shown in Fig. 11. Alternatively, the whole setup – including optics and enclosed lasers – could be designed in the form factor of PC104 boards.

After a successful first flight, the system can be optimized, which allows for extension of the setup to include more functionality. Small satellite experiments could then be developed from a single laser source to functional spectroscopy unit, atomic frequency reference or atomic cooling laser



Figure 11. Left: Reduced complexity options for laser system technology tests on nanosatellites: COmpact, AUtonomous LAser payload for Satellite operation (COALAS). Right: Prinipcal architecture of a 3U CubeSat housing COALAS.

system setups. With frequent low cost missions, the necessary TRL for complex science missions will be reached and fundamental tests of gravity with quantum sensors in space could utilize space-tested technology heritage.

4.1.7. Passive Cooling

A CubeSat in an equatorial LEO will experience temperature swings from about -10°C to 30°C during an orbit. By careful design, a payload could be shielded from the Sun and the Earth²⁴ and only exposed to the 2.7 K cosmic microwave background radiation. The payload will lose heat and come to thermal equilibrium when the heat load (internal power dissipation or through conduction through surround supports and residual thermal radiation from the rest of the satellite structure) is equal to the radiated power from the payload. For low power experiments, this could be below 20 K if sufficiently far from the Earth [110] and closer to Earth, temperatures of -30°C or colder can be achieved for cooling detectors.

4.1.8. Drag Free Systems

Even in space, the environment may not be quiet enough to operate highly sensitive experiments without additional help. This is especially true when looking at gravitational effects. Quantum sensors could be used to increase the sensitivity of experiments, or else directly probe the interplay of gravity and quantum mechanics. A payload will need to be shielded from external disturbances by the host satellite that surrounds it and allowed to follow geodesic trajectories without the perturbing effects of residual atmosphere, solar wind, or radiation pressure [111].

Such drag free systems (DFSs) have been utilized on large spacecraft such as Gravity Probe B and GOCE and is being tested on LISA Pathfinder. These consist of a test mass surrounded by the host vehicle. The DFS monitors the relative position of the host platform with respect to the test mass and a feedback signal is sent to microthrusters on the host to counteract any motion away from the desired position. As the test mass is shielded from external forces by the host, it follows a perfect geodesic trajectory, hence so does the host vehicle.

A 3U CubeSat DFS is under development [112] which consists of a Gravity Reference System (GRS) that monitors a test mass together with a cold gas microthruster to counteract extraneous perturbations (mostly aerodynamic drag). The key developments for CubeSat DFSs are in compact and highly sensitive displacement sensors to monitor the test mass position, charge control of the test mass (usually through UV light photoemission), and suitable microthrusters that have the ability to provide accurate and controllable momentum boosts of the order of 1mNs.

²⁴In LEO, the Earth covers nearly one hemisphere of the satellite’s view. The reflected sunlight during the day and 300 K thermal glow at night is a significant heat load to a satellite. To remove the effect of the Earth, this may require missions to be sent to the Lagrange points or highly elliptical orbits that spend much of the orbit far away.

Trapped cold atom/BEC systems have been proposed as inertial reference sensors that can detect both linear and angular accelerations [113]. These could be used as the basis for a drag free system with the advantages of high sensitivity, reduction of moving parts, and a reduction of volume with the use of microfabricated trapping optics. A DFS is essential for fundamental tests of gravity, such as looking for violations of the WEP.

4.1.9. Deployable Optics

A potential constraint for CubeSats is the possible size of an optical aperture. This limits the collection area of sensors, e.g. single photon detection, but also limits the range that quantum signals can be sent due to unavoidable beam divergence stemming from diffraction. For long distance transmission of quantum signals at the single photon level, optical apertures may have to be 20 cm - 40 cm [81], difficult to achieve within the body of a CubeSat.

Deployable optics is a very interesting avenue, and seems well suited for quantum communications, because the signals are usually monochromatic, and the systems operates only in a narrow field of view. Larger apertures can be produced once a CubeSat is in orbit by unfolding optical elements to make up a larger effective surface. Systems under development include a deployable petal telescope that unfolds 4 mirrors from the sides of a CubeSat to produce a 200 mm diameter f/7 Cassegrain mirror stowed in a 3U CubeSat that usually can only support a 100 mm diameter aperture [114]. Deployable structures on CubeSats in general ²⁵ are actively developed, the use of foldable composite beams allow large structures to be constructed in orbit through mechanical actuation [115]. This opens up the possibility of constructing large optical transmission and receiving aperture that can operate over large distances.

4.2. Platform Systems

The capabilities of large satellites are being brought to CubeSats through development of miniaturized systems [116]. The main areas to support greater mission capability are communications, power, pointing, propulsion and operations, or C3PO for short [117].

4.2.1. High Speed Communications

The data rate, or bandwidth of communications to and from the CubeSat will need to be increased to support greater amounts of data to be created and transferred. Onboard processing of data can be used to reduce the amount of information than needs to be transferred but for many science experiments the raw data may be needed for a full ground based analysis. An entanglement distribution mission between orbit and ground can generate gigabytes of timing information per pass to be compared in order to extract coincidences. For LEO, higher frequency transmitters are available (so-called X-band) that are able to transmit gigabytes of data per ground pass. For even higher volumes of data, optical data links are under active development for nanosatellites ²⁶.

4.2.2. Power

Although great strides have been made to reduce the power consumption of microelectronics, experiments are limited in the amount of power available due to the small storage batteries and area of solar cells. Available peak power can be quite high but the requirement to keep the depth

²⁵E.g. CubeSat deployable solar cell arrays are already a mature technology.

²⁶HYPERION laser comms for small platforms utilizes a modulated retroreflector on the vehicle to encode information in the reflected laser beam shone from the ground station [91]. A similar scheme has been proposed for performing quantum key distribution with a nanosatellite [118]. The OCSD (Optical Communications and Sensor Demonstration demonstrator), launched 8th October 2015, used a 6W laser on board the CubeSat to directly transmit an optical signal to the ground [119]. Unfortunately problems with its ADCS prevented the optical transmission experiments.

of discharge low on the CubeSat batteries means that average power is only a few watts. Some experiments can be operated with a low duty cycle so this is not usually a big constraint, but as experiments become more sophisticated or required power-hungry subsystems such as cooling, then power demands on the satellite subsystems will have to be met through larger deployable solar arrays, leading to a reduction in payload mass and volume or the need for a larger platform, e.g. going from 3U \rightarrow 6U. Large solar arrays will be able to supply a few tens of watts of electrical power in sunlight.

4.2.3. *Pointing*

For optical communication applications, such as QKD links and entanglement distribution, the ability to point the spacecraft accurately is a challenging aspect. Platform stability can be improved with specific design, such as vibration mounting, athermal optics, and careful positioning of mass within the structure to reduce tidal and aerodynamic effects. Attitude knowledge has been addressed with the development of commercial high resolution compact star trackers giving pointing precision of better than 0.002 deg [120]. These are combined with low vibration angular momentum control wheels and magnetic torque actuators for momentum dumping. Together, these improvements may lead to CubeSat platforms having attitude stability suitable for mounting actively stabilized optics to reach the micro-radian level of pointing accuracy required for single photon orbit to ground transmission together with tracking of a rapidly moving ground receiver.

4.2.4. *Propulsion*

For multi-satellite missions, the ability to control the trajectory of each element is important for achieving proper geometry. In LEO, some control of the along-track orbit can be achieved using differential drag by orienting the CubeSat in low or high drag configurations. At high altitudes, orbital changes will require the use of propellant. Small thrusters are being developed for CubeSats as they have applications in either orbital maintenance or de-orbit at the end of the useful service life. But these could also be employed to control the separation of two satellites, e.g. to study entanglement distribution as the distance increased. Microthrusters are also necessary for operating experiments in a drag-free configuration.

4.2.5. *Operations*

The ground segment (Earth-based infrastructure for operating the craft) for operating CubeSats is also evolving to meet the challenges of more complex missions. Traditionally, CubeSats were operated by Ham radio operators using amateur frequency bands from a single ground station with only a few ground passes a day depending on the orbit and the location of the ground station. With the use of higher bandwidth communications more sophisticated ground communication antenna arrays are needed to track the satellite. More frequent contact with a CubeSat can be made using a network of ground stations linked by internet protocols. Peer-to-peer satellite communication protocols are also under development allowing messages to hop from node to node until a ground station comes into range.

Being able to operate at large distances from the Earth and from other spacecraft will enable a host of fundamental science missions. For truly long baseline experiments, missions will need to go beyond LEO. Deep space missions will require more autonomy from the spacecraft to perform manoeuvres and function independently of ground control. CubeSats are already being utilized for interplanetary missions, e.g. the MarCO CubeSats will act as a communication relay from Mars for the landing of the InSight probe. NASA will send two CubeSats to the Moon in 2018 to map it for water and other volatiles. Challenges of deep space operation include increased radiation outside of the Earth's magnetosphere, long range communication, and greater autonomy. Optical communications are being developed to address bandwidth requirements, much of the underlying

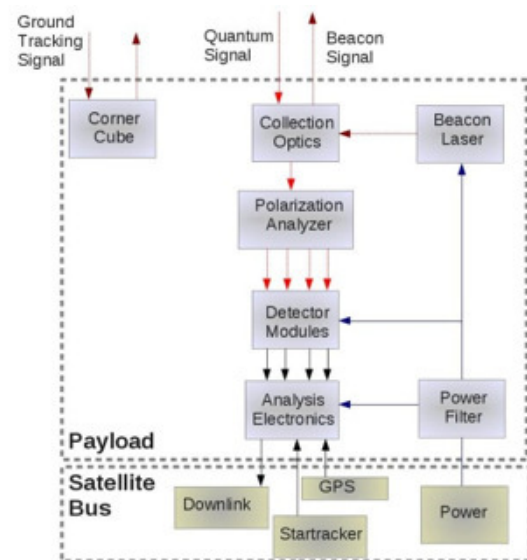
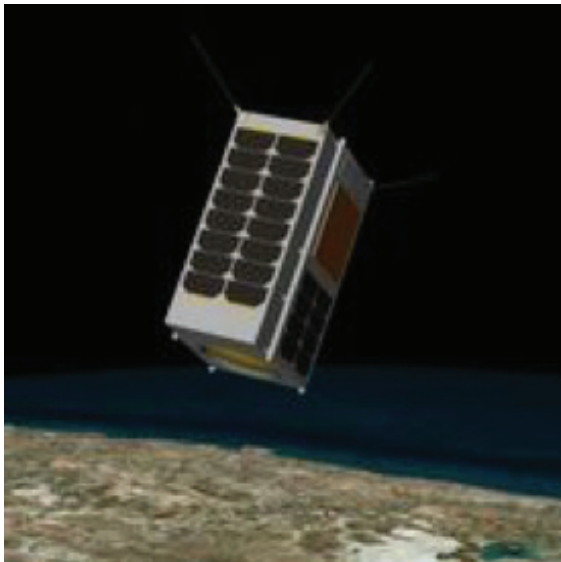

Figure 12. Left) Artists impression of the NanoQEY satellite. Right) Block diagram of the core payload components for NanoQEY. The incoming quantum signal will be analysed with a passive polarizing beam splitter assembly, which guides the photons onto individual photon detectors. The electronic detector signals are time-tagged in the FPGA based Analysis Electronics [31].

technology is shared with that of quantum communication.

5. Proposed Quantum CubeSat Missions

Several possible quantum CubeSat missions have been proposed, and we will provide some details of only two examples, one for a quantum receiver, the other for quantum transmitter.

A mission for demonstrating quantum communications to a space based receiver is the proposed QEYSSAT/NanoQEY mission [31], proposed by one of the authors (T. Jennewein) and his team (Fig. 12). This mission aims to demonstrate ground to space quantum communication to a quantum receiver, demonstrating entanglement science using a source of entangled photons, as demonstrating QKD using a weak coherent pulses source. The main concept of NanoQEY is to implement a simple polarization analyser and quantum receiver for photons. The payload is envisioned to have an aperture of 15 cm, and is designed to fly on existing and proven NEMO (Nanosatellite for Earth Monitoring and Observation) by the Space Flight Lab at the University of Toronto Institute for Aerospace Studies (SFL). The field-of-view (FOV) of the quantum receiver optics will be 0.4 deg, chosen to match the pointing accuracy of the satellite bus. Thus the payload will not require a fine-pointing system, which will reduce complexity, mass and power needs of the payload. The wide FOV of the receiver optics does however have the drawback that it will see a larger footprint of the area around the ground station, and consequently be more susceptible to background from light pollution or the Moon. Nevertheless, the link analysis for the mission shows that assuming a good, dark location of a ground station, entanglement between ground and space can be demonstrated, and quantum key transfer from ground to space can be demonstrated.

The CubeSat Quantum Communications Mission (CQuCoM) has been proposed by two of the authors (D. Oi and A. Ling) and an international consortium to perform orbit to ground QKD (Fig. 13)²⁷. This mission differs from NanoQEY as the quantum signal source is located in space whilst the receiver is located on the ground. This mission would test the ability for CubeSats to

²⁷The CQuCoM consortium consists of the University of Strathclyde, Clyde Space Plc, the Austrian Academy of Science, Ludwig Maximilian University, Technical University of Delft, University of Padua, and the National University of Singapore.

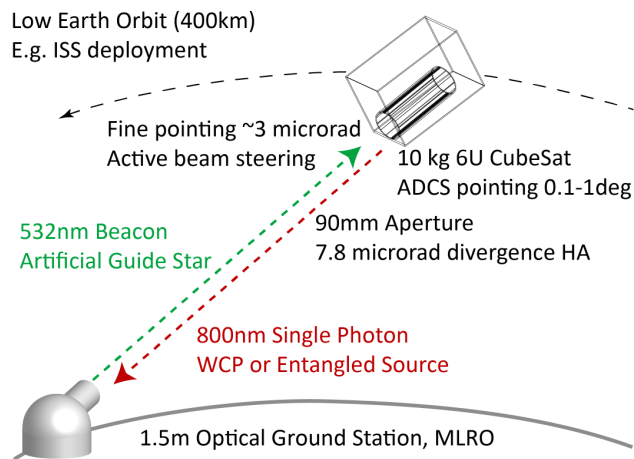

Figure 13. CQuCoM Concept of Operations. The CubeSat Quantum Communications Mission is a proposal to perform orbit to ground single photon transmission for distribution of quantum keys and entanglement. A 6U CubeSat would be deployed from the ISS into low Earth orbit. An artificial guide star sent from the optical ground station allows the CubeSat to acquire and track the site located at the Matera Laser Ranging Observatory (MLRO), Italy as it passes close by. A combination of platform pointing and active optics are designed to send single photons from an onboard quantum source towards the optical ground station. Two launches are proposed as part of the development campaign. The first flight uses a weak coherent pulse source to test the tracking and pointing system and for BB84 type QKD. A second mission would fly an entangled source that would allow fundamental tests of quantum mechanics as well E91 type QKD.

point and track ground targets with extremely high accuracy that is required for space to ground quantum communications. The quantum transmitter developed for CQuCoM could be developed into a auxiliary sub-system for integration into larger satellites, e.g. to secure command and control of high value orbital assets. A first flight would incorporate a WCP source for calibrating the pointing system and demonstrate QKD. A second flight would operate an entangled photon source to distribute entanglement between space and ground and allow fundamental tests of quantum theory.

6. Conclusion

The rapid pace of development in both CubeSats and quantum technologies is leading to exciting possibilities for combining their characteristics of miniaturization, ruggedization, and enhanced capability. CubeSats offer the possibility of in-orbit experience and space heritage of quantum components and sub-systems, conversely the new quantum technologies suggest novel missions for CubeSats. Development on a host of enabling technologies, both on the space and quantum fronts, widens the types of missions that can be considered with smaller platforms.

Spacecraft sizes fall upon a continuum and there is both movement to larger CubeSats (up to 20U have been proposed) and smaller microsats (around 50 kg) so we should not restrict ourselves unduly to a particular “class”. This gives flexibility to envision missions at intermediate cost and development effort that still can benefit from some of the CubeSat advantages (canisterized deployment, COTS components, miniaturized low power high capability sub-systems) but with the benefit of greater SWaP margins. CubeSats have a vital role in early development and proof-of-principle demonstrations. As both satellite and quantum technology improve, greater mission capability can be incorporated into the smaller platforms, mirroring the information technology boom fuelled by advances in microelectronics, processors, and storage.

To fully realize the promise of quantum technologies, it needs to become as ubiquitous as conventional “classical” technologies are at the moment. Space development serves two purposes. It can provide direct benefits to space applications and scientific discovery, but conversely developmental effort for the challenges of space are applicable to compact, lightweight, low-power and rugged

devices for terrestrial applications, greatly increasing the opportunities for deployment.

Quantum technology and science is making its first steps into space, the increased usage of CubeSats and the concurrent democratization of space access can only help accelerated this exciting development. Instead of concentrating upon a few high value, high cost missions, low-cost orbital access allows greater diversity of approaches along many different fronts. The quantum revolution is in a prime position to take full advantage of this.

7. Acknowledgements

DKLO and AL acknowledges fruitful discussions on CubeSat engineering and technology with Steven Greenland. DKLO acknowledges the Quantum Information Network Scotland (QUISCO). MK and AD acknowledge support by the German Space Agency (DLR) with funds provided by the Federal Ministry of Economics and Technology under grant numbers 50WM1345 and 50WP1432.

References

- [1] A. Bresson *et al.*, *Quantum mechanics for space applications*, Appl. Phys. B 84 (2006), 545-550
- [2] D. Rideout *et al.*, *Fundamental quantum optics experiments conceivable with satellites – reaching relativistic distances and velocities*, Class. Quantum Grav. 29 (2012), 224011
- [3] C. Lämmerzahl, *The search for quantum gravity effects I*, Appl. Phys. B 84 (2006), 551-562.
- [4] J. Collins *et al.*, *Lorentz invariance and quantum gravity: an additional fine-tuning problem?*, Phys. Rev. Lett. 93 (2004), 191301.
- [5] C. Kiefer, *Quantum gravity*, International Series of Monographs on Physics, 3rd ed., Oxford University Press, 2012.
- [6] J.-W. Pan, *Quantum science satellite*, Chin. J. Space Sci. 34 (2014), 547–549
- [7] N. Horiuchi, *View from... QCMC 2014: Expanding ambitions*, Nature Photonics 9 (2015), 13-14
- [8] T. Jennewein *et al.*, *Qeyssat: a mission proposal for a quantum receiver in space*, Proc. SPIE Advances in Photonics of Quantum Computing, Memory, and Communication VII 8997 (2014), 89970A.
- [9] H. Müntinga *et al.*, *Interferometry with Bose-Einstein condensates in microgravity*, Phys. Rev. Lett. 110 (2013), 093602.
- [10] J. Grosse *et al.*, *Thermal and mechanical design and qualification of an atom interferometer sounding rocket payload*, Proc. 22nd ESA Symposium on European Rocket and Balloon Programmes and Related Research (2015), 301-308.
- [11] D. Aguilera *et al.*, *STE-QUEST - Test of the universality of free fall using cold atom interferometry*, Class. Quantum Grav. 31 (2014), 115010.
- [12] J. Williams *et al.*, *Quantum Test of the Equivalence Principle and Space-Time aboard the International Space Station*, New J. Phys. 18 (2016), 025018.
- [13] G.M. Tino *et al.*, *Precision gravity tests with atom interferometry in space*, Nuclear Physics B - Proceedings Supplements 243-244 (2013), 203–217.
- [14] P.B. de Selding, October 21, 2015 <http://spacenews.com/with-revenue-looking-up-arianespace-seeks-to-bring-ariane-5-costs-down/>
- [15] I. Galysh *et al.*, *CubeSat: developing a standard bus for picosatellites*, International Symposium on Optical Science and Technology, International Society for Optics and Photonics (2000), 64–71.
- [16] JEM Small Satellite Orbital Deployer <http://iss.jaxa.jp/en/kiboexp/jssod/>
- [17] G.L. Skrobot and R. Coelho, *ELaNa - Educational Launch of Nanosatellite*, 26th Annual AIAA/USU Conference on Small Satellites; 13-16 Aug. 2012.
- [18] ESA Fly Your Satellite Programme http://www.esa.int/Education/CubeSats_and_Education_the_Fly_Your_Satellite!_programme
- [19] M.B. Plenio and V. Vedral, *Entanglement in Quantum Information Theory*, Contemp. Phys. 39 (1998), 431–466.
- [20] T. van Zoest *et al.*, *Bose-Einstein condensation in microgravity*, Science 328 (2010), 1540–1543.

- [21] R. Geiger *et al.*, *Detecting inertial effects with airborne matter-wave interferometry*, Nat. Comm. 2 (2011), 474.
- [22] T.C. Ralph and J. Pienaar, *Entanglement decoherence in a gravitational well according to the event formalism*, New J. Phys. 16 (2014), 085008.
- [23] B. Korzh *et al.*, *Provably secure and practical quantum key distribution over 307 km of optical fibre*, Nature Photonics 9 (2015), 163–168.
- [24] F. Xu *et al.*, *Measurement-device-independent quantum cryptography*, IEEE Journal of Selected Topics in Quantum Electronics 21 (2015), 148–158.
- [25] R. Bedington *et al.*, *Deploying quantum light sources on nanosatellites II: lessons and perspectives on CubeSat spacecraft*, Proc. SPIE 9648, Security and Defence (2015), 964811.
- [26] C.H. Bennett and G. Brassard, *Quantum Cryptography: Public key distribution and coin tossing*, Proc. Int. Conf. on Comp. Sys. and Signal Proc., Bangalore (1984), 175–179.
- [27] A.K. Ekert, *Quantum cryptography based on Bell's theorem*, Phys. Rev. Lett. 67 (1991), 661–663.
- [28] C.H. Bennett, G. Brassard and N.D. Mermin, *Quantum cryptography without Bell's theorem*, Phys. Rev. Lett. 68 (1992), 557–559.
- [29] T.C. Ralph, *Continuous variable quantum cryptography*, Phys. Rev. A 61 (2000), 010302.
- [30] H.-K. Lo, X. Ma and K. Chen, *Decoy State Quantum Key Distribution*, Phys. Rev. Lett. 94 (2005), 230504.
- [31] T. Jennewein *et al.*, *The NanoQEY mission: ground to space quantum key and entanglement distribution using a nanosatellite*, Proc. SPIE 9254, Security and Defence (2014), 925402.
- [32] U. Vazirani and T. Vidick, *Fully Device-Independent Quantum Key Distribution*, Phys. Rev. Lett. 113 (2014), 140501.
- [33] P. Kómár *et al.*, *A quantum network of clocks*, Nature Physics 10 (2014), 582–587.
- [34] P. Shadbolt, J.C.F. Mathews, A. Laing and J.L. O'Brien, *Testing foundations of quantum mechanics with photons*, Nature Physics 10 (2014), 278–286.
- [35] D.E. Bruschi *et al.*, *Testing the effects of gravity and motion on quantum entanglement in space-based experiments*, New J. Phys. 16 (2014), 053041.
- [36] N. Xu *et al.*, *Development of an atom interferometer gravity gradiometer for gravity measurement from space*, Appl. Phys. B 84 (2006), 647–652.
- [37] J. Prestage and D.L. Weaver, *Atomic clocks and oscillators for deep-space navigation and radio science*, Proc. IEEE 95 (2007), 2235–2247.
- [38] A. Wicht *et al.*, *A preliminary measurement of the fine structure constant based on atom interferometry*, Physica Scripta (2002), 82.
- [39] L. Cacciapuoti and Ch. Salomon, *Space clocks and fundamental tests: The ACES experiment*, The European Physical Journal Special Topics 172 (2009), 57–68.
- [40] T. Schuldt *et al.*, *An ultra-stable optical frequency reference for space*, International Conference on Space Optics (2014).
- [41] F. Sorrentino *et al.*, *The space atom interferometer project: status and prospects*, Journal of Physics: Conference Series 327 (2011), 012050.
- [42] B.P. Abbott *et al.*, *Observation of gravitational waves from a binary black hole merger*, Phys. Rev. Lett. 116 (2016), 061102.
- [43] H. Dittus, C. Lämmerzahl, and S.G. Turyshev (eds.), *Lasers, clocks and drag-free control: exploration of relativistic gravity in space*, Astrophysics and Space Science Library 349, Springer, Berlin, 2008.
- [44] T. Schuldt *et al.*, *Design of a dual species atom interferometer for space*, Exp. Astronomy 39 (2015), 167–206.
- [45] M. Kasevich and S. Chu, *Atomic interferometry using stimulated Raman transitions*, Phys. Rev. Lett. 67 (1991), 181–184.
- [46] C. Schubert *et al.*, *Differential atom interferometry with ^{87}Rb and ^{85}Rb for testing the UFF in STE-QUEST*, arXiv:1312.5963 (2013).
- [47] J.G. Williams *et al.*, *Lunar laser ranging tests of the equivalence principle*, Class. Quantum Grav. 29 (2012), 184004.
- [48] T.A. Wagner *et al.*, *Torsion balance tests of the weak equivalence principle*, Class. Quantum Grav. 29 (2012), 184002.
- [49] S. Herrmann *et al.*, *Testing fundamental physics with degenerate quantum gases in microgravity*, Microgravity Science and Technology 22 (2010), 529–538.

- [50] S. Dimopoulos *et al.*, *Testing general relativity with atom interferometry*, Phys. Rev. Lett. 98 (2007), 111102.
- [51] J.M. Hogan *et al.*, *An atomic gravitational wave interferometric sensor in low earth orbit (AGIS-LEO)*, General Relativity and Gravitation 43 (2011), 1953-2009.
- [52] NASA's Cold Atom Laboratory mission homepage, <http://coldatomlab.jpl.nasa.gov>
- [53] *HYPER mission summary*, Science in Perspective by ESA (2000).
- [54] I. Moric and Ph. Laurent, *Status of the flight model of the cold atoms space clock PHARAO*, European Frequency and Time Forum International Frequency Control Symposium (2013), 967-972.
- [55] D. Hils and J.L. Hall, *Improved Kennedy-Thorndike experiment to test special relativity*, Phys. Rev. Lett. 64 (1990), 1697-1700.
- [56] Pocketqube, Alba Orbital Ltd, <http://www.pocketqubeshop.com/>
- [57] Pumpkin Inc., <http://www.cubesatkit.com/>
- [58] Innovative Solutions in Space, ISIS BV, <http://www.isispace.nl/>
- [59] GomSpace ApS, <http://gomspace.com/>
- [60] Clyde Space Plc., <http://www.clyde-space.com/>
- [61] R. Birkeland and O. Gutteberg, *Overview of the NUTS CubeSat Project*, Proc 2nd IAA Conf. Uni. Sat. Missions & CubeSat Workshop, IAA Book Series, Vol. 2 (2013).
- [62] J. Straub, R. Marsh and S. Kerlin, *The Use of Additive Manufacturing for CubeSat Design and Testing*, Third Annual North Dakota Space Robotics Forum (2015).
- [63] R. Hevner, W. Holemans, J. Puig-Suari and R. Twiggs, *An Advanced Standard for CubeSats*, SSC11-II-3, 25th Annual AIAA/US Conference on Small Satellites (2011).
- [64] S. Altunc *et al.*, *X-band CubeSat Communication System Demonstration*, SSC15-IV-8, 29th Annual AIAA/USU Conference on Small Satellites (2015).
- [65] D. Gerhardt, *Passive Magnetic Attitude Control for CubeSat Spacecraft*, SSC10-VIII-5, 24th Annual AIAA/USU Conference on Small Satellites (2010).
- [66] Planet Labs, <http://spaceflightnow.com/2015/09/20/planet-labs-takes-rash-of-launch-failures-in-stride/>
- [67] K. Danzmann, LISA Pathfinder Team, & eLISA Consortium, *LISA and its pathfinder*, Nature Physics 11 (2015), 613-615.
- [68] A.G. Salas *et al.*, *Phonesat in-flight experience results*, Proc. Small Satellites and Services Symposium, 26-30 May 2014, Porto Petro, Majorca, Spain (2014).
- [69] M. Swartwout, *Secondary spacecraft in 2015: Analyzing success and failure*, IEEE Aerospace Conference (2015), 1-12.
- [70] M.A. Swartwout, *CubeSats: Toys, Tools or Debris Cloud?*, Talk at the St. Louis Space Frontier Gateway to Space Conference, 8 November 2014.
- [71] Space Flight, <http://www.spaceflight.com>
- [72] A. Chin *et al.*, *Standardization Promotes Flexibility: A Review of CubeSats Success*, AIAA-RS5-2008-4006, AIAA/6th Responsive Space Conference (2008).
- [73] <http://spacenews.com/smallsat-operators-have-yet-to-allay-concerns-about-space-junk/>
- [74] Union of Concerned Scientists, Satellite Database, <http://www.ucsusa.org/nuclear-weapons/space-weapons/satellite-database>
- [75] International Organization for Standardization (ISO) 24113, *Space Debris Mitigation requirements*.
- [76] P. Harkness *et al.*, *Development status of AEOLDOS A deorbit module for small satellites*, Advances in Space Research 54 (2014), 82-91.
- [77] Technology Readiness Level (TRL): The ESA Science Technology Development Route, <http://sci.esa.int/sre-ft/50124-technology-readiness-level/>
- [78] C. Ho, A. Lamas-Linares and C. Kurtsiefer, *Clock synchronization by remote detection of correlated photon pairs*, New J. Phys. 11 (2009), 045011.
- [79] T. Zhongkan *et al.*, *Generation and analysis of correlated pairs of photons on board a nanosatellite*, arXiv:1603.06659 (2016).
- [80] Spacecraft Name: GALASSIA, International Designator:2015-077E, NORAD Catalog Number: 41170
- [81] J.-P. Bourgoin *et al.*, *A comprehensive design and performance analysis of low Earth orbit satellite quantum communication*, New J. Phys. 15 (2013), 023006.
- [82] Y.C. Tan *et al.*, *Silicon avalanche photodiode operation and lifetime analysis for small satellites*, Optics Express 21 (2013), 16946-16954.

- [83] Y.C. Tan *et al.*, *Radiation tolerance of opto-electronic components proposed for space-based quantum key distribution*, Journal of Modern Optics 62 (2015), 1709.
- [84] X. Sun *et al.*, *Space-qualified silicon avalanche photodiode single-photon-counting modules*, Journal of Modern Optics 51 (2004), 1333.
- [85] J.A. Grieve *et al.*, *Correcting for accidental correlations in saturated avalanche photodiodes*, Optics Express 24 (2016), 3592.
- [86] M. Stipcevic, D. Wang and R. Ursin, *Characterization of a commercially available, large area, high detection efficiency single-photon avalanche diode*, Journal of Lightwave Technology 31 (2013), 3591.
- [87] D.H. Höhn, *Depolarization of a Laser Beam at 6328Å due to Atmospheric Transmission*, Appl. Optics 8 (1969), 367–369.
- [88] R. Ursin *et al.*, *Entanglement-based quantum communication over 144 km*, Nature Physics 3 (2007), 481–486.
- [89] G. Vallone *et al.*, *Quantum interference along satellite-ground channels*, arXiv:1509.07855 (2015).
- [90] J. Jin *et al.*, *Efficient time-bin qubit analyzer compatible with multimode optical channels*, arXiv:1509.07490 (2015).
- [91] Project HYPERION laser communications system for UAVs and small satellites, <http://projecthyperion.co.uk/> <https://www.epsrc.ac.uk/newsevents/news/hyperion/>
- [92] C. Quintana *et al.*, *Novel non-mechanical fine tracking module for retroreflective free space optics*, Proc. SPIE 9248, Unmanned/Unattended Sensors and Sensor Networks X (2014), 92480S.
- [93] V. D’Ambrosio *et al.*, *Complete experimental toolbox for alignment-free quantum communication*, Nat. Comm. 3 (2012), 961.
- [94] D. Elser *et al.*, *Satellite Quantum Communication via the Alphasat Laser Communication Terminal*, Int. Conf. Space Opt. Sys. and Applications (IEEE ICSOS 2015), 27-28 October, 2015.
- [95] H.L. Gutierrez, J.D. Gaines and M.R. Newman, *Line-of-sight stabilization and back scanning using a fast steering mirror and blended rate sensors*, Infotech@Aerospace 2011, 1–8, AIAA 2011.
- [96] S. Nauerth *et al.*, *Air-to-ground quantum communication*, Nature Photonics 7 (2013), 382–386.
- [97] M. Jofre *et al.*, *Fast beam steering with full polarization control using a galvanometric optical scanner and polarization controller*, Optics Express 20 (2012), 12247–12260.
- [98] T. Nguyen *et al.*, *Development of a pointing, acquisition, and tracking system for a CubeSat optical communication module*, Proc. SPIE 9354, Free-Space Laser Communication and Atmospheric Propagation XXVII (2015), 93540O.
- [99] M. Lezius *et al.*, *Space-born Frequency Comb Metrology*, in preparation (2016).
- [100] V. Schkolnik *et al.*, *A compact and robust diode laser system for atom interferometry on a sounding rocket*, Appl. Phys. B 122 (2016), 1–8.
- [101] A.N. Dinkelaker *et al.*, *Autonomous frequency stabilization of two extended cavity diode lasers at the potassium wavelength on a sounding rocket*, in preparation (2016).
- [102] J.A. Strozier *et al.*, *Wake vacuum measurement and analysis for the wake shield facility free flying platform*, Vacuum 64 (2001), 119–144 .
- [103] C.C. Nshii *et al.*, *A surface-patterned chip as a strong source of ultracold atoms for quantum technologies*, Nature Nanotechnology 8 (2013), 321-324.
- [104] E. Luvsandandim *et al.*, *Micro-integrated extended cavity diode lasers for precision potassium spectroscopy in space*, Optics Express 22 (2014), 7790–7798.
- [105] M. Schiemangk *et al.*, *High-power, micro-integrated diode laser modules at 767 and 780 nm for portable quantum gas experiments*, Appl. Optics 54 (2015), 5332–5338.
- [106] T. Leveque *et al.*, *A laser setup for rubidium cooling dedicated to space applications*, Appl. Phys. B 116 (2014), 997–1004.
- [107] T. Leveque *et al.*, *PHARAO laser source flight model: Design and performances*, Rev. Sci. Instrum. 86 (2015), 033104.
- [108] M. Giunta *et al.*, *Optical Frequency Combs for Space Applications*, Conference on Lasers and Electro-Optics, OSA Technical Digest (2016), (Optical Society of America, 2016), paper STh4H.5.
- [109] TEXUS-48 Pre-Flight Report. DLR-RB-MR, Issue 1.2 (2010).
- [110] A. Pilan-Zanoni *et al.*, *Performance of a radiatively cooled system for quantum optomechanical experiments in space*, arXiv:1508.01032 (2015).
- [111] C. Zanoni *et al.*, *The design of a dragfree CubeSat and the housing for its gravitational reference sensor*, 2nd IAA Conference On University Satellite Missions And Cubesat Workshop (2013).

- [112] C. Zanoni, *Drag-free Spacecraft Technologies: criticalities in the initialization of geodesic motion*, PhD Thesis, University of Trento, Italy, 2015.
- [113] Y. Le Coq *et al.*, *Coherent matter wave inertial sensors for precision measurements in space*, Appl. Phys. B 84 (2006), 627–632.
- [114] J. Champagne *et al.*, *CubeSat Image Resolution Capabilities with Deployable Optics and Current Imaging Technology*, SSC14-VII-2, 28th Annual AIAA/US Conference on Small Satellites (2014).
- [115] J. Reveles *et al.*, *The Development of a Low Mass Extendible Composite Boom for Small Satellite Applications*, SSC15-X-3, 29th Annual AIAA/US Conference on Small Satellites (2015).
- [116] C. Frost *et al.*, *Small Spacecraft Technology State of the Art*, NASA/TP2015216648/REV1 (2015).
- [117] D.T. Likins and R. Hunter, *CubeSats and Science Return*, ARC-E-DAA-TN27032, NASA Document ID 20150019727, NASA Technical Reports Server (2015).
- [118] G. Vallone *et al.*, *Experimental satellite quantum communications*, Phys. Rev. Lett. 115 (2015), 040502.
- [119] OCS D CubeSat Fact Sheet, ARC-E-DAA-TN25953, NASA Document ID 20150023534, NASA Technical Reports Server (2016).
- [120] D. Rowen, *Small Satellite Laser Comm Pointing*, Workshop on Optical Communication on SmallSats, CalTech, 11-14 July 2016