



**Deliverable 4.1: A comprehensive assessment of the applicability of available and proposed offshore mooring and foundation technologies and design tools for array applications**

<b>Lead partner:</b>	The University of Exeter
<b>Contributing partners:</b>	MARINTEK, Wave Energy Centre (WavEC), Tension Technology International (TTI) Ltd, University College Cork, Sandia National Laboratories, University of Edinburgh
<b>Authors:</b>	Sam Weller, Jon Hardwick, Lars Johanning, Madjid Karimirad, Boris Teillant, Alex Raventos, Stephen Banfield, Martin Delaney, Ben Yeats, Wanan Sheng, Tim Crawford, Jesse Roberts, Diana Bull and Todd Griffith

	<p>DTOcean - "Optimal Design Tools for Ocean Energy Arrays" is funded by the European Commission's 7<sup>th</sup> Framework Programme. Grant agreement number: 608597</p>
---	---

**D4.1: A comprehensive assessment of the applicability of available and proposed offshore mooring and foundation technologies and design tools for array applications**



Project: DTOcean - Optimal Design Tools for Ocean Energy Arrays

Code: DTO\_WP4\_ECD\_D4.1

	Name	Date
<b>Prepared</b>	Work Package 4	TBC
<b>Checked</b>	Work Package 9	TBC
<b>Approved</b>	Project Coordinator	TBC

The research leading to these results has received funding from the European Community's Seventh Framework Programme under grant agreement No. 608597 (DTOcean).

No part of this publication may be reproduced, stored in a retrieval system, or transmitted in any form – electronic, mechanical, photocopy or otherwise without the express permission of the copyright holders.

This report is distributed subject to the condition that it shall not, by way of trade or otherwise, be lent, re-sold, hired-out or otherwise circulated without the publishers prior consent in any form of binding or cover other than that in which it is published and without a similar condition including this condition being imposed on the subsequent purchaser.



<b>DOCUMENT CHANGES RECORD</b>			
<i>Edit./Rev.</i>	<i>Date</i>	<i>Chapters</i>	<i>Reason for change</i>
A/0	06/01/2014	All	New Document
1.0	23/01/2014	All	Report amended after review
2.0	27/01/2014	All	Final version

## **Abstract**

The function and type of mooring and/or foundation system are determined by a number of factors including: cost, site characteristics, expected environmental loading and environmental or legislative constraints. The design of the device and its mode of operation will also influence the decision making process. It is the role of DTOcean Work Package 4 to produce a decision making tool which has the capability to assess a range of technologies for the design and selection of mooring and foundation systems for marine renewable energy (MRE) device arrays. In this first deliverable report, criteria are introduced which can be used to appraise technologies and approaches relevant to MRE devices. Existing mooring and foundation technologies used in the offshore industry are summarised with examples given of MRE device deployments. A general overview of the design tools which are currently used for mooring and foundation design in the offshore and MRE industries is provided, along with a list of the capabilities of several commercially available software packages.

**Table of Contents**

<b>1. Introduction.....</b>	<b>8</b>
<b>2. Mooring and Foundation Selection and Assessment Criteria .....</b>	<b>11</b>
<b>2.1. Function and Cost .....</b>	<b>12</b>
<b>2.2. Installation and Decommissioning.....</b>	<b>14</b>
<b>2.3. Site .....</b>	<b>15</b>
<b>2.4. Durability .....</b>	<b>17</b>
<b>3. Technologies.....</b>	<b>23</b>
<b>3.1. Moorings .....</b>	<b>25</b>
<b>3.2. Foundations .....</b>	<b>32</b>
<b>3.3. Arrays .....</b>	<b>39</b>
<b>4. Design Tools .....</b>	<b>42</b>
<b>4.1. Moorings .....</b>	<b>43</b>
<b>4.2. Anchors and Foundations .....</b>	<b>49</b>
<b>5. Summary .....</b>	<b>54</b>
<b>6. References .....</b>	<b>55</b>
<b>Appendix A1 .....</b>	<b>60</b>
<b>Appendix A2 .....</b>	<b>61</b>
<b>Appendix B1 .....</b>	<b>63</b>
<b>Appendix B2 .....</b>	<b>64</b>
<b>Appendix C .....</b>	<b>65</b>

## Figures Index

Figure 1: Artist's impressions of MRE arrays.....	8
Figure 2: Steps in mooring and foundation assessment.....	9
Figure 3: Steps in mooring and foundation design.....	11
Figure 4: Example day rates for an anchor handling tug.....	15
Figure 5: Typical offshore platform examples.....	23
Figure 6: Floating wind turbine concepts for deep water locations.....	24
Figure 7: Example WEC devices.....	25
Figure 8: Schematic of possible mooring arrangements for a single MRE device	26
Figure 9: Offshore mooring system examples.....	28
Figure 10: Examples of mooring components.....	30
Figure 11: Load-extension behaviour of a new Nylon mooring rope sample subjected to 10 cycles of bedding-in.....	32
Figure 12: Schematic of possible foundation arrangements for MRE devices.....	33
Figure 13: Piled foundation examples.....	34
Figure 14: Pin pile foundation configurations.....	36
Figure 15: Tidal turbine gravity base foundations.....	37
Figure 16: Anchor examples.....	39
Figure 17: Schematic of proposed array layouts.....	40
Figure 18: Example design tool applications.....	42
Figure 19: Vessel and structure modelled in Simo.....	45
Figure 20: Examples of risers and moorings that can be modelled with Riflex/Mimosa.....	45
Figure 21: Example of ABAQUS. This shows radial pressure following the insertion of a pile.....	50
Figure 22: Screenshot of Pile-D software showing properties of a pile installed within a mixed material soil.....	51
Figure 23: Vryhof Anchor Ultimate Handling Capacity chart.....	61
Figure 24: Vryhof Anchor drag and penetration chart.....	62

## Tables Index

Table 1: Approximate costs of foundations and moorings in relation to installation, operations and maintenance (O&M) costs.....	13
Table 2: Possible factors affecting installation costs.....	14
Table 3: EIA baseline survey considerations for wave and tidal energy projects..	16
Table 4: Typical mooring and foundation system analysis stages.....	18
Table 5: Analysis approaches for mooring and foundation systems and specified factors of safety (FOS) from the API RP 2SK guidelines.....	20
Table 6: Safety levels as defined by the DNV-OSS-213: <i>Certification of Tidal and Wave Energy Converters</i> guidelines .....	21
Table 7: Features of common mooring types.....	27
Table 8: Selected properties of steel and several synthetic fibre materials.....	31
Table 9a: Features of common foundation types.....	34
Table 9b: Features of common anchor types.....	35
Table 10: Anchor design, installation and operational aspects .....	38
Table 11: Input parameters typically required by mooring system software.....	46
Table 12: Typical frequency dependent hydrodynamic parameters calculated by potential theory codes.....	46
Table 13: Existing Guidelines which may be relevant to mooring systems of MRE devices.....	48
Table 14: Design areas which would be typically documented for design certification.....	49
Table 15a: Existing offshore guidelines which may be relevant to the mooring of MRE devices.....	63
Table 15b: Existing offshore guidelines which may be relevant to the mooring of MRE devices.....	64
Table 16: Linear wave interaction analysis tools.....	65
Table 17a: Moored system analysis tools.....	66
Table 17b: Moored system analysis tools.....	67
Table 18: Foundation geotechnical analysis tools.....	68

## 1. Introduction

The purpose of a mooring and foundation system is to provide offshore equipment with a means of station-keeping that is sufficiently robust to resist environmental loading (e.g. tidal, wind, wave, current and ice), impact and operational procedures. Although the station-keeping of vessels and offshore equipment has been carried out for centuries, marine renewable energy (MRE) devices represent a relatively recent field of application with specific requirements and challenges. In December 2013 the *Research Councils UK Energy Programme Strategy Fellowship* identified the development of cost effective MRE foundations and support structures for deep water as a ‘High-level Research Challenge’:

*“...moorings and seabed structures require design optimisation to improve durability and robustness and reduce costs, particularly for deep water tidal; and ...improved station-keeping technologies.”*

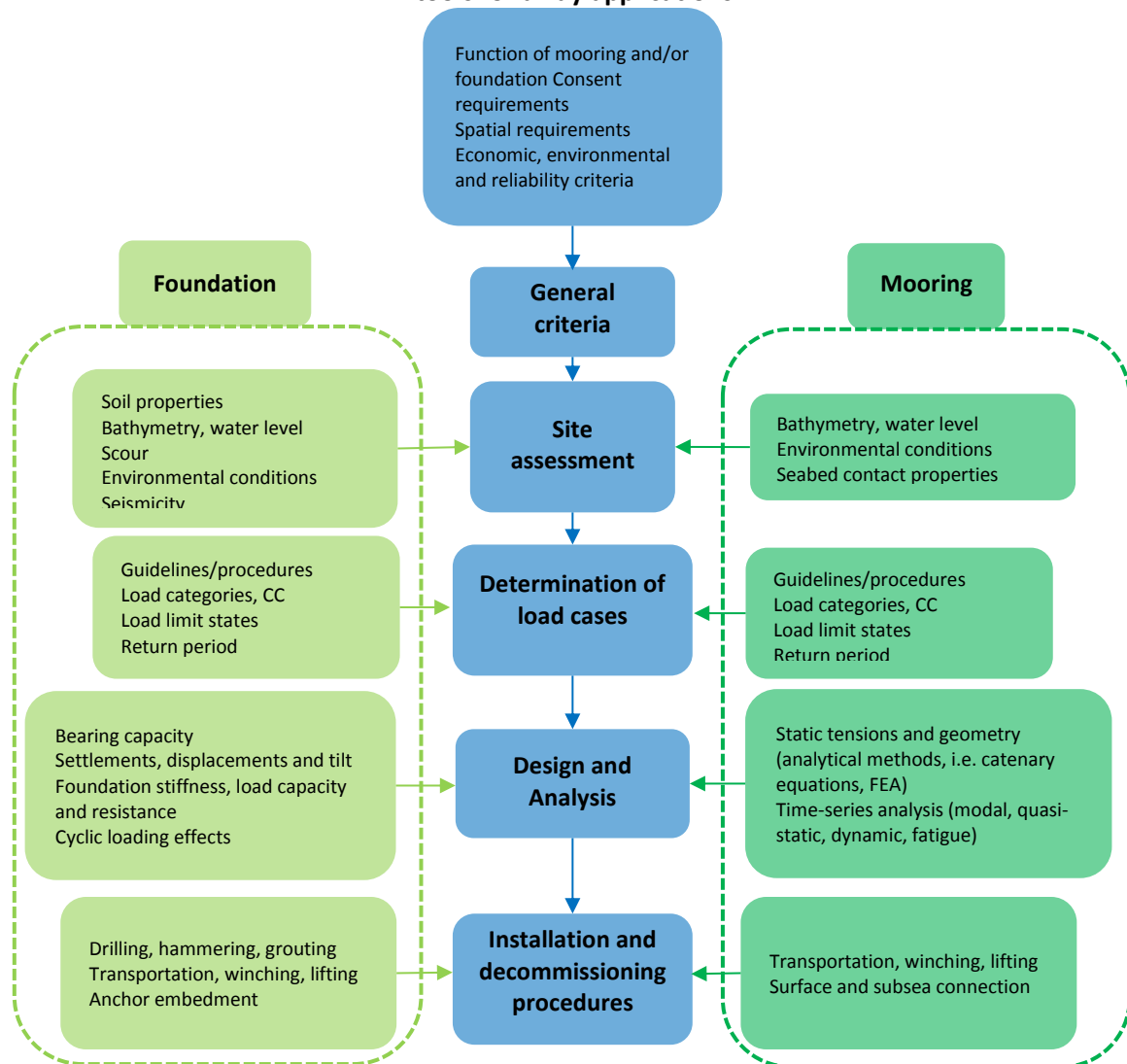

**Figure 1:** Artist’s impressions of MRE arrays: (left) [Wave Star](#) wave energy converter, (middle) [ScottishPower Renewables](#) Sound of Islay 10MW tidal turbine array, (right) [Uppsala University](#) wave power plant

To date a number of wave and tidal energy technologies have been trialled offshore to establish proof of concept, with funding competitions such as the Saltire Prize established to incentivise the MRE industry. Of the concepts which have so far reached the stage of full-scale prototype testing at sea (Technology Readiness Levels 7-8) most are either single devices or small arrays (<10 devices). In order for the MRE industry to reach commercial viability, large scale deployments comprising many tens or hundreds of devices are required (Figure 1).



applicability of available and proposed offshore mooring and foundation technologies and design tools for array applications



**Figure 2:** Steps in mooring and foundation assessment. Considerations specific to moorings (dark green) and foundations (light green) are shown. Note: the abbreviation ‘CC’ refers to Consequence Criteria (see Section 2.4).

Providing robust and economical mooring and foundation systems for a large number of array devices over the lifetime of the project will be a significant challenge to the MRE industry. Previous published assessments of mooring or foundation options have assessed station-keeping options for generic devices (e.g. [1]), reflecting the state of the industry and variety of possible MRE device designs.

Studies focused on particular technologies (e.g. [2]) provide valuable insight into the decision making process of device developers.

MRE mooring and foundation assessment comprises several steps as illustrated in Figure 2. The criteria for mooring or foundation assessment will depend on the starting point of the design process and the level of information provided. For example, a preliminary study may be conducted in which the MRE device has been selected and several site options exist which are dependent on the feasibility and cost of the mooring or foundation. Alternatively the complete MRE system and site may have already been defined and the selection of mooring or foundation components is required. In the following sections it is assumed that the device and site are prescribed based on the scenarios defined in WP1 of this project. In Section 2 several mooring and foundation selection criteria are discussed, followed in Section 3 by technologies which have been used in the offshore industry and those which have already been used for MRE devices. Numerical tools used in the design of mooring and foundation systems are reported in Section 4. The purpose of this document is not only to report on what has already been used for MRE systems, but also to consider the applicability of other offshore mooring and foundation technologies as well as novel designs, with emphasis placed on their suitability for MRE device arrays.

applicability of available and proposed offshore mooring and foundation technologies and design tools for array applications

## 2. Mooring and Foundation Selection and Assessment Criteria

In order to select the most suitable mooring and foundation system, general selection criteria are used in the first instance before more detailed assessments and analysis are carried out. A general approach to design based on these criteria is shown in Figure 3.

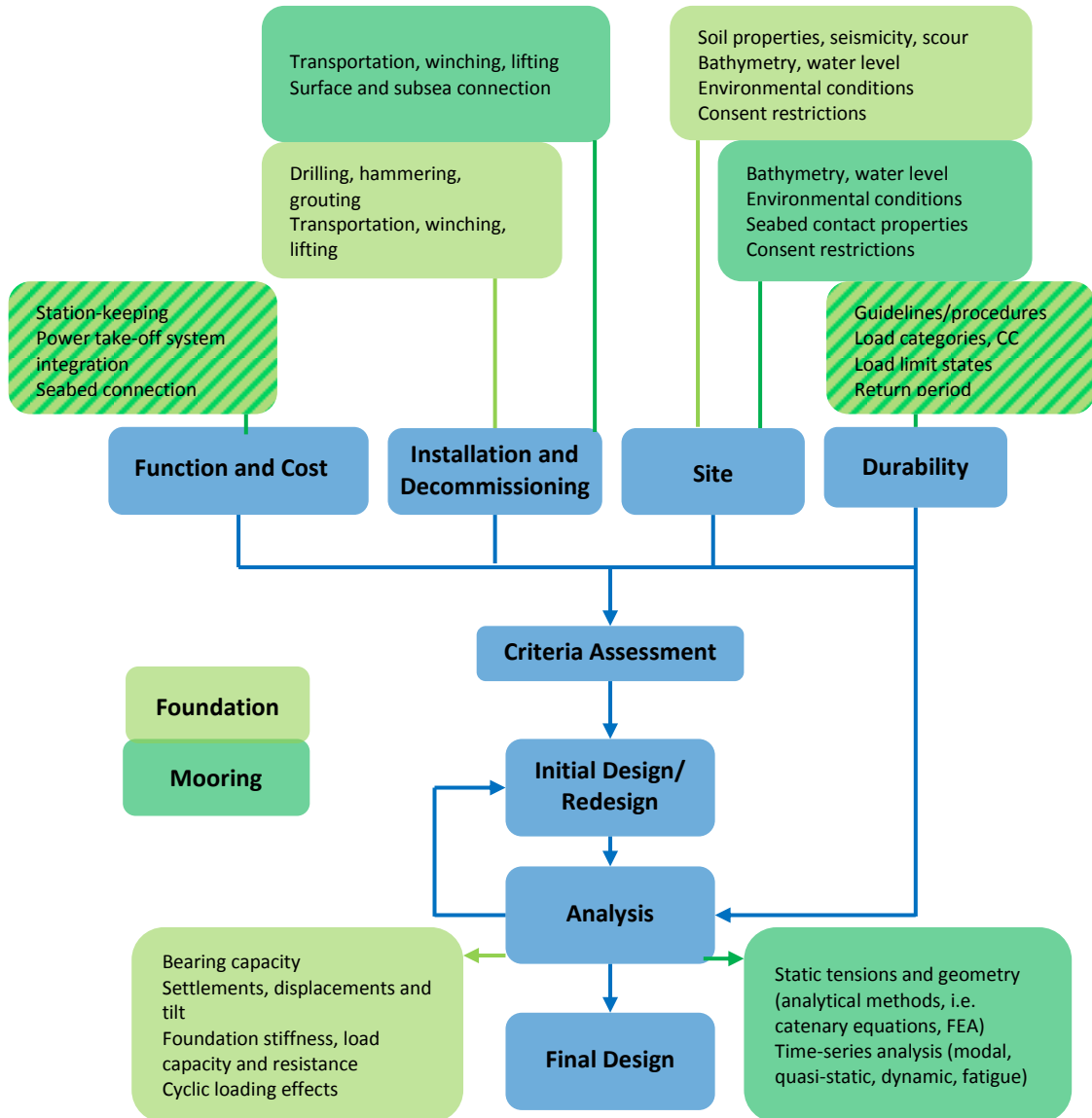

**Figure 3:** Steps in mooring and foundation design. Considerations specific to moorings (dark green) and foundations (light green) and common requirements (hatched) are shown.

**applicability of available and proposed offshore mooring and foundation technologies and design tools for array applications**

The design and certification of offshore structures is usually carried out in accordance with guidelines and procedures defined by certification agencies such as Det Norske Veritas, Bureau Veritas, the American Petroleum Institute and International Standards Organisation. For insurance underwriting, certification is required to provide evidence that the device has been designed in terms of reliability, survivability and risk control during the lifetime of the device (including installation, operation and decommissioning). In the context of MRE devices it is highly likely that certain criteria will have greater importance than others and indeed conflicting requirements will necessitate compromise. For example it would be unwise to use sub-standard, low-cost components in order to keep capital costs down and subsequently compromise device reliability and safety. In this Section several mooring and foundation assessment criteria are introduced in the context of MRE devices.

**2.1. Function and Cost**

The function and capital cost of the foundation system will impact the feasibility of certain choices and may preclude particular systems. For example, the ISSC report *Ocean, Wind and Wave Energy Utilization* [3], categorised tidal turbine support structures into six different types: pile mounted, moored, tethered, guyed tower, telescopic and sheath system. It is unlikely that a tidal turbine mounted on a sheath system would be attached to the seabed with a drag embedment anchor. Similarly there are several functions that a wave energy converter mooring system can provide (i.e. for station-keeping only or an integral part of the power take-off system: PTO). Station-keeping is necessary in order to maintain device position within acceptable limits for optimal device performance (in operating conditions) as well as preventing damage or impact with other array devices and water users (in extreme conditions). The ability to permit device weather-veining may also be required. The *Poseidon Floating Power Plant* uses a turret system for this purpose which is also used on floating production, storage and offloading (FPSO) vessels.

**applicability of available and proposed offshore mooring and foundation technologies and design tools for array applications**

By current estimates moorings and foundations represent a significant proportion of the overall capital cost of a project and must therefore be within the scope of the project development budget. With array configurations comprising tens or hundreds of devices (utility level installations) certain costs are likely to be scalable. The 2012 *Technology Innovation Needs Assessment (TINA): Marine Energy Summary Report* [4] estimated that mooring and foundation systems account for approximately 10% of the total cost of energy (Table 1). In this report *moorings* are classified as flexible line elements linking the MRE device with a fixed attachment point on the seabed, defined as a *foundation* (comprising foundation structures and anchoring systems). Particular MRE devices, such as bottom mounted tidal energy turbines do not require a mooring system and instead the support structure is directly attached to the foundation.

	<b>Cost of Energy (Wave, Tidal)</b>
Foundations and moorings	10%, 10%
Installation	10%, 35%
O&M	25%, 15%

**Table 1:** Approximate costs of foundations and moorings in relation to installation, operations and maintenance (O&M) costs [4]

Both function and cost are therefore mutually dependent criteria, as summarised in the 2013 report *Ocean Energy: Cost of Energy and Cost Reduction Opportunities* produced by the SIOCEAN project [5]:

*“Installation of floating tidal devices has different requirements to those with foundations. Replacing a foundation with a set of moorings raises a number of design challenges but allows deeper water, higher resource areas to be accessed. Installation of floating tidal devices or platforms should be significantly cheaper than installation of bottom mounted devices. Equally, installation of floating wave devices is significantly cheaper than installation of bottom-mounted devices.”*

## 2.2. Installation and Decommissioning

The installation requirements of different foundation and mooring systems also have a key role to play in the decision making process, including the design of the system and the ease of installation and decommissioning.

Factor	Considerations
<b>Environmental and geographical factors</b>	<ul style="list-style-type: none"> <li>• Probability of occurrence of a weather window with accessible conditions (significant impact on cost)</li> <li>• Distance and route to site during installation and demobilisation (fuel costs, transit time).</li> <li>• Utilisation of single or multiple ports. Road/rail transportation.</li> <li>• Access Space (between arrays, shared connection points). The risk of impact or entanglement may determine vessel requirements.</li> </ul>
<b>Equipment factors</b>	<ul style="list-style-type: none"> <li>• Vessel capabilities. Operating water depth, wave height and wave period, tidal current, vessel manoeuvrability, on-board equipment such as cranes and winches, ability to wait on station, i.e. crew accommodation.</li> <li>• Vessel availability. Typically dependent on season.</li> <li>• Vessel cost. Dependent on season and availability.</li> <li>• Access and waiting costs (due to adverse weather conditions) Generic or specialised vessels.</li> <li>• Availability and cost of auxiliary equipment, (i.e. is it best to charter or buy?)</li> </ul>
<b>Logistical factors</b>	<ul style="list-style-type: none"> <li>• Size of devices and scale of deployment (i.e. single device or arrays)</li> <li>• Expected installation duration and extent of contingency measures</li> <li>• Availability and cost of operations personnel, vessel crew and other specialists (i.e. dive teams, ROV operators)</li> <li>• Support Infrastructure (i.e. proximity of ports, dockside cranes)</li> <li>• Port dockside charges (berthing, cranes)</li> <li>• Insurance costs</li> </ul>

**Table 2:** Possible factors affecting installation costs [6]

The decision making process will also be guided by the costs associated with crew, equipment, vessels (e.g. Figure 4) and availability of each of these elements for the expected duration of transportation, installation, decommissioning and maintenance procedures. The time required to complete these procedures will also be influenced

by the complexity of each operation. The unavailability of jack-up barges led MCT to alter the design of foundation system for the *SeaGen* tidal turbine (Section 3.2). The factors affecting installation costs are highlighted in Table 2.

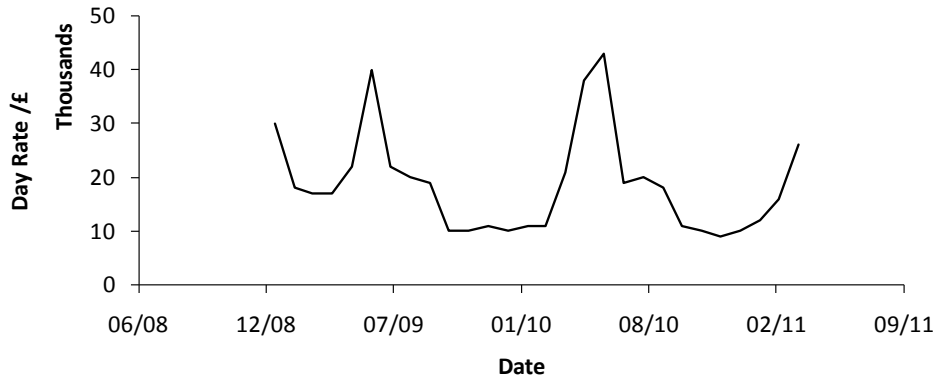

**Figure 4:** Example day rates for an anchor handling tug (December 2008 to April 2011) [7]

### 2.3. Site

Information obtained from a site assessment will inform the design of the mooring or foundation system and the selection of components. Assuming that a site has been selected, a preliminary study will be conducted to determine the site bathymetry, seabed type and environmental conditions. If the site has not be used previously, this information will have to be collated by the device developer, through the use of navigational charts, wave and current measurements, sonar and marine life surveys and resource modelling. The specialist nature of these studies may necessitate subcontracting the work out to companies or research institutes. Constraints to development (e.g. zoning restrictions, environmental impact and navigational issues) will have been identified at the consenting stage. The spatial distribution of mooring and foundation points for wave and tidal energy devices will be determined by the array layout and the need to provide access space between the devices (i.e. for operations and maintenance activities) and to avoid equipment damage or



**applicability of available and proposed offshore mooring and foundation technologies and design tools for array applications**

entanglement (with other mooring lines, water users or wildlife). A more detailed site investigation will then be conducted to assess soil properties, perhaps requiring core samples to be analysed.

It is crucial that the project has a minimal environmental impact to the site and marine species which inhabit it. The *Protocols for the Equitable Assessment of Marine Energy Converters* (EquiMar) document [8] outlines approaches for Environmental Impact Assessment (EIA) and Strategic Environmental Assessment (SEA). Other methodologies including Environmental Risk Assessment (ERA) and Life Cycle Assessment (LCA) are also discussed. Typically a site assessment will include a baseline study to determine environmental and socio-economic systems present in the site (e.g. Table 3) in order to predict possible impacts as well as providing a reference for future monitoring activities. Ideally at the end of the project lifetime all equipment should be removed and no trace of operations should remain at the site [9]. However, partial decommissioning may be acceptable if full decommissioning is impractical (e.g. cutting through pile structures at seabed level). The *Wave Hub Decommissioning Programme* document includes several decommissioning options which are relevant to MRE deployments [10].

<ul style="list-style-type: none"> <li>• Designated sites</li> <li>• Coastal sedimentary processes</li> <li>• Geology, hydrology and hydrogeology</li> <li>• Benthic ecology</li> <li>• Fish and shellfish</li> <li>• Commercial fisheries</li> </ul>	<ul style="list-style-type: none"> <li>• Marine mammals</li> <li>• Birds</li> <li>• Terrestrial habitats and ecology</li> <li>• Marine uses: navigation, fisheries, cultural heritage, recreation and access</li> <li>• Visual landscape and seascape</li> <li>• Noise and vibration</li> <li>• Cumulative and in-combination aspects</li> </ul>
---	--

**Table 3:** EIA baseline survey considerations for wave and tidal energy projects (content from [8])



## 2.4. Durability

Over the lifetime of the installation the mooring or foundation system must be able to withstand complex loading conditions to prevent overloading or fatigue of: electrical transmission cables and hydraulic hoses, connecting hardware, connection points, mooring line components, anchors or foundations. The failure of critical components (i.e. mooring line failure or anchor pull-out) could result in damage of the MRE device and lead to revenue being lost due to operational downtime. For this reason critical failure analysis must be conducted at the design stage. The term *durability* accommodates both holding capacity and reliability. Both of these aspects are required throughout the deployment, which could be at least 20 years. Hence all components must be designed so that they are functional for this period with sufficient allowances for wear, corrosion or changes to material properties. To ensure the continued functionality of components preventative maintenance must also be planned (e.g. bio-fouling, scour and corrosion protection).

Offshore station-keeping systems are scrutinised using guidance documents produced by certification agencies, such as the widely used API Recommended Practice 2SK [11] and DNV-OS-E301 *Position Mooring* [12] guidelines. Although compiled for the offshore oil and gas industry, the approaches to structural mooring system analysis outlined in these documents are a useful source of general guidance for the design and analysis of mooring systems. Therefore certain aspects may be relevant for MRE device developers. In addition compliance to the rules and practices defined by Lloyds Register (e.g. [13]) may be necessary, although again most of the framework for certification has been developed for the oil and gas industry. In Table 4 criteria which are likely to be analysed as part of mooring and foundation system assessment are listed. For brevity, aspects of analysis which are part of the site assessment process including geotechnical (i.e. soil and rock properties) and marine process considerations (i.e. scour and erosion) are not listed.

applicability of available and proposed offshore mooring and foundation technologies and design tools for array applications

Category	Analysis type	Scope	Method
<b>Mooring strength</b>	Static	Pretension of the system, mooring geometry, device draft	Geometric approximations based on static parameters
	Quasi-static	Maximum line tensions and mooring geometry and stiffness based on expected offsets	Load calculation at several fairlead position offsets (device and mooring dynamics neglected)
	Dynamic	Maximum line tensions and mooring geometry of the moored system subjected to external loading	Inclusion of inertia, stiffness, damping and fluid excitation force terms. Frequency domain, time domain and combined methods exist
	Fatigue	Calculation of fatigue damage through cyclic loading	Failure probability analysis (i.e. rainflow counting methods), S-N curves, finite element analysis, fracture mechanics
	Modal	Axial and transverse mode shape and resonance analysis	Non-linear time domain analysis
<b>Foundations</b>	Static and Dynamic	Drag embedment	Analytical techniques to determine: tripping and penetration, stability and holding capacity
		Suction	Analytical and finite element techniques to determine: holding capacity, penetration depth, adhesion factor, bearing capacity, underpressure, soil plug heave
		Driven pile	Geotechnical and structural strength analysis to determine: pile loads, penetration
		Gravity anchor	Analytical and finite element techniques to determine: bearing and lateral loading capacities as well as foundation settlement
		Plate anchor	Analytical and finite element techniques to determine: holding capacity, penetration depth and keying

**Table 4:** Typical mooring and foundation system analysis stages. Recommended analysis stages are reported in detail in offshore guidance documents such as API RP 2SK [11], DNV-OS-E301 [12], and SP-2209-OCN [14]

**applicability of available and proposed offshore mooring and foundation technologies and design tools for array applications**

The DNV-OS-E301 *Position Mooring* [12] guidelines load cases are defined by three limit state criteria (ultimate limit state, accident limit state and fatigue limit state) based on load category, return period and two consequence classes (CC) which describe the outcome of mooring system failure:

- Class 1: “Where mooring system failure is unlikely to lead to unacceptable consequences such as loss of life, collision with an adjacent platform, uncontrolled outflow of oil or gas, capsize or sinking” and
- Class 2: “Where mooring system failure may well lead to unacceptable consequences of these types.”

An additional, serviceability limit state (SLS) is used in the DNV-OS-J103 *Design of Floating Wind Turbine Structures* [15]. In this guidance, which arguably has more relevance for floating MRE devices, the loads applied to the structure, foundation and mooring system may arise from several sources including: permanent, variable, environmental, accidental, deformation and abnormal wind turbine loads. In the DNV mooring guidelines partial factors are applied to the minimum breaking strength (MBS) of mooring line components to account for statistical variations of characteristic material strength. For dynamic analysis, the mean and dynamic response components of the maximum line tension are considered. In this context factors of safety (FOS) are defined as ratio of load bearing capacity of the component to maximum applied load. Although direct comparison between the API [11] and DNV [12] approaches is not possible, applying a partial safety factor of 0.95 to the characteristic MBS of a component and assuming that the mean tension component is 20% (hence the dynamic component is 80%) then the DNV approach will give an overall FOS of around 1.5 for the ultimate limit state (intact) case, which is 10% lower than specified by the API guideline. Clearly the design of an economical mooring system favours the specification of lower FOS components and accumulated offshore experience and research is required in this area.

Category	Analysis type	Scope	Equivalent or specified FOS	
			Intact	Damaged
<b>Mooring lines</b>	Quasi-static	Maximum line tensions based on expected offsets	2.0 (1.79)	1.43 (1.16)
	Dynamic	Maximum line tensions of a moored system subjected to external loading	1.67	1.25
	Fatigue	Damage in tension-tension, bending-tension and free bending fatigue modes	N/A	N/A
<b>Foundations</b>	Dynamic	Drag anchor (permanent)	1.5	1.0
		Suction/Driven pile and Gravity anchor (permanent)	1.6 (lateral) 2.0 (axial)	1.2 (lateral) 1.5 (axial)
		Plate anchor (permanent)	2.0	1.5

**Table 5:** Analysis approaches for mooring and foundation systems and specified factors of safety (FOS) from the API RP 2SK guidelines [11]. Equivalent quasi-static factors of safety from the DNV-OS-E301 *Position Mooring* guidelines [12] are listed in parentheses for the quasi-static case

Previously, the factors of safety specified for synthetic ropes were considerably higher, but as a result of accumulated offshore experience and testing (particular polyester ropes, e.g. [16]) over the last ten years, the factors listed in Table 5 are inclusive for synthetic ropes, steel wire and chain. Despite this experience, the Lloyds Register rules still state factors of safety for synthetic ropes which are 20% higher than those specified in the API guidelines.

The likely consequence of mooring system failure for a MRE device will be comparatively less severe than for the types of large offshore equipment covered by existing offshore guidelines such as [12]. Possible consequences include: the leakage of internal fluids, beaching or collision of devices/other marine craft or species. Therefore it could be argued that the FOS specified in existing offshore guidelines are unnecessarily onerous, with the associated costs having a significant impact on the overall cost of the project. Recently it has been suggested that guidelines produced for other

**applicability of available and proposed offshore mooring and foundation technologies and design tools for array applications**

offshore equipment which are only manned for short intervals during their operational lifetime (e.g. fish farms) may have more relevance [18]. Clearly the use of commercially available mooring system components is still largely unproven due to a lack of long-term deployments. Whilst only a small number of MRE mooring system failures have occurred to-date, the catastrophic mooring system failures of *Oceanlinx* in May 2010 [19] and the *Wavedragon* prototype in January 2004 [20] resulted in significant damage to both devices. It is therefore unsurprising that conservative, high factors of safety are currently used given the uncertainties regarding the long-term performance and durability of mooring components for this new application.

Safety Level	Definition
Low	Where failure implies low risk of human injury and minor environmental and economic consequences.
Normal	For temporary conditions where failure implies risk of human injury, significant environmental pollution or high economic, asset damage or political consequences. This level normally aims for a risk of less than 10 <sup>-4</sup> per year of a major single accident, which corresponds to a major incident happening on average less than once every 10,000 installation years. This level equates to the experience level from major representative industries and activities.
High	For operating conditions where failure implies high risk of human injury, significant environmental pollution or very high economic or political consequences.

**Table 6:** Safety levels as defined by the DNV-OSS-213: *Certification of Tidal and Wave Energy Converters* guidelines [17]

One way to reduce factors of safety may be to incorporate redundancy into the system, such as the use of safety lines around critical components or multiple mooring lines which are capable of keeping the device on station after line failure. This is especially important for device designs which use a single line for mooring (i.e. between the float and power take-off system). A balance must be struck between the specification of a mooring system which is over-engineered (and hence not commercially viable for large scale deployments) and one which is not fit-for-purpose in terms of capability and reliability. Guidance for MRE devices currently exists, for

**applicability of available and proposed offshore mooring and foundation technologies and design tools for array applications**

example the DNV/Carbon Trust *Guidelines on design and operation of wave energy converters* [21] and DNV *Certification of Tidal and Wave Energy Converters* [17]. However, despite new safety classes being defined in both [17,21] (see Table 6), most of the guidance for moorings and foundations (such as load coefficients) is based on existing DNV offshore standard and recommended practices (e.g. [12], see Appendices B1 and B2). It is likely that developments in the MRE industry (e.g. the forthcoming International Electrotechnical Commission TC114 guidelines [22]) and accumulated offshore experience will shape future guidance and lead to more applicable factors of safety for components.

### 3. Technologies

The development of offshore mooring systems and foundations is linked to the trend of oil and gas exploration in increasing water depths, necessitating a departure from fixed to floating structures (Figure 5). Whilst the majority of offshore wind turbines installed to-date are supported by monopile or jacket structures, floating designs for deep water sites have been successfully trialled for example the [Hywind](#) and [WindFloat](#) concepts. In Figure 6, a selection of floating wind turbine concepts suitable for deep water applications is presented. The spar concept moored by catenary or taut mooring lines uses ballast at the bottom of the spar for stability. Tension leg platforms (TLP) achieve stability through the use of tendons and the buoyancy in the platform. Hybrid concepts such as the tension leg spar (TLS) can be used to obtain the advantages of both spar and TLP concepts [23].

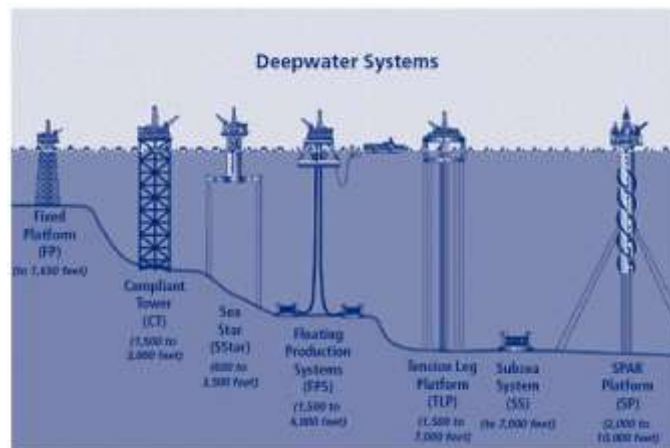
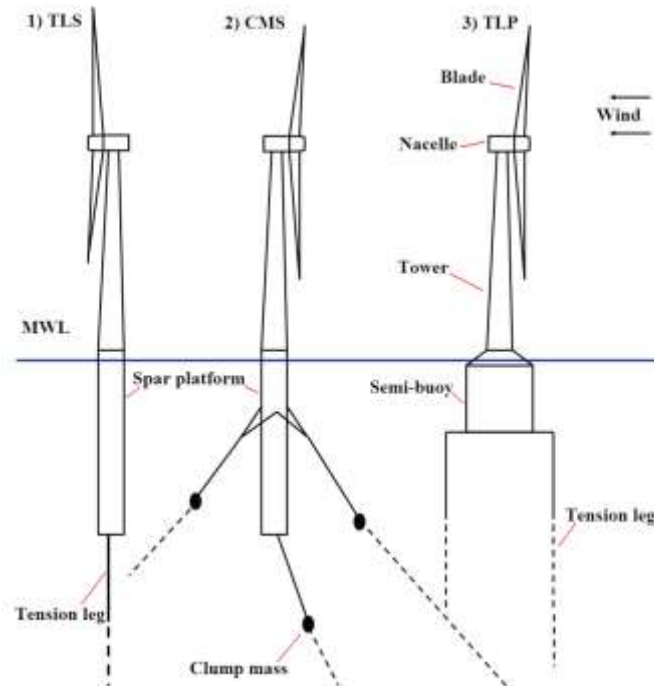

**Figure 5:** Typical offshore platform examples, [U.S. Minerals Management Service](#)

The offshore oil and gas industry has considerable experience in the design and construction of platforms for deep and very deep water sites. Coastal engineering has focused on the design of fixed structures for use in shallow water regions. The design objectives of the offshore wind energy and MRE industries differ with concepts likely to be placed in intermediate water depths (shallow to deep). In the offshore oil and gas industry, cost has a lower priority compared to other aspects



such as time scale, reliability and safety [23]. Although much useful knowledge can be gained from the experience of existing offshore industries, the design methods used may need to be modified for the MRE industry in order to avoid mooring and foundation systems and support structures which are over-engineered and costly or, at the other extreme, unreliable.



**Figure 6:** Floating wind turbine concepts for deep water locations (image source: [23])

MRE devices which are small compared to the incident wave length will dynamically respond to wave loading (first-order and second-order) as well as the combined effects of wind and currents. As a result, there is usually strong coupling between the device and mooring system responses [24,25] and potentially large, resonant motions can occur. Unlike existing offshore equipment which is designed to avoid such responses, wave energy converters (WECs) tend to be designed to maximize power extraction under such conditions in one or more modes of motion. Therefore the mooring and anchoring systems of WECs have to be sufficiently durable (in



terms of fatigue and capacity) to sustain cyclic loading and significant peak loads. Assuming that they are suitably durable for this new application, the use of commercially available components is a logical first step for MRE device developers. In part, this can be fulfilled with well-developed relationships with trusted supply chain companies.

### 3.1. Moorings

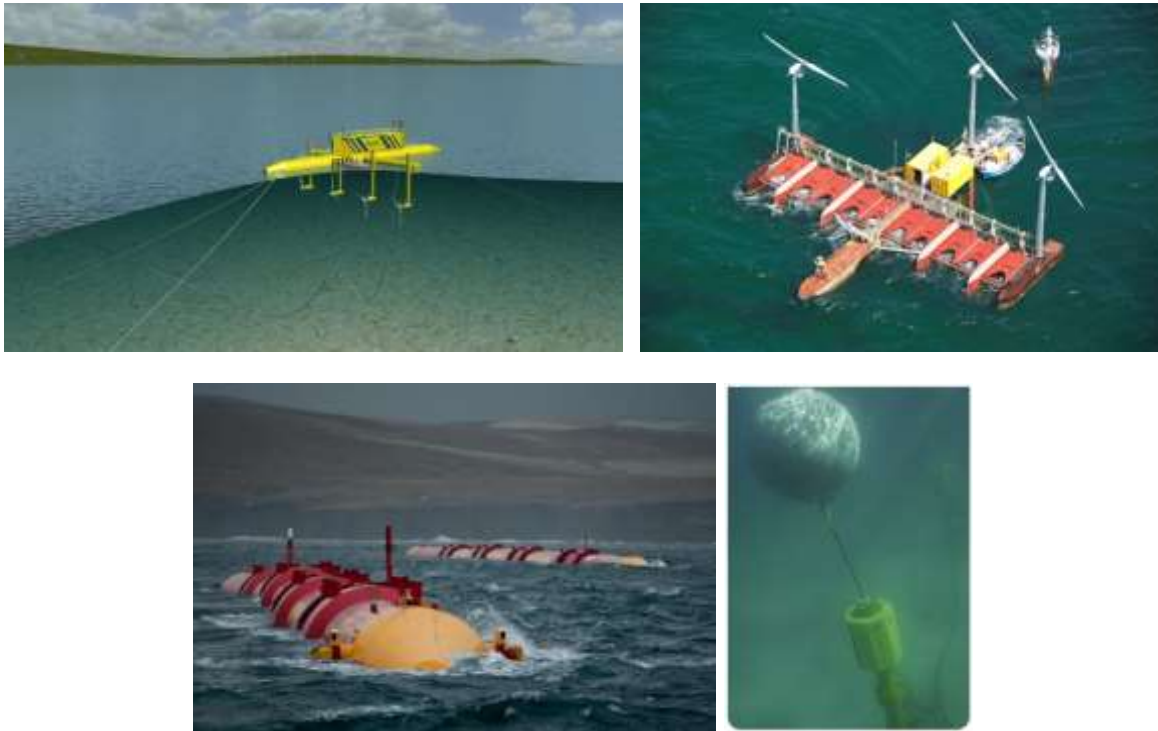

**Figure 7:** Example WEC devices (*top left*) [Bluewater BlueTEC](#) floating platform and (*top right*) [Poseidon Floating Power](#) platform. (*bottom left*) [Pelamis Wave Power P2](#) wave energy converter and (*bottom right*) [Carnegie Wave Energy CETO](#) wave energy converter

MRE mooring systems can be divided into three categories; passive, active and reactive. The main function of a *passive* mooring system is to provide station-keeping only. These systems tend to be used for large floating platforms which support multiple MRE devices (e.g. Figure 7). In addition to providing station-

keeping, the response of *active* mooring systems has a significant influence on the dynamic response of the moored device, to the extent that both responses are coupled and hence affect the power output of the device. Many of the proposed wave energy converter designs fit into this category, including the Pelamis Wave Power's *P2* device (Figure 7). In the case of a *reactive* system the mooring is an integral part of the system, perhaps linking the floating part of a wave energy converter (WEC) to the power take-off (e.g. Carnegie Wave Energy's *CETO* device and [26]).

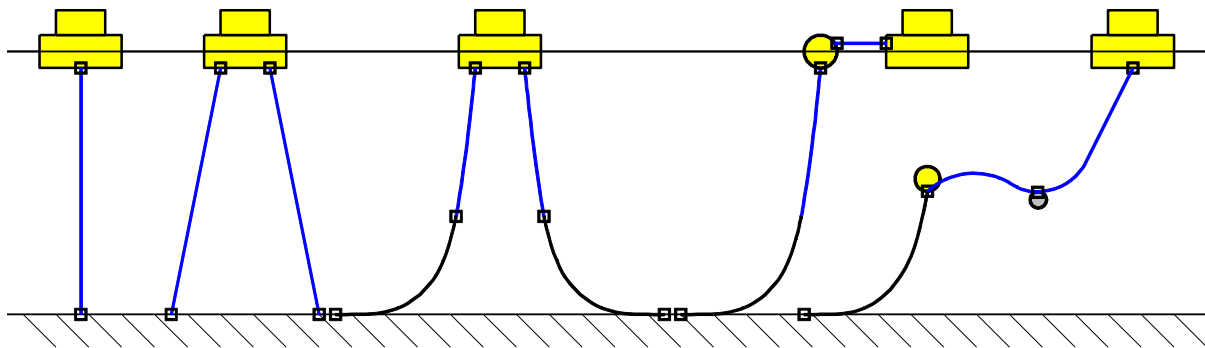

**Figure 8:** Schematic of possible mooring arrangements for a single MRE device: (from left) taut-moored systems with single and multiple lines, basic catenary system, catenary system with auxiliary surface buoy and lazy-wave system with subsea floater and sinker. The combined use of synthetic ropes and chains (blue and black lines respectively) may be feasible

Whilst several variants exist (as illustrated in Figure 8, with advantages and disadvantages listed in Table 7); broadly there are two geometries which are relevant to MRE devices, *catenary* and *taut* mooring systems. In this section a summary of mooring types is given and for more detailed assessment the reader is directed to published literature (e.g. [1]).

Type	Configuration	Advantages	Disadvantages
<b>Taut</b>	Single line	<ul style="list-style-type: none"> <li>1) Can provide a direct link between the floating part and PTO system</li> <li>2) Few components (cost and reliability implications)</li> </ul>	<ul style="list-style-type: none"> <li>1) No redundancy is provided in the case of line failure</li> <li>2) Not suitable for large tidal ranges (unless the floating part can be submerged)</li> <li>3) Anchors and foundations that can be loaded vertically are required</li> </ul>
	Multiple lines	<ul style="list-style-type: none"> <li>1) Redundancy is provided</li> <li>2) Allows the specification of lower capacity components than a single taut line system as tensions are shared</li> <li>3) Mooring system footprint is usually smaller than for catenary systems</li> <li>4) Horizontal restoring forces tend to be higher than for catenary systems</li> </ul>	<ul style="list-style-type: none"> <li>1) A significant tidal range may necessitate a large mooring footprint (unless the floating part can be submerged)</li> <li>2) Anchors and foundations that can be loaded vertically are required</li> <li>3) More components (cost and reliability implications)</li> </ul>
<b>Catenary</b>	Single line	<ul style="list-style-type: none"> <li>1) The compliance that is provided by the mooring geometry may mean lower peak loads than a taut system</li> <li>2) Suitable for large tidal range sites</li> <li>3) A wider range of anchor and foundation options are suitable</li> <li>4) Few components (cost and reliability implications)</li> </ul>	<ul style="list-style-type: none"> <li>1) No redundancy is provided in the case of line failure</li> <li>2) The floating part of the device may be capable of large horizontal motions which could have clearance implications for device arrays</li> </ul>
	Multiple lines	<ul style="list-style-type: none"> <li>1) Redundancy is provided</li> <li>2) Allows the specification of lower capacity components than a single taut line system as tensions are shared</li> </ul>	<ul style="list-style-type: none"> <li>1) More components (cost and reliability implications)</li> <li>2) Risk of line entanglement with adjacent devices in arrays</li> </ul>
	With surface buoy	<ul style="list-style-type: none"> <li>1) Horizontal peak loads lower than normal catenary and taut-mooring systems</li> </ul>	<ul style="list-style-type: none"> <li>1) More components (cost and reliability implications)</li> <li>2) Surface buoy will be subjected to wind and current loading</li> </ul>
	Lazy-wave	<ul style="list-style-type: none"> <li>1) Horizontal peak loads lower than normal catenary and taut-mooring systems</li> </ul>	<ul style="list-style-type: none"> <li>1) More components (cost and reliability implications)</li> <li>2) Surface buoy will be subjected to wind and current loading</li> </ul>

**Table 7:** Features of common mooring types

applicability of available and proposed offshore mooring and foundation technologies and design tools for array applications

Both catenary and taut moored systems are widely used in the offshore industry, particularly for floating production storage and offloading (FPSO), floating production storage (FPS) facilities (Figure 9) as well as Single Point mooring and Reservoir (SPAR) and Catenary Anchor Leg Mooring (CALM) structures. Other categories of moorings include: Single Anchor Leg Mooring (SALM), Articulated Loading Column (ALC) and Fixed Tower Mooring systems. In terms of device scale, geometry and mass, the CALM buoy [27] has perhaps the closest similarities with large buoy-like MRE devices. The majority of CALM buoys have been used for tanker loading in coastal locations (i.e. moored in water depths ranging from 20-160 metres). More recently deep water oil exploration has necessitated use in much deeper water depths [27].

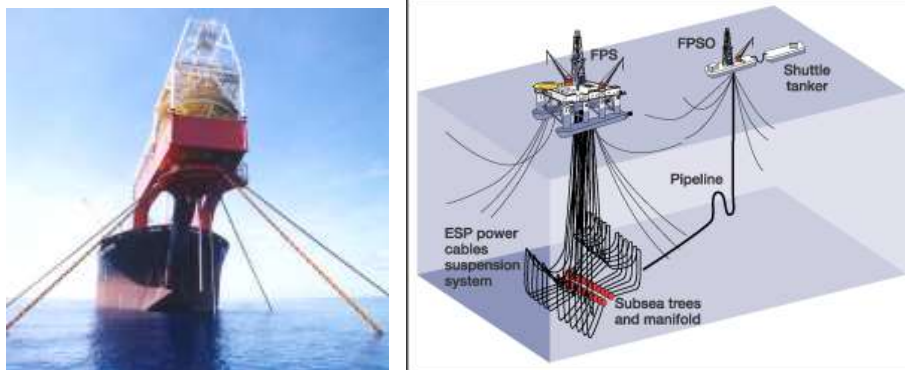

**Figure 9:** Offshore mooring system examples (left) [Buffalo Venture](#) FPSO with single point (taut) mooring and turret system. (right) Schematic of the [Lihua 11-1](#) semi-submersible platform and shuttle tanker moored with catenary lines

*Catenary mooring systems* comprise single or multiple lines with a catenary geometry to provide the necessary horizontal and vertical restoring forces to keep a device on station whilst allowing for changes in the water depth due to tidal variations. For MRE devices the compliance of a catenary system allows motions in several degrees-of-freedom (DoF) for power generation. The horizontal compliance of a catenary mooring system can be increased by ‘lazy-wave’ system which includes float and sinker components attached to the line. It is necessary at the

**applicability of available and proposed offshore mooring and foundation technologies and design tools for array applications**

design stage to determine what level of compliance is required to achieve the permissible magnitude of mooring tensions and device displacements. A system which is excessively compliant may allow large device motions in the desired degree(s)-of-freedom (i.e. heave for a WEC point absorber) but increase the risk of collision with adjacent devices or water users. Although it is possible to use steel components (wires and chains) for the entire length of the line, alternative materials (i.e. synthetic ropes) could be used for the mid or upper sections of the line to reduce the cost and weight of mooring system. 'Rider' or 'ground' chains are used for the lower sections to provide tension to the line whilst transferring loads horizontally to the anchor or foundation.

*Taut-mooring systems* provide a much stiffer connection between the device and seabed, with compliance only provided by the axial properties of the mooring components, such as synthetic ropes. Ropes constructed from polyester [16] have been successfully used for platforms located in deep and ultra-deep water locations. Because both horizontal and vertical restoring forces are provided by this type of mooring system, foundations and anchors must be specified which can operate under both loading directions (usually drag embedment type anchors are not suitable). Unless a large mooring footprint is specified, the limited compliance of a taut-moored system may mean that the device becomes submerged during large amplitude waves or in locations with high tidal ranges. Full or partial submersion of the device is not an issue for some designs (i.e. Carnegie Wave Energy's *CETO* device) and may be a way of limiting device displacements in large amplitude waves [28].



applicability of available and proposed offshore mooring and foundation technologies and design tools for array applications

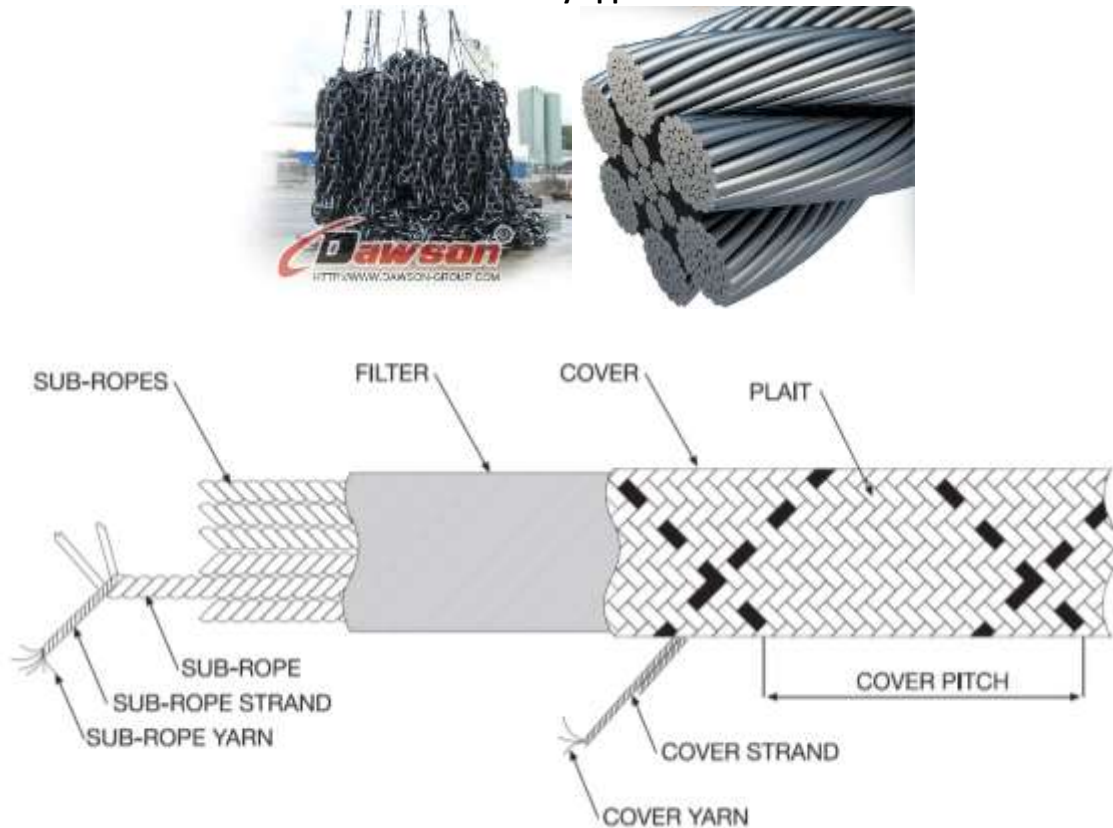

**Figure 10:** Examples of mooring components: (top left) [Dawson](#) stud link mooring chain, (top right) [Bridon](#) Diamond Blue wire rope and (bottom) [Bridon](#) Superline polyester rope.

Examples of commonly used mooring components are shown in Figure 10. Economic considerations for typical components are reported in the EquiMar deliverable *D7.3.2 Consideration of the cost implications for mooring MEC devices* [8]. Although these components provide bending flexibility along their length, the axial stiffness of steel components is considerably higher than alternative materials (Table 8). Ropes constructed from synthetic materials such as polyester, aramid, nylon and high-modulus polyethylene have been used successfully for the last two decades in the offshore industry for vessel mooring, towing and equipment station-keeping. One of the most common rope types is parallel stranded polyester as illustrated in Figure 10. Extensive testing regimes conducted as part of Joint Industry

applicability of available and proposed offshore mooring and foundation technologies and design tools for array applications

Projects have been used to qualify the performance of synthetic fibre ropes and enabled the development of fatigue curves (e.g. [16,30]) which have been subsequently adopted by certification agencies.

Material	Density (g/cm <sup>3</sup> )	Melting /charring point (°C)	Moisture (%)	Modulus (N/tex, GPa)	Tenacity (mN/tex)	Strength (MPa)	Break extension (%)
Steel	7.85	1600	0	20, 160	330	2600	2 (yields)
HMPE	0.97	150	0	100, 100	3500	3400	3.5
Aramid	1.45	500	1-7	60, 90	2000	2900	3.5
Polyester	1.38	258	<1	11, 15	820	1130	12
Polypropylene	0.91	165	0	7, 6	620	560	20
Nylon 6	1.14	218	5	7, 8	840	960	20

**Table 8:** Selected properties of steel and several synthetic fibre materials. HMPE stands for high modulus polyethylene. Further information regarding these values (particularly for nylon) can be found in [29].

Fibre ropes have particular advantages compared to steel components, including low cost and mass (per unit length) and load-extension properties that can be harnessed to reduce peak loadings [30]. It is feasible that utilisation of these materials could reduce the cost of energy of MRE mooring systems. Unlike steel components, materials such as polyester, nylon and elastomers have non-linear load-extension properties [31] that are time-dependent [32]. Changes to the compliance of these materials are possible over the lifetime of the component and this should be factored into the design. For example, after manufacture the initial loading of certain synthetic ropes results in permanent extension (Figure 11) and this should be accounted for in the design of mooring systems. Through extensive research over the last 20 years, the fatigue, durability and stiffness of polyester is well understood. Nylon ropes which are 2-3 times more compliant than polyester, could be suitable for MRE mooring systems [30]. Recently completed and on-going research (see Appendix A1 and [32]) is being conducted to establish the long-term durability and stiffness properties

of nylon ropes in the context of the highly dynamic loading of MRE mooring systems. As part of a maintenance plan, component inspection should be carried out (e.g. DNV-RP-E304 *Damage Assessment of Fibre Ropes for Offshore Mooring* [33] and [34]). Relevant procedures for the design and usage of mooring system components include DNV-OS-E301 *Position Mooring* [12], API Recommended Practice 2SM [35] for synthetic ropes, DNV-OS-E302 *Offshore Mooring Chain* [36], DNV-OS-E304 *Offshore Mooring Steel Wire Ropes* [37]. Further guidance documents are listed in Appendices B1 and B2.

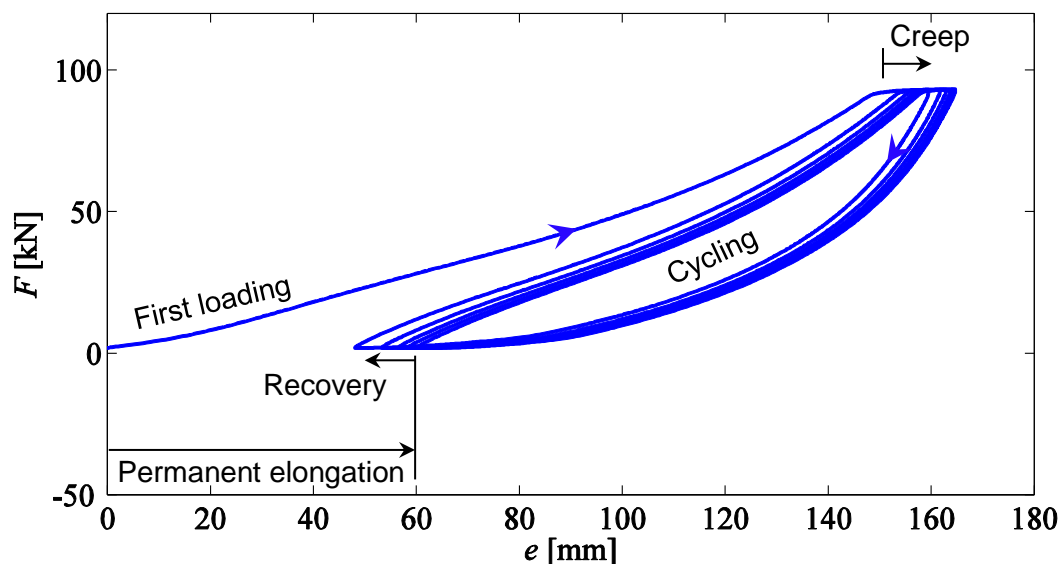

**Figure 11:** Load-extension behaviour of a new nylon mooring rope sample subjected to 10 cycles of bedding-in (tests reported in [32]). Stages of rope behaviour are labelled

### 3.2. Foundations

MRE foundation systems can be categorised in several ways, such as whether they are temporary (or easily removable) or permanent (requiring significant effort to remove). The relative advantages and disadvantages of each type are listed in Tables 9a and 9b. An alternative classification is if they form part of a support



structure, with pile foundations, gravity based structures and suction piles fitting into this category. Foundations can also provide a means of attachment between the seabed and mooring line(s). The main types of foundation are illustrated schematically in Figure 12.

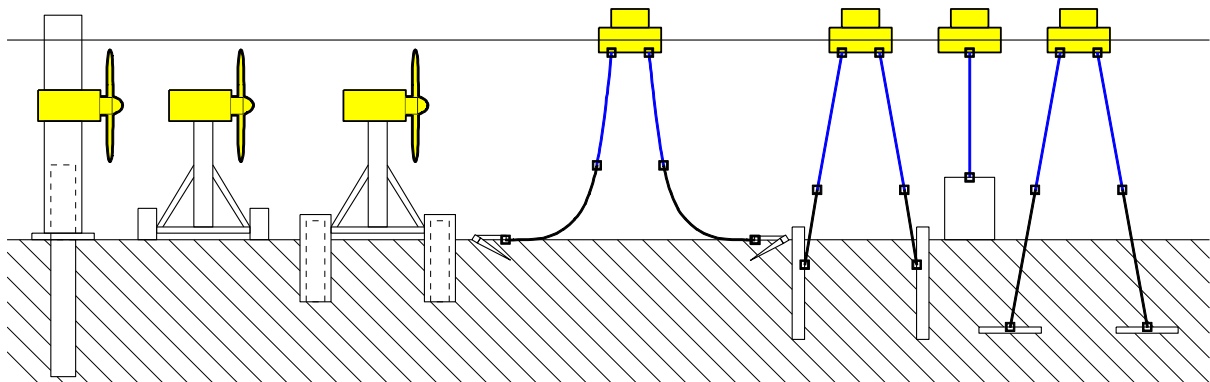

**Figure 12:** Schematic of possible foundation arrangements for MRE devices: (from left) piled foundation, gravity based structure, suction pile or caisson and several anchor types (fluke, pin pile, gravity and plate).

*Piled foundations* comprise singular (monopile) or multiple steel tubes or rods which are driven or hammered into the seabed after site preparation (such as clearing). Jack-up barges are commonly used for this type of installation. An alternative procedure is to use pre-fabricated concrete monopiles. These piles are hollow into which drilling machinery is placed, thereby allowing simultaneous drilling and installation. At certain sites (e.g. Barrow offshore wind farm) the gap between the pile and surrounding rock is filled with grout. For sites with high sediment transport, scour protection measures are also installed in order to retain foundation integrity. For wind turbine structures, the supporting tower is joined to a transition piece which is grouted onto the pile.



**Figure 13:** Piled foundation examples (*left*) [MCT](#) Seaflow monopile foundation system and (*right*) [OpenHydro](#) piled foundation system

Type	Advantages	Disadvantages
Piled	<ol style="list-style-type: none"> <li>1) Enables high axial loads to be transmitted through sediments to load bearing rock or soils</li> <li>2) Can be installed in a wide range of seabed types</li> <li>3) Well-established, simple technology</li> </ol>	<ol style="list-style-type: none"> <li>1) Requires considerable equipment, expertise and time for installation. Installation costs are therefore high</li> <li>2) Full decommissioning not possible</li> <li>3) Scour protection measures may be required</li> <li>4) Not suitable for deep water locations (+30m depth)</li> <li>5) Installation noise</li> </ol>
Gravity based structures	<ol style="list-style-type: none"> <li>1) Simple installation/recovery procedures are possible (i.e. float-out to site and lower to seabed). Installation costs tend to be low</li> <li>2) Suitable for rock and thin sediment sites</li> <li>3) Provides a stable structure for direct attachment of device</li> </ol>	<ol style="list-style-type: none"> <li>1) Lateral load resistance low compared to other foundation types and dependent on the seabed slope</li> <li>2) Size limited by transportation and lifting equipment</li> <li>3) May require the installation of pin piles</li> <li>4) Construction costs are high</li> </ol>
Suction piles or caissons	<ol style="list-style-type: none"> <li>1) Inexpensive installation (float-out may be feasible)</li> <li>2) Easy to remove and possibility of re-use</li> <li>3) Applicable for a wide range of water depths</li> <li>4) Noise during installation low compared to piling</li> </ol>	<ol style="list-style-type: none"> <li>1) Holding capacity in layered seabed types is unclear</li> <li>2) Construction costs may be high</li> <li>3) Large capacity lifting equipment may be required</li> <li>4) Detailed site data required</li> </ol>

**Table 9a:** Features of common foundation types

applicability of available and proposed offshore mooring and foundation technologies and design tools for array applications

Type		Advantages	Disadvantages
Anchors:	Fluke	<ul style="list-style-type: none"> <li>1) Well-established technology; a wide range of sizes and types are available</li> <li>2) High holding capacities are possible</li> <li>3) Can re-set in the event of pull-out</li> <li>4) Relatively easy to recover</li> </ul>	<ul style="list-style-type: none"> <li>1) Not suitable for vertical loading and only suitable for certain seabed types</li> <li>2) Holding capacity dependent on seabed continuity (e.g. scour may cause breakout)</li> <li>3) Requires significant mooring footprint</li> <li>4) Possibility of dragging and subsequent unequal mooring system loading</li> <li>5) Possibility of inaccurate placement during anchor setting</li> </ul>
	Plate/ Vertical load anchor (VLA)	<ul style="list-style-type: none"> <li>1) High capacity for resisting vertical and lateral loads</li> <li>2) Possibility of anchor dragging eliminated</li> <li>3) High holding-capacity-to-weight ratio than other anchor types</li> <li>4) Relatively lightweight for handling</li> <li>5) Accurate placement possible, no anchor setting required</li> </ul>	<ul style="list-style-type: none"> <li>1) Soil properties required for critical moorings</li> <li>2) Recovery not possible</li> <li>3) May be subject to fatigue or abrasion</li> <li>4) Installation limitations with water depth (i.e. for hammer-driven, screw and vibration operations)</li> </ul>
	Pile	<ul style="list-style-type: none"> <li>1) High vertical lateral loading capacities possible</li> <li>2) Anchor dragging and setting not required</li> <li>3) Enables small mooring footprint</li> <li>4) Attachment point can be at seabed level</li> </ul>	<ul style="list-style-type: none"> <li>1) Requires special equipment to install and recover</li> <li>2) High quality site data is required</li> <li>3) Has zero holding capacity once pull-out starts to occur</li> </ul>
	Gravity	<ul style="list-style-type: none"> <li>1) Suitable for rock and thin sediment sites</li> <li>2) Vertical force component can be large</li> <li>3) Construction materials are usually economical and readily available</li> <li>4) Can be used as a sinker in combination with drag embedment anchors</li> </ul>	<ul style="list-style-type: none"> <li>1) Size limited by transportation and lifting equipment</li> <li>2) Lateral load resistance low compared to other anchor types and dependent on seabed slope</li> <li>3) Can be an obstruction in shallow waters</li> </ul>

**Table 9b:** Features of common anchor types

applicability of available and proposed offshore mooring and foundation technologies and design tools for array applications

Since the first large scale deployments of wind turbines, the design of piles and transition pieces has been modified after issues were detected on the Horns Rev 1 array in 2009. As a result, a DNV joint industry project in 2010 established a method to improve axial load calculations. The Marine Current Turbine *Seaflow* system in Strangford Narrows uses a steel monopile foundation of a similar scale (2.1m diameter) to offshore wind turbine developments (diameters typically ranging between 3.5-6.0m) to support two turbines (Figure 13). The first OpenHydro deployment at the European Marine Energy Centre (EMEC) used two smaller diameter piles to support a frame structure.



**Figure 14:** Pin pile foundation configurations (*left*) Alstom/TGL 1MW turbine (image source: [38]) and (*right*) [Lifting](#) of the MCT *SeaGen* quadrapod foundation

*Gravity Based Structures* rely on the vertical forces imparted on the seabed due to the mass of the structure (Figure 14). The rationale for this design is ease of installation and recovery, usually requiring no driving or grouting operations. The second generation of OpenHydro turbines utilise a custom-made *Tryskell* installation barge to float the structure out to the site and lower it to the seabed. The Atlantis *AK1000™* tidal turbine was installed at EMEC using a similar approach (Figure 15). Steel pin piles (1m diameter) have also been used to restrain steel jacket structures for platforms, offshore wind turbines and MRE devices. A quadrapod, pinned foundation was developed for the *SeaGen* system due to a lack of jack-up installation barges (Figure 14).

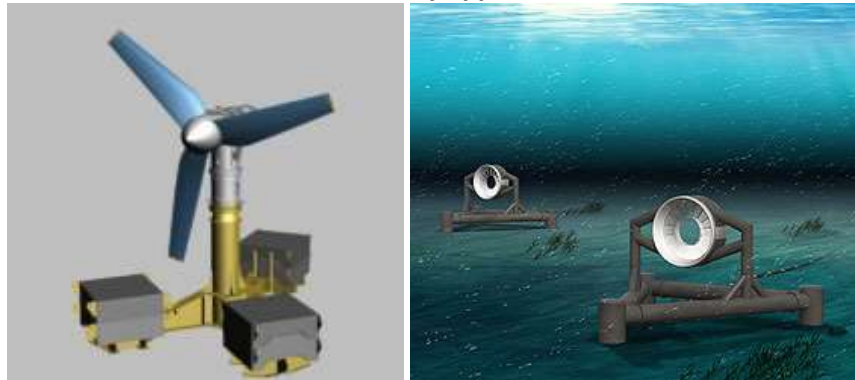

**Figure 15:** Tidal turbine gravity base foundations (*left*) Atlantis AK1000™ (image source: [38]) and (*right*) an array of [OpenHydro](#) turbines

*Suction piles or caissons* have been used extensively as foundations for GBS, TLP and jacket structures (e.g. the Draupner oil platform) in locations with sediment. The upturned bucket-like structure of a suction pile is imbedded into the sediment either through external force or by pumping water out of the inside of the pile, with design guidance in the DNV guideline DNV-RP-E303 *Geotechnical design and installation of suction anchors in clay* [39]. Three types of system exist; *active* systems (reliant on continuous pumping), *sealed top* (the negative pressure inside the pile resists pull-out) and *open top* (which is reliant on the contact friction of the surrounding sediment). As far as the authors are aware, this type of foundation has not yet been attempted for MRE devices.

There is a diverse range of *anchor* technologies which are available (Table 10) and the selection is largely dependent on the seabed conditions as well as the required holding capacity and load direction. The holding capacity of conventional fluke anchors (e.g. [Danforth](#), [Bruce anchors](#), [Vryhof Stevpris](#)) is dependent on anchor weight, fluke area, embedment depth and seabed soil type (usually medium to firm soils), see Appendix A2. Although readily deployable and recoverable, they are not capable of vertical loading (the Danforth type in Figure 16 has a maximum loading angle of 30° from the horizontal).



**applicability of available and proposed offshore mooring and foundation technologies and design tools for array applications**

<b>Anchor Type</b>	<b>Operation</b>	<b>Applications</b>	<b>Installation</b>	<b>Example Procedures</b>
<b>Fluke</b>	Flukes of anchor are buried in the sediment  Designed for horizontal loads (or very shallow angles)	Catenary moorings with 'rider' or ground chains in sediment locations	Propellant/explosive embedment  Drag embedment	DNV-RP-E301: Design and installation of fluke anchors in clay [40]
<b>Plate/ Vertical load anchor (VLA)</b>	Plate is buried deep in sediment and capable of holding vertical and horizontal loads	Sediment locations	Propellant/explosive embedment  Suction embedment plate anchor ( <a href="#">SEPLA</a> by InterMoor)  Self-embedment (OMNI-Max)	DNV-RP-E302: Design and installation of plate anchors in clay [41]
<b>Pile</b>	Steel members driven into sediment and rock after drilling. Grouting may be applied as with monopiles	Sediment/rock locations	Pin  Screw  Jetting	API RP 2A-WSD R2010 Planning, Designing and Constructing Fixed Offshore Platforms – Working Stress Design [42]
<b>Gravity</b>	'Dead' weight with large holding capacity	Sediment/rock locations	Lowered into position	DNV-OS-J103 Design of Floating Wind Turbine Structures [15]

**Table 10:** Anchor design, installation and operational aspects

In the case of a vertical load being applied and the entire mooring line is lifted, dislodgement of the anchor may occur leading to partial (or total in the case of single line systems) loss of the mooring system. Pile anchors provide lateral and vertical holding capacity, the magnitude of which is dependent on pile diameter and soil strength (typically for firm or hard soil types). They are used as a connection point for tension leg platform (TLP) tendons and installation often requires the use of a drilling rig or template. Piles can either be driven or screwed into screw or rock. Gravity

anchors, as with GBS systems are reliant on the mass of anchor (usually made from concrete or rock and/or steel), as well as properties of the soil (friction and shear strength) for lateral loading. Clump weight anchors fit into this category.



**Figure 16:** Anchor examples (*left*) 1.1 Tonne Danforth fluke anchor prior to deployment with the South West Mooring Test Facility (SWMTF, [43]), (*right*) vertically loaded [Delmar](#) OMNI-Max anchor

### 3.3. Arrays

In order to share infrastructure and also to take advantage of the influence of hydrodynamic interactions on power production [44,45], close separation distances between MRE devices positioned in arrays (tens of metres) have been proposed. The close proximity between devices means that particular considerations must be made regarding the siting of devices as well as the design of mooring, electrical and hydraulic infrastructure (e.g. Figure 18). One such factor is the permitted level of mooring system compliance. This is an important consideration to reduce the risk of mooring line entanglement and device collisions and to allow suitable clearances between the devices for vessel access during installation, maintenance and decommissioning procedures. The separation distance specified in the DNV-OS-E301 *Position Mooring* guidelines [12] between offshore accommodation units and fixed equipment is necessarily large for the application, but not relevant for MRE devices which are typically unmanned during operation. An alternative and arguably more suitable approach suggested in the DNV-OS-J103 *Design of Floating Wind*

applicability of available and proposed offshore mooring and foundation technologies and design tools for array applications

*Turbine Structures* guideline [15] is to base the separation distance on maximum possible surge or sway displacements during normal operation and if the failure of one mooring line occurs (assuming that the mooring system has built-in redundancy).

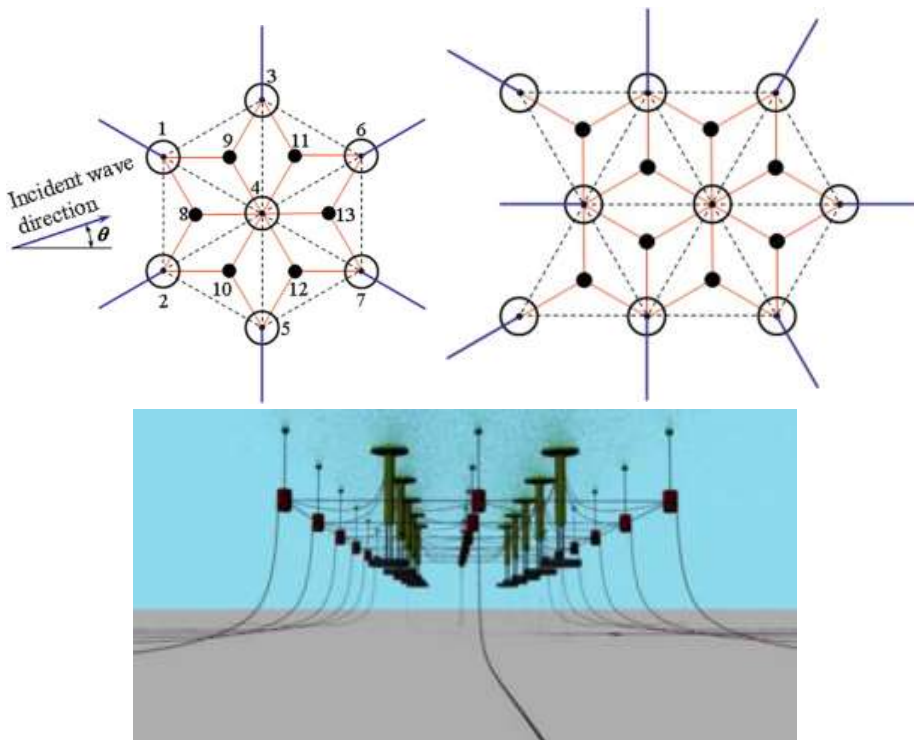

**Figure 17:** Schematic of proposed array layouts comprising (*top left*) seven and (*top right*) nine buoys with interconnecting lines (red) and shared connection points (black dots) [21]. (*bottom*) Wave energy array with *Karratu* mooring system [47]

Shared mooring system infrastructure (i.e. common anchoring points and/or device interconnections) have been suggested as a way of reducing capital costs and to reduce the number and difficulty of installation/decommissioning operations for MRE devices (Figure 17 and [46-49]). Such benefits are clearly scalable to large MRE arrays. This concept is not entirely new, with array-type moorings and shared anchor points used for aquaculture systems. With the exception of MRE devices attached to a common structure (e.g. Wave Star Energy's *Wave Star* system and MCT *SeaGen*), no arrays have been deployed comprising shared mooring or anchoring systems.



**applicability of available and proposed offshore mooring and foundation technologies and design tools for array applications**

However, proposed designs include the *Karratu* (meaning 'square' in Basque) system developed by Tecnalia [47]. This concept comprises a network of ropes and cables arranged in square cells the vertices of which are supported by buoys. This network, sitting 5-10m below the water surface is catenary moored to the seabed and provides an intermediate mooring system for point absorbers positioned within the cells.

#### 4. Design Tools

Numerical models provide designers and operators a platform to simulate the conditions of an offshore situation without having to carry out difficult and expensive operations. In terms of mooring and foundation systems it is essential to undertake modelling of the system in order to understand how it will react before it is deployed and to ensure that the best design is used. With a numerical model, conditions which would be unrealistic to test using laboratory methods (for example testing how a particular mooring system would react to a 100 year storm) can be simulated in a fast and cost effective way.

There are many commercially available tools on the market each with different capabilities, requirements and costs. From simple programmes which can model just one part of a system right up to CFD simulations of arrays of devices. Many models can be run using standard personal computer equipment however greater computing power such as computer clusters is often required for more complex models. For the most demanding models and CFD supercomputers may be needed to run the simulations.

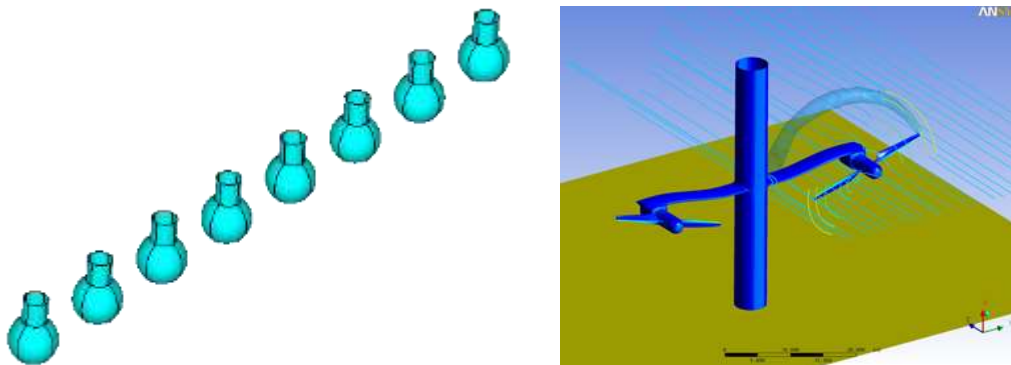

**Figure 18:** Example design tool applications (*left*) Array of eight buoys constructed with [WAMIT](#) software and (*right*) CFD simulation of a tidal turbine using [Ansys](#)

Mooring and foundation numerical tools designed for the shipping, oil and gas and offshore construction industries have many qualities that can be used in the modelling of MRE devices.

## 4.1. Moorings

It is possible to conduct detailed analysis of moored offshore structures using several commercial available tools. The body of the structure, mooring lines, risers and other components can be modelled and the simulations can be run to conduct static, quasi-static or dynamic analysis of a system. The hydrostatic responses and hydrodynamic interactions of multiple devices can be simulated by software such as *WAMIT*, *AQWA*, *WADAM* and *Seasam HydroD*. This software cannot directly simulate mooring or power take-off systems. Analysis of the mooring lines, chains and components can be done by software including: *Orcaflex*, *Optimoor*, *Deeplines*, *DIODORE*, *ARIANE7*, *Sesam DeepC* and *AQWA Suite*.

Some common features found with the linear analysis and mooring analysis tools include:

- Boundary Element Modelling solutions
- Hydrostatic modelling of a variety of bodies
- Diffraction and radiation of single or multiple bodies
- Frequency domain solutions of linear or non-linear responses
- Time domain solutions of linear or non-linear responses
- Hydrodynamics of bodies
- Simulation of mooring system
- Static analysis of mooring system
- Quasi-static and dynamic simulations of mooring system (taut and catenary)
- Simulation of DP vessels
- Finite Element Method models with 3 or 6 DoF.

Although widely used in the design of offshore equipment, it is not possible to model all of the distinct features of MRE devices using existing mooring system software. Qualities such as power take-off systems are not covered by the majority of currently available tools. 'Wave-to-Wire' models such as *WaveDyn* by GL-Garrad Hassan and

**applicability of available and proposed offshore mooring and foundation technologies and design tools for array applications**

*ACHIL-3D* by Ecole Centrale de Nantes have been developed to simulate the dynamic response of WECs. *WaveDyn* is designed to be standard software tool for the design of WECs, it is loaded with modules to model the hydrodynamics of WEC devices, the power-take-off, the structural dynamics and the mooring system. It has been subjected to validation studies specifically for WECs (e.g. [50]).

*Orcaflex* (latest version: 9.7) is a widely used software package for a number of modelling applications [51]. It can be used to undertake time domain analysis of different types of mooring systems, vessel objects and buoy objects. Software packages such as the latest release of *Orcaflex* are capable of accounting for the spatial variability of device of hydrodynamic interactions across devices arrays, hydrodynamic parameters are used based on array BEM simulations, hydrostatic and potential theory loads are calculated from diffraction/radiation programs (e.g. *WAMIT*) and then fed into *Orcaflex* for analysis. In terms of mooring system design such interactions should definitely be accounted for because device displacements and mooring loads are likely to differ from individual devices. Also a plug in module to account for power take-off could potentially be used with this.

Marintek have developed a number of tools which can undertake detailed analysis of offshore vessels, structures and buoys:

- **Simo**: is wave-induced analysis in time domain accounting the retardations based on a Boundary Element Method (BEM).
- **Riflex**: For time domain analysis of mooring lines, risers and umbilical lines.
- **Simo-Riflex**: Can do time domain analysis of coupled floating bodies, including floating and fixed wind turbines, tidal turbines and WECs.
- **SIMA**: is the new commercial version of the MARINTEK software including Simo-Riflex.
- **Mimosa**: is for mooring lines. It can calculate wave-frequency, low-frequency motions and tensions.

applicability of available and proposed offshore mooring and foundation technologies and design tools for array applications

Simo, Riflex and Mimosa are also available as part of DNV's Sesam DeepC package which, similar to Orcaflex and AQWA, can carry out time domain coupled analysis of moored structures as well as fixed bodies.

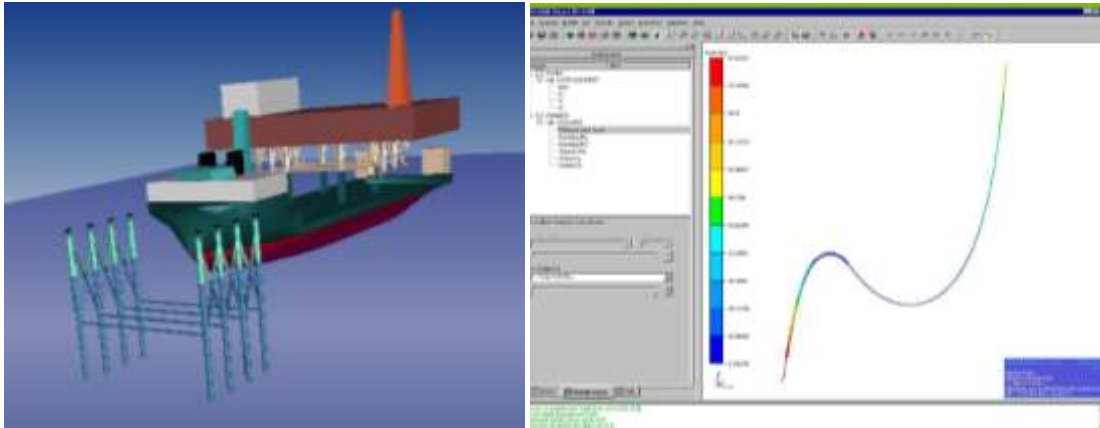

**Figure 19:** Vessel and structure modelled in Simo (*left*), screenshot showing analysis of flexible object with Riflex (*right*)

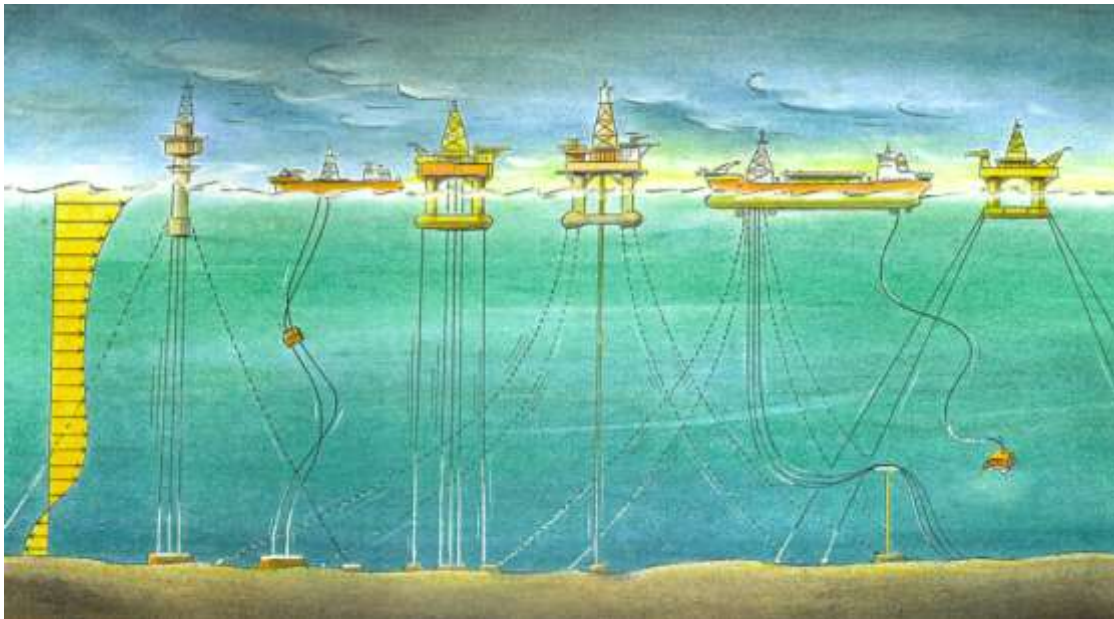

**Figure 20:** Examples of risers and moorings that can be modelled with Riflex/Mimosa.

**applicability of available and proposed offshore mooring and foundation technologies and design tools for array applications**

Some of the tools listed in Appendix C are stand-alone and can calculate the dynamic response of a moored body based on its physical attributes (geometry, dimensions, mass, inertia etc.), mooring system, site characteristics and environmental conditions. Other software requires hydrodynamic parameters to be specified in order to function (e.g. Table 11). Hydrodynamic parameters can be quantified by physical testing and/or using numerical codes based on potential theory (e.g. Table 12).

Contact parameters	Body/vessel motion characteristics
Mooring line geometry	Environmental loading
Mooring line component properties	Site characteristics

**Table 11:** Input parameters typically required by mooring system software

Potential theory codes are used to solve the velocity potential around a defined geometry caused by the radiation and diffraction of an incident wave-field. Boundary element methods (BEMs) are used to integrate the flow-field over the immersed surface of the geometry. In this approach it is assumed that the fluid is ideal (inviscid, incompressible and irrotational) and that the first and second order linear wave forces resulting from small amplitude waves lead to small device motions. Hence the variation of calculated hydrodynamic parameters with varying device position (i.e. draft) is not accounted for. Commercially available tools include: *WAMIT*, *AQUAPLUS*, *AQUADYN*, *HYDROSTAR*, *AQWA Diffraction* and *DIFFRAC*.

Excitation forces and phases (1 <sup>st</sup> and 2 <sup>nd</sup> order)	Added mass coefficients
Mean drift forces and moments	Radiation damping coefficients
Response amplitude operators	Pressure and fluid velocities

**Table 12:** Typical frequency dependent hydrodynamic parameters calculated by potential theory codes

These parameters are frequency dependent and can be used to solve the equation of motion in the frequency domain, provided the incident waves are harmonic. In order to account for irregular waves superposition is used. It is possible to include a



**applicability of available and proposed offshore mooring and foundation technologies and design tools for array applications**

basic representation of the mooring system in some potential theory codes (i.e. with a user-defined stiffness matrix).

Time domain analysis is necessary for non-linear system responses, where the equation of motion is solved at each time step. This allows coupled analysis to be carried out where one or more sub-systems are non-linear (i.e. PTO, mooring system and the performance of devices in arrays). The responses of the bodies that are modelled by software such as *Orcaflex* are the result of boundary element methods and as such this method may not provide accurate response predictions for large and non-linear or resonant motions within an array.

More complex hydrodynamics, wave breaking, sloshing, run-up, non-linear storm waves, large amplitudes (i.e. resonant responses, viscous effects due to large velocities) require advanced methods as the flow is no longer irrotational. Viscous effects can either be accounted for in linear models (i.e. the addition of viscous drag or damping using the Morison equation, or non-linear Froude-Krylov forces on the instantaneous immersed surface) or using CFD to solve the Reynolds-Average Navier-Stokes (RANS) equation. Smoothed particle hydrodynamics (SPH) is a relatively new application of CFD which is a mesh-free method of modelling the flow by dividing the fluid into discrete particles [52]. This enables the prediction of variables such as velocity, direction of flow, pressure and energy and can be used to model fluids in complex situations where traditional grid-based CFD simulations cannot.



Standard	Year	Issuing Organisation
Marine energy – Wave, tidal and other water current converters - Part 10: The assessment of mooring system for marine energy converters (MECs)	2003	IEC
Position Mooring: DNV-OS-E301	2010	DNV
Environmental Conditions and Environmental Loads: DNV-RP-C205	2010	DNV
Design of Floating Wind Turbine Structures: DNV-OS-J103	2013	DNV
Certification of Tidal and Wave Energy Converters: DNV-OSS-213	2012	DNV
Guidelines on design and operation of wave energy converters	2005	DNV/Carbon Trust
Classification of Mooring Systems for Permanent Offshore Units. NR 493 DT R02 E	2012	Bureau Veritas
Rules for the Classification of Offshore Loading and Offloading Buoys NR 494 DT R02 E	2006	Bureau Veritas
Petroleum and natural gas industries -- Specific requirements for offshore structures -- Part 7: Station keeping systems for floating offshore structures and mobile offshore units: ISO19901-7:2013	2013	ISO

**Table 13:** Existing Guidelines which may be relevant to mooring systems of MRE devices

There are a number of standards and guidelines issued by various classification and standards bodies which apply significantly to the design of marine renewable energy devices, listed in Table 13 are some of the legislation which is most relevant to the modelling of mooring systems for MRE devices. Relevant design areas for design certification purposes are listed in Table 14. A more complete list of standards is attached in Appendices B1 and B2.

<ul style="list-style-type: none"> <li>• Line and anchor pattern</li> <li>• Type and weight and dimension of all line segments</li> <li>• Characteristic line strength</li> <li>• Anchor type, size, weight and material specification</li> <li>• Arrangement of fairleads and anchor points/pretensions</li> <li>• Position and weight of buoyancy elements and weight elements</li> </ul>	<ul style="list-style-type: none"> <li>• Position and weight of buoyancy elements and weight elements</li> <li>• Windlass, winch and stopper design</li> <li>• Mooring line tensions in ULS and ALS limit states</li> <li>• Fatigue calculations of mooring line segments and accessories</li> <li>• Strength calculations of anchors, windlass components and fairleads</li> <li>• Corrosion allowance.</li> </ul>
---	---

**Table 14:** Design areas which would be typically documented for design certification according to the DNV-OSS-213 *Certification of Tidal and Wave Energy Converters* guidelines [17]

#### 4.2. Anchors and Foundations

There are a number of general geotechnical software packages available commercially. There are designed to undertake 2-dimensional or 3-dimensional analysis of geotechnical structures. Some common features include:

- Finite Element Analysis based models of structures and surroundings
- Geometry of structures, soils, fluids and materials,
- Intersections and meshing of structures,
- Multiple layers of different soils/materials
- Cyclic loading analysis
- Linear and non-linear elasticity
- Stress and strain analysis

Standardised anchor selection tools do not appear to exist, instead it is based on experience and the soil specification at the site (i.e. which is obtain from samples collected at the required depth; costs are associated with this and data is often not in the public domain).

applicability of available and proposed offshore mooring and foundation technologies and design tools for array applications

Efforts were made to develop an anchor penetration tool to determine holding capacity, this was in the form of a joint industry project that was a continuation of the DIGIN program developed by DNV however due to reliability issues, not all of the data has been released to users.

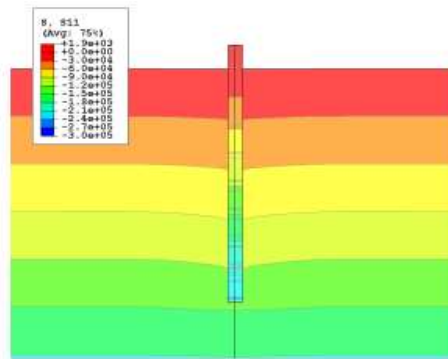

**Figure 21:** [Example of ABAQUS](#). This shows radial pressure following the insertion of a pile.

Foundation tools are mainly based around Finite Element Analysis (FEA) although some models, particularly those undertaking slope stability analyses, use Limit Equilibrium Analysis (e.g. *SLIDE*, *SLOPE/W*). FEA generates a mesh over a domain and breaks it down in to a number of smaller elements. It can be used to model the solution to a complex problem (for example installing a pile in a multi-layer seabed). Some of the commercially available software packages that can undertake geotechnical analysis are:

**ABAQUS:** This has been used widely for geotechnical analysis for a range of foundation technologies, including Gravity Based Structures [53], piled foundations [54] and suction caissons. It is able to analyse a model in both the time and frequency domain. There is the *ABAQUS/AQUA* module designed for offshore applications. It includes features for jackets and risers, bottom bending structures and floating objects. Structures can be subjected to drag, buoyancy and fluid forces. Wind effects can also be simulated.

**Plaxis 2D** and **Plaxis 3D** is able to model the linear and non-linear time dependent behaviour of soils. It is designed to deal with hydrostatic pressures within the soil. It is equipped with features to simulate the interactions of structures and the soils. A dynamics module is available to deal the propagation of waves through the soil and their influence on structures; this includes seismic loading and vibrations. Example foundation simulation (referred to as a ‘suction anchor’) in soft clay [55]

The **D-Pile** software suite is specifically designed to undertake 3D modelling of single or group piles. There are modules to account for elastic soil behaviour and cap interaction, although interactions between piles are not accounted for. Also available is the online service *Citrix* which allows the modelling parameters to be uploaded online and the simulations to be run on the powerful computing equipment on the central server. The results are then returned to customer via the website.

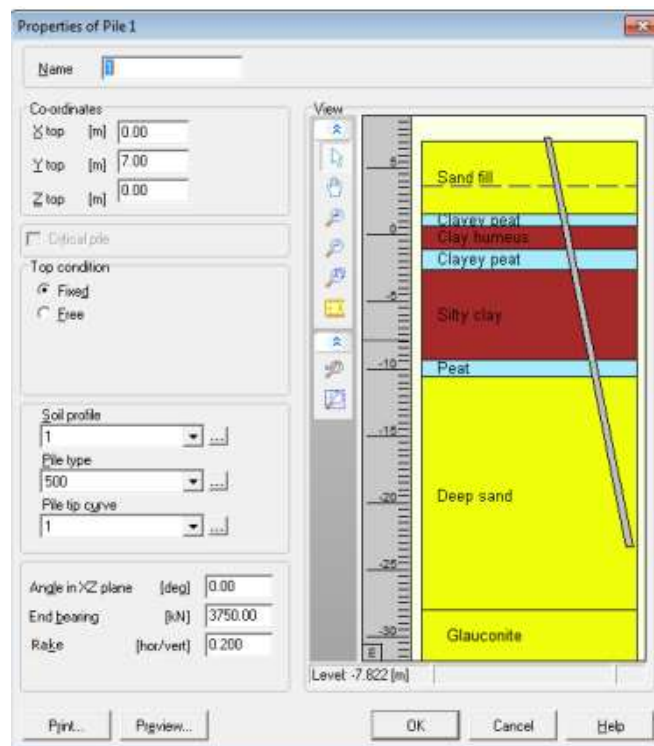

**Figure 22:** [Screenshot of Pile-D](#) software showing properties of a pile installed within a mixed material soil

**Slope/W** is a tool designed for analysing slope stability analysis. It is capable of modelling many stability scenarios including, natural rock slopes, fixings on slopes, earthquake and seismic loading.

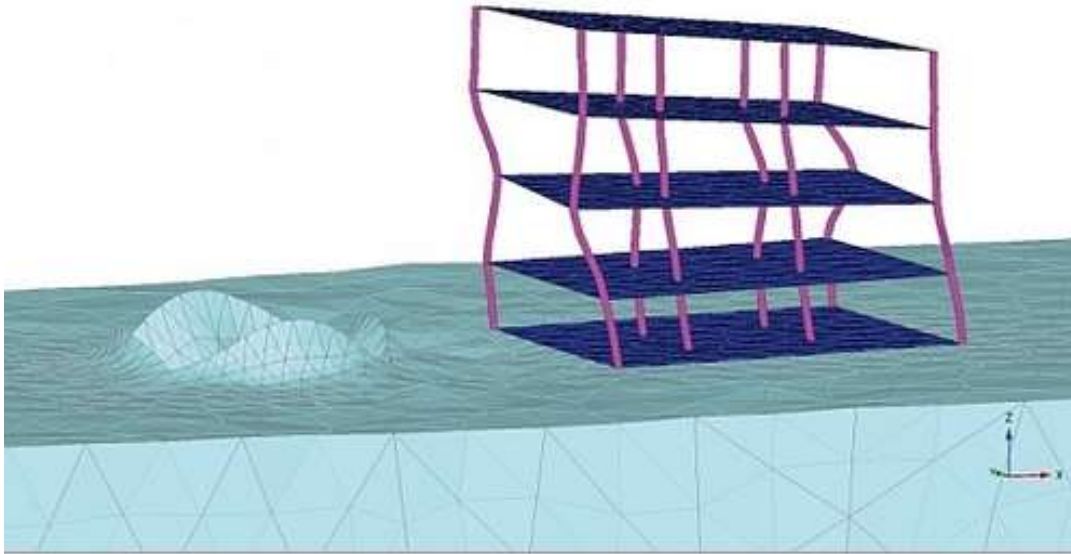

**Figure X:** [Dynamic effect on a structure](#), modelled on Plaxis3D

**LimitstateGeo:** This is also a stability analysis tool. It uses Discontinuity Layout Optimisation (DLO) as opposed to FEM and is therefore able to model collapses/failures directly without the need to iterate.

**STA Pile3:** A tool for the design and analysis of pile anchors. It can be used for suction embedding calculations and for capacity analysis of pile anchors.

Other software includes *BIFURC-3D* and *HVMCap* which are produced by the Norwegian Geotechnical Institute and have many similar capabilities as ABAQUS and Plaxis. Further information regarding this software can be found in Appendix C.



**applicability of available and proposed offshore mooring and foundation technologies and design tools for array applications**

Standards and guidelines that all geotechnical design tools will need to follow include:

- Piles API RP 2SK, Appendix E
- Shallow foundations API RP 2A, Section 6
- Anchors API RP 2SK, Appendix D



## 5. Summary

It has been the purpose of this report to provide an overview of several key aspects of MRE mooring and foundation design including; mooring and foundation technologies and the assessment criteria used in the design making process of mooring and foundation system design. The state-of-the-art numerical tools and guidance from certification agencies which are used for design and analysis of mooring and foundation systems have been summarised. The transferability of existing approaches to offshore structure design is questionable for MRE devices and more relevant guidance is required that can account for the particularities of MRE arrays (i.e. hydrodynamic interactions). This work is in progress, with certification agencies such as Det Norske Veritas and International Electrotechnical Commission at the forefront of guideline development in this field, for example the forthcoming IEC/TC 114 *Marine energy - Wave, tidal and other water current converters - Part 10: The assessment of mooring system for marine energy converters (MECs) guidelines*.

Several software packages have been examined within the fields of linear analysis, mooring system analysis and geotechnical analysis. The majority of modelling tools available have been designed for the shipping or oil and gas industries and how well they can be applied to MRE devices is a challenge for designers. Some software, however, is now being produced specifically for the wave and tidal energy sector. There appears to be a lack of software tools in the area of anchor selection. Geotechnical tools are available to simulate foundations; there is no reason that this also can be applied to the installation of tidal turbines and other MRE devices.



## 6. References

- [1] Harris, R.E., Johanning, L. and Wolfram, J. (2004) Mooring systems for wave energy converters: A review of design issues and choices. Proceedings of the 3<sup>rd</sup> International Conference on Marine Renewable Energy, Blyth, UK
- [2] Vaitkunaite, E., Ibsen, L.B., Nielsen, B.N. and Molina, S.D. (2013) Comparison of Foundation Systems for Wave Energy Converters Wavestar. Proceedings of the 10<sup>th</sup> European Wave and Tidal Energy Conference, Aalborg, Denmark
- [3] ISSC Specialist Committee V.4 (2009) Ocean, Wind and Wave Energy Utilization. Proceedings of the 17<sup>th</sup> International Ship and Offshore Structures Congress. Seoul, Korea
- [4] Low Carbon Innovation Coordination Group (2012) Technology Innovation Needs Assessment (TINA): Marine Energy Summary Report
- [5] SIOCEAN (2013) Ocean Energy: Cost of Energy and Cost Reduction Opportunities
- [6] Maisondieu, C., Johanning, L. and Weller, S. (2013) Best practice report - installation procedures. Deliverable 3.6.2 of the MERiFIC report.
- [7] Walker, R.T., van Nieukoop-McCall, J., Johanning, L. and Parkinson, R.J. (2013) Calculating weather windows: Application to transit, installation and the implications on deployment success. *Ocean Engineering*, 68, pp. 88-101
- [8] EquiMar (2011) Equitable testing and evaluation of marine energy extraction devices in terms of performance, cost and environmental impact
- [9] Department of Energy and Climate Change (2011) Decommissioning of offshore renewable energy installations under the Energy Act 2004
- [10] JP Kenny (2010) Wave Hub Decommissioning Programme
- [11] American Petroleum Institute (1996) API RP 2SK: *Recommended Practice for Design and Analysis of Stationkeeping Systems for Floating Structures*
- [12] Det Norske Veritas (2010) DNV-OS-E301: *Position Mooring*
- [13] Lloyds Register (2013) Rules and Regulations for the Classification of a Floating Offshore Installation at a Fixed Location

**applicability of available and proposed offshore mooring and foundation technologies and design tools for array applications**

- [14] Naval Facilities Engineering Command (2012) SP-2209-OCN *Handbook for Marine Geotechnical Engineering*
- [15] Det Norske Veritas (2013) DNV-OS-J103 *Design of Floating Wind Turbine Structures*
- [16] S.J. Banfield, N.F. Casey, R. Nataraja, (2005) Durability of Polyester Deepwater Mooring Rope. Proceedings of the 2005 Offshore Technology Conference, Houston, USA. OTC 17510
- [17] Det Norske Veritas (2008) DNV-OSS-312: *Certification of Tidal and Wave Energy Converters*
- [18] Paredes, G. M., Bergdahl, L., Palm, J., Eskilsson, C. and Pinto, F.T. (2013) Station keeping design for floating wave energy devices compared to offshore oil and gas platforms. Proceedings of the 10th European Wave and Tidal Energy Conference, Aalborg, Denmark
- [19] ABC News (2011) *Huge swells sinks wave energy converter* <http://www.abc.net.au/news/2010-05-17/huge-swell-sinks-wave-energy-generator/829282> (accessed online: 13/01/2014)
- [20] Christensen, L., Friis-Madsen, E. and Kofoed, J.P. (2005) The wave energy challenge. The Wave Dragon case. Proceedings of PowerGen 2005 Europe conference, Milan, Italy
- [21] Det Norske Veritas/Carbon Trust (2005) *Guidelines on design and operation of wave energy converters*
- [22] International Electrotechnical Commission (TBD) *TC114: Marine energy - Wave, tidal and other water current converters - Part 10: The assessment of mooring system for marine energy converters (MECs)*. In-progress
- [23] Karimirad, M. (2011) Stochastic Dynamic Response Analysis of Spar-Type Wind Turbines with Catenary or Taut Mooring Systems. PhD Thesis, Norwegian University of Science and Technology
- [24] Johanning, L. and Smith, G.H. and Wolfram, J. (2007) Measurements of static and dynamic mooring line damping and their importance for floating WEC devices. *Ocean Engineering* (2007), 1918-1934

**applicability of available and proposed offshore mooring and foundation technologies and design tools for array applications**

- [25] Fitzgerald, J. and Bergdahl, L. (2008) Including moorings in the assessment of a generic offshore wave energy converter: A frequency domain approach. *Marine Structures*, 23-46
- [26] Vicente, P.C., Falcão, A.F.O. and Justino, P.A.P. (2012) Nonlinear dynamics of a tightly moored point-absorber wave energy converter. *Ocean Engineering*, 59, pp. 20-36
- [27] Cozijn, J.L. and Bunnik, T.H.J. (2004) Coupled mooring analysis for a deep water CALM buoy. *Proceedings of the 23<sup>rd</sup> International Conference on Offshore Mechanics and Arctic Engineering*, Vancouver, Canada
- [28] Stallard, T.J., Weller, S.D. and Stansby, P.K. (2009) Limiting heave response of a wave energy device by draft adjustment with upper surface immersion. *Applied Ocean Research*, 31, (4), pp. 282–289
- [29] McKenna, H.A., Hearle, J.W.S. and O’Hear, N. (2004) *Handbook of Fibre Rope Technology*. Woodhead Publishing Limited
- [30] Ridge, I.M.L., Banfield, S.J. and Mackay, J. (2010). *Nylon Fibre Rope Moorings for Wave Energy Converters*. In *Proceedings of the OCEANS 2010 conference*, Seattle, USA
- [31] Flory, J.F., Banfield, S.J. and Petruska, D.J. (2004) Defining, Measuring, and Calculating the Properties of Fibre Rope Deepwater Mooring Lines. *Proceedings of the 2004 Offshore Technology Conference*, Houston, USA. OTC 16151
- [32] Weller S.D., Davies, P., Vickers, A.W. and Johanning, L. (TBD) *Synthetic Rope Responses in the Context of Load History: Operational Performance*. *In-Review*
- [33] Det Norske Veritas (2005) DNV-RP-E304 *Damage Assessment of Fibre Ropes for Offshore Mooring*
- [34] Noble Denton Europe Limited (2006) Floating production system JIP FPS mooring integrity. Research Report 444 prepared for the Health & Safety Executive
- [35] American Petroleum Institute (2007) API RP 2SM: *Recommended Practice for Design, Manufacture, Installation, and Maintenance of Synthetic Fiber Ropes for Offshore Mooring*
- [36] Det Norske Veritas (2008) DNV-OS-E302 *Offshore Mooring Chain*

**applicability of available and proposed offshore mooring and foundation technologies and design tools for array applications**

- [37] Det Norske Veritas (2009) DNV-OS-E304 *Offshore Mooring Steel Wire Ropes*
- [38] MeyGen Ltd (2011) MeyGen Phase 1 EIA Scoping Document <http://www.scotland.gov.uk/Resource/0043/00434044.pdf> (accessed online: 10/01/2014)
- [39] Det Norske Veritas (2012) DNV-RP-E301: *Geotechnical design and installation of suction anchors in clay*
- [40] Det Norske Veritas (2012) DNV-RP-E301: *Design and installation of fluke anchors in clay*
- [41] Det Norske Veritas (2002) DNV-RP-E302: *Design and installation of plate anchors in clay*
- [42] American Petroleum Institute (2010) API RP 2A-WSD R2010 *Planning, Designing and Constructing Fixed Offshore Platforms – Working Stress Design*
- [43] Johanning, L. Thies, P. and Smith, G. (2010) Component test facilities for marine renewable energy converters. Proceedings of the Marine Renewable and Offshore Wind Energy Conference, London, UK
- [44] Cruz, J., Sykes, R., Siddorn, P. and Taylor, R.E. (2010) Estimating the loads and energy yield of arrays of wave energy converters under realistic seas. IET Renewable Power Generation, 4, 6, pp. 488-497
- [45] Weller, S.D., Stallard, T.J. and Stansby, P.K. (2010) Experimental measurements of irregular wave interaction factors in closely spaced arrays. IET Renewable Power Generation, 4, 6, pp. 628-637
- [46] Vicente, P.C., Falcão, A.F.O., Gato, L.M.C. and Justino, P.A.P (2009) Dynamics of arrays of floating point-absorber wave energy converters with inter-body and bottom slackmooring connections. Applied Ocean Research, 31, (4), pp. 267–281
- [47] Ricci, P., Rico, A., Ruiz-Minguela, P., Boscolo, F. and Villate, J.L. (2012) Design, Modelling and Analysis of an Integrated Mooring System for Wave Energy Arrays. Proceedings of the 4th International Conference on Ocean Energy. Dublin, Ireland
- [48] Young, P.A. (2011) The Power of Many? Linked Wave Energy Point Absorbers. Master's thesis, University of Otago

**applicability of available and proposed offshore mooring and foundation technologies and design tools for array applications**

- [49] Draper, M. (2007) Mooring of arrays of buoy-like WECs. US Patent: US07886680. <http://www.google.com.tr/patents/US20070224895> (accessed online: 23/01/2014)
- [50] Goldsmith, J. (2012) Experience with Validating MHK Tools [http://www.nrel.gov/water/pdfs/mkh\\_workshop\\_jarrett\\_goldsmith.pdf](http://www.nrel.gov/water/pdfs/mkh_workshop_jarrett_goldsmith.pdf) (accessed online: 19/01/2014)
- [51] Orcina (2014) Orcaflex Documentation <http://orcina.com/SoftwareProducts/OrcaFlex/Documentation/index.php> (accessed online: 19/01/2014)
- [52] Omidvar, P., Stansby, P.K. and Rogers, B.D. (2012) SPH for 3D floating bodies using variable mass particle distribution. International Journal for Numerical Methods in Fluids, 72, 4, pp. 427-452
- [53] Andresen, L. Jostad, H.P., Andersen, K.H. and Skauk, K. (2008) Finite Element Analyses in Offshore Foundation Design. 12th International Conference of International Association for Computer Methods and Advances in Geomechanics
- [54] Zhan, Y-G., Wang, H. and Liu, F-U. (2012) Modeling Vertical Bearing Capacity of Pile Foundation by Using ABAQUS. The electronic journal of geotechnical engineering, Vol. 17
- [55] Edgers, L. et al. (2009) Capacity Analysis Of Suction Anchors In Clay By 3D. <http://kb.plaxis.nl/publications/capacity-analysis-suction-anchors-clay> (accessed online: 10/01/2014)



## **Appendix A1**

Recent MRE mooring and foundation Joint Industry Projects:

- A. Testing, qualification and commercialisation of advanced mooring system for wave & tidal arrays, study by Tension Technology, AWS, Bluewater, Bridon, Exeter University, Pelamis Vryhof, funded by Carbon Trust, January 2014.
- B. Synthetic fibre rope polymer lined fairleads, study by Tension Technology, Bridon, AWS and Bluewater, funded by Technology Strategy Board, Marine Energy Grant number 19116-141146, March 2013.
- C. Mooring systems, anchors and intermediate components (MOSAIC), study by Tension Technology, AWS, Ocean Power Technologies, Bridon, Promoor, Ecosea, funded by Carbon Trust, November 2007.
- D. Moorings and anchors for wave energy devices study by Tension Technology, AWS, Bridon, Promoor, Tencate, SSE Renewables and University of Exeter funded by Carbon Trust, January 2010



**Appendix A2**

**Stevin Mk3 UHC chart**

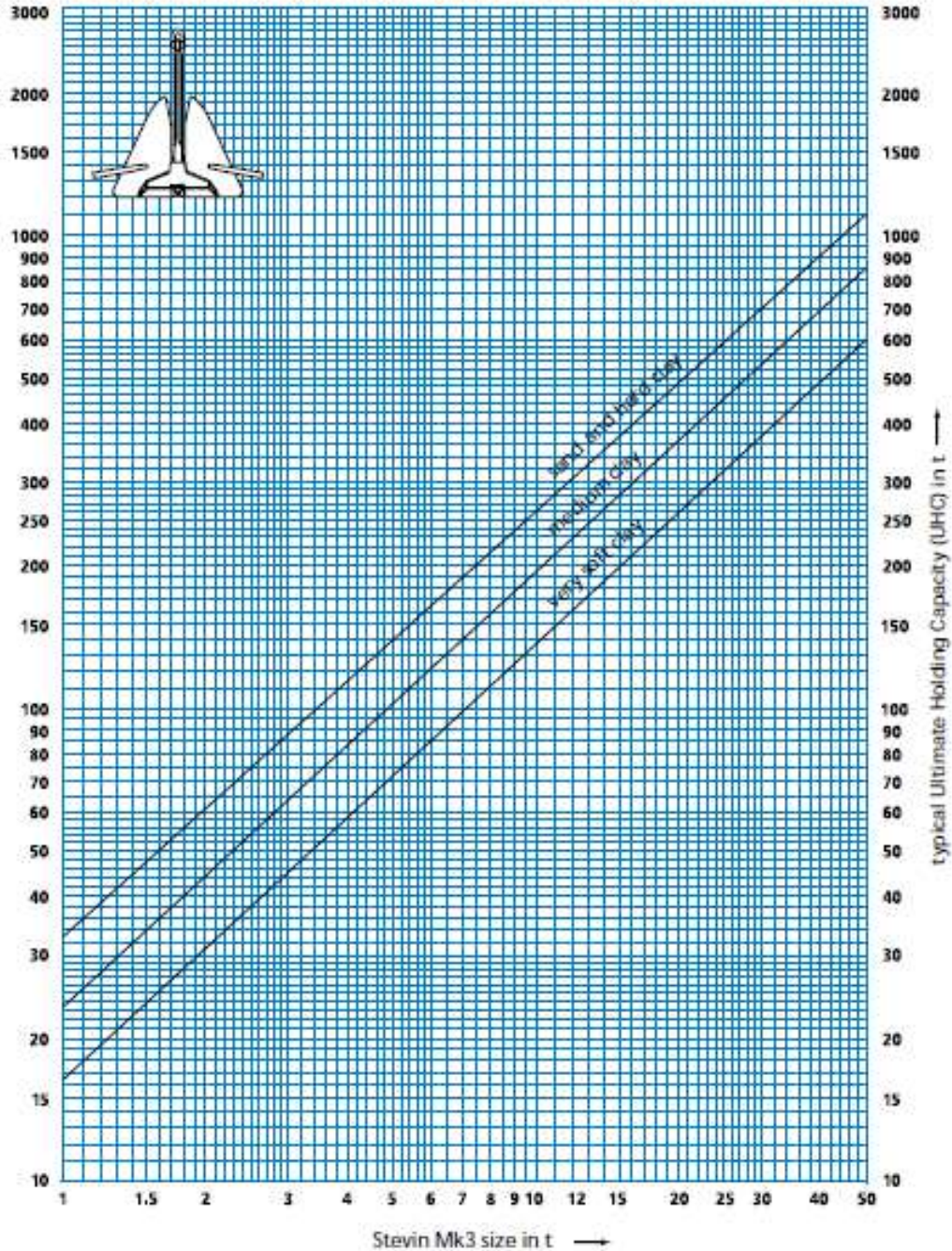

**Figure 23:** Vryhof Anchor Ultimate Handling Capacity (UHC) chart (image source: <http://www.vryhof.com/>)



### Stevin Mk3 drag and penetration chart

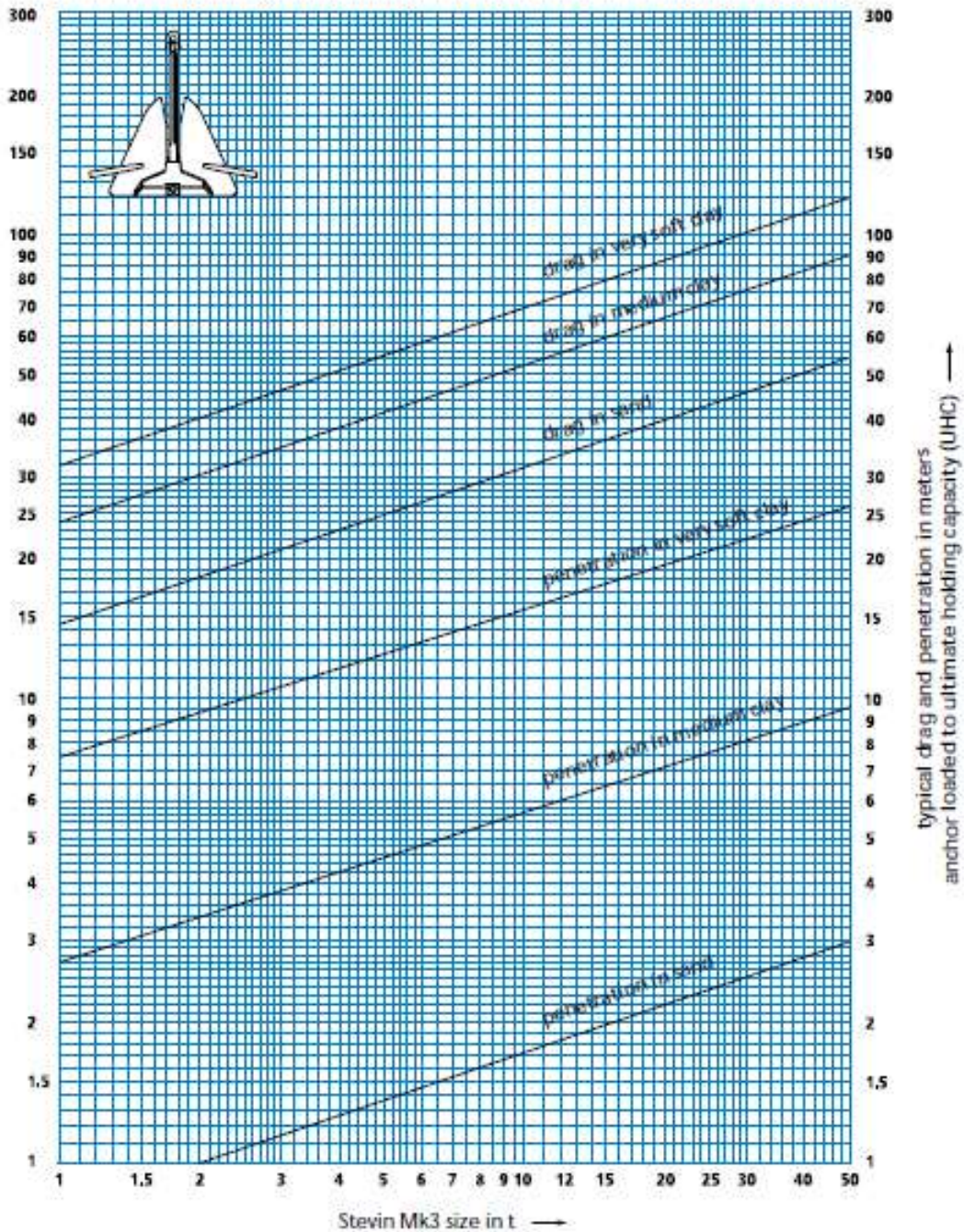

**Figure 24:** Vryhof Anchor drag and penetration chart (image source: <http://www.vryhof.com/>)

## Appendix B1

Guideline	Publication Date
<b>Det Norske Veritas</b>	
Certification of Tidal and Wave Energy Converters: DNV-OSS-213	2012
Cathodic protection design: DNV-RP-B401	2010
Design of offshore steel structures, general (LRFD method): DNV-OS-C101	2011
Fatigue analysis strength of offshore steel structures: DNV-RP-C203	2012
Design against accidental loads: DNV-RP-C204	2010
Environmental Conditions and Environmental Loads: DNV-RP-C205	2010
Offshore concrete structures: DNV-OS-C502	2010
Position Mooring: DNV-OS-E301	2010
Offshore Mooring Chain: DNV-OS-E302	2009
Offshore Fibre Ropes: DNV-OS-E303	2013
Offshore Mooring Steel Wire Ropes: DNV-OS-E304	2009
Design and Installation of Fluke Anchors: DNV-RP-E301	2012
Design and Installation of Plate Anchors in Clay: DNV-RP-E302	2002
Geotechnical Design and Installation of Suction Anchors in Clay: DNV-RP-E303	2005
Dynamic risers: DNV-OS-F201	2010
Design of Floating Wind Turbine Structures: DNV-OS-J103	2013
<b>Det Norske Veritas and Carbon Trust</b>	
Guidelines on design and operation of wave energy converters	2005
<b>Bureau Veritas</b>	
Classification of Mooring Systems for Permanent Offshore Units. NR 493 DT R02 E	2012
Certification of fibre ropes for deepwater offshore services. 2 <sup>nd</sup> edition. NI 432 DTO R01E	2007
Rules for the Classification of Offshore Loading and Offloading Buoys NR 494 DT R02 E	2006

**Table 15a:** Existing offshore guidelines which may be relevant to the mooring of MRE devices

## Appendix B2

Guideline	Publication Date
<b>American Petroleum Institute</b>	
Recommended Practice for Design and Analysis of Stationkeeping Systems for Floating Structures: API RP 2SK	1996
Recommended Practice for Design, Manufacture, Installation, and Maintenance of Synthetic Fiber Ropes for Offshore Mooring: API RP 2SM ( <i>amended version</i> )	2007
Mooring Chain. API Spec 2F	1997
<b>American Bureau of Standards</b>	
Guidance Notes on the Application of Fiber Rope for Offshore Mooring	2011
Guidelines for the purchasing and testing of SPM hawsers	2000
<b>Standards Norway</b>	
Marine fish farms - Requirements for site survey, risk analyses, design, dimensioning, production, installation and operation: NS 9415:2009	2009
<b>International Standards Organisation</b>	
Petroleum and natural gas industries -- Specific requirements for offshore structures -- Part 7: Stationkeeping systems for floating offshore structures and mobile offshore units: ISO19901-7:2013	2013
Fibre ropes for offshore stationkeeping: Polyester: ISO18692:2007	2007
Ships and marine technology -- Stud-link anchor chains: ISO1704:2008	2008
<b>Lloyds Register</b>	
Rules and Regulations for the Classification of a Floating Offshore Installation at a Fixed Location	2013
<b>British Standards Institute</b>	
Code of practice for geotechnical design: BS6349-1-3	2012

**Table 15b:** Existing offshore guidelines which may be relevant to the mooring of MRE devices

## Appendix C

Developer	Software name	Solver	Mooring system representation	Notes
WAMIT Inc	<a href="#">WAMIT</a>	Linear BEM based on potential flow theory. Full quadratic transfer function for slow drift. Diffraction and radiation	User-defined stiffness matrix	Multi-body
ANSYS	<a href="#">AQWA</a>	Linear BEM based on potential flow theory. Full quadratic transfer function for slow drift. Diffraction and radiation	User-defined stiffness matrix	Multi-body
MARIN	<a href="#">DIFFRAC</a>	Linear BEM based on potential flow theory. Full quadratic transfer function for slow drift. Diffraction and radiation	User-defined stiffness and pretensions	Multi-body
Ecole Centrale de Nantes	<a href="#">AQUAPLUS</a>	Linear BEM based on potential flow theory. Kelvin Green function (sources and dipoles)	N/K	For <10 bodies, but greater numbers are possible with 'multipole' and 'OWC' add-ons
Det Norske Veritas	<a href="#">Seasam</a> <a href="#">HydroD</a>	Linear BEM. Uses Wedam in frequency domain and Wasim in time domain	Can provide output to mooring analysis software (eg DeepC)	Up to 15 bodies

**Table 16:** Linear wave interaction analysis tools



**applicability of available and proposed offshore mooring and foundation technologies and design tools for array applications**

Developer	Software name	Solver	Body		Mooring analysis					Notes	
			Hydrostatics	Hydrodynamics	Modal	Static	Quasi-static	Dynamic	Fatigue		
Ecole Centrale de Nantes	<a href="#">ACHIL-3D</a>	Linear BEM based on potential flow theory. Kelvin sources and dipoles. Green function solved using 4 <sup>th</sup> order ODE	Yes	Yes	N/K	N/K	N/K	N/K	Yes	No	For <10 bodies
	<a href="#">LAMSWEC</a>	BEM. Kelvin sources and dipoles. Froude-Krylov forcing. Linearised radiation	Yes	Yes	N/K	N/K	N/K	N/K	Yes	No	Single body. Body hydrodynamics solved
Orcina	<a href="#">Orealflex</a>	Implicit or explicit integration using impulse response functions	Yes	See notes	Yes	Yes	Yes	Yes	Yes	Yes	Body hydrodynamics are either specified (i.e. calculated by BEM codes) or represented as Morison elements
Principia	<a href="#">Deeplines</a>	Time and frequency domain dynamic analyses	No	No	Yes	Yes	Yes	Yes	Yes	Yes	
	<a href="#">DIODORE</a>	Frequency and non-linear time domain simulations. Diffraction/radiation model.	Yes	Yes	Yes	Yes	Yes	Yes	See notes	No	Quasi-dynamic analysis is possible
Ansys	<a href="#">AQWA Suite with Coupled Cable Dynamics</a>	Time and frequency domain solvers	Yes	Yes	N/K	Yes	Yes	Yes	Yes	No	
TTI	<a href="#">Optimoor</a> <a href="#">FRM</a>		No	No	Yes	Yes	Yes	Yes	Yes	Yes	
Garrad Hassan	<a href="#">WaveDyn</a>		Yes	Yes	Yes	Yes	Yes	Yes	Yes	Yes	Designed for WECS
Veristar	<a href="#">ARIANEZ</a>		Yes	Yes	Yes	Yes	Yes	Yes	Yes*		*Line Dynamics Module from MCS

**Table 17a: Moored system analysis tools**

applicability of available and proposed offshore mooring and foundation technologies and design tools for array applications

Developer	Software name	Solver	Body		Mooring analysis					Notes	
			Hydrostatics	Hydrodynamic	Modal	Static	Quasi-static	Dynamic	Fatigue		
MARINTEK	<a href="#">Riflex</a>	For time domain analysis of mooring lines, risers and umbilical	See notes	See notes							Designed for risers but is capable of being used for mooring system analysis  Body motions based on motion transfer functions and/or time-series input
	<a href="#">Mimosa</a>				Yes	Yes	Yes	Yes	No		For mooring systems. Taught and catenary
	<a href="#">MOOROPT-2</a>	Performs cost minimization analysis for risers and mooring systems									Toolbox for Mimosa. WINDOPT is an extension of MOOROPT for floating wind turbines
	<a href="#">SIMA</a>	Simo-Riflex: can do time domain analysis of coupled floating bodies, including floating and fixed wind turbines	Yes	Yes	Yes	Yes	Yes	Yes	Yes	Yes	Commercial package of MARINTEK software including SIMO-Riflex
	<a href="#">SIMO</a>	Waveinduced analysis in time domain accounting for the retardations based on BEM	Yes	Yes							
Det Norsk Veritas	<a href="#">Seasam DeepC</a>		Yes	Yes	With Mimosa	With Mimosa	With Mimosa	With Mimosa	With Mimosa		Designed for deep water analysis
Dynamic Systems Analysis	<a href="#">ProteusDS</a>	Finite element model and hydrodynamics	Yes	Yes					Yes		

Table 17b: Moored system analysis tools

Developer	Software name	Solver	Criteria				Notes
			Installations	Multi Object	Cyclic Loading	Dynamics	
3ds	<a href="#">ABAQUS</a>	FEA.	Yes	Yes	Yes	Yes	
Plaxis	<a href="#">Plaxis2D</a> and <a href="#">Plaxis3D</a>	FEA tool for analysis of deformation and stability	Yes	Yes	Yes	Yes	Geotechnical engineering analysis
Norwegian Geotechnical Institute	<a href="#">BIFURC-3D</a>	FEA, general purpose geomechanical analysis	Yes	NK	Yes	Yes	
LimitState	<a href="#">HVMCap</a> <a href="#">LimitstateGEO</a>	Discontinuity Layout Optimization limit analysis technology	Yes	Yes	Yes	NK	
STA	<a href="#">Pile3</a>						Pile anchor design tool

**Table 18:** Foundation geotechnical analysis tools