

Trainba, Mahmud (2016). Estimation of the Developed Overvoltages at the Entrance of a HV/MV Substation. (Unpublished Doctoral thesis, City, University of London)



**CITY UNIVERSITY  
LONDON**

[City Research Online](#)

**Original citation:** Trainba, Mahmud (2016). Estimation of the Developed Overvoltages at the Entrance of a HV/MV Substation. (Unpublished Doctoral thesis, City, University of London)

**Permanent City Research Online URL:** <http://openaccess.city.ac.uk/16690/>

#### **Copyright & reuse**

City University London has developed City Research Online so that its users may access the research outputs of City University London's staff. Copyright © and Moral Rights for this paper are retained by the individual author(s) and/ or other copyright holders. All material in City Research Online is checked for eligibility for copyright before being made available in the live archive. URLs from City Research Online may be freely distributed and linked to from other web pages.

#### **Versions of research**

The version in City Research Online may differ from the final published version. Users are advised to check the Permanent City Research Online URL above for the status of the paper.

#### **Enquiries**

If you have any enquiries about any aspect of City Research Online, or if you wish to make contact with the author(s) of this paper, please email the team at [publications@city.ac.uk](mailto:publications@city.ac.uk).



# **Estimation of the Developed Overvoltages at the Entrance of a HV/MV Substation**

By

**MAHMUD A. TRAINBA**

[Mahmud.Trainba.1@city.ac.uk](mailto:Mahmud.Trainba.1@city.ac.uk)

A thesis submitted to  
CITY , UNIVERSITY OF LONDON  
for the Degree of  
**DOCTOR OF PHILOSOPHY**

**SUPERVISOR: Dr. LAMBROS EKONOMOU**

[Lambros.Ekonomou.1@city.ac.uk](mailto:Lambros.Ekonomou.1@city.ac.uk)

Department of Electrical and Electronics Engineering  
School of Engineering and Mathematical Sciences  
City, University of London  
United Kingdom

20<sup>th</sup> February 2016



## ABSTRACT

External overvoltages can cause several damages to a HV/MV substation, leading to insulation breakdowns. The appropriate protection of the substation against external overvoltages is critical, in order to ensure the efficient, reliable and safe operation of the system. Shielding wires, mast and surge arresters are the main parts of a lightning protection system.

The current PhD project deals with the effective lightning protection of HV/MV substations, examining the impact of various factors on the magnitude of the developed overvoltages at different positions of the system. The influence of the equivalent circuit model of the various components to the calculated overvoltages is also examined. Moreover, the substation outage rate due to lightning strokes is calculated, considering shielding failures and back-flashovers. In addition, special issues are discussed, i.e. induced overvoltages and installation of arresters in parallel.

In comparison with other studies, main contribution of the thesis is that does not focus only on the role of the grounding resistance, but examines the dominant influence of other parameters; the improvement of the lightning performance of the substation can be achieved by the appropriate adjustment of various factors of the system. The current work highlights also the advantages and drawbacks of each equivalent circuit model, providing a guide to other researchers in order to select the appropriate models. As far as the risk assessment analysis is concerned, innovation of the performed study constitutes the inclusion of the arresters' failure rate to the total substation failure rate, since their possible failure results in malfunction of the nominal operation of the system. The induced overvoltages arriving at the entrance of the substation are also calculated, examining the role of the lightning hit position, the waveform of the lightning current, emphasizing to the role of the installation position of the arresters. Finally, the need for good matching of the voltage – current characteristics of the arresters is revealed, otherwise, the expected equal sharing of the injected lightning current will not be achieved. The current Thesis indicates that the combination of the arresters in parallel does not influence the expected overvoltages, but has to do mainly with the absorbed energy by the arresters.

*Keywords: Lightning Overvoltages, Power Substations Models, Power Transformer, Surge Arresters, Transmission Lines.*



## **ACKNOWLEDGEMENTS**

First and foremost, I would like to express my sincere gratitude to my PhD supervisor Dr. LAMBROS EKONOMOU for his enthusiastic, constant guidance, valuable advices and encouragement in the completion of the project.

My most sincere gratitude and appreciation go to my wife for her patience, continuous encouragement and support over the past difficult years.

I am deeply indebted to my parents, brothers and sisters who gave me continuous support and encouragement throughout my life.

In addition, I would like to show appreciation to friends and staffs from the university who have assist me throughout the course of my studies.



## **DECLARATION**

I understand that all my project work must be my own unaided work. If I make use of material from any other source, I must clearly identify it as such in any interviews, reports.

I understand that my reports must be written unaided in my words, apart from any quoted material that I must identify clearly in the correct manner.

I understand the work, which I shall present for assessment, must be work carried out by myself only during the project period.



# TABLE OF CONTENTS

No.	DESCRIPTION	PAGE
	<b>ABSTRACT</b>	1
	<b>ACKNOWLEDGEMENT</b>	2
	<b>DECLARATION</b>	3
	<b>TABLE OF CONTENTS</b>	4
	<b>LIST OF FIGURES</b>	8
	<b>LIST OF TABLES</b>	20
	<b>LIST OF SYMBOLS</b>	21
	<b>CHAPTER 1</b>	
	<b>INTRODUCTION</b>	
1.1	Overview	25
1.2	Research Aims and objects	26
1.3	Research Contribution	27
1.4	Thesis Outlines	28
1.5	List of Authors' Publications	30
	<b>CHAPTER 2</b>	
	<b>LIGHTNING OVERVOLTAGES</b>	
2.1	Lightning Fundamentals	31
2.2	Lightning Parameters (Wave Shapes, Peak Values, Times etc.)	33
	2.2.1 Lightning Current Waveform	33
	2.2.2 Peak Current	34
	2.2.3 Current Rise Time	36
	2.2.4 Leader Approach Angle	38
2.3	Lightning Damage	39
2.4	Ground Flash Density (GFD) – Keraunik Level (T)	39
2.5	Conclusions	41
	References	



## CHAPTER 3

**LIGHTNING PROTECTION OF SUBSTATIONS**

3.1	Various Types of Substations	44
3.2	Basic Parts of Substations and Their Electrical Characteristics	46
3.2.1	Transmission Lines	46
3.2.2	Circuit Breakers	55
3.2.3	Current Transformers	57
3.2.4	Power Transformer	57
3.2.5	Disconnect Switches	59
3.2.6	Ground Switches	60
3.2.7	Cables	60
3.2.8	Busbars	61
3.3	Configuration of Substations	62
3.4	Grounding of Substations	64
3.4.1	Need for Grounding	64
3.4.2	Design of a Grounding System	65
3.5	Need for Lightning Protection of Substations	69
3.6	Development of Overvoltages in Substations	70
3.7	Design of Lightning Protection System	75
3.7.1	The fixed Angles Method	75
3.7.2	Empirical Curves Method	75
3.7.3	The Electrogeometrical Model	77
3.8	Surge Arresters	80
3.8.1	The Physical Model	85
3.8.2	The IEEE Model	85
3.8.3	The Pinceti–Gianettoni Model	86
3.8.4	The Fernandez–Diaz Model	87
3.9	Conclusions	89
	References	



## CHAPTER 4

**DESCRIPTION OF THE EXAMINED SYSTEMS**

4.1	Introduction	94
4.2	Topology of the Examined Substations	94
4.3	Characteristics of the Substations' Components	97
	4.3.1 Transmission lines	97
	4.3.2 Cables	99
	4.3.3 Power Transformers	99
	4.3.4 Surge Arresters	99
4.4	Simulation Models of the Substations' Components	100
	4.4.1 Circuit Representation of Overhead Transmission Lines and Cables	100
	4.4.2 Circuit Representation of Towers	102
	4.4.3 Circuit Representation of Surge Arresters	102
	4.4.4 Circuit Representation of Transformers, Busbars and Circuit Breakers	103
	4.4.5 Circuit Representation of Grounding System	103
	4.4.6 Circuit Representation of Insulators	104
4.5	Conclusions	105
	References	

## CHAPTER 5

**CALCULATION OF THE DEVELOPED OVERVOLTAGES**

5.1	Introduction	108
5.2	Overvoltages in Case of Direct Lightning Hit	108
5.3	Overvoltages in Case of Lightning hit on the ground wire	116
5.4	Impact of the Used Models of the Components to the Obtained Results	130
5.5	Impact of the Number of the Incoming Transmission Lines	142
5.6	Calculation of Developed Overvoltages for Interconnected Substations	144
5.7	Conclusions	148
	References	

## CHAPTER 6

**LIGHTNING RISK ASSESSMENT OF SUBSTATIONS**

6.1	Introduction	152
6.2	Calculation of Outage Rate due to Lightning Hits on Phase Conductors	152
6.3	Calculation of Outage Rate due to Lightning hits on ground wires	153
6.4	Failure Rate of Arresters	154





6.5	Calculation of the Total Substation Outage Rate	155
6.6	Results	156
6.7	Conclusions	157
	References	

## CHAPTER 7

### **SPECIAL ISSUES OF LIGHTNING PROTECTION OF SUBSTATIONS**

7.1	Introduction	179
7.2	Induced Overvoltages	179
	7.2.1 Literature review	179
	7.2.2 The LIOV code	185
	7.2.3 Configuration of the system under examination	187
	7.2.4 Results	187
7.3	Installation of Parallel Arresters	194
7.4	Conclusions	198
	References	

## CHAPTER 8

### **CONCLUSIONS, CONTRIBUTION AND FUTURE WORK**

8.1	Introduction	204
8.2	Conclusions	204
	8.2.1 Estimation of the Expected Overvoltages at Different Positions of the Substation	204
	8.2.2 The influence of the used Models of the Substations Components	205
	8.2.3 Outage Rate of the Substation due to Lightning Strokes	206
	8.2.4 Induced Overvoltages	206
	8.2.5 Parallel Arresters	207
8.3	Contribution	208
8.4	Future Work	210



## LIST OF FIGURES

Figure No.	DESCRIPTION	PAGE
<b>CHAPTER 2</b>		
LIGHTNING OVERVOLTAGES		
Figure 2.1	Cloud-to-Ground Lightning Flashes	32
Figure 2.2	Development of a Downward Negative Lightning Flash	33
Figure 2.3	Lightning Current Waveform	34
Figure 2.4	Distribution Function of the Peak Value of Lightning Flash	35
Figure 2.5	Stroke Current Range Probability for Strokes to Flat Ground	36
Figure 2.6	Current Waveforms of Negative Lightning First and Subsequent Stroke	37
Figure 2.7	World Map of Isokeraunik Level	40
Figure 2.8	Lightning Imaging Sensor of Optical Transient Density	41
<b>CHAPTER 3</b>		
LIGHTNING PROTECTION OF SUBSTATIONS		
Figure 3.1	Arrangement of a Typical Substation	45
Figure 3.2	Configuration of High Voltage Transmission Lines	46
Figure 3.3	Cut-off of Steel-Reinforced Aluminum Conductor	47
Figure 3.4	Overhead Line PI Model	48
Figure 3.5	J.Marti model	49
Figure 3.6	Tower Models	50
Figure 3.7	Typical Towers of (a) 150 kV	51
Figure 3.8	Equivalent Circuit Model of a Power Transformer	58
Figure 3.9	Simplified Network Model with Wave Impedance of a High Voltage Overhead Line and the Terminating Transformer Impedance	59
Figure 3.10	Disconnect Switch	60
Figure 3.11	Cut-off of a MV Cable	61
Figure 3.12	Basic configurations of HV/MV substations	63
Figure 3.13	Cases of Electric Shock	65
Figure 3.14	Wenner's Method	66



Figure 3.15	Configuration of a Typical Substation	71
Figure 3.16	Direct Lightning Stroke on Phase-Wire of a High Voltage Transmission Line	72
Figure 3.17	Direct Lightning Stroke on Phase-Wire of a High Voltage Transmission Line	73
Figure 3.18	Overvoltage Distribution and Insulation Breakdown Probability	74
Figure 3.19	Fixed Angles for Shielding Wires	76
Figure 3.20	Single Lightning Mast Protecting Single Ring of Object	77
Figure 3.21	Areas Protected by Multiple Masts	77
Figure 3.22	Electrogeometrical Model: Representation of Shield Wires and Phase Conductors	79
Figure 3.23	Principle of the Rolling Sphere	79
Figure 3.24	Multiple Shield Mast Protection for Stroke Current $I_s$	80
Figure 3.25	Protection by Shield Wires and Masts	80
Figure 3.26	Metal Oxide Surge Arrester cut	82
Figure 3.27	Voltage – Current Characteristic of a Metal Oxide Surge Arrester	82
Figure 3.28	Power Transformer Protected by a Surge Arrester	84
Figure 3.29	Developed Overvoltages at the Terminals of the Arrester and the Transformer	84
Figure 3.30	Physical Model	86
Figure 3.31	IEEE Model	86
Figure 3.32	Pianceti–Gianettoni Model	87
Figure 3.33	Fernandez–Diaz Model	88

## CHAPTER 4

### DESCRIPTION OF THE EXAMINED SYSTEMS

Figure. 4.1	Configuration1. Simple Topology and Simulation Model of a 150/20kv Substation	95
Figure. 4.2	Configuration.2;Complex Topology Consisting of Two Interconnected Transformers	97
Figure. 4.3	Tower of 150kV Transmission Line	98
Figure. 4.4	Grounding System of the Tower	98
Figure. 4.5	Two-port Equivalent Circuit Model of a Transmission Line	101
Figure. 4.6	High frequency model of the HV transformer side	103
Figure. 4.7	Insulation Flashover of a 150 kV Transmission Line	104

**CHAPTER 5**

## CALCULATION OF THE DEVELOPED OVERVOLTAGES

Figure 5.1	Lightning Hit on Phase Conductor of an Overhead Transmission Line	109
Figure 5.2	Overhead Transmission Line Protected by Surge Arresters	109
Figure 5.3	Power Transformer Protected by Surge Arresters	110
Figure 5.4	The developed overvoltages at positions B (UB) and D (UD) in function with the length of the cable (BD) in case of lightning hit on phase conductor of the connected line (no arresters)	111
Figure 5.5	The Developed Overvoltage at Position B (UB) in function with the Distance CD and the cable length (BD) in case of a Lightning hit on the Phase Conductor of the Connected Transmission Line (case a)	114
Figure 5.6	The Developed Overvoltage at Position B (UB) in function with the Distance CD and the cable length (BD) in case of a Lightning hit on the Phase Conductor of the Connected Transmission Line (case a)	114
Figure 5.7	The Developed Overvoltage at Position B (UB) in function with the Distance CD and the cable length (BD) in case of a Lightning hit on the Phase Conductor of the Connected Transmission Line (case b)	115
Figure 5.8	The Developed Overvoltage at Position B (UB) in function with the Distance CD and the cable length (BD) in case of a Lightning hit on the Phase Conductor of the Connected Transmission Line (case b)	115
Figure 5.9	Lightning hit on the Metallic Tower of an Overhead Transmission Line	116
Figure 5.10	Installation of Surge Arresters at an Overhead Transmission Line	117
Figure 5.11	The Developed Overvoltage at Position D (UD) In function with Tower Footing Resistance (Lightning hit on the Ground Wire of the Connected Transmission Line, No Arresters Installed)	118
Figure 5.12	The Developed Overvoltage at Position B (UB) in function with the Tower Footing Resistance (Lightning hit on the Ground Wire of the Connected Transmission Line, No Arresters Installed)	119
Figure 5.13	The Developed Overvoltage at Position D (UD) in function with the Distance CD and the Tower Footing Resistance (Lightning hit on the Ground Wire of the Connected Transmission Line, BD=300m, case a)	120
Figure 5.14	The Developed Overvoltage at Position D (UD) in function with the Distance CD and the Tower Footing Resistance (Lightning hit on the Ground Wire of the Connected Transmission Line, BD=600m, case a)	120



Figure 5.15	The Developed Overvoltage at Position D (UD) in function with the Distance CD and the Tower Footing Resistance (Lightning hit on the Ground Wire of the Connected Transmission Line, BD=1000m,case a)	121
Figure 5.16	The Developed Overvoltage at Position D (UD) in function with the Distance CD and the Tower Footing Resistance (Lightning hit on the Ground Wire of the Connected Transmission Line, BD=2000m,case a)	121
Figure 5.17	The Developed Overvoltage at Position B (UB) in function with the Distance CD and the Tower Footing Resistance (Lightning hit on the Ground Wire of the Connected Transmission Line, BD=300m, case a)	122
Figure 5.18	The Developed Overvoltage at Position B (UB) in function with the Distance CD and the Tower Footing Resistance (Lightning hit on the Ground Wire of the Connected Transmission Line, BD=600m, case a)	122
Figure 5.19	The Developed Overvoltage at Position B (UB) in function with the Distance CD and the Tower Footing Resistance (Lightning hit on the Ground Wire of the Connected Transmission Line, BD=1000m,case a)	123
Figure 5.20	The Developed Overvoltage at Position B (UB) in function with the Distance CD and the Tower Footing Resistance (Lightning hit on the Ground Wire of the connected Transmission Line, BD=2000m,case a)	123
Figure 5.21	The Developed Overvoltage at Position D (UD) in function with the Distance CD, the length of the cable (BD) and the Tower Footing Resistance (Lightning hit on the Ground Wire of the Connected Transmission Line, case a)	124
Figure 5.22	The Developed Overvoltage at Position D (UD) in function with the Distance CD, the length of the cable (BD) and the Tower Footing Resistance (Lightning hit on the Ground Wire of the Connected Transmission Line, case a)	124
Figure 5.23	The Developed Overvoltage at Position D (UD) in function with the Distance CD and the Tower Footing Resistance (Lightning hit on the Ground Wire of the Connected Transmission Line, BD=300m, case b)	125
Figure 5.24	The Developed Overvoltage at Position D (UD) in function with the Distance CD and the Tower Footing Resistance (Lightning hit on the Ground Wire of the Connected Transmission Line, BD=600m, case b)	125
Figure 5.25	The Developed Overvoltage at Position D (UD) in function with the Distance CD and the Tower Footing Resistance (Lightning hit on the Ground Wire of the Connected Transmission Line, BD=1000m,case b)	126



Figure 5.26	The Developed Overvoltage at Position D ( $U_D$ ) in function with the Distance CD and the Tower Footing Resistance (Lightning hit on the Ground Wire of the Connected Transmission Line, $BD=2000m$ , case b)	126
Figure 5.27	The Developed Overvoltage at Position B ( $U_B$ ) in function with the Distance CD and the Tower Footing Resistance (Lightning hit on the Ground Wire of the Connected Transmission Line, $BD=300m$ , case b)	127
Figure 5.28	Figure 5.28: The Developed Overvoltage at Position B ( $U_B$ ) in function with the Distance CD and the Tower Footing Resistance (Lightning hit on the Ground Wire of the Connected Transmission Line, $BD=600m$ , case b)	127
Figure 5.29	The Developed Overvoltage at Position B ( $U_B$ ) in function with the Distance CD and the Tower Footing Resistance (Lightning hit on the Ground Wire of the Connected Transmission Line, $BD=1000m$ , case b)	128
Figure 5.30	The Developed Overvoltage at Position B ( $U_B$ ) in function with the Distance CD and the Tower Footing Resistance (Lightning hit on the Ground Wire of the Connected Transmission Line, $BD=2000m$ , case b)	128
Figure 5.31	The Developed Overvoltage at Position B ( $U_B$ ) in function with the Distance CD, the length of the cable ( $BD$ ) and the Tower Footing Resistance (Lightning hit on the Ground Wire of the Connected Transmission Line, case b)	129
Figure 5.32	The Developed Overvoltage at Position D ( $U_D$ ) in function with the Distance CD, the length of the cable ( $BD$ ) and the Tower Footing Resistance (Lightning hit on the Ground Wire of the Connected Transmission Line, case b)	129
Figure 5.33	The developed Overvoltage at Position B ( $U_B$ ) for various Tower Models	133
Figure 5.34	The developed overvoltage at Position D ( $U_D$ ) for various Tower Models	133
Figure 5.35	The developed overvoltage at Position B ( $U_B$ ) for various surge Arrester Models	134
Figure 5.36	The developed overvoltage at Position D ( $U_D$ ) for various Surge Arrester Models	135
Figure 5.37	The developed Overvoltage at Position B ( $U_B$ ) for various Grounding Resistance Models	135
Figure 5.38	The developed Overvoltage at Position D ( $U_D$ ) for various Grounding	136



Resistance Models	
Figure 5.39	The developed Overvoltage at Position B ( $U_B$ ) for various Insulator Models 137
Figure 5.40	The developed Overvoltage at Position D ( $U_D$ ) for various Insulator Models 137
Figure 5.41	The developed Overvoltage at Position B ( $U_B$ ) for various Tower Models 138
Figure 5.42	The developed Overvoltage at Position D ( $U_D$ ) for various Tower Models 139
Figure 5.43	The developed Overvoltage at Position B ( $U_B$ ) for various Surge Arresters Models 139
Figure 5.44	The developed Overvoltage at Position B ( $U_B$ ) for various Surge Arresters models 140
Figure 5.45	The developed Overvoltage at Position B ( $U_B$ ) for various Grounding Resistance Models 140
Figure 5.46	The developed Overvoltage at Position D ( $U_D$ ) for various Grounding Resistance Models 141
Figure 5.47	The developed Overvoltage at Position B ( $U_B$ ) for various Insulator Models 141
Figure 5.48	The developed Overvoltage at Position D ( $U_D$ ) for various Insulator Models 142
Figure 5.49	Voltage at the Entrance of the Substation in function with the Distance between the Lightning Hit Position and the Substation 144
Figure 5.50	Overvoltage at Position A ( $U_A$ ) in function with Grounding Resistance for Direct (case (I)) or Indirect (case (II)) 145
Figure 5.51	Overvoltage at Position B ( $U_B$ ) in function with Grounding Resistance for Direct (case (I)) or Indirect (case (II)) 145
Figure 5.52	Overvoltage at Position C ( $U_C$ ) in function with Grounding Resistance for Direct (case (I)) or Indirect (case (II)) 146
Figure 5.53	Overvoltage at Position D ( $U_D$ ) in function with Grounding Resistance for Direct (case (I)) or Indirect (case (II)) 146
Figure 5.54	Overvoltage at Position E ( $U_E$ ) in function with Grounding Resistance for Direct (case (I)) or Indirect (case (II)) 147
Figure 5.55	Overvoltage at Position E ( $U_F$ ) in function with Grounding Resistance for Direct (case (I)) or Indirect (case (II)) 147

**CHAPTER 6****LIGHTNING RISK ASSESSMENT OF SUBSTATIONS**

Figure 6.1	Substation Outage Rate in case of lightning hit on the phase conductor of the connected line in function with the length of the cable (BD) and the distance between the arrester and the transformer (CD) (Case a)	157
Figure 6.2	Substation Outage Rate in case of lightning hit on ground wire of the connected line in function with the grounding resistance (R) and the distance between the arrester and the transformer (CD) considering BD=300m (Case a)	157
Figure 6.3	Substation Outage Rate in case of lightning hit on ground wire of the connected line in function with the grounding resistance (R) and the distance between the arrester and the transformer (CD) considering BD=600m (Case a)	158
Figure 6.4	Substation Outage Rate in case of lightning hit on ground wire of the connected line in function with the grounding resistance (R) and the distance between the arrester and the transformer (CD) considering BD=1000m (Case a)	158
Figure 6.5	Substation Outage Rate in case of lightning hit on ground wire of the connected line in function with the grounding resistance (R) and the distance between the arrester and the transformer (CD) considering BD=2000m (Case a)	159
Figure 6.6	Substation Outage Rate in function with the grounding resistance (R) and the distance between the arrester and the transformer (CD) considering BD=300m (Case a)	159
Figure 6.7	Substation Outage Rate in function with the grounding resistance (R) and the distance between the arrester and the transformer (CD) considering BD=600m (Case a)	160
Figure 6.8	Substation Outage Rate in function with the grounding resistance (R) and the distance between the arrester and the transformer (CD) considering BD=1000m (Case a)	160
Figure 6.9	Substation Outage Rate in function with the grounding resistance (R) and the distance between the arrester and the transformer (CD) considering BD=2000m (Case a)	161
Figure 6.10	Failure Rate of the arrester installed at position B in function with the	161





	Grounding Resistance and the distance between the arrester and the transformer (CD) considering $BD=300\text{m}$ (Case a)	
Figure 6.11	Failure Rate of the arrester installed at position B in function with the Grounding Resistance and the distance between the arrester and the transformer (CD) considering $BD=600\text{m}$ (Case a)	162
Figure 6.12	Failure Rate of the arrester installed at position B in function with the Grounding Resistance and the distance between the arrester and the transformer (CD) considering $BD=1000\text{m}$ (Case a)	162
Figure 6.13	Failure Rate of the arrester installed at position B in function with the Grounding Resistance and the distance between the arrester and the transformer (CD) considering $BD=2000\text{m}$ (Case a)	163
Figure 6.14	Failure Rate of the arrester installed at position D in function with the Grounding Resistance and the distance between the arrester and the transformer (CD) considering $BD=300\text{m}$ (Case a)	163
Figure 6.15	Failure Rate of the arrester installed at position D in function with the Grounding Resistance and the distance between the arrester and the transformer (CD) considering $BD=600\text{m}$ (Case a)	164
Figure 6.16	Failure Rate of the arrester installed at position D in function with the Grounding Resistance and the distance between the arrester and the transformer (CD) considering $BD=1000\text{m}$ (Case a)	164
Figure 6.17	Failure Rate of the arrester installed at position D in function with the Grounding Resistance and the distance between the arrester and the transformer (CD) considering $BD=2000\text{m}$ (Case a)	165
Figure 6.18	Substation Outage Rate including Arresters Faults in function with the Grounding Resistance and the distance between the arrester and the transformer (CD) considering $BD=300\text{m}$ (Case a)	165
Figure 6.19	Figure 6.19: Substation Outage Rate including Arresters Faults in function with the Grounding Resistance and the distance between the arrester and the transformer (CD) considering $BD=600\text{m}$ (Case a)	166
Figure 6.20	Substation Outage Rate including Arresters Faults in function with the Grounding Resistance and the distance between the arrester and the transformer (CD) considering $BD=1000\text{m}$ (Case a)	166
Figure 6.21	Substation Outage Rate including Arresters Faults in function with the Grounding Resistance and the distance between the arrester and the transformer (CD) considering $BD=2000\text{m}$ (Case a)	167



Figure 6.22	Comparison Substation Outage Rate including and not including Arresters Faults in function with the Grounding Resistance and the distance and the length of the cable (BD) considering CD=0m (Case a)	167
Figure 6.23	Substation Outage Rate in case of lightning hit on the phase conductor of the connected line in function with the length of the cable (BD) and the distance between the arrester and the transformer (CD) (case b)	168
Figure 6.24	Substation Outage Rate in case of lightning hit on ground wire of the connected line in function with the grounding resistance (R) and the distance between the arrester and the transformer (CD) considering BD=300m (case b)	168
Figure 6.25	Substation Outage Rate in case of lightning hit on ground wire of the connected line in function with the grounding resistance (R) and the distance between the arrester and the transformer (CD) considering BD=600m (case b)	169
Figure 6.26	Substation Outage Rate in case of lightning hit on ground wire of the connected line in function with the grounding resistance (R) and the distance between the arrester and the transformer (CD) considering BD=1000m (case b)	169
Figure 6.27	Substation Outage Rate in case of lightning hit on ground wire of the connected line in function with the grounding resistance (R) and the distance between the arrester and the transformer (CD) considering BD=2000m (case b)	170
Figure 6.28	Substation Outage Rate in function with the grounding resistance (R) and the distance between the arrester and the transformer (CD) considering BD=300m (case b)	170
Figure 6.29	Substation Outage Rate in function with the grounding resistance (R) and the distance between the arrester and the transformer (CD) considering BD=600m (case b)	171
Figure 6.30	Substation Outage Rate in function with the grounding resistance (R) and the distance between the arrester and the transformer (CD) considering BD=1000m (case b)	171
Figure 6.31	Substation Outage Rate in function with the grounding resistance (R) and the distance between the arrester and the transformer (CD) considering BD=2000m (case b)	172
Figure 6.32	Failure Rate of the arrester installed at position D in function with the	172



	Grounding Resistance and the distance between the arrester and the transformer (CD) considering $BD=300m$ (case b)	
Figure 6.33	Failure Rate of the arrester installed at position D in function with the Grounding Resistance and the distance between the arrester and the transformer (CD) considering $BD=600m$ (case b)	173
Figure 6.34	Failure Rate of the arrester installed at position D in function with the Grounding Resistance and the distance between the arrester and the transformer (CD) considering $BD=1000m$ (case b)	173
Figure 6.35	Failure Rate of the arrester installed at position D in function with the Grounding Resistance and the distance between the arrester and the transformer (CD) considering $BD=2000m$ (case b)	174
Figure 6.36	Substation Outage Rate including Arresters Faults in function with the Grounding Resistance and the distance between the arrester and the transformer (CD) considering $BD=300m$ (case b)	174
Figure 6.37	Substation Outage Rate including Arresters Faults in function with the Grounding Resistance and the distance between the arrester and the transformer (CD) considering $BD=600m$ (case b)	175
Figure 6.38	Substation Outage Rate including Arresters Faults in function with the Grounding Resistance and the distance between the arrester and the transformer (CD) considering $BD=1000m$ (case b)	175
Figure 6.39	Substation Outage Rate including Arresters Faults in function with the Grounding Resistance and the distance between the arrester and the transformer (CD) considering $BD=2000m$ (case b)	176
Figure 6.40	Comparison Substation Outage Rate including and not including Arresters Faults in function with the Grounding Resistance and the distance and the length of the cable (BD) considering $CD=0m$ (case b)	176

## CHAPTER 7

### SPECIAL ISSUES OF LIGHTNING PROTECTION OF SUBSTATIONS

Figure 7.1	Geometry for the Calculation of Overvoltages Induced on an Overhead Power Line by an Indirect Lightning Return Stroke.	183
Figure 7.2	Induced Overvoltage for various distances between the Measurement Point and the Lightning Hit Position	184
Figure 7.3	Number of Induced Voltages with Magnitude exceeding the BIL in	184



	function with the BIL for a MV line	
Figure 7.4	Figure 7.4 Configuration of the System under Examination	187
Figure 7.5	Induced Overvoltages at the position B for lightning hit on position A for various current waveforms (case a)	188
Figure 7.6	Induced Overvoltages at the position D for lightning hit on position A for various current waveforms (case a)	188
Figure 7.7	Induced Overvoltages at the position B for lightning hit on position K for various current waveforms (case a)	189
Figure 7.8	Induced Overvoltages at the position D for lightning hit on position K for various current waveforms (case a)	189
Figure 7.9	Induced Overvoltages at the position B for lightning hit on position L for various current waveforms (case a)	190
Figure 7.10	Induced Overvoltages at the position D for lightning hit on position L for various current waveforms (case a)	190
Figures 7.11	Induced Overvoltages at the position B for lightning hit on position A for various current waveforms (case b)	191
Figure 7.12	Induced Overvoltages at the position D for lightning hit on position A for various current waveforms (case b)	191
Figure 7.13	Induced Overvoltages at the position B for lightning hit on position K for various current waveforms (case b)	192
Figure 7.14	Induced Overvoltages at the position D for lightning hit on position K for various current waveforms (case b)	192
Figure 7.15	Induced Overvoltages at the position B for lightning hit on position L for various current waveforms (case b)	193
Figure 7.16	Induced Overvoltages at the position D for lightning hit on position L for various current waveforms (case b)	193
Figure 7.17	Voltages – Current Characteristics of Two Different Metal Oxide Gapless Surge Arresters	195
Figure 7.18	Two Arresters at the Entrance of a Substation in Paralleled for each Phase	195
Figure 7.19	Voltage – Current Characteristic of two Arresters in Parallel (Case 1)	196
Figure 7.20	Voltage – Current Characteristic of two Arresters in Parallel (Case 2)	196
Figure 7.21	Voltage – Current Characteristic of two Arresters in Parallel (Case 3)	197
Figure 7.22	Sharing of the Lightning Current (Cases 1, 2, 3)	197
Figure 7.23	The developed Overvoltages at Position B and D of the examined	198



Substation (Cases 1, 2, 3)

Figure 7.24

Substation Outage Rate and Arresters Failure Rate (Cases 1, 2,3)

198



## LIST OF TABLES

NO.	DESCRIPTION	PAGE
<b>CHAPTER 2</b>		
LIGHTNING OVERVOLTAGES		
Table 2.1	Mean Value and Standard Deviation of the Peak Value and Steepness of Various Lightning Flashes	38
<b>CHAPTER 3</b>		
LIGHTNING PROTECTION OF SUBSTATIONS		
Table 3.1	Tower Surge Impedance for Single Vertical Lossless Line Models	52
Table 3.2	Current Dependent Tower Grounding Resistance Models	54
Table 3.3	Leader Progression Models	55
Table 3.4	Transformer Ratio for different Windings Connections	57
Table 3.5	Range of Earth Resistivity	66
<b>CHAPTER 4</b>		
DESCRIPTION OF THE EXAMINED SYSTEMS		
Table 4.1	Electrical Characteristics of Power Transformer	99
Table 4.2	Electrical Characteristics of Surge Arresters	100
<b>CHAPTER 5</b>		
CALCULATION OF THE DEVELOPED OVERVOLTAGES		
Table 5.1	Used Tower Models for the Sensitivity Analysis	131
Table 5.2	Used Surge Arresters Models for the Sensitivity Analysis	131
Table 5.3	Used Grounding Resistance Models for the Sensitivity Analysis	131
Table 5.4	Used Insulator Models for the Sensitivity Analysis	132



## LIST OF SYMBOLS

SYMBOL	DESCRIPTION
$P(I)$	Probability that the peak current in any stroke will exceed $I$
$I$	Specified crest current of the stroke in kiloamperes
$i$	Peak value of the lightning current
$\varphi$	Angle between the conductor and the vector of the magnetic field.
GFD	Ground Flash Density (GFD) – Keraunik Level (T)
$N_g$	Number of flashes to earth per square kilometer per year
$T$	Average annual keraunic level, thunderstorm days
$h$	Tower height,
$v_T$	Surge propagation velocity equal to the speed of light.
$I_g$	Limiting current to initiate sufficient soil ionization (kA).
$\rho$	Soil resistivity ( $\Omega\text{m}$ ).
$r$	Equivalent radius of the tower footing (m).
$n$	Number of grounding electrodes.
$s$	Characteristic distance (m).
$V_{FO}$	Flashover strength (kV).
$D$	Insulator string length (m).
$t$	Elapsed time after lightning stroke ( $\mu\text{s}$ ).
$V$	Instantaneous voltage across the insulator string (kV).
$^*E_0$	600 (kV/m) and $1.3 \text{ k} (\text{m}^2 \cdot \text{kV}^{-2} \cdot \text{s}^{-1})$ , respectively, for cap and pin insulators.
$^{**}E_0$	Value according to insulator type and string length.
$E_{\text{touch}}$	Touch voltage (V).
$C_s$	Factor depended on resistivity $\rho_s$ of the earth beneath the surface material in (V-m) .
$\rho_s$	Resistivity of the earth beneath the surface material ( $\Omega\text{m}$ )
$Q_s$	Resistivity of the earth beneath the surface material in ( $\Omega\text{m}$ ).
$h_s$	Thickness of the surface material in (m).
$t_s$	Duration of shock current in (sec).



$R_g$	Substation ground resistance in ( $\Omega$ ).
$A$	Area occupied by the ground grid in ( $m^2$ ).
$L_T$	Total buried length of conductors in (m).
$h$	Depth of the grid in (m).
$R_1$	Ground resistance of grid conductors in ( $\Omega$ ).
$R_2$	Ground resistance of all ground rods in ( $\Omega$ ).
$R_m$	Mutual ground resistance between the group of grid conductors, $R_1$ , and group of ground rods, $R_2$ in ( $\Omega$ ).
$L_c$	Total length of all connected grid conductors in (m).
$a'$	Conductors buried at depth $h$ (m).
$a'$	For Conductor on earth surface (m).
$2a$	Diameter of conductor in (m).
$A$	Area covered by conductors in ( $m^2$ ).
$k_1, k_2$	Coefficients
$L_r$	Length of each rod in (m).
$2b$	Diameter of rod in (m).
$n_R$	Number of rods placed in area ( $A$ ).
$W$ and $L$	Dimensions of the substation (width and length)
$N$	Number of flashes to earth per square kilometer per year
$A$ and $b$	Constants dependent on the termination point
$I$	Prospective stroke current (kA).
$D_C$	Shielding failure exposure distance.
$D$	Vertical distance between points C and A
$I$	Current through the arrester.
$V$	Voltage across the arrester.
$\alpha$	Non-linearity exponent (measure of non-linearity).
$k$	Constant depended on the arresters type.
$c$	Propagation velocity of the voltage wave.
$S$	Front Steepness of the lightning overvoltage.
$LIWV$	Standard lightning impulse withstand voltage of the device to be protected (kV).
$U_\pi$	Lightning impulse protective level of the arrester (kV)
$d$	Length of arrester column in meters.
$n$	Number of parallel columns of metal oxide disks.
$V_n$	Arrester's rated voltage,





$V_{r(8/20)}$	Residual voltage for a 8/20 10 kA lightning current.
$V_{r(1/T_2)}$	Residual voltage for a 1/T <sub>2</sub> 10 kA lightning current.
n	Scale factor
L'1	Percentage increase of the residual voltage.
$V_{r(8/20)}$	Residual voltage for a 8/20 lightning current.
$V_{r(1/T_2)}$	Residual voltage for a 1/T <sub>2</sub> lightning current with the nominal amplitude.
l	Per unit length inductance of the line.
c	Per unit length capacitance of the line.
$\tau$	Transport delay of the voltage wave.
v	Propagation velocity of the wave.
d	Length of the line.
r	The per unit length resistance of the line.
r	Tower base radius (m).
a	Winding ratio
d	Length of the cable.
C	Propagation speed.
i	Lightning current.
L	Inductance of the connection wires of the arrester.
$R_s$	Grounding resistance of the arrester.
$U_{\text{transformer}}$	Voltage at the terminals of the transformer.
$U_{\text{arrester}}$	Residual voltage of the arrester.
U	Residual voltage of the arrester
E	Peak value of the incoming voltage surge.
n	Number of the incoming lines.
$V_{\text{max}}$	Overvoltage at the lightning hit position.
l	Distance between the lightning hit position and the substation.
k	Empirical coefficient between 0.0001 and 0.0004 (kV <sup>2</sup> km) <sup>-1</sup>
$SFR_x$	Shielding failure rate of the connected line (shielding failures/year) .
$X_{SF}$	Distance between the substation entrance and the lightning hit position (km).
SFR	Shielding failure rate of the incoming overhead line (shielding failures/100km/year) .
F(I)	Probability of lightning crest current being greater than I.
$I_{CSF}$	Minimum value of the lightning current hitting the phase conductor of



the connected transmission line at a distance  $X_{SF}$  from the substation entrance (kA) .

$I_{MSF}$	Maximum shielding failure current of the connected line.
$N_{SX}$	Rate of lightning strikes to shield wires of the connected line (strikes/year).
$X_{BF}$	Limit distance between the substation entrance and the lightning hit position(km) .
$u(t)$	Residual voltage of the arrester (kV)
$i(t)$	Value of the discharge current through the arrester (kA).
ArrFR	Probability that an arrester fails due to lightning stroke on a phase conductor.
ArrFR	Probability that an arrester fails due to lightning stroke on the overhead ground wire.
$I_A(T)$	Minimum stroke peak current in kA required to damage the arrester, when lightning hits on a phase conductor, depending on each time-to-half value ( $T$ ).
$I_B(T)$	Minimum stroke peak current in kA required to damage the arrester, when lightning hits on the overhead ground wire, depending on each time-to-half value ( $T$ ).
$f(I_p)$	Probability density function of the lightning current peak value.
$g(T)$	Probability density function of the time-to-half value of the lightning current.
$T$	Rise time of the incident waveform
$P_T$	Total failure probability of an arrester.
$A_T$	Arrester total failure rate in failures per year per line.
$N_L$	Number of lightning flashes to a line per 100km per year
$h_t$	Tower height in m, $g$ is the horizontal spacing in m, between the ground wires.
$g$	The horizontal spacing between the ground wires (m).
$N_g$	Ground flash density in flashes per $km^2$ per year and $L$ is the line length (km).



# CHAPTER 1

## INTRODUCTION

### 1.1 Overview

The protection of High-voltage/Medium-voltage (HV/MV) substations against atmospheric overvoltages and the improvement of their lightning performance are technical issues of great importance, since they are related to safe, uninterrupted and high quality power supply. HV/MV substations are critical part of the electrical power systems, that step down the HV level to a MV level of the distribution system. Power transformers, incoming overhead transmission lines, cables, circuit breakers, current transformers, disconnect switches, ground switches constitute the basic parts of a typical substation. External overvoltages can cause several damages to a substation, leading to insulation breakdowns; insulators, switching devices, cables and transformers are intensively stressed by lightning phenomena and their failure creates several serious malfunctions, interruptions and dangers. Moreover, the safety of the personnel must be considered in priority to avoid accidents. In addition, lightning surges may also cause dangerous electromagnetic interference problems to low voltage systems and especially to electronic devices. Hence, the study of the lightning repercussions and the design of an appropriate protection system against lightning is a crucial issue, since substations are complex installations of high investment cost.

The adoption of the appropriated protection measures according to the basic guidelines of the International Standards can contribute to the limitation of the developed overvoltages and the reduction of the expected lightning faults. The design of the lightning protection system has to take into consideration the stochastic nature of the external overvoltages phenomena and the various technoeconomical factors and restrictions of a substation. Added to this, the installation or not of surge arresters at various positions of the substations has a decisive impact on the magnitude of the developed overvoltages and, consequently, the expected outage rate. The protection of substations against the deleterious effects of lightning may be achieved by using highest insulation levels, taking into account the financial cost, or by installing overhead ground wires in order to intercept the lightning flashes. The implementation of metal oxide gapless surge arresters can also contribute to the improvement of the lightning performance of the installation, especially in regions with high soil resistivity. The position of the lightning hit, the geometrical characteristics of the external lightning



protection system, the grounding resistance, the basic insulation level are parameters that affect the intensity of the lightning impact.

Moreover, the incoming surges from the connected overhead transmission lines have to be considered. Considering that an external lightning protection system (overhead ground wires) combined with the achievement of low values of the grounding resistance of the substation offer an adequate protection against direct lightning hits, the incoming surges consist the main danger for the insulation of the installation. For this reason, the tower footing resistance has a key role for the lightning performance of the substation. Added to this, the length of the cable and the appropriate placement of the arresters have a decisive impact on the magnitude of the developed overvoltages and, consequently, the expected failure rate.

## 1.2 Research Aims and Objectives

The current PhD project deals with the effective lightning protection of HV/MV substations, examining the impact of various factors on the magnitude of the developed overvoltages at different positions of the system. The substation outage rate due to lightning strokes is also calculated, considering shielding failures and back flashovers. Moreover, special issues are discussed, i.e. induced overvoltages and installation of parallel arresters. In details, the basic objectives of the presented work are summarized as following:

- **Calculation of the developed overvoltages at different positions of the substation:** the expected overvoltages at different positions of the examined topologies are computed and a sensitivity analysis will be performed, considering the role of the grounding resistance, the length of the cable, the installation position of the arresters, the number of the incoming transmission lines. The presented analysis concerns lightning hits on the phase conductors and on the overhead ground wires of the connected transmission lines, considering that the external LPS of the substation protects adequately the substation against direct lightning hits. Compared with other similar studies, the current work reveals the important role of the length of the cable and examines different scenarios for the placement of the arresters. Scope of the thesis is to highlight that the lightning performance of the substations depends on various factors, except from grounding resistance.
- **Examination of the role of the used equivalent circuit models of the substations components:** A sensitivity analysis is performed, in order to examine the influence of the equivalent circuit model of the various components (i.e. tower, arresters, grounding and insulators) to the calculated overvoltages. The international research literature provides several models for the representation of the substations' equipment. The current work will



examine the appropriateness and the effectiveness of the various models, examining their impact on the simulation results. The expected outcomes are expected to become a guide for other researchers, in order to select the appropriate models.

- **Calculation of the outage rate of the substation due to lightning strokes:** the outage rate of the substation under study is computed, considering the role of the grounding resistance, the length of the cable and the installed arresters. Novelty of the current study is the inclusion of the failure rate of the installed metal oxide surge arresters to the total substation outage rate, since the protective devices are part of the equipment of the system and their damage consequences repair or replacement costs and malfunction of the system.
- **Calculation of the induced overvoltages:** the current work examines the expected induced overvoltages at the entrance of the substation under study, highlighting the impact of various factors and parameters on the magnitude of the computed surges. The magnitude and the consequences of the developed overvoltages is widely examined in the literature for the transmission and distribution lines, but the theoretical and field experience for HV/MV substations is limited.
- **Examination of the effectiveness of arresters installed in parallel:** In the current work, two arresters for each phase at the entrance of a substation are combined in parallel and the expected current that will pass through each arrester is computed, considering three cases, depending on the difference between the voltage – current characteristic of the arresters. Scope of this work is to indicate that the parallel installation of surge arresters improves the lightning performance of the system and reduces the energy stress of the arresters, only if specific requirements are satisfied.

### 1.3 Research Contribution

The contribution of the PhD project is described as following:

- The current work examines the lightning performance of substations, considering the influence of various parameters (not only the grounding resistance, which is the most common factor presented in the international research bibliography). The performed study highlights the role of the installation position of the arresters, the length of the cable that connects the incoming overhead transmission line and the transformer and the number of the connected lines, indicating that low values of grounding resistance cannot always ensure the adequate protection of the substation against lightning. In comparison with other studies, main contribution of the thesis is that does not focus only on the role



of the grounding resistance, but examines the dominant influence of other parameters; the improvement of the lightning performance of the substation can be achieved by the appropriate adjustment of various factors of the system.

- The obtained simulation results show that the impact of the used models for each component of the substation is not significant, since cannot change dramatically the estimation of the arising voltage surges. The current work highlights the advantages and drawbacks of each equivalent circuit model, providing a guide to other researchers in order to select the appropriate models.
- The calculation of the substation outage rate due to lightning strokes is presented, considering the role of the grounding resistance, the protection distance of the arresters and the configuration of the substations. Innovation of the performed study constitutes the inclusion of the arresters failure rate to the total substation failure rate, since arresters are part of the equipment of the substation and their possible failure results in malfunction of the nominal operation of the system.
- The induced overvoltages arriving at the entrance of the substation are calculated, including not only lightning hit on ground but considering different cases (hit on the mast, lightning current characteristics etc.). A sensitivity analysis is performed, indicating that induced overvoltages can be restrained by adopting appropriated protective measures. The thesis examines the role of the installed arresters for the restrain of the expected induced voltages.
- The parallel installation of surge arresters is a common practice in order to reduce the absorbed energy by them and, consequently, their failure probability. However, the current thesis reveals the need for good matching of the voltage – current characteristics of the arresters; otherwise, the expected equal sharing of the injected lightning current will not be achieved. The current thesis emphasizes to the fact that the combination of the arresters in parallel does not influence the expected overvoltages, but has to do mainly with the absorbed energy by the arresters.

## 1.4 Thesis Outlines

Scope of the current work is the study of the lightning performance of HV/MV substations and the examination of the appropriate protective measures that should be adopted, in order to restrain the developed overvoltages and reduce the expected failure rate. The outline of the Thesis is described as following:

- **Chapter.2** presents the basic characteristics of the lightning surges and describes the main mechanisms of their development. The range of the lightning current, the steepness and



the charge are factors that determine the consequent damages of a probable lightning hit. In addition, the ground flash density and the keraunik level are defined.

- **Chapter.3** deals with the main aspects of the lightning protection of substations, based on the international Standards, the results of other researchers and the common practice. Initially, the various types of substations are presented and their basic parts (transmission lines, cables, switches, busbars, grounding system etc.) are analyzed. The need for lightning protection of substation is highlighted and the mechanisms of the development of overvoltages are analytically presented, considering lightning hit either on a phase conductor or on overhead ground wire. The methods for the design of the lightning protection system of a substation are also presented (fixed angles method, empirical curves method, and electrogeometrical method). Finally, the main characteristics of metal oxide gapless surge arresters are presented, emphasizing the role of their installation position. Note, that for each component of the substation the most used equivalent circuit models are presented.
- **Chapter.4** presents the topologies of the examined systems and provides the characteristics of each component of the substation.
- **Chapter 5** the expected overvoltages at various positions of the substations under study are computed, considering lightning hit on phase conductors or ground wires of the incoming transmission lines. A sensitivity analysis is performed, in order to indicate the impact of the grounding resistance, the installation position of the surge arresters and the length of the MV cable. Furthermore, the influence of the applied simulation models of the components to the obtained results is also examined.
- **Chapter.6** performing the lightning risk assessment of substations and calculating the outage rate of the substation due to direct or indirect lightning hit. The outage rate for each case is computed according to the international Standards, examining the influence of various parameters. The failure probability of the installed surge arresters is also included to the extracted results.
- **Chapter.7** deals with the induced overvoltages and the parallel combination of arresters. The lightning hit position, the crest and the steepness of the injected lightning current are the main factors that influence the developed induced overvoltages. The effectiveness of



the combination of surge arresters is parallel is also examined, highlighting the role of the voltage-current characteristics of each arrester.

- **Chapter.8** summarizes the conclusions of the work.
- **Chapter.9** summarizes the contribution of the obtained results and proposes subjects for future research.

## 1.5 List of Authors' Publications

The following publications have produced based on the work presented in this Thesis:

### 1.5.1 *Journal Publications*

1. Trainba M., Ekonomou L., *Estimation of the Developed Overvoltages at the Entrance of a HV/MV Substation*, IET Science Measurement & Technology, SMT-2016-0029, (Under Review).
2. Trainba M., Ekonomou L., *A Sensitivity Analysis for the more Effective Lightning Protection of HV/MV Substations*, Electrical Power & Energy Systems, IJEPES-2016-132, (Under Review).

### 1.5.2 *Conference Publications*

1. Trainba M., Ekonomou L., *Lightning Performance of a HV/MV Substation*, 10th WSEAS International Conference on Energy & Environment (EE '15), Budapest, Hungary, pp. 28-32, 2015.





## CHAPTER 2

# LIGHTNING OVERVOLTAGES

### 2.1 Lightning Fundamentals

Lightning phenomena are generated due to electrostatic discharges during thunderstorms and are main cause of faults and damages in buildings and electrotechnical installations (Sabiha). Various theories have been proposed in order to describe and explain the formation and the separation of the developed charges in clouds and, consequently, the development of lightning strokes. The electrical charges are separated due to air currents movements, resulting to the development of potential difference between the regions of positive and negative charge, which may vary between 100 and 1000MV (Abdel-Salam et al.).

Depending on the hit position of the atmospheric overvoltages, lightning strikes are distinguished as following:

- Hits inside the cloud
- Hits between different clouds
- Hits on tall installations
- Hits that terminate on earth (IEEE Std 998-1996).

Moreover, atmospheric overvoltages can be characterized and classified by their polarization and the direction of the propagation of the leader toward ground. Figure 2.1 depicts the cases of lightning flashes between cloud and earth, as determined by the charge (positive or negative) and the direction of the initial leader (cloud to ground or ground to cloud) (Uman 2008). Note that the majority of the recorded lightning flashes are negative (approximately 90%). It is worth mentioning that the rest 10% of positive strikes (i.e. positive cloud and negative ground) are more violent.

The mechanism that describes the development of the lightning flashes includes a multi-step process, presented in Figure 2.2 (IEEE Std 998-1996). Necessary requirement is the development of leaders (upward and downward) due to the ionization of the air surrounding the charge centers. Between the cloud and the earth a strong electric field is arisen and the



dielectric strength of the air is reduced. The downward leader approaches the ground, since the upward leader has the opposite direction from ground to cloud. When the two leaders are joined, a lightning flash is occurred (return stroke). The return stroke, that follows the “electric” path formed by the stepped leaders, consist the main lightning current; its current median value is about 24kA and its velocity of propagation is 30000000m/s, i.e. 10% of the speed of the light.

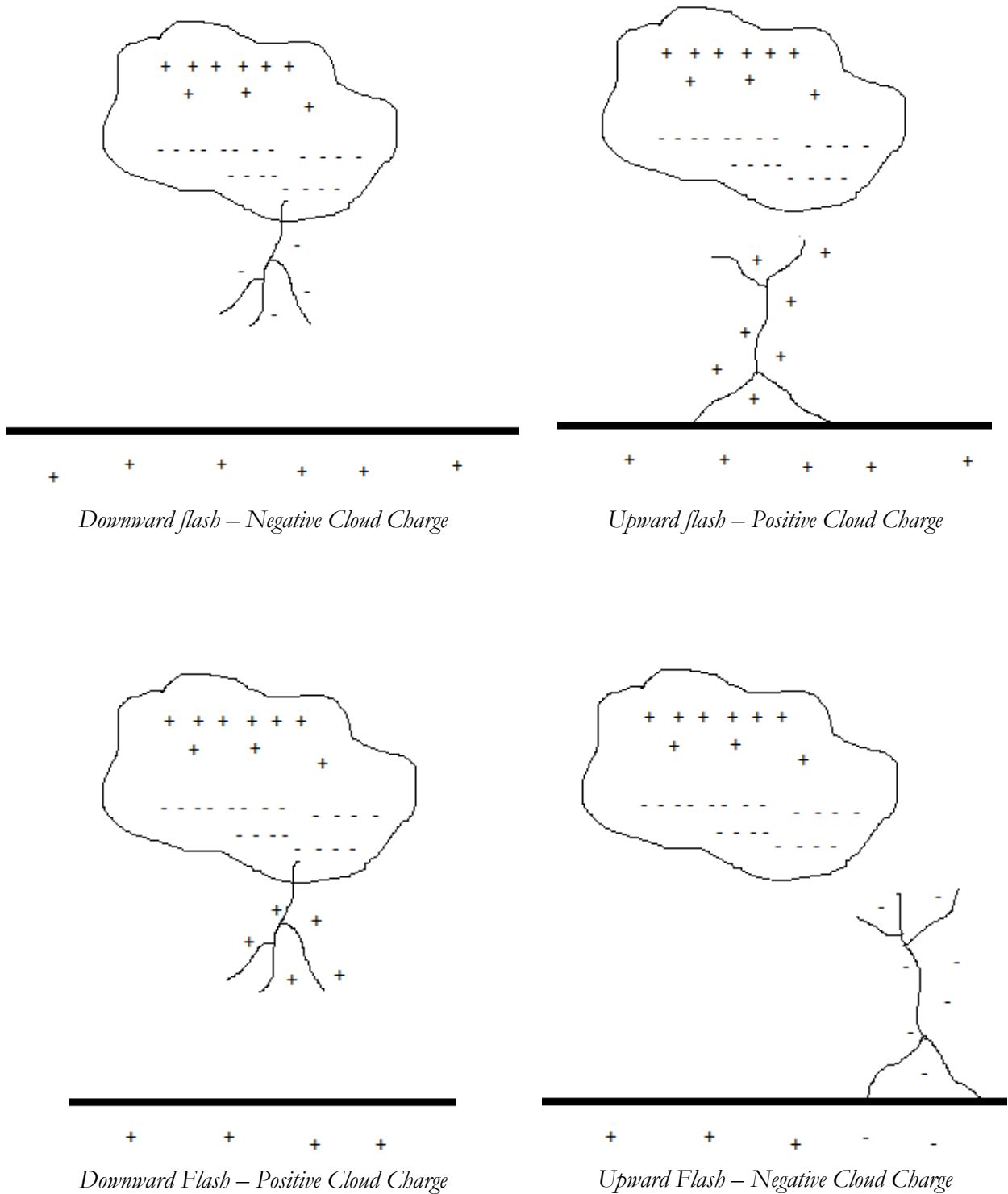

Figure 2.1: Cloud-to-Ground Lightning Flashes (Uman 2008)

Current magnitudes associated with stepped leaders are small (in the order of 100 A) in comparison with the final stroke current. The velocity of propagation is approximately 150000m/s, i.e. 0.05% of the light speed (Uman 2008), (IEC 62305-1 2006), (Anderson 1987). After the first stroke, subsequent strokes can be developed along the same or in similar paths. A positive lightning usually has only one strike. The downward negative flash is considered to be the most important discharge process for practical engineering applications.

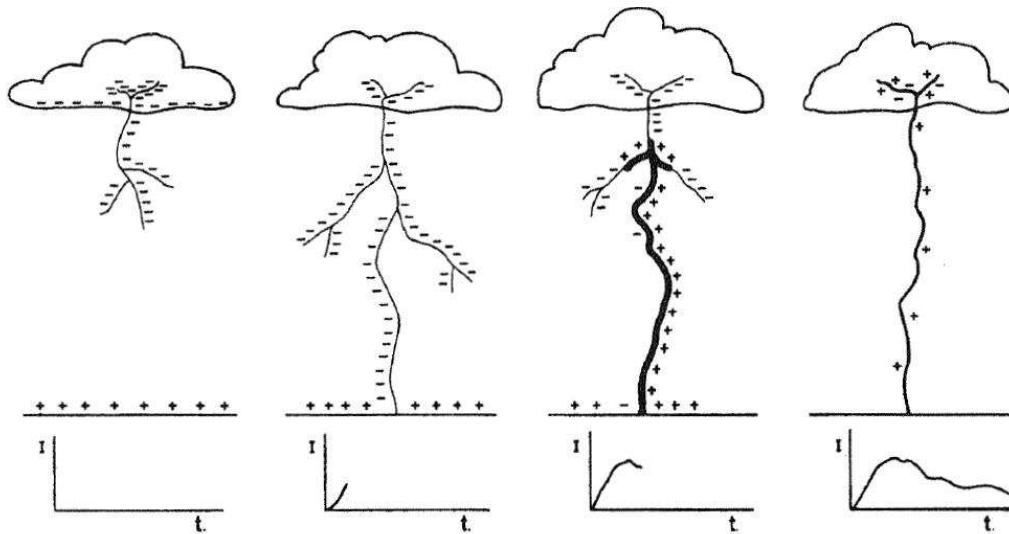

Figure 2.2: Development of a Downward Negative Lightning Flash (Abdel-Salam et al.)

## 2.2 Lightning Parameters (*Wave Shapes, Peak Values, Times etc.*)

### 2.2.1 *Lightning Current Waveform*

Figure 2.3 presents a typical double exponential waveform of a lightning current. The peak current and the duration of the waveform play important role for a series of electrical parameters.

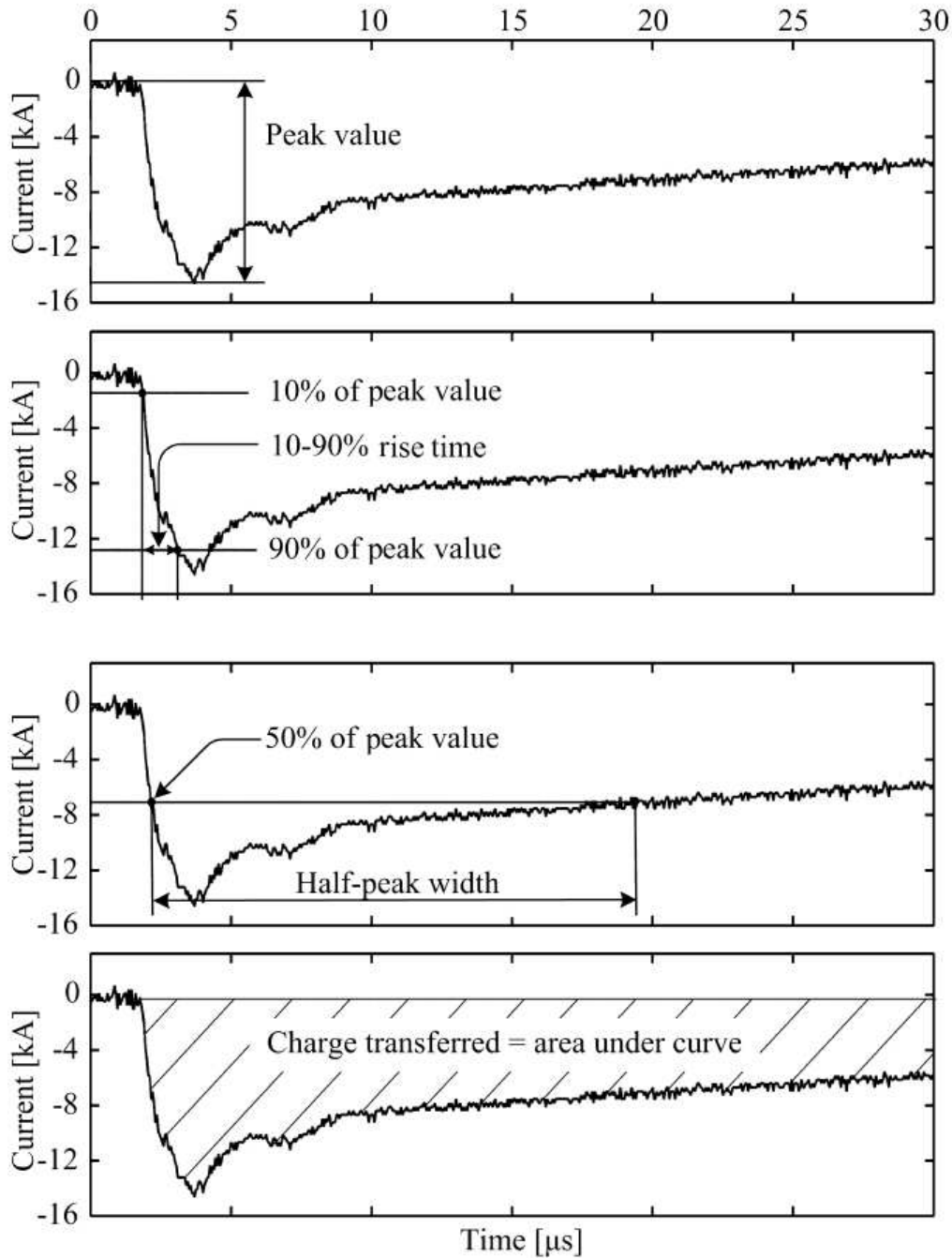

Figure 2.3: Lightning Current Waveform (IEEE Std 998-1996)

### 2.2.2 Peak Current

The peak value of the lightning current is one of the most significant parameters that determine the developed overvoltages. The median value of strokes to overhead ground wires, conductors, structures and masts is commonly considered to be 31 kA (Anderson 1987). According to (Anderson 1987) the probability that a certain peak current will be exceeded in any stroke is given as following:



$$P(I) = \frac{1}{1 + \left(\frac{I}{31}\right)^{2.6}} \quad (2.1)$$

Where;

$P(I)$  is the probability that the peak current in any stroke will exceed  $I$

$I$  is the specified crest current of the stroke in kiloamperes

In (Mousa, Srivastava 1989) is proposed that a median stroke current of 24 kA for strokes to flat ground results to the optimum correlation with available field observations data. In this case, the probability that a certain peak current will be exceeded in any stroke is given by the equation:

$$P(I) = \frac{1}{1 + \left(\frac{I}{24}\right)^{2.6}} \quad (2.2)$$

Figure 2.4 is obtained by the implementation of eq.(2.1); Figure 2.5 depicts the probability of lightning flash to a flat ground will be within the ranges shown on the abscissa (IEEE Std 998-1996).

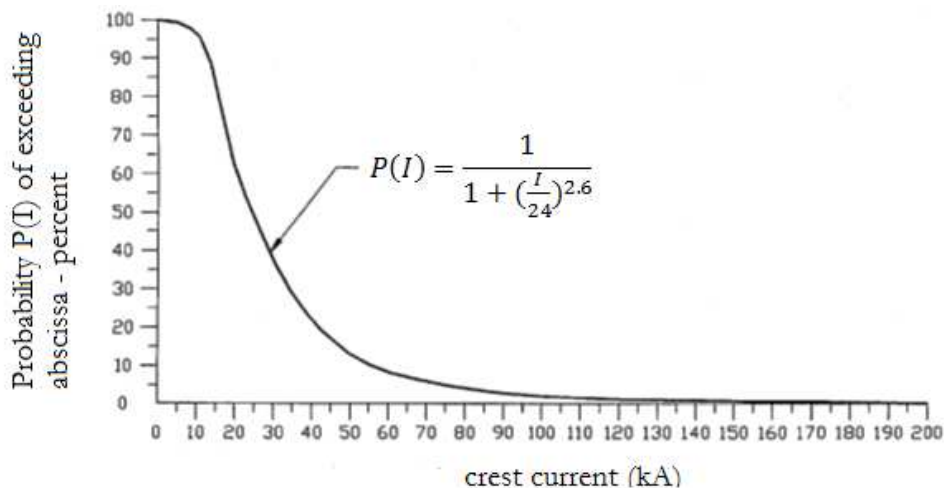

Figure 2.4: Distribution Function of the Peak Value of Lightning Flash (IEEE Std 998-1996)

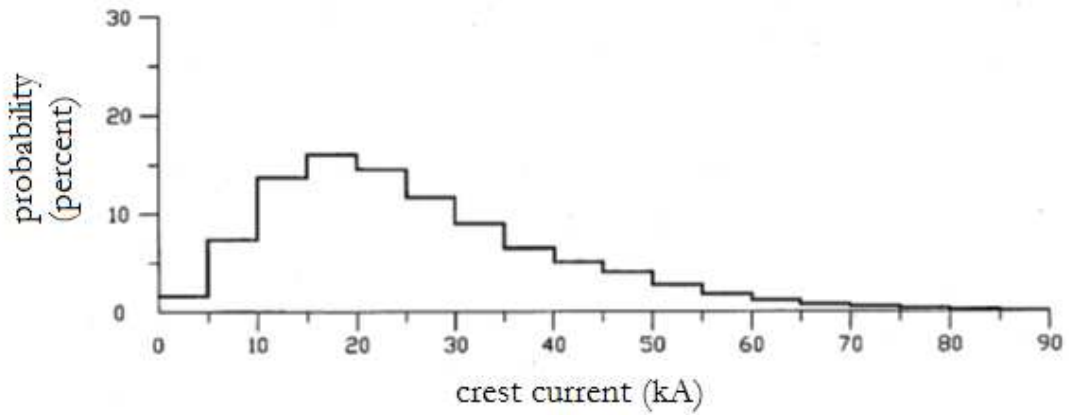

Figure 2.5: Stroke Current Range Probability for Strokes to Flat Ground (IEEE Std 998-1996)

### 2.2.3 Current Rise Time

The current rise time determines the induced surges. Various researchers have given probability distributions, based on real recorded measurements. Berger's results in (BRITISH STANDARD 6651 1999) give a median value of  $\mu\text{s}$  for the first stroke current and steeper fronts of up to  $100 \text{ kA}/\mu\text{s}$  for subsequent strokes. Other researchers give  $9\text{--}65 \text{ kA}/\mu\text{s}$  (median  $24 \text{ kA}/\mu\text{s}$ ) for the first stroke, and  $10\text{--}162 \text{ kA}/\mu\text{s}$  (median  $40 \text{ kA}/\mu\text{s}$ ) for subsequent strokes. In addition, BS6651 (Bouquegneau et al. 1986) gives  $(di/dt)_{\text{max}} = 200 \text{ kA}/\mu\text{s}$ .

In any case, the rate of change of current measured in (BRITISH STANDARD 6651 1999), for the first and the subsequent strokes, is given by the equations:

$$\frac{di}{dt} = 3.9 \cdot I^{0.55} (\text{kA}/\mu\text{s}) \text{ (First stroke)} \quad (2.3)$$

$$\frac{di}{dt} = 3.8 \cdot I^{0.93} (\text{kA}/\mu\text{s}) \text{ (Subsequent stroke)} \quad (2.4)$$

In (BRITISH STANDARD 6651 1999) are also provided mean values for the current tail duration and its statistical range:

- First stroke: mean  $75 \mu\text{s}$ , range  $30\text{--}200 \mu\text{s}$
- Later strokes: mean  $32 \mu\text{s}$ , range  $6.5\text{--}140 \mu\text{s}$ .



Figure 2.6 depicts the waveforms of a negative lightning flash, including the first and the subsequent strokes.

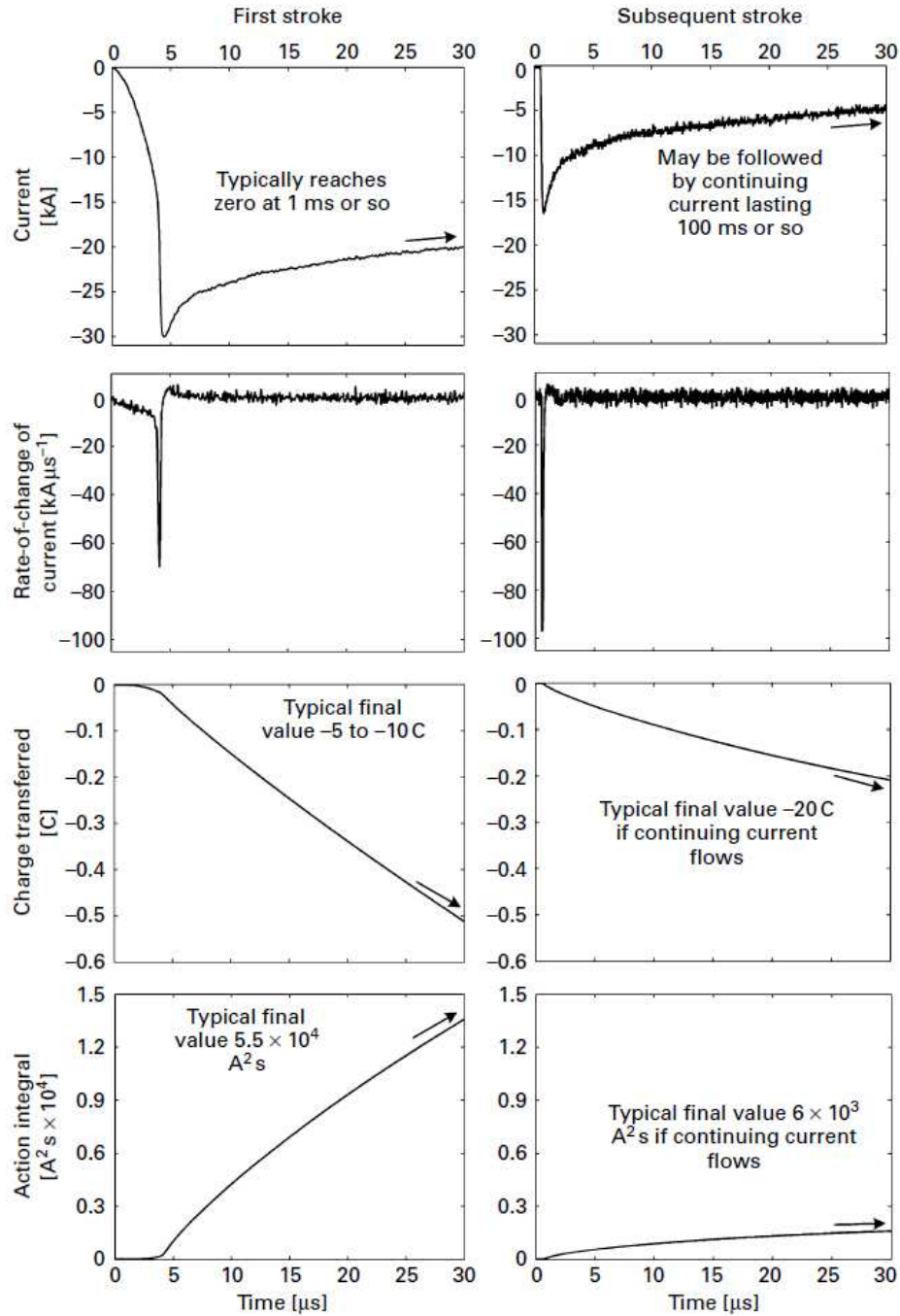

Figure 2.6: Current Waveforms of Negative Lightning First and Subsequent Stroke (Uman 2008)



Table 2.1 presents the mean value and the standard deviation of the peak value and the steepness of various lightning flashes.

*Table 2.1: Mean Value and Standard Deviation of the Peak Value and Steepness of Various Lightning Flashes (Berger et al. 1975), (CIGRE W.G. 1991), (Garbagnati et al. 1978)*

		Mean value	Dispersion
<b>Berger (Berger et al. 1975)</b>			
Positive Stroke	I (kA)	35	1.21
Positive Stroke	di/dt (kA/μs)	2.4	1.54
Negative Stroke	I (kA)	30	0.53
Negative Stroke	di/dt (kA/μs)	12	0.54
<b>CIGRE WG (CIGRE W.G 1991)</b>			
Negative Stroke	I (kA)	31.1	0.48
Negative Stroke	di/dt (kA/μs)	24.3	0.60
<b>Garbagnati et al (Garbagnati et al. 1978)</b>			
Negative Stroke	I (kA)	33	0.25
Negative Stroke	di/dt (kA/μs)	14	0.36

#### 2.2.4 Leader Approach Angle

The lightning stroke direction from cloud to ground is considered in general in a vertical path (Eriksson 1987), (Mousa, Srivastava 1989). However, in some cases an approach angle leader must be considered, according to a probability distribution, given by the following equation [Brown, whitehead1969]:

$$g(\varphi) = \begin{cases} 0, & \varphi < -\pi/2 \\ K_m \cos^m \varphi, & -\pi/2 < \varphi < \pi/2 \\ 0, & \varphi > \pi/2 \end{cases} \quad (2.5)$$

Where;

$m=1$  ( $K_m=1/2$ ), either

$m=2$  ( $K_2=2/\pi$ ) or

$m=\infty$  (case of vertical strokes).





### ***2.3 Lightning Damage***

In general, the effects of lightning strikes depend mainly on the conductivity of the materials and include electrical, thermal, electrodynamic, electromagnetic, electrochemical, acoustic and physiological repercussions (Abdel-Salam et al. 2000). The lightning effects and the consequent damages depend on the characteristics of the lightning current (see paragraph 2.2). The peak current of the lightning flash and the duration of the waveform determine the thermal consequences, which include increase of the temperature or melting of the conductors. In case that lightning hits objects that present high resistance (e.g. trees, wooden structures etc.) the produced thermal energy will be even higher, including also the danger of fire (IEC 62305-1 2006). Furthermore, mechanical effects can be caused by the lightning current, which are influenced by the peak value and the duration of the lightning current as well as by the elastic characteristics of the affected mechanical structure; in practice, both thermal and mechanical effects occur simultaneously. Lightning affecting a substation can cause serious damages to the insulation of the equipment, leading to potential interruption of the normal operation of the system. The damages and failures may also extend to the surroundings of the substation and even involve the local environment and the personnel. As far as the induced overvoltages is concerned, their magnitude is proportional to the self-inductance multiplied by the steepness of the lightning current (IEC 62305-1 2006).

### ***2.4 Ground Flash Density (GFD) – Keraunik Level***

Keraunic level is defined as the average annual number of thunderstorm days or hours for a given locality. A daily keraunic level is called a thunderstorm-day and is the average number of days per year on which thunder is heard during a day (24h). If thunder is recorded on any one day more than one time, the day is still classified as one thunder-day (IEEE Std 998-1996). The keraunic level (T) of various regions is given in appropriate maps (isokeraunik), which represent by using lines the annual frequency of thunderstorm days in the world (World Distribution of Thunderstorm Days, WMO No. 21, 1056). Figure 2.7 depicts the world map of isokeraunik level (HUBER & SUHNER Group 2010).

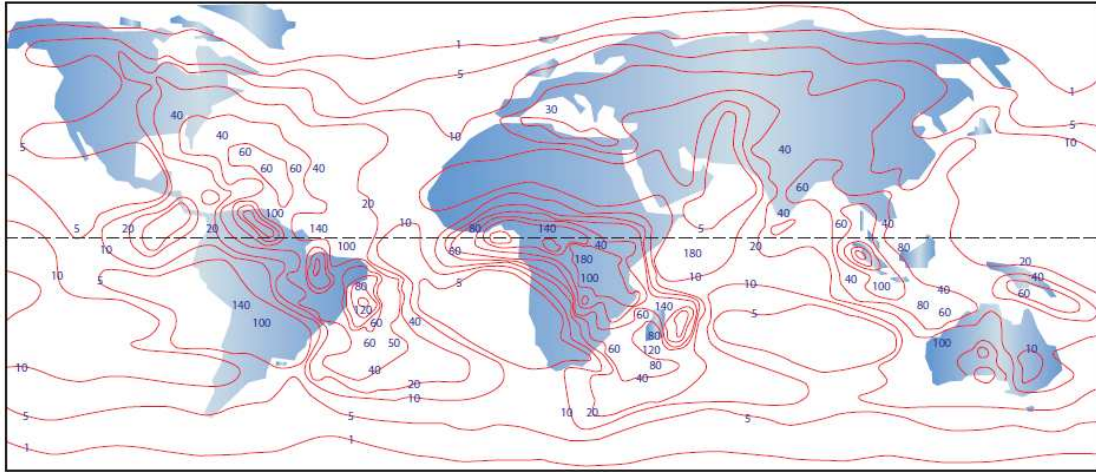

Figure 2.7: World map of Isokeraunik Level (HUBER & SUHNER Group 2010)

Ground flash density (GFD) is defined as the average number of strokes per unit area per unit time at a particular location. The GFD to earth, a substation, or a transmission or distribution line is, generally, roughly proportional to the keraunic level at the locality. Various researchers have proposed different approaches for the calculation of GFD, given by the following equations (IEEE No.3 1993), (IEEE Std 1243-1991 1997):

$$N_g = \frac{T}{5} \quad (2.6)$$

$$N_g = \frac{T}{7} \quad (2.7)$$

$$N_g = 0.19 \cdot T \quad (2.8)$$

$$N_g = 0.15 \cdot T \quad (2.9)$$

$$N_g = 0.13 \cdot T \quad (2.10)$$

$$N_g = 0.04 \cdot T^{1.25} \quad (2.11)$$

Where;

$N_g$  is the number of flashes to earth per square kilometer per year

$T$  is the average annual keraunic level, thunderstorm days (IEEE Std 998-1996).

The ground flash density can be directly recorded by using appropriate flash counters (such as CIGRE counter system and CCIR counter system which are located in most of European and Mediterranean countries (CIGRE W.G. 1991)). Otherwise, the ground flash density can be estimated by using NASA satellite's observations of average optical transient density for the geographical the region (NASA OTD Lightning 2008). Figure 2.8 presents a revised map from the NASA/MSFC lightning imaging sensor of optical transient density after completion of OTD mission and NSSTC analysis (Christian et al. 2003).

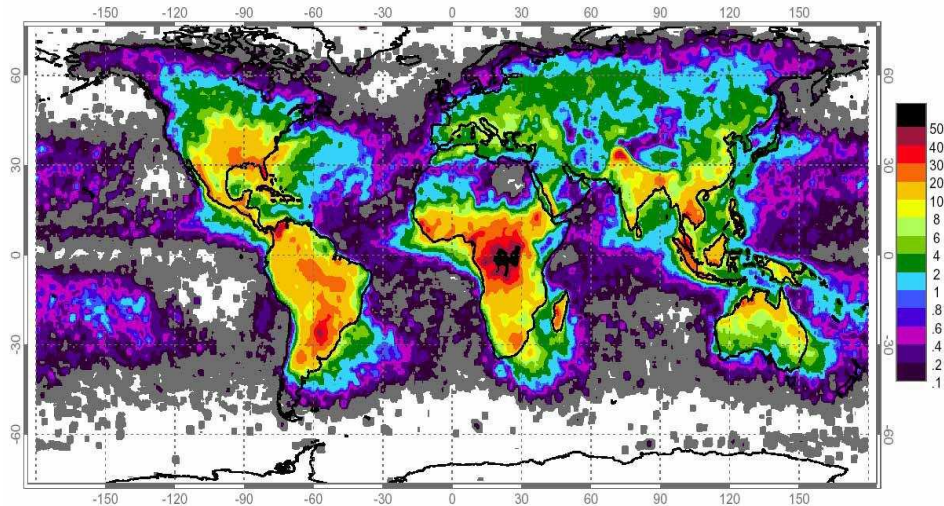

Figure 2.8: Lightning Imaging Sensor of Optical Transient Density after Completion of OTD Mission and NSSTC Analysis. (IC+CG) flashes per km<sup>2</sup> per year (Christian et al. 2003).

## 2.5 Conclusions

The current chapter presents the fundamentals of lightning surges that consist the main cause of stresses and damages of the equipment of the HV/MV substations. The knowledge of the lightning mechanism and the characteristics of the lightning currents are necessary, in order to obtain the appropriate protective measures. The peak current and the steepness of the lightning current determine the expected magnitude of the overvoltage and the range of the induced voltages. Furthermore, the duration of the lightning current waveform determines the energy consumption of the arresters, influencing their failure probability. The ground flash density and the keraunik level are also necessary information for lightning performance studies.



## References

- Abdel-Salam M., Anis H., El-Morsbedy A., Radwan R., "High Voltage Engineering, Theory and Practice", Marcel Dekker Inc, New York, 2000.
- Anderson J.G., Chapter 12 of *Transmission Line Reference Book 345 kV and Above*, 2nd Ed. Rev. Palo Alto, Calif.: Electric Power Research Institute, 1987.
- Anderson R.B, Eriksson A.J. *Lightning parameters for engineering application*. Electra No.69, CIGRE, 1980, pp65-102.
- Anderson R. et al., *Lightning and Thunderstorm Parameters*, in *Lightning and Power Systems*, London, IEE Conf. Publ. n° 236, 1984
- Berger K., Anderson R.B., Kroninger H., "Parameters of lightning flashes", *Electra*, no. 41, pp. 23-37, 1975.
- Bouquegneau C., Dubois M., Trekat J., *Probabilistic analysis of lightning performance of high-voltage transmission lines*, *Electr. Power Syst. Res.* 102 (1-2) (1986) 5-18.
- BRITISH STANDARD 6651: 'Code of practice for protection of structures against lightning', 1999
- Chisholm W.A., *Estimates of lightning ground flash density using optical transient density*, *IEEE PES Trans. Distribution Conf. Exposition 3* (2003) 1068-1071.
- Christian H.J., Blakeslee R.J., Boccippio D.J., Boeck W.L., Buechler D.E., Driscoll K.T., et al., *Global frequency and distribution of lightning as observed from space by the optical transient detector*, *J. Geophys. Res.* 108 (D1) (2003) 4005-4019.
- CIGRE Working Group 01 of Study Committee 33, "Guide to procedures for estimating the lightning performance of transmission lines", *CIGRE Tech. brochures*, no. 63, 1991.
- Eriksson J.A., "The incidence of lightning strokes to power lines", *IEEE Transactions of Power Delivery*, vol. 2, no. 3, pp. 859-870, July 1987
- Garbagnati E., Giudice E., Lopiparo G.B., "Messung von Blitzströmen in Italien- Ergebnisse einer statistischen Auswertung", *ETZ*, no. 11, pp. 664-668, 1978.
- Heidler F., Zischank W., Flisowski Z., Bouquegneau Cb., Mazzetti C., "Parameters of lightning current given in IEC 62305 – background, experience and outlook", *29th International Conference on Lightning Protection*, 23-26 June 2008, Uppsala, Sweden
- Hileman A. R., "Insulation Coordination for Power Systems", CRC Press, 1999.
- HUBER & SUHNER Group, "Lightning Protection", Edition 2010.
- IEC 62305-1, "Protection against lightning – Part 1: General principles", 2006.
- IEEE Std 1243-1991, "Guide for Improving the Lightning Performance of Transmission Lines", June 1997
- IEEE Std 998-1996, "IEEE Guide for Direct Lightning Stroke Shielding of Substations", 1996
- IEEE Working Group on Estimating the Lightning Performance of Transmission Lines, *Estimating the lightning performance of transmission lines. II. Updates to analytical models*, *IEEE Trans. PWRD* 8 (3) (1993) 1254-1267.
- IEEE Working Group on Lightning Performance of Transmission Lines, *A simplified method for estimating lightning performance of transmission lines*, *IEEE Trans. PAS* 104 (4) (1985) 919-927.
- IEEE Working Group Report, "Estimating Lightning Performance of Transmission Lines II – Updates to Analytical Models", *IEEE Transactions on Power Delivery*, Vol.8, No.3, July 1993
- Mousa A.M., Srivastava K.D., "The implications of the electrogeometrical model regarding effect of height of structure on the median amplitudes of collected lightning strikes", *IEEE Transactions on Power Delivery*, vol. 4, no. 2, pp. 1450-1460, 1989.
- NASA OTD Lightning, 2008, <http://thunder.nsstc.nasa.gov>.



*Sabiba N.A., "Lightning-induced overvoltages in medium voltage distribution systems and customer experienced voltage spikes", Doctoral Dissertation, Aalto University, School of Science and Technology, Faculty of Electronics, Communications and Automation, Department of Electrical Engineering.*

*Uman M.A., "The Art and Science of Lightning Protection", Cambridge University Press, 2008*

*World Distribution of Thunderstorm Days, "World Meteorological Organization", Geneva, Switzerland, WMO No. 21, 1056.*

*Brown, Gordon W; Whitehead, Edwin R, IEEE Transactions on Power Apparatus and Systems, 1969, Volume PAS-88, Issue 5*



## CHAPTER 3

# LIGHTNING PROTECTION OF SUBSTATIONS

### 3.1 Various Types of Substations

Electrical power systems are complex configurations that warrant the safe, economical and reliable transmission of the electrical energy and its distribution to the consumers. In general, electrical energy is transmitted and distributed by using ac high voltage, but in some cases technical and economic criteria impose the use of dc high voltage. ac voltage is easier to be transformed (changing the voltage level), since dc voltage presents lower power losses (but conversion of ac to dc and vice versa is demanded). The various parts of a typical power system are appropriately connected, in order to achieve high degree of continuity, maximum reliability, and flexibility (Siemens 2008, Abdel-Salam et al.). So, basic role of the substations is to connect the transmission lines, subtransmission feeders, generating units, and transformers and to meet the above demands and restriction with the highest possible economy (Siemens 2008, Abdel-Salam et al.).

There are four major types of electric substations (Grigsby 2007):

- **The switchyard substation:** it connects the generators to the utility grid.
- **The customer substation:** it is the main source of electric power supply for one particular business customer.
- **The system station:** it involves the transfer of bulk power across the network or switching facilities.
- **The distribution station:** it provides the distribution circuits that directly supply the customers.

The substations can also be categorized as following (Grigsby 2007, McDonald et al 2000):

- Outdoor type with air insulated substations (AIS) equipment
- Indoor type with air insulated substations (AIS) equipment
- Outdoor type with gas insulated substations (GIS) equipment
- Indoor type with gas insulated substations (GIS) equipment
- Mixed technology substations (AIS) & (GIS)
- Mobile substations



Moreover, substations are distinguished according to the voltage level (Siemens 2008):

- Medium Voltage / High Voltage (MV/HV)
- High Voltage/High Voltage (HV/HV)
- High Voltage/ Medium Voltage (HV/MV)

Fig. 3.1 depicts the configuration of a typical substation with multiple bus-bars.

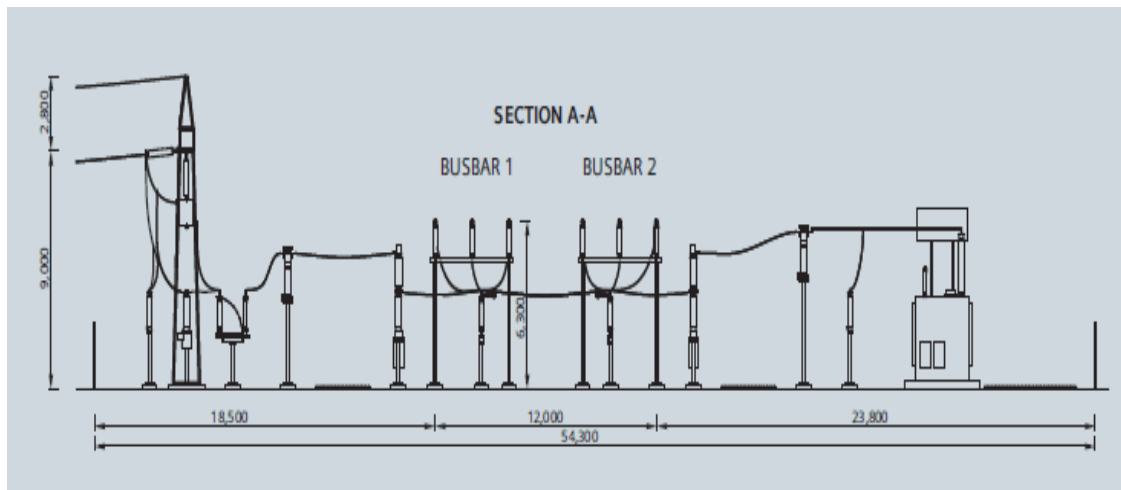

*Figure 3.1: Arrangement of a Typical Substation (Siemens 2008)*

Depending on the insulation material that will be used, three basic designs are possible (Siemens 2008):

- **Air-Insulated Substations (AIS):** AIS are preferred for voltage levels up to 800 kV, wherever space and environmental restrictions are not severe. Disadvantage of outdoor AIS is their exposure to environmental effects
- **Gas-Insulated Indoor or Outdoor Switchgear (GIS):** They are appropriate to be installed in urban or industrial regions, due to their compact design and their small dimensions. For this reason, they are preferred in cases that overhead high voltage transmission lines are not compatible.
- **Mixed Technology (Compact/Hybrid Solutions):** Except from the above conventional designs, there are also compact solutions available that can be realized with Air-Insulated and/or Gas-Insulated components (Siemens 2008).

Medium and low Voltage Switchgears are used for residential, commercial and industrial purposes, and are out of scope of the current work.

## 3.2 Basic Parts of Substations and their Electrical Characteristics

### 3.2.1 Transmission Lines

The electrical energy is transmitted to the substation through overhead high voltage transmission lines. A typical transmission line consists of the tower, the phase conductors, the insulators, the overhead ground wires and the grounding systems. Figure 3.2 presents various configurations of high voltage lines that are used in the current analysis; it is worth mentioning, that each type of tower results to differentiations of the applied electrogeometrical model, since the geometry of the line changes.

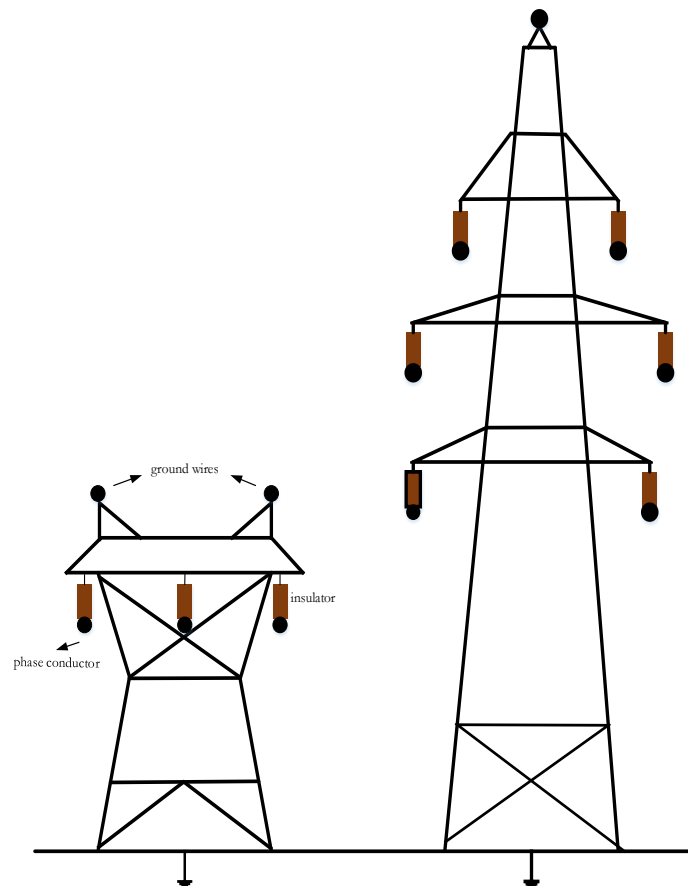

Figure 3.2: Configuration of High Voltage Transmission Lines  
(a) 150kV Single Circuit, (b) 400kV Double Circuit (Christodoulou et al. 2010)

Conductors are the basic components of the overhead line, since they carry the transferred electrical energy; for this reason, their materials and geometrical characteristics are of great importance, in order to ensure reliable and economical transmission of the power. The most





used conductive material is Aluminum, due to its very advanced characteristics, i.e. advantageous price, low weight and the achievement of minimum cross-sections (high conductivity). On the other hand, Aluminum is a very corrosive metal with limited mechanical strength. In order to reinforce the mechanical behavior of the conductors, compound conductors with a steel core (so-called aluminum conductor steel-reinforced (ACSR)) are used. Figure 2.3 presents the cut-off of various types of steel-reinforced aluminum conductors.

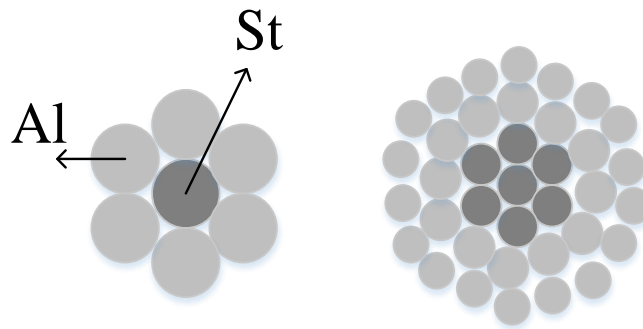

*Figure 3.3: Cut-off of Steel-Reinforced Aluminum Conductor (McDonald, J. et al 2000)*

Experience field data give an average lifetime of ACSR of years. The electrical resistance of the conductors is mainly depended on:

- The Material
- The Cross Section
- The Length

The temperature and the skin effect should also be taken into consideration. A current density of 0.5 to 1.0 A/mm<sup>2</sup> based on the aluminum cross-section has proven to be an economical solution in most cases. Furthermore, during the design of a transmission line and the selection of the conductor's electrotechnical characteristics high voltage gradients at the conductors' surface have to be avoided, since the resulting corona effects cause visible partial discharges, radio interferences, audible noise and energy losses. To this direction, ac voltage gradient should not exceed 15 to 17kV/cm. The effects of the Corona phenomenon are restrained by using multiple sub-conductors, in order to increase the equivalent cross-section of the conductor. This aspect is important for lines with voltages of 245 kV and above. As far the mechanical characteristics concern, the conductor has to be withstanding the environmental conditions and stressing loads by wind and ice.



Concerning the above characteristics of the transmission lines, the appropriate circuit representation is a critical issue, in order to guarantee the quality and the reliability of the lightning performance studies. To evaluate influence of various transmission lines models application on simulation results in insulation coordination studies, PI model, and frequency-dependent JMarti model are usually chosen to analysis.

Overhead lines models are based on PI circuit consist of linear RLC components. Typical transmission line PI model is presented in Figure 3.4.

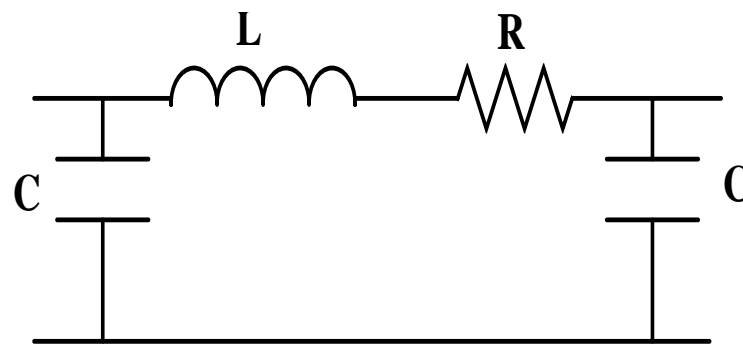

Figure 3.4: Overhead Line PI Model (Martinez & Castro-Aranda 2005)

PI (or  $\pi$ ) model is a simplified model for transient analysis studies, appropriate mainly for transmission lines of short length. In fact, PI model constitutes a discrete approximation of the constant distributed parameter model. PI model uses lumped parameters, which can result to false oscillation. The above disadvantage can be limited by connecting in parallel R-L elements. JMarti frequency-dependent model is more appropriate for the study of lightning performance of high voltage transmission lines, since it improves the reliability and the accuracy of the obtained results by approximating the characteristic admittance and the propagation constant by rational functions, in order to convert from mode domain to phase domain. JMarti model offers higher accuracy compared with PI model. In JMarti model, both the characteristic impedance  $Z$  as well as the propagation function are calculated using modal characteristics (calculated in defined frequency range for a constant transformation matrix). Thus, JMarti model computes the characteristic admittance and propagation constant by rational functions. JMarti model uses a constant transformation matrix in order to convert from mode domain to phase domain (although in case of modeling transmission line it does not matter, still it can have influence for cable line case). Model requires defined frequency



where the transformation matrix is calculated (this frequency should be dominant in the later transient study), and a steady state frequency for calculation of the steady state condition. The JMarti model needs in some cases modification of the default fitting data.

Fig 3.5 depicts the basic representation of each end of the multi-phase J.Marti model (Dommel et al. 1986, IEEE Fast Front Transients Task Force 1996, Marti 1982).

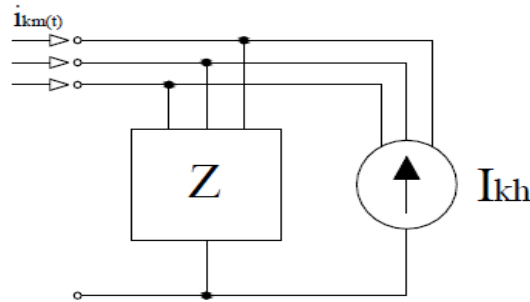

Figure 3.5: J.Marti model (IEEE Fast Front Transients Task Force 1996)

The circuit representation of line towers is a more complex procedure in comparison to the other parts of the line. The tower is divided in various segments, which are represented by vertical lossless single-phase frequency-independent distributed parameter line in combination with lumped circuit elements (IEEE W. G. P1243 1996, Hara & Yamamoto 1996, Ametani et al. 1994, Rondon et al. 2005, Gutierrez et al. 2003, Ishii et al. 1991, Yamada et al. 1995, Motoyama et al. 1998, Baba & Ishii 2000, Ametani & Kawamura 2005, Oettle E. E. 1988, Chisholm & Janischewskyj 1989, CIGRE W.G. 33.01 1991, Weck 1988, Chowdhuri 1996, Mikropoulos et al. 2010) (Figure 3.5). Tower equivalent circuit models can be distinguished as (Fig. 3.6):

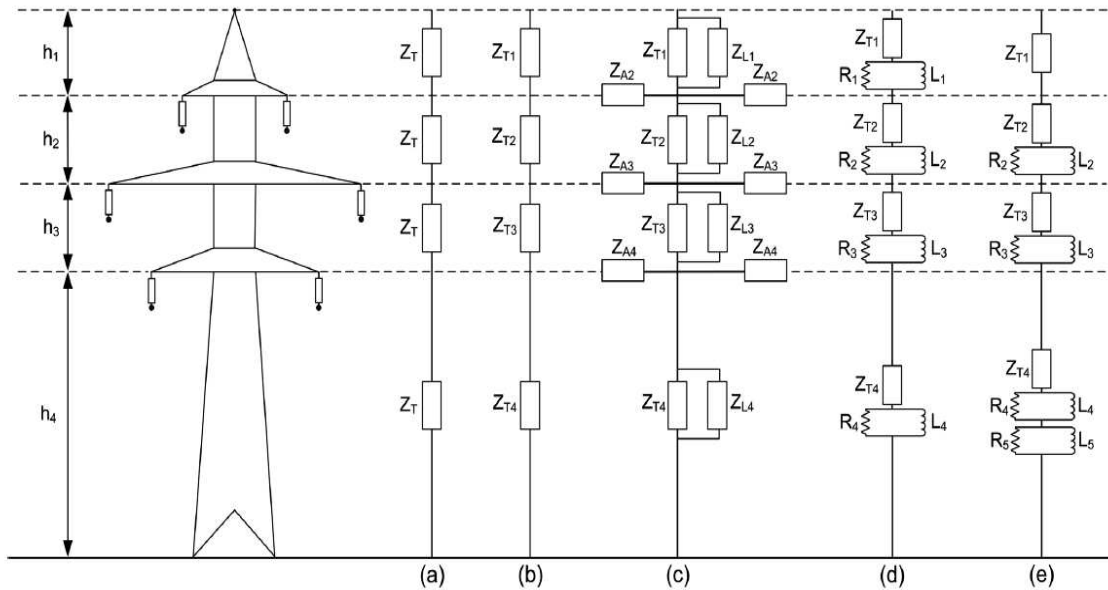

Figure 3.6: Tower Models

- (a) *Single Vertical Lossless Line Models* (IEEE W. G. P1243 1996, Hara & Yamamoto 1996, Ametani et al. 1994, Rondon et al. 2005, Gutierrez et al. 2003, Ishii et al. 1991, Yamada et al. 1995, Motoyama et al. 1998),
- (b) *Multi-Conductor Models* (Baba & Ishii 2000, Ametani & Kawamura 2005)
- (c) *Hara et al. Multi-Conductor Model* (Hara & Yamamoto 1996),
- (d) *Multistory Models* (Chisholm & Janischewskij 1989, CIGRE W.G. 33.01 1991, Weck 1988),
- (e) *Baba & Ishii Multistory Model* (Chowdhuri 1996).

- Single Vertical Lossless Line Tower Models:** the towers are represented bare regarded as cylinder or cone shape constructions and their surge impedance is given in Table 3.1. These equations are obtained by theoretical estimations or laboratory measurements. Note, so, that the propagation of the overvoltage wave is performed with a velocity equal to 85% of the light speed (IEEE W. G. PAS-104 1985).

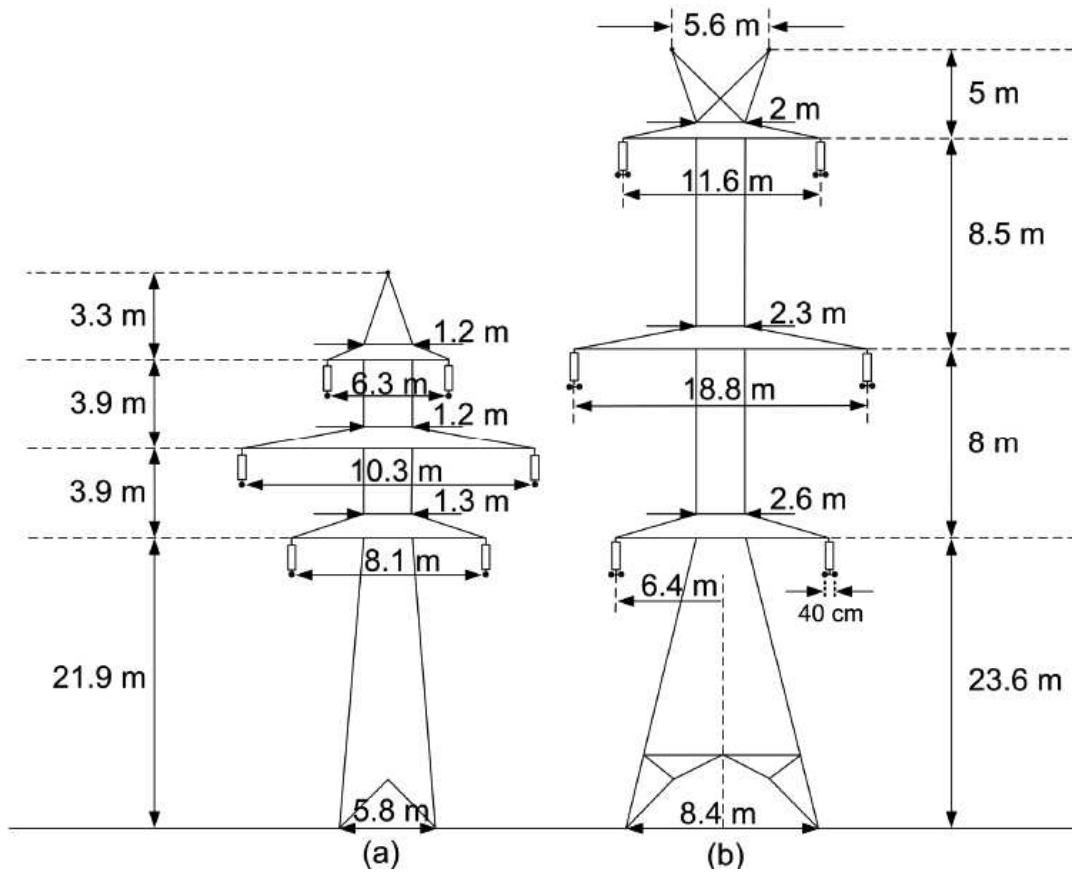

Figure 3.7: Typical Towers of :(a) 150 kV, (b) 400 kV Double-Circuit Lines; the length of insulator strings are 1.86 (m) and 3.62 (m) for the 150 kV and 400 kV line, respectively (Mikropoulos et al. 2010)

- Multi-conductor Tower Models:** the surge impedance of each segment is estimated by using electromagnetic field analysis. The proposed models represent each segment by single vertical lossless line with different surge impedance, considering also the effect of bracing and cross arms. The propagation of the overvoltage wave is performed with a velocity equal the light speed (IEEE W. G. PAS-104 1985).



Table 3.1: Tower Surge Impedance for Single Vertical Lossless Line Models

No	Model	Expression
1	Jordan (Jordan 1934)	$Z_r = 60 \ln \left( \frac{h}{r_2} \right) - 60$
2	Wagner &Hileman (Wagner & Hileman 1960)	$Z_r = 60 \ln \left( \sqrt{2} \frac{2h}{r} \right)$
3	Sargent &Darveniza (Sargent & Darveniza 1969)*	$Z_r = 60 \ln \left( \sqrt{2} \frac{2h}{r_3} \right) - 60$
4	Sargent &Darveniza (Sargent & Darveniza 1969)** IEEE WG (IEEE W. G. PAS-104 1985)	$Z_r = 60 \ln \left( \sqrt{2} \frac{\sqrt{r^2 + h^2}}{r} \right)$
5	Menemelis& Chum (Menemenlis & Chun 1982)	$Z_r = 50 + 35\sqrt{h}$
6	Chisholm et al. (Chisholm et al. 1985)**	$Z_r = 60 \ln \left( \cot \left( \frac{1}{2} \tan^{-1} \left( \frac{r}{h} \right) \right) \right)$
7	Chisholm et al. (Chisholm et al. 1985)*	$Z_r = 60 \ln \left( \cot \left( \frac{1}{2} \tan^{-1} \left( \frac{r}{h} \right) \right) \right) - 60$
8	Chisholm et al. (Chisholm et al. 1985)***	$Z_r = 60 \ln \left( \cot \left( \frac{1}{2} \tan^{-1} T \right) \right)$
9	Flash ver. 1.7 (IEEE W. G. P1243 1996)	$Z_r = \sqrt{\frac{\pi}{4}} 60 \left( \ln \left( \cot \left( \frac{1}{2} \tan^{-1} T \right) \right) - \ln \sqrt{2} \right)$
10	Hara &Yamatomo (Hara & Yamamoto 1996)	$Z_r = 60 \ln \left( \sqrt{2} \frac{2h}{r_2} \right) - 120$

\* Cylindrical Tower    \*\* Conical Tower    \*\*\* Waisted Tower

Where;

$r$  is the tower base radius(m),

$r_1$  is the tower top radius(m),

$r_2$  is the tower radius at waist(m),

$h$  is the tower height(m),

$h_1$  is the height from the base to waist(m),

$h_2$  is the height from the waist to top(m),

$$T = (r_1 h_2 + r_2 h + r h_1) / h^2 ,$$



$r_3$  is the cylinder radius representing the tower(m) (Sargent & Darveniza 1969).

**Multistory Tower Models:** each segment is represented by lossless line and R-L circuit (Figures 3.5(d) and 3.5(e)).  $R_i$  and  $L_i$  respectively, can be calculated for models (Ishii et al. 1991, Yamada et al. 1995, Motoyama et al. 1998) (Figure 3.6(d)) by using the following equations:

$$R_i = \frac{-2Z_{T_i} \ln \sqrt{\gamma}}{h_1 + h_2 + h_3} h_i, i = 1 - 3 \quad (3.1)$$

$$R_4 = -2Z_{T_4} \ln \sqrt{\gamma} \quad (3.2)$$

$$L_i = R_i \frac{k_i h}{v_T}, i = 1 - 4 \quad (3.3)$$

Where;

$h$  is the tower height(m) ,

$h_1, h_2, h_3$  are depicted in Figure 3.5,

$k_i = 2$ , and

$v_T$  is the surge propagation velocity equal to the speed of light.

As far the modeling of the grounding resistance of each tower is concerned, a concentrated earthing system can be represented as a constant resistance equal to the low current and low frequency grounding resistance (IEEE W. G. PAS-104 1985, Ametani & Kawamura 2005). Moreover, a concentrated tower grounding system can be represented by a current dependent grounding resistance,  $R(I)$ , in order to take into account soil ionization (Oettle E. E. 1988, Chisholm & Janischewskyj 1989, CIGRE W.G. 33.01 1991, Weck 1988, Chowdhuri 1996, Korsuntchev 1958, Yasuda et al. 2001).

Table 3.2 presents the most used current dependent tower grounding resistance models.



Table 3.2: Current Dependent Tower Grounding Resistance Models

Model	Expression
Oettle (Oettle E. E. 1988)	$\log \Pi_1 = -0.3 \cdot \log \Pi_2 - 0.62 ,$ $0.005 \leq \Pi_2 \leq 20$
Chisholm et al. (Chisholm & Janischewskyj 1989) (a) Chisholm et al. (Chisholm & Janischewskyj 1989) (b)	$\Pi_1 = 0.2631 \cdot \Pi_2^{-0.3082} , 0.3 \leq \Pi_2 \leq 10$
CIGRE WG (CIGRE W.G. 33.01 1991) from Weck (Weck 1988)	$R(I) = \frac{R_o}{\sqrt{1 + \frac{1}{I_g}}}$ $I_g = \frac{1}{2\pi} \cdot \frac{E_o \cdot \rho}{R_o^2}$
Chowdhuri (Chowdhuri 1996) from Korsuntcev (Korsuntchev 1958)	$\Pi_1 = 0.2965 \cdot \Pi_2^{-0.2867} , \Pi_2 \leq 5$ $\Pi_1 = 0.4602 \cdot \Pi_2^{-0.6009} , 5 \leq \Pi_2 \leq 50$ $\Pi_1 = 0.9534 \cdot \Pi_2^{-0.7536} , 50 \leq \Pi_2 \leq 500$ $\Pi_1 = 1.8862 \cdot \Pi_2^{-0.8693} , \Pi_2 > 500$
Yasuda et al. (Yasuda et al. 2001)	$R(I) = R_o, \quad I < I_g$ $R(I) = \frac{R_o}{\sqrt{\frac{I}{I_g}}}, \quad I \geq I_g$ $I_g = \frac{2\pi \cdot n \cdot r^2 \cdot E_o}{\rho}$

Where;

$I_g$  is the Limiting Current to initiate sufficient Soil Ionization(kA).

$\rho$  is the Soil Resistivity( $\Omega m$ ).

$r$  is the equivalent Radius of the Tower Footing(m).

$n$  is the Number of Grounding Electrodes.

$\Pi_1 = R \cdot s / \rho, \Pi_2 = (I \cdot \rho / s^2 \cdot E_o)$





$s$  is the Characteristic Distance (Chowdhuri 1996)( $m$ ).

Finally, when the developed overvoltage across the insulators of the line exceeds their dielectric strength, then a flashover is occurred. The flashover strength  $V_{FO}$  (kV) determined by the voltage-time characteristic of the insulator strings (Darveniza et al. 1975, IEEE W.G no. 3 1993). The flashover strength  $V_{FO}$ (kV) is given as (IEEE W.G no. 3 1993):

$$V_{FO} = (400 + 710 / t^{0.75}). D \tag{3.4}$$

Where;

$V_{FO}$  is The flashover strength (kV)

$D$  is the insulator string length(m),

$t$  is the elapsed time after lightning stroke( $\mu s$ ).

Except from the above approach, leader progression models (Weck 1981, Pignini et al. 1989) are used for circuit modeling of the insulators. Leader progression models are governed by the equation of Table 3.3, which are used for the computation of the leader length,  $L$ , at each time instant. Flashover occurs when  $L$  becomes equal to the insulator string length,  $D$ (Mikropoulos et al. 2010).

Table 3.3: Leader Progression Models

Model	Differential Equation
CIGRE (CIGRE W.G. 33.01 1991) Weck (Weck 1981)*	$dL/dt = k.V.[V/(D - L) - E_0]$
Pignini et al (Pignini et al. 1989)**	$dL/dt = 170.D.[V/(D - L) - E_0].exp[1.5.10^{-3}.V/D]$

Where;

$V$  is the Instantaneous Voltage across the Insulator String(kV).

\* $E_0$  is 600 for Cap (kV/m) & 1.3 for Pin Insulators  $k$  ( $m^2.kV^2.s^{-1}$ ).

\*\* $E_0$  Value according to Insulator Type and String Length.

### 3.2.2 Circuit Breakers

Circuit-breakers are the basic part of AIS and GIS switchgear. Main requirements that have to be fulfilled include (Siemens 2008):

- Reliability during opening and closing
- Adequate quenching ability during rated and short-circuit currents



- High-performance, reliable, maintenance-free operating mechanisms.

Figure 3.7 depicts a typical circuit breaker. Note, that circuit-breakers are assembled together with all individual electrical and mechanical components of an AIS installation on site. Main electrical characteristics of the circuit-breakers are: (Siemens 2008, Martinez-Velasco 2015)

- **Rated Voltage:** it is defined as the maximum level of the system voltage the circuit-breaker is designed for. Rated voltage determines the dielectric stresses is the major dimensioning criterion.
- **Rated Insulation Level:** it is the capability of the circuit-breaker to withstand various types of voltages (nominal voltages, switching surges, atmospheric overvoltages). The defined dielectric strength outcomes by impulse voltage (1.2/50 $\mu$ s) and power frequency voltage (50Hz) tests and concerns the developed phase-to-ground and phase-to-phase voltages and across the open contact gap.
- **Rated Normal Current:** it is the current that the circuit-breaker can continuously carry. The current passing through the components determines the increase of the temperature, which must not exceed the defined limits.
- **Rated Peak Withstand Current:** it is the peak value of the short-circuit current during a compensation process that the circuit-breaker (closed) can carry. Rated peak withstand current consist an index for the electrodynamic load of the device.
- **Rated Short-Circuit Making Current:** it is defined as the peak value of the making current in case of short-circuits at the terminals of the switching device. Comparing with the rated peak withstand current, the rated short-circuit making current is more violent, since dynamic forces may act against the contact movement.
- **Rated Breaking Current:** it is the load breaking current in normal operation.
- **Rated short-Circuit Breaking Current:** it is defined as the breaking current (rms) in case of short-circuits at the terminals of the circuit-breaker. (Siemens 2008, Martinez-Velasco Juan 2015).

Circuit breakers can be represented as ideal switches, ignoring dynamic phenomena and losses. Alternatively, more detailed circuit-breaker equivalent circuit models can be applied, in order to improve the accuracy of the simulation procedures. The most common models are (Siemens 2008):

- **Time Controlled Switch:** this model specifies the opening and closing times of the circuit-breaker, including also a current margin in order to simulate current chopping.



- **Statistical Switch:** appropriate distribution functions are applied in order to determine the switching operation of the device. The mean time and standard deviation are necessary inputs. Usually a few hundred simulations are run to determine the statistical distribution of interest such as the maximum relay currents.
- **Controlled Switch:** a control signal opens or closes the switch following a given strategy (Martinez-Velasco Juan 2015).

### 3.2.3 Current Transformers

Inductive ring type current transformers are installed inside or outside the substations enclosure, in order to record the current magnitude. Appropriate shielding against electric fields have to be performed, since high operating voltages and developed transient phenomena produce intense fields that may interfere to the reliable operation of the current transformers. The measured currents, converted to digital signs, are transmitted by using fiber optics to the control and protective relays (Grigsby 2007, McDonald 2003). The reliability of the current transformer depends on the electrical and insulation design, the manufacturing and processing technology used and the specific physical arrangement. The partial discharge performance under in-service conditions is a key determining factor in the life expectancy and long-term reliability of an instrument transformer (Siemens 2008).

### 3.2.4 Power Transformer

Power transformers constitute the basic component of the power substations, changing the voltage level of the transferred electrical energy. Substations power transformers are three phase and are classified according to their windings connection and their insulation (oil or solid dielectrics). The transformer ratio for any case is given in Table 3.4:

Table 3.4: Transformer Ratio for different Windings Connections

Windings connection	Transformer ratio
Yy	$a_{Yy} = V_{\text{Line-phase primary}} / V_{\text{line-phase secondary}}$
Yd	$a_{Yd} = \sqrt{3} a_{Yy}$
Dy	$a_{Dy} = \sqrt{3} / a_{Yy}$
Dd	$a_{Dd} = a_{Yy}$

The rated power, the rated frequency, the vector group, the insulation level, the insulation type, the rated primary and secondary voltages are the main specification data of the power



transformers are (Siemens 2008, Grigsby 2007, McDonald et al 2000, McDonald 2003, IEC 60071-2 1996). As far as the circuit representation of a power transformer, Figure 3.8 depicts the basic equivalent circuit model.

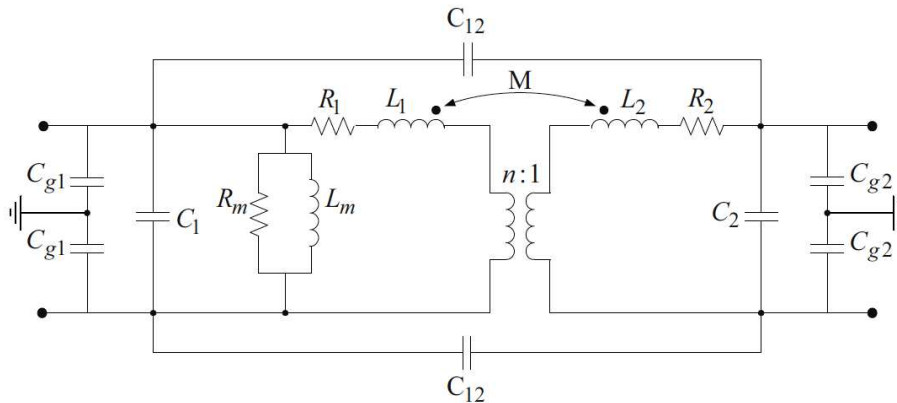

Figure 3.8: Equivalent Circuit Model of a Power Transformer

Where;

$n$  :Transformer's Ratio,

$R_m$  and  $L_m$ : core loss resistance and magnetization inductance to consider the no load current containing the core loss and magnetization current,

$R_1$  and  $R_2$  the primary and secondary winding resistances including conductors skin effects,

$C_1$  and  $C_2$ : series capacitances of the primary and secondary windings,

$C_{12}$ : parallel capacitance between two windings,

$C_{g1}$  and  $C_{g2}$ : capacitances between each winding and earth,

$L_1$  and  $L_2$  : self-inductances of windings,

$M$ : Mutual inductance between two windings)(Rahimpour & Bigdeli 2009).

However, the above basic circuit model does not adequately represent transient phenomena. High frequency models of power transformers are more appropriate for lightning performance studies, providing more accurate analysis and more reliable results. There are several approaches for power transformers circuit modeling, proper to reproduce transient interaction effects between the different high voltage power facilities. Figure 2.9 presents a simplified model of a transformer terminating a high voltage overhead line by its impedance. It is worth mentioning that single ended impedance representations do not consider coupling effects between phases and between low voltage and high voltage side, i.e. surge transfer is neglected (W. G. 02 of Study Committee 33 Report 39, 2000).

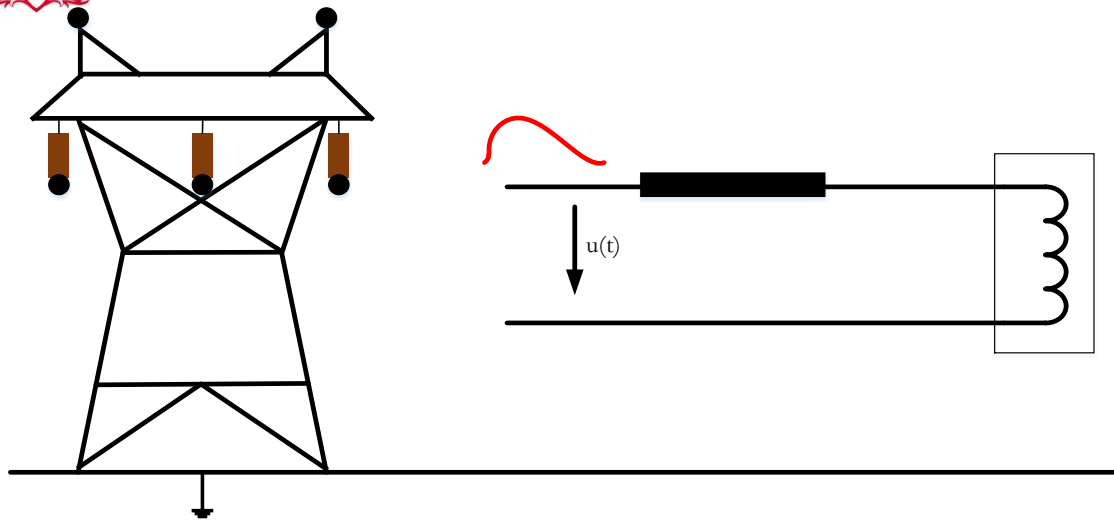

Figure 3.9: Simplified Network Model with Wave Impedance of a High Voltage Overhead Line and the Terminating Transformer Impedance. Transfer of arriving overvoltages to the Secondary Side is not considered (W. G. 02 of Study Committee 33 Report 39, 2000).

The main proposed computer modeling techniques concerning transformers' circuit representation can be categorized as (Francisco de Le6n, Semlyen Adam 1994):

- Modeling based on self and mutual inductances.
- Modeling based on leakage inductances.
- Modeling based on the principle of duality.
- Modeling based on measurements.
- Analysis based on electromagnetic fields.

### 3.2.5 Disconnect Switches

Disconnect switches are used to isolate equipment or to redirect current in a substation. A movable contact opens or closes a gap between stationary contacts, when activated by an insulating operating rod that is itself moved by a sealed shaft coming through the enclosure wall (Fig. 3.10).

The stationary contacts have shields that ensure the necessary distribution of the developed electric field, in order to restrain surface electrical stresses. The moving contact velocity is relatively low (compared to a circuit breaker moving contact) and the disconnect switch can interrupt only low levels of capacitive current or small inductive currents. (Grigsby 2007, McDonald et al 2000, McDonald 2003, IEC 60071-2 1996, Joint W. G. 33/23.12 1998).

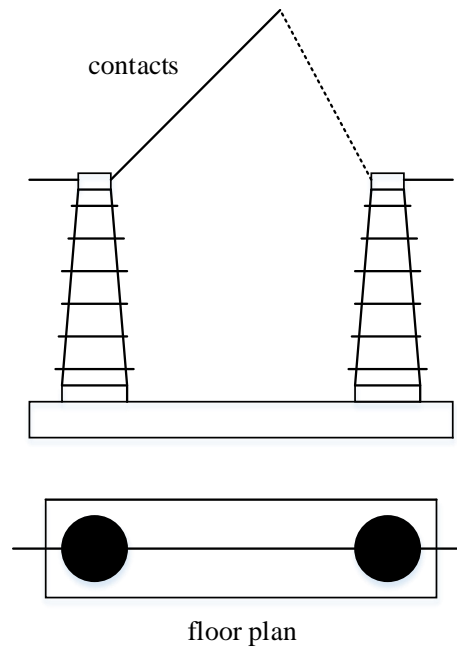

Figure 3.10: Disconnect Switch (McDonald et al 2000)

### 3.2.6 Ground Switches

Scope of ground switches is to ground and short-circuit switchgear parts, cables and overhead lines. Their design is similar to that of vertical-break di-connectors. Ground switches are interlocked with di-connectors, in order to avoid grounding during nominal operation of the system. (Grigsby 2007, McDonald et al 2000, McDonald 2003, IEC 60071-2 1996, Joint W. G. 33/23.12 1998).

### 3.2.7 Cables

HV and MV cables are used for the transmission and the distribution of the electrical power, in cases that the overhead transmission or distribution is impossible or dangerous. Basic parts of a HV or MV cable are:

- The conductor (Al or Cu)
- The semi-conductor layer for the restriction of the developed non uniform electric field
- The insulation (commonly XLPE)
- The metallic screen (Cu)
- The external insulation layer (commonly PVC)



Fig. 3.11 presents the cut-off a typical MV cable.

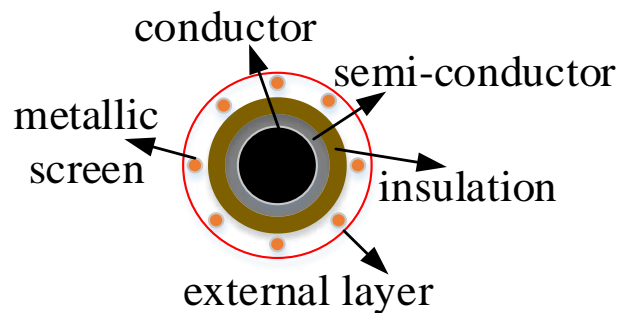

Figure 3.11: Cut-off of a MV Cable (McDonald et al 2000)

Cables can be vulnerable to lightning surges due their connection with overhead lines, which may be hit by external overvoltages. The condition of the insulation is the main factor for the lightning performance of the cable that influences the possibility of a breakdown. The testing procedures of the insulation layer include series and type tests during and after the construction of the cable (e.g. ac and impulse 1.2/50 $\mu$ s High Voltage Stress) and tests after the installation (e.g. Damped AC Voltages (DAC) and Very Low Frequency (VLF) tests). The joints between the different parts of the cables are usually susceptible points during the development of surges.

### 3.2.8 Busbars

Scope of busbars is to conduct substantial currents in limited space, ensuring, simultaneously, the continuity of power supply. The flexible design of the busbars, their electrical characteristics, their reliable operation and their withstand capability against strong electromechanical forces are of great importance, in order to warrant the uninterrupted operation of the system (Grigsby 2007, IEC 60071-2 1996). The compliance with demanded distances between live parts is also a critical issue, in order to ensure the necessary withstand insulation levels against internal and external over voltages. In general, busbars are made of aluminum and copper (ratio 1/3), which combine adequate conductivity and mechanical strength. Note that, for substations up to 200kV, lightning strikes is the dominant factor that determined the insulation level and the design of the protection system. For higher nominal operating voltages the role of the switching phenomena prevails (Abdel-Salam et al., Grigsby 2007, IEC 60071-2 1996).



### 3.3 Configuration of Substations

Substations are interconnected, creating a meshed network and increasing the reliability of the power system, since the interconnection provides alternate paths for the power flow in case of outages. For this reason, the circuit configuration of the network substations has to be appropriately designed carefully, in order to avoid power supply interruption (Siemens 2008, Abdel-Salam et al., Grigsby 2007). The main busbar configurations are (Siemens 2008, Grigsby 2007):

- Single-Busbar
- Double-Busbar with Double Breaker
- Double-Busbar with Single Breaker
- Main and Transfer Busbar
- Ring Bus

Fig. 3.12 presents the basic configurations of HV/MV substations.

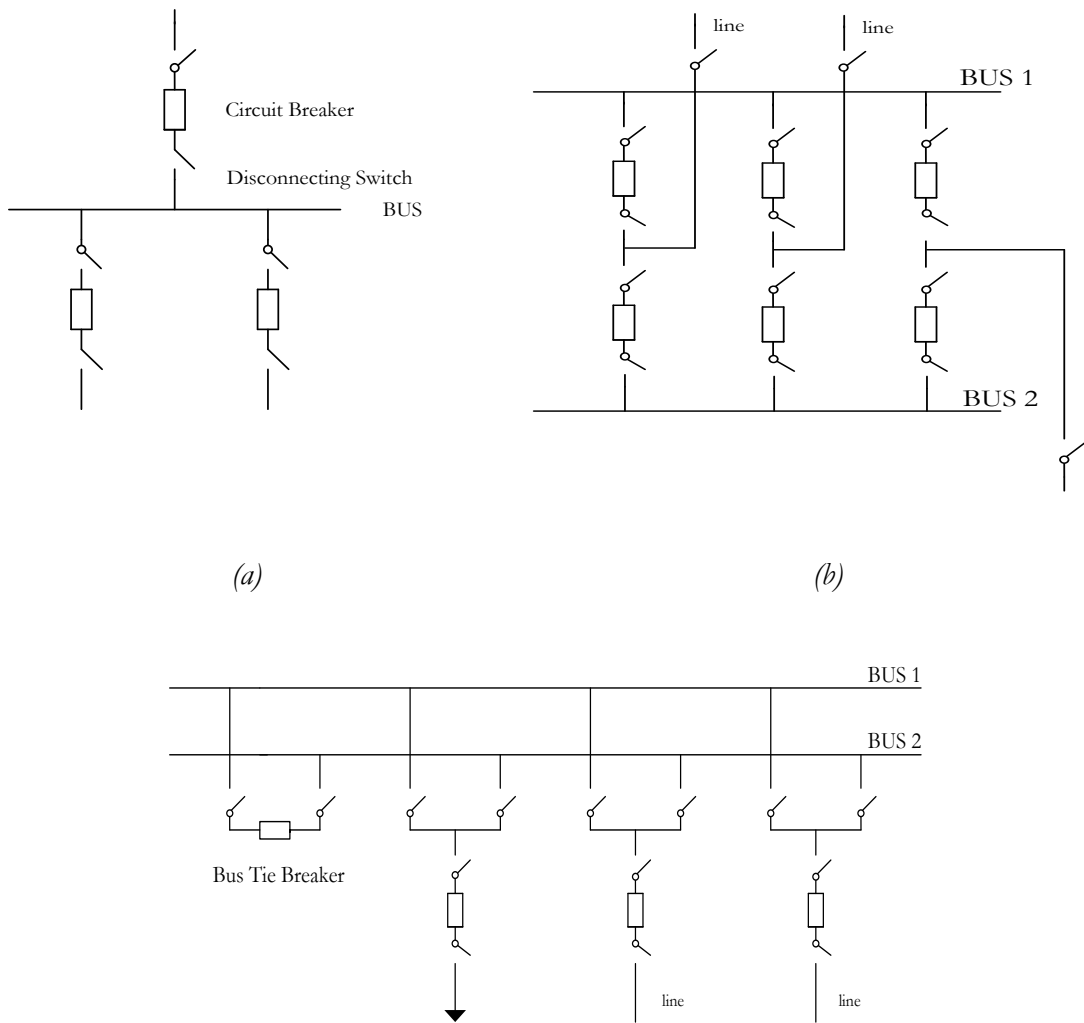



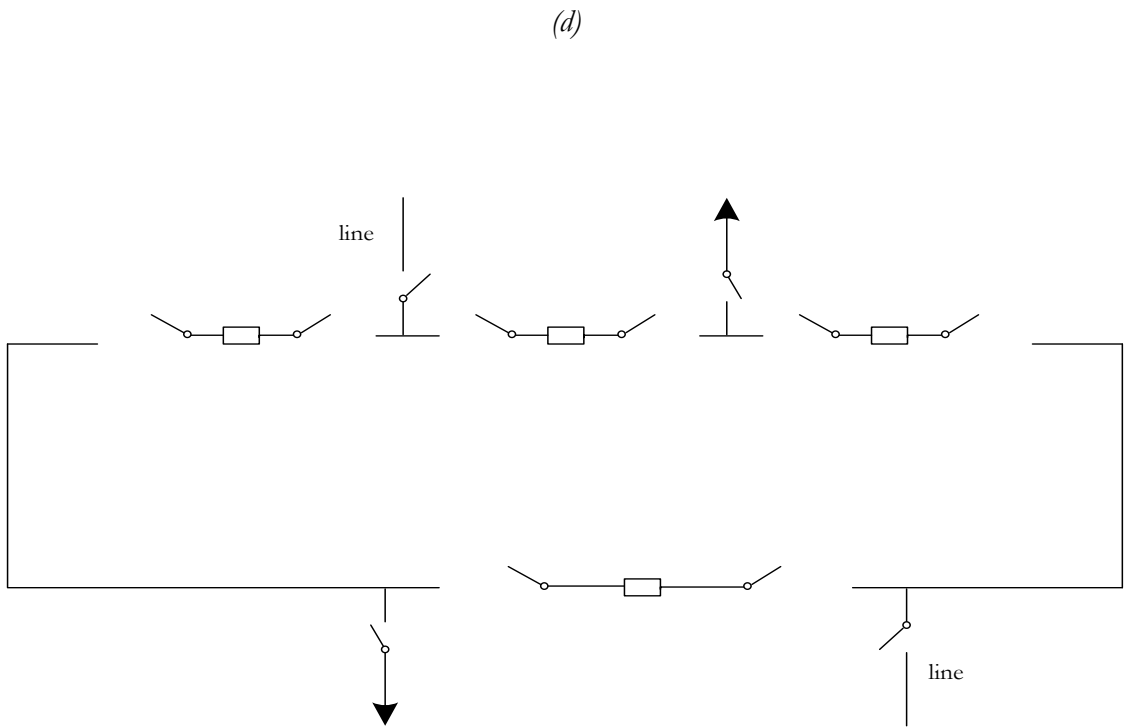
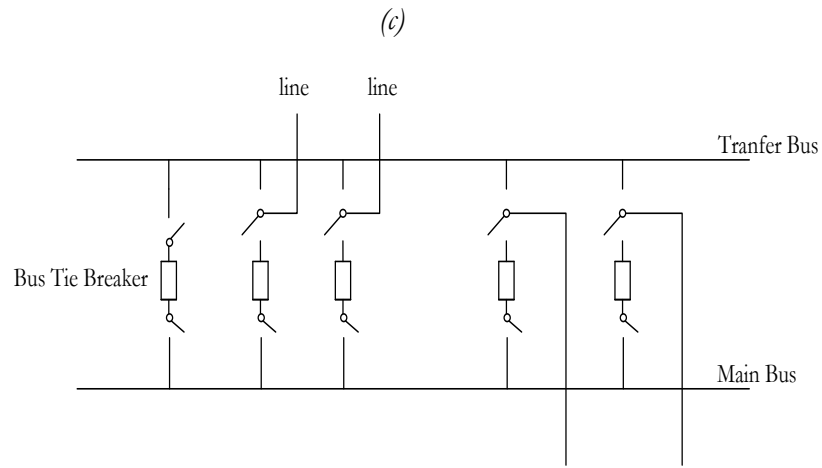

(e)

Figure 3.12: Basic configurations of HV/MV substations

- (a) Single-Busbar (Abdel-Salam et al.),
- (b) Double-Busbar with Double Breaker (Abdel-Salam et al.),
- (c) Double-Busbar with Single Breaker (Abdel-Salam et al.),
- (d) Main and Transfer Bus Bars (Abdel-Salam et al.),
- (e) Ring Bus (Abdel-Salam et al.)



## 3.4 Grounding of Substations

### *3.4.1 Need for Grounding*

The appropriate grounding of a substation and the achievement of low grounding resistance values are of great importance, in order to ensure the safety of the human and the installation. A proper grounding system offers a path and diverts the fault currents to earth, without exceeding the dielectric restrictions of the equipment; simultaneously, grounding system protects personnel against the dangers of electric shock under fault conditions (McDonald 2003).

The initial design is the first step for a safe and economical grounding system. Basic parts of the earthing system are the ground grid, consisted of conductors and rods. In addition, the grounding system includes all of the interconnected grounding facilities in the substation area, including the ground grid, overhead ground wires, neutral conductors, underground cables, etc. (McDonald 2003).

Various factors have a critical impact on the developed voltages in and around the substation area. The soil resistivity, the kind, the magnitude and the duration of the fault (short-circuit, lightning, switching overvoltages), the characteristics of the rods influence the effectiveness of the grounding systems and have to be taken into consideration during the design of the substation. For this reason the appropriate study and design of the grounding system and the measurement of the grounding resistance values after its construction are necessary, in order to achieve the optimum lightning performance of the installation. In case that the above parameters contribute to high potential gradient at the earth surface, the grounding system may be able to offer the necessary safety and protection, despite its capacity to carry the fault current in magnitudes and durations permitted by protective relays.

During typical ground fault conditions, the developed potential gradients along the earth surface may be high enough to endanger a person in the area. Moreover, hazardous voltages may arise between grounded structures or equipment frames and the nearby earth (Grigsby 2007). Figure 3.13 presents the cases that a person can be exposed to potential in a substation.

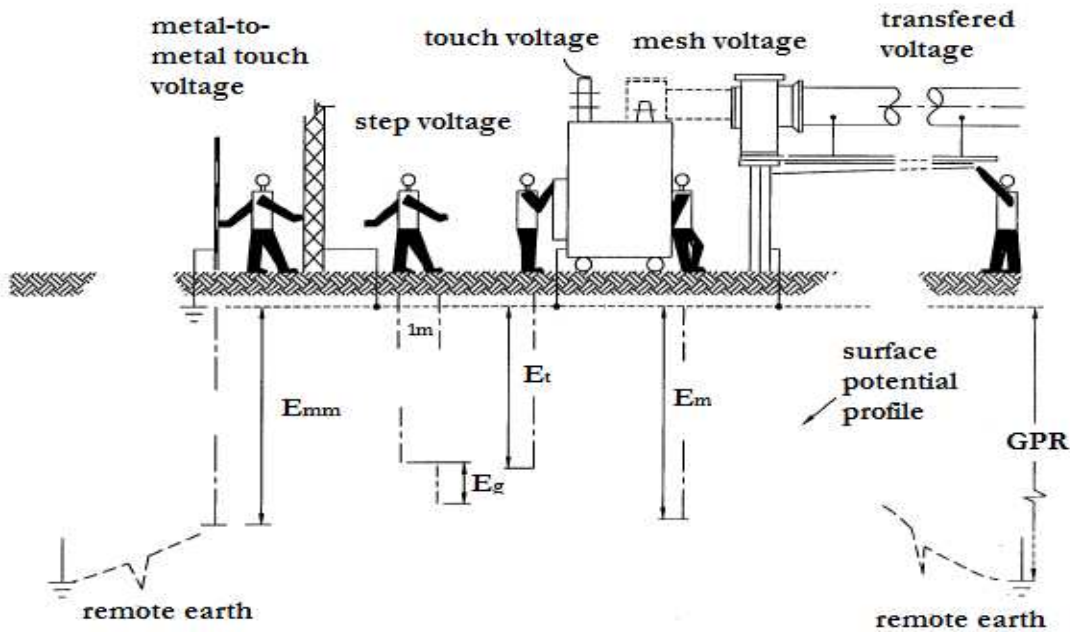

Figure 3.13: Cases of Electric Shock (Grigsby 2007).

### 3.4.2 Design of a Grounding System

Soil resistivity is a very critical factor that determines the soil structure and the value of the grounding resistance. The international literature gives various estimations of the soil resistivity, based on soil types (clay, loam, sand, shale, etc.).

However, the soil resistivity can change significantly during the year, due to variation of environmental factors (moisture, temperature, chemical content, etc.). For this reason, the measurement of the soil resistivity is necessary, in order to obtain an accurate aspect of the soil quality.

The most widely used test for determining soil resistivity data was developed by Wenner and is called either the Wenner method or four-pin method (Figure 3.14). Using four pins or electrodes driven into the earth along a straight line at equal distances of  $a$ , to a depth of  $b$ , current is passed through the outer pins while a voltage reading is taken with the two inside pins. Based on the resistance  $R$ , as determined by the voltage and current, the apparent resistivity can be calculated using the following equation (assuming  $b \ll a$ ) (Grigsby 2007):

$$\rho = 2\pi \cdot a \cdot R \quad (3.5)$$

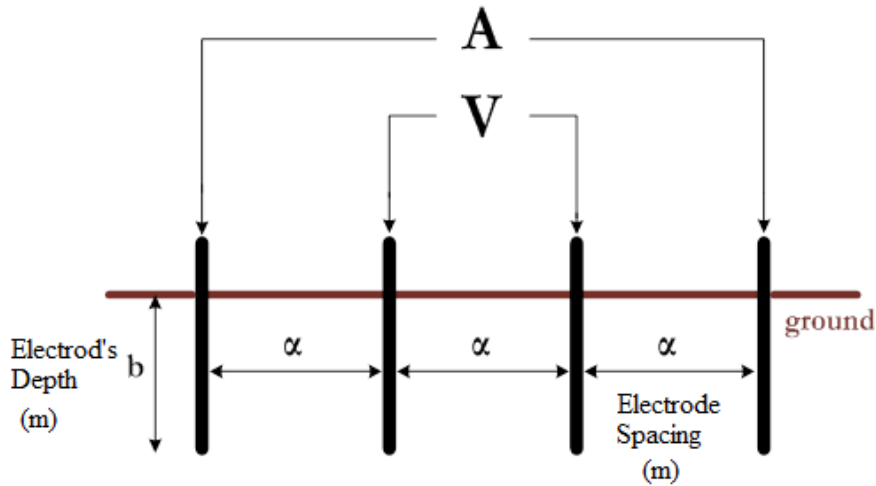

Figure 3.14: Soil Resistivity Measurement (Wenner's Method)

Table 3.5 presents indicative values of soil resistivity for various types of earth. Note that for more precise analysis and more accurate results, the multi-layer model is used, considering the variation of the soil quality for different depths.

Table 3.5: Range of Earth Resistivity (IEEE Std 80 2000)

Type of earth	Average resistivity ( $\Omega \cdot m$ )
Wet organic soil	10
Moist soil	$10^2$
Dry soil	$10^3$
Bedrock	$10^4$

Interpretation of the apparent soil resistivity based on field measurements is difficult. Uniform and two-layer soil models are the most commonly used soil resistivity models. The objective of the soil model is to provide a good approximation of the actual soil conditions. Interpretation can be done either manually or by the use of computer analysis. There are commercially available computer programs that take the soil data and mathematically calculate the soil resistivity and give a confidence level based on the test.

The achieved resistance of the constructed grid is mainly determined by the resistivity and the area of the site. Adding more conductors or changing the depth of the grid does little to lower



the resistance. The effect of ground rods depends on the location and depth of the ground rod with respect to the soil resistivity. The effects of ground rods on the resistance can be substantial, although it is sometimes difficult to determine the effects. In uniform soil, it is difficult to determine if the addition of more conductors or the addition of ground rods will affect the overall resistance the most. In most cases though, the addition of ground rods has a greater impact because the ground rods discharge current into the earth more efficiently than the grid conductors. Assuming a two-layer soil model with a lower resistivity soil in the lower layer, ground rods can have a substantial impact on the resistance of the grid. The more the ground rods penetrate into the lower resistivity soil, the more the rods will reduce the grid resistance. These rods also add stability since the variations in soil resistivity due to moisture and temperature are minimized at lower depths. The effects of moisture and temperature on the soil resistivity can be quite dramatic. Ground rods placed on the outside of the grid have a greater impact than those placed in the interior of the grid because of current density (Grigsby 2007, Joint W. G. 33/23.12 1998, IEEE Std 998-1996).

The importance of the lower ground grid resistance is reflected in the ground potential rise (GPR) and actual touch and step voltages. Lowering the resistance of the grid normally reduces the GPR, although not necessarily proportionally. Lowering the resistance may somewhat increase the grid current because the change is the current split between all the ground current return paths. Another way to decrease the resistance is to install counterpoises (Grigsby 2007, IEC 60071-2 1996, Joint W. G. 33/23.12 1998, IEEE Std 998-1996).

As far as the circuit representation of the grounding resistance, the simplest approach is the use of a constant resistance equal to the low current and low frequency grounding resistance,  $R_0$  (IEEE W. G. PAS-104 1985, Ametani & Kawamura 2005). The calculation of the grounding resistance of the substation, in case of uniform soil, can also be performed by using the following equation (IEEE Std 80 2000):

$$R_g = \frac{\rho}{4} \sqrt{\frac{\pi}{A}} \quad (3.6)$$

Where;

$R_g$  is the substation ground resistance in ( $\Omega$ ).

$\rho$  is the soil resistivity in ( $\Omega \cdot m$ ).

$A$  is the area occupied by the ground grid in ( $m^2$ ).



Laurent (Laurent 1951) and Niemann (Niemann 1952), based on the previous approach, propose the following equation for the estimation of the grounding resistance:

$$R_g = \frac{\rho}{4} \sqrt{\frac{\pi}{A}} + \frac{\rho}{L_T} \quad (3.7)$$

Where;

$L_T$  is the total buried length of conductors in (m).

Sverak (Sverak 1984) modified equation (3.9), considering the effect of grid depth:

$$R_g = \rho \left[ \frac{1}{L_T} + \frac{1}{\sqrt{20A}} \left( 1 + \frac{1}{1 + h \sqrt{\frac{20}{A}}} \right) \right] \quad (3.8)$$

Where;

$h$  is the depth of the grid in (m).

Schwarz (Schwarz 1954) proposes the following set of equations, in order to compute the grounding resistance of a system consisting of horizontal (grid) and vertical (rods) electrodes (Rüdenberg 1945, Sunde 1968).

$$R_g = \frac{R_1 R_2 - R_m^2}{R_1 + R_2 - 2R_m} \quad (3.9)$$

Where;

$R_1$  is the ground resistance of grid conductors in ( $\Omega$ ).

$R_2$  is the ground resistance of all ground rods in ( $\Omega$ ).

$R_m$  is the mutual ground resistance between the group of grid conductors,  $R_1$ , and group of ground rods,  $R_2$  in ( $\Omega$ ).



Ground resistance of the grid is given as:

$$R_1 = \frac{\rho}{\pi L_C} \left[ \ln \left( \frac{2L_C}{a'} \right) + \frac{k_1 \cdot L_C}{\sqrt{A}} - k_2 \right] \quad (3.10)$$

Where;

$\rho$  is the soil resistivity in ( $\Omega \cdot \text{m}$ ).

$L_C$  is the total length of all connected grid conductors in (m).

$a'$  is for conductors buried at depth  $h$  in (m), or

$a'$  is a for conductor on earth surface in (m).

$2a$  is the diameter of conductor in (m).

$A$  is the area covered by conductors in ( $\text{m}^2$ ).

$k_1, k_2$  are the coefficients [see Figure 25(a) and (b)]

Ground resistance of the rod bed is given as:

$$R_2 = \frac{\rho}{2\pi n_R L_R} \left[ \ln \left( \frac{4L_R}{b} - 1 + \frac{2k_1 \cdot L_r}{\sqrt{A}} (\sqrt{n_R} - 1)^2 \right) \right] \quad (3.11)$$

Where;

$L_r$  is the length of each rod in (m).

$2b$  is the diameter of rod in (m).

$n_R$  is the number of rods placed in area ( $A$ ).

Mutual ground resistance between the grid and the rod bed is given as:

$$R_2 = \frac{\rho}{\pi L_C} \left[ \ln \left( \frac{2L_C}{L_r} \right) + \frac{k_1 \cdot L_C}{\sqrt{A}} - k_2 + 1 \right] \quad (3.12)$$

### 3.5 Need for Lightning Protection of Substations

The study of the lightning repercussions and the design of an appropriate protection system against lightning is a crucial issue, since substations are complex installations of high investment cost. Moreover, the safety of the personnel must be considered in priority, in order to avoid accidents. In the current section, the dangers arisen to a network substation by an atmospheric discharge and the consequences of the lightning flashes to the normal operation of an electrical system will be presented.



External overvoltages can cause several damages to a substation, leading to insulation breakdowns. When the incoming surge exceeds the insulation level of the equipment a breakdown is occurred, resulting to serious damages and interruption of the power supply. Insulators, switching devices, cables and transformers are the main parts of the installation that are intensively stressed by lightning phenomena and their failure creates several serious malfunctions, interruptions and dangers.

In case of lightning hit on the incoming overhead transmission line a shielding failure or a backflashover, i.e. insulation failure of the ceramic or glass insulator, can be occurred, depended on the ground wires position, the peak current of the lightning flash and the grounding resistance. Such an insulation fault results to the development of a travelling wave, which will be directed to the entrance of the substation. The high voltage cables can also be influenced by the incoming surges; when the arisen overvoltages exceed the dielectric strength of the XLPE insulation a fault is occurred. The most vulnerable parts are joints and termination positions. Furthermore, a lightning surge can cause breakdown of the transformers insulators or the transformers dielectrics, resulting to thermal and electromechanical effects (fire, short-circuits, mechanical damages etc.).

The above indicate the need of appropriate lightning protection system, in order to avoid lightning outages and restrain the repairing costs of the equipment. The design of the lightning protection system has to take into consideration the stochastic nature of the external overvoltages phenomena and the various techno-economic factors of a substation. The striking point, the geometrical characteristics of the external lightning protection system and the grounding system, the basic insulation level are factors that influence the severity of the lightning impact. Protection of substations against the deleterious effects of lightning may be achieved by using highest insulation levels, taking of course into account the financial cost, or by installing overhead ground wires in order to intercept the lightning flashes. Moreover, surge arresters can contribute to the improvement of the lightning performance of the installation, especially in regions with high soil resistivity.

### **3.6 Development of Overvoltages in Substations**

Figure 3.15 presents the configuration of a typical substation. A direct or indirect lightning hit on an overhead transmission line can create a significant overvoltage, which can influence the normal operation of the other parts of the equipment (transformer, cables, etc.).

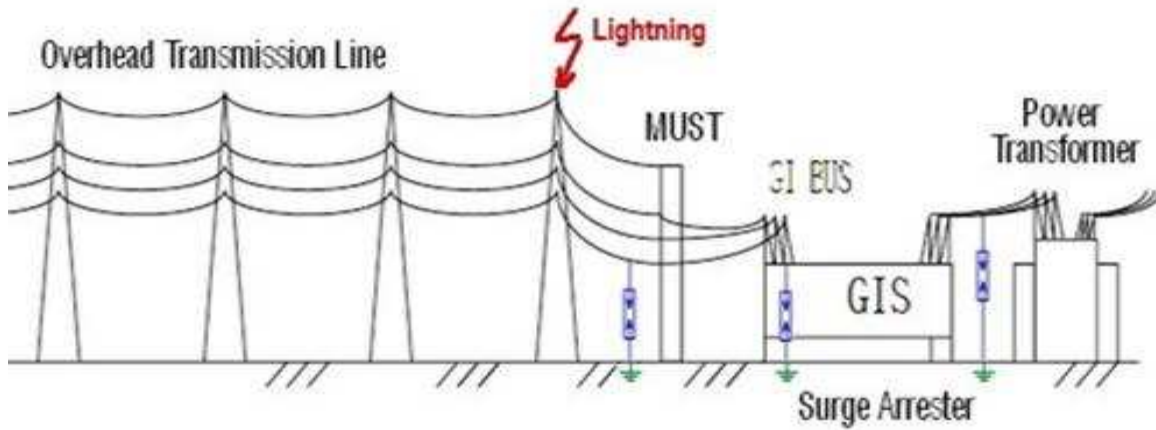
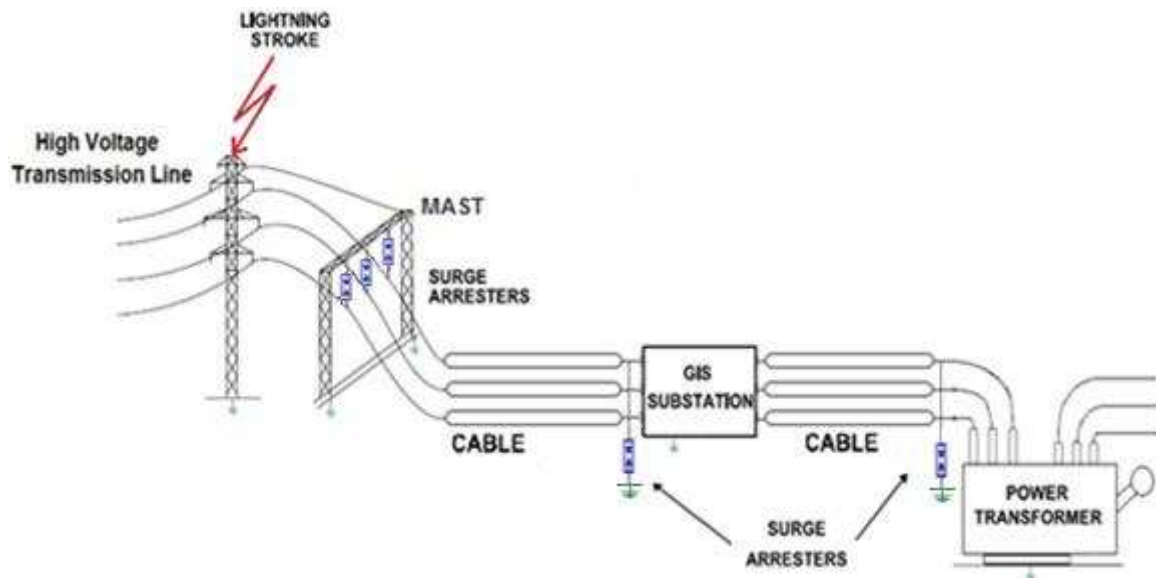

*Configuration (a)**Configuration (b)**Figure 3.15: Configurations (a) & (b) of Typical Substations (Piotr Oramus, Marek Florkowski, 2014)*

High voltage transmission lines must have high insulation levels, in order to prevent breakdown between phases or between phase and earth during operating or fault conditions. Phases are electrically separated by air, since ceramic or glass insulators offer electrical separation between phases and metallic towers. The inherently high insulation levels for transmission lines render them less susceptible to lightning damage in comparison to medium voltage or low voltage lines, and so the annual outage rate is in general low; however, the repercussions of a transmission line failure can be much more costly (McDonald et al. 2000, Joint W. G. 33/23.12, no. 176, 1998).



When a lightning stroke hits a phase conductor of a high voltage transmission line, the lightning current,  $i$ , is separated in two equal parts, each of them is traveling in opposite direction. Owing to the line characteristic impedance,  $Z$ , the two impulse lightning currents create two equal voltage traveling waves, as it is shown in Figure 3.16.

The value of the voltage traveling waves is (eq. 3.16):

$$u_1 = u_2 = \frac{1}{2} \cdot Z \cdot I \quad (3.13)$$

If the magnitude of the voltage traveling waves exceeds the rated basic insulation level (BIL) of the line, then a breakdown of the line insulation occurs. In case of line insulation breakdown, two voltage traveling waves  $u_1$  and  $u_2$  will be arisen, which are directed to the next towers (Figure 3.16).

Taking into account the geometrical characteristics and the insulators type of the tower, there is a critical lightning current value for each voltage level of the transmission line, above which the developed overvoltage is greater than the line BIL (Christodoulou et al. 2012).

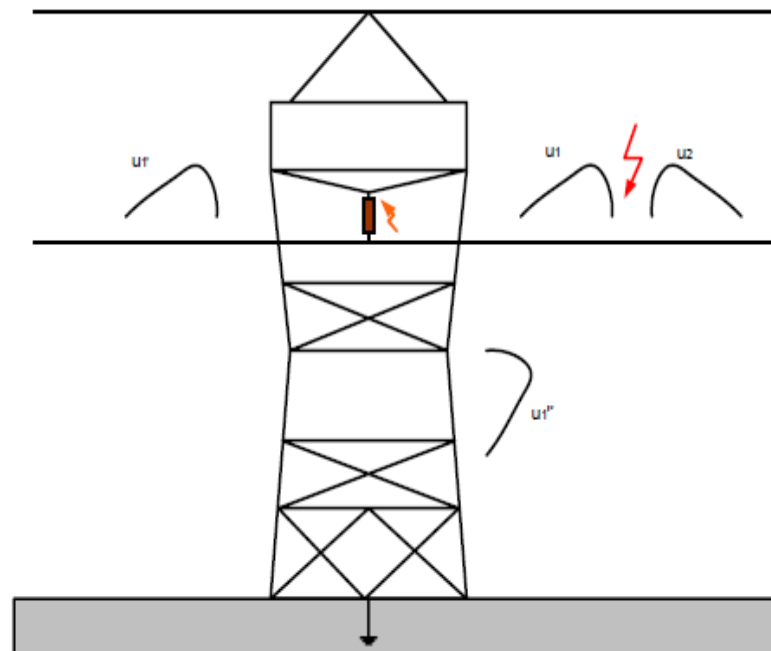

Figure 3.16: Direct Lightning Stroke on a Phase-Wire of a High Voltage Transmission Line (HVTL)[Shield Failure](Christodoulou et al. 2012)



When a lightning hits the tower structure or the overhead ground wire, the lightning impulse discharge current, flowing through the tower and tower footing resistance, produces potential differences across the line insulation. If the line insulation strength exceeds a defined value, a flashover happens, i.e. it appears a backflashover.

Since the tower voltage,  $u_3$  (Figure 3.17), which appears after a back-flashover, is highly depended on the tower resistance, it follows that footing resistance is an extremely important factor in determining lightning performance (IEEE Std 1243-1997).

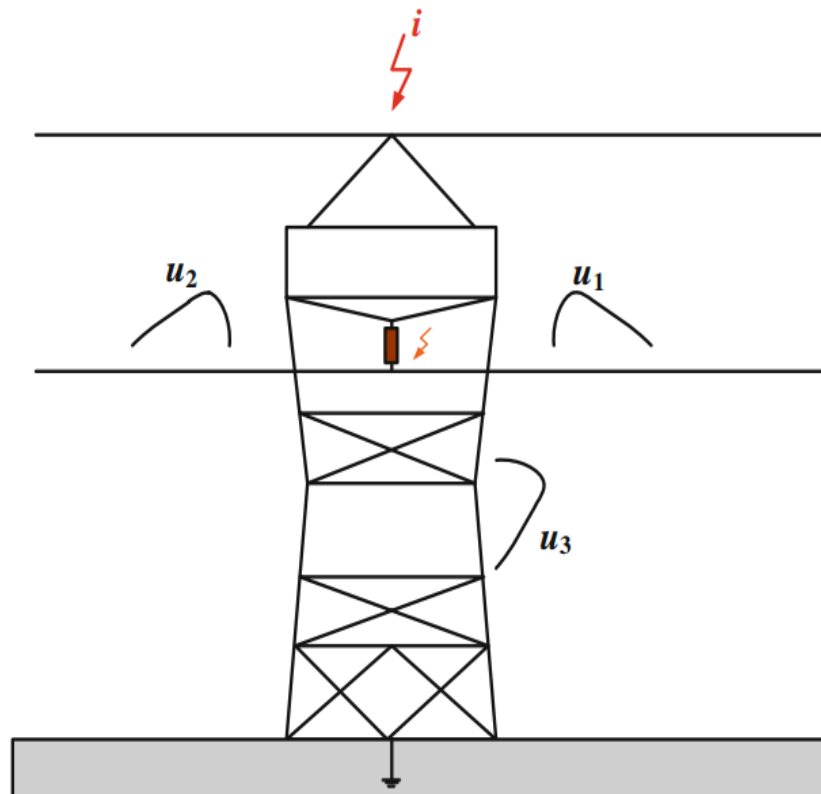

Figure 3.17: Indirect Lightning Stroke on a High Voltage Transmission Line(HVTL)

[Back-flashover] (Christodoulou et al. 2012)

It is worth mentioning, that any overvoltage surge appearing on a transmission line due to internal or external disturbances will propagate in the form of a traveling wave toward the ends of the line. During its travel the overvoltage surge will, in general, experience attenuation and distortion inflicted upon it by earth resistance and line losses, and corona discharges (Abdel-Salam et al.).

The above analysis highlights the importance of the insulation level for the adequate lightning performance of the network. Main factors that influence the efficiency of an insulating item



are the voltage characteristics (peak value, duration) that stress the item. Moreover, the strength of the insulation must be coordinated with the stresses that may occur on the power system. To this direction, the insulation coordination between the various components of the installation has to be insured, in order to limit the lightning outages and improve the reliability of the system. In details, insulation coordination is defined as the correlation of the insulation of electrical equipment with the characteristics of protective devices such that the insulation is protected from excessive overvoltages. In practice, it means that an insulation level is determined for each voltage level to which the equipment is designed and tested.

Moreover, proper grounding, shielding and surge arresters' implementation can contribute to the limitation of the developed overvoltages under the BIL (Wadhwa 2007).

An important aspect of external and internal overvoltages and breakdown withstand capability of the insulating materials is their stochastic nature. For this reason, the installation has to be protected against the worst probable (not just possible) condition. Otherwise, over dimensioning of the insulation leads to useless costs. This, however, would involve some level of risk failure, but it is desired to accept some level of risk of failure than to design a risk-free but a very costly system (Wadhwa 2007).

The distribution of breakdown for a given gap follows approximately normal or Gaussian distribution. The distribution of over voltages developed on a power system also follows the Gaussian distribution. For the coordination of the electrical stresses due to lightning or switching surges with the electrical strength of the insulators, the overvoltage distribution is represented in the form of probability density function and the insulation breakdown probability by the cumulative distribution function (Figure 3.18) (Wadhwa 2007).

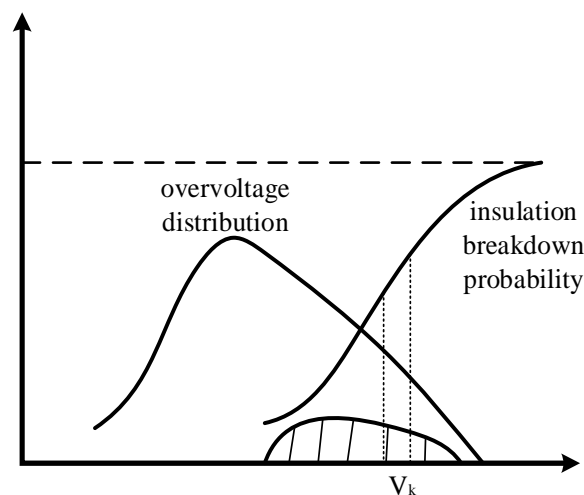

Figure 3.18: Overvoltage Distribution and Insulation Breakdown Probability (Wadhwa 2007)



### 3.7 Design of Lightning Protection System

Generally, the annual number of direct lightning strokes in a substation is given by the equation:

$$D = 10^{-6} \cdot W \cdot L \cdot N \quad (3.14)$$

Where;

$W$  and  $L$  are the dimensions of the substation (width and length)

$N$  is the number of flashes to earth per square kilometer per year [Equations (2.9) to (2.15)].

The design of lightning protection system is performed following appropriate methodologies.

The most widely used design methods to protect substation against lightning hits are:

- Fixed angles method
- Empirical curves method.
- Electrogeometrical method

#### 3.7.1 The fixed Angles Method

The fixed-angles method uses vertical angles in order to adjust the configuration of the external lightning protection system, i.e. the number, the position, and the height of shielding wires or masts. Figure 3.19 depicts the method applied for shielding wires and masts, correspondingly (McDonald et al. 2000, IEEE Std 998-1996).

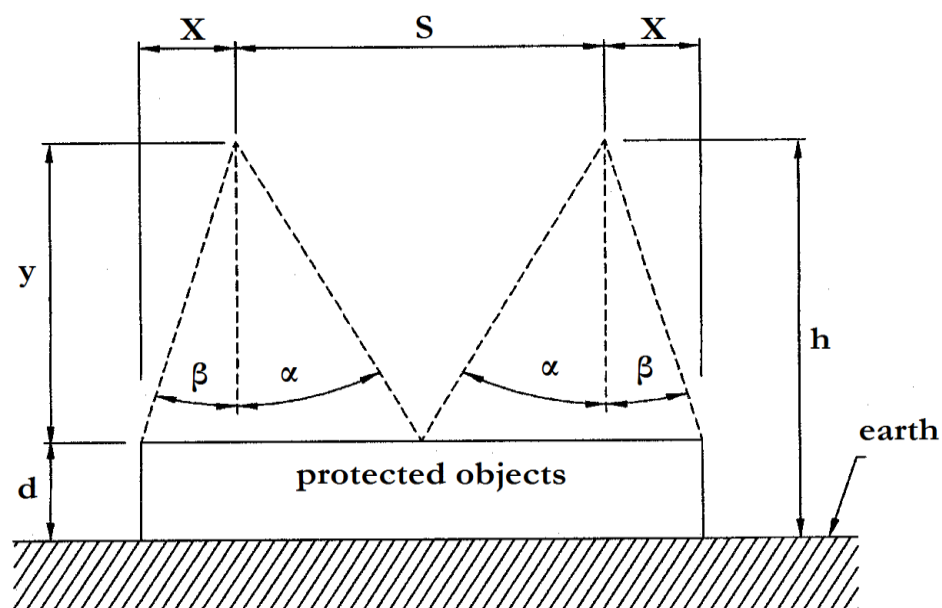

(a)

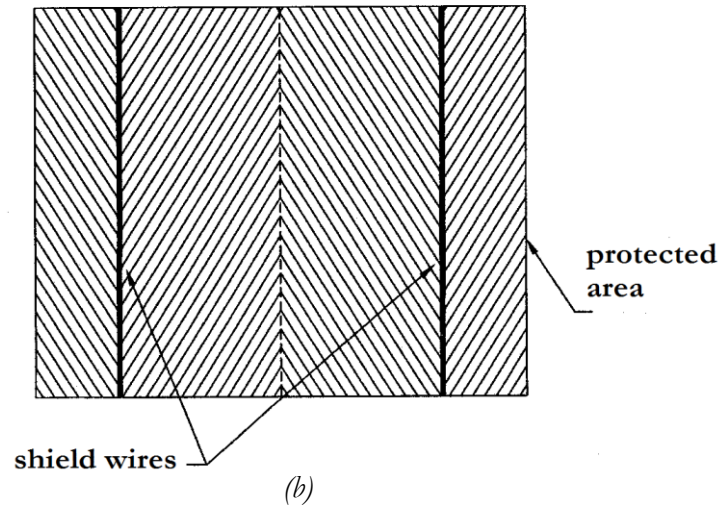

Figure 3.19: Fixed Angles for Shielding Wires (McDonald et al. 2000, IEEE Std 998-1996)

Critical factors that influence the calculated angles are:

- The degree of lightning exposure
- The importance of the substation being protected
- The physical area occupied by the substation.

The value of the angle alpha ( $\alpha$ ) that is commonly used is  $45^\circ$ . Both  $30^\circ$  and  $45^\circ$  are widely used for angle beta ( $\beta$ ) (McDonald et al. 2000, IEEE Std 998-1996).

### 3.7.2 Empirical Curves Method

Empirical curves, obtained by field studies and laboratory measurements, are used in order to determine the characteristics of the design lightning protection system, i.e. the number the position and the height of the shielding wires and the masts (McDonald et al. 2000, IEEE Std 998-1996). The curves have been developed considering shielding failure rates of 0.1%, 1%, 5%, 10% and 15%. A failure rate of 0.1% is commonly used in design. Figure 3.20 has been developed for a variety of protected object heights,  $d$ .

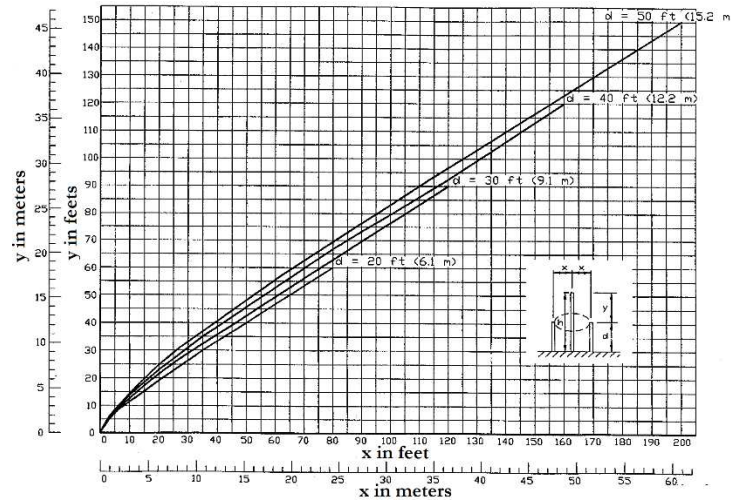

Figure 3.20: Single lightning Mast Protecting Single Ring of Object—0.1% Exposure.  
 (y: Height of Mast above Protected Object, s: Horizontal Separation,  
 d: Height of Protected Object) (McDonald et al. 2000, IEEE Std 998-1996)

Figure 3.21 depicts the areas that can be protected by two or more shielding masts. In case that two masts are used to protect an area, the empirical curves give shielding information only for the point B and for points on the semicircles drawn about the masts, with radius  $x$ . Any single point falling within the cross-hatched area should have  $<0.1\%$  exposure. Points outside the cross-hatched area will have  $>0.1\%$  exposure (McDonald et al. 2000, IEEE Std 998-1996). The lightning performance of the substation can be upgraded by moving the masts closer together (Figure 3.27). As illustrated in Figure 3.27b, the size of the areas with an exposure greater than 0.1% has been significantly reduced (McDonald et al. 2000, IEEE Std 998-1996).

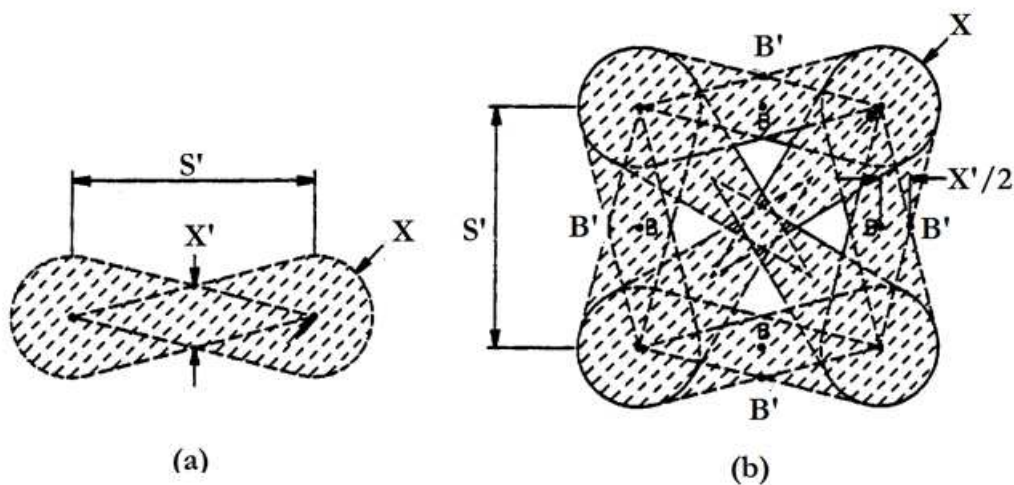

Figure 3.21: Areas Protected by Multiple Masts  
 (a) With Two Lightning Masts;  
 (b) with Four Lightning Masts (McDonald et al. 2000, IEEE Std 998-1996).





### 3.7.3 The Electrometrical Model

The electrometrical model (EGM) is based on the striking distance, a factor that is determined by the lightning peak current and the hit position. The striking distance  $r$  in m is given by the equation:

$$r = A \cdot I^b \quad (3.15)$$

Where;

$A$  and  $b$  are constants dependent on the termination point

$I$  is the prospective stroke current in kA

Several researchers have proposed various electrometrical models with different constants  $A$  and  $b$ . However, all of them agree to the following aspects (Christodoulou et al. 2010):

- Strokes arrive vertically
- The lightning leader develops unaffected by the existence of grounded objects until it arrives within striking distance from the grounded object
- The striking distance is related to the current of the return stroke.

The termination point of a lightning stroke to substation is of great importance, in order to predict the effects of the lightning surges and secure the installation against the incoming overvoltages. The most vulnerable part of a substation is the overhead lines. In case of overhead transmission lines, lightning can hit either a ground wire, phase conductor, tower or even ground. The fractions of lightning strikes  $b_A(I_p)$  and  $b_B(I_p)$  that will terminate on a phase conductor or on an overhead ground wire, can be calculated by the equations (3.17) and (3.18) (Christodoulou et al. 2010):

$$h_A(I_p) = \frac{D_C}{D} \quad (3.16)$$

$$h_B(I_p) = \frac{D - D_C}{D} \quad (3.17)$$

Where;

$D_C$  is the shielding failure exposure distance.

$D$  is the vertical distance between points C and A (Figure 3.22) (Christodoulou et al. 2010).



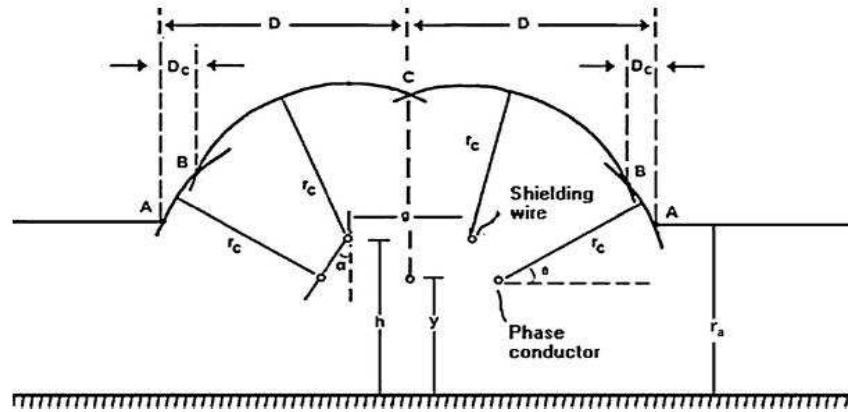

Figure 3.22: The Electrogeometrical Model: Representation of Shield Wires and Phase Conductors (Christodoulou et al. 2010)

The above analysis indicates that an overhead ground wire cannot always offer adequate protection for every lightning's current amplitude. In details, some lightning currents can penetrate the lightning protection system and terminate on a phase conductor; so, the insulation of the installation must be appropriately designed in order to withstand the developed overvoltages without flashover (McDonald et al. 2000). Figure 3.23 presents the application of the above method for a typical substation, by using the rolling sphere method. The rolling sphere method is based on the assumption that the striking distances to the ground, a mast or a wire are the same. The imaginary sphere of radius is equal to the striking distance rolls over the surface of the substation (Lightning masts, shield wires, substation fences and other grounded metallic objects that can provide lightning shielding). The parts of the equipment that remain below the curved surface of the imaginary sphere are protected. These parts that touch the sphere are not protected (McDonald et al. 2000, IEEE Std 998-1996).

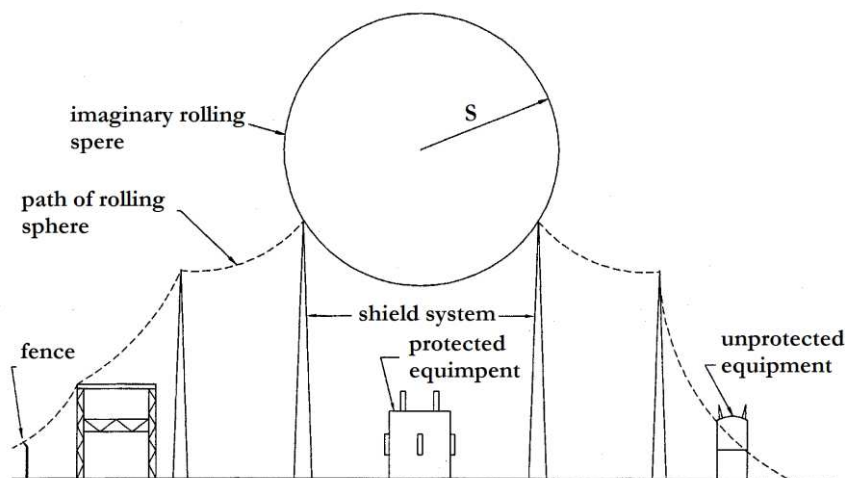

Figure 3.23: Principle of the Rolling Sphere (McDonald et al. 2000, IEEE Std 998-1996)



A typical substation, however, is much more complex. It may contain several voltage levels and may utilize a combination of shield wires and lightning masts in a three-dimensional arrangement. Figure 3.24 shows the application of the electrogeometrical model considering four shield masts in a multiple shield mast arrangement. The arc of protection for stroke current  $I_s$  is shown for each set of masts. The protective zone can again be visualized as the surface of a sphere that is rolled toward a mast until touching the mast, and then rolled up and over the mast such that it would be supported by the masts. Using the concept of rolling sphere of the proper radius, the protected area of an entire substation can be determined. This can be applied to any group of different height shield masts, shield wires, or a combination of the two. Figure 3.25 shows an application to a combination of masts and shield wires (McDonald et al. 2000, IEEE Std 998-1996).

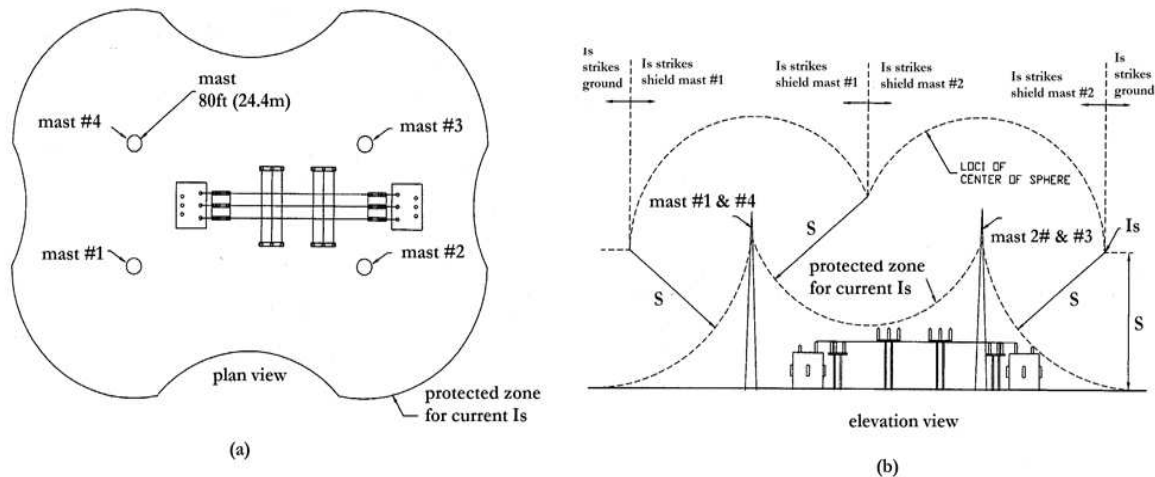

Figure 3.24: Multiple Shield Mast Protection for Stroke Current  $I_s$   
(McDonald et al. 2000, IEEE Std 998-1996)

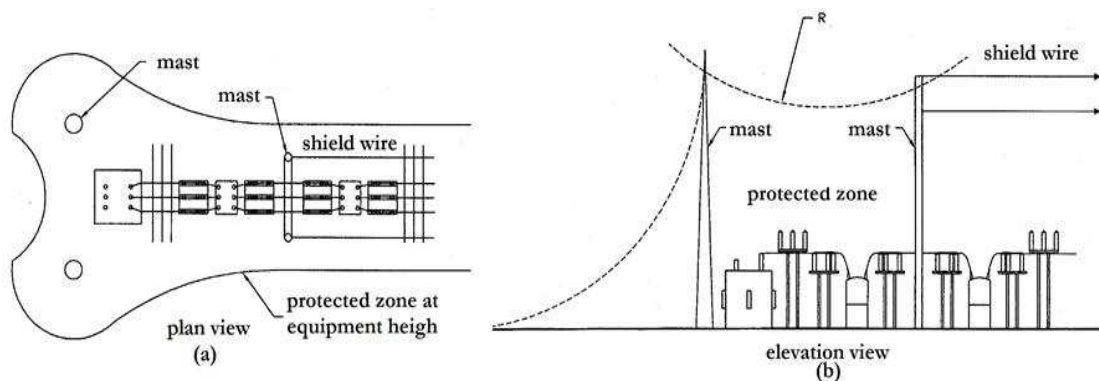

Figure 3.25: Protection by Shield Wires and Masts (McDonald et al. 2000, IEEE Std 998-1996)



### 3.8 Surge Arresters

The lightning performance of a substation can be improved by installing surge arresters. Surge arresters are semiconductor devices that protect the equipment of an electrical installation against incoming surges. Several different types of arresters are available and all perform in a similar way: they present high resistance during the normal operation of the network and low resistance during surge conditions. Nowadays, gapped surge arresters with varistors made of silicon carbide have been installed by gapless metal oxide arresters, due their advanced characteristics (Hinrichsen et al. 2001). In details, metal oxide arresters present more extreme non-linear voltage-current characteristic compared to silicon carbide ones, rendering unnecessary the disconnection of the resistors from the line through serial spark gaps (Hinrichsen et al. 2001). Metal oxide varistors have to fulfill the following demands:

- Low resistance during surges so that overvoltages are limited.
- High resistance during normal operation so as to avoid negative effects on the power system.
- Sufficient energy absorption capability for stable operation.

Main drawback of these varistors is the continuous flow of current to the ground (some  $\mu\text{A}$ ), since their resistance is not infinite. So, considering the applied operating voltage, there is constantly a leakage current (Siemens 2008).

The basic parts of a metal oxide surge arresters are:

- The cylindrical metal-oxide resistor blocks (varistor).
- The insulating housing.
- The electrodes.

Between the varistor column and the polymeric housing there is a glass-fiber structure that either completely encloses the resistor blocks or exerts sufficient force on the ends of the stack to hold the metal oxide blocks firmly together (Figure 3.26).

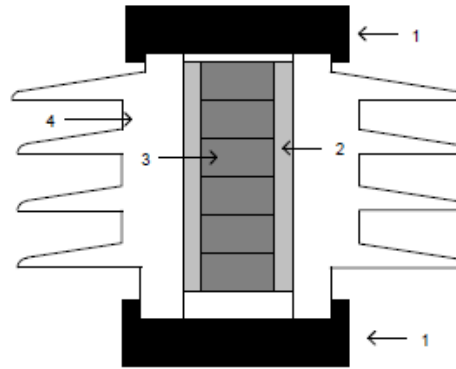

Figure 3.26: Metal Oxide Surge Arrester cut

(1: Electrodes, 2: Fiberglass, 3: Nonlinear Resistor, 4: External Insulator) (Spanias et al. 2010)

The non-linear voltage-current characteristic is described by equation (Lundquist et al. 1990, Christodoulou et al. 2009):

$$I = kV^\alpha, \quad \alpha > 1 \quad (3.18)$$

Where;

$I$  is the current through the arrester,

$V$  is the voltage across the arrester,

$\alpha$  is a non-linearity exponent (measure of non-linearity) and

$k$  is a constant depended on the arresters type.

The value  $\alpha$  characterizes the non-linear V–I characteristic; the greater the value of  $\alpha$ , the “better” the varistor. Modern arresters have values of  $\alpha$  between 25 and 60. Figure 3.27 depicts the voltage-current characteristic of a 420kV gapless surge arrester.

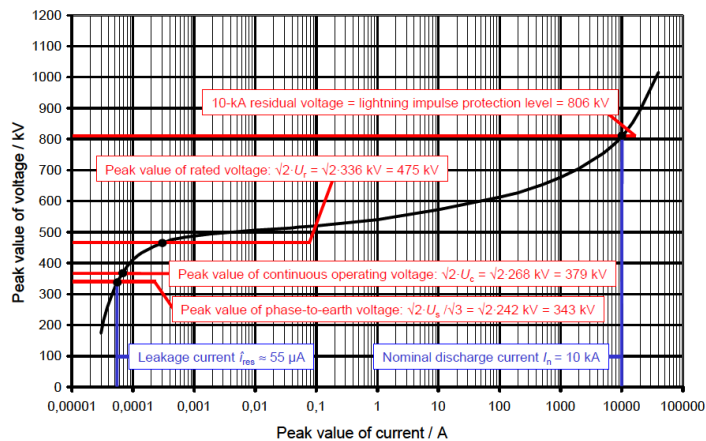

Figure 3.27: Voltage – Current Characteristic of a Metal Oxide surge Arrester (Hinrichsen et al. 2001)



The main electrical characteristics of gapless metal oxide surge arresters according to the IEC 60099-4 are (Hinrichsen et al. 2001, IEC 60099-4 2004–2005):

- **Continuous Operating Voltage:** Designated rms value of power frequency voltage that may be applied continuously between the terminals of the arrester. MCOV of the arrester must be higher than the maximum continuous operating voltage of the system.
- **Rated Voltage:** Maximum permissible rms value of power frequency voltage between arrester terminals at which is designed to operate correctly under temporary overvoltages.
- **Discharge Current:** Impulse current which flows through the arrester.
- **Residual Voltage:** Peak value of the voltage that appears between arrester terminals when a discharge current is injected.
- **Rated Discharge Current:** Peak value of lightning current impulse, which is used to classify an arrester.
- **Lightning Impulse Protective Level:** Voltage that drops across the arrester when the rated discharge current flows through the arrester.
- **Energy Absorption Capability:** Maximum level of energy injected into the arrester at which it can still cool back down to its normal operating temperature. Standards do not define energy capability of an arrester. In IEC exists the term line discharge class, but since this is not enough information, various manufacturers present thermal energy absorption capability in kJ/kV ( $U_c$ ), defined as the maximum permissible energy that an arrester may be subjected to two impulses according to IEC clause 8.5.5 (IEC 60099-4 2004–2005), without damage and without loss of thermal stability (Hinrichsen et al. 2001, IEC 60099-4 2004–2005).

The installation position of the arresters plays important role, due to the fact that overvoltages behave as travelling waves. The voltage level at every instant and at every point on the line; results from the sum of the different instantaneous values of each individual voltage wave considering the refractions and reflections because of the changes of the surge impedance. A connected transformer behaves as an un-terminated end, since its winding inductivity for fast voltage waveforms presents much higher impedance compared with the impedance of the line. Figure 3.28 depicts an overvoltage running towards a transformer, assuming a propagation velocity equal to the speed of the light. The arrester presents an ideal behavior, limiting the desired residual voltage. Figure 3.29 presents the overvoltages at the terminal ends of the arrester and the transformer. Note that, a voltage wave is totally reflected when



reaching an un-terminated end of a line. The voltage level at every instant and at every point on the line; results from the sum of the different instantaneous values of each individual voltage wave. Thus, at the terminated end this value will be doubled. A connected transformer appears similar to an un-terminated end since its winding inductivity for rapid functions exhibits a great impedance compared with the surge impedance of the line (Spanias et al. 2010).

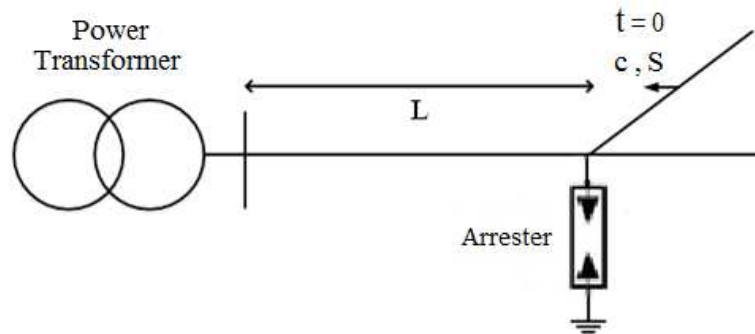

Figure 3.28: Power Transformer Protected by a Surge Arrester ( $L$  is the distance between arrester and transformer,  $c$  is the velocity of the light,  $S$  is the steepness of the lightning current)

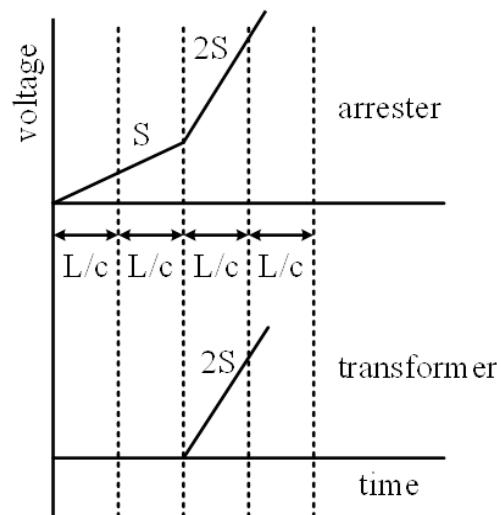

Figure 3.29: Developed Overvoltages at the Terminals of the Arrester and the Transformer ( $L$  is the distance between arrester and transformer,  $c$  is the velocity of the light,  $S$  is the steepness of the lightning current)

A significant parameter that determines the efficiency of the installed arrester is its protective zone, i.e. the maximum separation distance for which the insulation coordination demands are satisfied. Arresters should be installed as close as possible to the device to be protected, since fast-front surges may result to overvoltages at the terminals of the equipment under protection much higher than the residual voltage of the arrester.



The protective zone of an arrester, for the simple arrangement of a transformer connected to the end of a single feeder, can be estimated as following:

$$L_{max} = \frac{c}{2S} \left( \frac{LIWV}{1.25} - U_{\pi} \right) \quad (3.19)$$

Where;

$c$  is the propagation velocity of the voltage wave

$S$  is the front steepness of the lightning overvoltage (kV/ $\mu$ s) (typical value:1000)

$LIWV$  standard lightning impulse withstand voltage of the device to be protected in kV

$U_{\pi}$  lightning impulse protective level of the arrester (kV)

The normal operation of metal oxide arresters can be degraded by various factors. Ingress of moisture in the internal of the arresters, poor inter-disc contact and consequent losses due to electrical discharges, housing pollution, mechanical fractures because of thermal runaway after high-current surge are common reasons for arresters failures (James & Su 2008, Lundquist et al. 1990, Christodoulou et al. 2009). The above indicate the necessity of arresters' condition testing and monitoring, in order to ensure their reliable operation. Laboratory tests and on-line monitoring have been proposed (Hinrichsen 1997) in order to examine the situation of the protective devices. However, there is always an increased risk to result to false conclusions and lead to unnecessary repairs or replacements. In any case, the leakage current is the most used indicator for the condition of installed surge arresters.

Before the presentation of the equivalent circuit models of metal oxide surge arrester, it is important to emphasize that laboratory results about the characteristics of metal oxide surge arresters indicate a dynamic behavior: the residual voltage of the arrester is strongly influenced by the waveform of the lightning current and increases as the current front time decreases (IEEE W. G. 3.4.11 1992, Z'itnik et al. 2006, Bayadi et al. 2003).

So, metal oxide gapless surge arresters cannot be modeled by only a non-linear resistance, since their response depends on the magnitude and the rate of rise of the surge current. To these directions, several frequent dependent models have been developed, in order to represent the actual dynamic behavior of the arrester. The proposed equivalent circuit models (Martinez & Castro-Aranda 2005, Tarchini & Gimenez 2003, Montanes et al. 2002, Garcia-Gracia et al. 1999, Nakada et al. 1998, Zanetta & Pereira 2003) present some differences, concerning mainly the calculation of their parameters.



### 3.8.1. The Physical Model

Figure 3.30 depicts the most simple varistor model, which is non-frequency dependent.  $L$  is the inductance of conducting leads and  $C$  is the capacitance of the device package and zinc oxide material. At low currents, the varistor behaves as a high value resistance  $R_L$ , and at very high currents the low value bulk resistance  $R_B$  of the zinc oxide grains dominates the varistor response (Pinceti & Giannettoni 1999, Z'itnik et al. 2006, Suljanovic et al. 2006, Bayadi et al. 2003).

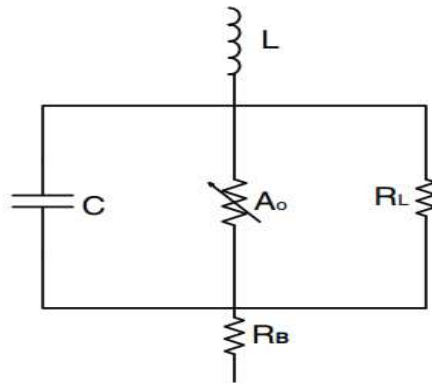

Figure 3.30: The Physical Model (Bayadi et al. 2003)

### 3.8.2 The IEEE Model

The IEEE Working Group 3.4.11 (IEEE W. G. 3.4.11 1992) proposes the model of Figure 3.31. The circuit is consisted of two nonlinear resistances  $A_0$  and  $A_1$ , separated by R–L filter. For slow front surges the filter impedance is low and the non-linear resistances are in parallel. For fast front surges filter impedance becomes high, and the current flows through the non-linear resistance  $A_0$ . The inductance  $L_1$  and the resistance  $R_1$  comprise the filter between the two varistors, since the inductance  $L_0$  is associated with magnetic fields in the vicinity of the arrester.  $R_0$  stabilizes the numerical integration and  $C$  represents the terminal-to-terminal capacitance. The equations for the above parameters and the per-unit V–I characteristic of the varistors are given in (IEEE W. G. 3.4.11 1992):

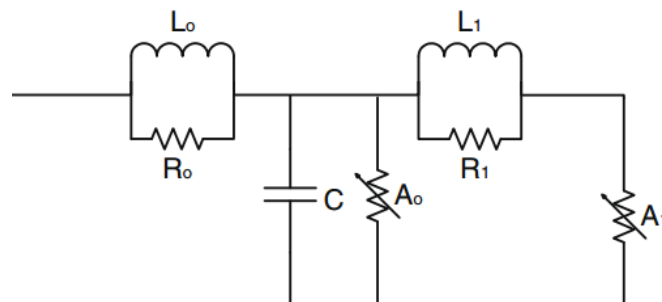

Figure 3.31: The IEEE Model (IEEE W. G. 3.4.11 1992)





$$L_1 = 15 \cdot d / n \mu\text{H} \tag{3.20}$$

$$R_1 = 65 \cdot d / n \Omega \tag{3.21}$$

$$L_o = 0.2 \cdot d / n \mu\text{H} \tag{3.22}$$

$$R_o = 100 \cdot d / n \Omega \tag{3.23}$$

$$C = 100 \cdot n / d \text{ pF} \tag{3.24}$$

Where;

$d$  is the length of arrester column in meters and

$n$  is the number of parallel columns of metal oxide disks.

### 3.8.3 The Pinceti–Gianettoni Model

The Pinceti–Gianettoni model is based on the IEEE model, but there is no capacitance and the resistances  $R_o$  and  $R_1$  are replaced by one resistance (approximately 1 M $\Omega$ ) (Figure 3.32).

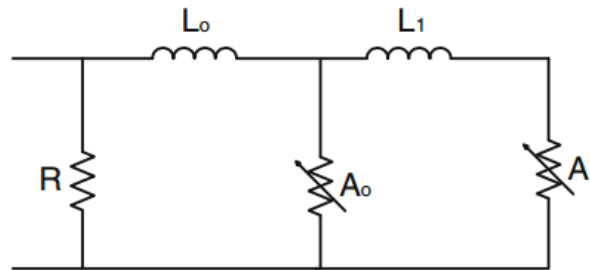

Figure 3.32: The Pinceti–Gianettoni Model (Pinceti & Gianettoni 1999).

The non-linear resistors are based on the curves of (IEEE W. G. 3.4.11 1992). The inductances  $L_o$  and  $L_1$  are calculated using the equations (Pinceti & Gianettoni 1999):

$$L_1 = \frac{1}{4} \cdot \frac{V_{r1/T_2} - V_{r8/20}}{V_{r8/20}} \cdot V_n \mu\text{H} \tag{3.25}$$

$$L_o = \frac{1}{12} \cdot \frac{V_{r1/T_2} - V_{r8/20}}{V_{r8/20}} \cdot V_n \mu\text{H} \tag{3.26}$$



Where;

$V_a$  is the arrester's rated voltage,

$V_{r(8/20)}$  is the residual voltage for a (8/20) 10 kA lightning current and

$V_{r(1/T_2)}$  is the residual voltage for a (1/T<sub>2</sub>) 10 kA lightning current.

### 3.8.4 The Fernandez–Diaz Model

Based also on IEEE model,  $A_0$  and  $A_1$  are separated only by  $L_1$  (Figure 3.33).  $C$  is added in arrester terminals and represents terminal-to-terminal capacitance of the arrester. The procedure for the computation of the parameters is given in (Zanetta & Pereira 2003). The V–I characteristics for  $A_0$  and  $A_1$  are calculated using manufacturers' data, considering the ratio  $I_0$  to  $I_1$  equal to 0.02. The inductance  $L_1$  is given as:

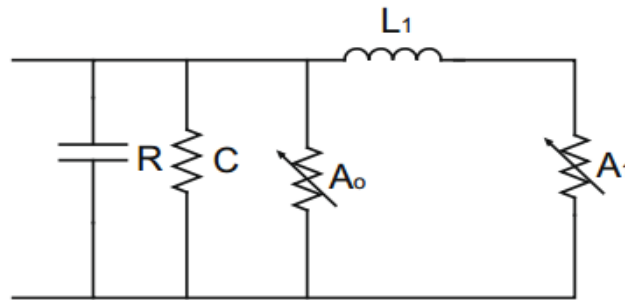

Figure 3.33: The Fernandez–Diaz Model (Fernandez & Diaz 2001).

$$L_1 = n \cdot L'_1 \tag{3.27}$$

Where;

$n$  is a scale factor and

$L'_1$  is given in (Fernandez & Diaz 2001), computing the percentage increase of the residual voltage as:

$$\Delta V_{res}(\%) = \frac{V_{r(1/T_2)} - V_{r(8/20)}}{V_{r(8/20)}} \cdot 100 \tag{3.28}$$

Where;

$V_{r(8/20)}$  is the residual voltage for a 8/20 lightning current.

$V_{r(1/T_2)}$  is the residual voltage for a 1/T<sub>2</sub> lightning current with the nominal amplitude.



### 3.9 Conclusions

This chapter presents the basic configuration schemes of HV/MV substations and analyzes the basic characteristics of the basic equipment of the substations. Substation  $\sigma$  are complex systems, consisting of various types of components and their appropriate operation is fundamental for the reliable and uninterrupted power supply. It is obvious that a potential lightning hit can influence a series of devices, resulting in the destabilization of the system and consequent malfunction. So, the need for lightning protection is highlighted, in order to safeguard the protection of the substation against internal and external overvoltages. In addition, the main methods and procedures for the lightning protection of the substation are depicted, providing also the circuit models that will be implemented in the next chapters.



## References

- ABB, *Surge Arresters-Buyer's Guide*, 5.1 ed., 2007
- Abdel-Salam M., Anis H., A. El-Morsbedy, Radwan R., "High Voltage Engineering, Theory and Practice", Marcel Dekker, New York.
- Ametani A. and Kawamura T., "A method of a lightning surge analysis recommended in Japan using EMTP," *IEEE Trans. Power Delivery*, vol. 20, no. 2, pp. 867–875, Apr. 2005.
- Ametani A., Kasai Y., Sawada J., Mochizuki A., and Yamada T., "Frequency-dependent impedance of vertical conductors and a multiconductor tower model," *IEE Gener. Transm. Distrib.*, vol. 141, no. 4, pp 339–345, Jul. 1994.
- Baba Y. and Ishii M., "Numerical electromagnetic field analysis on lightning surge response of tower with shield wire," *IEEE Trans. Power Delivery*, vol. 15, no. 3, pp 1010–1015, Jul. 2000.
- Bayadi A., Harid N., Zebar K., Belkhat S., *Simulation of metal oxide surge arrester dynamic behavior under fast transients*, in: *International Conference on Power Systems Transients*, New Orleans, USA, 2003.
- Chisholm W. A. and Janischewskyj W., "Lightning surge response of ground electrodes," *IEEE Trans. Power Delivery*, vol. 4, no. 2, pp. 1329–1337, Apr. 1989.
- Chisholm W. A., Chow Y. L., and Srivastava K. D. "Travel time of transmission towers," *IEEE Trans. Power App. Syst.*, vol. PAS-104, no. 10, pp. 2922–2928, Oct. 1985.
- Chowdhuri P., "Grounding for protection against lightning," in *Electromagnetic transients in power systems*. Research Studies Press Ltd., John Wiley & Sons Inc., New York, 1996, pp. 104-113.
- Christodoulou C.A., Argerinos M.V., Ekonomou L., Gonos I.F., Stathopoulos I.A., "Measurement of the resistive leakage current in surge arresters under artificial rain test and impulse voltage subjection", *IET Science, Measurement & Technology*, Vol. 3, Issue 3, pp. 256-262, May 2009.
- Christodoulou C.A., Ekonomou L., Fotis G.P., Gonos I.F., Stathopoulos I.A., "Assessment of surge arrester failure rate and application studies in Hellenic high voltage transmission lines", *Electric Power Systems Research*, Vol. 80, Issue 2, pp. 176-183, February 2010.
- Christodoulou C.A., Perantzakis G., Spanakis G.E., Karampelas P., "Evaluation of lightning performance of transmission lines protected by metal oxide surge arresters using artificial intelligence Techniques", *Springer, Energy Systems*, Vol. 3, Issue 4, pp. 379-399, December 2012.
- CIGRE Working Group 33.01, "Guide to procedures for estimating the lightning performance of transmission lines," *Technical Bulletin 63*, Oct. 1991.
- Darveniza M., Popolansky F., and Whitehead E. R. "Lightning protection of UHV lines," *Electra*, no. 41, pp. 39–69, Jul. 1975.
- Fernandez F., Diaz R., *Metal oxide surge arrester model for fast transient simulations*, in: *International Conference on Power System Transients (IPAT' 01)*, Rio De Janeiro, Brazil, 2001, Paper 14.
- Francisco de Le6n, Semlyen Adam, "COMPLETE TRANSFORMER MODEL FOR ELECTROMAGNETIC TRANSIENTS", *IEEE Transactions on Power Delivery*, Vol. 9, No. 1, January 1994.
- Garcia-Gracia M., Baldovinos S., Sanz M., Montanes L., *Evaluation of the failure probability for gapless metal oxide arresters*, in: *IEEE Transmission and Distribution Conference*, 1999.
- Grigsby Leonard L., "Electric Power Engineering Handbook", CRC Press, Taylor & Francis, 2007 Group
- Gutierrez J. A., Moreno P., Guardado L., Naredo J. L., "Comparison of transmission tower models for evaluating lightning performance", in *Proc. Power Tech*, Bologna, Italy, 2003, pp. 1-6.
- Hara T. and Yamamoto O., "Modeling of a transmission tower for lightning-surge analysis," *IEE Gener. Transm. Distrib.*, vol. 143, no. 3, pp. 283–289, May 1996.



- Hinrichsen V., *Metal-Oxide Surge Arresters, Fundamentals*, 1st ed., Siemens, 2001
- Hinrichsen V.: 'Monitoring of high voltage metal oxide surge arrester'. VI Jornadas Internacionales de Aislamiento Electrico, Bilbao, 22–23 October 1997 paper 6.4
- IEC 60071-2, *Insulation co-ordination – Part 2: Application guide*, 1996
- IEC 60099-4, *Surge Arresters—Part 4: Metal-Oxide Surge Arresters Without Gaps for a.c. Systems*, 2nd ed., 2004–2005.
- IEEE Std 1243-1997: *IEEE guide for improving the lightning performance of transmission lines (1997)*
- IEEE Std 80-2000, "IEEE Guide for Safety in AC Substation Grounding", January 2000
- IEEE Std 998-1996, "IEEE Guide for Direct Lightning Stroke Shielding of Substations", 1996
- IEEE Std 998-1996, "IEEE Guide for Direct Lightning Stroke Shielding of Substations", 1996
- IEEE Working Group 3.4.11, *Modeling of metal oxide surge arresters*, IEEE Trans. Power Delivery 7(1) (1992) 302–309.
- IEEE Working Group on Estimating Lightning Performance of Transmission Lines, "IEEE guide for improving the lightning performance of transmission lines," Proposed IEEE P1243 draft, 1996.
- IEEE Working Group, "A Simplified method for estimating lightning performance of transmission lines," IEEE Trans. Power App. Syst., vol. PAS-104, no. 4, pp. 919-932, Apr. 1985.
- IEEE Working Group, "Estimating lightning performance of transmission lines II – Updates to analytical models," IEEE Trans. Power Delivery, vol. 8, no. 3, pp. 1254-1267, Jul. 1993.
- Ishii M., Kawamura T., Kouno T., Ohsaki E., Shiokawa K., Murotani K., and Higuchi T., "Multistory transmission tower model for lightning surge analysis," IEEE Trans. Power Delivery, vol. 6, no. 3, pp. 1327–1335, Jul. 1991.
- James R.E., Su Q.: 'Condition assessment of high voltage insulation in power system equipment' (IET Power and Energy Series 53, 2008, 1st edn.)
- Joint Working Group 33/23.12, "Insulation co-ordination of GIS: Return of experience, on site tests and diagnostic techniques," *Electra*, no. 176, pp. 67-97, Feb. 1998.
- Jordan C. A., "Lightning computations for transmission lines with overhead ground wires," *Gen. Elec. Rev.*, vol. 37, 1934.
- Korsuntchev A. V., "Application of the theory of similitude to the calculation of concentrated earth electrodes," *Elektrichestvo*, no.5, pp. 31-35, May 1958.
- Laurent, P. G., "Les Bases Generales de la Technique des Mises a la Terre dans les Installations Electriques," *Bulletin de la Societe Francaise des Electriciens*, vol. 1, ser. 7, pp. 368–402, July 1951.
- Lundquist J., Stenstrom L., Schei A., Hansen B.: 'New method for measurement of the resistive leakage currents of metal oxide surge arresters in service', IEEE Trans. Power Deliv., 1990, 5, (4), pp. 1811–1822
- Martinez J.A., Castro-Aranda F., *Lightning performance analysis of overhead transmission lines using the EMTP*, IEEE Trans. PWRD 20 (3) (2005) 294–300.
- Martinez-Velasco Juan A., "Transient Analysis of Power Systems Solution Techniques, Tools and Applications", 2015
- McDonald, J. et al., "Electric Power Engineering Handbook", CRC Press, Boca Raton, FL, 2000
- McDonald, J., "Substation integration and automation—fundamentals and best practices", *IEEE Power & Energy*, 1, March 2003
- Menemenlis C. and Chun Z. T., "Wave propagation on non uniform lines," IEEE Trans. Power App. Syst., vol. PAS-101, no. 4, pp 833–839, Apr. 1982.
- Montanes L., Garcia-Gracia M., Sanz M., Garcia M.A., *An improvement for the selection of surge arresters based on the evaluation of the failure probability*, IEEE Trans. Power Delivery 17 (1) (2002) 123–128.
- Motoyama H., Shinjo K., Matsumoto Y., and Itamoto N., "Observation and analysis of multiphase



- back flashover on the Okushibhiku test transmission line caused by winter lightning," *IEEE Trans. Power Delivery*, vol. 13, no. 4, pp. 1391–1398, Oct. 1998.
- Nakada K., Yokoyama S., Yokota T., Asakawa A., Kawabata T., *Analytical study on prevention for distribution arrester outages caused by winter lightning*, *IEEE Trans. Power Delivery* 13 (4) (1998) 1399–1404.
- Nieman, J., "Unstellung von Hochspannungs-Erdungsalagen Aufden Betrieb Mit Starr Geerdetem Sternpunkt," *Electrotechnische Zeitschrift*, vol. 73, no. 10, pp. 333–337, May 1952.
- Nieman, J., "Unstellung von Hochspannungs-Erdungsalagen Aufden Betrieb Mit Starr Geerdetem Sternpunkt," *Electrotechnische Zeitschrift*, vol. 73, no. 10, pp. 333–337, May 1952.
- Oettle E. E., "A new general estimation curve for predicting the impulse impedance of concentrated earth electrodes," *IEEE Trans. Power Delivery*, vol. 3, no. 4, pp 2020–2029, Oct. 1988.
- Picher, P.; Lapworth, J.; Noonan, T.; Christian, J. et al, "Mechanical Condition Assessment of Transformer Windings using Frequency Response Analysis," *Cigre Report 342*, 2008.
- Pigini A., Rizzi G., Garbagnati E., Porrino A., Baldo G., and Pesavento G., "Performance of large air gaps under lightning overvoltages: Experimental study and analysis of accuracy of predetermination methods," *IEEE Trans. Power Delivery*, vol. 4, no. 2, pp 1379–1392, Apr. 1989
- Pinceti P., Giannettoni M., *A simplified model for zinc oxide surge arresters*, *IEEE Trans. Power Delivery* 14 (2) (1999) 393–398.
- Pinceti P., Giannettoni M., *A simplified model for zinc oxide surge arresters*, *IEEE Trans. Power Delivery* 14 (2) (1999) 393–398.
- Piotr ORAMUS, Marek FLORKOWSKI, *Simulations of lightning overvoltages in HV electric power system for various surge arresters and transmission lines models*, ISSN 0033-2097, R. 90 NR 10/2014
- Dommel, H., et al., *Electromagnetic Transient Program Reference Manual (EMTP Theory Book)*, 1986
- IEEE Fast Front Transients Task Force, *Modeling Guidelines for Fast Front Transients*, *IEEE Transactions on Power Delivery*, Vol. 11, No. 1, January 1996
- Marti J.R., "Accurate modeling of frequency-dependent transmission lines in electromagnetic transient simulations," *Power Engineering Review*, IEEE, vol. PER-2, no. 1, pp. 29–30, 1982
- Rahimpour Ebrahim and Bigdeli Mehdi, "Simplified transient model of transformer based on geometrical dimensions used in power network analysis and fault detection studies", *POWERENG 2009*, Lisbon, Portugal, March 18-20, 2009
- Rondon D., Vargas M., Herrera J., Montana J., Torres H., Camargo M., Jimenez D., and Delgadillo A., "Influence of grounding system modelling on transient analysis of transmission lines due to direct lightning strike," in *Proc. Power Tech*, St. Petersburg, Russia, 2005, pp. 1-6.
- Rüdenberg, R., "Grounding principles and practices—Part 1, Fundamental considerations on grounding currents," *Electrical Engineering*, vol. 64, no. 1, pp. 1–13, Jan. 1945.
- Sargent M. A. and Darveniza M., "Tower surge impedance," *IEEE Trans. Power App. Syst.*, vol. PAS-88, no. 5, pp. 680–687, May 1969.
- Schwarz, S. J., "Analytical expression for resistance of grounding systems," *AIEE Transactions on Power Apparatus and Systems*, vol. 73, no. 13, part III-B, pp. 1011–1016, Aug. 1954.
- Siemens, Energy Sector, "Power Engineering Guide: Answers for Energy", 5th Edition, 2008
- Spanias C.A., Christodoulou C.A., Gonos I.F., Stathopoulos I.A., "Electric Field Measurements around a Metal Oxide Surge Arrester", *Proceedings of the 2010 International Conference on High-Voltage Engineering and Application (ICHVE 2010)*, New Orleans, Louisiana, USA, October 11-14, 2010, pp. 278-281
- Suljanovic N., Mujic A., Murko V., *Practical issues of metal-oxide varistor modeling for numerical simulations*, in: *28th International Conference on Lightning Protection*, Kazanaka, Japan, 2006, pp. 1149–1154.



- Sunde, E. D., *Earth conduction effects in transmission systems*, New York: McMillan, 1968.
- Sverak, J. G., "Simplified analysis of electrical gradients above a ground grid; Part I—How good is the present IEEE method?" *IEEE Transactions on Power Apparatus and Systems*, vol. PAS-103, no. 1, pp.7–25, Jan. 1984.
- Tarchini J.A., Gimenez W., *Line surge arrester selection to improve lightning performance of transmission lines*, IEEE Bologna PowerTech Conference, Bologna, Italy, 2003.
- Wadhwa C.L., "High Voltage Engineering", New Age International Publishers, 2nd Edition, 2007
- Wagner C. F. and Hileman A. R., "A new approach to calculation of lightning performance of transmission lines III – A simplified method: Stroke to tower," *AIEE Trans. Power App. Syst.*, vol. 79, pp. 589–603, Oct. 1960.
- Weck K. H., "Lightning performance of substations," *CIGRE SC 33, Rio de Janeiro, Brazil, 1981*.
- Weck K. H., "The current dependence of tower footing resistance," *CIGRE 33-88 (WG01), 14 IWD, 1988*.
- Working Group 02 (Internal overvoltages) of Study Committee 33 (Overvoltages and Insulation Coordination), "Guidelines for Representation of Network Elements when Calculating Transients," *Cigré Report 39, 2000*.
- Yamada T., Mochizuki A., Savada J., Zaima E., Kawamura T., Ametani A., Ishii M., and Kato S., "Experimental evaluation of a UHV tower model for lightning surge analysis," *IEEE Trans. PowerDelivery*, vol. 10, no. 1, pp 393–402, Jan. 1995.
- Yasuda Y., Hirakawa Y., Shiraishi K., and Hara T., "Sensitivity analysis on grounding models for 500kV transmission lines," *Trans.IEE Japan B*, vol. 121, no. 10, pp. 1386–1393, 2001.
- Zanetta L.C., Pereira C.E. de M., *Application studies of line arresters in partial shielded 138-kV transmission lines*, *IEEE Trans. Power Delivery* 18 (1) (2003) 95–100.
- Zitnik B., Zitnik M., Babuder M., *The ability of different simulation models to describe the behavior of metal oxide varistors*, in: *28th International Conference on Lightning Protection, Kazanaga, Japan, 2006*, pp. 1111–1116.



# CHAPTER 4

## DESCRIPTION OF THE EXAMINED SYSTEMS

### 4.1 Introduction

Chapter 4 deals with the topology of the systems under examination. The basic equipment of the substation is presented in details, providing the necessary electrical and geometrical characteristic of each component. The depicted configurations correspond to typical substations 150/20kV of the Hellenic electrical network. Note, that the substations are interconnected, in order to increase the reliability of the system and ensure the uninterruptible operation of the system. Finally, the most used equivalent circuit models of each component are presented.

### 4.2 Topology of the Examined Substations

In the current thesis a lightning performance study for substation will be carried out, considering different configurations. Figures 4.1 – 4.3 depict the topology of the examined cases, presenting the basic parts of the substations.

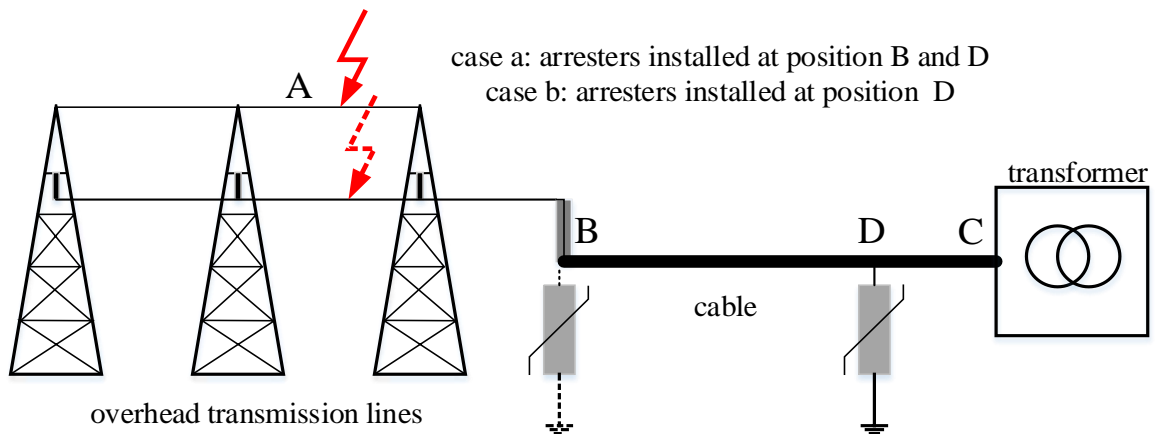

*Configuration (a) (Simple Topology of a 150/20kV Substation)*



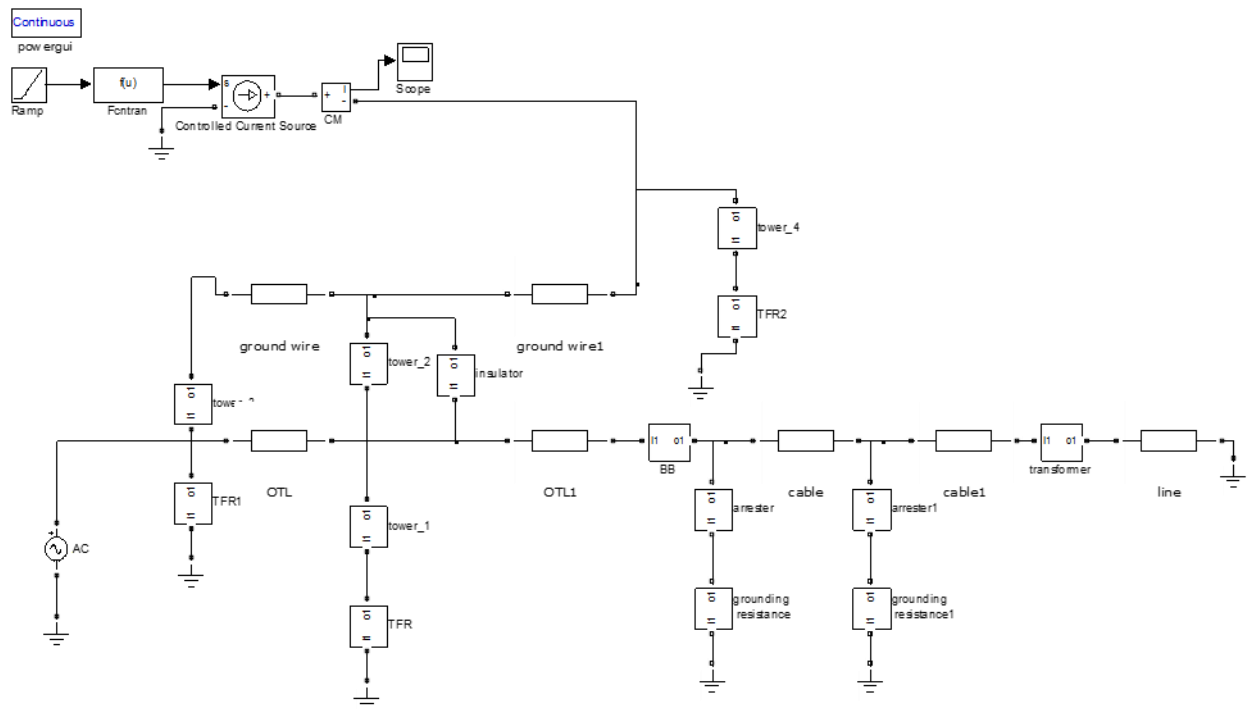

*Configuration (b)(Simulation Model)*

*Figure 4.1 Configuration1 (Simple Topology)and (Simulation Model) of a 150/20kv Substation*

Configurations (a) and (b) in the Figure 4.1 are: (a) is a simple topology of a 150/20kV substation and (b) is the Simulation Model. The basic components of the substation are:

- High voltage overhead transmission line
- High voltage cable
- Power transformer
- Busbars
- Surge arresters
- Grounding systems
- Circuit breakers.

A lightning flash current is injected in position A of the overhead transmission line, supposing that substation outages are mainly caused by impinging overvoltage surges, incoming from the connected overhead transmission lines, which exceeding the insulation level of the substation equipment result in interruptions in power supply and consequently in economic losses



(Mikropoulos et al. 2010). The substation is adequately protected against direct lightning flashes by ground wires and masts, according to methodologies described in Chapter 3.

In details, a 150kV single-circuit overhead transmission line is connected with a HV cable, in order to feed the power transformer. Each switchgear bay includes in practice the full complement of disconnecting switches (to isolate equipment or to redirect current flow), earthing switches (to protect the personnel), instrument transformers (voltage and current measurement) and control and protection equipment (to protect the substation against short-circuit currents). A lightning hits either a phase conductor or an overhead ground wire at position A, considering that the majority of the substations failures happen due to shielding failures or backflashover on the lines. The developed voltage surge travels through the conductor and the cable to the substation's transformer. The developed overvoltages at the joint position and at the terminals of the transformer are estimated. A sensitivity analysis is performed, considering

- the installation position of the arresters (distance between the transformer and the installed arrester  $CD=0\text{m}, 15\text{m}, 30\text{m}, 45\text{m}, 60\text{m}$ )
- the installation of arresters at the joint of overhead line and underground cable (case a and case b)
- the length of the underground cable ( $BD=300\text{m}, 600\text{m}, 1000, 2000\text{m}$ )
- the tower footing resistance ( $R=1\Omega, 5\Omega, 10\Omega, 15\Omega, 20\Omega, 25\Omega$ )

Note, that an overhead transmission line of 15km is regarded, since the span between the towers is considered equal to 300m. Moreover, a constant substation grounding resistance equal to  $1\Omega$  has been supposed. The achievement of low grounding resistance values is a decisive parameter, in order to ensure the adequate lightning protection of the substation.

**Configuration 2** is a more complex topology, consisting of two interconnected transformers (substation 1 is connected with substation 2 by using a high voltage cable). An overhead transmission line is undergrounded at terminals I and II, which are connected by using a high voltage cable. A lightning hits either the overhead transmission line 1 (case a) or the overhead transmission line 2 (case b); in any case the developed overvoltages at various positions of the examined system are estimated, performing a sensitivity analysis for the role of the grounding resistance. Scope of the study is to indicate that the installation of external lightning protection system does not guarantee the elimination of the lightning faults, since lightning strokes on the connected transmission lines can create significant surges that stress the components of the equipment (cables, transformers etc.) and can result to faults and damages.

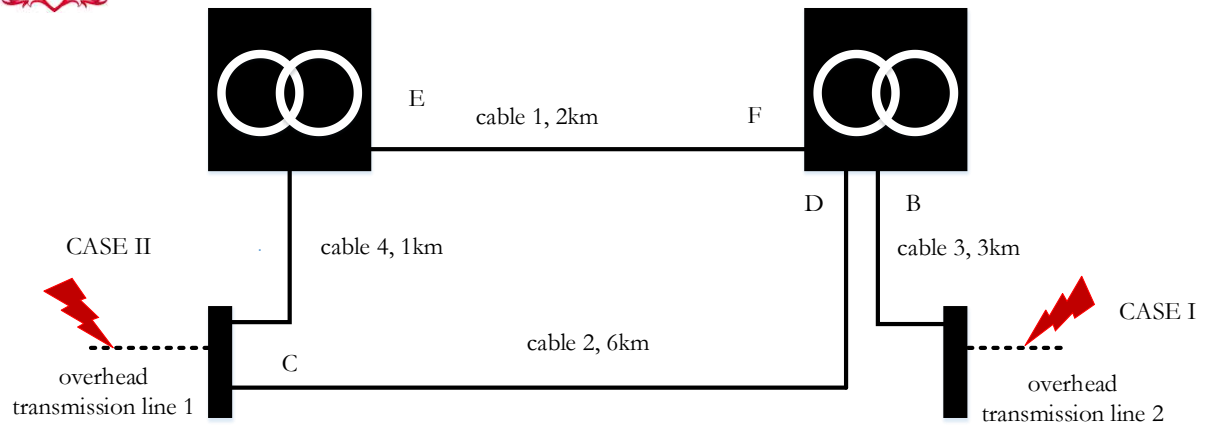

Figure 4.2 Configuration 2

### 4.3 Characteristics of the Substations' Components

#### 4.3.1 Transmission lines

The overhead transmission line has nominal voltage of 150kV (phase-phase, rms) and are consisting of:

- The Metallic Towers.
- The Phase Conductors.
- The Overhead Ground Wires.
- The Insulators.
- The Grounding System.

Figure 4.3 depicts the geometrical configuration of a typical tower of a single circuit 150kV overhead transmission line of the Greek electrical network . The insulators are consisting of ten ceramic discs, offering an insulation level of 750kV. The overhead ground wires are installed in a way to protect the phase conductors against external overvoltages, according to the electrogeometrical model.

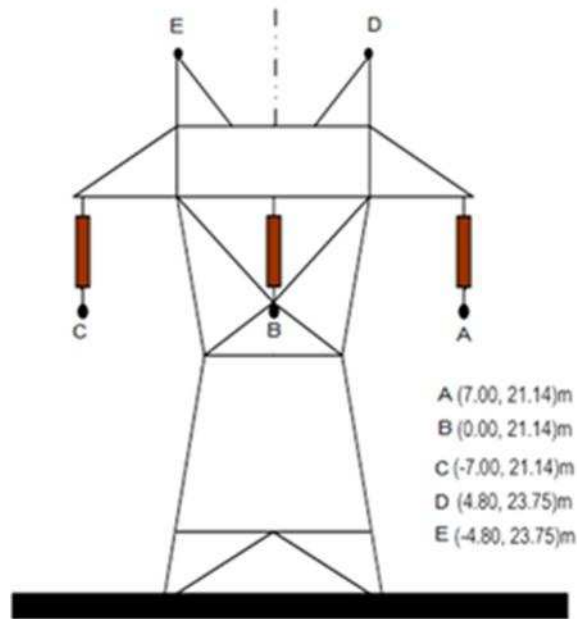

Figure 4.3 Tower of 150kV Transmission Line

The cross-section of the Aluminium conductor steel-reinforced (ACSR) conductors is 636MCM, since the nominal current is 789A. Fig. 4.4 presents the configuration of the grounding system of the line. The span between the towers is regarded equal to 300m.

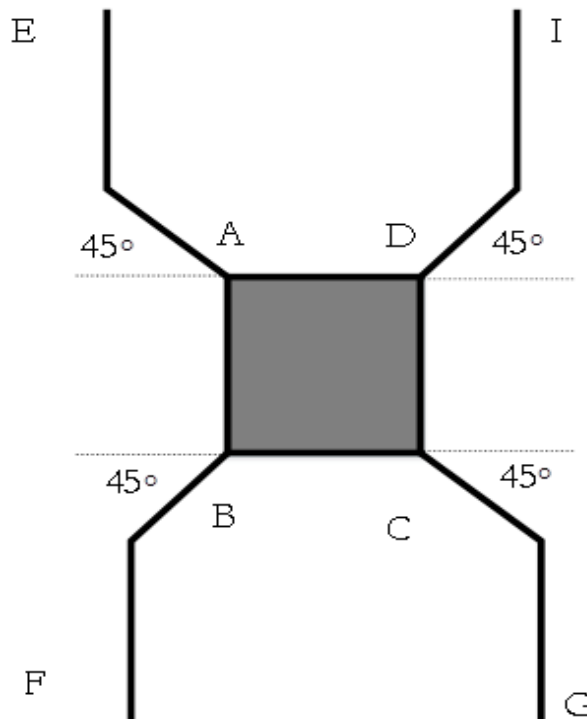

Fig. 4.4 the Grounding System of the Tower ( $ABCD$  the Basis of the Tower,  $AE=DI=BF=CG=60m$ )



### **4.3.2 Cables**

Cables connect the overhead transmission lines to the substations; they also connect the terminals of configuration 2. The conductors of the cables are made of aluminum (Al), their cross section is  $800\text{mm}^2$  and the nominal current is 830A. The insulation of the cable is made of XLPE and the external layer is made of PVC. The cables are buried and the connection between the different parts of the cables and the substations is performed by using appropriate joints.

### **4.3.3 Power Transformers**

The power transformers are the main part of the substation. Details about power transformers are given in Chapter 3. Table 4.1 presents the electrical characteristics of the used power transformers.

Table 4.1 Electrical Characteristics of Power Transformer

<b>Rated Power</b>	50MVA
<b>Rated Frequency</b>	50Hz
<b>Primary Rated Voltage</b>	150kV
<b>Secondary Rated Voltage</b>	20kV
<b>Vector Group</b>	Dyn1

### **4.3.4 Surge Arresters**

Surge arresters are installed at the entrance of the substation, in order to protect the equipment and keep the developed overvoltages below the Basic Insulation Level (BIL 750kV for a system with nominal voltage 150kV). Table 4.2 presents the electrical characteristics of the used surge arresters, which are installed at the high voltage side of the substations.



Table 4.2 Electrical Characteristics of Surge Arresters

<b>Maximum Continuous Operating Voltage</b>		86kV
<b>Rated Voltage</b>		108kV
<b>Residual Voltage</b>	5kA	242kV
	10kA	254kV
	20kA	280kV
	40kA	313kV
<b>Discharge energy class</b>		Class 3
<b>Energy Capability</b>		8 kJ/kV

## 4.4 Simulation Models of the Substations' Components

### 4.4.1 Circuit Representation of Overhead Transmission Lines and Cables

The circuit representation of overhead high voltage transmission lines is performed by using the distributed parameter line model of Simulink, based on the Bergeron's theory. The distributed parameter line block uses an N-phase distributed parameter line model with lumped losses, based on the Bergeron's Traveling Wave Method (Dommel 1969). The lossless distributed line is characterized by the surge impedance ( $Z_C$ ) and the phase velocity ( $v$ ), according to the equations:

$$Z_C = \sqrt{l \cdot c} \quad (4.1)$$

$$v = \frac{1}{\sqrt{l \cdot c}} \quad (4.2)$$

Where;

$l$  is the per unit length inductance of the line.

$c$  is the per unit length capacitance of the line.

The model considers that the voltage at the start of the line should arrive at the end of the line without changes, after a time given by the equation (Dommel 1969):

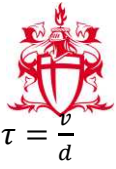

$$\tau = \frac{d}{v} \tag{4.3}$$

Where;

$\tau$  is the transport delay of the voltage wave.

$v$  is the propagation velocity of the wave.

$d$  is the length of the line.

By lumping  $R/4$  at both ends of the line and  $R/2$  in the middle and using the current injection method the circuit of Figure 4.5 is extracted.

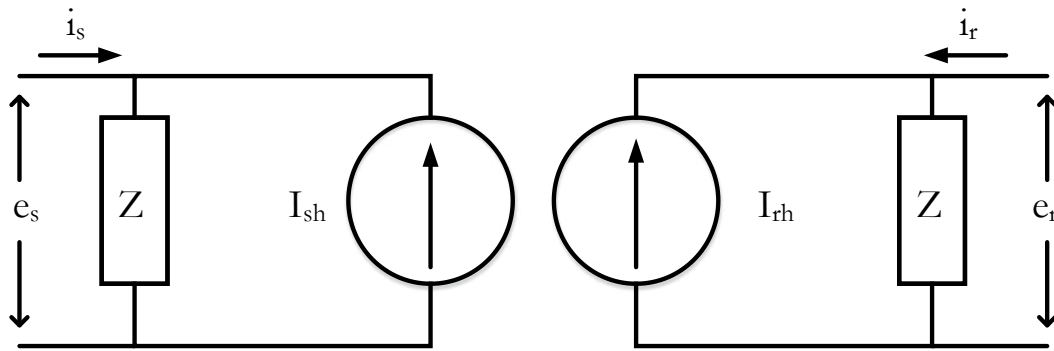

Figure 4.5 Two-Port Equivalent Circuit Model of a Transmission Line

The above equivalent circuit is governed by the equations (Dommel 1969):

$$I_{sh}(t) = \left(\frac{1+h}{2}\right) \cdot \left(\frac{1+h}{Z} \cdot e_r(t-\tau) - h \cdot i_r(t-\tau)\right) + \left(\frac{1-h}{2}\right) \cdot \left(\frac{1+h}{Z} \cdot e_s(t-\tau) - h \cdot i_s(t-\tau)\right) \tag{4.4}$$

$$I_{rh}(t) = \left(\frac{1+h}{2}\right) \cdot \left(\frac{1+h}{Z} \cdot e_s(t-\tau) - h \cdot i_s(t-\tau)\right) + \left(\frac{1-h}{2}\right) \cdot \left(\frac{1+h}{Z} \cdot e_r(t-\tau) - h \cdot i_r(t-\tau)\right) \tag{4.5}$$

$$Z = Z_C + \frac{r}{4} \tag{4.6}$$

$$h = \frac{Z_C - r/4}{Z_C + r/4} \tag{4.7}$$

Where;

$Z_C$  is the surge impedance

$\tau$  is the transport delay of the voltage wave.

$r$  is the per unit length resistance of the line.

$h$  is the height of the Transmission Line.



#### ***4.4.2 Circuit Representation of Towers***

The tower of the transmission lines were represented by the Chisholm et al. model, presented in (Chisholm et al. 1985), according to the equation:

$$Z_r = 60 \ln \left( \cot \left( \frac{1}{2} \tan^{-1} \left( \frac{r}{h} \right) \right) \right) \quad (4.8)$$

Where;

r is the tower base radius(m).

Six more tower models are also implemented, in order to examine the influence of the used tower equivalent circuit model to the obtained simulation results. These are:

- Jordan (Jordan 1934).
- Wagner & Hileman (Wagner and Hileman 1960).
- Sargent & Darveniza (Sargent and Darveniza 1969).
- Ametani et al. (Ametani et al. 1994).
- Rondon et al. (Rondon et al. 2005).
- Yamada et al. (Yamada et al. 1995).

#### ***4.4.3 Circuit Representation of Surge Arresters***

Metal oxide gapless surge arresters cannot be modeled only as non-linear resistances, since their response, i.e. their residual voltage for a given current, is a function of the magnitude and the slope of the injected pulse. The accuracy of the results is strongly depended on the adjustment of the parameter values, for each model. In the current thesis, metal oxide gapless surge arresters are represented by using the IEEE model (IEEE WG 3.4.11 1992), which takes into consideration the dynamic behavior of the nonlinear resistors of the protective device. The IEEE model is widely used for lightning performance studies and gives adequate results. Moreover, two more circuit models are used for sensitivity analysis purposes, i.e. the Pinceti-Giannettoni model and the Fernandez – Diaz model (Pinceti and Giannettoni 1999, Fernandez and Diaz 2001). These models are simplified versions of the IEEE model and they use different methodology for the computation of the circuit's parameters.



#### 4.4.4 Circuit Representation of Transformers, Busbars and Circuit Breakers

Substation apparatus and busbars also are modeled as frequency dependent elements, according to (IEEE Task Force 1996). In details, busbars are modeled as distributed parameters line of impedance equal to  $50\Omega$ , since the power transformer is represented by the circuit of Fig. 4.6 ( $C_D=460\text{pF}$ ,  $C_E=2000\text{pF}$ ,  $R_1=148\mu\Omega$ ,  $L_1=18\text{mH}$ ). As far as the circuit breakers is concerned, a capacitance equal to  $50\text{pF}$  has been implemented. Fig. 4.6 depicts the

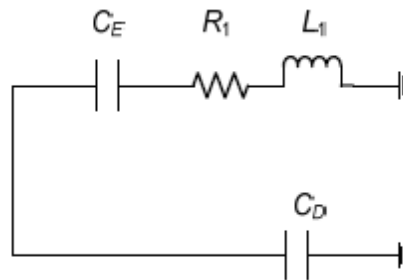

Figure 4.6: High frequency model of the HV transformer side ( $C_D$  HV side windings capacitance,  $C_E$ ,  $R_1$ ,  $L_1$  capacitance, resistance and inductance of HV bushings)

#### 4.4.5 Circuit Representation of Grounding System

The appropriate modeling of the grounding system of the tower and the substation is a great importance, in order to obtain reliable results for the lightning performance of the system. The achievement of low values of grounding resistance reduces the developed overvoltages due to lightning hits and limits the probability of serious faults and damages. It is worth mentioning that the grounding resistance depends on the soil resistivity, which is usually known during the initial design stage. Furthermore, the use of the total fault current as the current discharge by the grounding system is a contestable approach, since results in overestimations and expensive solutions. The division of the fault current depends on (IEEE St 80 2000):

- The number of transmission lines with shield wires tied to the ground grid
- The substation grounding resistance
- The number of power source and non-power source terminals
- The soil resistivity
- The self-impedance of shield wire
- The tower footing resistance.
- The mutual impedance between faulted phase conductor & shield wires.

As far as the circuit modeling grounding resistance of the towers is concerned, the corresponding Cigre model(CIGRE W.G. 33.01 1991)from Weck (Weck 1988)) is used, considering the soil ionization phenomenon ( $\rho=200\Omega\text{m}$ ) (see Table 3.2).

#### 4.4.6 Circuit Representation of Insulators

The simplest approach for the representation of the insulators is to model them as a switch, which closes when the voltage exceeds a defined limit. Indeed, the developed overvoltages stress the insulators of the line, resulting in a flashover in case of exceedance of the BIL (Figure 4.7). However, the flashover depends on various factors, such as the shape of the insulating disk, the pollution of the surface of the discs etc. In the current work The flashover strength  $V_{FO}(\text{kV})$  is determined by the equation (3.4), which includes the insulator string length and the elapsed time after a lightning hit. Furthermore, the leader progression models of Table 3.3 are used, in order to perform a sensitivity analysis about the role of the used models.

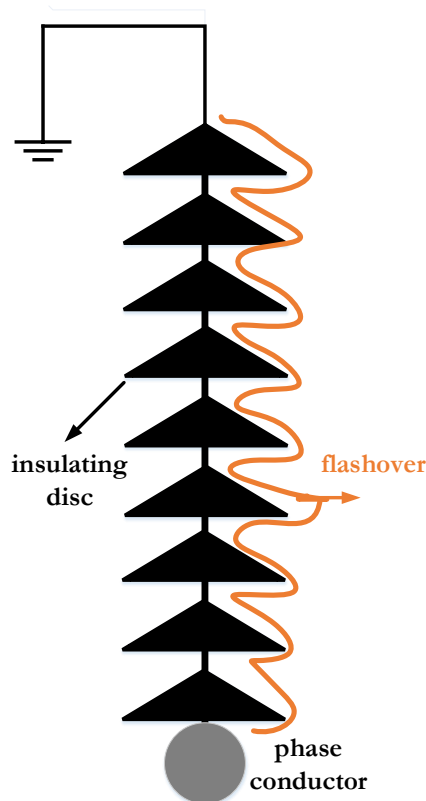

Fig. 4.7 Insulation Flashover of a 150 kV Transmission Line



## 4.5 Conclusions

Chapter 4 discussed the topology of the systems under examination. In the current thesis a lightning performance study for substation will be carried out, considering different configurations. The depicted configuration correspond to typical substations 150/20kV of the Hellenic electrical network. The substations were interconnected, in order to increase the reliability of the system and ensure the uninterrupted operation of the system. The basic equipment of the substation was presented in details, providing the necessary electrical and geometrical characteristic of each component. Finally, the most used equivalent circuit models of each component were presented.



## References

- Ametani A., Kasai Y., Sawada J., Mochizuki A., Yamada T., "Frequency-dependent impedance of vertical conductors and a multiconductor tower model," IEE Gener. Transm. Distrib., vol. 141, no. 4, pp 339–345, Jul. 1994.*
- Chisholm W. A. and Janischewskyj W., "Lightning surge response of ground electrodes," IEEE Trans. Power Delivery, vol. 4, no. 2, pp. 1329–1337, Apr. 1989.*
- Chisholm W. A., Chow Y. L., Srivastava K. D. "Travel time of transmission towers," IEEE Trans. Power App. Syst., vol. PAS-104, no. 10, pp. 2922–2928, Oct. 1985.*
- CIGRE Working Group 33.01, "Guide to procedures for estimating the lightning performance of transmission lines," Technical Bulletin 63, Oct. 1991.*
- Dommel, H., "Digital Computer Solution of Electromagnetic Transients in Single and Multiple Networks," IEEE Transactions on Power Apparatus and Systems, Vol. PAS-88, No. 4, April, 1969*
- Fernandez F., Diaz R., Metal oxide surge arrester model for fast transient simulations, in: International Conference on Power System Transients IPST'01, Paper 14, Rio De Janeiro, Brazil, June 24–28, 2001.*
- IEEE Std 80-2000, "IEEE Guide for Safety in AC Substation Grounding", January 2000*
- IEEE Task Force, "Modeling guidelines for fast front transients," IEEE Trans. Power Delivery, vol. 11, no. 1, pp. 493–506, Jan. 1996*
- IEEE Working Group 3.4.11, Modeling of metal oxide surge arresters, IEEE Transactions on Power Delivery 7 (1) (1992) 302–309.*
- IEEE Working Group, "A Simplified method for estimating lightning performance of transmission lines," IEEE Trans. Power App. Syst., vol. PAS-104, no. 4, pp. 919-932, Apr. 1985.*
- Jordan C. A., "Lightning computations for transmission lines with overhead ground wires," Gen. Elec. Rev., vol. 37, 1934.*
- Mikropoulos P., Tsovilis T., Manousaridis I., Laloumis G., Dramis A., "Lightning Risk Assessment of a 170 kV GIS Substation connected to the Hellenic Transmission System through Underground Cables", 7th Mediterranean Conference and Exhibition on Power Generation, Transmission, Distribution and Energy Conversion (MedPower 2010), 7-10 Nov. 2010, Agia Napa.*
- Oettle E. E., "A new general estimation curve for predicting the impulse impedance of concentrated earth electrodes," IEEE Trans. Power Delivery, vol. 3, no. 4, pp 2020–2029, Oct. 1988.*
- Pinceti P., Giannettoni M., A simplified model for zinc oxide surge arresters, IEEE Transactions on Power Delivery 14 (2) (1999) 393–398.*
- Rondon D., Vargas M., Herrera J., Montana J., Torres H., Camargo M., Jimenez D., and Delgadillo A., "Influence of grounding system modelling on transient analysis of transmission lines due to direct lightning strike," in Proc. Power Tech, St. Petersburg, Russia, 2005, pp. 1-6.*
- Sargent M. A. and Darveniza M., "Tower surge impedance," IEEE Trans. Power App. Syst., vol. PAS-88, no. 5, pp. 680–687, May 1969.*
- Wagner C. F. and A. R. Hileman, "A new approach to calculation of lightning performance of transmission lines III – A simplified method: Stroke to tower," AIEE Trans. Power App. Syst., vol.*



79, pp. 589–603, Oct. 1960.

Yamada T., Mochizuki A., Savada J., Zaima E., Kawamura T., Ametani A., Ishii M., and Kato S., “Experimental evaluation of a UHV tower model for lightning surge analysis,” *IEEE Trans. Power Delivery*, vol. 10, no. 1, pp 393–402, Jan. 1995.

Yasuda Y., Hirakawa Y., Shiraishi K., and Hara T., “Sensitivity analysis on grounding models for 500kV transmission lines,” *Trans.IEE Japan B*, vol. 121, no. 10, pp. 1386–1393, 2001.



# CALCULATION OF THE DEVELOPED OVERVOLTAGES

## 5.1 Introduction

Scope of the presented analysis in the current Chapter is the calculation of the developed overvoltages at different positions of the substations under study (presented in Chapter 4), considering lightning hits on the phase conductors or the ground wires of the connected overhead transmission lines. To this direction, the mechanisms of the development of the incoming surges at the entrance of the substation due to shielding failure or backflashover are analytically described. A sensitivity analysis is also performed, in order to examine the influence of various parameters (grounding resistance, length of the cable, installation position of the arresters, and number of the incoming lines) on the magnitude of the expected surges. In addition, the impact of the used equivalent circuit modes of the equipment (transmission lines, switches, arresters, cables, grounding system, insulators etc.) on the obtained results is investigated.

## 5.2 Overvoltages in Case of Direct Lightning hit

In general, the substations are adequately protected against direct lightning hits, according to the methodologies and the electrogeometrical models, presented in Chapter 4. Consequently, lightning surges that impinge on the overhead transmission lines that are connected with the substations are the main cause of overvoltage stresses of the insulation of the substations' equipment. In case that lightning hits directly the phase conductors of the transmission lines, two travelling waves appear, the magnitude of which depends on the lightning peak current and the surge impedance of the conductors (Figure 5.1). The overvoltage wave will arrive at the entrance of the substation and can result in several serious damages of the components of the substations. It is worth mentioning, that the developed overvoltage is not influenced by the tower footing resistance and the unique protective measure is the installation of surge arresters. Moreover, the position of the lightning hit, the length of the cable, the characteristics of the implemented surge arresters, the position of the installation of the arresters and the grounding resistance of the arresters are critical factors that determine the efficiency of the lightning protection system and affect the lightning performance of the substation.

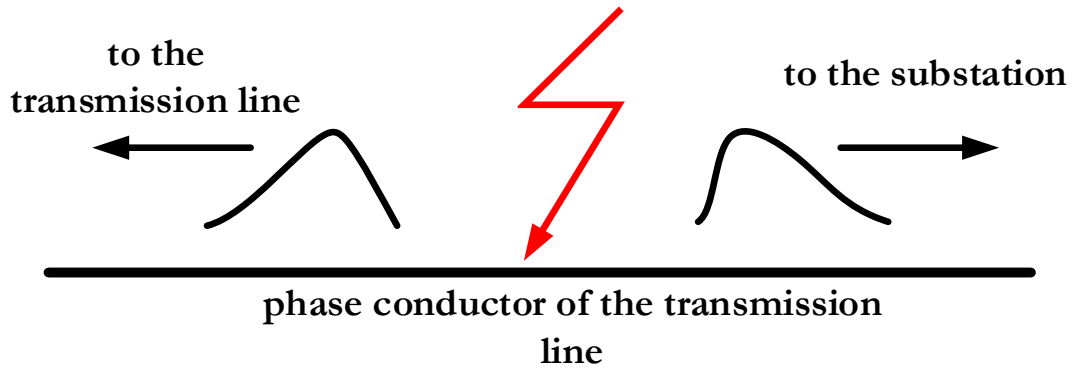

Figure 5.1: Lightning Hit on Phase Conductor of an Overhead Transmission Line

If surge arresters are installed between phase and earth of a transmission line, part of the lightning current will be diverted to the grounding system (Figure 5.2), depending on the achieved grounding resistance. Figure 5.3 depicts a surge arresters installed at the entrance of a power transformer. The low values of the grounding resistance ensure that almost the total current will pass through the arrester and the developed overvoltage will not exceed the insulation level of the system.

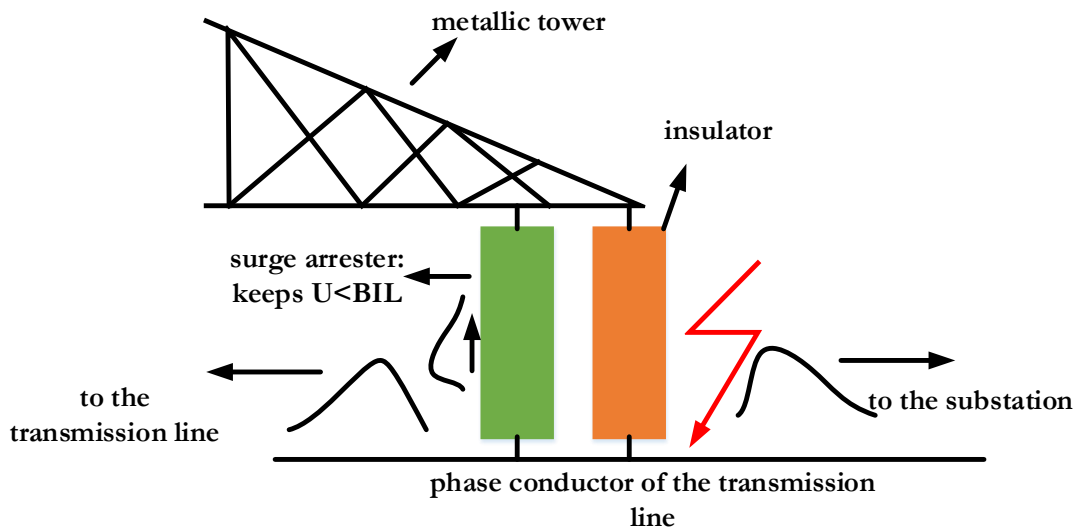

Figure 5.2: Overhead Transmission line Protected by Surge Arresters

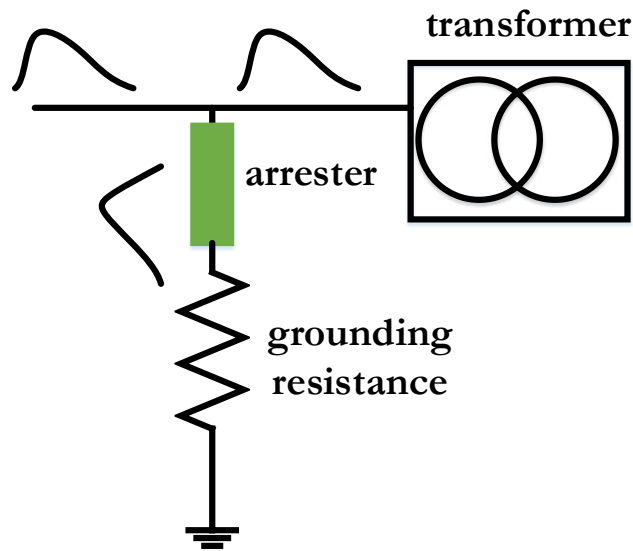

Figure 5.3: Power Transformer protected by Surge Arresters

The current analysis is performed for the configuration of Figure 4.1. The amplitude of the lightning surge which can occur is determined by using of the geometrical model, presented in (A.R. Hileman, “Insulation coordination for Power Systems”, CRC Press, 1999). Time to half values for the first and following strokes were selected according to (CIGRE, Working Group 01 (Lightning) of Study Committee 33 (Overvoltages and Insulation Coordination) “Guide to Procedures for Estimating the Lightning Performance of Transmission Lines, brochure 63, CIGRE, Paris, France, October, 1991). The front time of the lightning surge is given by the equation:

$$t_1 = \frac{I}{24 \cdot \left(\frac{1}{P} - 1\right)^{0.25}} \quad (5.1)$$

where

I is the peak value of the lightning current,

P is the probability of a crest current exceeding the magnitude of I (H.M Ryan, “High voltage engineering and testing”, Peter Peregrinus Ltd. 1<sup>st</sup> edition, 1994).

Applying the above procedure, a 35kA 7.5/200 $\mu$ s lightning current is applied for a lightning hit on a phase conductor of the connected line. The developed voltage surge travels through the conductor and the cable to the substation’s transformer (150/20kV).

The developed overvoltages at the beginning (position B) and the end (position D) of the cable are estimated, by using appropriate simulation tool (Simulink/MATLAB). Time-steps in the range of 5-50ms are used in typical switching transients, ranging the simulation time from





20-200ms. In lighting studies, the time-step depends upon the steepness of the surge, the minimum length of travelling wave models, plus the use of flashovers gaps and surge arresters with significant lead lengths. In the current work, it is in the range of 1-20 ns, with a simulation length of 20-50 ms. A sensitivity analysis is performed, considering the length of the cable, the installation position of the arresters and the tower footing. The towers of the overhead lines and the installed metal oxide gapless surge arresters are modeled according to the Chilsom model and the IEEE model, correspondingly. As far as the grounding resistance is concerned the Cigre model is selected; finally, V-t curve is implemented for the circuit representation of the insulators. Figures 5.4 – 5.5 depict the obtained results.

In details, the figures of results (Fig.5.4) presents the estimated overvoltages at the positions B and D of the topology under study in function with the length of the cable (BD) in case that the substation is not protected by surge arresters. The results indicate that long cables can be adequately protected, since the expected overvoltages do not exceed the BIL (750kV for 150kV nominal voltage).

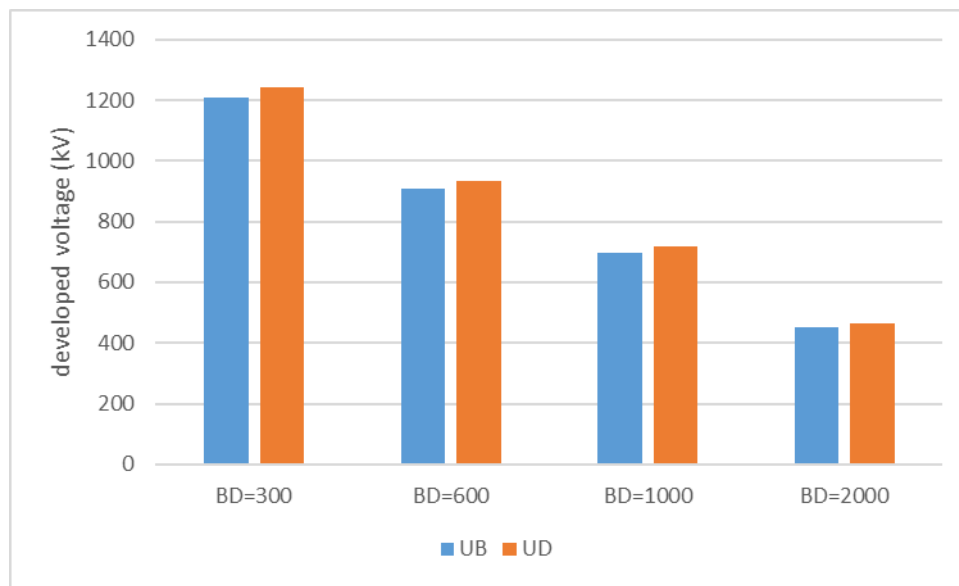

*Fig. 5.4 The developed overvoltages at positions B ( $U_B$ ) and D ( $U_D$ ) in function with the length of the cable (BD) in case of lightning hit on phase conductor of the connected line (no arresters)*

Regarding the surge impedance of the cable and the transmission line equal to  $40\Omega$  and  $350\Omega$ , respectively, a reflection factor equal to  $-0.8$  is estimated; that means that the 20% of the initial surge ( $U$ ) comes into the cable. However, at position D (connection between cable and transformer) the travelling wave is doubled and will be reflected. The reflected wave ( $0.4U$ ) is also reflected at position B (connection between cable and overhead transmission line) considering a reflection factor  $0.8$ . Thus, the developed surge ( $0.8 - 0.4U = 0.32U$ ) is



superimposed to the initial surge  $0.4U$ , resulting in the increase of the voltage at position D ( $0.4U+0.32U=0.72U$ ). The above procedure is repeated and the developed overvoltage may exceed the withstand capability of the insulation.

The overvoltage at the positions B and D is given as (Siemens 2008, ABB 2007, Hinrichsen V 2001):

$$U_D = \begin{cases} U \cdot \delta(1 + a_D) & \text{if } \frac{T}{d} \leq \frac{2}{C} \\ U \cdot \delta(1 + a_D)(1 + a_B \cdot a_D) & \text{if } \frac{2}{C} < T/d \leq 4/C \\ U \cdot \delta(1 + a_D)(1 + a_B \cdot a_D +)(a_B \cdot a_D)^2) & \text{if } \frac{2}{C} < T/d \leq 4/C \end{cases} \quad (5.2)$$

Where;

$$\delta = \frac{2Z_{cable}}{Z_{cable}+Z_{line}} \quad (5.3)$$

$$a_B = \frac{Z_{line} - Z_{cable}}{Z_{cable}+Z_{line}} \quad (5.4)$$

$$a_D = \frac{Z_{transformer} - Z_{cable}}{Z_{cable}+Z_{transformer}} \quad (5.5)$$

$d$  is the length of the cable

$C$  is the propagation speed.

$$U_B = \begin{cases} \max[U, U \cdot \delta \cdot a_D(1 + a_B)] & \text{if } \frac{T}{d} \leq \frac{2}{C} \\ \max[U \cdot \delta + U \cdot \delta \cdot \alpha_D \cdot (1 + a_B), U \cdot \delta \cdot \alpha_D \cdot (1 + a_B)(1 + a_B \cdot a_D)] & \text{if } \frac{2}{C} < \frac{T}{d} \leq \frac{4}{C} \\ \max[U \cdot \delta \cdot \alpha_D \cdot (1 + a_B)(1 + a_B \cdot a_D), U \cdot \delta \cdot \alpha_D(1 + a_B)(1 + \alpha_D \cdot a_B + (\alpha_D \cdot a_B)^2)] & \text{if } \frac{2}{C} < \frac{T}{d} \leq \frac{4}{C} \end{cases} \quad (5.6)$$

Furthermore, the installation position of the arresters is of great importance for the appropriate lightning performance of the substation. The increase of the distance between the arrester and the transformer reduces the effectiveness of the installed arresters, in a way that the overvoltage may exceed the BIL, depending on the other parameters, i.e. the magnitude of the surge, the grounding resistance and the length of the cable. Especially, in case of cables of length lower than 1000m the problem is more intense, since the initial surge is higher and a non-appropriately installed arrester will not protect the equipment. For this reason, the



protection distance of the arresters (see Chapter 3) has to be taken into consideration during the initial design of the installation and the selection of the characteristics of the arresters.

The role of the grounding resistance is also crucial in order to limit the overvoltages at the entrance of the substation. In general, the voltage that is implemented at the primary of the primary transformer is given by the equation(ABB 2007):

$$U_{transformer} = U_{arrester} + i \cdot R_{sa} + L \cdot \frac{di}{dt} \quad (5.7)$$

Where;

$i$  is the lightning current.

$L$  is the inductance of the connection wires of the arrester.

$R_{sa}$  is the grounding resistance of the arrester.

$U_{transformer}$  is the voltage at the terminals of the transformer.

$U_{arrester}$  is the residual voltage of the arrester.

Figures 5.5-5.8 present the results of the performed sensitivity analysis for cases a and b regarding the following parameters:

- The Installation Position of the Arresters
- The Grounding Resistance of the Arresters
- The Length of the Cable.

In details :

- ***The Installation Position of the Arresters:*** The distance between the transformer and the arrester varies between 0m and 60m (0m, 5 m, 15 m, 30 m, 45 m, 60m)
- ***The Grounding Resistance of the towers:*** The grounding resistance varies between 1Ω and 25Ω (1 Ω, 5 Ω, 10 Ω, 15 Ω, 20 Ω, 25Ω)
- ***The Length of the Cable:*** The length of the cable ranges between 300m and 2000m (300 m, 600 m, 1000 m, 2000m).

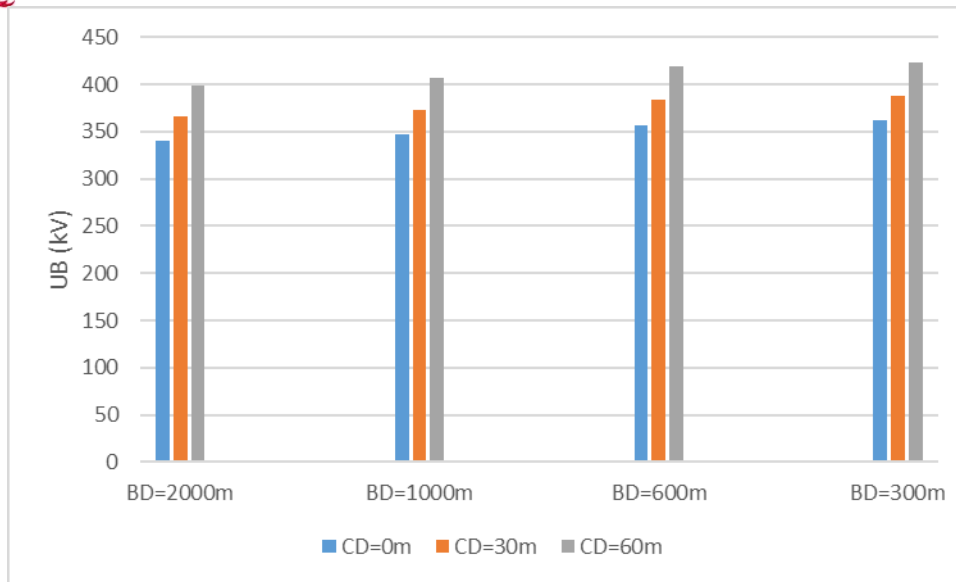

Figure 5.5: The Developed Overvoltage at Position B ( $U_B$ ) in function with the Distance CD and the cable length (BD) in case of a Lightning hit on the Phase Conductor of the Connected Transmission Line (case a)

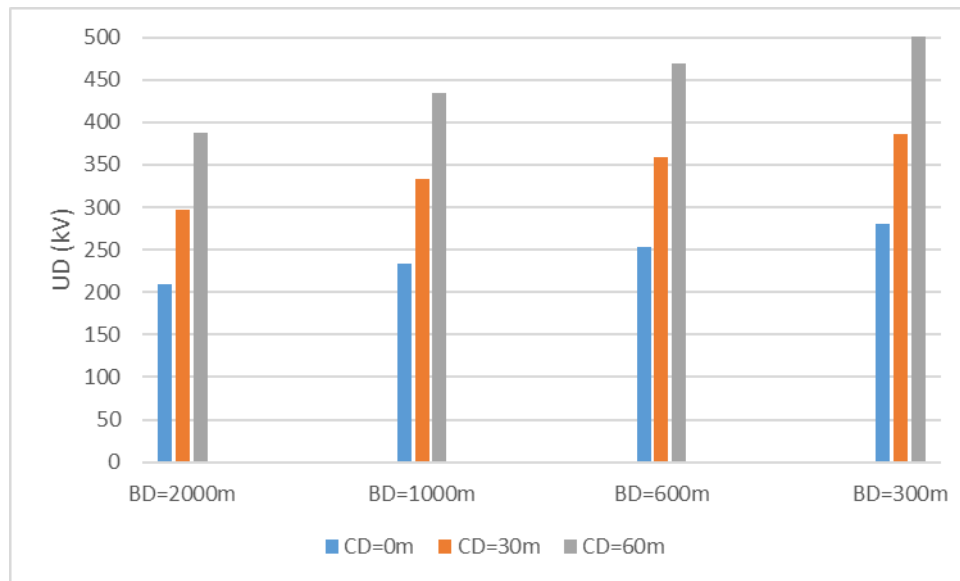

Figure 5.6: The Developed Overvoltage at Position B ( $U_B$ ) in function with the Distance CD and the cable length (BD) in case of a Lightning hit on the Phase Conductor of the Connected Transmission Line (case a)

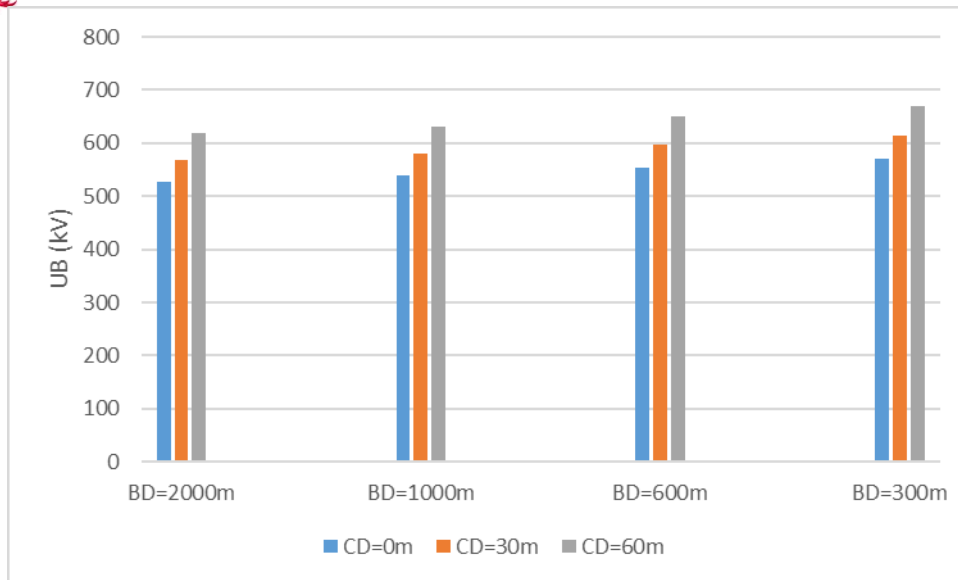

Figure 5.7: The Developed Overvoltage at Position B (UB) in function with the Distance CD and the cable length (BD) in case of a Lightning hit on the Phase Conductor of the Connected Transmission Line (case b)

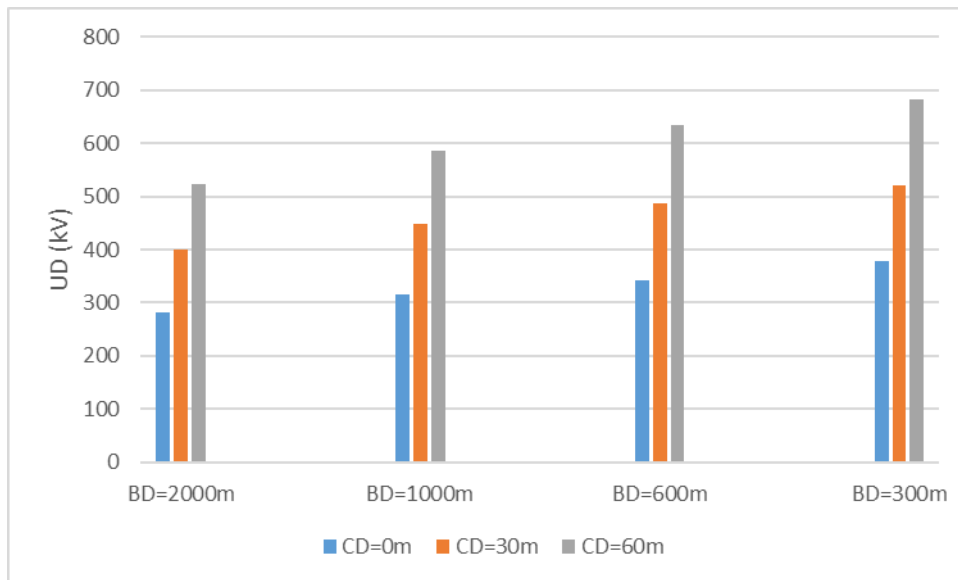

Figure 5.8: The Developed Overvoltage at Position B (UB) in function with the Distance CD and the cable length (BD) in case of a Lightning hit on the Phase Conductor of the Connected Transmission Line (case b)

The performed sensitivity analysis results in the following conclusions, about the behavior of the substation in case of a lightning hit on the phase conductor of the connected overhead transmission line:

- The developed overvoltages at the end of the cable are greater than those ones at the beginning, due to the reflection phenomena of the traveling waves.
- The developed overvoltages are strongly dependent on the length of the cable. Long cables present a better lightning performance.

- Tower footing resistance has no influence on the expected overvoltages.
- The arresters should be installed near the transformer; otherwise the voltage at the equipment to be protected will be considerably higher than the residual voltage at the terminals of the arrester.
- The installation or not of surge arrester at the joint between the incoming overhead transmission line and the underground cable definitely influences the magnitude of the expected overvoltages. Surge arresters at position B contribute significantly to the reduction of the developed surges and the improvement of the lightning performance of the system.

### 5.3 Overvoltages in Case of Lightning hit on the ground wire

When a lightning hits the ground wire or the tower of an overhead transmission line, the magnitude of the developed overvoltage depends on the tower footing resistance, the induction of the tower and the rise time of the injected lightning current (Figure 5.9). If the overvoltage exceeds the insulation level of the line, a backflashover is occurred. The resulting surge propagates to the connected substation and can lead to serious malfunctions of the system. Backflashover at the connected transmission lines is a common reason of faults and damages of the substations' equipment.

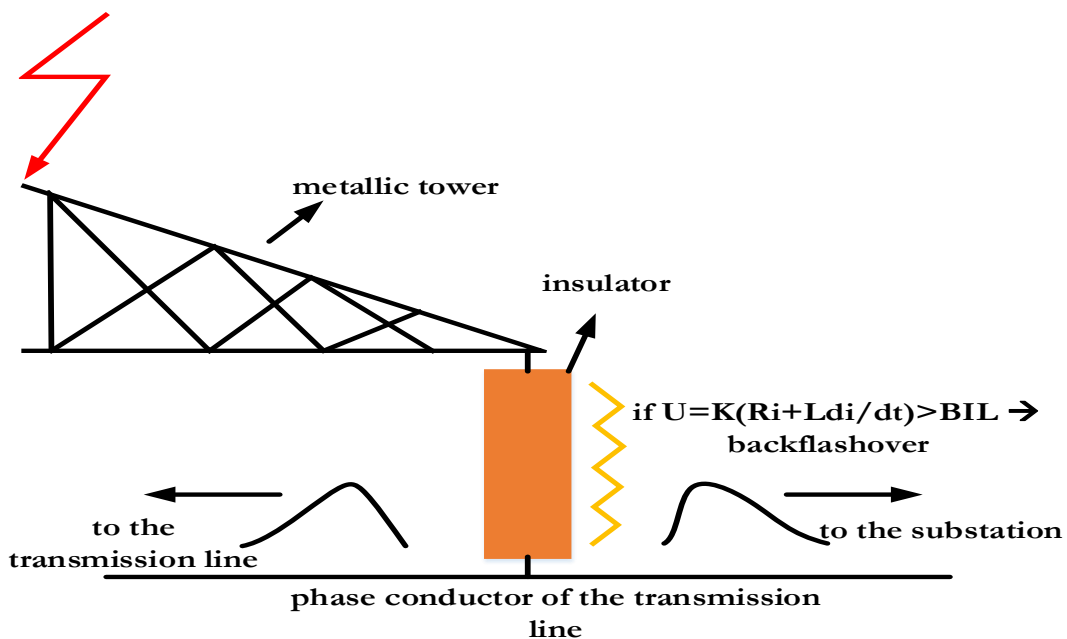

Figure 5.9: Lightning hit on the Metallic Tower of an Overhead Transmission Line



The lightning performance of the system can be improved by installing surge arresters in parallel with the insulators and at the primary side of the transformer (Figure 5.10). Surge arresters divert the current of the lightning strike to earth and restrain the voltage at the terminals of the equipment below the BIL. The installation of metal oxide gapless surge arresters is necessary; else the incoming voltage waves will stress the insulation of the equipment, resulting in faults and interruption of the normal operation of the substation.

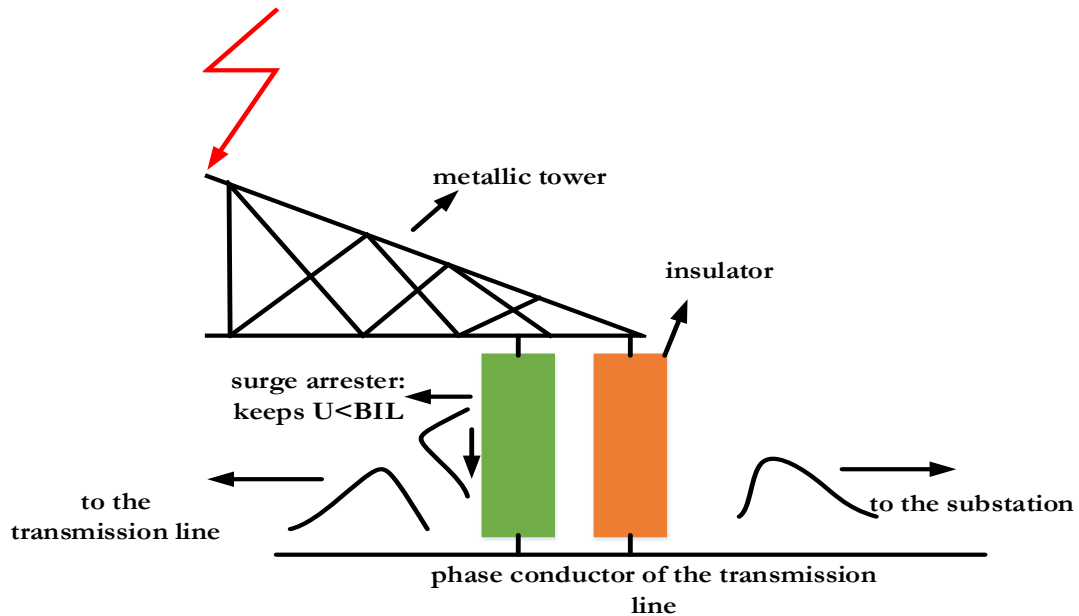

Figure 5.10: Installation of Surge Arresters at an Overhead Transmission Line

Applying the procedure presented in the previous section (equation 5.1), a 200kA, 10.5/200 $\mu$ s lightning current is implemented in case of hit on overhead ground wire of the incoming 150kV overhead transmission line. If the arising voltage exceeds the basic insulation level (750kV) then a backflashover is occurred. The developed voltage surges travel through the conductor and the cable to the substation's transformer (150/20kV). The developed overvoltages at the beginning (position B) and the end (position D) of the cable are estimated, by using appropriate simulation tool (Simulink/MATLAB). The towers of the overhead lines and the installed metal oxide gapless surge arresters are modeled according to the Chilsom model and the IEEE model, correspondingly. As far as the grounding resistance is concerned the Cigre model is selected; finally, V-t curve is implemented for the circuit representation of the insulators. A sensitivity analysis is performed, considering the length of the cable, the installation position of the arresters and the tower footing resistance.

It is worth mentioning that the selected level of the injected lightning current is extremely higher compared to the considered one in case of direct hit, since according to the applied



electrogeometrical model, high currents strike the towers or the overhead ground wires and low currents hit the phase conductors.

A lightning current of 200kA peak may create an overvoltage above the defined limit, influenced by the grounding resistance, the insulators and the implementation (or not) of arresters. Figures 5.11 and 5.12 present the estimated overvoltages at position B and D of the configuration of Figure 4.1, taking into consideration the length of the cable (BD). The role of the tower footing resistance is critical, since it determines the occurrence or not of the backflashover and influences the magnitude of the voltage surge. Moreover, the length of the cable also defines the lightning performance of the system, in a way that long cables are less vulnerable to stresses due to lightning hits.

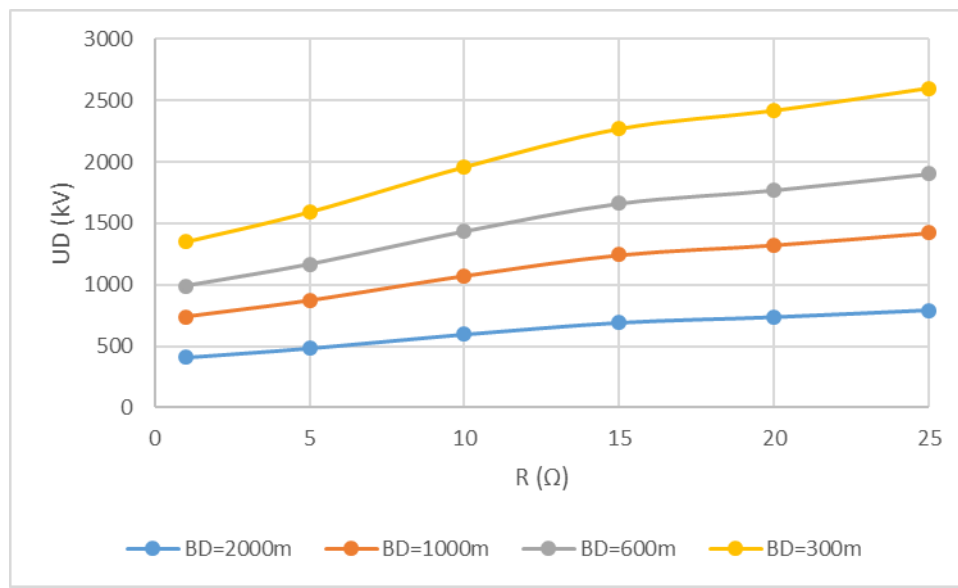

Figure 5.11: The Developed Overvoltage at Position D ( $U_D$ ) In function with Tower Footing Resistance (Lightning hit on the Ground Wire of the Connected Transmission Line, No Arresters Installed)



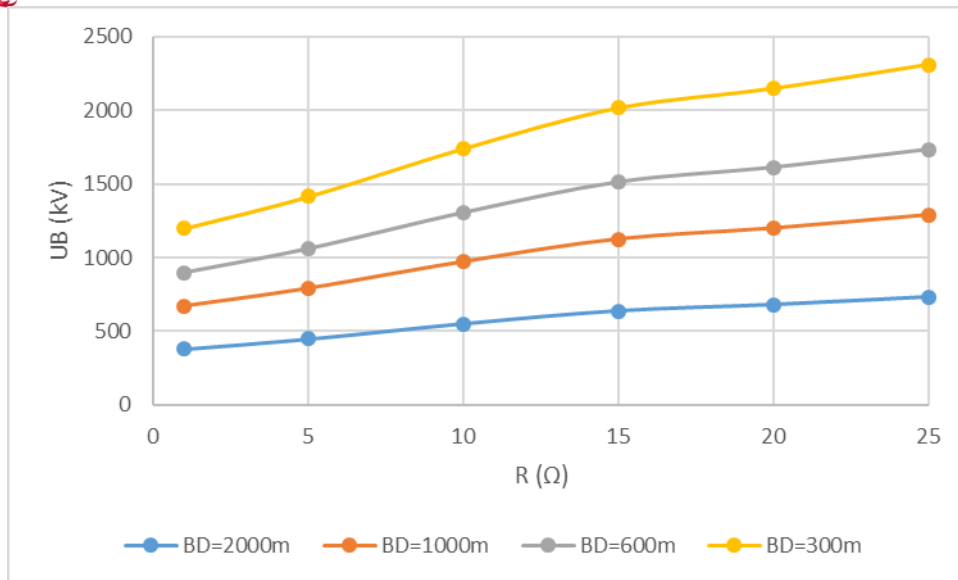

Figure 5.12: The Developed Overtoltage at Position B ( $U_B$ ) in function with the Tower Footing Resistance (Lightning hit on the Ground Wire of the Connected Transmission Line, No Arresters Installed)

The following figures 5.13-5.20 for case a (see Fig. 4.1) depict the calculated voltages in case that appropriate surge arresters have been installed. The achievement of low grounding resistance values is a decisive parameter, in order to ensure the adequate lightning protection of the substation. Note that a constant grounding resistance of  $1\Omega$  of the substation has been supposed. Surge arresters cannot offer the demanded protection level, if the grounding system is not appropriate. Consequently, the installation of surge arresters cannot always warrant the reduction of the expected overvoltages.

The efficiency of the surge arresters is also reinforced by the length of the cable. The calculations show that the estimated overvoltages are strongly dependent on the distance (BD). In addition, the installation position of the arresters is of great importance, regarding the protective distance, according to the analysis of Chapter 3.

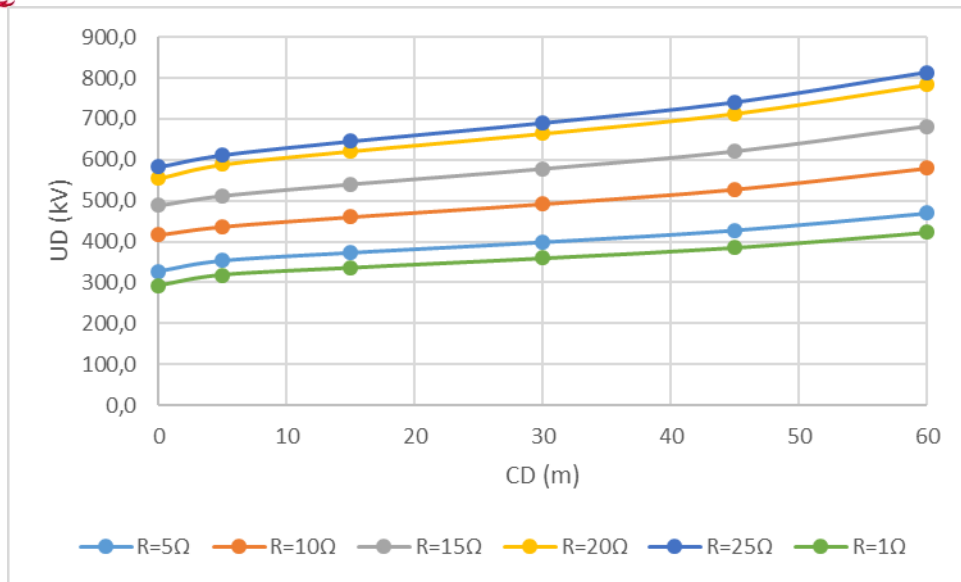

Figure 5.13: The Developed Overvoltage at Position D ( $U_D$ ) in function with the Distance CD and the Tower Footing Resistance (Lightning hit on the Ground Wire of the Connected Transmission Line,  $BD=300m$ , case a)

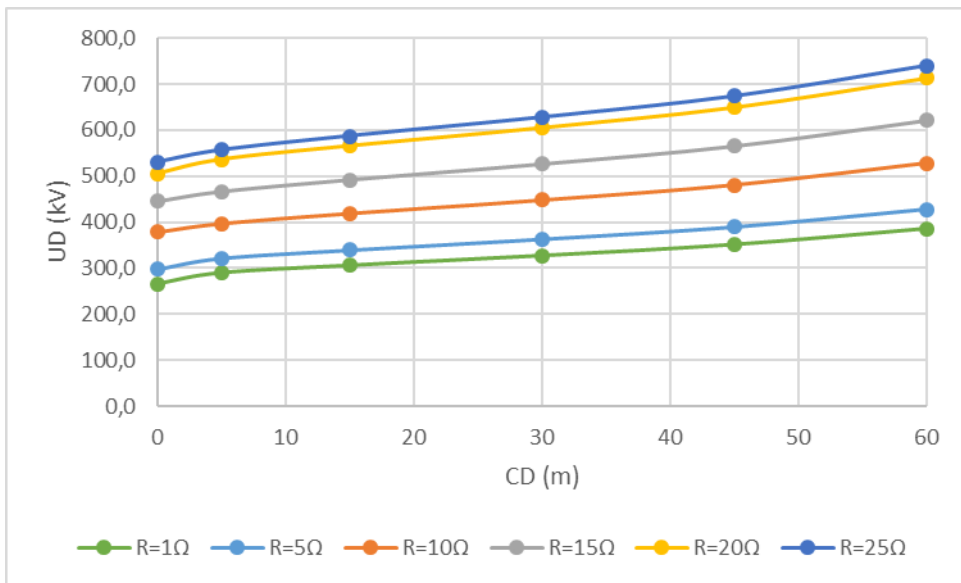

Figure 5.14: The Developed Overvoltage at Position D (UD) in function with the Distance CD and the Tower Footing Resistance (Lightning hit on the Ground Wire of the Connected Transmission Line,  $BD=600m$ , case a)

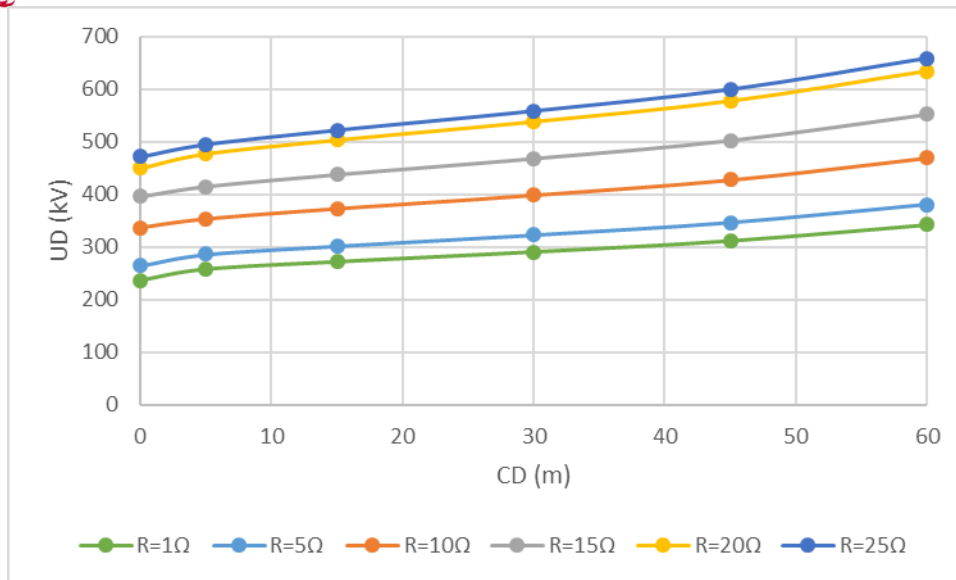

Figure 5.15: The Developed Overvoltage at Position D ( $U_D$ ) in function with the Distance CD and the Tower Footing Resistance (Lightning hit on the Ground Wire of the Connected Transmission Line,  $BD=1000m$ , case a)

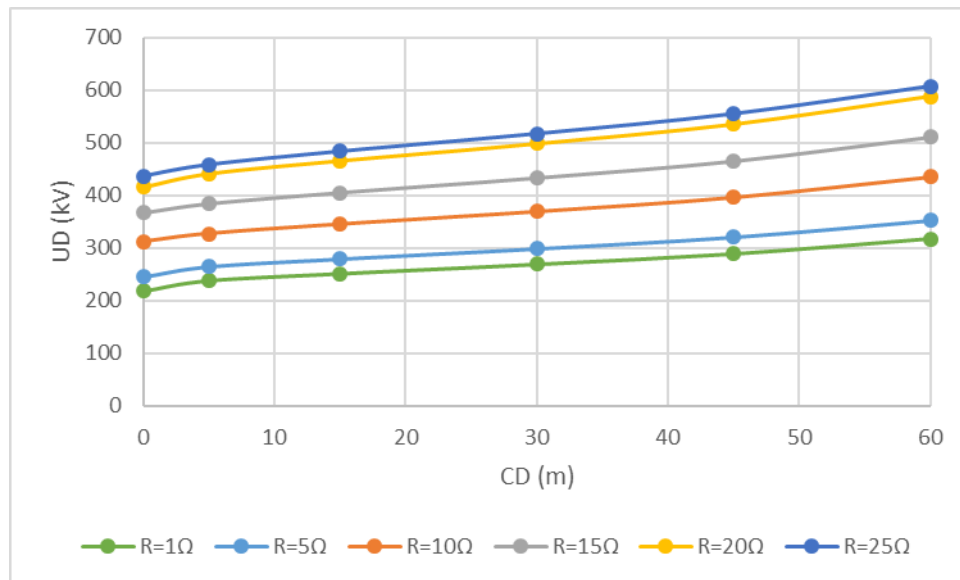

Figure 5.16: The Developed Overvoltage at Position D ( $U_D$ ) in function with the Distance CD and the Tower Footing Resistance (Lightning hit on the Ground Wire of the Connected Transmission Line,  $BD=2000m$ , case a)

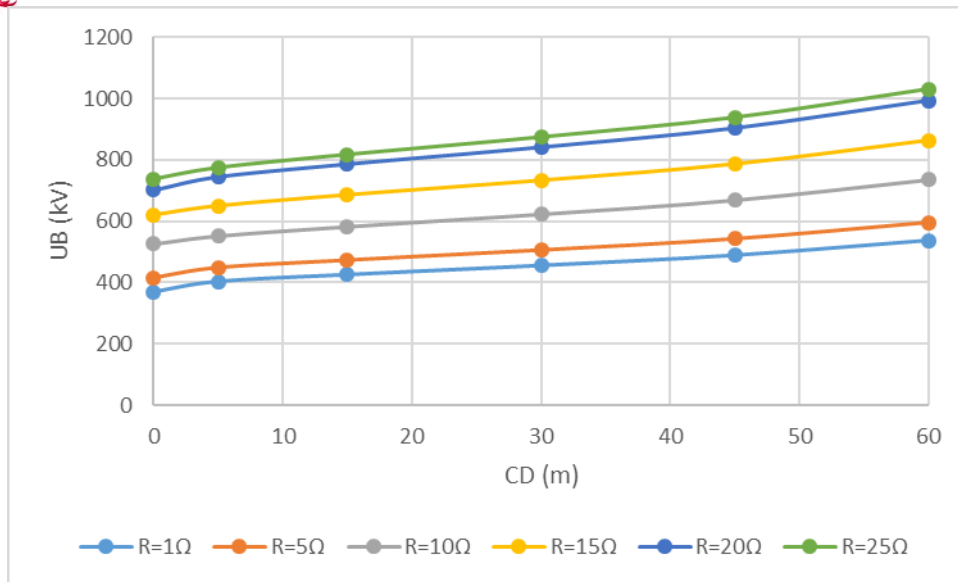

Figure 5.17: The Developed Overvoltage at Position B ( $U_B$ ) in function with the Distance CD and the Tower Footing Resistance (Lightning hit on the Ground Wire of the Connected Transmission Line,  $BD=300m$ , case a)

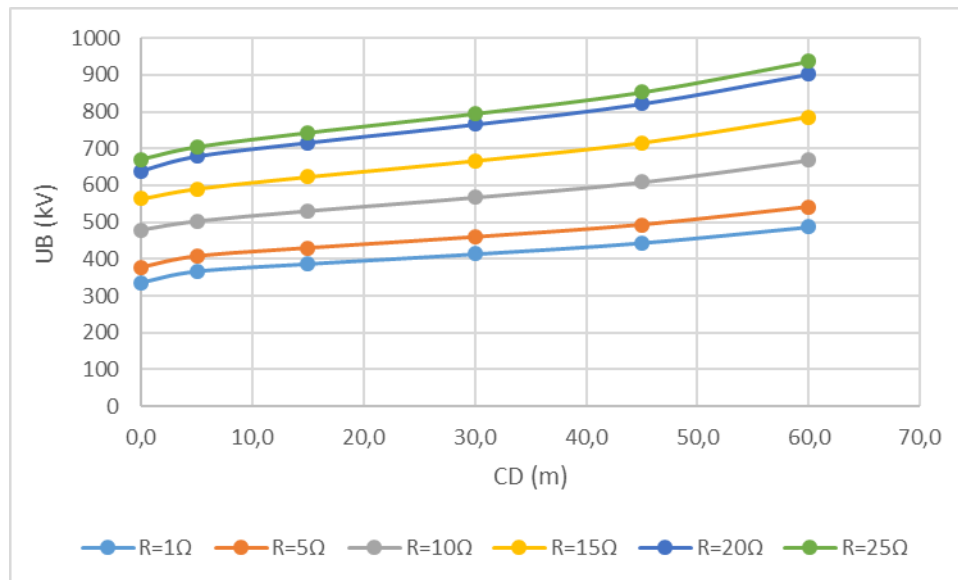

Figure 5.18: The Developed Overvoltage at Position B ( $U_B$ ) in function with the Distance CD and the Tower Footing Resistance (Lightning hit on the Ground Wire of the Connected Transmission Line,  $BD=600m$ , case a)

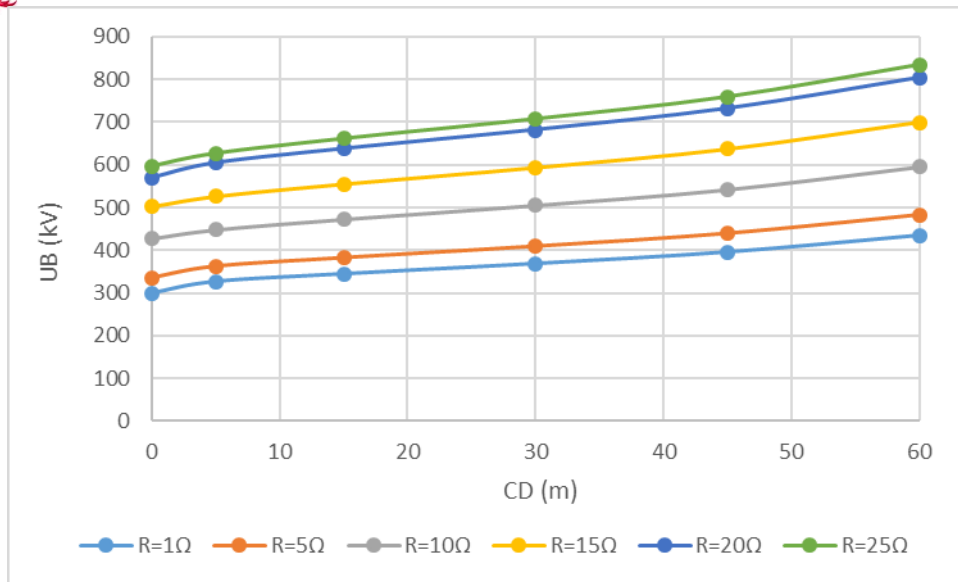

Figure 5.19: The Developed Overvoltage at Position B ( $U_B$ ) in function with the Distance CD and the Tower Footing Resistance (Lightning hit on the Ground Wire of the Connected Transmission Line,  $BD=1000m$ , case a)

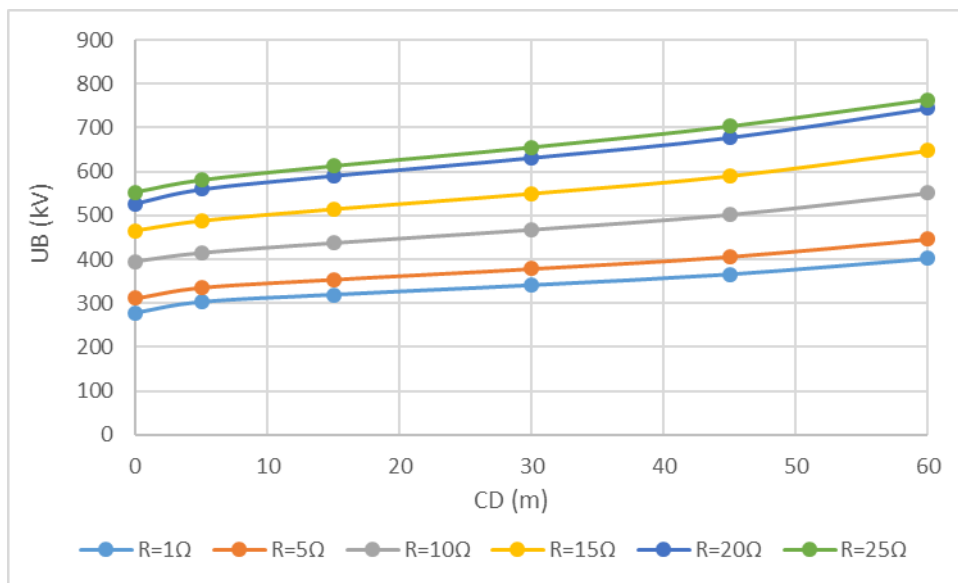

Figure 5.20: The Developed Overvoltage at Position B ( $U_B$ ) in function with the Distance CD and the Tower Footing Resistance (Lightning hit on the Ground Wire of the Connected Transmission Line,  $BD=2000m$ , case a)



Figures 5.21 and 5.22 summarize the above results, indicating the impact of the length of the cable, the tower footing resistance and the installation position of the surge arresters, considering case a.

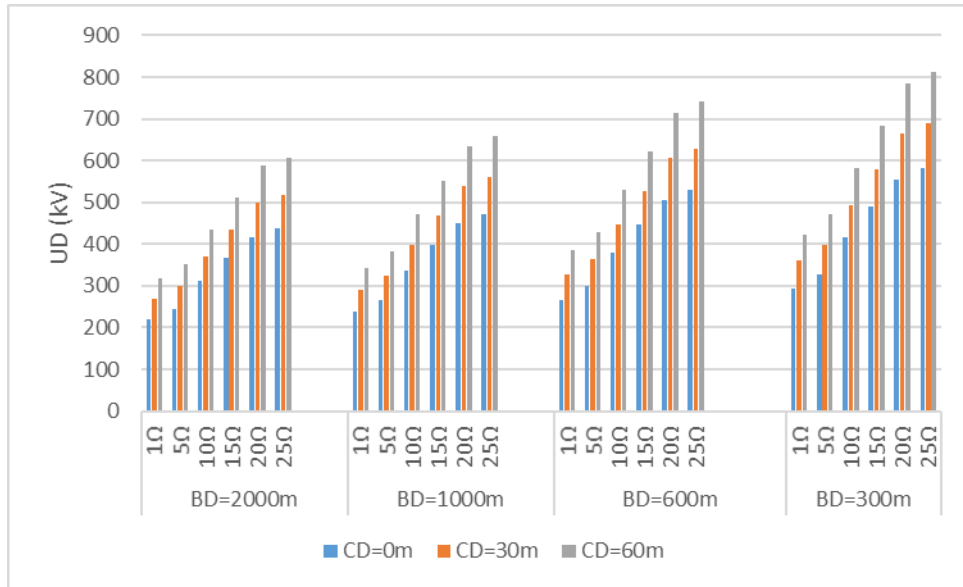

Figure 5.21: The Developed Overvoltage at Position D ( $U_D$ ) in function with the Distance CD, the length of the cable (BD) and the Tower Footing Resistance (Lightning hit on the Ground Wire of the Connected Transmission Line, case a)

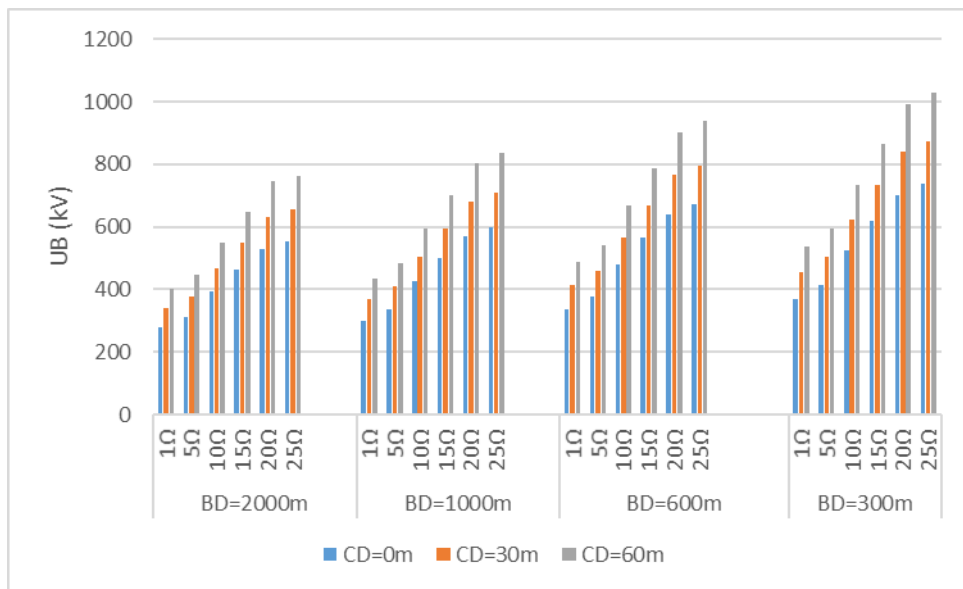

Figure 5.22: The Developed Overvoltage at Position D ( $U_D$ ) in function with the Distance CD, the length of the cable (BD) and the Tower Footing Resistance (Lightning hit on the Ground Wire of the Connected Transmission Line, case a)



Figures 5.23-5.30 depict the obtained results, concerning case b of Fig. 4.1. The extracted outcomes indicate the impact of the installation of arresters at position B, compared with the developed surges of case a.

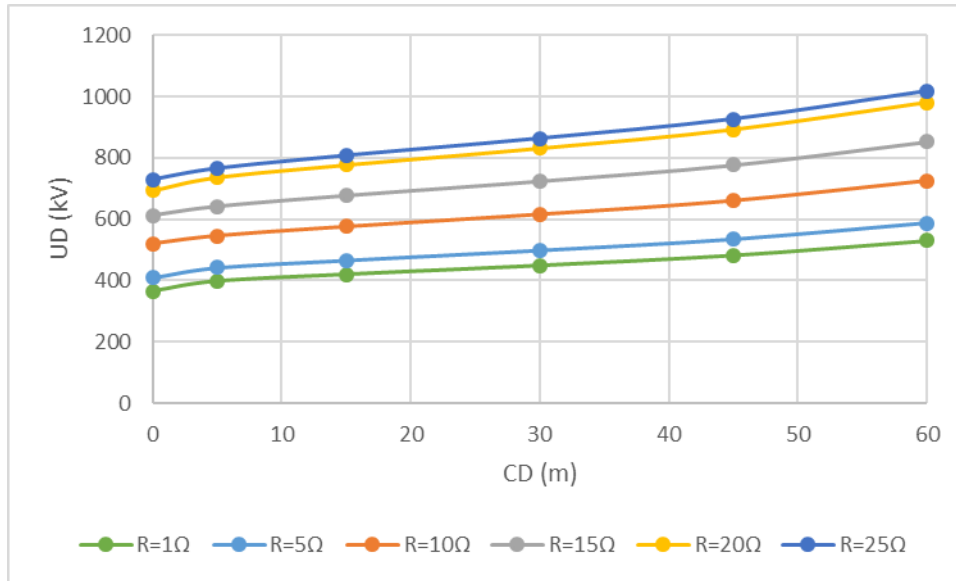

Figure 5.23: The Developed Overvoltage at Position D ( $U_D$ ) in function with the Distance CD and the Tower Footing Resistance (Lightning hit on the Ground Wire of the Connected Transmission Line,  $BD=300m$ , case b)

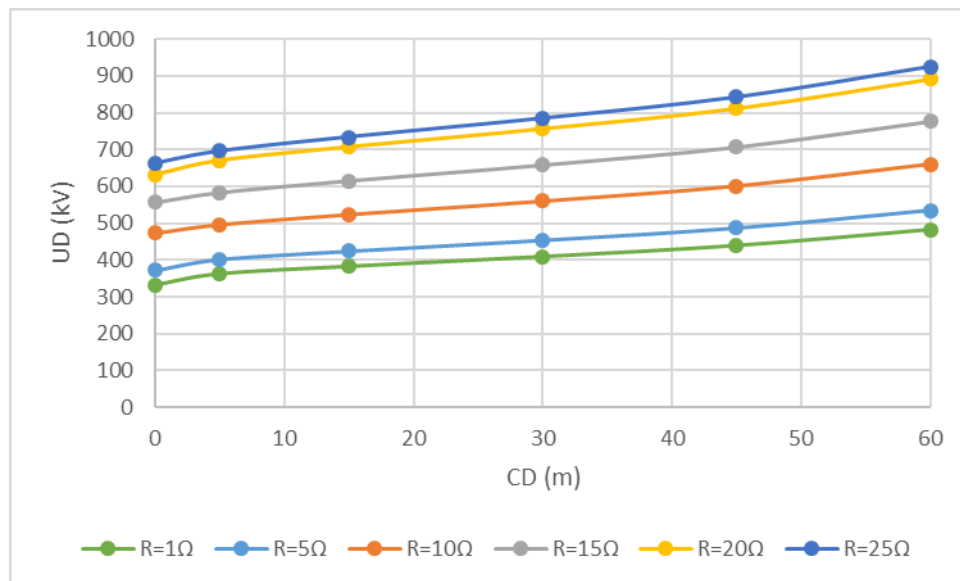

Figure 5.24: The Developed Overvoltage at Position D (UD) in function with the Distance CD and the Tower Footing Resistance (Lightning hit on the Ground Wire of the Connected Transmission Line,  $BD=600m$ , case b)

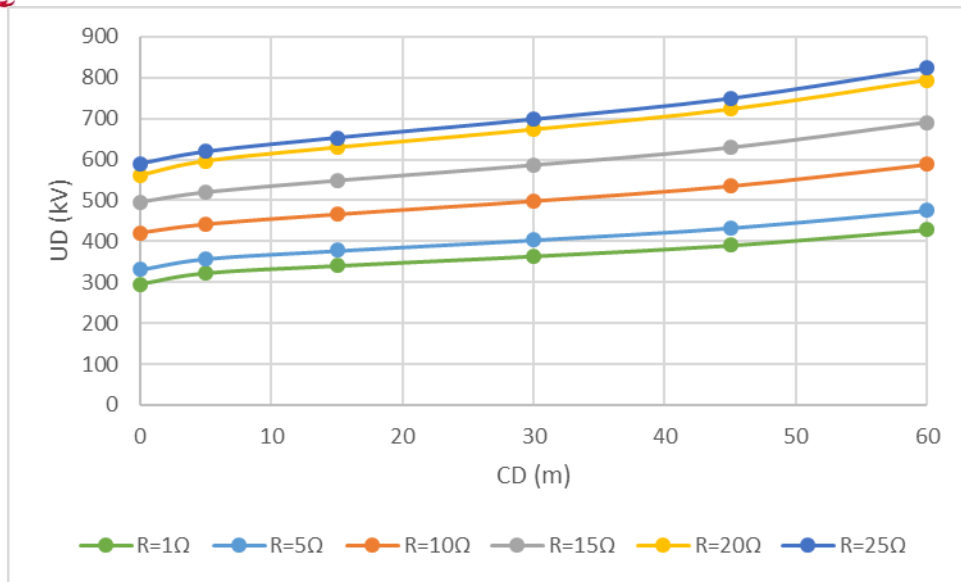

Figure 5.25: The Developed Overvoltage at Position D ( $U_D$ ) in function with the Distance CD and the Tower Footing Resistance (Lightning hit on the Ground Wire of the Connected Transmission Line,  $BD=1000m$ , case b)

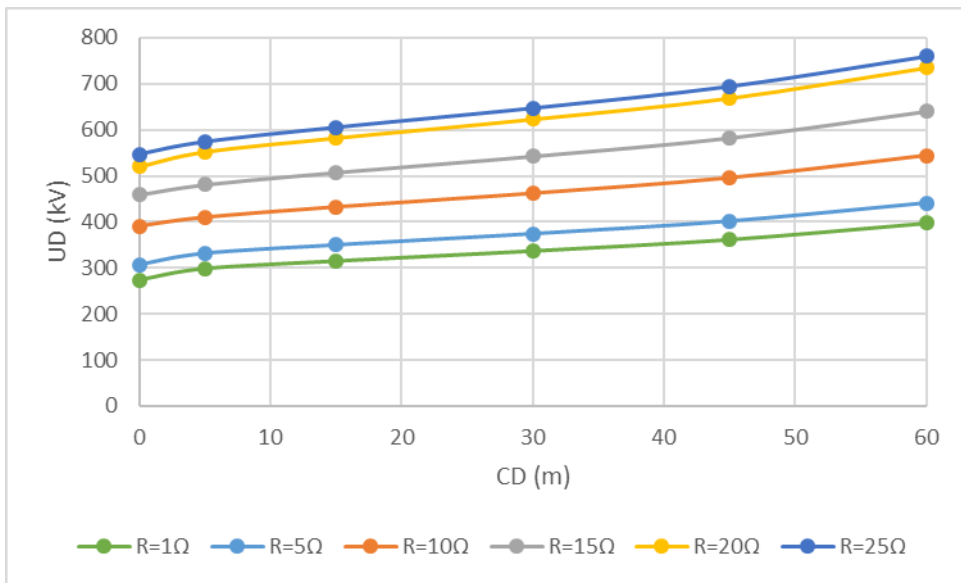

Figure 5.26: The Developed Overvoltage at Position D ( $U_D$ ) in function with the Distance CD and the Tower Footing Resistance (Lightning hit on the Ground Wire of the Connected Transmission Line,  $BD=2000m$ , case b)



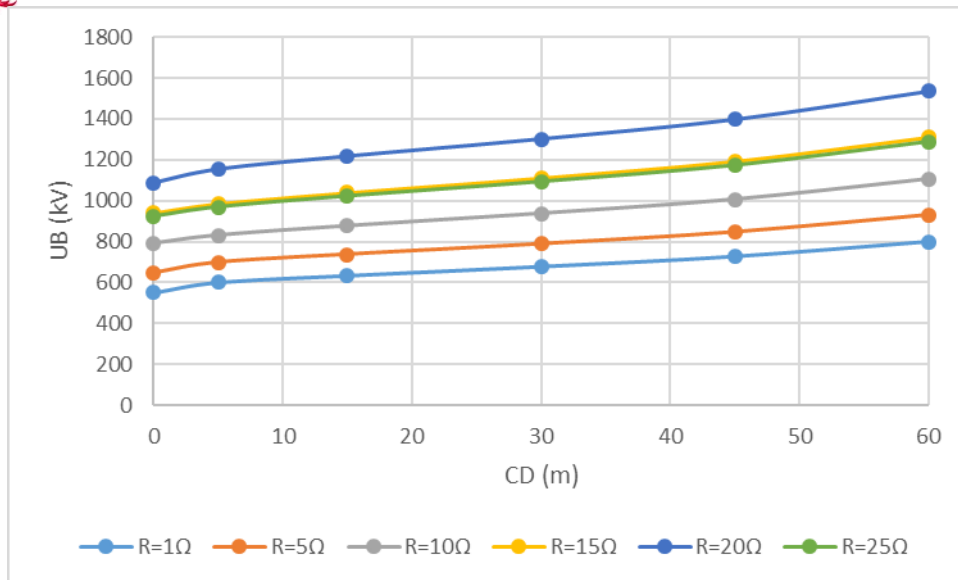

Figure 5.27: The Developed Overvoltage at Position B ( $U_B$ ) in function with the Distance CD and the Tower Footing Resistance (Lightning hit on the Ground Wire of the Connected Transmission Line,  $BD=300m$ , case b)

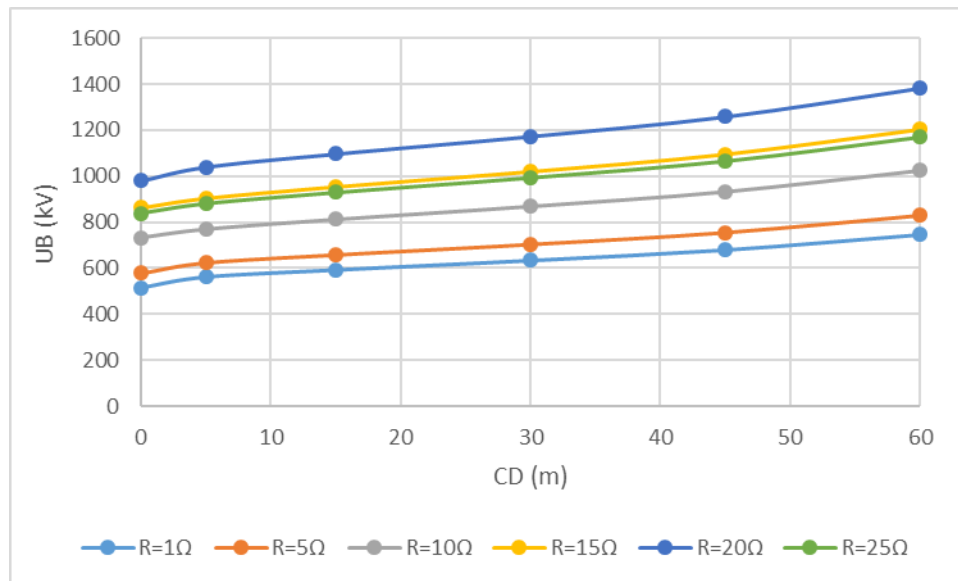

Figure 5.28: The Developed Overvoltage at Position B ( $U_B$ ) in function with the Distance CD and the Tower Footing Resistance (Lightning hit on the Ground Wire of the Connected Transmission Line,  $BD=600m$ , case b)

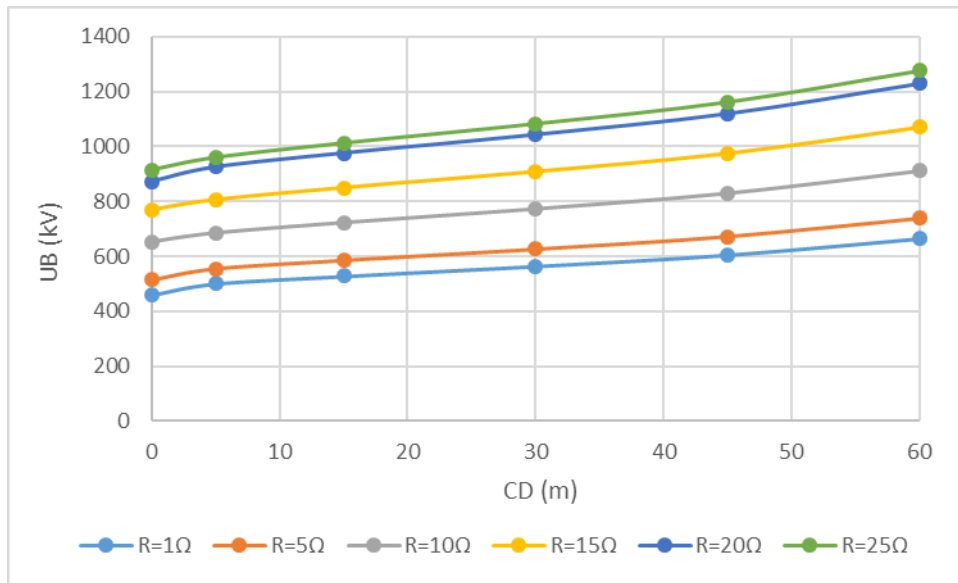

Figure 5.29: The Developed Overvoltage at Position B ( $U_B$ ) in function with the Distance CD and the Tower Footing Resistance (Lightning bit on the Ground Wire of the Connected Transmission Line,  $BD=1000m$ , case b)

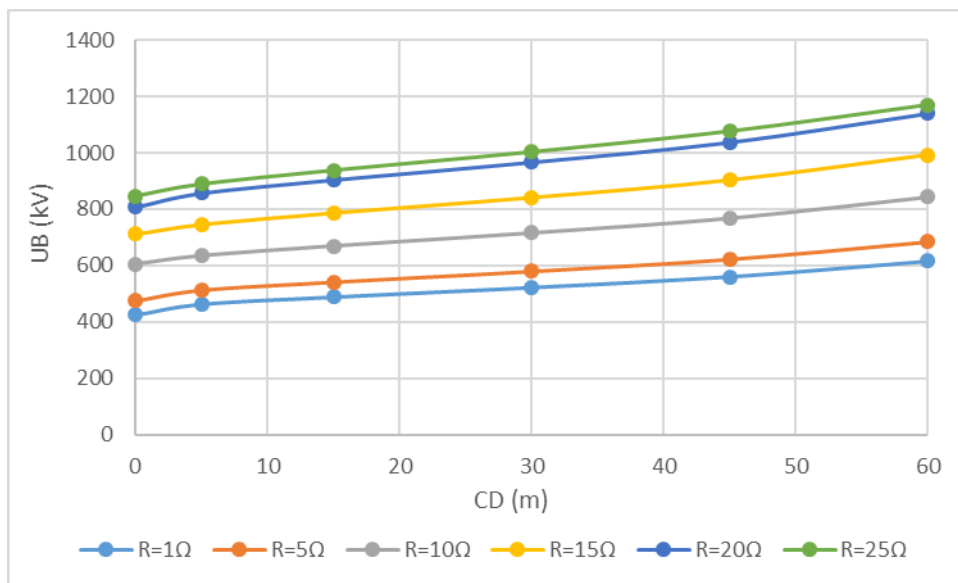

Figure 5.30: The Developed Overvoltage at Position B ( $U_B$ ) in function with the Distance CD and the Tower Footing Resistance (Lightning bit on the Ground Wire of the Connected Transmission Line,  $BD=2000m$ , case b)



Figures 5.31 and 5.32 summarize the above results (case b), indicating the impact of the length of the cable, the tower footing resistance and the installation position of the surge arresters.

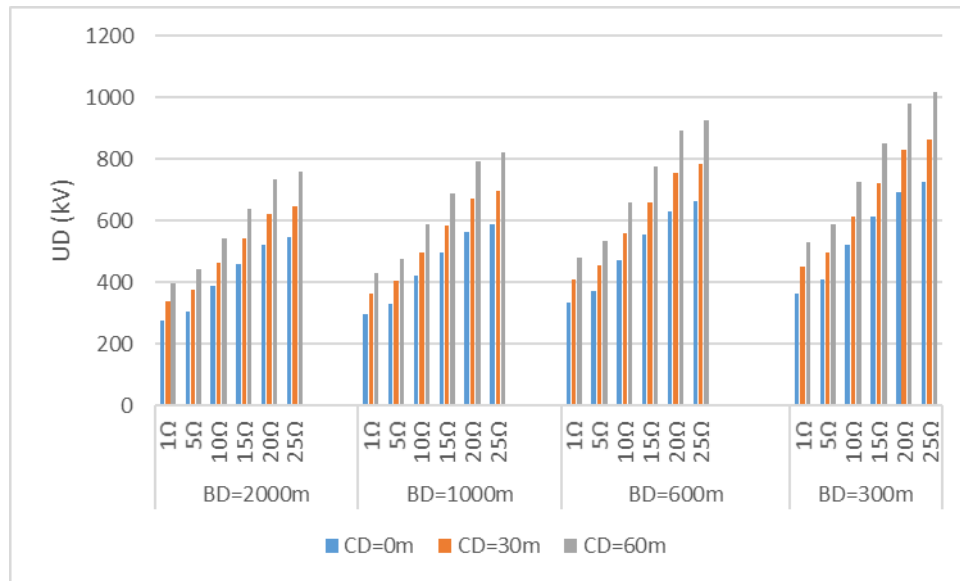

Figure 5.31: The Developed Overvoltage at Position B ( $U_B$ ) in function with the Distance CD, the length of the cable (BD) and the Tower Footing Resistance (Lightning hit on the Ground Wire of the Connected Transmission Line, case b)

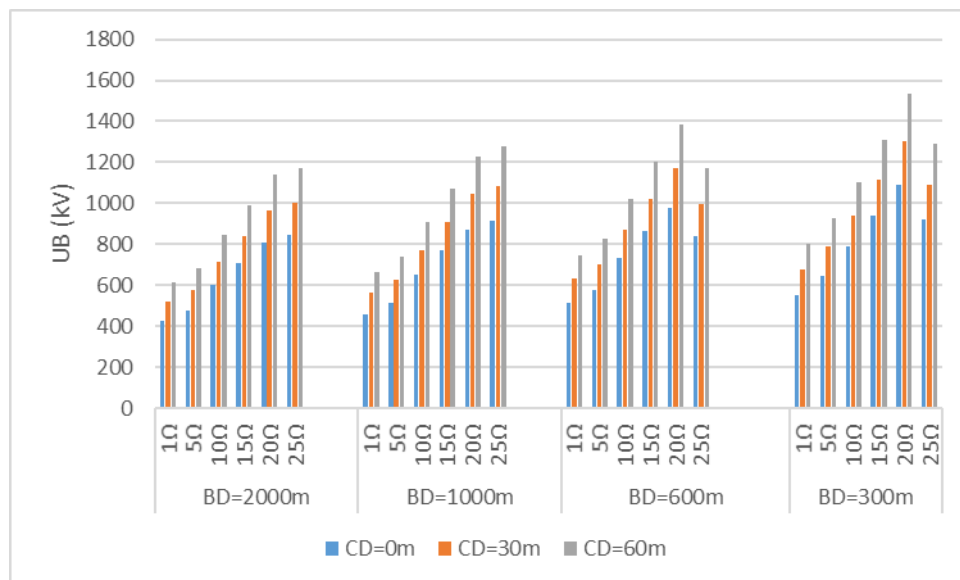

Figure 5.32: The Developed Overvoltage at Position D ( $U_D$ ) in function with the Distance CD, the length of the cable (BD) and the Tower Footing Resistance (Lightning hit on the Ground Wire of the Connected Transmission Line, case b)



In conclusion, lightning hits on the tower or the ground wires of the connected transmission lines consist a serious threat for the safety and the normal operation of the substations. The appropriate protection against backflashover phenomena requires the knowledge of the expected surges, in order to design the lightning protection configuration and select the electrical characteristics of the protective means. To these directions, the performed analysis highlights various aspects that the designer should take into account during the initial study of the lightning protection system of the substation:

- Low values of grounding resistance values, either for the tower or for the surge arresters, always improve the lightning performance of the line. Low tower footing resistances do not allow the potential of the tower to exceed the BIL and prevents backflashover. The arresters' grounding resistance must be low keeps the voltage at the terminals of the transformer below the desired limits.
- Long cable lengths contribute to the reduction of the expected overvoltages. Especially, in case that the grounding resistance of the towers cannot be improved, the increase of the cable length can balance the negative effects of the inadequate grounding system.
- The installation of the arresters away from the equipment to be protected reduces their efficiency, resulting in the development of significant overvoltages higher than the nominal residual voltage of the arresters. Furthermore, the installation of arresters at the joint between the line and the cable reduces the expected surges and provides more efficient protection against the incoming overvoltages.

#### 5.4 Impact of Used Models of the Components to the Obtained Results

The current section deals with the examination of the impact of the implemented simulation models of each device of the substation on the extracted outcomes. Considering for each component a default model, an appropriate analysis is performed, in order to examine the influence of the equivalent circuit models of the various components (i.e. tower, arresters, grounding, and insulators) to the obtained results.

- **Tower;** table 5.1 gives the considered equivalent circuits models for tower.

-

*Table 5.1: Used Tower Models for the Sensitivity Analysis*

No	Tower Models
1	Jordan (Jordan 1934)
2	Wagner (Wagner and Hileman 1960)
3	Sargent (Sargent and Darveniza 1969)
4	Ametani (Ametani et al. 1994)
5	Rondon (Rondon et al. 2005)
6	Yamada & Chilsom (Yamada et al. 1995)

- **Surge Arresters:** table 5.2 gives the used surge arresters equivalent circuits models for the sensitivity analysis

*Table 5.2: Used Surge Arresters Models for the Sensitivity Analysis*

No	Surge Arrester Model
1	Physical(Bayadi et al. 2003)
2	Pinceti – <i>Giannettoni</i> (Pinceti & Giannettoni 1999)
3	Fernandez – Diaz(Fernandez & Diaz 2001)
4	IEEE(IEEE W. G. 3.4.11 1992)

- **Grounding Resistance:** table 5.3 gives the implemented models for the sensitivity analysis.

*Table 5.3 Used Grounding Resistance for the Sensitivity Analysis*

No	Grounding Resistance Models
1	Oettle (Oettle E. E. 1988)
2	Chisholm et al. (a) (Chisholm & Janischewskyj 1989)
3	Chisholm et al. (b) (Chisholm & Janischewskyj 1989)
4	IEEE (IEEE W. G. PAS-104 1985, IEEE Std 80 2000)
5	Yasuda et al. (Yasuda et al. 2001)
6	Sverak (Sverak 1984)
7	CIGRE WG (CIGRE W.G. 33.01 1991)



- **Insulator Representation:** Table 5.4: Used Insulator Models for the Sensitivity Analysis

*Table 5.4: Used Insulator Models for the Sensitivity Analysis*

No	Insulator Models
1	Weck (Weck 1981)
2	Pigini (Pigini et al. 1989)
3	V-t curve (IEEE W.G no. 3 1993)

**The default models;** the considered default models are :

- Chilsom model for the Towers,
- IEEE model for the Arresters,
- Cigre model for the grounding resistance,
- V-t curve for the insulator.

The following figures depict the comparison of the calculated overvoltages by using the above circuit models.

**Tower:** Figures 5.33-5.34 depict the developed overvoltages at positions B and D, respectively, for various tower models (Table 5.1), considering:

- The lightning hit on the phase conductor of the connected transmission line.
- The tower footing resistance is equal to  $10\Omega$ .
- The length of the cable is 2km.
- The distance between the transformer and the arrester is 1m.
- Arresters have been installed at the entrance of the power transformer (case b).

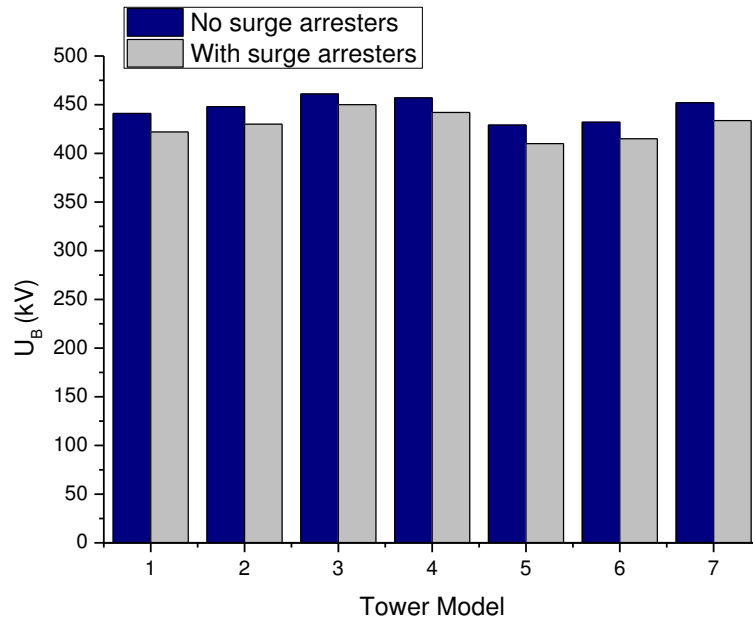

Figure 5.33: The Developed Overvoltage at Position B ( $U_B$ ) for Various Tower Models

( $R=10\Omega$ ,  $BD=2000m$ ,  $L_{CD}=1m$ , Lightning hit on Phase Conductor of Connected Transmission Line)

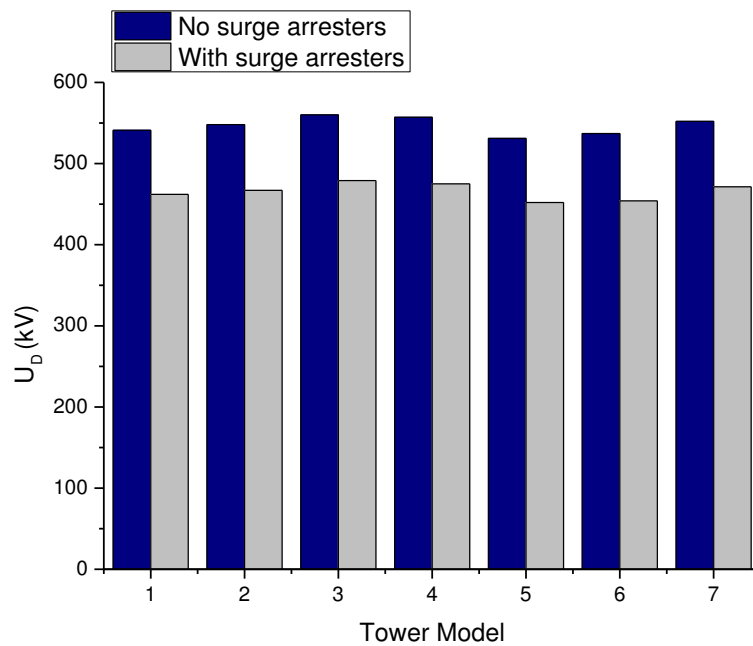

Figure 5.34: The Developed Overvoltage at Position D ( $U_D$ ) for Various Tower Models

( $R=10\Omega$ ,  $BD=2000m$ ,  $L_{CD}=1m$ , Lightning hit on Phase Conductor of Connected Transmission Line)

The obtained results indicate that the selected tower model influences the theoretical estimations, but its impact is not critical.



**Surge Arrester** : Figures 5.35 and 5.36 present the Influence of the Used Surge Arresters Models, according to Table 5.2.

All the simulated models are able to reproduce with good accuracy the residual voltage and the absorbed energy. Although the Fernandez–Diaz model gives in general greater peak residual voltage values, the IEEE model absorbs more energy; this is owned to the shape of the waveform, since the area under the residual voltage curve is bigger for the IEEE model.

The advantage of the three dynamic models, apart from the fact that they decrease the relative error, is that they can represent the frequency-dependent behavior of the metal oxide surge arrester, which is really important when the time to crest value of the lightning current is not constant. It has been proved that the decision on which model should be used depends on the available data, the complexity of the system and the demanded speed of the simulation, since the Pinceti–Gianetoni and the Fernandez–Diaz model are simpler than the IEEE model.

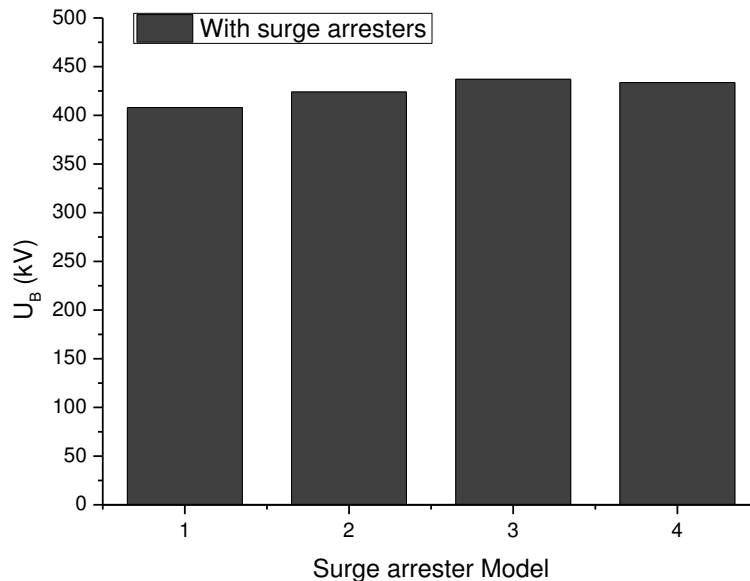

*Figure 5.35: The Developed Overvoltage at Position B ( $U_B$ ) for Various Surge Arrester Models ( $R=10\Omega$ ,  $BD=2000m$ ,  $L_{CD}=1m$ , Lightning hit on Phase Conductor of Connected Transmission Line)*



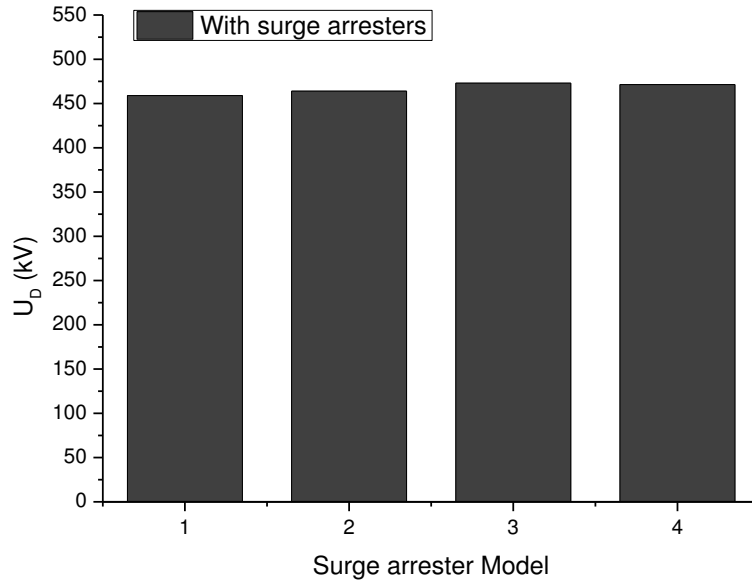

Figure 5.36: The Developed Overvoltage at Position D ( $U_D$ ) for Various Surge Arrester Models ( $R=10\Omega$ ,  $BD=2000m$ ,  $L_{CD}=1m$ , Lightning hit on Phase Conductor of the Connected Transmission Line)

**Grounding Resistance:** Figures 5.37 – 5.38 depict the Calculated Overvoltages for Various Grounding Resistance Models according to Table 5.3

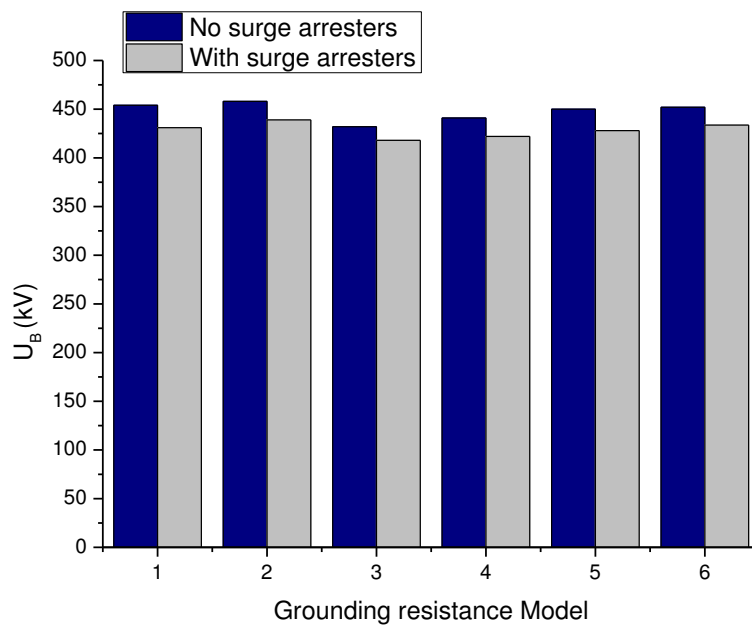
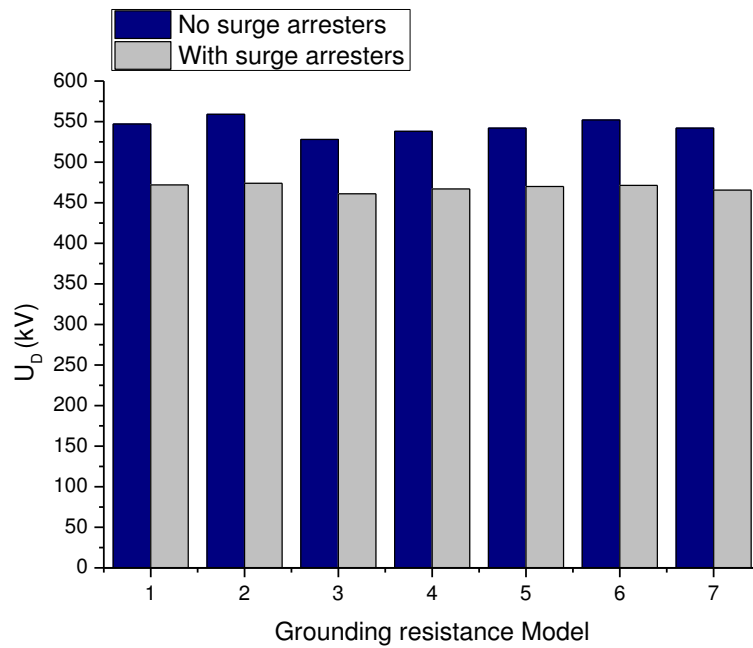

Figure 5.37: The Developed Overvoltage at Position B ( $U_B$ ) for Various Grounding Resistance Models ( $R=10\Omega$ ,  $BD=2000m$ ,  $L_{CD}=1m$ , Lightning hit on Phase Conductor of the Connected Transmission Line)



*Figure 5.38: The Developed Overvoltage at Position D ( $U_D$ ) for Various Grounding Resistance Models ( $R=10\Omega$ ,  $BD=2000m$ ,  $L_{CD}=1m$ , Lightning hit on Phase Conductor of the Connected Transmission Line)*

From the previous figures (5.37 – 5.38) it can be concluded that the estimated values of the overvoltages vary insignificantly. Model no 3 [Chisholm et al. (b)] gave a lower estimation of the arising overvoltages in comparison to the other models. The use of model 2 [Chisholm et al. (a)] resulted in increased values of overvoltages.

**Insulator.** Figures 5.39 – 5.40 examine the Influence of the Insulator Model According to Table 5.4.

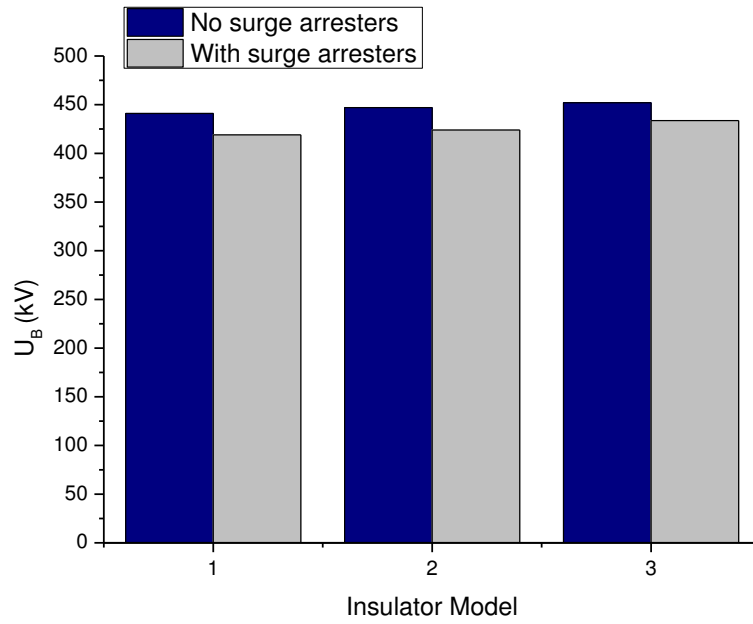

Figure 5.39: The Developed Overvoltage at Position B ( $U_B$ ) for Various Insulator Models ( $R=10\Omega$ ,  $BD=2000m$ ,  $L_{CD}=1m$ , Lightning hit on the Phase Conductor of the Connected Transmission Line)

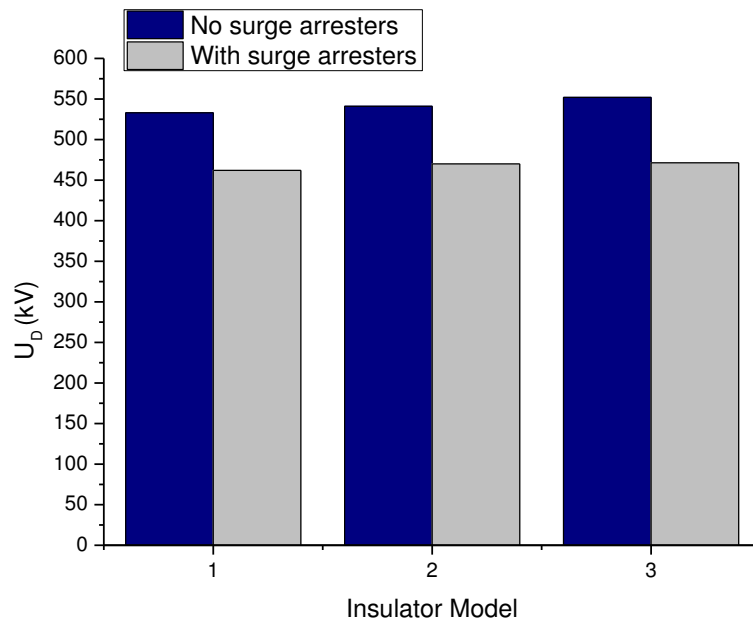

Figure 5.40: The Developed Overvoltage at Position D ( $U_D$ ) for Various Insulator Models ( $R=10\Omega$ ,  $BD=2000m$ ,  $L_{CD}=1m$ , Lightning hit on Phase Conductor of the Connected Transmission Line)



The previous figures (5.33 – 5.40) show that the estimated surges do not vary significantly among the implemented equivalent circuit models. The difference between the highest and the lowest value of the estimated overvoltage at positions B and D does not exceed 4%, indicating that the used models result in similar outcomes.

The above analysis was repeated for :

- The lightning hit on the ground wires of the connected transmission lines,
- The lightning peak current is 200kA,
- The tower footing resistance is  $5\Omega$ ,
- The length of the cable is 1000m ,
- The distance between the arresters' installation position and the transformer to be protected equal to 1m.

Figures 5.41 – 5.48 present the results of the performed sensitivity analysis in case of indirect lightning hit.

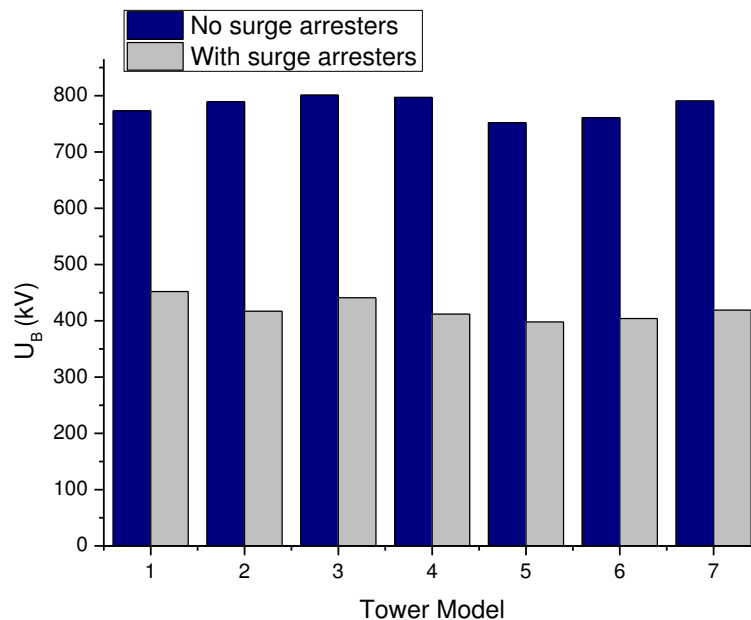

Figure 5.41: The Developed Overvoltage at Position B ( $U_B$ ) for Various Tower Models

( $R=5\Omega$ ,  $BD=1000m$ ,  $L_{CD}=1m$ , Lightning hit on the Ground Wire of the Connected Transmission Line)

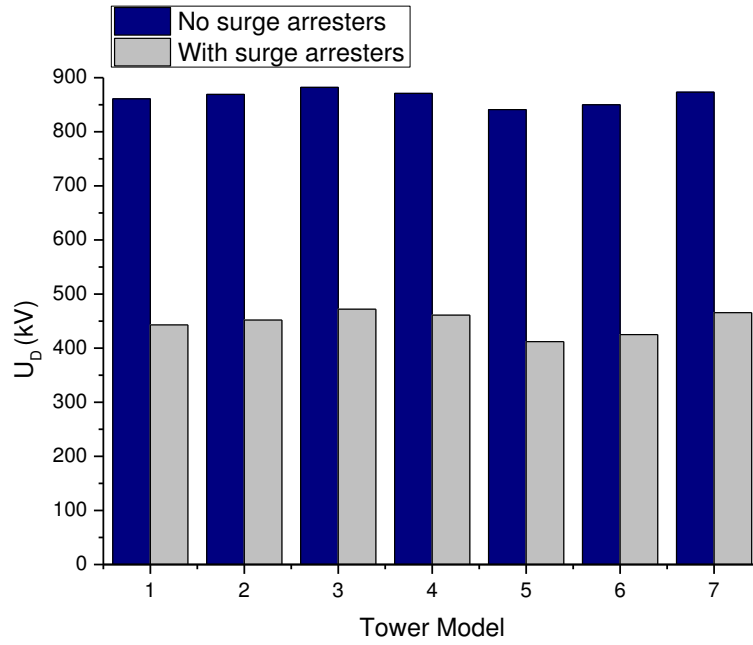

Figure 5.42: The Developed Overvoltage At Position D ( $U_D$ ) for Various Tower Models

( $R=5\Omega$ ,  $BD=1000m$ ,  $L_{CD}=1m$ , Lightning hit on the Ground Wire of the Connected Transmission Line)

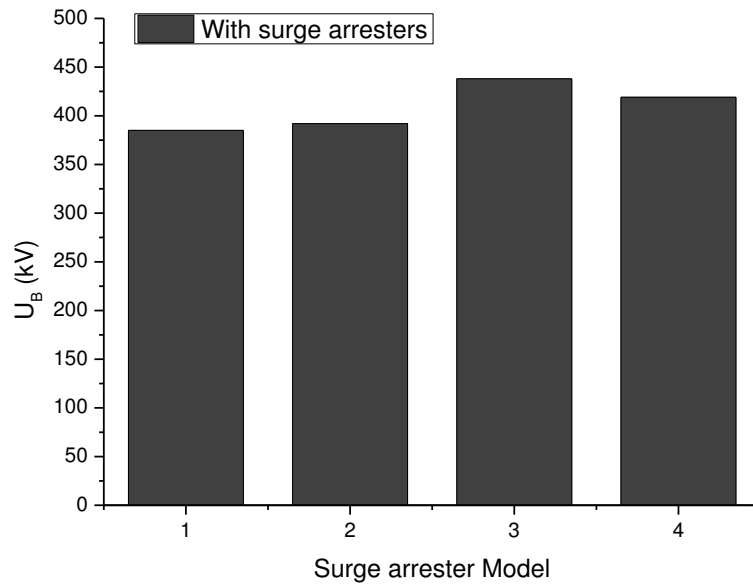

Figure 5.43: The Developed Overvoltage at Position B ( $U_B$ ) for Various Surge Arresters Models

( $R=5\Omega$ ,  $BD=1000m$ ,  $L_{CD}=1m$ , Lightning hit on the Ground Wire of the Connected Transmission Line)

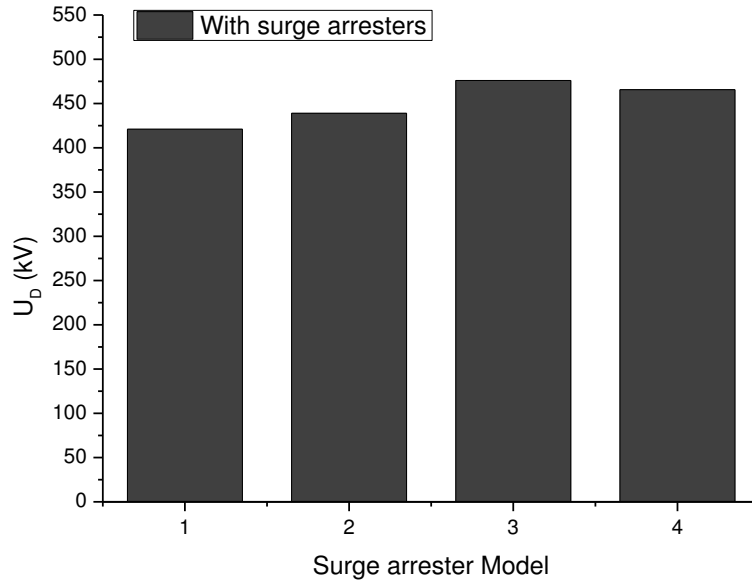

Figure 5.44: The Developed Overvoltage at Position B ( $U_B$ ) for Various Surge Arresters Models ( $R=5\Omega$ ,  $BD=1000m$ ,  $L_{CD}=1m$ , Lightning hit on the Ground Wire of the Connected Transmission Line)

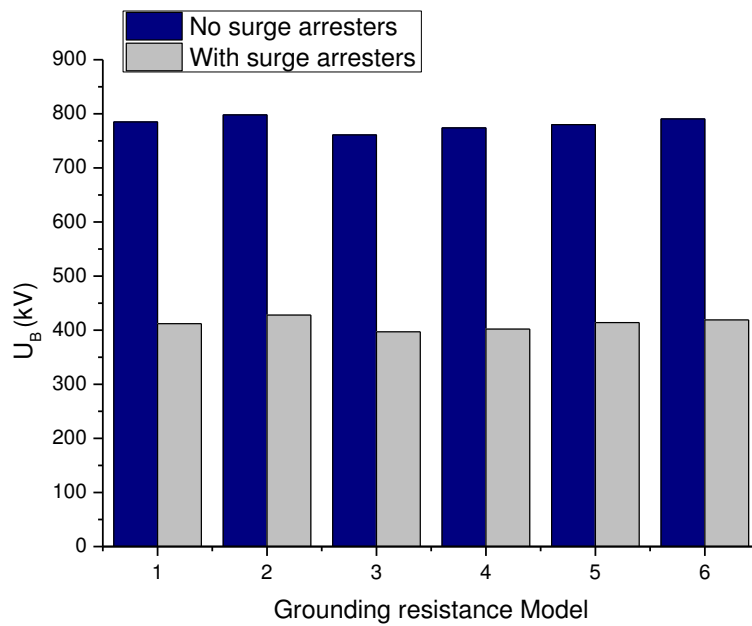

Figure 5.45: The Developed Overvoltage at Position B ( $U_B$ ) for Various Grounding Resistance Models ( $R=5\Omega$ ,  $BD=1000m$ ,  $L_{CD}=1m$ , Lightning hit on the Ground Wire of the Connected Transmission Line)

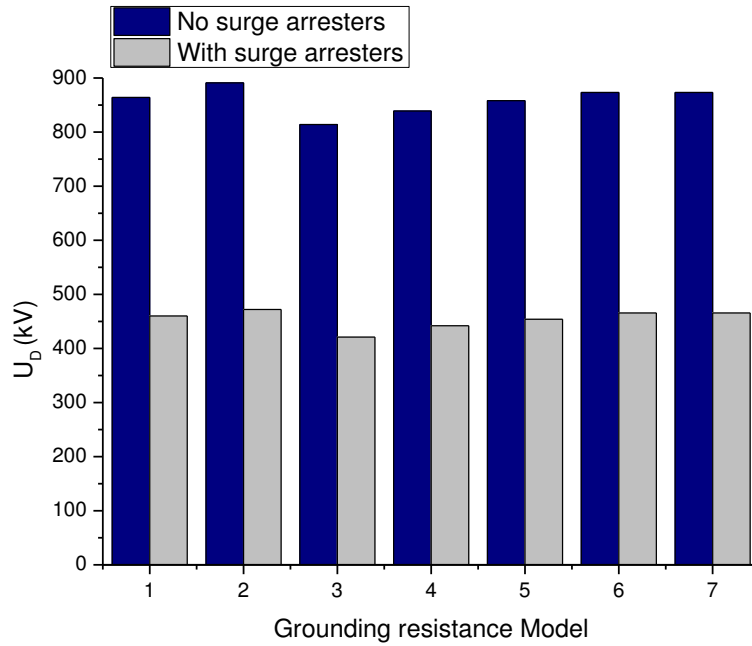

Figure 5.46: The Developed Overvoltage at Position D ( $U_D$ ) for Various Grounding Resistance Models ( $R=5\Omega$ ,  $BD=1000m$ ,  $L_{CD}=1m$ , Lightning hit on the Ground Wire of the Connected Transmission Line)

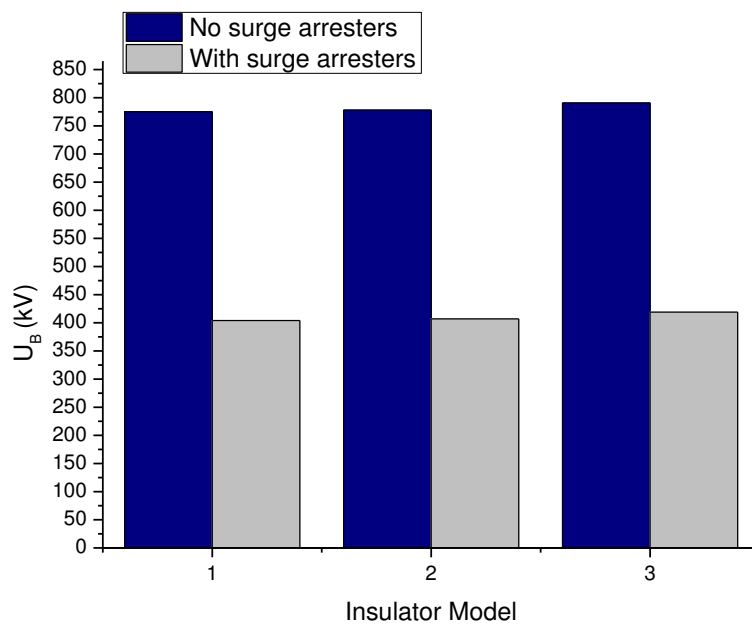

Figure 5.47: The Developed Overvoltage at Position B ( $U_B$ ) for Various Insulator Models ( $R=5\Omega$ ,  $BD=1000m$ ,  $L_{CD}=1m$ , Lightning hit on the Ground Wire of the Connected Transmission Line)

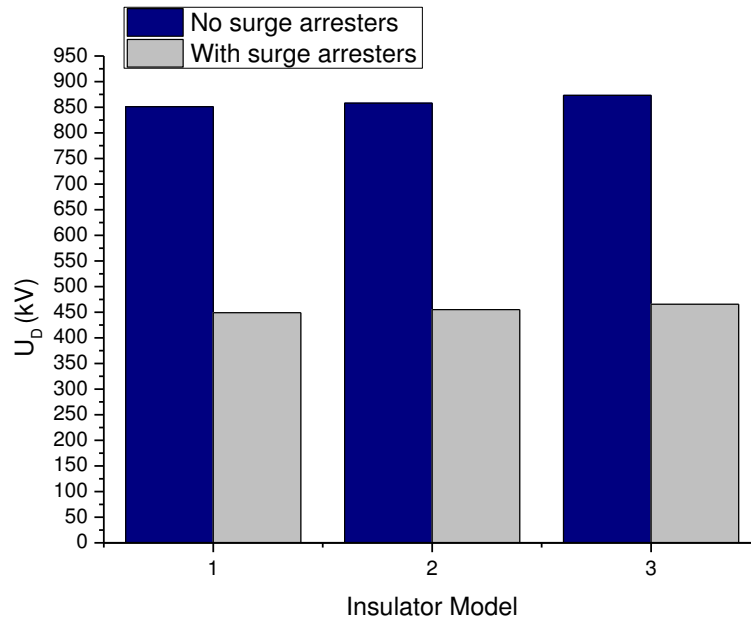

Figure 5.48: The Developed Overvoltage at Position D ( $U_D$ ) for Various Insulator Models

( $R=5\Omega$ ,  $BD=1000m$ ,  $L_{CD}=1m$ , Lightning hit on the Ground Wire of the Connected Transmission Line)

Summarizing the presented analysis in the current section, the developed surges at the entrance of a 150/20kV substation due to lightning hit on the connected overhead transmission line are computed, considering various equivalent circuit models for the main devices of the substation's equipment. The effect of each model does not seem to be crucial for the reliability of the simulation results, since the computed overvoltage do not vary significantly among the implemented models. The performed analysis can be useful for insulation coordination studies, in order to select the appropriate equivalent circuits.

## 5.5 Impact of the Number of the Incoming Transmission Lines

In this section the relation between the developed overvoltages and the number of the incoming lines to the substation is examined. The arising overvoltages are strongly dependent on the number of the lines and the lightning hit position ( $L$  is the distance between the lightning hit position and the busbar,  $E$  is the overvoltage of the busbar). The peak value and the rise time of the incoming voltage surges decrease with the increase of the number of the transmission lines, since the overvoltage "faces" the parallel combination of the incoming lines. Furthermore, the probability of lightning hit on a transmission lines is reduced as the number of the incoming lines is increased. Considering that all the transmission lines present





the same surge impedance, the overvoltage at the entrance of the substation is given by the equation (McDonald, J. et al 2000, Siemens 2008):

$$E = \frac{2U}{n} \quad (5.8)$$

Where;

$U$  is the peak value of the incoming voltage surge

$E$  is the overvoltage at the entrance of the substation

$n$  is the number of the incoming lines.

It is worth mentioning that  $U$  is not the overvoltage at the position of the lightning hit, but the surge just before the entrance of the substation. The following equation is an empirical approach to estimate the voltage  $U$ :

$$U = \frac{V_{max}}{k \cdot l \cdot V_{max} + 1} \quad (5.9)$$

Where;

$V_{max}$  is the overvoltage at the lightning hit position.

$l$  is the distance between the lightning hit position and the substation.

$k$  is an empirical coefficient between  $0.0001$  and  $0.0004$   $(\text{kV} \cdot \text{km})^{-1}$ .

Figure 5.49 present the calculated results for the topology of Fig. 4.2. The obtained outcomes indicate that the expected overvoltage at the entrance of the substation is reduced for higher number of incoming transmission lines. The impact of the lightning hit position is also highlighted, indicating the influence of the distance between the lightning stroke position and the substation to the incoming surge voltages.

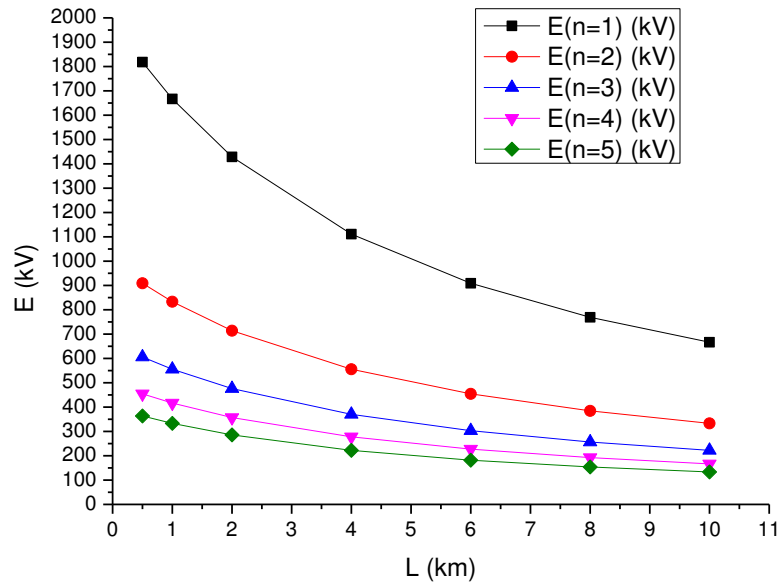

Figure 5.49: Voltage at the Entrance of the Substation in function with the Distance between the Lightning hit Position and the Substation

## 5.6 Calculation of Developed Overvoltages for Interconnected Substations

Figures. 5.50 – 5.55 present the estimated overvoltages at various positions of the topology depicted in Fig. 4.2. The performed simulations consider the case of lightning hit on the phase conductors of the ground wires and the implementation or not of metal oxide gapless surge arresters. The behavior of the expected overvoltage for each position of the system is examined in function with the tower footing resistance. The results highlight the need for protection of the system by installing surge arresters and the achievement of low values of grounding resistance. The analysis performed by using appropriate simulation tool (Simulink/MATLAB). The towers of the overhead lines and the installed metal oxide gapless surge arresters are modeled according to the Chilsom model and the IEEE model, correspondingly. As far as the grounding resistance is concerned the IEEE model is selected; finally, V-t curve is implemented for the circuit representation of the insulators.

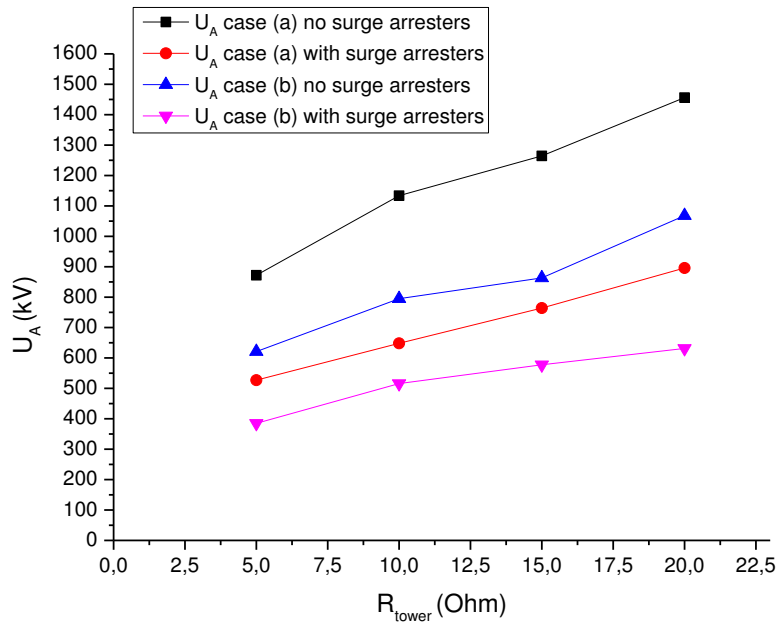

Figure5.50: Overvoltage at Position A ( $U_A$ ) in function with Grounding Resistance for Direct (case (I)) or Indirect (case (II)) Lightning hit for the Topology of Figure 4.2, Protected or Not by Surge Arresters

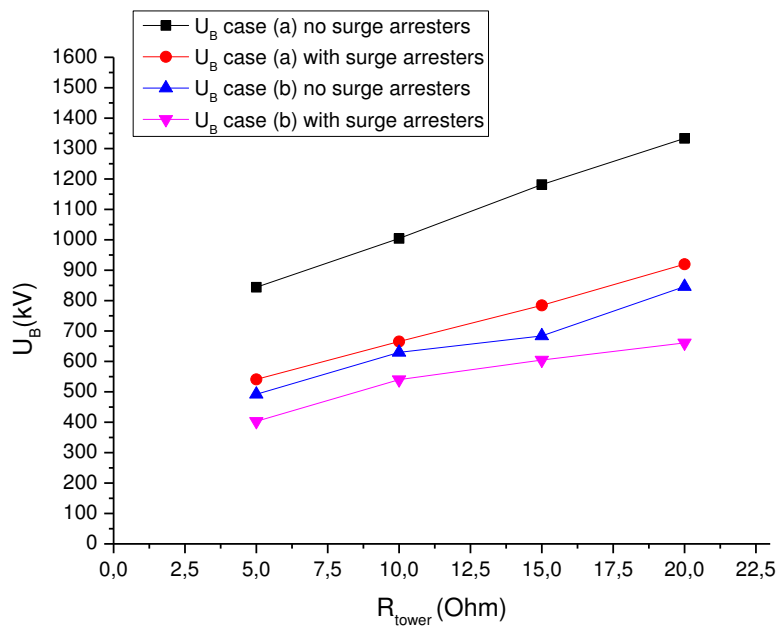

Figure5.51 : Overvoltage at position A ( $U_B$ ) in function with Grounding Resistance for Direct (case (I)) or Indirect (case (II)) Lightning hit for the Topology of Figure 4.2, Protected or Not by Surge Arresters

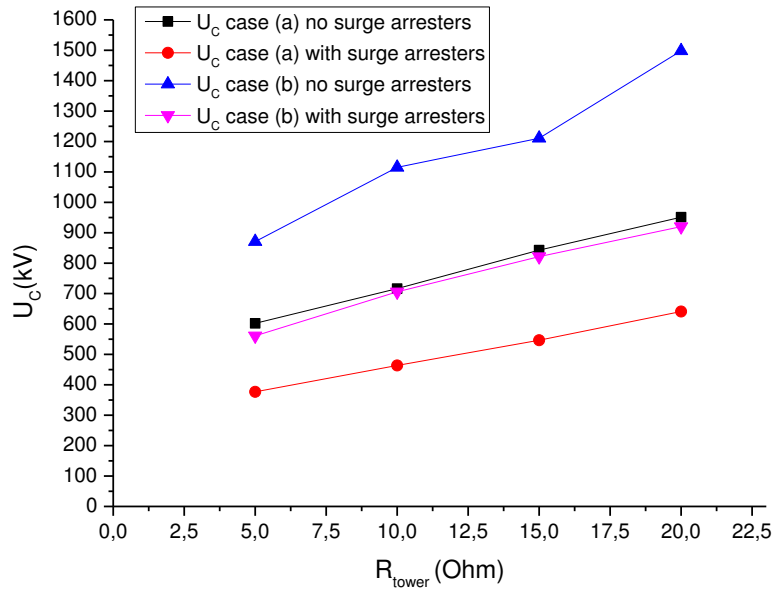

Figure 5.52: Overvoltage at Position C ( $U_c$ ) in function with Grounding Resistance for Direct (case (I)) or Indirect (case (II)) Lightning hit for the Topology of Figure 4.2, Protected or Not by Surge Arresters

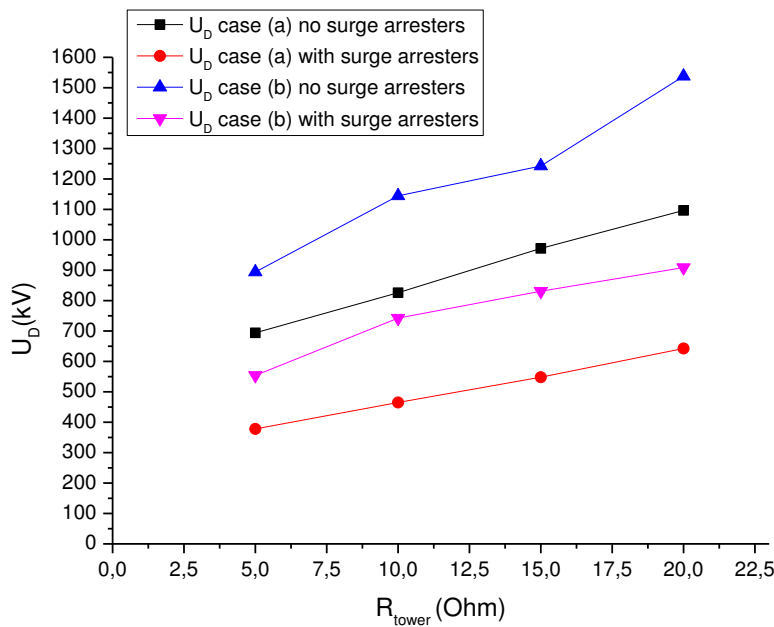

Figure 5.53: Overvoltage at Position D ( $U_D$ ) in function with Grounding Resistance for Direct (case (I)) or Indirect (case (II)) Lightning hit for the Topology of Figure 4.2, Protected or Not by Surge Arresters

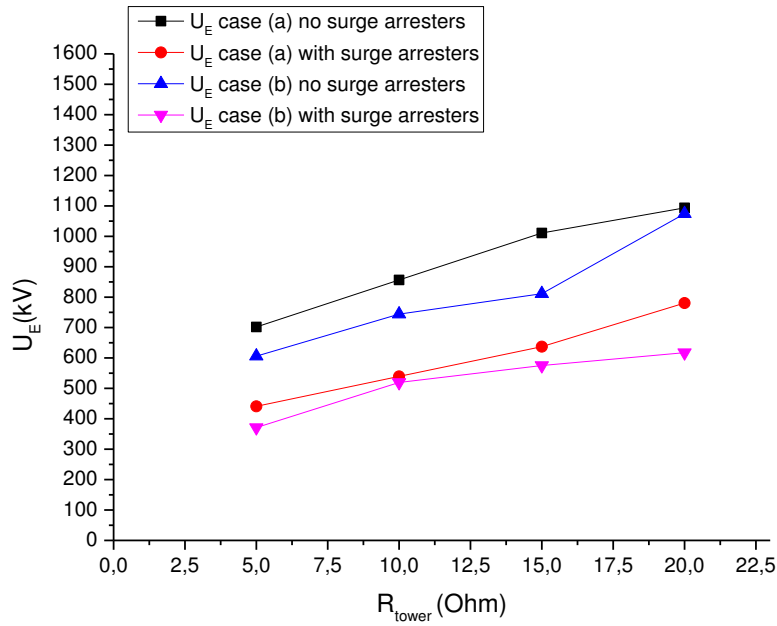

Figure 5.54: Overvoltage at Position E ( $U_E$ ) in function with Grounding Resistance for Direct (case (I)) or Indirect (case (II)) Lightning hit for the Topology of Figure 4.2, Protected or Not by Surge Arresters

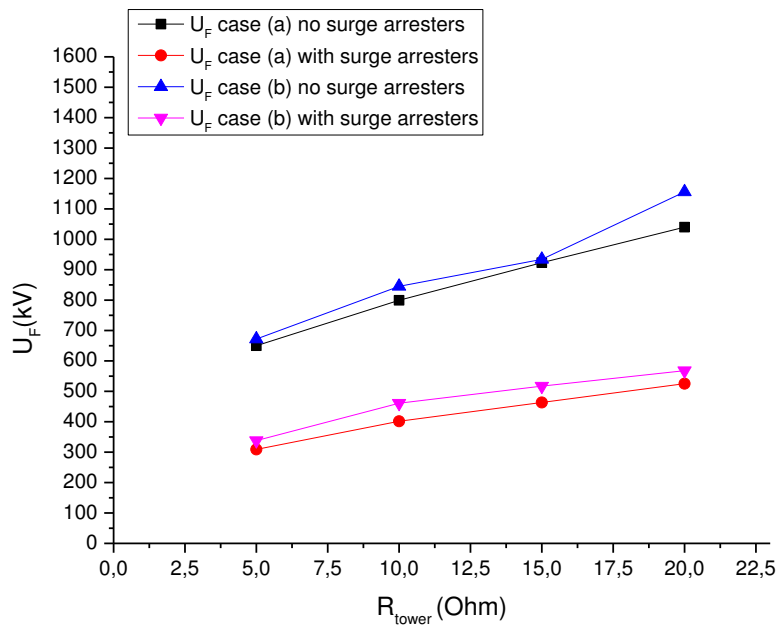

Figure 5.55: Overvoltage at Position F ( $U_F$ ) in function with Grounding Resistance for Direct (case (I)) or Indirect (case (II)) Lightning hit for the Topology of Figure 4.2, Protected or Not by Surge Arresters



## 5.7 Conclusions

The efficient protection of HV/MV substations against overvoltages is an issue of priority for electrical power corporations, since lightning is a major cause of dielectric stress of the equipment, ageing of the insulators and possible outages and damages of the substation components. A substation fault results in important consequences for the normal operation of the system, i.e. interruption of the power transmission and distribution and need for repair or replacement of the destroyed parts of the installation. Common practice for the protection of the HV/MV substations against lightning hits is the installation of external lightning protection system combined with surge arresters at the primary and the secondary of the power transformer. However, many factors affect the efficient protection that the implemented surge arresters offer; the lightning hit position, the distance between the arresters and the equipment to be protected, the grounding resistance are factors that influence the lightning performance of the system and determine the range of the arising overvoltages.

In case of open substations, the achievement of low values of grounding resistance and the installation of surge arresters at the entrance of the substation can improve the lightning performance of the system. In case that the transformer and the overhead transmission lines are connected with HV cables, the length of the cable is a critical factor for the restriction of the developed surges. The performed simulations indicate the dependence of the arising overvoltages at the entrance of HV/MV substations on the tower footing resistance, the installation position of the arresters and the length of the cable that connects the incoming overhead transmission lines with the transformer. The implementation of surge arrester definitely reduces the range of the developed voltage surges, compared to those ones without the use of surge arresters, but in cases of high grounding resistance values or high distance between the protective measures and the transformer, the developed overvoltages exceed the BIL. The significance of the length of the cable is also highlighted. As far as the influence of the used equivalent circuit models is concerned, the results show that the applied models give satisfactory results, presenting acceptable variations. Moreover, the relation between the developed overvoltages and the number of the incoming lines to the substation and the lightning hit position is examined, indicating that the range and the rise time of the incoming voltage surges decrease with the increase of the number of the transmission lines.

Main novelty of the current work is that examines the lightning performance of a substation, separately for a lightning hit on a phase conductor or a ground wire of the connected line, considering not only the grounding resistance (which is the common practice in similar studies of other researchers) but the cable length and the installation position of the arresters. Indeed,



the literature review indicated that the majority of the relative studies mainly focus on the role of the grounding resistance, ignoring or minimizing the importance of the other parameters. Regarding that the external LPS of the substation protects adequately the substation against direct lightning hits, the Thesis highlights that the lightning performance of the substations depends on various factors, except from grounding resistance. Moreover, in case of the Hellenic system, arresters are usually installed at the primary of the power transformer. In the current work, different scenarios for the placement of the transformer are examined (installation at the joint of the transmission line with the cable), revealing its impact on the expected overvoltages. The efficient design of the substation has to take into account these factors, in order to reduce the outage rate of the substation. It is worth mentioning that for long cables, the developed surges do not exceed the basic insulation level even if no arresters have been installed. Finally, the thesis reveals the role of the number of the incoming lines to the arising overvoltages.



## References

- Bayadi A., Harid N., Zebar K., Belkhiat S., *Simulation of metal oxide surge arrester dynamic behavior under fast transients*, in: *International Conference on Power Systems Transients*, New Orleans, USA, 2003.2 Pinceti P., Giannettoni M., *A simplified model for zinc oxide surge arresters*, *IEEE Trans. Power Delivery* 14 (2) (1999) 393–398.
- Chisholm W. A., Chow Y. L., and Srivastava K. D. “Travel time of transmission towers,” *IEEE Trans. Power App. Syst.*, vol. PAS–104, no. 10, pp. 2922–2928, Oct. 1985.4
- CIGRE Working Group 33.01, “Guide to procedures for estimating the lightning performance of transmission lines,” *Technical Bulletin 63*, Oct. 1991.
- CIGRE, Working Group 01 (Lightning) of Study Committee 33 (Overvoltages and Insulation Coordination) “Guide to Procedures for Estimating the Lightning Performance of Transmission Lines, brochure 63, CIGRE, Paris, France, October, 1991
- Fernandez F., Diaz R., *Metal oxide surge arrester model for fast transient simulations*, in: *International Conference on Power System Transients (IPAT’ 01)*, Rio De Janeiro, Brazil, 2001, Paper 14. IEEE Working Group 3.4.11, *Modeling of metal oxide surge arresters*, *IEEE Trans. Power Delivery* 7(1) (1992) 302–309.-
- Hileman A.R., “*Insulation coordination for Power Systems*”, CRC Press, 1999
- IEEE Std 80-2000, “*IEEE Guide for Safety in AC Substation Grounding*”, January 2000 Yasuda Y., Hirakawa Y., Shiraishi K., and Hara T., “Sensitivity analysis on grounding models for 500kV transmission lines,” *Trans.IEE Japan B*, vol. 121, no. 10, pp. 1386–1393, 2001.6 Sverak (Sverak 1984)
- IEEE Working Group, “*Estimating lightning performance of transmission lines II – Updates to analytical models*,” *IEEE Trans. Power Delivery*, vol. 8, no. 3, pp. 1254-1267, Jul. 1993.
- Jordan C. A., “*Lightning computations for transmission lines with overhead ground wires*,” *Gen. Elec. Rev.*, vol. 37, 1934 Wagner (Wagner and Hileman 1960)
- Oettle E. E., “*A new general estimation curve for predicting the impulse impedance of concentrated earth electrodes*,” *IEEE Trans. Power Delivery*, vol. 3, no. 4, pp 2020–2029, Oct. 1988.2 Chisholm et al. (a) (Chisholm & Janischewskyj 1989)
- Pigini A., Rizzi G., Garbagnati E., Porrino A., Baldo G., and Pesavento G., “*Performance of large air gaps under lightning overvoltages: Experimental study and analysis of accuracy of predetermination methods*,” *IEEE Trans. Power Delivery*, vol. 4, no. 2, pp 1379–1392, Apr. 1989
- Rondon D., Vargas M., Herrera J., Montana J., Torres H., Camargo M., Jimenez D., and Delgadillo A., “*Influence of grounding system modelling on transient analysis of transmission lines due to direct lightning strike*,” in *Proc. Power Tech, St. Petersburg, Russia*, 2005, pp. 1-6 Yamada & Chilsom (Yamada et al. 1995)
- Ryan H.M, “*High voltage engineering and testing*”, Peter Peregrinus Ltd. 1st edition, 1994).





- Sargent M. A. and Darveniza M., "Tower surge impedance," IEEE Trans. Power App. Syst., vol. PAS-88, no. 5, pp. 680–687, May 1969*
- Ametani (Ametani et al. 1994)*
- Siemens, Energy Sector, "Power Engineering Guide: Answers for Energy", 5th Edition, 2008*
- Weck K. H., "Lightning performance of substations," CIGRE SC 33, Rio de Janeiro, Brazil, 1981.*



## CHAPTER 6

# LIGHTNING RISK ASSESSMENT OF SUBSTATIONS

### 6.1 Introduction

The current Chapter deals with the computation of the outage rate due to lightning overvoltages, concerning the substation configurations of Chapter 4. A detailed methodology for the computation of the outage rate of HV/MV substations is provided, considering lightning hit on the phase conductors or the overhead ground wires of the connected transmission lines. Assuming that a HV/MV substation is adequately protected against direct lightning strikes, incoming surges from the connected transmission line are the main cause of substation outages, resulting in interruption and repair/replacement costs. The above consequences are more intense in case that cables are used for the connection of the incoming line with the substation, since potential damages of the cable insulation results in higher repair costs and longer term outages (Mikropoulos et al. IET). For these reasons, a lightning risk assessment of HV/MV substations and the evaluation of their lightning performance is critical, in order to adopt the necessary protective measures against lightning phenomena. In the current work, lightning risk assessment of a 150/20kV substation of the Hellenic network is carried out, considering the incoming lightning surges due to either backflashover or shielding failure in the connected overhead transmission lines, based on the scenario and the data of the previous chapters (configuration of the substation (Fig. 4.1.), sensitivity analysis data, simulation models).

### 6.2 Calculation of Outage Rate due to Lightning Hits on Phase Conductors

The outage rate of the substation due to shielding failures in the connected lines, i.e. lightning flash to phase conductors,  $SORSF$  (outages/year), is given as(IEC 60071-2, 1996):



$$SFR_{ph} = SFR_X[F(I_{CFS}) - F(I_{MSF})] \quad (6.1)$$

Where:

$SFR_X$  (shielding failures/year) is the shielding failure rate of the connected line

$X_{SF}$ (km)is the distance between the substation entrance and the lightning hit position

The shielding failure rate of the connected line  $SFR_X$  is given by the equation:

$$SFR_X = \frac{SFR}{100} X_{SF} \quad (6.2)$$

Where;

$SFR$  (shielding failures/100km/year) is the shielding failure rate of the incoming overhead line (Mikropoulos & Tsovilis-IEEE, Mikropoulos et al., 2010).

$F(I)$  is the probability of lightning crest current being greater than  $I$ , given by the equation Anderson, 1982):

$$F(I) = \frac{1}{1 + (I/31)^{2.6}} \quad (6.3)$$

Where

$I_{CSF}$  (kA) is the minimum value of the lightning current hitting the phase conductor of the connected transmission line at a distance  $X_{SF}$  from the substation entrance that results in the development of overvoltages greater than the basic insulation level(Hileman, 1999, IEEE T. F., vol. 11, no. 1, 1996).

$I_{MSF}$  is the maximum shielding failure current of the connected line (Mikropoulos & Tsovilis, IET).

### 6.3 Calculation of Outage Rate due to Lightning hits on ground wires

The substation outage rate due to incoming backflashover surges, that is, flashover of line insulation caused by lightning flash to shield wire,  $SORBF$  (outages/year), can be estimated as(IEC 60071-2, 1996):

$$SOR_{gw} = 0.6N_{SX}F(I_{CBF}) \quad (6.4)$$

Where;



$N_{SX}$  (strikes/year) is the rate of lightning strikes to shield wires of the connected line

$X_{BF}$  (km) is the limit distance between the substation entrance and the lightning hit position.

$N_{SX}$  is given as:

$$N_{SX} = \frac{N_S}{100} X_{BF} \quad (6.5)$$

Where

$N_S$ (strikes/100km/year) is the number of lightning hits on ground wires of the overhead transmission line (Mikropoulos & Tsovilis, IEEE).

$I_{CBF}$  (kA) is the minimum value of the lightning current hitting the ground wire at a distance  $X_{SF}$ . Distance from the substation entrance that results in the development of overvoltages greater than the basic insulation level (Hileman, 1999, IEEE T. F., vol. 11, no. 1, 1996).

## 6.4 Failure Rate of Arresters

In case that the absorbed energy (by the arresters) exceeds their withstand capability, the arresters are damaged (failure); the lightning energy  $E$ (in Joules) absorbed by a surge arrester is computed by the relation (Christodoulou et al. 2010):

$$E = \int_{t_0}^t u(t) \cdot i(t) dt \quad (6.6)$$

Where;

$u(t)$  is the residual voltage of the arrester in kV

$i(t)$  is the value of the discharge current through the arrester in kA.

Considering the energy required causing damage to an arrester, the failure probability of an arrester is calculated by (Christodoulou et al. 2010):

$$ArrFP_1 = \int_{T_r}^{\infty} \left\{ \int_{I_A(T_r)}^{\infty} f(I_p) \cdot h_A(I_p) dI_p \right\} g(T_t) dT_t \quad (6.7)$$

$$ArrFP_2 = \int_{T_r}^{\infty} \left\{ \int_{I_B(T_r)}^{\infty} f(I_p) \cdot h_B(I_p) dI_p \right\} g(T_t) dT_t \quad (6.8)$$

Where;



$ArrFP_1$  is the probability that an arrester fails due to lightning stroke on a phase conductor,

$ArrFP_2$  is the probability that an arrester fails due to lightning stroke on the overhead ground wire,

$I_A(T_d)$  is the minimum stroke peak current in kA required to damage the arrester, when lightning hits on a phase conductor, depending on each time-to-half value,

$I_B(T_d)$  is the minimum stroke peak current in kA required to damage the arrester, when lightning hits on the overhead ground wire, depending on each time-to-half value,

$f(I_p)$  is the probability density function of the lightning current peak value,

$g(T_d)$  is the probability density function of the time-to-half value of the lightning current,

$T_r$  is the rise time of the incident waveform,

$P_T$  is the total failure probability of an arrester,

The total failure rate of the arrester is given by the equation(Christodoulou et al. 2010):

$$ArrFR = N_L \cdot (ArrFP_1 + ArrFP_2) \quad (6.9)$$

$A_T$  is the arrester total failure rate in failures per year per line,

$N_L$  is the number of lightning flashes to a line per 100km per year, equal to (Christodoulou et al. 2010):

$$N_L = \frac{N_g}{10} \cdot (28h_t^{0.6} + g) \quad (6.10)$$

$h_t$  is the tower height in m,  $g$  is the horizontal spacing in m, between the ground wires,

$N_g$  is the ground flash density in flashes per km<sup>2</sup> per year and  $l$  is the line length in km.

## 6.5 Calculation of the Total Substation Outage Rate

The total substation outage rate,  $SOR$ (outages/year), due to lightning hits on the connected transmission lines is:

$$SOR = SOR_{ph} + SOR_{gw} \quad (6.11)$$

Finally, in case that the arresters' failures are included to the substations damages, then the total substation failure rate is given as:

$$SOR' = SOR + ArrFR \quad (6.12)$$



## 6.6 Results

The above analysis indicates that the estimation of the substation outage rate is a complex procedure that demands the knowledge of various parameters and factors that influence the lightning performance of the system. In this section, a sensitivity analysis of the expected failure rate of the substation of Fig.4.1 in function with the tower footing resistance, the length of the cable and the arresters installation position is presented, based on the data presented in previous Chapters.

The analysis performed by using the Simulink/MATLAB software tool. The towers of the overhead lines and the installed metal oxide gapless surge arresters are modeled according to the Chilsom model and the IEEE model, correspondingly. As far as the grounding resistance is concerned the Cigre model is selected; finally, V-t curve is implemented for the circuit representation of the insulators (see Chapters 3 and 4).

The following results highlight the great impact of the grounding resistance, the length of the cable and the installation position of the implemented arresters to the expected failure rates. In details, the grounding resistance is the dominant factor that determines the lightning performance of the system, since it influences the occurrence or not of backflashover phenomena and affect the effectiveness of the protection that surge arresters provide. Furthermore, the length of the cable is of great importance, since influences the magnitude of the expected overvoltages, as indicated in Chapter 5. The distance between the transformer and the arresters affects the lightning performance of the system, imposing their installation near the entrance of the substation. As far as the arresters failure rate is concerned, the behavior of the arresters depends on the grounding resistance. In general, the achievement of low values of grounding resistance contributes to the more efficient operation of the protective devices, since ensures a low-resistance path in order to divert the lightning current to earth.

In details Fig. 6.1 depict the substation outage rate in case of lightning hit oh phase conductor of the connected line in function with the length of the cable and distance between the arrester and the entrance of the power transformer, considering case A of Fig.4.1. It is worth mentioning that the tower footing resistance has no impact on the expected outage rates. The results indicate clearly the improvement of the lightning performance of the substation under study after the installation of surge arresters and highlights the role of the length of the cable and the installation position of the arresters, confirming the simulation results of Chapter 5.

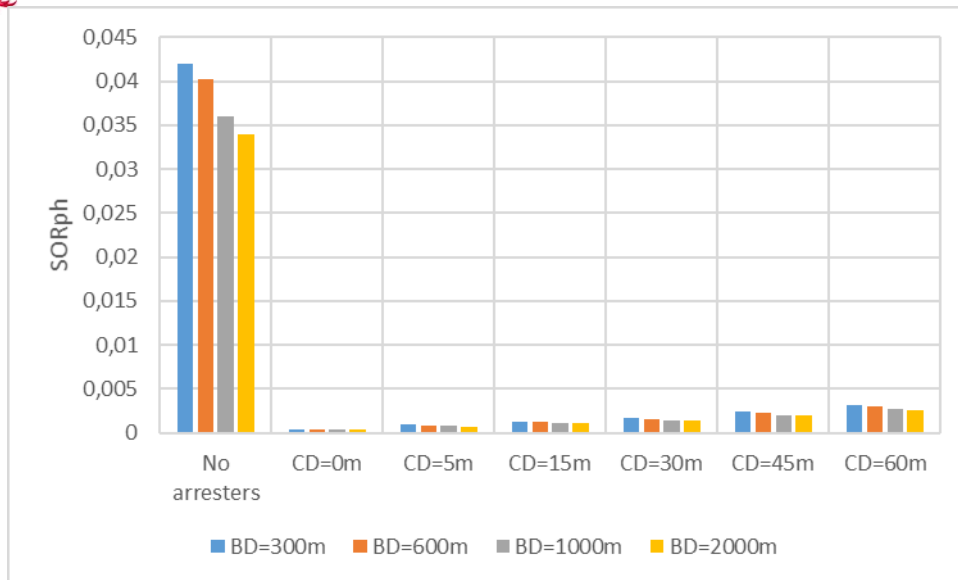

Figure 6.1 : Substation Outage Rate in case of lightning hit on the phase conductor of the connected line in function with the length of the cable (BD) and the distance between the arrester and the transformer (CD) (Case a)

Fig. 6.2 – 6.6 present the results in case of a lightning hit on the overhead ground wire of the incoming line, considering case A of Fig. 4.1. The calculated outage rates reveal the dominant role of the tower footing resistance, since low values of the grounding resistance reduce the expected failures. Note that in case of long cables and installation of the arresters at the entrance of the power transformers, the substation outage is almost eliminated.

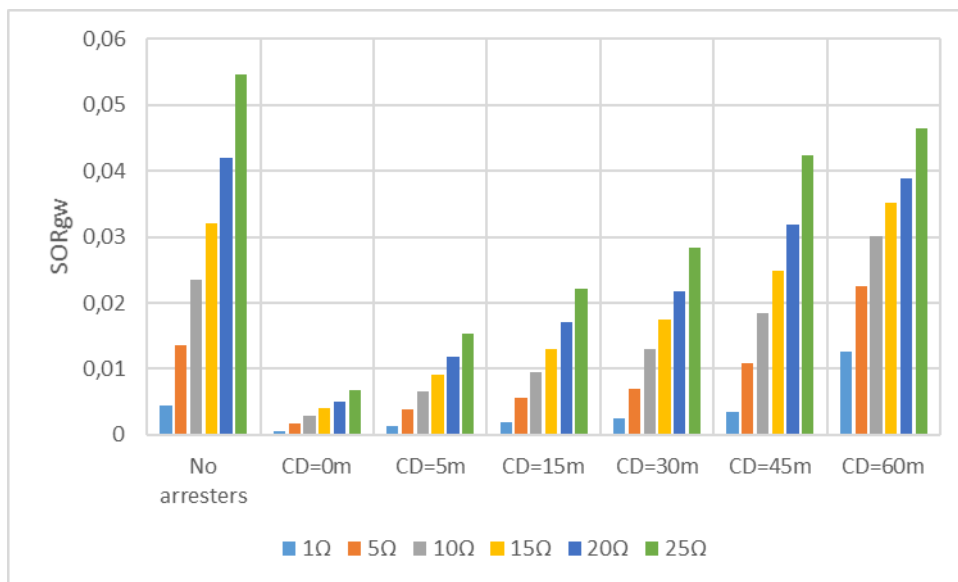

Figure 6.2: Substation Outage Rate in case of lightning hit on ground wire of the connected line in function with the grounding resistance (R) and the distance between the arrester and the transformer (CD) considering BD=300m (Case a)

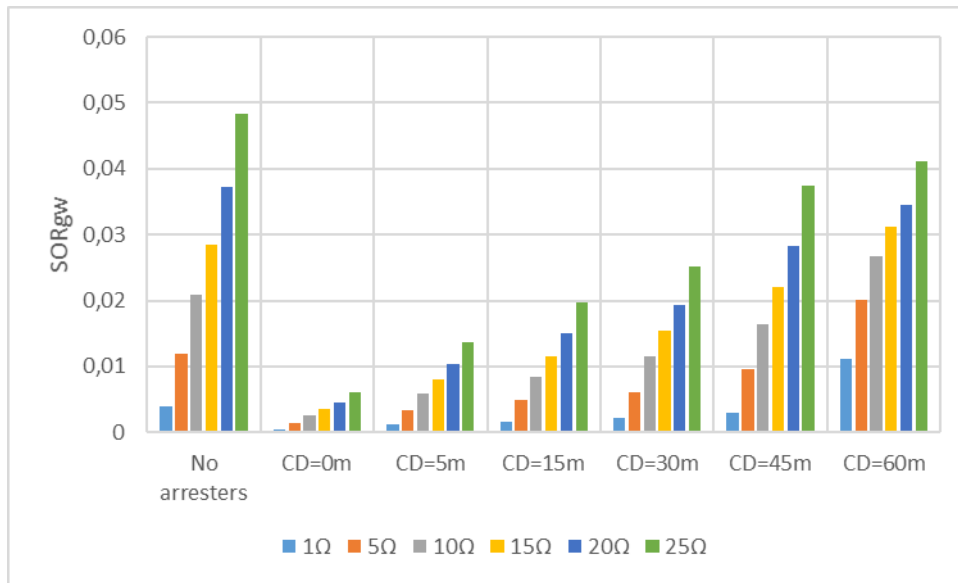

Figure 6.3: Substation Outage Rate in case of lightning hit on ground wire of the connected line in function with the grounding resistance (R) and the distance between the arrester and the transformer (CD) considering  $BD=600m$  (Case a)

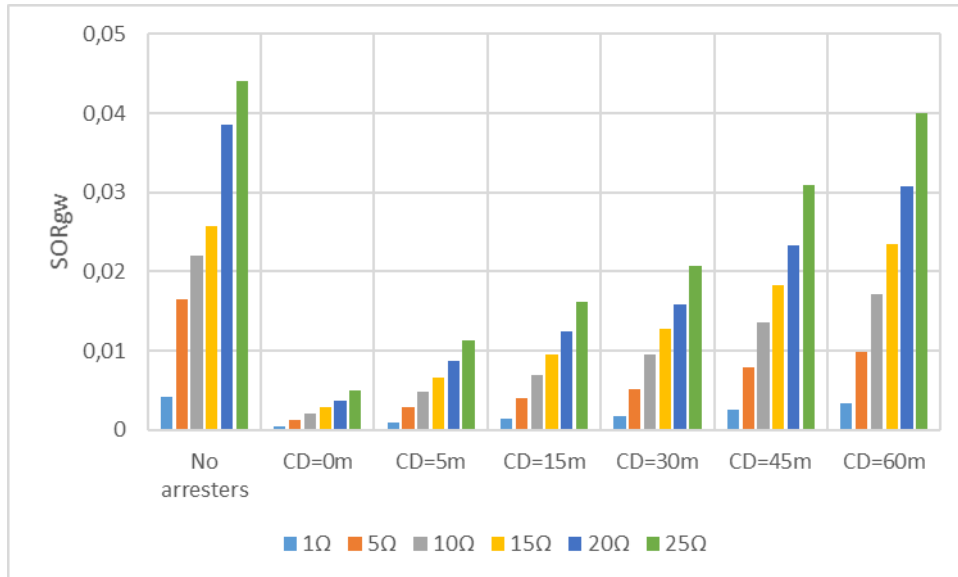

Figure 6.4: Substation Outage Rate in case of lightning hit on ground wire of the connected line in function with the grounding resistance (R) and the distance between the arrester and the transformer (CD) considering  $BD=1000m$  (Case a)



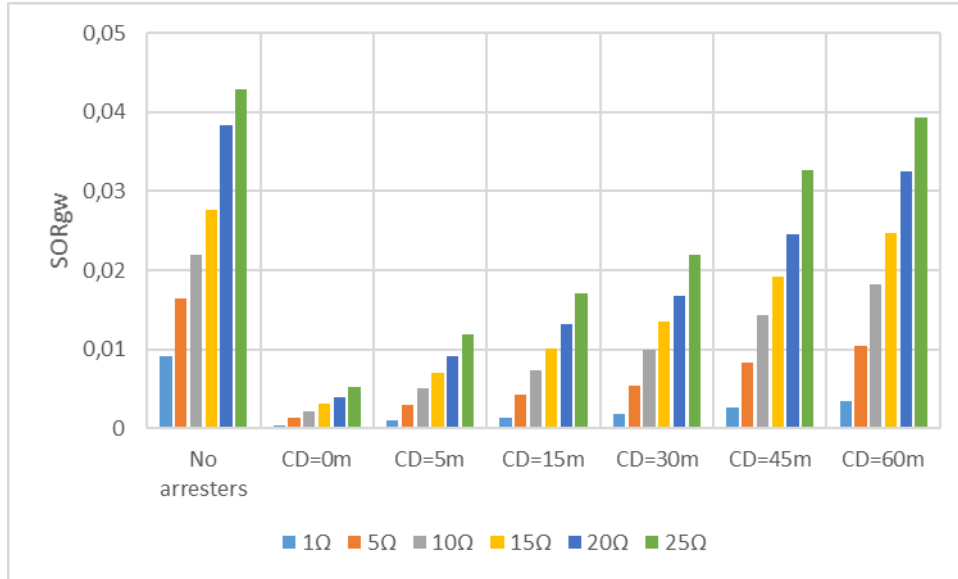

Figure 6.5: Substation Outage Rate in case of lightning hit on ground wire of the connected line in function with the grounding resistance (R) and the distance between the arrester and the transformer (CD) considering  $BD=2000m$  (Case a)

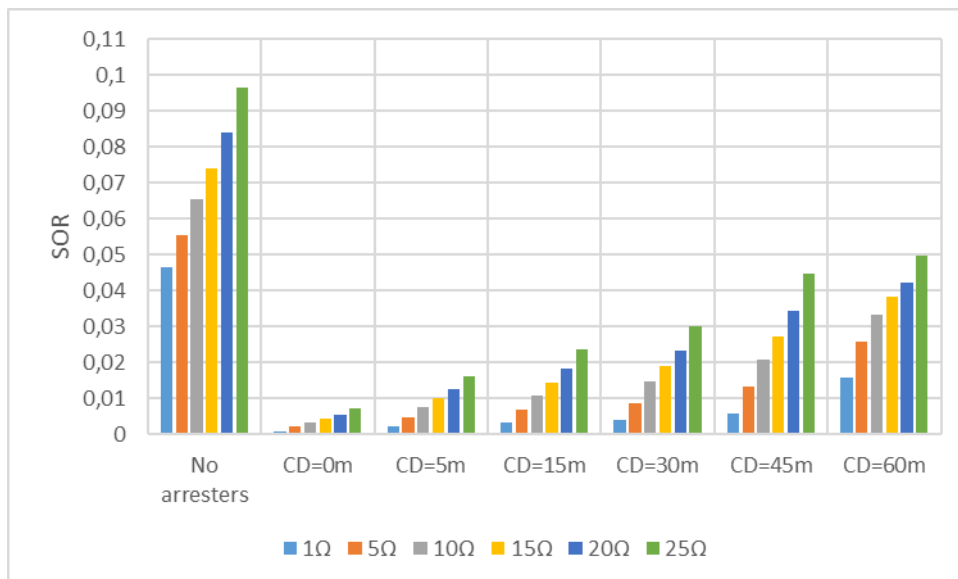

Figure 6.6: Substation Outage Rate in function with the grounding resistance (R) and the distance between the arrester and the transformer (CD) considering  $BD=300m$  (Case a)



Figures 6.7 – 6.9 presents the total substation outage rate, according to the evaluations presented in Figures 6.1 – 6.6. The installation of surge arresters combined with the achievement of low values of tower footing resistance and long cables ensure the improvement of the lightning performance of the substation.

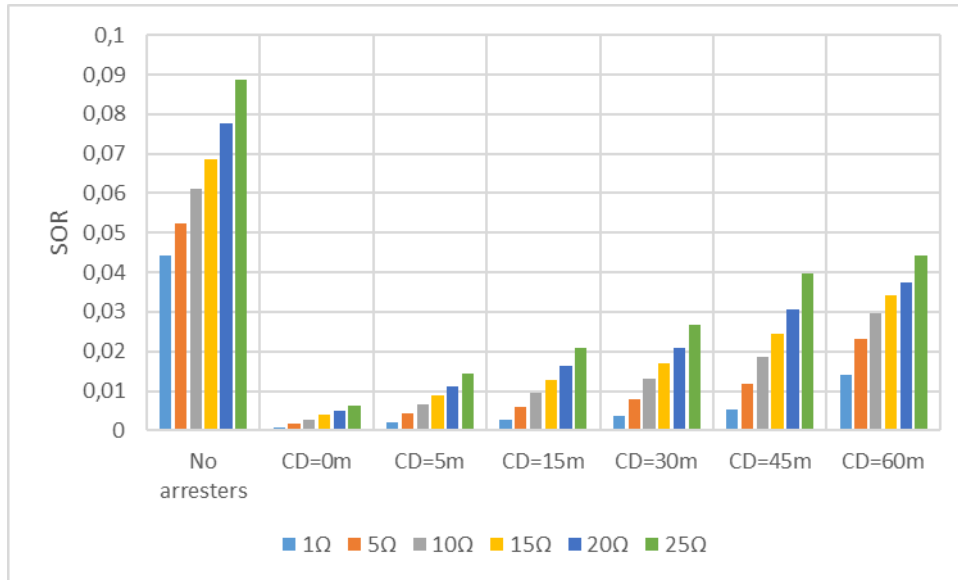

Figure 6.7: Substation Outage Rate in function with the grounding resistance (R) and the distance between the arrester and the transformer (CD) considering  $BD=600m$  (Case a)

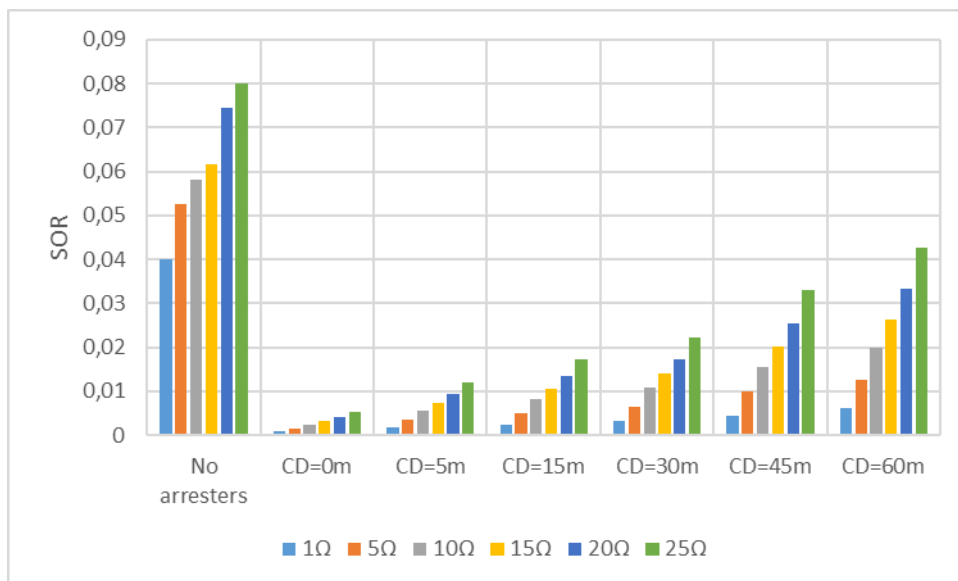

Figure 6.8: Substation Outage Rate in function with the grounding resistance (R) and the distance between the arrester and the transformer (CD) considering  $BD=1000m$  (Case a)

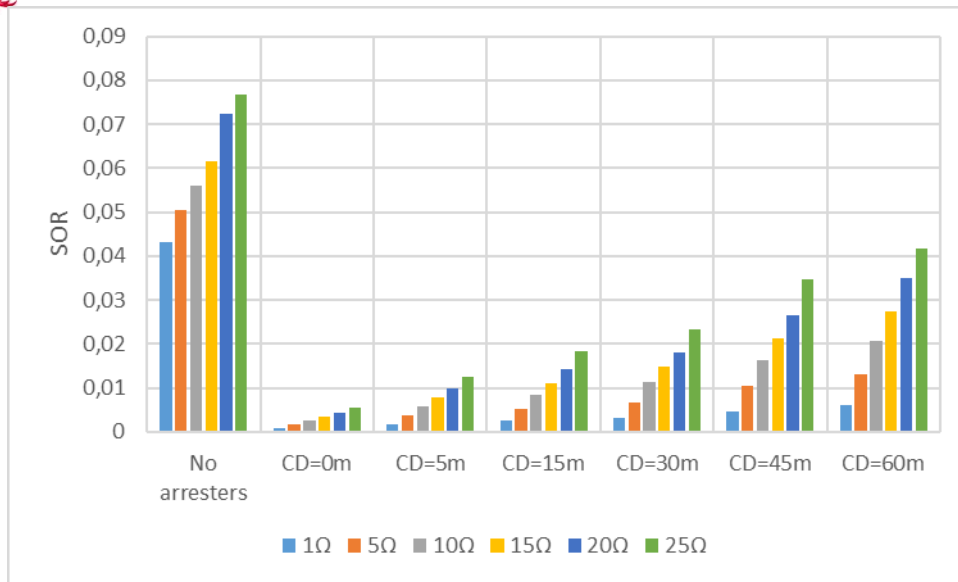

Figure 6.9: Substation Outage Rate in function with the grounding resistance ( $R$ ) and the distance between the arrester and the transformer ( $CD$ ) considering  $BD=2000m$ (Case a)

Figures 6.10 – 6.17 depict the expected failure rate for the arresters installed at positions B and D. Critical factors that influence the energy passed through the arresters are the tower footing resistance (that determines the incoming surge, due to backflashover) and the installation position of the arresters (arresters at position B have higher failure rate compared with those installed at position D).

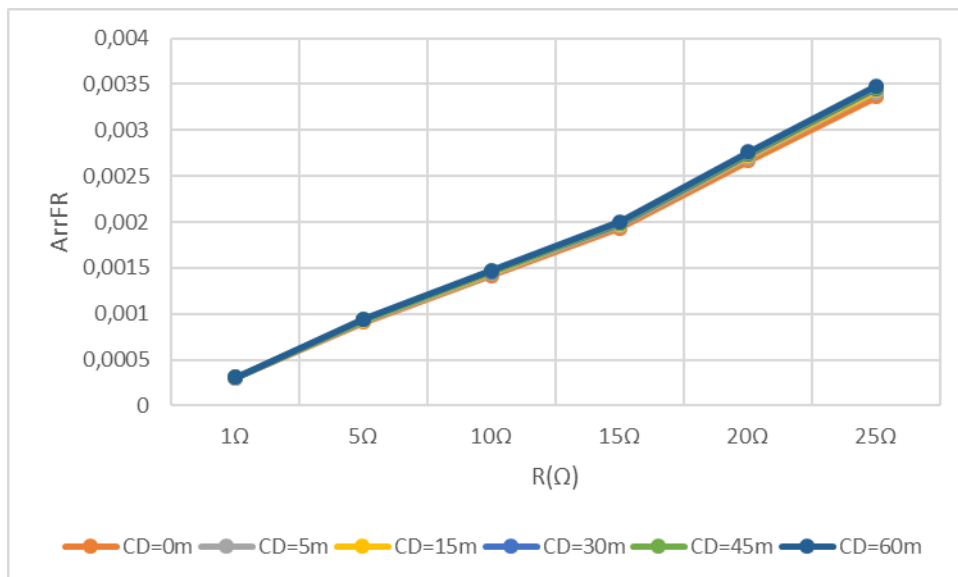

Figure 6.10: Failure Rate of the arrester installed at position Bin function with the Grounding Resistance and the distance between the arrester and the transformer ( $CD$ ) considering  $BD=300m$  (Case a)

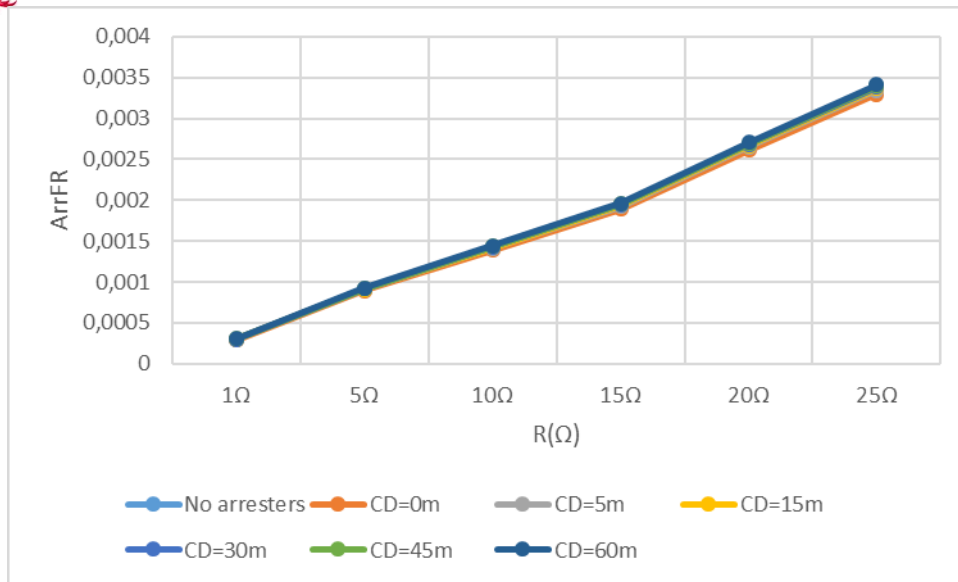

Figure 6.11: Failure Rate of the arrester installed at position Bin function with the Grounding Resistance and the distance between the arrester and the transformer (CD) considering BD=600m(Case a)

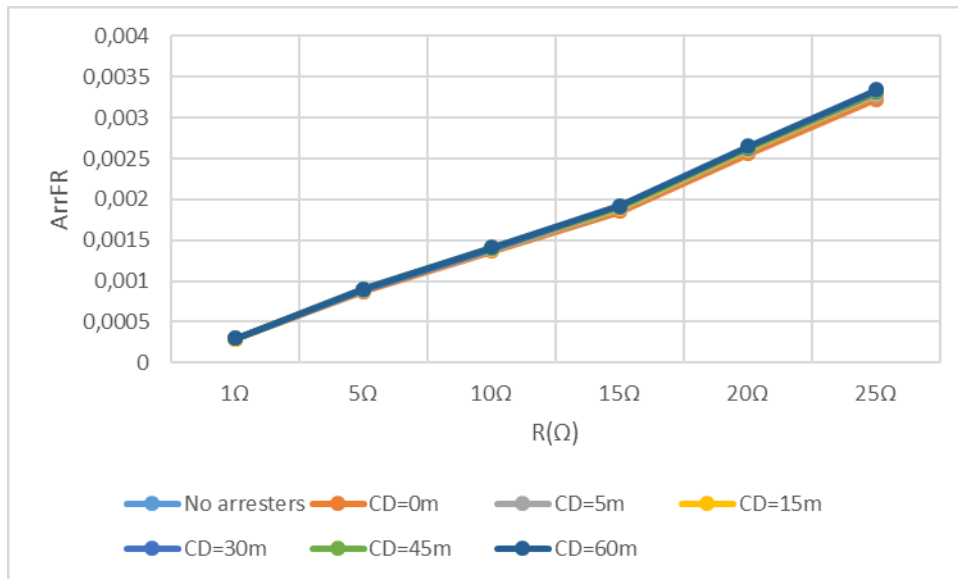

Figure 6.12: Failure Rate of the arrester installed at position Bin function with the Grounding Resistance and the distance between the arrester and the transformer (CD) considering BD=1000m (Case a)

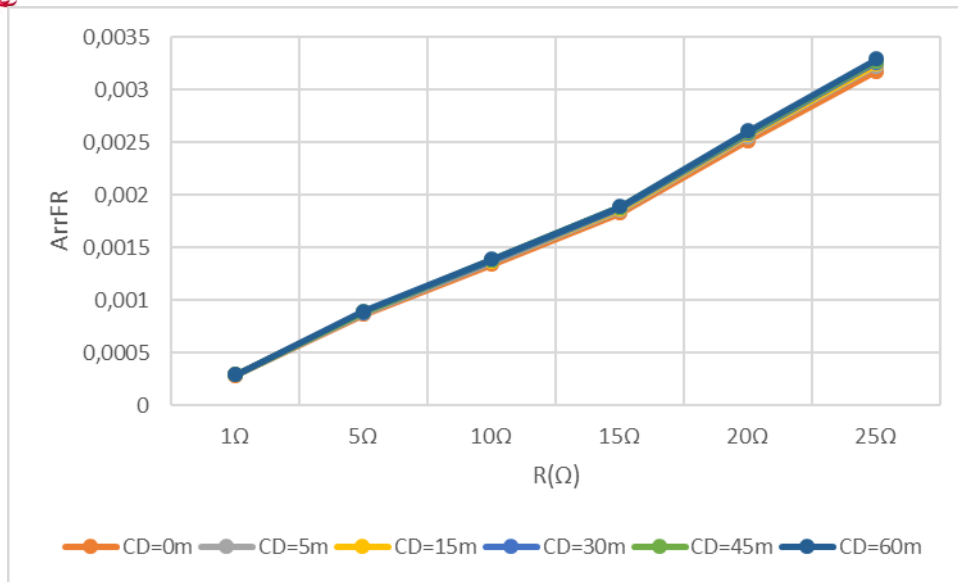

Figure 6.13: Failure Rate of the arrester installed at position Bin function with the Grounding Resistance and the distance between the arrester and the transformer (CD) considering  $BD=2000m$ (Case a)

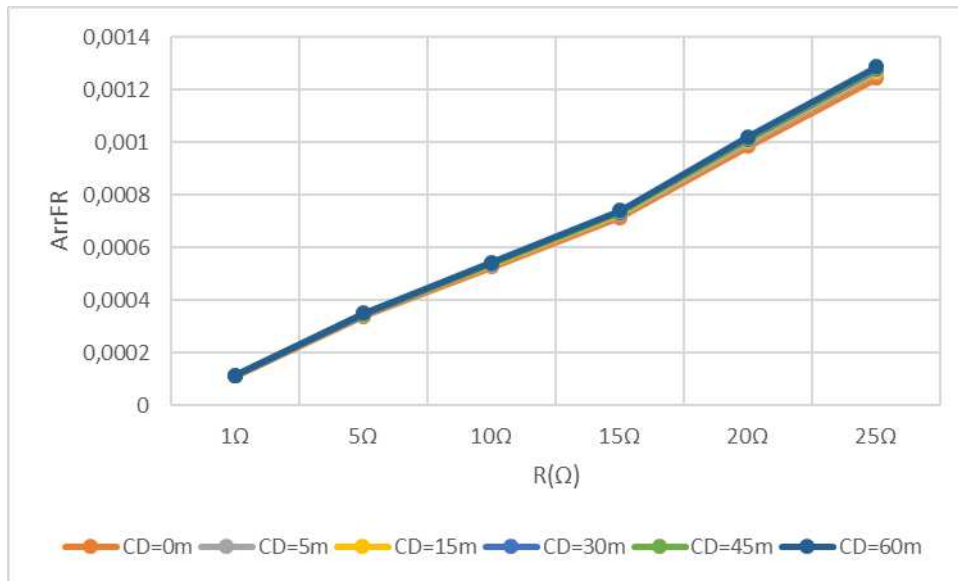

Figure 6.14: Failure Rate of the arrester installed at position Din function with the Grounding Resistance and the distance between the arrester and the transformer (CD) considering  $BD=300m$  (Case a)

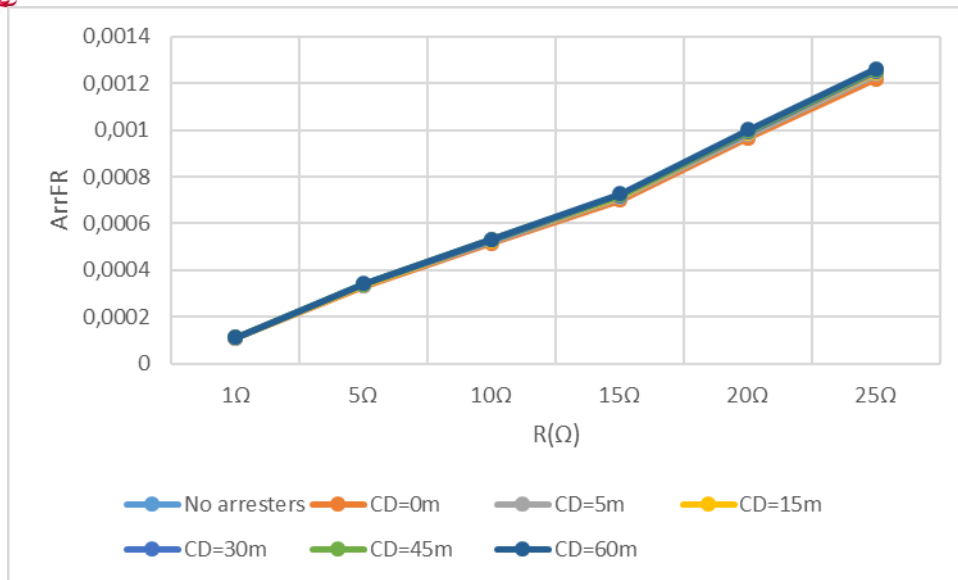

Figure 6.15: Failure Rate of the arrester installed at position  $D_{in}$  function with the Grounding Resistance and the distance between the arrester and the transformer (CD) considering  $BD=600m$ (Case a)

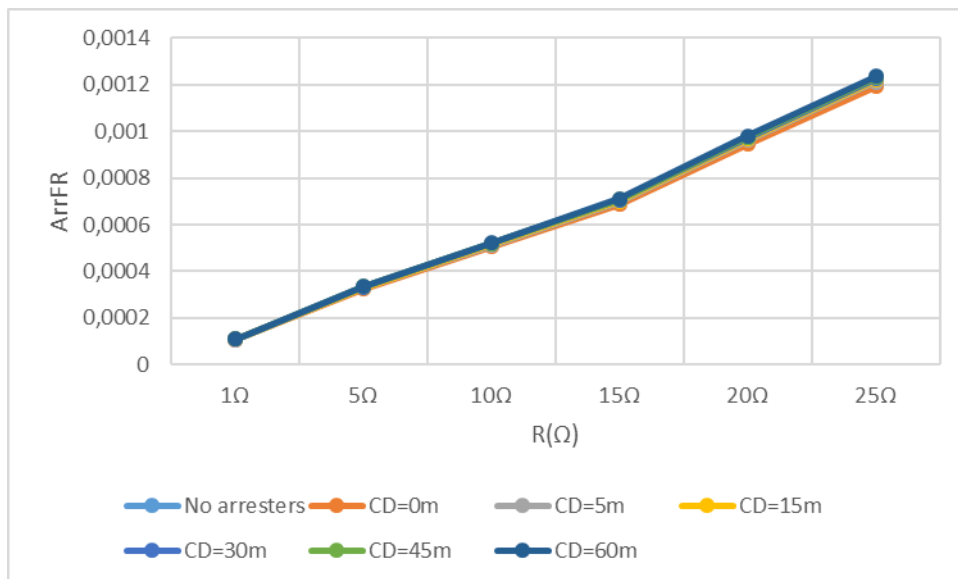

Figure 6.16: Failure Rate of the arrester installed at position  $D_{in}$  function with the Grounding Resistance and the distance between the arrester and the transformer (CD) considering  $BD=1000m$  (Case a)

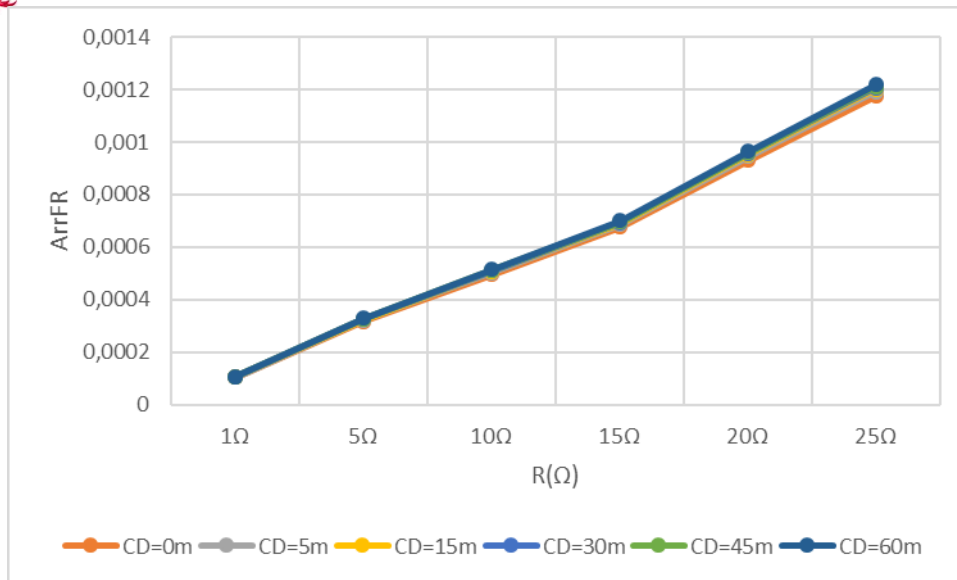

Figure 6.17: Failure Rate of the arrester installed at position *D* in function with the Grounding Resistance and the distance between the arrester and the transformer (CD) considering  $BD=2000m$  (Case a)

Figures 6.18 – 6.21 present the total substation outage rate including the arresters failure rate. Fig. 6.22 summarizes the obtained results for the case a of Fig. 4.1, comparing the substation outage rate including or not the arresters failure rate.

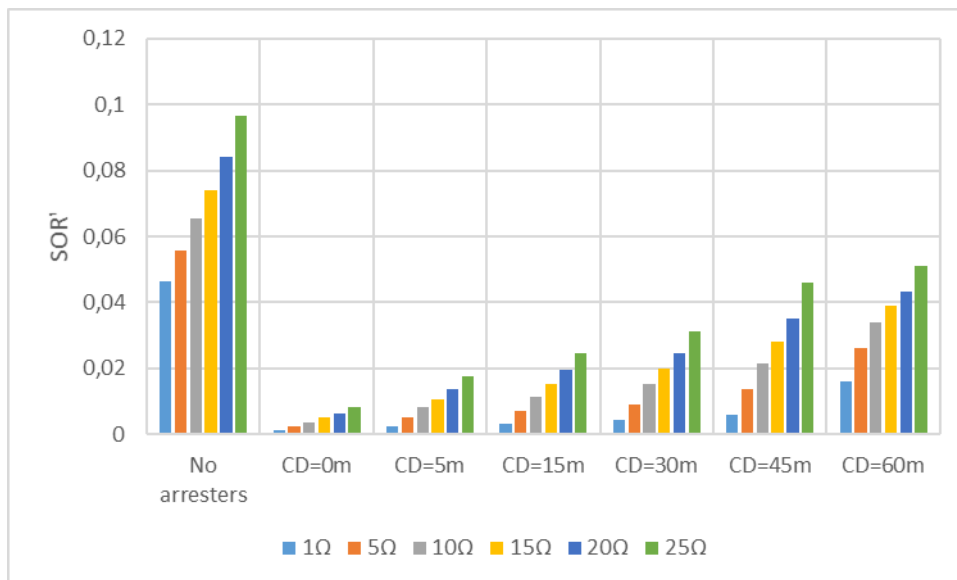

Figure6.18: Substation Outage Rate including Arresters Faults in function with the Grounding Resistance and the distance between the arrester and the transformer (CD) considering  $BD=300m$  (Case a)

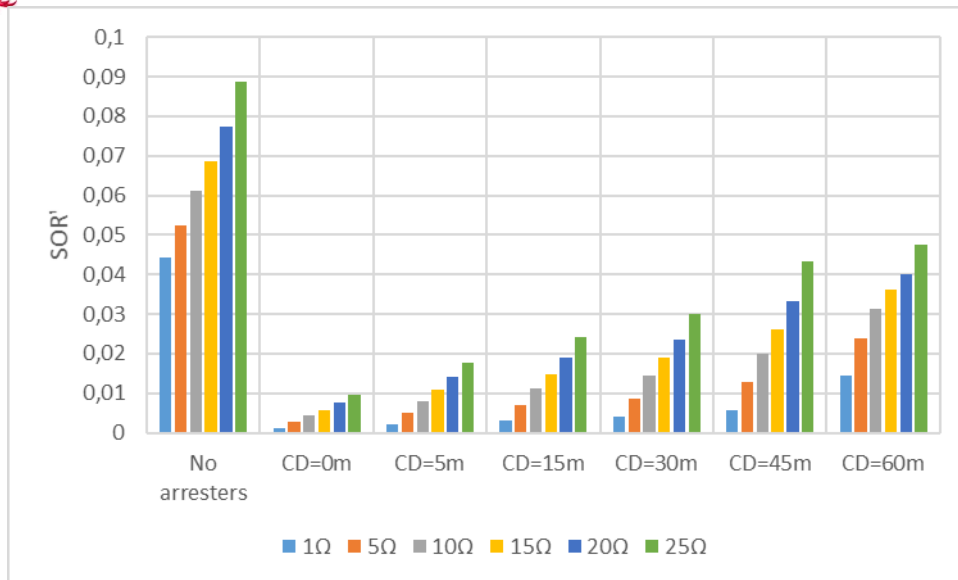

Figure6.19: Substation Outage Rate including Arresters Faults in function with the Grounding Resistance and the distance between the arrester and the transformer (CD) considering BD=600m (Case a)

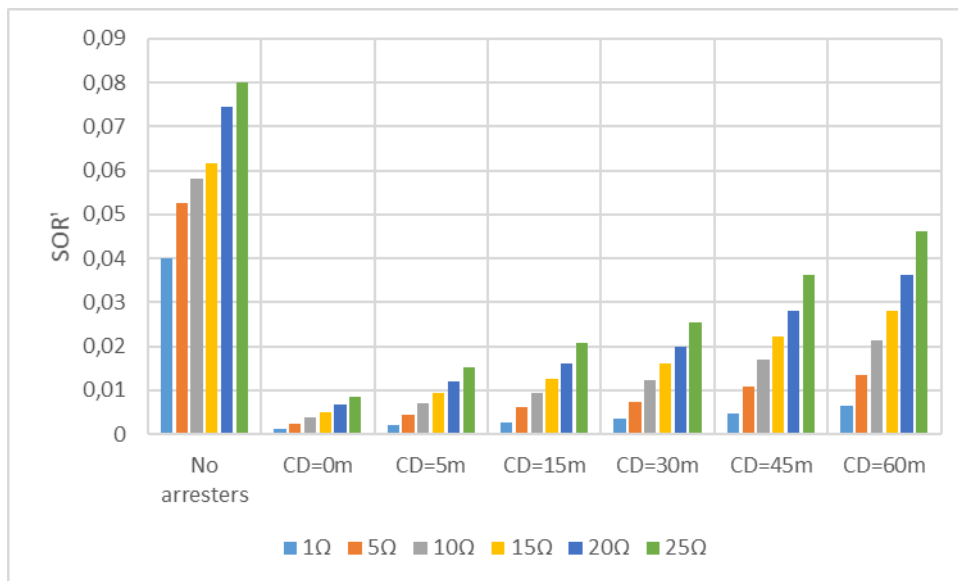

Figure6.20: Substation Outage Rate including Arresters Faults in function with the Grounding Resistance and the distance between the arrester and the transformer (CD) considering BD=1000m (Case a)



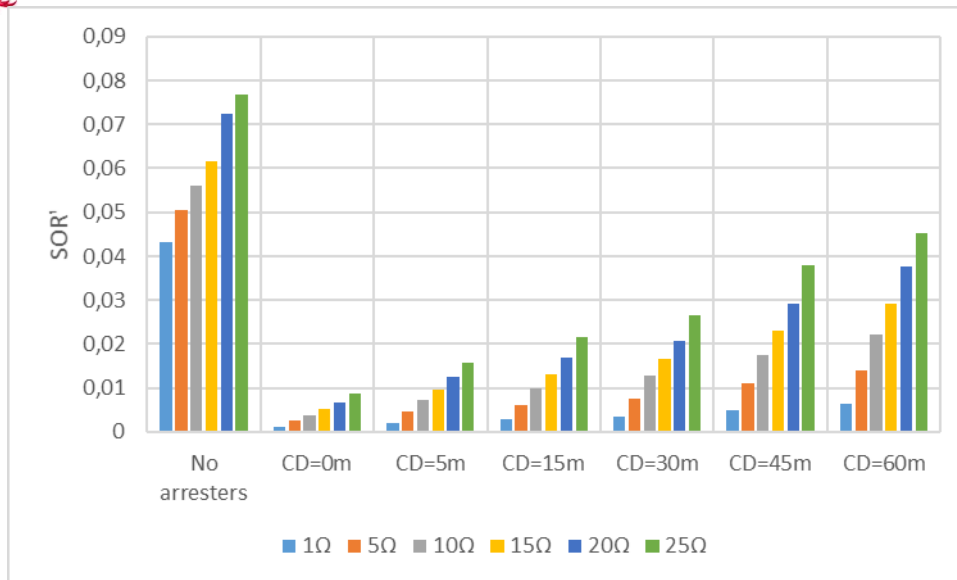

Figure6.21: Substation Outage Rate including Arresters Faults in function with the Grounding Resistance and the distance between the arrester and the transformer (CD) considering BD=2000m (Case a)

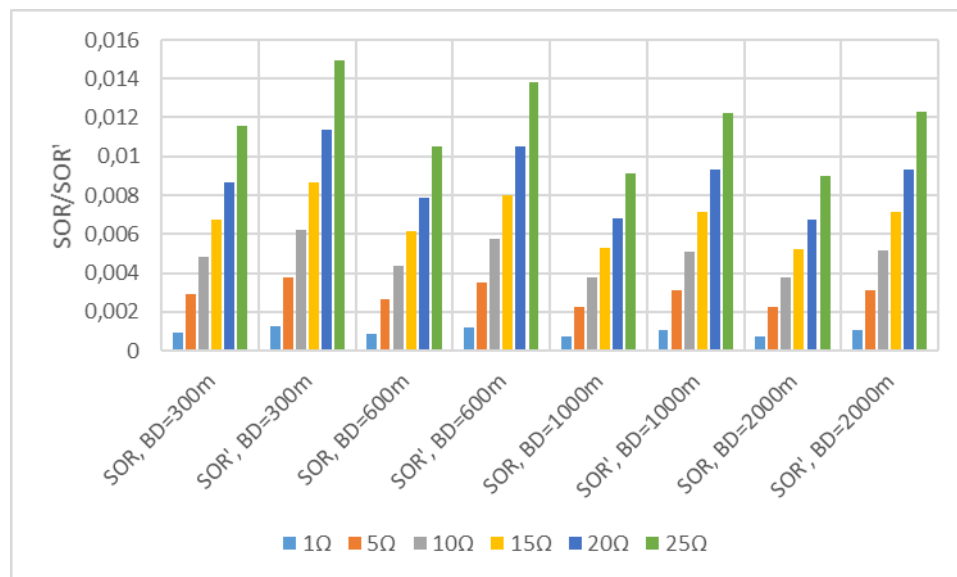

Figure6.22: Comparison Substation Outage Rate including and not including Arresters Faults in function with the Grounding Resistance and the distance and the length of the cable (BD) considering CD=0m (Case a)

The same procedure is performed considering case b of Fig. 4.1 (installation of arresters only at the entrance of the power transformer). The results indicate that the lightning performance of the substation is downgraded, due the absence of arresters at the joint between underground cable and the overhead transmission line. Figures 6.22 – 6.40 depict the simulation results for case b, indicating the necessity of installation of arresters at position B, in order to ensure the more efficient protection of the substation against lightning overvoltages.

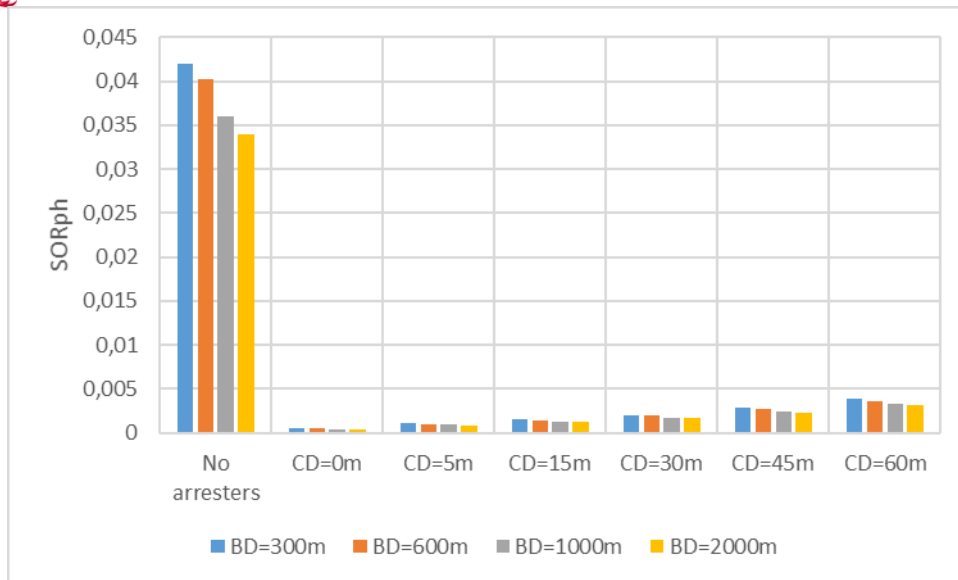

Figure 6.23: Substation Outage Rate in case of lightning hit on the phase conductor of the connected line in function with the length of the cable (BD) and the distance between the arrester and the transformer (CD) (case b)

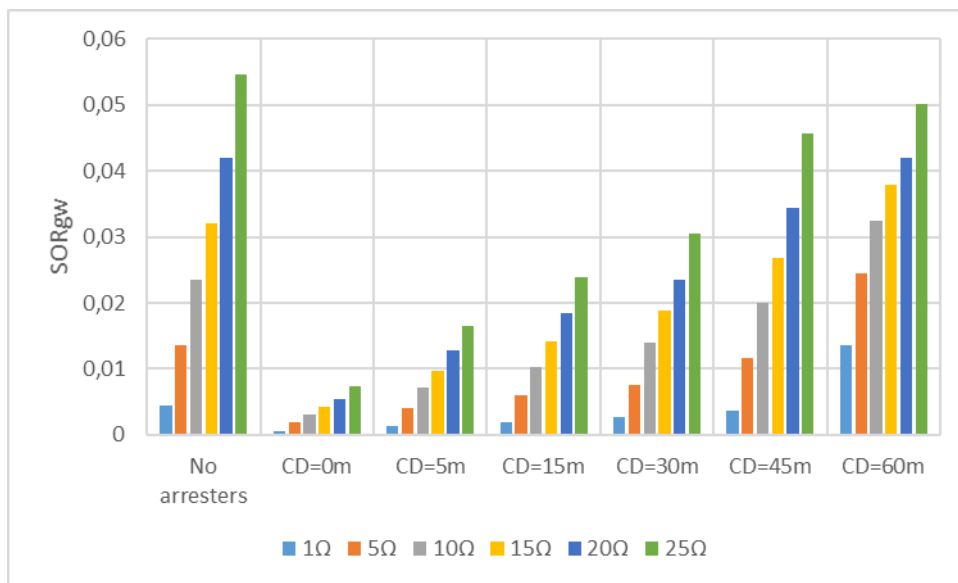

Figure 6.24: Substation Outage Rate in case of lightning hit on ground wire of the connected line in function with the grounding resistance (R) and the distance between the arrester and the transformer (CD) considering BD=300m (case b)

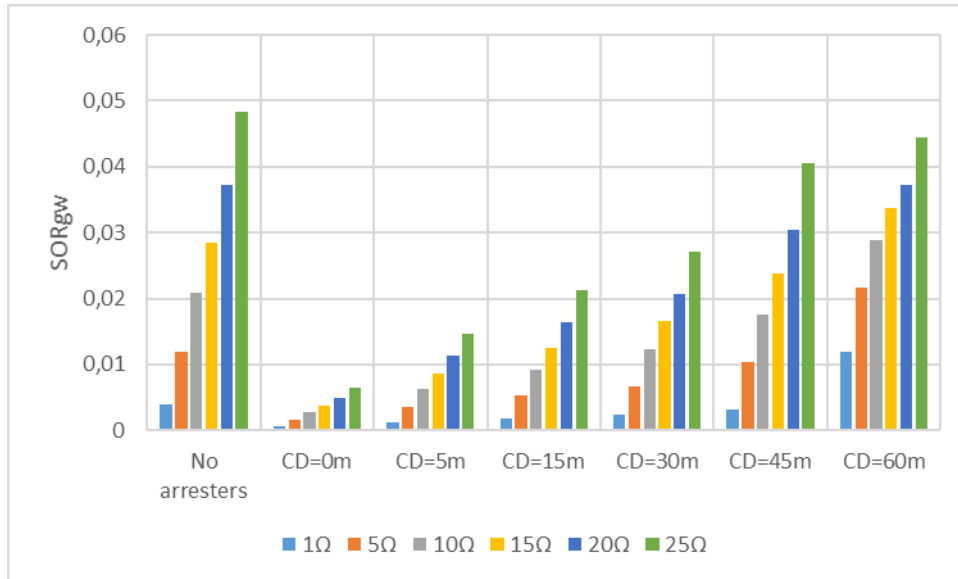

Figure 6.25: Substation Outage Rate in case of lightning hit on ground wire of the connected line in function with the grounding resistance (R) and the distance between the arrester and the transformer (CD) considering  $BD=600m$  (case b)

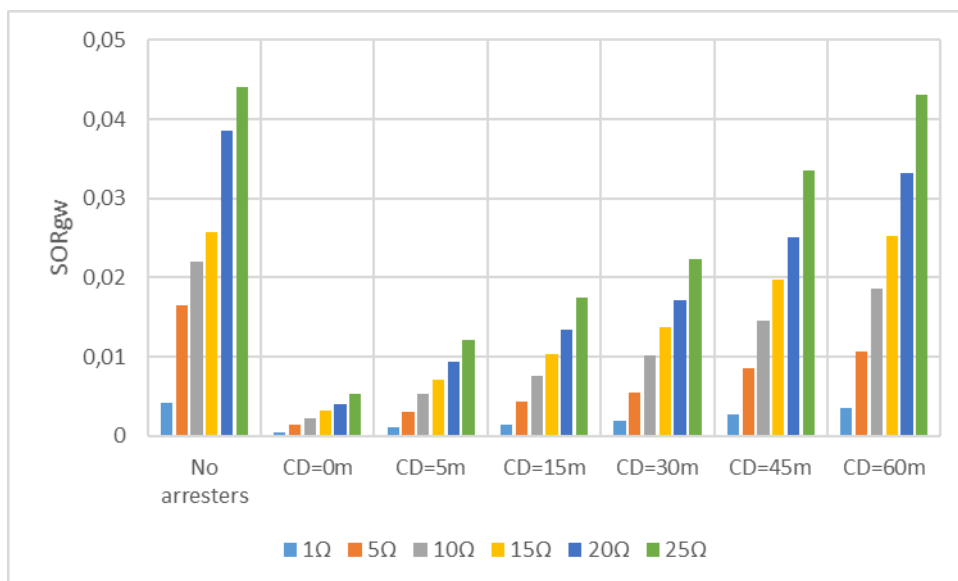

Figure 6.26: Substation Outage Rate in case of lightning hit on ground wire of the connected line in function with the grounding resistance (R) and the distance between the arrester and the transformer (CD) considering  $BD=1000m$  (case b)

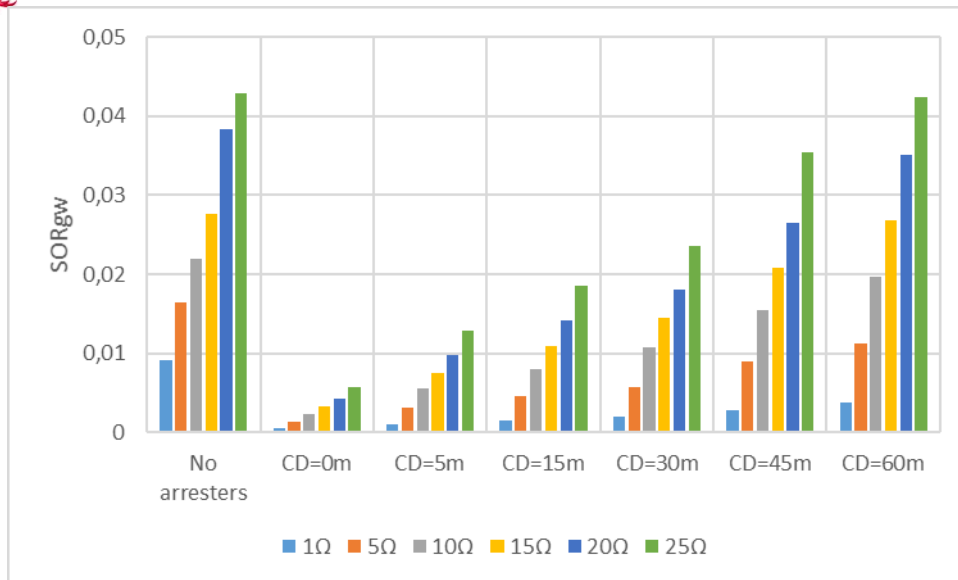

Figure 6.27: Substation Outage Rate in case of lightning bit on ground wire of the connected line in function with the grounding resistance (R) and the distance between the arrester and the transformer (CD) considering  $BD=2000m$  (case b)

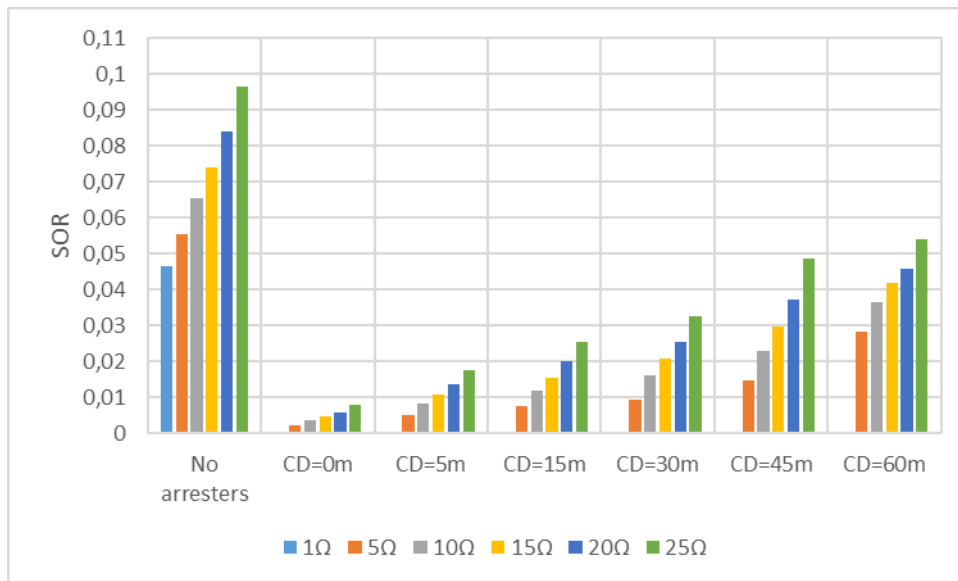

Figure 6.28: Substation Outage Rate in function with the grounding resistance (R) and the distance between the arrester and the transformer (CD) considering  $BD=300m$  (case b)

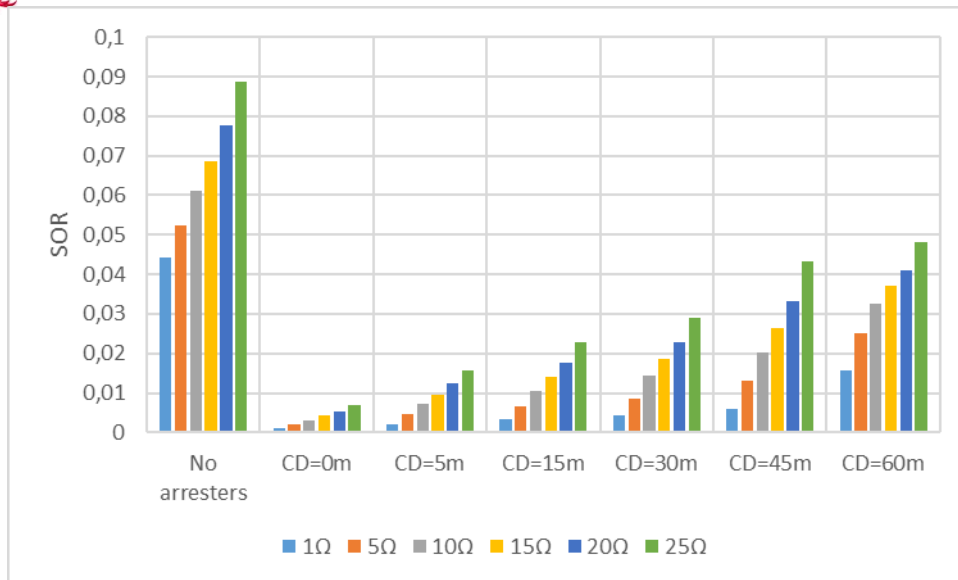

Figure 6.29: Substation Outage Rate in function with the grounding resistance (R) and the distance between the arrester and the transformer (CD) considering  $BD=600m$  (case b)

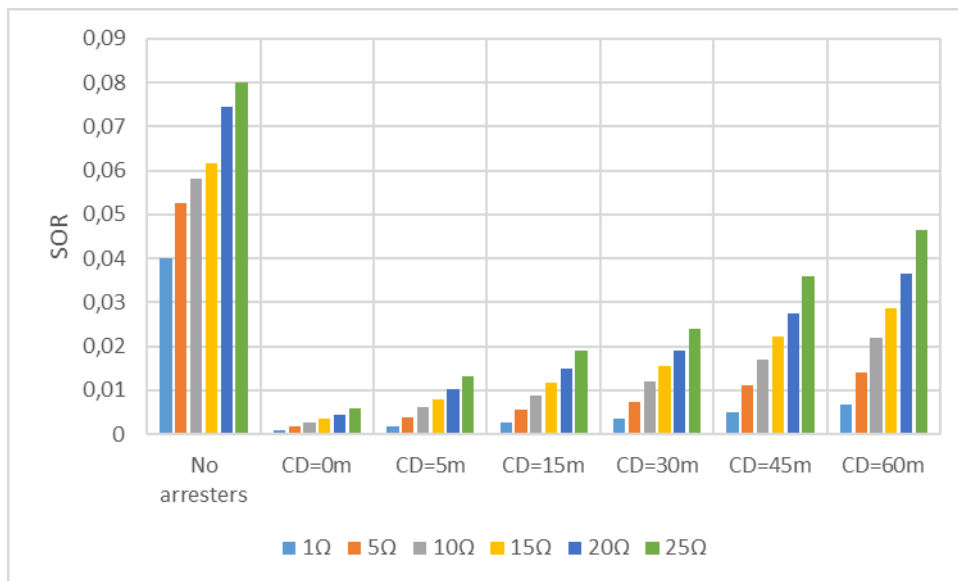

Figure 6.30: Substation Outage Rate in function with the grounding resistance (R) and the distance between the arrester and the transformer (CD) considering  $BD=1000m$  (case b)

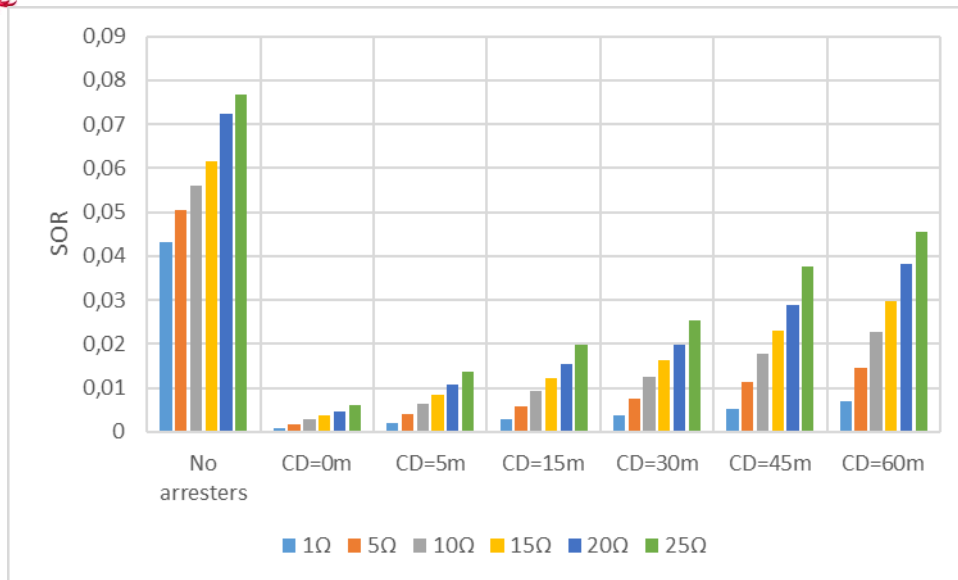

Figure 6.31: Substation Outage Rate in function with the grounding resistance (R) and the distance between the arrester and the transformer (CD) considering  $BD=2000m$  (case b)

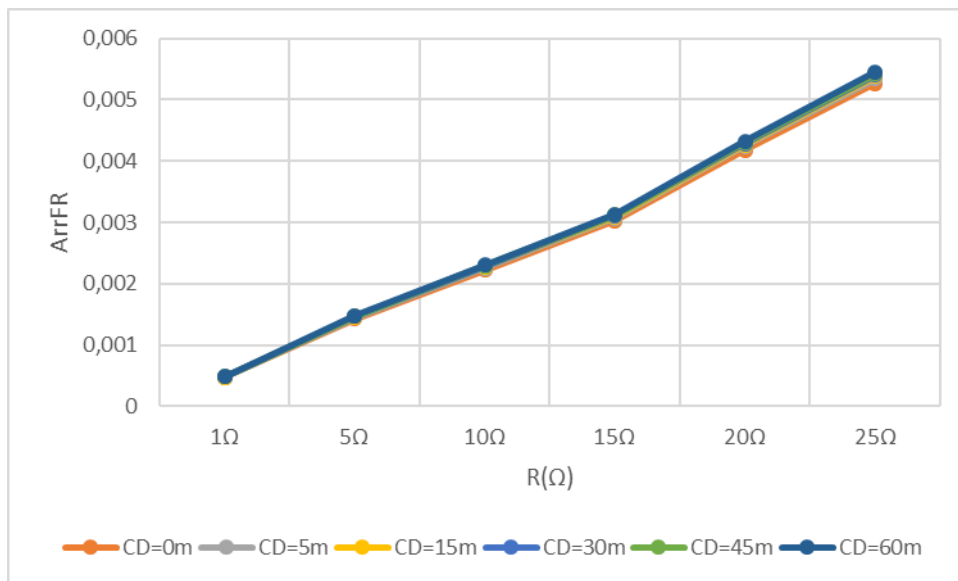

Figure 6.32: Failure Rate of the arrester installed at position  $D_{in}$  in function with the Grounding Resistance and the distance between the arrester and the transformer (CD) considering  $BD=300m$  (case b)

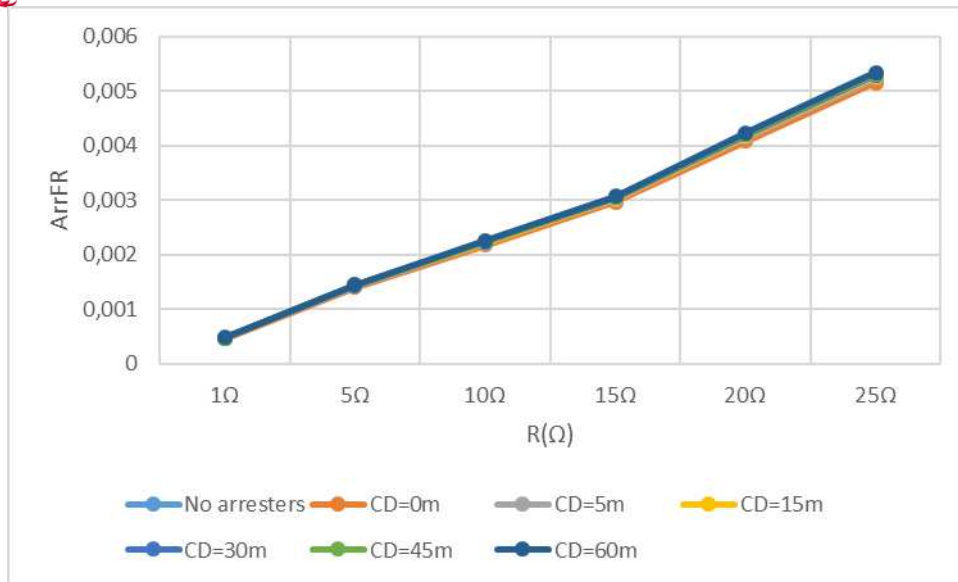

Figure 6.33: Failure Rate of the arrester installed at position  $D_{in}$  function with the Grounding Resistance and the distance between the arrester and the transformer (CD) considering  $BD=600m$  (case b)

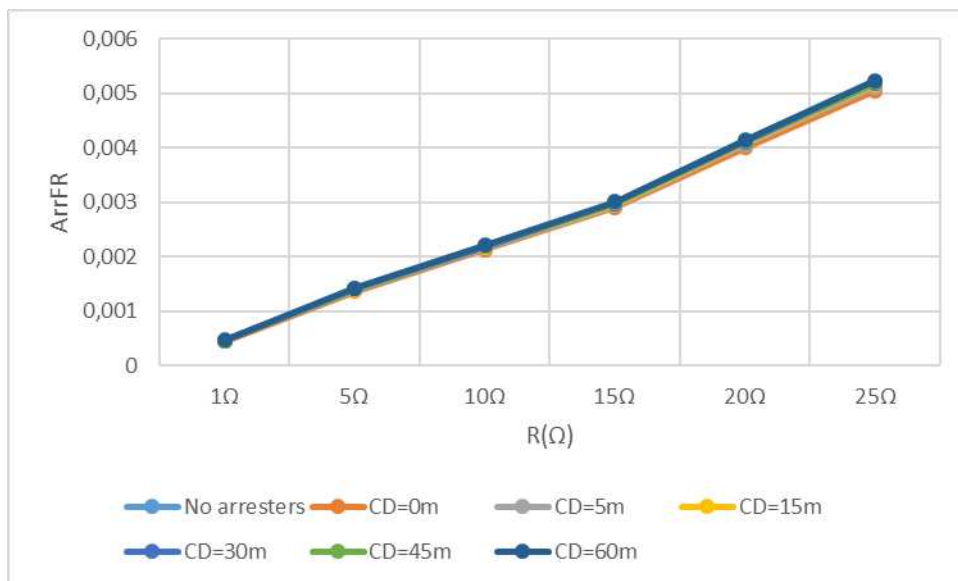

Figure 6.34: Failure Rate of the arrester installed at position  $D_{in}$  function with the Grounding Resistance and the distance between the arrester and the transformer (CD) considering  $BD=1000m$  (case b)

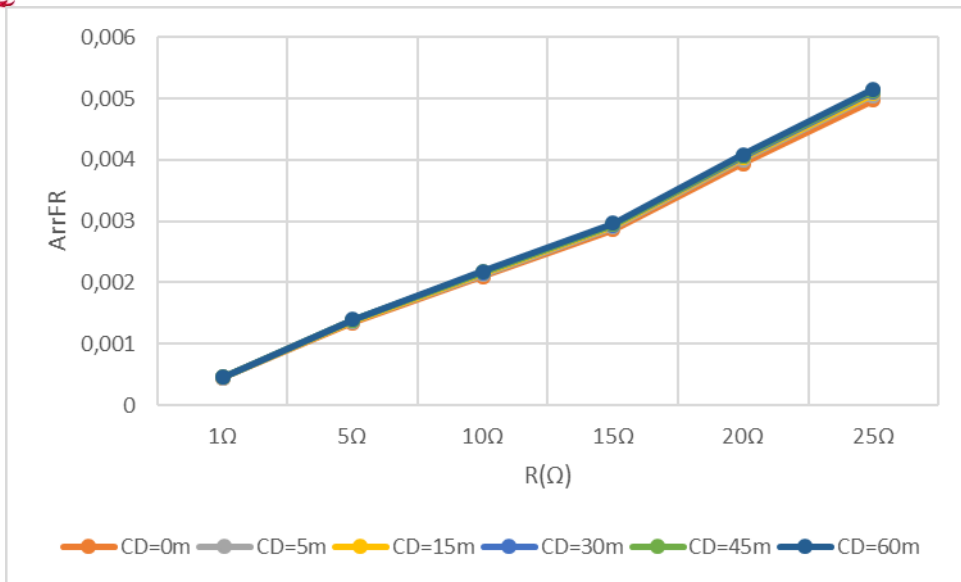

Figure 6.35: Failure Rate of the arrester installed at position  $D_{in}$  in function with the Grounding Resistance and the distance between the arrester and the transformer (CD) considering  $BD=2000m$  (case b)

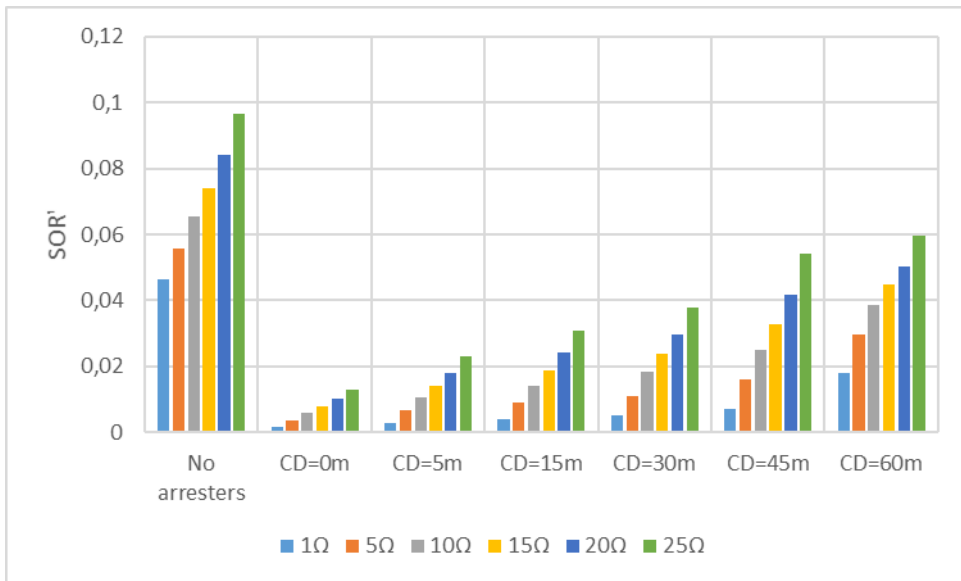

Figure 6.36: Substation Outage Rate including Arrester Faults in function with the Grounding Resistance and the distance between the arrester and the transformer (CD) considering  $BD=300m$  (case b)



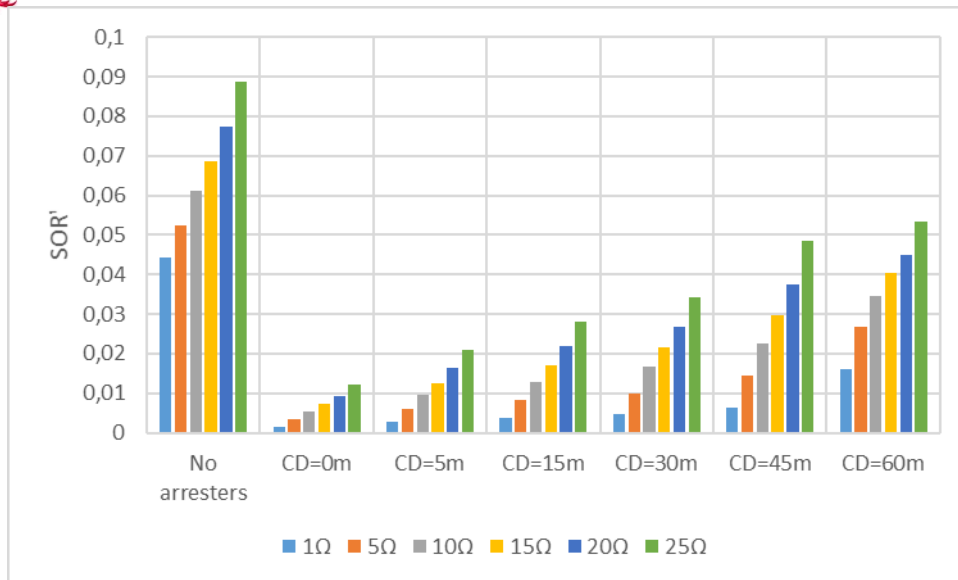

Figure6.37: Substation Outage Rate including Arresters Faults in function with the Grounding Resistance and the distance between the arrester and the transformer (CD) considering BD=600m (case b)

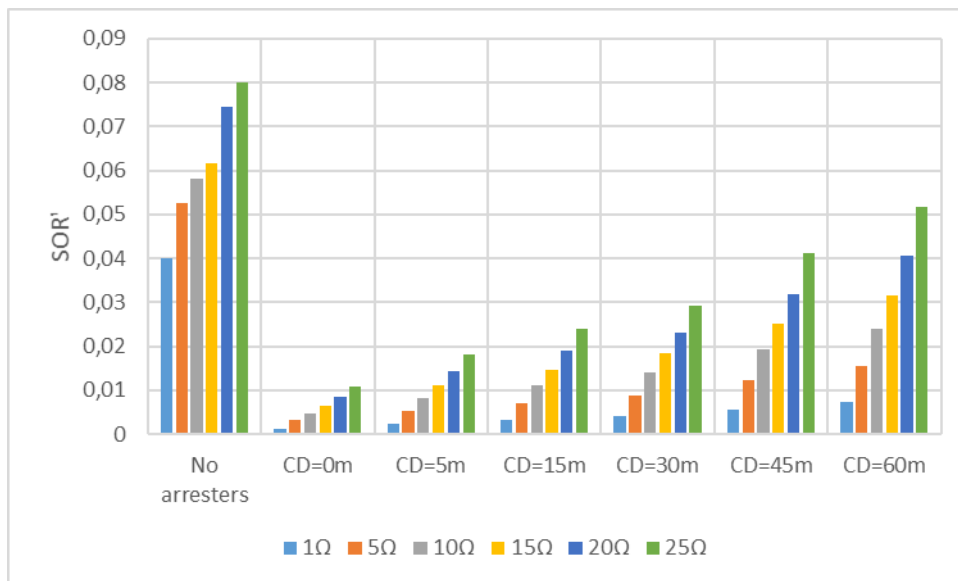

Figure6.38: Substation Outage Rate including Arresters Faults in function with the Grounding Resistance and the distance between the arrester and the transformer (CD) considering BD=1000m (case b)

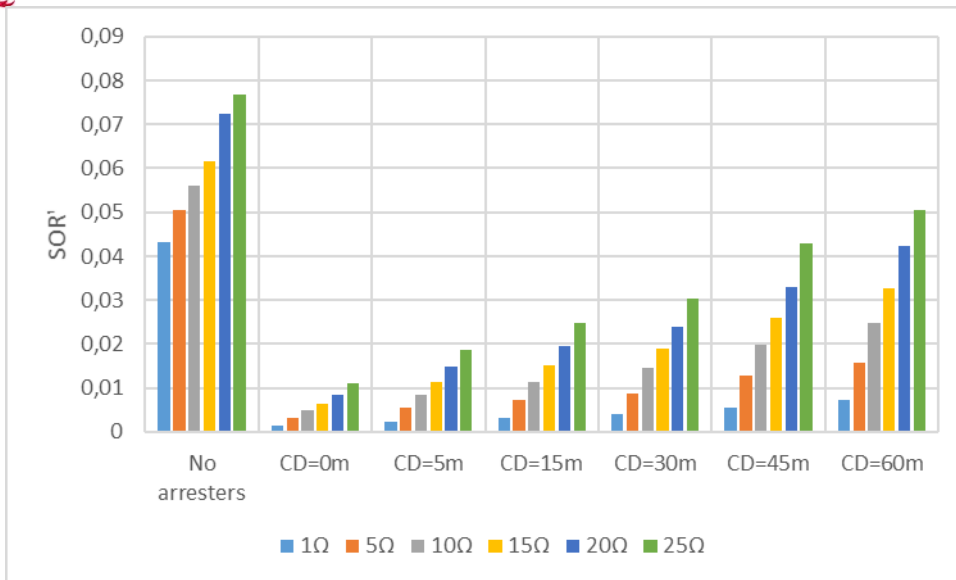

Figure6.39: Substation Outage Rate including Arresters Faults in function with the Grounding Resistance and the distance between the arresster and the transformer (CD) considering BD=2000m (case b)

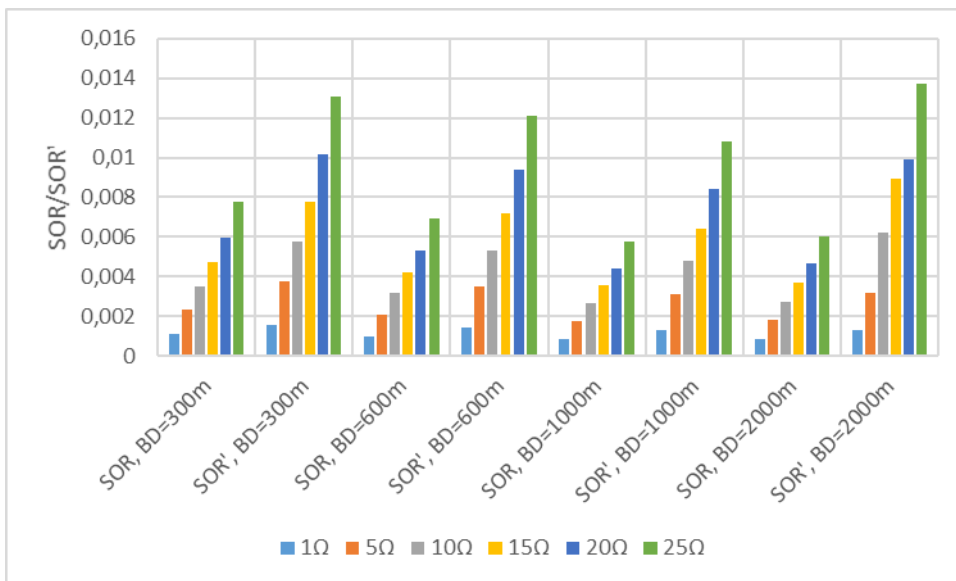

Figure6.40: Comparison Substation Outage Rate including and not including Arresters Faults in function with the Grounding Resistance and the distance and the length of the cable (BD) considering CD=0m (case b)



## 6.7 Conclusions

Lightning risk assessment of a HV/MV substation connected to the transmission system through underground cables has been performed by considering both shielding failure and backflashover surges incoming from the connected overhead lines. The obtained results by the simulation procedures clearly indicate the improvement of the lightning performance of the substation under study, after the installation of metal oxide gapless surge arresters, highlighting, simultaneously, the dominant role of the grounding resistance, the length of the cable and the installation position of the arresters. Low values of grounding resistance are definitely contribute to the improvement of the lightning performance of the substation, but the construction of adequate grounding systems is not always an attainable goal, due to technical restrictions. The installation of the arresters near the transformer to be protected and the use of long MV underground cables reduce the expected failures, even if the achieved grounding resistance values are high. In any case, the design of the lightning protection system and the demanded specification of the characteristics of the protection equipment have to obey to technoeconomical criteria. Furthermore, the current work includes the arresters failure rate to the total outage rate of the substation, denoting the fact that surge arresters are vulnerable to damages, if high current pass through them, especially in case of low grounding resistance values; low values of the grounding resistance contribute to the restrain of the developed overvoltages and to the reduction of the outage rate, but increase the failure probability of the installed arresters.

Innovation of the performed study consists the inclusion of the arresters failure rate to the total substation failure rate, since arresters are part of the equipment of the substation and their damage consequences repair or replacement costs and malfunction of the system.. Similar studies by other researchers do not examine the arresters behavior and do not regard the arresters failure as a line/substation outage. Novelty of the Thesis is that highlights the arresters failure rate, revealing how important is to avoid arresters damage; in that case, arresters will not be operational and will not protect the substations, downgrading the future lightning performance of the substation.. Note, that the appropriate selection of the electrical characteristics and the installation position of the arresters is the first step for the reduction of the expected lightning failures. A damaged arrester is not effective anymore and does not protect the line or the substation; in addition, the replacement costs have to be taken into consideration. For these reasons, arresters faults have to be included in the total substation failure rate.



## References

- Anderson G.J., *Transmission Line Reference Book – 345 kV and above, 2nd ed. Palo Alto, CA: Electric Power Research Institute, 1982, ch. 12.*
- C.A. Christodoulou, L. Ekonomou, G.P. Fotis, I.F. Gonos, I.A. Stathopoulos, “Assessment of surge arrester failure rate and application studies in Hellenic high voltage transmission lines”, *Electric Power Systems Research, Vol. 80, Issue 2, pp. 176-183, February 2010.*
- CIGRE Working Group 33.01, “Guide to procedures for estimating the lightning performance of transmission lines,” *Technical Bulletin 63, Oct. 1991.*
- Hileman A. R., “The incoming surge and open breaker protection,” in *Insulation Coordination for Power Systems. Boca Raton, FL: CRC Press, Taylor & Francis Group, New York, 1999.*
- IEC 60071-2, *Insulation Coordination, 1996.*
- IEEE Task Force, “Modeling guidelines for fast front transients,” *IEEE Trans. Power Delivery, vol. 11, no. 1, pp. 493–506, Jan. 1996.*
- Mikropoulos P. N. and Tsovilis T. E., “Estimation of lightning incidence to overhead transmission lines,” *IEEE Trans. Power Delivery, in press.*
- Mikropoulos P. N. and Tsovilis T. E., “Lightning attachment models and maximum shielding failure current of overhead transmission lines: Implications in insulation coordination of substations,” *IET Gener. Transm. Distrib., submitted.*
- Mikropoulos P. N. and Tsovilis T. E., “Shielding performance of typical overhead transmission lines,” *IEEE Trans. Power Delivery, submitted.*
- Mikropoulos P. N., Tsovilis T. E., and Zlitidis D. E., “Software development for the evaluation of the lightning performance of overhead transmission lines,” in *Proc. 45th UPEC, Cardiff, Wales, UK, 2010, accepted.*



## CHAPTER 7

# SPECIAL ISSUES OF LIGHTNING PROTECTION OF SUBSTATIONS

### 7.1 Introduction

This chapter deals with special issues of the lightning protection of HV/MV substations, i.e. the arising induced overvoltages and the connection of surge arresters in parallel. The magnetic field (due to the lightning discharge current) around the flash channel and the masts or the overhead ground wires results in the development of induced overvoltages in the formed wiring loops of the installation; these induction loops can include only active wires or both live and protective conductors. The magnitude of the developed surges depends on the lightning characteristics, the geometrical characteristics of the system and the position of the stroke hit.

In details, the steepness of the lightning current determines the level of the induced overvoltage, since the induced voltages are proportional to the self-inductance of the loop multiplied by the steepness of the lightning current. Induced overvoltages increase also with dimensions of the formed loops and decrease with attenuation of the magnetic field strength. As far as the hit position concerns, the severity of the overvoltage is inversely proportional to the distance of the point of impact. To this direction, a sensitivity analysis is performed, in order to examine the way that various factors (peak current and steepness of the lightning current, lightning hit position) affect the expected induced voltages. As far as the parallel combination of the installed surge arresters is concerned, the decisive role of the voltage – current characteristics of the non-linear resistors is demonstrated, in order to achieve the equal sharing of the discharged impulse current and to reduce the arresters failure probability.

### 7.2 Induced Overvoltages

#### *7.2.1 Literature review*

The international literature deals mainly with the induced overvoltages on transmission and distribution lines. The developed induced voltages have not been widely examine, since it is regarded that cannot cause any damage to the substation equipment. Despite the fact that the



induced overvoltages are expected to be low, they can influence already stressed insulation and affect the electronic equipment of the substation. Various researchers have examined the developed induced overvoltages in electrical networks, focusing mainly on the transmission and distribution lines, since the field experience concerning HV/MV substations is limited. The literature provides several methodologies and equivalent models for the evaluation of the induced voltages, considering different systems configuration. An equivalent circuit for the analysis of the lightning-induced voltage at a transition point is introduced in (Sekioka 2005). The reliability of the proposed model is confirmed by comparing the calculated results of the proposed equivalent circuit with results obtained by the application of the finite difference method. A methodology for stochastic analysis of transient overvoltages caused by lightning and switching in substations, is presented in (Kraulich L. et al. 2015), based on the ATP simulation tool and the Monte Carlo Method for representing the randomness of these types of events. In (Costea and Nicoara 2010) is analyzed how a lightning overvoltage occurred in a superior voltage level (high or medium) could be transmitted to the inferior voltage network, considering the influence of various factors. The study was performed on a real configuration of network subjected of different shape and amplitude of lightning overvoltages. In (Ren et al. 2008), the lightning-generated electromagnetic fields over lossy ground produced by lightning strikes either to flat ground or to a tall tower are estimated, applying the 2-D finite difference time-domain method. The performed analysis reveals the dependence of the induced voltages on ground conductivity somewhat influenced by return-stroke speed, and essentially independent of return-stroke model. Furthermore, the induced overvoltages that may appear on the SF<sub>6</sub> substation enclosure during transient phenomena is examined in (Vukasović et al. 2010), highlighting the role of the peak current and the waveform of the injected lightning surge, the dielectric strength of the SF<sub>6</sub> gas and the geometry of the substation and its grounding. In addition, lightning surges may also cause dangerous electromagnetic interference problems to low voltage systems and especially to electronic devices [Psalidas M. et al. 2004. Meliopoulos et al. 2001)].

Despite that the indirect hits result in the development of induced voltage surges with small amplitude, comparing with those ones developed due to direct strikes, they influence the nominal operation of electrical installations. Especially, in case of medium voltage level, indirect strokes constitute main source of lightning faults (Viscaro 2005, Viscaro 2007, Sabiha 2009). For this reason the induced overvoltages developed at various positions of a substation have to be studied, in order to prevent faults and damages due to nearby lightning hits.

The calculation of the induced-voltage flashover rate due to indirect lightning strokes, demands data of the keraunik level of the region and the application of appropriate lightning



attachment models, in order to estimate the interception radius of the conductors of the overhead lines. An electrogeometrical model can be used for the estimation of the interception radius (Mikropoulos and Tsovilis 2011, IEEE Std 1410-2004). However, the interception radius can be also regarded as a statistical quantity, affected by the peak value of the current, the geometrical characteristics of the line and the lightning interception probability (Mikropoulos and Tsovilis 2008, Mikropoulos and Tsovilis 2009, Mikropoulos and Tsovilis 2010).

The magnetic field around the flash channel of the lightning current may induce significant overvoltages on overhead power lines situated in the vicinity. The return stroke phase of the lightning discharge is considered to be the major responsible for the arising induced voltage surges, since the intensity of the electromagnetic radiation during this phase is greater in comparison to other phases of the phenomenon (Uman and McLain 1969). The estimation of the induced overvoltages requires the following steps (Lambert et al. 2009, Nucci and Rachidi 1999):

- a) Adoption of a return-stroke model: an appropriate return-stroke model that determines the spatial and temporal distribution of the lightning current during the return-stroke phase is selected. A certain number of return stroke models have been proposed in the literature (Thottappillil and Uman 1993, Nucci 1995, Rakov and Uman 1998, Nucci et al. 1988, Rakov and Dulzon 1991).
- b) Calculation of the electromagnetic field radiated by the lightning return-stroke current: for distances less than few kilometers, the perfect ground conductivity assumption seems to be an adequate approach for the vertical component of the electric field and for the horizontal component of the magnetic field (Zeddani and Degauque 1990, Rubinstein 1996). Simplified equations are presented in (Rubinstein 1996, Cooray 1994, Wait 1997, Rachidi et al. 1996).
- c) Evaluation of the induced overvoltages: overvoltages developed due to the interaction between the electromagnetic field and the conductors of the electrical installation are estimated by coupling models. The most used coupling models are those proposed by Rusck (Rusck 1958), by Chowdhuri and Gross (Chowdhuri and Gross 1967), and by Agrawal et al. (Agrawal et al. 1980).

The magnitude of the expected induced overvoltages depends on various parameters, such as the distance between the lightning hit position and the developed voltage at a given point of the system, the characteristics of the lightning current and the grounding resistance. The steepness



of the lightning current determines the level of the induced overvoltage, since the induced voltages are proportional to the self-inductance of the loop multiplied by the steepness of the lightning current. Induced overvoltages increase also with dimensions of the loop and decrease with attenuation of the magnetic field strength. As far as the hit position concerns, the severity of the overvoltage is inversely proportional to the distance of the point of impact.

In details, the first step includes the calculation of the electromagnetic field radiated by the lightning current. The lightning channel is assumed to be a vertical antenna with a current flowing from the channel base to the cloud at a constant speed chosen equal to 1.108 m/s.

The variation of the current amplitude is supposed to be given by the following double-exponential function (Lambert et al. 2009, Uman & McLain 1969):

$$i(0, t) = I_0 \cdot (e^{-\frac{t}{\tau_1}} - e^{-\frac{t}{\tau_2}}) \quad (7.1)$$

The current is given by the equation:

$$i(z, t) = i\left(0, t - \frac{z}{v}\right) \text{ for } z \leq v \cdot t \quad (7.2)$$

$$i(z, t) = 0 \text{ for } z \geq v \cdot t \quad (7.3)$$

Where;

$z$  is the height of the considered point in the channel

$v$  is the velocity of the current waveform.

The vertical and horizontal components of the electric field radiated by the current channel are then calculated by considering the channel as a set of vertical elementary dipoles and by integrating over the channel height the contribution of each dipole and image. Those two calculated field components are required as input source terms for the adopted field -to-overhead line coupling model used for evaluating the induced voltages.

For the computation of the induced voltages, the Agrawal field-to-transmission line model is implemented (Agrawal et al. 1980).



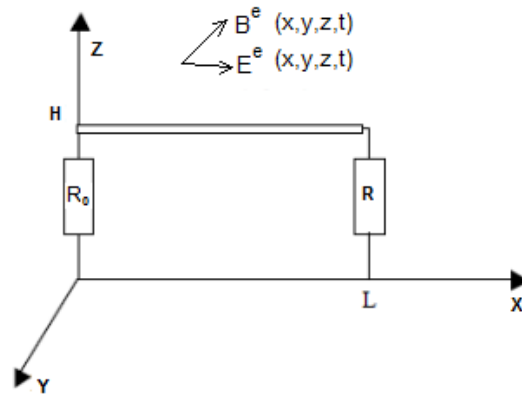

Figure 7.1 Geometry for the Calculation of Overvoltages Induced on an Overhead Power Line by an Indirect Lightning Return Stroke (Mimouni et al. 2007).

The coupling equations for a single wire horizontal line at height  $H$  above the ground (Figure 7.1) are given as:

$$\frac{\partial u^s(x,t)}{\partial x} + R \cdot i(x,t) + L \cdot \frac{\partial i(x,t)}{\partial t} = E_x^e(x,H,t) \quad (7.4)$$

$$\frac{\partial i(x,t)}{\partial x} + G \cdot u^s(x,t) + C \cdot \frac{\partial u^s(x,t)}{\partial t} = 0 \quad (7.5)$$

Where;

$R$  is the line resistance per unit length

$L$  is the line inductance per unit length

$G$  is the line conductance per unit length

$C$  is the line capacitance per unit length

$E_x^e(x,H,t)$  is the horizontal component of the exciting electric field along the x-axis at the conductor's height  $H$ ,

$u^s(x,t)$  is the so-called scattered voltage, defined by:

$$u^s(x,t) = - \int_0^H E_z^s(x,z,t) dz \quad (7.6)$$

Where;

$E_z^s(x,H,t)$  is the vertical component of the scattered electric field.



The exciting electric field is the sum of the incident field radiated by the lightning stroke and of its ground reflected field, both considered in absence of overhead wire. The scattered electric field represents the reaction of the overhead wire to the exciting field. The boundary conditions for the scattered voltage are:

$$u^s(0, t) = -R_o \cdot i(0, t) - u^e(0, t) \quad (7.7)$$

$$u^s(L, t) = -R_L \cdot i(L, t) - u^e(L, t) \quad (7.8)$$

Where;

$u^e(0, t)$  and  $u^e(L, t)$  are the voltage sources at the two extremities of the line, obtained from the exciting voltage  $u^e(x, t)$  given by:

$$u^e(x, t) = \int_0^h E_z^e(x, z, t) dz \quad (7.9)$$

The solution of equation (5.12) and (5.13) gives the scattered voltage  $u^s(x, t)$  at a given point along the line, from which one can obtain the total voltage according to:

$$u(x, t) = u^s(x, t) - u^e(x, t) \quad (7.10)$$

Figure 7.2 depicts the waveforms of the induced overvoltage at a given position of an electrical system as a function of the distance of the lightning hit point, presented in (Nucci and Rachidi 2009).

.

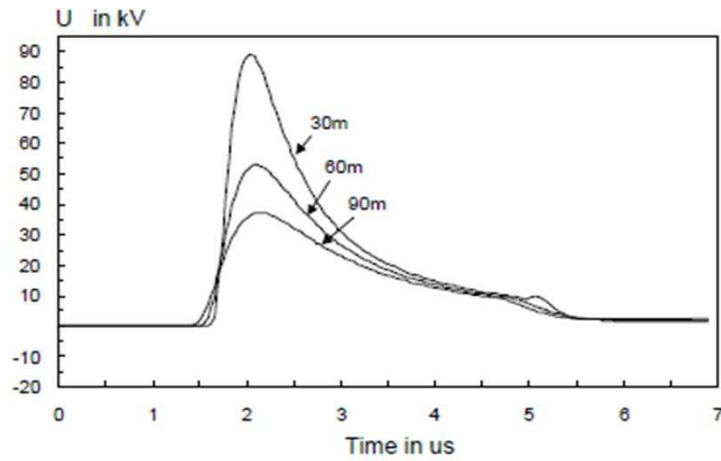

Figure 7.2 Induced Overvoltage for Various Distances between the Measurement Point and the Lightning Hit Position (Nucci and Rachidi 2009)

The line height and the ground conductivity influence substantially the number of induced voltages greater than a given BIL (Borghetti and Nucci 1998). In Figure 7.3, the dependence of the number of events as a function of the BIL for a 2-km long line is presented, taking into account different values for the ground conductivity (Nucci and Rachidi 2009).

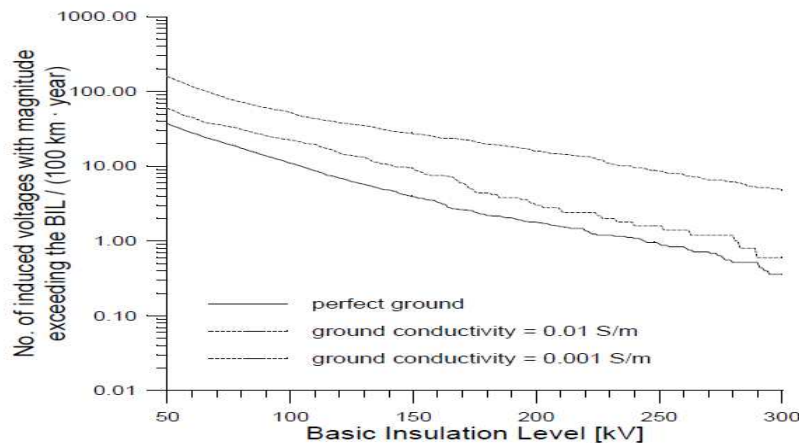

Figure 7.3 Number of Induced Voltages with Magnitude exceeding the BIL in function with the BIL for a MV line (Nucci and Rachidi 1999, Borghetti and Nucci 1998)

### 7.2.2 The LIOV code

Based on the presented theoretical analysis, an appropriate simulation tool has been developed (Nucci and Rachidi 2003) for the calculation of the induced overvoltages, which can be combined with other tools. The LIOV (Lightning-Induced Over Voltage) code, is a computer code which allows for the calculation of lightning-induced voltages on multi conductor lines above a lossy soil as a function of the line geometry, lightning current wave shape, return-stroke velocity, soil electrical parameters, etc. (Nucci and Rachidi 2003).



The evaluation of lightning induced overvoltages is generally performed in the following way:

- The lightning return-stroke electromagnetic field change is calculated at a number of points along the line employing a lightning return-stroke model, namely a model that describes the spatial and temporal distribution of the return stroke current along the channel. To this end, the return stroke channel is generally considered as a straight, vertical antenna.
- the evaluated electromagnetic fields are used to calculate the induced overvoltages making use of a field-to-transmission line coupling model which describes the interaction between the LEMP and the line conductors.
- the Modified Transmission Line model with Exponential Decay (MTLE) (Nucci et al. 1988, Rachidi and Nucci 1990) is used for the specification of the spatial-temporal distribution of current along the lightning return stroke channel.

For the calculation of the vertical component of the electric field, the assumption of a perfectly conducting ground was considered (this assumption has been shown to be reasonable for distances not exceeding a few kilometers or so). On the other hand, the horizontal component of the electric field is appreciably affected by the finite conductivity of the ground. This component is computed using the Cooray-Rubinstein formula (Rubinstein 1996, Cooray 2002). Note that in the freely downloadable version, the line and ground are supposed to be perfect conductors. For the evaluation of the electromagnetic coupling, the implemented model in LIOV is based on the transmission line theory and on the field-to-transmission line coupling model of Agrawal et al. (Agrawal et al. 1980). The coupling equations are solved using the finite difference-time domain-technique (FDTD). The LIOV code has been experimentally validated using a number of experimental data related to natural and triggered lightning, Nuclear Electromagnetic Pulse Simulators and reduced scale models (Paolone et al. 2009, Rachidi 2009). The full version of the LIOV code takes into account a certain number of features such as frequency dependence of line parameters (Rachidi et al. 2009), multi conductor lines (Rachidi et al. 1997), leader induction effects (Rachidi et al. 1997), corona phenomenon (Nucci et al 2000), nonlinear components (surge protective devices) and shielding wires (Paolone et al. 2004), etc.

In (Paolone M et al. 2013) interface between the LIOV code and the EMTP-RV has been developed in order to properly simulate the response of realistic distribution networks against external electromagnetic fields produced by nearby lightning; the developed interface is proved to be appropriate for the distribution networks response against nearby lightning, insulation coordination studies, lightning-to-fault correlation, design and optimal placement of protection devices. In (Paolone et al. 2005) the LIV-ATP and LIOV-EMTP software tools for



the estimation of induced overvoltages due to lightning hits are compared. The theoretical approach of the programs is discussed and simulation procedure are carried out, concerning various topologies and scenarios.

### 7.2.3 Configuration of the system under examination

In the current work the arising induced overvoltages at the entrance of the substation of the configuration of Figure 7.4 are calculated by using the LIOV (Lightning-Induced Over Voltage) tool, taking into consideration various factors that affect the expected magnitudes of the developed surges, i.e. the grounding resistance, the steepness of the waveform of the lightning discharge current, the crest value of the lightning current and the lightning position hit.

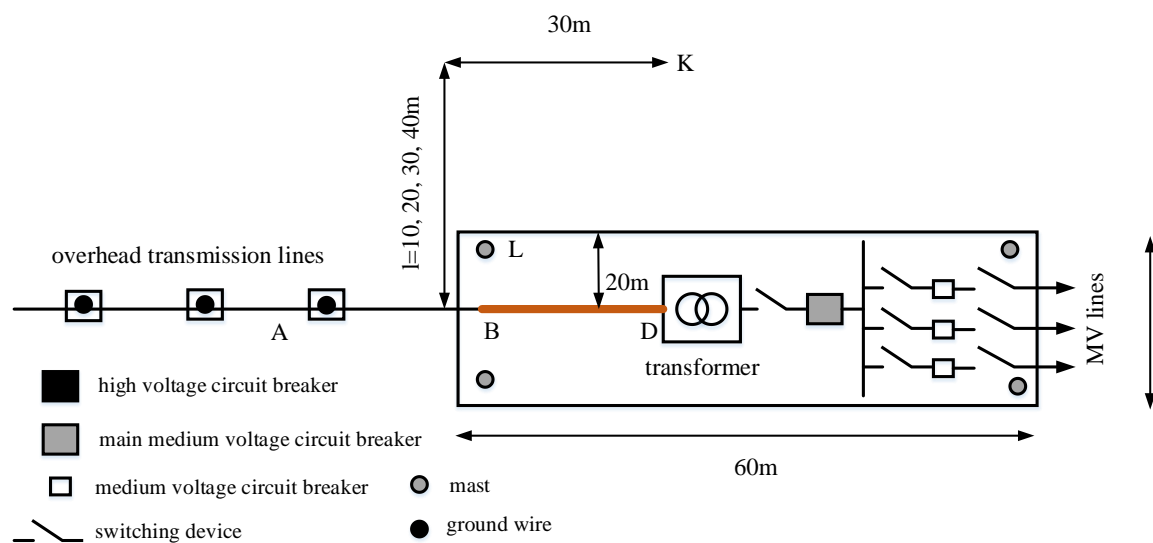

Figure 7.4 Configuration of the Model of the Arising Induced Overvoltages at the Entrance of the Substation

Three different lightning stroke positions are considered according to Fig. 7.4 (A, K, L). The grounding resistance of the towers and the substation are equal to  $5\Omega$  and  $1\Omega$ , respectively. For each lightning stroke position, the developed overvoltages at the beginning and the end of the cable (BD) are evaluated for various lightning current waveforms, considering the cases a and b of Fig. 4.1.

### 7.2.4 Results

Figure 7.5-7.16 depict the obtained results, highlighting the impact of the magnitude and the rise time of the lightning current, the lightning hit position and the installation or not of surge arresters at the joint between the incoming overhead transmission line and the underground cable.

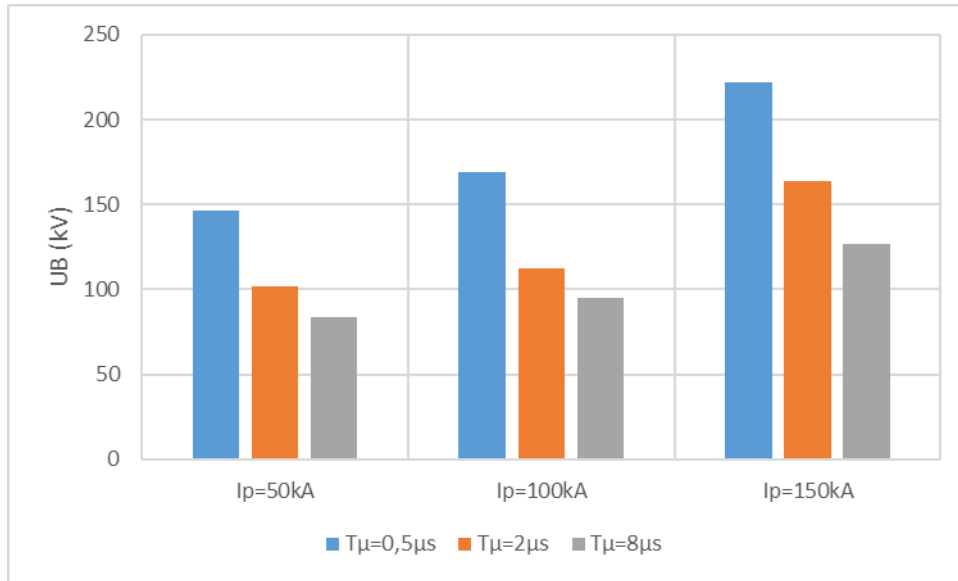

Figure 7.5 Induced Overvoltages at the position B for lightning hit on position A for various current waveforms (case a)

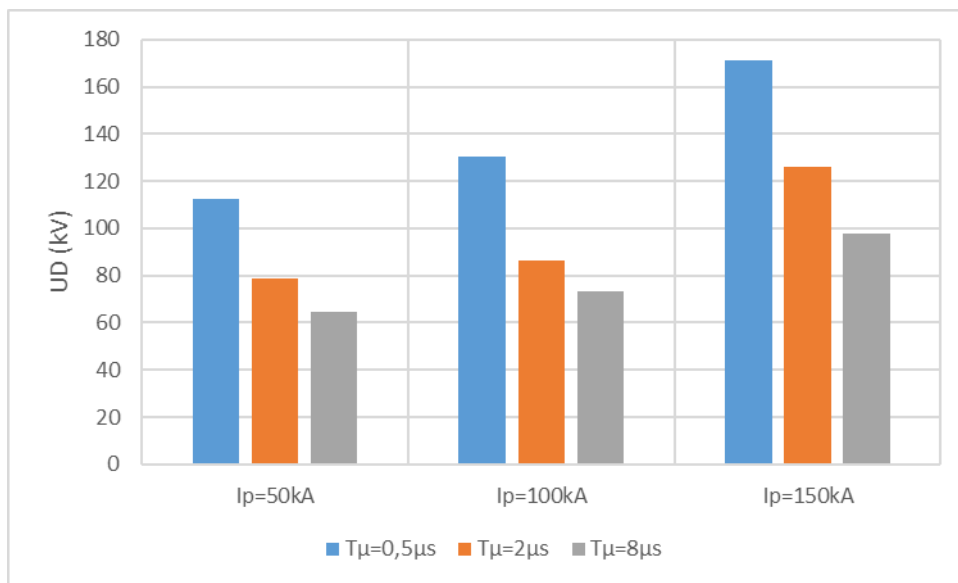

Figure 7.6 Induced Overvoltages at the position D for lightning hit on position A for various current waveforms (case a)

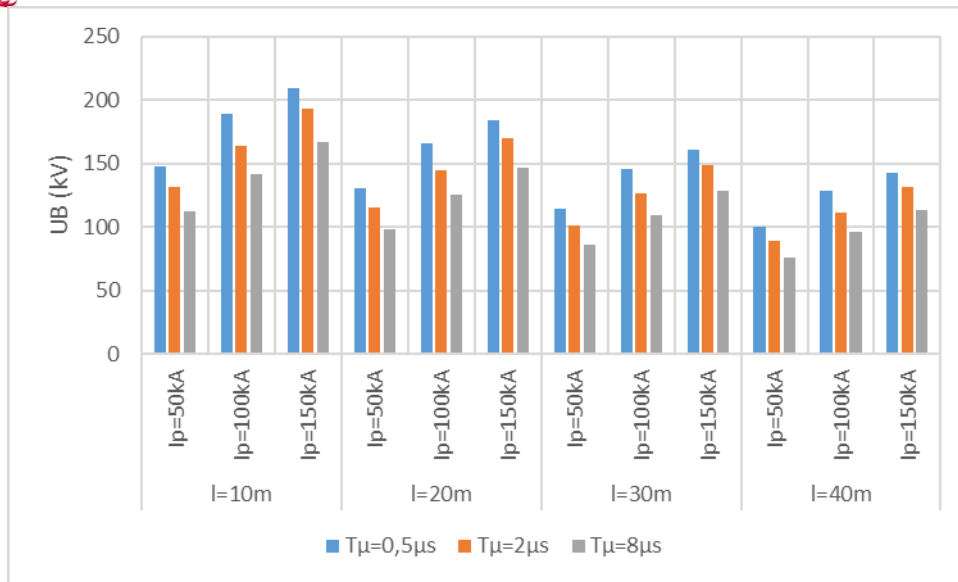

Figure 7.7 Induced Overvoltages at the position B for lightning bit on position K for various current waveforms (case a)

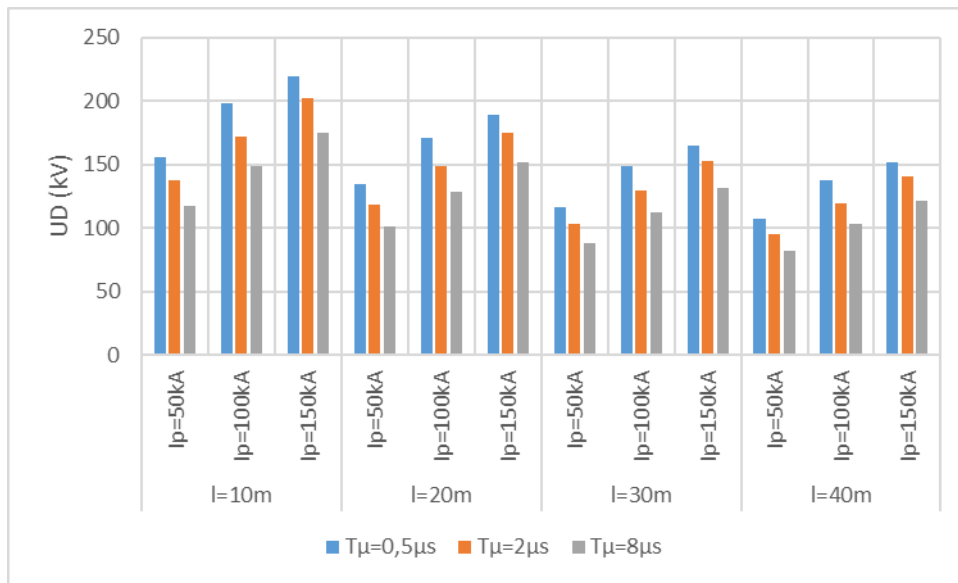

Figure 7.8 Induced Overvoltages at the position D for lightning bit on position K for various current waveforms (case a)

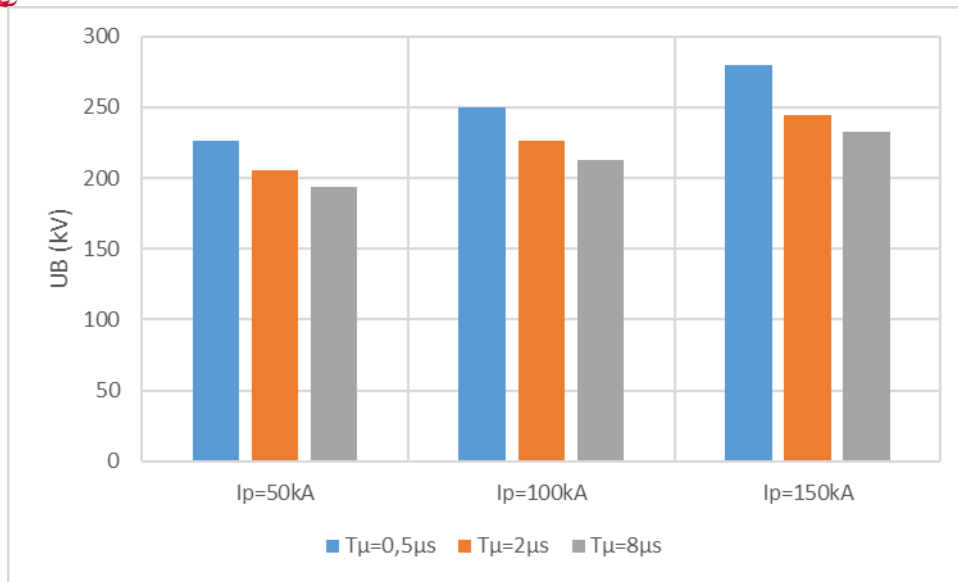

Figure 7.9 Induced Overvoltages at the position B for lightning hit on position L, for various current waveforms (case a)

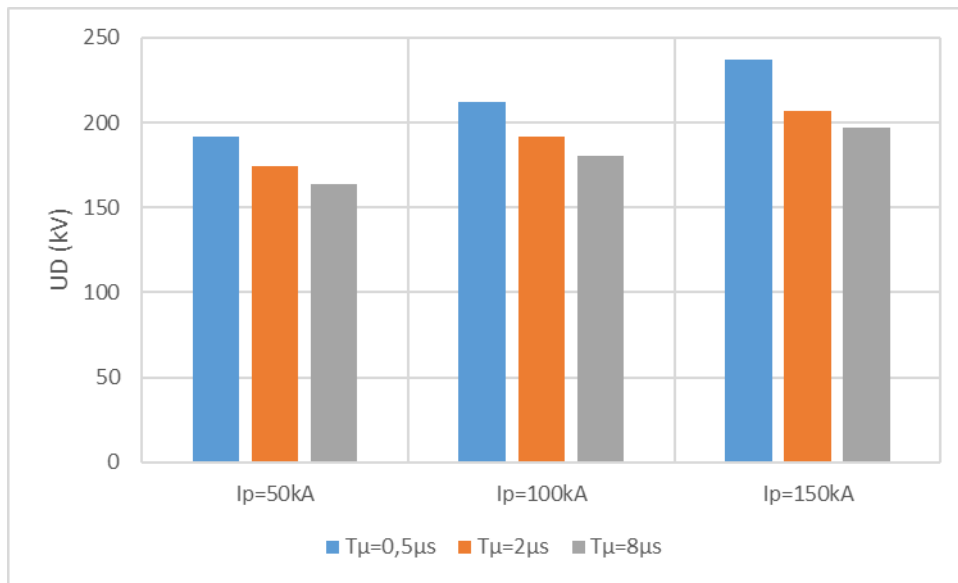

Figure 7.10 Induced Overvoltages at the position D for lightning hit on position L, for various current waveforms (case a)



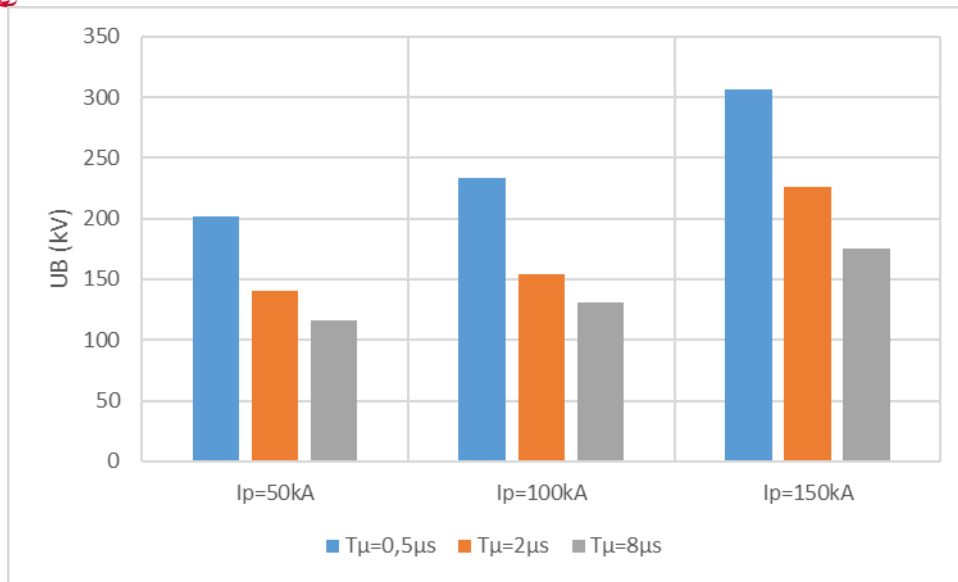

Figure 7.11 Induced Overvoltages at the position B for lightning hit on position A for various current waveforms (case b)

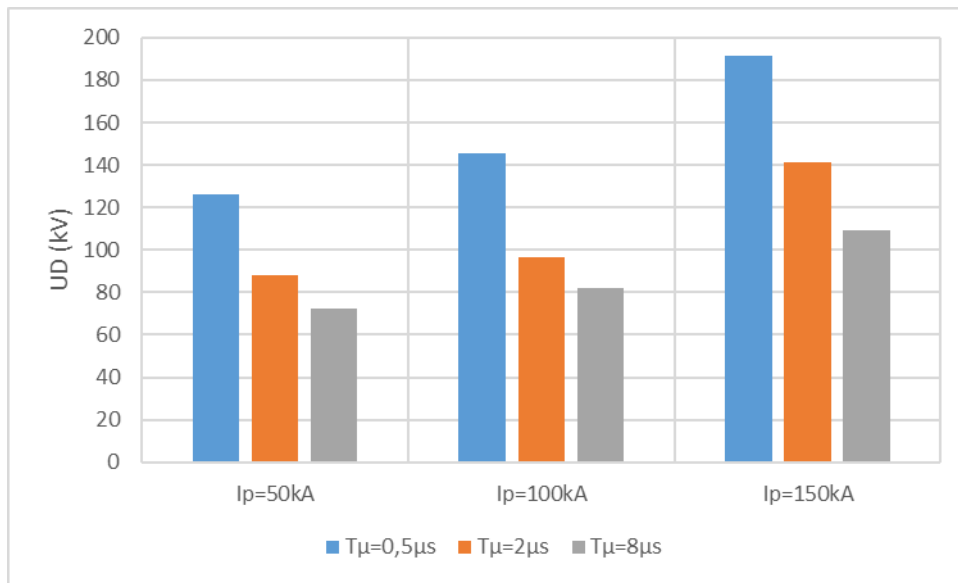

Figure 7.12 Induced Overvoltages at the position D for lightning hit on position A for various current waveforms (case b)

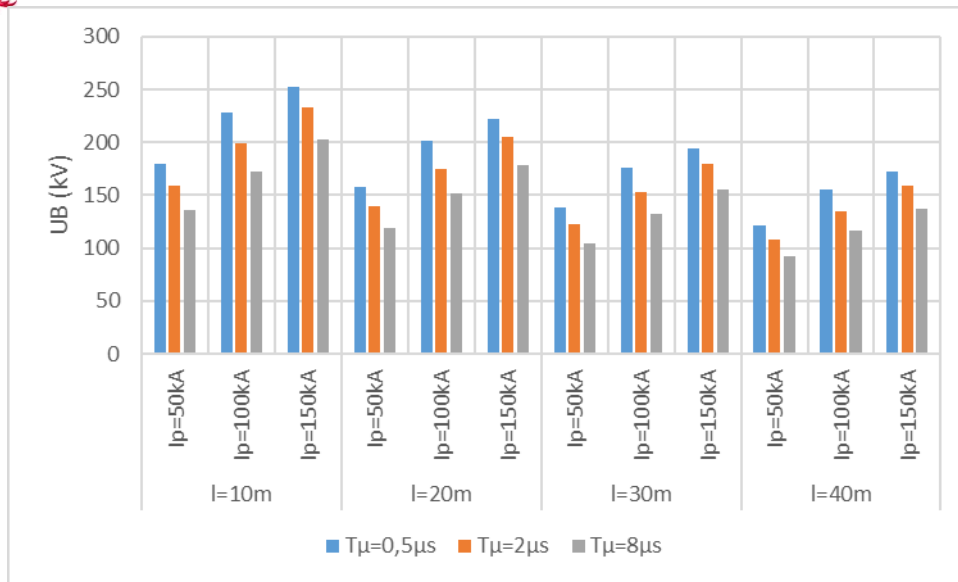

Figure 7.13 Induced Overvoltages at the position B for lightning bit on position K for various current waveforms (case b)

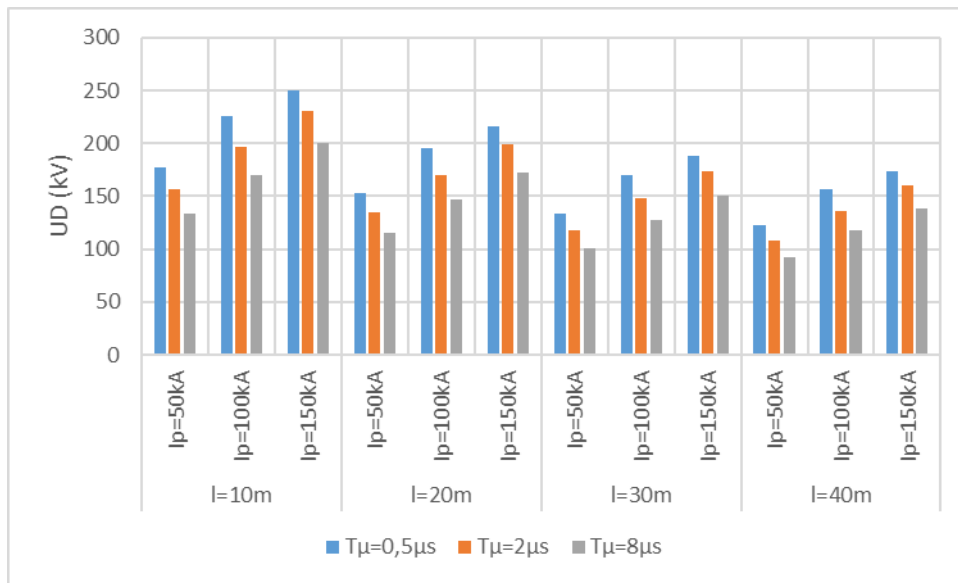

Figure 7.14 Induced Overvoltages at the position D for lightning bit on position K for various current waveforms (case b)

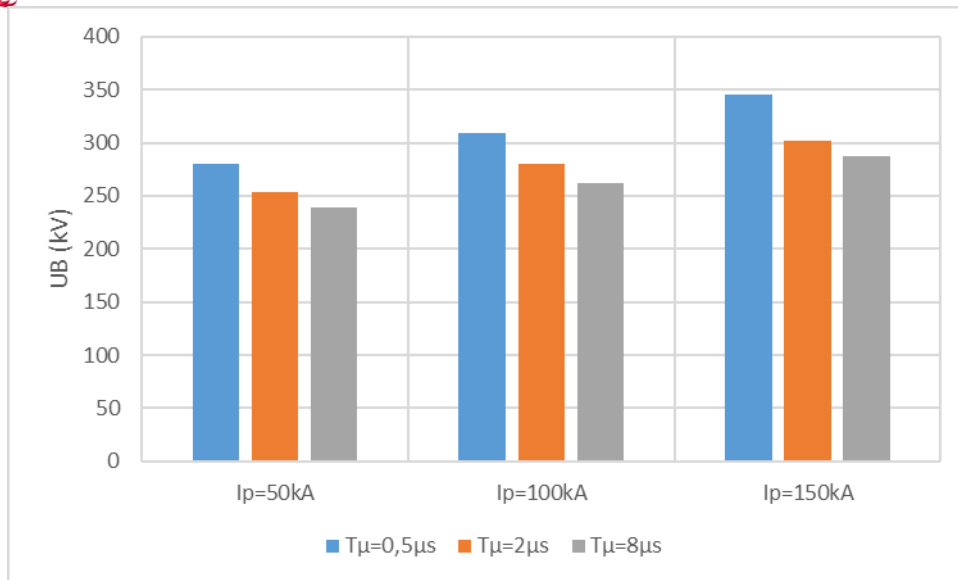

Figure 7.15 Induced Overvoltages at the position B for lightning hit on position L for various current waveforms (case b)

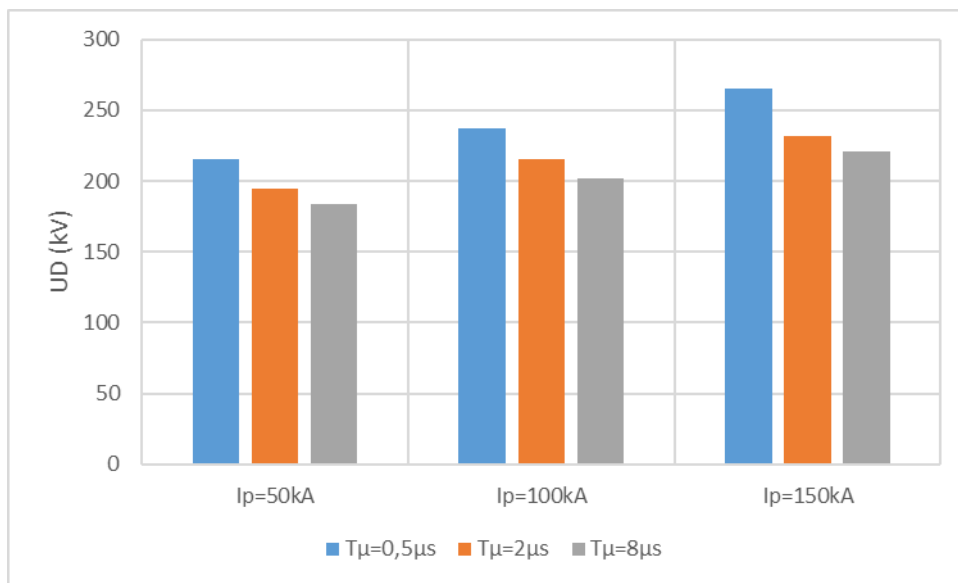

Figure 7.16 Induced Overvoltages at the position D for lightning hit on position L for various current waveforms (case b)

The results indicate that higher steepness of the lightning current waveform results in increased induced overvoltages. Moreover, the crest value of the impulse current is a dominant factor that determines the magnitude of the developed induced voltages. Indeed, higher peak values of the discharge current result in the increase of the expected voltage surges due to induction phenomena. The dependence of the developed induced overvoltages on the distance between the lightning hit position and the substation is clearly showed in



Figures 7.7-7.8 and 7.13-7.14. The attenuation of the magnetic field reduces the induced surges as the distance increases. As far as the installation position of the arresters is concerned, the outcomes reveal the role of the implementation of arresters at position B (case b). In conclusion, the results indicate that the arising induced overvoltages are not a significant threat for the normal operation of the substation and their influence can be adequately restrained by adopting appropriate protective measures. However, the impact of the computed overvoltages on the data/communication cables of the substation is an issue of further research.

### 7.3 Installation of Parallel Arresters

Metal oxide surge arresters constitute a basic protective measure against external and internal transient phenomena, installed at the entrance of the substations, ensuring that the incoming voltage surges will not exceed the insulation withstand capability of the system. However, surge arresters are stressed by the discharge currents flowing through them and their effectiveness and normal operation may be degraded. In case that the absorbed energy exceeds their energy absorption capability, arresters cannot cool back-down to their normal operating temperature and, consequently, they fail. A damaged arrester cannot protect anymore the installation against lightning and switching overvoltages and has to be repaired or replaced. If not, subsequent lightning hits can cause serious damages to the substation. The international literature does not provide extended research results, concerning the installation of metal oxide gapless surge arresters in parallel at various positions of HV/MV substations. Studies about distribution transformers and low voltage circuits have been presented, examining the current sharing between the parallel non-linear resistors (Chatterton 2002, Putrus et al. 2001).

The installation of parallel surge arresters contributes to the reduction of the absorbed energy by them, since the lightning current is shared, diverted to earth by two paths. In this way, the energy rating of the arresters is doubled and the arresters failure probability due to lightning overvoltages is reduced. Indeed, manufacturers of surge arresters recommend their parallel combination, taking into consideration their voltage – current characteristics. In case that voltage – current characteristics are not carefully matched, the sharing of the discharge currents will be not adequate to reduce the failure probability of the arresters.

Figure 7.17 depicts the voltage – current characteristics of two different metal oxide gapless surge arresters. Arrester 1 present lower resistance (Red line) compared with arrester 2 (Green



line), so the lightning current will not be equally shared, but the major part will pass through arrester 1.

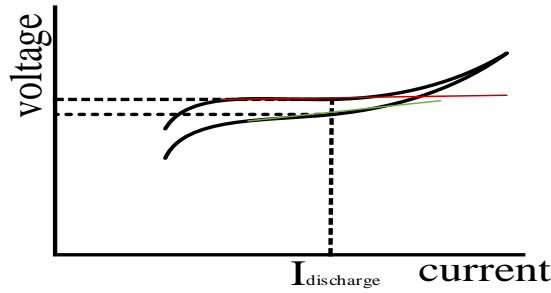
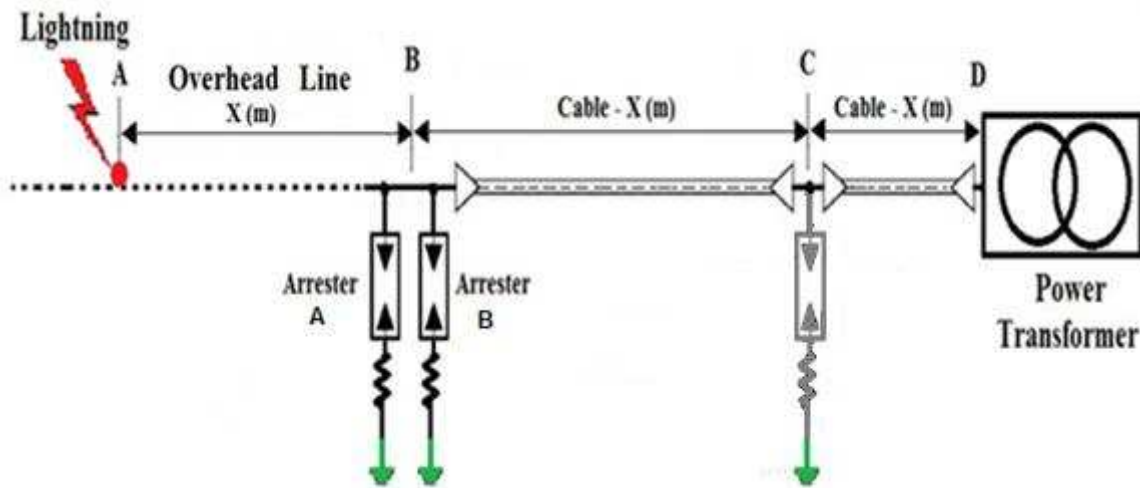

Figure 7.17 Voltages – Current Characteristics of Two Different Metal Oxide Gapless Surge Arresters

The above remark highlights the need for matching of the voltage –current characteristics of the combined arresters, otherwise arresters that present the more intense conducting behavior will be stressed more.

In the current work, two arresters for each phase at the entrance of a substation are paralleled (Figures 7.18) and the expected current that will pass through each arrester is computed, considering three cases, depending on the difference between the voltage – current characteristic of the arresters. Details about the system characteristics are given in Chapter 4.



Figures 7.18 Two Arresters at the Entrance of a Substation in Paralleled for each Phase

Figures 7.19 – 7.21 depict the characteristics of the arresters for each case (case 1, case 2 and case 3, depending on the difference between the voltage – current characteristic of the arresters1.).

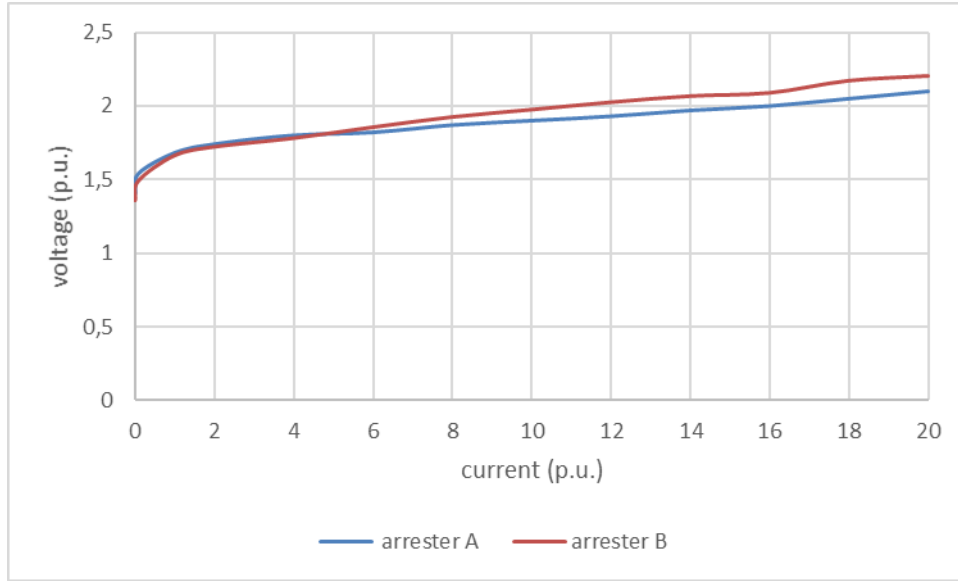

Figure 7.19 Voltages – Current Characteristic of the Two Arresters in Parallel (Case 1)

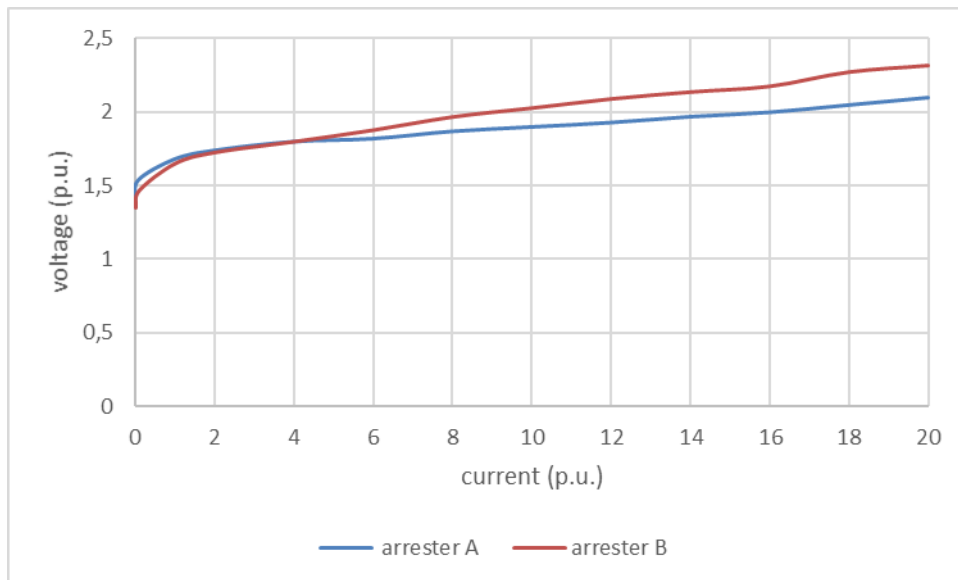

Figure 7.20 Voltages – Current Characteristic of the Two Arresters in Parallel (Case 2)

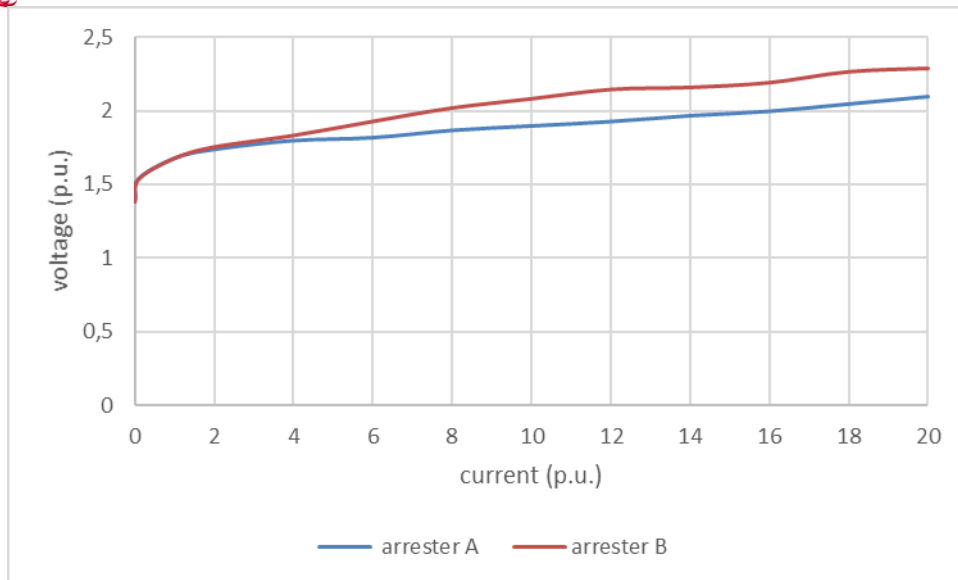

Figure 7.21 Voltages – Current Characteristic of the Two Arresters in Parallel (Case 3)

Figures 7.22 – 7.24 present the results of the performed analysis. The current sharing is strongly dependent on the differences between the voltages – current characteristics of the combined arresters. Even slight differences between the characteristics result in uneven sharing of the lightning discharge current. The arresters which present more intense non linearity of its characteristic are stressed more and present greater probability to fail. So, the careful choice of the electrical characteristics of the arresters to be connected is critical, in order to achieve an adequate sharing of the lightning current and reduce the annual failure rate of the arresters.

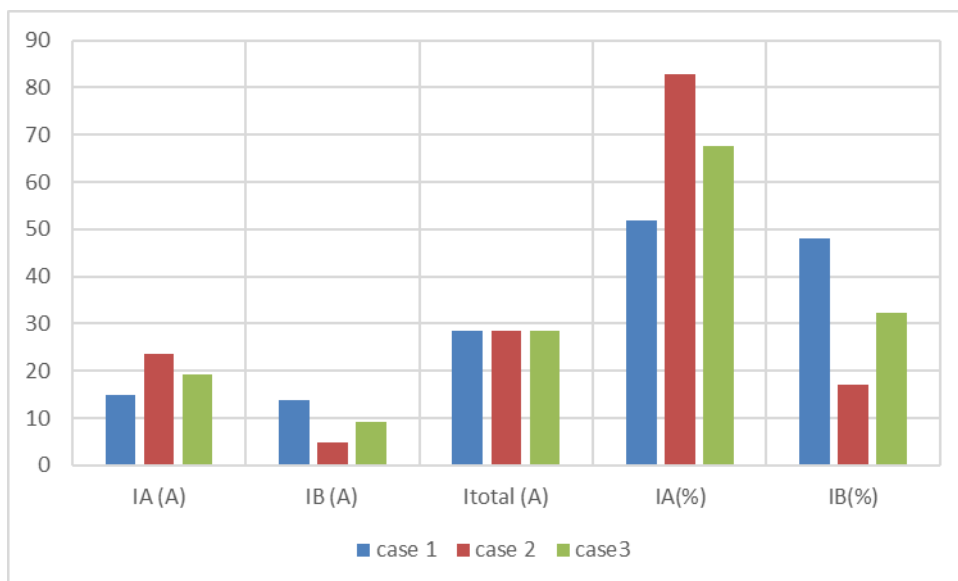

Figure 7.22 Sharing of the Lightning Current (Cases 1, 2, 3)

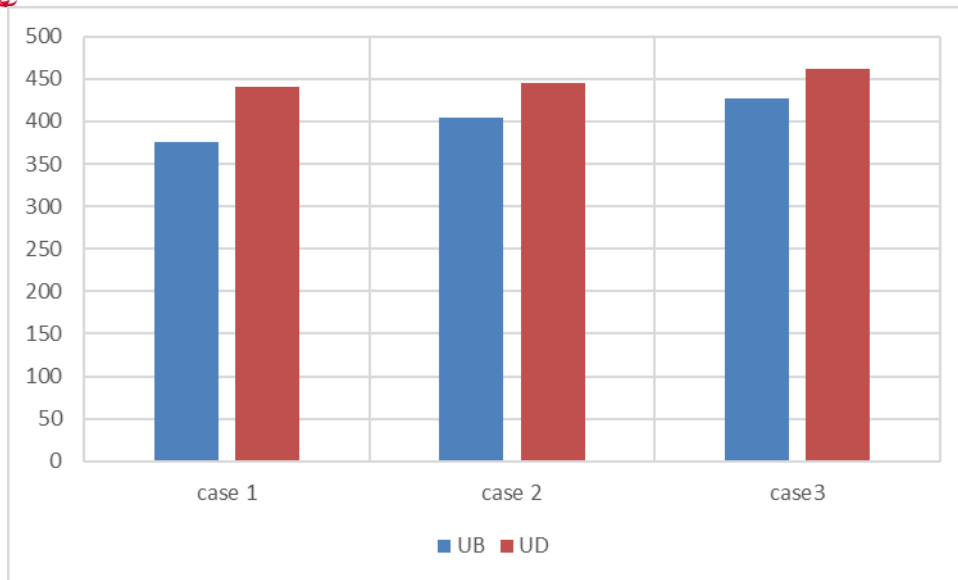

Figure 7.23 The Developed Overvoltages at Position B and D of the Examined Substation (Cases 1, 2, 3)

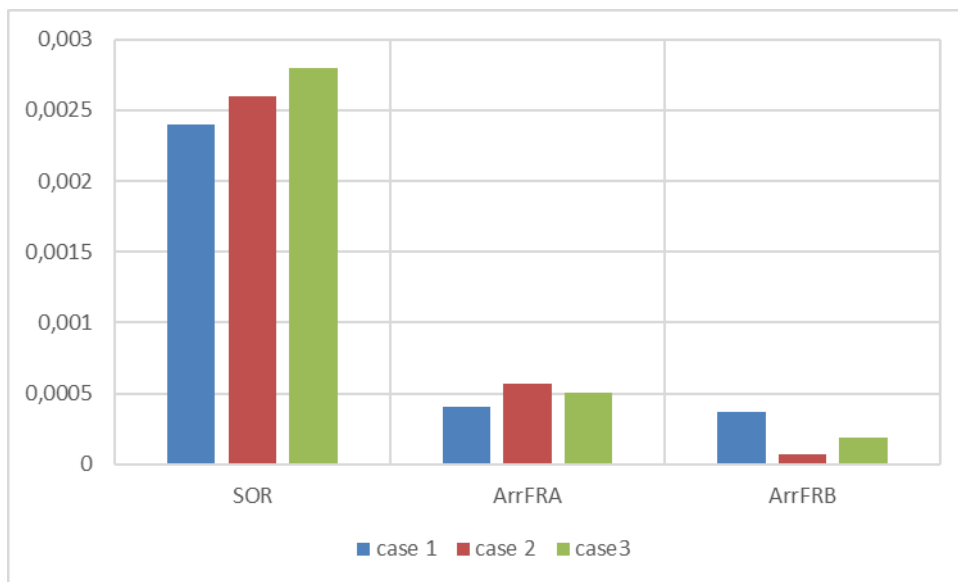

Figure 7.24 Substation Outage Rate and Arresters Failure Rate (Cases 1, 2, 3)

## 7.4 Conclusions

The current Chapter examines the range of the developed induced overvoltages at the entrance of a HV/MV substations, revealing the role of the lightning current waveforms, the lightning hit position and the installation position of the arresters. The results indicate that the arising induced overvoltages are not a significant threat for the normal operation of the substation and their influence can be adequately restrained by adopting appropriate protective measures. Main contribution of the current work is the examination of the role of the arresters





to the magnitude of the developed induced voltages. Further work would include the impact of the induced overvoltages of the data/communication cables, that can influence the normal operation of the system.

As far as the parallel combination of the arresters, three cases are examined, considering arresters with different voltage – current characteristic. The obtained results indicate that slight differences between the characteristics can lead to unequal sharing of the injected impulse current. The arresters which present more intense non linearity of their characteristic are stressed more and present greater probability to fail. In the current work, two arresters for each phase at the entrance of a substation are combined in parallel and the expected current that will pass through each arrester is computed, considering three cases, depending on the difference between the voltage – current characteristic of the arresters. Main contribution of the performed analysis is the clarification that the parallel installation of surge arresters has no significant impact on the reduction of the arising surges and reduces the energy stress of the arresters, only if specific requirements are satisfied.



## References

- Agrawal A.K., Price H.J., Gurbaxani S.H., "Transient response of a multiconductor transmission line excited by a nonuniform electromagnetic field", *IEEE Trans. on EMC*, Vol. EMC-22, No. 2, pp. 119-129, May 1980.
- Borghetti A., Nucci C.A., "Estimation of the frequency distribution of lightning-induced voltages on an overhead line above a lossy ground: a sensitivity analysis", *Int. Conf. On Lightning Protection*, Birmingham, Sept. 1998.
- Chatterton Baden George, "The use of surge arresters in parallel for the lightning protection of pole mounted distribution transformers in Eskom", *School of Electrical and Electronic Engineering University of Natal*, December 2002, *Master of Science Thesis*
- Chowdhuri P., Gross E.T.B., "Voltage surges induced on overhead lines by lightning strokes" *Proc. IEE*, Vol. 114, No. 12, pp. 1899-1907, Dec. 1967.
- Cooray V., "Horizontal fields generated by return strokes," *Radio Science*, vol. 27, pp. 529-37, 1992; – "Some considerations on the "Cooray-Rubinstein" formulation used in deriving the horizontal electric field of lightning return strokes over finitely conducting ground", *IEEE Trans on EMC*, Vol. 44, No. 4, November 2002.
- Costea M. and Nicoara B., "Influence factors on the transmitted overvoltages from high voltage to low voltage networks", *U.P.B. Sci. Bull., Series C*, Vol. 72, Iss. 1, 2010
- Franc B., Filipović-Grčić B., Milardić V., "Lightning overvoltage performance of 110 kV air-insulated substation", *Electric Power Systems Research* Vol. 138, pp. 78-84, Sept. 2010
- IEEE Guide for improving the Lightning Performance of Electric Power Overhead Distribution Lines*, *IEEE Std. 1410-2004*, Jul. 2004
- Iorio R., Nucci C.A., Porrino A., Rachidi F., "Lightning-induced overvoltages on distribution overhead lines in presence of distribution transformers or short cables ", *International CIGRÉ Symposium on Power System Electromagnetic Compatibility*, Lausanne, Oct. 1993.
- Kraulich L., Marchesan A. C., Mariotto L., Loose F., Camargo M. C., Marchesan G., Cardoso G., "Stochastic Analysis of Transient Overvoltages at Substations by Applying the Monte Carlo Method Integrated with ATP", *International Conference on Power Systems Transients (IPST2015)*, Cavtat, Croatia June 15-18, 2015
- Lambert R., Xémard A., Fleury G., Tarafi R., Zeddani A., "Estimating the expected failure rate of distribution type equipment due to lightning induced overvoltages", *IPST 2009*
- Mikropoulos P. N and Tsovilis T. E.: "Estimation of lightning incidence to overhead transmission lines", *IEEE Trans. Power Delivery*, Vol. 25, No. 3, pp. 1855-1865, Jul. 2010
- Mikropoulos P. N. and Tsovilis T. E. "Interception probability and shielding against lightning", *IEEE Trans. Power Delivery*, Vol. 24, No. 2, pp. 863-873, Apr. 2009



Mikropoulos P. N. and Tsovilis T. E., "A statistical method for the estimation of induced-voltage flashover rate of unshielded overhead distribution lines", XVII International Symposium on High Voltage Engineering, Hannover, Germany, August 22-26, 2011

Mikropoulos P. N. and Tsovilis T. E.: "Striking distance and interception probability", IEEE Trans. Power Delivery, Vol. 23, No. 3, pp. 1571-1580, Jul. 2008

Mimouni A., Azouzi Z., Gbemri B., "Lightning induced overvoltages on overhead lines: modelling and experimental validation", Journal of Electrical Engineering, Vol. 58, no. 3, 2007, pp. 146-151

Nucci C. A., Mazzetti C., Rachidi F., Ianoz M., "On lightning return stroke models for LEMP calculations", 19th International Conference on Lightning Protection, Graz, April 1988.

Nucci C.A and Rachidi F., "Interaction of electromagnetic fields generated by lightning with overhead electrical networks," in *The Lightning Flash*, V. Cooray, Ed. London: IEE, 2003, pp. 425-478.

Nucci C.A., "Lightning-induced voltages on overhead power lines. Part I: return stroke current models with specified channel-base current for the evaluation of the return stroke electromagnetic fields", *Electra*, No. 161, pp. 74-102, August 1995.

Nucci C.A., Guerrieri S., Correia de Barros M.T., Rachidi F., "Influence of corona on the voltages induced by nearby lightning on overhead distribution lines", IEEE Trans. on Power Delivery, Vol. 15, No. 4, pp. 1265-1273, October 2000.

Nucci C.A., Mazzetti C., Rachidi F., Ianoz M., "On lightning return stroke models for LEMP calculations", Proc. 19th Int. Conf. on Lightning protection, Graz, April, 1988.

Nucci C.A., Rachidi F., "Lightning-Induced Overvoltages", IEEE Transmission and Distribution Conference, Panel Session "Distribution Lightning Protection", New Orleans, April 14, 1999

Paolone M, Rachidi F., Borghetti A., Napolitano F., Nucci C.A., "An advanced interface between the Lightning Induced Overvoltage Code (LIOV) and EMTP-RV, EMTP-RV European User Group Meeting, April 3, 2012 – Paris, La Defense, France

Paolone M., Nucci C.A., Petrache E. and Rachidi F., "Mitigation of Lightning-Induced Overvoltages in Medium Voltage Distribution Lines by Means of Periodical Grounding of Shielding Wires and of Surge Arresters: Modelling and Experimental Validation", IEEE Trans. on Power Delivery, Vol. 19, No. 1, pp. 423-431, Jan. 2004

Paolone M., Perez E., Borghetti A., Nucci C.A., Rachidi F. and Torres H., "Comparison of Two Computational Programs for the Calculation of Lightning-Induced Voltages on Distribution

Paolone M., Rachidi F., Borghetti A., Nucci C.A., Rakov V.A., Uman M.A., "Lightning Electromagnetic Field Coupling to Overhead Lines: Theory, Numerical Simulations and Experimental Validation", IEEE Transactions on Electromagnetic Compatibility, Vol. 51, No. 3, August 2009, pp. 532-547.

Psalidas M., Agoris D., Pyrgioti E., Karagiannopoulos C., "Modeling for the Calculation of Overvoltages Stressing the Electronic Equipment of High Voltage Substations due to Lightning", 8th WSEAS International Conference on Circuits, July 2004

Putrus G., Ran L., Ahmed M., "Improving current sharing between parallel varistors", ISIE 2001, Pusan,

Rachidi F., "A Review of Field-to-Transmission Line Coupling Models with Special Emphasis to Lightning-Induced Voltages", *IEEE Transactions on Electromagnetic Compatibility*, Vol 54, No. 4, pp. 898 - 911, 2012.

Rachidi F., Nucci C.A., "On the Master, Lin, Uman, Standler and the Modified Transmission Systems", *International Conference on Power Systems Transients (IPST'05) in Montreal, Canada on June 19-23, 2005* Paper No. IPST05 - 250

Rachidi F., Nucci C.A., Ianoz M., Mazzetti C., "Influence of a lossy ground on lightning-induced voltages on overhead lines", *IEEE Trans. On Electromagnetic Compatibility*, Vol. 38, No. 3, pp. 250-264, Aug. 1996.

Rachidi F., Nucci C.A., Ianoz M., Mazzetti C., "Influence of a lossy ground on lightning-induced voltages on overhead lines", *IEEE Trans. on Electromagnetic Compatibility*, Vol. 38, No. 3, August 1996.

Rachidi F., Nucci C.A., Ianoz M., Mazzetti C., "Response of multiconductor power lines to nearby lightning return stroke electromagnetic fields", *IEEE Trans. on Power Delivery*, Vol. 12, pp. 1404-1411, July 1997.

Rachidi F., Rubinstein M., Nucci C.A., Guerrieri S., "Voltages induced on overhead lines by dart leaders and subsequent return strokes in natural and rocket-triggered lightning", *IEEE Trans. on Electromagnetic Compatibility*, Vol. 39, No. 2, May 1997.

Rakov V., Dulzon A.A., "A modified transmission line model for lightning return stroke field calculations", *Proc. 9th Int. Symposium on EMC, Zurich, Switzerland*, pp. 229-235, March 1991.

Rakov V., Uman M.A., "Review and evaluation of lightning return stroke models including some aspects of their application", *IEEE Trans. On EMC*, Vol. 40, No. 4, pp. 403-426, Nov. 1998.

Ren He-Ming, Zhou Bi-Hua, Rakov Vladimir A., Shi Li-Hua, Gao Cheng, and Yang Jian-Hua, "Analysis of Lightning-Induced Voltages on Overhead Lines Using a 2-D FDTD Method and Agrawal Coupling Model", *IEEE Transaction on Electromagnetic Compatibility*, Vol. 5, no. 3, August 2008, pp.651-659

Rubinstein M., "An approximate formula for the calculation of the horizontal electric field from lightning at close, intermediate, and long range," *IEEE Trans. on Electromagnetic Compatibility*, vol. 38, pp. 531-535, 1996 1996.

Rubinstein M., "An approximate formula for the calculation of the horizontal electric field from lightning at close, intermediate, and long range", *IEEE Trans. on EMC*, Vol. 38, No. 3, Aug. 1996.

Rusck S., "Induced lightning overvoltages on power transmission lines with special reference to the overvoltage protection of low voltage networks", *Transactions of the Royal Institute of Technology, Stockholm*, No. 120, 1958.

SabibaNehmdob A., "Lighting-induced overvoltages in medium voltage distribution systems and customer experienced voltage spikes", *Doctoral Dissertation Aalto University School of Science and Technology Faculty of Electronics, Communications and Automation Department of Electrical Engineering* 2009

Sekioka S., "An Equivalent Circuit for Analysis of Lightning-Induced Voltages on Multiconductor System



*Using an Analytical Expression*”, *International Conference on Power Systems Transients (IPST'05) in Montreal, Canada on June 19-23, 2005 Paper No. IPST05 – 029*

Thottappillil R, Uman M.A., "Comparison of lightning return-stroke models", *J. Geophys. Res.*, vol. 98, pp. 22,903-22,914, Dec. 1993.

Uman M.A., McLain D.K., "Magnetic field of lightning return stroke", *J. Geophys. Res.*, Vol. 74, 1969.

Viscaro S., "Direct Strokes to Transmission Lines: Considerations on the mechanisms of Overvoltage Formation and their Influence on the Lightning Performance of Lines", *Journal of Lightning Research*, Vol. 1, pp. 60-68, 2007

Viscaro S., "Lightning: an Engineering Approach" (in Portuguese), *ArtLiber Edit-Sao, Wait J.R.*, "Concerning horizontal electric field of lightning", *IEEE Trans. on EMC*, Vol. 39, No. 2, May 1997.

Vukasović V., Baus Z., Barukečić M., "The Influence of Atmospheric Overvoltages on High-Voltage SF6 Substations", *International journal of electrical and computer engineering systems*, Vol.2 No.1 May 2011.

Zeddani A., Degauque P., "Current and voltage induced on telecommunications cable by a lightning return stroke", *Lightning Electromagnetics*, Edited by R. L. Gardner, *Hemisph. publ. Corp.*, pp.377-400, 1990.

A.P. Meliopoulos, G. Cokkinides, A. Arora, J.C. Braz, "Analysis and Mitigation of Induced Voltages on Substation Control Cables", *International Conference on Power System Transients*, June 24-28, 2001, IPST 2001, Rio de Janeiro, Brazil, pp. 529-534



## CHAPTER 8

# CONCLUSIONS, CONTRIBUTION AND FUTURE WORK

### 8.1 Introduction

The current thesis dealt with the lightning performance of HV/MV substations and the examination of the appropriate protective measures that should be adopted, in order to restrain the developed overvoltages and reduce the expected failure rate. To this direction, two different topologies of substations are examined and a sensitivity analysis is performed, considering the impact of various factors on the expected voltage surges at different position of the system and substation outage rate.

### 8.2 CONCLUSIONS

#### 8.2.1 Estimation of the Expected Overvoltages at Different Positions of the Substation

As far as the calculation of the arising overvoltages at the entrance of the substations is connected, the performed sensitivity analysis results in the following conclusions, about the behavior of the substation in case of a lightning hit on the phase conductor of the connected overhead transmission line:

- The developed overvoltages at the end of the cable are greater than those ones at the beginning, due to the reflection phenomena of the traveling waves.
- The developed overvoltages are strongly dependent on the length of the cable. Long cable lengths present a better lightning performance and contribute to the reduction of the expected overvoltages. Especially, in case that the grounding resistance cannot be improved, the increase of the cable length can balance the negative effects of the inadequate grounding system. The results indicate that long cables can be adequately protected, since the expected overvoltages do not exceed the BIL (750kV for 150kV nominal voltage).



- Low grounding resistance values contribute to the decrease of the developed overvoltages, diverting significant part of the lightning current to the grounding system. Low values of grounding resistance values, either for the tower or for the surge arresters, always improve the lightning performance of the line. Low tower footing resistances do not allow the potential of the tower to exceed the BIL and prevents backflashover. The arresters' grounding resistance keeps the voltage at the terminals of the transformer below the desired limits.
- The arresters should be installed near the transformer; otherwise the voltage at the equipment to be protected will be considerably higher than the residual voltage at the terminals of the arrester. The protective distance of the installed arresters depends on the steepness of the incoming surge and the nominal protection level of the device. The installation of the arresters away from the equipment to be protected reduces their efficiency, resulting in the development of significant overvoltages higher than the nominal residual voltage of the arresters.

Furthermore, the impact of the number of the connected overhead transmission lines is examined. The arising overvoltages are strongly dependent on the number of the lines and the lightning hit position. The peak value and the rise time of the incoming voltage surges decrease with the increase of the number of the transmission lines, since the overvoltage "faces" the parallel combination of the incoming lines. The probability of lightning hit on a transmission lines is reduced as the number of the incoming lines is increased.

### **8.2.2 The influence of the used Models of the Substations Components**

A sensitivity analysis is performed, in order to examine the influence of the equivalent circuit model of the various components (i.e. tower, arresters, grounding, and insulators) to the obtained results. As far as the tower models concerns the Jordan, Wagner, Sargent, Ametani, Rondon, Yamada and Chilsom circuits are considered. Physical model, Pinceti-Giannettoni,

Fernandez-Diaz and IEEE model are used for the representation of the surge arresters.

The implemented models for the grounding resistance include Oettle, Chilsom, Weck, Yasuda, Sverak and IEEE models. Finally, the Weck, Pignini and V-t curve models are used for the insulator representation. As default models are considered the Chilsom model for the towers, the IEEE model for the arresters, and the Cigre model for the grounding resistance and the V-t curve for the insulator. Two cases are examined, i.e. surge arresters have been installed or





not. The obtained results indicate that the selected tower model influences the theoretical estimations, but its impact is not critical.

### **8.2.3 Outage Rate of the Substation due to Lightning Strokes**

A sensitivity analysis of the expected failure rate in function with the tower footing resistance, the length of the cable and the arresters installation position is presented. The obtained outcomes indicate that the expected overvoltage at the entrance of the substation is reduced for higher number of incoming transmission lines. The impact of the lightning hit position is also highlighted, indicating the influence of the distance between the lightning stroke position and the substation to the incoming surge voltages.

The results emphasize also the great impact of the grounding resistance, the length of the cable and the installation position of the implemented arresters to the expected failure rates. In details, the grounding resistance is the dominant factor that determines the lightning performance of the system, since it influences the occurrence or not of backflashover phenomena and affect the effectiveness of the protection that surge arresters provide. Furthermore, the length of the cable is of great importance, since influences the magnitude of the expected overvoltages. The distance between the transformer and the arresters affects the lightning performance of the system, imposing their installation near the entrance of the substation.

### **8.2.4 Induced Overvoltages**

The magnitude of the expected induced overvoltages depends on various parameters, such as the distance between the lightning hit position and the developed voltage at a given point of the system, the characteristics of the lightning current and the grounding resistance. The steepness of the lightning current determines the level of the induced overvoltage, since the induced voltages are proportional to the self-inductance of the loop multiplied by the steepness of the lightning current. Induced overvoltages increase also with dimensions of the loop and decrease with attenuation of the magnetic field strength. As far as the hit position is concerned, the severity of the overvoltage is inversely proportional to the distance of the point of impact.

The presented study calculated the expected induced overvoltages at the entrance of the substation under study, highlighting the impact of various factors and parameters on the magnitude of the computed surges. However, the results indicated that the arising induced





overvoltages are not a significant threat for the normal operation of the substation and their influence can be adequately restrained by adopting appropriate protective measures.

### **8.2.5 Parallel Arresters**

In the current thesis, two same arresters for each phase at the entrance of a 150/20kV substation were combined in parallel and the expected current that will pass through each arrester was computed, considering three cases, depending on the difference between the voltages – current characteristic of the arresters. The current sharing was strongly dependent on the differences between the voltages – current characteristics of the combined arresters. The performed analysis indicated that even slight differences between the characteristics result in uneven sharing of the lightning discharge current. The arresters which present more intense non linearity of its characteristic were stressed more and present greater probability to fail. So, the careful choice of the electrical characteristics of the arresters to be connected was critical, in order to achieve an adequate sharing of the lightning current and reduce the annual failure rate of the arresters.



### 8.3 CONTRIBUTION

The contribution of the PhD project is described as following:

- The current work examines the lightning performance of substations, considering the influence of various parameters (not only the grounding resistance, which is the most common factor presented in the international research bibliography). The performed study highlights the role of the installation position of the arresters, the length of the cable that connects the incoming overhead transmission line and the transformer and the number of the connected lines. Compared with other research outcomes, main contribution of the thesis is that does not focus only on the role of the grounding resistance, but examines the dominant influence of other parameters, revealing that the improvement of the lightning performance of the substation can be achieved by the appropriate adjustment of various factors of the system.
- The obtained simulation results show that the impact of the used models equivalent circuit for each component of the substation is not significant, since cannot change dramatically the estimation of the arising voltage surges. Each equivalent circuit model has advantages and drawbacks, but in general all the proposed models are appropriate for transient analysis studies, extracting adequate results. The current work highlights the advantages and drawbacks of each equivalent circuit model, providing a guide to other researchers in order to select the appropriate models.
- The estimation of the substation outage rate due to atmospheric overvoltages is carried out, considering the role of the tower footing resistance, the protection distance of the arresters and the configuration of the substations. Innovation of the performed study constitutes the inclusion of the arresters failure rate to the total substation failure rate, since arresters are part of the equipment of the substation and their possible failure results in malfunction of the nominal operation of the system.
- The induced overvoltages developed at the entrance of the system under examination are estimated by using appropriate simulation tool, considering various lightning current waveforms and lightning hit positions. The current thesis contributes to the study of the induced surges on substations, by examining the role of the installed arresters for the restrain of the expected induced voltages.



- The parallel installation of surge arresters is a common practice in order to reduce the absorbed energy by them and, consequently, their failure probability. However, the current work emphasizes the need for good matching of the voltage – current characteristics of the arresters; otherwise, the expected equal sharing of the injected lightning current will not be achieved. The outcomes of the analysis reveal that the combination of the arresters in parallel does not strongly influence the expected overvoltages, but has to do mainly with the absorbed energy by the arresters.



## 8.4 FUTURE WORK

Future work includes:

- Examination of other topologies (substations without cable connections, interconnection between the power transformers, different types of metallic towers): the performed analysis presented in the current Thesis should be carried for different topologies, in order to gain a general perspective about the impact of the examined factors on the developed overvoltages and the expected outage rate of the substations.
- Study of the lightning performance of MV/LV substations, in order to protect the LV consumers against lightning surges: MV/LV transformers are vulnerable to atmospheric overvoltages, that affect the normal power supply and may cause serious damages to the consumers. Surge arresters installed at the MV side of the transformer offer protection against direct or indirect lightning strokes to the MV distribution line. However, the efficiency of the protection level that MV surge arresters provide is strongly dependent on the achieved grounding resistance of the transformers and the installation position of the arresters. Considering that the demanded grounding resistance ( $1\Omega$ ) is rarely achieved, the impact of the grounding resistance on the developed overvoltages has to be studied, considering also the installation position of the arresters. Furthermore, surges arising at the LV side of the power transformer due to lightning strokes to the LV distribution line have to be studied, concerning that LV side is not usually protected by surge arresters.
- Implementation of arresters with different characteristics (V-I characteristics, Maximum Continuous Operating Voltage, Energy Class etc.): the current work examines the parallel connection of surge arresters, presenting different voltage – current characteristics. The study of parallel connection of arresters that present different maximum operating voltage or energy class would contribute to reveal the role of the nominal electrical characteristics of the arresters, in an effort to reduce their failure rate.
- Combination of arresters with other protective devices (e.g. spark gaps): it is common practice to use spark gaps, instead of metal oxide gapless surge arresters, for the protection of the HV side of the power transformer, in an effort to reduce the installation and the potential repair or replacement cost. The examination of the effectiveness of the spark gaps and the study of their behavior in parallel connection with surge arresters is an issue for further investigation. Moreover, the arresters' failure probability in case that they operate in combination with spark gaps should be evaluated.



- Laboratory or field measurements in order to confirm the theoretical approaches: the installation of monitoring systems in order to record the lightning hits and the arising overvoltages at different positions of a substation, laboratory experiments for the measurement of the discharge current through the arresters in case of installation of parallel protective measures should be carried out, in order to verify the appropriateness and the reliability of the performed theoretical analysis.
- Methodologies for the improvement of the tower footing resistance in order to reduce the lightning failure rate of the substation: the current thesis indicated the critical role of the tower footing resistance, in an effort to improve the lightning performance of the substations and reduce the expected outage rate. The improvement of the grounding resistance of the towers of the connected lines, according to technoeconomical criteria, is an issue of priority for the power utilities. Despite the fact that several methods for the improvement of the tower footing resistance are provided in the international literature, the selection of the appropriate procedure (type and dimensions of grounding system, soil etc) and the estimation of the critical number of towers, the grounding resistance of which should be improved, are subject to be investigated.
- Development of appropriate computer tool for the optimum design of the Lightning Protection System (LPS) of the substation and the selection of the electrical characteristics of its components: the method has to take into consideration the geometrical characteristics and the type of the substation, the resistivity of the ground, the grounding system and the achieved grounding resistance, the characteristics and the installation position of the arresters, the keraunik level of the regions and other critical parameters. The proposed software will be useful for the engineers to design efficient LPSs, considering the common practice and technoeconomical criteria.