

Pal, A., Sen, R., Bremer, K., Yao, S., Lewis, E., Sun, T. & Grattan, K. T. V. (2012). "All-fiber" tunable laser in the 2 μ m region, designed for CO₂ detection. *Applied Optics*, 51(29), pp. 7011-7015. doi: 10.1364/AO.51.007011



**CITY UNIVERSITY
LONDON**

[City Research Online](#)

Original citation: Pal, A., Sen, R., Bremer, K., Yao, S., Lewis, E., Sun, T. & Grattan, K. T. V. (2012). "All-fiber" tunable laser in the 2 μ m region, designed for CO₂ detection. *Applied Optics*, 51(29), pp. 7011-7015. doi: 10.1364/AO.51.007011

Permanent City Research Online URL: <http://openaccess.city.ac.uk/14971/>

Copyright & reuse

City University London has developed City Research Online so that its users may access the research outputs of City University London's staff. Copyright © and Moral Rights for this paper are retained by the individual author(s) and/ or other copyright holders. All material in City Research Online is checked for eligibility for copyright before being made available in the live archive. URLs from City Research Online may be freely distributed and linked to from other web pages.

Versions of research

The version in City Research Online may differ from the final published version. Users are advised to check the Permanent City Research Online URL above for the status of the paper.

Enquiries

If you have any enquiries about any aspect of City Research Online, or if you wish to make contact with the author(s) of this paper, please email the team at publications@city.ac.uk.

“All-fiber” tunable laser in the 2 μm region, designed for CO_2 detection

Atasi Pal,^{1,2,*} Ranjan Sen,¹ Kort Bremer,² Shuang Yao,² Elfed Lewis,³ Tong Sun,² and Kenneth T. V. Grattan²

¹Fiber Optics & Photonics Division, Council of Scientific & Industrial Research-Central Glass & Ceramic Research Institute, Kolkata-700032, India

²School of Engineering and Mathematical Sciences, City University London, London EC1V 0HB, UK

³Optical Fiber Sensors Research Centre, University of Limerick, Castleroy, Ireland

*Corresponding author: atasi@cgcric.res.in

A stable and tunable thulium-doped “all-fiber” laser offering a narrow linewidth has been created specifically to act as a compact and simple laser source for gaseous CO_2 detection. This has been done through a careful design to match the laser output wavelengths to the CO_2 absorption lines at 1.875 and 1.997 μm , respectively. A sustainable output power of 11 mW over a tuning range of 7 nm has been obtained by using a combination of a high-reflective fiber Bragg grating with a low-reflective broadband mirror, fabricated at the end of the fiber through silver film deposition. The tuning was achieved using the relaxation-compression mechanism of the fiber Bragg grating, which formed an integral part of the laser resonant cavity. A fiber Bragg grating at 1.548 μm was utilized as a wavelength reference to monitor the tuning of the laser output over the 2 μm wavelength range with a simple and inexpensive interrogator, to avoid the use of an expensive optical spectrum analyzer and to facilitate “in-the-field” operation. This “all-fiber” laser resonator has been shown to be superior in terms of laser tuning range, output power, and linewidth compared to that created with a fiber Bragg grating pair, which was limited by the nonuniform strain transfer to both fiber Bragg gratings.

1. Introduction

Absorption spectroscopy, recognized as a highly sensitive technique for the measurement of gas concentrations for environmental monitoring, has drawn significant interest from industry and academia for many years. While a known and carefully controlled operating wavelength is vital in absorption spectroscopy, semiconductor lasers are usually not readily available at the sort of specific wavelengths that provide a close “match” to key absorption features of gases of interest. Thus they have limitations compared to fiber lasers in terms of their suitability for

this type of application, as well-designed fiber lasers offer potentially much wider wavelength ranges, in addition to valuable and distinctive features such as stability, narrow linewidth, and tunability at room temperatures. A fiber Bragg grating (FBG)-based laser resonator can be readily created to target specifically the signature absorption bands of the gas of interest, eliminating the need for more expensive optical components, while at the same time allowing a wide tuning range. The detection of very low concentrations of CO_2 , the target of the system designed in this work, has considerable importance both for atmospheric studies and for carbon emission control, for example, for climate change monitoring. It has been reported that a tunable fiber laser at a wavelength of 1.5 μm has been used for CO_2 sensing [1]

in spite of a number of known difficulties with using such a short wavelength for detection of this gas. Thus the overlap of several absorption lines from familiar environmental gases in the 1.5 μm wavelength range points to the use of absorption bands in a more distinctive region of the spectrum. In this work, wavelengths around 2 μm have been chosen to enable more specific detection where, for example, the absorption of CO_2 over the 2 μm wavelength band is 1,000 times stronger than that of the 1.5 μm region [2]. The broad fluorescence spectra of the thulium ion in silica glass allows the fabrication of a widely tunable fiber laser with tuning range from 1.7 to 2.1 μm , thus providing an excellent overlap with the strong absorption lines that are suitable for CO_2 measurement [3]. Furthermore, a number of groups have demonstrated tunability of the Tm laser emission in the near IR by using bulk components, such as gratings and birefringent tuning plates [4,5]. Recently a tunable Tm-doped fiber ring laser based on a Fabry–Perot filter (from Micron Optics) has been reported in the work of Geng *et al.* [6]. Employing a large wavelength tuning range obtained through the relaxation and compression of the FBG is a well-established technique for the wavelength range of 1.5 μm [7–9]. However, for longer operating wavelengths of around 2 μm , the bending loss is higher for standard commercial photosensitive fibers (typically with a cutoff wavelength at ~ 1.3 μm), thus limiting tuning capability through compression-relaxation. Additionally, in order to achieve a stable laser output, it is important to ensure an equal strain be transferred to the FBG pair. Despite the constraints in tuning range, a compact “all-fiber” laser system is a real boon for “in-the-field” use for environmental monitoring. Such a laser system has the advantage of being more robust, making it more rugged and reliable for installation and maintenance.

In this paper, a simple, inexpensive, and effective solution is proposed to create a better laser-monitoring system for use outside the laboratory and thus to replace bulky, external components for tuning the fiber laser. In this work, two different fiber laser configurations are set up, tested, evaluated, and cross compared, with an aim of achieving the best compact “all-fiber” laser with a narrow linewidth. In both fiber laser configurations, a short piece of highly Tm-doped single-mode and single-clad fiber is used as the gain medium. The difference, however, lies in the configuration of resonant cavities, with one using a matched pair of narrow-linewidth FBGs and the other a combination of a high-reflective FBG and a low-reflective broadband mirror coated on the end surface of the fiber. The Bragg wavelengths of the FBGs used in both cavities are designed to target the specific absorption lines of CO_2 at wavelengths around 2 μm . The laser resonators are conveniently tuned by relaxation-compression of the packaged FBG pair in the first laser setup or of the high-reflective FBG in the second. The stability of the laser wavelengths achieved, the linewidths, and the output

powers obtained are discussed and cross compared for both approaches in light of the application discussed.

2. Background and Experimentation

Prior to setting up the Tm-doped “all-fiber” laser system, an erbium-doped fiber laser operating at 1.6 μm (with output power of 130 mW) was configured as a pump laser by using 1.5 m of Er-doped fiber (Er^{3+} concentration, $\sim 5,000$ ppm) with a matched pair of FBGs, where both Bragg wavelengths are centered at 1.6 μm (highly reflective [HR] FBG $\sim 99.9\%$ and low-reflective [LR] FBG $\sim 26\%$) and the pump source at 980 nm. The advantage of pumping the Tm-doped fiber at 1.6 μm rather than 0.79 μm is twofold. First, there is the unavailability of a single-mode pump source operating at 0.79 μm beyond the output power of 100 mW, which restricts the use of a single-mode and single-clad Tm-doped fiber. However, a single-mode pump source at 1.6 μm can be readily built up by utilizing Er-doped fiber, pumped by a commercially available and inexpensive light source at 0.98 μm , allowing the creation of an “all-fiber” laser system in standard single-clad configuration. Second, the lasing efficiency for in-band pumping at 1.6 μm is higher than that for pumping at 0.79 μm unless cross-relaxation phenomena is triggered by means of very high concentrations of Tm^{3+} .

Both the Er-doped fiber and Tm-doped single-mode fiber used were fabricated “in-house” by using the modified chemical vapor deposition process coupled with the solution-doping technique. In order to form a laser resonator in the 2 μm region, 15 cm of Tm-doped (Tm^{3+} concentration, ~ 0.3 mol. %; Al^{3+} concentration, ~ 6.8 mol. %) aluminosilicate fiber was employed. Such high aluminum codoping in the core enhanced the solubility of the high concentration of Tm^{3+} without clustering and reduced the silica glass phonon energy significantly by improving the excited level lifetime of Tm^{3+} (the measured lifetime of the $^3\text{F}_4$ level, responsible for the 2 μm emission, is 830 μs). This phenomenon was presented in an earlier publication [10]. The pump absorption at 1.6 μm has a value of around 21 m^{-1} .

The recorded amplified spontaneous emission (ASE) spectrum of the Tm-doped fiber used for the laser resonator (only replacing the FBG pair) in the wavelength range from 1.75 to 2.1 μm , with pumping at 1.6 μm , is shown in Fig. 1. The spectrum shows excellent overlap with the $\nu_1 + 2\nu_2 + \nu_3$ combination absorption bands of CO_2 , located at around 2 μm . Figure 1 shows the absorption spectrum of CO_2 at wavelengths of around 1.875 and 1.997 μm together with an inset showing, with a finer resolution, the absorption line strength (HITRAN’2008 database). Targeting these two wavelength bands, two pairs of FBGs centered at 1.875 and 1.997 μm , respectively, were fabricated in-house by utilizing the phase mask technique in a commercial single-mode boron-germanium codoped photosensitive optical fiber. The FBG fabrication process was monitored by using both the ASE from the Tm-doped fiber and a

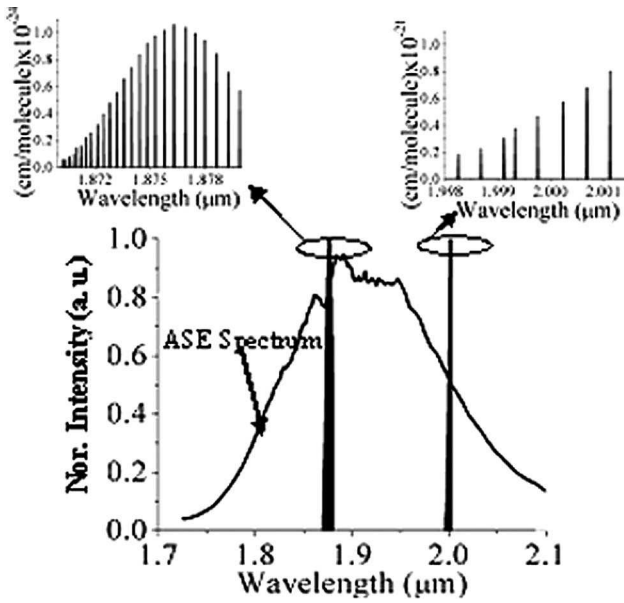

Fig. 1. ASE spectrum from Tm-doped fiber overlapped with the absorption spectrum of CO₂. Inset: zoomed spectra of CO₂ showing absorption line strength on the y axis.

(long-wavelength range) optical spectrum analyzer (OSA; AQ6375, Yokogawa). For the laser resonator operating at 1.875 μm, the reflectivities of the HR FBG and the LR FBG were ~99.9% and ~40%, respectively, while for the laser resonator at 1.997 μm, the reflectivities for the HR FBG and the LR FBG were ~99.9% and ~80%, respectively. This specific difference was aimed to achieve a lower threshold as the emission cross section of Tm in silica glass is lower at 1.997 μm than that at 1.875 μm [10]. The linewidth of both lasers that was achieved was 0.14 nm, measured by use of the OSA (with a resolution of 0.05 nm).

In order to tune the laser wavelength, both the FBGs forming the laser resonator were embedded into a flexible material (Makroform Vivak clear 099) having a Young's modulus of 2,050 N/mm², by using cyanoacrylic adhesive (Loctite 435). Together with the grating pair, a reference FBG at a wavelength of around 1.548 μm was also embedded in the same material to monitor the laser wavelength shift through an interrogator. This material was firmly adhered to the fiber to prevent any drift during the tuning process. In the compression mount, a horizontal displacement (Δz) was achieved by driving the fixing mount through a microscrew. The resulting mechanical compression ($\epsilon_z = \Delta z / L$) imposed on the FBG modified its period and effective refractive index, resulting in a Bragg wavelength shift. The stressed fiber length, L , was 44 mm. The schematic diagram of the FBG pair-based laser resonator is shown in Fig. 2(a).

In the second fiber laser configuration, shown in Fig. 2(b), the above low-reflective FBG was replaced by a low-reflective broadband mirror to enable only one FBG to be tuned. In order to fabricate this broadband mirror, the cleaved fiber end was carefully

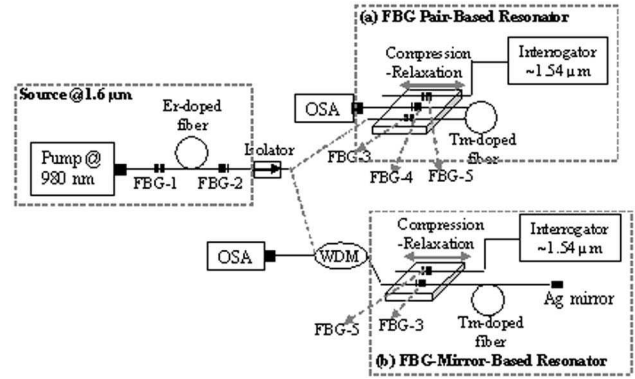

Fig. 2. Schematic diagram of tunable laser resonator (a) created by FBG pair and (b) created by an HR FBG and an LR broadband mirror at the fiber end. FBG-1, 99.9% HR FBG at 1.6 μm; FBG-2, 26% LR FBG at 1.6 μm; FBG-3, 99.9% HR FBG at 1.997 μm; FBG-4, 80% LR FBG at 1.997 μm; FBG-5, reference FBG at 1.548 μm.

prepared to achieve a high-quality outcome: it was cleaned with a stannous chloride solution (0.2%) to sensitize the coating area and then rinsed with de-ionized water. A dextrose solution (0.4 ml, 0.25 M) was poured into a tube containing Tollens' reagent and the fiber end was then dipped into the solution. The silver film was thus formed very rapidly. Finally, the fiber was thoroughly cleaned with de-ionized water [11]. The rate of deposition was controlled by changing the strength of the Tollens' reagent, and as a result the fabrication process was very repeatable. A reference mirror was fabricated and calibrated with a standard mirror having 100% reflectivity. Then a set of mirrors with 10% to 85% reflectivity were fabricated by controlling the silver film deposition rate and deposition time, where the reflectivity of the fabricated mirrors was estimated with respect to the reference mirror with reflectivity of 100%. The reflection spectrum of the fabricated mirror was monitored online through a white light source, 3 dB coupler, and OSA, and this is shown in Fig. 3 over the wavelength range from 1.5 to 1.6 μm. The fabricated mirror, having reflectivity in the range of 30% to 85%, was used together with an HR FBG to form a laser resonator. On the basis of maximum laser output powers obtained, a mirror with reflectivity of 80%

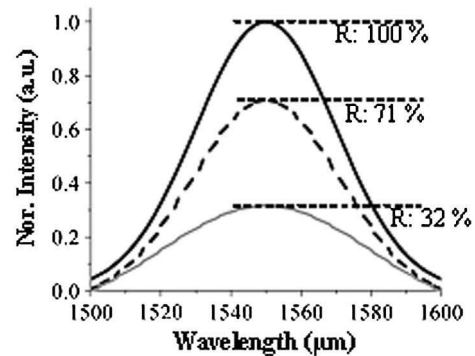

Fig. 3. Reflection spectrum of fabricated mirror at the fiber end face.

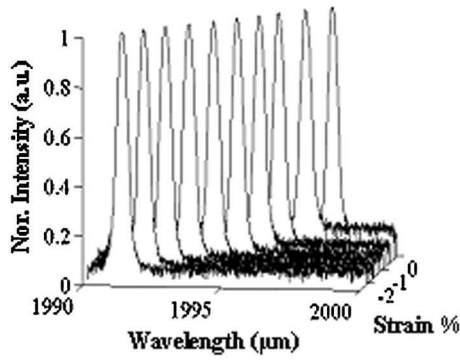

Fig. 4. Three-dimensional trace of normalized laser spectrum (at $\sim 1.997 \mu\text{m}$) as a function of negative strain or compression.

was finally selected. To achieve tuning at both wavelengths of 1.875 and 1.997 μm using this setup, only the HR FBGs and reference FBG were embedded in the material and subjected to the relaxation-compression process.

3. Results and Discussion

Figure 4 illustrates the normalized laser spectrum, as a function of the compression (negative strain) over the tuning wavelength range for the laser resonator, achieved by either tuning the grating pair simultaneously or tuning only the embedded HR FBG and keeping the broadband mirror unchanged.

The Tm-doped fiber laser exhibits a linewidth of 0.14 nm with an output power of 11 mW at 1.875 μm and 3.2 mW at 1.997 μm . The measured slope efficiency is 12% for lasing at 1.875 μm and 7% for lasing at 1.997 μm above the threshold. Research targeted at improvement of fiber design and the core composition, as well as the pumping scheme, is in progress to enhance the lasing efficiency further. However, the laser meets the key criteria where the power is sufficient for the gas-sensing application under consideration, and the narrow linewidth achieved is suitable for tuning the laser to allow an overlap with the absorption lines of the gas. It is estimated that the wavelength difference between the absorption lines in the above-mentioned wavelength range is

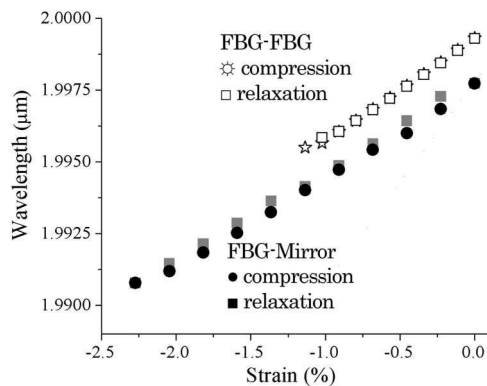

Fig. 5. Variation of the laser wavelength (at $\sim 1.997 \mu\text{m}$) with compression.

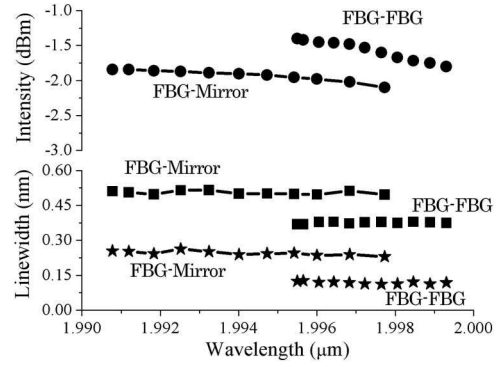

Fig. 6. Laser power, FWHM, and $1/e^2$ linewidth as a function of tuned lasing wavelength range of 1.997 μm for both resonator configurations. Circles, laser intensity; squares, FWHM laser linewidth; stars, $1/e^2$ laser linewidth.

around 0.28 nm and above. Although the laser output power at 1.997 μm is lower by comparison to that of 1.875 μm , the higher absorption line strength of CO_2 at around 1.997 μm (around 1,000 times) compensates for this to allow better device sensitivity for the prime gas-detection application. Figure 5 shows the linearity and repeatability of the tuning wavelength for both the FBG pair-based laser and the laser created using a combination of HR FBG and mirror (for laser at 1.997 μm).

It was observed that a repeatable tuning over a range of 7 nm was obtained for the laser resonator formed by using the HR FBG and the LR broadband mirror, while the tuning range is less, at only 3.8 nm, for the laser resonator with an FBG pair. Beyond this tuning range, the laser power, the linewidth, and the line shape observed were found to be difficult to maintain. Figure 6 shows the constant power seen over the lasing wavelength range of 1.997 μm . In order to monitor the laser line shape, the FWHM and the $1/e^2$ linewidth are characterized over the tuning range as shown in Fig. 6. The constant power and the stable linewidth are the key requirements for the spectroscopic-based sensor systems for which these lasers were designed as key components.

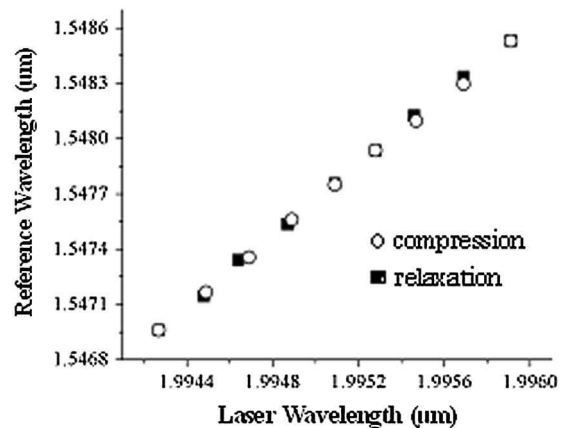

Fig. 7. Variation of reference FBG wavelength as a function of tunable laser wavelength at 1.997 μm .

It was observed that the tunable range is restricted not only by the capability of compressing the FBGs used but also by the loss of the fiber in the wavelength range around 2 μm . Further tuning is restricted here by the bending loss in the 2 μm range as the photosensitive fiber for FBG used in the system has a cutoff wavelength of 1.3 μm . The tuning range for the laser resonator using an FBG pair is lower due to the difficulty in ensuring that the same amount of compression is transferred to both FBGs, thus meeting the “matching” condition. This limitation, however, has been eliminated by using the laser resonator with an HR FBG and LR mirror.

The linear variation of the reference FBG wavelength with the laser tuning wavelength is shown in Fig. 7. This offers an effective solution capable of practical implementation through the use of a reference FBG rather than an expensive OSA, for determining the laser wavelength in the 2 μm range through a simple interrogator in the range of 1.55 μm and previous calibrated data. This approach offers the potential for the use of a simple FBG interrogator to monitor the laser wavelength over the tuning range.

4. Conclusion

The laser resonator created with the combination of an HR FBG and a broadband mirror coated at the end of the fiber produced a wider tuning range of 7 nm, compared to that created with an FBG pair, which is limited by the nonuniform strain transfer to both FBGs. Such a compact, stable, and tunable “all-fiber” laser in the 2 μm wavelength range with output power of 11 mW and linewidth of 0.14 nm, a key requirement for spectroscopic-based sensor systems, is demonstrated for the first time. The significant advantages of this “all-fiber” tunable laser-based sensor are simplicity, robustness, low cost, and convenience for use “in the field.” The strong absorption in this spectral region of the target gas, CO_2 , allows a reduction of the optical path needed to only a few millimeters, which further

ensures the compactness and portability of the sensor system.

The authors are pleased to acknowledge the support of the Council of Scientific & Industrial Research (CSIR), India, and the Engineering and Physical Research Council (EPSRC), UK, for funding.

References

1. G. Whitenett, G. Stewart, H. Yu, and B. Culshaw, “Investigation of a tuneable mode locked fiber laser for application to multipoint gas spectroscopy,” *J. Lightwave Technol.* **22**, 813–819 (2004).
2. “HITRAN’2008 database,” <http://www.cfa.harvard.edu/hitran/vibrational.html>.
3. W. A. Clarkson, N. P. Barnes, P. W. Turner, J. Nilsson, and D. C. Hanna, “High-power cladding pumped Tm-doped silica fiber laser with wavelength tuning from 1860 to 2090 nm,” *Opt. Lett.* **27**, 1989–1991 (2002).
4. F. J. McAleavey, J. O’Gorman, J. F. Donegan, B. D. MacCraith, J. Hegarty, and G. Mazé, “Narrow linewidth, tunable Tm doped fluoride fiber laser for optical-based hydrocarbon gas sensing,” *IEEE J. Sel. Top. Quantum Electron.* **3**, 1103–1111 (1997).
5. L. E. Nelson, E. P. Ippen, and H. A. Haus, “Broadly tunable sub-500 fs pulses from an additive-pulse mode-locked thulium doped fiber ring laser,” *Appl. Phys. Lett.* **67**, 19–21 (1995).
6. J. Geng, Q. Wang, J. Wang, S. Jiang, and K. Hsu, “All-fiber wavelength-swept laser near 2 μm ,” *Opt. Lett.* **36**, 3771–3773 (2011).
7. M. R. Mokhtar, C. S. Goh, S. A. Butler, S. Y. Set, K. Kikuchi, D. J. Richardson, and M. Ibsen, “Fibre Bragg grating compression-tuned over 110 nm,” *Electron. Lett.* **39**, 509–511 (2003).
8. A. Iocco, H. G. Limberger, R. P. Salathé, L. A. Everall, K. E. Chisholm, J. A. R. Williams, and I. Bennion, “Bragg grating fast tunable filter for wavelength division multiplexing,” *J. Lightwave Technol.* **17**, 1217–1221 (1999).
9. J. Sun, C. C. Chan, and X. Y. Dong, “A wide tunable range fiber Bragg grating filter,” *J. Optoelectron. Adv. Mater.* **8**, 1250–1253 (2006).
10. A. Pal, A. Dhar, S. Das, S. Y. Chen, T. Sun, R. Sen, and K. T. V. Grattan, “Ytterbium-sensitized thulium-doped fiber laser in the near-IR with 980 nm pumping,” *Opt. Express* **18**, 5068–5074 (2010).
11. D. W. Kim, Y. Zhang, K. L. Cooper, and A. Wang, “In-fiber reflection mode interferometer based on a long-period grating for external refractive-index measurement,” *Appl. Opt.* **44**, 5368–5373 (2005).