

Mujic, E., Kovacevic, A., Stosic, N. & Smith, I. K. (2011). Noise generation and suppression in twin screw compressors. Proceedings of the Institution of Mechanical Engineers, Part E: Journal of Process Mechanical Engineering, 225(2), pp. 127-148. doi: 10.1177/1464419311403875



**CITY UNIVERSITY
LONDON**

[City Research Online](#)

Original citation: Mujic, E., Kovacevic, A., Stosic, N. & Smith, I. K. (2011). Noise generation and suppression in twin screw compressors. Proceedings of the Institution of Mechanical Engineers, Part E: Journal of Process Mechanical Engineering, 225(2), pp. 127-148. doi: 10.1177/1464419311403875

Permanent City Research Online URL: <http://openaccess.city.ac.uk/4420/>

Copyright & reuse

City University London has developed City Research Online so that its users may access the research outputs of City University London's staff. Copyright © and Moral Rights for this paper are retained by the individual author(s) and/ or other copyright holders. All material in City Research Online is checked for eligibility for copyright before being made available in the live archive. URLs from City Research Online may be freely distributed and linked to from other web pages.

Versions of research

The version in City Research Online may differ from the final published version. Users are advised to check the Permanent City Research Online URL above for the status of the paper.

Enquiries

If you have any enquiries about any aspect of City Research Online, or if you wish to make contact with the author(s) of this paper, please email the team at publications@city.ac.uk.

Noise generation and suppression in twin screw compressors

E. Mujic, A. Kovacevic, N. Stosic, I. K. Smith

City University London
Centre for Positive Displacement Compressor Technology
City University, London EC1V 0HB, U.K.

1 ABSTRACT

Screw compressors generate a substantial level of noise during operation. The first stage in reducing it is to identify and minimise its causes. To this end, sources of noise within these machines have been reviewed, the most significant of which are identified, and methods of minimising their effect are evaluated.

KEYWORDS: Screw compressor, noise, gas pulsations, rotor rattling, transmission error

2 INTRODUCTION

Screw compressors generate a substantial level of noise during operation, arising from both mechanical and fluid sources.

Mechanical sources of noise have been thoroughly investigated by Stosic [21] and Holmes [7,8] who proposed methods for their reducing their effects.

Investigations of gas pulsations, regarded as the most important fluid source of noise, have been published by different authors. These began in 1986 when Fujiwara and Sakurai [4] first measured gas pulsation, vibration, and noise in a screw compressor. Subsequently, Koai and Soedel [10, 11] 1990, developed an acoustic model in which they analysed flow pulsations in a twin screw compressor and investigated their influence upon its performance. More recently, Sangfors 1999 [16], Tanttari 2000 [22] and Huagen et al 2004 [9] developed mathematical models for the prediction of gas pulsations in screw compressor suction and discharge chambers.

These authors explored the influence of various screw compressor parameters upon gas pulsations in the compressor suction and discharge chambers. The influence of the majority of them, which mainly affect the pressure difference between the compressor chambers, will be explained in more details in this paper. The most recent investigation on gas pulsations carried by Mujic et al 2005 [14] included the influence of the discharge port area as another important parameter, previously neglected. Results showed that changing the shape of a screw compressor discharge port alters gas pulsations in the discharge chamber, with reduced pulsation amplitude leading to lower overall noise levels.

3 TEST COMPRESSOR

Both analytical and experimental studies were carried out on an ELGI E102, oil flooded industrial air compressor, shown in Figure 1. The test compressor was placed in the laboratory test rig, which was built to meet CAGI and PNEUROP test standards. The compressor was driven by an electric motor through a gearbox, with speed variation obtained by use of a frequency inverter.

Testing was carried out according to ISO 1706, with the delivery flow measured by an orifice plate according to BS 5600. A pressure transducer Endevco model 8530B-500 positioned inside the compressor discharge chamber was used for measurements of the gas pulsations. An SJK Scientific Ltd – Integrating Averaging Sound Level Meter HML 323 was used to measure the Sound Pressure Level (SPL) around of the compressor. The screw compressor was positioned in a room rather more reverberant than an anechoic chamber and noise measurement are carried out according to standard ISO 3744 [23].

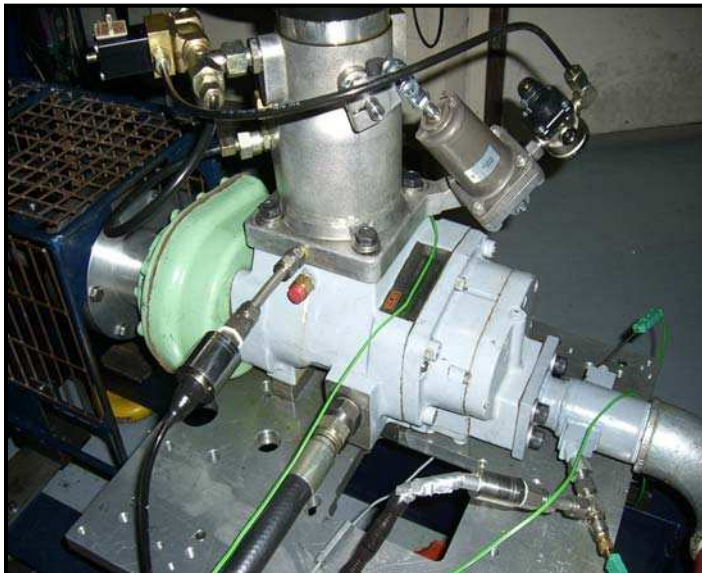

Compressor E102 design parameters		
Centre distance	[mm]	71
Rotor length	[mm]	158
Wrap angle	[deg]	300
		Main Gate
Number of lobes	[mm]	4 5
Outer diameter	[mm]	102 80
Pitch diameter	[mm]	63 79
Inner diameter	[mm]	62 40

Figure 3.1 Test compressor in the test rig **Table 1. Test compressor design parameters**

The most important design parameters of the test compressor are given in Table 1. These parameters, together with operational parameters, were used as inputs to analytical models. The compressor was operated over an outlet pressure range of 3 and 12 bar and a speed range of 2000 to 6000 rpm.

4 SOURCES OF NOISE WITHIN SCREW COMPRESSORS

During a compressor operating cycle, part of the energy is dissipated in the form of flow and mechanical disturbances such as gas pulsations or rotor rattling. These generate both system vibrations and pressure waves, with a range of frequencies and intensity levels, called noise. It is impossible to remove these noise sources completely, but some improvements are possible if efforts are directed towards the reduction of disturbances created during the compressor working process. To do that, one has first to distinguish between the different mechanisms of noise generation and to classify them according to both, their significance and the possibility of their reduction.

4.1 Mechanical sources of noise

The main source of mechanical noise is intermittent contact between the compressor rotors, especially in an oil injected compressor. This is the result of variation in the torque transferred from the male to the female rotor. New and more efficient rotor profiles introduce a very small negative torque to the female rotor compared with that of the male rotor. This torque, generated by the pressure induced forces acting on the female rotor, is of the same order of magnitude as that created by other means, such as contact friction and oil drag forces. Since the negative female rotor torque acts in the opposite direction to other two, the net torque may change in sign from negative to positive within one lobe rotation cycle as indicated by Stošić et al [21]. This may cause instability in the female rotor rotational motion, resulting in flutter and, in the extreme case rattling. Stošić proposed new type of the profile, called "silent" which maintains positive torque on the female rotor and prevents this kind of noise to occur.

Holmes [7,8] suggests another reason for noise generation, called transmission error. Transmission error occurs in the driven component of a screw pair when its instantaneous angular position differs from the theoretical angular position. This causes, earlier or later than expected, contact between rotor lobes which generates noise. Holmes suggests the reasons for the existence of the transmission error might be lead mismatch, lead non-linearity, pitch errors, housing bore imperfection, bearing deflections, and the rotor deflection due to gas forces. Holmes suggests relieving of the rotor's profiles to enable smoother contact between the lobes and reduce noise.

The noise reduction procedures proposed by both Stošić and Holmes resulted in reported overall noise attenuation of 4 to 6 dBA.

Theoretically, there should be no contact between the rotors in an oil free compressor. In that case, the source of mechanical noise is contact of the synchronizing gears. Due to the number of teeth in the gears being much greater than the number of rotor lobes, the produced noise is of a higher frequency. Apart from synchronizing gears, driving gears are present in a screw compressor. Very often a step up gearbox is an essential part of the machine and the gears contained in it produce noise as well. The main causes of noise, described by Holmes for rotors, may be applied to noise generated by the gears. More details of this are given by Munro [15] and Smith [18].

4.2 Fluid sources of noise

According to Sangfors [16,17], Koai and Soedel [10,11], Tanttari [22] and Huagen et al 2004 [9], gas pulsations are the main source of noise generated by fluid flow in screw compressors. These are created by unsteady fluid flow through the suction and the discharge ports which change the pressure within the suction and discharge chambers. The flow rate depends mainly on the pressure difference between the chambers and starts with the exposure and finishes with the cut-off of the suction or discharge port, as the rotors revolve past them.

The amplitudes of the gas pulsations in the compressor suction and discharge chambers are very high. A typical frequency spectrum of pressure pulsations in the suction and discharge chambers of the test screw compressor used in this investigation is shown in Figure 4.1. As can be seen, the gas pulsations are higher in the discharge chamber than in the suction chamber. However, while the discharge port is completely enclosed in the housing, the suction port may be more exposed to its surroundings, which are separated from the atmosphere only by the suction filter. Therefore, despite the smaller pulsations, noise generated in the suction chamber requires similar attention to that generated in the discharge chamber.

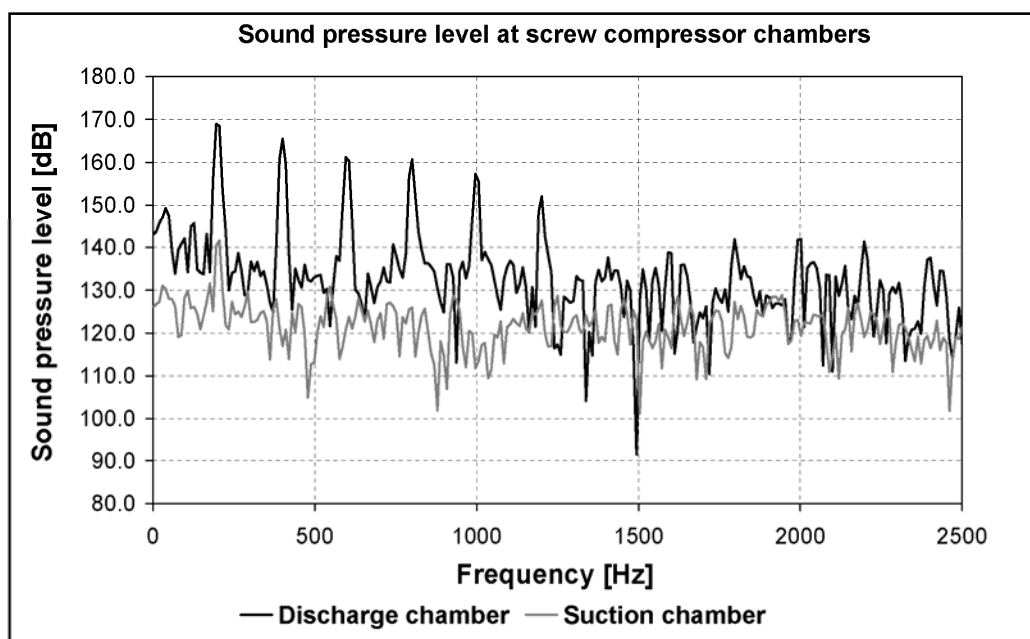

Figure 4.1 Sound pressure spectrum in suction and discharge chambers

Another cause of fluid flow noise in screw compressors is turbulent fluid flow through the ports and the clearance gaps. Soedel [20] believes that turbulent noise contributes to the overall sound mainly in the higher frequency ranges between 3-6 kHz. However, compressor noise in that frequency spectrum is relatively low. So, this source of noise is rightly neglected.

5 PARAMETERS WHICH INFLUENCE GAS PULSATIONS

To minimize screw compressor noise, generated by gas pulsations in the suction and discharge chambers, it is necessary to determine the parameters which influence them. Previous studies have reported the influence of some of these as well as on other aspects of compressor design and operation. However, reasons for selecting these parameters from the many others possible were not given. To investigate this and to find if there are any other significant parameters, previously overlooked, the discharge process has been analysed here. As the processes in the suction chamber are very similar, the conclusions drawn from this study are also applicable to this chamber.

5.1 Main factors which affect gas pulsations

The working and discharge chambers, connected through the discharge port are shown schematically in Figure 5.1. Both of these are also connected to the rest of the system outside the compressor. The compressor working chamber is connected to other working chambers or to the suction chamber through leakage paths, while the discharge chamber itself is connected to the discharge pipe. The connections between the chambers and their surrounding are always present. However, the connection between working and discharge chambers is of a periodical nature. Accordingly, the discharge process of the working chamber starts with the opening of the discharge port and lasts only until the port is closed.

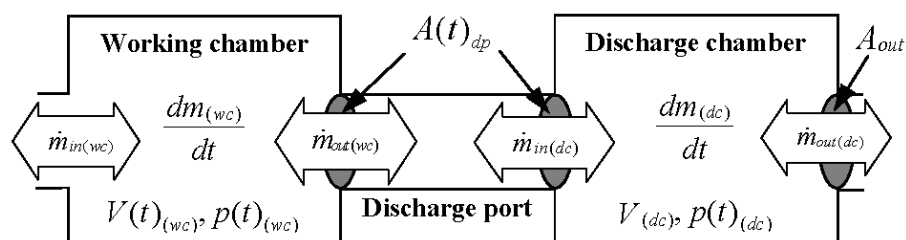

Figure 5.1 Screw compressor discharge system

If heat transfer through the chamber walls is neglected, then the gas condition in the chamber is determined by the change of the chamber volume and by the mass and energy transfer rates between the chamber and its surroundings. The volume of the working chamber is defined by the machine geometry and is expressed as a volume function $V(t)_{(wc)}$ but the volume of the discharge chamber $V_{(dc)}$ is constant. Therefore, it follows that the gas state in the discharge chamber is influenced only by the mass and energy transfer rates. This corresponds with the fact that gas pulsations in a chamber occur when the mass of the gas in the chamber vary with time, as shown in (5.1).

The term $dm_{(dc)}/dt$ is regarded here as a measure of the amplitudes of the gas pulsations. Higher mass variation causes greater amplitude of gas pulsations and is caused by substantial increase in unsteady inlet or outlet flows. Therefore, it is necessary to determine when this occurs during the screw compressor cycle and which parameters influence it most.

$$\frac{dm_{(dc)}}{dt} = \dot{m}_{in(dc)} - \dot{m}_{out(dc)} \quad (5.1)$$

In Figure 5.1, two mass flows are shown between the discharge chamber and its surroundings. The first is the mass inflow into the discharge chamber from the compressor working chamber. The second is the mass outflow from the discharge chamber into the compressor discharge system consisting of pipes, oil separators and similar components. Both flows are time dependent and need to satisfy the continuity equations (5.2) and (5.3).

$$\dot{m}_{in(dc)} = \rho v A(t)_{dp} \quad (5.2)$$

$$\dot{m}_{out(dc)} = \rho v A(t)_{out} \quad (5.3)$$

These equations show that both mass flows depend upon the instant gas density and the velocity. The fluid velocity is dependent upon the difference of fluid enthalpies in the chambers. For compressors, this is equivalent to the velocity being proportional to the square root of the pressure difference between the chambers, as shown in equation (5.4).

$$v = C_D \sqrt{2(h_{HP} - h_{LP})} = C_D \sqrt{2 \frac{\gamma}{\gamma - 1} \left(\frac{P_{HP}}{\rho_{HP}} - \frac{P_{LP}}{\rho_{LP}} \right)} \quad (5.4)$$

Therefore, the pressure difference between the working and discharge chambers is a parameter which influences the gas pulsation levels. The highest pressure difference happens when discharge begins, and it reduces as the discharge process is progresses. The pressure difference between the discharge chamber and the pipe system is a result of the gas pulsations rather than their cause. Therefore it will not be investigated here.

By analysing equations (5.2) and (5.3) two more parameters can be identified which influence mass flows and later gas pulsations. The first is the outlet area A_{out} , where the discharge chamber is connected to the discharge pipe. This outlet area is constant and it is good to make it as large as possible. A larger area will cause less pressure difference for the same flow between the discharge chamber and pipe and will therefore stabilize the pressure in the discharge chamber.

The second parameter which influences the mass flow, which has not been properly considered in previous studies, is the cross sectional area between the working and discharge chambers, $A(t)_{dp}$, defined at the discharge port. According to equation (5.2) the effect of variation of the discharge port size is of the same order of magnitude as that of changes in density or velocity. This implies that the gas flow variation and pressure pulsation can be altered by modifying the discharge port area function. This can be achieved by changing the shape of the discharge port.

It follows that the two basic parameters which influence the level of gas pulsations in the discharge chamber are the pressure difference and the discharge port area function. In order to decrease the amplitude of gas pulsations in the discharge chamber these two parameters need be optimised. It is necessary to explore and to optimise at least one of these two parameters.

5.2 Flow area of the discharge port

As explained in the previous section, the flow area may have an important influence on gas pulsations and the influence of different discharge ports on gas pulsations was noted, by Errol and Ahmet [2]. However no explanation for this was published beyond the fact that the flow areas of the discharge ports were altered by changing ports. Accordingly, the most likely parameter responsible for this is the port shape.

Using the calculation method presented by Mujic et al [14], it was possible to calculate the discharge flow area for the test compressor. The light line in Figure 5.2 shows the conventional shape of the discharge port and the calculated discharge area that this allows through the entire discharge process is given also by a light line in Figure 5.3. This port shape follows the shape of the rotor profile exactly and enables the port to open simultaneously along the entire trailing edge of the rotor profile. As a result, at the instant of opening, the port area has a high rise gradient as shown in the diagram.

Such a large flow area, accompanied by a high pressure difference at the beginning of the discharge process, generates substantial inflow to the discharge chamber. As already explained, this has a negative effect on the amplitude of gas pulsation. It is possible to reduce the discharge flow area, which will also reduce mass inflow to the discharge chamber, by changing the shape of the port as is shown in Figure 5.2 by the bold line. This port shape reduces the discharge flow area at the beginning of the discharge process and, as shown in Figure 5.3, by the bold line, leads to a discharge flow area with a lower rise gradient and therefore smaller flow area when discharge starts. This should reduce mass inflow into discharge chamber and consequently reduce the amplitude of the gas pulsations.

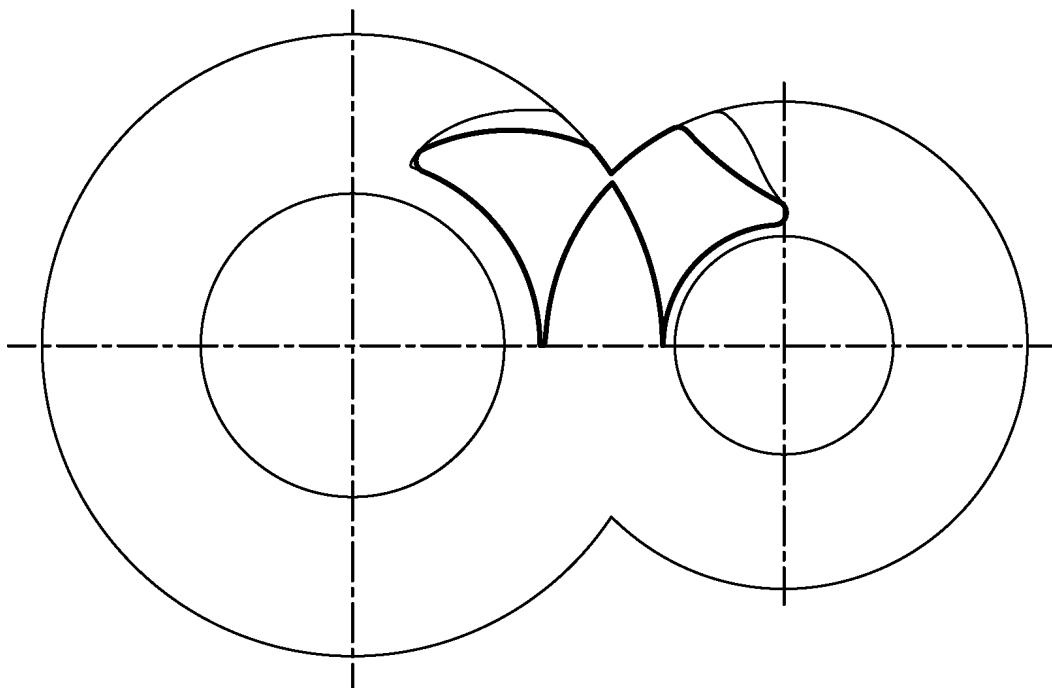

Figure 5.2 Screw compressor discharge port geometry

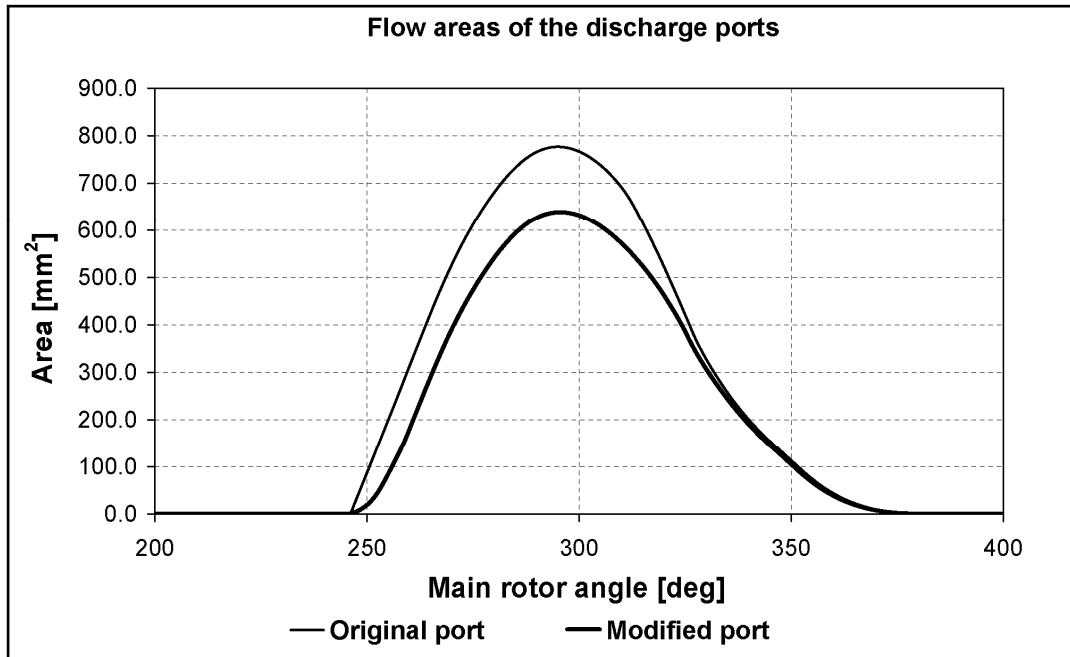

Figure 5.3 The flow area function of the discharge ports

The results shown in Figure 5.5 were derived by use of the mathematical model previously described by Mujic et al [14]. It is clear that predicted level of gas pulsations for the modified port is reduced across the test compressor working range. The predicted results were compared with results obtained from the test compressor, which had its discharge port modified. This was done by machining two slots on the male and female sides of the port to remove the original port from the compressor housing. Two metal inserts which formed the shape of the new port were then inserted into the slots. The new and old port shapes are shown in Figure 5.4.

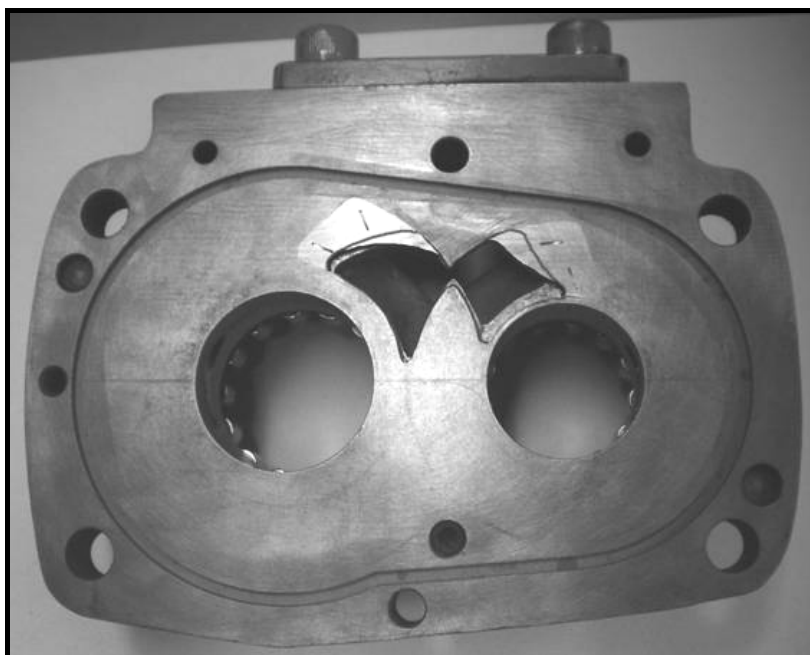
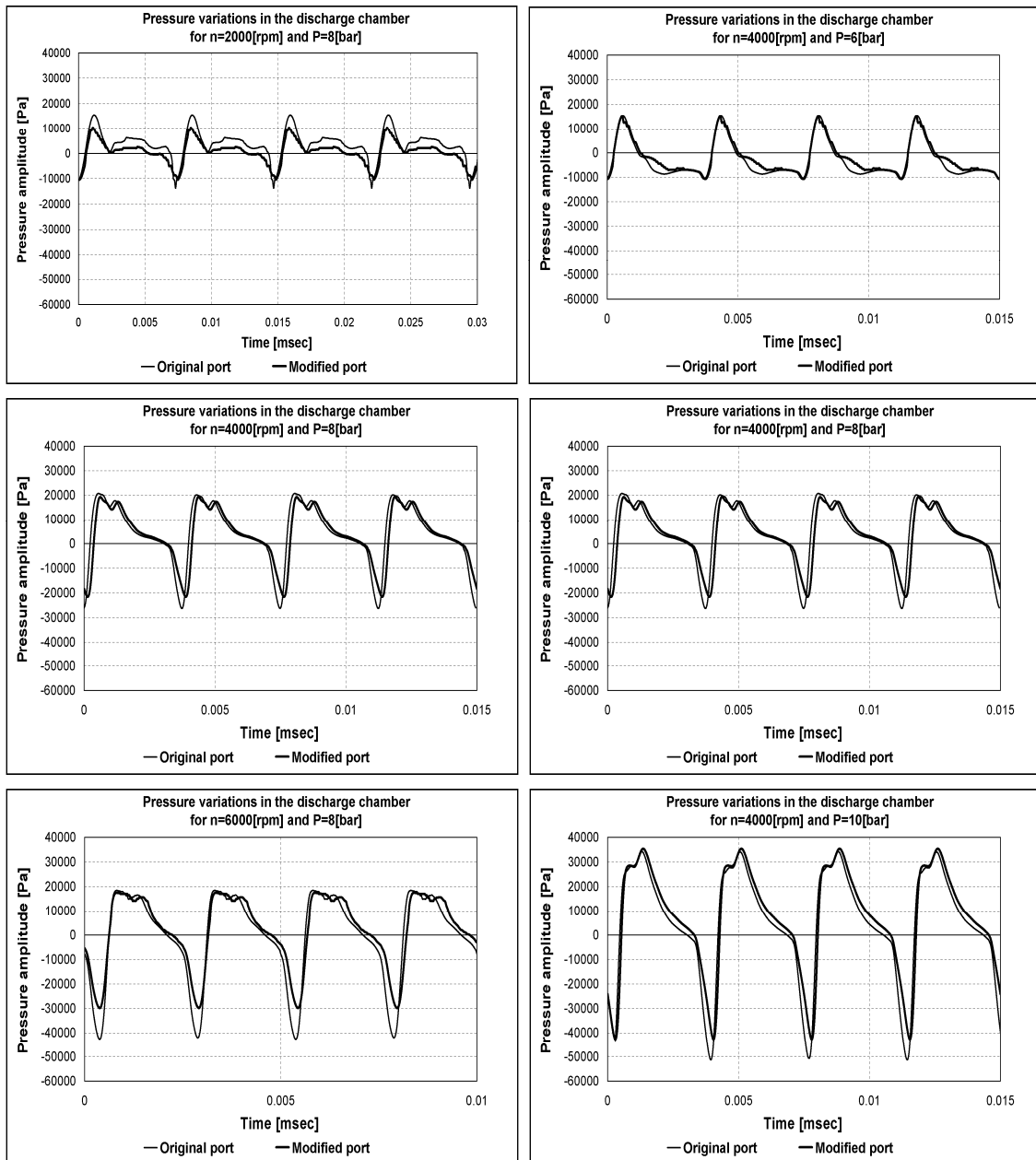

Figure 5.4 Discharge port geometry modification



a) Outlet pressure 8 [bar]

b) Compressor speed 400[rpm]

Figure 5.5 Comparison of calculated gas pulsations for original and modified discharge ports

The measured pressure history obtained from the original and modified shapes of the discharge port is shown in Figure 5.6 while the calculated values of the Sound Pressure Level (SPL) are shown in Figure 5.7 and Figure 5.8. In all these diagrams the results for the original port shape are plotted by light lines while those for the modified port are shown in bold. It can be seen that the amplitudes of the gas pulsations are reduced across the whole range of the working conditions.

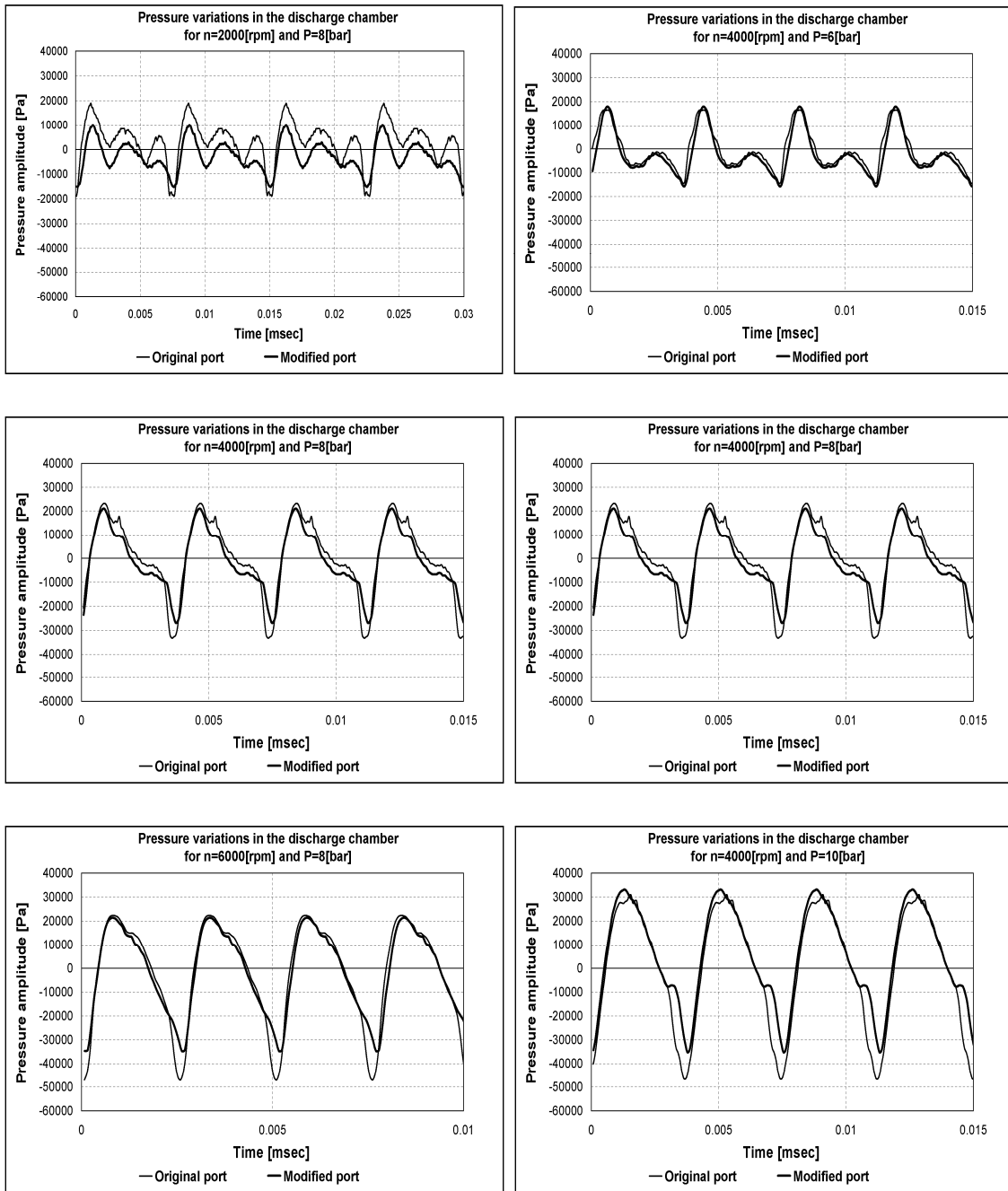

a) Outlet pressure 8 [bar]

b) Compressor speed 400[rpm]

Figure 5.6 Comparison of experimental data for original and modified discharge ports

Figure 5.7 shows the effect of varying the outlet pressure upon the gas pulsations. It can be seen that the minimum level of gas pulsations is at an outlet pressure of approximately 6 bar. Since this corresponds to the smallest pressure difference between the working and discharge chambers, and the pressure difference increases with the outlet pressure, the gas pulsations, the reduction in the level of the gas pulsations was greatest for the modified ports at the higher pressures. Thus, the reduction of gas pulsations varies from 2 dB at an outlet pressure $p_{ou} = 6$ bar to almost 5 dB at $p_{ou} = 12$ bar .

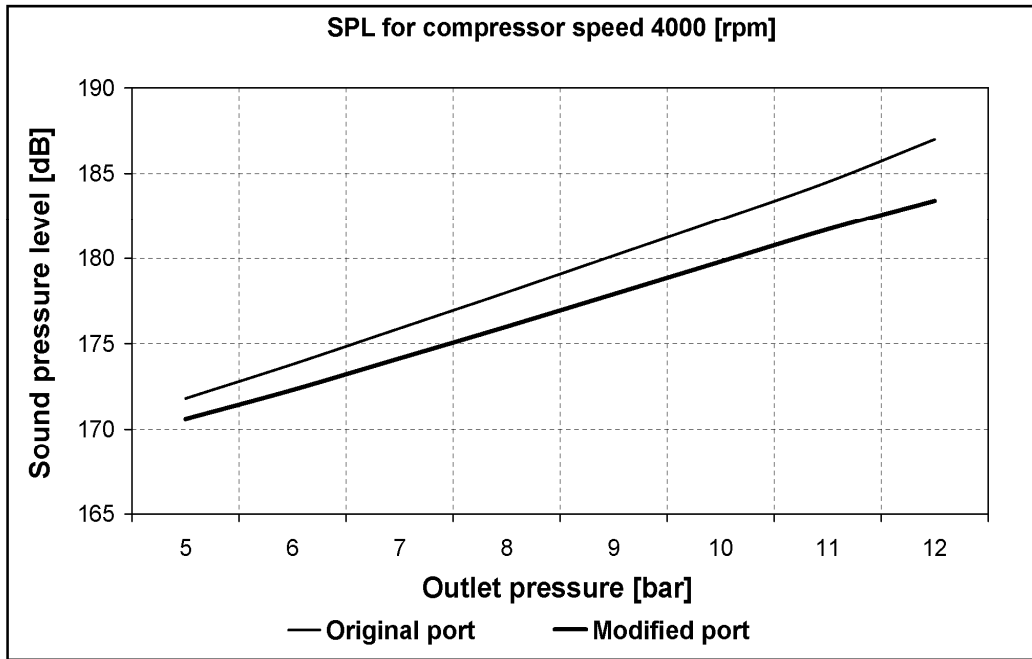

Figure 5.7 Calculated SPL for different outlet pressures

The reduction of noise is expected to increase with compressor speed. However, this is not shown in Figure 5.8. The maximum reduction is achieved at a shaft speed of $n = 2000$ rpm because the amplitude of the gas pulsations has been reduced across the whole cycle and not only for the peaks as is case for other speeds. The reduction over whole speed range is between 3-4 dB.

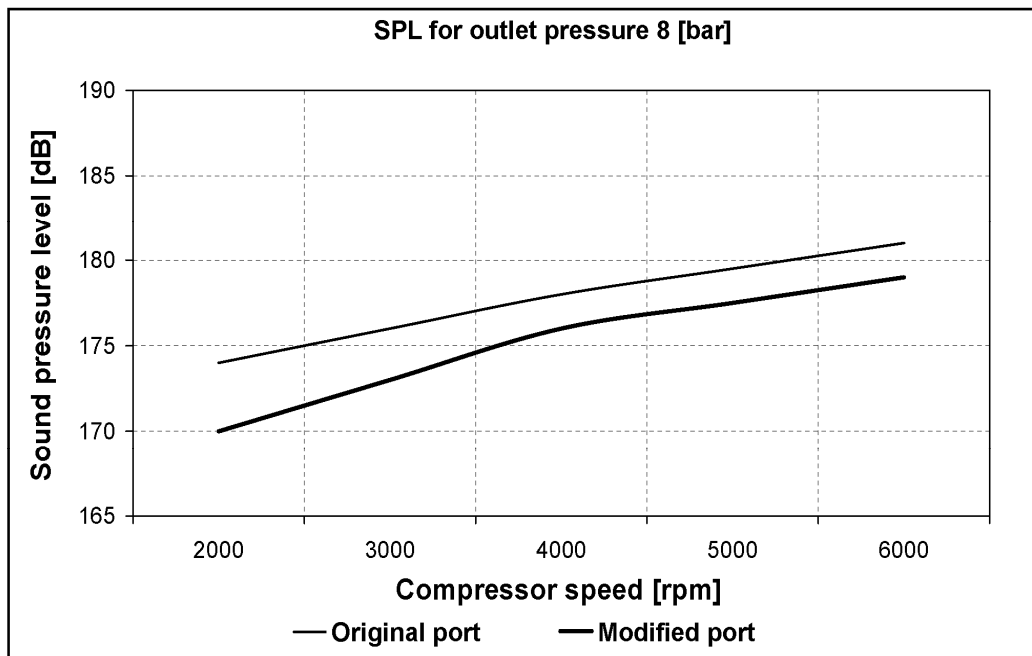

Figure 5.8 Calculated SPL for different compressor speeds

Reduction in magnitude of the gas pulsation affected the overall noise and it can be concluded from Figure 5.9, that the SPL measured in the compressor environment was reduced by 3 dB at a compressor speed $n = 4000$ rpm over the entire range of pressures. It was also effective over the

entire compressor speed range as is shown in Figure 5.10, where the noise reduction is between 2 dB for shaft speed of 2000 rpm and 5 dB when the speed rises to 6000 rpm.

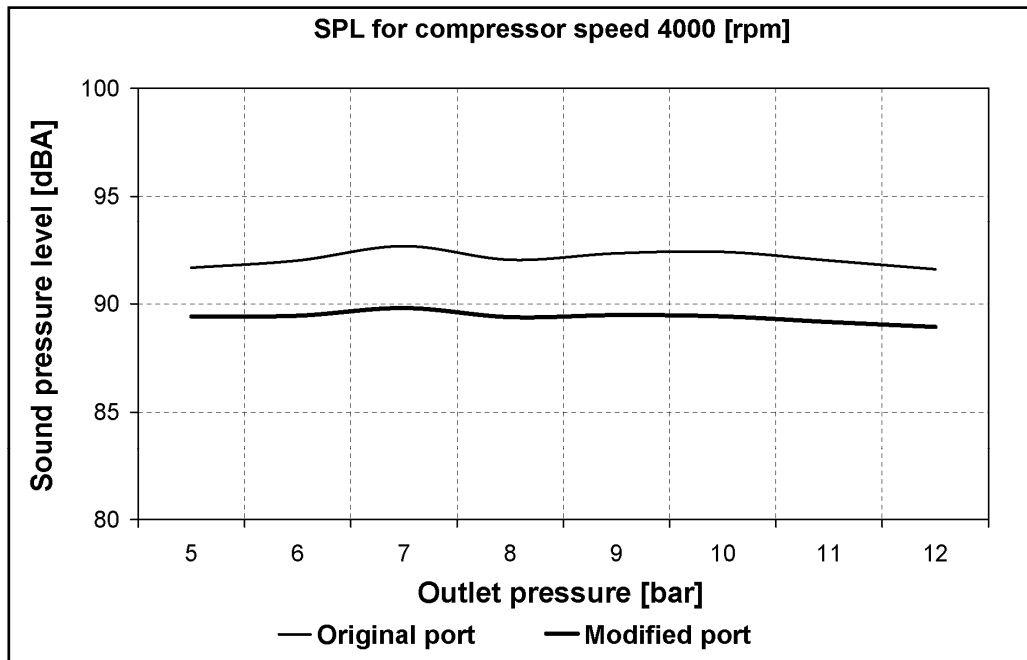

Figure 5.9 Measured SPL for different outlet pressures

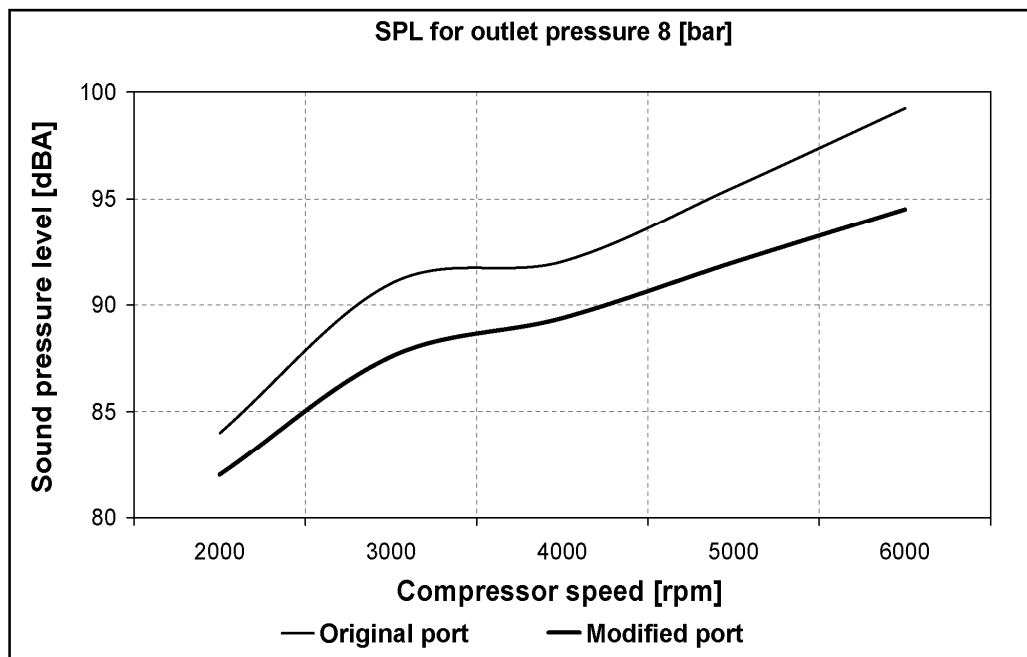

Figure 5.10 Measured SPL for different compressor speeds

The pattern of captured gas pulsations is not fully replicated in the overall compressor noise measurements. Other sources of noise, present in the compressor test cell, affected the overall level of noise measured outside. This is particularly noticeable at lower compressor speeds and outlet pressures when the noise generated by the screw compressor is fairly low and therefore the overall noise is more influenced by other sources.

Since modification of the discharge port reduced the flow area, the flow losses are increased, thereby affecting the compressor performance. The compressor with the modified port requires more power than that with the original port and a comparison of the specific power for the two versions of the machine is presented in Figure 5.11 and in Figure 5.12. Figure 5.11 shows that over the whole speed range the compressor with the modified port consumed more power at a constant outlet pressure of $p_{ou} = 8 \text{ bar}$.

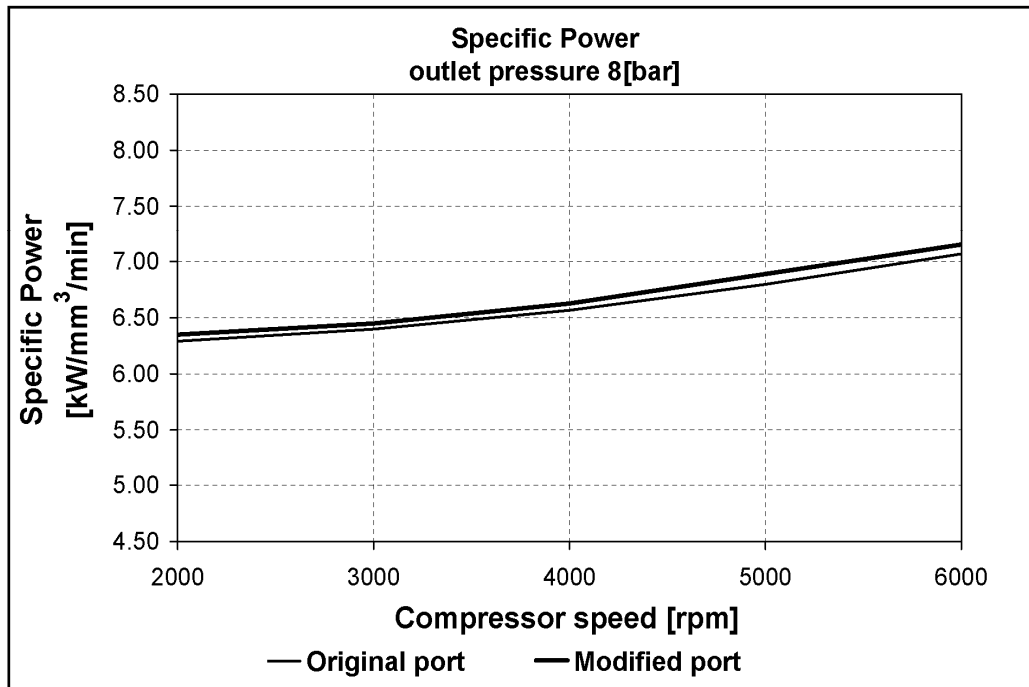

Figure 5.11 Compressor specific power for different outlet pressures

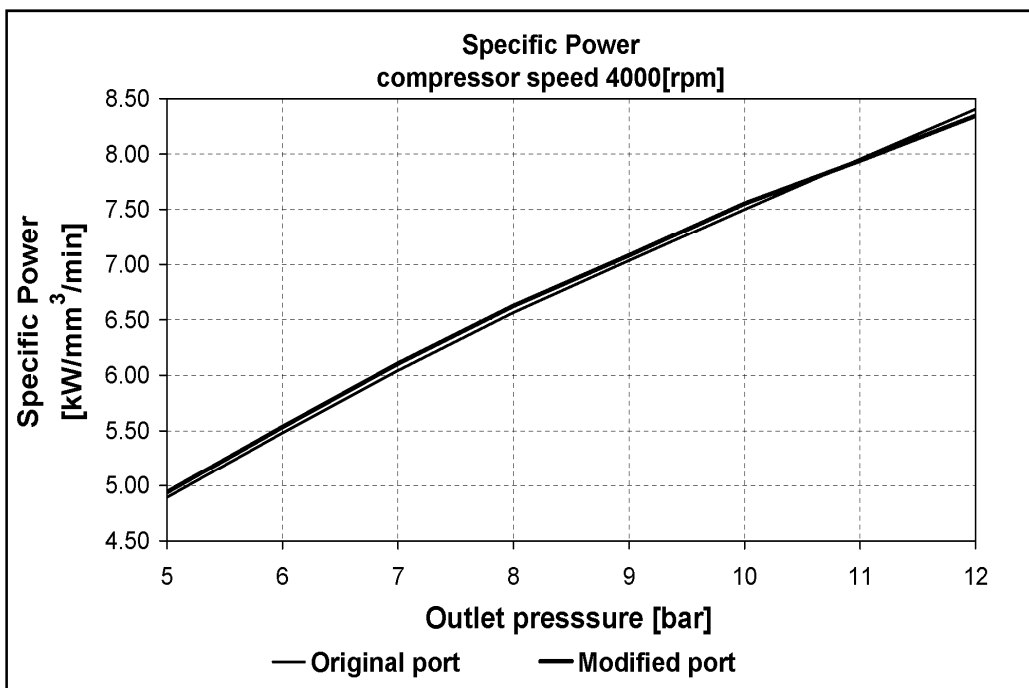

Figure 5.12 Compressor specific power for different speeds

A comparison of the specific power, presented in Figure 5.12 for a compressor constant speed of 4000 rpm shows that the compressor with the modified port consumes more power for the majority of the pressure range. However, for the highest pressures in the range, specific power is lower for the new port. The reason for this is that the new port shape reduces back flow when the compressor operates at higher pressures.

5.3 Pressure difference

The pressure difference considered here is the difference in pressure between the gas in the working chamber and the gas in the discharge chamber at the end of compression. The gas pressure in the working chamber at the end of the compression is determined by the machine built in volume ratio. On the other hand, the gas pressure in the discharge chamber depends on the outlet pressure. Studies of Koai and Soedel [10], Sangfors [16] and Gavric [5] showed that the difference between the pressures in the working and the discharge chambers at the end of the compression is the most important factor in the generation of gas pulsations. According to equations (5.2) and (5.4), the mass flow rate between the two chambers increases with the pressure difference between them, which further increases term the dm/dt regarded as the measure of gas pulsations. As shown in Figure 5.13 the pressure difference is a maximum at the start of the exposure of the working chamber to the discharge port.

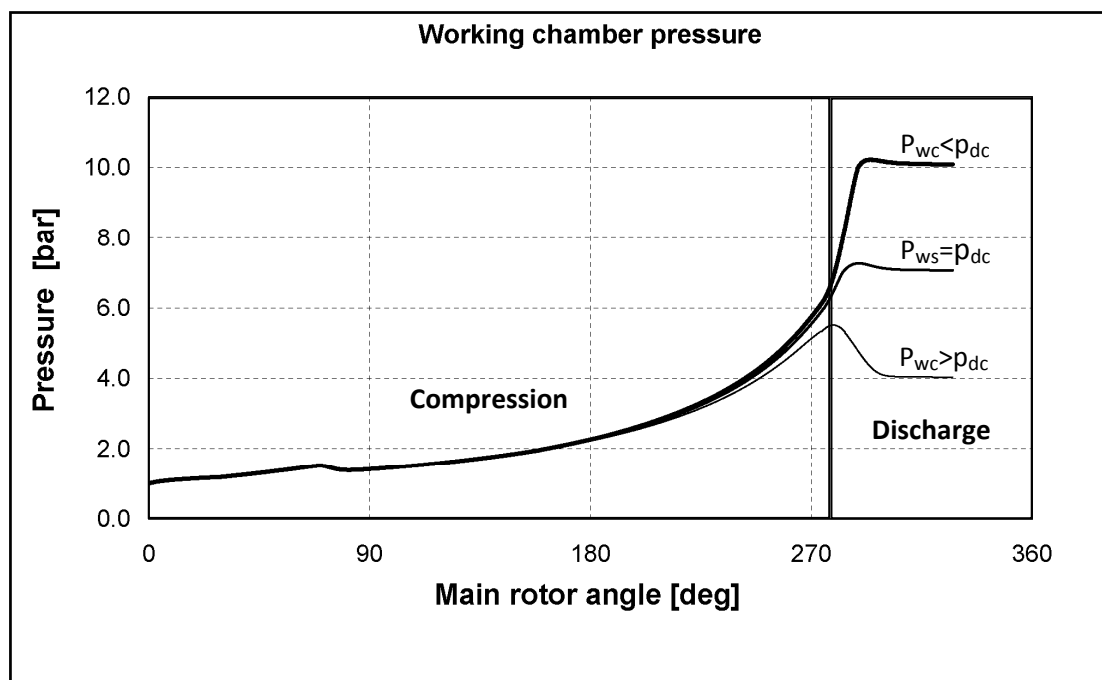

Figure 5.13 Over-compression and under-compression in working chamber

If the discharge port opens late, over-compression in the working chamber will occur and its pressure p_{wc} will be higher than the pressure in the discharge chamber, p_{dc} as presented in Figure 5.13. The pressure difference is then positive and fluid will flow from the working chamber into the discharge chamber. This velocity caused by positive pressure difference is further supported during the cycle by the movement of the rotors. This increases the mass flow rate from the working to the discharge chamber and hence, the pressure amplitude is thereby bigger.

Similarly if there is under-compression in the working chamber, then, at the point of its exposure to the discharge chamber, p_{wc} will be less than p_{dc} , and the direction of flow will be reversed. The velocity generated by the pressure difference is then in the opposite direction to that of the rotor movement. If under compression is low, then the fluid back flow thus generated can be of the same level as the flow generated by the rotor movement. In that case there will be little or no pressure oscillation in the discharge chamber at the beginning of the discharge process, as reported by Koai, Soedel [10] and Gavric [5]. However, for higher under-compression a greater pressure drop in the discharge chamber will occur, leading again to larger gas pulsations.

Reduction of the pressure difference between the working and discharge chambers certainly reduces gas pulsations in the discharge chamber. However, this pressure difference is not an independent parameter which can be varied and, in turn, is dependent on many other compressor parameters. These parameters were considered together with their effect upon the flow area function and how they might be modified to minimise gas pressure pulsations.

5.3.1 Outlet pressure

The outlet pressure, considered to be the pressure in the outlet reservoir, is one of the two previously mentioned pressures which determine pressure difference. Screw compressors are usually designed to provide acceptable performance across a wide discharge pressure range. This means that the compressor outlet pressure is generally not a fixed value. Thus, the pressure difference between the working and discharge chambers when discharge starts is not always the same. It depends on the outlet pressure and it is zero when the outlet pressure is equal to that in the working chamber. The minimum amplitude of the gas pulsations can thus be associated with this condition.

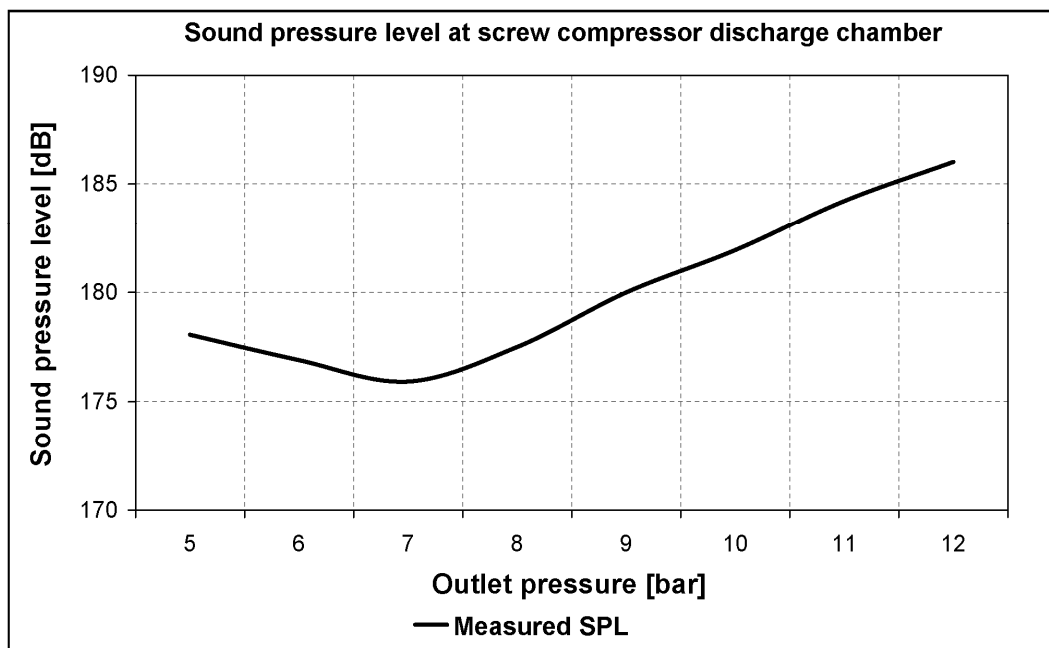

Figure 5.14 Influence of discharge pressure on sound pressure level

The Sound Pressure Level (SPL) generated in the discharge chamber of the test compressor is shown in Figure 5.14 for the entire compressor range of outlet pressures. It confirms that the gas pulsations in the discharge chamber have a minimum at an outlet pressure close to that in the working chamber. These results correspond to the findings of Sangfors [16] and Huagen et al [9], who found that this phenomenon has a large influence on the first three harmonics of the gas pulsation function. Their results showed that this minimum does not fall exactly to the outlet pressure matching to that achieved in the machine built-in volume ratio. According to Gavric [6], it coincides with a slight under-compression in the working chamber.

Although gas pulsations of the test compressor have a minimum that depends on the outlet pressure, this cannot be used to minimise their level because it is a compressor operational parameter which is defined by the user's requirements and, these do not necessarily correspond with the value required to minimise noise generation.

5.3.2 Built in volume ratio

The built in volume ratio is a compressor parameter which determines the gas pressure at the end of compression in the working chamber. It represents the ratio of the working chamber volume at the suction cut off to that at the discharge opening, as given in equation (1.5).

$$\mathcal{E}_{bl} = \frac{V_{3cs}}{V_{3ce}} \quad (1.5)$$

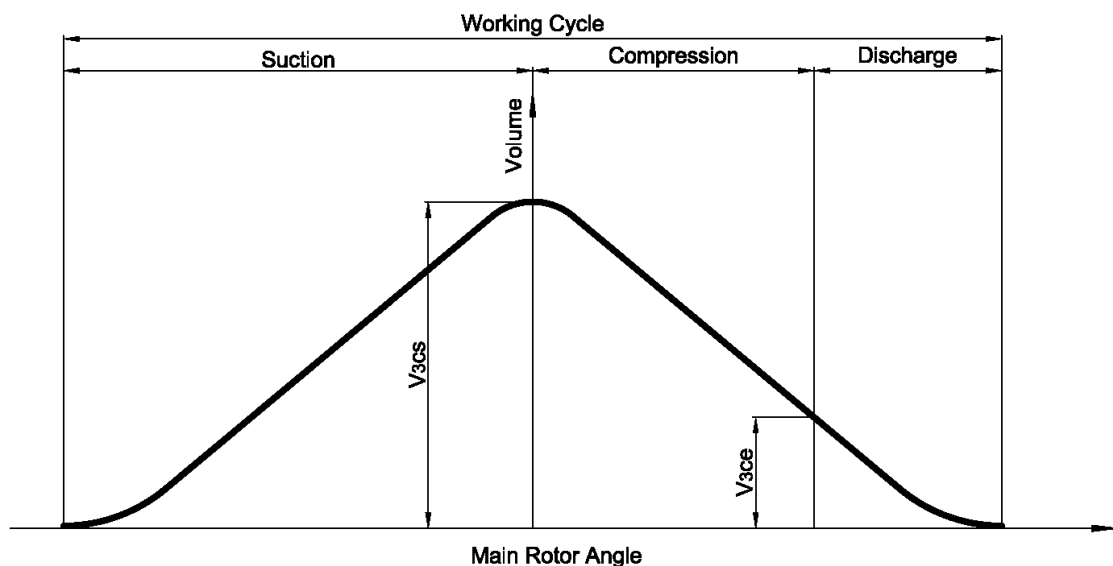

Figure 5.15 Working chamber volume curve

The built in volume ratio is selected to produce the best compressor performance for the required range of outlet pressures. For a constant cut-off position on the suction side, the built in volume ratio can be determined by the position of the discharge port opening, as shown for three standard port cases in Figure 5.16. Apart from determining different pressures in the working chamber at the end of the compression, this also influences the flow area of the discharge port. Thus if the flow area of the discharge port is changed, the gas pulsations in the discharge chamber may be affected.

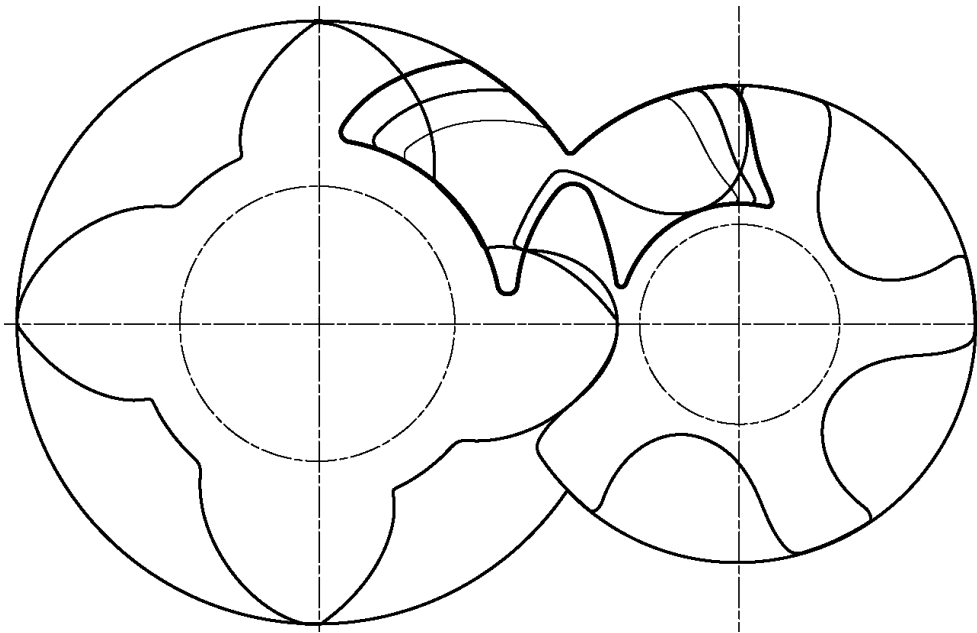

Figure 5.16 Examples of screw compressor axial discharge ports

The middle port presented in Figure 5.16 is called the nominal discharge port which is generated to achieve a built in volume ratio for optimum compressor performance over its specified working range. Larger or smaller discharge ports are generated to reduce or increase the built in volume ratio respectively. Thus a larger discharge port will give a lower compressor pressure at the end of compression and vice versa for a smaller discharge port.

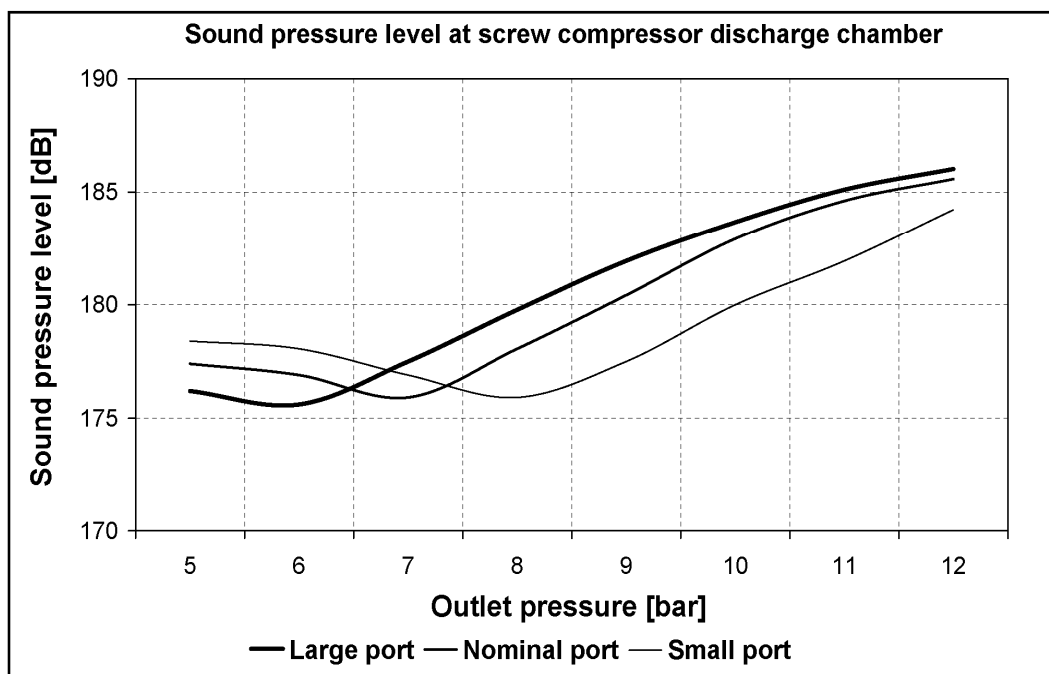

Figure 5.17 Influence of built in volume ration on sound pressure

The trend is for the pulsations to be a minimum when the pressure differences between the working and discharge chambers are the smallest. The root mean square amplitudes of the pressure variations in the discharge chamber converted to Sound Pressure Level (SPL) with respect to the

acoustic threshold pressure are presented in Figure 5.17. It is clear that the minimum value for different built in volume ratios varies with the outlet pressure, with, minimum gas pulsations attained at a lower outlet pressure for smaller built in volume ratios than for higher built in volume ratios. Hence, gas pulsations cannot be reduced over the entire pressure range with only one built in volume ratio.

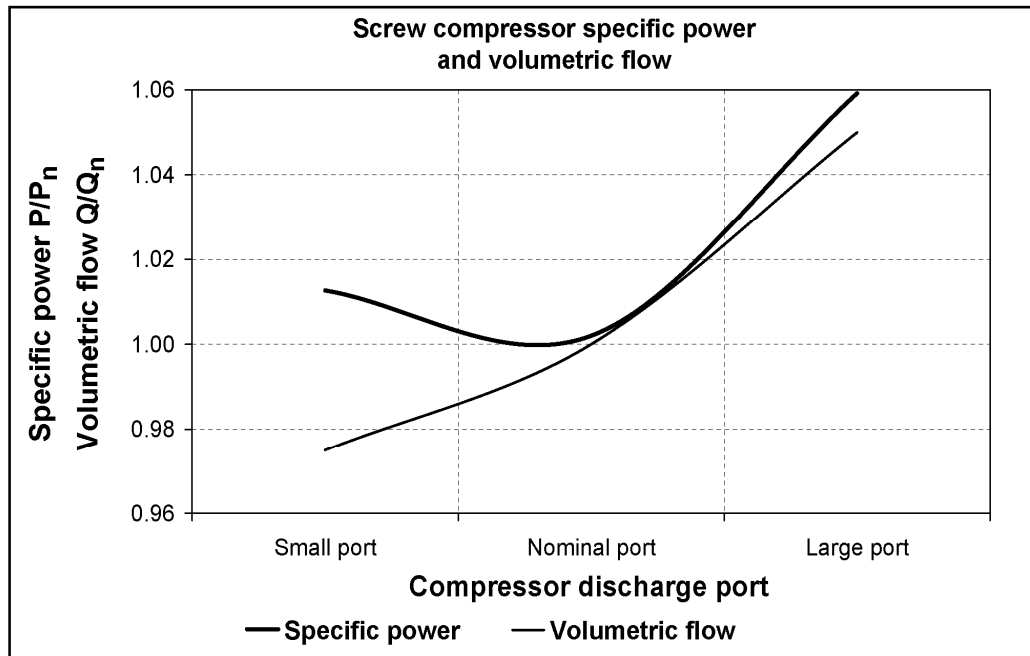

Figure 5.18 Screw compressor specific power and volumetric flow

The results of power and flow measurements on the test compressor are given in Figure 5.18. As can be seen, the built in volume ratio affects the screw compressor performance significantly and the value selected for it should give the best possible compressor performance across the required range of discharge pressures. To achieve this, the pressure in the working chamber at the end of the compression needs to be equal to the nominal outlet pressure specified for the compressor design.

At that pressure, the compressor performance will be at its best. At all outlet pressures lower than that achieved in the working chamber prior to discharge, over-compression conditions arise and the compressor will consume more power by compressing the gas to a higher pressure than needed. For all pressures higher than that achieved in the working chamber prior to discharge, there will be under-compression conditions at the opening of the discharge port and reverse flow occur into the working chamber. Reverse flow increases the pressure in the working chamber which consequently increases the thermodynamic work of the compression. This again causes the compressor to consume more power than is necessary. Flow is also affected by the size of the discharge port as shown in Figure 5.18. Also a smaller discharge port raises the pressure at the end of compression and thus increases leakage towards the compressor suction end, thereby reducing the compressor flow.

Since maximising the compressor efficiency and minimising the gas pulsations both require minimising the pressure difference between the working and discharge chambers, it follows that the built in volume ratio chosen to produce the best possible compressor performance across the

required pressure range, strongly corresponds with that required for minimum compressor noise. This is confirmed in Figure 5.17 and Figure 5.18 where it can be seen that the nominal port provides both the best compressor performance and the best choice for noise suppression across the entire outlet pressure range.

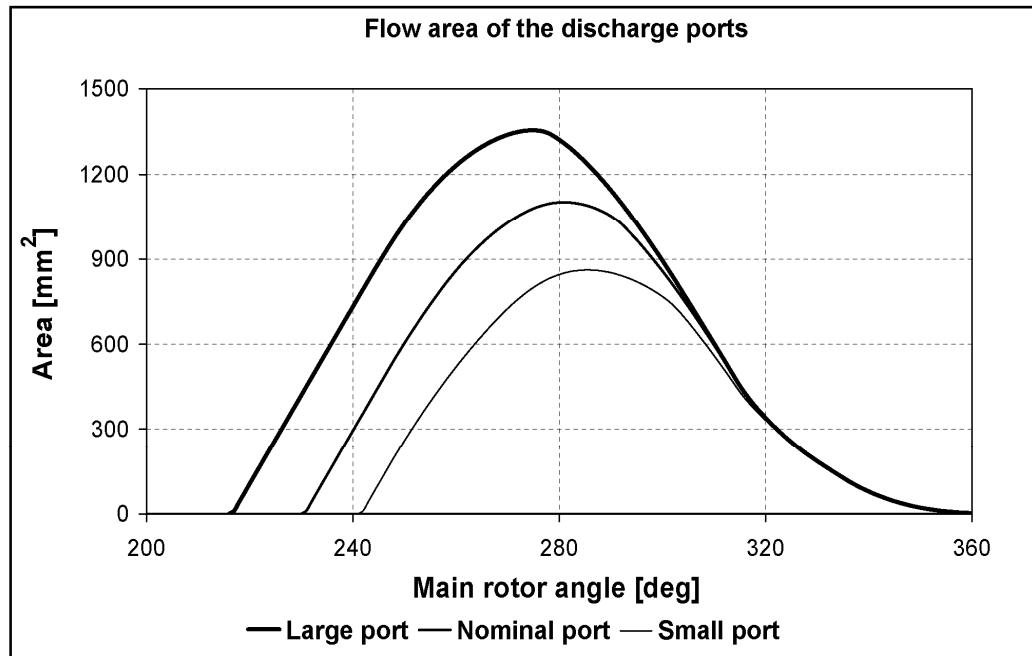

Figure 5.19 Flow area functions of the discharge ports

Gas pulsation across the operating pressure range is clearly influenced by the pressure difference between the working and discharge chambers, as shown in Figure 5.17 and this has virtually the same characteristic for any size of port. The influence of different discharge flow area can be analysed from diagram given in Figure 5.19, where the flow area functions of the large, nominal and small discharge ports are presented. As shown, for different built in volume ratios, the discharge ports open at a different male rotor rotation angle and this causes the difference in the flow areas of these ports. However, all the ports close at the same position. Hence, the last part of all their area functions is the same. Closer analysis shows that the area functions are also identical at the port opening. Therefore, the difference between the area functions of these three ports is only in their middle section.

It has been explained already in section 5.2 that the starting section of the flow area function has the maximum influence on the level of gas pulsations due to the pressure difference being highest at that point. Later, as the pressure difference is reduced, it is highly unlikely that changes in the middle section influence the level of gas pulsations. This section is expected to have more influence on fluid flow and dynamic losses due to reduction in the size of the port.

5.3.3 Compressor speed

The increase of the amplitude of the gas pulsations during the discharge process with the rotational speed was reported by Sangfors [17] and Haugen et al [9]. The influence of the compressor speed on the level of gas pulsations in the discharge chamber is presented in Figure 5.21. The left ordinate in the diagram is for the SPL measured within the discharge chamber, while the right ordinate is for the SPL measured around the compressor.

The average amplitude of gas pulsations in the discharge chamber in relation to the speed of the compressor used in the tests is presented by the bold line in Figure 5.21. The significant increase in gas pulsation with the compressor speed is because the time available for the discharge process decreases as the compressor speed increases. This leads to an increase in the value of the term $dm_{(dc)} / dt$ in equation (5.1) and, consequently, greater amplitude of the gas pulsations. At the same time the mass of the gas in the working chamber becomes slightly larger, due to lower relative leakage at higher speeds. That amount of mass now has to be discharged in a shorter time and this increases the mass flow rate from the working chamber into the discharge chamber. According to equation (5.2), mass inflow for the unchanged pressure difference can be increased only by increasing the discharge flow area. This is shown in Figure 5.20, where the change of the flow area function of the discharge port with speed is presented. The most significant difference is that the flow area of the discharge port is larger at the beginning when the pressure difference is highest.

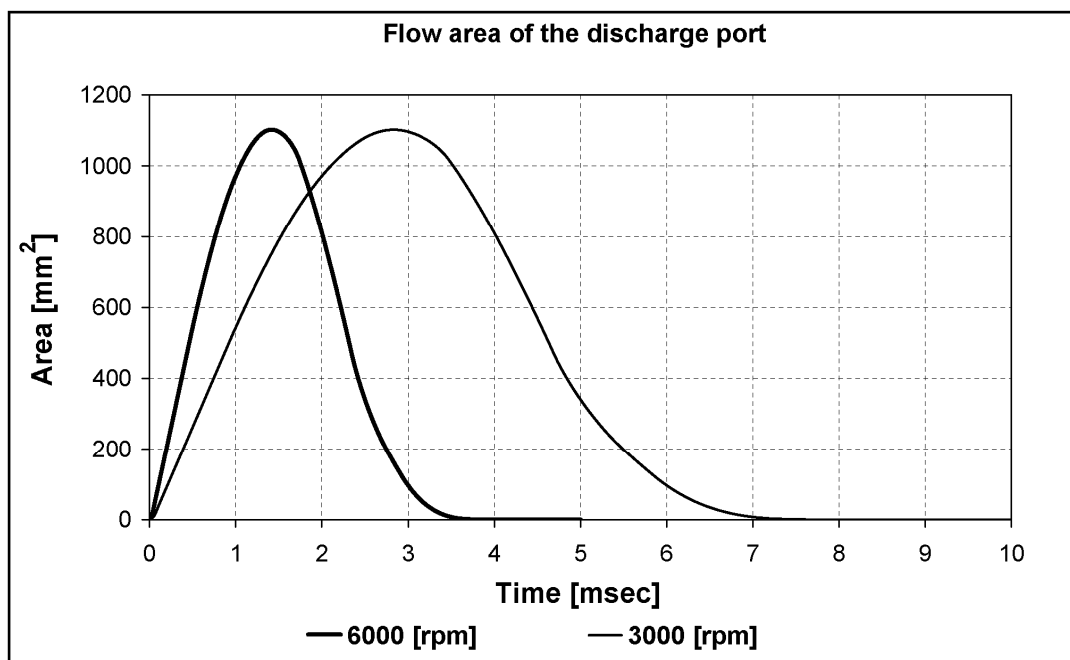

Figure 5.20 Influence of compressor speed on discharge port area function

The light line in Figure 5.21 shows the overall compressor noise measured outside the compressor. This also increases with speed. The overall noise increases more than that generated by the gas pulsations. This is due to the influence of other sources of noise in the compressor, such as mechanical contact and vibration of the drive, which are also increase with speed.

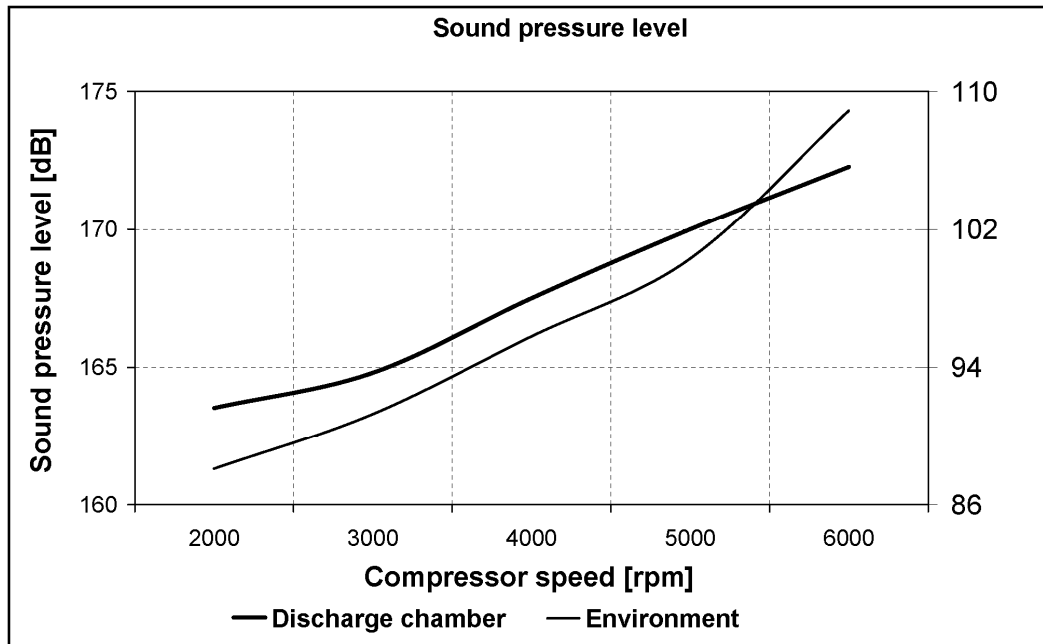

Figure 5.21 Influence of compressor speed on sound pressure levels

From Figure 5.21 it can be concluded that it is possible to reduce noise by decreasing the compressor speed. This will reduce not only the noise generated by gas pulsations but also all other sources of noise. However, any reduction in the compressor speed will mean an increase in the compressor size if the same delivery is to be achieved. Compressor volumetric efficiency is also reduced at lower speeds. This has to be taken into account when considering compressor speed as a parameter to reduce noise generation.

5.3.4 Compressor clearances

Compressor clearances affect pressure differences between the chambers and therefore they also affect gas pulsations. The three types of clearances are considered here:

1. Clearances between the rotors and the housing at the discharge side, called end clearances.
2. Clearances between the tip of the rotor lobe and the compressor housing are called radial clearances.
3. Clearances between the rotor lobes are called interlobe clearances

The clearance gaps form leakage paths through which the working fluid flows between the working chambers and/or the suction and discharge chambers. These clearances determine the size of three out of six internal leakage paths, as explained by Fleming [3]. The end clearance determines the leakage on the discharge end face. The radial clearance determines the rotor tip leakage, while the interlobe clearance determines the leakage through the rotor meshing line. Other leakage paths are identified as leakage through the blow hole and leakage on the compressor suction side. The leakages on the compressor suction side are fairly low, due to the small pressure difference and they are not considered here.

The blow hole area is defined by the rotor profiles rather than by the size of the clearances. The leakage through the blow hole is similar to that through the radial clearances. Therefore, the conclusions derived for the radial clearance are valid for the blow hole area.

The leakage mass flow rate depends on the pressure difference between the chambers, the length of the sealing line and the size of the clearances. Its direction is from the higher pressure chamber to that at lower pressure. Thereby, each of the working chambers gain and lose mass through the clearances at the same time. The leakage affects the pressure in the chambers. Such pressure changes may affect the pressure difference between the working and the discharge chambers which, in turn influences the gas pulsation.

The influence of each of the three types of clearance, upon the pressure difference between the working and discharge chambers is presented here both for under-compression and over-compression conditions. The screw compressor discharge and working chambers and position and notation of different fluid pressures are shown schematically in Figure 5.22.

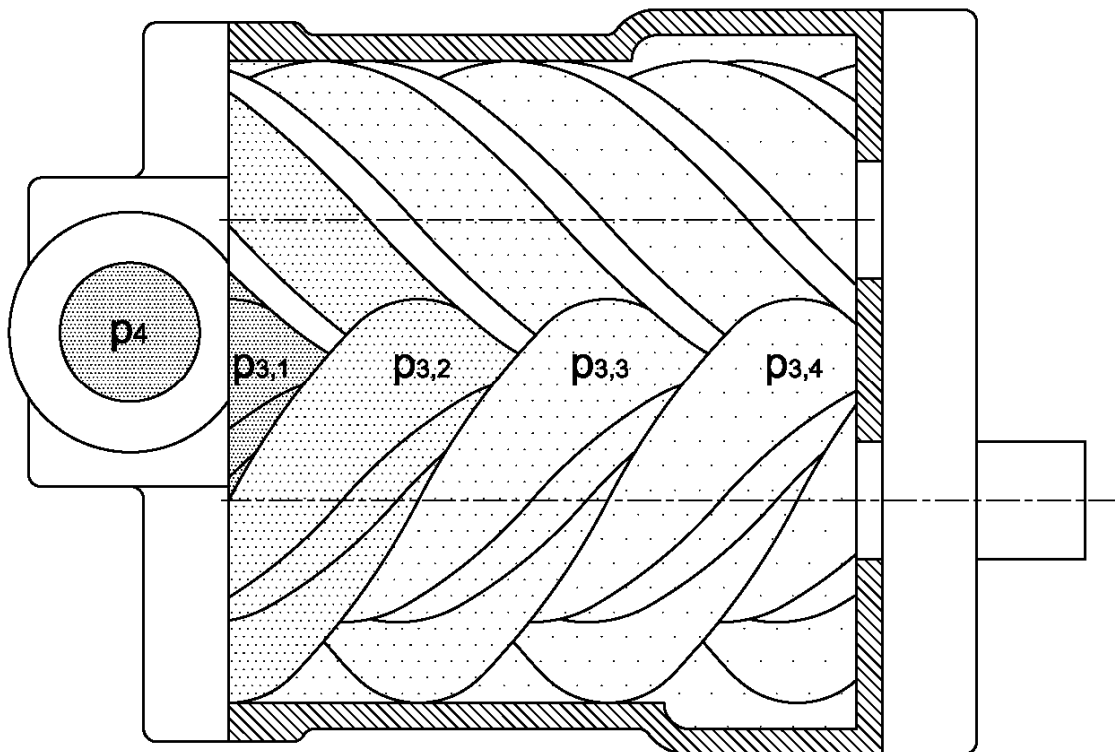

Figure 5.22 Pressure distribution in screw compressor

5.3.4.1 Over-compression

When there is over-compression, the pressure $p_{3,2}$ in the working chamber 2, prior to the opening of the discharge port, is higher than both the discharge pressure p_4 and the pressure $p_{3,1}$ in the working chamber 1. The working chamber 2, being at the highest pressure, will lose fluid through the clearances. This reduces the pressure in the chamber and brings its pressure $p_{3,2}$ closer to the discharge pressure p_4 .

Upstream and downstream conditions for flow through the leakage paths are dependent on the type of clearance and are determined as follows.

The end clearance connects the working chamber to other working chambers as well as to the discharge and suction chamber. The radial clearance connects the consecutive working chambers which follow each other. The interlobe clearance connects the working chamber under consideration to the working chamber at suction conditions or even to the suction port.

The clearances will affect the gas pulsations by changing the pressure difference between the working and discharge chambers, Δp in the case of over-compression or under-compression. Therefore, the influence of the size of the clearances upon this pressure difference will be used here to indicate changes in the level of the gas pulsations. Variation in the sizes of the clearances will alter the mass flow rate between the compressor chambers and change the pressure difference between the discharge and working chambers, as shown in Figure 5.23. The diagram also shows that increase in clearance for all three types reduces the pressure difference Δp , which also reduces the gas pulsation level.

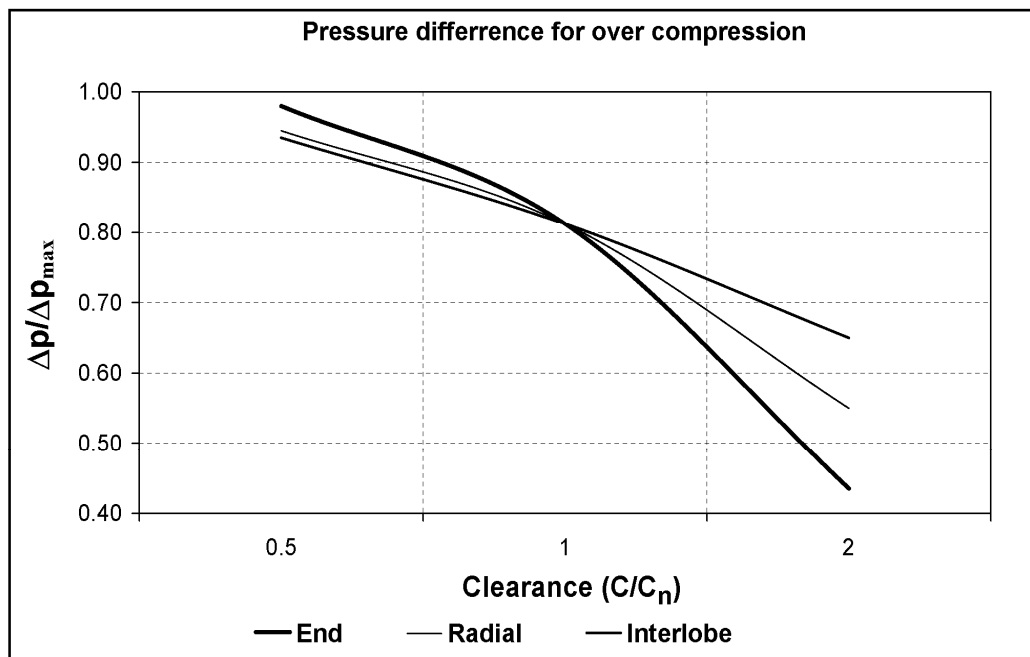

Figure 5.23 Pressure difference for over compression conditions

5.3.4.2 Under-compression

For under-compression conditions the discharge chamber together with working chamber 1 has the highest pressure of all the chambers, with the pressure in the other working chambers decreasing towards the suction side of the compressor. In this case the working chamber 2 gains some mass flow from the discharge chamber and working chamber 1 through the end and radial clearance. This increases the pressure in the working chamber 2, so that the pressure difference becomes smaller. Increasing the size of the axial and radial clearances, reduces the pressure difference even more, as is shown in Figure 5.24.

However, increase in the interlobe clearances makes the pressure difference higher. This is because it connects the working chamber 2 to the suction side of the compressor at low pressure. This causes the pressure to drop in the working chamber 2 and makes the pressure difference higher, compared with that in the discharge chamber.

According to Soedel [19], change in the compressor clearance has its greatest influence on the first four harmonics of the gas pulsation function.

In any case, change in the clearances affects the compressor performance more than it affects the gas pulsations. Therefore, changes in the compressor clearances are not suitable as a means of reducing gas pulsations.

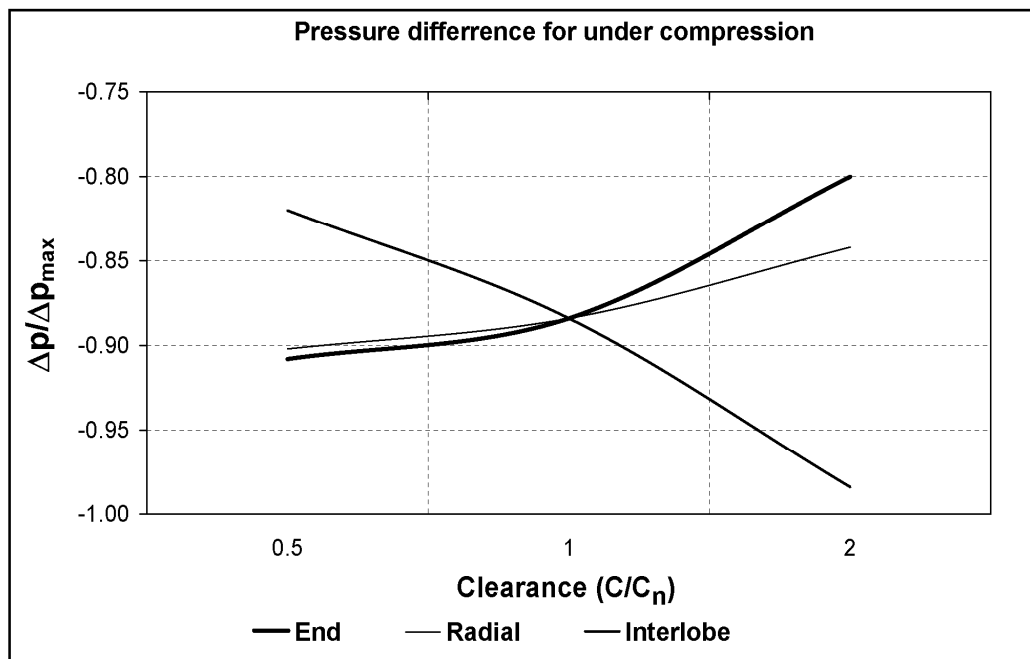

Figure 5.24 Pressure difference for under compression conditions

5.3.5 Number of rotor lobes

It has been reported by Sangfors [16] that compressors with a higher number of rotor lobes generate lower levels of gas pulsations. The reason for this is that with more lobes, the working chamber is smaller and a smaller chamber volume causes less mass to be transferred between it and the discharge chambers during the discharge process. The lower mass flow rate between the chambers has less effect on the pressure in the discharge chamber and due to that the level of gas pulsations is reduced. Figure 5.25 shows two different rotor configurations, 3/5 and 6/7, where the male rotor is of the same diameter. Figure 5.26 shows their volume functions relative to the volume of the discharge chamber.

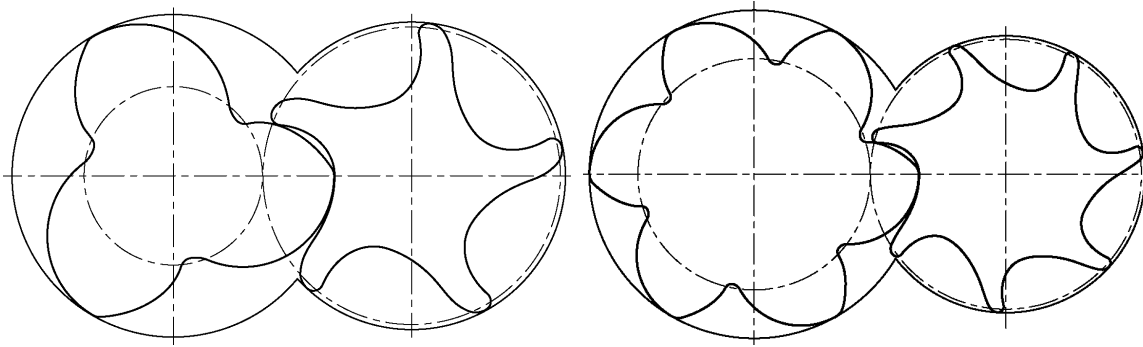

Figure 5.25 Screw compressor rotor configuration

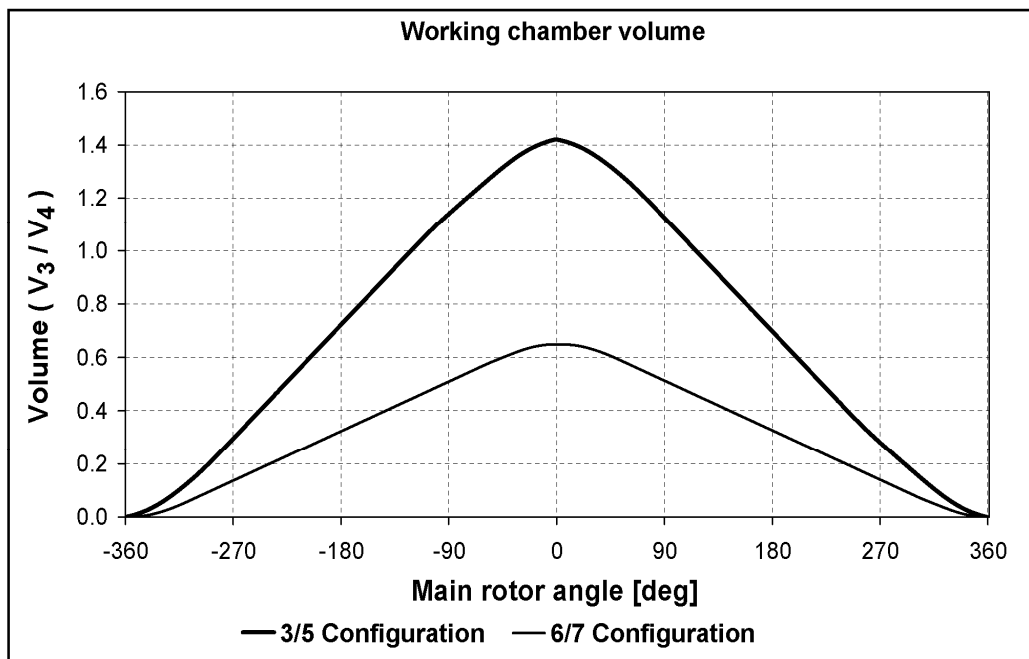

Figure 5.26 Working chamber volume curves

Another reason for the lower level of gas pulsations, for compressors with a higher number of rotor lobes, is the flow area function of the discharge port. The size of the discharge flow area also changes with changes in the lobe configuration. Figure 5.27 shows area functions for 3/5 and 6/7 lobe configuration for the same built in volume ratio. As shown, for the same rotor diameters, the discharge port for the smaller lobe number is larger. However, this, together with the different shape of the area function at the closing stage, should not affect the gas pulsations, because, the gas pulsations are affected by the starting part of the area functions which are compared in Figure 5.27 for the given lobe configurations. The area function corresponding to the 3/5 lobe configuration has a higher starting gradient. This has already been shown to be a feature of the area function which causes higher levels of gas pulsation. In contrast to this, the area functions of the higher lobe configuration will always have a smoother start which will probably reduce gas pulsations. For equal rotor diameters, the rotors with more lobes have a shorter trailing edge. This causes the area function to increase at a lower rate, thus reducing its starting gradient.

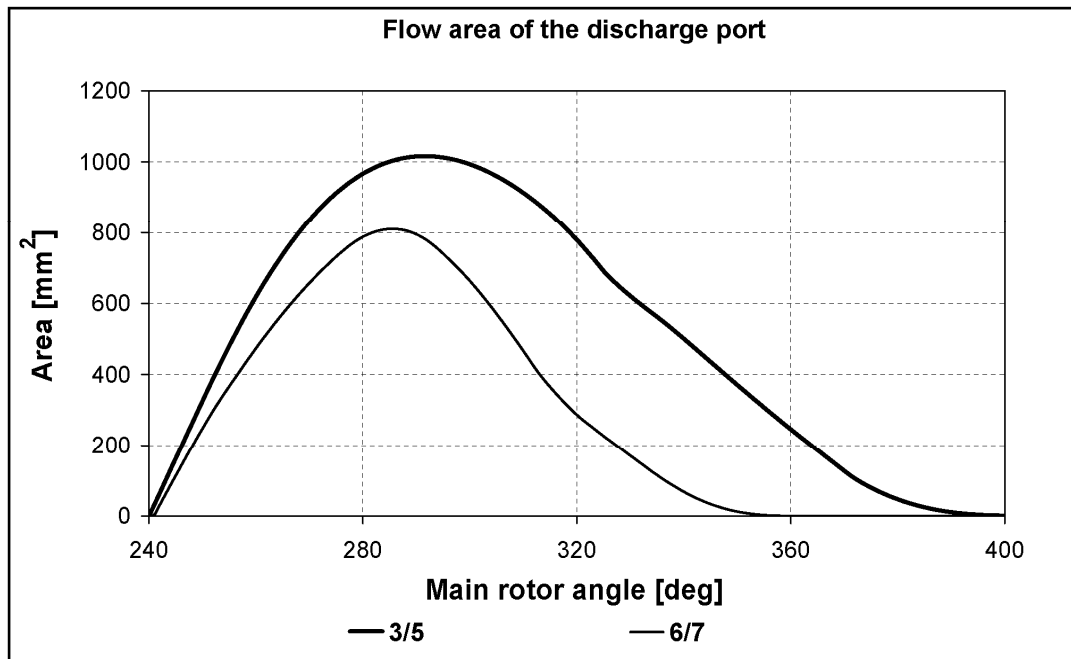

Figure 5.27 Starting gradients of the discharge ports areas

Although a higher number of rotor lobes generates a lower level of noise in absolute terms, the perception of noise can be different, and may appear to be worse. The machines with a higher number of lobes generate noise of higher frequency than those with a lower number of lobes, because the human ear perceives noise across frequency spectra differently. It is very likely that the high frequency noise, although lower in absolute level, will be perceived to be at a higher noise level. This makes the number of lobes not to be quite a suitable parameter for the reduction of gas pulsations. Nonetheless, the number of rotor lobes, required to achieve the best performance, differs with the compressor application.

5.3.6 Length of the discharge chamber

The length of the discharge chamber does not affect the pressure difference or the area function. However, according to Sangfors [16], the length of the discharge chamber has a substantial influence upon the gas pulsations and generated sound pressure level (SPL). Its influence is significant because the SPL is dependent on the chamber length and passes through its minimum. The incident wave generated in the compressor discharge port travels through the discharge chamber until it reaches the end of the chamber where it is reflected. The incident wave together with the reflected wave generates a resultant wave. The amplitude of this wave depends on the difference in phase between the incident and the reflected waves. The phase angle depends on the chamber length and the speed of sound of the working fluid. If the waves are in phase, resonance occurs and the amplitude of gas pulsations may become higher than the amplitude of the incident wave.

The length of the discharge chamber is not a parameter which determines amplitude of the incident wave. It is rather a parameter which amplifies or attenuates the superimposed wave in the discharge chamber. However as such, it has a great influence upon the gas pulsation amplitude as is shown in Figure 5.28. This phenomenon should be taken into account when designing the discharge system.

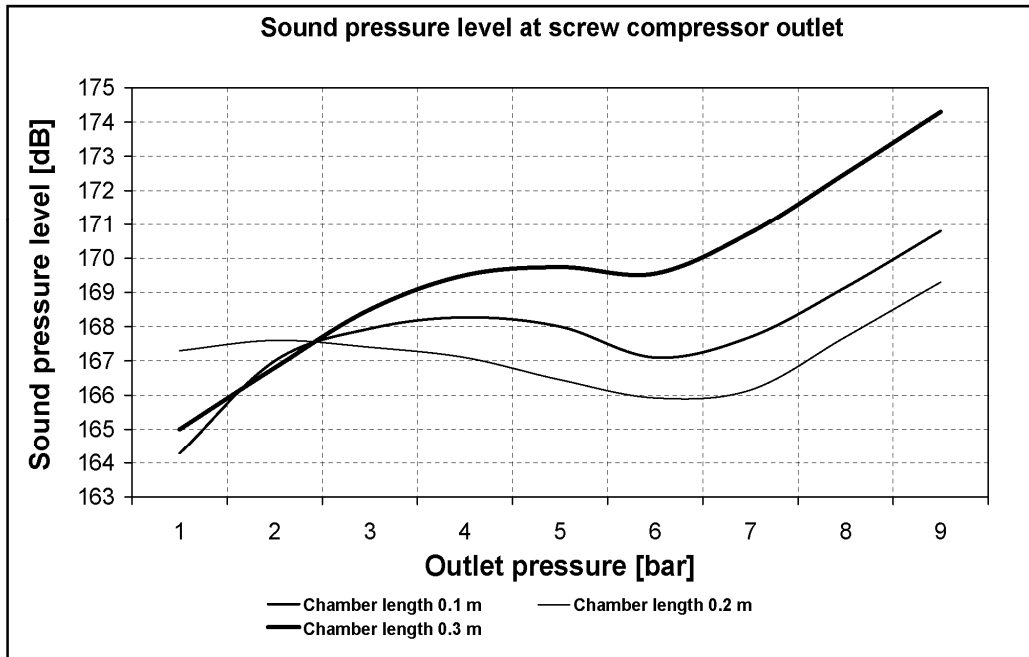

Figure 5.28 Influence of discharge chamber length on sound pressure level [16]

5.3.7 Other influential parameters

Oil has an attenuating effect upon the noise generation process. According to Sangfors [16] this affects only the high-level harmonics, above the 3rd harmonic. Tantari [0] states that this is noticeable only above the 5th harmonic.

Sangfors [16] stated that the length to diameter ratio has no practical influence on the generated noise level. He noticed that the wrap angle has a very small influence of upon the gas pulsations. He reported a reduction of 1 dB when the wrap angle was changed by 150 deg.

An experimental investigation carried out by Andrews and Jones [1] showed that both, the gas pulsations and the generated SPL depend on the compressor load. They analysed the influence of both, the mechanical source of noise and gas pulsations over the entire range of noise.

At higher compressor loads, the gas pulsations increased, resulting in a higher level of noise. For lower compressor loads, the gas pulsations have lower amplitudes. However, the overall noise level does not follow the trend of the flow generated noise. This is due to mechanically generated noise which becomes a primary source of noise at higher compressor loads.

6 CONCLUSION

Basic analysis has shown that the two most influential parameters affecting gas pulsations in a screw compressor discharge chamber are the pressure difference between the compressor working and discharge chambers and the discharge port area.

The parameters which affect pressure difference comprise the outlet pressure, speed, built in volume ratio, compressor clearances, sealing line length and the number of lobes. These are determined in advance to obtain the best compressor performance. Although they influence the gas pulsations, they hardly can be varied to reduce the compressor noise, because even small variations have a large influence on the compressor performance. However, their influence on noise should not be neglected during screw compressor design.

A second group of parameters like the size, shape and position of the discharge port influence the gas pulsations and consequently compressor performance. By their variation, noise reduction can be achieved with some sacrifice of the compressor performance. However, it should be noted that optimising these parameters can also improve compressor performance when a compressor operates in the higher pressure range.

REFERENCES

1. **Andrews R W and Jones J D, 1990:** Noise source identification in semi-hermetic twin-screw compressors, In The 1990 International Compressor Engineering Conference at Purdue, pp. 825-834
2. **Erol H and Ahmet G, 2000:** The noise and vibration characteristics of reciprocating compressor: Effects of size and profile of discharge port, In The 2000 International Compressor Engineering Conference at Purdue, pp. 677-683
3. **Fleming J S, Tang Y, Cook G, 1998:** The twin helical screw compressor Part 1: development, applications and competitive position, Proceedings of the I MECH E Part C Journal of Mechanical Engineering Science, Volume 212, Number 5, 1998 , pp. 355-367
4. **Fujiwara A and Sakurai N, 1986:** Experimental analysis of Screw Compressor Noise and Vibration, In The 1986 International Compressor Engineering Conference at Purdue
5. **Gavric L and Badie-Cassagnet A, 2000:** Measurement of gas pulsations in discharge and suction lines of refrigerant compressors, In The 2000 International Compressor Engineering Conference at Purdue, pp. 627-634

6. **Gavric L 2001:** Modelling and Analysis of Excitation Mechanisms, Short course and workshop on noise and vibration of compressors, Cetim, Senlis, 11-14.06.2001., France
7. **Holmes C S, 2003:** Inspection of Screw rotors for prediction of compressor performance, reliability and noise, Proceedings of the 4th International Conference on Compressor and Refrigeration, pp. 82-96, Xi'an Jiaotong University, Xi'an City, China 2003.
8. **Holmes C S, 2005:** Transmission error in screw compressors, and methods of their compensation during rotor manufacture, International Conference on Compressors and their Systems 2005, additional paper, London, UK
9. **Huagen W, Ziwen X, Xueyuan P, Pengcheng S 2004:** Simulation of discharge pressure pulsation within twin screw compressors, Proceedings of the I MECH E Part A Journal of Power and Energy, Volume 218, Number 4, 1 August 2004 , pp. 257-264(8)
10. **Koai K L and Soedel W, 1990:** Gas pulsations in twin screw compressors – Part I: Determination of port flow and interpretation of periodic volume source, In The 1990 International Compressor Engineering Conference at Purdue, pp. 369-377
11. **Koai K L and Soedel W, 1990:** Gas pulsations in twin screw compressors – Part II: Dynamics of discharge system and its interaction with port flow, In The 1990 International Compressor Engineering Conference at Purdue, pp. 378-387
12. **Kovačević A, Mujić E, Stošić N, Smith I. K, 2007:** An integrated model for the performance calculation of Screw Machines, International Conference on Compressors and Their Systems, London, IMechE Proceedings, p.757
13. **Kovačević A, Stošić N, Smith I. K, 2003:** Three Dimensional Numerical Analysis of Screw Compressor Performance, Journal of Computational Methods in Sciences and Engineering, vol. 3, no. 2, pp. 259- 284
14. **Mujić E, Kovačević A, Stošić N, Smith I K, 2005:** The influence of port shape on gas pulsations in screw compressor discharge chamber, Proc. IMechE, Part E: J. Process Mechanical Engineering, 2008, 222(E4), 211-223.

15. **Munro R. G. 1979:** A Review of the Single Flank Method for Testing Gears. Annals of the CIRP 28/01/1979, pp. 325-334
16. **Sangfors B, 1999:** Computer simulation of gas-flow noise from twin-screw compressors, In International Conference on Compressor and Their Systems, 13-15, London, pp.707-716
17. **Sangfors B, 2000:** Modelling, Measurement and Analysis of Gas-Flow generated Noise from Twin-Screw Compressors, The 2000 International Compressor Engineering Conference at Purdue, pp. 971-978
18. **Smith D J, 1999:** Gear noise and vibration, Marcel Dekker, ISBN: 0-8247-6005-0
19. **Soedel W, 1978:** Gas Pulsations in Compressor and Engine Manifolds, Short Course Text Book of Purdue Compressor Technology Conference, 1978, Purdue University, West Lafayette, USA
20. **Soedel W, 1978:** Sound and Vibration of Positive Displacement Compressors, ISBN 10-0-8493-7049-3, Taylor Francis Group, New York
21. **Stošić N, Mujić E, Kovačević A, Smith I K, 2007:** Development of rotor profile for silent screw compressor operation, International Conference on Compressors and their Systems 2007, pp 133-145, London, UK
22. **Tanttari J, 2000:** On Twin-Screw Compressor Gas Pulsation Noise, The 29th International Congress and Exhibition on Noise Control Engineering, 27-30 August, 2000. p. 2369-2372, Nice, France
23. http://www.iso.org/iso/iso_catalogue/catalogue_tc/catalogue_detail.htm?csnumber=9240: Acoustics -- Determination of sound power levels of noise sources using sound pressure - Engineering method in an essentially free field over a reflecting plane. Ref. No.: ISO 3744:1994

APPENDIX

NOTATION

A	[m ²]	area
C_D		discharge coefficient
h	[J/kg]	fluid specific enthalpy in chamber
m	[kg]	fluid mass in chamber
\dot{m}	[kg/s]	mass flow
p	[Pa]	fluid pressure in chamber
t	[s]	time
v	[m/s]	fluid velocity
V	[m ³]	fluid volume in chamber
γ		adiabatic index
ρ	[kg/m ³]	fluid density
θ	[deg]	male rotor angle

Subscripts

A	axial discharge port	in	inlet
dc	discharge chamber	out	outlet
dp	discharge port	wc	working chamber
HP	high pressure	LP	low pressure