



# Validation of a gravimetric PM<sub>2.5</sub> impactor using particle sizing techniques

CENTRE FOR ENVIRONMENTAL GEOCHEMISTRY  
Open Report OR/16/028





BRITISH GEOLOGICAL SURVEY

CENTRE FOR ENVIRONMENTAL GEOCHEMISTRY PROGRAMME

OPEN REPORT OR/16/028

# Validation of a gravimetric PM<sub>2.5</sub> impactor using particle sizing techniques

D. J. Beriro, L. P. Field & M. R. Cave

## *Authors*

The National Grid and other Ordnance Survey data © Crown Copyright and database rights 2016. Ordnance Survey Licence No. 100021290 EUL.

## *Keywords*

dust, gravimetric PM<sub>2.5</sub>, particle sizing, STEM.

## *Front cover*

Photographs taken by Darren Beriro

## *Bibliographical reference*

BERIRO, D.J., FIELD L.P., CAVE, M.R.. 2016. Validation of a gravimetric PM<sub>2.5</sub> impactor using particle sizing techniques. *British Geological Survey Open Report*, OR/16/028. 39pp.

Copyright in materials derived from the British Geological Survey's work is owned by the Natural Environment Research Council (NERC) and/or the authority that commissioned the work. You may not copy or adapt this publication without first obtaining permission. Contact the BGS Intellectual Property Rights Section, British Geological Survey, Keyworth, e-mail [ipr@bgs.ac.uk](mailto:ipr@bgs.ac.uk). You may quote extracts of a reasonable length without prior permission, provided a full acknowledgement is given of the source of the extract.

## BRITISH GEOLOGICAL SURVEY

The full range of our publications is available from BGS shops at Nottingham, Edinburgh, London and Cardiff (Welsh publications only) see contact details below or shop online at [www.geologyshop.com](http://www.geologyshop.com)

The London Information Office also maintains a reference collection of BGS publications, including maps, for consultation.

We publish an annual catalogue of our maps and other publications; this catalogue is available online or from any of the BGS shops.

*The British Geological Survey carries out the geological survey of Great Britain and Northern Ireland (the latter as an agency service for the government of Northern Ireland), and of the surrounding continental shelf, as well as basic research projects. It also undertakes programmes of technical aid in geology in developing countries.*

*The British Geological Survey is a component body of the Natural Environment Research Council.*

*British Geological Survey offices*

### **BGS Central Enquiries Desk**

Tel 0115 936 3143 Fax 0115 936 3276  
email [enquiries@bgs.ac.uk](mailto:enquiries@bgs.ac.uk)

### **Environmental Science Centre, Keyworth, Nottingham NG12 5GG**

Tel 0115 936 3241 Fax 0115 936 3488  
email [sales@bgs.ac.uk](mailto:sales@bgs.ac.uk)

### **The Lyell Centre, Research Avenue South, Edinburgh EH14 4AP**

Tel 0131 667 1000 Fax 0131 668 2683  
email [scotsales@bgs.ac.uk](mailto:scotsales@bgs.ac.uk)

### **Natural History Museum, Cromwell Road, London SW7 5BD**

Tel 020 7589 4090 Fax 020 7584 8270  
Tel 020 7942 5344/45 email [bgs london@bgs.ac.uk](mailto:bgs london@bgs.ac.uk)

### **Columbus House, Greenmeadow Springs, Tongwynlais, Cardiff CF15 7NE**

Tel 029 2052 1962 Fax 029 2052 1963

### **Maclean Building, Crowmarsh Gifford, Wallingford OX10 8BB**

Tel 01491 838800 Fax 01491 692345

### **Geological Survey of Northern Ireland, Department of Enterprise, Trade & Investment, Dundonald House, Upper Newtownards Road, Ballymiscaw, Belfast, BT4 3SB**

Tel 028 9038 8462 Fax 028 9038 8461

[www.bgs.ac.uk/gsni/](http://www.bgs.ac.uk/gsni/)

*Parent Body*

### **Natural Environment Research Council, Polaris House, North Star Avenue, Swindon SN2 1EU**

Tel 01793 411500 Fax 01793 411501  
[www.nerc.ac.uk](http://www.nerc.ac.uk)

Website [www.bgs.ac.uk](http://www.bgs.ac.uk)

Shop online at [www.geologyshop.com](http://www.geologyshop.com)

# Foreword

This report is the published product of a study undertaken on behalf of DustScan Ltd (DustScan), by the British Geological Survey (BGS). The purpose of the study was to validate the collection efficiency of a PM<sub>2.5</sub> impactor, designed for use with the DustScan DS500X sampling equipment, by using a variety of particle size analysis techniques. The work was undertaken by the BGS Centre for Environmental Geochemistry between January and March 2016.

# Acknowledgements

The authors thank DustScan Ltd. for providing the necessary equipment and Tarmac Trading Ltd. for allowing BGS access to their site at Ballidon Quarry for sample collection.

# Contents

<b>Foreword</b> .....	<b>1</b>
<b>Acknowledgements</b> .....	<b>1</b>
<b>Contents</b> .....	<b>1</b>
<b>Summary</b> .....	<b>4</b>
<b>1 Introduction</b> .....	<b>5</b>
<b>2 Methodology</b> .....	<b>5</b>
2.1 Sample collection .....	7
2.2 Sample preparation for SEM analysis .....	8
2.3 SEM analysis .....	8
2.4 Sample preparation for STEM analysis.....	9
2.5 STEM microscopy .....	9
2.6 Laser diffraction particle size analysis .....	10
2.7 Exploratory data analysis.....	11
<b>3 Results</b> .....	<b>12</b>
3.1 summary of the samples collected.....	12
3.2 SEM and STEM.....	14
3.3 Laser diffraction particle size analysis .....	19
<b>4 Conclusions</b> .....	<b>20</b>
<b>Appendix 1</b> .....	<b>23</b>
Images of cellulose filters .....	23
<b>Appendix 2</b> .....	<b>33</b>
Results of the laser diffraction particle size analysis by Escubed Limited. ....	33
<b>Acronyms</b> .....	<b>34</b>

**References ..... 35**

**FIGURES**

Figure 1 – Summary of methods used in the current study..... 6

Figure 2 – Diagram of the size selective impactor..... 6

Figure 3 – Ballidon Quarry primary crusher shed with monitoring station shown on left hand side..... 7

Figure 4 – Impactor showing oversize particulate matter adhered to impactor plate ..... 8

Figure 5 – Ballidon Quarry primary crusher shed showing the author setting up the monitoring station..... 13

Figure 6 – Particulate matter collecting in the funnel section of the impactor ..... 13

Figure 7 – Inlet tubes showing significant particulate matter deposits collected on the side walls..... 14

Figure 8 –Distributions of the particle size recorded for each filter ..... 16

Figure 9 – Relative cumulative frequency distribution for all samples ..... 17

Figure 10 – Relative cumulative frequency distribution for individual samples sample data with the x-axis limited to 10 µm..... 17

Figure 11 – Bi-plot of the percentiles for the pairs of filters collected during each sampling visit ..... 18

Figure 12 – Resampled median and upper and lower confidence intervals..... 19

Figure 13 – Particle size distribution plotted on log x-axis derived by laser diffraction analysis of oversize particles collected from six impactor plates over three visits ..... 19

**PLATES**

Plate 1. Images illustrating the STEM imaging and processing. A) A low magnification view of the TEM grid showing the copper grid and the particle distribution. B) A STEM image showing a large particle, numerous sub-micron particles and the holey-carbon grid. The dark area in the lower right corner adjacent to the particle is the edge of the copper grid. C) A secondary SEM image showing that the large particle is one particle and not an aggregate. Note the charging on the uncoated particle in secondary mode. D) a STEM image of a grid square used for IMAGEJ processing. E) The IMAGEJ binary image of (D). F) The final processed image of (D) showing the outlined and numbered particles analysed by IMAGEJ..... 10

Plate 2 – STEM and LFD images showing typical particle aggregates (filter 53). These can be compared to large, discrete particles shown below in Plate 3 ..... 14

Plate 3 – STEM (A) and LFD (B) images showing one the largest particles identified (filter 06)..... 15

Plate 4. Photograph of filter 47 following sub-sampling for STEM analysis. .... 23

Plate 5. BSED image showing the density of particle coverage on the filter surface. .... 24

Plate 6. BSED image of a large particle in-situ within the particle coating of the filter. The measurement was carried out live within the FEI software..... 24

Plate 7. Photograph of filter F10 following sub-sampling for STEM analysis..... 25

Plate 8. BSEM image showing the general coating of particles across the filter..... 25

Plate 9. BSED image showing three larger particles within the coating on the filter.  
 Measurements were carried out live within the FEI software. .... 26

Plate 10. Photograph of filter 44 following sub-sampling for STEM analysis. .... 26

Plate 11. Photograph of the one-quarter segment taken for STEM analysis following sonication.  
 Almost all the particulate material has been removed from the filter. The darker spots are  
 where the filter membrane has been damaged by handling by tweezers and cut by scalpel. . 27

Plate 12. BSEM image showing the particle distribution across the filter. .... 27

Plate 13. BSEM image showing two larger particles within the particle coating. Measurements  
 were carried out live within the FEI software. .... 28

Plate 14. Photograph of filter 44 following sub-sampling for STEM analysis. .... 28

Plate 15. BSEM image showing the general distribution of particles across the filter surface. ... 29

Plate 16. BSEM image of a larger particle. The majority of particles are clearly around 2.5  
 microns or less in diameter. .... 29

Plate 17. Photograph of filter 06 following sub-sampling for STEM analysis. This sample was  
 quite thickly coated and the centre of the sample has suffered de-lamination as some of the  
 particulate material has come away from the filter. This had occurred pre-subsampling. .... 30

Plate 18. An LFD image showing the morphology of the delamination in the centre of the  
 sample. This is also an indication of how thickly coated the filter is. .... 30

Plate 19. A BSEM image at the edge of the delamination (see lower left corner of image),  
 showing a larger particle. The measurement was carried out live within the FEI software... 31

Plate 20. Photograph of filter 53 following sub-sampling for STEM analysis. Like its counterpart  
 filter, BA-F-06-260216, filter 53 had also suffered from some delamination in the centre of  
 the filter. .... 31

Plate 21. BSEM image showing the general distribution of particles on filter 53. .... 32

Plate 22. BSEM image showing a larger particle within the sample. The measurement was  
 carried out live within the FEI software. .... 32

**TABLES**

Table 1 – Operating parameters for the Malvern Mastersizer 3000 with the Hydro MV dispersion  
 cell method reference INS-SOP002-3 ..... 11

Table 2 – Operational parameters and measurements used to calculated the particle size  
 analysis ..... 11

Table 3 – Summary of all samples collected and reported ..... 12

Table 4 – Summary of the particulate data generated by STEM analysis and IMAGE-J  
 processing ..... 16

Table 5 – Original and resampled median data with upper and lower confidence intervals for  
 each filter ..... 18

Table 6 - Repeatability of BA-OS-ALL-150316 (ID 16-079-01)..... 20

## Summary

Particulate matter sampling was conducted at Ballidon Quarry, Ballidon, Derbyshire. The quarry is owned and managed by Tarmac Trading Ltd. (Tarmac). The monitoring station deployed comprised two DS500X gravimetric samplers fitted with PM<sub>2.5</sub> impactors, that were placed side by side in the primary crusher shed during February 2016. Monitoring was conducted over three, seven day periods. Particulate matter from six filters and oversize particulate matter collected from the impactor plates were analysed by BGS on behalf of DustScan using Scanning Transmission Electron Microscopy and Laser Diffraction granulometry. The results of the work show that the DS500X fitted with a PM<sub>2.5</sub> size selective impactor is capable of separating particles with a projected area diameter of  $\leq 2.5 \mu\text{m}$  from ambient air, retaining them on filter media for subsequent quantification. The overall median particle size recorded on the filters was 0.46  $\mu\text{m}$ , the mean was 0.74  $\mu\text{m}$  and the 95<sup>th</sup> percentile was 2.15  $\mu\text{m}$  (n = 6343). A number of observations were made during this study and included in the full report which should be considered when interpreting the results.



# 1 Introduction

British Geological Survey (BGS) were appointed by DustScan Ltd. (DustScan) to conduct the following work:

1. Ambient air sampling for suspended particulate matter with an aerodynamic diameter ( $d_{ae}$ ) of  $\leq 2.5 \mu\text{m}$  ( $\text{PM}_{2.5}$ ) using the DS500X monitoring station;
2. Scanning Transmission Electron Microscopy (STEM) analysis of the particulate matter that pass the size selective impactor and are collected on the filter media to quantify the size of individual particles; and
3. Laser Diffraction (LD) granulometry of the oversize particulate matter collected on the impactor plate of the size selective impactor.

The purpose of this work was to provide DustScan with particle size analysis results that they can use to assist with the validation of their DS500X monitoring station fitted with a size-selective jet inlet impactor designed to collect  $\text{PM}_{2.5}$  suspended in ambient air.

This report summarises the results of  $\text{PM}_{2.5}$  sampling at Ballidon Quarry, Derbyshire and the associated analyses. The STEM and LD analysis were both designed to quantify the proportion of particles that are  $\leq \text{PM}_{2.5}$ . These results are reported factually along with relevant observations made during the course of the work. The sampling and STEM analysis were conducted by BGS and the LD subcontracted to Escubed Limited (a company specialising in analytical services in colloids, particles and powder technology). There are no traceable reference standards for measuring  $\text{PM}_{2.5}$  so the methods adopted reflect good scientific practice in quantifying micro-particles collected at low sample masses.

The British Standards definition of  $\text{PM}_{2.5}$  is:

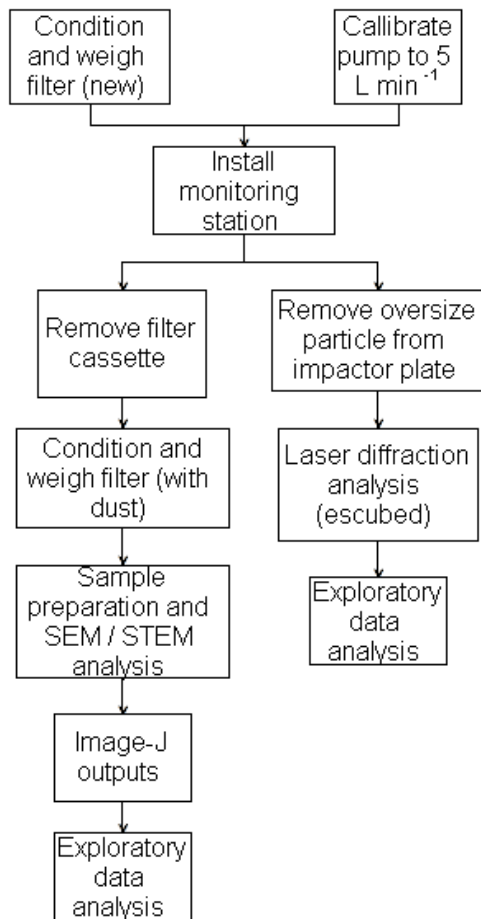
*“Particulate matter suspended in air which is small enough to pass through a size-selective inlet with a 50 % efficiency cut-off at  $2.5 \mu\text{m}$  aerodynamic diameter”* British Standard EN 12341:2014

The efficiency of the inlet of a size selective impactor may have a significant effect on the fraction of particulate matter surrounding the 50% cut-off point which affects the mass concentration of  $\text{PM}_{2.5}$  collected. The definition highlights that size selective impactors are not expected to collect particulate matter that is only  $< 2.5 \mu\text{m}$ . This is because the morphology and density of individual particles is varied in environmental samples.

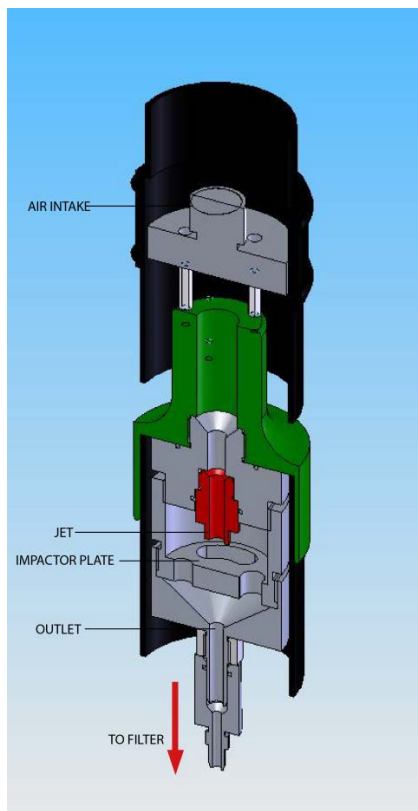
## 2 Methodology

The methods selected by BGS and DustScan for this study quantify the projected area diameter ( $d_{PA}$ ) (Vincent, 2007) of individual particles rather than  $d_{ae}$ . This is because insufficient sample mass was collected over the recognised 7-day sampling intervals, even in a dusty environment. A summary of the methodology is presented in Figure 1.

The DustScan DS500X gravimetric sampler is a battery (12V 40ah) or mains powered fine particulate matter monitoring system. The sampling units have been designed to run for 7 days and utilise a twin diaphragm pump that is set to run at and maintain a  $5 \text{ L min}^{-1}$  flow rate. The sampler units are connected to a size selective inlet jet impactor system housed inside a post. Air is drawn through the impactor at the desired flow rate and particulate matter is accelerated through the size selective jet. The dimensions of the inlet are such that only the target size particulate matter is accelerated fast enough to escape the system and be collected by a filter cassette inside the sampler unit. Larger particulate matter collects on the impactor plate and must be periodically removed. A diagram of the size selective inlet jet impactor is shown in Figure 2.



**Figure 1 – Summary of methods used in the current study**



**Figure 2 – Diagram of the size selective impactor**

## 2.1 SAMPLE COLLECTION

The DS500X monitoring station manufactured by DustScan was installed at Ballidon Quarry, Derbyshire to collect suspended PM<sub>2.5</sub> in ambient air. Ballidon Quarry is owned by Tarmac and is used to produce high quality crushed limestone, powders and manufactured blocks. The monitoring station was located in an enclosed primary crusher shed on the site (Figure 3).

Six samples were collected from the quarry over a period of three weeks: two DS500X systems were run concurrently at the same locality for each seven day period. Samples comprised of two parts: i) the filter containing particulate matter that passed through the size selective impactor; and ii) an oversize portion collected from the impactor plate. The oversize fraction was removed from the impactor plate using a clean stainless steel spatula and placed on a pre-weighed piece of tin foil and the mass determined using the balance.

The concentration of dust in ambient air during the sampling period was calculated using the following equation:

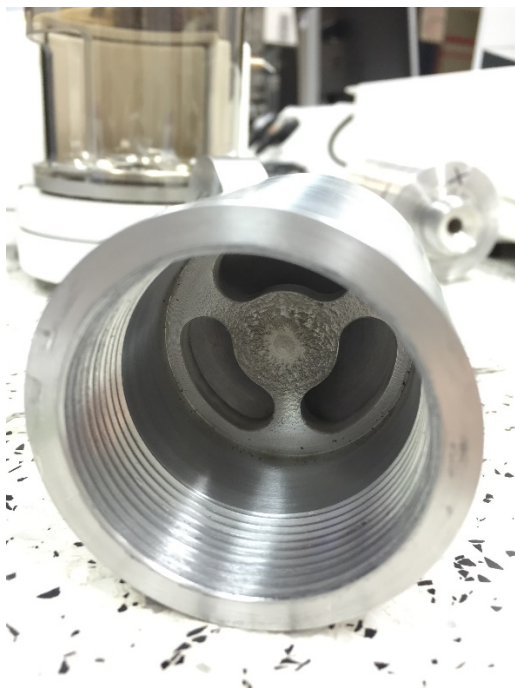
$$\text{Concentration of dust } (\mu\text{g m}^{-3}) = \frac{\text{mass of dust } (\mu\text{g})}{\text{volume of air } (\text{m}^3)}$$

The filter cassette was installed with a 25 mm  $\varnothing$ , 3  $\mu\text{m}$  Whatman mixed cellulose ester filter and was fitted inline within the DS500X sampler unit. The filter was pre-conditioned in a desiccator (relative humidity ~35%, room temperature ~21 °C) for a minimum of 48 hrs before being weighed on a micro-balance. The internal diaphragm pump in the sampler unit was calibrated prior to use using a certificated mechanical flow meter to 5 L min<sup>-1</sup>.



**Figure 3 – Ballidon Quarry primary crusher shed with monitoring station shown on left hand side**

The conditioned filter and cassette were collected from Ballidon Quarry and returned to the laboratory. The oversize particulate matter, which is shown in Figure 4, was collected from the impactor plate using a stainless steel spatula. The impactor was then cleaned with a lint free tissue. Petroleum jelly was reapplied to the impactor plate prior to reuse within the monitoring station. Petroleum jelly is a requirement of the impactor design as it aids oversize particle collection.



**Figure 4 – Impactor showing oversize particulate matter adhered to impactor plate**

Upon return to the laboratory the filter was post-conditioned in the desiccator for a minimum of 48 hrs prior to being reweighed on the same balance. The difference between the two filter paper masses provided the net mass of the particulate matter on the filter paper.

## 2.2 SAMPLE PREPARATION FOR SEM ANALYSIS

In order to minimise any contamination the bench and surrounding area was scrubbed clean and wiped with high-purity (HPLC-grade) isopropyl alcohol (isopropanol), prior to sampling the filters. A fresh piece of Sterilin™ BenchGuard was placed over the bench to ensure a clean surface.

Each filter was sub-sampled by carefully removing a small piece of the filter (approx. 5 mm x 5 mm) using a scalpel blade. A new scalpel blade was used and this was cleaned between sub-sampling each filter with high-purity (HPLC-grade) isopropyl alcohol (isopropanol). Each piece of filter was mounted onto a double-sided adhesive carbon tab fixed on a 10 mm diameter aluminium stub. The stubs were imaged uncoated in order to prevent any contamination from debris onto the filter samples during the carbon coating process, therefore as far as possible ensuring that any particles imaged originated from the filter.

## 2.3 SEM ANALYSIS

Morphological observations were made of the mounted filter papers on the stubs using backscattered scanning electron microscopy (BSEM), and a large field detector (LFD) which facilitates secondary electron microscopy (SEM) imaging under low vacuum conditions. BSEM was carried out using a FEI Company QUANTA 600 environmental scanning electron microscope (ESEM) equipped with an Oxford Instruments INCA Energy 450 energy-dispersive X-ray microanalysis (EDXA) system with a 50 mm<sup>2</sup> Peltier-cooled (liquid nitrogen free) silicon drift detector (SSD) X-ray detector capable of operating at very high input X-ray count rates (up to ~10<sup>6</sup> counts per second). The ESEM was operated in low vacuum mode, with an electron beam accelerating voltage of 12.5 kV, and beam probe currents of 0.26 nA and a working distance of ~10 mm. SEM and BSEM photomicrographs were obtained and recorded as 8 bit greyscale TIF digital images. Images were collected over a range of magnifications, primarily at a resolution of 1024 x 943 pixels. Larger particles were measured live using the FEI software suite, xTm, version 4.1.14.2205.

## 2.4 SAMPLE PREPARATION FOR STEM ANALYSIS

Samples for Scanning Transmission Electron Microscopy (STEM) analysis were prepared as dispersed particle mounts on standard 3.05 mm diameter, 400 mesh copper Transmission Electron Microscopy (TEM) grids. Only the filter samples were used for this type of analysis. These grids were supplied, pre-prepared, with a holey carbon support film (purchased from a specialist electron microscopy supplier – Agar Aids Limited). The holey carbon film would have been prepared by vacuum evaporation of carbon, and has holes of the order of 0.1 to 2  $\mu\text{m}$  diameter throughout. The objective of the sample preparation is to prepare a dispersion of dust particles on the TEM grid with the minimum of particle overlap so as to enable individual particle dimensions and morphology to be readily discriminated.

In order to minimise any contamination, prior to sampling the filters, bench and surrounding area were scrubbed clean and wiped with high-purity (HPLC-grade) isopropyl alcohol (isopropanol). A fresh piece of Sterilin<sup>TM</sup> BenchGuard was placed over the bench to ensure a clean surface. Fresh Pasteur pipettes and Ependorf<sup>®</sup> vials were used at each stage of the preparation (for each sample and each dilution throughout), to prevent any cross-contamination. A new scalpel blade was used and the scalpel blade and all tweezers used were cleaned prior to, and between, sub-sampling each filter, with high-purity (HPLC-grade) isopropyl alcohol (isopropanol).

One quarter of each filter was placed in a 2 ml clear plastic ‘Safe Lock’ Ependorf<sup>®</sup> vial, to which 1 ml of high-purity (HPLC-grade) isopropyl alcohol (isopropanol) was added and the Ependorf<sup>®</sup> vial sealed. The vial was then placed upright in a 50 ml beaker part-filled with distilled water, so that the vial was not submerged. This was then placed in an ultrasonic bath and subjected to ultrasonic agitation for 5 minutes to achieve full dispersion of the sample in the isopropyl alcohol without any disintegration of the cellulose filter itself. From this stock solution, 0.5 ml was removed and placed in a fresh Ependorf<sup>®</sup> vial, to which an additional 0.5 ml of isopropyl alcohol was added, forming a x2 dilution. This dilution was then subjected to ultrasonic agitation for 5 minutes. Tests performed on samples supplied to BGS by DustScan for method development purposes determined that this x2 dilution provided the optimum dispersion for this analysis.

TEM grid mounts were prepared from both the stock and the x2 dilution suspensions. The aim was to achieve grids with sufficient material for observation but minimising any overlapping of particles. A 400 mesh TEM grid with holey carbon support film was placed on the rim of a small brass tube (c. 5 m diameter) to provide support while preparing the mount. A drop of suspension was placed on the top of the TEM grid using the tip of a fine glass Pasteur pipette. The TEM grid (resting on its brass support tube) was then placed in a Perspex clip-lock dust-proof box to allow it to air-dry, before the TEM grid was carefully transferred into a TEM grid store box for safe storage until required for analysis by STEM.

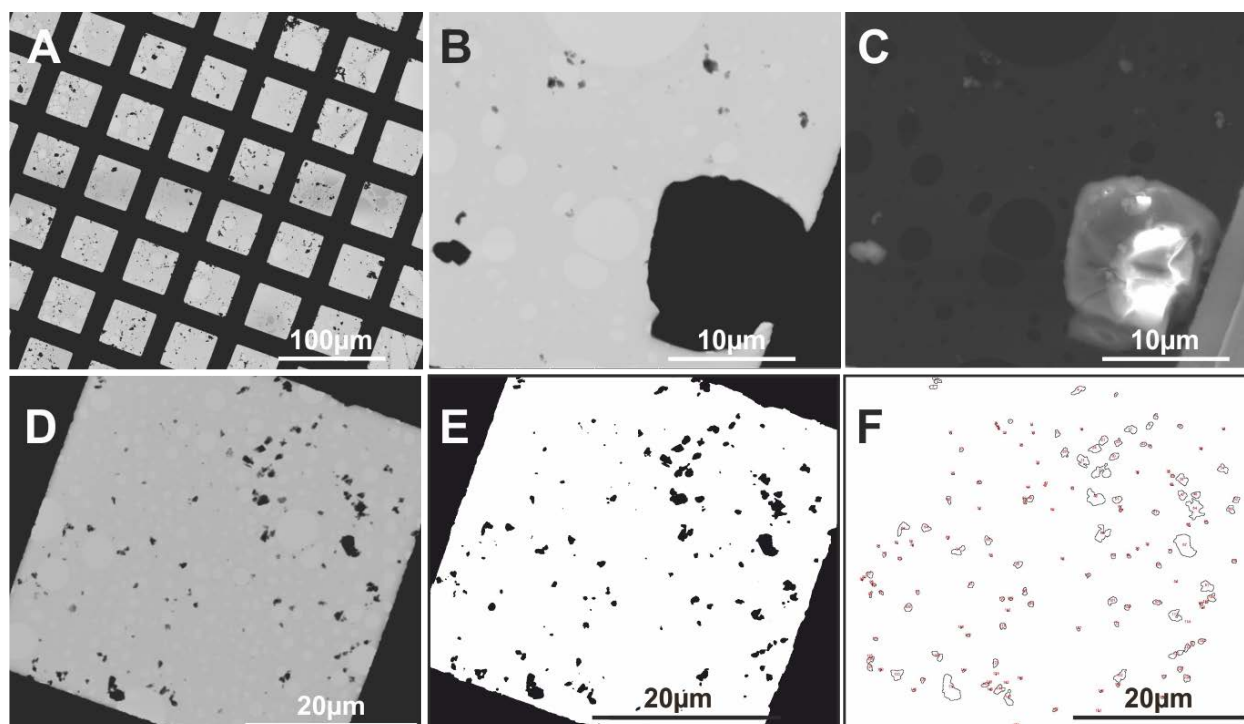
## 2.5 STEM MICROSCOPY

STEM analysis was carried out at the BGS using a FEI Company QUANTA 600 environmental scanning electron microscope (ESEM). This ESEM instrument is equipped with a specialised Peltier-cooled ESEM / WetSTEM sample stage with an inbuilt solid-state STEM detector. This ESEM system has the capability to enable the observation of both wet and dry samples by STEM, as well as by secondary electron imaging, and in addition the samples can be viewed in either dark-field or bright-field modes.

Individual TEM grid samples were inserted into a special copper grid holder, which holds the grid securely in place with a screw top. The grid holder was then inserted into the WetSTEM sample stage. The ESEM instrument operated under conventional high vacuum conditions (vacuum better than  $1 \times 10^{-4}$  torr), with a sample-to-lens working distance of approximately 10 mm. Optimal imaging conditions were explored using electron beam accelerating potentials of between 15 to 30 kV, and nominal electron beam currents of around 0.55 nA. STEM images were recorded as 8 bit

greyscale TIF format digital images, and were collected over a range of magnifications at a resolution of 1024 x 884 pixels.

A series of images were taken from each grid (e.g. Plate 1 A-D) and processed using IMAGEJ freeware image processing software (e.g. Plate 1E and F). IMAGEJ was calibrated to match the scale for each image, and then the images were thresholded to ensure particles were separated from background. This has the effect of converting them to binary (B&W) images (e.g. Plate 1E). Particle analysis was then applied (e.g. Plate 1F) which automatically provides a number of measurement parameters for each particle, including major and minor axis dimensions, exported to a Microsoft Excel<sup>®</sup> spreadsheet for processing in R. It is not possible to separate out aggregated and flocculated particles, so these are treated as one particle. Large particles were verified to be single particles or aggregates by checking the morphology under secondary SEM conditions and recorded in the results spreadsheet.



**Plate 1. Images illustrating the STEM imaging and processing. A) A low magnification view of the TEM grid showing the copper grid and the particle distribution. B) A STEM image showing a large particle, numerous sub-micron particles and the holey-carbon grid. The dark area in the lower right corner adjacent to the particle is the edge of the copper grid. C) A secondary SEM image showing that the large particle is one particle and not an aggregate. Note the charging on the uncoated particle in secondary mode. D) a STEM image of a grid square used for IMAGEJ processing. E) The IMAGEJ binary image of (D). F) The final processed image of (D) showing the outlined and numbered particles analysed by IMAGEJ.**

## 2.6 LASER DIFFRACTION PARTICLE SIZE ANALYSIS

The following laser diffraction method and associated analysis was implemented by Escubed Limited (UKAS certification number: 8467) under sub-contract to BGS.

### 2.6.1 Particle Size Analysis

The work was carried out using a Malvern Mastersizer 3000 with the Hydro MV dispersion cell. The dispersion cell was filled with de-ionised water and thermal equilibrium allowed to take place before checking the cleanliness of the system. Once clean, a background was determined, the laser

aligned and a background measurement taken. The settings and requirements used for the analysis are shown in Table 1.

**Table 1 – Operating parameters for the Malvern Mastersizer 3000 with the Hydro MV dispersion cell method reference INS-SOP002-3**

Parameter	Setting
Dispersion Cell	Hydro MV
Dispersant	Purified water
Surfactant	5% v/v Igepal CA-630 in water
Background Sweep	20 seconds
Measurement Time	10 seconds
Number of Measurements	10
Stirrer/Pump Speed	2700 rpm
Obscuration	4 – 5%

### 2.6.2 Optical Properties

The scattering pattern was de-convolved (to produce the particle size distribution) using Mie theory. Mie theory requires knowledge of the refractive index of both sample and the dispersant along with the absorption (imaginary refractive index) of the sample. The settings and measurements used for the analysis are shown in Table 2.

**Table 2 – Operational parameters and measurements used to calculated the particle size analysis**

Parameter	Setting / measurement
Refractive Index	1.59
Imaginary Refractive Index	1
Analysis Model	General Purpose (Normal Sensitivity)
Particle Shape	Non-Spherical

The results presented are the mean equivalent sphere diameter in  $\mu\text{m}$  as a proportion of the total volume of sample and the repeat measurements taken. The result has been represented by the 10<sup>th</sup>, 50<sup>th</sup>, and 90<sup>th</sup> percentiles Dv (10), Dv (50) and Dv (90) and a volume density distribution plot.

## 2.7 EXPLORATORY DATA ANALYSIS

Exploratory data analysis was conducted using the R statistical programming language. The distribution of the data was plotted as density plots (interpolated smoothed histograms) and summary statistics for the data calculated for each sample. Efficiency plots were produced as cumulative relative frequency distributions. The data were compared within sampling visits and between sampling visits to test for reproducibility and repeatability.

The median particle size and associated 95<sup>th</sup> percentile confidence intervals (CI) for each filter data set were estimated by bootstrap resampling of the measured data. If median CIs for each set of filter data overlap then they are not statistically different. The overall range in CIs over all samples gives a measure of the overall precision of the samplers over the different monitoring visits.

## 3 Results

### 3.1 SUMMARY OF THE SAMPLES COLLECTED

A summary of the samples collected, collection dates, mass on the filter and concentration of suspended particulate matter is shown in Table 3.

The results show that the total mass of suspended particulate matter collected on each filter varied from 3.8 to 9.2 mg and that the concentrations ranged from 75 to 183  $\mu\text{g m}^{-3}$ . These values reflect the dusty nature of the environment used for monitoring. A photograph of the author installing the monitoring station in the primary crusher shed is shown in Figure 5.

**Table 3 – Summary of all samples collected and reported**

Sample number	Description	Collection date	Filter mass (mg)	Filter and sample mass (mg)	Sample mass (mg)	$\mu\text{g m}^{-3}$	Analysis type
BA-F-47-100216	Filter # 47	10/02/2016	22.695	26.463	3.768	74.762	SEM STEM
BA-F-10-100216	Filter # 10	10/02/2016	22.083	26.334	4.251	84.345	SEM STEM
BA-F-44-190216	Filter # 44	19/02/2016	22.809	27.311	4.502	89.325	SEM STEM
BA-F-52-190216	Filter # 52	19/02/2016	22.733	27.434	4.701	93.274	SEM STEM
BA-F-06-260216	Filter # 06	26/02/2016	22.788	31.161	8.373	166.131	SEM STEM
BA-F-53-260216	Filter # 53	26/02/2016	22.970	32.190	9.220	182.937	SEM STEM
BA-OS-ALL-150316	>PM2.5 (oversize)	Combined	na	na	na	na	LD

During the sampling (field and laboratory) a number of observations were made which are considered to be important and relevant to this validation report. These are:

- The primary crusher is a very dusty area which meant that the sampling was representative of high suspended particulate matter conditions present in a limestone quarry;
- When the impactor was dismantled there was a noticeable accumulation of particulate matter (not quantified) remaining on the funnel section of impactor (Figure 6);
- When the filter cassette was removed there was a noticeable accumulation significant mass of particulate matter (>1 mg or over 10% of the total mass recorded on the filter in the tube connecting the sampler inlet to the cassette (Figure 7). The mass was quantified by weighing the tube, cleaning it with dry lint free tissue and then re-weighing. The difference was assumed to be the net mass of particulate matter present in the tube; and
- When the petroleum jelly was re-applied to the impactor it was difficult to ascertain whether the mass applied was the same each time, although it is not known if this factor is an important consideration

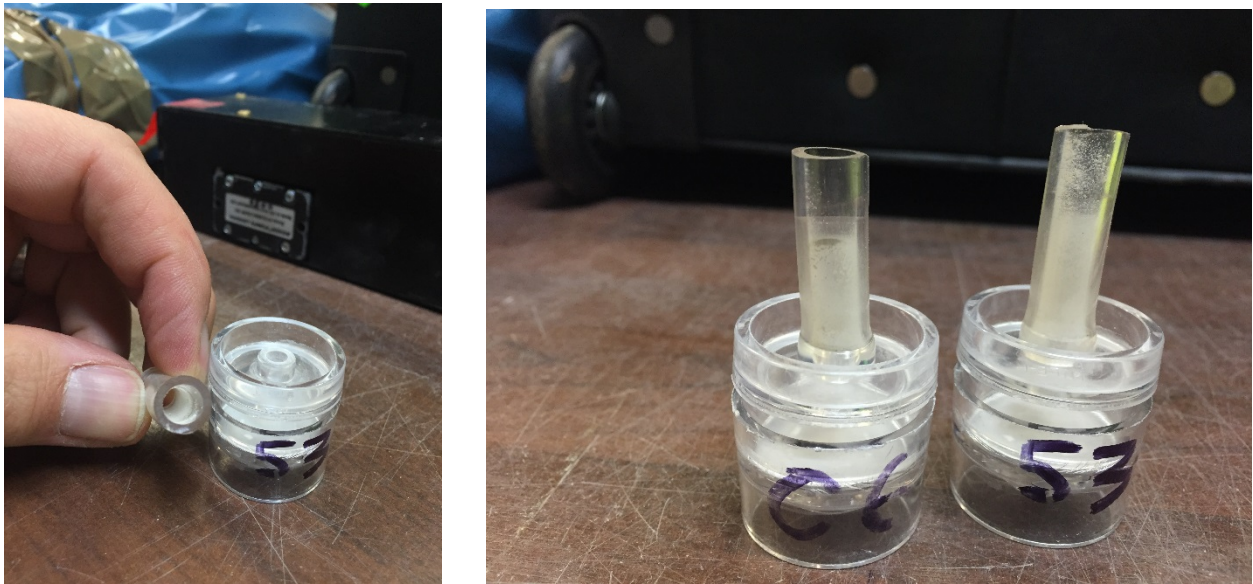




**Figure 5 – Ballidon Quarry primary crusher shed showing the author setting up the monitoring station**



**Figure 6 – Particulate matter collecting in the funnel section of the impactor**



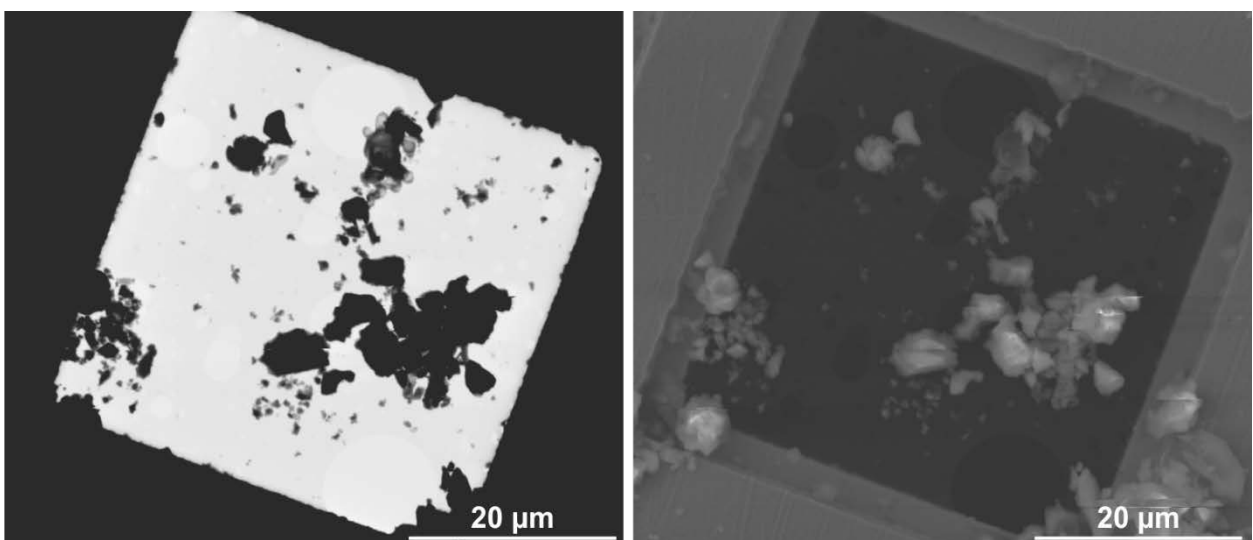
**Figure 7 – Inlet tubes showing significant particulate matter deposits collected on the side walls**

## 3.2 SEM AND STEM

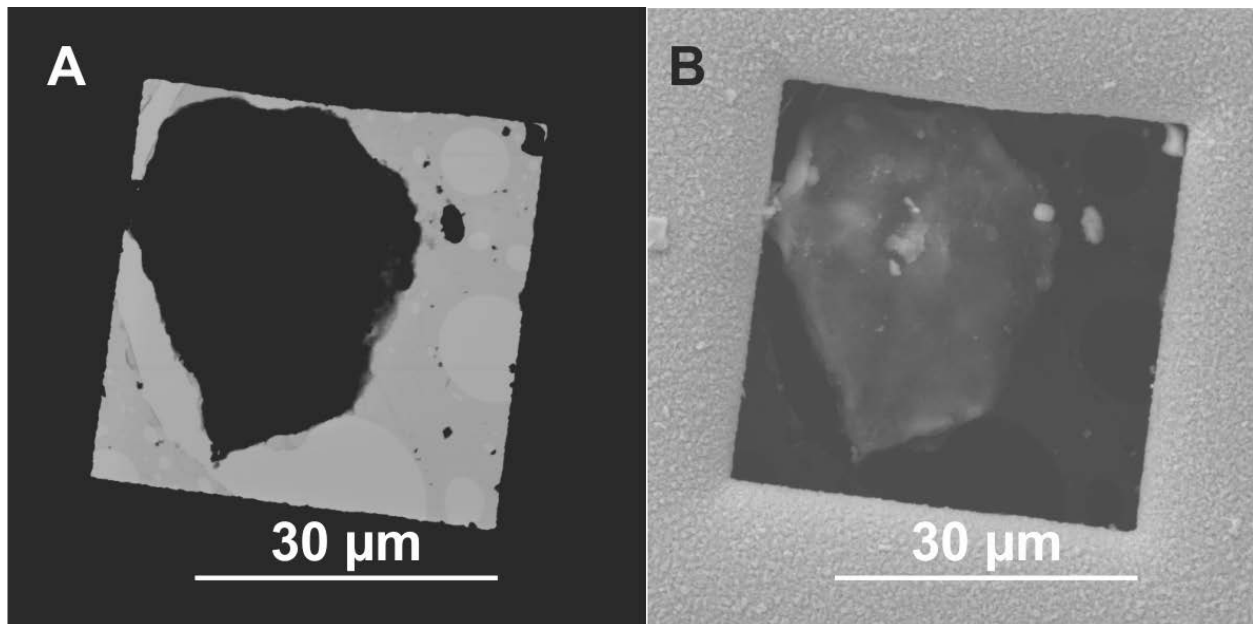
### 3.2.1 Microscopy

The filters were thickly coated in particulate matter with filters 53 and 06 from the final week (26<sup>th</sup> February 2016) of collection being the most thickly coated. Both of these filters displayed delamination in the centre of the filters. The coating for these filters was also lighter grey in colour compared to the previous four filters. SEM analysis of the uncoated, stub-mounted filter papers identified particles larger than 2.5  $\mu\text{m}$  in diameter in all samples (refer to Appendix 1 for examples), although imaging suggests that the majority of particles are below this diameter.

The x2 dilution proved optimal for STEM analysis, and these grids were used for STEM analysis in all cases. Some aggregation of particles was observed: this may be due to flocculation during the dilution process or agglomeration in ambient air prior to sample collection. Larger particles were checked under secondary conditions to verify if they were a discrete particle or an aggregate (e.g. Plate 2 and Plate 3).



**Plate 2 – STEM and LFD images showing typical particle aggregates (filter 53). These can be compared to large, discrete particles shown below in Plate 3**



**Plate 3 – STEM (A) and LFD (B) images showing one the largest particles identified (filter 06)**

### 3.2.2 Exploratory data analysis

The particle size data derived from the STEM analysis is summarised in Table 4. The median value for the combined data for all filters is  $0.46\ \mu\text{m}$  with a mean of  $0.74\ \mu\text{m}$  ( $n=6,343$ ) – these values indicate a strong positive skew. The minimum ( $0.3$  to  $0.4\ \mu\text{m}$ ), median ( $0.35$  to  $0.54$ ) and  $95^{\text{th}}$  percentile ( $1.82$  to  $2.41$ ) values are reasonably consistent between filters, whereas the maximum has far greater range ( $8$  to  $35\ \mu\text{m}$ ).

The distribution of particle size for each filter is presented as density plots using log x-axes in Figure 8. The plots show the data present a strong positive skew and that the majority of particles are  $<2.5\ \mu\text{m}$ .

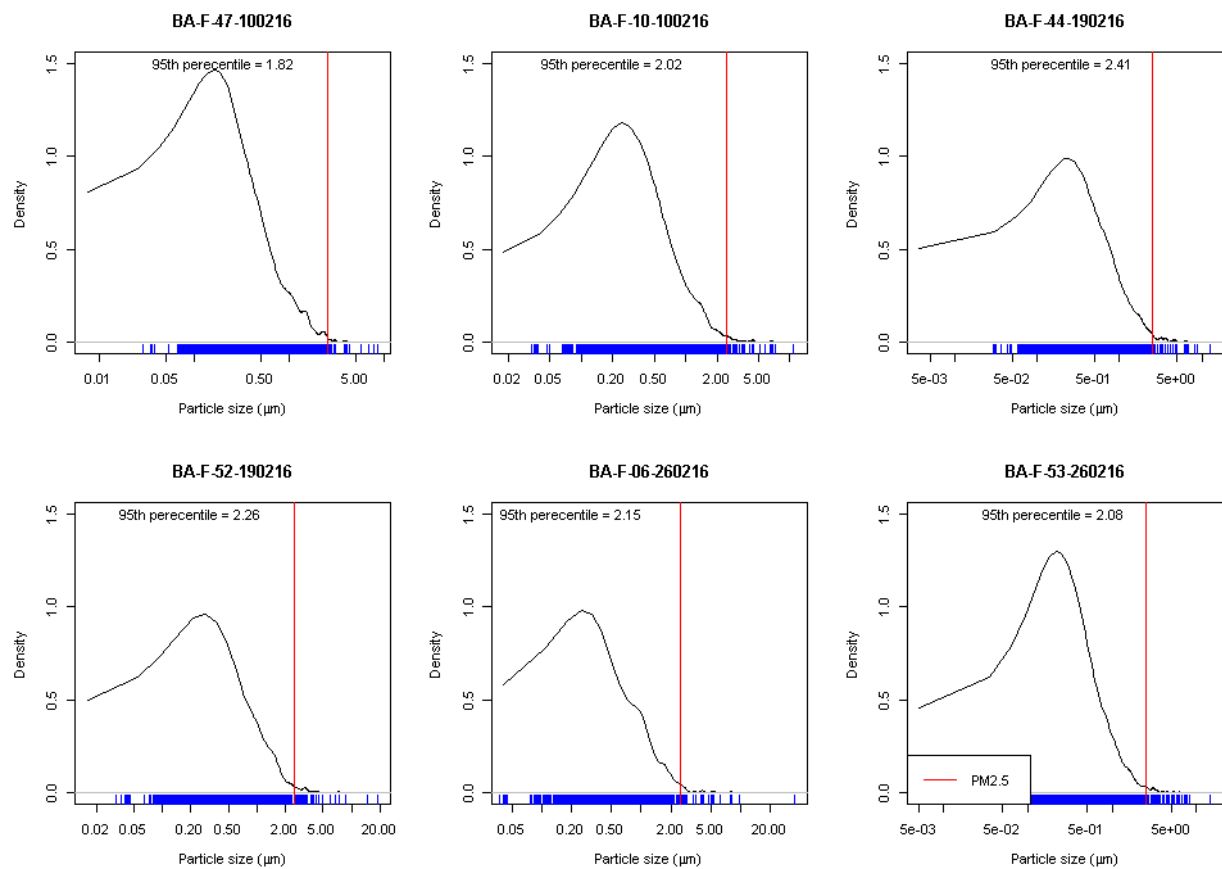
The combined all sample and individual filter data are presented as a relative cumulative frequency distribution in Figure 9 and Figure 10 respectively. These plots show that most of the particles are below  $2.5\ \mu\text{m}$ . The relative cumulative frequency distribution is very similar for each filter, suggesting performance between monitoring stations and visits is consistent.

Further analysis of the repeatability of the particulate matter collected by the two impactors during each of the three sampling rounds has been made using percentiles ( $0$  to  $99^{\text{th}}$  percentile at  $0.1$  percentile intervals). Percentiles were used to smooth the effect of extreme values (principally the upper region of the range including the maximum values) in the raw data. Figure 11 shows these percentiles as bi-plots for each sampling visit demonstrating that there is reasonable agreement with minimal variation in the distribution of the particle size collected by each monitoring station within and between visits. Linear models were fitted to each visit dataset to compare the relationship between the two impactors. Each model produced an  $R\text{-squared} > 0.95$ , suggesting good repeatability within sampling visits.

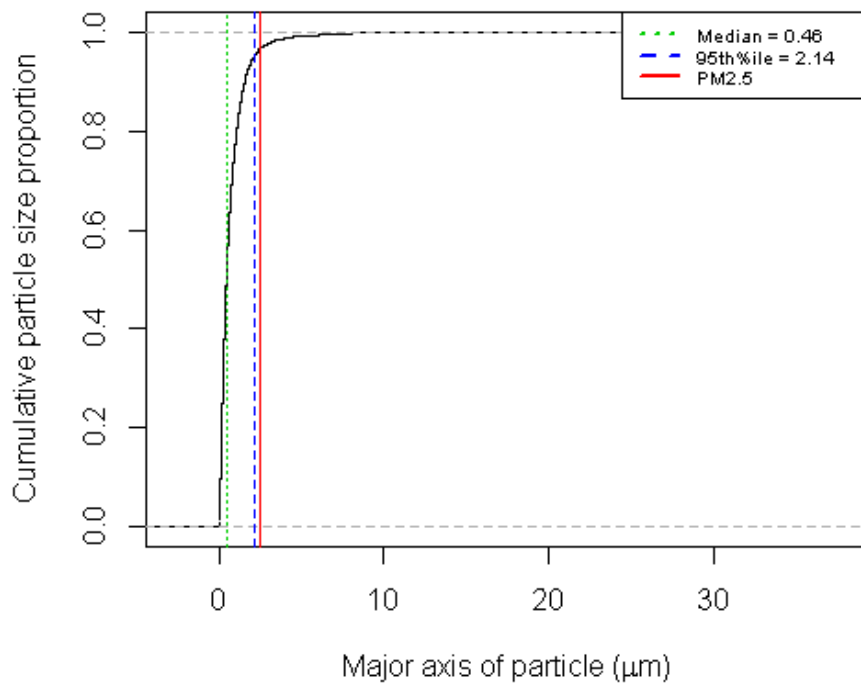
The medians and the  $95^{\text{th}}$  percentile CIs of  $d_{\text{PA}}$  of particles measured for each filter were estimated using bootstrap resampling. The resampled medians and the CIs are presented in Table 5 and Figure 12. The results of the resampling show that there are some significant differences between some but not all of the CIs. These are probably due to slightly different conditions at different time periods (e.g. humidity, day to day variations). The overall CI range of  $0.3$  to  $0.6\ \mu\text{m}$  for all samples suggests a good level of precision in the particulate matter collected by the DS500X monitoring system both between parallel stations and visits.

**Table 4 – Summary of the particulate data generated by STEM analysis and IMAGE-J processing**

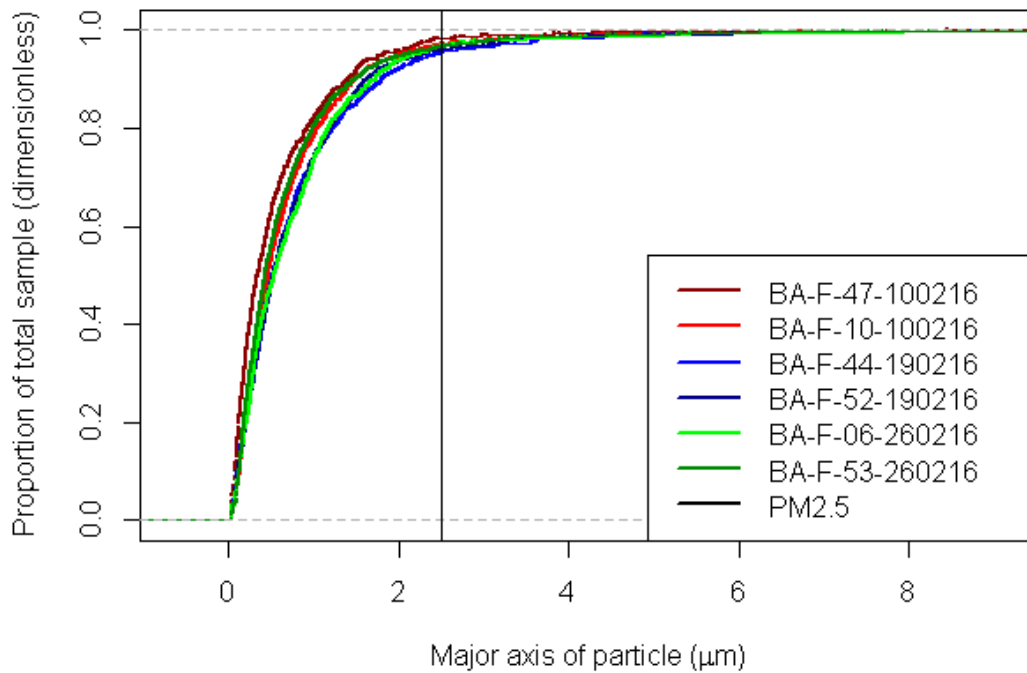
	Filter # 47	Filter # 10	Filter # 44	Filter # 52	Filter # 06	Filter # 53	All
	Visit 1		Visit 2		Visit 3		
Minimum (µm)	0.03	0.03	0.03	0.03	0.04	0.04	<b>0.03</b>
Mean (µm)	0.59	0.72	0.83	0.83	0.84	0.70	<b>0.74</b>
Median (µm)	0.35	0.47	0.52	0.54	0.53	0.43	<b>0.46</b>
Maximum (µm)	8.44	10.91	12.54	19.17	34.84	14.56	<b>34.84</b>
Standard deviation (µm)	0.74	0.84	1.02	1.17	1.54	0.91	<b>1.02</b>
Relative standard deviation (%)	125	117	123	142	182	129	<b>139</b>
95 <sup>th</sup> percentile (µm)	1.82	2.02	2.41	2.26	2.15	2.08	<b>2.14</b>
n	993	1334	922	850	760	1484	<b>6343</b>



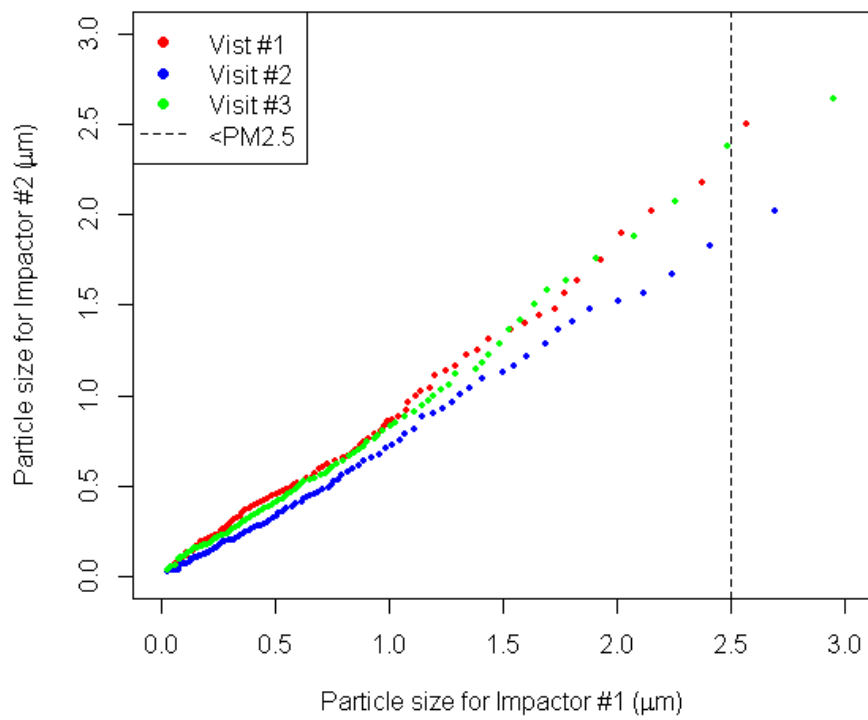
**Figure 8 –Distributions of the particle size recorded for each filter**



**Figure 9 – Relative cumulative frequency distribution for all samples**



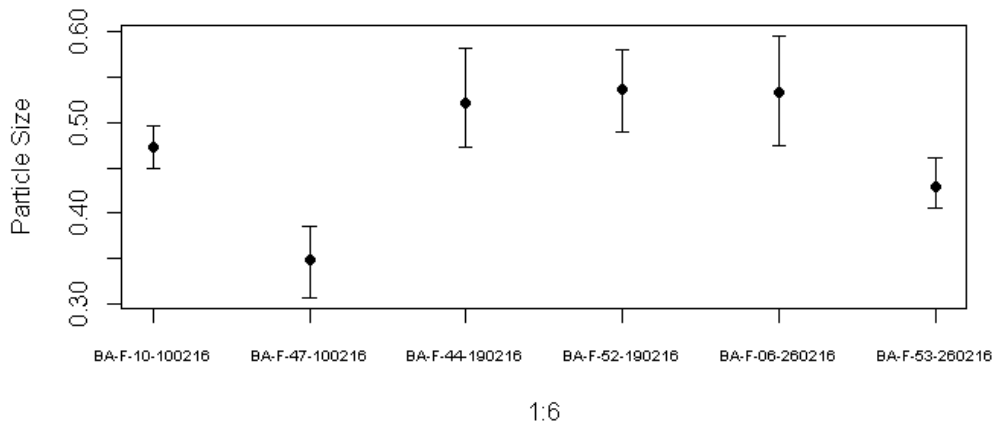
**Figure 10 – Relative cumulative frequency distribution for individual samples sample data with the x-axis limited to 10 µm**



**Figure 11 – Bi-plot of the percentiles for the pairs of filters collected during each sampling visit**

**Table 5 – Original and resampled median data with upper and lower confidence intervals for each filter**

Visit	Filter	Resampled lower confidence interval (µm)	Resampled median (µm)	Resampled upper confidence interval (µm)
1	#47	0.30	0.35	0.38
	#10	0.45	0.47	0.50
2	#44	0.48	0.52	0.59
	#52	0.50	0.54	0.57
3	#06	0.48	0.53	0.60
	#53	0.40	0.43	0.46



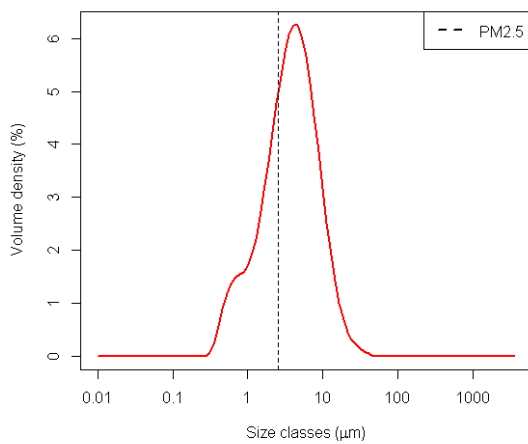
**Figure 12 – Resampled median and upper and lower confidence intervals**

**3.3 LASER DIFFRACTION PARTICLE SIZE ANALYSIS**

The certificate of analysis for the LD conducted by Escubed Limited is presented in Appendix 2.

A summary of the particle size distribution plotted on a log x-axis is presented in Figure 13. The results show that the majority of particles present in the oversize sample are > 2.5 μm, where the median (Dv50) is 4.01 μm.

Table 6 shows the Dv (10), Dv (50) and Dv (90) for the sample together with the standard deviation and coefficient of variation (%CV), which show the repeatability between measurements. It is stated in ISO 13320 that the %CV should not exceed 3% around the median and 5% around the extremities. Below 10μm, these maximum values should be doubled.



**Figure 13 – Particle size distribution plotted on log x-axis derived by laser diffraction analysis of oversize particles collected from six impactor plates over three visits**

**Table 6 - Repeatability of BA-OS-ALL-150316 (ID 16-079-01)**

Sample Name	Particle Size ( $\mu\text{m}$ )		
	Dv (10)	Dv (50)	Dv (90)
16-079-01 BA-OS-ALL-150316 Rep 4	1.06	3.98	10.73
16-079-01 BA-OS-ALL-150316 Rep 4	1.07	3.99	10.72
16-079-01 BA-OS-ALL-150316 Rep 4	1.07	4.00	10.74
16-079-01 BA-OS-ALL-150316 Rep 4	1.07	4.01	10.77
16-079-01 BA-OS-ALL-150316 Rep 4	1.07	4.02	10.71
16-079-01 BA-OS-ALL-150316 Rep 4	1.07	4.02	10.64
16-079-01 BA-OS-ALL-150316 Rep 4	1.07	4.02	10.66
16-079-01 BA-OS-ALL-150316 Rep 4	1.08	4.02	10.62
16-079-01 BA-OS-ALL-150316 Rep 4	1.08	4.03	10.58
16-079-01 BA-OS-ALL-150316 Rep 4	1.08	4.03	10.55
Average	1.07	4.01	10.67
Standard Deviation	0.00	0.02	0.07
%CV	0.41	0.40	0.70

## 4 Conclusions

The results of this investigation show that the DustScan DS500X system fitted with the PM<sub>2.5</sub> size selective impactor is capable of separating particles with a  $d_{PA}$  of  $\leq 2.5 \mu\text{m}$  from ambient air and retaining them on filter media for subsequent quantification. This statement relates to test sampling conducted at Ballidon Quarry for the limestone particulate matter generated in the primary crusher shed. The overall median particle size measured on the filters was  $0.46 \mu\text{m}$ , the mean was  $0.74 \mu\text{m}$  and the 95<sup>th</sup> percentile was  $2.15 \mu\text{m}$  ( $n = 6343$ ). The results of the particle size analysis of the oversize fraction collected from the impactor plate by Escubed Limited report the median as  $4.01 \mu\text{m}$ .

The median values are lower than might be expected for the filters if the following PM<sub>2.5</sub> definition is applied:

*“Particulate matter suspended in air which is small enough to pass through a size-selective inlet with a 50 % efficiency cut-off at  $2.5 \mu\text{m}$  aerodynamic diameter”* British Standard EN 12341:2014

The particle size analysis conducted by BGS and Escubed report the  $d_{PA}$  on a 2D plane and equivalent sphere diameter in solution as oppose to  $d_{ae}$  referred to in the British Standard definition. Although the definition is applicable validating the collection efficiency of the DS500X system, the results are essentially surrogates for  $d_{ae}$ . Further analysis of  $d_{ae}$  would only be possible if significantly greater sample mass was made available, this is not an option with the current configuration of the DS500X. Notwithstanding, the measurements presented in this study are extremely encouraging and show that the majority of the particles collected on the filter are less than  $2.5 \mu\text{m}$  and that those collected on the impactor plate are greater than  $2.5 \mu\text{m}$ . This indicates that the DS500X fitted with the PM<sub>2.5</sub> size selective impactor is an effective method for collecting the desired particle sizes.

Exploratory data analysis of the particulate matter collected on the filters showed that the particle size distribution between and within sampling visits was very consistent. These indicators of the



precision of the DS500X system suggest a good level of collection repeatability between stations and reproducibility between visits.

The following observations were made during the monitoring visits to Ballidon Quarry and the subsequent gravimetric and particle sizing analyses:

1. The primary crusher shed at Ballidon Quarry was a very dusty environment (Figure 3);
2. The particulate matter collected and analysed for this study is limited to a single principle source comprising limestone rock with similar density of morphology characteristics;
3. When the impactor was dismantled for oversize particulate matter collection and cleaning a significant mass of particulate matter remained on the funnel section of impactor (Figure 6);
4. When the filter cassette was removed there was a significant mass of particulate matter ( $> 1 \mu\text{g}$ ) in the tube connecting the box inlet to the cassette (Figure 7);
5. Physical differences observed between filters from the first two weeks of sample collection and the last week of sample collection (quantity of material, delamination in the centre of the filters, and colour of material collected);
6. When the petroleum jelly was re-applied to the impactor it was difficult to ascertain whether the thickness applied was the same each time. It is not known how significantly this factor contributes to collection efficiency;
7. Some of the larger particles observed using secondary STEM conditions were a determined to be aggregate particles. It was not possible to differentiate between whether this is due to flocculation during the dilution process or agglomeration in ambient air prior to sample collection.

The experiments demonstrated that the DS500X samplers fitted with nominally  $\text{PM}_{2.5}$  size-selective inlets could collect samples in a dusty environment with a high degree of precision. BGS recommend that the causes of the observations reported above are investigated. Further investigations are also recommended to evaluate the device in other environments and further consideration should also be given to how the  $d_{\text{PA}}$  results reported relate to the  $d_{\text{ae}}$  to help fulfil the British Standards definition of  $\text{PM}_{2.5}$ .

# Appendices

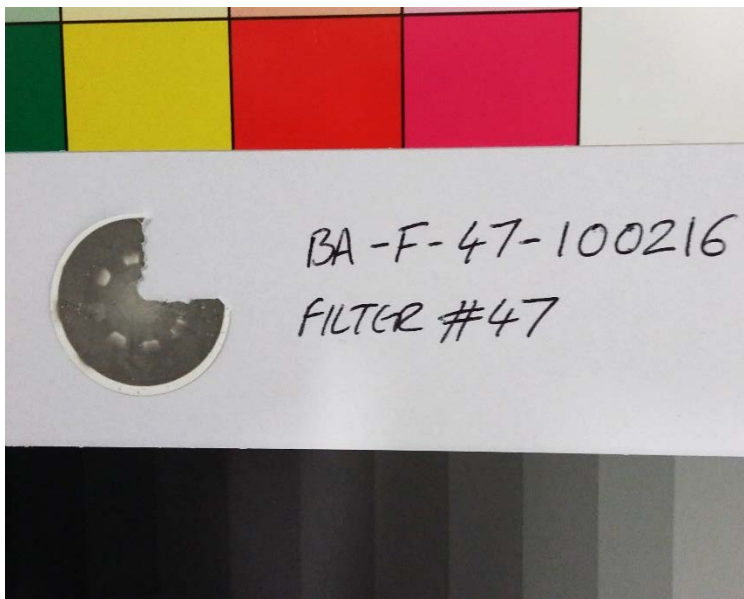
# Appendix 1

## IMAGES OF CELLULOSE FILTERS

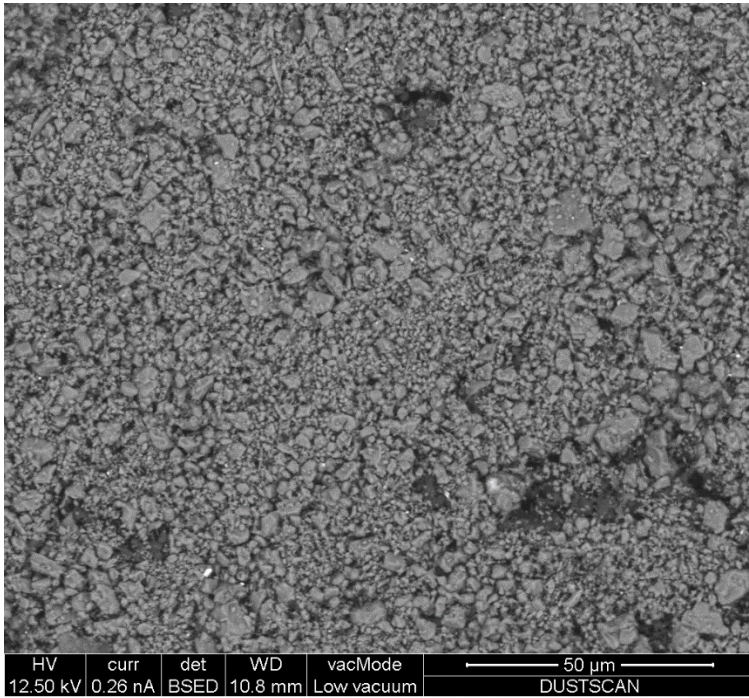
The filters were imaged after a one-quarter segment was removed for STEM analysis. The following images show each filter in turn for reference. An image has also been included of the one-quarter segment for Filter #44 post-sonication to show the amount of material removed from the filter by this preparation method.

Morphological SEM images were taken of each filter to record a general record of the density and particle size range for each filter.

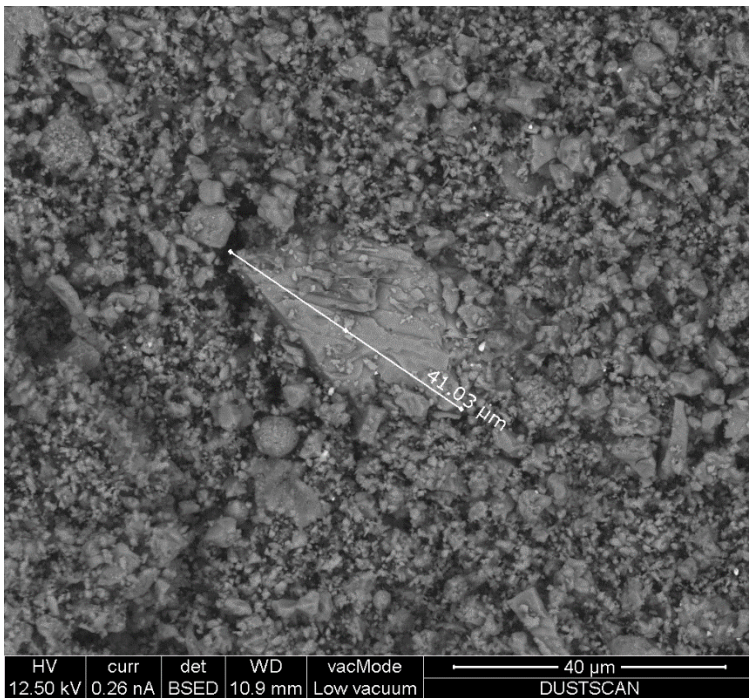
### BA-F-47-100216



**Plate 4. Photograph of filter 47 following sub-sampling for STEM analysis.**

**BA-F-47-100216 – SEM images of the filter**

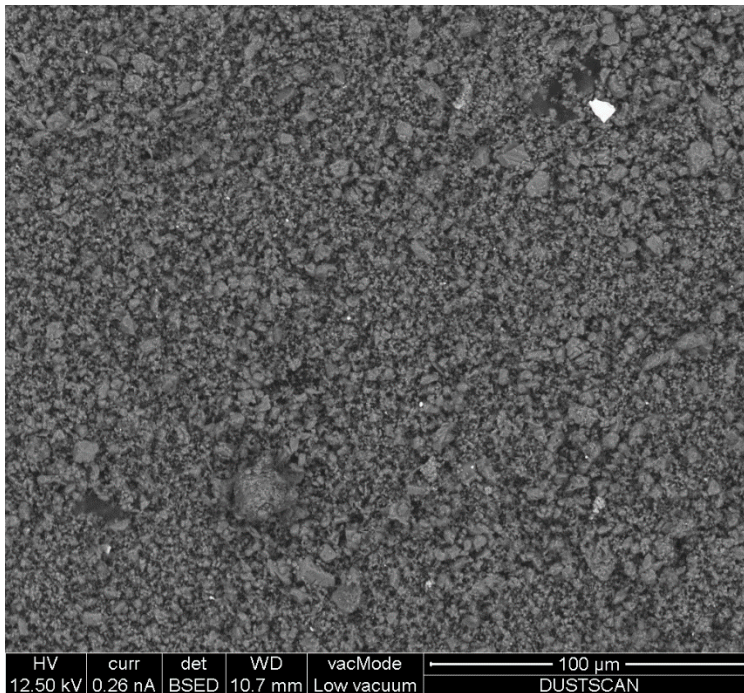
**Plate 5. BSED image showing the density of particle coverage on the filter surface.**



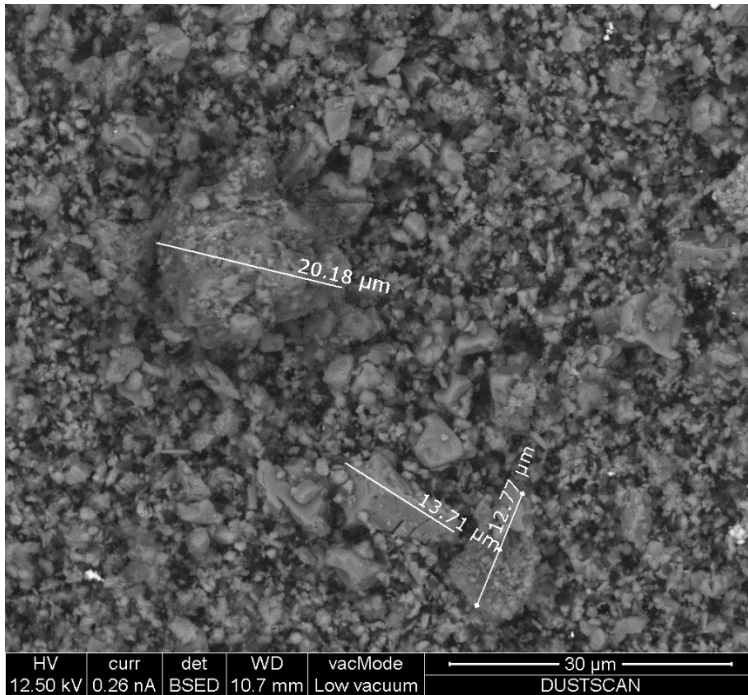
**Plate 6. BSED image of a large particle in-situ within the particle coating of the filter. The measurement was carried out live within the FEI software.**

**BA-F-10-100216**

**Plate 7. Photograph of filter F10 following sub-sampling for STEM analysis.**

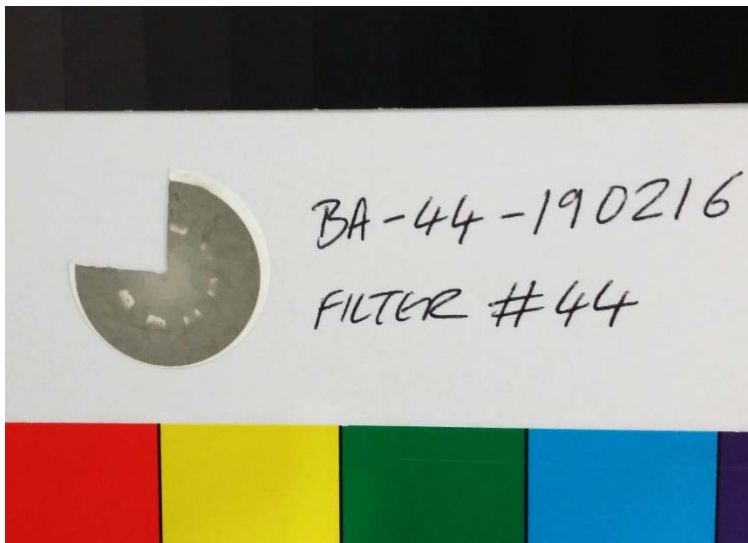


**Plate 8. BSEM image showing the general coating of particles across the filter.**

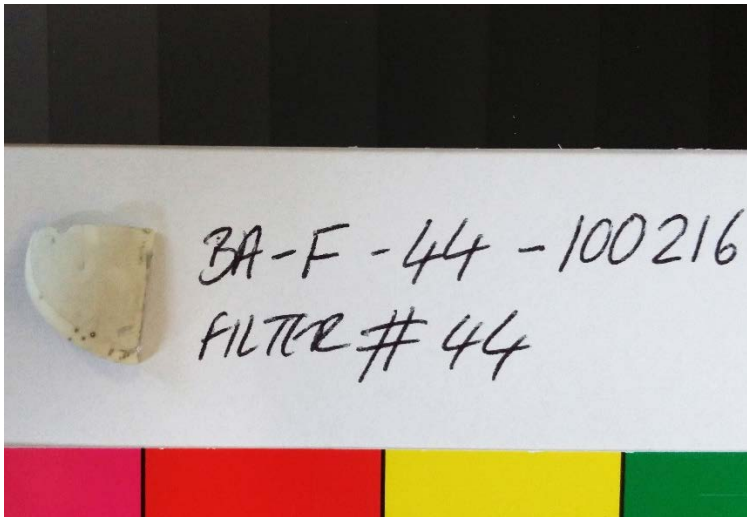


**Plate 9. BSED image showing three larger particles within the coating on the filter. Measurements were carried out live within the FEI software.**

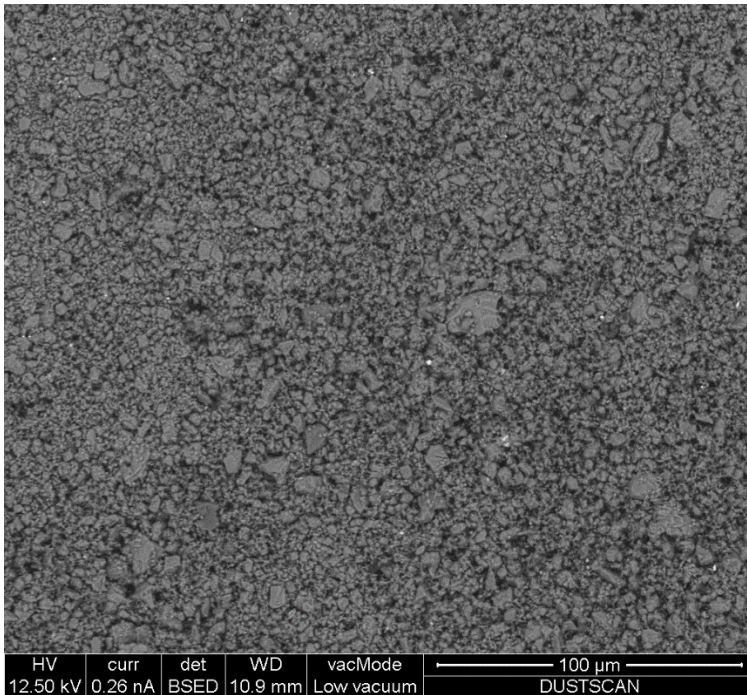
**BA-F-44-190216**



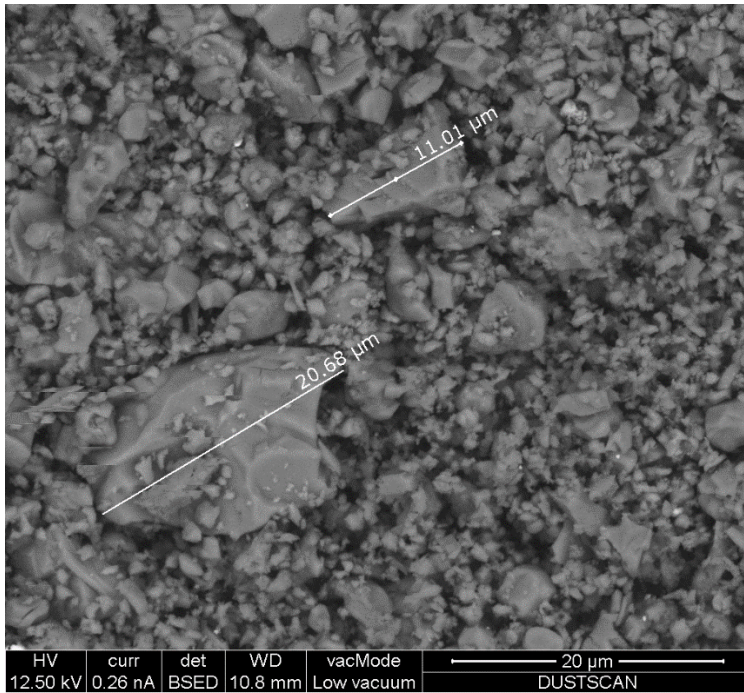
**Plate 10. Photograph of filter 44 following sub-sampling for STEM analysis.**



**Plate 11. Photograph of the one-quarter segment taken for STEM analysis following sonication. Almost all the particulate material has been removed from the filter. The darker spots are where the filter membrane has been damaged by handling by tweezers and cut by scalpel.**



**Plate 12. BSEM image showing the particle distribution across the filter.**



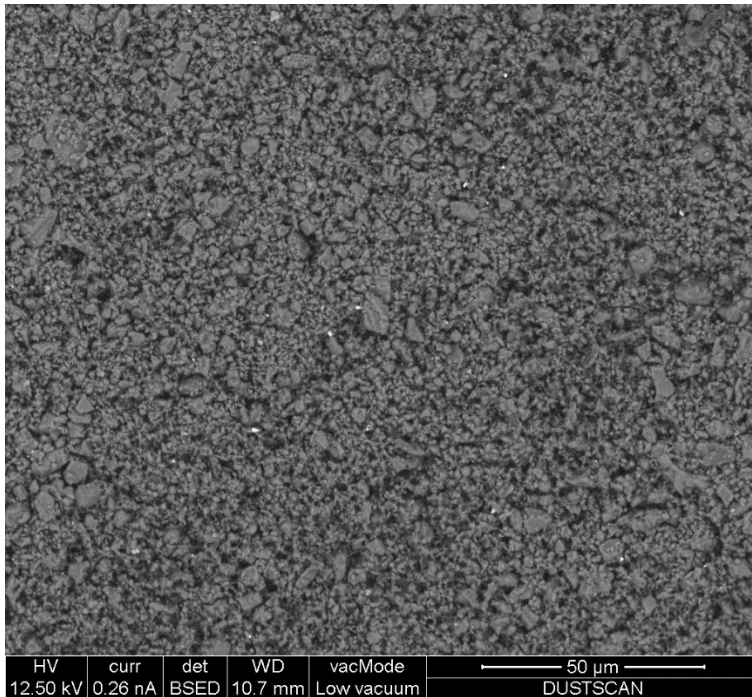
**Plate 13. BSEM image showing two larger particles within the particle coating. Measurements were carried out live within the FEI software.**

**BA-F-52-190216**

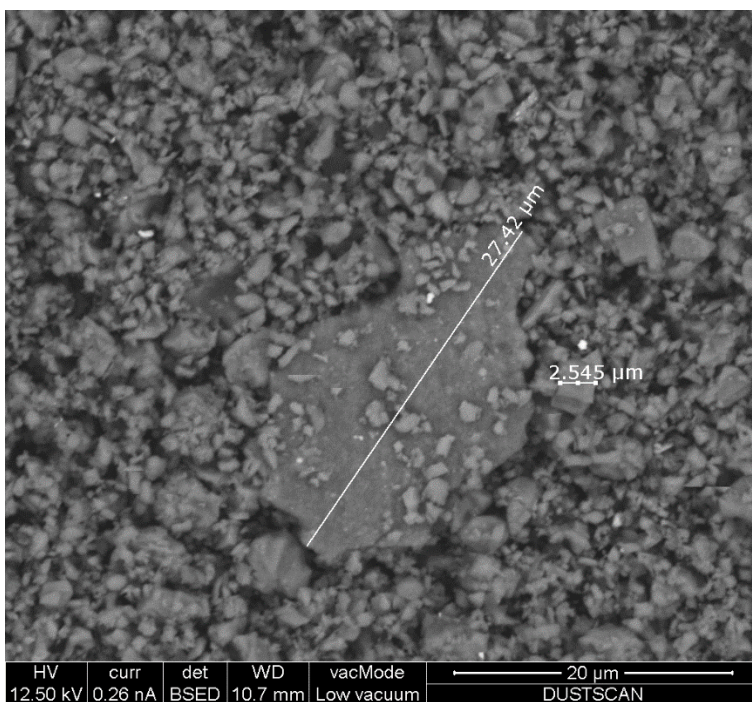


**Plate 14. Photograph of filter 44 following sub-sampling for STEM analysis.**





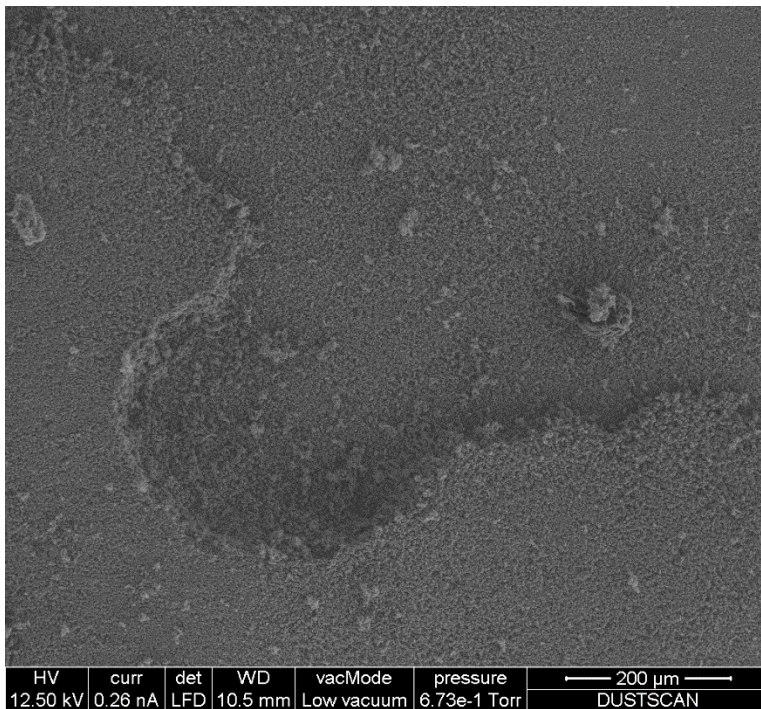
**Plate 15. BSEM image showing the general distribution of particles across the filter surface.**



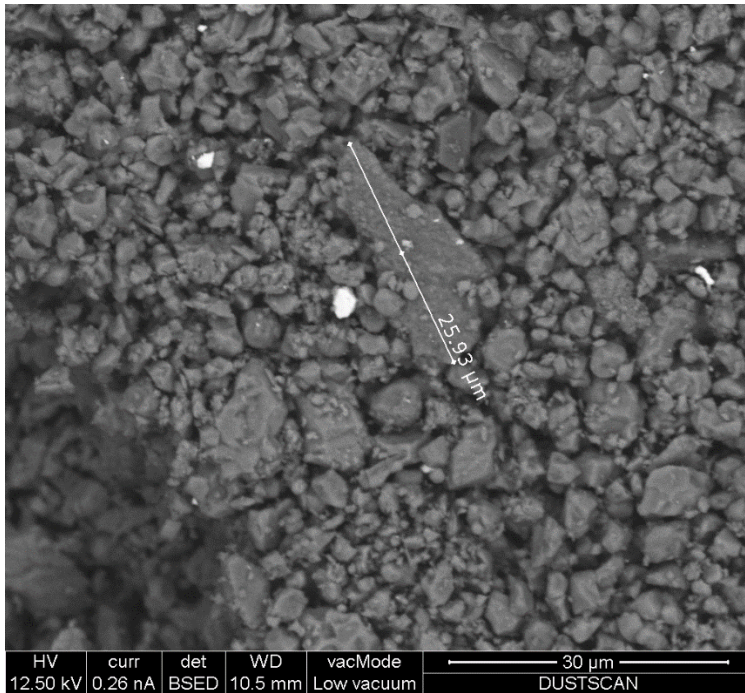
**Plate 16. BSEM image of a larger particle. The majority of particles are clearly around 2.5 microns or less in diameter.**

**BA-F-06-260216**

**Plate 17. Photograph of filter 06 following sub-sampling for STEM analysis. This sample was quite thickly coated and the centre of the sample has suffered de-lamination as some of the particulate material has come away from the filter. This had occurred pre-subsampling.**

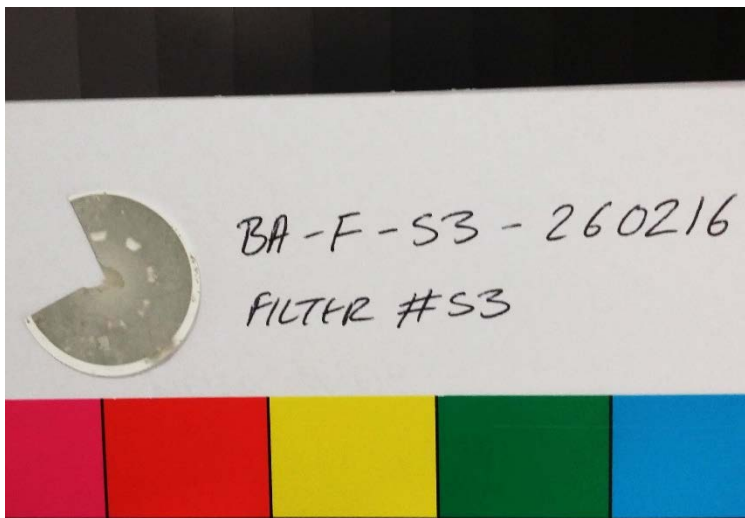


**Plate 18. An LFD image showing the morphology of the delamination in the centre of the sample. This is also an indication of how thickly coated the filter is.**

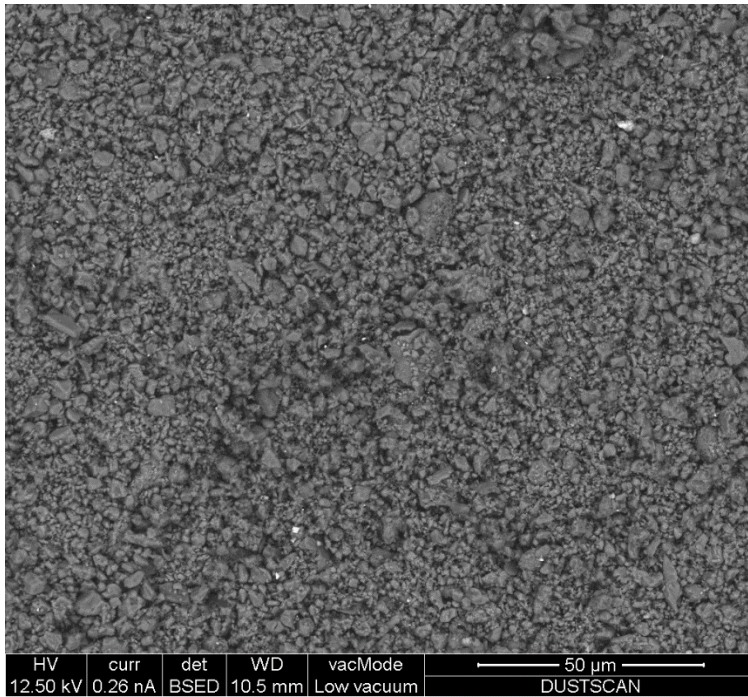


**Plate 19.** A BSEM image at the edge of the delamination (see lower left corner of image), showing a larger particle. The measurement was carried out live within the FEI software.

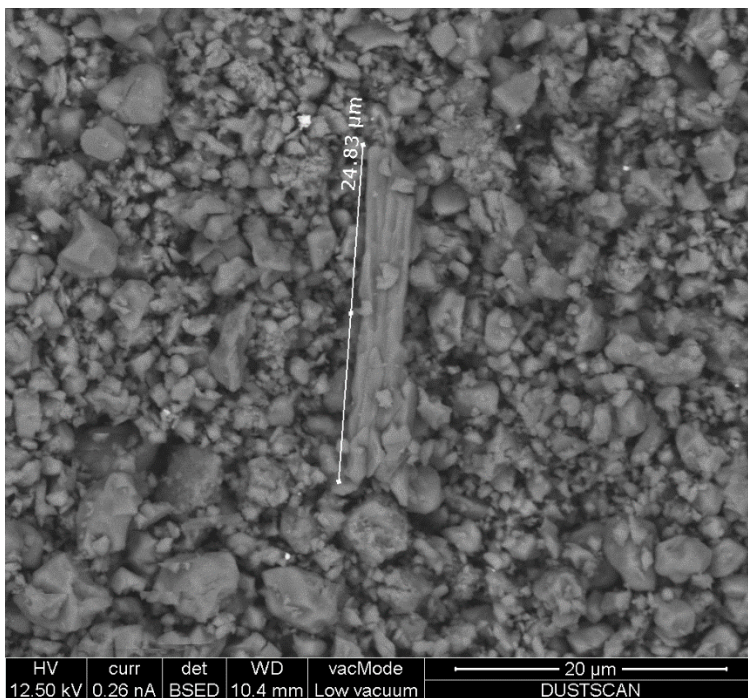
**BA-F-53-260216**



**Plate 20.** Photograph of filter 53 following sub-sampling for STEM analysis. Like its counterpart filter, BA-F-06-260216, filter 53 had also suffered from some delamination in the centre of the filter.



**Plate 21. BSEM image showing the general distribution of particles on filter 53.**






**Plate 22. BSEM image showing a larger particle within the sample. The measurement was carried out live within the FEI software.**

# Appendix 2

## **RESULTS OF THE LASER DIFFRACTION PARTICLE SIZE ANALYSIS BY ESCUBED LIMITED.**

## CHARACTERISATION REPORT

**Title:** Particle Size Analysis of Limestone Dust  
**Company:** British Geological Survey  
**Company Address:** Nicker Hill, Keyworth NG12 5GG  
**Company Contact:** Dr Darren Beriro  
**Quotation Reference:** PC-16-079  
**Sample Receipt Date:** 18Mar2016  
**Date of Report:** 23Mar2016  
**Laboratory Address:** Unit 1 BioIncubator, Garstang Building, University of Leeds, Leeds, LS2 9JT

<b>Prepared by:</b> Lucile Chan	<b>Signed:</b> 
<b>Job Title:</b> Scientist	<b>Date:</b> 24 Mar 2016
<b>Checked by:</b> Paul Senior	<b>Signed:</b> 
<b>Job Title:</b> Scientist	<b>Date:</b> 24 mar 2016
<b>Approved by:</b> Kylie Griffin	<b>Signed:</b> 
<b>Job Title:</b> Quality Manager	<b>Date:</b> 24 MAR 2016



The particle size analysis by laser diffraction carried out in this report has been UKAS accredited to comply with ISO/IEC 17025:2005. The scope of this accreditation does not cover any opinions or interpretations stated.

escubed limited, Leeds Innovation Centre, 103 Clarendon Road, Leeds, LS2 9DF. UK.  
Registered in England and Wales No: 6295505  
VAT No: 933840713

## 1.0 Summary

escubed ID	Client Sample ID	Particle Size ( $\mu\text{m}$ )		
		Dv (10)	Dv (50)	Dv (90)
16-079-01	BA-OS-ALL-150316	1.07	4.01	10.67

Table I: Summary of Results

## 2.0 Introduction

One sample of limestone dust was submitted for particle size analysis using the Malvern Mastersizer 3000. A summary of results is given in Table I.

## 3.0 Methodology

### 3.1 Particle Size Analysis

The work was carried out using a Malvern Mastersizer 3000 with the Hydro MV dispersion cell. The dispersion cell was filled with de-ionised water and thermal equilibrium allowed to take place before checking the cleanliness of the system. Once clean, a background was determined, the laser aligned and a background measurement taken. The following settings and requirements were used for the analysis:

Method Reference	INS-SOP002-3
Dispersion Cell	Hydro MV
Dispersant	Purified water
Surfactant	5% v/v Igepal CA-630 in water
Background Sweep	20 seconds
Measurement Time	10 seconds
Number of Measurements	10
Stirrer/Pump Speed	2700 rpm
Obscuration	4 – 5%

#### 3.1.1 Optical Properties

The scattering pattern was deconvolved (to produce the particle size distribution) using Mie theory. Mie theory requires knowledge of the refractive index of both sample and the dispersant along with the absorption (imaginary refractive index) of the sample.

Refractive Index	1.59
Imaginary Refractive Index	1
Refractive Index of Dispersant	1.33
Analysis Model	General Purpose (Normal Sensitivity)
Particle Shape	Non-Spherical

The result is presented as a mean based volume result in  $\mu\text{m}$  of the repeat measurements taken. The result has been represented by the 10<sup>th</sup>, 50<sup>th</sup>, and 90<sup>th</sup> percentiles Dv (10), Dv (50) and Dv (90).

## 4.0 Results

### 4.1 Particle Size Analysis

The analysis reports for the samples are included in the appendix; showing the mean result of the repeat measurements taken.



Table II show the Dv (10), Dv (50) and Dv (90) for the sample together with the standard deviation and coefficient of variation (%CV), which show the repeatability between measurements. It is stated in ISO 13320 that the %CV should not exceed 3% around the median and 5% around the extremities. Below 10 $\mu$ m, these maximum values should be doubled.

Sample Name	Particle Size ( $\mu$ m)		
	Dv (10)	Dv (50)	Dv (90)
16-079-01 BA-OS-ALL-150316 Rep 4	1.06	3.98	10.73
16-079-01 BA-OS-ALL-150316 Rep 4	1.07	3.99	10.72
16-079-01 BA-OS-ALL-150316 Rep 4	1.07	4.00	10.74
16-079-01 BA-OS-ALL-150316 Rep 4	1.07	4.01	10.77
16-079-01 BA-OS-ALL-150316 Rep 4	1.07	4.02	10.71
16-079-01 BA-OS-ALL-150316 Rep 4	1.07	4.02	10.64
16-079-01 BA-OS-ALL-150316 Rep 4	1.07	4.02	10.66
16-079-01 BA-OS-ALL-150316 Rep 4	1.08	4.02	10.62
16-079-01 BA-OS-ALL-150316 Rep 4	1.08	4.03	10.58
16-079-01 BA-OS-ALL-150316 Rep 4	1.08	4.03	10.55
Average	1.07	4.01	10.67
Standard Deviation	0.00	0.02	0.07
%CV	0.41	0.40	0.70

Table II: Repeatability of BA-OS-ALL-150316 (ID 16-079-01)

## 5.0 Appendix

Only the particle size analysis by laser diffraction carried out in this report has been UKAS accredited to ISO/IEC 17025:2005. Any interpretations and opinions are not accredited.



# Analysis

Created by: LucileChan  
Last edited: 18/03/2016 08:18:33



## Measurement Details

<b>Sample Name</b>	Average of '16-079-01 BA-OS-ALL-150316 Rep 4'	<b>Measurement Date Time</b>	23/03/2016 15:40:23
<b>Sample Description</b>	>PM2.5 (oversize-all)	<b>Analysis Date Time</b>	23/03/2016 16:30:57
<b>Operator Name</b>	LucileChan	<b>Result Source</b>	Averaged
<b>SOP File Name</b>	HydroMV.cfg	<b>Alignment Date</b>	23/03/2016 15:31:38
<b>Instrument Serial No.</b>	MAL1107462	<b>Performance Verification</b>	01Mar2016
<b>File Name</b>	PC-16-079	<b>Record Number</b>	240

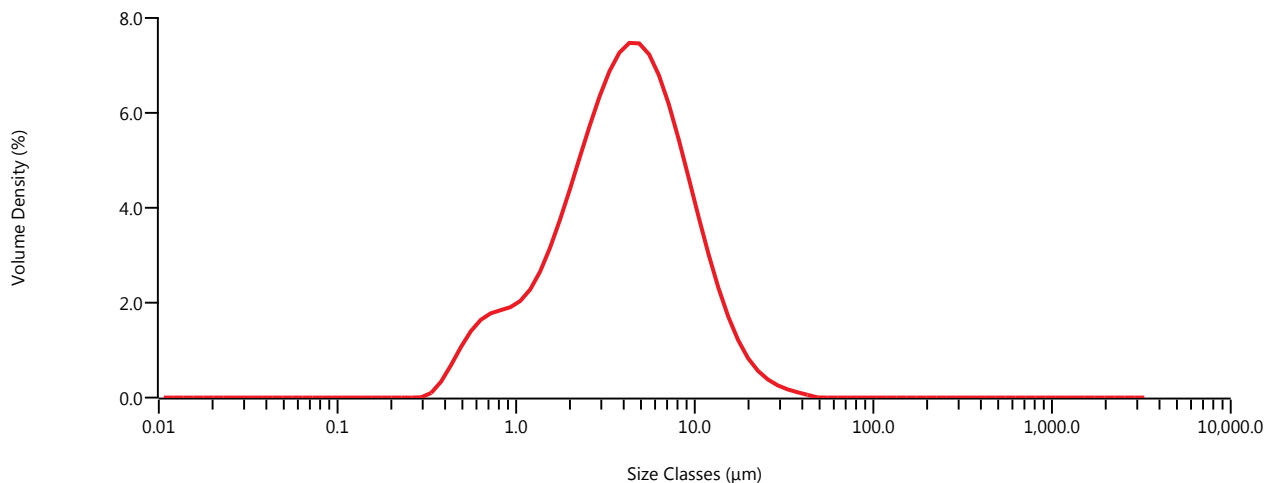
## Analysis

<b>Particle Name</b>	1.59/1	<b>Particle Refractive Index</b>	1.590
<b>Dispersant Name</b>	Water	<b>Dispersant Refractive Index</b>	1.330
<b>Particle Absorption Index</b>	1.000	<b>Laser Obscuration</b>	4.33 %
<b>Weighted Residual</b>	0.51 %	<b>Scattering Model</b>	Mie
<b>Analysis Model</b>	General Purpose	<b>Analysis Sensitivity</b>	Normal
<b>Stirrer Speed Achieved</b>	2700 rpm		

## Result

<b>Concentration</b>	0.0013 %	<b>Span</b>	2.393
<b>Uniformity</b>	0.763	<b>Result Units</b>	Volume
<b>Specific Surface Area</b>	2414 m <sup>2</sup> /kg	<b>Dv (10)</b>	1.071 μm
<b>D [3,2]</b>	2.485 μm	<b>Dv (50)</b>	4.011 μm
<b>D [4,3]</b>	5.231 μm	<b>Dv (90)</b>	10.672 μm

Frequency (compatible)



[240] Average of '16-079-01 BA-OS-ALL-150316 Re

Size (μm)	% Volume In	Size (μm)	% Volume In	Size (μm)	% Volume In	Size (μm)	% Volume In	Size (μm)	% Volume In	Size (μm)	% Volume In	Size (μm)	% Volume In
0.010	0.00	0.068	0.00	0.460	0.89	3.125	5.74	21.205	0.46	143.897	0.00	976.475	0.00
0.011	0.00	0.077	0.00	0.523	1.18	3.550	6.07	24.092	0.31	163.490	0.00	1109.435	0.00
0.013	0.00	0.088	0.00	0.594	1.37	4.034	6.25	27.373	0.21	185.752	0.00	1260.499	0.00
0.015	0.00	0.100	0.00	0.675	1.48	4.583	6.24	31.100	0.14	211.044	0.00	1432.133	0.00
0.017	0.00	0.113	0.00	0.767	1.54	5.207	6.04	35.335	0.09	239.780	0.00	1627.136	0.00
0.019	0.00	0.128	0.00	0.872	1.58	5.916	5.67	40.146	0.05	272.430	0.00	1848.692	0.00
0.022	0.00	0.146	0.00	0.991	1.69	6.722	5.16	45.613	0.00	309.525	0.00	2100.416	0.00
0.024	0.00	0.166	0.00	1.125	1.89	7.637	4.54	51.823	0.00	351.670	0.00	2386.415	0.00
0.028	0.00	0.188	0.00	1.279	2.21	8.677	3.86	58.880	0.00	399.555	0.00	2711.357	0.00
0.032	0.00	0.214	0.00	1.453	2.63	9.858	3.17	66.897	0.00	453.960	0.00	3080.544	0.00
0.036	0.00	0.243	0.00	1.651	3.12	11.201	2.51	76.006	0.00	515.772	0.00	3500.000	
0.041	0.00	0.276	0.00	1.875	3.66	12.726	1.92	86.355	0.00	586.001	0.00		
0.046	0.00	0.314	0.07	2.131	4.22	14.458	1.41	98.114	0.00	665.793	0.00		
0.053	0.00	0.357	0.27	2.421	4.77	16.427	1.00	111.473	0.00	756.449	0.00		
0.060	0.00	0.405	0.57	2.750	5.29	18.664	0.69	126.652	0.00	859.450	0.00		



## Acronyms

<i>BSEM</i>	Backscatter electron microscopy
<i>Ependorf</i> <sup>®</sup> vial	Trade name for a liquid tight micro-centrifuge tube
<i>ESEM</i>	Environmental scanning electron microscopy
<i>LFD</i>	Large field detector.
<i>STEM</i>	Scanning transmission electron microscopy
<i>SEM</i>	Scanning electron microscopy
<i>TEM</i>	Transmission electron microscopy
<i>PM</i>	Particulate matter
$d_{ae}$	Aerodynamic diameter
$d_{PA}$	Projected area diameter

## References

British Geological Survey holds most of the references listed below, and copies may be obtained via the library service subject to copyright legislation (contact libuser@bgs.ac.uk for details). The library catalogue is available at: <https://envirolib.apps.nerc.ac.uk/olibcgi>.

The British Standards Institution. (2015). *Ambient air — Standard gravimetric measurement method for the determination of the PM10 or PM2.5 mass concentration of suspended particulate matter*. BSI Standards Limited.

Vincent, J. H. (2007). *Aerosol Sampling – Science, Standards, Instrumentation and Applications*. John Wiley & Sons.