

INNOVATION AND TECHNOLOGY TRANSFER

This issue

	Page
INNOVATION POLICY	
VALUE adopted	2
RESEARCH AND DEVELOPMENT POLICY	
Council decides on seven RTD programmes	3
Common position on three other RTD programmes	4
Vice-President Pandolfi proposes new ideas for RTD Framework Programme	5
ESPRIT calls for proposals 1989	5
European Community contest for young scientists	5
R&D newsletters of the CEC	6
Commission proposes THERMIE Programme	7
NETT: Network for Environmental Technology Transfer	7
Second phase of ERASMUS Programme	8
RACE '89	9
CTS-WAN Eurolabs open for business	10
COMMUNITY R&D RESULTS	
Participation of the Commission in SIMAC '89	13
Ceramics get space-age treatment	15
The VALUE teams	19
INDUSTRIAL PROPERTY RIGHTS AND INNOVATION	
Patent applications recently published	21
CONFERENCES AND SYMPOSIA	
European meetings on astronomy and space	23
Seminars on energy efficiency	25
PUBLICATIONS	
A selection of recent publications	26
Regular information on new R&D publications	27
CORDIS data base service well under way	27
SPRINT - THE EUROPEAN PROGRAMME FOR INNOVATION AND TECHNOLOGY TRANSFER	
EACRO successfully started	29
ANVAR days in Strasbourg	31
Conference 'Enterprise, Innovation and 1992'	32
New CIT convened	33
SPRINT call for proposals for the Europeanisation of conferences	34
First European congress on Contract Research Associations	35
TechTransCentre '90	35
SPRINT design promotion activities	36
Conferences under SPRINT	40
New guide to Contract Research Associations	40

Note to readers

On 20 June 1989 the Council of Ministers for Research had an extensive exchange of views on the review of the current Community Framework Programme for R&DT. In addition, it approved seven new R&D programmes and reached common positions on three others. The outcome of this important meeting is reported on in this issue of I&TT.

One of the new research activities approved on 20 June concerns the **VALUE** Programme, which is the second component of the Commission's innovation promotion activity alongside the **SPRINT** Programme. **VALUE** aims at improving the dissemination and transfer to industrial applications of the results obtained from Community supported R&D projects. In other words, **VALUE helps to convert the know-how generated by European researchers** cooperating in the various Commission programmes **into new applications, products and processes.**

Exchanges of experience and mutual information on matters of technology are an essential for those who want to prepare themselves for the Single Market. In this issue of I&TT alone you will find announcements for **three European conferences** under the **SPRINT** Programme, covering the entire spectrum of the innovation process: the first European conference on **Value Analysis**, to be held in October 1989 in Milan. The first European conference of **Contract Research Organizations** for which the Commission will be joining up with EACRO in February 1990, in Amsterdam, and the **PATINNOVA '90** conference in Madrid in May 1990, where the role of patents in the context of innovation will be discussed for the first time at European level.

A.S. Strub
Director for Exploitation of Research, Technological Development, Technology Transfer and Innovation

VALUE PROGRAMME ADOPTED

At its meeting of 20 June 1989 the Council gave its final approval to the VALUE Programme, which complements the various R&D activities of the Community under the Framework Programme by specific measures for the evaluation, exploitation and dissemination of the research results. VALUE is thus the 'technology transfer' programme for the results of the Commission's RTD activities.

Its budget will be 38 million ECU for the period 1989-92.

There will be two sub-programmes:

SUB-PROGRAMME I: DISSEMINATION AND UTILISATION OF THE RESULTS OF COMMUNITY RTD ACTIVITIES

The objective is to disseminate by appropriate channels the results of Community R&D activities, so as to ensure an improvement in the level of exploitation and the resulting creation of economic activities by the following means:

1. **Collection and dissemination of information** concerning existing or planned Community RTD programmes, using appropriate methods and means, such as computerised data bases, electronic information services, information and dissemination centres in the Member States, and editing and distribution of printed matter (newsletters, brochures, reviews, articles).
2. **Identification, characterisation and screening**, to establish their suitability for dissemination or exploitation, **of relevant results of Community RTD** activities by examining contracts and reports, assessing their scientific/technical and utilisation potential and examining the need for protection by means of patent applications, etc.
3. Action on **legal protection** of the results by having recourse to selected patent agents/advisers, examining reports to ensure confidentiality and protection before publication, assisting contractors and inventors, and through information and awareness activities.
4. **Dissemination of results** which need not be protected by publications (books, reports, summaries, newsletters, etc.), organisation of and participation in seminars, conferences, exhibitions, etc., organisation of targeted dissemination activities, transfer of knowledge by (short-term) secondment of research workers participating in Community RTD projects, collaboration with and assistance to organisations in the Member States in setting up mechanisms for dissemination and electronic means such as data bases and associated services.
5. **Promotion of the exploitation** of relevant results by assessing, with the help of experts, the potential for exploitation of the results, providing expert advice in the setting-up and planning of exploitation projects, assisting in matters of legal and technical protection, exhibitions, assisting in finding partners for joint ventures or work under licence, providing financial and technical support for developing laboratory prototypes for collaborative precompetitive use, and advising participants in finding financial support from third parties.

SUB-PROGRAMME II: COMPUTER COMMUNICATIONS NETWORKS

The objective of this sub-programme is to contribute to the creation of a common integrated computer communications infrastructure and associated services, as well as to develop a network linking up the research and development community in Europe.

1. General support to the development of computer communications networks in the field of RTD.

Technical assistance and support to the RARE (Réseaux associés pour la recherche européenne) Association, particularly its pan-European projects (e.g. in the message handling and file transfer areas), to the implementation phase of the EUREKA COSINE project, and to Member States wishing to develop or adapt networks for the purposes of this programme.

2. Work on requirements for confidentiality and integrity of Community RTD information.

Further information on VALUE can be obtained from Mr J.N. Durvy, Commission of the European Communities, DG XIII/C/2, B4/107, Jean Monnet Building, L-2920 Luxembourg, Tel.: (352) 4301-3610, Tlx: 2423 / 3446 COMEUR LU, Fax: (352) 4301-4129.

See also article on page 18.



INTERNATIONAL CONFERENCE ON ENGINEERING DESIGN 22nd to 25th AUGUST '89, HARROGATE INTERNATIONAL CENTRE, UK

Organised by: INSTITUTION OF MECHANICAL ENGINEERS; Sponsored by the CEC under the SPRINT Programme

ICED '89 is about improving engineering design in industry by consideration of the latest international developments in technology, management, education and training.

All enquiries about the Conference should be addressed to: Miss M. Lee, Conferences Manager ex 314, Conference Department C 377, The Institution of Mechanical Engineers, 1 Birdcage Walk, UK-London SW1H 9JJ, Tel.: (44) 1 222.78.99, Tlx: 917944, Fax: (44) 1 222.98.81.

THE COUNCIL DECIDES ON SEVEN COMMUNITY RESEARCH AND TECHNOLOGICAL DEVELOPMENT PROGRAMMES

At its meeting of 20. 6. 1989 the Council took a series of important decisions concerning research and technological development (R&TD). It adopted definitively seven specific programmes which will now be implemented by the Commission:

1. **FLAIR** (food technologies): 25 million ECU for the period 1989 to 1993
2. **MAST** (marine science and technology): 50 million ECU for the period 1989 to 1992
3. **MONITOR** (strategic analysis, forecasting and assessment, programme evaluation): 22 million ECU for the period 1989 to 1992
4. **DOSES** (statistical instruments): 4 million ECU for the period 1989 to 1992
5. **VALUE** (the dissemination and utilisation of the results of Community research): 38 million ECU for the period 1989 to 1992
6. **EUROTRA** (automatic translation): 7 million ECU for the period until 1990
7. **RADIATION PROTECTION**: 21.2 million ECU for the period 1990 to 1991

This means that 91 % of the financial resources of the Framework Programme for Research and Technological Development has now been committed; a further 6 % is associated with the programmes for which the Council has reached a common position (see page 4). Thus most of the specific implementing programmes are now in operation.

1. FOOD-LINKED AGRO-INDUSTRIAL RESEARCH (FLAIR)

FLAIR is aimed at improving the processing and distribution of food, with particular emphasis on quality standards and consumer demands.

The research activities proposed in the programme will be grouped into three areas:

- a. The measurement and enhancement of food quality
- b. Food hygiene, safety and toxicology
- c. Nutrition and food wholesomeness

Further information on FLAIR can be obtained from Mr P. F. Rexen, Commission of the European Communities, DG XII/F/3, SDME 03/73, 200, rue de la Loi, B-1049 Brussels, Tel.: (32) 2 236.31.64 / 23631.64 / 236.09.73, Tlx: 21877 COMEUR B, Fax: (32) 2 236.20.07 / 236.01.45 (see also section 'Calls for proposals' on page 11).

2. MARINE SCIENCE AND TECHNOLOGY (MAST)

MAST is the first Community research programme specifically devoted to the marine environment. It will cover four main sectors:

- a. Basic and applied marine science
- b. Coastal zone science and engineering
- c. Marine technology
- d. Supporting initiatives

Further information on MAST can be obtained from the Commission of the European Communities, DG XII-E, 200, rue de la Loi, B-1049 Brussels, Tlx: 21877 COMEUR B, Fax: (32) 2 236.30.24. See also Official Journal C 155 of 23/06/1989.

3. MONITOR PROGRAMME

The MONITOR Programme is concerned with the identification of new directions and priorities in the common research and technological development policy of the Community, and with improving the evaluation of R&D programmes. It consists of three activities which are different but nevertheless complementary.

- a. Strategic Analysis in the field of Science and Technology (SAST)
- b. Forecasting and Assessment in Science and Technology (FAST)
- c. Support programme for a European Assessment of Research (SPEAR)

Further information on MONITOR can be obtained from Mr H. Allgeier, Commission of the European Communities, DG XII, 200, rue de la Loi, B-1049 Brussels, Tel.: (32) 2 235.40.55, Tlx: 21877 COMEUR B (see also Official Journal C 161 of 28/06/1989 and section 'Call for proposals' on page 11).

4. THE DEVELOPMENT OF STATISTICAL EXPERT SYSTEMS (DOSES)

This programme aims at the development of an enhanced capacity to produce and use statistical information, employing advanced data processing techniques.

Further information on DOSES can be obtained from Mr R. Desay, Commission of the European Communities, OS-Statistical Office, C2/57A, Jean Monnet Building, L-2920 Luxembourg, Tel.: (352) 4301-4310 / 3555, Tlx: 2423 / 3446 COMEUR LU, Fax: (352) 4301-3015 (see also Official Journal C 170 of 5.7.1989).

5. THE VALUE PROGRAMME

See articles on VALUE on pages 2 and 18.

6. THE DEVELOPMENT OF A MACHINE TRANSLATION SYSTEM (EUROTRA)

EUROTRA is a programme aimed at the creation of an automatic machine translation system of advanced design capable of dealing with all official languages of the Community.

Further information on EUROTRA can be obtained from Mr S. Perschke, Commission of the European Communities, DG XIII-B, B4/005, Jean Monnet Building, L-2920 Luxembourg, Tel.: (352) 4301-3423 / 2907, Tlx: 2423 / 3446 COMEUR LU, Fax: (352) 4301-3909.

7. RADIATION PROTECTION

This programme is a continuation of the current radiation protection programme which is aimed at the most cost-effective protection of human beings and their environment. It will deal with the following subject areas:

- a. Human exposure to radiation and radioactivity
- b. The consequences of radiation exposure for human beings
- c. The risks and management of radiation protection.

Further information can be obtained from Mr G. Gerber, Commission of the European Communities, DG XII/D/3, ARTS 02/48, 200, rue de la Loi, B-1049 Brussels, Tel.: (32) 2 235.40.45, Tlx: 21877 COMEUR B, Fax: (32) 2 236.20.06. See also section 'Call for proposals' on page 11.

COUNCIL REACHES COMMON POSITIONS ON THREE R&D PROGRAMMES

The Council also reached common positions on three new specific programmes. These programmes will now be reexamined in a second reading at the European Parliament.

1. **STEP-EPOCH** (environment, climatology and natural hazards): 115 million ECU for the period 1989 to 1992
2. **BRIDGE** (biotechnology): 100 million ECU for the period 1990 to 1994
3. **RAW MATERIALS AND RECYCLING**: 45 million ECU for the period 1990 to 1992

1. STEP-EPOCH (ENVIRONMENT, CLIMATOLOGY AND NATURAL HAZARDS)

STEP will comprise research into the environment and human health, risks associated with chemicals, air and water quality, soil and ground-water protection, ecosystems, protection of the European cultural heritage, environmental protection technologies, major technological hazards and fire safety.

EPOCH will comprise research into past climates and climatic change, climate processes and models, climatic impacts, and climate-related and seismic hazards.

Further information on STEP and EPOCH can be obtained from Mr H. Ott, Commission of the European Communities, DG XII/E/1, SDME 03/60, 200, rue de la Loi, B-1049 Brussels, Tel.: (32) 2 235.11.82 / 235.04.15, Tlx: 21877 COMEUR B, Fax: (32) 2 235.01.45.

2. BRIDGE (BIOTECHNOLOGY RESEARCH FOR INNOVATION, DEVELOPMENT AND GROWTH IN EUROPE)

BRIDGE will continue the work of the Biotechnology Action Programme in strengthening the scientific basis of Europe's biotechnology, and hence improve its international competitiveness.

A call for proposals is being launched comprising the so-called Network projects (strand N) and the targeted projects (strand T) (see also section 'Calls for proposals on page 11).

Further information on BRIDGE and on the call for proposals can be obtained from Mr D. de Nettancourt, Commission of the European Communities, DG XII/F/2, SDME 03/67, 200, rue de la Loi, B-1049 Brussels, Tel.: (32) 2 235.40.44, Tlx: 21877 COMEUR B.

3. RAW MATERIALS AND RECYCLING

This programme aims to help enhance the international competitive position of the Community's industries involved with raw materials and recycling. It will include primary raw materials, the recycling of non-ferrous and strategic metals, renewable raw materials (forestry and wood products), and the recycling of waste (see also section 'Calls for proposals on page 11).

Further information can be obtained from Mr M. Donato, Commission of the European Communities, DG XII/C/5, MO75 01/36, 200, rue de la Loi, B-1049 Brussels, Tel.: (32) 2 235.39.55, Tlx: 21877 COMEUR B, Fax: (32) 2 235.06.56; see also Official Journal C 164 of 1.7.1989.

COMMISSION SETS OUT NEW IDEAS FOR COMMUNITY RTD ACTIVITIES IN THE 90s

Vice-President Pandolfi proposes a new structure for the next Framework Programme

In addition to the adoption of various new research programmes (see page 3), the Research Council meeting of 20.6.1989 was devoted to a general discussion on the future of Community R&D initiatives during the 90s.

In a discussion document, the Commission suggested that the new Framework Programme should aim at actions which complement those being undertaken at both national and regional levels. The choice of actions will be made following analysis and critical assessment and there will be greater flexibility in the way they are implemented. Their implementation should be based on an increased flexibility. A greater selectivity for determining new Community actions is envisaged, too.

Three major strands of activity have been envisaged by the Commission for further consideration:

1. **disseminating technologies** (information technologies and telecommunications; industrial technologies; advanced materials, and biotechnology);
2. the management of **natural resources (environment and energy)**;
3. the management of **human resources**, by better use of the Community's scientific potential, including enhancement of the mobility of researchers.

The discussions will be continued between the Member States and the Commission to work out a concrete proposal for the new Framework Programme, to be discussed at the next R&D Council meeting, scheduled for 17 October.

Further information can be obtained from

- Mr E. Bock, DG XII, SDME 01/42, Tel.: (32) 2 235.41.32 (languages: DE, EN, DA, NL),
- Mr M. André, DG XII, SDME 01/38, Tel.: (32) 2 236.07.81 (languages: F, ES, PO, IT) or from
- Mr P. Wragg, DG XII, SDME 01/40, Tel.: (32) 2 236.01.26 (languages: EN, F, GR)

Commission of the European Communities, 200, rue de la Loi, B-1049 Brussels, Tlx: 21877 COMEUR B, Fax: (32) 2 236.20.07.

EUROPEAN COMMUNITY CONTEST FOR YOUNG SCIENTISTS

The Commission has decided to sponsor a contest in the EC for young scientists which will be held in Brussels at the end of October 1989. Top finalists from EC and other European countries will participate. Students in secondary schools or higher between 15 and 21 years of age will be eligible, alone or in teams. The prizes will be scholarships for further study: six 5 000 ECU scholarships and six worth 3 000 ECU. The work will be judged by scientists of international renown.

Further information and the application forms can be obtained from Mr A. Pozzo, Commission of the European Communities, DG XII/H, 200, rue de la Loi, B-1049 Brussels, Tel.: (32) 2 235.40.67, Tlx: 21877 COMEUR B, Fax: (32) 2 235.06.56.

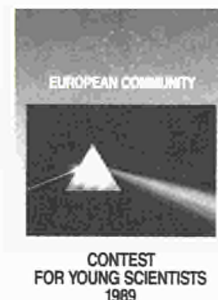

ESPRIT: MICRO-ELECTRONICS AND PERIPHERAL TECHNOLOGIES 1989 CALL FOR PROPOSALS

The Commission has issued its 1989 call for proposals for the micro-electronics and peripheral technologies sector under the second phase of the Esprit programme. The total cost of the projects likely to result from the proposals submitted is up to 150 million ECU, half of which would be financed by the European Communities. The focus will be on three main areas:

- CMOS and Sol high-density technologies and III-V compound semiconductor technology;
- equipment and automation;
- peripheral technologies.

Proposals must cover collaborative and precompetitive research and development work as defined in the 1989 Esprit work programme. Contracts may be for a duration of two to three years and will be extendable for successful projects of continuing relevance to the programme. As in the first phase of Esprit, it is envisaged that small and medium-sized companies will feature significantly in the response to the call.

It is expected that there will be again a high level of competition between consortia making proposals. An information package is available on request, containing background information and advice to assist organizations in submitting well-formulated and structured proposals.

The closing date for proposals to arrive is 4 September 1989, and intending proposers are requested to submit a notification of intent by 30 June 1989. Information can be obtained from:



The Commission of the European Communities, Esprit Operations Office, A25 - 9/12, 200 rue de la Loi, B-1049 Brussels, Fax +32.2-235.06.55

The European Strategic Programme for R+D in Information Technology — ESPRIT — was launched in February 1984 with a budget of 1,5 thousand million ECU, co-funded equally by the participants and the Community. The 3,2 thousand million ECU second phase was approved by the Council of Ministers in April 1988. ESPRIT represents some 30% of European R+D in information technology at precompetitive level.

INFORMATION ON THE R&D INITIATIVES OF THE COMMISSION

VARIOUS NEWSLETTERS TO KEEP YOU UP TO DATE WITH RELEVANT R&D DEVELOPMENTS

A concern often expressed by industrialists and researchers is that they are looking for more **precise information on the Community's RTD policy** and the corresponding activities. We hope that I&TT is able to make a contribution to improving this situation. But there are also a lot of other newsletters issued by the various services responsible for the implementation of the Commission's R&D initiatives. We like to give you a short overview of these EC publications. If you wish to receive one or more of these, please write to the following addresses:

<p>Information Market P.O. Box 2373 L-1023 Luxembourg</p>	<p>Content: IMPACT Programme Information industries</p>	
<p>ESRA Newsletter Mr H.J. Flamm Joint Research Centre I-21020 Ispra (Varese)</p>	<p>Newsletter of the European Safety and Reliability Association concerned with the advance of safety and reliability techniques</p>	
<p>Environmental Research Newsletter Mr M. Borlé-Talpaert Joint Research Centre I-21020 Ispra (Varese)</p>	<p>Environmental research and related matters</p>	
<p>Entech Mr M. Trousson Commission of the European Communities DG XII-E SDME 03/29 200, rue de la Loi B-1049 Brussels</p>	<p>JOULE Programme Non-nuclear energies</p>	
<p>European Cultural Heritage Mr A. Sors Commission of the European Communities DG XII/E/1 SDME 03/63 200, rue de la Loi B-1049 Brussels</p>	<p>Research in the field of maintaining the European cultural heritage</p>	
<p>EBN - European Biotechnology Newsletter Editions Scientifiques Elsevier 29, rue Buffon F-75005 Paris (Price: FF 2680 - 22 issues per year)</p>	<p>R&D initiatives and news from biotechnology research</p>	
<p>ies news ESPRIT Information Exchange System Editions Saphir 23, rue des Genêts L-1621 Luxembourg</p>	<p>ESPRIT Programme Information technologies</p>	

COMMISSION PROPOSES NEW RESEARCH PROGRAMME ON COMPETITIVENESS OF AGRICULTURE AND MANAGEMENT OF AGRICULTURAL RESOURCES (1989 to 1993)

The Commission has just published its proposal for a new research programme in the field of agriculture (see Official Journal C 146 of 13.6.1989). In order to best realize the research objectives emphasis will be placed on improvements in production techniques, reduction of costs in agricultural production systems, more environmentally aware production, etc.

Further information can be obtained from Mr Ph. Moulart, Commission of the European Communities, DG VI, Agriculture, 200, rue de la Loi, B-1049 Brussels, Tel.: (32) 2 235.24.18, Tlx: 21877 COMEUR B.

COMMISSION PROPOSES THERMIE PROGRAMME

Reinforced initiatives in the field of energy management technologies

For the past decade the Energy Directorate-General of the Commission (DG XVII) has operated Energy Demonstration and Hydrocarbon Technology Programmes as an integral component of its policy of achieving the Community's energy objectives. During this period EC financial support of over 1350 million ECU has been given to 1700 Demonstration Projects and 640 Hydrocarbon Technology Projects.

Both of these programmes finish at the end of this year and, in the light of independent evaluations conducted for the Commission, the Commission has proposed to the Council a single **new Programme for European Technologies for Energy Management : THERMIE**, to run for the five-year period 1990-94. This recognises the significant role which can be played by energy technology in achieving the aims of the Single European Market, strengthening the technological basis of EC industry, meeting environmental challenges, strengthening economic and social cohesion and creating social benefits.

New features of the proposed THERMIE programme are: a much stronger emphasis on the **dissemination and replication of successfully developed new energy technologies**; **consolidation activities** undertaken in collaboration with other Community programmes; the facility for the Commission itself to **target projects in key areas** and seek contractors to implement them; a more **flexible call-for-tender** procedure; and faster **decision-making procedures** for smaller projects.

At the Council of Energy Ministers on 11 May 1989 there was an initial exchange of views: the Council welcomed the proposal and agreed with the basic conclusions of the Commission. Discussions are now taking place at Council Working Group level, with a view to having the Programme operational for 1 January 1990.

Further information on THERMIE can be obtained from Mr M. Gowen, Commission of the European Communities, DG XVII/E/2, 200, rue de la Loi, B-1049 Brussels, Tel.: (32) 2 236.04.36, Tlx: 21877 COMEUR B, Fax: (32) 2 235.01.50.

CONFERENCE ON THE SINGLE MARKET AND THE ENVIRONMENT: MARKETS, STANDARDS, PROSPECTS IN THE EUROPEAN COMMUNITY

The Environmental Protection industry in Europe is undergoing major change in the run-up to 1992. The world market for goods and services has been estimated at 75 thousand million ECU per annum, with 40% of the expenditure in Western Europe. Growth rates in most regions will exceed 4% and in some reach 10% p.a. How will the EC's 5,000 firms in the sector respond? Some 10,000 companies in Europe are expected to change hands in the next few years. How many will be in the environmental sector?

Acquisitions, strategic alliances and joint ventures are on the agendas of most dynamic companies. The **first NETT conference** will be concerned with these issues and bring together European experts in:

- Market Prospects
- Environmental Policy
- Mergers and Acquisitions
- Buyouts and Joint Ventures
- Legal and Financial Aspects

NETT: NETWORK FOR ENVIRONMENTAL TECHNOLOGY TRANSFER

NETT is a major new initiative established with the support of the Commission of the European Community to **stimulate the wider adoption of clean and environmental technologies**. Launched in 1988 at the end of the European Year of the Environment, the aims of establishing such a network are to help the exchange of knowhow between companies and organisations and speed up the transfer of technologies throughout Europe by providing detailed information on markets, standards, technologies, finding partners and collaborating with advisory services, consultants, manufacturers and trade associations, university research departments and chambers of commerce to take full advantage of the opportunities offered by the new 'Single European Act'.

FOR FURTHER DETAILS CONTACT THE NETT Secretariat

NETT (Network for Environmental Technology Transfer), 25 Square de Meeus, B-1040 BRUSSELS, Telephone: (32 2) 511 2462, Telefax: (32 2) 511 2522

THE FIRST

NETT
Network for
Environmental
Technology
Transfer

INTERNATIONAL CONFERENCE

ENVIRONMENTAL INDUSTRY
AND SERVICES '92:

Markets, Standards, Prospects
in the European Community



- BRUSSELS -

23 - 24 November 1989

ENVIRONMENTAL ETHICS

VAL DUCHESSE, BRUSSELS
10-12 MAY 1989



COMMISSION OF THE EUROPEAN COMMUNITIES

SIXTH ECONOMIC SUMMIT CONFERENCE ON BIO-ETHICS

A distinguished group of experts from the seven economic summit countries met in Brussels to discuss the principles and priorities needed for an ethics of the environment and the role of human beings in it. The conference benefited from a high degree of convergence between people from different cultures, East and West, and a wide variety of disciplines including scientists, engineers, lawyers, philosophers and historians.

A summary of the discussion results can be obtained on written request from Mr O. von Schwerin, Commission of the European Communities, DG XII-A, SDME 01/35, B-1049 Brussels, Tel.: (32) 2 235.25.59, Tlx: 21887 COMEUR B, Fax: (32) 2 236.20.07.

STUDENT EXCHANGES: COMMISSION PROPOSES SECOND PHASE OF ERASMUS PROGRAMME - 192 MILLION ECU OVER THREE YEARS TO MOBILISE 30 000 STUDENTS IN 1992

The Commission has adopted its proposals for the second phase of the ERASMUS Programme for student mobility in the Community. ERASMUS has four lines of action: the setting-up of a European network of cooperation between universities, direct financial support for students, improved academic recognition of diplomas and periods of study through the introduction of a system of transferrable course credits, and complementary measures (support for university associations, ERASMUS award, conferences, etc.).

The second phase of ERASMUS will be for a period of five years (1990-1994); the Commission is only proposing **budgetary funding for the first three years: 192 million ECU** broken down as follows: 1990 - 58 million ECU, 1991 - 64 million ECU, and 1992 - 70 million ECU. This funding will make it possible to **finance the mobility of 30 000 students in 1992**, or 2 % of the Community's student population.

Further information on ERASMUS can be obtained from Mr D. Lenarduzzi, Commission of the European Communities, DG V/C/2, A-1 08/9, 200, rue de la Loi, B-1049 Brussels, Tel.: (32) 2 235.41.85, Tlx: 21877 COMEUR B, Fax: (32) 2 235.01.29.

220 PROPOSALS FOR ECLAIR BIOTECHNOLOGY-BASED RESEARCH AND TECHNOLOGICAL DEVELOPMENT

The deadline for the first Call for Proposals, 31 March 1989, brought 220 proposals which included 1410 participants and requests for more than 400 million ECU of support from the Commission.

The proposals underwent a technical evaluation procedure which was carried out by 95 experts from the Member States and a wide range of disciplines. The proposals were of a very high standard. They included partners from different European countries, each for specific tasks and working in collaboration for the project as a whole. The proposals ranged from primary production through harvesting, conditioning and industrial transformation, many involving integrated approaches. The majority of proposals were concerned with agronomic species of plants, but there were also proposals on new species, forestry, aquaculture, and animals.

The technical evaluation and selection of projects were completed in June and the final results communicated to the proposers in early July 1989, and the final shortlist will be released shortly.

For further information please contact: Mr F. REXEN, DG XII F-3, Agro-Industrial Research, 200 Rue de la Loi, B-1049 Brussels

COMMISSION PROPOSES R&D PROGRAMME IN THE FIELD OF MANAGEMENT AND STORAGE OF RADIOACTIVE WASTE

The programme is aimed at perfecting and demonstrating a system for managing the radioactive waste produced by the nuclear industry ensuring, at the various stages, the best possible protection of man and the environment.

For further information see Official Journal C 144 of 10 June 1989 or contact Mr S. Orłowski, Commission of the European Communities, DG XII/D/2, ARTS 02/21, 200, rue de la Loi, B-1049 Brussels, Tel.: (32) 2 235.40.63, Tlx: 21877 COMEUR B, Fax: (32) 2 236.20.06.

TELEMAN PROGRAMME

The objective of this R&D programme will be to perfect telemanipulators, and it will particularly allow the nuclear industry to meet the requirement of exposing workers to the smallest possible doses of radiation, which must always remain within applicable limits without compromising inspection, upkeep and repair tasks.

Further information can be obtained from Mr H. de Nordwall, Commission of the European Communities, DG XII/D/1, ARTS 03/38, 200, rue de la Loi, B-1049 Brussels, Tel.: (32) 2 235.53.55, Tlx: 21887 COMEUR B, Fax: (32) 2 236.20.06.



COMMUNICATING WITH THE PUBLIC ABOUT MAJOR ACCIDENT HAZARDS

These conference proceedings are available from Mrs M. Piera Moretti, Joint Research Centre, Ispra Establishment, I-21020 Ispra (Varese), Tel.: (39) 332 78.91.11, Tlx: 380.042 / 380.058 EUR I.

AUGUST 16 - 18, 1989 · MUNICH · DEU

MT SUMMIT II

MACHINE TRANSLATION

MT SUMMIT II
c/o Mrs. J. Briehn
Deutsche Gesellschaft fuer Dokumentation e.V. (DGD)
Westendstrasse 19, D-6000 Frankfurt am Main 1
☎ 069-740805

RACE '89 - RESEARCH AND DEVELOPMENT IN ADVANCED COMMUNICATIONS TECHNOLOGIES IN EUROPE

The RACE Programme is focused on Integrated Broadband Communications (IBC) and the development of technology for the introduction of commercial IBC services in 1995. The programme was adopted by the Council of Ministers in December 1987, and work started in January 1988. Within its framework, about 2000 leading experts are collaborating in 85 projects. Telecommunications network operators in the Community and EFTA countries, all major European telecommunications and information technology equipment manufacturers, most major research establishments, many small enterprises and numerous universities are collaborating in joint teams, sharing work, experience and results.



The report RACE '89 describes the work of the 85 projects underway in the RACE Programme 1989.

With all the available funds under RACE having been committed, no further calls for proposals are planned. The Commission is currently involved in a planning exercise concerning initiatives and programmes to complement and extend the RACE programme beyond 1991.

A copy of the report and further information can be obtained from Mr J. Rosenbaum, Commission of the European Communities, DG XIII-E, J-37 01/23, 200, rue de la Loi, B-1049 Brussels, Tel.: (32) 2 235.92.35 / 235.05.60, Tlx: 21877 COMEUR B, Fax: (32) 2 236.27.23.



STAR - TELECOMMUNICATIONS INFRASTRUCTURE FOR LESS-DEVELOPED REGIONS

The process of European integration requires action to reduce the remaining inequalities between different regions in the European Community. These inequalities have led to the creation of **STAR (Special telecommunications action for regional development)**, a Community programme with the aim of introducing advanced telecommunications services in the less-advanced regions in order to strengthen their economic fabric and generate employment.

STAR has the following main lines of action:

- the coordinated **development of telecommunications infrastructures**;
- the creation of a **single internal market in terminals and equipment**;
- the implementation of a **pre-normative and pre-competitive R&D programme** in the field of integrated broadband communications technologies;
- the improvement of the way in which these services and advanced networks are introduced in the **least-developed peripheral regions** of the Community;
- the development of **common European positions** in international negotiations.



Further information on STAR can be obtained from Mr J. Rosenbaum, Commission of the European Communities, DG XIII-E, J-37 01/23, 200, rue de la Loi, B-1049 Brussels, Tel.: (32) 2 235.92.35 / 235.05.60, Tlx: 21877 COMEUR B, Fax: (32) 2 236.27.23.

INFORMATION MARKET OBSERVATORY SUMMARY REPORTS NOW AVAILABLE

The Information Market Observatory (IMO) reports No 3 (1987) and No 4 (1988) are now available. They form part of the IMPACT Programme and provide a statistical analysis of the worldwide supply of professional database services in 1987. The main conclusions are:

- the **USA dominates world production of online databases**, with about 80 % of the databases on CD-ROM originating in the United States;
- despite a growing share of commercial information providers, the **non-profit sector still predominates in EEC production**;
- the **EEC is strong** in the production of **reference databases** but weak in the production of source databases;
- the **EEC exports more databases to the USA than it imports** from them;
- **commercial database** producers have a greater share in CD-ROM database publishing within the EEC than in online publishing;
- **source databases** are predominant in CD-ROM products published by the EEC.

Copies of the Information Market Observatory reports can be obtained from Mr S. Lustac, Commission of the European Communities, DG XIII-B, B4/016, Jean Monnet Building, L-2920 Luxembourg, Tlx: 2423 / 3446 COMEUR LU, Fax: (352) 4301-2847.

TEDIS Conference

Brussels 12-13 July 1989

The current TEDIS Programme was launched at the beginning of 1989 and will run until the end of 1989. It aims to ensure compatibility between commercial electronic data interchange systems (EDI). In order to review progress to date and to lay the foundations for future activities, the Commission is holding a Conference.

The results of various workshops held in June 1989 will be presented on the first day of the Conference, together with a review of the latest developments within the EDIFACT Board and a report on the working of the EDIFACT Board Secretariat. The second day of the Conference will be devoted to the various user groups already active in European EDI. Leading representatives of all the groups recognised by TEDIS will present the activity within their sector.

Further information on TEDIS and the conference can be obtained from Mr R. Wakeling or Mr E. Peeters, Commission of the European Communities, DG XIII/D/4, J-37 02/15, 200, rue de la Loi, B-1049 Brussels, Tel.: (32) 2 235.73.30, Tlx: 21877 COMEUR B, Fax: (32) 2 235.02.99.

COSINE-ADVANCED COMMUNICATIONS NETWORK

COSINE 'Cooperation for Open Systems Interconnection Networking in Europe' - is a EUREKA project. COSINE was set up to establish an **advanced communications network for the hundreds of scientific and industrial research institutes all over Europe**. COSINE strives to make present-day research networks in Europe interwork. A language researcher in Helsinki should be able to work as easily with his colleague in Valencia as with his neighbour next door. The Commission support for the COSINE project is part of subprogramme II 'Computer Communications Networks' of the VALUE Programme (see page 2).

Further information on COSINE can be obtained from the COSINE Secretariat, Commission of the European Communities, DG XIII, A-25 5/15, 200, rue de la Loi, B-1049 Brussels, Tel.: (32) 2 235.45.16, Tlx: 21877 COMEUR B, Fax: (32) 2 235.06.55.



COUNCIL DECIDES ON R&D WORK FOR THIRD PARTIES IN THE JOINT RESEARCH CENTRE

In Newsletter 3/88 (page 2) we reported that the Research Council had decided that, for the purpose of fulfilling the overall objectives of the Community relating to research and technological development, the Commission may place the installations, equipment or expert assistance of the Joint Research Centre at the disposal of third parties, whether public or private as appropriate, against payment. This decision is effective following its publication in Official Journal L 142 of 25.5.1989.

Contact: Joint Research Centre, Ispra Site, I-21020 Ispra (Varese), Tel.: (39) 332 78.91.11, Tlx: 280.042 / 280/058 EUR I, Fax: (39) 332 78.90.45.

CONFORMANCE TESTING SERVICES: CTS-WAN EUROLABS OPEN FOR BUSINESS

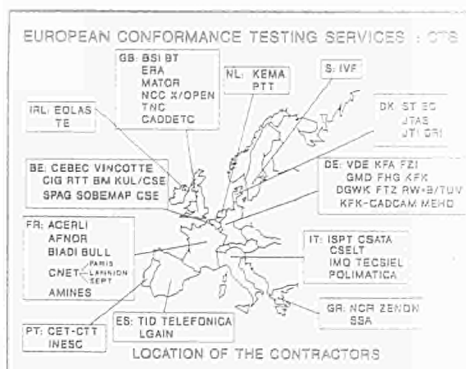

The new Open Systems Testing Consortium is the latest step in an effort to clear up Europe's fragmented approach to testing. **CTS aims to harmonize standards activity in Europe** and end problems caused when tests, and results, differ from country to country. The European CTS-WAN Eurolabs are now open for business. This means that customers can have their MHS, FTAM, Teletex, Transport & Session, and Network (X.25 and X.21) **data communications products tested** at several different sites throughout Europe.

These facilities have been set up with the support of the CEC, which sponsors many centres of excellence within Europe who develop and use testing technology, to harmonise their expertise and produce public services (see I & TT, 2/89, page 10).

Hence, CTS-WAN Eurolabs offering ten different testing services are now opening throughout Europe.

The CTS-WAN/OSTG Status report is available from Maggie Smith, PDMB Secretariat, **The National Computing Centre Limited**, Oxford Road Manchester M1 7ED UK, Telephone: + 4461 228 6333 Telefax: + 4461 228 2579 Telex: 668962 G

Further information and a guide on CTS are available from Mr F. Jørgensen, Commission of the European Communities, DG XIII/E/4, J-37 4/24, 200, rue de la Loi, D-1049 Brussels, Tel.: (32) 2 235.05.81, Tlx: 21877 COMEUR B, Telefax: (32) 2.35.62.72.3

COMMUNITY RESEARCH AND DEVELOPMENT PROGRAMMES DEADLINES FOR THE NEXT CALLS FOR PROPOSALS

Programme	Directorate-General responsible	Deadline
FLAIR (see article on page 3 and OJ C 162 of 29.06.1989)	XII	18.09.1989
STEEL R&D (ECSC)	XII	31.08.1989
TECHNOLOGY RESEARCH - COAL (ECSC)	XVII	31.08.1989
STEP/EPOCH - Areas of Tropospheric and Stratospheric Research (further calls on the other areas of STEP/EPOCH are expected to be launched within the next few months; see article on page 4 and OJ C 162 of 29.06.1989)	XII	15.09.1989
DECOMMISSIONING OF NUCLEAR POWER STATIONS (see OJ C 146 of 13. 6. 1989)	XII	30.09.1989
PILOT AND DEMONSTRATION PROJECTS (ECSC)	XII	01.10.1989
PLAN TO FACILITATE ACCESS TO LARGE-SCALE SCIENTIFIC FACILITIES (see article on page 4 in I&TT 2/89 and OJ C 93 of 14.04.1989; the deadline for the preselection procedure is 17.07.1989; see OJ C 130 of 26.5.1989)	XII	01.10.1989
SPRINT (Conferences to be held later than 30.08.1990; see article on page 34)	XIII	30.11.1989
ESPRIT (see article on page 5)	XIII	04.09.1989
TELEMAN - Remote handling in nuclear hazardous and disordered environments (see article on page 8)	XII	01.12.1989
BRIDGE - Biotechnology research for innovation (see article on page 4 and OJ C 169 of 4.7.1989)	XII	15.12.1989
STD - SCIENCE AND TECHNOLOGY FOR DEVELOPMENT	XII	31.12.1989
BCR (Metrology and Reference Materials)	XII	no deadline
SCIENCE: Plan to stimulate the international cooperation and interchange needed by european researchers	XII	no deadline
SPES - A plan to stimulate cooperation in economic sciences (see OJ C 89 of 07.04.1989 and I&TT, 2/89, page 8)	XII	no deadline
MONITOR Expression of interest (see article on page 3 and OJ C 144 of 10.06.1989)	XII	no deadline

Application forms can be obtained from the Directorate-Generals concerned (Commission of the European Communities, DG, 200, rue de la Loi, B-1049 Brussels).

FORTHCOMING CALLS

Programme	Call expected
PRIMARY RAW MATERIALS	End of July 1989
SPRINT Call for specific projects (see article on page 33)	End of July 1989
FAR - Fisheries & Aquaculture Research	Sept. 1989
ECLAIR (second call)	Spring 1990
RADIOACTIVE WASTE	Spring 1990

The information above is a sort of early warning system and reflects our knowledge at the time 'I&TT' goes to print. The dates indicated above may change and are not definitive. 'I&TT' declines all responsibility for any changes.

**REPORT ON COMUNITY DEMONSTRATION PROGRAMME:
BIOMASS AND ENERGY FROM WASTE**

(Information on demonstration projects)
Status March 1989

A copy of the report can be obtained from the Commission of the European Communities, DG XVII, Directorate for Energy Saving, Alternative Sources of Energy, Electricity and Heat, 200, rue de la Loi, B-1049 Brussels.



EVALUERING
af
ENERGI - DEMONSTRATIONSPROGRAM
PROJEKTER FOR ENERGIEFFEKTIVITET
OG
VEDVARENDE ENERGIKILDER
Kommissionen for de Europæiske Fællesskaber
Generaldirektoratet for Energi



Evaluation of the Energy Demonstration Programme

This programme is run in parallel with the hydrocarbons schema by DG XVII. It is governed by Regulation 3640/85 (O.J. L 350 of 27. 12. 1985) and will come to an end in December 1989. Likewise, the evaluation contains information on the major results and recommendations for the future.

This brochure can be obtained in all Community languages from the CEC, DG XVII/C-1, Oil Policy Division, Mr E. Millich, 200, rue de la Loi, B-1049 Brussels, Tlx: 21877 Comeur B, Fax: (32) 2 235.01.50.

FOCUS ON ENERGY IN EUROPE

Energy resources are a crucial factor in meeting the needs of the population, maintaining industrial production and ensuring that the entire social and economic system can continue to function.

'Energy in Europe' is published as a guide to the energy activities of the European Community and is a compilation of the latest news about energy policy, trends and prospects, markets, planning and technology.

Published in a bilingual version (EN/FR) twice a year on behalf of the Directorate-General for Energy of the CEC.

Subscription price (VDX): ECU 10.50

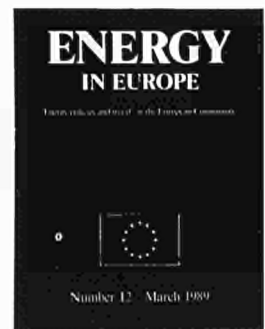

To be sent to: Office for Official Publications of the European Communities
2, rue Mercier
L-2985 Luxembourg

I wish to take out a subscription to 'Energy in Europe'

Payment on receipt of invoice

Name: _____

Address: _____

Date: _____ Signature: _____

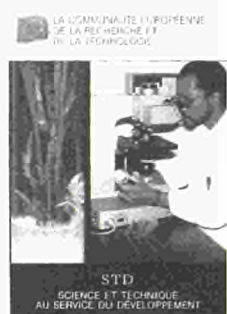

The brochure 'BCR — Measurements For Europe' can be obtained from Mr H. Marchandise, Commission of the European Communities, DG XII/C/6, MO75 03/9, 200, rue de la Loi, B-1049 Brussels, Tel.: (32) 2 235.50.14, Tlx: 21877 COMEUR B, Fax: (32) 2 236.33.07.

The brochure 'STD — Science and Technology for Development' can be obtained from Mr C. Uzureau, Commission of the European Communities, DG XII, Tel.: (32) 2 235.97.74, Tlx: 21877 COMEUR B, Fax: (32) 2 236.20.07.



BROCHURE ON INNOVATIONS FROM COMMUNITY RESEARCH

Order Form

Please send me your brochure (language):

DE	DK	EN	ES	F	I	GR	NL	P
----	----	----	----	---	---	----	----	---

Name: _____ Address: _____

Date: _____ Signature: _____

Please return to: Mr M. Leipold, Commission of the European Communities, DG XIII/C/2, B4/086, Jean Monnet Building, L-2920 Luxembourg, Tel.: (352) 4301-2936, Tlx: 3423, 3446 COMEUR LU, Fax: (352) 4301-4129.

**CIVIL ENGINEERING, PUBLIC WORK INDUSTRIES AND BUILDING:
Participation of the Commission in SIMAC '89**

SIMAC is the most comprehensive fair held in Portugal for civil engineering, the public works industries and building. The 1989 event, held in Lisbon from 10 to 14 May, saw major participation by the Commission through a stand run by DG XIII/C/2. Eight products developed under Community research contracts were exhibited, which all attracted interest from numerous professional users.

Further information on these products (see I&TT 2/89, page 14) can be obtained from Mr F. Engels, Commission of the European Communities, DG XIII/C/2, B4/106, Jean Monnet Building, L-2920 Luxembourg, Tel.: (352) 4301-2356, Tlx: 2423 / 3446 COMEUR LU, Fax: (352) 4301-4129.



The photo shows, from left to right, Mr Alves, DG XIII/C/2, Dr Strub, Director of DG XIII-C, Prof. Aucena Paiva, State Secretary for Science and Technology, Prof. Veiga Aímao, President of LNETI (National Laboratory for Industrial and Technological Engineering), and Dr Omar Karim, Vice-President of API (Portuguese Industrial Association).



 Commission of the European Communities - Directorate-General XIII
 Technological Research and Innovation
 Directorate C
 Technology for the Environment, the Sea and the Atmosphere
 December 10 - 14, 1989



 INNOVATION AUS DER GEMEINSAMEN FORSCHUNG
 INNOVATION FROM COMMUNITY RESEARCH
 Rauchgasentschwefelungsprozess "Ispira Mark 13A"
 "Ispira Mark 13A" flue gas desulphurization process





 Comissão da Comunidade Europeia
 Direcção-Geral XIII
 Investigação Científica e Tecnológica
 Direcção C
 Tecnologia para o Ambiente, o Mar e a Atmosfera
 Dezembro de 1989



 IN BUILDING AND CONSTRUCTION EXHIBITION
 LISBOA, 10 - 14, 5, 1989

Inovações provenientes da investigação comunitária
 Innovations from Community research

	Page
1	1
2	2
3	3
4	4
5	5
6	6
7	7
8	8
9	9
10	10

The catalogues on SIMAC '89 and ENVITEC '89 (see page 15) can be obtained from Mr M. Leipold, Commission of the European Communities, DG XIII/C/2, B4/086, Jean Monnet Building, L-2920 Luxembourg, Tel.: (352) 4301-2936 / 2356, Tlx: 2423 / 3446 COMEUR LU, Fax: (352) 4301-4129.



CEC stand (VALUE programme) at the SIMAC '89

INNOVATIONS FROM COMMUNITY R&D

Under this section 'Innovation and Technology Transfer' reports regularly on recent innovations stemming from Community-funded research.

1. STEAM PURGE IMPREGNATION OF TEXTILE MATERIALS

The absorption of processing liquors by textile materials, particularly woven fabrics, to obtain rapid, uniform and completely penetrated impregnation, is difficult to achieve even at relatively high temperatures. The barrier to diffusion arises mainly from the interfacial tension between liquor and textile surface, which in turn is dependent upon liquor composition and chemicals present on the textile; the geometry of the material also has an effect.

The STEAM PURGE impregnation system for processing fabrics enables air to be displaced from the interstices of the fabric construction, thereby bringing about complete wetting-out of the textile material. The use of this system for preparation (desizing, scouring, bleaching), dyeing or finishing, will **provide one or more of the following benefits:**

- (i) elimination of wetting agents and more efficient use of chemicals;
- (ii) use of cold impregnation liquors;
- (iii) rapid, uniform and complete impregnation of fabric, particularly in the loom-state;
- (iv) negligible steam consumption and, thus, low running costs;
- (v) separate stages of a process can be combined, saving time, energy, water, effluent and labour costs;
- (vi) use of less equipment, saving maintenance costs.

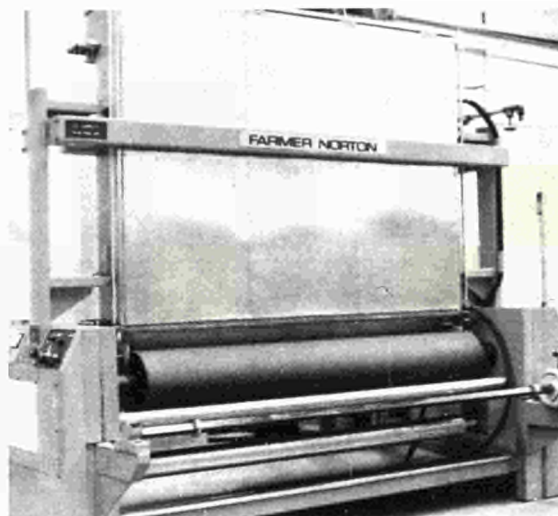

The system can be used in either batch or continuous processing and it gives rise to **cleaner processing** because there is no excess liquor on the fabric surface. Typically, a conventional three-stage hot process of desizing, scouring and bleaching of cotton fabric, having an energy consumption of up to 40 GJ per tonne of fabric, can be replaced by a single-stage cold process consuming as little as 3.4 GJ per tonne when a STEAM PURGE system is used. The technique was developed by Shirley Institute (Didsbury, Manchester, M20 8 RX, UK) from whom further information can be obtained.

The STEAM PURGE equipment is manufactured under licence by: Sir James Farmer Norton & Company (International) LTD, Adelphi Street, Salford, Manchester M60 9HH, United Kingdom, Tel.: 061-832 5511

2. CHANCE-CRYSTAL: ONE OF THE FIRST RESULTS OF THE ESPRIT PROGRAMME

The MUST research project — part of the Esprit programme — has enabled the young Belgian company ABSY, a member of the ACEC group, to develop a special high-tech application in the area of database management systems. This application permits the **definition of a user-friendly man/industrial process dialogue** and the employment of artificial intelligence principles in the area of process control.

CHANCE-CRYSTAL is a software system **for controlling and monitoring industrial processes** (chemistry, food industry, power generation, cement production) **and electro-mechanical installations** (rolling mills, production lines).

CHANCE-CRYSTAL incorporates expert system concepts and is highly innovative because of its ease of use and its almost universal field of application. **CHANCE-CRYSTAL permits a company to:**

- (i) guarantee a consistent and reproducible production quality, at the same time increasing quality standards;
- (ii) reduce and control production costs because of improved energy management and material flow;
- (iii) increase safety by relieving personnel of routine tasks;
- (iv) react quickly to any irregularity or error by adjusting the process;
- (v) maintain a record of production conditions by manipulating and storing information;
- (vi) put into practice its own method of production within a given set of constraints.

The CHANCE-CRYSTAL system builds on know-how gained from the Esprit programme and is already being applied successfully, not only in the European Community, but also in Asia and Africa.

For further information contact: ABSY SA, 4, rue de Genève, PO Box 25, 1140 Brussels, Belgium, Tel.: (02) 242 59 40



NEW TECHNOLOGY DEVELOPED AT THE JRC: CERAMICS GET SPACE-AGE TREATMENT

A process based on three newly-developed technologies from the JRC, Karlsruhe, is making it now possible to **manufacture amorphous ceramics or metal alloys**.

Spheres of the material to be treated are melted in an ultrasound field in a high-pressure chamber by bombardment with a high-energy laser and then cooled at a rate of -10^6 K/s by rapid switch-off of the laser beam.

This ultra-rapid quenching prevents the formation of crystals in the material and results in an amorphous condition.

Materials treated in this way have special chemical and physical properties which are used in industry.

The process described here is based on three specially-developed new technologies which have applications in other fields.

1. Acoustic levitation of a body is a technique perfected by the JRC, Karlsruhe. One possible application might be **contact-free holding of a body in conditions of weightlessness** (e.g. for a Spacelab experiment).
2. For **dynamic measurement of the high-temperature materials** a special 6-wavelength pyrometer was developed with a hitherto unattainable accuracy and dynamic range. This again should find applications in other fields.
3. A measuring process based on X-ray absorption was developed for **dynamic measurement of the expansion of the body** levitating at high temperatures. The process incorporates a normal video camera with its electronics adapted to allow high-speed photography. The image sequences obtained are stored in a computer for analysis. This technology, too, could find industrial applications wherever rapid treatment of materials is required.

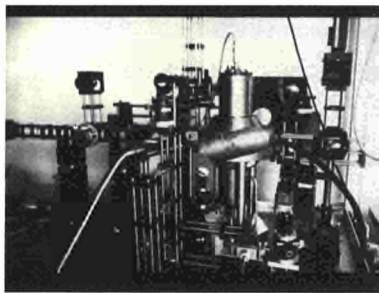
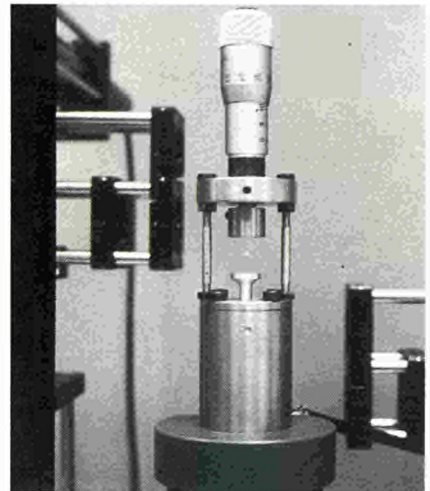

The autoclave with the optical bank for laser-beam splitting

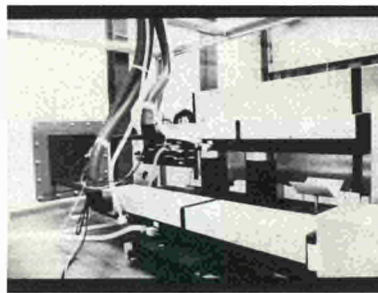

*The two Nd-YAG lasers:
The autoclave is positioned beyond the dark flange on the protection wall*

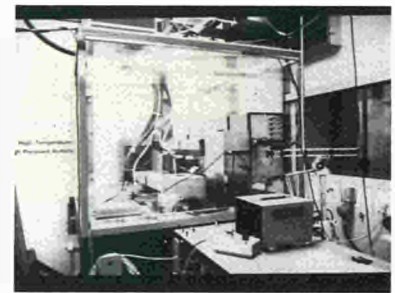

The lasers with the 6-wavelength pyrometer and the sample monitoring system

Further information can be obtained from Mr P. Herzberger, Commission of the European Communities, DG XIII/C/2, B4/111, Jean Monnet Building, L-2920 Luxembourg, Tel.: (352) 4301-2953 / 3453, Tlx: 2423 / 3446 COMEUR LU, Fax: (352) 4301-4129.

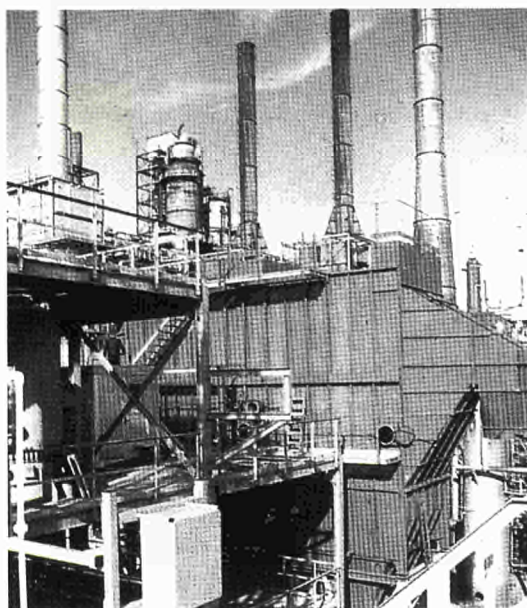

The ISPRA Mark 13A flue gas desulphurization process exhibited at the ENVITEC Fair in Düsseldorf (10-14.4.1989)

The Commission, together with one of the partners in the industrial exploitation of the Mark 13A process, the German company Kraftanlagen Heidelberg, and its licensee Ferlini Technology, exhibited this process on a common stand, where it attracted much attention from the industrial and public sectors.

You may recall that the Mark 13A desulphurizes flue gases (e.g. from combustion of sulphur-containing coal and/or oil) by converting sulphur dioxide and water into two products - sulphuric acid and hydrogen - instead of into waste products which are costly to dispose of (see also page 13).

Further information can be obtained from Mr P. Herzberger, Commission of the European Communities, DG XIII/C/2, B4/111, Jean Monnet Building, L-2920 Luxembourg, Tel.: (352) 4301-2953/3453, Tlx: 2423 / 3446 COMEUR LU, Fax: (352) 4301-4129.

The Mark 13A installation at the Saros di Sarroch refinery (Italy).

SIDEROMETALURGICA

The Commission will be exhibiting at SIDEROMETALURGICA a series of innovations stemming from Community R&D:

The Radial Jet Electrolysis Process

The Krupp Horizontal Caster

Flue Gas Desulphurization by the Ispra Mark 13A Process

Décapage non polluant de tôles INOX, UG 3P

Torche à plasma

Reference Faults for non — destructive testing equipment

Sistemas Automáticos para Control de Calidad por Ultrasonidos

Error Detection in Rollers

BACCHUS®, Visualisation d'un champ d'ultrasons pour contrôle périodique de capteurs d'ultrasons

PERL — X², préparation de perles en vue d'analyse

Mesure de granulométrie, système optique d'analyse en continu de la répartition granulométrique

Coupe optique, mesure de la section des produits longs d'acier

Planheitsmessrolle für Kaltwalzwerke

FLUCOmat, Messung von Öl auf fließendem Wasser

PROFImat, Elektrofilter für die Staubprobenahme

Vollautomatisches Containerlabor für die Produktionskontrolle vor Ort

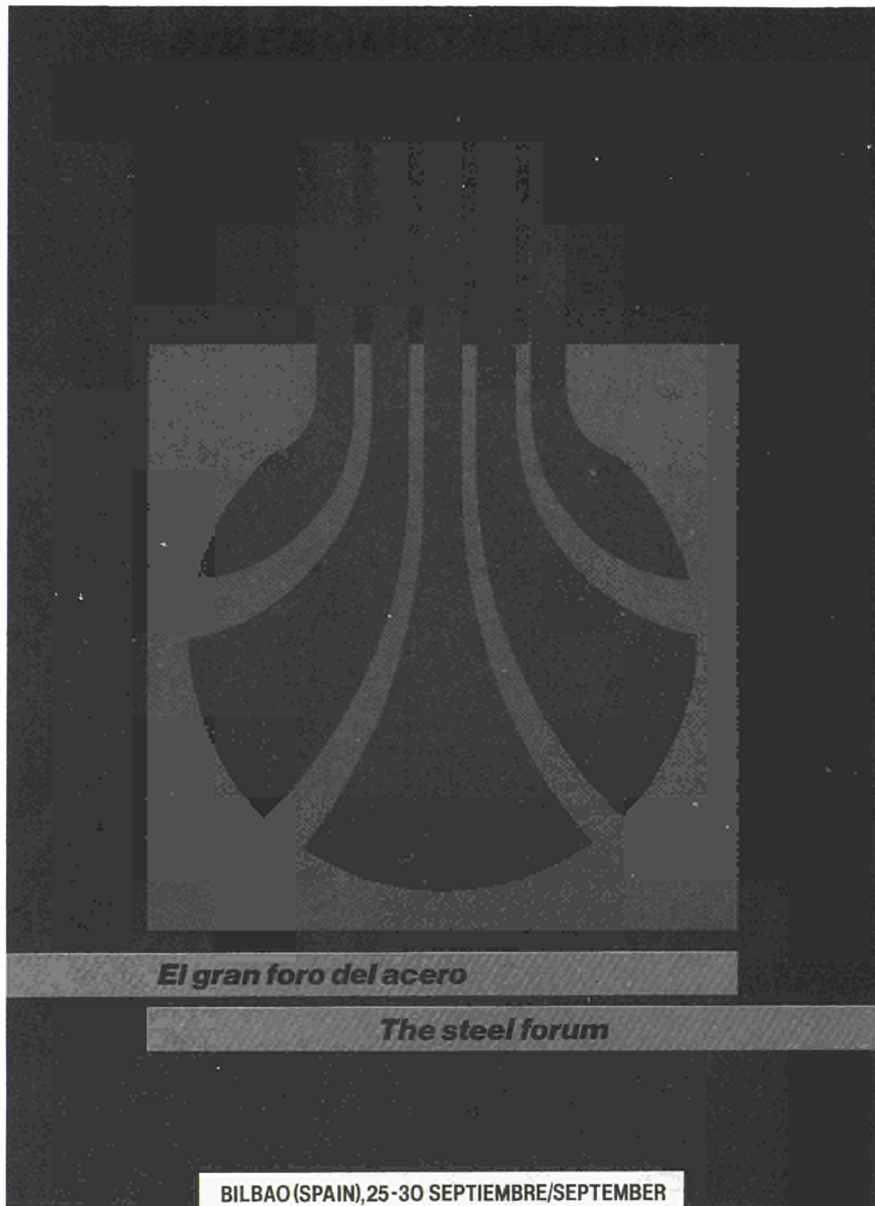

El gran foro del acero

The steel forum

BILBAO (SPAIN), 25-30 SEPTIEMBRE/SEPTEMBER

Further information can be obtained from Mr F. Engels, Commission of the European Communities, DG XIII/C/2, B4/106, Jean Monnet Building, L-2920 Luxembourg, Tel.: (352) 4301-2952, Tlx: 2423, 3446 COMEUR LU, Fax: (352) 4301-4129.

Kem-Tek Conference
November 7 to November 10, 1989, at the Bella Center, Copenhagen.

8th int. fair for plant and equipment for the biotechnological, chemical and food industries.



KEM-TEK 1989

BELLA CENTER COPENHAGEN

The KEM-TEK Conference is based upon a brand-new concept - a non-profit arrangement where conference participants as well as exhibitors participate free of charge.

The conference form is new in that the companies themselves present background material, research results, visions of the future, and other matters influencing the development of one or more specific products.

Further information:

Bella Center A/S
Center Boulevard
DK-2300 Copenhagen S
Contacts: Erik Nöhrind and Bo Rasmussen
Tel.: +45 32 52 88 11
Telex: +45 31 188 bella dk
Telefax: +45 31 51 96 36

The Danish Technological Institute
Att: Mr. Henrik Berg
Gregersensvej
DK-2630 Taatstrup
Tel.: +45 42 99 66 11
Telefax: +45 42 99 54 36

WHY DOES A PRODUCT LOOK THE WAY IT DOES?

- an invitation to companies to submit contributions free of charge to the Kem-Tek Conference.

Last date of registration: August 31, 1989.



IMPROVING THE UTILISATION OF PUBLICLY FUNDED RESEARCH

FIRST COMPREHENSIVE REPORT ON THE STATE OF TECHNOLOGY TRANSFER IN THE COMMUNITY NOW AVAILABLE

— STUDIES ON THE SITUATION IN THE MEMBER STATES PUBLISHED —

There has been growing concern in recent years that the **results of publicly funded research and development should be fully exploited** and that society should derive maximum benefit from them.

First of all, there has been a **lack of information on the actual measures adopted throughout the Community** and on their effectiveness. In order to fill this gap and to identify measures which might have general utility, the Commission initiated a series of studies to be made under the SPRINT Programme by groups of experts from university or the economy (See list of authors below). The objectives of these studies were to examine the procedures adopted in each Member State **to promote the effective utilisation of publicly funded R&D**, and to suggest measures which, in the opinion of the consultants, would be useful at both national and Community level. These studies have now been published:

Title: **Utilisation of the results of public research and development** (plus the name of the Member State concerned)
 Edited by: H. Corsten/K.-O. Junginger-Dittel/B.B. Goodmann/A.v. Witzleben - 1989, Published by: CEC, DG XIII-C, Kirchberg, Luxembourg, Price (excluding VAT) in Luxembourg: ECU 5 to 15

IMPROVING THE UTILISATION OF PUBLIC AND PUBLICLY FUNDED R&D RESULTS

List of studies and authors:

Summary report EUR No. 11528 EN ISBN 92-825-8269-8	John T. McMullan Centre for Energy Research University of Ulster UK-Coleraine BT52 1SA	Ireland EUR No. 11534 EN ISBN 92-825-9050-X	B.A. O'Sullivan and D.J. Cogan Science Policy Research Centre Department of Business Administration University College Dublin
Netherlands EUR No. 11537 EN ISBN 92-825-9052-6	F.A. de Jonge Stichting LICENTEC Bernadottelaan 15 NL-3503 RH Utrecht	Italy EUR No. 11535 EN ISBN 92-825-9062-3	Giuseppe Bellei, Domenico Corradetti and Renato Facci FORMIT Fondazione per la Ricerca sulla Migrazione e sulla Integrazione delle Tecnologie Via Giovanni Gemelli Careri 11 I-00147 Roma
Denmark EUR No. 11530 EN ISBN 92-825-9046-1	Leif Christensen DTO - Danish Technical Information Service Rygaards All 131 A DK-2900 Copenhagen, Hellerup	Luxembourg EUR No. 11536 FR ISBN 92-825-9051-8	M. Oestreicher LUXINNOVATION 7, rue Alcide de Gasperi, B.P. 1304, L-1013 Luxembourg
France EUR No. 11531 FR ISBN 92-825-9047-X	Thomas Durand, Thierry Gonard and Roland Schell ANVAR 43, rue de Caumartin F-74536 PARIS Cédex 09	Spain and Portugal EUR No. 11538 EN ISBN 92-825-9053-4	Prof. Pedro Nueno IESE, Universidad de Navarra Avenida Pearson 21 E-08034 Barcelona
Germany EUR No. 11532 DE ISBN 92-825-9048-8	Gerhard Bräunling Fraunhofer-Institut für Systemtechnik und Innovationsforschung Breslauer Strasse 48 D-7800 Karlsruhe 1 and Michael Maas Universität - GHS Duisburg	United Kingdom EUR No. 11539 EN ISBN 92-825-9054-2	R.E. Quince Segal Quince Wicksteed Economic and Management Consultants Hall Keeper's House 42, Castle Street UK-Cambridge CB3 0AJ
Greece EUR No. 11533 EN ISBN 92-825-9049-6	D. Deniozos, T. Giannitsis and H. Tspouri University of Athens Omirou 19, GR-10672 Athens		

A copy of the revised version of the study on Belgium taking into account the most recent developments can be obtained on written request from Mr A. v. Witzleben, CEC, DG XIII-C, JMO, B4-091, L-2920 Luxembourg, Tlx: 2423/3446 Comeur LU, Fax: (352) 4301-3351.

Utilisation
des résultats de la recherche
et du développement publics
en France

COLLECTION
INNOVATION
& TRANSFERT
de TECHNOLOGIE

Utilization
of the results of public
research and development
in Italy

COLLECTION
INNOVATION
& TECHNOLOGY
TRANSFER

Utilization
of the results of public
research and development
in the United Kingdom

COLLECTION
INNOVATION
& TECHNOLOGY
TRANSFER

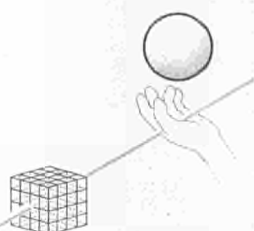

COMMISSION DES COMMUNAUTÉS EUROPÉENNES

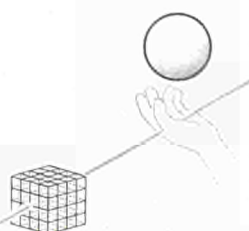

COMMISSION DELLE COMUNITÀ EUROPEE

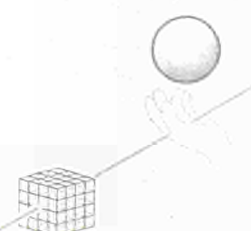

COMMISSION OF THE EUROPEAN COMMUNITIES

REMOTE SENSING APPLICATION TECHNIQUES AT THE JOINT RESEARCH CENTRE

REMOTE SENSING FOR LAND MONITORING AND MANAGEMENT

The JRC research activity in this field aims at the study and evaluation of practical methods for:

- land use planning in less favoured areas of EC member countries;
- monitoring of renewable resources in the Sahelian region based upon the integration of remote sensing data.

Research activities deal with the development of suitable techniques and methods for land use statistics and maps, the study of vegetation dynamics, including agricultural production, crop prediction and environmental degradation phenomena such as desertification and deforestation.

REMOTE SENSING FOR MONITORING OF MARINE ENVIRONMENT AND RESOURCES

The JRC research activity in this field is centered on three main projects, namely:

- 1) **Surveillance of the sea pollution.** This research area is dealing with the development and testing of suitable instrumentation and methods for the (remote) detection, identification and quantification of pollutant spills (hydrocarbons and other chemicals) on the sea.
- 2) **Coastal transport of pollution.** This activity is dealing with the monitoring and the analysis of the physical and biological processes related to anthropogenic pollutants in coastal areas. Systematic satellite data and in-situ measurements are used to develop and validate computer models describing the complex dynamic conditions of the sea in coastal areas.
- 3) **Study of upwelling areas.** This project is concerned with the potential application of remote sensing data (e.g. sea color and sea surface temperature) in the analysis of the physical and biological processes connected with coastal upwelling and marine productivity.

REMOTE SENSING FOR AGRICULTURE STATISTICS

This is a research activity carried out in support to the Directorate General for Agriculture and the Statistical Office of the Commission. It deals with the development and validation of methods for the integration of remote sensing data in the EEC agricultural statistical system, specially for crop area estimation and crop yield estimation and prediction.

The required input data come from the satellite SPOT, THEMATIC MAPPER, LANDSAT and the meteorological satellites NOAA-AVHRR.

ADVANCED TECHNIQUES

The JRC is devoting an increasing effort in the development and testing of new remote sensing techniques such as:

- laser fluorescence remote sensing and
- microwave remote sensing.

Laser induced fluorescence and the application of an advanced airborne fluorosensor are being investigated for environmental applications, in particular for the identification and characterization of oil pollution at the sea surface. Potential applications of this advanced sensor are, e.g. the monitoring of sea water quality (chlorophyll, algae, yellow substances) and the monitoring of vegetation stress.

Microwave remote sensing R&D activities, focused on the application of the Synthetic Aperture Radar (SAR), include the creation of a radar cross section data base, the development of knowledge based algorithms for information extraction, the conduction of European campaigns for data acquisition and training of users (e.g. AGRISAR 86, AGRISCATT 87, MAESTRO 88-89), and the participation in pilot projects using ERS-1 (First European Remote Sensing Satellite) data.

A map of chlorophyll concentration (mg/m³) of coastline facing the Neaples harbour (I). The image was derived from TM data of Nov. II 1987 and compared with contemporary in-situ measurements.

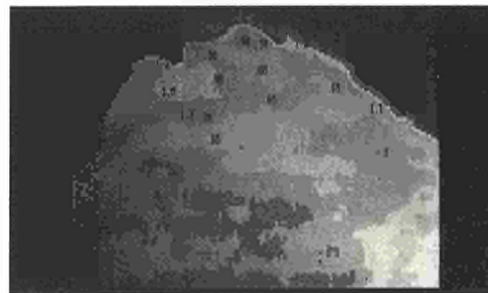

Perspective view of the ARDECHE Department (France) obtained by superposing the image of July 5th (1984) of the satellite Thematic Mapper on a digital elevation model representing the relief of the region.

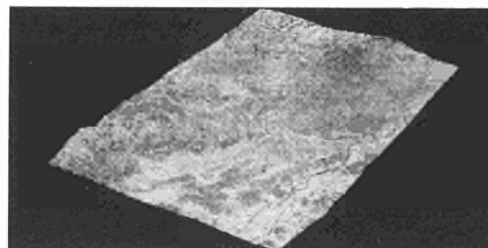

Remote sensed map of Chlorophyll and total suspended matter in the Northern Adriatic sea. Satellite data (CZCS, AVHRR) are used to set up a computer model describing all phenomena of interest in the marine environment.

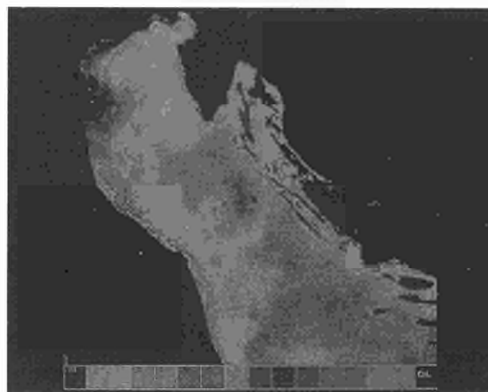

The AVHRR instrument carried on board of the NOAA satellites provides regional views of resource distribution on a nearly daily basis. The image shown here is used to study the seasonal development of vegetation and the role of fires (red dots) as an agent of environmental degradation (West Africa).

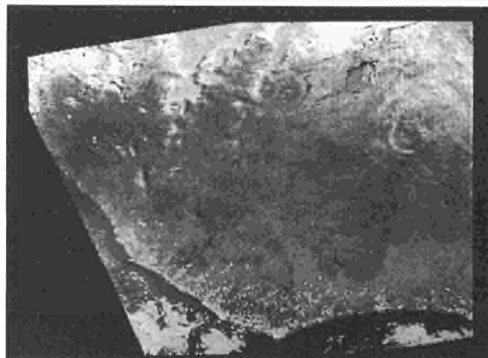

INSTITUTE OF REMOTE SENSING APPLICATIONS COMMISSION OF THE EUROPEAN COMMUNITIES - JOINT RESEARCH CENTRE

The complete set of fact sheets on remote sensing in support of development can be obtained from Mrs M. Piera Moretti, Joint Research Centre, Ispra Establishment, I-21020 Ispra (Varese), Tel.: (39) 332 78.91.11, Tlx: 380.042 / 380.058 EUR I.

THE VALUE TEAMS

Further to the approval of the VALUE Programme, 'I&TT' wishes to give its readers a short 'overview' of the various departments in charge of the VALUE Programme. In this issue we start with the unit 'Promotion of the exploitation of Community research and technological development'.

Below we publish the names of the team of project engineers in this service:

Mr J. N. DURVY, Head of unit, Tel.: (352) 4301-3610

Mr F. ENGELS, CECA projects, Tel.: (352) 4301-2952/2356

Mr J. ALVES, Information technology and communication projects, Tel.: (352) 4301-4765/4406

Mr P. HERZBERGER, Joint Research Centre projects, Tel.: (352) 4301-2953/3452

Mr W. HEIERS, Energy demonstration projects, Tel.: (352) 4301-2928/2356

Mr J. HERNANDEZ-ROS, Energy R&D and Environment R&D projects, Tel.: (352) 4301-4533

Mr P. TROUSSON, Industrial technology and new materials projects, Tel.: (352) 4301-4297/3453

Mr M. LEIPOLD, Participation in fairs and exhibitions, Tel.: (352) 4301-2936/2356.



The photo shows, from left to right: Messrs Hernandez-Ros, Herzberger, Alves, Verbruggen, Laopodis (CORDIS), Mrs Franzetti, Messrs Leipold, Scheer, Durvy, Mrs Zapf, Messrs Engels, Trousson, Cidone, Miss Richter

CHEAPER WIND ENERGY

Seam-free polyester rotors for wind power plants

Several Community RTD programmes are promoting the development of clean and renewable sources of energy. In the case of wind energy, in particular, work is now concentrating on the development of safe, efficient and profitable wind power plants.

Ecotecnia, a Spanish company, has completed the design and manufacture of 30-150 kW wind power plants and of stand-alone equipment for the wind power sites located in Spain.

With the support of the Commission of the European Communities (DG XII-E) a high-performance rotor using a new method of manufacture has been designed. There are **several advantages** when compared with existing techniques:

- absence of seams between blades;
- minimum use of polyester resin;
- optimum shape and length (with a diameter of up to 30 m);
- improved technical design;
- lower production cost;
- need for less-skilled labour force.

The technique can be applied to **any other hollow component** which requires better quality than can be achieved using traditional manufacturing methods or other types of material (epoxy resin, carbon fibre, etc.).

Further information can be obtained from Ecotecnia S. Coop., Calle Demostenes 6, E-08028 Barcelona, Tel.: (34) 3 330.78.60, Fax: (34) 3 411.23.45, and from Mr J. Hernandez-Ros, Commission of the European Communities, DG



XIII/C/2, B4/121, Jean Monnet Building, L-2920 Luxembourg, Tel.: (352) 4301-4533, Tlx: 2423 / 3446 COMEUR LU, Fax: (352) 4301-4129.

HUNTING AMONG THE GREY LITERATURE

— 'Passport' to grey literature now available —

An initiative of the Commission of the European Communities, in cooperation with the major information and documentation centres in the member countries, led to the establishment of the 'System for Information on Grey Literature in Europe' (SIGLE), which became operational in 1981. The Scientific and Technical Communication Unit of the Commission (DG XIII/C/3) has now issued a leaflet describing the current status of SIGLE.

A copy of 'Your passport to grey literature' can be obtained by writing to Mr E. Philips, Commission of the European Communities, DG XIII/C/3, B4/078, Jean Monnet Building, L-2920 Luxembourg, Tel.: (352) 4301-2916, Tlx: 2423, 3446 COMEUR LU, Fax: (352) 4301-4129.



Commission of the European Communities

FIRST ANNOUNCEMENT

PATINNOVA '90

MADRID, 21-23 MAY 1990

Palacio de Congressos

— STRATEGIES FOR THE PROTECTION OF INNOVATION —

IMPROVING THE ENVIRONMENT FOR EUROPE'S COMPETITIVENESS

PATINNOVA '90 will be the first European congress dealing with **patent and innovation** matters. It will focus on how to promote innovation and accelerate the spread of new technologies by means of the patent system.

Its overall objective is to improve general awareness of the economic and marketing importance of the patent system. **PATINNOVA '90** aims to have a lasting impact on those who should be concerned in Europe.

PATINNOVA '90 will both highlight to the public the importance of property rights in the innovation process and bring together those currently working in the field of industrial property rights for a mutual and transnational exchange of views and experience.

The following issues will be addressed:

- **protection and filing policies** for technical innovations as part of the systematic marketing of technology;
- the role of **patent attorneys** and other **patent consultants** in filing and protection strategies;
- **patent-assisted marketing** of inventions from university and research institutions;
- impact of **patent-assisted marketing of licences on the competitiveness of SMEs** in the Single Market;
- strategies for avoiding and solving **patent disputes and litigation**;
- requirements to be met **in future by the system of industrial property rights** and by the patent system in particular.

The programme for **PATINNOVA '90** will be available by the end of August 1989. It can be obtained on written request from Dr A. v. Witzleben, Commission of the European Communities, DG XIII/C/1, B4/091 Jean Monnet Building, L-2920 Luxembourg, Tlx: 2423 / 3446 COMEUR LU, Fax: (352) 4301-4129, or from Dr U. Täger, IFO - Institut für Wirtschaftsforschung, Poschinger Straße 5, D-8000 München 86, Tel.: (49) 89 92.24-0, Tlx: 522.269, Fax: (49) 89 985.369.

Registration: Mrs Maria Gasca Elosegui, OEC, Organizacion de Exposiciones y Congresos, S.A., Plaza de la Encarnacion 2, 28013 Madrid, Tel. 247 70 42/36, Telex: 49515, Fax: 542 75 49

Announcement
and Call for Papers

**9th European
Photovoltaic
Solar Energy
Conference
and Exhibition**

Albert-Ludwig University
Freiburg
Fed. Rep. of Germany
25-29 September 1989

Sponsored by the
Commission of the European Communities

9TH EUROPEAN PHOTOVOLTAIC SOLAR ENERGY CONFERENCE AND EXHIBITION

ALBERT-LUDWIG UNIVERSITY

FREIBURG, WEST GERMANY - 25-29 SEPTEMBER 1989

As in previous years, the conference (organized by the Commission of the European Communities), will cover all aspects of photovoltaic activities - from laboratory devices to complete photovoltaic systems, from material research to economic projections, from university research to industrial production.

Further information can be obtained from Prof. G. Wrixon or Dr S. MacCarthy, NMRC, University College, Lee Maltings, Prospect Row, Cork, Ireland, Tel.: (353) 21 276.871 ext. 2256/2171.

PATENT APPLICATIONS RECENTLY PUBLISHED

The Patent Applications shown in this Section concern Inventions resulting from EC-funded or cost-shared EC Contract Research.

1. CONTINUOUSLY VARIABLE LASER BEAM ATTENUATOR

Ref.: EUR Pat 2213

Inventors : M.R. TAGHIZADEH, I.R. REDMOND

Conventional laser beam attenuation by means of attenuation plates inserted into the beam path has the disadvantage that, as the attenuation rate depends on the absorption material and plate thickness, any variation of the attenuation rate implies replacement or adjunction of the attenuation plates being used. This newly invented attenuator assembly for a collimated laser beam allows a graduated absorption density with a high level of energy to be absorbed and a wide range of attenuation rates to be modified continuously.

In a housing (3), a dichromated gelatin holographic plate (4) is fixed in a frame (5) supported by an elastic mount (6) and linked with adjustment means (eccentric cam 7 and screw 8) capable of pivoting it about an axis substantially perpendicular to the axis (9) of the laser beam (1) arriving through an inlet window (2). Downstream of the holographic plate, a dump diaphragm (10) coated with an absorption layer (12) gives free passage through its central hole to the undiffracted (zero order) laser beam and intercepts, by its rim, the diffracted (higher order) beams created by the holographic plate at a rate depending on its inclination with respect to the laser beam axis. As the absorption takes place in the absorption layer (12) of the diaphragm, the holographic plate can support very high continuous laser intensities without destroying the input beam profile. A spatial filter placed in the output beam path of the attenuator and including two collecting lenses (13, 13'), as well as a pinhole diaphragm (14), re-establishes a Gaussian intensity profile of the beam. The diaphragm (10) can be associated with cooling means for removal of the energy absorbed.

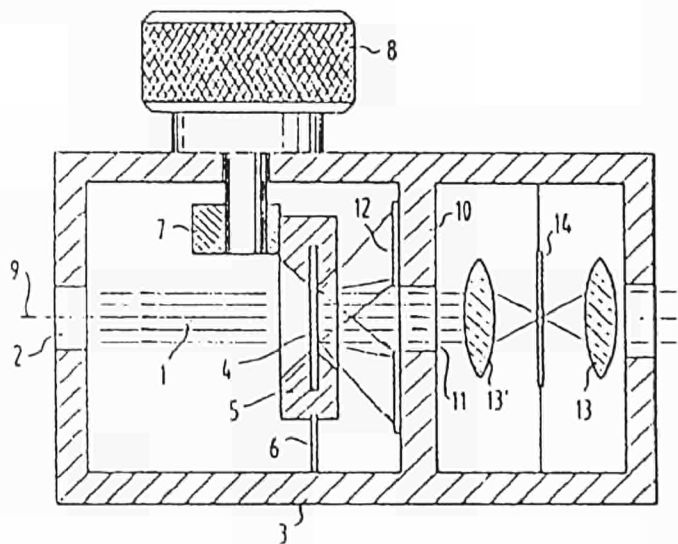

2. METHOD AND DEVICE FOR PURIFYING A GAS CONTAINING HYDROGEN ISOTOPES

Ref.: EUR Pat 2215

Inventors : G. PIERINI, H. DWORSCHAK, B. SPELTA, E.F.M. VANSANT

This safe and economical method has been conceived in particular for purifying a gas mixture to be withdrawn, at regular intervals, from a thermonuclear fusion reactor where impurities occur due to the reaction of the plasma with the reactor components. A simple, compact device provides each purification stage with two units respectively (2, 3, 4, -2', 3', 4'), to be connected in parallel and operated alternatively through a valve (14), so that a regeneration cycle following the adsorption cycle rejects the adsorbed products for isotope recovery in a quasi continuous manner.

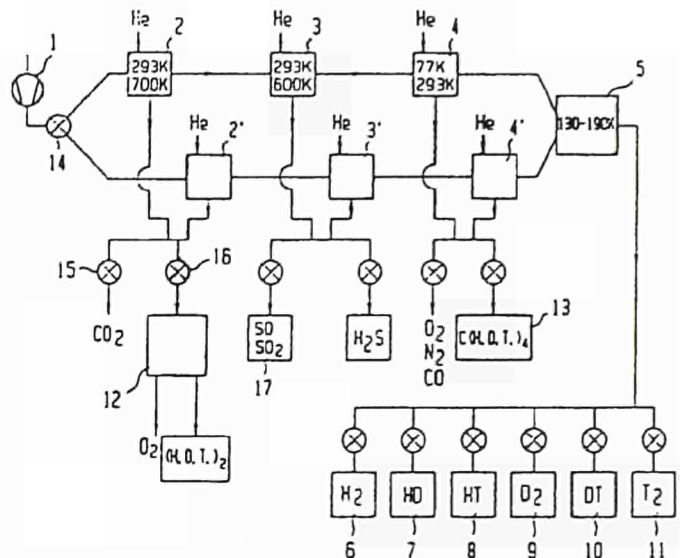

A dosimetric pump 1 injects the gas mixture into a water and CO₂ adsorption stage 2, adsorbing the light, heavy, and tritiated water vapours and traces of CO. Then, adsorption stage 3 adsorbs, by a zeolite at ambient temperature, the sulphur compounds SO, SO₂, H₂S, and remaining CO₂ traces. The remaining mixture still containing helium, hydrogen isotopes and N₂, O₂, CO, C(H,D,T)₄ is fed into a hydrogen adsorption/separation stage 4, completely adsorbing all remaining compounds except helium by a mordenite-type zeolite subsequently heated-up for separation of the hydrogen isotopes, then directed into stage 5, split into the adsorbed six isotopomeric hydrogen species (H₂, HD, HT, D₂, DT, T₂) and directed successively towards getter-type adsorption traps (6, 7, 8, 9, 10, 11).

By heating up the stage-4 zeolite, the other impurities adsorbed are released one by one. All non-tritiated compounds (O₂, N₂, CO, CO₂) are directed to a chimney, and the tritiated hydrocarbons C_n(H, D, T)_{2n+m} to a methane trap 13n, where the hydrocarbons are decomposed and hydrogen isotopes recovered by bed regeneration.

3. BRAKING DEVICE FOR A CAPSULE AT THE END OF A TRAJECTORY

Ref.: EUR Pat 2220

Inventors : Ch. MURRAY, R. JAMET

This braking device permits the efficient and calibrated deceleration of an instrument capsule descending onto the sea bed at a speed close to free fall. It comprises several discs and a hydraulic shock absorbing system. The capsule glides down by gravity along a plastic-coated guiding cable (3) which passes through an axial guiding channel. At the cable's lower end, the capsule hits in succession the braking discs (6, 7, 8, 9) individually mounted on the cable by squeezing means (11) consisting of two PVC blocks applied against the cable by screws (12). The blocks define the position of the respective disc in the absence of exterior forces. As soon as the axial impact force exerted on a disc passes beyond a threshold value adjusted by the screws, the blocks and the disc glide along the cable, activating the braking process as a function of the friction between the cable, the squeezing means, and the inertia of the water below the disc. The cable's plastic coating increases the reproducibility of force of the squeezing means. The braking effect is propagated from one disc to the other down to the shock absorbing system (10), which consists of a cylinder (13) rigidly fixed to the cable end and of a piston (14) mounted on the cable by PVC blocks (15) similar to the discs' squeezing means. The cylinder wall comprises numerous holes (17) with decreasing diameter towards the bottom. A helical spring (18) is able to push against the piston's front face in order to prevent it from hitting the cylinder bottom.

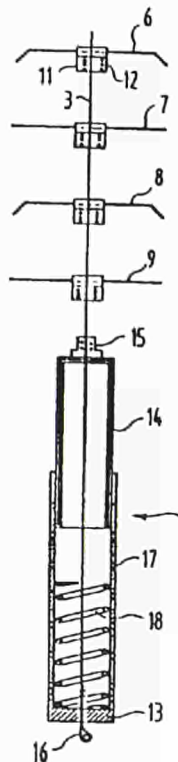
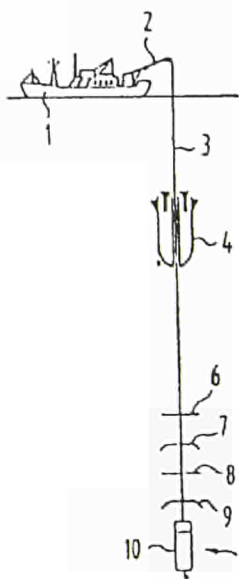

With diminishing capsule speed and increasing friction force of the squeezing means, the braking movement is propagated to the last disc (9) which finally hoits the squeezing means of the piston causing it to penetrate into the cylinder, thereby pushing the water out of its holes. As the piston advances, the number of holes letting water out diminishes, while the force opposing the capsule's inertia increases, being further intensified by the force of the spring as soon as the piston abuts against it.

4. A TARGET TRACKING DEVICE

Réf.: EUR Pat 2226

Inventors : G.A. Parker, R.J.R. Mayer, I.G. Taylor, D.G. Bailey

This assembly has been conceived for remotely measuring the position of the moving head (1) of a robot (2) place between two identical stationary and mutually distant su-systems (5, 6). Each sub-system has a linearly polarized laser source (7) generating a laser beam (36) which passes, through a quarter-wave plate (8) optically isolating it and a collimator (9) expanding it to a convenient diameter, towards two plane mirrors (10,11) with mutually perpendicular pivot axes (14,15) deflecting the beam (37) onto the cat's-eye reflector of the target (4) mounted on the robot head. The orthogonally pivotable mirrors are each driven by a brushless DC motor (12, 13) and over-

head manner on the motor shaft supported by gas bearings. A digital angle encoder (16,17) coupled to the shaft detects the current mirror position and delivers signals which allow evaluation of the corresponding target 3D coordinates. In order to make the deflected laser beam (37) follow the centre of the target, the distance between incident and return beam reflected by the cat's-eye is measured by a lateral effect photodetector (18) receiving the beam after its repeated reflection on the two mirrors and its deviation from the main path through the beam splitter (19) interposed between the collimator and the mirrors. Thus, the mirror position can be adjusted according to signals deviated from the photo-detector's output signals in such a way as to reflect a beam approaching the cat's-eye centre, so that the distance between incident and reflected beam becomes zero. The DC motors driving the mirrors are also controlled by detector output signals in accordance with an error signal depending on the instantaneous difference between the present and the requested mirror position. A dynamic-state space controller receiving the mirror pivot control signals eliminates the resonance of the mirrors and their drive amplifiers.

Compared to known tracking systems, this invention promises increased accuracy, target speed and working volume without affecting target stability.

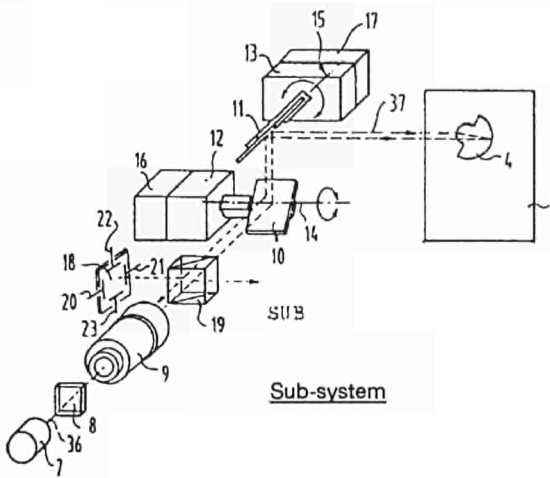
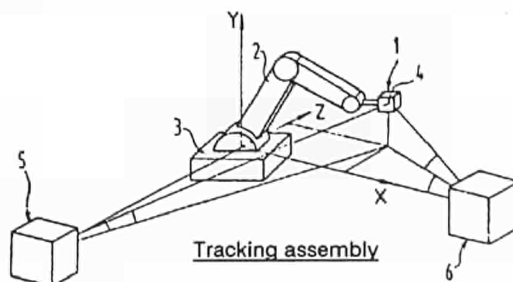

Further information can be obtained from Ms L. Gerlach, Commission of the European Communities, DG XIII/C/1, B4/068, Jean Monnet Building, L-2920 Luxembourg, Tel: (352) 4301-2922, Tlx: 2423 / 3446 COMEUR LU, Fax: (352) 4301-4129.

ENERGY EFFICIENCY IN BUILDINGS

International Conference

Palais des Congrès, Lille, 28-30 November 1989

Organised by the Commission of the European Communities and the Conseil Régional de Nord-Pas de Calais in collaboration with the Agence Française pour la Maîtrise de l'Energie. The Conference will review progress made to date, evaluate the scope for future improvements, assess future prospects, and stimulate the dissemination and implementation of technology in buildings.

Languages of the conference: French, English, German, Italian.

Further information on this conference can be obtained from Mr M. Gowen, Commission of the European Communities, DG XVII/E/2, 200, rue de la Loi, B-1049 Brussels, Tel.: (32) 2 236.04.36, Tlx: 21877 COMEUR B, Fax: (32) 2 235.01.50.

Seminar on

Reactor Safety Research

20-24 November 1989, Congress Centre 'Villa Ponti', Varese (Italy)

The seminar is organized by the Joint Research Centre (JRC) of the Commission of the European Communities with the aim of presenting the results of the Reactor Safety Research Programme carried out between 1984 and 1988.

Request for further information

Surname

Forename

Mailing address

Please return to: Mr. W. Krischer, Commission of the European Communities, Institute of Safety Technology, Joint Research Centre — Ispra Site, I-21020 Ispra (Varese), Italy

Tel.: + 39-332-789610 · Telex: 380042 EUR I
Fax: + 39-332-789045

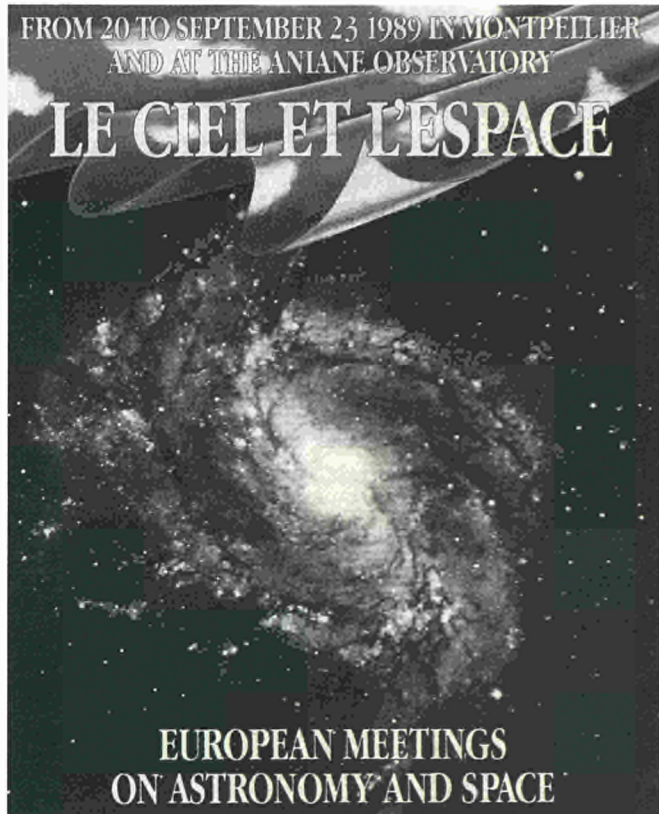

Showing the difficulties encountered in the European education systems, explaining the stakes of research and space techniques, presenting the consequences of space developments, showing the dissemination tools and possibilities of such subject matters to the general public, are the aims of these meetings.

Organized by the Observatory of the French Association of Astronomy located in Aniane (Herauld). Under the aegis of the European Commission, with the participation of the European Space Agency and the European Southern Observatory.

Further information on the European Meetings on Astronomy and Space can be obtained from Mr M. André, Commission of the European Communities, DG XII, SDME 01/38, 200, rue de la Loi, B-1049 Brussels, Tel.: (32) 2 236.07.81, Tlx: 21877 COMEUR B, Fax: (32) 2 236.20.07.

THE 1989 INTERNATIONAL CONFERENCE ON DECOMMISSIONING OF NUCLEAR INSTALLATIONS

Brussels, 24 - 27 October 1989

The European Community is conducting **research on the decommissioning of nuclear installations** with the prime objective of developing effective techniques and procedures to ensure the protection of man and his environment against the potential hazards of nuclear installations that have been finally shut down.

A conference will be organised again upon completion of the programme, to present the results achieved and to provide an opportunity for discussions between experts and scientists from within and outside the European Community on the issue and options for future research.

Topics which will be covered are:

- | | |
|---|--|
| — Long-term integrity of buildings and systems; | — Large waste containers; |
| — Decontamination for decommissioning purposes; | — Estimation of radioactive waste quantities; |
| — Dismantling techniques; | — Influence of installation design features; |
| — Treatment of specific waste materials; | — Testing of new techniques under real conditions. |

Only invited papers will be presented by scientists involved in the programme through contracts, members of the Commission's scientific staff and guest experts. **The Scientific Secretary** is: Mr K. Pflugrad, Commission of the European Communities, DG XII, 200, rue de la Loi, B-1049 Brussels, Tel. (32) 2 235.84.25 or 236.04.63, Tlx: 21877 COMEUR B, Fax: (32) 2 236.20.06.

Information regarding the conference programme, registration, fees, accommodation, transport, official and social events:

CONFERENCE SERVICES

Mrs. F. Rey · Avenue de l'Observatoire 3 · Boîte 17 · B-1180 BRUSSELS

JOINT RESEARCH CENTRE, ISPRA, WILL BE HOLDING THE FOLLOWING SEMINARS:

- A. Information Science**
Cellular Automata: Methods and Applications
 11-15 September 1989
Selected Topics of Monte Carlo: Applications in Science and Technology
 6-10 November 1989
- B. Remote Sensing**
Imaging Spectroscopy: Fundamentals and Prospected Applications
 23-27 October 1989
- C. Reliability and Risk Analysis/Structural Reliability**
 18-22 September 1989, Lisbon, Portugal
- D. Energy**
Parameter Identification Techniques for the Thermal Analysis of Buildings
 9-11 October 1989
- E. Various/Scientific Methods in Dating and their Applications**
 9-13 October 1989, Athens, Greece

Further information can be obtained from ISPRA Courses Secretariat, Joint Research Centre, I-21020 ISPRA (Varese), Tel.: (39) 332 78.98.39 / 78.98.19, Tlx: 380042 / 380058 EUR I.



COMMISSION OF THE EUROPEAN COMMUNITIES
DIRECTORATE GENERAL XII

Environment Research Programme Joint Research Centre
Rue de la Loi, 200 Ispra Establishment
1049 BRUSSELS / Belgium 21020 ISPRA (VA) Italy

FIFTH EUROPEAN SYMPOSIUM ON PHYSICO-CHEMICAL BEHAVIOUR OF ATMOSPHERIC POLLUTANTS

September 25 - 28, 1989
Congress Centre "Villa Ponti"
Varese (Italy)

Organized by the
Commission of the European Communities
within the framework of the
CONCERTED ACTION
PHYSICO-CHEMICAL BEHAVIOUR
OF ATMOSPHERIC POLLUTANTS
(COST-611)

For further information, please contact:
 Mr G. RESTELLI
 Joint Research Centre
 Ispra Establishment
 Bldg. 27b
 I-21020 ISPRA (Varese)

C.R.M. C.E.C.

High Temperature Materials for Power Engineering 1990

Fourth Conference organised by
C.R.M. LIEGE, BELGIUM

Under the auspices of
COST-501 and COST-505

The European Collaborative Programmes on High Temperature Materials Initiated and Supported by the
Commission of the European Communities

First announcement and call for papers

September 24-27, 1990
Palais des Congrès, Liège - Belgium

The Conference will consider recent progress in the development of high temperature materials for power engineering

Correspondence:
 M. Lamberigts, Non Ferrous and New Materials Branch
 Centre de Recherches Métallurgiques (CRM)
 Rue Ernest Solvay, 11
 B-4000 Liège (Belgium)
 Tel.: (041) 54 62 11 — Telefax (041) 54 64 64 GII-III

IXe CONGRES TECHNIQUE INTERNATIONAL DE LA CHAUSSURE

NANTES (France)
11 - 13 octobre 1989

Secretariat du congrès:
CTC
 4, rue Hermann Frenkel
 69367 LYON CEDEX 07
 France
 Téléphone: 78.69.50.12
 Téléx: 340.497
 Téléfax: 78.61.28.57

SEMINARS AND CONFERENCES ON ENERGY EFFICIENCY

EUROPEAN SEMINAR ON TECHNOLOGIES AND PROCESSES APPROPRIATE FOR THE RATIONAL UTILISATION OF ENERGY IN THE TEXTILE SECTOR IN THE CASES OF SPINNING AND FINISHING

Venue: Centro di Cultura Scientifica, 'Alessandro Volta', Villa Olmo, Como, Italy — 20 - 21 October 1989

Organised jointly by the Commission of the European Communities - Directorate-General for Energy, Federtessile

The aim of this seminar is to disseminate the energy-saving techniques for waste heat from textile production that have been learned through the Energy Demonstration Programme and to foster new and innovative ideas that can be pursued by companies in the textile sector.

The seminar will cover the following topics: direct and indirect heat recovery, process optimisation, the Energy Demonstration Programme and application of modern technology to the textile industry.

EUROPEAN SEMINAR ON COGENERATION

This Seminar aims at presenting a panorama of the current situation of cogeneration in European industry as well as in industry in non-EEC countries. Topics that will be covered include:

- international experience and legislation
- state of advancement in the EEC Member States
- financial aspects involved
- environmental impact
- EEC demonstration projects
- on-site technical visit.

Languages: English and Spanish with simultaneous translation.

No registration fee. Places will be allocated on a 'first come first served' basis. Not later than September 22, 1989.

Organized by the Commission of the European Communities and the Instituto para la Diversificacion y Ahorro de la Energia IDAE with the cooperation of Gomez Padro foundation's energy Commission Madris — 10. - 11. October 1989.

Information: Mr J. Sirchis, Commission of the European Communities, DG XVII/E/2, Terv 06/11, 200, rue de la Loi, B-1049 Brussels, Tel.: (32) 2 235.36.33, Tlx: 21877 COMEUR B.

FIRST ANNOUNCEMENTS

EUROPEAN SEMINAR ON ENERGY EFFICIENCY IN THE FOUNDRY SECTOR OF INDUSTRY

Venue: The Conference Centre, Bilbao, Spain — 25 - 26 September 1989

Organised jointly by the Commission of the European Communities - Directorate-General for Energy, The Basque Enterprise for Energy, The International Fair of Bilbao

The aim of the seminar is to disseminate the energy saving techniques for waste heat from foundries that have been learned through the Energy Demonstration Programme and to foster new and innovative ideas that can be pursued by companies in the foundry sector. The seminar will cover the following topics: direct and indirect heat recovery, process optimisation and the Energy Demonstration Programme.

FURTHER SEMINARS AND CONFERENCES ON ENERGY EFFICIENCY

1. European Conference on the Application of Microprocessors in Energy Management in Industry

Paris, probably April 1990

This conference aims to present the extent of applications that microprocessors have in industry in the sector of energy management.

2. European Seminar on the Ceramics Industry

Italy, first quarter 1990

The seminar aims to present the latest developments in energy saving in the ceramics industry

3. European Seminar on Energy Efficiency in the Fertilizers Industry

The seminar aims to present the latest developments in the energy-efficiency sector of the fertilizers industry. It is scheduled for the end of 1989 at a location not yet specified.

Further information on these seminars will be available at the end of August from Mr J. Sirchis, Commission of the European Communities, DG XVII/E/2, Terv 06/11, 200, rue de la Loi, B-1049 Brussels, Tel.: (32) 2 235.36.33, Tlx: 21877 COMEUR B.

A SELECTION OF RECENT PUBLICATIONS FROM THE SCIENTIFIC AND TECHNICAL COMMUNICATIONS SERVICES

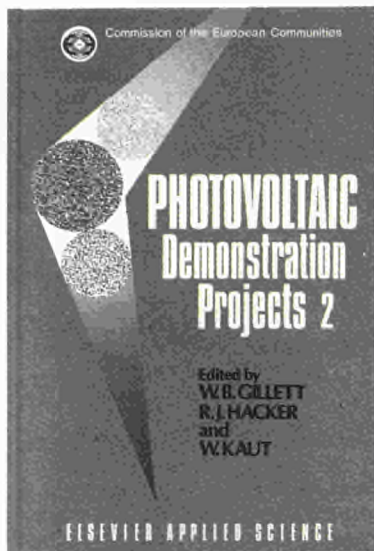

PHOTOVOLTAIC DEMONSTRATION PROJECTS

Edited by W.B. GILLETT, R.J. HACKER and W. KAUT

Proceedings of the third contractors' meeting organised by the Commission of the European Communities, Directorate-General for Energy, held at the Joint Research Centre, Ispra, Italy, 18-20 May 1988.

Published by the Commission of the European Communities, DG XIII-C, EUR 12090, ISBN 1-85166-379-7

Elsevier Applied Science Publishers Ltd., Crown House, Linton Road, Barking, Essex IG11 8JU, United Kingdom, London, New York, Brussels and Luxembourg, 1989.

EUROPEAN GEOTHERMAL UPDATE

Edited by K. LOUWRIER, E. STAROSTE, J.D. GARNISH and V. KARKOULIAS

Proceedings of the Fourth International Seminar on the Results of EC Geothermal Energy Research and Demonstration, Florence, 27-30 April 1989

Published by the Commission of the European Communities, DG XIII-C, EUR 12038

Kluwer Academic Publishers, P.O. Box 17, NL-3300 AA Dordrecht, Brussels and Luxembourg, 1989.

BIOGAS END-USE IN THE EUROPEAN COMMUNITY 47

Edited by M. CONSTANT, H. NAVEAU, G.-L. FERRERO and E.-J. NYNS

In Europe over the past few years the generation of biogas for energy and environmental purposes has been gaining in importance. Industrial wastewaters, cattle manure, sewage sludges, urban wastes, crop residues, algae and aquatic biomass are all typical of the materials being utilised.

Biogas End-Use in the European Community provides essential information for all those involved in the production and use of biogas and should make a significant contribution towards improving the use of biomass and wastes as energy sources.

Published by the Commission of the European Communities, DG XIII-C, EUR 12034

Elsevier Applied Science Publishers Ltd., Crown House, Linton Road, Barking, Essex IG11 8JU, United Kingdom, London, New York, Brussels and Luxembourg, 1989.

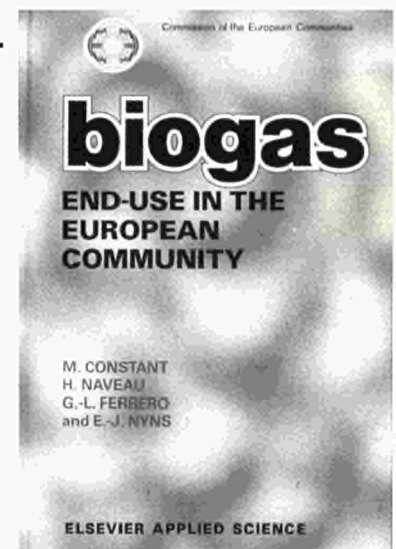

**RECOVERY OF PLASTICS WASTE
LE RECYCLAGE DES DÉCHETS DE MATIÈRES PLASTIQUES**

Edited by P. L'HERMITE, Ch. METTELET and G. L. FERRERO

The Commission of the European Communities and the Agence Nationale pour le Récupération et l'Élimination des Déchets - 'LES TRANSFORMEURS' - are very active in promoting these technologies, which are beneficial for the environment and at the same time conserve energy and raw materials in this sector.

Published by the Commission of the European Communities, DG XIII-C, EUR 11717 EN-FR, ISBN 92-825-8914-5

Office for Official Publications of the European Communities, Luxembourg, 1989

VACCINATION AND CONTROL OF AUJESZKY'S DISEASE

Edited by J. T. VAN OIRSCHOT

This volume presents the latest results of AD research, reviews recent developments in molecular biology, vaccinology and discusses the detection of epitope-specific antibodies to AD virus.

Published by the Commission of the European Communities, DG XIII-C, EUR 11876, ISBN 0-7923-0184-6

Kluwer Academic Publishers, P.O. Box 17, NL-3300 AA Dordrecht, Brussels and Luxembourg, 1989.

REGULAR INFORMATION ON SCIENTIFIC AND TECHNICAL PUBLICATIONS NOW AVAILABLE

Regular information on scientific and technical publications resulting from the work of the European Communities can be found in a **new booklet** issued by the Scientific and Technical Communication Unit of DG XIII-C. To be issued four times per year, the booklet includes news of reports arising from the research and technological development programmes as well as publications on innovation and technology transfer and on science policy. The current issue includes books and reports on

- agriculture
- biotechnology
- energy
- environment and quality of life
- industrial health and safety
- nuclear science and technology
- physical sciences
- radiation protection
- science and technology policy.

A specimen copy can be obtained on written request from Dr E. Phillips, Commission of the European Communities, DG XIII/C/3, B4/078, Jean Monnet Building, L-2920 Luxembourg, Tlx: 2423 / 3446 COMEUR LU, Fax: (352) 4301-4129.



PREPARATIONS FOR CORDIS DATA BASE SERVICE WELL UNDER WAY

Coincidental with the final decision approving the VALUE Programme on 20.6.1989, developments on CORDIS (The Community R&D Information Service), which is part of this programme, are progressing on schedule (see I&TT, 2/89, page 23).

A test period for the service run from July until the end of October. A number of selected users will have access to the initial databases to be offered through CORDIS and will provide feedback on the user interfaces, the user documentation, other user support functions and the content of the databases themselves.

The databases envisaged initially for CORDIS will include one describing Community Research and Technological Development Programmes, another describing projects under each of these programmes, and finally an enhanced version of the EABS database (see I&TT, 4/88, page 21) giving abstracts of documents and publications in the public domain from Community R&D activities. No date has yet been set for the launch of CORDIS to the public, although it is still expected to be before the end of 1989.

I&TT will keep you up to date with developments.

Further publications:

WIND-DIESEL AND WIND-AUTONOMOUS ENERGY SYSTEMS

Edited by H. NACFAIRE

This book gives an overview of Community demonstration projects on autonomous and wind-diesel systems presented during a meeting organised in Mykonos, Greece, 25-26 April 1988 for the contractors involved in demonstration projects supported by the Commission of the European Communities.

Published by the Commission of the European Communities, DG XIII-C, EUR 11931, ISBN 1-85166-388-X

Elsevier Applied Science Publishers Ltd., Crown House, Linton Road, Barking, Essex IG11 8JU, United Kingdom, London, New York, Brussels and Luxembourg, 1989.

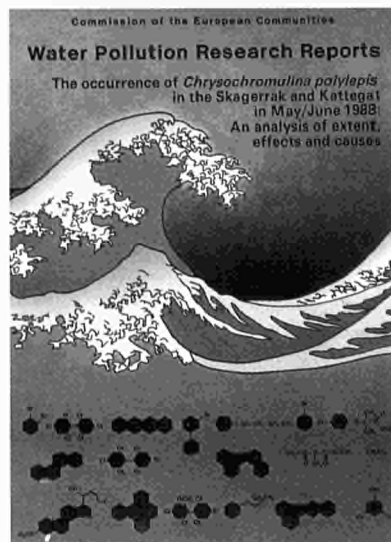
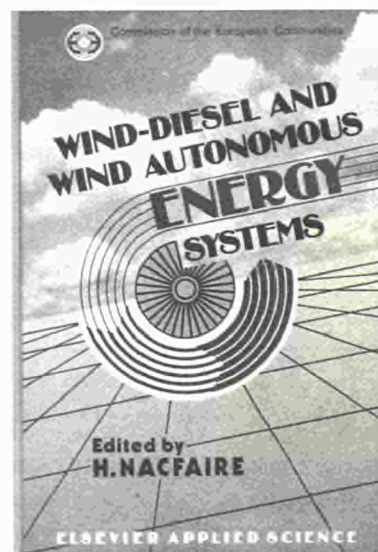

WATER POLLUTION RESEARCH REPORT 10

THE OCCURRENCE OF CHRYSOCHROMULINA POLYLEPIS IN THE SKAGERRAK AND KATTEGAT IN MAY/JUNE 1988: AN ANALYSIS OF EXTENT, EFFECTS AND CAUSES

Edited by H. BARTH and A. NIELSEN

Published by the Commission of the European Communities, DG XIII-C, EUR 12069, ISBN 92-8259654-0

Office for Official Publications of the European Communities, Luxembourg, 1989.

PUBLICATIONS ON AGRICULTURAL RESEARCH

PUBLICATIONS RESULTING FROM THE AGRIMED PROGRAMME 1984-1988

- Constituent meeting of the varietal and health improvement network for the apricot tree (RAVSA) - Papers presented, Murcia (Spain), 4-6 June 1988. EUR 10935 ES-EN-FR-IT
- First seminar on 'Alternative non-surplus crops', Papers presented, Milazzo, Sicily, 21-24 July 1987 EUR 11709 FR-EN-IT
- Evaluation of Mediterranean sheep and goats, 'Philostios' Symposium, Fonte Boa (Vale de Santarem, Portugal), 23-25 September 1987 EUR 11893 FR-EN
- Tropical and subtropical crops for the Mediterranean regions, Papers presented, Malaga (Spain), 16-18 May 1988. EUR 11922 FR-EN-ES-IT
- Tobacco protein utilization perspectives. Proceedings of a seminar held in Perugia, Italy, 22 July 1988 EUR 11923

PUBLICATIONS RESULTING FROM THE LAND USE PROGRAMME 1984-1988

- Detailed study of soil working and cropping systems in relation to the maintenance of fertility and soil conservation, Report of Activity under EEC research contract 5410. This report can be obtained from Mr D. Dessylas, Commission of the European Communities, DG VI Agriculture, 200, rue de la Loi, B-1049 Brussels.
- Computerization of land use data. Proceedings of a symposium held in Pisa (Italy), 20-22 May 1987 EUR 11151 EN

All the above-mentioned publications except the report on contract 5410 can be ordered from the Office for Official Publications of the European Communities, L-2920 Luxembourg (please indicate EUR number).

- During the past decade an **EC soil-map at scale 1:1 million** was made and digitized. To support soil scientists in modelling at regional scale it is necessary to connect an analytical data base to the soil-map. For this purpose the second edition of the catalogue of computerized land evaluation data bases in the EC - containing 132 data bases - was again sponsored by DG XIII and DG VI agricultural research. With suggestions for further updating please contact Dr Axel Noer, National Cadastre and Survey, South Regional Department, Moltrapvej 1, DK-6100 Hadenlev.

PYROLYSIS AS A BASIC TECHNOLOGY FOR LARGE AGRO-ENERGY PROJECTS

Commission of the European Communities



ABRUZZO REGION



Pyrolysis as a basic technology for large agro-energy projects

Edited by E. MATTUCCI, G. GRASSI and W. PALZ

Proceedings of a workshop held in L'Aquila, Italy, on 15 and 16 October 1987.

Published by the Commission of the European Communities, DG XIII-C, EUR 11382 EN, ISBN 92-825-9464-5

Office for Official Publications of the European Communities, Luxembourg, 1989

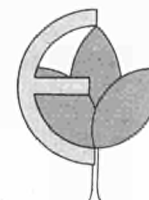

EUR 11382 EN

— AGRICULTURE —

COMPUTERIZATION OF LAND USE DATA

Edited by J. A. JONES and B. BIAGI

Proceedings of a symposium in the Community programme for coordination of agricultural research, held in Pisa on 20-22 May 1987.

Published by the Commission of the European Communities, DG XIII-C, EUR 11151 EN, ISBN 92-825-9686-9

Office for Official Publications of the European Communities, Luxembourg, 1989

SPRINT PUBLICATION ON TRAINING IN INNOVATION MANAGEMENT

Edited by R. Miège and F. Mahieux

Proceedings of a European symposium organized jointly by the Commission of the European Communities, DG XIII, the Ministry of Research and Higher Education (France) and ANVAR (Agence nationale de valorisation de la recherche) and held in Paris on 14 and 15 April 1988.

EUR 11868, ISBN 92-825-9192-1 (English) and 92-825-9193-X (French), Brussels and Luxembourg, 1989



SPRINT, THE EUROPEAN PROGRAMME FOR INNOVATION AND TECHNOLOGY TRANSFER

EACRO - THE EUROPEAN ASSOCIATION OF CONTRACT RESEARCH ASSOCIATIONS

New SPRINT initiative successfully started

At the meeting of the SPRINT Working Party on Contract Research Associations (CROs) on 19.4.1989, Mr Mordchelles-Regnier, Chairman of EACRO, presented a progress report on the first months of work of his new European association. He pointed out that EACRO emanated from the first CRO meeting convened by the Commission last October. It was formed by the Association of Independent Research and Technology Organisations (AIRTO), UK, representing 45 CROs, the Association des Sociétés Indépendantes de Recherche et Développement Industriels (ASIRDI), France, representing 10 CROs, the Italian Contract Research Organisations CISE, CESI and ISMES, the Fraunhofer Gesellschaft, West Germany, with its 20 individual centres, and TNO from the Netherlands. The meeting also discussed the proposal for a Symposium on Contract Research in Europe (see page 35).

EACRO has as general aims:

- * the **promotion of Contract Research Organisations** in Europe and the defence of their interests;
- * the **translation and dissemination of results** of precompetitive research for the benefit of Small and Medium-Sized Enterprises (SMEs);
- * the identification of **common needs** for new generic technologies in European industries;
- * the establishment of a **European network** to disseminate methodologies and know-how between the members of EACRO;
- * the provision of **help and services** to build up a CRO base in countries where no national CRO infrastructure exists;
- * the establishment of **links** with other research-oriented professional associations (e.g. FEICRO).

Further information on EACRO can be obtained from Mr I. Traill, Commission of the European Communities, DG XIII/C/1, B4/105, Jean Monnet Building, L-2920 Luxembourg, Tel.: (352) 4301-4532, Tlx: 2423 / 3446 COMEUR LU, Fax: (352) 4301-4129.

JUST PUBLISHED: BROCHURE ON INDUSTRIAL RESEARCH ASSOCIATIONS COOPERATING UNDER SPRINT

SPRINT is currently providing partial financial **support to 16 transnational cooperation projects between 94 industrial research associations** in the Community. The core objective of each project is to compile and diffuse information likely to assist innovation and technological development on a broad front among the firms in the corresponding sector. A list of these institutions was published in I&TT 1/89, page 23.

Five of these, being considered fairly typical, have been selected to feature in a new brochure, which has just been published. The industries concerned are wood, footwear, building, paint and composite materials.

Order Form

Please send me your brochure (language: DE EN ES F I)

Name: _____

Address: _____

Date: _____ Signature: _____

Please return to: Mr D. Janssens, Commission of the European Communities, DG XIII/C/1, B4/101, Jean Monnet Building, L-2920Luxembourg, Tel.: (352) 4301-4407 / 4372, Tlx: 3423, 3446 COMEUR LU, Fax: (352) 4301-4129.

<p>INNOVIEREN IN DEN TRADITIONELLEN INDUSTRIEZWEIGEN EUROPAS</p>  <p>Das SPRINT Netzwerk für industrielle Forschungseinrichtungen</p>	<p>INTRODUCING INNOVATION INTO EUROPE'S TRADITIONAL INDUSTRIES</p>  <p>The SPRINT network of industrial research associations</p>	<p>DIFFUSER LA NOUVEAUTE DANS LES INDUSTRIES TRADITIONNELLES DE L'EUROPE</p>  <p>Le réseau SPRINT de centres techniques industriels</p>
---	---	---

TECNOVA⁸⁹

SALON INTERNACIONAL DE LA INNOVACION Y LA TECNOLOGIA
INTERNATIONAL INNOVATION AND TECHNOLOGY EXHIBITION

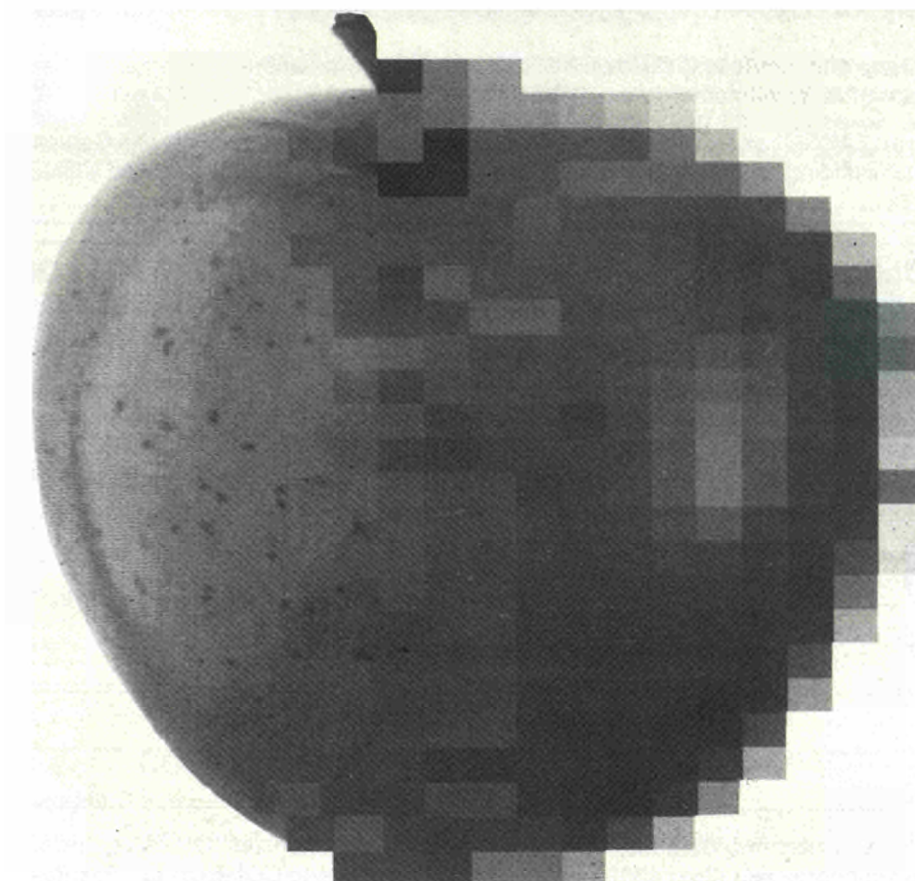

17/20 • OCTUBRE • 1989
RECINTO FERIAL CASA DE CAMPO • MADRID

PARTNERS FOR A TECHNOLOGICAL EUROPE / JOURNEES NATIONALES DE L'ANVAR

'Partners for a Technological Europe' was the 'leitmotiv' of the 5th 'Journées Nationales de l'ANVAR' (National Agency for the Exploitation of Research), which took place on 6 and 7 June 1989 in Strasbourg in the presence of Mr Hubert Curien - the French Minister for Research and Technology - and Mr Fauroux - the French Minister for Industry and National Development.

The 'Journées Nationales de l'ANVAR' focused on one central topic, i.e. European, technological and financial partnership.

Apart from a series of general sessions, the ANVAR event consisted of three major parts:

1. Training and information seminars

The seminars gave a practical illustration of the different challenges facing the European entrepreneur in the light of the European Internal Market of 1993. Subjects like financing for innovative companies, industrial property, commercial and technological strategies, Community programmes for SMEs etc. were discussed.

In the seminar 'Technology for winning in Europe', Dr Strub, Director of DG XIII-C, outlined the SPRINT Programme. His presentation was illustrated by the exposé given by Dr Knight from the British Technology Group, which is the coordinating organisation in the SPRINT-sponsored Eurotech project (see page 35).

Mr Louis Berreur, Director of ID-Conseil Paris, who is involved in a SPRINT network, provided in his presentation a methodical approach on how to conduct a market study for technological products on an international level.

2. Services and Information Centre

One hundred business consultants, including about 15 SPRINT contractors, offered their advisory services on a continuous basis to firms in their respective specialities: financing, opportunity research, technology transfer, feasibility studies, industrial property, etc.

In addition, EACRO, the European Association of Contract Research Organisations, recently established with the assistance of the SPRINT Programme, provided an information stand (see also page 29).

Several Community technology programmes were presented in the European section of the information centre. DG XIII was represented by a SPRINT information desk.

3. European Business Exchanges

In collaboration with EVCA (European Venture Capital Association), a European capital forum was organised to foster contacts between French and foreign firms and European investors.

A European technology exchange 'bourse' helped to establish contacts between French and foreign firms seeking or supplying new technologies.

For further information, please contact Ms Gaby Hetterich, Commission of the European Communities, DG XIII/C/1, Office B4/105, Jean Monnet Building, L-2920 Luxembourg, Tel. (352) 4301.4788, Tlx: 2423/3446 COM EUR LUX or Mrs Elisabeth Walter, ANVAR, 43, rue de Caumartin, F-75436 Paris Cedex 09, Tel.: (1) 40178341, Fax: (1) 40178319.

EUROPEAN CONFERENCE ON VALUE ANALYSIS

**1992: L'ANALISI DEL VALORE
FATTORE DI SUCCESSO
DELL'IMPRESA EUROPEA**

**1° CONVEGNO EUROPEO
DI ANALISI DEL VALORE**

Milano, Hotel Executive, 16-17 ottobre 1989

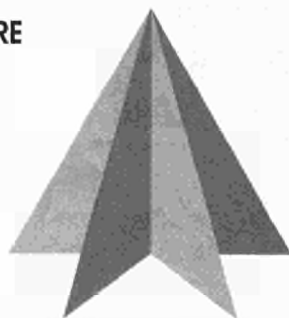

The AIIV (Italian Value Analysis Association) in conjunction with the following European national associations:

ADV — Belgium, AEAV — Franc, APAV — Portugal
VDI — Germany, ZWA — Austria and the assistance of specialists from Ireland, The Netherlands, The United Kingdom and Spain announces the

1st EUROPEAN CONFERENCE ON VALUE MANAGEMENT

The event is part of the 'Value Analysis Project' of the EEC's SPRINT Programme.

The Conference will include presentations by the most respected VM specialists in Europe and the world, along with testimonials by qualified users from the world of industry, services and public administration. Debates and round tables will offer the opportunity to compare different schools of thought and operating schemes, opinions and results.

Further information can be obtained from the Organizing, Secretariat, MGR S.r.l., Via Servio Tullio, 4, I-20123 Milano, Tel.: (39) 2 481.35.58, Tlx: 315469 MGRMIL I, Fax: (39) 2 498.07.23. For information on the SPRINT Working Party on 'Value Analysis' contact Mr J. Tiscar, Commission of the European Communities, DG XIII/C/1, B4/102, Jean Monnet Building, L-2920 Luxembourg, Tel.: (352) 4301-4102, Tlx: 2433 / 3446 COMEUR LU, Fax: (352) 4301-4129.

**1992: VALUE MANAGEMENT
KEY TO SUCCESS IN
EUROPEAN BUSINESS**

**1st EUROPEAN CONFERENCE
ON VALUE MANAGEMENT**

Milano, Executive Hotel, October 16-17 1989





TII — THE INNOVATION LINK IN EUROPE

News from TII, the European Association for the Transfer of Technologies and Industrial Information

Programme of TII events

- 18-20 September 1989 **Group visit** to Dublin/Waterford/S.E. Region of Ireland
- 25-26 September 1989 **Group visit of university industrial liaison officers**, in association with UDIL, Edinburgh
- 28-30 September 1989 **ISPIM Conference**, Consulting in Innovation, in conjunction with TVA, TII, EFMD, DABEI, Berlin
- 26-27 October 1989 **TII Conference** 'Enterprise, Innovation and 1992 - Innovation-Support Services in Europe', Nice

Contact: TII secretariat, 3, rue des Capucins, L-1313 Luxembourg, Tel.: (352) 46.30.35.



TII - EUROPEAN ASSOCIATION FOR THE
TRANSFER OF TECHNOLOGY,
INNOVATION AND
INDUSTRIAL INFORMATION

FIRST ANNOUNCEMENT
AND
CALL FOR PAPERS

EUROPEAN CONFERENCE

ENTERPRISE, INNOVATION AND 1992 :
INNOVATION SUPPORT SERVICES IN EUROPE

NICE
October 26-27, 1989



in association with AMAS-PHIRAMA
with the support of Association "La Route des Hautes Technologies"
under the patronage of "Ministère de la Recherche et de la Technologie"
and
"C.R.C.I. Provence, Alpes, Côte d'Azur et Corse"



with the financial support of the SPRINT programme of the C.E.C.
under the patronage of the President of the European Parliament

EUROPEAN CONFERENCE

"ENTERPRISE, INNOVATION AND 1992: INNOVATION SUPPORT SERVICES IN EUROPE"

Aims of the conference

To highlight the **rich variety of innovation-support services** available to firms in Europe.

To emphasise the **growing economic importance of these services**, individually and collectively.

To **exchange views and experience** on trends and working methods in innovation support.

To **promote multi-disciplinary and transnational contact and cooperation** between innovation-support organisations and professionals.

Reply

Surname _____

Forename _____

Function/title _____

Organisation _____

Full postal address _____

Tel.: _____ Fax: _____ Telex: _____

I wish to receive the final programme for the conference

Return to: TII

3, rue des Capucins
L-1313 LUXEMBOURG
Tel.: (352) 46 30 35
Telefax: (352) 46 21 85
Telex: 6105111 GMA Lu

AFTER APPROVAL OF THE SPRINT PROGRAMME: NEW CIT CONVENED

The first meeting of the CIT (Committee for Innovation and Technology Transfer) after the approval of the new SPRINT Programme (see I&TT, 2/89, page 2) was convened in Luxembourg on 20 and 21 April 1989. Among the topics discussed was the implementation of the SPRINT Programme, the current calls for proposals (see I&TT, 2/89, page 28) and specific projects for intra-Community technology transfer (see article below).



The CIT at its meeting of 20/21 april 1989

List of the members of the CIT:

Mr N. LOUVET,
Ministère des Affaires économiques,
Belgium

Mr J. LAURENT
Services de programmation de la politique
scientifique, Belgium

Mr J. HARNE
National Agency for Industry and Trade,
Denmark

Mr H. G. BRAEUNLING
Fraunhofer Institut für Systemtechnik und
Innovationsforschung, Germany

Dr Chr. BREBECK
Bundesministerium für Wirtschaft,
Germany

Mr José M. MESEGUER PEINADO
IMPI, Spain

Mr I. ATORRASGASTI TELLERIA
IMPI, Spain

Mr Fr. BIENENFELD
Ministère de la recherche et de l'enseigne-
ment supérieur, France

Mr JOLY
Ministère de l'industrie & de l'aménage-
ment du territoire, France

Mrs Sophia CHRYSSAFI
Head of Technology Division
General secretariat of Research and
Technology, Greece

Mr Constantinos BENEKOS
Head of Innovation & Technology Dept.
HOMMEH, Greece

Mr N. COSTELLO
Dept. of Industry and Commerce
Office of Science & Technology, Ireland

Dr O. McBREEN
The Irish Science & Technology Agency
EOLAS, Ireland

Dott. D. PRESACANE
Ministero Partecipazioni Statali
D.G. Programmi e Sviluppo, Italy

Dott. C. de VINCENTIS
Ministero Industria e Commercio
D.G.P.I. - Div. III, Italy

Mr G. SCHMIT
Ministère de l'économie et des classes
moyennes, Luxembourg

Mr Y. OESTREICHER
Luxinnovation, Luxembourg

Mrs R.M. WIJNANDS
Ministerie van Economische Zaken
Directie Algemeen Technologiebeleid, The
Netherlands

Mr J. van ENST
Ministerie van Economische Zaken
D.G. Industrie en Regionaal Beleid, The
Netherlands

Mr Fernando GONÇALVES
Secretaria de Estado da Ciencia e Tec-
nologia, Portugal

Mr Victor Corado SIMOES
Istituto do investimento estrangeiro
Director of Marketing, Portugal

Mr J. NIBLETT
Department of Trade and Industry
Research & Technology Division, United
Kingdom

Mr M. PORTER
Department of Trade & Industry
Research & Technology Division, United
Kingdom

President: Dr A. STRUB, CEC - DG XIII-C
Secretary: Mr R. MIÈGE, CEC - DG XIII/C/1
Secretariat: Mrs S. DEPAUS, CEC - DG
XIII/C/1

SPRINT CALL FOR SPECIFIC PROJECTS IMMINENT

The Commission intends to launch a new SPRINT Call for Proposals to provide financial support for the definition phase of **Specific Projects for Intra-Community Innovation Transfer**.

This call is expected to be published during August 1989 in the Official Journal, a copy of which can be received **on written request** from Mr R. Miège, Commission of the European Communities, DG XIII/C/1, B4/099, Jean Monnet Building, L-2920 Luxembourg, Tel.: (352) 4301-4180 / 4371, Tlx: 2423 / 3446 COMEUR LU, Fax: (352) 4301-4129.

DIRECTORY OF COLLECTIVE INDUSTRIAL RESEARCH CENTRES IN EUROPE

A directory containing the coordinates of about 400 collective industrial research centres in Europe - often called 'industrial research associations' in the United Kingdom, 'centres techniques' in France and 'Forschungsgemeinschaften' in Germany - has been compiled on a country-by-country basis as a part of the SPRINT action to promote transnational cooperation between these centres.

Further information on 'industrial research centres' can be obtained from Mr D. Janssens, Commission of the European Communities, DG XIII/C/1, B4/101, Jean Monnet Building, L-2920 Luxembourg, Tel.: (352) 4301-4407, Tlx: 2423 / 3446 COMEUR LU, Fax: (352) 4301-4129. A copy of this directory can be obtained on written request from Mrs S. Dria (see address above).

SPRINT CALL FOR PROPOSALS FOR THE PROMOTION OF EUROPEAN CONFERENCES OR WORKSHOPS ON TECHNOLOGY AND INNOVATION

This scheme is intended to promote the Community-wide dissemination of information concerning innovation and/or technology transfer. Proposals will be invited from the organizers of conferences on innovation or technology who are prepared to give a European dimension to conferences which would normally be held on a national or regional basis. Proposals may be submitted by any natural or legal person, public or private body, institution or group established in the territory of a Member State by 30. 11. 1989. Only proposals for European conferences etc. which are scheduled to take place after 31 August 1990 will be accepted.

.....>

ORDER FORM FOR APPLICATION FORMS

(to be returned to the SPRINT Secretariat — see address below)

Name of the person requesting the application form(s)

If applicable, name of the enterprise or organization which you represent

Address

Telephone

Telefax

Telex

Please send to the above address an application form for the promotion of European conferences on technology and innovation

Please send the application form in the following languages:

ENGLISH

FRENCH

GERMAN

Please return to: The SPRINT Secretariat, Commission of the European Communities, DG XIII/C1, B4/100, Jean Monnet Building, L-2920 Luxembourg.

ACTUATOR 90

In June 1990, the Second International Congress on New Actuators will be held in Bremen, West Germany. This congress, organized by the VDI/VDE Centre for Information Technology, will present the latest results achieved in research and development and provide an opportunity for discussions between scientists, experts and users. Topics are:

Fluid-technique

- Sensors
- Control concepts
- Interfaces
- Drive systems

Power Semiconductors

- Smart power
- Hybrid modules
- Bipolar and MOS-semiconductors

Electric Drive Systems

- Controlled drives
- Stepper drives
- Linear drives
- Microelectronics

New Actuator Concepts

- Smart materials
- Piezoelectric drives
- Magnetic drives
- Magic fluids

New actuators will bring a revolution by making machines, robots and precise positioning devices smaller, faster and more powerful. **ACTUATOR 90** will help in transferring scientific results out of the labs into new products. **ACTUATOR 90** is sponsored by the CEC (SPRINT-Programme).

Further information from:

VDI/VDE Centre for Information Technology
Bremen Office
Am Wall 119
D-2800 Bremen
Tel.: 0421/170531, Fax.: 0421/171686



MICROMINIATURE GYRO SPIN MOTOR

FIRST EUROPEAN CONGRESS ON CONTRACT RESEARCH ORGANISATIONS

— Amsterdam, February 26-27, 1990 —

The first aim of this congress is to **emphasize the role of CROs** in improving the competitiveness of European industry, bringing efficient technologies with lower cost and delay to their customers, and converting the results of scientific research and large national or European programmes into practical know-how.

The second aim is to examine better ways of **cooperation** among members of the profession, its clients, governments and the Commission.

The congress is sponsored and organised jointly by the **SPRINT Programme of DG XIII of the Commission and by EACRO**, the recently founded European Association of Contract Research Organisations, which has already gathered together a major part of the profession within Europe.

According to a recent survey carried out for the SPRINT Programme, CROs in Europe represent more than 100 organisations, 20 000 employees and one thousand million ECU in contracts (see announcement on page 40). It is thus a very important tool for technological development in Europe. EACRO and the Commission expect that the congress will form a good basis for the future development of contract research in Europe and for better use of all its potential by industry and the EC.

Further information on this congress can be obtained from Mr W. A. De Jong, T.N.O., P.O. Box 297, NL-2501 BD The Hague, Tel.: (31) 70 49.65.12, Fax: (31) 70 85.57.00, and Mr T. Jones, Commission of the European Communities, DG XIII/C/1, B4/103, Jean Monnet Building, L-2920 Luxembourg, Tel.: (352) 4301-3461, Tlx: 2423 / 3446 COMEUR LU, Fax: (352) 4301-4129.

Further details will be announced as they become available.

HIGH TECH FAIR IN DENMARK: TECHTRANS CENTRE '90

... aims to build a **bridge between high technology and the producer** and ...

... will be an **international forum for exchanges of ideas** between suppliers of high-technology products, new technologies and techniques, as well as advanced processes, systems and know-how on the one side, and industrialists and technicians, producers looking for new results, licences and patents, investors, product developers and scientists, as well as technology and patent brokers on the other side. Furthermore, TechTrans Centre '90 will be a meeting place for colleagues with the opportunity to exchange experience and points of view at both conference and exhibition level.

TechTrans Centre '90, which takes place at the same time as the Herning Fair '90, **will concentrate on five key areas:**

- intelligent products, new technologies, processes and techniques
- new energy technologies and techniques
- new materials
- infrastructure
- bioengineering

**Sponsored by the Commission of the EC
under the SPRINT Programme**

Organizer:

Messecenter Herning, (Exhibition Centre Herning), Vardevej 1, DK-7400 Herning,
Phone: +45 97 12 60 00, Fax.: +45 97 22 30 60, Telex: 62 135 (herhal dk)

Danish Technology Transfer



92, Store Kongensgade
P.O. Box 2205
DK-1018 Copenhagen K
Denmark
Telephone + 45 1 32 13 25
Telex 210 93 mscent dk
Telefax + 45 1 2 50 90

EUROTECH PROJECT

The second meeting of this project (supported by SPRINT) took place on 15-16 June in Madrid and was attended by representatives of the 5 founding members and of the 5 active observers (see I&TT 4/88, page 17 and 1/89, page 29).

A presentation was made by the Belgian Institute for the Encouragement of Scientific Research in Industry and Aquaculture (IRSI/IWONL) which is also planning to join the EUROTECH network as an active observer.

Further information can be obtained from Mr M. Knight, British Technology Group, 101, Newington Causeway, UK-London SE1 6BU, or Mr D. Janssens, Commission of the European Communities, DG XIII/C/1, B4/101, Jean Monnet Building, L-2920 Luxembourg, Tel.: (352) 4301-4407 / 4372, Tlx: 2423 / 3446 COMEUR LU, Fax: (352) 4301-4129.

MEMBER OF SPRINT NETWORK EXPLORES OPPORTUNITIES FOR A NEW FORM OF LICENSING FAIR IN THE UK IN EARLY 1990

Catalogue of 5000 licence opportunities planned

In a desire to increase the efficiency of the process by which technology is transferred to manufacturing industry, the U.K. Department of Trade and Industry have commissioned The Technology Exchange (a member of the SPRINT network) to explore the potential interest of manufacturers who currently offer licence opportunities to manufacturing industry in a new form of licensing fair which is planned for a UK venue early in February 1990.

The format of the event will involve the **advance production of a comprehensive indexed catalogue of at least 5000 currently available licence opportunities** from organisations around the world which will be priced to attract the maximum interest but pitched at a level which will deter the attendance of the casual visitor.

It is planned to make the book available well in advance of the Licensing Fair to enable contacts to be established.

This method of operation is intended to allow visiting manufacturers to decide in advance whether the cost in time and travelling to attend the Fair is likely to be economically justified, and both exhibitor and visitor can arrange for appropriately qualified people to take part in the discussions.

Further information can be obtained from Mr B. Padgett, Managing Director, The Technology Exchange, South Bank Technopark, 90 London Road, UK-London SE1 6LN, Tel.: (44) 1 922.88.15, Tlx: 941.37.06 SBT, Fax: (44) 1 633.09.41.

SPRINT DESIGN PROMOTION ACTIVITIES

During the meeting of the CIT Working group on design a consensus was reached on the following activities:

1. Current Projects

- a seminar on CAD/CAM applications will be held (organiser: ADI, Marco Piva, Milan, Tel.: (39) 2 782.044);
- various measures to promote awareness for design are being envisaged (contact: J. Bernsen, Copenhagen, (45) 1 146.688);
- the Design Auditing working party will be convened soon (contact: Bilbao Design Centre P. JAUREGUI, Bilbao, Tel.: (34) 4 442.51.00);
- the staff exchange programme between national design promoting institutions will be continued (contact: Industriel ontwerpen Nederlands, M. Kamphuis, Rotterdam, Tel.: (31) 10 411.21.44);

2. European Community Design Prize (ECDP) 1990

The national selections are under way. Proposals for the ECDP 1990 can be put forward by the national delegations. A consensus was reached on a list of members for the international jury.

The award ceremony will take place in Spain in March or April 1990.

Further information on design promotion activities under the SPRINT Programme can be obtained from Mr E. Faroult, Commission of the European Communities, DG XIII/C/1, B4/075a, Jean Monnet Building, L-2920 Luxembourg, Tel.: (352) 4301-4851, Tlx: 2423 / 3446 COMEUR LU, Fax: (352) 4301-4129.

VALUE ANALYSIS IN PORTUGAL

Two conferences on **Value Analysis** were held, one in Lisbon and one in Oporto, at the initiative of the Laboratório Nacional de Engenharia e Tecnologia Industrial, with the financial support of the SPRINT programme.

The aim of these initiatives was to familiarise both public and private Portuguese entities in the innovation business with Value Analysis as an instrument for optimization of investment and resources.

Several European Associations for Value Analysis (from Germany, Italy, France and Belgium) and two Portuguese associations dealing with related matters collaborated in the initiative.

The **main recommendations** following these two days of debate were:

- to set up in Portugal a multi-annual programme (1988-1993) for such activities as annual training, consultancy, national and international working groups, study missions, carrying out the 1st National Congress before 1992 and the 5th European Congress in 1993, in Portugal, collaboration with schools, and publishing of a newsletter;
- to integrate Value Analysis into the various schemes aiming to promote innovation, increase quality and reduce costs;
- to create the conditions for the national dissemination of this new instrument (Value Analysis).

Further information can be obtained from Mr Siva Serra, LNET, Laboratório Nacional de Engenharia e Tecnologia Industrial, Grupo de Estudos Heurísticos de Maximização Tecnológica, Az. dos Lameiros à Estrada do Paco do Lumiar, P-1699 Lisboa Codex, Tel.: (351) 1 758.27.12 / 758.72.11, Tlx: 42486 LNETI P, Fax: (351) 1 758.09.01.

THE SPANISH INNOVATION AUTHORITY: THE CENTRE FOR INDUSTRIAL TECHNOLOGICAL DEVELOPMENT (CDTI)

Diskette with details of Spanish Technology Transfer institutions now available

The Centre for Industrial Technological Development (CDTI) was founded in 1978 by the Ministry of Industry and Energy to stimulate R&D and innovation. Today CDTI is entrusted with the implementation and development of Spanish industrial innovation policy. These tasks consist of:

- identification of priority fields in technology;
- promotion of industrial utilization of the technologies developed;
- financial assistance for pre-production manufacture and the marketing of new products and processes;
- the granting of loans on favourable terms for the financing of technological development projects;
- cooperation with the Interministerial Commission for Science and Technology in securing scientific, technological and industrial feedback from international programmes in which Spain is participating.

Another special division of the General-Directorate of Scientific and Technical Research is responsible for the coordination of a network of industrial liaison offices within universities and public research institutions which was set up during the last decade. CDTI has just produced a **diskette (MS-DOS-format)** with addresses, names and other interesting data from the Spanish innovation infrastructure.

Further information on CDTI and the diskette (free of charge) can be obtained from Mr Luis Crespo, Edificio Cuzco IV, P.^o de la Castellana, 141, 13^o, E-28046 Madrid, Tel.: (34) 1 581.55.00, Tlx: 23121 CDTI E, Fax: (34) 1 581.55.76/84.

The brochure 'The System of Science and Technology in Spain' can be obtained from Mr Antonio Cortés Arroyo, Comisión Interministerial de Ciencia y Tecnología, Rosario Pino, 14-16, E-28020 Madrid, Tel.: (34) 1 572.00.98 - ext. 266, Tlx: 49692 POLCI E, Fax: (34) 1 571.57.81.



The Spanish 'innovation team': Mr J. L. Barcena, Fiancial Director, Mr L. Crespo, Director for Technology Transfer, Mrs C. Canda, General Secretary, Mr A. Carvajal, Director-General

THE 2ND EUROPEAN TECHNOLOGY TRANSFER & INNOVATION OPPORTUNITIES EXHIBITION & CONFERENCES

22-24 May 1990 Scottish Exhibition & Conference Centre Glasgow UK

In March 1988 'Eurotech Scotland' arrived as a major event for companies, organisations and institutions active in research and development. In 1990, Eurotech will take place under the new banner of TRANSTECH EUROPE to cover the range of technology transfer frontiers. Main backing for the event will be from the Commission of the European Communities.

TRANSTECH EUROPE will be stressing five main areas:

- | | |
|---|------------------------------------|
| <i>European Technology</i> | <i>1992 and the Open Market</i> |
| <i>Industrial/Academic Collaboration</i> | <i>Finance and Venture Capital</i> |
| <i>Discovery & Creativity in Science and the Arts</i> | |

Organised by SITE in cooperation with the Commission of the European Communities, Scottish Industrial & Trade Exhibitions Ltd, 8a Charlotte Square, Edinburgh EH2 4DR, Tel: 031 225 5486, Telex: 72 8117 SELEH G, Fax: 031 226 3848



S & A IV
Kent at
Canterbury
25-27 September
1989

Programme and Registration Form

Sensors & their Applications IV

Organised by
The Institute of Physics

Co-sponsored by
Royal Society of Chemistry
The Institution of Electrical Engineers (Electronics Division)
The Institution of Measurement and Control (IMEKO)
The Institution of Mechanical Engineers

Supported by the COMMISSION OF EUROPEAN COMMUNITIES



The programme and further information can be obtained from Dr K.T.V. GRATTAN, The Institute of Physics, 47 Belgrave Squarer, London SW1X 8QX, Tel.: 01-235 6111, Telex 918453, Fax: 01-259 6002

A EUROPEAN CONFERENCE

THE COOPERATION PHENOMENON
- PROSPECTS FOR SMALL FIRMS AND THE SMALL ECONOMIES
6-7 NOVEMBER 1989, DUBLIN, IRELAND

This conference will examine critically the recent experience of small firms in networking and cooperation - particularly in the smaller economy context - and the regional, national, international and EC policies and programmes aimed at encouraging and enhancing that cooperation. The Conference is intended for international, national and regional decision makers, as well as advisers and researchers who are interested in maximising the benefits for SMEs of the cooperation phenomenon.

For further information please contact Ms Renee Browne, Head - Industrial Education Programme, EOLAS - The Irish Science and Technology Agency, Glasnevin, Dublin 9, Ireland, Tel.: (353) 1 37.01.01 ext. 2327, Fax: (353) 1 37.96.20.

Sponsored by the Commission of the European Communities under the guidance of the ECSC

Organised by
EOLAS
THE IRISH SCIENCE AND TECHNOLOGY AGENCY

SPRINT COOPERATION IN THE FOOD SECTOR

Under the SPRINT scheme for Industrial Research Associations the Instituto de Agroquímica y Tecnología de Alimentos (IATA), a Research Centre of the Consejo Superior de Investigaciones Científicas (CSIC) of the Ministry of Science and Education, and the Campden Food and Drink Association (D.F.D.R.A.) in the U.K., are cooperating in order to achieve the following:

- establishment of a system for the exchange of technologies and information on the preservation of food between centres and industries;
- evaluation of the state of the art and needs of SMEs in the field of thermal treatment of foods (HTST), with particular reference to thermoresistance problems and aseptic processes;
- dissemination of these new technologies between member firms in Spain and the U.K.

Further information can be obtained from Mr M. Rodrigo, IATA, Calle Jaime Roig 11, E-46010 Valencia, Tel.: (0034) 6 369.08.00, Fax: (0034) 6 393.00.01.

FIST ESPACE TECHNO PLUS SUCCESS

The partners of the SPRINT network between GW Saar, Sagazde Alava S.A., the Scottish Development Agency and Arist (Orleans) were represented with a common stand at the FIST ESPACE TECHNO PLUS in Orleans (23-25 May, 1989).

More than 100 people participated in the Technology Transfer Day on 25 May. Among these were other European innovation advisory bodies, e.g. NDC (Newcastle), the Industrial Liaison Office of the University of Utrecht and Innovare srl (Naples).

Further information can be obtained from Mr J. C. Jolivet, Chambre Régionale de Commerce et d'Industrie 'Centre', B.P. 109, Zone d'Activité d'Ingré, 6, rue Pierre-et-Marie-Curie, F-45142 Saint-Jean-de-la-Ruelle Cédex, Tel.: (33) 8 38.43.19.90, Tlx: 780274.



The common stand of the SPRINT partners at the FIST 89

NEW TECHMART Birmingham 10 - 12 then October 1989

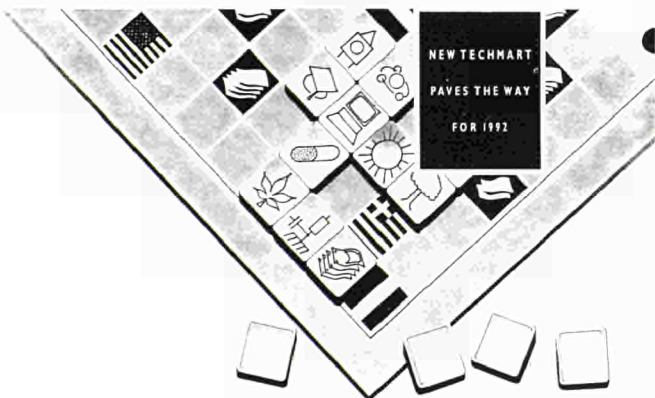

National Exhibition Centre, Birmingham, England, 10-12th October 1989



The brochure, 'New Techmart paves the way for 1992', gives full details about the exhibition and can be obtained from Mrs G. Jackson, Focus Events Limited, Greencoat House, Francis Street, SWIP IDG Tel: 01-834 1717, Fax: 01-828 0999, Telex: 941 9564

organised by



Softech'89

The technical and scientific software symposium
(exhibition and conferences)

Palais des Congrès

Liège, 28th / 29th november 89

Aims

The creation of a unique meeting-place for Belgian and foreign specialists
80 producers and specialists in technical and engineering software
60 conferences presenting this software

Who for ?

Engineers from all fields
Architects
Technical executives from research bureaux in companies and the civil service

Supported by the Eric Smeets Programme

Practical information

Place

Palais des Congrès, Liège

Dates

Tuesday, 28th November from 2 pm - 7 pm
Wednesday, 29th November from 9 am - 7 pm

Exhibition

Open from 2 pm - 7 pm, Tuesday, 28th November
9 am - 7 pm, Wednesday, 29th November
80 stands, each 9 m²

Conferences

From 3 pm - 5:30 pm, on Tuesday, 28th November
9:30 am - 12 noon and 3 pm - 5:30 pm
on Wednesday, 29th Nov
60 conferences covering subjects given
in four parallel sessions

Admission

Exhibition and conferences: 500 FB (inc. tax) per person, 2 days

Information

M^{lle} Corinne De Rycker
Socran Centre
Avenue Pré Aily, 4900 Angleur
tel. (041) 67 83 33

Edit resp Robert Fredencz av Pré Aily 4900 Angleur

ORDER FORM FOR "INNOVATION AND TECHNOLOGY TRANSFER" ('I & TT')

"Innovation and Technology Transfer" is published by DG XIII-C of the Commission of the European Communities and reports regularly on

- the Community's R&D policy under the RTD Framework Programme
- new research results originating from the CEC Joint Research Centre
- implementation of the SPRINT Programme and related matters.

Innovation and Technology Transfer (issues per year) can be obtained free of charge.

 Please send me on a regular basis 'Innovation and Technology Transfer'

Name: _____

Organisation: _____

Address: _____

Postal Code: _____ Town: _____

Date: _____ Signature: _____

Only forms filled in by typewriter or in block capitals can be accepted - Return to address below (please include address label or your business card)

ORDER FORM FOR CENTRES INTERESTED IN DISTRIBUTING 'I&TT'

Any organisation, such as Associations, Chambers of Handicrafts, Chambers of Commerce, Regional Development Agencies, etc., wishing to disseminate 'I&TT' to their members can receive more copies on request, up to a maximum of 100. If you wish to receive more than 100, please give your reasons.

 Please send me on a regular basis copies of 'Innovation and Technology Transfer'

Name: _____

Organisation: _____

Address: _____

Postal Code: _____ Town: _____

Date: _____ Signature: _____

Only forms filled in by typewriter or in block capitals can be accepted - Return to address below

 To be returned to Mr A. von Witzleben, Commission of the European Communities, DG XIII/C/1, B4/091, JMO, L-2920 Luxembourg

SFOR-COM 1989 - SUBCONTRACTING EXHIBITION AND CONFERENCES

Turin, June 7-11, 1989

The Association for Metallurgical and Mechanical Industries organised this **first international exhibition and series of conferences for subcontracting companies** to be held in Turin. Over 300 companies were represented at the exhibition and the conference series, which covered the issues of internationalisation and development of the subcontracting industry. Speakers included Mr Renato Ruggiero, Minister for Foreign Trade and Mr Norman Scott of the United Nations Economic Commission in Europe.

One session was devoted to support policies of the European Commission for technological integration of SMEs and included presentations on the SPRINT Programme by Mr Ian E. Traill, DG XIII/C/1, and on BC-Net by Professor Antonio Barbero of Turin Technical University and SOGES.

Further information can be obtained from Mr P. Burlando, SOGES SpA, Cso F. Turati 49, I-10128 Turin, Tel.: (39) 11 319.08.33, Fax: (39) 11 319.02.92.

Under the SPRINT Programme the Commission is promoting the Europeanisation of conferences on new technologies. Here is an overview of some of the forthcoming events:

Date	Title	Venue	Organizer	See page or contact
22-25.8.89	International Conference on Engineering Design	Harrogate (UK)	Institution of mechanical engineers, London (UK)	2
25-27.9.89	4th Conference on sensors and their applications	Canterbury (UK)	Dr. K.T.V. Grattan, Dept. of electrical, electronic and information engineering, City University, London (UK)	37
5-6.10.89	Venture capital and the Greek market: a start-up	Athens (GR)	Katsigiannis Associates, Athens (GR)	Mr Katsigiannis, Irakliou 5 GR-10673 Athens
11-14.10.89	European Footwear Technologies Days	Nantes (F)	Centre Technique Cuir, Chaussure, Maroquinerie, Lyon (F)	24
26-27.10.89	Enterprise, Innovation and 1992: Innovation support services in Europe	Nice (F)	TII, Luxembourg (L)	32
2-4.11.89	La gestion totale de la qualité, clé de la mutation que les PME européennes doivent réussir pour relever le défi de 1992	Lille (F)	Eurosoft-System SA, Bruxelles (B)	Mr C. Baldé s.a. Eurosoft-Systems, av. Louise 327 bte 18, B-1050 Brussels
6-7.11.89	The cooperation phenomenon in industry - Prospects for smaller economies	Dublin (IRL)	EOLAS, Dublin (IRL)	37

Further information on the SPRINT Europeanisation scheme of conferences can be obtained from: Mr. E. Pérez Carbonell, Commission of the European Communities, DG XIII/C/1, B4/092, Jean Monnet Building, L-2920 Luxembourg, Tel.: (352) 4301-4117, Tlx: 3423/3446 COMEUR LU, Fax: (352) 4301-4129.

JUST PUBLISHED

DIRECTORY OF CONTRACT RESEARCH ORGANIZATIONS IN THE EEC

Edited by R. Miège / I. Traill

This first major survey and Directory of over 150 European Contract Research Organisations (CROs) has been published by DG XIII as part of its innovation promotion activities under the SPRINT Programme.

The report analyses for the **first time the nature and structure of contract research** in each of the EEC Member States and points out the vital role of CROs in technology transfer.

It further recommends strengthening of cooperation between the CROs at the European level.

Following these recommendations, the European Association of Contract Research Organisations has been formed by the associations of CROs in France and Britain in conjunction with major CROs in Germany, the Netherlands and Italy (see page 29).

✂.....

Please send a copy of the publication 'Contract Research Organisations in the EEC', EUR 12112, ISBN EN-92-825-9766-0, FR-92-825-9767-9 (price 40 ECU) in English , French to:

Name: _____

 Address: _____

Please return to: Office for Official Publications, 2, rue de Mercier, L-2985 Luxembourg