

FINAL REPORT: PHASE THREE

MARCH 2001



*Center for Transportation
Research and Education*

IOWA STATE UNIVERSITY

The contents of this report reflect the views of the authors who are responsible for the facts and accuracy of the data presented herein. The contents do not necessarily reflect the views or policies of the Iowa Department of Transportation, the Michigan Department of Transportation, or the Minnesota Department of Transportation at the time of its publication. This report does not constitute a standard, specification, or regulation.

The authors and the sponsoring states do not endorse products or manufacturers. Trade or manufacturers' names appear herein solely because they are considered essential to the objectives of the report.

CTRE's mission is to develop and implement innovative methods, materials, and technologies for improving transportation efficiency, safety, and reliability, while improving the learning environment of students, faculty, and staff in transportation-related fields.

HIGHWAY MAINTENANCE CONCEPT VEHICLE FINAL REPORT: PHASE THREE

Principal Investigator

Bill M. McCall

Associate Director

Center for Transportation Research and Education, Iowa State University

Principal Contributor

Dennis Kroeger

Motor Carrier Specialist

Center for Transportation Research and Education, Iowa State University

Project Consortium



**Minnesota
Department of
Transportation**



U.S. Department of Transportation
Federal Highway Administration

Prepared by

**Center for Transportation Research and Education
Iowa State University**

ISU Research Park

2901 South Loop Drive, Suite 3100

Ames, Iowa 50010-8632

Telephone: 515-294-8103

Fax: 515-294-0467

<http://www.ctre.iastate.edu>

CTRE Management Project 99-42

March 2001

TABLE OF CONTENTS

EXECUTIVE SUMMARY	xi
1 INTRODUCTION	1
1.1 The Consortium.....	1
1.1.1 Minnesota Prototype Vehicle.....	2
1.1.2 Iowa Prototype Vehicle.....	3
1.1.3 Michigan Prototype Vehicle	4
1.2 Vendor Meeting.....	5
2 HIGHWAY MAINTENANCE CONCEPT VEHICLE EVALUATION FRAMEWORK	9
2.1 Why Evaluate the Highway Maintenance Concept Vehicle?.....	9
2.2 HMCV Evaluation Framework	10
2.2.1 Goals of HCMV Evaluation.....	10
2.2.2 HMCV Field Evaluation Methodology	11
2.3 Implementation of HMCV Technology	13
2.4 Interfacing with the National ITS Architecture.....	13
2.4.1 Description of National ITS Architecture.....	14
2.4.2 HMCV Applicability to National ITS Architecture.....	15
3 PHASE III WORK PLAN TASKS AND RESEARCH ACTIVITIES	17
3.1 Establishment of Individual State Oversight Committee (Task 1).....	17
3.2 Description of the Vehicle and Subsystems to Be Considered (Task 2).....	21
3.3 Development of Field Evaluation Plan (Task 3).....	21
3.3.1 Operations Assessment	22
3.3.2 Description of the SALTAR Friction Meter	22
3.3.3 Description of the Pavement and Air Temperature Sensors	23
3.3.4 Description of the Automatic Vehicle Location Subsystem.....	23
3.3.5 Description of the Materials Distribution Intelligence Subsystem	23
3.3.6 Description of Pavement Freezing Point Subsystem.....	24
3.3.7 Description of Fiber Optic Lights	24
3.3.8 Description of Power Boost.....	25
3.3.9 Description of Rear Obstacle Alarm.....	25
4 OPERATIONS ASSESSMENT OF SALTAR FRICTION METER (TASK 4)	27
4.1 Redesign of SALTAR Friction Meter	27
4.1.1 SALTAR Electronic Braking System.....	28
4.1.2 Pneumatic System.....	28
4.1.3 SALTAR Computer	28
4.1.4 SALTAR Data Link Options	30
4.1.5 Measurement Procedure and Software	30
4.1.6 Calibration and Level Modifications	32
4.2 Field Testing of SALTAR at NASA Wallops Flight Facility	32

4.2.1	Winter Runway Friction Testing Background.....	32
4.2.2	Winter Runway Friction Testing Objectives	33
4.2.3	Winter Runway Friction Testing Goals	33
4.3	Field Testing of SALTAR at North Bay, Ontario	35
4.3.1	Joint Winter Runway Friction Measurement Program Background.....	36
4.3.2	Friction Tests with SALTAR.....	38
4.3.3	North Bay Test Results	39
4.4	SALTAR Data from Norway	42
4.5	Minnesota Experience with SALTAR Friction Meter	45
4.6	Iowa Experience with SALTAR	46
4.7	Failure Analysis of SALTAR Friction Measuring Device.....	46
4.7.1	Steps of Analysis.....	47
4.8	Recommendations	50
4.9	Conclusions	51
5	PROOF OF CONCEPT FOR ADDITIONAL TECHNOLOGIES AND APPLICATIONS INTELLIGENCE (TASK 5).....	53
5.1	Introduction	53
5.2	Goals.....	53
5.3	Design Description	53
5.4	Status	54
5.5	Partner Issues (Task 6, Task 7)	54
6	BENEFIT-COST ANALYSIS (TASK 8).....	57
6.1	Infrared Air/Pavement Thermometer Comparison.....	62
6.1.1	Test Procedure	62
6.1.2	Results.....	63
6.1.3	Conclusions of Air/Pavement Thermometer Comparison Study.....	63
7	TIME TO IMPLEMENTATION AND DATA FLOW.....	69
7.1	Time to Implementation (Task 9).....	69
7.2	Data Flow Maps Suggesting Methods to Integrate Data with Existing and Planned State Systems (Task 10).....	78
7.3	Information Flow Process Maps and Suggested Methods to Integrate the Information with Existing and Planned Management Decisions Systems (Task 11)	78
7.4	The Final HMCV Specification (Task 12, Task 13)	79
8	CONCLUSIONS AND RECOMMENDATIONS	81
8.1	Phase III Conclusion	81
8.2	Recommendations for Future Research	82
	ACKNOWLEDGMENTS	85

APPENDIX A: SPECIFICATIONS

- A.1 Mn/DOT Concept Vehicle Hydraulic Specifications
- A.2 SALTAR Functional Specification
- A.3 Iowa DOT Concept Vehicle Spreader Control Specifications
- A.4 SALTAR Product Specification

APPENDIX B: CDRM, INC., TEST AND EVALUATION

- B.1 Proposed Test Plan for Phase III of Project: Test and Evaluation of Friction Measuring Devices for Winter Maintenance Applications
- B.2 Friction Measurement Techniques for Snow and Ice Road Operations

APPENDIX C: NORWEGIAN ROAD ADMINISTRATION TEST AND REPORT

- C.1 Test Plan for SALTAR in Sør-Trøndelag
- C.2 SALTAR Friction Unit for Winter Maintenance

APPENDIX D: NORSEMETER TEST COMPARISON AND REPORT

- D.1 Comparison of Test Plans in USA and Norway
- D.2 Norsemeter SALTAR Report

APPENDIX E: HIGHWAY MAINTENANCE CONCEPT VEHICLE—TECHNOLOGY QUESTIONNAIRE

TABLE OF FIGURES

Figure 1.1	Minnesota prototype vehicle Phase III	2
Figure 1.2	Tyler V-blend, dual-chamber V-box spreader used on Minnesota vehicle	3
Figure 1.3	Iowa prototype vehicle Phase III	4
Figure 1.4	Meeting participants at Monroe, Wisconsin	5
Figure 1.5	Wrap-up session following vendor meeting	7
Figure 2.1	Evaluation path	10
Figure 2.2	HMCV goals-based evaluation plan	11
Figure 2.3	National ITS Architecture and HMCV vision	14
Figure 3.1	Iowa network diagram	18
Figure 3.2	Minnesota network diagram	19
Figure 3.3	Michigan network diagram	20
Figure 4.1	Redesigned SALTAR friction meter	27
Figure 4.2	SALTAR computer system	29
Figure 4.3	Operator panel and user interface host vehicle	30
Figure 4.4	SALTAR versus ASTM E-274 friction measurements	36
Figure 4.5	SALTAR compared to other friction measuring devices at Wallops Island	37
Figure 4.6	Iowa DOT vehicle at North Bay, Ontario	38
Figure 4.7	NASA instrumented tire-test vehicle	39
Figure 4.8	RUNAR friction trailer	39
Figure 4.9	Speed effect at low-friction values for SALTAR	40
Figure 4.10	Calculated friction coefficient at low speed in winter conditions	41
Figure 4.11	Coefficient of friction at three different speeds	42
Figure 4.12	Friction by SALTAR and ROAR on a section of road covered with ice	42
Figure 4.13	Ice-covered road with hot and cold sand applied to the midsection	43
Figure 4.14	Correlation of SALTAR and ROAR	43
Figure 4.15	Data from Figure 4.11 with correlations applied	44
Figure 4.16	Data from Figure 4.12 with correlations applied	44
Figure 4.17	Friction measurement at different speeds	45
Figure 4.18	SALTAR friction-measuring device	46
Figure 4.19	SALTAR unit used in Minnesota	47
Figure 4.20	Removing the flange and box assembly cover	48
Figure 4.21	Using a puller to remove flange	48
Figure 4.22	SALTAR with flange and cover removed	49
Figure 4.23	Shaft with some corrosion	49
Figure 4.24	SALTAR with gear removed	50
Figure 5.1	Decision matrix block diagram	54
Figure 5.2	Area of separation on driver's side of V-box spreader	55
Figure 5.3	Area of separation on passenger side of V-box spreader	55
Figure 5.4	Area of separation near the conveyor belt	56
Figure 6.1	Typical sensor mounting	61
Figure 6.2	Typical temperature sensor system diagram	61
Figure 6.3	Surface Systems, Inc., SCAN CAST page	64
Figure 6.4	Supplements to supervisor's daily log	65
Figure 6.5	SCAN CAST pavement forecast page	67

Figure 7.1 Data flow for HMCV Phase III	78
Figure 7.2 Storm management information flow.....	79

LIST OF TABLES

Table 6.1 Forecast Tools for Iowa DOT	60
Table 6.2 Results of the Two-Year Comparison Test.....	62
Table 6.3 Roadway Weather Information System Data	67
Table 6.4 Mobile Data from Onboard Sensor.....	68
Table 7.1 Iowa Concept Vehicle Management Subsystems.....	70
Table 7.2 Iowa Concept Vehicle Communications System.....	71
Table 7.3 Iowa Concept Vehicle Fleet and Information Management Agency Systems	72
Table 7.4 Minnesota Concept Vehicle Management Subsystems.....	74
Table 7.5 Minnesota Concept Vehicle Communications System.....	75
Table 7.6 Minnesota Concept Vehicle Fleet and Information Management Agency Systems	76

EXECUTIVE SUMMARY

Project Background

This report documents Phase III of a four-phase project. The goals of the project are to study the feasibility of using advanced technologies from other industries to improve the efficiency and safety of winter highway maintenance vehicle operations, and to provide travelers with the level of service defined by policy during the winter season at the least cost to the taxpayers. The evaluation of highway maintenance concept vehicle (HMCV) applications and the resulting documentation of its benefits and impacts are priority areas for the pooled fund study sponsored by Iowa Department of Transportation, the Minnesota Department of Transportation, the Michigan Department of Transportation, and the Federal Highway Administration. The evaluation and resulting information will help the partners to better understand the impacts of technology on the transportation system and users of the transportation system, which can help departments of transportation make more informed decisions about deploying, designing, and operating maintenance applications.

Providing the accepted level of service was to be accomplished by using advanced technology to identify actual road conditions, communicate those road conditions to the maintenance garages, who would then plan and execute appropriate snow and ice control activities. In Phase III of the HMCV Study, we planned to evaluate the various technologies, develop benefit-cost analyses, develop user acceptance, and develop “real-time” data for storm management decision-making. Another consequential goal of the study is to lay a foundation for future data and systems integration within the state agency’s communication networks that will provide the basis for Phase III of the study.

The project began in 1995, when the consortium initiated a proposed four-phase research effort, with the assistance of the Center for Transportation Research and Education (CTRE) at Iowa State University that focused on evaluating and documenting the benefits and impacts of the concept maintenance vehicle. More specifically, the research team proposed to accomplish the following:

- document the state-of-the-practice winter maintenance applications and reported benefits;
- develop a highway maintenance concept vehicle evaluation framework for the consortium; and
- work with the consortium in applying and refining the concept vehicle evaluation framework.

The results of the first phase of the research were documented in the *Concept Highway Maintenance Vehicle Final Report: Phase One* dated April 1997, which describes the desirable functions of a concept maintenance vehicle and evaluating its feasibility. Phase I began with a literature review of materials related to winter highway maintenance activities. It then continued with an examination of the ideal capabilities of a winter maintenance vehicle as identified through a series of focus groups. Private sector partners were introduced to the project and asked to join the research effort. The private sector partners committed to providing equipment and expertise for Phase II of the project. Phase I concluded by establishing the technologies that would be assembled and tested on the prototype vehicles in Phase II.

The results of the second phase of the research were documented in the *Concept Highway Maintenance Vehicle Final Report: Phase Two* dated December 1998, which describes the feasibility of using advanced technologies to improve the efficiency and safety of winter highway maintenance vehicle operations. The primary goals of Phase II were to install the selected technologies on the prototype winter maintenance vehicles and to conduct proof of concept in advance of field evaluations planned for Phase III. Phase II reported that the proof of concept was successful for that stage of the project. Each state department of transportation in the consortium provided one snowplow truck equipped with plows, winter chemical and abrasive spreader systems, and in-cab displays and operator controls. Fabrication and installation activities during Phase II proved the feasibility of making a significant amount of technology and information available to the operator in the cab. Each vehicle is unique, but each vehicle provided similar plowing and spreading capabilities. Generally, installation of the PlowMaster display, operator controls, and gauges in the cabs made cab conditions quite crowded, but each state modified the in-cab installations to provide a safe and efficient operating environment for drivers.

This Phase III final report documents the work completed since the end of Phase II. During this time period, the Phase III work plan was completed; the redesigned friction meter was field tested at the National Aeronautics and Space Administration facilities at Wallops Island, Virginia, and North Bay, Ontario. Also, the consortium held a vendor meeting in Monroe, Wisconsin, to discuss future private sector participation and the new design for the Iowa vehicle. In addition, weather and roadway condition data were collected from the roadway weather information systems at selected sites in Iowa and Minnesota, for comparison to the vehicles' onboard temperature sensors. Furthermore, the team received new technology, such as the mobile Frensor unit, for bench testing and later installation.

Phase III Objectives

A study team consisting of representatives from the consortium states, private-sector partners, and CTRE directs the study activities. The study team decided upon these research objectives for Phase III of the project:

1. evaluate technology
2. assess cost implications of technology applications
3. develop benefit-cost analyses
4. improve roadway safety for the driving public
5. develop operator input and acceptance
6. investigate integration of data with department of transportation management systems
7. develop "real-time" data for storm management decisions

The study team approved a detailed Phase III work plan to guide CTRE's accomplishment of these objectives. This report describes progress on and accomplishments of the tasks.

Objective 1: Evaluate Technology

The first objective of Phase III was to examine and assess the technology that was installed on the prototype maintenance vehicles. Many of the technologies used on the Highway

Maintenance Concept Vehicles were developed for applications in other industries. These technologies were then adapted to be used on the HMCVs in harsh winter conditions.

For Phase III, the friction meter was redesigned and installed on the HMCVs in Iowa and Minnesota (the Michigan Department of Transportation chose not to install a new friction meter on its vehicle in Phase III). The new friction meter, given the name SALTAR by Norsemeter, was designed to be smaller, lighter, and more durable than the ROAR unit used in Phase II.

Objective 2: Assess Cost Implications of Technology Applications

CTRE investigated the initial cost implications of the technologies installed on the prototype vehicles. As with most new technological devices, the initial costs are high for implementation. Phase III testing and evaluation of the devices have moved some vendors to redesign their products (e.g., friction meter). What effect the redesign will have on the products' costs remains to be seen.

Objective 3: Develop Benefit-Cost Analyses

In summary, the analysis attempted to determine whether the investment in the technologies listed would reduce the recurring costs of winter road maintenance operations and system maintenance. The analysis examined, what effect, if any, the technologies would have on staff levels, and the effectiveness of the staff.

Objective 4: Improve Roadway Safety for the Driving Public

The information technologies on the prototype vehicles and global positioning systems (GPS) collect information about the environment, air and pavement temperature data, friction data, and freezing-point data, and it was important for CTRE to collect these data and compare them to roadway safety information.

The information technologies that were used in Phases II and III were found to provide data that were reasonably accurate. Friction readings that were collected on the roadway and the data that were collected at tests in Wallops Island, Virginia, and North Bay, Ontario, were found to be reasonable. Unfortunately, not enough data were collected under winter roadway conditions to make statistically significant determinations of improvements in roadway safety.

Objective 5: Develop Operator Input and Acceptance

During Phase III, operators were asked their opinions of the technologies added to the vehicles. For the most part, the operators were satisfied with the vehicles' operations. Some regional differences occurred, however, with their acceptance of the technologies. For example, vehicle operators in Minnesota did not accept the friction meter as a practical device. They do, however, view the high-intensity lights as an important safety feature for vehicle conspicuity during snowplow operations. Operators in Iowa on the other hand, have a more favorable view of the friction meter.

Objective 6: Investigate Integration of Data with Department of Transportation Management Systems

CTRE was asked to predict the time it will take to implement selected technologies. Time to implementation includes installing the production version of the technology on the vehicle, activating the data communication system, and integrating the data collected by the technology on the vehicle with the necessary agency data and information systems. Technologies that were

tested, such as the friction meter, are not ready for widespread implementation by maintenance fleets. Other technologies, such as GPS, are readily available for installation. There are packages available to integrate the data retrieved into department of transportation management systems. The systems are still being developed at the time of the writing of this report.

Objective 7: Develop “Real-Time” Data for Storm Management Decisions

CTRE worked with pooled fund study states to develop data flow based on each state’s current and planned systems and estimate the cost of integrating the data collected by the concept vehicle into current and planned data processing systems. The data flow describes the path data take from the point of collection on the vehicle through the data communications system and agency data process systems. The data flow includes information describing existing interfaces with agency data processing systems as well as new interfaces. The information is designed to assist vehicle operators and managers in making operational decisions.

Phase III Conclusions and Recommendations

Phase III of the research study has been partially successful. The technologies such as the pavement temperature sensors, lights, and rear-obstacle alarms have proven reliability to this point. Regarding the other subsystems, such as the onboard system interface and surface pavement freezing point, the consortium has not had a chance to fully develop to this date. The surface pavement freezing point system, which was delivered in the spring of 2000, is scheduled for bench testing at Iowa State University as soon as the software is delivered.

The SALTAR friction meter shows promise. The field tests that were performed at Wallops Island, Virginia, and North Bay, Ontario, demonstrated that the principle of continuously measuring friction and transferring those data to the vehicle management system is sound. The smaller design of the unit is also highly desirable. The friction meter, however, does have problems that need to be addressed. One friction meter that was installed on the concept vehicle did not perform up to expectations. The installation proved to be challenging and once it was installed, the unit never provided us with repeatable data, partly due to the mild winter that we experienced. This particular friction meter also developed mechanical problems that we could not repair before the winter season ended.

A baseline has been established for the benefit-cost analysis. The benefit-cost analysis is based on comparing the resources necessary to achieve the target road surface condition in a given maintenance area. Once the concept vehicles are fully equipped, the onboard vehicle systems will include pavement temperature, automatic vehicle location, and automated materials distribution subsystems. These subsystems will be taken into account in the benefit-cost analysis.

The HMCV system will then be used as the benchmark for developing operational savings. The following relationship is used to estimate the impact technology may have on operational costs (operational and maintenance cost savings):

$$\text{OMS} = (\text{materials application based on point RWIS road surface temperature} - \text{materials application based on road surface temperature from the mobile temperature sensor}) \times \text{EIA/hr} \times \text{the time taken to reach target condition.}$$

The following recommendations are based on the results of the tasks completed for this Phase III report.

- The use of friction data from the HMCV should be examined and their impact on maintenance practices will be investigated more closely.
- The SALTAR friction meter should include an operations and maintenance manual to assist in installation and troubleshooting.
- The results of the bench testing of the pavement surface freezing point systems will be analyzed, documented, and reported.
- Now that the baseline has been established for the benefit-cost analysis; the model will be put into place for the upcoming season to determine the benefit-cost ratios. Once the concept vehicles are fully equipped, the onboard vehicle systems will include pavement temperature, automatic vehicle location, and automated materials distribution subsystems. These subsystems will be taken into account in the benefit-cost analysis.

The data that are developed from the technologies applied to the highway maintenance concept vehicles will continue to be evaluated in Phase IV. In addition, there will be an evaluation of the feasibility and cost effectiveness to carry the research project into a broader application, a fleet evaluation in each of the consortium states.

Report Organization

This report is organized into the following major chapters:

1. Introduction. This chapter provides an overview of the research effort and organization.
2. Highway Maintenance Concept Vehicle Evaluation Framework. This chapter summarizes the components of the evaluation framework and presents the HMCV evaluation framework for the consortium.
3. Highway Maintenance Concept Vehicle Phase III Research Activities. This chapter reviews the consortium's Phase III research study activities to date.
4. Operations Assessment of SALTAR Friction Meter. This chapter summarizes the testing and evaluation of the redesigned friction meter. Norsemeter, the manufacturer of the friction-measuring device, offered a redesigned model of the ROAR unit that was used in Phase II called SALTAR. Although, the ROAR device passed the proof of concept in Phase II, the process clearly showed that the ROAR device was not designed for application in the harsh snow and ice removal environment. The redesigned SALTAR unit is smaller, more robust, and employs a simplified electronic system that was tested in Phase III.
5. Conducting Proof of Concept for Additional Technologies and Applications Intelligence. This chapter provides the proof of concept for the additional technologies installed on the HMCV in Phase III.

6. **Benefit-Cost Analysis.** This chapter summarizes the benefit-cost analysis by the consortium to address the issues of using technology by maintenance garages during winter driving conditions and winter maintenance costs. The value of establishing and maintaining uniform surface conditions according to agency policy has not been quantified. The impact technology may have on cost can be estimated.
7. **Time to Implementation and Data Flow.** This chapter shows the time to implementation of many of the technologies that are available on the HMCV. Many of the technologies on the concept vehicles are presently available for a variety of applications. Their uses on the HMCV, however, have been adapted for highway maintenance practices. One of the guiding principles of the HMCV project was to use available technology, in order to keep costs down and get the prototype vehicle into the field as quickly as possible. Data flow maps are also presented.
8. **Conclusions and Recommendations.** This chapter provides conclusions derived from the research activities and provides recommendations for implementing the research resulting from the project and developing future project-specific HMCV-related strategies.

The appendices provide additional information on product specifications and testing that was conducted.

1 INTRODUCTION

The goal of the Highway Maintenance Concept Vehicle (HMCV) pooled-fund study is to provide travelers with the level of service defined by policy during the winter season at the least cost to the taxpayers

1.1 The Consortium

The consortium comprises the departments of transportation (DOTs) of Iowa, Minnesota, and Michigan. Leland D. Smithson, deputy director of the Maintenance Division of the Iowa Department of Transportation, is the study's chairperson. The primary members of the research consortium are

- Iowa Department of Transportation (Iowa DOT)
- Minnesota Department of Transportation (Mn/DOT)
- Michigan Department of Transportation (MDOT)
- Center for Transportation Research and Education (CTRE), Iowa State University

Furthermore, in Phase III, private sector members provide equipment and technical expertise. They are

- Monroe Truck Equipment
- Raven Industries
- Thom-Tech Design Company
- Norsemeter Company
- Enator AS
- Boyer Ford
- Bristol Company
- Federal Signal Corporation
- Force America
- Global Sensor Systems
- Innovative Warning Systems
- O'Halloran International
- Sprague Controls Company
- Tyler Industries, Division of Case

Previously, in Phase II of the study, Rockwell International served as a systems integrator and provided onboard computer technology that tied all the vehicle subsystems together. However, just prior to the beginning of Phase III, representatives from Rockwell informed the consortium that Rockwell could no longer support the project. In a business decision, Rockwell planned on selling the transit portion of its business, in order to concentrate on its core communications businesses. Thus, Rockwell's decision left the consortium without the onboard the global positioning system support and other communications systems onboard the vehicles.

The team spent several months locating a firm to fill the void left by Rockwell. Eventually, Mn/DOT chose Thom-Tech Design, and Iowa DOT agreed to terms with Monroe Truck

Equipment and Raven Industries. These firms will provide the equipment and support needed to successfully complete Phase III of the project.

As in Phase II, each state provided a snowplow truck and plows on which add-on technologies were installed. Different private sector partners provided the material applicators for each of the three prototype vehicles, which were configured to meet the needs of each state. Because of the differences in trucks, the in-cab displays were also configured differently in each state's vehicle. Each prototype maintenance vehicle is therefore unique. Specific details are discussed in the following sections describing each state's vehicle.

1.1.1 Minnesota Prototype Vehicle

The base vehicle used by Mn/DOT is a 1996 Ford L9000 supplied by Boyer Ford, located in Minneapolis, Minnesota. Tyler Ice, a division of Tyler Industries, Incorporated, located in Benson, Minnesota, functioned as the fabricator for, and provided initial installation of, the prototype truck's technological components.

The materials spreader on this vehicle is a slip-in Tyler V-blend; dual-chamber V-box is located inside the dump body. It is a divided spreader box, allowing operators to distribute a ratio of two granular materials. In addition, the vehicle has a 900-gallon liquid tank. The anti-icing, deicing, and prewetting functions are controlled in the cab using a Tyler Industries quantum controller and a Tyler Industries LDS-1000 anti-ice system. These systems enable the equipment operator to specify and maintain predetermined material application rates. In addition, the quantum controller uses a speed sensor to automatically maintain uniform material flow relative to the vehicle speed and gear selection. A manual "blast" mode can be selected to allow the equipment operator to override the material application rate for a short time. As in Iowa and Michigan, the operators appreciated the convenience of the semi-automated spreader system.



FIGURE 1.1 Minnesota prototype vehicle Phase III.



FIGURE 1.2 Tyler V-blend, dual-chamber V-box spreader on Minnesota vehicle.

1.1.2 Iowa Prototype Vehicle

The base vehicle that Iowa DOT used in Phase III was a 1996 International Navistar 4900, model number NAV 4900 supplied by O'Halloran International, Incorporated, of Altoona, Iowa. Monroe Truck Equipment (Monroe), located in Monroe, Wisconsin, was the fabricator and installed the snowplows and the chemical and abrasive spreaders. Monroe also installed and conducted initial testing of Iowa's prototype vehicle's technological components.

The plows and spreaders used in Phase III were the same as those used in Phase II of the project. The front plow is an MTE MV-96-84-50-304-SS model. The wing plow is a heavy-duty benching wing with 11-foot moldboard and a benching height of 60 inches. The model number is MTE HDBW-11. The eight-foot moldboard underbody plow's (scraper) model number is MTE TS961B.

The materials spreader is a slip-in; single skid-mounted, 900-gallon liquid tank and 5.2 cubic yard Monroe Brute MSV heavy-duty V-box spreader are located inside the Iowa prototype vehicle's dump box. The anti-icing and prewetting systems are controlled by the vehicle operator in the cab by a SYN/CON controller provided by Bristol Company. A Spreadrite controller provided by Component Technology dispenses granular materials. Bristol Company, located in Broomfield, Colorado, supplied the SYN/CON onboard controller system in the cab for deicing and prewetting system control. This controller can store up to eight settings for liquid and granular material, each with six subsettings for prewetting material applications. These settings and subsettings allow for custom chemical and abrasive material applications that respond to level-of-service requirements and storm conditions. Component Technology, located in Des Moines, Iowa, supplied the Spreadrite GL-400 modular spreader control system, which automatically adjusts material application rates to compensate for changing travel speeds. After a material application rate has been selected, the GL-400 uses a vehicle speed sensor to automatically adjust the feeder drive and maintain a uniform spread rate. The GL-400 also has a

manual mode option, which allows the equipment operator to manually control the material application rate, and a manual “blast” mode that overrides the selected material application rate for short time periods.

A change that was made on the Iowa and Minnesota prototype vehicles was the installation of the SALTAR friction meter. The display for the SALTAR device was different in Phase III. To make the displays easily seen by the drivers mechanics mounted them in another location to the front and right of the driver, on the dash. In Phase II, the friction meter measurements were incorporated into the PlowMaster displays. In Phase III the SALTAR measurements were displayed on a separate unit that was mounted next to the PlowMaster console.

The mechanics also encountered challenges installing the friction meter computer. This computer was first located upright behind the passenger seat, which provided minimal legroom for the passenger. To overcome this, DOT mechanics removed the passenger seat’s suspension base, built a custom-made cabinet/box suspension combination, and placed it underneath the passenger seat. The cabinet has a “drawer” for easy access to the computer unit.



FIGURE 1.3 Iowa prototype vehicle Phase III.

1.1.3 Michigan Prototype Vehicle

The base truck used by Michigan DOT was a 1996 International Navistar 2574, model number NAV 2574, supplied by Navistar International Corporation, located in Fort Wayne, Indiana. Monroe functioned as the fabricator and provided initial installation of the prototype truck’s technological components.

The plows used on the Michigan prototype vehicle were the same as in Phase II. Monroe supplied all three plows for Michigan’s prototype vehicle. The front plow is an MTE DSM-120-86-48/304-MICH model. The wing plow is a model MTE RMJW-10. The underbody plow’s (scraper) model number is MTE 050-9012-0000-MICH.

As in Phase II, Michigan’s vehicle has a 6.5 cubic yard Monroe DuzMor chassis-mounted, self-unloading V-box with a spinner spreader and permanent 900-gallon liquid tank mounted in front of the V-box. The anti-icing and prewetting systems use a Raven de-ice system controller in the cab. Raven Industries, Incorporated, located in Sioux Falls, South Dakota, supplied a DCS 700 de-ice system controller for the anti-icing and prewetting system. The DCS 700 consists of a

computer-based control console, a speed sensor, two control valves, flow meter, granular rate sensor, and cable controls. The console mounts directly in the cab of the vehicle for operator use. The speed sensor is mounted on the vehicle. The motorized control valves, flow meter, and granular rate sensor are mounted to the vehicle framework. The equipment operator sets the target application rate for each product, and the DCS 700 uses the speed sensor to automatically maintain uniform material flow relative to vehicle speed and gear selection. A manual “blast” mode can be selected to allow the equipment operator to override the material application rate for short periods of time. The DCS 700 also monitors distance and speed, and totals all materials spread, to help analyze material output amounts and rates.

For Phase III, MDOT did not install a new SALTAR friction-measuring device. MDOT chose to concentrate its efforts on testing and evaluating the other technologies in this project.

1.2 Vendor Meeting

In August 1999, as a type of “kick-off” meeting to Phase III of the project, the highway maintenance concept vehicle consortium and invited guests met at the company headquarters of Monroe Truck Equipment in Monroe, Wisconsin, to discuss the progress made on the concept maintenance vehicle project. Almost all of the vendors and equipment suppliers from that participated in Phase II were present.



FIGURE 1.4 Meeting participants at Monroe, Wisconsin.

Briefly, the meeting reiterated that Phase II showed that there was “proof of concept” for the technologies on the concept maintenance vehicle. That is, the consortium demonstrated that the deployment of a technologically advanced winter maintenance vehicle is possible, and even feasible. Phase III of the project, therefore, was to demonstrate that the technology is cost-effective and that proper data management can smoothly incorporate the information gathered by the technologies with existing winter maintenance management systems. Specifically, the consortium was to determine what to do with this information once it is obtained.

Other areas of discussion at the meeting included conducting a benefit-cost analysis of the additional technologies on the concept maintenance vehicle. The consortium decided to calculate the benefit-cost ratio as cost-per-lane-mile as determined by Federal Highway Administration (FHWA) statistics.

Along with conducting a benefit-cost analysis, there are redesigned technologies on the concept maintenance vehicle. The friction-measuring device has been redesigned for Phase III. The SALTAR replaces the ROAR friction-measuring device in Phase III. The SALTAR is smaller, more robust, and should prove to be more pertinent to highway maintenance applications.

Other new technologies being assessed in Phase III are the pavement surface freezing point and material distribution intelligence. These technologies were installed on each of the concept vehicles and are subject to proof of concept and benefit-cost analyses.

Each of the partner states was given the opportunity to discuss its activities in the project. Leland D. Smithson of the Iowa Department of Transportation presented a progress report for Iowa's vehicle. Larry White of the Michigan Department of Transportation presented for Michigan, and John Scharffbillig of Minnesota Department of Transportation made a presentation on behalf of Minnesota. The consortium continues to develop new methods for collecting and analyzing data to provide real-time information to support improved highway maintenance activity.

The consortium also discussed the new and redesigned technologies for Phase III. Again, the technologies being evaluated are a pavement surface freezing point system, a materials distribution intelligence system, and an operations, material, and asset management system.

Regarding the pavement surface freezing point system that is used to develop chemical traces to support chemical mixture distribution decisions, the study team was charged with developing a performance specification and benefit-cost ratio for the system.

The materials distribution intelligence system was to use pavement surface temperature, chemical trace, and friction data, along with other weather forecasting data, to develop algorithms to support materials distribution decisions. Again, the consortium was to develop a performance specification and benefit-cost ratio for this system.

The operations, material, and asset management systems was to be designed to assist managers to improve winter maintenance operations by tying all these on-board systems together with the desk-side information systems to enhance winter maintenance operations. The study team was assigned to investigate potential software applications that can be applied to real-time material management, forecasting information, vehicle route optimization, and material inventory.

A wrap-up session followed in which the consortium took questions from the meeting's participants to tie up any loose ends. Following this wrap-up session, the meeting adjourned with the group concluding that through the use of advanced technologies, vital information such as winter roadway conditions, friction values, pavement temperatures, and surface conditions can be documented. These data, along with others, can be used to improve winter maintenance operations and provide the traveling public with credible information to make informed trip decisions.



FIGURE 1.5 Wrap-up session following vendor meeting.

2 HIGHWAY MAINTENANCE CONCEPT VEHICLE EVALUATION FRAMEWORK

2.1 Why Evaluate the Highway Maintenance Concept Vehicle?

Before significant detail is provided on specific evaluation methods, it is necessary to review why we evaluate HMCV. The reasons for evaluating technology provide a context for developing a technical evaluation framework and corresponding measures.

This evaluation is being performed to

- Understand the impacts. The project is being evaluated to better understand the action-effect relationship between the adapted technology on the concept vehicle and the associated improvement in travel conditions. The effect on the HMCV and operators, as well as its social, economic, and environmental impacts, creates a comprehensive evaluation package. A better understanding of the impacts of the HMCV also can help in the following tasks.
- Quantify the benefits. Budgetary concerns encourage federal, state, and local governments to measure their performance and quantify the benefits of public/private sector investments. The focus of this research project is not only to quantify the benefits that may be derived from deploying the HMCV, but to provide policy makers and the traveling public with reliable information regarding the road and weather conditions in order to make better informed decisions.
- Help make future investment decisions. This evaluation is designed to optimize public sector investments by providing information about the ideal conditions for implementation and likely range of impacts, which can be used to make future investment or deployment decisions.
- Optimize existing system operation or design. The information resulting from this evaluation can help to identify areas of improvement for existing winter maintenance operations or systems, enabling operators or designers to better manage, correct, improve, or “fine-tune” system operation or design.

Figure 2.1 shows the hypothesized path of the highway maintenance concept vehicle evaluation. To date, most of the evaluation has focused primarily on quantifying the impacts of technology on winter maintenance operations. A focus on the monetary benefits of the HMCV (i.e., benefit-cost analysis) is necessary to demonstrate that the technologies and applications are mature and ready to be deployed.

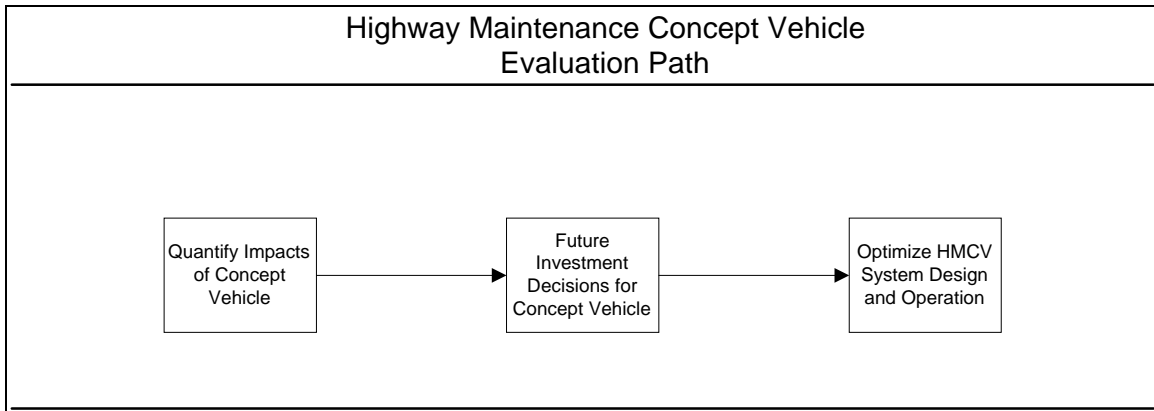

FIGURE 2.1 Evaluation path.

2.2 HMCV Evaluation Framework

A goals-based transportation evaluation framework is illustrated in Figure 2.2. This common method of evaluating complex transportation systems consists of measuring the progress or contribution toward stated transportation goals and objectives. The progress or contribution toward stated goals is quantified by selecting evaluation measures that directly relate to the goals and objectives.

This part of the report focuses on the evaluation framework, which consists of the following:

- Stating the goals and objectives of HMCV. A brief explanation of the evaluation goals and objectives is provided.
- Stating the Evaluation Measures. A brief explanation of the evaluation measures used to gauge progress toward the HMCV goals and objectives is provided.

Figure 2.2 represents the project specific evaluation plan as developed by the HMCV research team. The evaluation plan indicates the goals, objectives, measures, and data collection items used in this evaluation.

2.2.1 Goals of HCMV Evaluation

Based upon the previous phases of the research and the developments in Phase III, the following top-level evaluation goals have been established:

1. evaluate technology
2. assess cost implications of technology applications
3. develop benefit-cost analyses
4. improve roadway safety for the driving public
5. determine operator input and acceptance
6. investigate integration of data with DOT management systems
7. integrate “real-time” data for storm management decisions

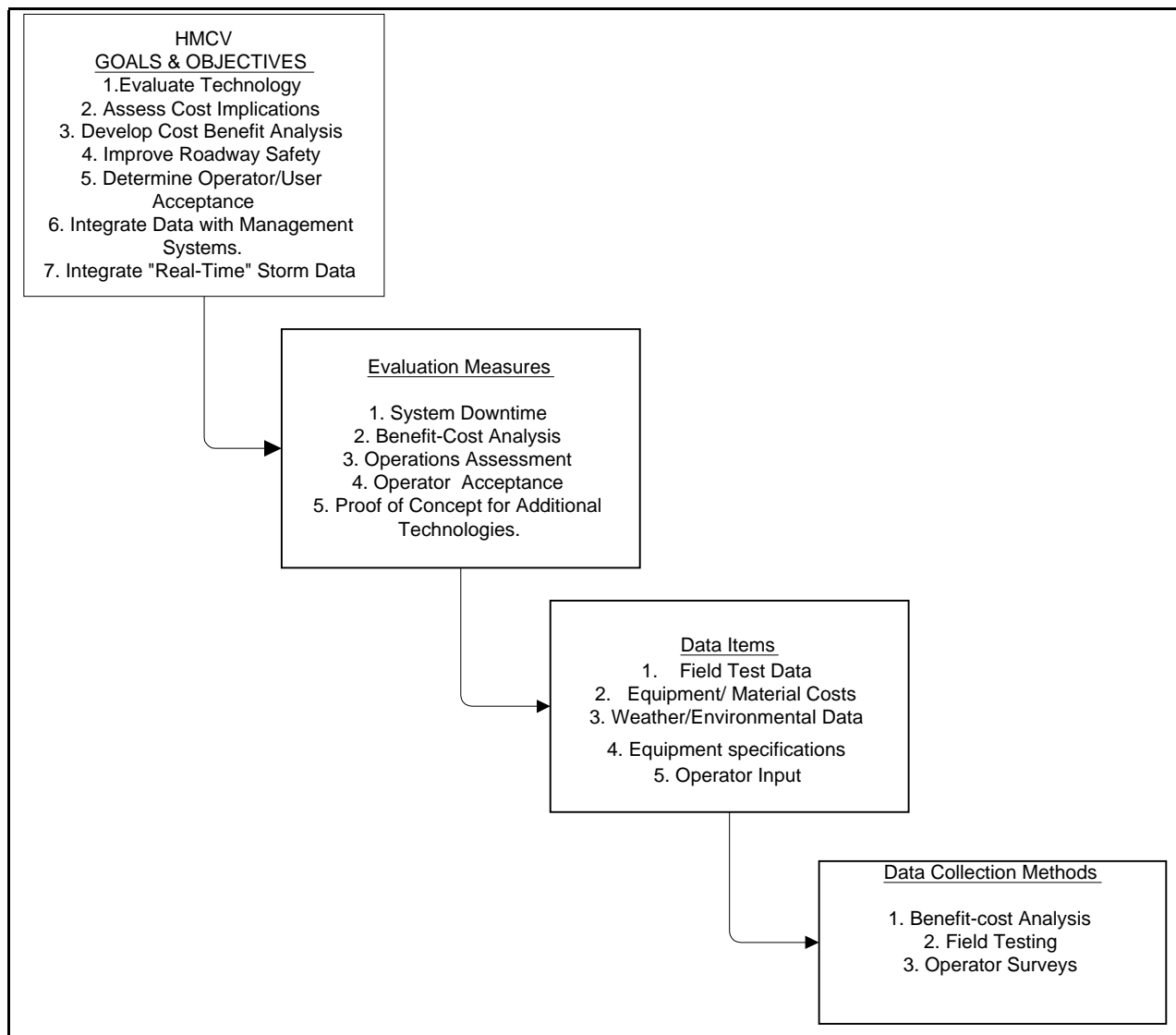

FIGURE 2.2 HMCV goals-based evaluation plan.

2.2.2 HMCV Field Evaluation Methodology

In this section, the evaluation goals are broken down into specific areas of inquiry for objective examination. The objectives within each evaluation goal and the measures used to evaluate the HMCV are presented in this section.

Responsibility for collecting data for an evaluation goal is divided among the Center for Transportation Research and Education and the Iowa DOT and Mn/DOT. The DOTs are primarily responsible for collecting data associated with system performance and institutional issues, while the CTRE team is primarily responsible for collecting data associated with user acceptance, decision effectiveness, benefit-costs, and system integration.

The following sections more clearly define the evaluation goals. Each of these preliminary evaluation goals of the study, with supporting study objectives is presented in more detail below:

2.2.2.1 Evaluate Technology The performance of the technology involves the data accuracy and operational availability and effectiveness of the equipment on the vehicles. The Phase III field evaluation focuses on these areas:

- Downtime:
 - What is the system's availability and reliability?
- Reliable outputs:
 - Do the technologies work as specified?
- Interoperability with other systems:
 - What is the system's effectiveness?
 - Will the HMCV communicate with other systems?
- Transferability to other systems:
 - Can HMCV technology be transferred to other state systems?
 - Can HMCV technology be used in local systems?
- Maintainability:
 - Are systems easily repaired, maintained?

2.2.2.2 Assess Cost Implications of Technology Applications The performance of HMCV involves an assessment of cost of applying the technology on the vehicles. The Phase III evaluation focuses on these areas:

- Key advantages considered by agencies when applying the technologies.
- Key disadvantages considered by agencies when applying the technologies.

2.2.2.3 Develop a Benefit-Cost Analysis The issues associated with developing a benefit-cost analysis of applying technology to winter maintenance operations are described here. The Phase III evaluation focuses on these areas:

- Reduce administration, operation costs of maintenance vehicles.
- Reduce road damage resulting from material application.
- Improve environmental quality from less material application and fuel savings.
- Route optimization of maintenance vehicles.

2.2.2.4 Improve Roadway Safety for the Driving Public The performance of HMCV involves an assessment of any improvement in roadway safety for the driving public as a result of applying advanced technology to the vehicles and their related systems. The Phase III evaluation focuses on these areas:

- More efficient material application and real-time communication of road and weather conditions.
- Reduction in traffic accidents.
- Reduction in backing accidents involving the concept vehicles.

2.2.2.5 Determine Operator Input and Acceptance The performance of the HMCV involves an assessment of operator and user acceptance as a result of applying advanced technology to the vehicles and their related systems. The Phase III evaluation focuses on these areas:

- What are the effects of HMCV on operational procedures of agencies?
- Was the information received from the HMCV useful to winter maintenance operations?
- Will agencies continue implementation of the HMCV following completion of the study?

2.2.2.6 Investigate Integration of Data with DOT Management Systems The performance of the HMCV involves an assessment of the integration of data with the state agencies' management and related systems. The Phase III evaluation focuses on these areas:

- Determine that HMCV systems are designed to support other, existing agency management systems.
- Determine the effects on improved data availability for safety, design, planning, etc.

2.2.2.7 Integrate “Real-Time” Data for Storm Management Decisions The performance of the HMCV involves an assessment of the development of “real-time” data for storm management decisions within the winter maintenance operations area. The Phase III evaluation focuses on these areas:

- What are the effects of obtaining up-to-the minute weather information?
- What are the effects of obtaining up-to-the minute road information?
- What is the accuracy of information obtained?
- What is the reliability of information obtained?

2.3 Implementation of HMCV Technology

Since the beginning of the highway maintenance concept vehicle project, technology and winter maintenance operations have changed dramatically. The types of technology and applications that were only being discussed have been routinely adopted in many areas. Presently, the technologies such as global positioning systems (GPS) and automated vehicle locations (AVL) have gained wide acceptance in the industry. Other applications such as prewetting and anti-icing are also gaining wide acceptance in the winter maintenance community. The high-intensity discharge (HID) lights are also becoming more important to maintenance crews as vehicle conspicuity is an important issue. The SALTAR friction-measuring device, however, is a prototype technology, unique to this project. As pavement surface friction is critical to keeping vehicles moving, the consortium recognized the importance of incorporating a friction-measuring device on the prototype vehicles to assist operators about applying materials to maintain surface friction at an optimal level. The remaining technologies used in the study are readily available.

2.4 Interfacing with the National ITS Architecture

The HMCV study team envisions the concept vehicle functionality fitting into the National ITS Architecture subsystem and communications architecture very smoothly. Figure 2.3 illustrates the placement of the functionality.

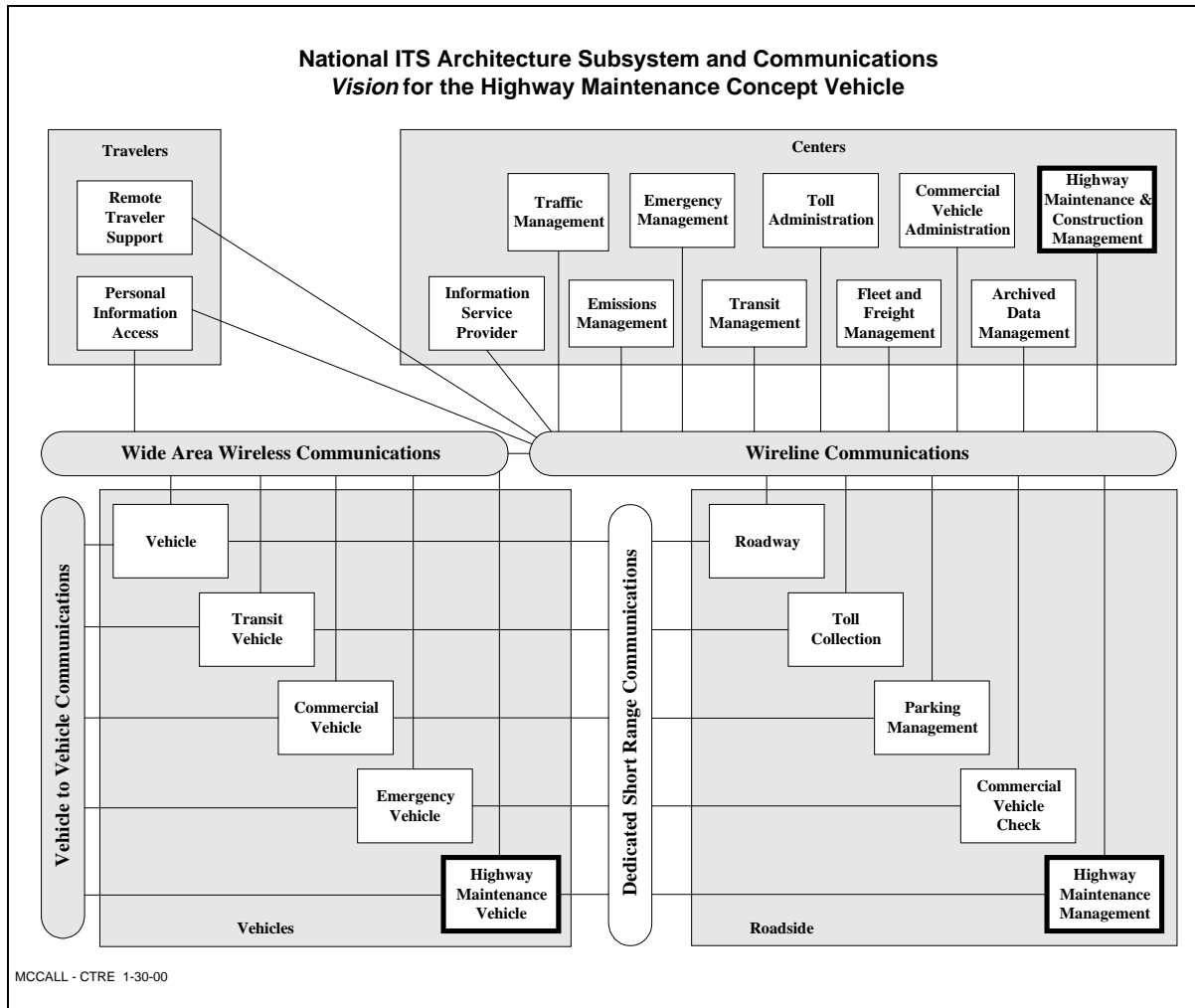

FIGURE 2.3 National ITS Architecture and HMCV vision.

2.4.1 Description of National ITS Architecture

According to the U.S. DOT, the National Intelligent Transportation Systems (ITS) Architecture provides a common framework for planning, defining, and integrating intelligent transportation systems. It is a mature product that reflects the contributions of a broad cross section of the ITS community (transportation practitioners, systems engineers, system developers, technology specialists, consultants, etc.) over a five-year period. The architecture defines

- the functions (e.g., gather traffic information or request a route) that are required for ITS
- the physical entities or subsystems where these functions reside (e.g., the roadside or the vehicle)
- the information flows that connect these functions and physical subsystems together into an integrated system

2.4.2 HMCV Applicability to National ITS Architecture

While winter maintenance functions demonstrated with HMCV project are not directly addressed by the current version of the National ITS Architecture, the HMCV project is in compliance with the ITS architecture approach. This determination is based on the study team's review of the architecture philosophy and standards, previous ITS work conducted by Iowa DOT, Mn/DOT, MDOT, and CTRE, and by comparing it to other user services within the architecture.

For example, as part of the "Weather Information for Surface Transportation ITS Field Operational Test," the highway maintenance concept vehicle provides air and pavement temperatures to the Foretell Consortium, to assist in the calibration of a new road and weather forecast model. It is envisioned that the advanced technology maintenance vehicles in Phase IV of this research will serve as Foretell's mobile platforms using National Transportation Communications for ITS Protocol (NTCIP) "ESS" protocol standards to radio air temperatures, wind speeds, pavement data, and maintenance operations reports in real time to Foretell ITS service centers. These ITS service centers will provide the interface between ITS and ITS users, allowing progressive deployment of weather, roadway, and other ITS applications throughout the service center area.

3 PHASE III WORK PLAN TASKS AND RESEARCH ACTIVITIES

The focus of the research was an investigation of advanced technology on working vehicle that will support equipment operators and fleet managers in making more informed and cost effective decisions. The following are the Phase III work plan tasks as listed in the work plan of June 10, 1999:

- Task 1: Establish individual state oversight committees for each of the participating states.
- Task 2: Describe the vehicle and subsystems to be considered.
- Task 3: Develop a field evaluation plan for technologies on the three prototype vehicles and conduct the evaluation.
- Task 4: Conduct proof of concept for redesigned technologies
- Task 5: Conduct proof of concept for additional technologies and onboard intelligence.
- Task 6: Obtain additional state pooled-fund partners.
- Task 7: Obtain additional private sector partners.
- Task 8: Conduct benefit-cost analysis.
- Task 9: Develop time to implementation projections.
- Task 10: Develop data flow maps and suggest methods to integrate the data with existing and planned state systems.
- Task 11: Develop information flow process maps and suggest methods to integrate the information with existing and planned management decision systems.
- Task 12: Write the final specifications.
- Task 13: Write final report.

This chapter and subsequent chapters follow the tasks as described in the Phase III work plan. Tasks 1, 2, and 3 are discussed in this chapter; task 4 is the subject of Chapter 4; Chapter 5 deals with tasks 5, 6, and 7, Chapter 6 with task 8, and Chapter 7 the remaining tasks.

The following section documents the work completed since the project's partners accepted the highway maintenance concept vehicle Phase III work plan.

3.1 Establishment of Individual State Oversight Committee (Task 1)

One of the first tasks undertaken by the consortium was the establishment of a project technical advisory committee. The formation of this oversight committee was done at the request of the project partners. The committee was established to ensure all technical components on board the prototype vehicles meet the stated objectives of the research. One person from each consortium state was selected to the committee. The committee would then make recommendations to the state agencies to accept or reject new management practices or technologies to their respective agencies, based on the performance of the highway maintenance concept vehicle. The oversight committee consists of Paul Keranen of the Minnesota Department of Transportation and Leland D. Smithson of the Iowa DOT.

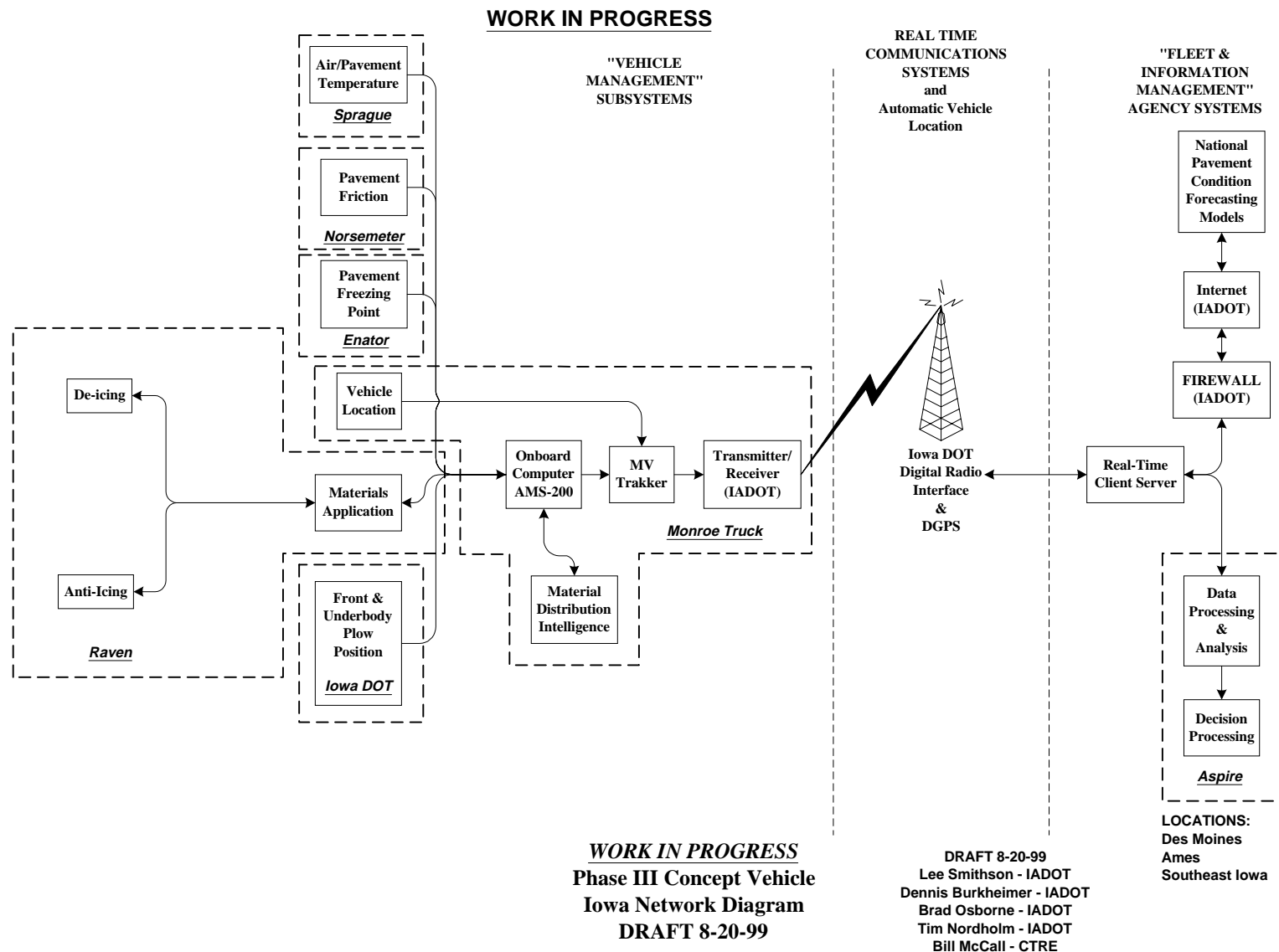

FIGURE 3.1 Iowa Network Diagram.

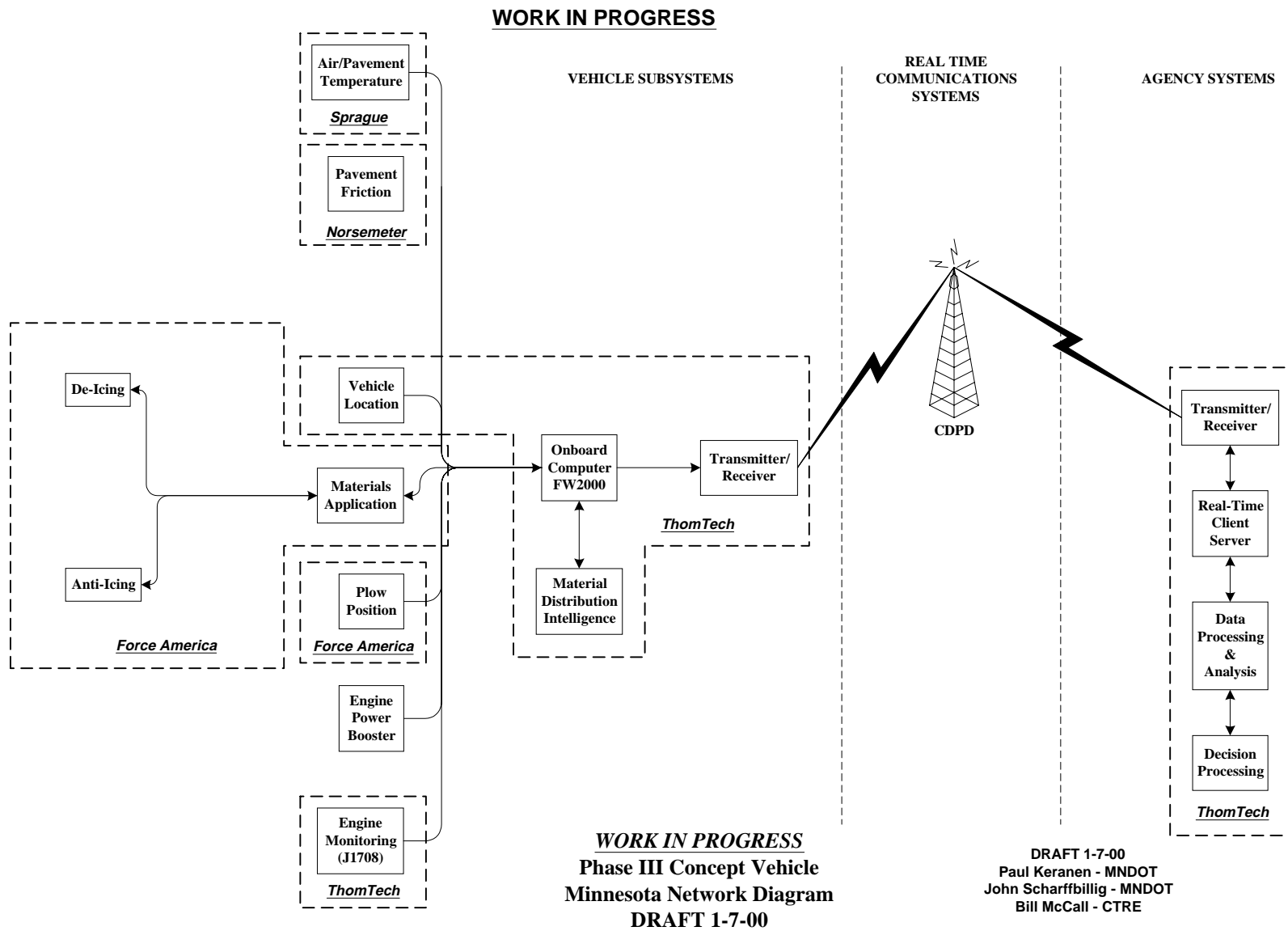
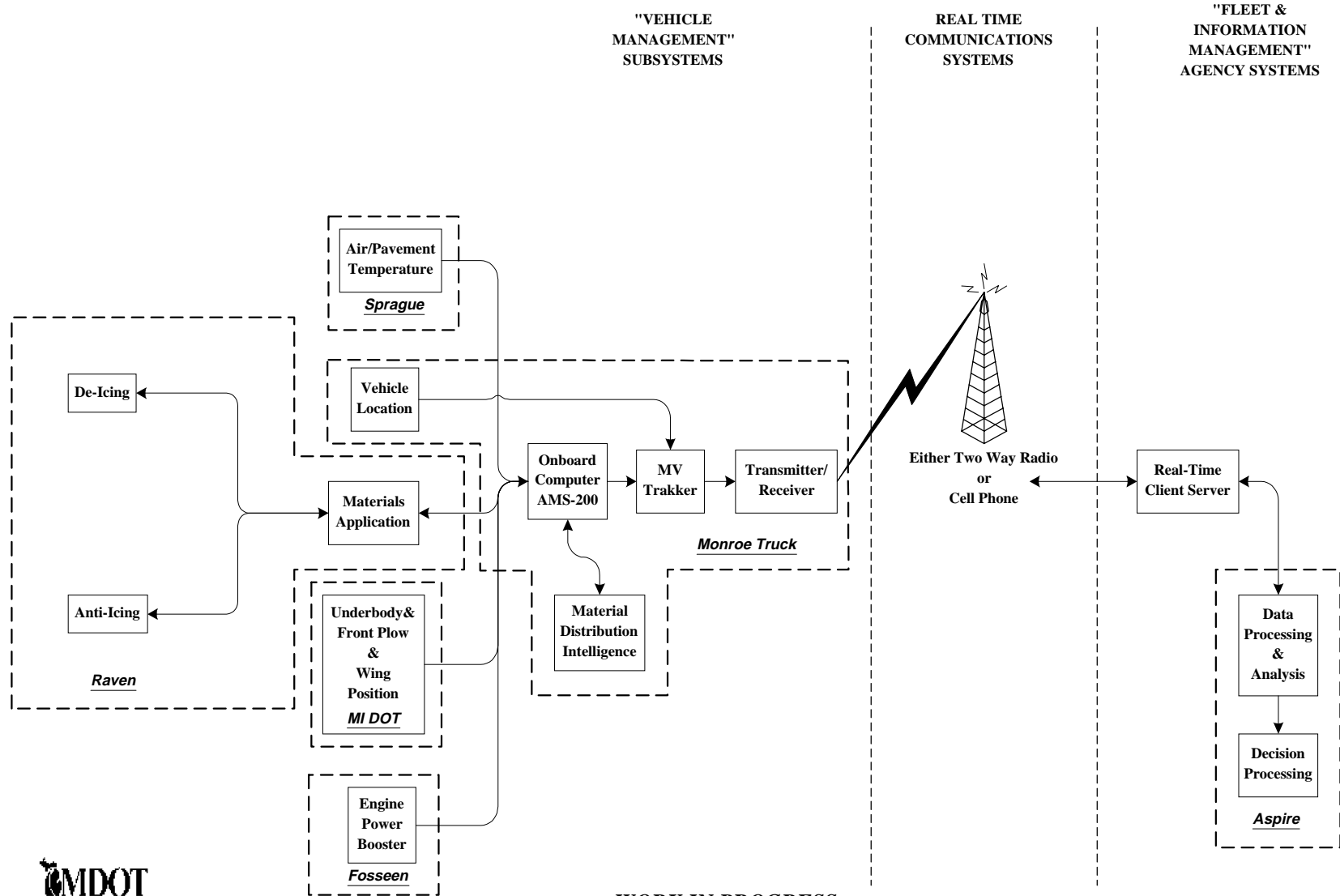

FIGURE 3.2 Minnesota Network Diagram.



WORK IN PROGRESS
Phase III Concept Vehicle
Michigan Network Diagram

DRAFT 8-20-99
 Larry White - MIDOT
 Bill McCall - CTRE

FIGURE 3.3 Michigan Network Diagram.

3.2 Description of the Vehicle and Subsystems to Be Considered (Task 2)

In Phase III of the concept vehicle project, progress has been made in integrating the communication systems on board the vehicles with desk side applications. Figure 3.1 describes the vehicle network in Iowa. Figure 3.2 describes the vehicle network in Minnesota. Figure 3.3 describes the vehicle network in Michigan.

Communication and access to information as it occurs is key to successfully managing day-to-day operations. To accommodate diverse environments, the team investigated applications that are capable of operating over local and wide-area networks (LAN / WAN), via remote dial-in connections, or using Internet/intranet technologies for providing functionality to remote users, as depicted in the previous network diagrams. The applications that will be used in later studies must be able to connect remote facilities, regional locations and headquarters and fully integrate the entire service network.

Computer-assisted route planning is one of the powerful solutions government agencies use to improve winter maintenance operations. Previous studies have shown computer-assisted route optimization produces efficiency gains of 10 to 25 percent.¹ Efficiency improvements are realized through reductions in equipment and maintenance, improved material utilization, and an overall reduction in the time required servicing a storm. In addition to the cost reductions through improved efficiency, significant service improvements are achieved through better systems and program design. The network diagrams depict the management tools that can improve winter maintenance operations and assist government agencies in successfully implementing service plans to achieve the high expectations of today's traveling public.

In Phase III the team also prepared the draft specification of each subsystem. CTRE worked with each of the states to identify the communication systems that will meet the requirements for real-time communications. The preparation of the draft specification has proven to be more difficult than originally anticipated, as the states have upgraded their communication systems. Minnesota, for example, is in the process of upgrading its statewide communication structure to a 800 MHz system. Thus, as this communications upgrade is taking place, it has so far been difficult to determine how the winter maintenance operations communications fit in with the overall communications scheme.

3.3 Development of Field Evaluation Plan (Task 3)

This section summarizes the components of the technical evaluation framework used by the research team in Phase III. The later part of this section presents suggested steps to be taken for further evaluation to quantify project-specific benefits and impacts in Iowa, Minnesota, and Michigan.

The following technologies were selected for implementation by the consortium during Phase II to be evaluated in Phase III:

- friction meter
- pavement and air temperature sensors
- automatic vehicle location
- real-time data communication

¹*Automated Vehicle Location Successful Transit Applications, A Cross-Cutting Study*, FHWA-OP-99022, EDL No. 11487. Federal Highway Administration, Washington, D.C., August 2000.

- automated materials applicator
- fiber optic lights
- engine power booster
- rear obstacle alarm
- on-board computing

The previous section described the evaluation framework from which the field evaluation plan is derived.

3.3.1 Operations Assessment

This section of the report describes the components of the highway maintenance concept vehicle and the associated tasks or activities that constitute the evaluation program for the HMCV project. The purpose of the evaluation was to assess the benefit-costs of applying advanced technologies on the concept vehicles, over a one-year operational period. The following sections provide descriptions of the technologies installed on the HMCVs and their migration from Phase II to Phase III.

3.3.2 Description of the SALTAR Friction Meter

Two vehicles included in the HMCV project had a SALTAR friction meter installed on the vehicle to measure friction while traveling on the highway at normal operational speeds. The SALTAR is a second-generation prototype friction-measuring device equipped with a rugged design to be more durable while operating in the harsh winter climate.

The SALTAR friction meter is a device designed to measure friction on road surfaces contaminated by winter weather, and based on the measurements the unit takes, classify the condition of the surface using five condition levels. Fundamentally the SALTAR unit is a small very durable frame equipped with an electronic brake and a measurement tire. The brake is controlled by advanced software and electronic control system designed to simulate car-braking action and measure the generated friction coefficient between a measuring wheel and surface.

The measuring wheel together with the holding bracket can be retracted or lowered by means of a pneumatic mechanism that also provides the controlled and calibrated load for the measurement tire. For measuring the wheel is lowered on to the surface with a predetermined and controlled vertical load by means of two pneumatic cylinders that are integrated and are part of the frame and holding bracket of SALTAR. As the host vehicle moves on the measured surface, the electronic brake periodically restrains the measuring wheel and the effective braking power during a braking cycle, where the wheel is stopped from rolling freely to a locked position is registered by the control system.

The measuring wheel is mechanically geared to the high precision and durable electronic brake. The device measures the effective braking power during a braking cycle, where the wheel is stopped from freely rolling to a locked position. The measurement is based on the principle of measuring of the time necessary to speed up the measurement wheel from locked position to freely rolling. The complex and sophisticated control software computes the necessary parameters from the acquired physical parameters measured during the braking cycle and calculates the effective braking power.

Additional equipment such as a data link can also be installed. This link can transmit the measuring results to a personal computer (PC), either remotely by radio or directly to a portable PC in the driver's cab, for storage, presentation or further processing.

3.3.3 Description of the Pavement and Air Temperature Sensors

The RoadWatch temperature indicating system consists of the infrared sensors, the in-cab processor and display, and a shielded cable connecting the sensors to the display. The in-cab display shows the air temperature (at the top of the display) and the road surface temperature (at the bottom of the display). The display also has a small beeper and a warning light that are activated when either temperature cools to 35°F. The infrared sensors are mounted on the driver's side-view mirror. The two-inch digital gauge is mounted in the vehicle cab. The road surface temperature range is -40°F to +200°F, and the air temperature range is -40°F to +120°F. Its manufacture-stated accuracy is plus or minus one percent of full scale, or 1°F. The response time is 0.1 second. The RoadWatch pavement and air temperature readings are collected on the onboard computer system.

The system is a passive infrared temperature indicator that uses infrared technology to translate surface energy into a temperature reading. For road surface temperatures, an infrared sensor absorbs heat energy from the road surface through a small lens on the bottom of the sensor, converts that energy into an electrical signal, sends the signal to a processor in the vehicle cab, and converts the electrical signal to a temperature display. The process is similar to a light meter in a camera that absorbs light energy and converts it to an electrical signal; the pavement surface temperature sensor absorbs heat energy and converts it to an electrical signal.

3.3.4 Description of the Automatic Vehicle Location Subsystem

Through the use of a mobile computer system the concept vehicle is a fully integrated global positioning system (GPS)-based automatic vehicle location (AVL) and two-way messaging system developed for the public works industry.

To be useful in management systems, data collected by the prototype vehicles' sensors must be spatially referenced; that is, the data must be correlated to specific locations on the earth's surface along the vehicles' routes where the data are collected. GPS technology is a worldwide, precision navigation and location tool that uses three-dimensional positioning capabilities to identify spatial references. It is based on triangulation of radio signals from a constellation of 24 satellites orbiting the earth. A local GPS location system receives radio signals from a satellite, calculates the signal's travel time from the satellite to the GPS antenna, and then translates the travel time into distance between the satellite and the GPS antenna. To determine a specific location (e.g., the location of a prototype maintenance vehicle) using GPS, an onboard GPS receiver would simultaneously calculate the distance of at least three satellites (synchronized by atomic clocks in the satellites), triangulate the three distances to find their common location on the earth, and record the location in latitude and longitude, along with the GPS time the signals were received.

3.3.5 Description of the Materials Distribution Intelligence Subsystem

The materials distribution intelligence subsystem was a new application for Phase III. The idea for this subsystem is to develop a system to optimize the spreading of de-icing chemicals on roadways, the timing, and dosage of the chemical application is critical. In order to

predict the risk for ice developing on the roadway, it is necessary to have knowledge about surface and air temperature, humidity, and precipitation and whether the pavement is dry or not.

A system of materials distribution intelligence based on input from sensors mounted on the vehicle will attempt to determine whether there is any moisture on the pavement and, if so, whether the freezing point temperature of the moisture is well below the temperature to be expected or whether it will freeze unless more chemicals are applied?

The materials distribution intelligence uses pavement surface temperature; chemical trace; and friction data, along with weather forecasting data, using inputs derived from algorithms to support chemical mixture distribution.

3.3.6 Description of Pavement Freezing Point Subsystem

The pavement freezing point subsystem is also a new application for Phase III. The system, as developed by Enator, will be installed on the concept vehicle in Iowa. The system consists of four sensors (Fensors) and one electronic board. A Fensor is placed on the vehicle, positioned in the wheel spray area, to collect the chemical mixture from the roadway. The Fensors are supplied with power from onboard, and the signals from the Fensors are evaluated by a microprocessor on the board. The board also measures inputs such as air and ground temperature, humidity, and wind speed.

The pavement freezing point subsystem, in combination with materials distribution intelligence, is designed to assist managers to improve maintenance operations, reduce costs, increase safety, improve mobility, and reduce the environmental impact of winter weather applications. The evaluation team was assigned investigate potential software technology applications that can be applied to real-time material management, forecasting requirements, vehicle route optimization, and material inventory.

3.3.7 Description of Fiber Optic Lights

The fiber optic lights were installed and tested in Phase II and remained in use during Phase III. The systems spectra high-intensity discharge (HID) fiber-optic lightning system, HIDSYS-01, supplied by Innovative Warning Systems, located in Minneapolis, Minnesota, projects light instead of reflecting it, directing all of the light energy where it is required. The Spectra system also uses color contrasting, which creates a powerful attention-getting flash effect by changing colors instead of flashing the lights on and off. Spectra can produce numerous color or combination of color patterns.

The heart of the spectra distributed light system is the light engine, which uses a HID short-arc lamp. The light engine's 60-watt lamp is resistant to shock and vibration failure because it has no filament. This lamp has 10 times the life and uses less than one-third the energy of four halogen lamps. It may replace the typical revolving warning light. The Spectra system also has a rapid-start and instant-restart technology to ensure a warning signal is always available when needed.

Light from the light engine is transmitted through "light pipes"—flexible, plastic optical fibers that conduct the light produced by the light engine to its ultimate destination. Light pipes can diverge and distribute light in any direction and at any intensity, allowing a single high-intensity lamp to replace multiple halogen lamps, thus dramatically lowering current draw.

The light pipes are connected to light converters, which take light from the light pipes and project it outwardly in any desired direction and intensity. Light converters have a variety of designs and can be mounted in spaces that do not accommodate larger conventional lights.

In November of 1999, the operators of the prototype vehicles were asked to rate the performance of the fiber optic lights. Operators of all three vehicles rated the lights very highly. Here are some of their responses:

- They worked well at night. They could be seen a long distance away but when you were close up they didn't blind you.
- They aren't as irritating as a standard strobe light.
- The lights work well and "could be seen very good."
- They should be installed on all our snowplows.

Following these responses, no further testing of the fiber optic lights was conducted in Phase III.

3.3.8 Description of Power Booster

The power booster was installed on the vehicles in Phase II and remained on the vehicles for Phase III. Fosseen Manufacturing and Development Ltd. (Fosseen), located in Radcliffe, Iowa, supplied a custom-built "Hydrous-Ethanol Hydrofire Injection System and Power Booster" for each prototype vehicle. The Hydrofire fuel injection system consists of an electronic control unit (DriverMax) in the cab; an auxiliary fuel tank mounted on the outside of the vehicle; and a pump to inject fuel from the auxiliary tank into the engine's airstream intake, along with related plumbing and exhaust treatment devices, under the vehicle's hood. The auxiliary tank contains Hydrofire fluid, a water-alcohol-lubricant blend fuel. Hydrofire is premixed and, provided by Fosseen. DriverMax, the electronic fuel controller, has preset values that determine when the engine needs more power and then engages turbo boost pressure to automatically inject the Hydrofire.

The injection of hydrous-ethanol results in a cleaner running engine with a longer engine life. Increased engine performance, longer life, decreased nitrogen oxide emissions, particulate matter reduction, and savings of petroleum fuels are among the benefits of the Hydrofire injection system.

In Phase II the engine power booster on the Iowa DOT vehicle was tested on a dynamometer in Des Moines, Iowa. The vehicle was tested three times, first without any alteration to the vehicle, second the installation of the supplemental injectors and manifold but using only diesel fuel, and third with the Hydrofire parts and alcohol based fuel additive. The tests with the new Hydrofire system resulted in not only an increase engine horsepower but also a drop in exhaust pressure.

Fosseen also examined the effects of the engine power booster on the prototype vehicles in Minnesota and Michigan. The tests on these vehicles indicated a boost in wheel horsepower by approximately 20 horsepower and a decrease in exhaust temperatures by 50° to 75°.

In Phase III, the power booster remained on the vehicles and was used to add horsepower to the wheels, when required. As the technology proved to be effective in the previous phase of the project, no formal testing of the technology was conducted in Phase III.

3.3.9 Description of Rear Obstacle Alarm

Search-Eye Sensor System, supplied by Global Sensor Systems, Inc., located in Mississauga, Ontario, detects the presence of objects behind the prototype vehicles when reverse gear is engaged and automatically applies the brakes.

The system consists of sensors mounted on the rear of the vehicle and wired into the braking system. Placing the gearshift lever in reverse turns on the system. If an object is detected while backing up, the brakes are applied automatically and an audible “Sonalert” and large red light on the cab control box warn the driver. Moving the gearshift to any other position turns the system off.

The search-eye sensor system can be used with either hydraulic brakes or air brakes. The units have a manual override switch that permits the operator to disable the automatic braking system when the need arises, such as when backing up to a loading dock. The audible beeping sound will continue until the manual override switch is reset. The systems that are supplied for vehicles equipped with hydraulic brakes consist of two rear-mounted sensors, a heavy-duty plunger-type solenoid, and a transceiver. The heavy-duty air brake system consists of three rear-mounted sensors, one electrically operated air relay valve, and a transceiver.

Again, this system was installed on the vehicles in Phase II of the project and remained on the vehicle throughout Phase III. Anecdotal evidence in Phase III indicated that the system worked as expected; the vehicle stopped automatically when it approached an obstacle while backing up. For example, an operator from Iowa DOT reported that the reverse sensor obstacle alarm prevented him from backing up and colliding with a school bus that had pulled into his path. No formal testing, however, of attributing a reduction of backing accidents to the reverse sensor obstacle alarm was conducted in Phase III.

4 OPERATIONS ASSESSMENT OF SALTAR FRICTION METER (TASK 4)

4.1 Redesign of SALTAR Friction Meter

One outcome of Phase II of the highway maintenance concept vehicle Project was a redesign of the friction meter for Phase III. Norsemeter, the manufacturer of the friction-measuring device, offered a redesigned model of the ROAR unit called SALTAR. Although, the ROAR device passed the proof of concept in Phase II, the process clearly showed that the ROAR device was not designed for application on a maintenance vehicle in the harsh snow and ice removal environment. The redesigned SALTAR unit is smaller, more robust, and employs a simplified electronic system. The redesigned SALTAR friction meter is depicted in Figure 4.1.

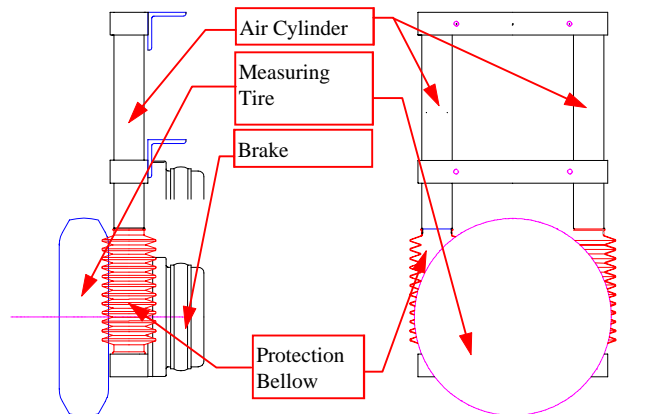

FIGURE 4.1 Redesigned SALTAR friction meter.

The main mechanical component in the SALTAR device is the measuring wheel system. The measuring wheel mechanism is designed as an extendable ladder frame. The frame consists of three horizontal crossbars and two vertical cylinders (see Figure 4.1). The frame is made of highly corrosive resistant, strong, very durable and light aluminum alloy.

The ladder frame consists of two main components:

1. the upper frame consisting of two cross bars and the fixed part of the vertical cylinders; and
2. the lower frame consisting of the lower crossbar and the moving cylinder parts covered by the protection bellows (see Figure 4.1).

The two vertical air-cylinders have triple functions in the design. The stationary upper part of the cylinders provides mechanical stability of the SALTAR frame and firmly connecting the two upper crossbars. Together with the upper crossbars they form a solid very strong but light frame that can be mounted onto any vehicle with relative ease.

The lower movable frame has the function of holding the electronic brake and measuring wheel construction. The lower frame connected with the measuring wheel and brake assembly is retractable by the movable parts of the air cylinders covered by the protection bellows.

The SALTAR device is equipped with a fail-safe lifting mechanism. If there is a pneumatic failure or air loss in the system, two strong springs placed inside the cylinder assembly lift the unit off the ground.

Another change that was made to the SALTAR that was distinct from the ROAR was a new measurement tire. After Phase II was completed, the team asked that the next friction-measuring device be equipped with a tire that was more like that used on passenger cars, rather than the ASTM-1551 used on the ROAR device. The SALTAR, being smaller than the ROAR, came equipped with a Bridgestone 8F-228 135 x 12 tire.

4.1.1 SALTAR Electronic Braking System

To restrict the measurement wheel from rolling freely to a locked stage in a very short period of time and then release, much like an ABS braking system, the SALTAR system is equipped with a fast and strong electronically controlled brake.

The brake unit is a SEW BM30 electronic brake with a BSG electronic rectifier and control unit. The brake has a 600 Nm maximum braking torque and can be operated by standard 24 V power. The brake unit is enclosed in cast iron casing and can be used under any weather conditions.

4.1.2 Pneumatic System

The SALTAR measuring system has a separate pneumatic system, fitted in the rear of the truck. The pneumatic system is designed for two different host vehicle environments. The pneumatic system can be used in trucks and utility vehicles with their own auxiliary air supply or in vehicles with no usable air system. The system can be connected directly to the air supply system of trucks. SALTAR has an automatic air pressure regulator and can be connected without any prior modifications to most trucks. This system consists of a pressure accumulator, regulating system, valves, and piping.

The system is designed for vehicles with no direct air supply therefore it is a stand-alone design. This system consists of an electrically driven pump, a pressure accumulator, regulating system, valves and piping. The system is a self-contained unit. Power to the pneumatic system is supplied by the electric system of the base car.

4.1.3 SALTAR Computer

The SALTAR computer system is of type SALTAR Mk I computer system, specially designed for the SALTAR friction tester. It consists of two basic units:

1. central computer
2. operator panel and user interface

The central computer is an industrial high performance computer that can be operated under extremely harsh conditions. The small size and the rugged design of the compartment makes it fit to be mounted nearly anywhere on the host vehicle.

The computer unit is connected to the measurement sensors located in the brake and measuring wheel assembly by two wires supplying the power to the brake and to the sensors and carrying the control and measurement signals.

The SALTAR Mk I computer is based on the state of the art industry leader microcontroller AMD AM186EM controller processor and a fully fledged real-time kernel. The schematic layout of the controller can be seen in Figure 4.2.

A keyboard operates the computer system with a display for operator guidance. The keyboard operator panel is a palm size “remote control” unit of the measurement system that also

displays in real time the measurement results. The control buttons indicators and LEDs are arranged to give the operator maximum flexibility and easy observation. Because of the small size the operator panel can be placed anywhere in the driver's cabin of the host vehicle.

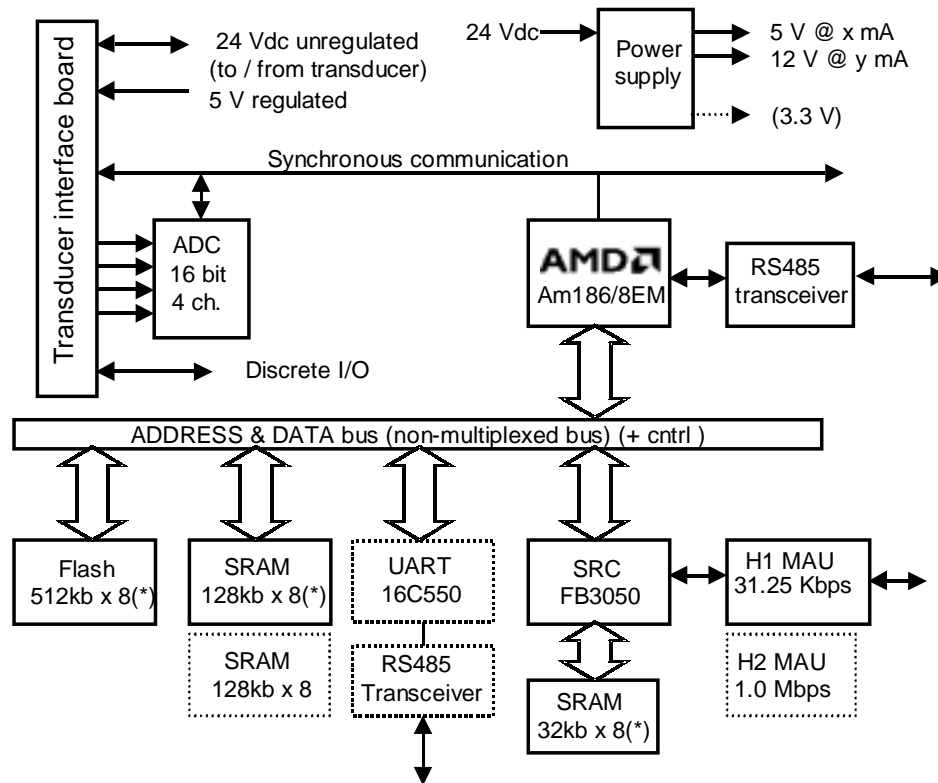

(*) Memory may be scaled down if application require less memory
Copyright © Norsemeter AS, 1998

FIGURE 4.2 SALTAR computer system.

The Mk I computer system is easy to calibrate. Calibration is done automatically via a laptop computer and a standard RS232 port connection to the computer. The keyboard is detachable and can be moved.

The system is easy to maintain and is made up of only three easily replaceable units. It also has a built-in self-test function.

The Mk I computer system is fitted with a data link interface for transfer of measurement values to a PC for storing/presentation. The data link can be connected to a radio link modem, or a link to a portable PC in the car. See Figure 4.3.

The SALTAR friction meter was designed with mobility and versatility in mind. The symmetrical layout of the mounting frame and the in-line design of the whole unit make the SALTAR device very modular. The extremely slim design perpendicular to the direction of travel/measurement gives the opportunity to mount the device virtually anywhere on a large plow truck or winter maintenance vehicle. The unit was designed to be mounted in the left or right wheel track or in the middle of the vehicle. SALTAR's unique and simplified design makes it possible to operate the unit in forward or reverse direction without any difficulty. Thus, the unit can be turned 180° if mounting it to the vehicle makes that decision necessary.

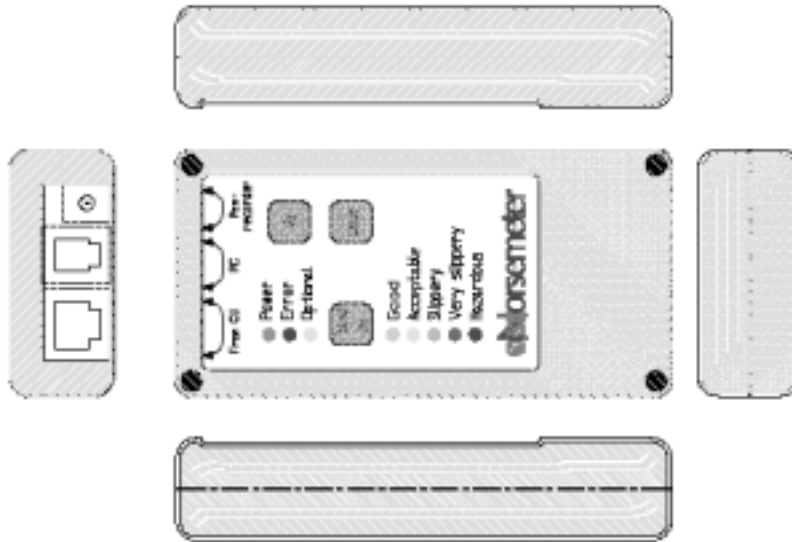

FIGURE 4.3 Operator panel and user interface host vehicle.

4.1.4 SALTAR Data Link Options

After each measurement SALTAR transfers the acquired and processed measurement data through its RS232 “PC” port (see Figure 4.3), which can be collected with a standard Windows accessory, the HyperTerminal, or the Norsemeter data collection software.

The setup for the communication is as follows:

- bit per second: 57600 bps
- data bits: 8
- parity: none
- stop bits: 1
- flow control: none

The SALTAR user interface is equipped with an analogue output providing a 0–20 mA signal according to the measured data. This signal can be connected to other control or recording equipment through a standard (Chassidon 1, 3 mm) connector. (See Figure 4.3.)

4.1.5 Measurement Procedure and Software

The control computer is equipped with software that runs a thorough self-test every time the power of the system is turned on. The program checks the status of the printed circuit motherboard and the other electrical components of the control system. When this step is passed the software will run a check of all the external hardware equipment like the transducers and signal converters.

Additionally the computer is equipped with a watchdog circuit that ensures a safe and reliable operation. The watchdog electrical circuit together with the software continuously monitors the state of the control computer and executes safety related tasks whenever encounters an error in the normal operation.

The control system is designed and operating with a soft power down feature. When a measurement session is finished and the operator wishes to switch the equipment off by pressing the power-off button, the system executes a software-controlled power-down sequence.

The power-off button is not switching the power supply of the computer system directly; instead it gives the power-down command to the control computer. The control software receiving this command then executes a number of safety tasks and switches the power of the system off.

After the system has been powered up it is ready with a minimum delay for conducting measurements. The operation is very simple and straightforward. By pressing the power button, the system will execute the initial self-test procedures and indicate an error if any are encountered. These procedures take less than a second of time, after which the unit is ready for operation.

Pressing the “down” button the unit will lower the measuring wheel to the ground and the measurement will start. After pressing the “up” button the measuring wheel will be lifted from the ground and the measurement will be suspended until the “down” or “power” buttons are once again pushed.

During the measurement the control system will execute a complete measurement cycle (brake and release), data collection, data processing and display every four seconds. If the DataLink option is purchased then besides the user interface, the collected and processed data are sent onto the laptop or other computer device via the serial communications link.

If the DataLink option is purchased, the control computer will continuously transmit its processed data in real time. The transmitted data are formatted as one line ASCII string with the following configuration:

```
<SD><RC>,<MC>,<FL><cr> ,
```

where

```
<SD> is the start delimiter of a data record and is always equal to '>>' = ;  
<RC> = reference speed count, range 0-9999 ;  
<MC> = measured friction, range 0-9999 ;  
<FL> = calculated friction level, range 0-5 ;  
0 means invalid data ;  
<cr> = carriage return character, which marks the end of the current data record .
```

Here is an example of the received data record: '>>643,478,4<cr>'.

All data are separated with a comma sign, ','—thus; it is possible to import the captured and saved data file to a spreadsheet, text editor, or database software. Here is sample of data taken from the SALTAR on January 6, 2000:

Reference Speed	Measured Friction	Friction Level
>>163	87	4
>>175	92	4
>>188	49	3
>>185	90	3
>>169	122	4
>>163	134	5
>>178	111	5
>>187	189	5

4.1.6 Calibration and Level Modifications

If the SALTAR unit is purchased with the DataLink option, the calibration and friction level modification can be executed through the laptop PC with ease and simplicity. The control software is prepared to take a calibration command at any time throughout the operation of the unit with the following format:

<SD><FL1>,<FL2>,<FL3>,<FL4>,<FL5><cr> ,

where

<SD> is the start delimiter of the calibration command and is always equal to <<TA' = ;
< FL1> = Friction Level 1 in the range 0 – 9999 ;
< FL2> = Friction Level 2 in the range FL1 – 9999 ;
< FL3> = Friction Level 3 in the range FL2 – 9999 ;
< FL4> = Friction Level 4 in the range FL3 – 9999 ;
< FL5> = Friction Level 5 in the range FL4 – 9999 ;
<cr> = carriage return character, which marks the end of the current data record .

Upon receiving this command, the control software will update the evaluation table and criteria in the program immediately.

If the control computer received the calibration command while in a measurement session, then the data displayed and transmitted through the DataLink will be according to the new calibration values from the time forward the command was received.

Once calibrated, the control computer displays the friction level in five categories. For Phase III the consortium decided that displaying the friction levels by categories would be more useful and understandable to the vehicle operators and managers. The coefficient of friction and the corresponding categories, as displayed on operator panel (see Figure 4.3) are presented below, where μ equals the coefficient of friction:

- hazardous: $\mu < 0.15$
- very slippery: $0.15 < \mu < 0.25$
- slippery: $0.25 < \mu < 0.4$
- acceptable: $0.4 \mu < 0.5$
- good: $0.5 < \mu$

4.2 Field Testing of SALTAR at NASA Wallops Flight Facility

In May of 1999, the Iowa DOT took its HMCV, mounted with the SALTAR unit, to Wallops Island, Virginia, to participate in a NASA-sponsored friction-testing workshop. The purpose of these tests was to collect data from the SALTAR, and then compare those data to an industry standard. The reasonableness of the data (goodness-of-fit test), collected by the SALTAR was then compared to several other friction measuring devices, including the ASTM E-274 skid trailer, the industry standard for pavement friction measurements.

4.2.1 Winter Runway Friction Testing Background

The Winter Runway Friction Measurement Program is a joint five-year effort among the National Aeronautics and Space Administration, Transport Canada (TC), and the Federal Aviation Administration (FAA). The program started in January 1996 with instrumented aircraft

and friction measuring ground vehicle tests at North Bay, Ontario. Since then, four different aircraft—the NASA Langley B737 and B757, FAA B727, NRC Falcon 20, and a de Havilland Dash 8 aircraft—have been tested together with 13 different ground vehicles under more than 30 winter runway conditions.

4.2.2 Winter Runway Friction Testing Objectives

The objectives of the program are to

- reduce traction-related aircraft accidents;
- provide airport operators better runway surface friction monitoring tools and more cost-effective techniques for obtaining acceptable runway operating conditions;
- improve designs of aircraft systems to meet ground-handling requirements; and
- help achieve success in other NASA programs such as aviation systems capacity, and next generation tools/X-planes.

4.2.3 Winter Runway Friction Testing Goals

The 1999 winter test program represented the fourth year of the multiyear Winter Runway Friction Measurement Program directed by NASA, Transport Canada, the Canadian National Research Council (NRC), and the Federal Aviation Administration. This international effort has been strongly supported by the Canadian Department of National Defense, the Norwegian Civil Aviation Authority, the French STAB, the International Civil Aviation Organization (ICAO), the American Society for Testing and Materials (ASTM) E17 Committee, aircraft and ground vehicle manufacturers, and other aviation agencies and organizations. The aims of this winter season's test program include the following:

- Assess the effectiveness of different ground friction measuring instruments on various winter contaminated runway surfaces.
- Verify the correlation between the different ground friction measuring instruments.
- Further develop and validate methodology for the establishment of the proposed International Runway Friction Index (IRFI).
- Establish/validate the aircraft braking coefficients for various winter contaminated runway surfaces, and determine if a correlation exists between these coefficients and the proposed IRFI.
- Establish the contamination drag effect of various winter contaminated runway surfaces on aircraft performance.
- Assess the capability of (certain) ground friction measuring instruments to measure contamination drag.
- Obtain additional data to validate, and if necessary, refine the Canadian Runway Friction Index tables for landing distance corrections.
- Obtain additional data toward the establishment of more accurate models for the effect of contamination on continued takeoff and rejected takeoff aircraft performance.

By participating in the Winter Runway Friction Workshop, the HMCV team believed that the friction data and conclusions gathered at this workshop could be readily applied to our testing and evaluation of the SALTAR.

The SALTAR tests at Wallops Island were conducted under the supervision of Dr. James C. Wambold¹ of the engineering consulting firm CDRM, Inc. Wambold also assisted the concept vehicle project earlier in Phase II.

Dr. James C. Wambold provided the following analysis of the friction measurement tests at the Wallops Flight Facility. As the workshop was held in May, the tests were conducted on wet pavement, as opposed to snow and ice conditions. The wet pavement still provided vital data for the SALTAR friction-measuring device.

The runway conditions upon which the vehicles ran the tests consisted of the following:

- One grooved concrete runway, approximately 50 feet wide by 350 feet in length.
- One smooth concrete runway, approximately 50 feet wide by 350 feet in length.

For the tests, water was applied to the runway surfaces in these amounts:

- For a wet test, approximately 0.03 to 0.05 inches of water depth was applied.
- For a flooded test, approximately 0.1 to 0.2 inches of water depth was applied.

These tests were to evaluate, from comparative data, the effect of surface type on wet friction levels, collected on grooved and smooth concrete and asphalt surfaces. Through these tests, the HMCV team hoped to obtain a better understanding of the SALTAR's performance under adverse weather conditions and acquiring friction measurements.

There are presently some 19 different friction sites, ranging in wet friction from 0.01 to almost 1.0. In 1999 there were some ten different friction-measuring devices; however, to date there are data for six of the devices:

USFT	U.S. version of the airport surface friction tester from Sweden with two different tires
SALTAR	friction tester designed by Norsemeter for winter maintenance vehicles
SFT79	1997 Saab friction tester owned by Transport Canada
BV11	Swedish-designed friction tester owned by the FAA
RFT	runway friction tester by K. J. Law owned by the FAA
E274	ASTM E274 skid tester from the Virginia Department of Transportation

All of the friction-measuring devices were run on some or all of the 19 sites in a self-watering mode. Values of the different friction measuring devices show as much as a 50 percent difference in their measured friction values. SALTAR always gives values within the range of the other devices; however, it measures higher friction values with increased speed in all but a few cases. All of the other devices generally give lower values with increasing speed. Investigation into the SALTAR showed that the computation done by Norsemeter should be somewhat speed sensitive; however, it was designed for speeds of plow and salt trucks and

¹ Dr. James C. Wambold holds a Ph.D. in mechanical engineering and is professor emeritus of mechanical engineering at Pennsylvania State University. Presently, he is president of CDRM, Inc., State College, Pennsylvania.

indeed at the 50 kilometers per hour (32 mph) speed, and the SALTAR measured in the middle of the range of the rest of the devices. Furthermore, when the SALTAR results are plotted versus the E274 trailer at 30 kilometers per hour, both devices measure the same friction values. Thus, it would be expected that at low friction and low speeds the SALTAR should give good friction measurements. The results of the SALTAR tests on wet pavement are graphically displayed in Figure 4.4. The trend line was added to the trend between the SALTAR measurements and the ASTM E-274 skid trailer.

Further investigation revealed that during these tests, the tests with the SALTAR were run with a constant water flow rate, whereas the other devices were run with a varying flow rate with speed to produce the same water film thickness at all speeds. This means that the SALTAR had smaller water film thickness with increased speed and thus should have increased friction with speed. New tests need to be run to eliminate the water thickness problem to determine just what the real effect of speed is on SALTAR. Since SALTAR is designed to measure winter conditions, a series of tests should be run and compared this winter with some other friction-measuring devices.

In these series of tests the SALTAR trend line shows an effect of friction increasing as speed increases. As the investigation showed, this increase in friction was due to constant water flow to the tire. Thus, the water film thickness decreased as the speed of the vehicle increased, creating more friction between the tire and the pavement surface. Accordingly, the tests showed that the SALTAR does consistently measure friction; however, more testing was needed to specifically determine whether the speed of the vehicle also played a factor in the “reverse” trend line. Figure 4.5 shows a comparison of the SALTAR test results to the other friction measuring devices participating in the tests at the Wallops Facility.

4.3 Field Testing SALTAR at North Bay, Ontario

Since the SALTAR was designed with winter maintenance operations in mind, the study team decided to conduct more field-testing in winter conditions. As the past winter in the Midwest was unusually mild, the consortium decided to send the concept vehicle to an additional NASA-sponsored friction workshop in North Bay, Ontario. The workshop was held January 17 – 31, 2000, at the Jack Garland Airport in North Bay. The highway maintenance concept vehicle participated during the second week of the workshop, in which the ground friction vehicle tests were run. The purpose of this workshop was to field test the SALTAR in winter conditions on ice- and snow-packed roadway surfaces.

Again, the North Bay tests were conducted under the supervision of Dr. James C. Wambold of CDRM, Inc. The friction measurement tests at the North Bay Joint Winter Runway Friction Workshop were conducted on various contaminated pavement surfaces, such as snow, ice and snow, and hard-packed snow. Wambold provided the following preliminary analysis of the data from North Bay.

Because the highway maintenance concept vehicle study team needed to test the SALTAR in a winter environment, under controlled conditions, the HMCV study team participated in the Joint Winter Runway Friction Measurement Program in North Bay in January 2000. The objectives of the Joint Winter Runway Friction Measurement Program are summarized as follows:

- to perform a series of winter tests to determine the relationship between ground friction measuring devices and aircraft braking performance on winter contaminated runways;
- to develop an international runway friction index to minimize pilot difficulties in making critical takeoff and landing decisions

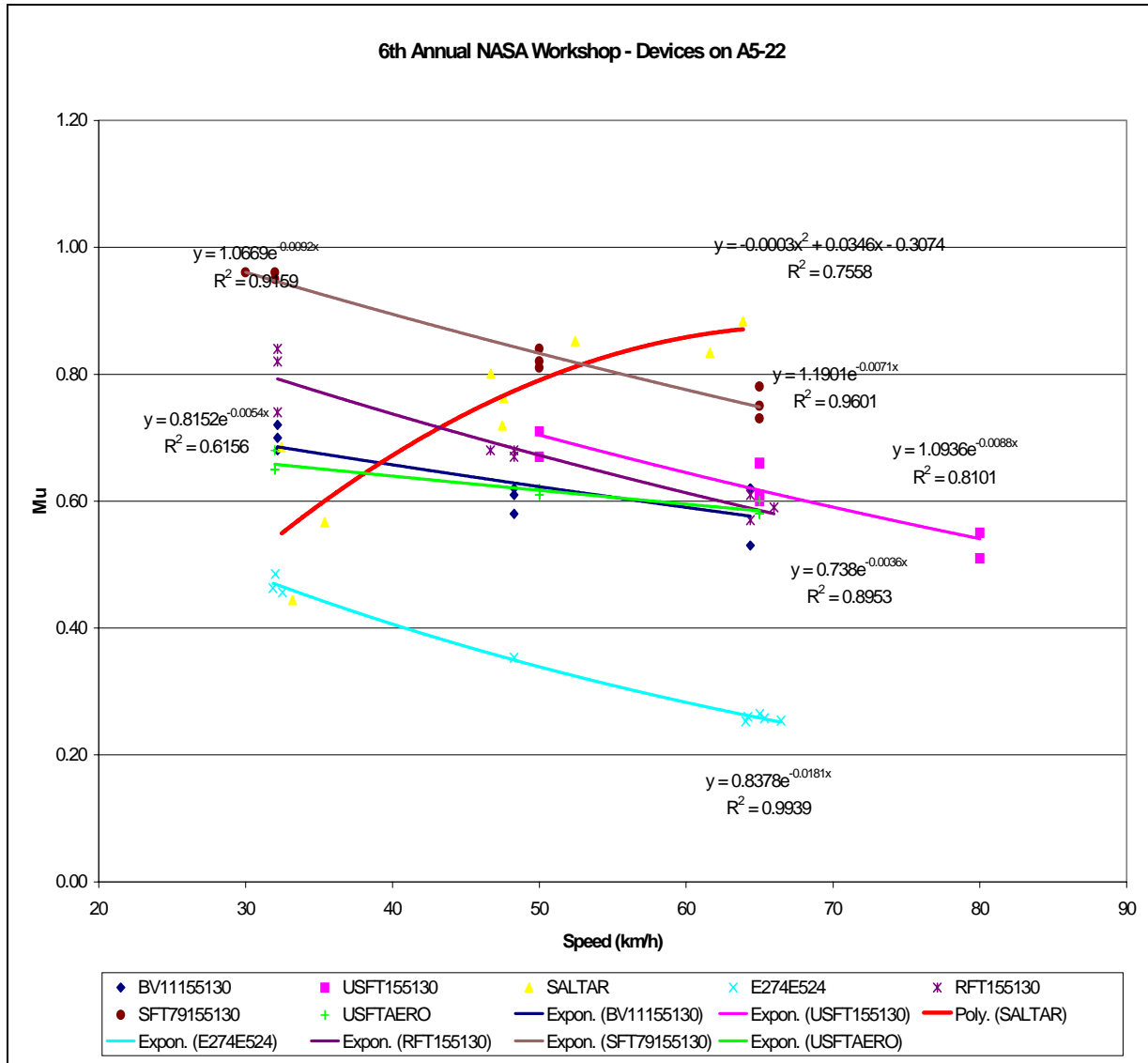

FIGURE 4.4 SALTAR versus ASTM E-274 friction measurements, May 1999 (a sample comparison from the Sixth Annual NASA Runway Friction Workshop).

4.3.1 Joint Winter Runway Friction Measurement Program Background

The work of the international Joint Winter Runway Friction Measurement Program is designed to increase the safety of all aircraft ground operations under winter weather conditions. Initiated as a five-year program in 1995, the work has been extended to March 2003.

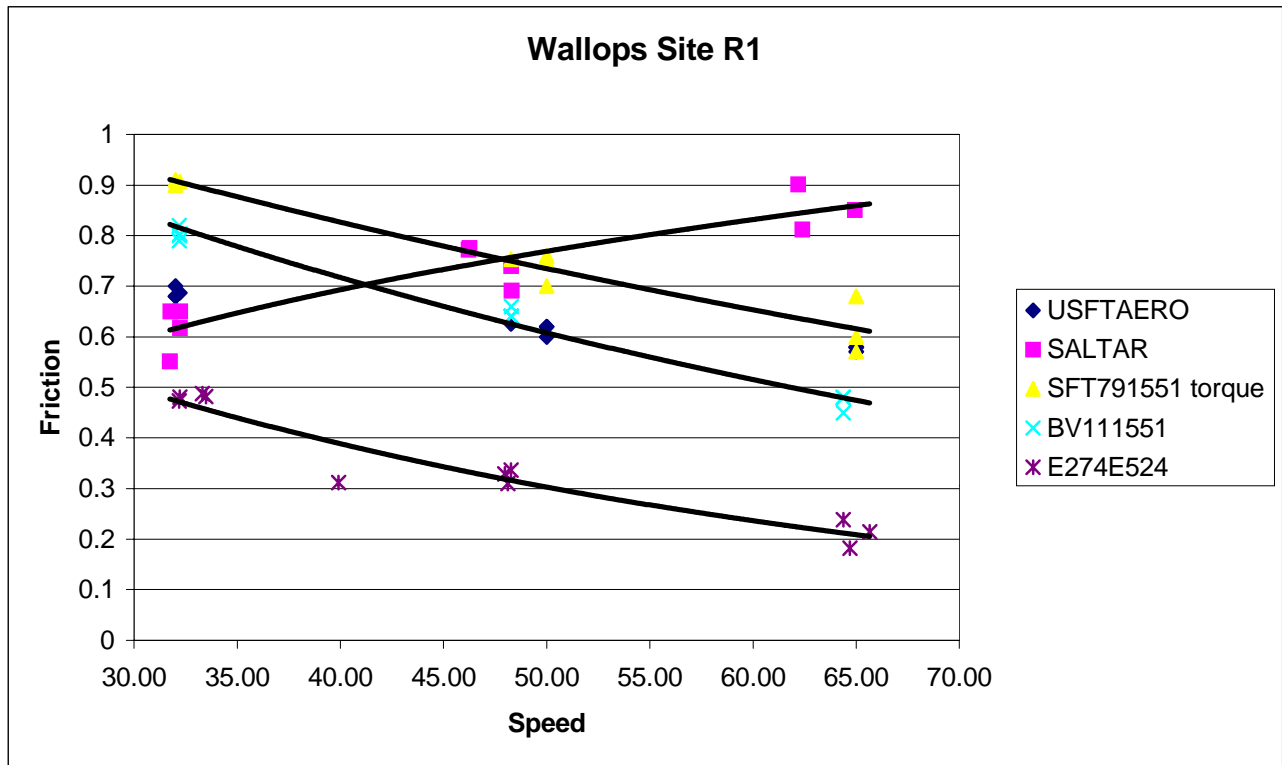

FIGURE 4.5 SALTAR compared to other friction measuring devices at Wallops Island.

Initial tests at Jack Garland Airport, North Bay, in the 1995–1996 and 1996–1997 winters included braking tests with instrumented aircraft and various ground friction-measuring devices. The tests were conducted using NASA’s B 737, the National Research Council Canada’s F 20, the U.S. Federal Aviation Administration’s B 727, and the de Havilland Dash 8 aircraft on surface conditions that were artificially varied to expand the range of data collected. Many different friction measuring ground vehicles—vans, trailers, and modified cars—took readings with continuous and fixed slip devices under similar runway conditions, for comparison with each other and with the braking performance of the instrumented aircraft.

In the 1997–1998 winter, additional data were collected at North Bay with the Falcon 20, the de Havilland Dash 8, and 13 assorted ground friction measuring vehicles. A one-week test period in early March at the new airport facility in Oslo, Norway, was also supported by a variety of ground test vehicles. At the Fifth Annual NASA Tire/Runway Friction Workshop in May, held at the NASA Wallops Flight Facility, more ground vehicle friction information was added to the already substantial database.

The 1998–1999 winter followed a similar pattern, with aircraft tests at North Bay and Gwinn Sawyer Airbase, Michigan, ground vehicle tests in Oslo, and tests with a B 757 and ground vehicles at the Wallops Flight Facility. In 1999–2000, work focused on

- quantifying the effects of ice-control chemicals on runway friction
- determining why aircraft seem less sensitive to surface slipperiness than are ground friction measuring instruments
- increasing the understanding of the relationship between readings from ground friction measuring instruments and aircraft braking friction performance

Tests were held as usual in North Bay at the end of January.

In summary, information acquired in the 1999–2000 winter includes the following: Data on over 400 test runs with aircraft and 8 000 with ground friction vehicles have been collected. Three international meetings (in 1996, 1997, and 1999) have been held in Montreal to disseminate the results of the program.

The James Brake Index, used in Canada to help pilots to calculate landing distance on a contaminated runway, has been revised as a direct result of the data gathered in North Bay. It is now referred to as the Canadian Runway Friction Index. The IRFI is constantly refined as additional data are acquired, and a virtual reference device has been selected. An IRFI methodology standard that defines procedure and accuracy requirements is under review for approval by an ASTM committee.

4.3.2 Friction Tests with SALTAR

There were nine other ground friction-measuring devices participating in these tests. Along with the SALTAR, the following devices were also used:

USFT	U.S. version of the airports surface friction tester from Sweden with two different tires
SFT79	1997 Saab friction tester owned by Transport Canada
BV11	Swedish-designed friction tester owned by the FAA
RFT	runway friction tester by K. J. Law owned by the FAA
E274	ASTM E274 skid tester from the Virginia Department of Transportation
GT	Scottish-designed grip tester
IMAG	French-designed friction-measuring device
ERD	electronic recording decelerometer owned by Transport Canada
ITTV	NASA's instrumented tire-test vehicle

The following pictures show three of the ground friction vehicles running tests at the workshop.



FIGURE 4.6 Iowa DOT vehicle at North Bay, Ontario.



FIGURE 4.7 NASA instrumented tire-test vehicle.



FIGURE 4.8 RUNAR friction trailer.

All of the friction-measuring devices were run on some or all of the nine test sites. The surface conditions at these tests were as follows:

- loose and compacted snow
- smooth and rough ice
- sanded and chemically treated ice
- slush

4.3.3 North Bay Test Results

The SALTAR unit, mounted on the HMCV, was tested along other ground friction measuring devices during the Joint Winter Runway Friction Measurement Program. Testing on the SALTAR showed that at very low temperatures, -30°C for example, that the pneumatic lines within the SALTAR needed better winterization as any water in the lines froze causing low tire-pavement contact pressure. The preliminary results show some variation at very low friction

levels as shown in Figure 4.9. The variation is due to the accuracy of the measuring instrument, possibly caused by ice in the airline.

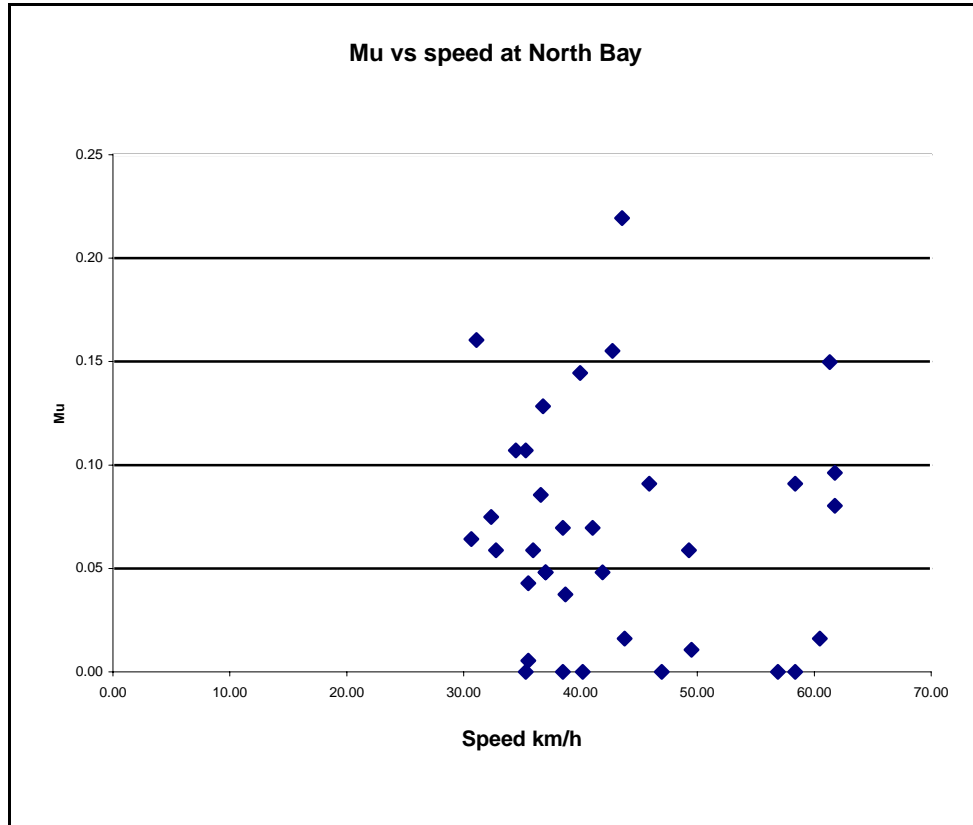

FIGURE 4.9 Scatter effect at low-friction values for SALTAR.

Figure 4.10 displays preliminary data samples of SALTAR’s friction measurements covering a distance of 1,000 meters over two types of roadway conditions. This particular test run was conducted at 20 mph, over a road surface that was one-half hard packed snow treated with sand, and one-half dry pavement. The graph plots the friction coefficient (Y-axis) against the number of measurements taken over 1,000 meters (X-axis). As indicated in the graph, the SALTAR measured lower friction values while running over the hard packed snow. The SALTAR measured higher friction values while running over dry pavement. Thus, in this particular test, the SALTAR performed as expected providing good friction measurements at a low speed.

Preliminary analysis revealed that the SALTAR was sensitive to cold temperatures. When the pneumatic system was exposed to cold temperatures for period of time, there was a delay in the lowering of the wheel to the road surface and holding the wheel on the surface. Once this delay was discovered, the down pressure was adjusted. Subsequent tests were run after the wheel was lowered and set in place for two minutes. The SALTAR performed as expected following these adjustments.

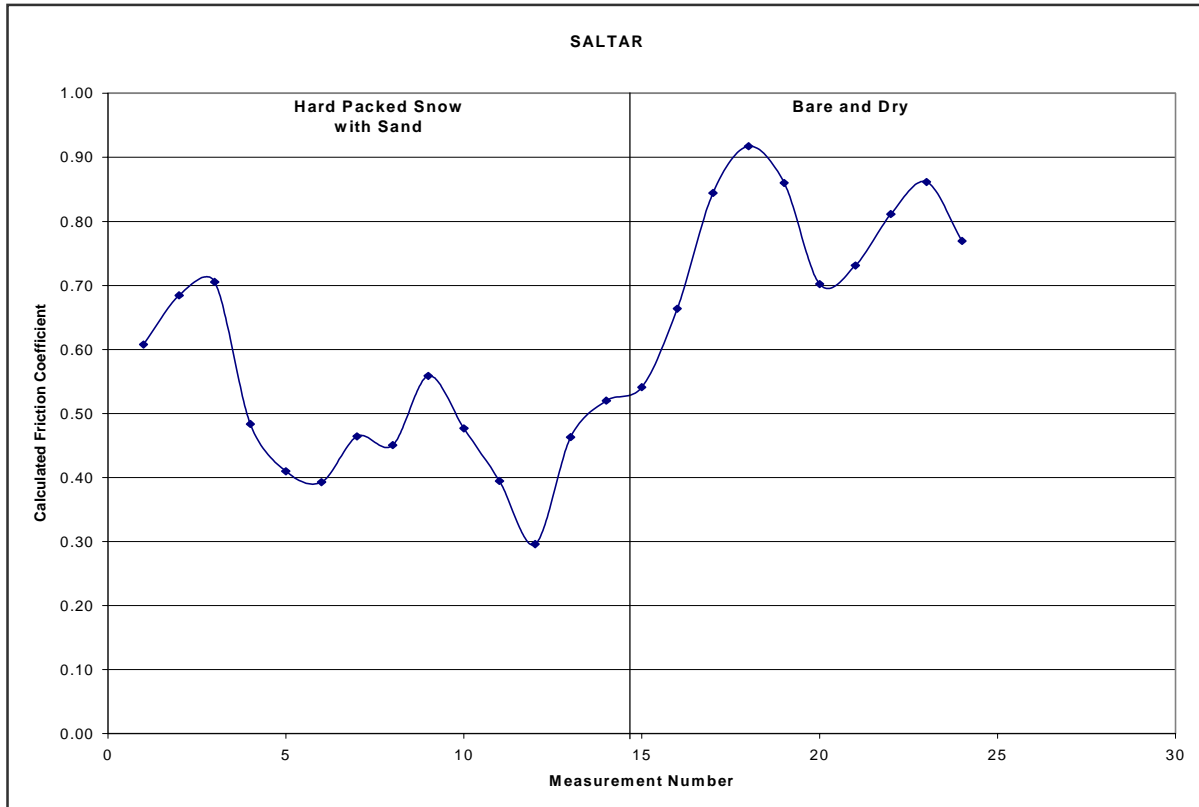

FIGURE 4.10 Calculated friction coefficient at low speed in winter conditions.

Dr. James C. Wambold’s preliminary analysis of the SALTAR data from North Bay also showed a mixed review. During these tests there were variations in friction measurements at varying speeds. Figure 4.11 shows the results the tests run at three speeds, describing the increase in friction with increasing speed.

Over all comparisons of the SALTAR measurements showed that the friction values were low when compared to the reference device. However, no calibrations were carried out since it could not be determined when the low reading was due to low tire–pavement contact pressure or if it was a low reading with the proper tire–pavement contact pressure. Since the data from Norway were without these problems, those data were used to make comparisons.

Dr. Wambold further concludes that the SALTAR unit, while it shows promise, needs additional improvement in order to perform as expected in the harsh conditions that it is subject to in winter maintenance operations. Furthermore, it does appear that from the road test made after the tire–pavement contact pressure load was increased that the SALTAR system worked much better and the measurement results appear to be more within the accepted ranges. Figure 4.10 shows the measured friction coefficient of the SALTAR after the tire –pavement contact pressure was adjusted. These measurements were taken on two surface types, one with hard packed snow and the other surface was bare and dry. As one can see the measured friction coefficient, μ increased on the bare and dry surface, with the proper tire–pavement contact pressure.

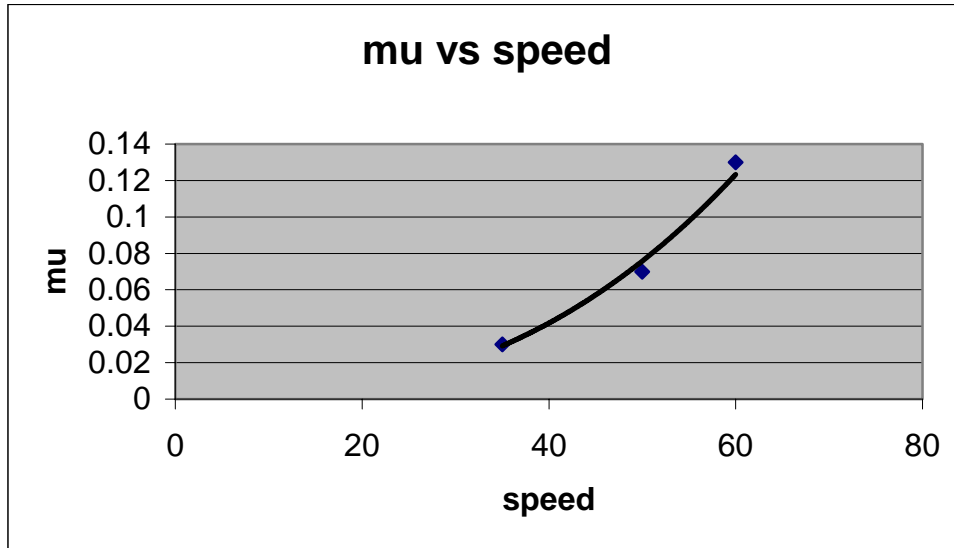

FIGURE 4.11 Coefficient of friction (μ) at three different speeds.

4.4 SALTAR Data from Norway

Similar testing was conducted in Norway by the Norwegian Road Administration (NRA), where the SALTAR and ROAR were run together in order to make comparisons. Figure 4.12 shows that the SALTAR measures low when compared to ROAR; however, SALTAR does appear to increase or decrease in a similar manner. Hot sand, followed by cold sand, was then applied to same section of pavement, and the measurements were then repeated. Figure 4.13 shows these results that clearly indicate that SALTAR does measure the change in friction level, but reads lower than the ROAR unit.

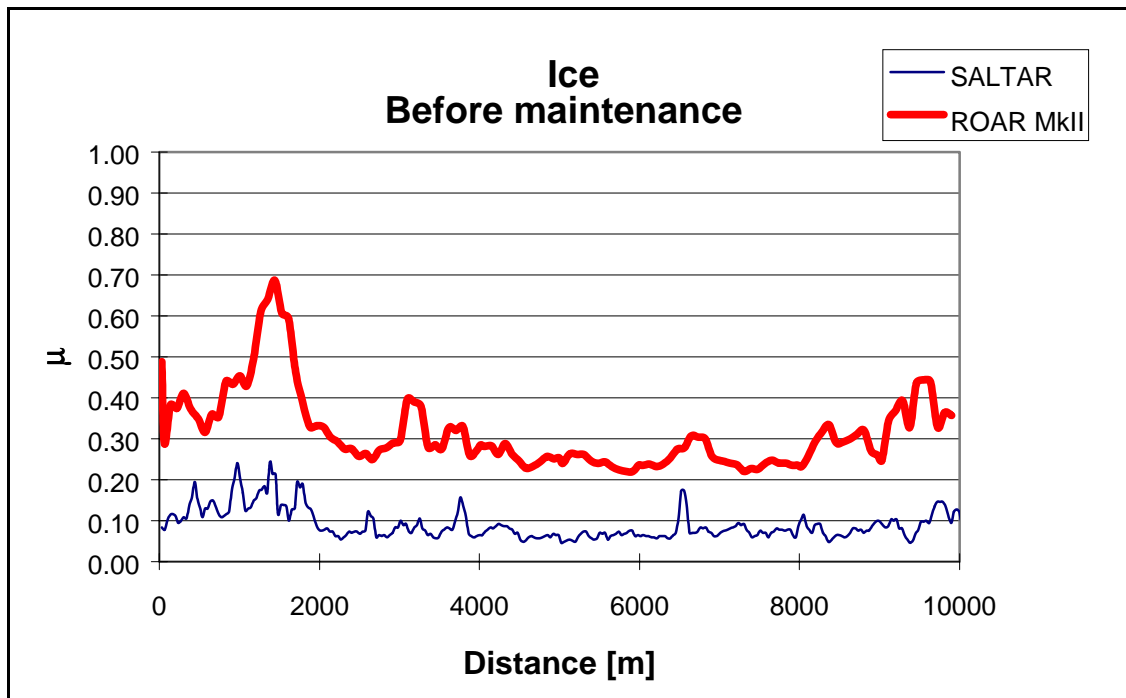

FIGURE 4.12 Friction by SALTAR and ROAR on a section of road covered with ice.

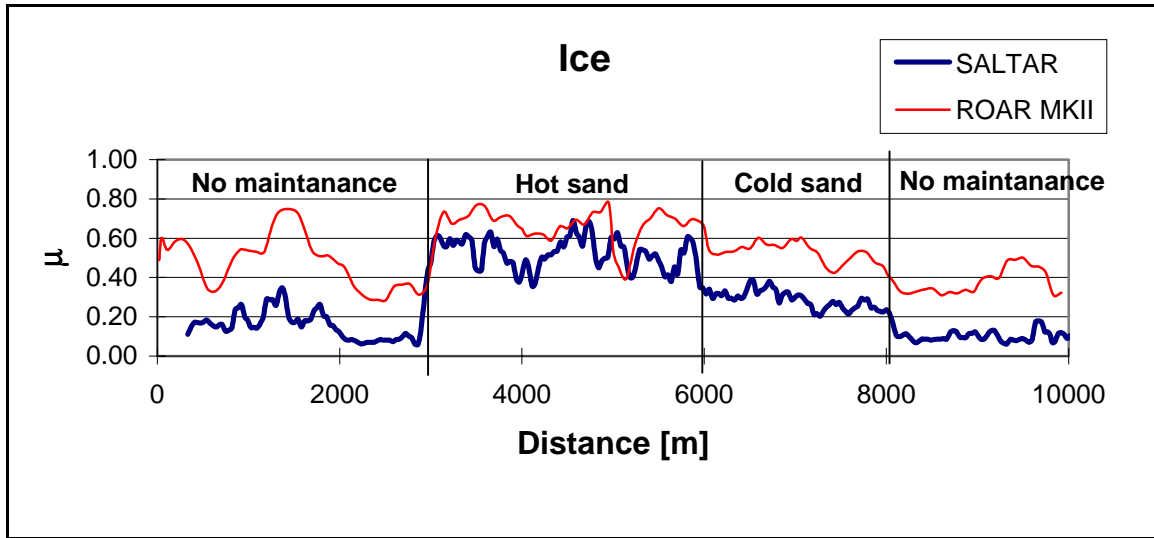

FIGURE 4.13 Ice-covered road given in Figure 4.12 with hot and cold sand applied to the midsection.

Based on the result of this test, a calibration was made and those results are shown in Figure 4.14. This calibration was then applied to the data from Figures 4.12 and 4.13 and they were replotted as Figures 4.15 and 4.16. It is felt that with the calibration, the SALTAR reads the friction values satisfactorily.

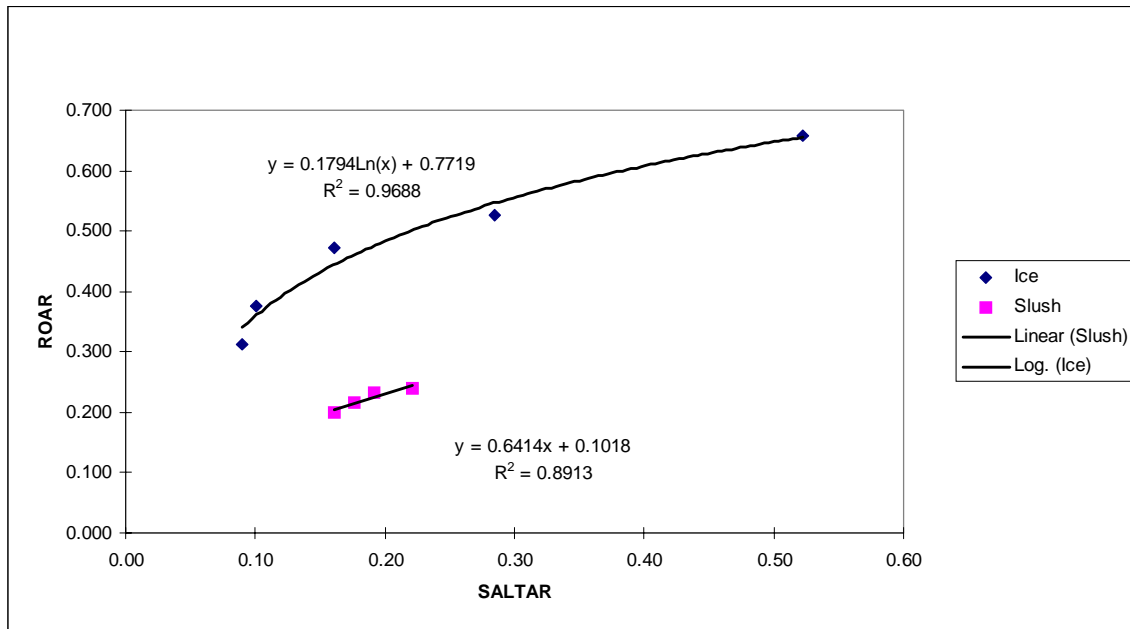

FIGURE 4.14 Correlation of SALTAR and ROAR.

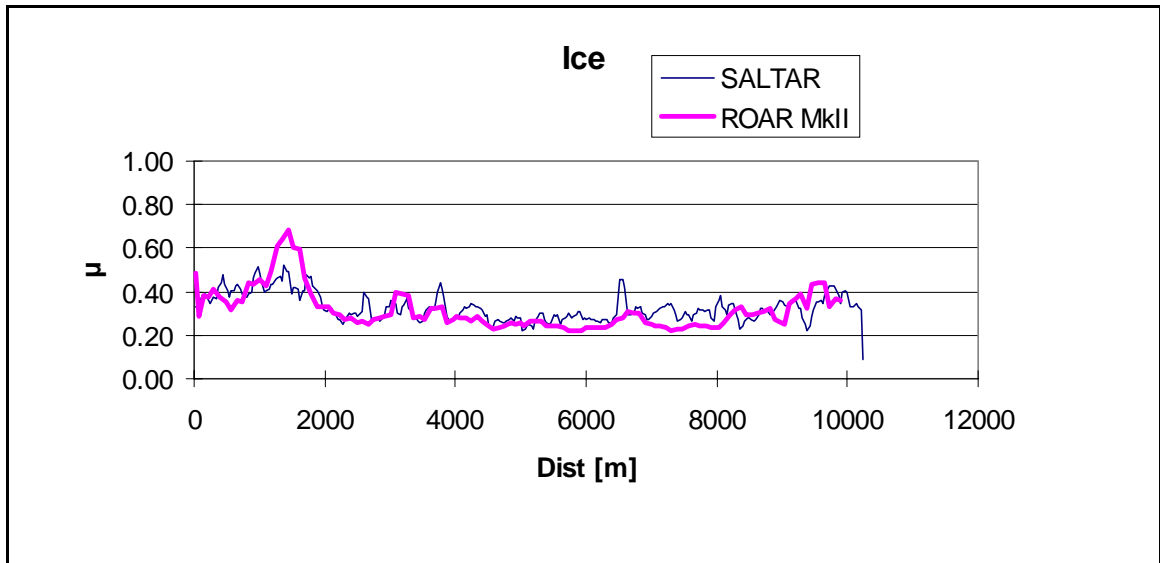

FIGURE 4.15 Data from Figure 4.12 with correlations applied.

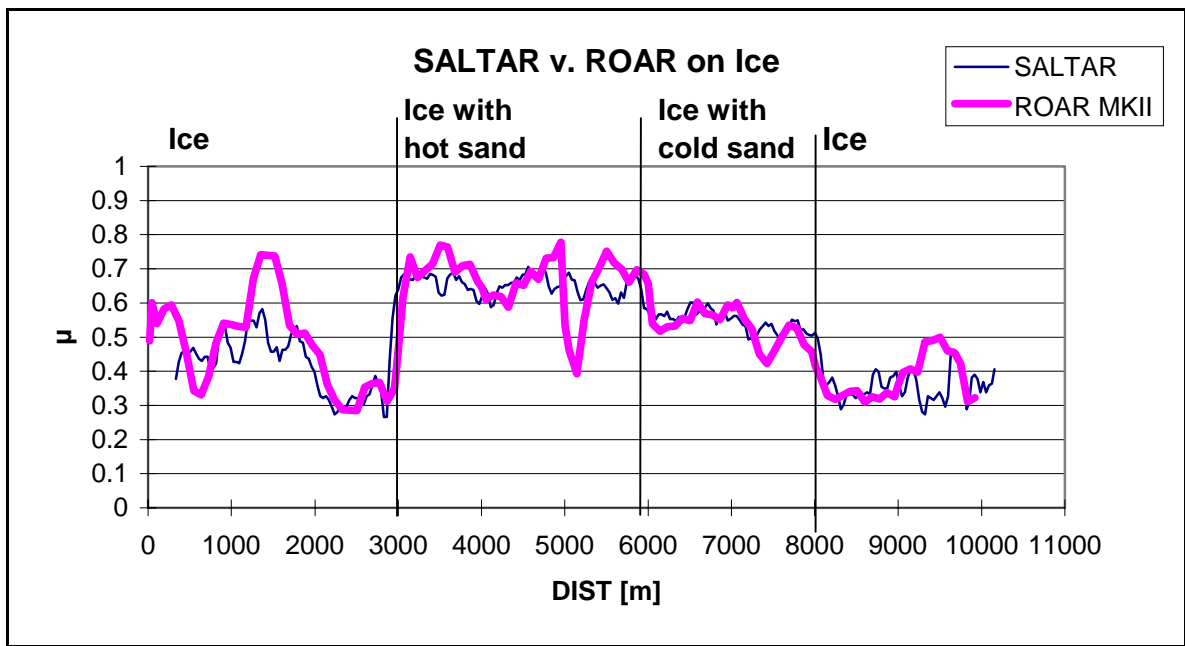

FIGURE 4.16 Data from Figure 4.13 with correlations applied.

From tests at different speeds on hard-packed snow, we see in Figure 4.17 that there is a very slight increase in friction with speed, but nothing like that at the NASA Wallops tests. These tests consisted of three rounds at three different speeds (one at 30 kilometers per hour, one at 50 kilometers per hour, one at 70 kilometers per hour) and one round with four speeds (one run at 90 kilometers per hour was added.)

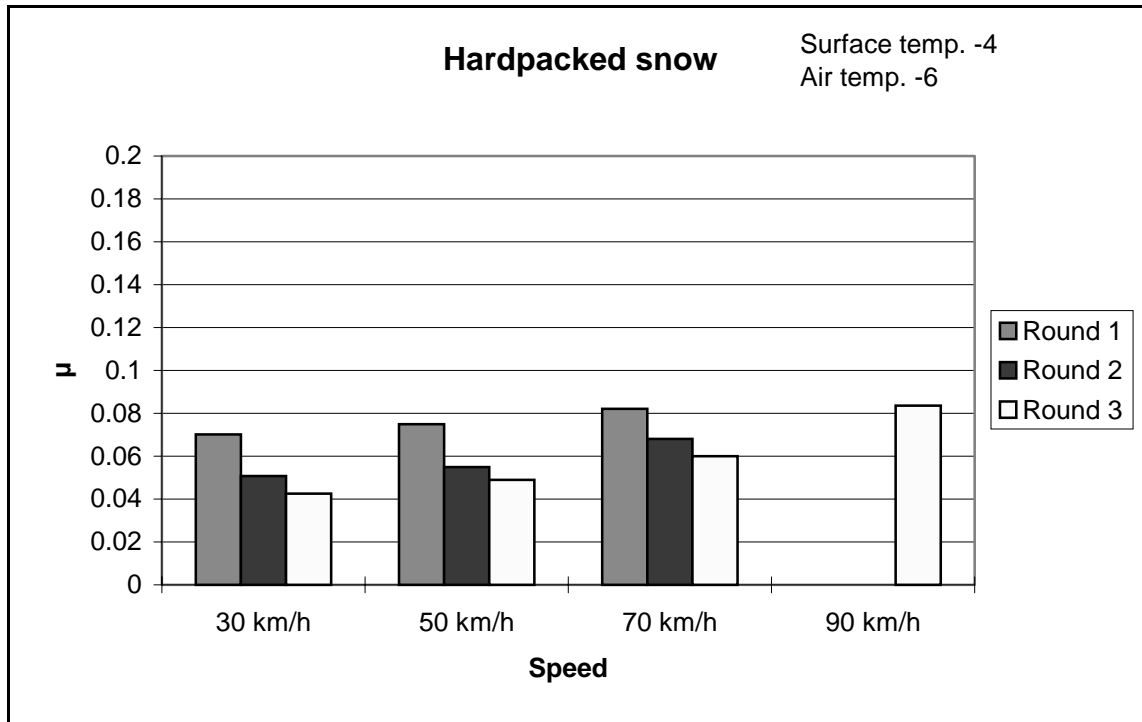

FIGURE 4.17 Friction measurement at different speeds.

4.5 Minnesota Experience with SALTAR Friction Meter

The field-testing for passing proof of concept with the SALTAR was conducted with the Iowa and Minnesota prototype vehicles. The SALTAR unit on the Minnesota vehicle, however, was unable to fully conduct field-testing. First, installation proved to be more challenging than anticipated. There was a delay in obtaining a 24 V to 12 V power converter for the Mn/DOT unit. Numerous contacts were made among Mn/DOT, Iowa DOT, CTRE, and Norsemeter to solve the installation procedures. Once the unit was installed, acceptance testing was conducted to ensure that the unit was functional.

In January 2000, acceptance tests were run on the SALTAR and the Mn/DOT vehicle. A sample of the data are shown here:

Reference Speed	Measured Friction	Friction Level
358	103	2
416	103	3
426	361	5
432	171	5
425	214	5
424	22	5
431	18	4

Second, because of the delays in installation and an unusually mild winter that included a lack of snow, only one test run was observed that showed the SALTAR in actual field conditions.

Third, when a snowstorm did arrive, the wheel hub on the Mn/DOT SALTAR unit locked up and the wheel would not rotate, causing it to fail. Norsemeter is aware of the situation and is working with the consortium to solve the problem.

4.6 Iowa Experience with SALTAR

On Iowa's vehicle, the SALTAR friction meter was installed in the same location as the ROAR unit was in Phase II, in front of the left dual rear wheels. Because the SALTAR smaller in size than the ROAR unit, the SALTAR did not interfere with the underbody blade as the ROAR did previously.

The Iowa DOT was able to conduct several field tests with its SALTAR unit. As was previously reported, the Iowa unit was tested at Wallops Island and North Bay. These field tests revealed two problems. In the first case, as was discussed earlier; by dispensing a constant amount of water before the measurement tire an increase in friction relative to an increase in speed was measured. For any new tests on wet pavement, the tests will have to be conducted by increasing the water flow in relation to increased speeds in order to maintain consistent measurements on wet pavement. A second problem was observed during the cold weather tests in North Bay. It was discovered during these field tests that the down pressure in the pneumatic cylinders that hold the wheel firmly to the surface was insufficient for consistent measurements. The team was able to make the proper adjustments to the down pressure in the cylinders; however, the tests showed that the SALTAR might be temperature sensitive.

The Iowa DOT also encountered very little snowfall with which to field test the SALTAR unit during actual winter snow plowing conditions. Once the vehicle returned from North Bay, there was one snowstorm with which to collect data. The SALTAR performed and recorded the friction data during that storm event.

4.7 Failure Analysis of SALTAR Friction Measuring Device

An analysis of the mechanical and structural components is vitally important to safe and cost effective operation of any system in which the materials are susceptible to environmental degradation. Performance assurance that is closely related to life prediction is equally important to ensure that the system will operate as per design for the duration of its life. This section will examine the SALTAR friction-measuring device used in Minnesota and determine what happened to the unit. Figure 4.18 shows the SALTAR installed on the snowplow truck.



FIGURE 4.18 SALTAR friction-measuring device.

At the forefront of our research efforts is to determine the reason for performance failure of the SALTAR prototype used in Minnesota. Thus, the team worked together to determine the needs for reliability and performance in the equipment. Research initiatives included assessing damage and potential for failure from destructive elements such as fatigue and corrosion.

4.7.1 Steps of Analysis

Following the measuring wheel locking up, an initial analysis of the failure was made. Several attempts at troubleshooting the SALTAR were initiated once the failure was reported, but the results of those efforts proved to be unsatisfactory.

The measurement wheel was removed and attempts were made to remove the flange and box assembly cover; however, those attempts to remove the cover were not successful. It was hoped at that by removing the box assembly cover, an examination of the components could then be made and a cause of the failure could be determined. It was at this point that Mn/DOT personnel reported some rust and contamination on the wheel shaft.

During these attempts at removing the box assembly cover numerous contacts were made between Mn/DOT, CTRE, and Norsometer to correct this problem. Unfortunately, the SALTAR could not be repaired in time to complete the winter snow removal season; consequently the SALTAR was removed from the Mn/DOT vehicle.

Iowa DOT and CTRE later obtained the SALTAR from Mn/DOT and brought it to the Iowa DOT Central Shop for analysis. An initial, visual examination of the SALTAR indicated that the tire had burst, leaving a large hole in it; the wheel was missing three of four lug nuts, and there was scarring on the outer housing. Figure 4.19 shows the SALTAR after being removed from the vehicle.



FIGURE 4.19 SALTAR unit used in Minnesota.

Figures 4.20 and 4.21 show the equipment used to remove the box assembly cover and flange following the removal of the wheel. The puller was used to provide equal force on each side of the flange in order to remove it.

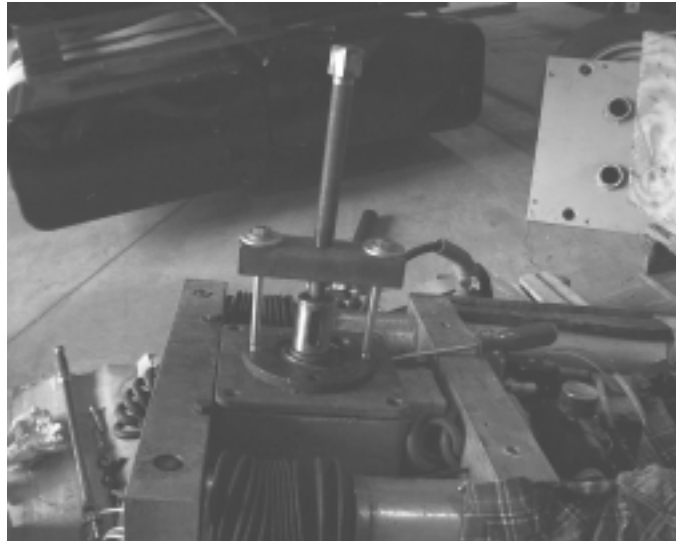

FIGURE 4.20 Removing the flange and box assembly cover.

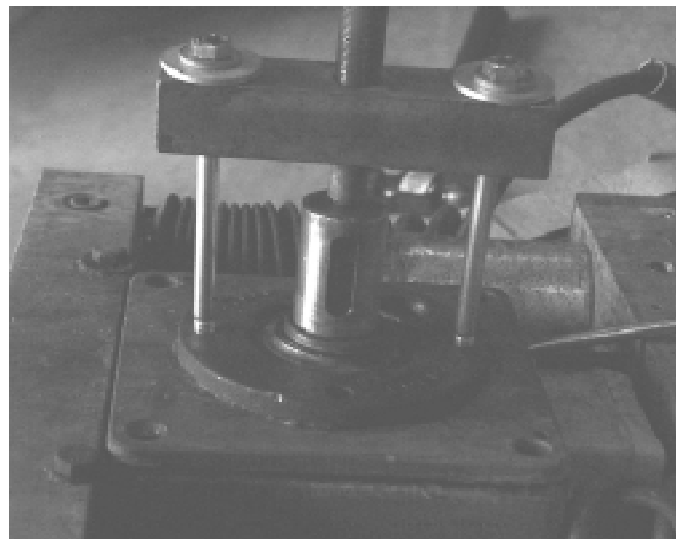

FIGURE 4.21 Using a puller to remove flange.

Figures 4.22 and 4.23 indicate the extent of the corrosion inside the gear assembly. The ferrous material on the gear wheel, shaft and the interior of the assembly box displayed a significant amount of contamination.

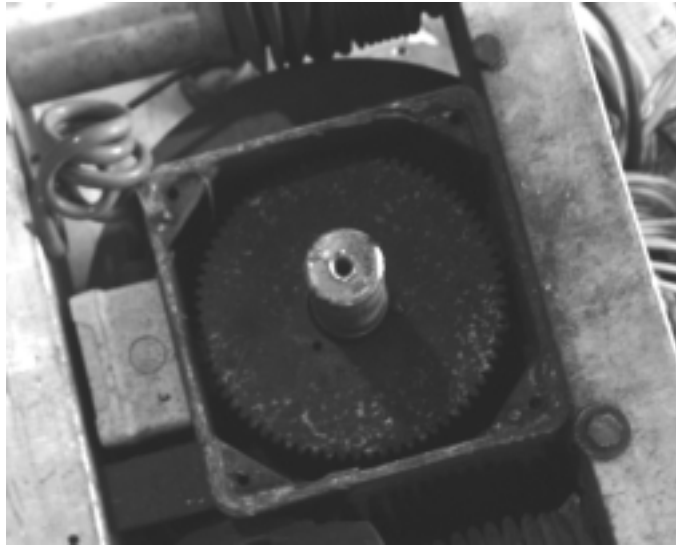

FIGURE 4.22 SALTAR with flange and cover removed.



FIGURE 4.23 Shaft with some corrosion.

Figure 4.24 shows the assembly with the gear wheel removed. The arrow indicates the position of the proximity switch. The proximity switch “reads” the teeth of the gear wheel, calculates speed and activates the brake. The visual inspection showed that the corrosion in the box damaged the proximity switch, causing the wheel to brake. If the proximity switch does not work properly, the brake would activate as a safety measure. Following this examination, we concluded our visual inspection and forwarded our findings to Norsemeter.

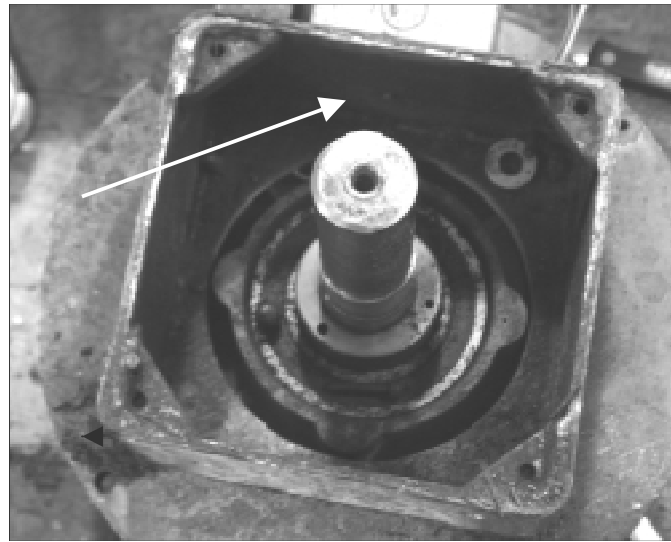

FIGURE 4.24 SALTAR with gear removed.

4.8 Recommendations

Besides the SALTAR friction–measuring device used by Minnesota DOT, two other SALTAR prototype devices have been field–tested. The Norwegian Road Administration (NRA) tested one unit in Norway. The Iowa DOT field–tested the other unit. All three of the units were exposed to harsh winter weather conditions. Following our analysis of the prototype SALTAR used in Minnesota, the team discussed possible changes to the SALTAR device with Norsemeter. Following those discussions Norsemeter offered the following solutions for successful operations with the SALTAR.

Issue 1 regarding the lifting and lowering mechanism: The design of the seal and driving rings in the two main pneumatic cylinders were proven to be insufficient in both material and precision fabrication. This led to the fact that the raising and lowering of the measuring wheel used an excessive amount of time and that the downward pressure on a rough road was insufficient. To remedy this Norsemeter has redesigned the rings using a different material and fabrication process.

Solution: Norsemeter will produce the necessary rings and provide the necessary written procedure for the installation.

Issue 2 regarding the electronic junction box of the basic unit: On the first prototype the electronic junction box was placed in a position that proved to be wrong. The original position was difficult to protect and seal with regard to water and other contaminants and lead to electrical problems. This was already solved on the Iowa and Minnesota units prior to shipment.

Solution: Norsemeter will prepare written procedures to open, inspect, and reseal this junction box in preparation for the upcoming winter season.

Issue 3 regarding the electromechanical brake: The testing has shown that despite the manufacturer's rating of IP65 sealing the brake unit does not perform according to specifications. The moving parts of the brake originally have been sealed with a rubber bellows that have been fortified by Norsemeter with two steel clamps. The accumulated water, slush, snow, etc., are melted by the heat generated by the brake and the resulting water enters into the brake and degrades the torque characteristics of the brake discs. This has led to the point where the brake was not capable of fully locking the wheel on high friction surfaces.

Solution: Norsemeter has developed a new method of sealing with a special liquid rubber sealant that makes the rubber bellow and steel clamps IP65 and the seal can be re-opened. The instructions and materials necessary for the resealing of the brake will be sent to Iowa.

Issue 4 regarding the bearing housing and sensor box: The bearing housing was performing on the units, with the exception of the Minnesota unit, where severe damage in the components including the main shaft was inflicted by corrosion. This leads to the conclusion that there was some damage done to the bearing housing on the Minnesota unit leading to the damage to the box itself or to the seal on the housing.

Solution: Norsemeter will send instructions for the opening, maintenance and resealing of the bearing housing in preparation for the winter season.

Issue 5 regarding the main wheel shaft: The main wheel shaft has been designed and made of materials to withstand harsh environment. Thus, the corrosion even in an aggressive corrosive environment should be minimal.

Solution: The shaft of the remaining units should be inspected and painted or galvanized if excessive corrosion can be observed. Also, a corrosion resistant grade of stainless steel should be used on the outer body chassis, gear wheel, shaft, and assembly box, equivalent to ASTM 316 grade of stainless steel.

4.9 Conclusions

While SALTAR is a prototype, it was shown to be able to establish friction levels and shows great promise to be able to measure road friction under winter conditions. The brake system works according to specifications and the overall principal works well. Further investigation and development of the device are required and the following actions are recommended:

- Since the environment that the SALTAR operates in is extremely harsh, the device must be rugged and designed to withstand the harsh conditions and still operate. Maintenance requirements must be rudimentary and easily performed.
- Since the test tires are consumable items, replacement tires must be readily available, inexpensive, and easily installed.
- An ASTM Standard must be developed for SALTAR for consistency and reliability.
- The pneumatic system must be fully winterized to withstand the harsh climate that it is exposed to in winter maintenance operations.
- A calibration procedure needs to be fully developed to ensure accuracy of measurements.
- The reason for the low readings, as compared to the ROAR, is eliminated with further development so that absolute friction values are measured and read.

- One method to possibly prevent corrosion is to clean the road salt and other debris from the SALTAR after each use.

5 PROOF OF CONCEPT FOR ADDITIONAL TECHNOLOGIES AND APPLICATIONS INTELLIGENCE (TASK 5)

5.1 Introduction

The overall goal of the highway maintenance concept vehicle project is to provide travelers with a defined level of service during the winter season at the least cost to the taxpayers. The concept vehicle seeks to bring technology applications from other industries to highway maintenance to improve customer service, enhance operator safety, and optimize material distribution. The approach is evolutionary in that as emerging technologies and applications appear, they potentially may provide support to improving and optimizing the many facets of highway maintenance.

Three additional technologies were to be tested for proof of concept in Phase III of the HMCV proof. These three technologies are

1. a pavement surface freezing point system that will be used to develop a local, regional, or statewide chemical traces to support chemical mixture distribution decisions;
2. a material distribution intelligence that will use pavement surface temperature; chemical trace; and friction data, along with weather forecasting data to develop algorithms to support chemical mixture distribution; and
3. an operations, material, and asset management system that assists managers to improve maintenance operations, reduce costs, increase safety, improve mobility, and reduce the environmental impact of winter weather applications.

5.2 Goals

The concept vehicle for Minnesota requires the integration of the temperature sensor, friction meter, SALTAR/controller, GPS receiver, and mobile data terminal. In addition, the concept vehicle requires an on-board computer and data storage device. This is accomplished with a made-rugged laptop. The project began development of material distribution intelligence that will provide algorithms to support chemical mix distribution resulting in a level of service determined by the pavement status.

The concept vehicle for Iowa requires the same type of integration, only with the data integration and storage occurring on the AMS 200 onboard computer. The next phase in the evolution of the project is to send the data to the home base in real time communication via cellular package or other communication systems.

5.3 Design Description

The task is to develop material distribution intelligence software algorithms that will support the mix, distribution, and amount of chemicals from the onboard sensor information. This task involves developing methods whereby the on-board pavement temperature sensor and friction meter can be employed to automatically adjust the for the distribution of materials for snow removal operations. Figure 5.1, as provided by ThomTech Design's Greg Thompson, provides a block diagram of the initial decision matrix to achieve these goals.

The inputs for analysis are the air temperature, road surface temperature, and road friction reading. An algorithm to determine the optimum type and rate of material distribution would be developed to achieve a desired pavement status. Feedback is employed to adjust the spreading rate and type of material as the road friction and surface temperature vary during the snowplow's route.

There are several issues to be resolved to complete this portion of the project. The process would require that a friction reading be measured post application to determine the result of the snowplow's activity.

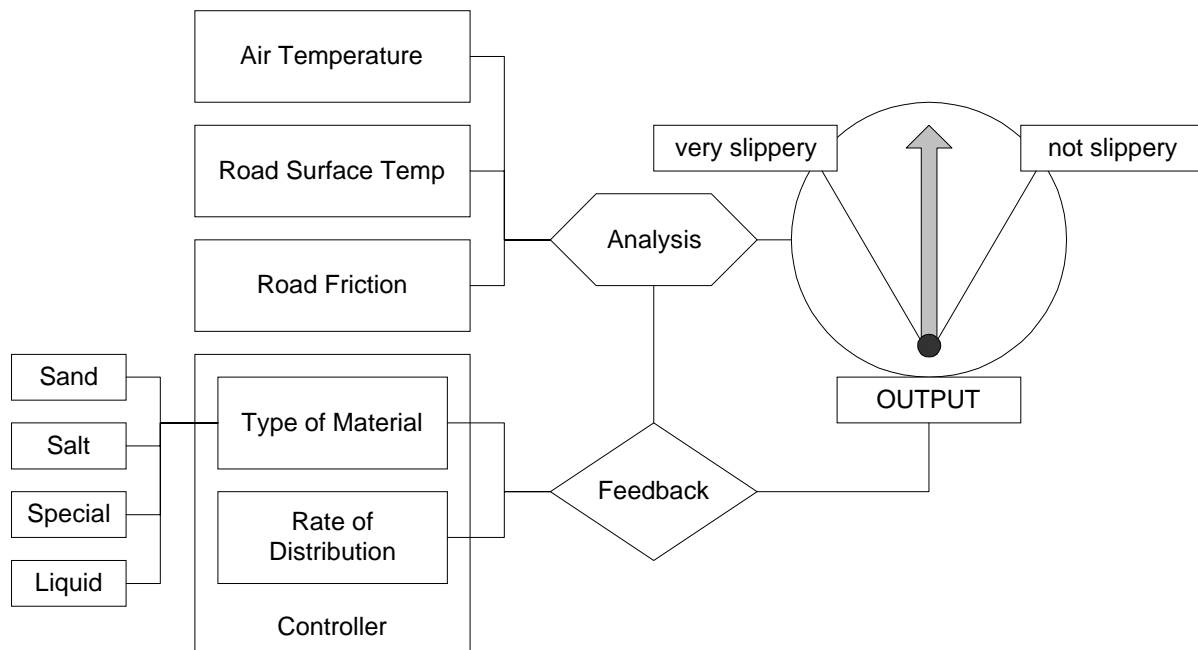

FIGURE 5.1 Decision matrix block diagram.

5.4 Status

The basic approach has been discussed within the framework of the design description. The next step is to complete the interface with the friction meter, however, the friction meter output has been unavailable and action on this portion of the project has been delayed until the friction data are available.

5.5 Partner Status (Task 6, Task 7)

Since the Michigan Department of Transportation decided not to participate in the friction-measuring portion of Phase III of the HMCV project, the consortium has been actively searching for new partners. The consortium feels that the more of a geographic representation there is in the study the better the results will be. The consortium has made numerous contacts to states such as California, Colorado, Wisconsin, Missouri, and Pennsylvania. At this time no additional states have signed on, but the effort to obtain additional partners continues.

The consortium has been successful in attracting additional private sector partners. Enator, a Swedish firm is supplying the mobile Frensor, the pavement freezing point sensor. Also Raven Industries, a specialty-manufacturing firm of flow control systems, many of which are used in precision farming equipment, is supplying the materials distribution control head.

In Phase III, Minnesota continued the use of the slip-in Tyler V-blend, dual-chamber V-box located inside the dump body of the truck. It is a divided spreader box, allowing the operators to distribute a ratio of two granular materials. As can be seen in the pictures below, the spreader box did not hold up under the harsh winter climate. The arrows in the pictures point to areas of degradation in the spreader box.

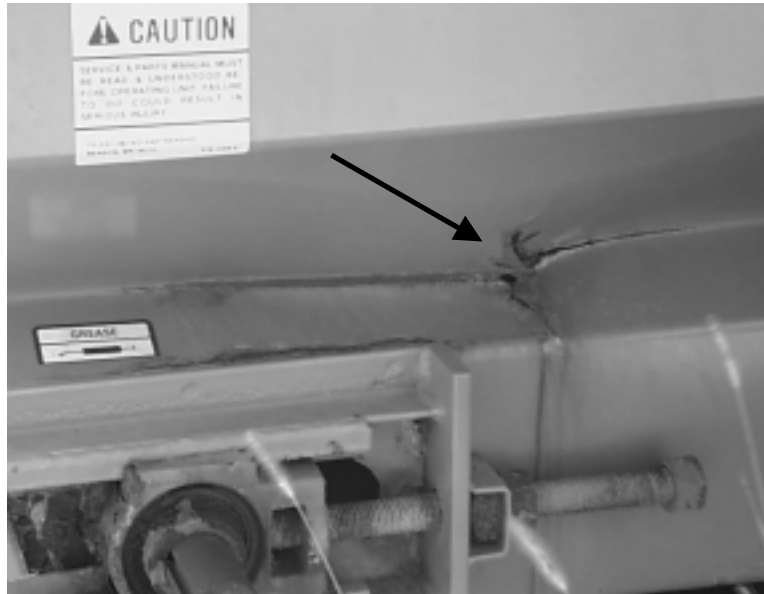

FIGURE 5.2 Area of separation on driver's side of V-box spreader.

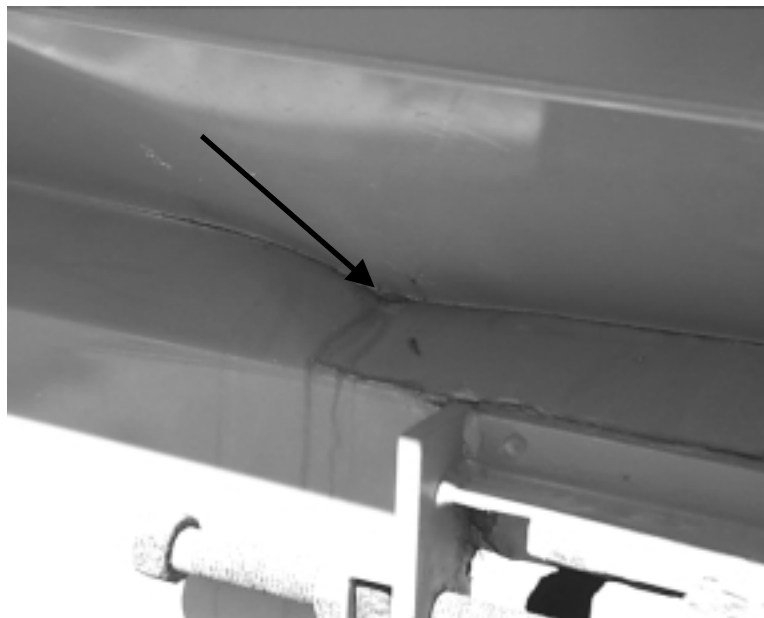

FIGURE 5.3 Area of separation on the passenger side of V-box spreader.

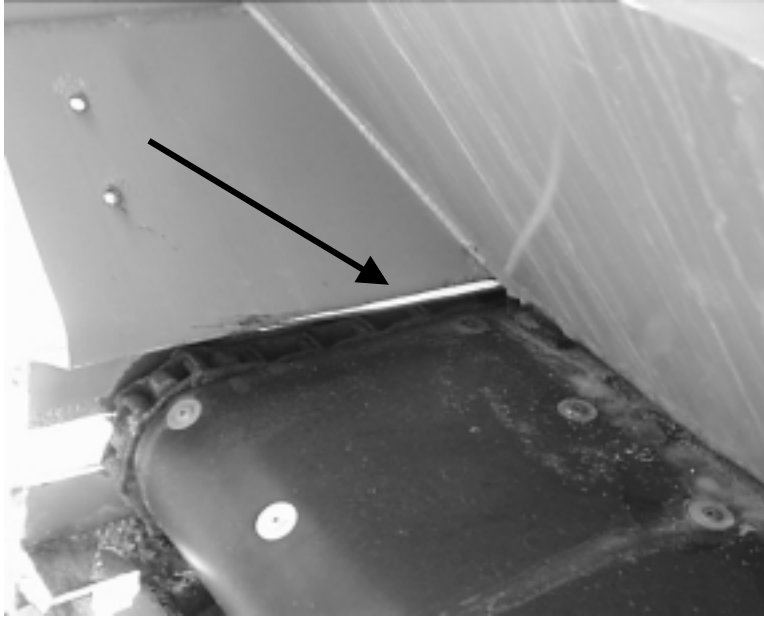

FIGURE 5.4 Area of separation near the conveyor belt.

The dual chamber design of this box was a prototype design for the manufacturer. The design is very desirable for the field as it allows for the simultaneous application of two types of materials. Part of the mission of the study team was to investigate and test various technologies and report on any weaknesses found during the tests. The weaknesses discovered during the use of this prototype design have been improved on and corrected with future designs of the hopper.

6 BENEFIT-COST ANALYSIS (TASK 8)

One of the critical aspects of the HMCV is the benefit-cost analysis of the technologies as they are applied to winter maintenance operations. An initial benefit-cost analysis was conducted during the winter 1999–2000 with the Ames Area Maintenance Garage, examining mobile pavement temperature sensors.

Our preliminary analysis showed the following: The major problem to be addressed using technology is road surface uniformity among maintenance areas during winter driving conditions and winter maintenance costs. The value of establishing and maintaining uniform surface conditions according to Iowa DOT policy has not been numerically quantified. The impact technology may have on cost can be estimated.

Benefit-cost was discussed for the following technologies:

1. pavement and air temperature sensors
2. automatic vehicle location (AVL)
3. SALTAR friction meter
4. pavement freezing point
5. materials distribution intelligence

The benefit-cost model is based on benefit-cost studies of Automated Vehicle Location Systems conducted by the Virginia Department of Transportation. The model is:

$$BC = \frac{OMS + ES}{SC + OC + MC} ,$$

where

BC = benefit-cost ratio;
OMS = operation and maintenance savings;
ES = environmental savings;
SC = start-up costs;
OC = operations costs;
MC = maintenance costs.

The operation and maintenance cost savings (OMS) are the savings to the agency on the expenditures for labor, equipment, and materials resulting from the use of the advanced technology and the concept vehicles.

These savings are described as

$$OMS = LS + EQS + MAT ,$$

where

LS = labor savings;
EQS = equipment savings;
MAT = materials savings.

The labor savings are the savings on the expenditures for the agency's own employees. The equipment savings are the savings on the expenditures for the agency's own equipment and those hired to assist with snow and ice control (if any) resulting from the use of the concept vehicle. Material savings are the savings on the expenditures for chemicals and abrasives resulting from using the concept vehicle.

The environmental savings are the savings to the traveling public and environment due to the use of concept vehicle. These savings include estimates of less chemical run-off, and reduced travel times.

The start-up costs are the costs directly related to the purchase, installation, and operation of the technologies on the concept vehicles. These include capital costs for the equipment and software, additional equipment (frame brackets, holders, etc.) needed for the systems that were not included and initial training costs. Start-up costs will be amortized over the expected useful life of the technology. The evaluation team will agree on the amortized life for the calculation.

The operations costs are the recurring technology costs, such as communications, and any other related costs incurred after deployment. The maintenance costs are the costs related to the maintenance and replacement of technology.

The Ames Area Garage operational practices are in accordance with the Iowa Department of Transportation, Maintenance Division, Office of Maintenance Safety Services Instructional Memorandum: Snow and Ice Control, Title: Snow and Ice Removal Operations (No: 8.100; effective date, October 15, 1984; revision date, October 1, 1999). Ames Maintenance Area Supervisor Paul Durham has established an estimated average combined cost per hour that includes the following factors in the benefit-cost calculation:

- operator time (labor)
- equipment time
- material usage
- chemical usage

The estimated average asset investment per hour (EAI/hr) is based on the following calculation:

$$\text{EIA/hr} = \text{operator cost/hour} + \text{truck cost/hour} + \text{materials cost/mile} \times \text{miles/hr} \quad (6.1)$$

Operator cost/hour (OH/hr) is based on the state average of function code 675 plus a 40 percent additive:

$$\text{OC/hr} = 13.75 + 0.4 \times 13.75 = \$19.24/\text{Hr} \quad (6.2)$$

Tandem truck cost/hour (TTC/hr) is based on the state average of function code 675.

$$\text{TTC/hr} = \$18.12/\text{hr}$$

Three primary types of winter maintenance operations are considered in this analysis: plowing and winging, de-icing, and anti-icing. Plowing and winging operations typically do not include distributing materials. Therefore, the EIA/hr for plowing and winging operations

(EIA/hr_{pw}) is the sum of operator cost/hour and truck cost per hour. The plowing and winging operation is typically done at 25 mph.

$$\begin{aligned} \text{EIA/hr}_{pw} &= 19.24 + 18.12 \\ \text{EIA/hr}_{pw} &= \$37.36 \text{ or } \approx \$37 \end{aligned}$$

Materials cost is based on the cost per purchase unit and the type of activity, either de-icing or anti-icing.

- purchase price for salt per ton is \$28
- purchase price for salt brine per gallon is \$0.04 (based on 2.2 pounds of salt per gallon of water)

Materials cost for a de-icing activity using 200 pounds of salt per mile and 7.5 gallons of salt brine per mile is calculated as follows:

$$\begin{aligned} \text{materials cost de-icing (MCDI) per mile for salt} &= 200/2000 \times 28 = \$2.8/\text{mile} \\ \text{MCDI per mile for salt brine} &= 7.5 \times 0.04 = \$0.30/\text{mile} \\ \text{MCDI per mile for de-icing activity} &= \$2.80 + \$0.30 = \$3.10/\text{mile} \end{aligned}$$

De-icing activity is typically done at 25 mph. Therefore, using the relationship in equation (6.1), EIA/hr for de-icing (EIA/hr_{di}) is

$$\text{EIA/hr}_{di} = 19.24 + 18.12 + 2.86 \times 25 \approx \$109/\text{hr} .$$

Materials cost for an anti-icing activity using 40 gallons of salt brine per mile is calculated as follows:

$$\text{MCDI per mile for salt brine} = 40 \times 0.03 = \$1.20 .$$

Anti-icing activity is typically done at 50 mph.

Therefore, using the relationship in equation (6.1), EIA/hr for anti-icing (EIA/hr_{ai}) is

$$\text{EIA/hr}_{ai} = 19.24 + 18.12 + 6.80 \times 50 \approx \$97/\text{hr} .$$

Iowa DOT uses \$50 EIA/hr to more clearly understand the investment necessary to be in accord with IM 8.100. The \$50 EIA/hr is an estimate that combines plowing and winging, anti-icing, and de-icing functions.

The benefit-cost analysis is based on comparing the resources necessary to achieve the target road surface condition in a given maintenance area. Other items to include in the analysis include pavement temperature, automatic vehicle location, and automated materials distribution subsystems. The data are stored for future analysis.

Once a benchmark for developing operational savings is established, the following relationship is used to estimate the impact technology may have on operational costs (operational and maintenance cost savings).

OMS = (materials application based on point RWIS road surface temperature – materials application based on road surface temperature from the mobile temperature sensor) x EIA/Hour x the time taken to reach target condition

A storm event that occurred December 21 through December 24, 1999, was selected for the OMS calculation. Because the common server used to store and route the data failed, the analysis was not possible. A storm second event that occurred January 19, 2000, was selected for the analysis. The storm event that occurred on January 19, 2000, the timing, tools, and actions used are based on those described in Table 6.1.

TABLE 6.1 Forecast Tools for Iowa DOT

Time in Advance of Event	Area Maintenance Snow and Ice Control Tool	Primary Actions Available
24 hour advance	SSI Forecast	Alert
2 hour advance	SSI Nowcast	Alert and anti-icing
Current point conditions	RWIS	Alert and de-icing
Current route conditions	Mobile temperature sensors	Alert and de-icing

Regarding the application of materials at various temperatures, the maintenance staff provided the following information:

Granular Materials—

- 35°F down to 20°F, apply salt
- 20°F down to 15°F, apply salt with discretion
- 15°F down to 0°F, apply salt/sand with discretion
- 0°F and below, apply straight sand

Liquids—

- Ambient temperature down to 20°F, apply salt brine as anti-icing and/or prewet material
- 20°F down to 10°F, apply salt brine as a prewet material
- 10°F down to the bottom of the scale, apply calcium chloride

Ice ban salt brine mixes can be used in the same conditions as salt brine. The ice ban mix works well at the eutectic point, but not more than a 5°F difference.

The benefit-cost analysis was to determine a ratio between the costs of operating and maintaining the new technology on the prototype vehicle and the benefits derived from these technologies, such as improved efficiencies, reductions in materials costs, labor costs, and equipment costs. We had also hoped to compare the prototype vehicles to standard issue vehicles. However, a comprehensive analysis was not made due to several factors. First, there were delays in getting the various equipment installed on the vehicles. The AVL, materials distribution intelligence, and pavement freezing point sensors were not installed and ready by the end of the winter. Second, as previously documented, the friction-measuring device on the Mn/DOT unit did not perform as expected. And third, the winter in the Midwest was unusually mild and it was possible to collect data on only one snowstorm when the equipment was ready and functioning.

One area that was documented, however, was a comparison of the mobile pavement temperature sensors that are used on the vehicles. Figure 6.1 shows a mobile temperature sensor that is typically mounted in the front of the truck.

The storm event that occurred on January 19, 2000, used the tools listed in Table 6.1. The I-35 route is selected because the RWIS site is located near milepost 113 on I-35. Therefore, mobile pavement surface temperature data along route I-35 and point specific pavement surface temperature data collected at RWIS site can be compared.

Following the snow event the vehicle operators were asked if they used the vehicle mounted temperature sensors to make decisions in applying chemicals to winter road surfaces. The operators stated that any changes in chemical application rates are not based solely on pavement temperature. Additional weather and environmental conditions enter into the decision-making process. Drivers and field supervisors need to know the pavement condition. For example, they would need to know the amount of snow or ice on the pavement and whether the pavement was wet. Drivers and field supervisors also need to know the trend of the current temperature. For example, they need to know if the temperature rising or falling as that change in temperature may impact the road surface condition. They also need to know the time of day the temperature was taken. If the temperature was taken early morning or late afternoon, the surface conditions could change rapidly. They also need to know what the traffic conditions are. If the traffic volume is increasing, the driver will apply chemical accordingly in order clear the road surface of snow and ice and keep the traffic moving.



FIGURE 6.1 Typical sensor mounting.

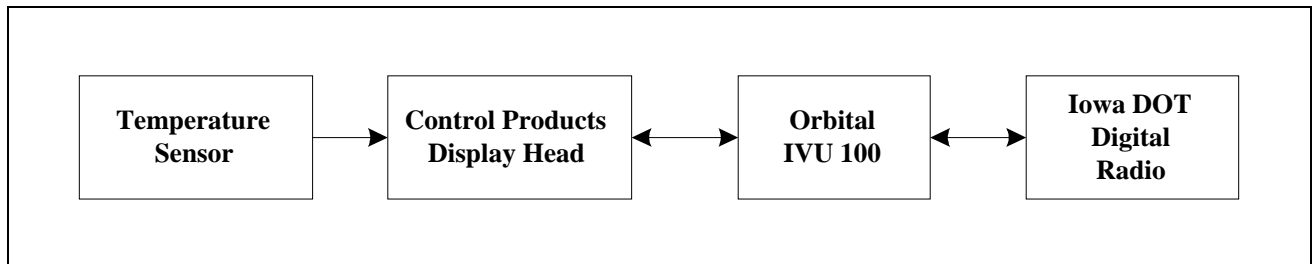

FIGURE 6.2 Typical temperature sensor system diagram.

During the interviews with the Ames Area staff, they pointed out that there are many factors to take into consideration when determining the mix and rate of materials to be applied. The operators were asked that they provide a very general and rough guide to materials mix and application rate based on pavement temperature. The staff pointed out that both predicted and current actual pavement surface temperatures are considered. The point the staff made was that the application of materials depends on many factors in addition to pavement surface temperature. Area Maintenance Supervisor Paul Durham stated, “Pavement surface temperature is one of the most important factors when determining materials distribution along with forecasts, Nowcasts, and RWIS.”

6.1 Infrared Air/Pavement Thermometer Comparison

To ensure confidence in the decision-making process, the operators and supervisors must have confidence in the accuracy of the environmental data that they receive. To that end, the Iowa DOT from January of 1998 through March of 2000 conducted a comparison of RWIS sensors and vehicle-mounted sensors independent of the HMCV project. The intent of this study was to collect information under a variety of pavement temperatures, pavement conditions, and sky conditions and to determine the accuracy of the thermometers under true field conditions. The following section summarizes the tests conducted by the Iowa DOT.

6.1.1 Test Procedure

A Ford Taurus station wagon was equipped with two vehicle-mounted temperature thermometers according to manufacturer recommendations, in a location so that they would be measuring the pavement temperature unobstructed from the vehicle frame. One thermometer was a Sprague sensor, one of the project partners; the other was a model from a different manufacturer.

The vehicle then drove by a RWIS site and recorded the pavement, deck, and air temperatures from the vehicle-mounted thermometers while traveling at slow speeds over the RWIS site-sensors. The data collected from the vehicle-mounted sensors were then compared to the data recorded by the RWIS site.

TABLE 6.2 Results of the Two-Year Comparison Test

Environmental Conditions	Manufacturer	
	Other	Sprague
Air temperature:		
Accuracy average difference	1.7	4.3
Standard deviation	2.2	3.4
Pavement temperature:		
Accuracy average difference	3.7	1.9
Standard deviation	2.3	1.7
Deck temperature:		
Accuracy average difference	3.4	2.2
Standard deviation	2.3	1.8
Other measurements:		
Clear conditions	2.5	1.5
Cloudy conditions	1.6	1.0
Wet conditions	2.1	1.2
Below 32°	3.1	1.0

6.1.2 Results

During the testing period a total of 77 RWIS site to vehicle-mounted sensors comparisons were made, 39 in the first year of testing, 38 in the second year. The relatively mild winters also provided few observations (38 percent) below what might be considered the critical decision-making zone (40°F and below). Of the total observations, 23 percent were taken during wet conditions and 66 percent occurred during overcast or partly cloudy conditions. Pavement temperatures from the vehicle-mounted thermometers tended to always be colder than the RWIS sites, while the air temperatures were almost always warmer than the RWIS sites. Table 6.2 provides the results of the two-year comparison test.

6.1.3 Conclusions of Air/Pavement Thermometer Comparison Study

This test was designed to test two infrared thermometers during true operational conditions and determine which product would provide the most accurate pavement and deck temperature information for a mobile platform. One assumption in this test was the RWIS site pavement and deck temperature sensors were accurate. A service technician from the vendor of the system, Surface Systems, Inc., calibrates RWIS sites annually, but under transitions from sunlight to cloud cover there is a tendency for the sensors to be off for a period of time because they are influenced by radiation absorbed by the epoxy used to install the sensors in the pavement. According to the manufacturer this misreading does not occur when the pavement is wet since the moisture tends to equalize surface temperatures across different materials easier.

Based on the limited number of observations over these past two winters it is difficult to make a firm conclusion on which is the better infrared thermometer but initial numbers appear to indicate that the Sprague model was more accurate from the data collected from these tests. The independent laboratory tests of the two products, however, that compared them against a known temperature source at different temperatures reported the other thermometer not only provided better accuracy at all temperatures but also performed better at lower temperatures. Our tests did not reveal the same results. The differences in results may be due to fewer samples obtained, especially at lower temperature ranges or a flaw in the placement of the sensors.

Reports from the field indicate that the Sprague infrared thermometer is the easiest to install and is less sensitive to temperature reading fluctuations, which makes it easier to read in the cab of a moving vehicle. Air temperature readings from the two infrared thermometers were influenced by engine heat during the tests. If the vehicle idled for very long at one place the air temperature would rise to match the engine temperature and would considerable time (30 minutes or longer) to recover. The manufacturer has corrected that problem with their new sensor by providing a separate cable for the air thermometer, which permits it to be located away from the infrared thermometer and any heat sources. The pavement temperature readings from both units did not appear to be influenced by the engine heat since they were installed to make sure that the field of vision for the infrared sensor was clear of any obstructions.

For example, when using the Sprague thermometers care should be taken in the installation of these units to ensure that the field of vision between the thermometer and the roadway is not obstructed and that the units are placed away from heat sources. The Sprague units are built with emissivity set at 0.96, and the user should be aware that not all surfaces being measured have the same emissivity. A difference in emissivity causes different temperature readings. Concrete has an emissivity of 0.92, asphalt has a reading of 0.95, and smooth ice has a reading of 0.96. A 0.04 difference in emissivity can equate to a temperature difference of as much as 6°F. The other unit has the ability to adjust the emissivity based on the type of roadway.

User should also be aware that the infrared thermometers measure only what is in their field of vision. If the roadway is covered with snow, the thermometer will be measuring the temperature of the snow, not the underlying surface.

Data received from infrared thermometers used in combination with RWIS can provide useful information to operators and supervisors in the treatment of roadways during winter operations.

Figure 6.3 is an example of the SSI forecast data used by maintenance personnel. The SCAN CAST page provides information regarding the environmental conditions that are being forecast for the next 24 hours. The information that is included in the forecast consists of probability of precipitation, the rate of precipitation, temperature trends, wind direction and velocity, and cloud cover. This type of information is critical to the decision making process to effectively deploy equipment and personnel.

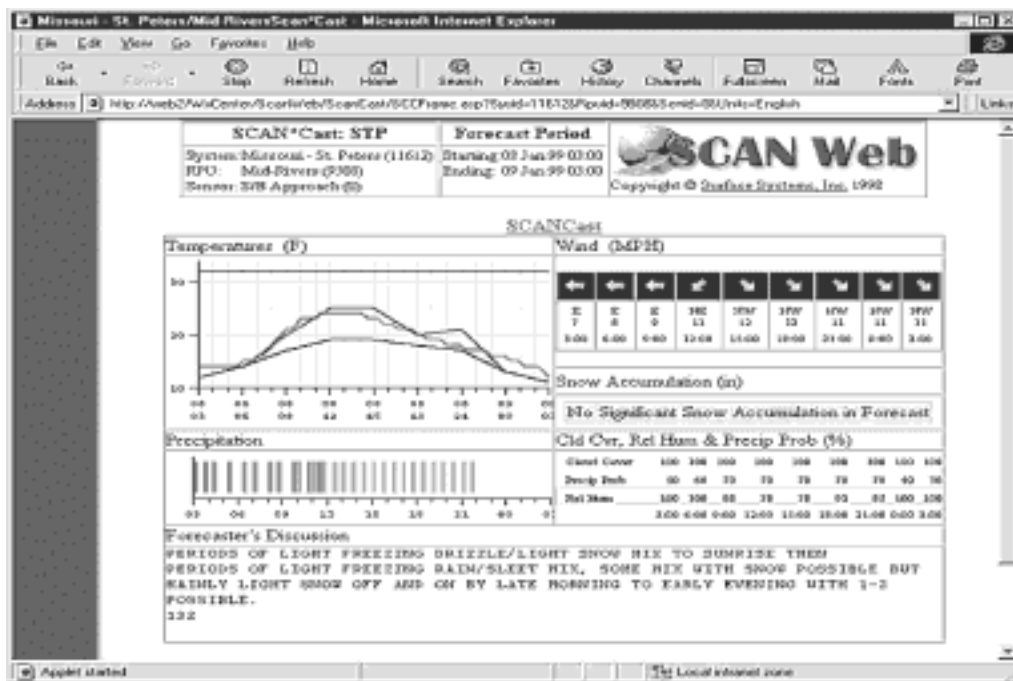

FIGURE 6.3 Surface Systems, Inc., SCAN CAST page.

Another piece of information for managing winter storms is the Winter Supplement to Supervisor's Daily Log. The supplement (see Figure 6.4) was completed by Iowa DOT and dated January 19, 2000. The report is used to describe the storm event and actions taken to mitigate the road hazards. The log provides the pertinent environmental data, along with the equipment used, the amount of material and chemical used, and the time when the roads were near normal driving condition. This information provides a basis for making a post-storm analysis of the actions that were taken during the storm to determine whether any changes are needed for the next storm event, as shown in Figure 3.1 the Iowa Network Diagram under the Fleet and Information Management Agency Systems.

Winter Supplement to Supervisor's Daily Log

(To be completed daily between October 15 and April 15. Covers period 12 a.m. to 12 p.m.)

Cost Center : 551802 — AMES	Normal conditions <input type="checkbox"/>
Date : 01/18/2000 Tuesday	Updated By : Tim Peterson
Completed By : Jim Van Sickle	Last Update : 01/18/2000

1. Bridge Frost

Frost Forecast <input type="checkbox"/> Yes <input checked="" type="checkbox"/> No	Frost Found <input type="checkbox"/> Yes <input checked="" type="checkbox"/> No	Forecast Correct <input checked="" type="checkbox"/> Yes <input type="checkbox"/> No
---	--	---

2. Weather Conditions

Precipitation			Storm	Sky	Temperature		Wind		Visibility
Started	Ended	Type	Direction	Conditions	Air	Pavement	Direction	Velocity	in miles
12:01 AM	1:30 AM	Freezing Rain	NW	Fog	28	28	SE	3	E. 1 or more

3. Crew Information

Started	Ended	Operation	Service	Granular	Salt / Sand	Liquid	Plow	Ice Blade	Wing	Rotary
			Level	Material	Mix	Material				

4. Road Closures

Route	Location	closed	Reason	Opened

5. Road Conditions

" A-B " Roads reasonably near normal : " A " - <input type="text"/> " B " - <input type="text"/>	" C " Roads reasonably bare inside wheel path : <input type="text"/>	" D " Roads reasonably bare inside wheel path : <input type="text"/>
---	--	--

6. 24 Hour Summary (if blank no usage has been reported)

Trace of Snow : <input type="checkbox"/>	Salt Brine : <input type="text"/> gal.
Snow Amt today : <input type="text"/> in.	Cacl Brine : <input type="text"/> gal.
Salt Used : <input type="text"/> 53 tons	Cacl Flakes : <input type="text"/> gal.
Sand Used : <input type="text"/> tons	Outside Sales : <input type="text"/> tons

7. Equipment Information

Pulled off Time	Reason	Back on Time

8. Comments

00:01 fog and light mist all roads wet no problems keeping eye on things 3:00 fog lifting roads damp and trying to dry some no problems
 6:00 all roads damp and drying no problems didn't have to treat anything
 53 tons for salt brine

FIGURE 6.4 Supplements to supervisor's daily log.

" A-B " Roads reasonably near normal : "A" - 2:00 PM " B " - 3:00:00 PM	" C " Roads reasonably bare inside wheel path : 4:00 PM	" D " Roads reasonably bare inside wheel path : 4:00 PM
---	--	--

6. 24 Hour Summary (if blank no usage has been reported)

Trace of Snow :	<input type="checkbox"/>	Salt Brine :	17347	gal.
Snow Amt today :	7	Cacl Brine :		gal.
Salt Used :	127	Cacl Flakes :		gal.
Sand Used :	6	Outside Sales :		tons

7. Equipment Information

<i>Pulled off Time</i>	<i>Reason</i>	<i>Back on Time</i>
------------------------	---------------	---------------------

8. Comments

5:00 all roads normal called three in to pretreat for snow or freezing rain coming starting with I-35 first then US30
 07:30 Moderate snow falling, all roads wet treating 300# salt, all roads 14:00 snow has ended have been plowing and winging on all roads and treating each round heavy snows 4 to 5 inches south end of county 6 to 7 inches on north end a and bs are all wet widing out ramps still have some slush on c and ds plowing and winging cleaning up all trucks out
 1530 all surfaces m
 1700 Wind Gusting to 31 MPH Visibility 1/2 Mile 27.8 air Temp 30.8 Surface Temp all Roads Covering up still have wet wheel Tracks 12 Out Ames and Colo
 2100 6 out at Ames and Colo Surface temp 14.6 Air Temp 8.5 Wind 18-21 out of the NW Surfaces 75% Dry 25% Packed Snow getting some minor Drifting
 2400 1.4 degrees Surface 8.5 degrees Wind 21-24 out of the NW all surfaces blowing dry 75% 25% Packed Snow still getting some Minor drifting. Getting 1 out to run back drifts 3 more will be in at 400AM

FIGURE 6.4 Continued.

Figure 6.5 shows an example of the pavement temperature forecast as depicted by SSI. The SCAN CAST pavement forecast page provides maintenance crews with a pavement temperature forecast for the next 24 hours. This information is pulled from the RWIS sites so that the supervisors can make informed decisions as to what the pavement condition is predicted to be within the next few hours, if left untreated.

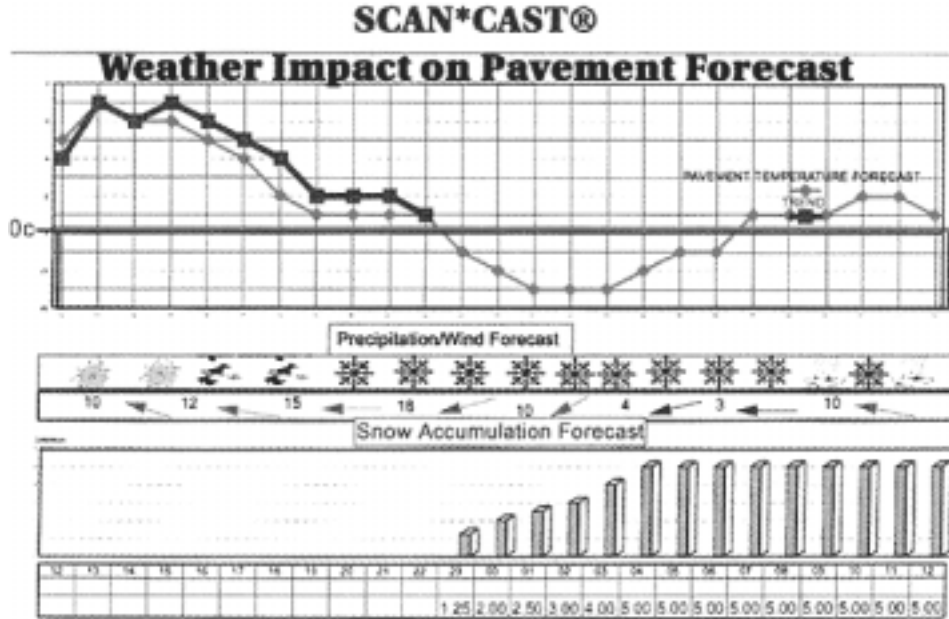

FIGURE 6.5 SCAN CAST pavement forecast page.

Table 6.3 contains RWIS data taken from the RWIS site near I-35. The table provides a snapshot of the environmental conditions during a snowstorm. The data are taken every few minutes to confirm whether the storm conditions are in fact worsening.

TABLE 6.3 Roadway Weather Information System Data

Time ^a	Surface ^b (°F)	Sub ^c (°F)	Air ^d (°F)	RH ^e (%)	DP ^f (°F)	Ave WS ^g (mph)	Gust ^h (mph)	Dir ⁱ	Type ^j	Intensity ^k
20:39	15.4	33	10.8	86	7	21	27	NW	Snow	Light
20:33	15.7	33	11.4	86	8	24	27	NW	Snow	Light
20:23	15.8	33	12.0	86	9	18	22	NW	Snow	Light
20:14	16.0	33	12.2	87	9	24	29	NW	Snow	Light
20:06	16.3	33	12.3	87	9	28	33	NW	Snow	Light
20:04	16.4	33	12.3	87	9	28	32	NW	Snow	Light

^aAll data are taken on January 19, 2000.

^bPavement surface temperature.

^cSubsurface temperature.

^dAir temperature.

^eRelative humidity.

^fDew point.

^gAverage wind speed.

^hGust speed.

ⁱDirection.

^jType of precipitation.

^kIntensity of precipitation.

Table 6.4 depicts the information gathered from the onboard sensors providing time, location, and direction information. These data can be compared to the stationary RWIS sensors to make determinations in winter roadway treatment applications. Operators must use a number of pieces of information to make decisions in their chemical application process in order to achieve normal winter driving conditions.

TABLE 6.4 Mobile Data from Onboard Sensor

ID ^a	Event Type ^b	Source ^c	Time ^d	East ^e	North ^e	Latitude ^f (°)	Longitude ^f (°)
116230	100	28488	20:37	0	0	42.1660416	-93.5807936
116231	101	28488	20:37	0	0	42.1660896	-93.576224
116235	100	28488	20:38	0	0	42.1674528	-93.5696
116236	101	28488	20:39	0	0	42.1702624	-93.5704512
116237	100	28488	20:39	0	0	42.1747104	-93.5705152
116238	100	28488	20:40	0	0	42.1825888	-93.5704896

^aID is sequential number of events.

^bEvent type is material application code: 100 is no application, 101 is applying material.

^cSource is the vehicle number.

^dTime is the time of the event. All data are taken on January 19, 2000.

^eEast and North are navigation headings

^fLatitude and longitude are GPS coordinates.

The primary objective of this chapter of the study was to compare and evaluate the benefits and costs of applying advanced technology to winter maintenance operations. While the technologies have demonstrated potential, we were not able to fully determine the benefit-cost ratio because of several environmental and technical problems. Other studies have also attempted to determine the benefit-cost of winter maintenance operations, but the indirect costs often prove to be intangible to detect. One study by Hanbali, for example, studying county practices in Wisconsin, Illinois, and New York, concluded that winter maintenance operations on two-lane highways cause direct economic savings to road users of \$6.50 for each \$1.00 spent on winter road maintenance operations during the first four hours of salt spreading. He further concluded that winter road maintenance service pays for itself within the first 25 minutes after establishing bare pavement.¹ These results were determined without the use of the advanced technologies that are operated by the prototype vehicles. Technologies such as AVL and pavement temperature sensors are gaining acceptance in the maintenance community. However, the prototype mobile friction-measuring device and pavement freezing point technologies have yet to be fully proven to operate in a harsh winter climate. By measuring the direct economic impact of advanced technology to winter maintenance operations, in Phase IV, we hope to, at a minimum, replicate these types of results from previous studies.

¹ Hanbali, R. M. Economic Impact of Winter Road Maintenance on Road Users. *Transportation Research Record 1442*, TRB, Washington, D.C., 1994.

7 TIME TO IMPLEMENTATION AND DATA FLOW

7.1 Time to Implementation (Task 9)

In this section, tables are presented that show the time to implementation of many of the technologies that are available on the HMCV. As one can see, many of the technologies on the concept vehicles are presently available. Their uses on the HMCV, however, have been adapted for highway maintenance practices. One of the guiding principles of the HMCV project was to use available technology, in order to keep costs down and get the prototype vehicle into the field as quickly as possible.

Some of the technologies that were tested, such as the friction meter, however, are not quite ready for implementation by maintenance fleets. The tables on the following pages show the time to implementation for the various technologies tested on the HMCV by Iowa DOT and Mn/DOT. The tables follow the logic as described in the network architecture diagrams in Chapter 3.

Table 7.1 shows the time to implementation for the Iowa vehicle management subsystems. Table 7.2 shows the time to implementation for the communications systems as established by Iowa. Table 7.3 indicates Iowa's time to implementation for fleet and information management agency systems, as best as we can determine. Notes to Tables 7.1–7.3 are given here:

1. Integration with mobile communications requires test of the solution presented by IDA. The test is now being planned.
2. One month after successful completion of the field test.
3. Six months for each field location and six months for the central location.
4. One month after successful completion of the interface test.
5. The functionality from integration with mobile communications to the common server design and build will be available for all technologies.

Tables 7.4–7.6 show the Minnesota highway maintenance concept vehicle time to implementation. The Minnesota concept vehicle status is based on the Minnesota network diagram dated September 11, 2000. Notes to Tables 7.4–7.6 are given here:

1. The SALTAR unit is available. However, the outcome of the analysis on the SALTAR unit tested by Mn/DOT may cause redesign.
2. The redesigned unit, Force America Model 5100, was not tested.
3. The decision support systems decision processing module is under development awaiting Mn/DOT requirements.
4. The real-time communication system selected by Mn/DOT to support the Phase III concept vehicle short term is CDPD. Long term the state-owned 800 MHz system to be deployed in metro areas and along interstate and heavily traveled primary corridors will support winter mobile data communications.
5. Decision support system requirements have not been established by Mn/DOT.
6. Mn/DOT doesn't intend to pursue winter roadway friction measurement.
7. The system functionality from the mobile transmitter/receiver to the decision support system, data processing, and analysis is available for all mobile technologies.

Table 7.1 Iowa Concept Vehicle Management Subsystems

Number	Technology (1)	Partner (2)	Bench Test (3)	Proof of Concept (4)	Redesign (5)	Field Test Initial Design or Redesign (6)	Technology Available or Projected Availability (7)	Integrated with Control and Processor (8)	Field Test Integration with Control and Processor (9)	Integration Available or Projected Availability (10)	Integration with Mobile Communication (11)	Field Test Integration with Mobile Communication (12)	Integrated Mobile Communications Available or Projected Availability (13)
1	Air/pavement temperature	Sprague	Yes	Yes	No	Yes	Yes	Yes	No	Available	Note 1	1 month	Note 2
2	Pavement friction	Norsemeter	Yes	Yes	Yes	Yes	Yes	Yes	No	Available	Note 5	Note 5	Note 3
3	Pavement freezing point	Enator	No	No	—	—	1 month	No	No	12 months	Note 5	Note 5	Note 3
4	Vehicle location	Monroe Truck	Yes	Yes	Yes	No	Available	Yes	No	Available	Note 5	Note 5	Note 3
5	Materials application control and processor	Monroe Truck and Raven	Yes	Yes	Yes	No	Available	Yes	No	Available	Note 5	Note 5	Note 3
6	Materials distribution intelligence	Raven	No	No	No	No	6 months	No	No	6 months	Note 5	Note 5	Note 3
7	Front and underbody plow position	Monroe Truck and Iowa DOT	Yes	Yes	No	No	Available	Yes	Yes	Available	Note 5	Note 5	Note 3
8	Mobile transmitter/receiver	IDA and Iowa DOT	No	No	No	No	6 months	Yes	No	6 months	Note 5	Note 5	Note 3
9	Decision support systems data processing and analysis	Aspire	Yes	Yes	No	No	6 months	No	No	12 months	Note 5	Note 5	Note 3
10	Decision support systems decision processing	Aspire	Yes	Yes	No	No	6 months	No	No	12 months	Note 5	Note 5	Note 3

TABLE 7.2 Iowa Concept Vehicle Communication System

Number	Technology (1)	Partner (2)	Communications System Design and Build (14)	Communication System Test (15)	Communications System Available or Projected Availability (16)
1	Air/pavement temperature	Sprague	6 months	1 month	Note 3
2	Pavement friction	Norsemeter	Note 5	Note 5	Note 3
3	Pavement freezing point	Enator	Note 5	Note 5	Note 3
4	Vehicle location	Monroe Truck	Note 5	Note 5	Note 3
5	Materials application control and processor	Monroe Truck and Raven	Note 5	Note 5	Note 3
6	Materials distribution intelligence	Raven	Note 5	Note 5	Note 3
7	Front and underbody plow position	Monroe Truck and Iowa DOT	Note 5	Note 5	Note 3
8	Mobile transmitter/ receiver	IDA and DOT	Iowa Note 5	Note 5	Note 3
9	Decision support systems data processing and analysis	Aspire	Note 5	Note 5	Note 3
10	Decision support systems decision processing	Aspire	Note 5	Note 5	Note 3

TABLE 7.3 Iowa Concept Vehicle Fleet and Information Management Agency Systems

Number	Technology (1)	Partner (2)	Communications Interface Design and Build (17)	Communications Interface Test (18)	Communications Interface Available or Projected Availability (19)	Server Array Design and Build (20)	Server Array Test (21)	Server Array Available or Projected Availability (22)	Common Server Design and Build (23)	Server Test (24)	Common Server Available or Projected Availability (25)	RWIS Connection with Common Server Design and Build (26)	RWIS Connection with Common Server Test (27)
1	Air/pavement temperature	Sprague	6 months	1 month	Note 4	No	No	6 months	Yes	Yes	Yes	Yes	Yes
2	Pavement friction	Norsemeter	Note 5	Note 5	Note 4	Note 5	Note 5	Note 5	No	No	No	No	No
3	Pavement freezing point	Enator	Note 5	Note 5	Note 4	Note 5	Note 5	Note 5	No	No	No	No	No
4	Vehicle location	Monroe Truck	Note 5	Note 5	Note 4	Note 5	Note 5	Note 5	Yes	Yes	Yes	Yes	Yes
5	Materials application control and processor	Monroe Truck and Raven	Note 5	Note 5	Note 4	Note 5	Note 5	Note 5	No	No	No	No	No
6	Materials distribution intelligence	Raven	Note 5	Note 5	Note 4	Note 5	Note 5	Note 5	No	No	No	No	No
7	Front and underbody plow position	Monroe Truck and Iowa DOT	Note 5	Note 5	Note 4	Note 5	Note 5	Note 5	No	No	No	No	No
8	Mobile transmitter/receiver	IDA and Iowa DOT	Note 5	Note 5	Note 4	Note 5	Note 5	Note 5	No	No	No	No	No
9	Decision support systems/analysis	Aspire	Note 5	Note 5	Note 4	Note 5	Note 5	Note 5	No	No	No	No	No
10	Decision support systems decision processing	Aspire	Note 5	Note 5	Note 4	Note 5	Note 5	Note 5	No	No	No	No	No

TABLE 7.3 Continued

Number	Technology (1)	Partner (2)	RWIS Connection with Common Server Available or Projected Availability (28)	Internet Connection with Common Server Design and Build (29)	Internet Connection with Common Server Test (30)	Internet Connection with Common Server Available or Projected Availability (31)	Intranet Connection Between Common Server and Decision Support Systems (32)	Decision Support Systems Design and Build (33)	Decision Support Systems Test (34)	Decision Support Systems Available or Projected Availability (35)
1	Air/pavement temperature	Sprague	Available	Yes	Yes	Available	Yes	No	No	9 months
2	Pavement friction	Norsemeter	6 months	No	No	6 months	No	No	No	9 months
3	Pavement freezing point	Enator	6 months	No	No	6 months	No	No	No	9 months
4	Vehicle location	Monroe Truck	Available	Yes	Yes	Available	Yes	No	No	9 months
5	Materials application control and processor	Monroe Truck and Raven	6 months	No	No	6 months	No	No	No	9 months
6	Materials distribution intelligence	Raven	6 months	No	No	6 months	No	No	No	9 months
7	Front and underbody plow position	Monroe Truck and Iowa DOT	6 months	No	No	6 months	No	No	No	9 months
8	Mobile transmitter/ receiver	IDA and Iowa DOT	6 months	No	No	6 months	No	No	No	9 months
9	Decision support systems/ analysis	Aspire	6 months	No	No	6 months	No	No	No	9 months
10	Decision support systems decision processing	Aspire	6 months	No	No	6 months	No	No	No	9 months

TABLE 7.5 Minnesota Concept Vehicle Communications System

Number	Technology (1)	Partner (2)	Design and Build Communications System (14)	Communication System Test (15)	Communications System Available or Projected Availability (16)
1	Air/pavement temperature	Sprague	Available	Yes	Available
2	Pavement friction	Norsemeter	Note 7	Note 7	Note 7
3	Vehicle location	ThomTech	Note 7	Note 7	Note 7
4	Materials application control and processor	Force America and ThomTech	Note 7	Note 7	Note 7
5	Materials distribution intelligence	ThomTech	Note 7	Note 7	Note 7
6	Plow position	Force America and ThomTech	Note 7	Note 7	Note 7
7	Mobile transmitter/ receiver	ThomTech	Note 7	Note 7	Note 7
8	Communications and client server	ThomTech	Note 7	Note 7	Note 7
9	Decision support systems data processing and analysis	ThomTech	Note 7	Note 7	Note 7
10	Decision support systems processing	ThomTech	Note 7	Note 7	Note 7

TABLE 7.6 Continued

Number	Technology (1)	Partner (2)	Decision Support System Data Processing and Analysis System Design and Build (24)	Decision Support System Data Processing and Analysis System Test (25)	Decision Support System Data Processing and Analysis System Available or Projected Availability (26)	Decision Support System Decision Processing Design and Build (27)	Decision Support System Decision Processing Test (28)	Decision Support System Decision Processing Available or Projected Availability (29)
1	Air/pavement temperature	Sprague	Available	Yes	Available	In Progress	In Progress	Note 5
2	Pavement friction	Norsemeter	Note 6	Note 6	Note 6	Note 6	Note 6	Note 6
3	Vehicle location	ThomTech	Yes	Yes	Yes	Note 5	Note 5	Note 5
4	Materials application control and processor	Force America and ThomTech	No	No	No	Note 5	Note 5	Note 5
5	Materials distribution intelligence	ThomTech	No	No	No	Note 5	Note 5	Note 5
6	Plow position	Force America and ThomTech	Available	Yes	Available	Note 5	Note 5	Note 5
7	Mobile transmitter/ receiver	ThomTech	Available	Yes	Available	Note 5	Note 5	Note 5
8	Communications and client server	ThomTech	Available	Yes	Available	Note 5	Note 5	Note 5
9	Decision support systems data processing and analysis	ThomTech	Available	Yes	Available	Note 5	Note 5	Note 5
10	Decision support processing	ThomTech	No	No	No	Note 5	Note 5	Note 5

7.2 Data Flow Maps Suggesting Methods to Integrate Data with Existing and Planned State Systems (Task 10)

Figure 7.1 shows the planned data flow for Phase III of the highway maintenance concept vehicle. The diagram shows the additions planned for the pavement surface chemical mixture to the data and the communications planned between the vehicle and the agency. The information flow map describes the path that the information takes from the point of collection through the data communications system and agency process data processing systems. Presently the data must be transferred from the vehicle via a PCMCIA card or similar device. While those data are useful, they provide for only poststorm analysis. Therefore, preparations are being made for providing for real-time communication via CDPD or similar means. For example, Iowa DOT is planning for a radio frequency system of communication with their vehicles. Mn/DOT is planning to use CDPD communication with their vehicles.

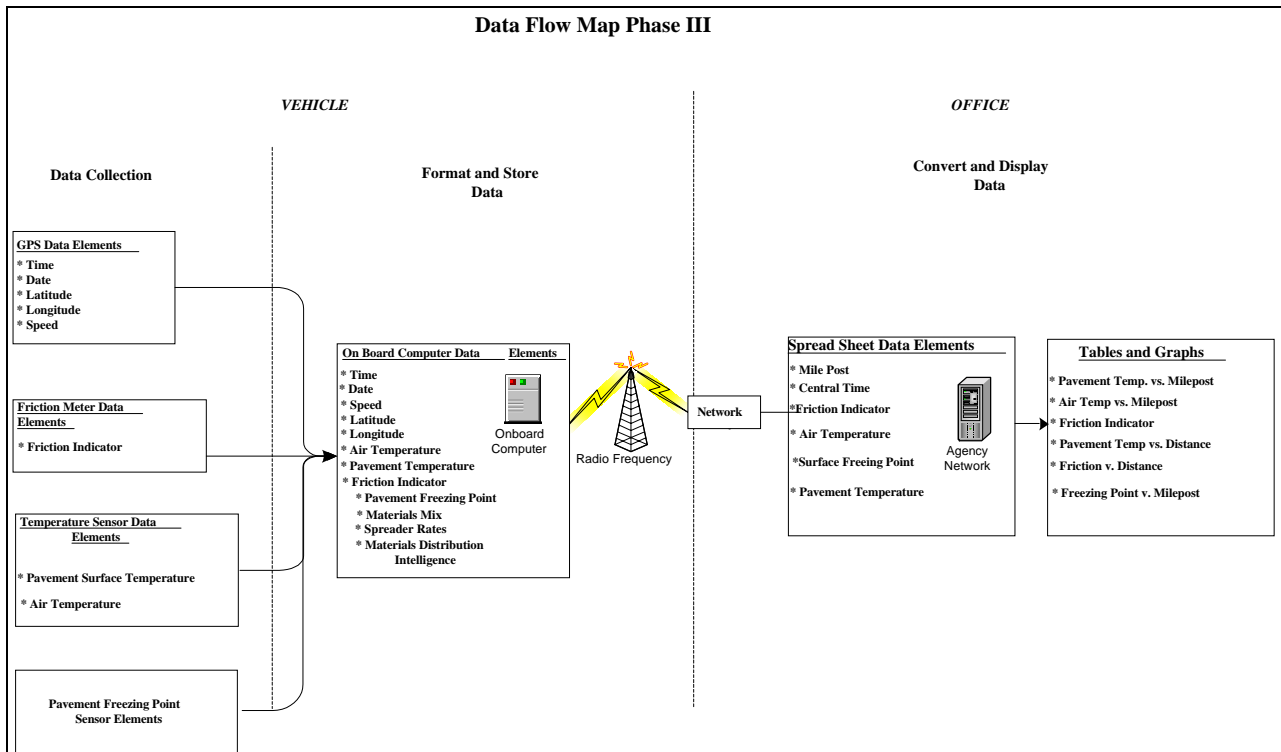

FIGURE 7.1 Data flow for HMCV Phase III.

7.3 Information Flow Process Maps and Suggested Methods to Integrate the Information with Existing and Planned Management Decision Systems (Task 11)

CTRE has worked with the state partners to develop data flow map based on each of the state's current and planned systems. The consortium also plans to estimate the cost of integrating the data collected by the concept vehicles into the planned data processing systems. The following information flow map shows the planned information flows, using the Iowa example, for information systems.

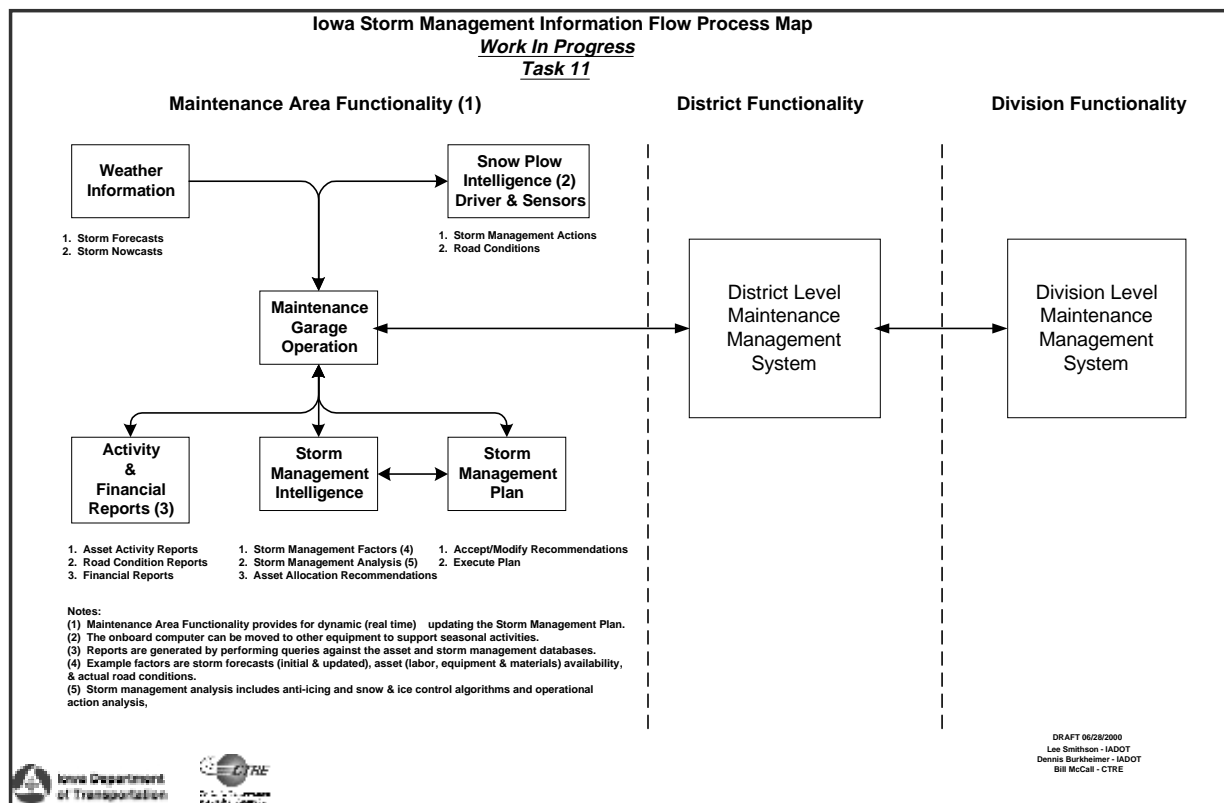

FIGURE 7.2 Storm management information flow.

7.4 The Final HMCV Specification (Task 12, Task 13)

The document describing the method, procedure, and specification for the integration of sensor data, material distribution, and other systems has not been completed. CTRE has, however, completed the specifications for the available technology. CTRE is working with each state agency and the vendors to determine the equipment integration specifications for each vehicle subsystem so that the systems meet the agencies' requirements and optimal performance capabilities. See Appendix A for the specifications that have been completed. This Phase III final report constitutes task 13.

8 CONCLUSIONS AND RECOMMENDATIONS

This final research report presents the framework for evaluating the benefits and impacts of the HCMV applications. The evaluation framework is based upon evaluating progress toward the goals as stated in the plan:

- evaluate technology
- assess cost implications of technology applications.
- develop benefit/cost analyses.
- improve roadway safety for the driving public
- develop operator input and acceptance
- investigate integration of data with DOT management systems
- develop “real-time” data for storm management decisions

The following conclusions are based on the results of the tasks completed for this Phase III report.

8.1 Phase III Conclusions

Phase III of the research study has been partially successful. The technologies such as the pavement temperature sensors, lights, and rear-obstacle alarms have proven reliability to this point. Regarding the other subsystems, such as the onboard mobile data terminal and pavement surface freezing point, the technology has not been bench tested nor field-tested at this date. The pavement surface freezing point system, which was delivered in the spring of 2000, is scheduled for bench testing at the Center for Transportation Research and Education as soon as the software is delivered.

The SALTAR friction meter shows promise. The field tests that were performed on the redesigned unit at Wallops Island, Virginia, and North Bay, Ontario, demonstrated that the principle of continuously measuring friction and transferring those data to the vehicle management system is sound. The friction meter, however, does have problems that need to be addressed. The friction meter that was installed on the truck in Minnesota did not perform up to expectations. The installation proved to be challenging and once it was installed we were never able to collect data from it. The unit failed to perform because of corrosion in the gearbox assembly.

A baseline has been established for the benefit-cost analysis. The benefit-cost analysis is based on comparing the resources necessary to achieve the target road surface condition in a given maintenance area. Once the concept vehicles are fully equipped, the onboard vehicle systems will include pavement temperature, automatic vehicle location, and automated materials distribution subsystems. These subsystems will be taken into account in the benefit-cost analysis.

The HCMV system will then be used as the benchmark for developing operational savings. The following relationship is used to estimate the impact technology may have on operational costs (operational and maintenance cost savings):

$$\text{OMS} = (\text{materials application based on point RWIS road surface temperature} - \text{materials application based on road surface temperature from the mobile temperature sensor}) \times \text{EIA/hr} \times \text{the time taken to reach target condition.}$$

Additional conclusions based on the results of the tasks completed over the duration of the evaluation include:

- Need for accurate pavement and air temperature information. To be able to effectively combat storms and provide an acceptable level of service to the traveling public, operators and supervisors need accurate air and pavement information. Accurate temperature information is vital to ensuring the proper actions are taken to alleviate the impacts of winter weather on the roadways.
- Need for hands-free data collection. Because the operator is busy with operating the snowplow, data need to be collected without interfering with the operators' duties of removing snow and debris from the highway. Environmental conditions, pavement and surface conditions all need to be collected without distracting the driver.
- Success of divided dump boxes. The newly designed divided hoppers provided the DOTs the ability to haul more than one product when plowing snow. By having more than one type of material on board, the operator can adjust the application of materials to the weather conditions while in transit. Thus, applying material more effectively and efficiently.
- Each state agency needs the flexibility to adopt technology that suits its own needs. The Highway Maintenance Concept Vehicle project remained sensitive to each state's unique needs and strategic direction. Thus, the project encouraged each participating state to test technologies that they felt suited their particular needs. Not all participants felt the need to test all the various technologies that were being tested and evaluated. For example, new high-intensity discharge lights were tested on plow and not others.

8.2 Recommendations for Future Research

The following recommendations are based on the results of the tasks completed for this Phase III report. A Phase IV final report for this research project is expected in the spring of 2001.

- The SALTAR data from the field tests performed in Wallops Island, Virginia, and North Bay, Ontario, will be investigated in more detail. The conclusions reached for this report should be verified and the data analyzed more closely to allow statistically significant conclusions to be made. This task will be completed as part of the project.
- The use of friction data from the HMCV should be examined and their impact on maintenance practices will be investigated more closely.
- The SALTAR friction meter should include an operations and maintenance manual to assist in installation and troubleshooting.
- The results of the bench testing of the pavement surface freezing point systems will be analyzed, documented, and reported.

- Now that the baseline has been established for the benefit-cost analysis; the model will be put into place for the upcoming season to determine the benefit-cost ratios. Once the concept vehicles are fully equipped, the onboard vehicle systems will include pavement temperature, automatic vehicle location, and automated materials distribution subsystems. These subsystems will be taken into account in the benefit-cost analysis.

The data that are developed from the technologies applied to the highway maintenance concept vehicles will continue to be evaluated in Phase IV. In addition, there will be an evaluation of the feasibility and cost effectiveness to carry the research project into a broader application, a fleet evaluation in each of the consortium states.

ACKNOWLEDGMENTS

The authors gratefully acknowledge and thank the pooled-fund study team, both public and private sector members, for their technical assistance and cooperation throughout Phase III.

Public sector members included the following agencies:

Iowa Department of Transportation
Federal Highway Administration
Michigan Department of Transportation
Minnesota Department of Transportation

We wish to thank Mr. Lee Smithson, deputy director of the Maintenance Division, Iowa Department of Transportation and chairperson of the pooled-fund study team; Mr. John Scharffbillig, Mr. Paul Keranen, and Ms. Jane Butzer of the Minnesota Department of Transportation; and Mr. Larry White, team leader for the Michigan Department of Transportation for their teams' technical support and guidance.

Private sector members included the following companies:

Boyer Ford, Minneapolis, Minnesota
Bristol Company, Broomfield, Colorado
Component Technology, Des Moines, Iowa
Enator AS, Sweden
Federal Signal Corporation, Tinley Park, Illinois
Force America, Burnsville, Minnesota
Fosseen Manufacturing and Development Ltd., Radcliffe, Iowa
Global Sensors Systems, Mississauga, Ontario, Canada
Innovative Warning Systems, Minneapolis, Minnesota
Monroe Truck Equipment, Monroe, Wisconsin
Navistar International Corporation, Fort Wayne, Indiana
Norsemeter Company, Rud, Norway
O'Halloran International, Altoona, Iowa
Raven Industries, Sioux Falls, South Dakota
Sprague Controls Company, Canby, Oregon
Thom-Tech Design Company, St. Paul, Minnesota
Tyler Industries, Division of Case, Benson, Minnesota

We wish to thank all the private sector partners for their generous contributions, technical support, and cooperation.

Special thanks goes to Dr. James C. Wambold, Ph.D., president, CDRM, Inc., for analyzing the friction data and participating in writing this report.

Appendix A: Specifications

A.1 Mn/DOT Concept Vehicle Hydraulic Specifications

A.2 SALTAR Functional Specification

A.3 Iowa DOT Concept Vehicle Spreader Control Specifications

A.4 SALTAR Product Specification

A.1 Mn/DOT Concept Vehicle Hydraulic Specifications

A.1.1 Hydraulic Pump

The hydraulic pump shall be a U.S.-manufactured axial piston pressure and flow compensated load-sensing type. The pump shall be cast iron construction and rated to 6.1 cubic inches per revolution at maximum stroke. The pump shall have a 2-inch suction line. The pump shall be rated for up to 2600 rpm and 3000 psi. The pump shall have a 1.25-inch keyed drive shaft and SAE type-C mounting flange. The pump shall be model PAVC 100 Parker load-sensing pump. A 1-inch steel ball valve shall be at the outlet of the pump.

A.1.2 Mounting

The hydraulic pump shall be mounted with shaft centerline parallel to the crankshaft centerline and at a level to create not more than a three-degree angle on the driveline. Pump mounting shall be incorporated with a bracket fabricated to mount in the extended frame rails of the truck.

A.1.3 Driveline

The hydraulic pump shall be driven directly off the engine crankshaft via a driveline to allow for movement. The driveline shall include grease fittings on both u-joints. (e.g., Spicer model 1310 series).

A.1.4 Reservoir

Hydraulic reservoir shall be “Slim Line” 30-gallon capacity 10 gauge and equipped with the following:

- basket type filler breather cap
- magnetic drain plug
- two-inch NPT suction with 100 mesh screen type filter
- separate return port for control drain line
- sight temperature gauge externally mounted

The hydraulic reservoir shall also be equipped with an electric level-sending unit to be wired to the control panel and backlit for designated warning. Suction line shut off via 2-inch low-pressure brass ball valve.

A.1.5 Filter

The hydraulic oil filter shall be mounted at the reservoir. The hydraulic filter shall be 10-micron spin on type and rated for no less than 80 gpm. The filter shall be Force America model SF510-150-25-10CLR-PG with filter condition indicator gauge. Return line check 1.25 model BRV-1220-2-03. A 12-volt indicator switch shall be installed and wired to the control panel and backlit for filter bypass warning.

A.1.6 Control Center General

The Control Center must be an integral center for controlling all hydraulic functions including all automated salt controls. The unit must be supplied with separate easy to service

feed back connection, speedometer connection, valve control connection, and main power connection. The center must also be supplied with color-coded wiring throughout. Manuals, service literature, and driver and service training must be supplied at no charge.

Control center is to include the following:

Joystick Controls

- proportional hoist control with center interlock
- dual-axis valve control for plow lift and angle
- dual-axis valve control for wing toe and heel
- dual-axis valve control for underbody raise and angle
- spreader standby to on
- spreader blast

Sander Control

- spreader on/off
- prewet on/off
- direct application on/off
- menu select, scroll and rate increase/decrease joystick
- spinner control
- plow float enable/disable

Control center is to be CommandAll model CC5000-3MJ modular design.

A.1.7 Control Center Spreader Controls

The electronic spreader control shall be designed for precise, closed loop control of material application. The electronic spreader control shall have a battery back up to protect memory functions. The control unit must have password protection to prevent unauthorized use of set up, complete operation, and calibration parameters. The control unit shall be capable of self-calibration of auger/conveyor feed rates and require no additional timepieces to calibrate. Programming shall allow for blast function to be set one of three ways: momentary, timed, or by distance traveled. The unit must also be capable of spreading up to three different materials and up nine gate settings per material. Programming shall provide for automatic feedback failure. The unit must provide three operational modes: manual, open loop (ground speed only), and closed loop (ground speed with auger/conveyor feedback). Programming shall also provide for two-speed axle input as required.

Text display shall inform the operator of spread rate information and calibration parameters. The unit must be capable of downloading data to a serial printer or PC computer. The unit will provide real time and date. In addition, the unit must provide rotary spinner speed adjustment, standby (pass) feature, and stationary unload. A programmable jump-start to provide immediate material flow at start up. Unit shall control an onboard closed loop liquid prewet system and closed-loop direct liquid application. All chemical applications shall be operated from single joystick control for remote standby (on/off) and blast.

A.1.8 Hydraulic Valve

The hydraulic valve shall be of modular manifold design. Each hydraulic function requires an individual manifold stacked together to form the manifold base. The manifold base shall consist of an inlet section with SAE No. 16 inlet porting, SAE No. 20 outlet porting, and SAE No. 4 load sense porting. The hydraulic control valves shall be pulse-width modulated, proportionally controlled. Each hydraulic valve segment shall be serviceable without removing any hydraulic hoses or any other hydraulic valve segments. Each segment shall be equipped with a rack and pinion manual override except for the auger and spinner sections. Valve segments shall be “Add-a-Fold” model or prior approved equal.

Valve to be arranged as follows:

- hoist four-way w/ relief
- midinlet
- plow raise three-way
- plow angle four-way
- wing toe three-way
- wing heel three-way
- underbody raise four-way w/ accumulator system, lock valve, and warning light
- underbody angle four-way
- auger four-way
- spinner four-way

A.1.9 Hydraulic Valve Enclosure

The valve assembly shall be mounted in a weather-tight enclosure. The valve enclosure shall be fabricated of 12-gauge steel. The valve enclosure shall have a jacketed “L” cover to ensure easy access. The cover shall be held to the enclosure by two heavy rubber latches (one on each side). All plumbing shall be external, directly into the bottom of the valve manifold base (no hydraulic plumbing in the enclosures).

A.2. SALTAR Functional Specification

- User interface:
 - Pen-recorder and light-indicator as an option for the user interface
- Speed range: 30–80 kilometers per hour (19–50 mph)
- Operational conditions:
 - Winter conditions with ice and snow, with the investigation of the possibility to operate on summer surfaces
 - Operating temperature range: -40°C to $+5^{\circ}\text{C}$, with the option to use in summer conditions
 - Friction: $0.05 < \mu < 0.5$, with the optional use on summer surface
 - Measuring interval: one measurement in every 2 seconds
 - Output parameter: 5 level information about the relative braking action
 - Power: 24 or 12 V power from the host vehicle battery, with the lowest possible power consumption and with the option for both 24 and 12 V
 - Measuring parameters: relative brake action in intervals
 - Output: three–five levels of information for the brake action
- The measuring unit should be mounted under a truck, bus, maintenance vehicle
 - Option: mounting behind a pickup or van
- The measuring unit must measure in the wheel track of the measuring vehicle
- The unit should require as minimum maintenance as possible. Few parts, few movable parts, minimal wear of the parts, only mass production components
- The unit must be tolerant to rough environments like salt, water, ice, and slush. No corrosive parts
- Lifetime: based on the very rough environment under a truck the lifetime is set to 5 years.
- Simple mounting and de-mounting of unit for seasonal use: 4 screws and one contact
- Service, maintenance and calibration should be done by trained personnel according to the manual
- Compliance with standards and directives:
 - The system should comply with the EU directive on Machines and carry the CE mark
- Measuring parameter range:
 - Friction: $0.05 < \mu < 0.5$, with the optional use on summer surface
 - Measuring interval: one measurement in every 2 seconds
- Output parameter:

The output of this measurement shall be a five-level information output about the relative braking action, which is related to a friction level measured by OSCAR. The output shall be displayed on the user interface, and shall be transmitted to an external data collection unit.
- Five level:
 - Hazardous: $\mu < 0.15$ of OSCAR
 - Very slippery: $0.15 < \mu < 0.25$ of OSCAR
 - Slippery $0.25 < \mu < 0.4$ of OSCAR
 - Acceptable: $0.4 < \mu < 0.5$ of OSCAR

- Good: $0.5 < \mu$ of OSCAR
- Operating ranges:
 - Measuring speed range: 30 to 80 kilometers per hour
 - Ambient operating temperature range: -40°C to $+5^{\circ}\text{C}$, with the option to use in summer conditions
 - Storage temperature: -40°C to $+50^{\circ}\text{C}$
 - Contamination of road range: maximum 100-millimeter winter contamination
- Other general requirements:
 - Weight: it shall light enough to be able the handle it by one man
 - Size: it shall be small enough to be able to mount under most of the 16–26 t trucks. It should have a transport position where the clearance from the ground is minimum 300 millimeters
 - Power: 24 or 12 V power from the host vehicle battery, with the lowest possible power consumption and with the option for both 24 and 12 V
- Accuracy and repeatability:
 - Accuracy: in all the level it shall be ± 10 percent
 - Repeatability: not defined at this stage, it will be tested out during the test
- Reliability and maintainability:
 - Lifetime: five years, based on the very rough environment under a truck
 - Operating environment: it must be tolerant to rough environments like salt, de-icing material, water, ice and slush; no corrosive parts
 - Maintainability: service, maintenance and calibration should be done by trained personnel according to the manual
 - The device shall not get damaged by traveling trough small obstacle (maximum 10 centimeters high) or holes (maximum 10 centimeters deep) on the road
 - The unit should not get damaged if the vehicle is moving in reverse
- Optional:
 - Connection to external PC
 - Pen-recorder
 - Light indicator
- Connection to salting control unit:
 - Lifting/lowering switch, which will be separated from the control system
- Installation:
 - Simple mounting and de-mounting for seasonal use. One person should be able to mount it to the truck within one hour, without using any additional equipment than a wrench.
- Operation:
 - The system operation shall be simple enough to be handled by the host vehicle operator

A.3 Iowa DOT Concept Vehicle Spreader Control Specifications

A.3.1 DCS 710 Spreader Control

- four granular products
- granular, granular and pre-wetting, anti-icing with granular add back
- standard spinner control, lane width (spread pounds per lane mile), forward speed canceling (zero velocity)
- DGPS ready
- tiered spray bar capable for very low application rates if needed (anti-icing)
- back lighting
- display air and pavement temperature
- basic operations know by current operators from last winter
- meets current data information requested by the state
- prescription application*
- and more

A.3.2 AMS 200 Interface Console

- connects to DCS 710 spreader control
- records *all* spreader activity on 64 Meg data card
- two-way messaging interface
- 25 user definable messages
- interface for DGPS receiver, spreader control, and waypoint switch console
- waypoint switch console is used as a marking tool (geo reference)
- the user can write a prescription with included software for the spreader control
- will alert operator to pre geo referenced obstructions
- comes with a batch file for downloading into ArcView GIS software
- and more

A.3.3 MV Trakker

- radio interface
- connects to AMS 200
- AVL system maps, analysis software
- displays vehicle information
- displays spreader control information
- and more

The following figures graphically depict the AVL spreader control displays that are provided with the AVL package. The header in Figure A.1 shows the dispatcher that an alert has happened regarding the spreader control.

Group	ID	Alias	Date/Time	Truck ID	Speed	Heading	Gr Type	Gr Rate	Lq Type	Lq Rate	PTemp	Plow
1	1	001-001	06/21/1999 12:35 PM	2345678	9	045° NE	prd1	76	a-ice	125	100° c	Dn

FIGURE A.1 Alert header.

The header in Figure A.2 shows a sample of information, available to the dispatcher that is displayed along with the alert messages. This header shows the type and amount of chemical that is being applied to the road surface, the rate of application, the position of the plow, the position of the dump body, and weather information gathered from the truck’s sensors.

Raven Vehicle Info

Truck Information
 Group/ID: 001-001 Date/Time: 06-21-1999 12:35 PM
 Truck ID: 12345678 Speed: 9

Granular Granular Type: Product 1 Remote Rate: 76.0	Alarm Status Granular Rate: Yes Granular Low Limit: Yes Granular Low Tank: No Pre-wet Rate: Yes Pre-wet Low Limit: No Pre-wet Low Tank: No Anti-ice Rate: No Anti-ice Low Limit: No Anti-ice Low Tank: No Spinner: No Speed Limit: No Mater Sensor: No	Switch States Blast Button: Off Master Switch: On Key Switch: On Left Lane: On Center Lane: On Right Lane: On Second Tier: Off Third Tier: Off	Plow Status Plow Down: Down Left Wing: Down Left Wing Toe: Down Left Wing Heal: Down Right Wing: Down Right Wing Toe: Down Right Wing Heal: Down Scraper: Unkn Dump Body: Down Scraper Rotate: Center Plow Orient: Center
--	--	---	---

FIGURE A.2 Vehicle information header.

The header in Figure A.3 is a snap shot of the spreader control activity. This information describes the amount and type of chemicals that are available for application on board the vehicle. This information is useful for monitoring application activity.

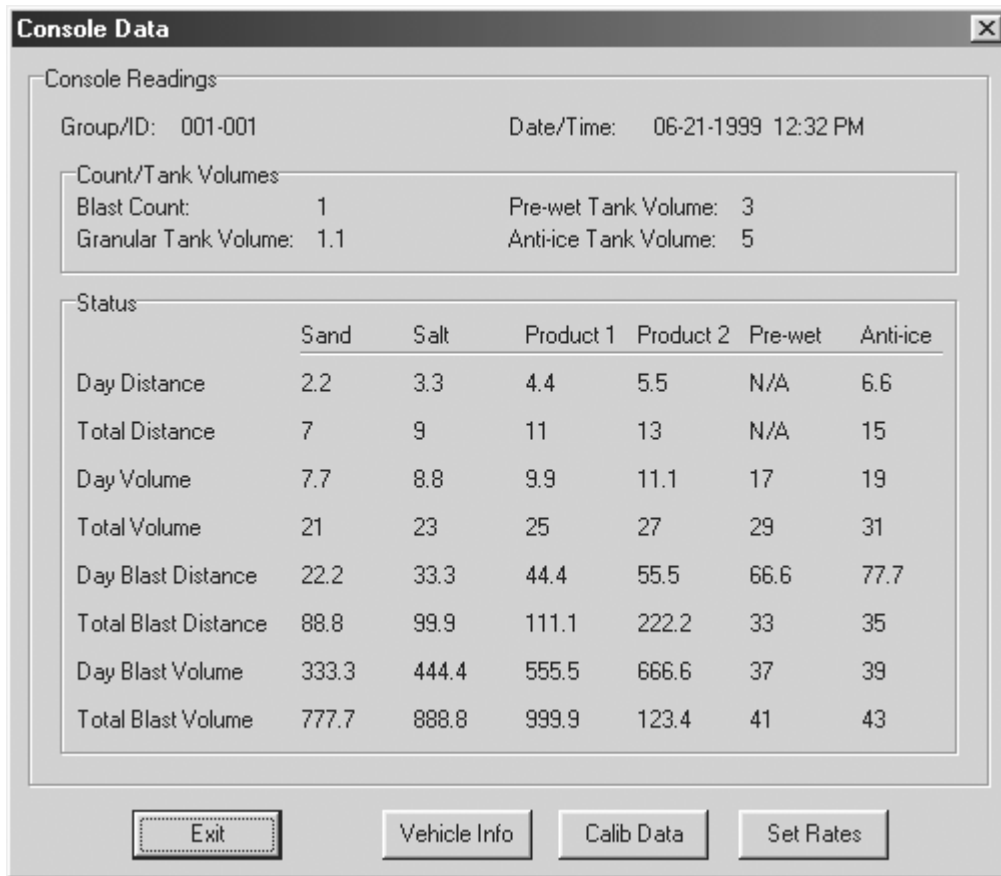

FIGURE A.3 Spreader control data.

The header in Figure A.4 displays the spreader controls calibration information.

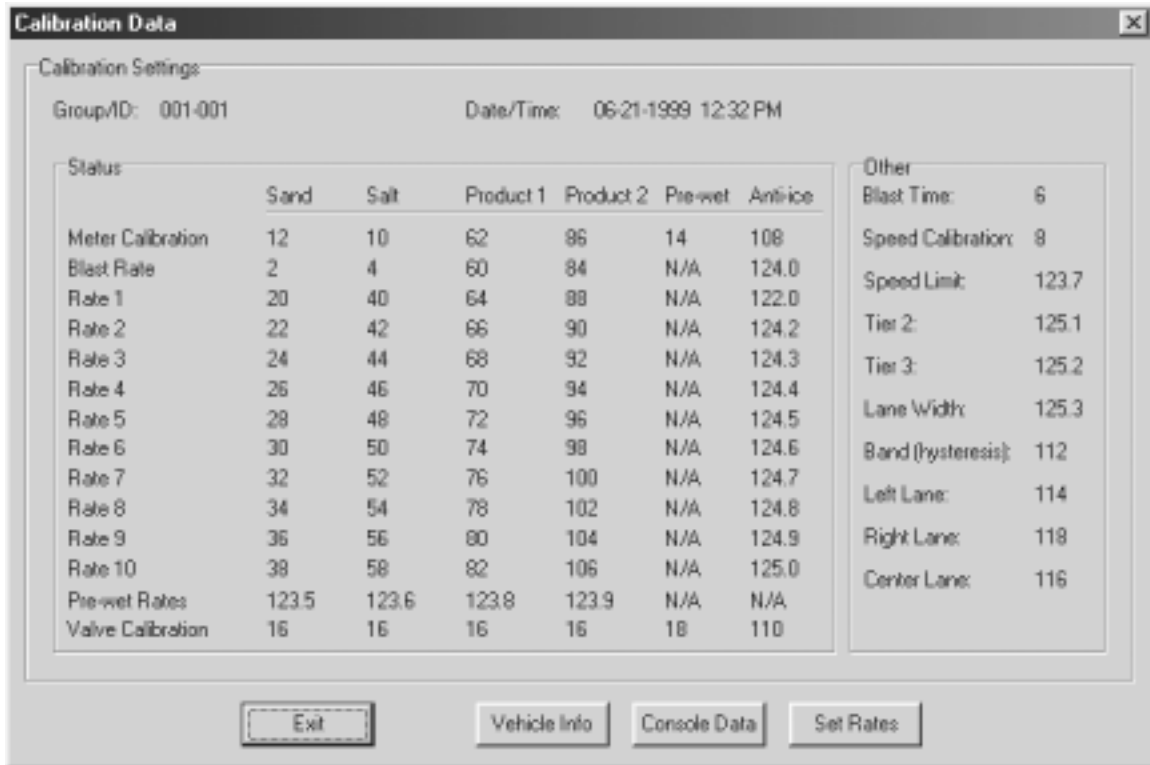

FIGURE A.4 Spreader calibration data.

The header in Figure A.5 allows the dispatcher to change the spreader control from the office.

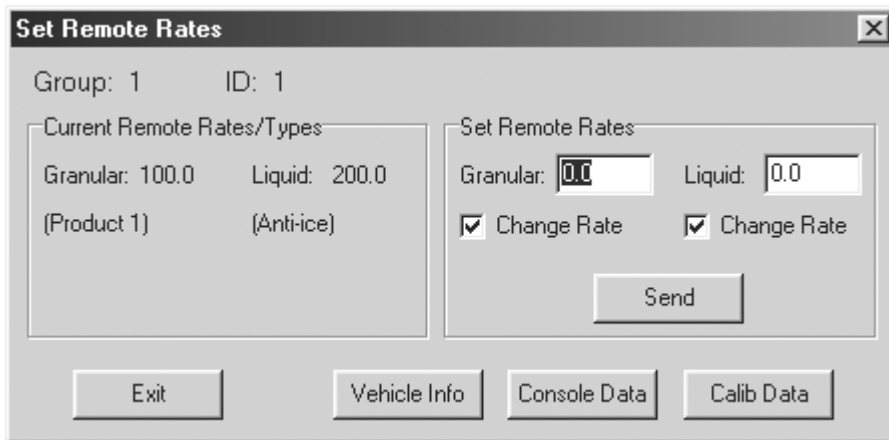

FIGURE A.5 Remote sensor information.

SALTAR Product Specification

© Norsemeter AS

Issue: 1

Revision: 1.0.a

Issue Date: June 3, 1999

Contents:

- 1. *General Description and Basic Principle***
- 2. *Friction Measuring Equipment and Installation***
 - 2.1. Mounting Bracket and Measuring Wheel**
 - 2.2. Electronic Brake**
 - 2.3. Pneumatic System**
 - 2.4. Computer**
- 3. *Host Vehicle***
 - 3.1. Standard**
 - 3.2. Option**
- 4. *Options***
 - 4.1. Data Link**
 - 4.2. Pen Recorder**
- 5. *Measuring Procedure and Software***
 - 5.1. Self Test**
 - 5.2. Measuring Mode**
 - 5.3. Calibration**
 - 5.4. Level Modifications**



1. General Description and Basic Principle

The SALTAR Friction Tester is a device designed to measure friction on travelled winter contaminated surfaces and based on the measurements classify the condition of the surface using five condition levels. Fundamentally the SALTAR unit is a small very durable frame equipped with an electronic brake and a measurement tire. The brake is controlled by an advanced software and electronic control system to simulate car-braking action and measure the generated friction coefficient between a measuring wheel and surface.

The measuring wheel together with the holding bracket can be retracted or lowered by means of a pneumatic mechanism that also provides the controlled and calibrated load for the measurement tire. For measuring it is lowered on to the surface with a predetermined and controlled vertical load by means of two pneumatic cylinders which are integrated and are part of the frame and holding bracket of SALTAR. As the host vehicle moves on the measured surface, the measuring wheel is periodically restrained by the electronic brake and the effective braking power during a braking cycle, where the wheel is stopped from rolling freely to a locked position is registered by the control system.

The measuring wheel is mechanically geared to the high precision and durable electronic brake. The device measures the effective braking power during a braking cycle, where the wheel is braked from freely rolling to locked position. The measurement is based on the principle of measuring of the time necessary to speed up the measurement wheel from locked position to freely rolling. The complex and sophisticated control software computes the necessary parameters from the acquired physical parameters measured during the braking cycle and calculates the effective braking power.

As extra equipment a data link can be installed. This link can transmit the measuring results to a PC, either in remote location by radio or direct to a portable PC in the driver's cab, for storage, presentation or further processing.

2. Friction Measuring Equipment and Installation

2.1. Mounting Bracket and Measuring Wheel

The main mechanical component in the SALTAR device is the measuring wheel system. The measuring wheel mechanism is designed as an extendable ladder frame. The frame consists of three horizontal crossbars and two vertical cylinders (see Figure 1.) The frame is made of highly corrosive resistant, strong, very durable and light aluminum alloy.

The ladder frame consists of two main components:

1. The upper frame consisting of two cross bars and the fixed part of the vertical cylinders.
2. The lower frame consisting of the lower crossbar and the moving cylinder parts covered by the protection bellows (see Figure 1.)

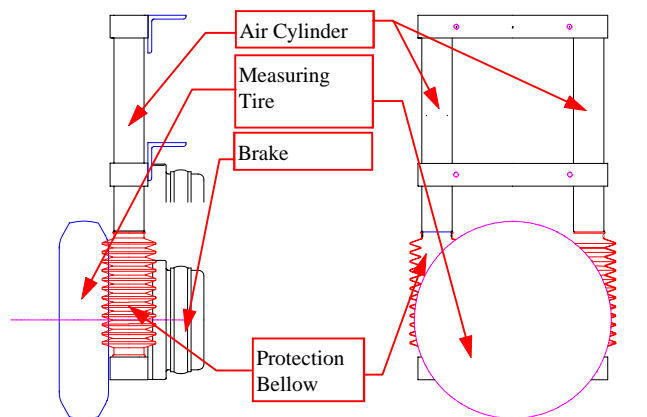

Figure 1. SALTAR frame

The two vertical air-cylinders have triple functions in the design. The stationary upper part of the cylinders provides mechanical stability of the SALTAR frame and firmly connecting the two upper crossbars. Together with the upper crossbars they form a solid very strong but light frame which can be mounted onto any vehicle with relative ease.

The lower movable frame has the function of holding the electronic brake and measuring wheel construction. The lower frame connected with the measuring wheel and brake assembly is retractable by the movable parts of the air cylinders covered by the protection bellows.

The SALTAR device is equipped with a fail-safe lifting mechanism. If there is a pneumatic failure or air loss in the system, two strong springs placed inside the cylinder assembly lift the unit off the ground.

2.2. Electronic Brake

To restrict the measurement wheel from rolling freely to a locked stage in a very short period of time and then release in an ABS braking style the SALTAR system is equipped with a fast and strong electronically controlled brake.

The brake unit is a SEW BM30 electronic brake with a BSG electronic rectifier and control unit. The brake has a 600 Nm maximum braking torque and can be operated by standard 24V power.

The brake unit is enclosed in cast iron casing and can be used under any weather conditions.

2.3. Pneumatic System

The SALTAR measuring system has a separate pneumatic system, fitted in the rear of the car. The pneumatic system designed for two different host vehicle environments. One for trucks and utility vehicles with their own auxiliary air supply and one for vehicles with no usable air system.

1. The system can be connected directly to the air supply system of trucks. SALTAR has an automatic air pressure regulator and can be connected without any prior modifications to most trucks. This system consists of a pressure accumulator, regulating system, valves and piping.
2. The system designed for vehicles with no direct air supply is a stand-alone design. This system consists of an electrically driven pump, a pressure accumulator, regulating system, valves and piping. The system is a self-contained unit. Power to the pneumatic system is supplied by the electric system of the base car.

2.4. Computer

The SALTAR computer system is of type SALATAR Mk I Computer system, specially designed for the SALTAR Friction Tester. It consists of two basic units:

- Central computer
- Operator panel and user interface

The central computer is an industrial high performance computer that can be operated under extremely harsh conditions. The small size and the rugged design of the compartment makes it fit to be mounted nearly anywhere on the host vehicle.

The computer unit is connected to the measurement sensors located in the brake and measuring wheel assembly by two wires supplying the power to the brake and to the sensors and carrying the control and measurement signals.

The SALATAR Mk I computer is based on the state of the art industry leader micro-controller AMD AM186EM controller processor and a fully fledged Real Time Kernel. The schematic layout of the controller can be seen in Figure 2.

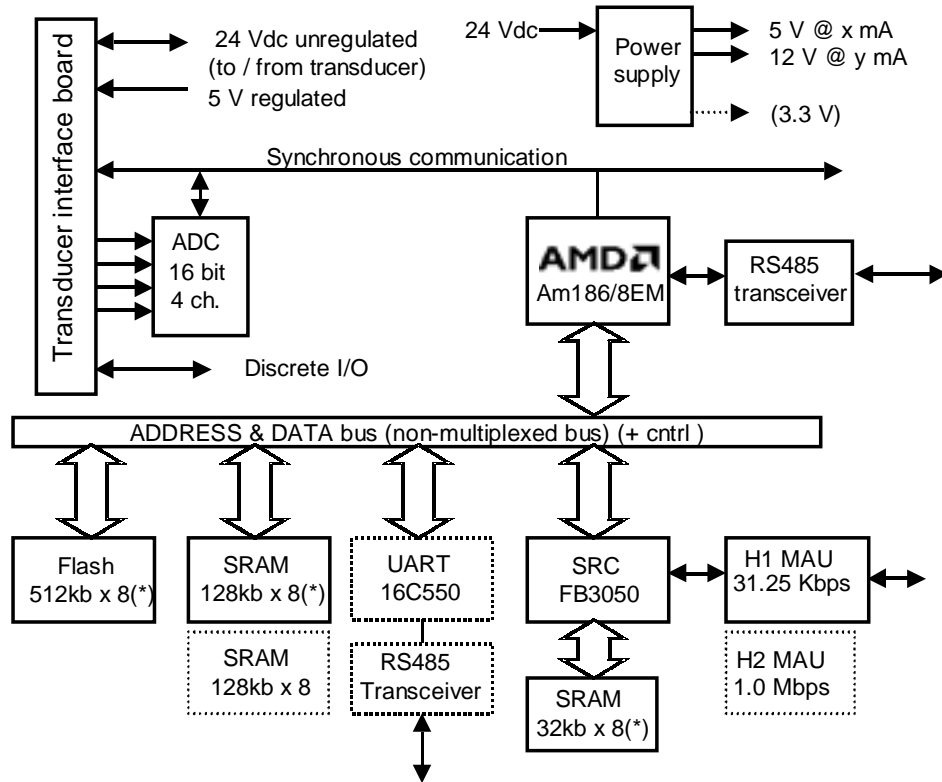

(*) Memory may be scaled down if application require less memory

Copyright © Norsemeter AS, 1998

Figure 2. SALTAR Mk I Computer

A keyboard operates the computer system with a display for operator guidance. The keyboard operator panel is a palm size “remote control” unit of the measurement system that also displays in real time the measurement results. The control buttons indicators and LED’s are arranged to give the operator maximum flexibility and easy observation. Because of the small size the operator panel can be placed anywhere in the driver’s cabin of the host vehicle.

The Mk I computer system is easy to calibrate. Calibration is done automatically via a laptop computer and a standard RS232 computer. The keyboard is detachable and can be moved.

The system is easy to maintain and is made up of only three easily replaceable units. It has a built-in self-test function.

The Mk I Computer System is fitted with a data link interface for transfer of measurement values to a PC for storing/presentation. The data-link can be connected to a radio link modem, or a link to a portable PC in the car.

See Figure 3.

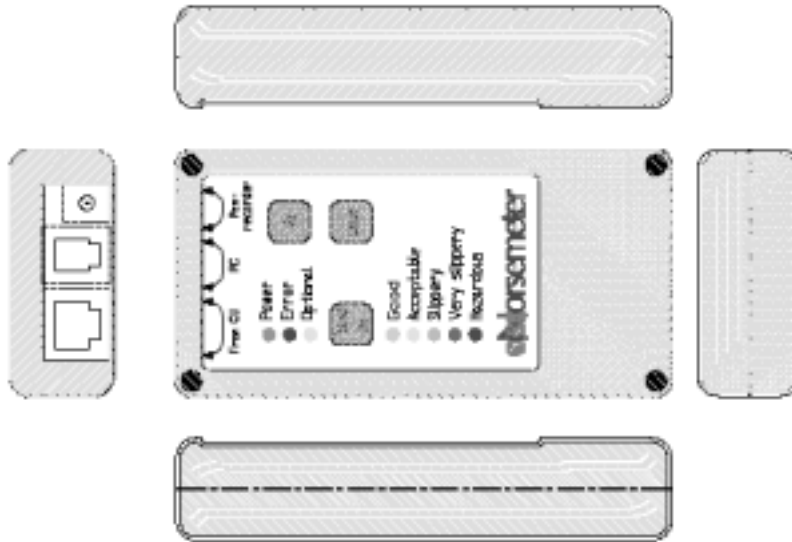

Figure 3. Operator Panel and User Interface

3. Host Vehicle

The SALTAR measurement device was designed with mobility and versatility in mind. The symmetrical layout of the mounting frame and the in-line design of the whole unit make the SALTAR device very modular. The extremely slim design perpendicular to the direction of travel/measurement gives the opportunity to mount the device virtually anywhere on a large plow truck or winter maintenance vehicle. The unit was designed to be mounted in the left or right wheel track or in the middle of the vehicle. The electronic, mechanic, and pneumatic design makes it possible to operate the unit in forward or reverse direction without any difficulty. Thus, the unit can be turned 180° if the mounting makes it necessary.

3.1. Standard

The standard mounting design of the unit is prepared for the maintenance and plow vehicles.

3.2. Option

With the optional standalone pneumatic system the SALTAR unit can be mounted with no modifications on any vehicle including trailers and pick-up trucks.

4. Options

4.1. Data Link

After each measurements SALTAR transfers the acquired and processed measurement data through its RS232 “PC” port see Figure 3, which can be collected with a standard Windows™ accessory, the HyperTerminal or the Norsemeter data collection software.

The Set-up for the communication is the following:

- · Bit per second: 57600 bps
- · Data bits: 8
- · Parity: none
- · Stop bits: 1
- · Flow control: none

4.2. Pen Recorder

The SALATAR user interface is equipped with an analogue output providing a 0-20 mA signal according to the measured data. This signal can be connected to other control or recording equipment through a standard (Chassidon 1,3 mm) connector. (See Figure 3)

5. Measuring Procedure and Software

5.1. Self -Test

The control computer is equipped with software that runs a thorough self-test every time the power of the system is turned on. The program checks the status of the printed circuit motherboard and the other electrical components of the control system. When this step is passed the software will run a check of all the external hardware equipment like the transducers and signal converters.

Additionally the computer is equipped with a watchdog circuit that ensures a safe and reliable operation. The watchdog electrical circuit together with the software continuously monitors the state of the control computer and executes safety related tasks whenever encounters an error in the normal operation.

5.2. Soft Power-down

The control system is designed and operating with a soft power down feature. When a measurement session is finished and the operator wishes to switch the equipment on by pressing the power off button the system executes a software controlled power down sequence.

The power off button is not switching the power supply of the computer system directly; instead it gives the power-down command to the control computer. The control software receiving this command then executes a number of safety tasks and switches the power of the system off.

5.3. Measuring Mode

After the system has been powered up it is ready with a minimum delay for conducting measurements. The operation is very simple and straightforward. By pressing the power button the system will execute the initial self-test procedures and indicate an error if any are encountered. These procedures take less than a second of time, after which the unit is ready for operation.

Pressing the “Down” button the unit will lower the measuring wheel to the ground and the measurement will start. After pressing the “Up” button the measuring wheel will be lifted from the ground and the measurement will be suspended until the “Down” or “Power” buttons are once again pushed.

During the measurement the control system will execute a complete measurement cycle (brake and release), data collection, data processing and display every four seconds. If the DataLink option is purchased then besides the user interface, the collected and processed data are sent onto the laptop or other computer device via the serial communications link.

If the DataLink option is purchased then the control computer will continuously transmit its processed data in real time. The transmitted data are formatted as one line ASCII string with the following configuration:

<SD><RC>,<MC>,<FL><cr>

Where:

- <SD> is the start delimiter of a data record and always equal to '>>' =
- <RC> = reference speed count, range 0-9999
- <MC> = measured friction, range 0-9999
- <FL> = calculated friction level, range 0-5
0 means invalid data
- <cr> = carriage return character, which marks the end of the current data record

An example of the received data record: '>>643,478,4<cr>'

All data are separated with a comma-sign, ',' Thus; it is possible to import the captured and saved data file to a spreadsheet, text editor or database software.

5.4. Calibration & Level Modifications

If the SALTAR unit is purchased with the DataLink option then the calibration and friction level modification can be executed through the laptop PC with ease and simplicity. The control software is prepared to take a calibration command at any time throughout the operation of the unit with the following format:

<SD><FL1>,<FL2>,<FL3>,<FL4>,<FL5><cr>

Where:

- <SD> is the start delimiter of the calibration command and always equal to '<<TA' =
- <FL1> = Friction Level 1 in the range 0 - 9999
- <FL2> = Friction Level 2 in the range FL1 - 9999
- <FL3> = Friction Level 3 in the range FL2 - 9999
- <FL4> = Friction Level 4 in the range FL3 - 9999
- <FL5> = Friction Level 5 in the range FL4 - 9999
- <cr> = carriage return character, which marks the end of the current data record

Upon receiving this command the control software will update the evaluation table and criteria in the program immediately.

If the control computer received the calibration command while in a measurement session then the data displayed and transmitted through the DataLink will be according to the new calibration values from the time forward the command was received.

Appendix B: CDRM, Inc., Test and Evaluation

B.1 Proposed Test Plan for Phase III of Project: Test and Evaluation of Friction Measuring Device for Winter Maintenance Applications

B.2 Friction Measurement Techniques for Snow and Ice Road Operations

B.1
CDRM, Inc

**Proposed Test Plan For
Phase III of Project**

TEST AND EVALUATION
OF
FRICTION MEASURING DEVICES
FOR
WINTER MAINTENANCE APPLICATIONS

To

**Bill McCall
Center for Transportation
Research and Education**

From

**CDRM, Inc
P.O. Box 1277
State College, PA 16804**

November 10, 1998

Introduction

Phase III

Field test and evaluate the selected devices under either simulated or actual winter conditions. These tests will establish the repeatability of measurements for each device over the selected range of values. They will also be used to measure and evaluate the difference in and significance of values between the fixed-slip and variable slip metering devices. These tests will also be used to determine the optimal vehicle speed and frequency of measurement - i.e., spacing of a set of readings or individual readings as appropriate

TEST PLAN

The test plan outlined below is what is considered necessary in order to get test data from which basic statistics can be obtained. It is realized that all of the test sites may not be obtainable.

TWO CATEGORIES OF TESTING

- 1) Maintenance related, regular
- 2) Special tests on a selected site that does not interfere with regular maintenance time. St. Cloud test track would do nicely. Site needs to be one that can be left after a snowfall and then testing and maintenance can be performed when crews are not busy with regular maintenance.

Site conditions

Each site should have the following baseline tests performed on them before and after testing:

- . Sand Patch (ASTM 965) at 5 places along the site to get the Mean Texture Depth (MTD)
- . British Pendulum Test (ASTM 303) at the same 5 places to get the British Pendulum Number(BPN)
- . Photograph of the overall site and a close-up of the surface with a label for the site and a length reference.

MAINTENANCE RELATED

Predetermined and fixed route for all tests.

Test runs are preformed when there is:

- A) No danger from the slipper surface
- B) Weather forecasts predicts good conditions
- C) Sufficient personnel will be available

Test route to include different pavement types.

Test route to include roads when salted and when not salted.

Test route to include weather stations.

Measure at normal truck speed in normal traffic.

Make one data file per route completed.

TESTS:

- 1) One test on bare pavement of each section.
- 2) One test one or two hours before weather requires maintenance.
- 3) One test every time maintenance is performed.
- 4) One test 4-8 hours after maintenance completed.

Conditions should include wet and dry snow less than 1" and more than 2" and more than 6"; hard packed snow; wet and dry ice; and slush.

SPECIAL TESTS

On each of the sites and conditions the devices should test at 35 mph. The following is the test matrix to be run. New tracks should be used for each run.

NUMBER OF RUNS			
SITE	CONDITION	20 mph	35 mph*
Loose snow <1"	dry (T<25)	1	5
Loose snow >2"	dry (T<25)	1	5
Loose snow <1"	wet(T near 32)	1	5
Loose snow >2"	wet(T near 32)	1	5
Slush > 1"	wet(T near 32)	1	5
Slush > 1"	wet(T near 32)	1	5
Packed Snow	T < 25	1	5
Packed Snow	(T near 32)	1	5
Ice	T < 25	1	5
Ice	(T near 32)	1	5

* these test are to be used to calculate the coefficient of variation for each device and should be run at this speed or the speed most common for maintenance vehicles. The last four, Packed snow and Ice are the most important, the loose snow and slush should be secondary and run if available.

B.2

Friction Measurement Techniques for Snow and Ice Road Operations

Prof. Dr. J. C. Wambold, CDRM, Inc, USA

ABSTRACT

Maintenance agencies are looking for a relatively inexpensive device that can measure roadway friction under winter conditions and will tell the snowplow operator in real time whether there is friction present or not. This method would assist the operator in determining when and where abrasives and/or chemicals are required to be applied during snow and ice control operations under all conditions. There have been studies that utilized braking action friction measurements as an indicator. However, this method cannot be used during high traffic volume conditions.

Field studies have been conducted at NASA Wallops flight facility and in Iowa, Minnesota, Michigan and Norway using Norsemeter's Roar and later SALTAR to determine applicability of the equipment to snow & ice operation, reliability, and durability. The measuring device is mounted on a snowplow and the measurement is achieved by employing wheel braking to 100% and then measuring the braking friction force that the road surface exerts against the wheel when the wheel spins up. Each measurement uses a variable slip speed measurement and records peak friction, slip at peak friction and the friction verses slip shape factor. Data was collected concerning precipitation, pavement condition, pavement temperature, air temperature, speed of the measuring device and the friction values.

The equipment, measurement procedures, and findings are described in detail. This preliminary research study shows that the different contaminant conditions can be separated and the friction level can be evaluated to determine whether or not to salt, salt light or salt heavy. Also, a supervisor can evaluate the effectiveness of abrasives and/or chemicals applied.

INTRODUCTION

A joint project on Winter Road Friction Measurement with Norsemeter, the Norwegian Road Administration, the Norwegian Director and the Norwegian Road Research Laboratory was carried out in 1994-1995. The study mapped maintenance guidelines and looked at current technology in friction measurements, as well as the PIARC friction and texture research project. Based on this study, Norsemeter developed ROAR (ROad Analyzer and Recorder). The unit was designed to be used as a stand-alone tester when mounted on a trailer or to allow mounting on a salt spreader truck. Field studies have been conducted in Minnesota and Norway during the 1995-96-winter season in a joint Minn DOT/Norsemeter project. This work was then carried over to a joint concept snowplow project to incorporate state of the art equipment on a snowplow. The project started with the States of Iowa (lead State), Minnesota and Michigan. Other States are now joining the group and a coordinated study is being done in Norway. This paper is a summary of these field studies describing the equipment, measuring procedures, and the findings of this preliminary research study and include some of the data from the Norwegian study as well.

TEST APPARATUS-ROAR

The measuring device (ROAR) is a continuous measuring type with a variable slip test wheel. It was mounted on a two-wheel trailer and towed by a host vehicle. The test wheel is located in the left wheel track and mounted directly on the axle of a hydraulic wheel slip controller that is programmed to perform a desired braking action on the test wheel. One braking action is a linearly decreasing rotational wheel

speed from free rolling to locked wheel. During this action the torque on the wheel axle is measured and converted to a friction coefficient by the digital computer of the device. A vertical static load of 1.5kN (300 lbf) is applied on the test wheel which has a four bar suspension with no spring and no shock absorber. The ASTM E-1551 is used as the test tire with inflation pressure 207 kPa (30 psi). The instrumentation has provision for acquisition of the torque acting on the test wheel, which is converted to friction coefficients in a digital computer, and the rotational speed of the test wheel converted to a distance and distance traveled per unit time. The computer is programmed to calculate several friction process parameters, including peak friction coefficient, the slip speed at which the peak friction occurred, the slope of the friction coefficient curve as a variable of slip speed and more. The computer program uses the Rado Friction Model for deriving these parameters. Friction coefficients for all slip speeds can be computed from each braking action, including friction at lower slip ratios like 15 or 18.5 % and at other traveling speeds than the one measurements were taken at. The measured values are stored in the computer and outputted as printout on a strip chart and data files on diskette.

Reduction and Analysis Data

The Norsemeter ROAR measures variable slip as shown in Figure 1 below.

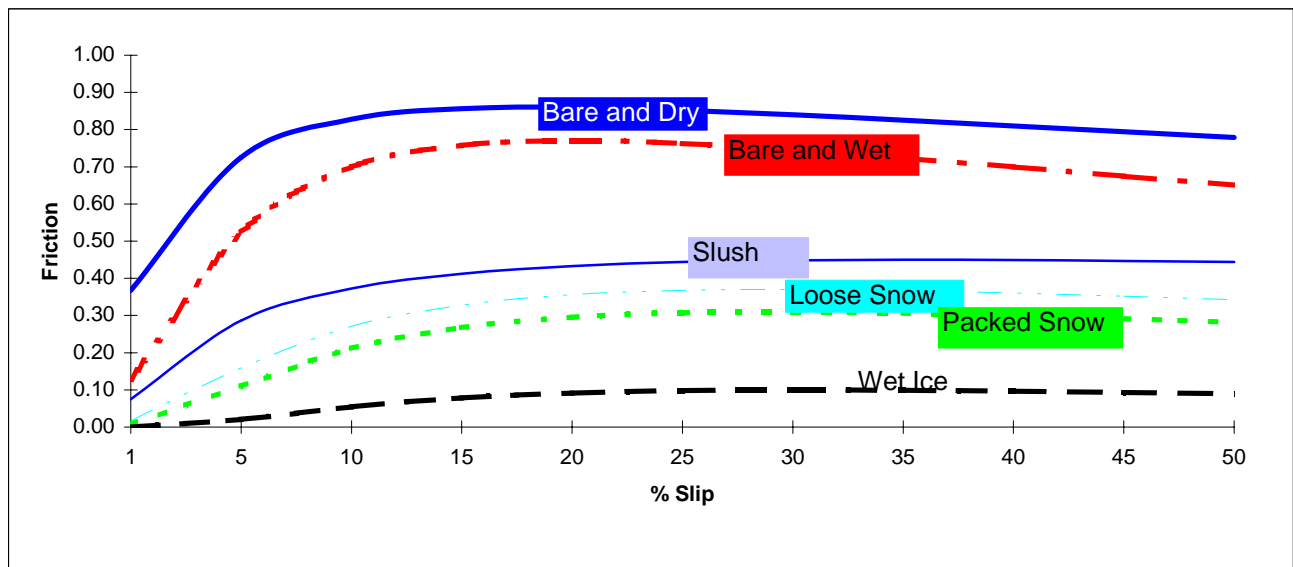

Figure 1. Sample friction verses percent slip for six conditions

The figure gives an example from the baseline dry tests and an example for wet, slush, loose and packed snow from the MinnDOT tests as well as an example on ice from the Norwegian tests. The data is fitted to the Rado model to provide the three coefficients required to produce the friction -slip speed curve. The three coefficients are μ_{peak} (value of the peak friction), S_{peak} (value of slip speed at which the peak friction occurred) and C (a value that gives the shape of the curve, called the shape factor). It is these values that were to be studied to see what is needed to determine the type of contamination and if salting is needed. Note that Figure 2 shows that the wet friction drops faster with speed and this has been shown to be correlated to macrotexture. Note that the percent slip at which the peak value occurs is around 18% on dry, 20% on wet, and near 30 % on the winter contaminated surfaces. This along with the drop in the peak value appears to be a tell tale sign. The shape factor also separates the loose snow and slush from the packed snow and ice and the ice is separated from the packed snow by the low friction.

This preliminary project was successful in establishing better values and showed that the Rado Model constants can be used to differentiate contaminants. The peak friction along with the slip speed at the peak separates the ice and snow from dry or wet. The shape factor then separates loose snow and slush from packed snow and ice. The project showed that friction levels can be monitored in real time and

salting control does appear to be feasible either with a go-no- go or perhaps with varying levels of salting. Since salting control does appear to be feasible, it was planned to continue the study in the US and Norway with more experiments. Iowa, MinnDOT and Michigan mounted units on a salting truck and evaluate its use the coming winter season.

Second Year testing of ROAR at St. Paul’s Test Track

The three States brought their ROAR mounted units to the test track at St. Paul Minnesota. The Michigan unit was mounted on a trailer, The IOWA unit was mounted just behind the cab on the left wheel track and the Minnesota unit was mounted on the front bumper in the left wheel track. In addition Minnesota and Iowa provided two KJ Law ASTM E-275 skid trailers to be used for comparisons. Four sites were used at the test track to evaluate the units. Table 1 gives the Speed Gradient and MTD for the texture of the four sites.

Table 1. Texture of test sites at St. Cloud, MN, test track

Track Site	Speed Gradient (Km/hr)	Mean Texture Depth (MTD in mm)
1	74.0	0.75
2	16.2	0.24
3	46.3	0.51
4	182.2	1.71

The tests were conducted under both wet and dry pavement conditions at speeds of 32, 48, 64, and 80 km/hr. It was found that the units did compare favorably in their measurement of μ_{peak} and F40 with correlations of R^2 of 0.8 and 0.75. However the Iowa unit gave a different slope than the others for μ_{peak} . The units were later tested in each state individually by the states under winter conditions. The Iowa unit did not do well structurally and in general it was found that the units measured satisfactory, but that they were not durable. The environment associated with snowplows is extremely harsh and demanding. Durability and cost of the ROAR units led Norsemeter to then develop a less expensive unit that incorporated ruggedness in their design of a unit for snowplows and called the unit SALTAR.

TEST APPARATUS-SALTAR

The measuring device (SALTAR) is a continuous measuring type with a variable slip test wheel. It was mounted on the snowplow frame behind the driver in the left wheel track. The unit uses an electric brake to bring the test wheel to a stop. The braking action is released and the rotational wheel speed goes from locked wheel to free rolling. During this action the wheel speed is measured and the torque on the wheel is calculated and converted to a friction coefficient. A vertical static load of 70kg (155 lbs) is applied on the test wheel. A Bridgestone 8F-228 135R X 12 tire is used as the test tire with inflation pressure 207 kPa (30 psi). The computer is programmed to calculate average friction and that is used to provide the operator with a one to five level of friction, one being poor and 5 being the best. For evaluation and research, the actual friction calculated can be reported.

EVALUATION OF SALTAR AT NASA WALLOPS FLIGHT CENTER

Annually, NASA holds a runway friction workshop at their Wallops Flight Facility. There are presently some 19 different friction sites, ranging in wet friction from .01 to almost 1.0. In 1999 there were some 10 different friction-measuring devices, however to date there is data for six of the devices that include the following:

- USFT US version of the Airport Surface Friction Tester from Sweden with two different tires
- SALTAR A friction tester designed by Norsemeter for Salt trucks.
- SFT79 A 1997 Saab Friction Tester owned by Transport Canada.
- BV11 A Swedish designed friction Tester owned by FAA.
- RFT Runway Friction Tester by K.J. Law owned by FAA.
- E274 An ASTM E274 skid tester from VADOT

All of the testers were run on some or all of the 19 sites in a self-watering mode. Values of the different testers show as much as 50% difference in their measured friction values. SALTAR always gives values within the range of the other testers; however, it measured higher friction values with increased speed in all but a few cases (see appendix). All of the other testers generally gave lower values with increasing speed. Investigation into the SALTAR showed that the computation done by Norsometer should be somewhat speed sensitive, however, it was designed for speeds of plow and salt trucks and indeed at the 50 km/hr (32 mph) speed the SALTAR measured in the middle of the range of the rest of the testers. Also when the SALTAR results were plotted versus the E-274 trailer at 30 km/h, they both give the same friction values. Thus, it would be expected that at low friction and low speeds the SALTAR should give good friction measurements.

Further investigation revealed that the SALTAR was run at a constant water flow rate, whereas the other devices are run at a varying flow rate with speed to produce the same water film thickness at all speeds. This means that the SALTAR had lower water film thickness with increased speed and thus should have increased friction with speed. New tests would need to be run to eliminate the water thickness problem to determine just what the real effect of speed is on SALTAR. Since SALTAR is designed to measure winter conditions, a series of tests were run in the 1999-2000 winter and compared with other friction measuring devices.

NORTH BAY, CANADA

The Iowa SALTAR unit was taken, mounted on their snowplow, to North Bay, Canada in January 2000 and was tested along with the Joint Winter Runway Friction Measurement Program. Testing showed that at very low temperatures, -30°C that the air lines needed better winterization as any water in the lines froze causing low normal load on the test tire. Overall results did not show a speed effect, but rather a scatter at very low friction levels as shown in figure 2. The scatter is due to the varying normal load caused by the air line.

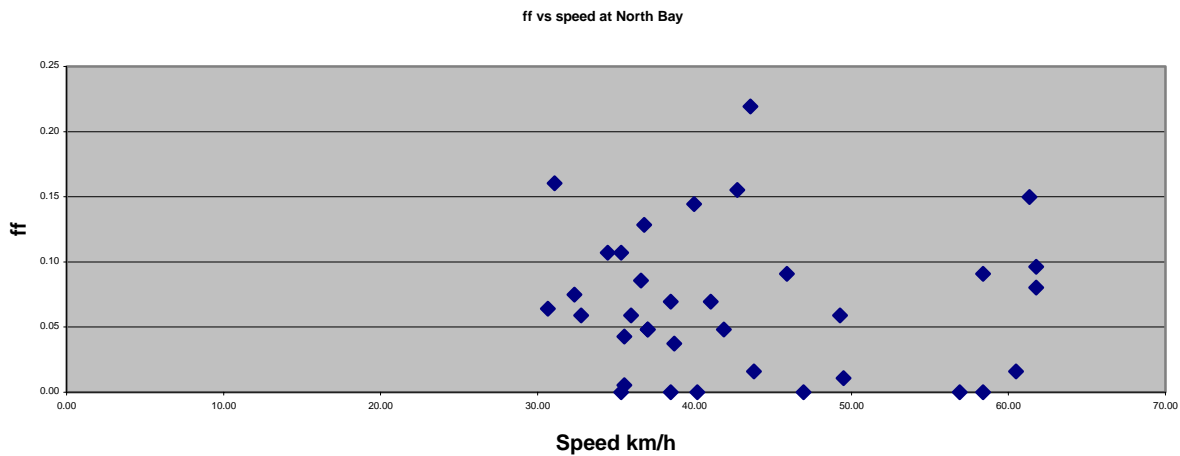

Figure 2 Speed effect at low friction values for SALTAR

Over all comparisons of the SALTAR measurements showed that the friction values were low when compared to the reference device. However, no calibrations were carried out since it could not be determined when the low reading was due to low contact pressure or if it was a low reading with the proper contact pressure. Since the data from Norway was without these problems, that data was used to make comparisons.

SALTAR DATA FROM NORWAY

Similar testing was conducted in Norway by the Road Administration where SALTAR and ROAR were run together to make comparisons. Figure 3 shows that SALTAR measures low when compared to ROAR; however, SALTAR does appear to increase or decrease in a similar manner. The same section then had hot sand, followed by cold sand placed on the middle half and the measurements were then repeated. Figure 4 shows these results that clearly show

that SALTAR does change with friction level, but reads low. Based on this a calibration was made and the results are shown in Figure 5. This calibration was then applied to the data from Figures 3 and 4 and they were replotted as Figures 6 and 7. It is felt that with the calibration, SALTAR reads satisfactory. It must also be pointed out that SALTAR measures the average friction value over a slip range whereas ROAR measures friction at a fixed slip or at the peak. Thus, the ROAR would naturally measure friction somewhat higher than SALTAR. However, the actual difference in the tests was more than one would expect, so the calibrations are applied to account for the difference.

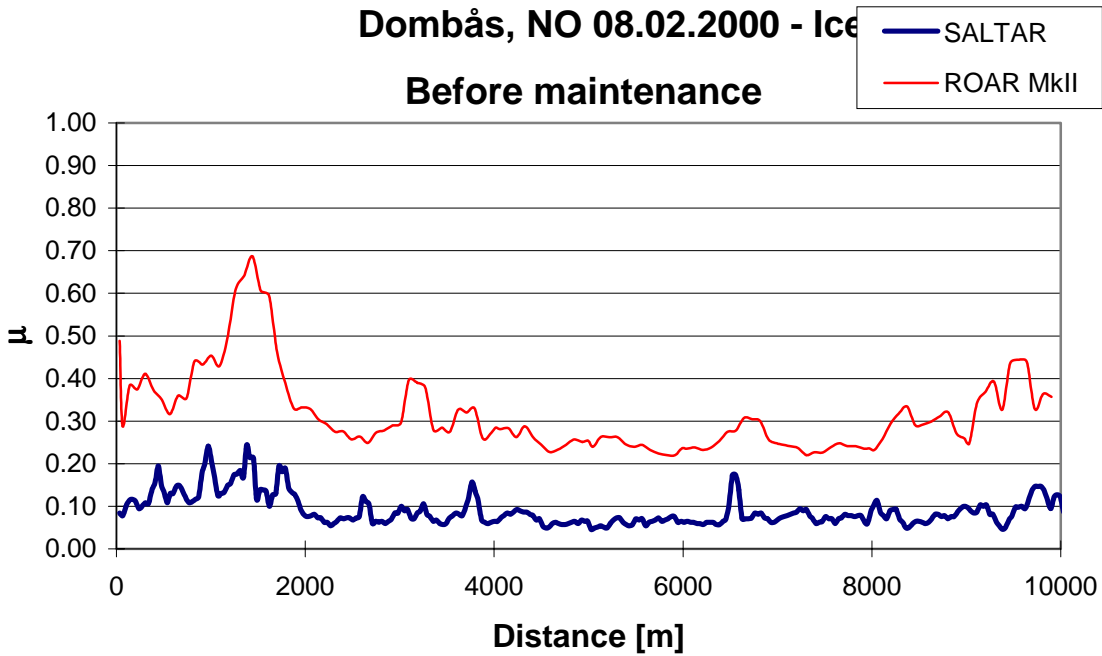

Figure 3 Friction by SALTAR and ROAR on a section of road covered with ice.

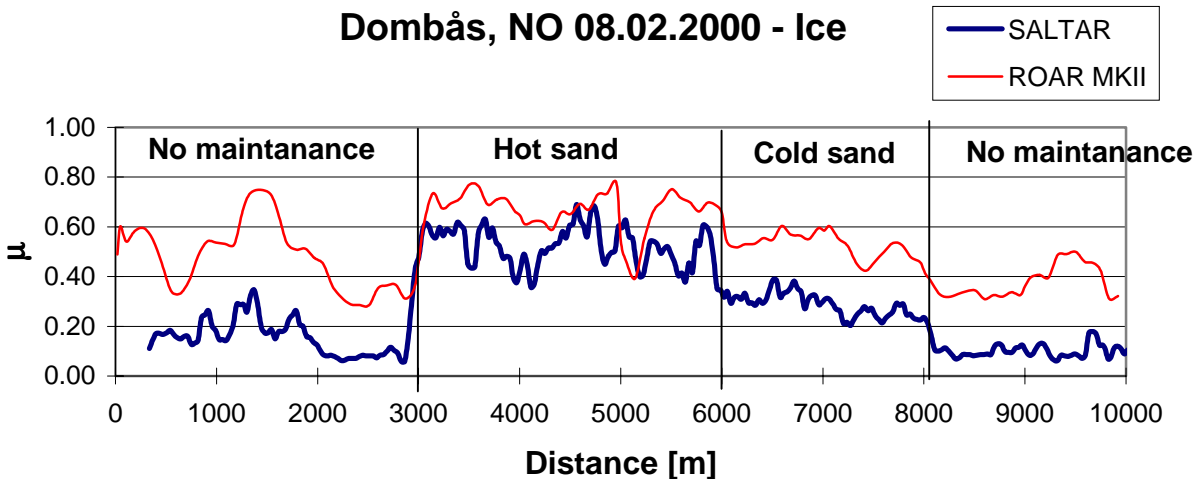

Figure 4. Ice covered road given in figure 3 with hot and cold sand applied to the mid-section.

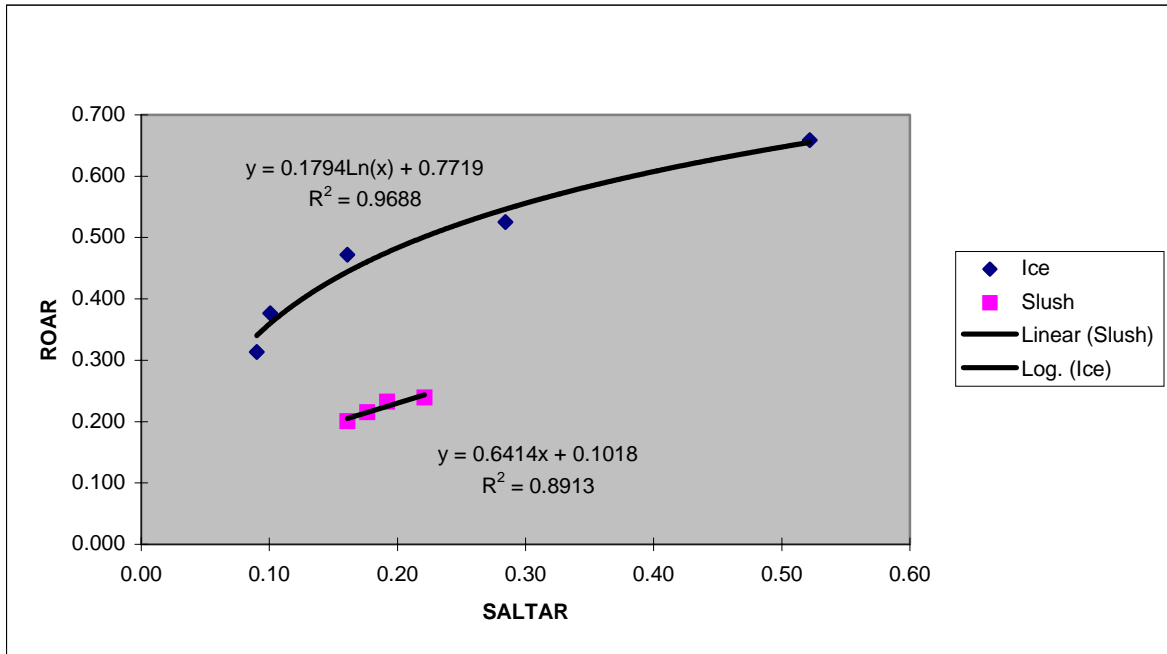

Figure 5. Correlation of SALTAR and ROAR

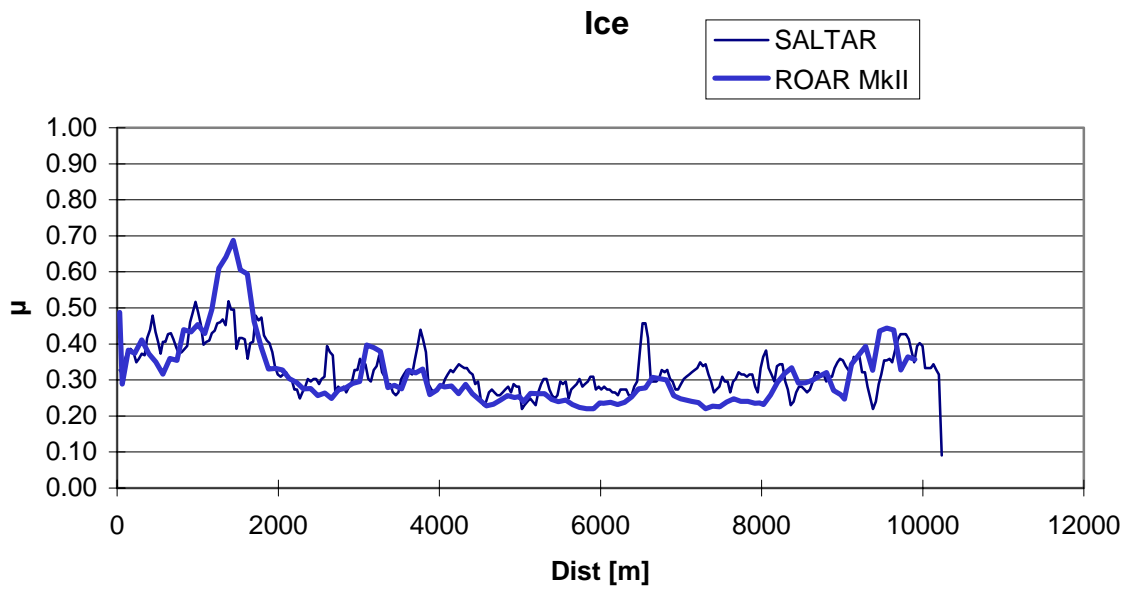

Figure 6. Data from Figure 3 with correlations applied.

Dombås, NO 08.02.00

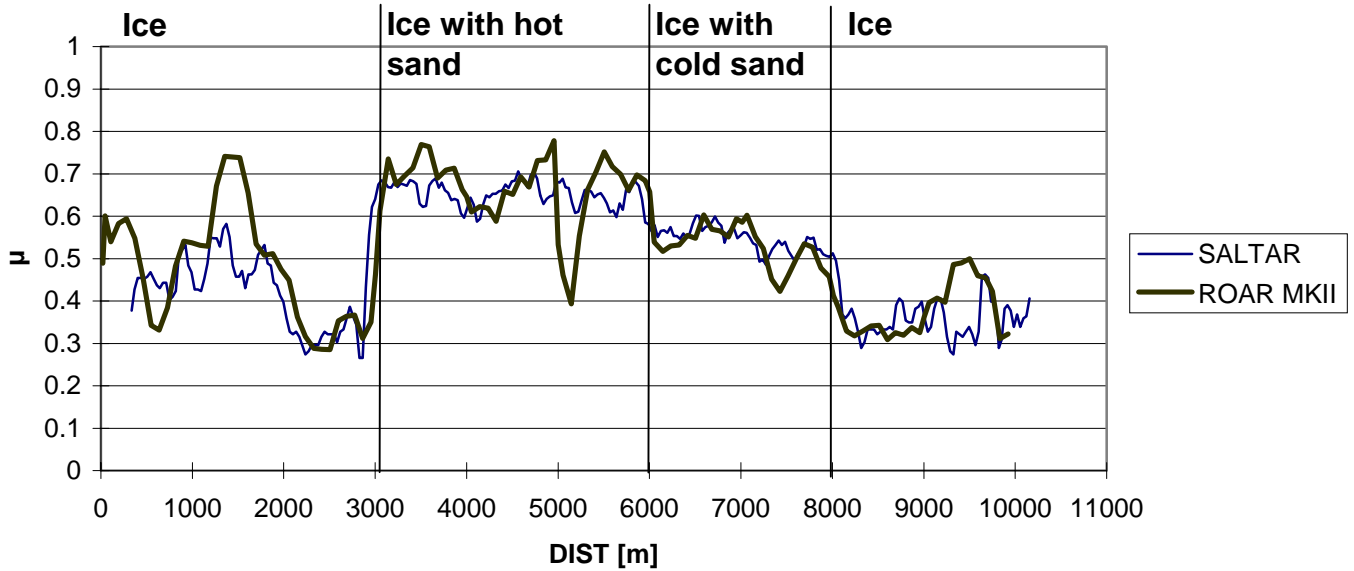
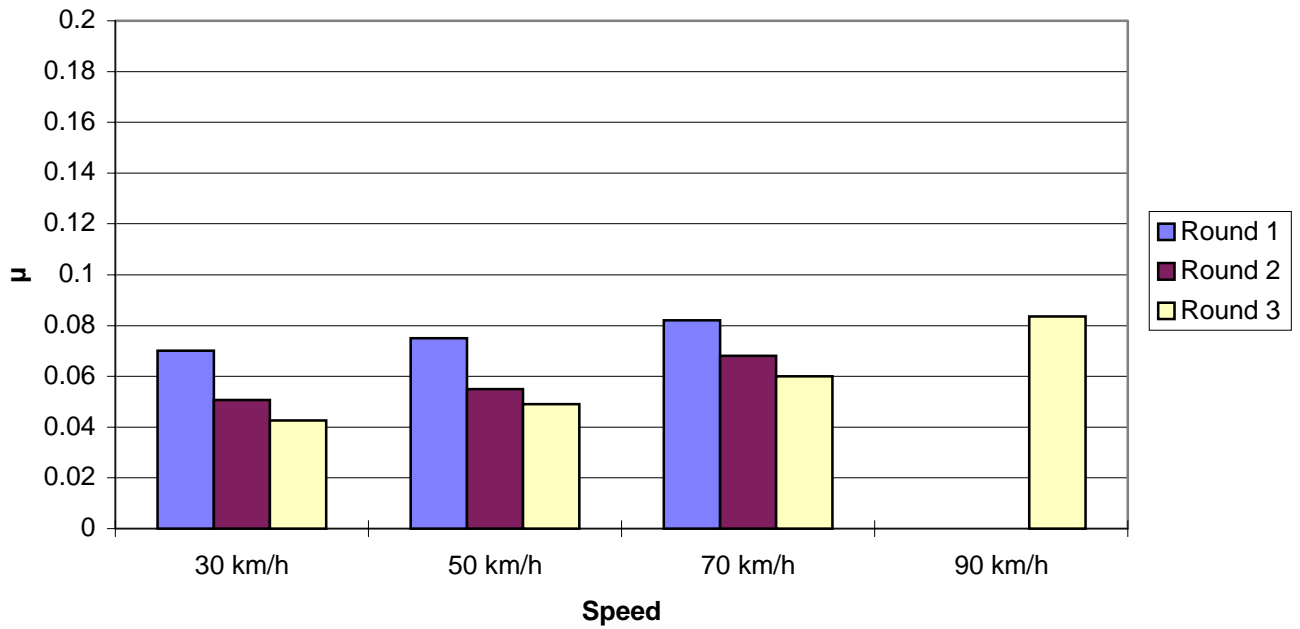

Figure 7. Figure 4 with Correlations applied.

From tests at different speeds on hard-packed snow, we see in Figure 8 that there is a very slight increase in friction with speed, but nothing like that at the NASA Wallops tests.

Hardpacked snow

Surface temp. -4
Air temp. -6



CONCLUSIONS

While SALTAR is a prototype, it was shown to be able to establish friction levels and shows great promise to be able to measure road friction under winter conditions. The brake system works according to specifications and the overall principal works well. Further development by Norsemeter is required and the following is recommended:

- An ASTM Standard be developed for SALTER.
- A Standard tire and manufacture be found.
- The air system must be fully winterized.
- A calibration procedure needs to be developed.
- The reason for the low readings be eliminated with further development so that absolute friction values are measured and read.
- Further reliability be added in future models or find out why the Minnesota model was locked up.

REFERENCES

Norsemeter/Norwegian Road Adm., *Winter testing reports*

Handbook Of Snow, Edited by D.M. Gray and D.H. Male, Pergamon Press

Zoltán Radó ,*A Study of Road Surface Texture and Its Relationship to Friction*, Phd Thesis, 1994, Penn State University

F. Navin, M. Macnabb, and C. Nicolleti, *Vehicle Traction Experiments on Snow and Ice*, SAE 960652,2-96

Wambold et al ,*Evaluation of Ground Test Friction Measuring Equipment on Runways and Taxiways Under Winter Conditions*, A Joint Transport Canada/Norsemeter Winter Runway Friction Program Report, January 1996

Concept Highway Maintenance Vehicle, Final Report: Phase One, April 1997, Center for Transportation Research and Education, Iowa State University

Concept Highway Maintenance Vehicle, Final Report: Phase Two, December 1998, Center for Transportation Research and Education, Iowa State University

Wambold, J. C., Antle, C. E., Henry, J. J., Rado, Z. (1995), "International PIARC Experiment to Compare and Harmonize Texture and Skid Resistance Measurements", *Final Report, PIARC Paris, France*.

ASTM (1996): "Standard Test Method of Measuring Surface Macrotexture Depth using a Volumetric Technique", Standard No. E965-96, *American Society for Testing and Materials Book of Standards Part 04.03*, Philadelphia, PA.

ASTM (1997): "Standard Test Method for Skid Resistance of Paved Surfaces Using a Full-Scale Tire, Standard No. E274-97, *American Society for Testing and Materials Book of Standards Part 04.03*, Philadelphia, PA.

ASTM (1993): "Standard Test Method for Measuring Surface Frictional Properties using the British Pendulum Tester", Standard No. E303-93, *American Society for Testing and Materials Book of Standards Part 04.03*, Philadelphia, PA.

ASTM (1998): "Standard Test Method for Measuring Paved Surface Frictional Properties Using the Dynamic Friction Tester", Standard No. E1911-98, *American Society for Testing and Materials Book of Standards Part 04.03*, Philadelphia, PA.

ASTM (1993): "Standard Specification for Special Purpose Smooth-tread Tire, operated on Fixed Braking Slip Continuous Friction Measuring Equipment", Standard No. E1551-93, *American Society for Testing and Materials Book of Standards Part 04.03*, Philadelphia, PA.

Appendix C: Norwegian Road Administration Test and Report

C.1 Test Plan for SALTAR in Sør-Trøndelag

C.2 SALTAR Friction Unit for Winter Maintenance

Test plan for

SALTAR

in

Sør-Trøndelag, Norway

Introduction

Statens vegvesen will during the test period have one prototype of SALTAR available. The prototype will be ready for mounting in the end of February and will be tested in March and April. Initially the unit is supposed to be tested in Sør-Trøndelag. Depending on the weather conditions it can be preferable to move the unit to another part of the country to find suitable conditions.

The measuring unit will be mounted on the same trailer as ROAR Mark II.

Goals for the test

The test plan is based on Norsemeter's needs of verification and Statens vegvesen's needs for testing.

The main goal with the test from Norsemeter's side is to expose the unit for as much stress as possible to detect weak components or bad solutions.

In addition to that it should be verified that the unit is suitable for the tasks it is meant for.

Another goal in the test is to investigate if the given intervals are suitable for reporting.

An important issue for the test is that the unit will be used as much as possible during the two months available for testing.

Registration form

Details about the measurements should be reported in a form, where information about the weather, surface, air temperature, surface temperature and maintenance actions will be registered.

In addition to that date, time, filename and road id should be registered.

Fixed route

The unit should regularly drive a fixed route. For this route it should be measured when it is expected to be slippery.

In addition some measurements should be done on bare dry and wet surfaces, mainly to test out how long SALTAR can measure on these kinds of surfaces without overheating of the brake.

- The test route should include sections who are both salted and not salted.
- The test route should include a weather station.
- Measurements should be done in normal traffic speed.

Surfaces

Different surfaces should be investigated:

- Bare dry road
- Bare wet road
- Loose snow
- Hard packed snow
- Dry ice
- Wet ice
- Slush

The thickness of snow layers of slush layers should be estimated and reported with other information.

Five (5) repeated runs on all kinds of surfaces should be done at 50 km/h.

Speeds

All kinds of surfaces should be investigated in different speeds. It should be measured in 30, 50 and 80 km/h.

Extreme conditions

The measuring unit should be exposed to “extreme” surfaces to investigate if it is stable, or if any conditions can influence the measuring results.

It should be measured in:

- Rough surfaces with a lot of bumps that will “beat” the unit
- Extreme low temperature: -30°C
- Extreme contamination surfaces: salt, rocks, slush etc.

It should also be done measurements in different temperatures. The ideal would be to measure within the whole range in the specification. These temperatures should be registered in the form.

Maintenance

Measurements should be done in relation to maintenance actions. That can be done during natural winter maintenance on the road or by artificial preparations.

Measurements in relation to maintenance actions like salting and sanding should be done according to the following plan:

- One round before maintenance

- One round immediately after maintenance
- One round about one hour after maintenance
- One round about 4 - 8 hours after maintenance

Comparative testing

Since SALTAR will be mounted on the same trailer as ROAR it can be an option to make comparable measurements with the two units.

It can also be an issue to collect several of the different types of equipment Statens vegvesen have for a common test.

Test Matrix:

Site condition	Number of runs at 30 km/h	Number of runs at 50 km/h	Number of runs at 80 km/h
Bare dry	1	5	1
Bare wet	1	5	1
Loose Snow	1	5	1
Packed snow	1	5	1
Dry ice	1	5	1
Wet ice	1	5	1
Slush	1	5	1

SALTAR

Friction Unit

For

Winter Maintenance

Report

July 2000

Statens vegvesen • Norsemeter AS

Content

Acknowledgment

Summary

1. Introduction

2. Technical description

2.1 SALTAR

2.2 The choice of different solutions

2.2.1 Principal measuring techniques

2.2.2 Design and components

3. Test of SALTAR

3.1 Results

3.2 Summary

4. Comparison of SALTAR and OSCAR/ROAR

5. USA measurements

5.1 Minnesota/Iowa

5.2 NASA Wallops Flight Center

5.3 North Bay, Canada

6. Conclusions and recommendations

Appendix 1

Figures

Figure 1: Measurements with SALTAR before and after maintenance on ice. Two areas are treated with hot and cold sand.

Figure 2: Measurements with SALTAR on slush with some bare spots.

Figure 3: Wet and dry measurements with SALTAR.

Figure 4: Average values for different conditions measured with SALTAR.

Acknowledgment

This report describes the results and the project from a cooperative effort between The Norwegian Road Administration, SND and Norsemeter AS. The project was mainly to develop a new friction-measuring device called SALTAR.

A work group with representatives from both The Norwegian Road Administration and Norsemeter AS has been responsible for the project. The project leader has been Arnulf Ingulstad (Vegdirektoratet) and other members in the work group have been Bjørn Ove Ofstad (Statens vegvesen, Sør-Trøndelag), Wilhelm Foslien (Statens vegvesen, Buskerud), Roald Hanssen, Per Harald Hansen, Jon Dahlen og Øystein Larsen (Vegdirektoratet), Bjørn Are Carlsson, Edit Radone and Eirin Torgersen (Norsemeter AS). In addition Zoltan Rado (Norsemeter) has contributed to the project, even though he has not been part of the work group.

The project is based on a pre-project started summer 1997. During the pre-project the technical specifications and the requirements to the device where settled.

Summary

The main goal with the test of SALTAR was to verify that the product meets the requirements that The Norwegian Road Administration has defined for this measuring equipment.

SALTAR is a measuring device designed for winter use, where the surface should be classified according to five levels.

Summer 1997 a pre-project was initiated where the specifications for the equipment were worked out. The specifications are summarized in Appendix 1.

Three prototypes were developed. These were built from robust, standard components with simple maintenance. The prototypes were placed in Sør-Trøndelag (Norway), Minnesota and Iowa. The prototypes were mounted on totally different vehicles. The unit in Sør-Trøndelag was mounted on a trailer, while the units in Minnesota and Iowa were mounted on big plowing trucks.

Mainly they were tested on winter surfaces, but there have also been some measurements on wet and dry roads.

After the tests are finished it can be determined if SALTAR fulfills the requirements worked out in the pre-project.

Based on experience from both this project and previous work with friction measurements the project will recommend a measurement standard for friction measurements on winter surfaces. A standard will prevent the problems occurring today with different equipment giving different results since measuring principle and measuring tire are different.

Results from the test can briefly be summarized as the following:

- More than 1000 km (?) is measured in USA and Norway (Can this be verified?)
- The test is done in the temperature range -40°C to $+30^{\circ}\text{C}$.
- Measurements are done in the total friction range
- SALTAR meets the requirements in the specification (See Appendix 1)
- SALTAR has good repeatability
- SALTAR can distinguish between different surfaces and can detect short areas with changed friction level
- The brake chosen is according to the expectations. At the end of the test period there have been a few problems with the brake taking in humidity. There are several suggestions for how to seal the brake better to solve this problem.

1. Introduction

For a while there had been a wish from The Norwegian Road Administration and road administration abroad (USA), for a simple friction measuring equipment specially dedicated for winter operation. The Norwegian Road Administration and Norsemeter have cooperated in previous development of the advanced friction measuring equipment called ROAR (ROad Analyzer and Recorder). Later there has been a need for a simpler and least but not last a less expensive unit to be used in a bigger scale.

The Norwegian Road Administration and Norsemeter started in the Summer of 1997 the planning and development of a simpler friction-measuring device called SALTAR. A pre-project was done where the technical specifications for the unit were defined.

For the technical specifications input from road authorities in Minnesota (MinDOT) and Iowa (Iowa DOT) were taken into the consideration.

Fall 1998 the main project where started and three prototypes of SALTAR were ready for testing March 1999. The Norwegian Road Administration with Sør-Trøndelag road office, Minnesota DOT and Iowa DOT had one prototype each for testing.

The goals for the testing of SALTAR can be summarized as the following:

- Expose the unit for as much stress as possible to be able to detect weak components or bad solutions.
- Verify that the unit is suitable for the tasks it is meant for.
- Investigate the quality and repeatability
- Investigate if the set intervals are suitable, and in accordance with a standard. (? Define standard)

Testing of the prototypes has been done during the last part of the winter 1998/1999 and the whole winter 1999/2000.

2. Technical description

2.1 SALTAR

The SALTAR Friction Tester is a device designed to measure friction on traveled winter contaminated surfaces and based on the measurements classify the winter contaminants and or surface in five levels. Fundamentally the SALTAR unit is a small very durable frame equipped with an electronic brake and a measurement tire. The brake is controlled by an advanced software and electronic control system to simulate car braking action and measure the generated friction coefficient between a measuring wheel and surface.

2.2 Principal measuring techniques

The measuring wheel together with the holding bracket can be retracted or lowered by means of a pneumatic mechanism, which also provides the controlled and calibrated load for the measurement tire. For measuring it is lowered on to the surface with a predetermined and controlled vertical load by means of two pneumatic cylinders which are integrated and ear part of the frame and holding bracket of SALTAR. As the host vehicle moves on the measured surface, the measuring wheel periodically braked by the electronic brake and the effective braking power during a braking cycle, where the wheel is braked from freely rolling to locked position is registered by the control system.



The measuring wheel is mechanically geared to the high precision and durable electronic brake. The device measures the effective braking power during a braking cycle, where the wheel is stopped from freely rolling to locked position. The measurement is based on the principle of measuring of the time necessary to speed up the measurement wheel from locked position to freely rolling. The complex and sophisticated control software computes the necessary parameters from the acquired physical parameters measured during the braking cycle and calculates the effective braking power.

2.3 The choice of different solutions

As extra equipment a data link can be installed. This link can transmit the measuring results to a PC, either in remote location by radio or direct to a portable PC in the drivers cab, for storage, presentation or further processing. The software now available are writing friction values to a file related to a distance, and it can give graphical output of the friction value related to distance.

3. Test of SALTAR

The Norwegian Road Administration and Norsesmeter worked out a program for testing of SALTAR. The test plan was also compared to the test program in USA. The Norwegian Road Administration had one prototype of SALTAR in Sør-Trøndelag and two prototypes have been in Minnesota and Iowa last winter.

The test program is done, and in total there are done measurements on more than 1000 km. To be able to analyze the data, SALTAR was connected to an external computer. This computer was equipped with software that was able to register the friction according to the measured distance. A printer was also connected, and the results could be printed after the round. The software is mentioned under options and is already developed.

3.1 Results

Figure 1 shows the measurements done with SALTAR before and after maintenance with sand. The section was initially ice, where they put on cold sand on one section, hot sand on the next section and at the beginning and the end there was no maintenance.

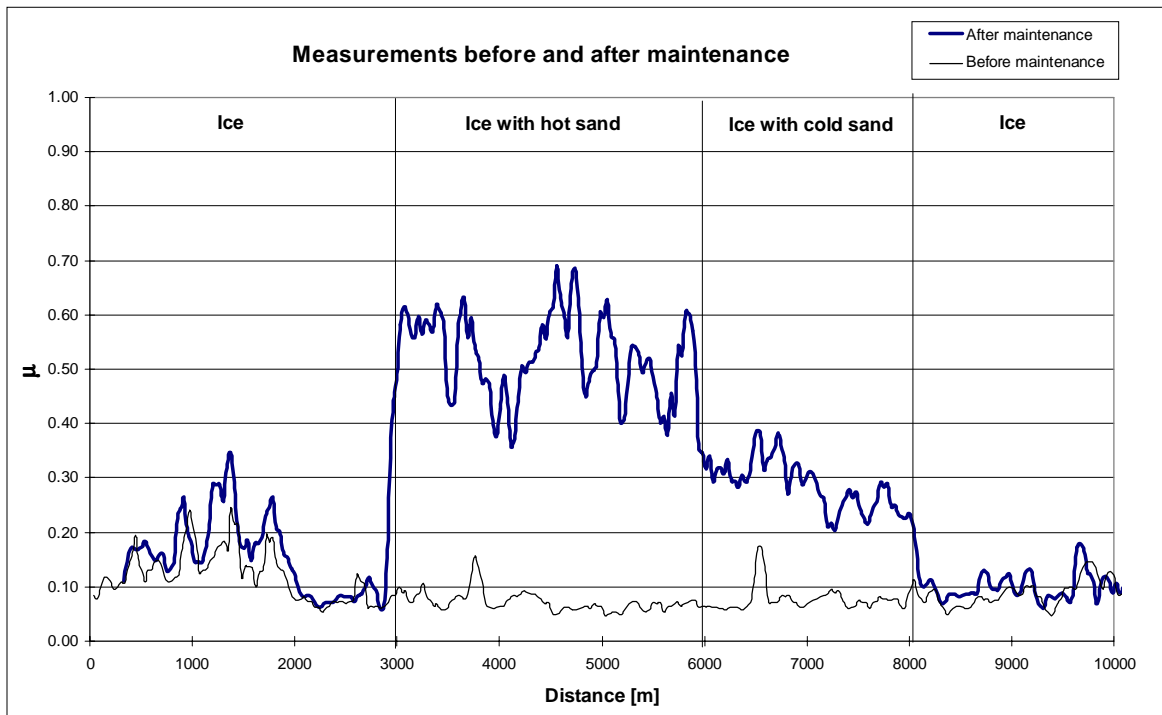

Figure 1: Measurements with SALTAR before and after maintenance on ice. Two areas are treated with hot and cold sand.

- First round is done before any maintenance on ice. This is a long section, 10 km, showing almost the same level of friction on the whole section.
- After the section is sanded there is an obvious change in friction levels for the different surfaces and maintenance action. This is also according to the expectations we have for the different operations. ROAR is also showing the same variations in friction levels for the different surfaces.
- The repeatability is very good for the two runs done on the ice. The same unevenness' on the surfaces appears for both runs.

In Figure 2 measurements with SALTAR on slush are plotted. One run is done at 30 km/h and three runs are done at 50 km/h. There is an increase for the values from first to last run, but this is due to changes in the surface when the slush is melting more and more. From the peaks in the plot it is possible to detect bare spots.

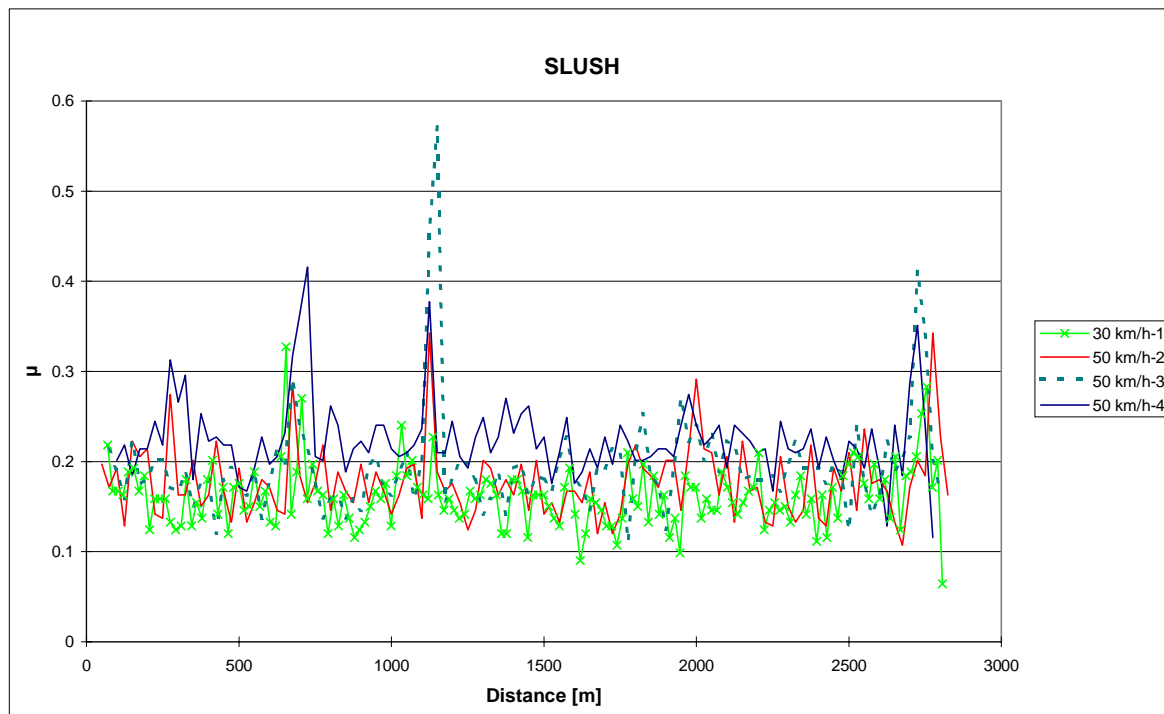

Figure 2: Measurements with SALTAR on slush with some bare spots.

Figure 3 shows measurements with SALTAR on both dry and wet road. This shows very good repeatability for the two different sets of runs.

First season there were quite a lot of measurements on bare wet road both in Norway and in USA. These measurements did not show any tendency for heating of the brake, so it seems like the unit can handle these conditions well.

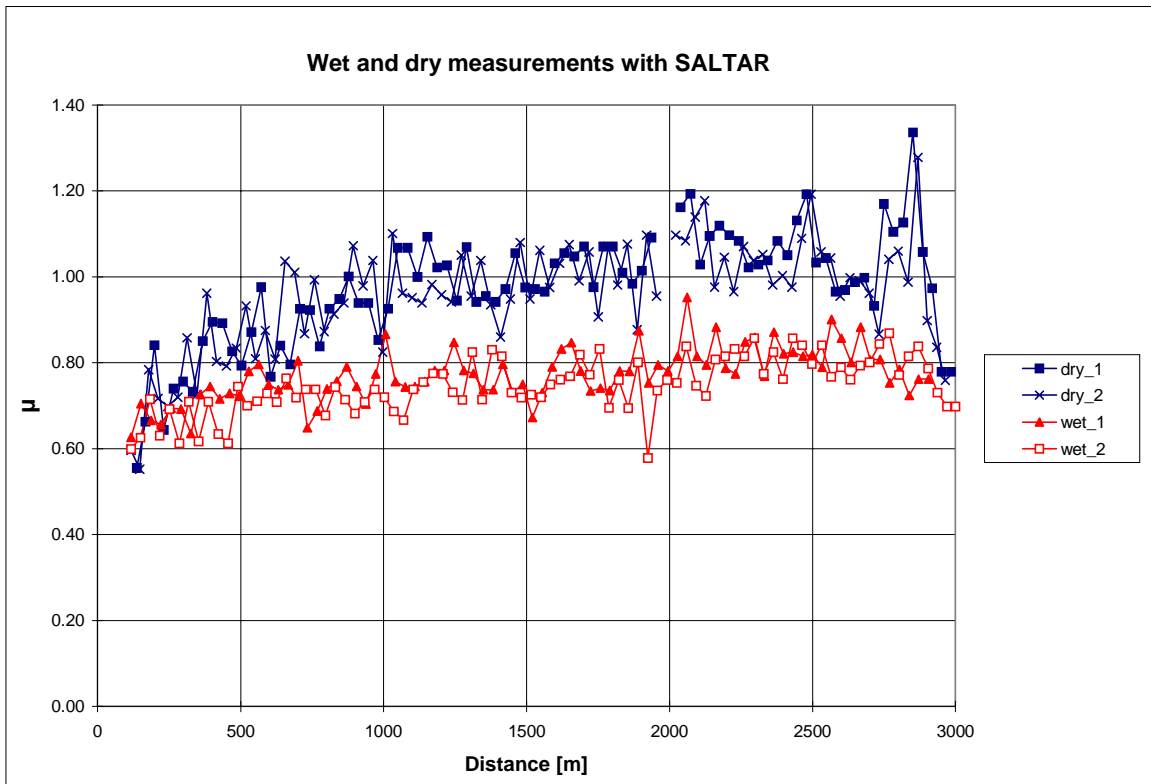

Figure 3: Wet and dry measurements with SALTAR.

Several more measurements, not presented here, are done on different surfaces. Only a few measurements are presented to illustrate some of the results achieved with SALTAR. In Figure 4 average values for different surfaces measured with SALTAR. All these measurements are done in 50 km/h or 60 km/h.

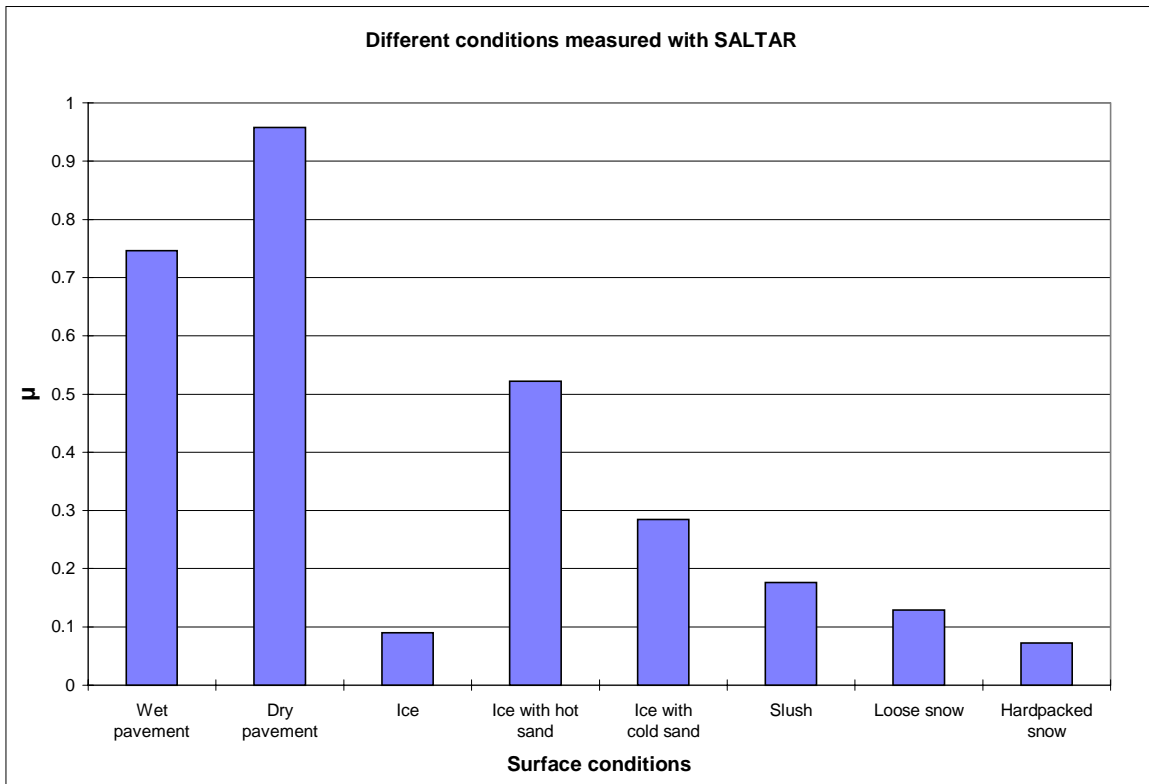

Figure 4: Average values for different conditions measured with SALTAR.

- SALTAR can distinguish between different surfaces.
- SALTAR gives different levels
- The results are found after measurements on two different continents Norway and North America (Wallops Island, Virginia and North Bay, Ontario)
- 8 different surfaces are presented. In addition there are done a lot of measurements that are combinations of these.

3.2 Summary

- SALTAR and the structure of the unit have been working in the total friction range.
- SALTAR units have been mounted on two totally different vehicles, trailer and plowing trucks, and have been working well on both
- SALTAR has been tested in extreme temperature ranges. The unit and the brake have worked and that shows that the unit is able to operate during these conditions.
- SALTAR has proven to have the ability to distinguish between different surfaces, as it is designed for.

4. Comparison of SALTAR and OSCAR/ROAR

5. USA measurements



5.1 Minnesota/Iowa

5.2 NASA Wallops Flight Center

5.3 North Bay, Canada

5. Conclusions and recommendations

The test and project described in this report were initiated fall 1998 and finalized spring 2000.

The results from the test can be summarized as the following:

- SALTAR meets the requirements in the specification
- SALTAR has good repeatability
- SALTAR can distinguish between different conditions and can detect short sections with changed friction levels
- It is tested in extreme temperature ranges, down to -40 °C. The unit and the brake have been working, and that proves the ability of working under these conditions.
- SALTAR can handle measurements on wet and dry road with temperatures up to 30 °C. The goal with this test was to test during winter conditions. The test also indicates that we can get meaningful data for wet and dry surfaces. SALTAR has a potential to be used for summer measurements and accident investigations. To use SALTAR for this purpose a standard must be developed based on SALTAR, as for winter maintenance. Also a watering system must be used. (USA results must include cold weather problems.)
- The chosen brake is according to the expectations. During the end face there have been a problem with moisture coming into the brake. The consequences of this is that the brake where not able to lock the wheel on surfaces with high friction. Norsemeter have developed a solution for this problem.
- SALTAR has been mounted on two totally different vehicles; trailer and plowing truck, and have been working well in both.

Some weak components and bad solutions are changed for SALTAR. After these modifications it seems like the product is working very well. (Need discussion in Section 3)

After two winter seasons with testing of SALTAR there are some experiences both from the measurements and problems occurring and being solved. Norsemeter has the following recommendations after the test:

- * Measuring tire should be standardized. It should be a patterned tire with diameter 12" or 13". A tire manufacturer should be contacted and a standard should be written for the tire.
- * To avoid problems with different equipment operating after different principles and different tire types giving different results, a standard for friction measurements should be established. It is very difficult to establish good comparison between different equipment with the exception of ROAR and OSCAR in variable slip mode. They can be used to simulate other equipment with very good results and can be used as a basis for a friction standard.

Appendix 1

Technical specification

Standards and directives:

The system should comply with the EU directive on Machines and carry the CE mark.

Measuring parameter range

Friction: $0.05 < \mu < 0.50$

Measuring interval: one measurement in every 2 seconds

Output parameter

Output: Five levels of information for the braking activity friction activity?

Measuring parameters: Relative braking activities in intervals

The output shall be displayed on the user interface, and shall be transmitted to an external data collection unit.

Five levels

Hazardous: $\mu = 0.15$ of OSCAR

Very slippery: $0.15 < \mu = 0.25$ of OSCAR

Slippery: $0.25 < \mu = 0.4$ of OSCAR

Acceptable: $0.4 < \mu = 0.5$ of OSCAR

Good: $\mu > 0.5$ of OSCAR

Operating ranges

Measuring speed range: 30 to 80 km/h

Ambient operating temperature range: -30°C to $+10^{\circ}\text{C}$

Storage temperature: -30°C to $+50^{\circ}\text{C}$

Contamination of road range: max. 100mm winter contamination

Other general requirements

Weight: It shall light enough to be able the handle it by one man

Size: It shall be small enough to be mounted under most of the 16-26 t trucks. It should have a transport position where the clearance from the ground is min 300 mm

Power: 12 V power from the host vehicle battery, max. 75 W capacity

Accuracy

Accuracy: in all the level it shall be $\pm 10\%$ (of μ ?)

Reliability and Maintainability

Lifetime: 5 years, based on the very rough environment under a truck

Operating environment: it must be tolerant to rough environments like salt, de-icing material, water, ice and slush. No corrosive parts

Maintainability: Service, maintenance and calibration should be done by trained personnel, according to the manual. The unit should have as simple maintenance as possible. Few movable parts, minimum wear of parts, only mass production components.

The device shall not get damaged by traveling through small obstacles (max. 10 cm high), or holes (max. 10 cm deep) on the road

User Interface

It shall be as small as possible. It shall be easily mounted anywhere in the driver's cab.

Standard

Start/ Stop button

5 level indicator of the relative braking activity, which will be also used for warning signal

Optional

Connection to external PC

Registration of friction and speed according to distance. Printout to paper or to file.

Connection to Salting Control unit

Lifting/lowering switch, which will be separated from the control system

Pen writer

Installation

Simple mounting and de-mounting for seasonal use. One man should be able to mount it in max. one hour, without using any additional equipment other than a wrench.

Operation

The system operation shall be simple enough to be handled by the host vehicle operator.

Appendix D: Norsemeter Test Comparison and Report

D.1 Comparison of Test Plans in USA and Norway

D.2 Norsemeter SALTAR Report

D.1 Comparison of test plans in USA and Norway (© Norsemeter)

Test	USA	Norway
Base line test:	Base line test: <ul style="list-style-type: none"> • Sand patch • British Pendulum Test • Photograph of the overall site and a close-up of the surfaces with a label for the site and a length reference 	No base line test in Norway with texture devices
Predetermined and Fixed route	For all tests	Measured regularly, but measurements should also be done on interesting conditions outside the fixed route.
Measured when:	<ul style="list-style-type: none"> • No danger of slippery road • Weather forecasts predicts good conditions 	Basically when slippery conditions are expected
Test route should include	Different pavement Salted and not salted roads Weather station Measure at normal truck speed in normal traffic Make one data file per route completed	Not that important YES YES YES YES
Measurements related to maintenance	<ul style="list-style-type: none"> • One data collection session one or two hours before weather requires maintenance. • One data collection session every time maintenance is performed. • One data collection session 4-8 hours after maintenance completed. 	<ul style="list-style-type: none"> • One round before maintenance • One round immediately after maintenance • One round about one hour after maintenance • One round about 4 - 8 hours after maintenance
Extreme conditions:		<ul style="list-style-type: none"> • Rough surfaces with a lot of bumps that will “beat” the unit • Extreme low temperature: -30°C • Extreme contamination surfaces: salt, rocks, slush etc.
Comparative testing with other equipment:	E274 Tester and Others at Wallops	Measurements with both SALTAR and ROAR, since SALTAR will be mounted on the same trailer as ROAR

Test matrix:

	USA	Norway
Loose snow	Dry (T<25°F) and Wet (T~32°F, <1 inch)	Not defined, write down in a log what the conditions are (snow depth and temperature).
Slush	Wet (T~32°F) and both < and > 1 inch	
Packed snow	Dry (T<25°F) and Wet (T~32°F)	
Ice	Dry (T<25°F) and Wet (T~32°F)	Dry and wet
Speed	1 run at 32 km/h, 5 runs at 56 km/h	1 run at 30km/h and 80 km/h, 5 runs at 50 km/h

D.2 (© Norsemeter)

**Report summarizing the analysis of the data collected in the United States
by the SALTAR prototype winter friction measurement equipment during
the season 1999-2000**

by
Zoltán Radó

Tuesday, 29 August 2000

CONTENTS

Item
1. Summary
2. Introduction
3. Data Base
3.1. Raw Data
3.2. Data Files
4. Analysis
5. Results
6. Conclusions

1. Summary

The data base was established on the data collected during the annual Wallops Friction Workshop during the summer of 1999 and the Joint Winter Program measurement session in North Bay Canada during the winter season of 1999 and 2000.

The main goal for the test of the SALTAR device was to verify that the product meets the requirements defined by the winter maintenance experts from Iowa, Minnesota and Norway for the measuring equipment. SALTAR is a measuring equipment designed for winter use, where the surface should be classified according to five levels.

Summer 1997 a pre-project where initiated where the specifications for the equipment where worked out.

Three prototypes where developed. These where built from robust, standard components for simple maintenance and reliable operation. The prototypes where placed in Sør-Trøndelag (Norway), Minnesota and Iowa. The prototypes where mounted on totally different vehicles. The unit in Sør-Trøndelag was mounted on a trailer, while the units in Minnesota and Iowa where mounted on big ploughing trucks.

They been tested on both winter surfaces and on wet and dry road.

After the test is finished it can be concluded that SALTAR fulfils the requirements worked out in the preliminary pilot project.

Results from the test can briefly be summarized as the following:

- More than 1000 km is measured in USA and Norway
- The test is done in the temperature range -40°C to +30°C.
- Measurements are done in the total friction range
- SALTAR meets the requirements in the specification
- SALTAR has good repeatability
- SALTAR can distinguish between different surfaces and can detect short areas with changed friction level
- The brake chosen is according to the expectations. At the end of the test period there has been a few problems with the brake taking in humidity. There are several suggestions for how to seal the brake better to solve this problem.

2. Introduction

For some time the need for a simple friction measuring equipment specially dedicated for winter operation was present in Europe and in the USA. The authorities in Iowa, Minnesota and Norway together with Norsemeter have co-operated in the planning and development of a simpler friction measuring device called SALTAR. A pre-project where done where the technical specifications for the unit where defined.

For the technical specifications input from road authorities in Minnesota (MinDOT) and Iowa (Iowa DOT) where taken into consideration.

Fall 1998 the main project where started and three prototypes of SALTAR where ready for testing March 1999. The Norwegian Road Administration with Sør-Trøndelag road office, Minnesota DOT and Iowa DOT have had one prototype each for testing.

The goals for the testing of SALTAR can be summarized as the following:

- Expose the unit for as much stress as possible to be able to detect weak components or bad solutions.
- Verify that the unit is suitable for the tasks it is meant for.
- Investigate the quality and repeatability
- Investigate if the set intervals are suitable, in. ex. according to a standard.

Testing of the prototypes have been done during the last part of the winter 1998/1999 and the whole winter 1999/2000.

3. Data Base

The data base was established on the data collected during the annual Wallops Friction Workshop during the summer of 1999 and the Joint Winter Program measurement session in North Bay Canada during the winter season of 1999 and 2000.

The measurements were made with a SALTAR unit installed on a plough truck from Iowa (Figure 1)



Figure 1. SALTAR Installation on plough truck

3.1. Raw Data

The data was received by Norsemeter in a raw data format produced by the data logger installed in the concept vehicle to collect and store the measurement records. The data was collected into ASCII files in a space delimited format.

The data base consists of two separate data sets from two different locations:

- Wallops (USA)
- North Bay (Canada)

The data from the Wallops testing contains measurement values collected on different pavement surfaces under summer conditions. Since the SALTAR unit has been mounted on a winter maintenance truck the correct watering equipment required for summer friction measurements was not available for the Wallops testing. The measurements were conducted by the truck so that a pre-vetting vehicle was used prior to the measurement by the SALTAR unit. The separate equipment travelled through the measuring section and pre-vetted the surface. The section then was measured by the SALTAR equipment.

The data collected during the winter measurements in North Bay contains the data which have been measured on different winter contaminated surfaces. The measurements during the winter workshop were conducted in the same way as for the other types of friction measurement equipment.

3.2. Data Files

The following data have been received by Norsemeter from the Wallops workshop test in May 1999:

6th Annual NASA Tire/Runway Friction Workshop:

TireConfigID	TestRunID	LaneID	Standard Run ID
SALTAR	1082-01	REJUV-22	32F100
SALTAR	1082-02	REJUV-22	32F100
SALTAR	1082-03	REJUV-22	32F100
SALTAR	1082-04	REJUV-22	50F100
SALTAR	1082-05	REJUV-22	50F100
SALTAR	1082-06	REJUV-22	50F100
SALTAR	1082-07	REJUV-22	65F100
SALTAR	1082-08	REJUV-22	65F100
SALTAR	1082-09	REJUV-22	65F100
SALTAR	1091-11	MICRO322	50F100
SALTAR	1091-12	MICRO404	50F100
SALTAR	1091-13	MICRO122	65F100
SALTAR	1100-01	RP22	32F100
SALTAR	1100-02	ALU-04	32F100
SALTAR	1100-03	RP22	50F100
SALTAR	1100-04	ALU-04	50F100
SALTAR	1100-05	RP22	65F100
SALTAR	1100-06	ALU-04	65F100
SALTAR	1166-01	JENN-28	32F100
SALTAR	1166-02	JENN-28	32F100
SALTAR	1166-03	JENN-28	32F100
SALTAR	1166-04	JENN-28	50F100
SALTAR	1166-05	JENN-28	50F100
SALTAR	1166-06	JENN-28	50F100
SALTAR	1166-07	JENN-28	65F100
SALTAR	1166-08	JENN-28	65F100
SALTAR	1166-09	JENN-28	65F100
SALTAR	1171-01	JENREF10	32F100
SALTAR	1171-02	JENREF10	32F100
SALTAR	1171-03	JENREF10	32F100
SALTAR	1171-04	JENREF10	50F100
SALTAR	1171-05	JENREF10	50F100
SALTAR	1171-06	JENREF10	50F100
SALTAR	1171-07	JENREF10	65F100
SALTAR	1171-08	JENREF10	65F100
SALTAR	1171-09	JENREF10	65F100

The data from the North Bay tests contains the following measurement files

3rd Annual Joint Winter Program Workshop:

TireConfigID	TestRunID
SALTAR	1326-01
SALTAR	1326-02
SALTAR	1326-03
SALTAR	1326-04
SALTAR	1336-01
SALTAR	1336-02
SALTAR	1341-01
SALTAR	1341-02
SALTAR	1341-03
SALTAR	1341-04
SALTAR	1341-05
SALTAR	1341-06
SALTAR	1341-07
SALTAR	1341-08
SALTAR	1341-09
SALTAR	1341-11
SALTAR	1341-12
SALTAR	1349-01
SALTAR	1349-02
SALTAR	1392-01
SALTAR	1392-02
SALTAR	1402-01
SALTAR	1402-02
SALTAR	1425-01
SALTAR	1425-02
SALTAR	1425-03
SALTAR	RD_Test01
SALTAR	RD_Test02
SALTAR	RD_Test03
SALTAR	RD_Test04

The data used in this report from the measurements made in Norway came from individual measurement files which were not organised according to the same protocol as the measurements in the USA. Therefore a list of those files is not given here. Upon request to the Norwegian Road Directorate the raw data files as well as the analysis and the processed Excel sheets can be obtained.

4. Analysis

In pictures from Figure 2 to Figure 16 the measurements by the different participating friction measuring equipment on the summer condition measurements of the Wallops testing can be observed.

The data from SALTAR are highlighted by a red square larger than the markers of the other devices.

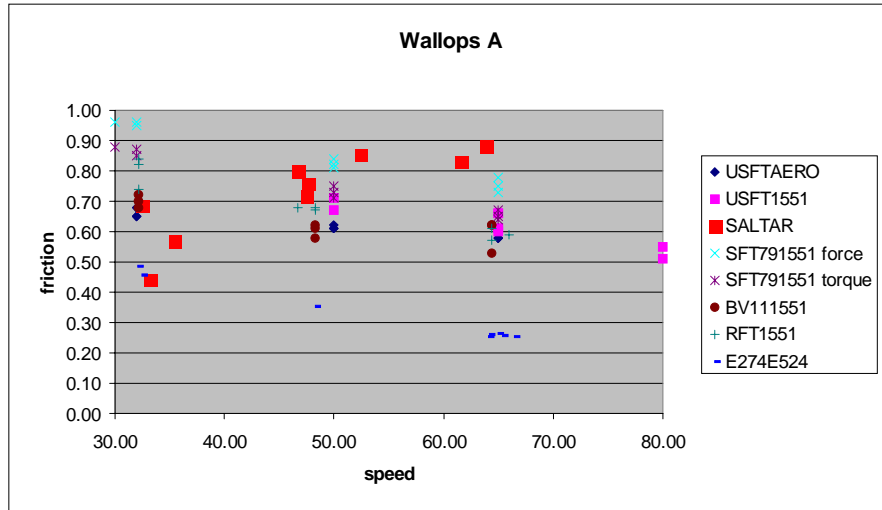

Figure 2. Measurements on section "A" Smooth Portland Cement Concrete

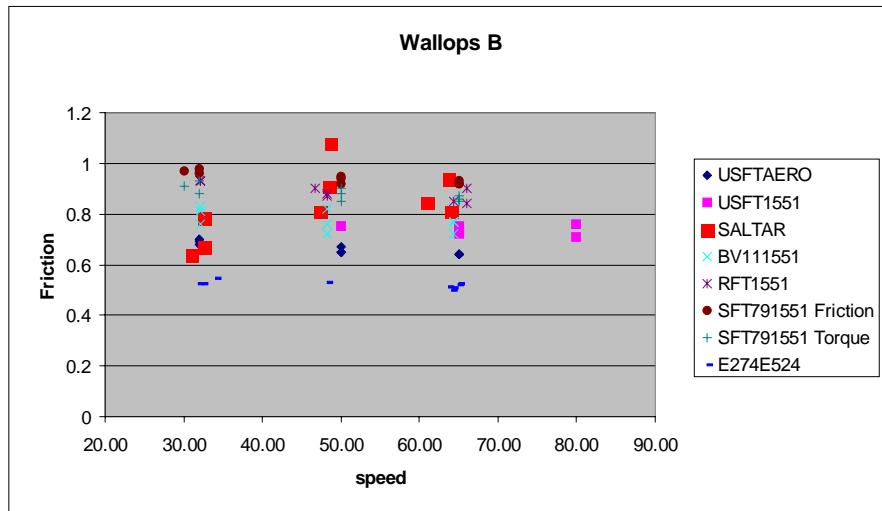

Figure 3. Measurements on section "B" Smooth+Grooved Portland Cement Concrete

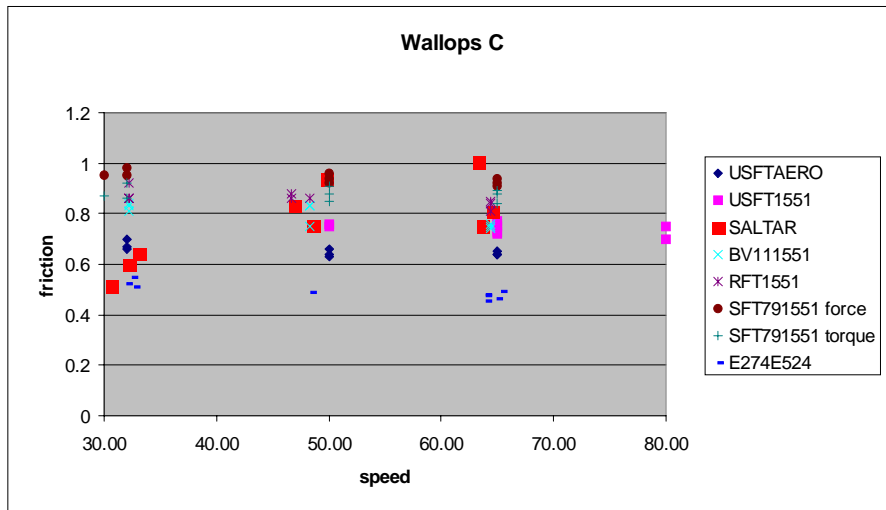

Figure 4. Measurements on section "C" Textured+Grooved Portland Cement Concrete

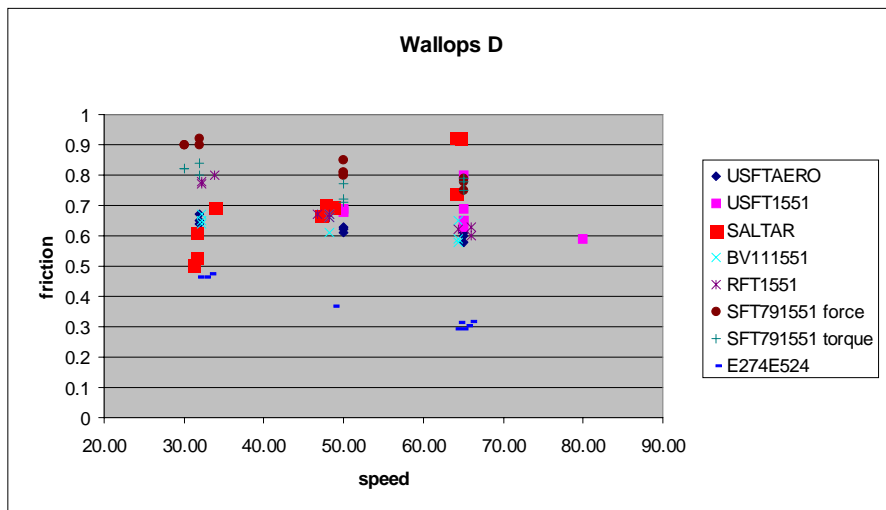

Figure 5. Measurements on section "D" Textured Portland Cement Concrete

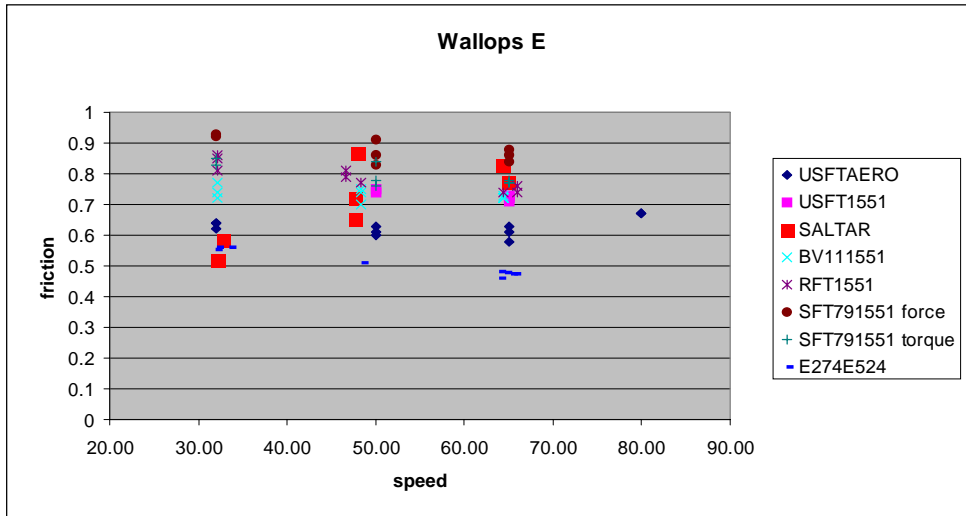

Figure 6. Measurements on section "E" Asphalt Concrete

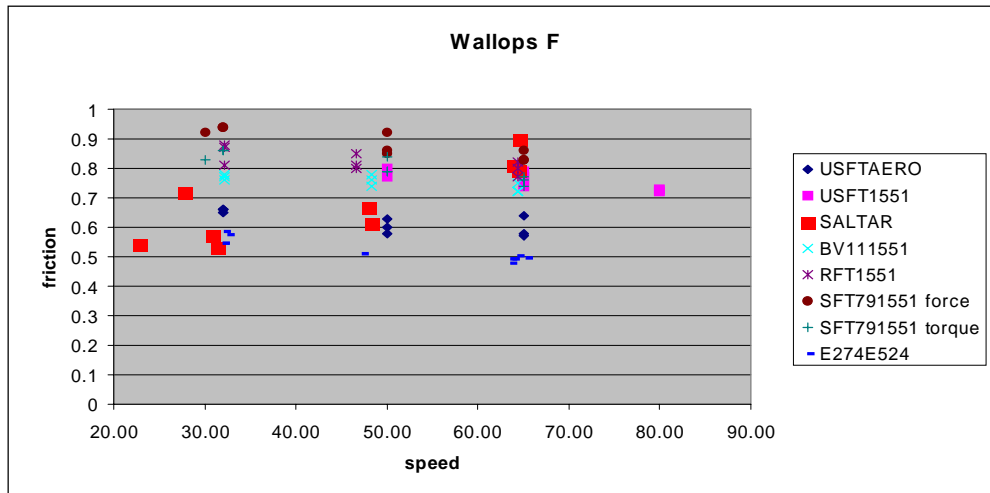

Figure 7. Measurements on section "F" Wide Grooved Asphalt Concrete

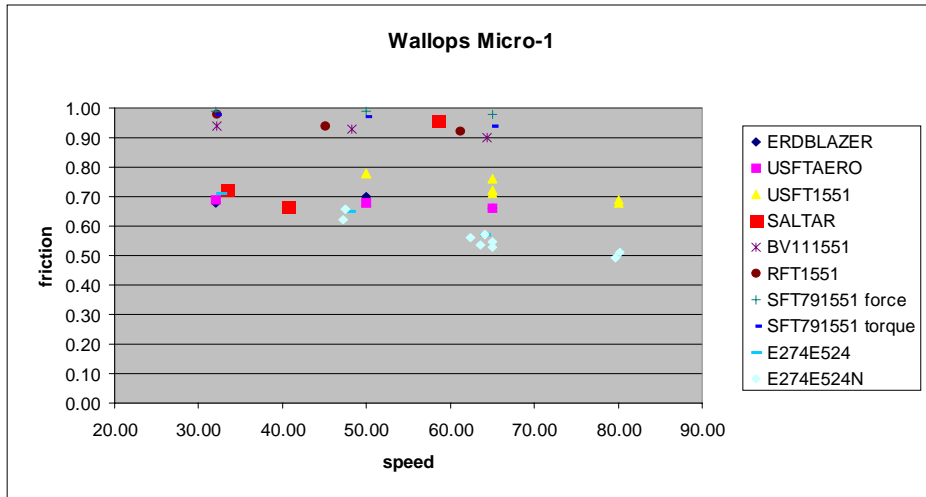

Figure 8. Measurements on section "Micro-1" Micro-Textured Synthetic Surface

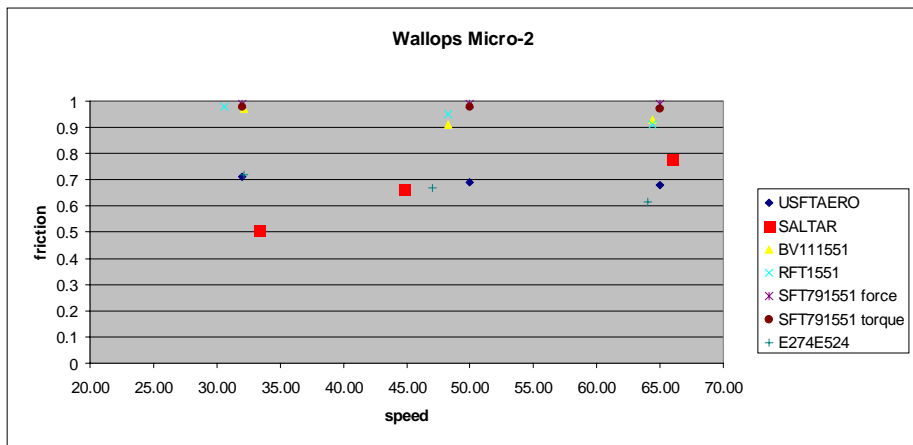

Figure 9. Measurements on section "Micro-2" Micro-Textured Synthetic Surface

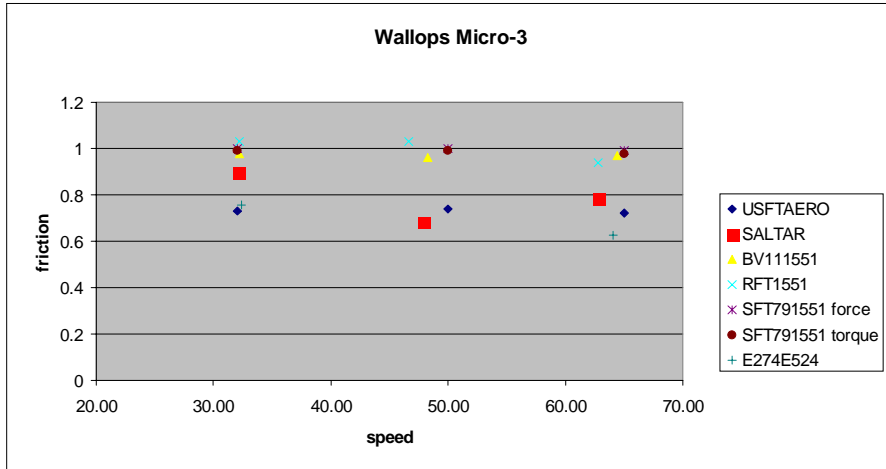

Figure 10. Measurements on section "Micro-2" Micro-Textured Synthetic Surface

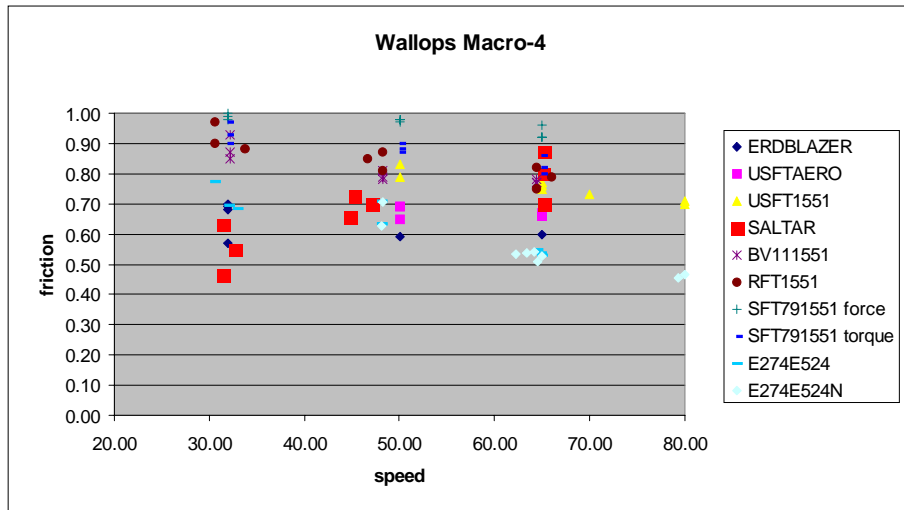

Figure 11. Measurements on section "Micro-4" Micro-Textured Synthetic Surface

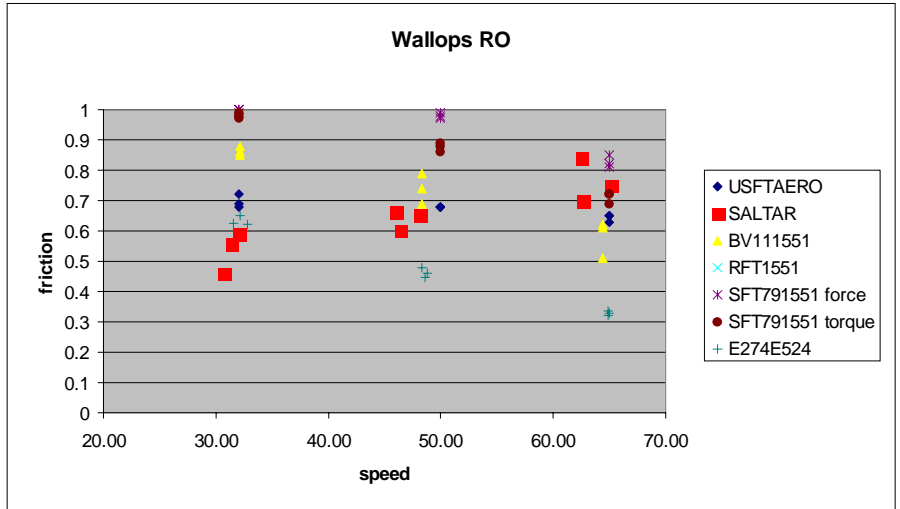

Figure 12. Measurements on section "R0" Reference Panel Surface

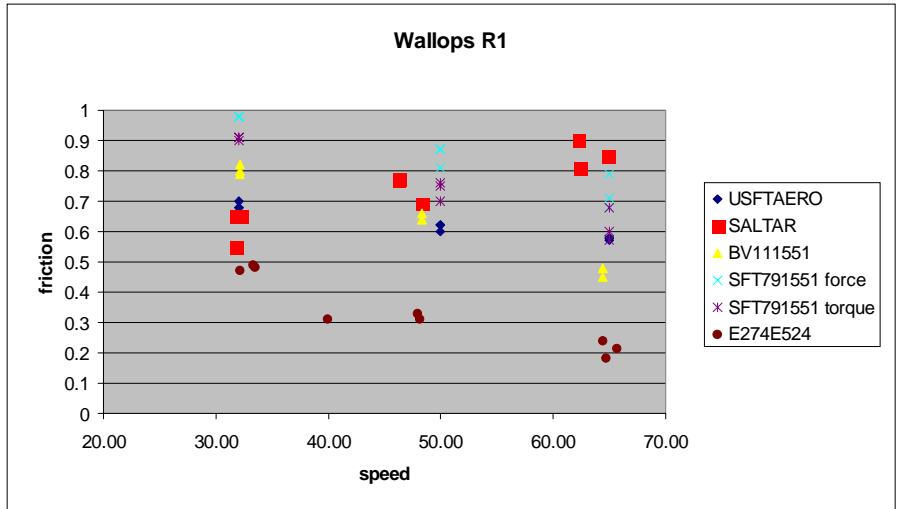

Figure 13. Measurements on section "R1" Reference Panel Surface

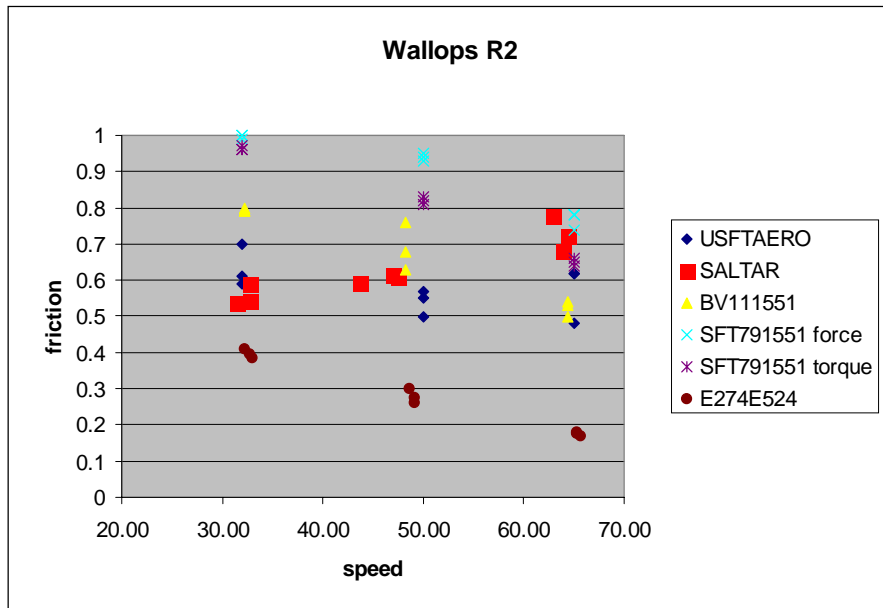

Figure 14. Measurements on section "R3" Reference Panel Surface

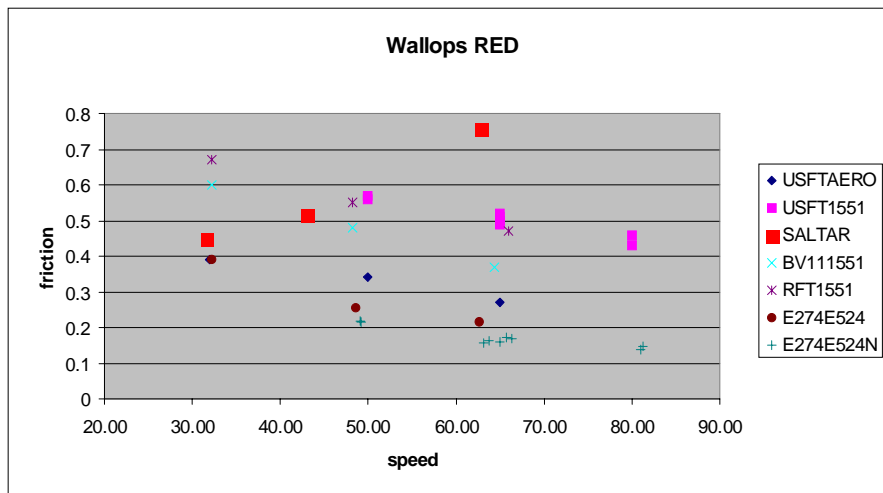

Figure 15. Measurements on section "RED" Reference Panel Surface

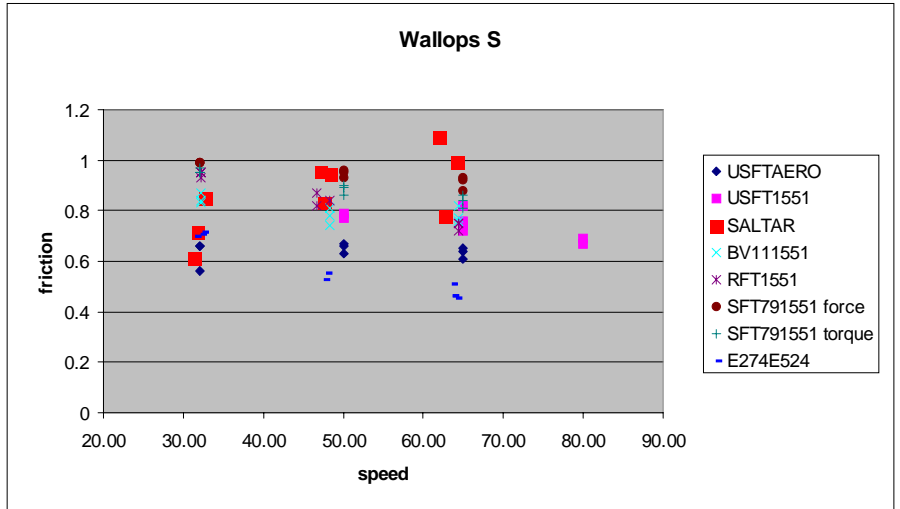

Figure 16. Measurements on section "S" Skid Abraded Surface

In picture Figure 17 a summer condition measurement with repeated runs on dry and wet surfaces with controlled water flow can be observed. The water delivery device of a high precision ROAR equipment was used for the measurements with the SALTAR unit.

The red lines and symbols represent the measurements done with the watering system and the blue lines and symbols represent the dry data.

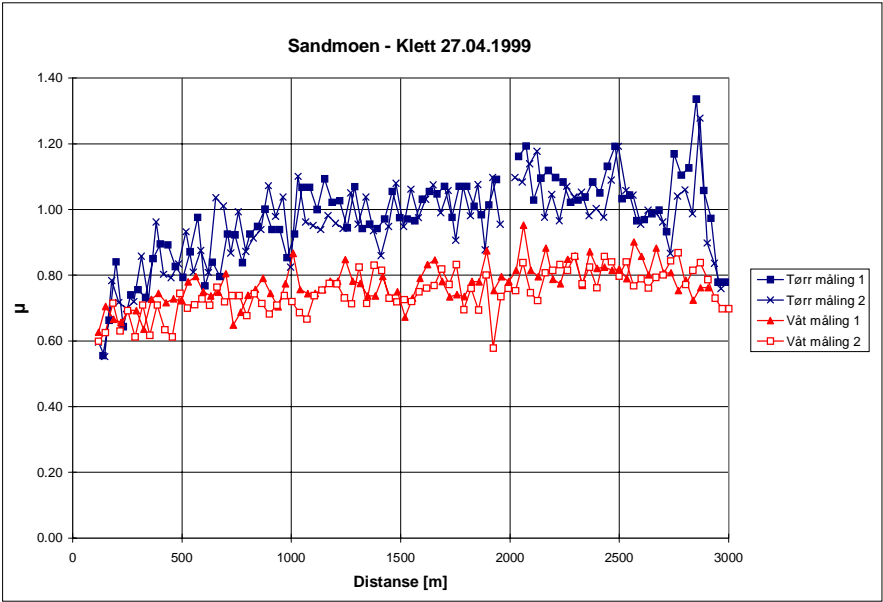

Figure 17. Measurements on dry and wet pavement in Norway

In Figure 18 average values for different winter surfaces measured with SALTAR presented. All these measurements were collected using 50 km/h or 60 km/h constant vehicle speed.

The first two column in the bar chart represents an average values on wet and dry asphalt measured with the SALTAR device for comparison purposes.

Data in this graph represents measurements made by the Iowa SALTAR device in North Bay and by the SALTAR in Norway.

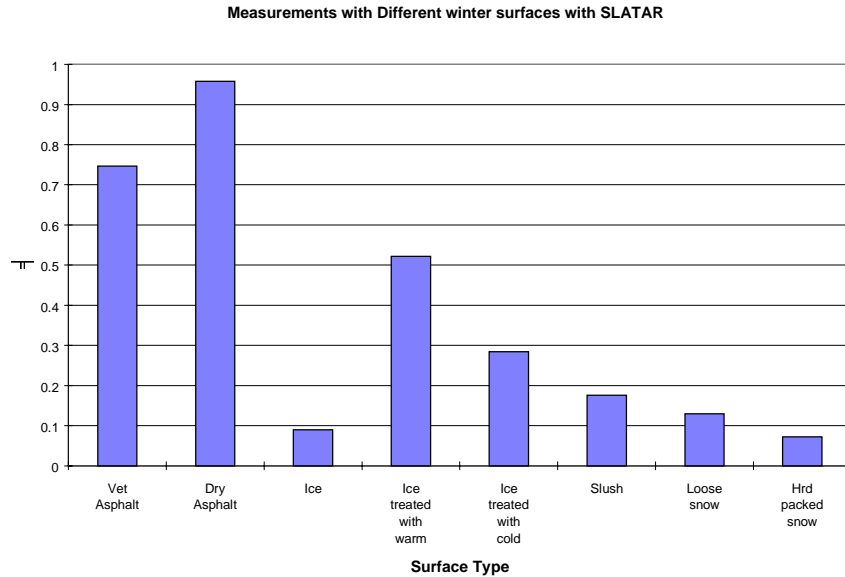

Figure 18. Measurements of different winter contaminants with SALTAR

In Figure 19 some repeated measurements made by the Norwegian SALTAR device are presented. The measurements were done on a slush surface and four different measurement runs were made with 30 and 50 km/h speed,

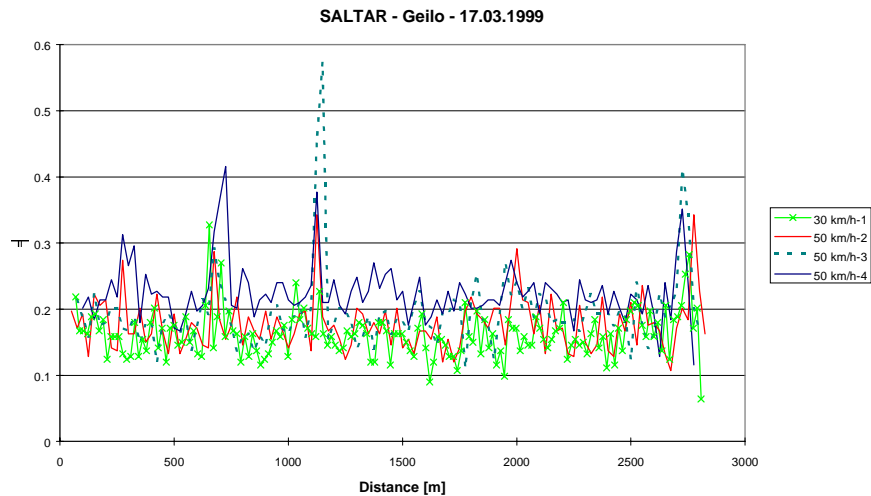

Figure 19. Repeated measurements in slush condition

5. Results

Based upon the data and the analysis of the measured values the following conclusions can be drawn:

- SALTAR can distinguish between different surfaces under both winter and summer conditions.
- On summer conditions the device measures comparable values to those measured by other more sophisticated and more expensive equipment
- SALTAR gives different levels on different winter surfaces.
- The results are found matching in different conditions after measurements on two different continents Norway and USA (Wallops and North Bay)
- SALTAR and the structure of the unit have been working in the total friction range.
- SALTAR have been mounted on two totally different vehicles, trailer and ploughing truck, and have been working on both
- It has been tested in extreme temperature ranges. The unit and the brake have worked and that shows that the unit is able to operate during these conditions.
- SALTAR has proven to have the ability to distinguish between different surfaces, as it is designed for.

During the testing in North Bay the measured data from the SALTAR device has consistently shown different characteristics related to measuring speed than that of the other friction measurement devices.

To investigate the case extensive study has been undertaken on the data from Wallops testing.

To check the device and its repeatability the data has been analysed for the different runs on the different surfaces with the speeds used to measure the friction. The speeds were usually 30, 60 and 80 km/h and three repeated runs were conducted on each surface at each speed.

For the illustration of the different runs at the same speed see Figure 20 and Figure 21. The repeatability of those runs are good and comparable to the repeatability of the measurements done in Norway.

A clear increase of the friction values averaged for each different section with the increase of the speed can be observed. This behaviour of the device is contrary to that of the other equipment's behaviour which shows a decreasing friction tendency with increasing speed.

The data from the tests at Wallops are indicating that the water supply for the SALTAR unit was insufficient for the measurements. Thus, the used method of pre - vetting the surface with a separate vehicle in front of the plough truck proved to produce relatively decreasing water depth with increasing speed.

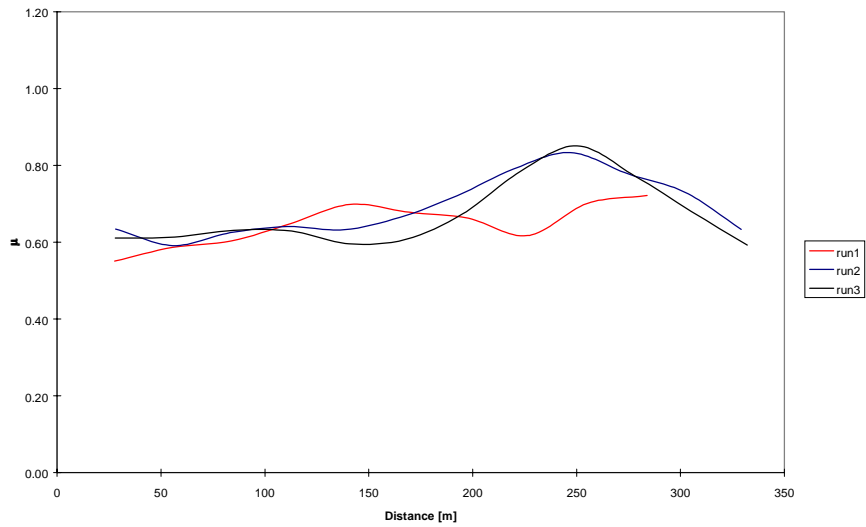

Figure 20. Repeated measurements on a Wallops Surface 60km/h

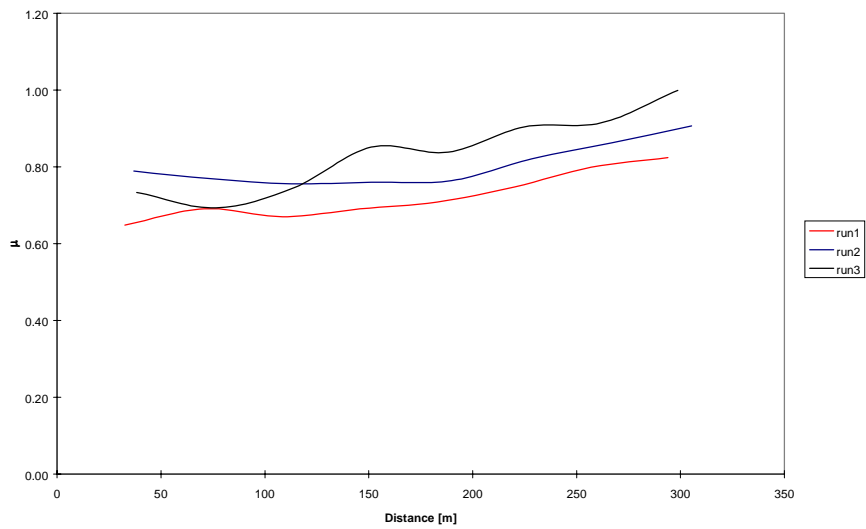

Figure 21. Repeated measurements on a Wallops Surface 80km/h

The tendency in the case of decreasing water depth and increasing measuring speed in theory could produce a linear increase of friction in relation to measurement speed.

The analysis of the data from the Wallops testing proves that the assumption of the decreasing water depth caused the somewhat unexpected behaviour of the SALTAR unit is acceptable.

Figure 22 shows an almost perfect linear relationship between the measurement values and the measurement speed.

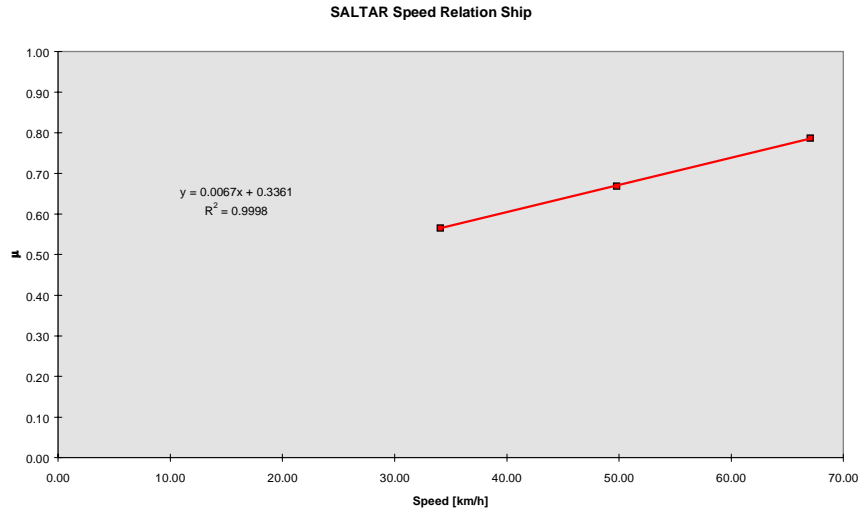

Figure 22. Speed- Friction relation ship

6. Conclusions

Based upon the data and the analysis of the measured values the following conclusions can be drawn:

- The SALTAR unit was successfully used to measure friction on both summer and winter surfaces.
- The measurements by the SALTAR unit on both winter and summer conditions are comparable to those measured by other devices.
- SALTAR can distinguish between different surfaces under both winter and summer conditions.
- SALTAR gives different levels on different winter surfaces.
- The results are found matching in different conditions after measurements on two different continents Norway and USA (Wallops and North Bay)
- SALTAR and the structure of the unit have been working in the total friction range.
- SALTAR have been mounted on two totally different vehicles, trailer and ploughing truck, and have been working on both
- It has been tested in extreme temperature ranges. The unit and the brake have worked and that shows that the unit is able to operate during these conditions.
- SALTAR has proven to have the ability to distinguish between different surfaces, as it is designed for.

Appendix E: Highway Maintenance Concept Vehicle—Technology Questionnaire

As part of our evaluation of the Highway Maintenance Concept Vehicle, it is our task to examine the various technologies and devices that have been used on each of the vehicles. Specifically, we are asking for your opinions of the effectiveness of the high intensity lights and reverse sensor alarm systems.

Would you please have your operators answer the following questions and return the questionnaire to me, in the self-enclosed stamped envelope. Thank you.

Please answer each of the following questions.

Date

Vehicle Location (Garage)

1. Please rate the performance of the high intensity lights, on a rising scale
(1 = poor, 2 = below average, 3 = average, 4 = above average, 5 = excellent)

1 2 3 4 5

Please explain your rating. (For example, did the lights perform as well as expected?
If no, then what was lacking in their performance?)

2. Please rate the performance of the reverse sensor alarm system, on a rising scale
(1 = poor, 2 = below average, 3 = average, 4 = above average, 5 = excellent)

1 2 3 4 5

Please explain your rating. (For example, did the alarm perform as expected?
If no, then explain what was lacking in its performance?)

3. Were these devices easy or hard to use?

4. Were there any problems that you encountered with either of these devices? If so, what were they?

5. If you could make a recommendation to the manufacturer of the high intensity lights, regarding their installation, operation, maintenance, performance, etc., what would you recommend?

6. If you could make a recommendation to the manufacturer of the reverse sensor system regarding its installation, operation, maintenance, performance, etc., what would you recommend?

7. Would you recommend continued use of the high intensity lights on the concept highway maintenance vehicle?

8. Would you recommend continued use of the reverse sensor alarm system on the concept highway maintenance vehicle?

Thank you for your time.