



Publicly Accessible Penn Dissertations

1-1-2015

A Novel Role for and Potential Therapeutic Targeting of Heme Oxygenase-1 in HIV Neuropathogenesis

Alexander Julian Gill

University of Pennsylvania, agill@mail.med.upenn.edu

Follow this and additional works at: <http://repository.upenn.edu/edissertations>

 Part of the [Neuroscience and Neurobiology Commons](#), [Psychiatric and Mental Health Commons](#), and the [Virology Commons](#)

Recommended Citation

Gill, Alexander Julian, "A Novel Role for and Potential Therapeutic Targeting of Heme Oxygenase-1 in HIV Neuropathogenesis" (2015). *Publicly Accessible Penn Dissertations*. 1736.
<http://repository.upenn.edu/edissertations/1736>

This paper is posted at ScholarlyCommons. <http://repository.upenn.edu/edissertations/1736>
For more information, please contact libraryrepository@pobox.upenn.edu.

A Novel Role for and Potential Therapeutic Targeting of Heme Oxygenase-1 in HIV Neuropathogenesis

Abstract

HIV-associated neurocognitive disorders (HAND) affect up to 50% of HIV-infected adults despite potent viral suppression with antiretroviral therapy (ART) and are associated with persistent neuronal damage, monocyte/macrophage activation, chronic inflammation, and oxidative stress. Heme oxygenase-1 (HO-1) is a highly inducible, detoxifying enzyme critical for limiting oxidative stress, inflammation, and cellular injury within the central nervous system (CNS) and other tissues. Our analysis of HO-1 expression in the brain prefrontal cortex from HIV-infected individuals demonstrated a significant HO-1 protein deficiency, even in HIV-infected subjects treated with ART. This HO-1 deficiency associated with a diagnosis of HAND and HIV-encephalitis (HIVE) as well as with elevated CNS HIV replication, type I interferon responses, and macrophage activation. Within this cohort longer variants of a HO-1 promoter region (GT)_n microsatellite polymorphism, which cause reduced HO-1 gene expression, associated with increased risk of HIVE and elevated CNS macrophage activation. HIV replication in macrophages, a primary CNS HIV reservoir, selectively reduced HO-1 protein and RNA expression and induced production of neurotoxic levels of glutamate. This HO-1 deficiency and associated neurotoxin production was a conserved feature of infection with macrophage-tropic HIV-1 and HIV-2 strains that correlated closely with the extent of replication. ART regimens applied to macrophages after HIV infection was established failed to prevent this HO-1 loss and associated neurotoxin production. HO-1 siRNA knockdown and enzymatic inhibition in HIV-infected macrophages increased supernatant glutamate and neurotoxicity. In contrast, increasing HO-1 expression through siRNA derepression or with pharmacologic inducers, including the CNS-penetrating drug dimethyl fumarate (DMF), decreased supernatant glutamate and neurotoxicity. These findings identify HO-1 as a host factor that is deficient in the brains of HIV-infected individuals and suggest that loss of HO-1 and its protective functions may contribute to HIV neuropathogenesis. Moreover, this work defines a predictable and conserved relationship between HIV replication, HO-1 loss, and neurotoxin production in macrophages that likely reflects processes in place in the HIV-infected brain of individuals receiving ART. Correcting this HO-1 deficiency could provide a novel approach for neuroprotection in individuals with or at risk for developing HAND above that provided by current ART.

Degree Type

Dissertation

Degree Name

Doctor of Philosophy (PhD)

Graduate Group

Neuroscience

First Advisor

Dennis L. Kolson

Keywords

Glutamate, Heme Oxygenase-1, HIV, Inflammation, Macrophage, Neurocognitive

Subject Categories

Neuroscience and Neurobiology | Psychiatric and Mental Health | Virology

A NOVEL ROLE FOR AND POTENTIAL THERAPEUTIC TARGETING OF
HEME OXYGENASE-1 IN HIV NEUROPATHOGENESIS

Alexander J. Gill

A DISSERTATION

in

Neuroscience

Presented to the Faculties of the University of Pennsylvania

in

Partial Fulfillment of the Requirements for the

Degree of Doctor of Philosophy

2015

Supervisor of Dissertation

Dennis L. Kolson, M.D., Ph.D., Professor of Neurology

Graduate Group Chairperson

Joshua I. Gold, Ph.D., Professor of Neuroscience

Dissertation Committee

Susan R. Weiss, Ph.D., Professor of Microbiology
Virginia M.Y. Lee, Ph.D., M.B.A., Professor of Pathology and Laboratory Medicine
Phyllis A. Dennergy, M.D., F.A.A.P., Professor of Pediatrics
Paul F. Bates, Ph.D., Professor of Microbiology

A NOVEL ROLE FOR AND POTENTIAL THERAPEUTIC TARGETING OF
HEME OXYGENASE-1 IN HIV NEUROPATHOGENESIS

COPYRIGHT©

2015

Alexander Julian Gill

DEDICATION

This thesis is dedicated to one of the earliest, and perhaps most influential, forces in my academic life, my first-grade teacher, Kathy Horstmeyer. From the first day of school, she inspired me and my fellow classmates to fervently explore the many worlds around us. Her classroom was never a classroom – it was the Peruvian rainforest, a space station orbiting a distant planet, the plains of the Serengeti, or an underwater research laboratory. Through this unconventional and surprisingly demanding educational environment, she drew the best out of me at an early age. Over the course of that brief, yet formative, year, she instilled in me a life-long joy for learning and a deep passion for scientific discovery. For that I am forever grateful.

ACKNOWLEDGEMENTS

There are many people that I need to thank and acknowledge. Although completing this thesis work was challenging and at times even frustrating, my course through graduate school was made all the easier as a result of the support and friendship that so many people have shown me. To each and every person who has helped guide me along my path during this process, I sincerely thank you.

First and foremost, I thank Dennis Kolson for his mentorship, encouragement, and enthusiasm. I am so incredibly grateful for having had the opportunity to learn from him. From day one Dennis treated me as a scientific and professional peer, and from there our rapport has only grown stronger. Dennis's own passion for science and clinical medicine and his eagerness for passing that passion on to his students are inspiring. Regardless of how busy he was, he always had time for his students. This dedication to training is one of the many attributes of his I hope to emulate as a future physician-scientist. There is no question that I personally owe most, if not all, of my graduate student success to Dennis's unparalleled support. I consider Dennis not only my graduate school mentor, but also a life-long colleague and friend.

I also acknowledge each and every person who has helped me with my thesis project and graduate training. As is typical with graduate school, many issues, both small and large, arise over the course of training. I am privileged to have had the support from so many faculty, staff, post-docs, and students that made this work possible. My sincerest gratitude to Stephanie Cross, Colleen Kovacsics, Patricia Vance, and Lorraine Kolson and former members of the Kolson laboratory. You have all had invaluable roles in supporting my science and making our lab such a wonderful and enjoyable place to work. Thanks to our incredible collaborator and colleague Ben Gelman. Ben's generosity and expertise made so much of this work possible and I am honored to have worked with him. Thanks to Ron Collman for his continued counsel, mentorship, and

advancement of my training. A special thanks to Susan Weiss for all her guidance and for her invaluable role as the chair of my thesis committee. Thanks to my other thesis committee members Virginia Lee, Phyllis Dennery, and Paul Bates, and additional faculty mentors Kelly Jordan-Sciutto, Sam Soldan, and Bob Doms for their continued encouragement and support. To each and every one of you who supported my training, thank you.

I would like to acknowledge all the additional training and research support provided by the University of Pennsylvania. First, I would like to thank the entire Penn MSTP program, particularly Skip Brass, Maggie Krall, and Maureen Kirsch. As a result of all the hard work you and others put in this truly is the best MSTP program in the galaxy. Thanks to the Neuroscience Graduate Group and the Microbiology Department for their valued roles in my graduate training. I would also like to acknowledge the research support from the Penn Center for AIDS Research (CFAR) and the Mahoney Institute of Neurological Sciences (MINS). The nurturing, collaborative, and scholarly environment at Penn was truly instrumental to my scientific and professional training.

To all my friends near and far – thank you for your friendship. If it were not for you all, I would not have so many fond memories and great times to look back on over these graduate school years. Nothing can cheer you up after a demoralizing day (or week or month) in the lab like the bonds of friendship. I need to especially thank my classmates Sara Small, Andrew Migliaccio, Lance Peterson, Steven Siegel, Nabil Thalji, and Jacob Till for their continued and treasured camaraderie over the past six years. You are an extraordinary bunch and I know you will all excel in whatever career and life paths you pursue. Molly, Raphy, Sam, Jenny, Katrina, Evan, and James – I cannot even describe how much all your friendships mean to me and how thankful I am to have you all in my life. Thanks again to all my friends who have made these years (and years to come) filled with that much more joy.

Finally, I would like to acknowledge all my family without whom I never would have made it this far. To my dad, mom, and sister – I love you all so very much. Little sis, thanks for always challenging me throughout our childhood and thanks for always being there for me once we grew up. You have no idea how proud of you I am. Mom and Dad, I cannot express how grateful I am and always will be for your continued and unwavering support of every aspect of my life. I owe so much of who I am to you both and I could not have wished for better role models.

ABSTRACT

A NOVEL ROLE FOR AND POTENTIAL THERAPEUTIC TARGETING OF HEME OXYGENASE-1 IN HIV NEUROPATHOGENESIS

Alexander J. Gill

Dennis L. Kolson, M.D., Ph.D.

HIV-associated neurocognitive disorders (HAND) affect up to 50% of HIV-infected adults despite potent viral suppression with antiretroviral therapy (ART) and are associated with persistent neuronal damage, monocyte/macrophage activation, chronic inflammation, and oxidative stress. Heme oxygenase-1 (HO-1) is a highly inducible, detoxifying enzyme critical for limiting oxidative stress, inflammation, and cellular injury within the central nervous system (CNS) and other tissues. Our analysis of HO-1 expression in the brain prefrontal cortex from HIV-infected individuals demonstrated a significant HO-1 protein deficiency, even in HIV-infected subjects treated with ART. This HO-1 deficiency associated with a diagnosis of HAND and HIV-encephalitis (HIVE) as well as with elevated CNS HIV replication, type I interferon responses, and macrophage activation. Within this cohort longer variants of a HO-1 promoter region (GT)_n microsatellite polymorphism, which cause reduced HO-1 gene expression, associated with increased risk of HIVE and elevated CNS macrophage activation. HIV replication in macrophages, a primary CNS HIV reservoir, selectively reduced HO-1 protein and RNA expression and induced production of neurotoxic levels of glutamate. This HO-1 deficiency and associated neurotoxin production was a conserved feature of infection with macrophage-tropic HIV-1 and HIV-2 strains that correlated closely with the extent of replication. ART regimens applied to macrophages after HIV infection was established failed to prevent this HO-1 loss and associated neurotoxin production. HO-1 siRNA knockdown and enzymatic inhibition in HIV-infected macrophages increased supernatant glutamate and neurotoxicity. In contrast, increasing

HO-1 expression through siRNA derepression or with pharmacologic inducers, including the CNS-penetrating drug dimethyl fumarate (DMF), decreased supernatant glutamate and neurotoxicity. These findings identify HO-1 as a host factor that is deficient in the brains of HIV-infected individuals and suggest that loss of HO-1 and its protective functions may contribute to HIV neuropathogenesis. Moreover, this work defines a predictable and conserved relationship between HIV replication, HO-1 loss, and neurotoxin production in macrophages that likely reflects processes in place in the HIV-infected brain of individuals receiving ART. Correcting this HO-1 deficiency could provide a novel approach for neuroprotection in individuals with or at risk for developing HAND above that provided by current ART.

Table of Contents

DEDICATION	iii
ACKNOWLEDGEMENT	iv
ABSTRACT	vii
LIST OF TABLES	xiii
LIST OF FIGURES	xiv
LIST OF ABBREVIATIONS	xvii
CHAPTER 1: Introduction	1
CHAPTER 2: HIV Biology and Pathogenesis	7
2.1 Introduction	8
2.2 HIV Biology and Viral Life Cycle	8
2.3 HIV Pathogenesis and Disease	16
2.4 Conclusion	21
CHAPTER 3: HIV Neuropathogenesis	23
3.1 Introduction	24
3.2 HIV-Associated Neurocognitive Disorders (HAND)	25
3.3 HIV Neuropathology	26
3.4 CNS HIV Tropism and HAND: Challenging Conventional Thinking	30
3.5 Role for HIV 'Blipping'	32
3.6 Conclusion	36
CHAPTER 4: HAND Comorbidities	38
4.1 Introduction	39

4.2 Hepatitis C Co-Infection	39
4.3 Drugs of Abuse	43
4.4 Aging	48
4.5 ART Neurotoxicity	52
4.6 Conclusion	53
CHAPTER 5: Heme Oxygenase-1 (HO-1) and the Endogenous Antioxidant Response.....	54
5.1 Introduction	55
5.2 Regulation of the Endogenous Antioxidant Response and HO-1	56
5.3 HO-1 and Heme/Hemoglobin Scavenging.....	59
5.4 HO-1 as an Anti-Inflammatory and Anti-Oxidative Enzyme	60
5.5 HO-1 in Diseases of Inflammation and Oxidative stress.....	63
5.6 Conclusion	65
CHAPTER 6: Materials and Methods	67
6.1 Material and Methods for Chapter 7	68
6.2 Material and Methods for Chapter 8	71
6.3 Material and Methods for Chapter 9	80
6.4 Material and Methods for Chapter 10	82
6.5 Material and Methods for Chapter 11	87
CHAPTER 7: Central and Peripheral Markers of Neurodegeneration and Monocyte Activation in HAND	91
7.1 Abstract.....	92
7.2 Introduction	92
7.4 Results	95
6.5 Discussion.....	101

CHAPTER 8: Brain Heme Oxygenase-1 Deficiency Accompanies

Neuropathogenesis of HAND106

8.1 Abstract.....	107
8.2 Introduction	107
8.3 Results	109
7.4 Discussion.....	119

CHAPTER 9: HO-1 (GT)n Promoter Region Microsatellite Polymorphism

Associates with HIV-Encephalitis126

9.1 Abstract.....	127
9.2 Introduction	127
9.3 Results	129
9.4 Discussion.....	138

CHAPTER 10: Induction of HO-1 Deficiency and Associated Glutamate-Mediated Neurotoxicity is a Highly Conserved HIV Phenotype of Chronic

Macrophage Infection.....140

10.1 Abstract.....	141
10.2 Introduction	141
10.3 Results	144
10.4 Discussion.....	162

CHAPTER 11: HO-1 Modulates Neurotoxin Production from HIV-Infected

Macrophages.....169

11.1 Abstract.....	170
11.2 Introduction	170
11.4 Results	172
11.5 Discussion.....	183

CHAPTER 12: Fumaric Acid Esters (FAEs) as Potential Adjunctive Therapy	
in HIV Infection: Targeting HO-1/ARE and Inflammation	187
12.1 Abstract.....	188
12.2 Introduction	188
12.3 Pharmacokinetics.....	189
12.4 Mode of Action in Different Cell Lineages: Immunomodulation & Antioxidant Response	190
12.5 FAEs in Inflammatory Disease.....	197
12.6 FAEs as Candidate Adjunctive Therapy for Systemic HIV Disease	206
12.7 FAEs as Candidate Adjunctive Therapy for CNS HIV Disease	214
12.8 Safety of FAE Therapy.....	218
12.9 Conclusions	220
CHAPTER 13: Work in Progress	222
13.1 Differences in Clade or Transmitted/Founder HO-1 Regulation	223
13.2 SIV Infection and HO-1	229
13.3 Cytokine and Chemokine Regulation of HO-1 in Macrophages	232
CHAPTER 14: Summary and Implications	235
CHAPTER 15: Bibliography	241

LIST OF TABLES

Table 4.1	Effects of cocaine, methamphetamine (meth), opioids, and dopamine on HIV, SIV, and neuroinflammation.	45
Table 5.1	Studies that identified longer HO-1 promoter region (GT) _n microsatellite polymorphisms as a risk factor for worse clinical outcomes in various disease states.....	64
Table 6.1	Demographic and clinical characteristics of HIV autopsy cohort for study entitled "Central and Peripheral Markers of Neurodegeneration and Monocyte Activation in HAND" (Chapter 7).	70
Table 6.2	Demographic, clinical, and antiretroviral therapy data for DLPFC cohort for studies entitled Brain Heme Oxygenase-1 Deficiency Accompanies Neuropathogenesis of HIV-Associated Neurocognitive Disorders" (Chapter 8) and "HO-1 (GT) _n Promoter Polymorphism Associates with HIV-Encephalitis" (Chapter 9).	73
Table 6.3	Primary neurocognitive test scores used to establish domain clinical T-scores. ...	74
Table 6.4	Demographic, clinical, and antiretroviral therapy data for brain regional analysis cohort for studies entitled Brain Heme Oxygenase-1 Deficiency Accompanies Neuropathogenesis of HIV-Associated Neurocognitive Disorders" (Chapter 8). ...	76
Table 6.5	Quantitative real-time PCR primer and probe sets.	78
Table 6.6	Primary antibodies for Western blotting.	78
Table 6.7	Secondary antibodies for Western blotting.	79
Table 6.8	Characteristics of select HIV-1 clade B strains	84
Table 6.9	Small interfering RNAs (siRNAs) used for knockdown experiments.....	89
Table 8.1	DLPFC HO-1 expression in HIV+ subjects correlates differentially with neurocognitive domain T-scores in racial subpopulations.	117

LIST OF FIGURES

Figure 2.1	Diagram of mature HIV viral particle.	9
Figure 2.2	Organization of the HIV-1 and HIV-2 genomes.....	10
Figure 2.3	HIV-1 viral life cycle.....	12
Figure 2.4	Clinical course of HIV-1 infection.	18
Figure 3.1	Schematic model of HIV Neuropathogenesis.	29
Figure 3.2	Hypothetical time course of cerebrospinal fluid viral blips, neuroinflammation, and neuronal injury.....	34
Figure 4.1	CNS inflammatory effects of HIV and HCV infection on monocytes, macrophages, and microglia.....	41
Figure 7.1	CSF NFL is elevated in individuals with HAD and a history of immunosuppression.	97
Figure 7.2	Monocyte activation markers intra-compartmentally correlate within the CSF and plasma.....	98
Figure 7.3	CSF NFL correlates negatively with plasma CD4+ T-lymphocyte count and positively with HIV-1 RNA load.	98
Figure 7.4	Neurofilament concentrations positively correlate with monocyte activation markers within the CSF.....	100
Figure 8.1	HO-1 protein expression is deficient in the DLPFC of HIV-infected subjects (β -tubulin).....	110
Figure 8.2	HO-1 protein expression is deficient in the DLPFC of HIV-infected subjects (GAPDH).....	111
Figure 8.3	ART exposure is not associated with DLPFC HO-1 deficiency in HIV ⁺ subjects with or without HIVE.	113
Figure 8.4	HO-1 is deficient in the striatum of HIV-infected subjects with HIVE (β -tubulin)..	115
Figure 8.5	HO-1 is deficient in the striatum of HIV-infected subjects with HIVE (GAPDH)..	116
Figure 8.6	DLPFC HO-1 protein expression correlates with CSF and brain HIV RNA levels (β -tubulin).....	120
Figure 8.7	DLPFC HO-1 protein expression correlates with CSF and brain HIV RNA levels (GAPDH).....	121
Figure 8.8	DLPFC HO-1 protein expression correlates with brain innate immune responses and macrophage markers (β -tubulin).....	122
Figure 8.9	DLPFC HO-1 protein expression correlates with brain innate immune responses and macrophage markers (GAPDH).....	123

Figure 9.1	HO-1 promoter region (GT) _n polymorphism allele repeat length has a bimodal distribution.....	131
Figure 9.2	HO-1 (GT) _n polymorphism repeat length does not correlate with prefrontal cortex HO1 mRNA nor protein.	132
Figure 9.3	Longer HO-1 (GT) _n polymorphism repeat length correlates with prefrontal cortex CD163 RNA.	134
Figure 9.4	HO-1 (GT) _n polymorphism repeat length did not correlate with CNS HIV replication or markers of macrophage activation within the prefrontal cortex of HIV+ subjects.	135
Figure 9.5	Longer HO-1 promote region (GT) _n polymorphism repeat length associates with increased risk of HIV-encephalitis (HIVE).	137
Figure 10.1	HIV infection of MDM reduces HO-1 protein expression and concomitantly increases supernatant glutamate levels and neurotoxicity.....	145
Figure 10.2	Supernatant reverse transcriptase activity and cell-associated HIV-1 p24 antigen content are highly correlated markers of HIV-1 replication in macrophages.....	147
Figure 10.3	HIV-1 strain replication in primary human macrophages from different donors.....	148
Figure 10.4	HIV-1 replication consistently induces HO-1 deficiency in macrophages.	150
Figure 10.5	HIV-1 replication level predicts HO-1 loss within an HIV-MDM culture.....	151
Figure 10.6	HIV-MDM HO-1 protein expression correlates with HO-1 RNA expression.....	152
Figure 10.7	HIV-1 infection of MDM induces glutamate-associated supernatant neurotoxicity. ...	154
Figure 10.8	Supernatant neurotoxicity and glutamate levels correlate with HO-1 loss and replication in HIV-MDM.	156
Figure 10.9	Targeted siRNA knockdown of HO-1 or the HO-1 repressor BACH1 in uninfected MDM does not alter supernatant neurotoxicity or glutamate content.	157
Figure 10.10	Antiretroviral drug treatment prior to, but not after, HIV-infection of MDM prevents HO-1 loss and associated neurotoxicity.	159
Figure 10.11	HIV-1 accessory genes <i>nef</i> , <i>vpr</i> , and <i>vpu</i> are not required for induction of HO-1 deficiency or associated neurotoxicity in HIV-MDM.....	161
Figure 10.12	HIV-2 replication in MDM induces HO-1 deficiency and associated supernatant neurotoxicity.	163
Figure 10.13	HIV-2 replication in MDM induces HO-1 deficiency and associated extracellular glutamate and supernatant neurotoxicity.	164
Figure 11.1	Inducers of HO-1 expression reduce HIV-MDM supernatant glutamate accumulation and neurotoxicity independently of HIV replication.	173
Figure 11.2	CoPP and SnMP induce HO-1, but not HO-2, protein expression in MDM.	174

Figure 11.3	Exposure of HIV-MDM to an inhibitor of heme oxygenase enzymatic activity (SnMP) enhances glutamate release and supernatant neurotoxicity independently of HIV replication.....	176
Figure 11.4	Exposure of non-infected MDM to an inhibitor of HO-1 and HO-2 enzymatic activity (SnMP) enhances supernatant glutamate and neurotoxicity.	177
Figure 11.5	HO-1 and BACH1 siRNAs effectively knockdown and induce HO-1 expression, respectively, in uninfected and infected MDM.....	179
Figure 11.6	Knockdown of HO-1 and BACH1 by siRNA modulates extracellular glutamate and supernatant neurotoxicity in HIV-MDM independently of HIV replication.....	180
Figure 11.7	Time course of HO-1 induction in MDM by tBHQ, MMF, and DMF.	182
Figure 11.8	DMF and MMF reduce glutamate release and associated supernatant neurotoxicity in HIV-MDM independently of HIV replication.....	184
Figure 11.9	Concurrent treatment with DMF and MMF does not protect neurons in neuroglial cultures from HIV-MDM mediated neurotoxicity.....	185
Figure 12.1	Effects of the fumaric acid esters (FAEs) DMF and MMF on the Nrf2-dependent antioxidant response and NF- κ B pathways.....	193
Figure 12.2	Potential effects of dimethyl fumarate (DMF) therapy on systemic and CNS HIV disease pathogenesis.	213
Figure 13.1	HIV-1 clade D transmitter/founder replication in macrophages.	225
Figure 13.2	HIV-1 clade D transmitter/founder infection of MDM does not significantly reduce HO-1 protein expression despite efficient replication.....	226
Figure 13.3	HIV-1 clade D transmitter/founder infection of MDM enhances supernatant neurotoxicity, but not extracellular glutamate.....	228
Figure 13.4	SIV/17E-Fr infection of pigtail macaque MDM does not decrease HO-1 protein expression.....	231
Figure 13.5	Chronic cytokine and chemokine exposure in macrophages may result in loss of HO-1 protein expression	234

LIST OF ABBREVIATIONS

ACTG	AIDS Clinical Trials Group
AIDS	Acquired immunodeficiency syndrome
ALS	Amyotrophic lateral sclerosis
ANI	Asymptomatic Neurocognitive Impairment
ARE	Antioxidant response element
ART	Antiretroviral therapy
BACH1	BTB and CNC homology 1
BBB	Blood-brain barrier
cART	Combined antiretroviral therapy
CCL	CC chemokine ligand
CCR	CC chemokine receptor
CD	Cluster of differentiation
CXCL	CXC chemokine ligand
CXCR	CXC chemokine receptor
CHARTER	CNS Anti-Retroviral Therapy Effects Research
CNS	Central nervous system
CSF	Cerebrospinal fluid
CoPP	Cobalt (III) protoporphyrin IX chloride
CT	Camptothecin
DLPFC	Dorsolateral prefrontal cortex
DMF	Dimethyl fumarate
DMSO	Dimethyl sulfoxide
DPI	Days post infection
DIV	Days post infection
EFV	Efavirenz
FAEs	Fumaric acid esters
FTH1	Ferritin heavy chain 1
GAPDH	Glyceraldehyde 3-phosphate dehydrogenase
GPX1	Glutathione Peroxidase-1
GSTP1	Glutathione S-transferase pi 1
HAD	HIV-associated dementia
HAND	HIV-Associated Neurocognitive Disorders
HAART	Highly-active antiretroviral therapy
HCV	Hepatitis C virus

HD	Huntington's disease
HIV	Human immunodeficiency virus
HIV-MDM	HIV-infected monocyte-derived macrophages
HIVE	HIV-Encephalitis
HO-1	Heme oxygenase-1
HO-2	Heme oxygenase-2
HSK	Herpes stromal keratitis
HSV	Herpes simplex virus
ICAM	intercellular adhesion molecule
IFN	Interferon
IL	Interleukin
INSTI	integrase strand transfer inhibitor
IQR	Interquartile range
IRF1	Interferon regulatory factor 1
ISIG15	Interferon stimulated gene 15
LPS	Lipopolysaccharide
MAP2	Microtubule-associated protein 2
MDM	Monocyte-derived macrophages
MEF	Monoethyl fumarate
miR	microRNA
MMF	Monomethyl fumarate
MND	Mild Neurocognitive Disorder
MS	Multiple sclerosis
M-tropic	Macrophage tropic
MX1	Myxovirus resistance 1
NCN	Neurocognitively normal
NF-κB	Nuclear factor kappa-light-chain-enhances of activated B cells
NFL	Neurofilament Light Chain
NNTC	National NeuroAIDS Tissue Consortium
NQO1	NAD(P)H quinone oxidoreductase 1
NRF2	Nuclear factor erythroid 2-related factor 2
NRTI	Nucleoside reverse transcriptase inhibitor
NNRTI	Non-nucleoside reverse transcriptase inhibitor
PBMC	Peripheral blood mononuclear cell
PI	Protease inhibitor
pNFH	Phosphorylated neurofilament Heavy Chain

PRDX1	Peroxiredoxin 1
qPCR	Quantitative real-time PCR
ROS	Reactive oxygen species
RT	Reverse Transcriptase
sCD14	Soluble CD14
sCD163	Soluble CD163
SOD1	Superoxide dismutase 1
SIV	Simian Immunodeficiency Virus
SnMP	Tin (IV) mesoporphyrin IX dichloride
tBHQ	Tert-butylhydroquinone
TNFα	Tumor necrosis factor-alpha
TRXR1	Thioredoxin reductase 1
UT	Untreated
WT	Wild-type

CHAPTER 1

INTRODUCTION

Introduction

As of 2013, approximately 35 million people are living with human immunodeficiency virus (HIV) infection worldwide. The continued increase in prevalence from previous years is a result of both an estimated 2.1 million new HIV infections globally in 2012 (a 38% decline in incidence from 2001) and an increase in the number of infected people living longer due to life-saving antiretroviral therapy (ART). Standard ART treatment consist of a combination of at least three antiviral drugs that decrease HIV replication to undetectable levels by standard clinical assays (< 50 copies HIV RNA/ml). This reduction in HIV replication prevents HIV-mediated loss of CD4+ T-lymphocytes and the resulting progression to acquired immune deficiency syndrome (AIDS), the final and most serious stage of untreated HIV disease. As of June 2014, approximately 13.5 million adults living with HIV (~38%) had access to and were receiving ART. This increased access to ART and other global health initiatives aimed at limiting HIV transmission have resulted in a 35% decrease in AIDS-related deaths since the peak of 2.4 million deaths in 2005 (1). ART has fundamentally changed HIV-infection from a rapidly lethal disease into a manageable chronic condition. Today, a 20 year-old individual with HIV infection and starting ART is now expected to live into his or her 60s (2).

Despite the many success of ART, virally suppressed HIV-infected patients continue to demonstrate chronic low-level immune activation, inflammation, and oxidative stress (reviewed in (3) and (4); see Chapter 2). This persistent inflammation and oxidative stress is believed to drive numerous non-communicable, age-related morbidities in HIV-positive individuals (5), including neurocognitive deficits known as HIV-associated neurocognitive disorders (HAND) (see Chapter 3 and 4). Currently, ART is the only approved treatment for HAND. However, a significant proportion of patients on ART (30-50%) continue to develop neurocognitive impairment (6-17) in association with systemic and central nervous system (CNS) inflammation (18-24), particularly within the monocyte/macrophage compartment. Persistent systemic and CNS markers of

monocyte/macrophage activation predict neurocognitive impairment (25-33), even in individuals with excellent virological suppression (34-40). Supporting these previous findings, we have demonstrated a positive correlation between expression of cerebrospinal fluid markers of monocyte/macrophage activation and neuronal injury in a HIV-infected cohort (see Chapter 7). Within the CNS, effects of infection are driven in part by HIV replication within the macrophage/microglia reservoir (41). These infected macrophages/microglia promote neuronal injury and associated neurocognitive impairment through the release of cytokines and chemokines that drive neuroinflammation and through the direct release of numerous neurotoxins, including the excitotoxin glutamate. Thus current research highlights the central role of macrophages/microglia and persistent neuroinflammation and oxidative stress in HAND in individuals receiving ART and underscores a critical need for adjunctive therapies that target these persistent neuropathological processes.

To this end we studied the endogenous antioxidant response pathway in HIV-infection *in vivo* in brain tissue and *in vitro* in HIV-infected macrophages and have identified heme oxygenase-1 (HO-1) as a potential therapeutic target in HAND (42, 43). HO-1 is a rapidly inducible detoxifying enzyme that is a critical effector for limiting oxidative stress, inflammation, and cellular injury within the CNS and other tissues in both physiological and disease states (see Chapter 5). These protective functions of HO-1 have been linked to its degradation of heme and the subsequent generation of carbon monoxide, biliverdin, and bilirubin, which have immunomodulatory and anti-oxidative properties (reviewed in (44)). Numerous studies have demonstrated that ability of the HO-1 pathway and its products to limit the clinical severity of a variety of conditions in animal disease models that are characterized by oxidative stress and inflammation, including ischemia-reperfusion injury, autoimmune neuroinflammation, inflammatory lung diseases, and infection/sepsis models. Moreover, clinical human studies have demonstrated associations between HO-1 promoter region polymorphisms and altered incidence and/or progression of various diseases associated with inflammation, including cardiovascular disease (e.g. coronary

artery disease), pulmonary disease (e.g. lung function in smokers), and infectious disease (e.g. sepsis and pneumonia) (reviewed in (45)). These complimentary animal and human studies highlight the broad role of HO-1 in modulating pathological conditions, particularly those with inflammatory and oxidative stress pathology, such as HAND.

This body of work describes a heretofore unreported deficiency of the sentinel cytoprotective enzyme HO-1 in the brains of HIV-infected individuals that may promote neuronal injury through inflammation-associated excitotoxic injury, particularly from the CNS macrophage/microglia reservoir. Our analysis of HO-1 expression in the brain prefrontal cortex of HIV-infected individuals from a well-characterized post-mortem autopsy cohort demonstrated a significant loss of HO-1 protein expression that was particularly striking in individuals with a pathological diagnosis of HIV-encephalitis (HIVE). Moreover, this HO-1 deficiency associated with a clinical diagnosis of HAND as well as with elevated CNS HIV replication, type I interferon responses, and macrophage activation (see Chapter 8). Further linking HO-1 to HIV neurological disease, individuals within this cohort with longer variants of a HO-1 promoter region (GT)_n microsatellite polymorphism, which are linked to reduced HO-1 gene expression, associated with increased risk of HIVE and elevated CNS macrophage activation (see Chapter 9). These results suggest an association between HO-1 and HIV neurological disease progression and neuroinflammation and are consistent with an anti-inflammatory role of HO-1. Specifically, these data link HO-1 with CNS macrophage activation and suggest that altered HO-1 protein expression or gene regulation may modulate inflammation within the CNS of HIV-infected individuals.

To further define the role of HO-1 in HIV neuropathogenesis, we examined HO-1 expression and the effects of modulating HO-1 in our *in vitro* HIV neurotoxicity model (see Chapter 10). In this model primary human monocyte-derived macrophages, a major CNS HIV reservoir, are infected with HIV resulting in robust viral replication and production of neurotoxic levels of the excitotoxin glutamate (46). HIV replication in macrophages predictably reduced HO-1 protein expression in a

time and replication dependent manner in association with elevated supernatant neurotoxicity and glutamate levels. We determined that this macrophage HO-1 deficiency and associated neurotoxin production did not require the HIV-1 accessory genes *nef*, *vpr*, and *vpu* and, moreover, was a conserved feature of infection with macrophage-tropic HIV-1 and HIV-2 strains. While pre-treatment of macrophages with ART prior to infection could prevent HIV replication and the associated HO-1 loss and neurotoxin production, the application of ART after HIV infection was established failed to prevent both HO-1 loss and neurotoxin production. These findings demonstrate that this HO-1 deficient neurotoxic phenotype is a relatively conserved feature of macrophage HIV infection that is resistant to ART once infection is established.

This association between HO-1 deficiency and glutamate production suggests that loss of HO-1 may promote macrophage neurotoxin production and further suggests a potential therapeutic benefit of restoring HO-1 expression in HIV-infected brain macrophages. This benefit of restoring HO-1 may be particularly critical as this HO-1 deficient phenotype may persist in long-lived HIV-infected macrophage reservoirs in the presence of ART. To this end, we have shown that knockdown and enzymatic inhibition of HO-1 in HIV-infected macrophages increased supernatant glutamate and neurotoxicity. Moreover, we have demonstrated by using both pharmacological and genetic approaches that HO-1 induction decreased HIV-infected macrophage glutamate production and associated neurotoxicity independent of viral replication (see Chapter 11). Specifically, we demonstrated that the clinically prescribed HO-1 inducing drug dimethyl fumarate (DMF) and its primary CNS-penetrating metabolite monomethyl fumarate (MMF) can effectively suppress production of neurotoxic levels of glutamate from HIV-infected macrophages at *in vivo* relevant concentrations. These findings in conjunction with DMF's other known anti-inflammatory and anti-oxidative effects highlight the potential role for DMF as an adjunctive therapy to limit HAND and other inflammation-associated comorbidities in HIV-infected individuals on ART (see Chapter 12). These data provide evidence that HIV-mediated macrophage HO-1 deficiency

augments neurotoxin production and that correction of this deficiency may in turn ameliorate neurotoxin production and associated neuronal injury.

The findings presented in this thesis identify HO-1 as a host factor that is deficient in the brains of HIV-infected individuals with HAND and suggest that loss of HO-1 and its protective functions may contribute to HIV neuropathogenesis. Moreover, this work defines a predictable and conserved relationship between HIV replication, HO-1 loss, and neurotoxin production in macrophages that likely reflects processes in place in the HIV-infected brain of individuals receiving ART. These studies provide evidence for induction of HO-1 expression as a protective strategy against HIV macrophage-mediated neurological disease progression in patients with HAND, and they further suggest that HO-1 inducing drugs such as DMF could serve this therapeutic role.

CHAPTER 2

HIV BIOLOGY AND PATHOGENESIS

2.1 Introduction

Human immunodeficiency virus (HIV) is a member of the family retroviridae and genus lentivirus. HIV expresses archetypal retroviral structural proteins and enzymes encoded by *gag*, *pol*, and *env* genes that allow for replication in host cells through the process of reverse transcribing viral genomic RNA into DNA that is subsequently stably integrated into the host genome. In addition, HIV expresses several regulatory and accessory proteins that promote virus propagation. Virions of HIV, like other lentiviruses have spherical envelopes (80-100nm in diameter) that appear rough with ~8nm spikes, isometric nucleocapsids, and concentric and truncated cone shape nucleoids (Figure 2.1). The provirus genomic organization of HIV reveals multiple overlapping open reading frames (Figure 2.2). Human lentiviruses, HIV type 1 (HIV-1) and HIV type 2 (HIV-2), are distinguished by their use of the CD4 surface protein as a receptor, thus limiting their tropism to CD4+ cells. This section will briefly discuss the basic biology and clinical disease of HIV-1, the primary pandemic lentivirus infecting humans.

2.2 HIV Biology and Viral Life Cycle

HIV tropism

The CD4 glycoprotein has been identified as the primary essential receptor for HIV-1 entry (47). However, CD4 receptor expression is not sufficient for HIV entry and additional co-receptors are required for entry and infection of target cells (48). Two co-receptors utilized by HIV-1 are the chemokine receptors CCR5 and CXCR4 (49-51). Transmitted/Founder HIV-1 virions, the viruses that are transmitted from person to person and establish clinical infection, are almost always CCR5-tropic (R5), with CXCR4-tropic (X4) strains evolving later in disease (52-54). Notably, individuals homozygous for CCR5 Δ 32 (a 32 base pair deletion in CCR5 gene resulting in protein

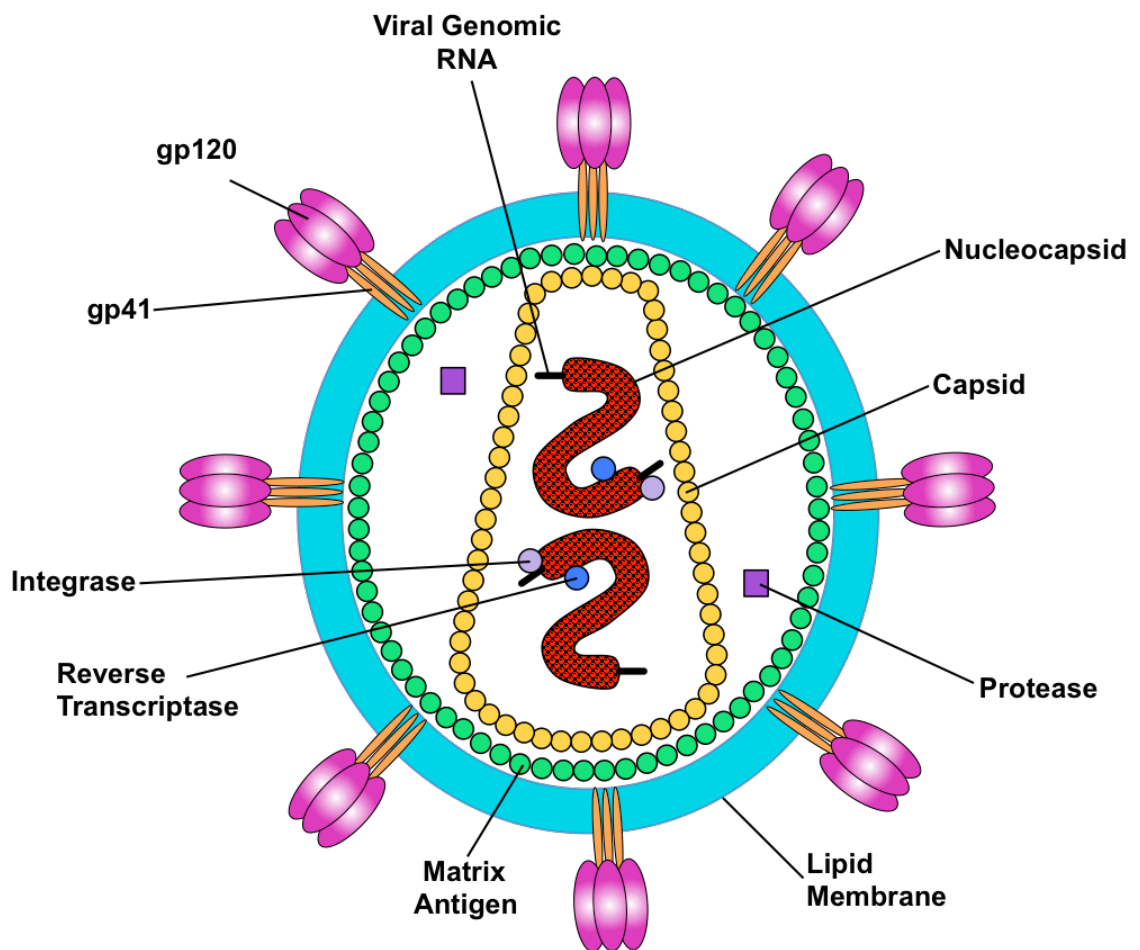

Figure 2.1 Diagram of mature HIV viral particle.

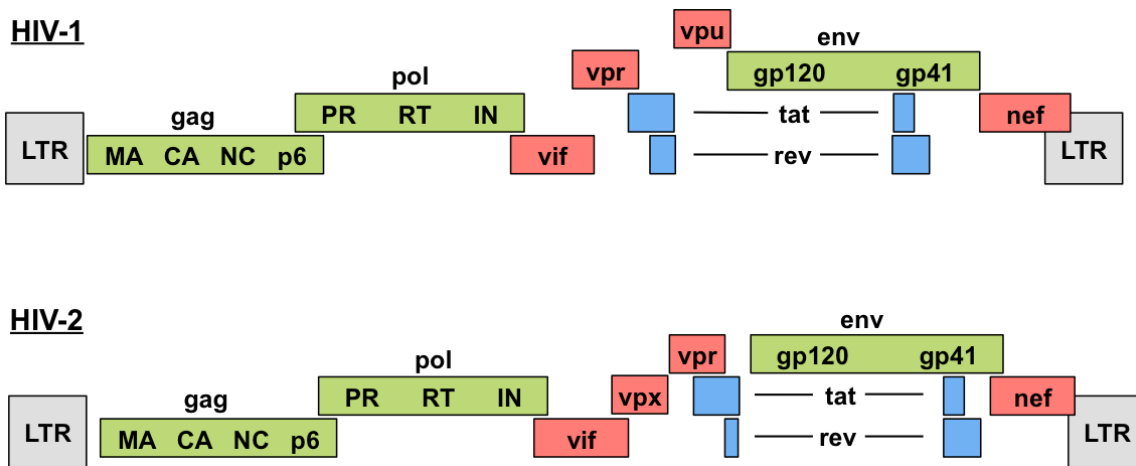

Figure 2.2 Organization of the HIV-1 and HIV-2 genomes.

truncation and lack of surface expression) are almost completely resistant to HIV-1 infection, highlighting the importance of CCR5 in HIV transmission (55). CD4 is found on the surface of immune cells, such as T helper cells, monocytes, macrophages, microglia, and dendritic cells. CCR5 is predominantly expressed on T cells, macrophages, dendritic cells, eosinophils, and microglia. In contrast, CXCR4 is widely expressed on most cell types, including hematopoietic (e.g. T cells, B cells, monocytes, macrophages, neutrophils, and eosinophils) lung, colon, heart, kidney, liver, endothelial, and epithelial cells in addition to cells of the central nervous system (CNS), including astrocytes and microglia (56-58). Thus, productive HIV infection is largely restricted to CD4+ and CCR5+/CXCR4+ T-cells, macrophages, and microglia.

CCR5 is the main co-receptor used by HIV-1 to infect macrophages and microglia (50, 51, 59, 60), thus CCR5-using viruses are often referred to as macrophage-tropic (M-tropic). However, CCR5-tropism is not required for infection of microglia, as some CXCR4 HIV-1 isolates can productively infect microglia (61) and some CCR5 isolates do not replicate in macrophages (62), indicating additional factors, beside co-receptor usage, involved in regulating macrophage and microglia tropism. One such factor is the ability of HIV-1 viruses to utilize low levels of CD4, as macrophages and microglia express much lower surface CD4 expression than CD4+ T-cells (63). The ability of HIV to infect macrophages and microglia is believed to be a central neuropathologic driver of HIV CNS disease (see section 3.4)

HIV life cycle: entry through viral particle release

This section presents a brief overview of the HIV life cycle (Figure 2.3; reviewed in (64)), with the roles for specific HIV-1 proteins presented subsequently. Upon binding to CD4 and an appropriate co-receptor, the HIV-1 virion fuses with the cell, depositing the viral core in the cytoplasm. After breakdown of the viral core and shedding of the capsid proteins, the viral genome is reverse transcribed from RNA into double-stranded DNA. Upon completion of reverse

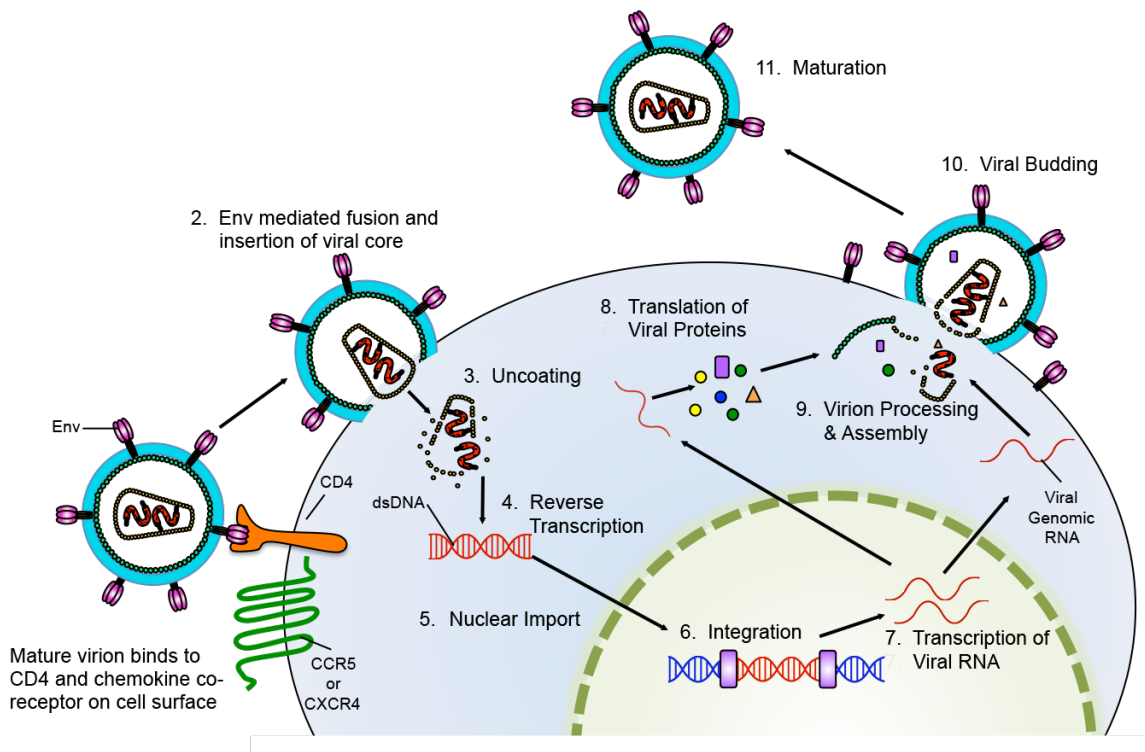

Figure 2.3 HIV-1 viral life cycle.

transcription, the now formed DNA pre-integration complex is transported to the nucleus where it is integrated into the cellular chromosomal DNA, forming the provirus. HIV-1 proviral transcription results in the production of viral RNA and mRNA that are transported to the cytoplasm and translated into viral proteins, many of which require post-translational processing and/or proteolytic processing by the viral and cellular proteases. The exact mechanism of viral assembly, packing viral proteins and genomic viral RNA, and maturation is not completely understood. However, upon maturation viral particles are able to bud from the cell membrane by the process of exocytosis, where they are released into the extracellular space and can infect a new target cell.

HIV structural proteins

Group Specific Antigen (Gag): The *gag* gene produces a polyprotein precursor containing the myristylated protein (Pr55 Gag), which is subsequently proteolytically processed by the viral protease into three structural proteins: Matrix Antigen (MA/p17), Nucleocapsid (NC/p7), Capsid Antigen (CA/p24) (Figure 2.1). MA is responsible for targeting Gag polyprotein to the plasma membrane and is involved in recruiting *env* glycoproteins to viral budding sites (65). Additionally, MA may have a role in viral uncoating. NC is important for the encapsidation of full-length genomic RNA into forming virions (66). After viral maturation CA, also commonly referred to as p24, forms the viral capsid and assists in viral budding. CA/p24 is commonly quantified by ELISA as a measure of viral replication and is one of three major proteins tested, along with gp120/160 and gp41, by Western blot to detect HIV-infection (67).

DNA Polymerase (Pol): The *pol* gene is the most conserved region of HIV-1 and the three viral enzymes encoded, reverse transcriptase (RT), integrase (IN), and protease (PR) (Figure 2.1), are targets for currently used antiretroviral drugs in HIV-infected individuals. These enzymes are initially encoded as part of a Gag-Pol precursor polyprotein, which is processed by the viral

protease. RT is an RNA-dependent DNA polymerase that converts the HIV genomic RNA into both minus and plus strands of viral DNA as well as degrading the HIV genomic RNA present in the RNA-DNA hybrid intermediates (68). Enzymatic activity of RT is commonly assayed as a measure of viral replication in cell culture. IN mediates the integration the full-length HIV DNA genome produced by RT into the host cell genome (69). PR is responsible for processing precursor polyproteins into their individual components and is essential for viral infectivity (70).

Envelope (Env): *Env* gene translation produces a heavily glycosylated precursor protein (gp160) that is cleaved by endogenous proteases into the surface (gp120) and transmembrane (gp41) subunits (Figure 2.1), which trimerize to form the native gp120-gp140 glycoprotein complex (71). This glycoprotein complex is responsible for viral particle binding and fusion on target cells through interaction with cell surface receptors CD4 and either co-receptor CCR5 or CXCR4 (72).

HIV regulatory proteins

HIV encodes two essential regulatory proteins, transactivator of transcription (Tat) and regulator for expression of viral proteins (Rev). Tat binds to the trans-activating response element (TAR), found at the 5' ends of nascent HIV-1 transcripts, and activates transcription elongation by recruiting endogenous cellular proteins, resulting in increased steady-state levels of viral RNA by several hundred fold (73). Rev binds to an Rev responsive element (RRE) sequence present in the viral unspliced and partially spliced Gag-Pol, Gag, and Env mRNAs and promotes their nuclear export, allowing them to be efficiently translated by ribosomes in the cytoplasm (74).

HIV accessory proteins

HIV-1 encodes an additional four proteins (Nef, Vif, Vpr, and Vpu) that are referred to as accessory proteins as initial reports suggested that they were not essential for HIV-1 replication.

However, more recent evidence has demonstrated a vital role of these HIV proteins in promoting steps in viral replication and counteracting cellular proteins that interfere with HIV replication, most notably anti-viral host restriction factors (75).

Negative Factor (Nef): Nef manipulates multiple cellular host factors to provide optimal conditions for viral replication and propagation. These changes include modulation of cell surface expression (decreased CD4 and CTLA-4), cytoskeletal remodeling (reduce T-cell receptor signaling during early infection), and signal transduction (increased IL-2 production) (76). These effects are important in modulating the activation state of infected cells, which plays an important role in the success rate of HIV-1 infection. While Nef often markedly elevates viral titers, it is often considered dispensable for HIV-1 replication.

Viral Infectivity Factor (Vif): Vif disrupts the antiviral activity of the endogenous human restriction factor APOBEC3G through induction of polyubiquitination and subsequent degradation (77). APOBEC3G limits HIV replication through deamination of cytosine (C) to uridine (U) in the first newly synthesized DNA-strand of HIV-1, resulting in guanosine (G) to adenosine (A) mutations in the complementary strand (78). Vif expression is essential for viral replication in primary CD4+ T-cells and macrophages.

Viral Protein R (Vpr): Vpr is involved in the nuclear import of the HIV-1 pre-integration complex, growth arrest of target cells in G2 phase, and transactivation of viral genes (79).

Viral Protein U (Vpu): Vpu enhances the degradation of CD4 in the endoplasmic reticulum (ER), likely to prevent improper Env assembly into virions as a result of Env-CD4 binding in the ER (80). Vpu also promotes the release of viral particles from the plasma membrane through neutralization of the cellular restriction factor tetherin, which impedes release of viral particles

through physical tethering of virions to each other and the plasma membrane through binding to the viral envelope (80)..

2.3 HIV Pathogenesis and Disease

Transmission of HIV

As HIV infection is restricted to humans, with no animal reservoir or vector, HIV transmission occurs exclusively from one human to another. Transmission can occur when certain bodily fluids from an HIV-infected individual (blood, semen, pre-seminal fluid, rectal fluids, vaginal fluids, and breast milk) come into contact with a mucous membrane, damaged tissue, or the bloodstream. The most common modes of transmission are vaginal or anal sex and sharing needles, syringes, or other equipment used for intravascular drug use (81). Other less common modes of transmission include mother-to-child transmission during pregnancy, birth, or breastfeeding; being stuck with an HIV-contaminated needle or sharp object; receiving blood, blood products, or organ/tissue transplants contaminated with HIV; and oral sex (fellatio, cunnilingus, and rimming) (82-84).

Acute infection of HIV-1

Acute or primary HIV infection occurs within the first 2-4 weeks after transmission and establishment of infection. During this stage the virus is replicating rapidly within the CD4⁺ T-cell compartment, with peak viremia reaching 10^6 to 10^7 virus particles per milliliter of blood (85) (Figure 2.4). Concomitant with this high viremia is a rapid drop in the number of circulating and intestinal mucosal CD4⁺ T cells (Figure 2.4) as a result of HIV induced cell lysis and killing of infected CCR5 CD4⁺ T-cells (85). Despite this high viremia and rapid drop in CD4⁺ T-cells, some individuals acutely infected with HIV show little or no symptoms. Acute infection symptoms may

include fever, decreased appetite, headache, rash, malaise, sore throat, muscle aches, and swollen lymph nodes, though individuals who experience symptoms often mistake them for the flu or other viral illness (85). Thus, most people with acute HIV infection do not know they have been infected, resulting in ~15% of people in the United States living with HIV being unaware of their seropositive status (86). This primary stage of infection lasts until the immune system creates antibodies against HIV (seroconversion) and activation of a partially-effective CD8+ T cell response (85), which results in a reduction, but not elimination, of circulating virus and a partial rebound in circulating CD4+ T-cells. Although initially partially effective, this immune response fails to control the virus resulting in chronic HIV-infection.

Chronic immune activation and inflammation in systemic HIV disease progression

After the initial acute HIV infection in an untreated individual, there is a clinically latent phase of the disease, often lasting years. However, continuous HIV replication during this period results in further CD4+ T-cell loss and a state of generalized immune activation (Figure 2.4). As a result of CD4+ T-cell depletion and eventually immune system failure, untreated individuals eventually (over years) progress to Acquired Immunodeficiency Syndrome (AIDS), a condition characterized by deficiency in cell-mediated immunity resulting in increased susceptibility to opportunistic infections, certain forms of cancer, and neurocognitive impairment. Treating HIV-infected individuals with combination antiretroviral therapy (ART), which inhibits multiple HIV enzymes simultaneously, reduces viral replication, increases CD4+ T cell counts, and significantly reduces HIV-associated morbidity and mortality, especially when initiated early in infection (87, 88) (Figure 2.4). Today, a 20 year-old individual with HIV infection and starting cART is now expected to live into his or her 60s (2).

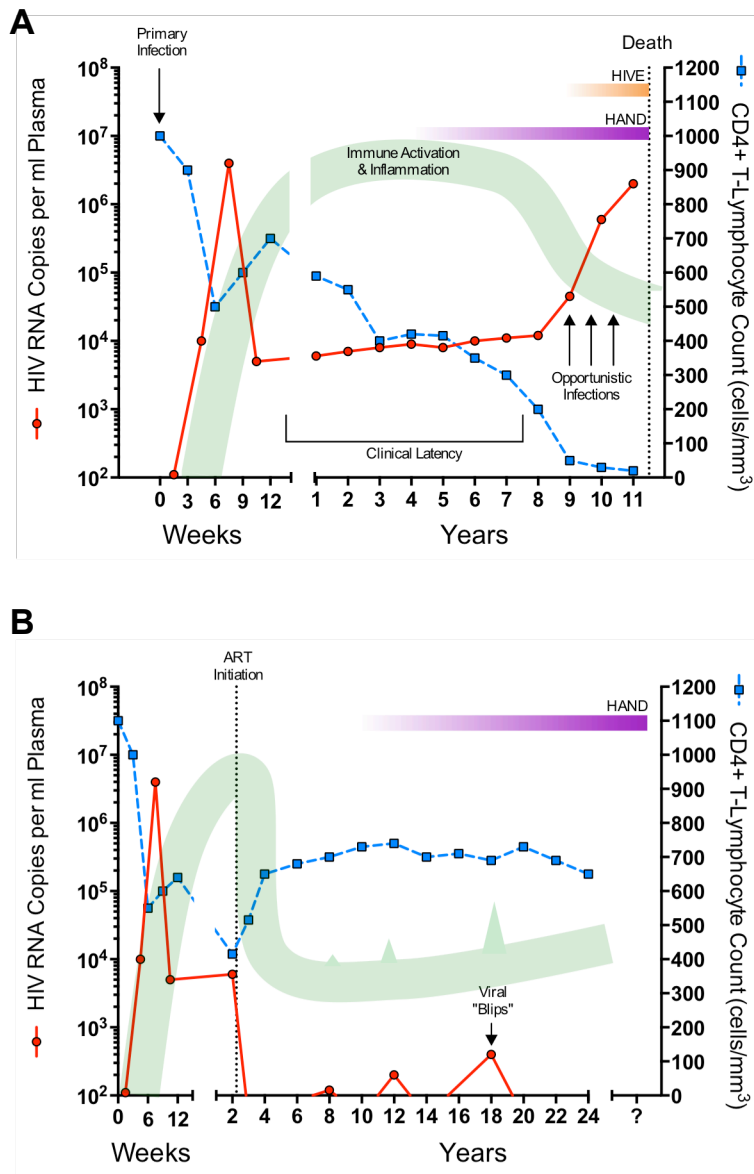

Figure 2.4 Clinical course of HIV-1 infection. Representative clinical course of HIV-1 infection in an individual **A)** never on ART **B)** and initiating ART after primary infection. Diagrams depict plasma HIV RNA (red line), peripheral CD4+ T-lymphocyte count (blue line), the trend of immune activation and inflammation (green block), the development of HAND and HIVE, as well as other characteristics of clinical HIV infection.

However, a growing body of evidence has defined chronic inflammation associated with immune activation as a major contributor to systemic and CNS disease progression in HIV-infected individuals, even in individuals treated with ART (3, 5, 89-103). Although ART significantly reduces viral replication and associated morbidity and mortality in HIV-infected individuals, lower life expectancy remains, particularly in individuals beginning ART after becoming immunosuppressed (CD4 T-lymphocyte counts < 200 cells/ μ l) (104-108). Elevated plasma levels of the associated biomarkers IL-6, D-dimer, C-reactive protein (CRP), and fibrinogen correlate strongly with HIV mortality in such individuals (109, 110). Such chronic immune activation is thought to result in large part from increased microbial translocation across the damaged gastrointestinal tract, which might harbor more pathogenic bacterial populations than in non-infected individuals (111, 112). In HIV-infected humans and simian immunodeficiency virus (SIV)-infected macaques gut microbial translocation results from depletion of mucosal CD4+ T lymphocytes, mucosal immune activation and inflammation, damage to mucosal epithelium, and transmigration of microbial products into the mesenteric lymph nodes and distal sites through the portal and systemic circulation (111). The translocated microbial products include lipopolysaccharide (LPS) (91, 97, 111), which associates with LPS-binding protein (LBP) in a complex that binds to monocyte CD14 and toll-like receptor 4 (TLR4) on immune cells. These LPS/LBP interactions with these receptors can activate monocytes and T-lymphocytes leading to induction of NF- κ B activation, cytokine production, T-lymphocyte sequestration in lymphoid tissues, increased T-lymphocyte turnover, and associated events (113-115). The associated T-lymphocyte turnover could generate new memory CD4+ T lymphocytes, thus providing additional targets for HIV replication (111, 116). Depletion of both CD4+ and CD8+ T-lymphocyte populations, which is strongly associated with disease progression (117), occurs in late stages of disease and is associated with and proposed to be caused by immune activation (118, 119).

In addition to increasing plasma levels of LPS, HIV can induce immune activation of monocyte/macrophages through direct effects of infection or through the release of factors that

can interact with bystander uninfected monocyte/macrophages. For example, the HIV envelope glycoprotein gp120 is shed from virions and can transduce signals in monocytes when presented as a soluble protein or as a component of the virus particle even when presented on non-infectious virions (as in plasma *in vivo*). (120, 121) Gp120 interacts with non-infected, bystander monocytes/macrophages and activates intracellular pathways that lead to monocyte/macrophage immune activation (120, 121). Other factors released from HIV-infected macrophages, such as TNF α and other proinflammatory cytokines, can also induce bystander cell immune activation (122-124). This monocyte activation is associated with elevated blood levels of soluble CD14 (sCD14), soluble CD163 (sCD163), and monocyte-associated CD14 and CD16 (37, 96, 125). The CD16⁺ monocyte subset is more permissive for HIV infection than the CD16⁻ subset (126), and the level of circulating CD14⁺/CD16⁺ monocytes correlates with an increased risk of disease progression (125).

Because systemic immune activation is driven by HIV replication, suppression of HIV replication with ART suppresses such immune activation; however this suppression is often incomplete (91, 92, 94, 95, 111, 127-131) (Figure 2.4) The presence of viral 'blips', defined as periodic detection of viral RNA in plasma which spontaneously returns to undetectable levels in chronically 'suppressed' ART-treated individuals has been associated with increased expression of immune activation markers and accelerated disease progression (132). The significance of these 'blips' remains undetermined, although their association with immune activation in the systemic and CNS compartments is receiving intense scrutiny (132-134). Nonetheless, the persistence of immune activation despite suppression of HIV replication with or without viral 'blipping' remains a major obstacle to preventing further disease progression in ART-treated individuals. Successful therapeutic targeting of persistent immune activation has now been proposed as a critical goal for further improving long-term survival, lowering risk of associated end-organ diseases, and improving quality of life in HIV-infected cART-treated individuals (111, 116).

Systemic oxidative stress in HIV/AIDS: A target for adjunctive antioxidant therapy

HIV infection can also induce systemic oxidative stress (135-138) through both chronic immune activation (139-141) and direct effects of HIV proteins (142-145) (reviewed (4)). Increased oxidative stress in HIV-infected individuals was first suggested after confirmation of diminished levels of reduced glutathione in plasma, lymphocytes, PBMCs, and monocytes isolated from such individuals (146-148). These early findings were supported by later studies demonstrating reduced levels of thioredoxin (a thiol antioxidant) in HIV-infected cells (149) and elevated serum levels of the lipid peroxidation products malondialdehyde (150, 151) and lipid hydroperoxides (152) in HIV-infected individuals. Moreover, the HIV proteins gp120 (142, 145, 153-156), Vpr (144, 157), and Tat (143, 145) have been directly implicated in the induction of cellular oxidative stress. Oxidative stress in turn can drive NF- κ B-driven HIV replication (158-160) and inflammatory cytokine release (158, 161-165), thus perpetuating chronic systemic immune activation and disease progression in HIV-infected individuals. Furthermore, *in vivo* markers of oxidative stress correlate with systemic disease progression in HIV-infected individuals (166-168). One study showed that glutathione deficiency in CD4⁺ T-lymphocytes from HIV-infected patients was associated with markedly increased mortality (169). These findings implicate oxidative stress in HIV disease pathogenesis and mortality and highlight the potential for adjunctive antioxidant therapies to ameliorate disease progression in ART-treated patients.

2.4 Conclusion

Using CD4 as its primary receptor and either CCR5 or CXCR4 as a co-receptor, HIV-1 productively infects cells of the human immune system, including CD4⁺ T-lymphocytes, macrophages, and microglia. Upon establishment of clinical infection, HIV replicates rapidly resulting in depletion of CD4⁺ T-lymphocytes. The immune system is unable to effectively control viral replication resulting in a chronic infection associated with systemic immune activation,

inflammation, and oxidative stress. The resulting dysfunction in cell-mediated immunity, monocyte/macrophage activation, and pro-inflammatory state drive the clinical sequela of HIV-infection. Treatment with ART suppresses HIV replication and associated immune activation; however, this suppression is often incomplete and elevated systemic immune activation and inflammation persist; this persistence remains a major obstacle to preventing further disease progression in ART-treated individuals. Thus, adjunctive therapy that successfully targets the persistent inflammation and oxidative stress is a critical goal for lowering risk of associated end-organ diseases and improving quality of life in ART-treated HIV-infected individuals.

CHAPTER 3

HIV NEUROPATHOGENESIS

Part of this work was originally published in *Current Opinion in HIV and AIDS*. Chen MF, Gill AJ, Kolson DL. Neuropathogenesis of HIV-associated neurocognitive disorders: roles for immune activation, HIV blipping, and viral tropism. *Curr Opin HIV AIDS*. 2014; 9(6):559-64. Copyright © 2014 Wolters Kluwer Health, Inc

3.1 Introduction

In addition to systemic disease, HIV infection is also associated with neurological disease including neurocognitive impairment in HIV-infected individuals. Early brain infection by HIV is a consistent consequence of HIV infection (170) and cerebrospinal fluid (CSF) HIV RNA levels correlate with severity of neurocognitive dysfunction in ART-naïve subjects, thus linking central nervous system (CNS) dysfunction to CNS HIV replication in those individuals (171, 172). HIV is believed to enter the brain through migrating infected monocytes and/or lymphocytes that cross the blood brain barrier (BBB) early in infection (173) (Figure 3.1). Once infection is established, perivascular macrophages are the major CNS site of productive HIV replication, although endogenous brain microglia can also harbor virus (41). Associated with both early and chronic brain infection is amplification of pro-inflammatory cascades, production of reactive oxygen species, expression of HIV proteins, oxidative stress, and increased production of glutamate and other excitotoxins, all of which have been linked directly or indirectly to neuronal injury and dysfunction and subsequent neurocognitive impairment (174) (Figure 3.1). These links were strongly established in the pre-antiretroviral therapy (ART) era, although the validity of these links in individuals on suppressive ART is now being challenged, as detection of CSF HIV RNA is more rare and often not correlated with neurocognitive dysfunction in those individuals (reviewed in (175)). However, there is no credible evidence that ART can irreversibly suppress or clear HIV from or within the CNS and high rates of neurocognitive impairment persist in HIV-infected ART-treated individuals. Furthermore, interruption of ART can be associated with viral rebound in the CSF, neuronal injury, and worsened neurocognitive performance (176-178). With recent studies confirming surprisingly high rates of CSF viral escape (blipping) in individuals felt to be in a state of HIV suppression, a role for persistent CNS HIV infection and replication, even if intermittent, in HIV neuropathogenesis in ART-experienced patients appears likely (179).

3.2 HIV-Associated Neurocognitive Disorders (HAND)

HIV infection causes varying degrees of cognitive, motor, and behavioral deficits collectively known as HIV-associated neurocognitive disorders (HAND) in up to 50% of ART treated individuals (180-184). HAND consists of three sub-classifications (the Frascati criteria (180)) that span a neuropsychological spectrum of impairment:

Asymptomatic neurocognitive impairment (ANI): 1.0 standard deviation below the mean for age-education-appropriate norms on neuropsychological tests in two or more cognitive domains with no functional impairment

Mild neurocognitive disorder (MND): 1.0 standard deviation below the mean for age-education-appropriate norms on neuropsychological tests in two or more cognitive domains with mild functional impairment of daily living

HIV-Associated Dementia (HAD): 2.0 standard deviations below the mean for age-education-appropriate norms on neuropsychological tests in two or more cognitive domains with marked functional impairment of daily living

At least five cognitive domains must be assessed for a proper diagnosis of HAND. These cognitive domains include abstract/executive function, speed of information processing, attention/working memory, memory (learning and recall), sensory-perceptual, motor skills, and verbal language. Additionally the pattern of cognitive impairment cannot meet criteria for delirium and there must be no evidence of another, pre-existing cause for the neurocognitive impairment (e.g. substance abuse, CNS infection, cerebrovascular disease, major depression with functional limitations, or CNS neoplasm). Screening tools, many of which are simple and brief, are available for use in the clinic to screen for further follow-up with a complete neuropsychological examination for a concrete diagnosis (185). Unfortunately, despite these tools, HAND, especially milder forms, is highly underdiagnosed in the HIV-positive population.

Currently, ART is the only treatment for HAND. Effective ART has decreased the prevalence of HAD (6, 186, 187), the most severe form of HAND, however, a significant proportion of patients on ART (30-50%) continue to develop milder neurocognitive impairments (ANI and MND), despite reduced plasma viremia, improved immunological parameters, and decreased progression to AIDS (6-17). A recent study even showed a significant increase in the prevalence of the milder forms of HAND in the ART era (9). These milder forms of HAND are associated with a decreased ability to perform complex daily tasks, poorer quality of life, and difficulty obtaining employment (188). One possibility for this persistence is poor ART penetration and availability within the CNS, with CSF ART concentrations falling below the concentrations needed to inhibit wild-type virus replication for several drugs (189). This led to the hypothesis that ART regimens with high CNS penetration would better prevent HAND. However, the evidence that ART regimens that effectively penetrate the CNS can better protect from HIV-related neuronal injury and neurocognitive dysfunction is controversial (16). The high prevalence of HAND and other neurologic manifestations of HIV-infection despite the introduction of ART underscore a critical need for adjunctive therapies that target persistent neuropathological processes within the CNS compartment (190-195).

3.3 HIV Neuropathology

Neuroinflammation

The neuropathogenesis of HAND has been associated with decreased CNS neuronal synaptic and dendritic density (196-198), neuronal apoptosis and necrosis (199-202), and altered neuronal physiology (203-211), linked to both systemic and CNS inflammation. Systemically, elevated levels of circulating CD16⁺ monocytes, CD14⁺ monocyte HIV DNA content, soluble CD14, soluble CD163, microbial translocation, and low CD4⁺ T-cell nadir correlate with an increased risk for HAND (212), indicating a central role for systemic monocyte activation and immune

dysfunction in pathogenesis. Within the CNS effects of infection are largely driven by HIV replication in macrophages/microglia (41), and possibly astrocytes. Productive HIV replication in the brain occurs primarily within perivascular monocyte-derived macrophages (MDM) and microglia, while restricted, non-productive replication occurs in astrocytes (213-216). Persistent CNS HIV infection drives immune activation of resident macrophages/microglia, pervasive reactive astrocytosis, perivascular inflammation and infiltration of monocytic cells (217), which can result in HIV-encephalitis (HIVE), particularly in individuals not receiving ART (218). The introduction of ART has decreased morbidity/mortality of HIV infection, the severity of neurocognitive impairment and associated neuroinflammation in HAND, and the prevalence of encephalitis (18, 20-23, 219). Despite these beneficial effects of ART, neuroinflammation and neuropathological damage persists (18-24), and persistent systemic and CNS markers of monocyte/macrophage activation predict neurocognitive impairment (25-33), even in individuals with excellent virological suppression (34-40). Moreover, the clinical severity of HAND correlates more strongly with monocyte infiltration and MDM/microglia activation than with CNS viral antigen load or number of HIV-infected cells in the brain (40, 197, 199, 220, 221). In summary, current research highlights the central role of macrophages/microglia and persistent neuroinflammation in HAND in individuals receiving ART.

Role of CNS macrophages, microglia, and astrocytes in HIV-mediated neurotoxicity

The neuronal dysfunction in HIV-infected individuals is likely in part a consequence of neurotoxins released from HIV-infected MDM (HIV-MDM) and immune activated MDM/microglia and astrocytes (222-225) (Figure 3.1). Our laboratory and others have demonstrated that a major component of HIV-MDM neurotoxins are small (<3 kDa), heat-stable, protease-resistant excitotoxins that act through N-methyl-D-aspartate-receptor (NMDAR) activation, a finding supported by studies in animal models of HIV neurotoxicity (226-228). Many candidate excitotoxins released from HIV-MDM have been described including glutamate (46, 229),

quinolinic acid (230, 231), NTox (232), platelet activating factor (233), TNF α (234), and the viral proteins gp120 (235, 236) and Tat (228, 237, 238) among others. HIV-infected individuals express increased levels of glutamate (239-241), quinolinic acid (242, 243), platelet activation factor (233), TNF α (244), and other neurotoxins in their CSF, which correlate with increased severity of HAND and neuroinflammation. Many of these neurotoxins released from HIV-MDM, such as the proinflammatory cytokine TNF α also dysregulate astrocyte function, particularly glutamate homeostasis (Figure 3.1).

Proper functioning of glutamate uptake and metabolism by astrocytes is vital to prevent glutamate-dependent excitotoxicity as astrocytes are the major regulator of glutamate in the brain (245, 246). Astrocyte control of extracellular glutamate is regulated through multiple mechanisms including direct uptake of glutamate, Ca²⁺-dependent release of glutamate, and catabolism of glutamate by glutamine synthetase (245, 246). Each of these processes can be perturbed through the actions of HIV coat protein gp120 (247-250), TNF α (251-254), arachidonic acid (247), prostaglandins (255), reactive oxygen species (256), and associated neuroinflammation (246), each of which is also associated with HIV replication within CNS macrophages and microglia. This further emphasizes the link between inflammation, oxidative stress, and neurodegeneration in HIV CNS infection. Accordingly, the identification of endogenous pathways that regulate HIV-MDM production of neurotoxins and factors that result in astrocyte dysfunction will provide novel therapeutic targets for ameliorating neurodegeneration and neurocognitive impairment in HAND.

CNS oxidative stress in HAND

HIV infection can induce CNS oxidative stress (161, 257-259) through chronic immune activation (139-141) and direct effects of HIV proteins. The HIV viral proteins gp120 (142, 145, 260), Vpr (144, 261), and Tat (143, 145) have been directly implicated in the induction of oxidative stress in CNS-relevant cell types. Oxidative stress drives NF- κ B-driven HIV replication (158-160), inflammatory cytokine release (158, 161-165), and neurotoxin production (162, 259, 262-266).

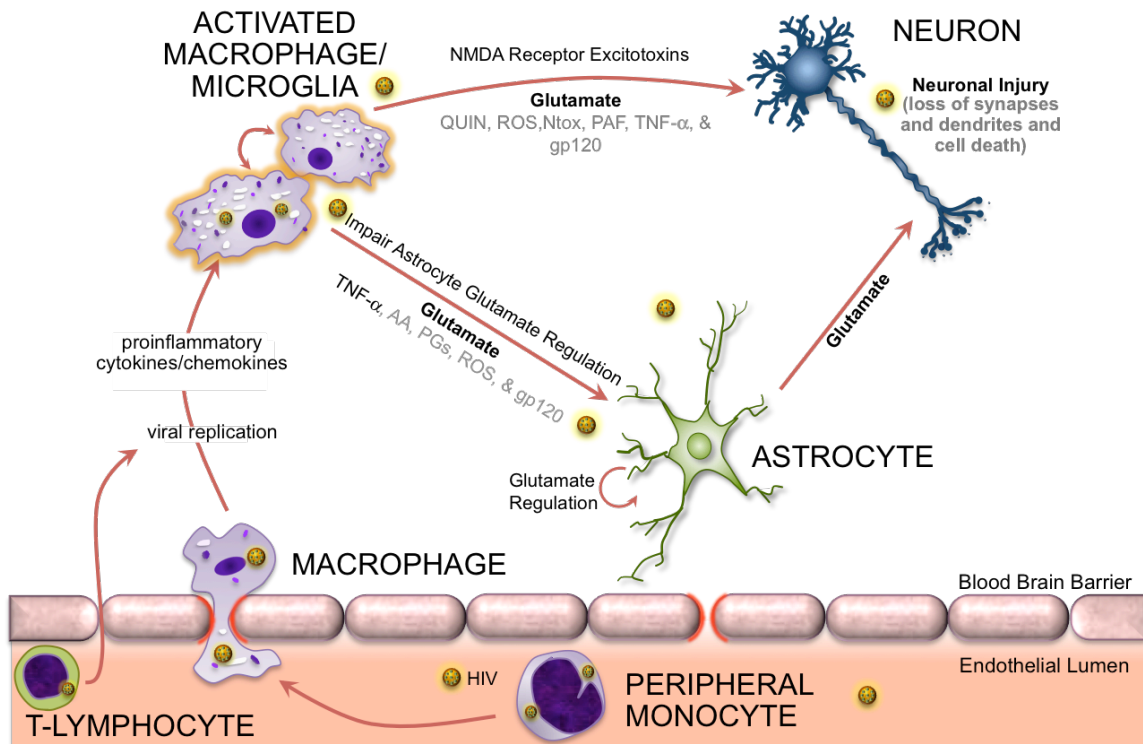

Figure 3.1 Schematic model of HIV Neuropathogenesis. Abbreviations used: arachidonic acid (AA), platelet activating factor (PAF), prostaglandins (PGs), quinolinic acid (QUIN), reactive oxygen species (ROS).

Furthermore, *in vivo* markers of oxidative stress correlate with neurocognitive impairment (161, 265, 267) as well as systemic disease progression (166-168) in HIV-infected individuals. The ubiquitous antioxidant response pathway provides endogenous protection against cellular oxidative stress (see Chapter 5). The antioxidant response is driven by the Nrf2 transcription factor, and gp120-induced oxidative stress and inflammation in astrocytes was reported to be significantly higher when Nrf2 expression was suppressed by siRNA (162). Finally, in addition to its role in HAND, oxidative stress has been implicated in the pathogenesis of other neurodegenerative disorders, including Alzheimer's disease, Parkinson's disease, and Huntington's disease (264, 268-276), which emphasizes the broad potential value of developing effective CNS therapies against oxidative stress.

3.4 CNS HIV Tropism and HAND: Challenging Conventional Thinking

Establishing a CNS HIV reservoir within the macrophage and microglial lineages by macrophage-tropic (M-tropic) strains, conventionally defined as those that infect both T lymphocytes and macrophages, has been considered a necessary, but not sufficient precursor to the development of HAND. Individuals with the severest form of HAND, HIV-associated dementia (HAD) often have genetically distinct M-tropic variants in their CSF that are not found in the plasma (277), consistent with a central role for replication of M-tropic strains within the CNS in the pathogenesis of HAND. However, recent evidence also suggests that not only M-tropic strains but also 'T cell-tropic' strains, conventionally defined as those that infect T lymphocytes but not macrophages, can be isolated from the CNS and that each contributes to the development of HAD (277). Schnell et al (277) found genetically compartmentalized T cell- and M-tropic HIV populations within the CSF that were distinct from those found in the plasma of eight of eight subjects with neurocognitive dysfunction (seven HAD, one milder dysfunction). Three subjects had compartmentalized T cell-tropic populations and five had compartmentalized M-tropic

populations. This study challenged the established hypothesis that M-tropic strains are primarily responsible for driving the pathogenesis of HAND.

More recently, the same group further analyzed genetic and phenotypic characteristics cloned *env* sequences of paired CSF/plasma isolates from five individuals and confirmed that CSF-derived viruses segregated into two distinct groups: M-tropic and T cell tropic and, based upon their relative ability to infect cell lines engineered to express tightly-controlled low- and high-level CD4 surface expression respectively (278). This well-defined segregation of naturally-occurring HIV phenotypes does not strictly predict the conventional M-tropic and T cell-tropic infection patterns in primary monocyte-derived macrophages or primary CD4⁺ T lymphocytes. Furthermore, how this phenotype segregation might apply to infection of CD4-negative cell types, such as astrocytes, is unanswered. Thus, the issue of the distribution of HIV strains within different cell lineages/reservoirs within the CNS and the relevance of each to HAND neuropathogenesis has been re-opened. This is particularly relevant to persistence of HIV within the CNS in ART-suppressed patients, the genesis of CSF HIV blips linked to neuroinflammation (see 3.5 Role for HIV 'Blipping'), and for consideration of CNS HIV eradication strategies.

Thus, our understanding of the role for HIV tropism in determining early events leading to CNS invasion, establishment of viral reservoirs, and long-term selection pressures within the CNS continues to evolve. We are re-examining our long-held belief that macrophage tropism is the predominant HIV determinant of neurovirulence driving HAND, although it appears certain that it is a common factor in HIV neuropathogenesis. Nonetheless, HIV neuropathogenesis might not be an exclusive function of M-tropic strains, and the importance of thoroughly evaluating early events and the role of T-cell tropism in CNS infection are critical for optimizing treatment strategies and achieving better neuroprotection.

3.5 Role for HIV 'Blipping'

HIV 'blips' are thought to represent new rounds of HIV replication that result in increased viral loads above the established lowest level of quantifiable HIV RNA. Viral (HIV) blips are defined as spontaneous expression of viral RNA copies (plasma, CSF) in individuals on ART with sustained antecedent undetectable viral loads with return to undetectable levels (133). CSF discordant blipping is generally defined as a higher RNA copy level of ≥ 0.5 log in the CSF in comparison with plasma. An overall plasma HIV blip (> 50 HIV RNA copies/ml) frequency of $\sim 25\%$ has been demonstrated in an observational cohort study ($n=3550$ virally suppressed patients) (133). Several causes of blipping are proposed, including differences in viral load assay sensitivity (279) and factors affecting HIV replication (ART adherence, immune activation, viral resistance, among others) (132-134). A role for blips in contributing to increased immune activation and accelerated disease progression has been suggested (132), although this has been challenged (280).

The significance of viral blips remains undetermined, and their possible association with HAND is under increasing investigation (134, 281, 282). Emerging evidence supports a role for blipping in promoting increased immune activation in the systemic circulation and CNS compartment, which is linked with development of HAND. A link between plasma HIV blips and systemic immune activation has recently been demonstrated in a prospective study of matched blippers and non-blippers (283). The study involved 82 individuals with plasma viral blips (VL > 50 and < 1000 copies/ml after at least 180 days at undetectable VL on ART) matched with 82 cohort controls without blips. The patients with plasma viral blips after suppressive ART showed increased T cell activation (CD3+HLA-DR+ T lymphocyte level) compared with patients without blips. This suggests that plasma blips might identify those patients at increased risk for immune activation associated with disease progression. Additionally, Castro et al (132) retrospectively analyzed responses in a ART interruption study and found that subjects with plasma blips above 200 copies/ml prior to ART interruption had lower CD4+ T cell levels under ART, and poorer CD4+ T

cell recovery and increased expression of immune activation markers after ART interruption. This study provided evidence not only that blipping could drive immune activation, but also that the magnitude of the blip can determine future virological failure.

Evidence suggesting that blips might merely maintain an established state of immune activation rather than increase immune activation has also been presented. Benmarzouk-Hidalgo et al (280) studied patients who were switched to simplification treatment of darunavir/ritonavir monotherapy for 24 months after a 6 month period of sustained HIV suppression with combination ART. Outcome groups were assigned as those with continuous aviremia, blips (one plasma VL > 50 copies/ml, preceded and followed by undetectable VL) and intermittent viremia (episodes of VL > 20 copies/ml without blips or failure). Virological failure was defined as two consecutive VL > 200 copies/ml. Only virological failure and not blipping or intermittent viremia was associated with increased immune activation (CD4+ and CD8+ T lymphocyte activation, primarily T_{CM} CD4+ T lymphocytes) from the baseline status. In addition, monocyte activation (plasma sCD14 levels) remained unchanged in the blipping and intermittent viremia groups, while decreasing in the aviremic group. Thus, sustained aviremia associated with significant decreases in activation of CD4+ and CD8+ T lymphocytes and monocytes while virological failure associated with increases in activation of each T lymphocyte subset. Those individuals with blipping and intermittent viremia maintained their previous levels of immune activation. These studies add to the growing evidence indicates that suppression of viral blipping could help in controlling and/or suppressing immune activation in many HIV-infected individuals and they support the importance of determining these associations in the CNS.

Defining the possible associations between blipping in the CNS compartment and increased risk for HAND is critical; HAND persists in HIV-suppressed populations and blipping is surprisingly common in such populations (133, 284). A study of 200 HIV-infected individuals with sustained HIV suppression (median 48 months; range 3.2-136.6) found an overall prevalence of HAND of

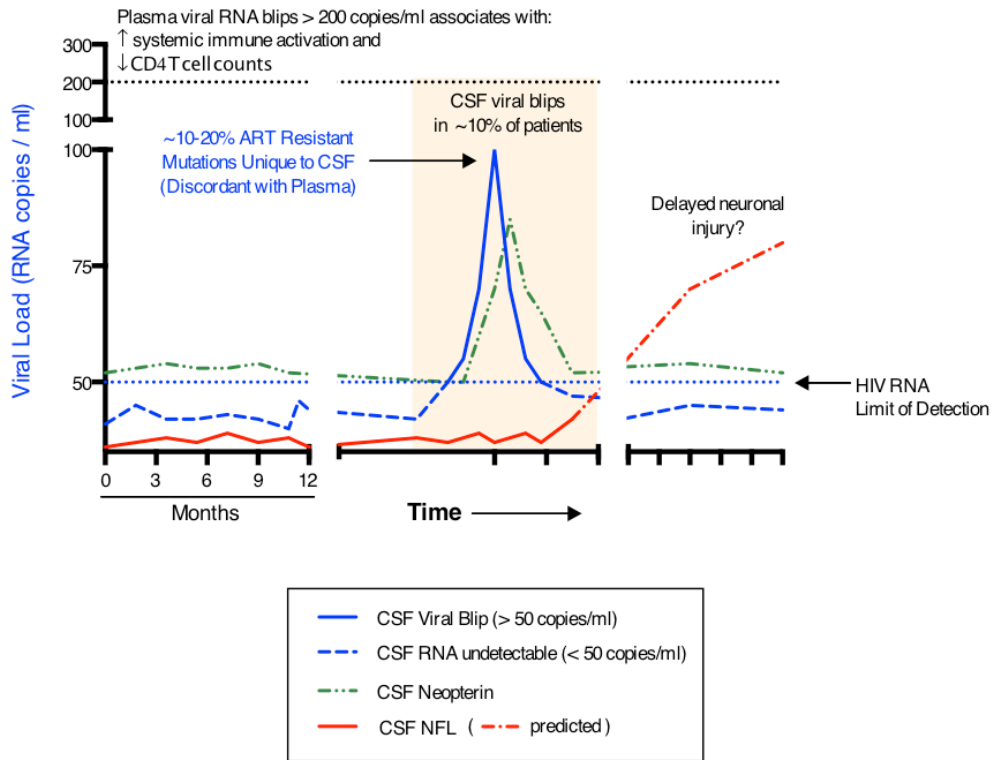

Figure 3.2 Hypothetical time course of cerebrospinal fluid viral blips, neuroinflammation, and neuronal injury. Diagram outlining the postulated temporal associations between CSF HIV viral blips, neuroinflammation (CSF neopterin), and neuronal injury (CSF neurofilament light chain, NFL).

69% including a 19% prevalence of significant functional neurological impairment (17% MND, 2% HAD) (8). Although not designed to detect viral blips, this study suggests persistence of neurological dysfunction in individuals considered to be appropriately treated (HIV suppression) with ART. Given the prevalence of blips in other studies, it raises the question of whether plasma and/or CSF viral blips might contribute to this risk for HAND in suppressed populations.

Recently published and ongoing, unpublished studies directly address the relationships between CSF HIV blipping, inflammation and HAND risk. Eden et al (281) found that ~10% of 69 neurologically normal, HIV 'suppressed' patients had detectable CSF HIV RNA, consistent with ongoing HIV replication in the CNS compartment. Furthermore those with detectable CSF RNA had significantly higher CSF expression of markers of monocyte activation (neopterin) and also a longer duration of ART treatment. Follow up studies have indicated that the elevated CSF neopterin levels are not associated with neuronal injury (elevated CSF neurofilament (NFL) levels) at the time of sampling (Figure 3.2), but whether these blips will associate with future risk for neuronal injury remains to be determined (285).

Because blips can associate with increased duration of ART and the emergence of ART resistance (281, 286), determining the frequency of ART resistance mutations in blippers is critical for ART management of HAND risk. Canestri et al (134) found ART resistance mutations in 7 of 8 CSF specimens from CSF blippers in a small group (n=11) of HIV suppressed (~18 months) patients with neurological symptoms. Ten of the patients had CSF pleocytosis, indicating a strong association between CSF blipping and inflammation. Notably, however, the patients were not evaluated by HAND criteria and so the relationship to HAND is speculative. Additional evidence for emergence of ART resistance in CSF blippers is provided by the ongoing UK PARTITION STUDY of CNS ART penetration (287). Three of three CSF specimens tested from a cohort of 38 CSF blippers showed reverse transcriptase resistance mutations, which supports the earlier demonstration and previous reports of a high prevalence of drug resistance in CSF

blippers (179). Prospective monitoring for drug resistance in the CSF is necessary to determine the risk for developing HAND.

In summary, the argument for a causal relationship between HIV blips, increased immune activation, and risk for disease progression in both systemic and CNS compartments is increasing in strength. A role for intermittent HIV replication within the CNS in HAND pathogenesis in virally 'suppressed' ART-experienced patients appears likely. As average ART duration increases, the risks of recurrent blipping will likely become more apparent, and the challenges of monitoring blipping in the CSF as well as plasma will need to be resolved.

3.6 Conclusion

HIV-associated neurocognitive disorders (HAND) remain prevalent despite apparently effective suppression of HIV replication by ART in most treated individuals (171, 175, 288). The underlying neuropathological processes in the brain that contribute to neurological dysfunction in HAND in the era of ART are probably significantly attenuated by such therapy, resulting in a more protracted and less severe clinical course of HAND. Although fulminant encephalitis is now distinctly uncommon in HIV infection, CSF biomarkers of neuroinflammation and brain neuroimaging biomarkers of glial activation and neuronal injury are frequently detected in virally-suppressed individuals. This persisting neuroinflammation likely leads to persisting production of HAND-associated neurotoxins from infected and activated glia, particularly macrophages and microglia. Partial protection against HAND by ART confirms a direct and possibly incomplete link to HIV replication; however longitudinal studies in ART-experienced cohorts indicate surprisingly frequent episodes of CNS viral escape (HIV blipping) in those thought to have complete viral suppression. This suggests a persistent link between CNS HIV replication, immune activation, inflammation and neurological dysfunction that escapes full suppression by current ART. The high prevalence of HAND and other neurologic manifestations of HIV-infection despite the

introduction of ART underscore a critical need for adjunctive therapies that target the persistent inflammation and oxidative stress within the CNS compartment.

CHAPTER 4

HAND COMORBIDITIES

This work was originally published in *Current HIV/AIDS Reports*. Gill AJ, Kolson DL. Chronic inflammation and the role for cofactors (hepatitis C, drug abuse, antiretroviral drug toxicity, aging) in HAND persistence. *Curr HIV/AIDS Rep.* 2014; 11(3):325-25. Copyright © 2014 Springer International Publishing

4.1 Introduction

HIV-associated neurocognitive disorders (HAND) are a group of syndromes of varying degrees of cognitive impairment affecting up to 50 % of HIV-infected individuals. The neuropathogenesis of HAND is thought to be driven by HIV invasion and productive replication within brain perivascular macrophages and endogenous microglia, and to some degree by restricted infection of astrocytes. The persistence of HAND in individuals experiencing suppression of systemic HIV viral load with antiretroviral therapy (ART) is incompletely explained, and suggested factors include chronic inflammation, persistent HIV replication in brain macrophages, effects of aging on brain vulnerability, and comorbid conditions including hepatitis C (HCV) co-infection, substance abuse, and neurotoxicity of ART, among other factors. This chapter discusses several of these co-morbid conditions: co-infection with HCV, drugs of abuse, aging, and antiretroviral drug effects. Effectively managing these co-morbid conditions in individuals with and without HAND is critical for improving neurocognitive outcomes and decreasing HIV-associated morbidity.

4.2 Hepatitis C Co-Infection.

Detection of HCV genomes and active HCV replication within the central nervous system (CNS) has prompted great interest in HCV infection as a contributor to neurocognitive impairment in HIV-infected individuals (289-292) (293-295). One recent estimate of the prevalence of HCV infection across all populations within the US at 2% (296) and other studies estimate that 20-30% of HIV+ individuals worldwide are co-infected with HCV (297, 298). These high rates of co-infection emphasize the potentially high risk of HCV increasing the morbidity associated with HAND when both viruses infect the brain. Indeed, replicating HCV has been detected in autopsied brain tissue predominantly in CD68+ macrophages/microglia, and to a lesser degree in astrocytes, which suggests a shared HCV/HIV reservoir within the brain (289, 299). Furthermore,

brain macrophage HCV infection is associated with increased macrophage expression of pro-inflammatory cytokines (300), which is also a feature shared with HIV infection of macrophages that can contribute to neurodegeneration (Figure 4.1).

The prevalence of neurocognitive dysfunction attributable to HCV infection alone is difficult to determine and probably highly variable, with estimates ranging from ~10-49% (reviewed in (290)), while the prevalence of neurocognitive dysfunction in HIV/HCV co-infection has been estimated as high as ~63% (301). Individuals seropositive for HCV are twice as likely to have global neuropsychological impairment than seronegative individuals, independent of HIV infection (302). Such impairment is commonly associated with metabolic and structural brain abnormalities, as detected in magnetic resonance spectroscopy (MRS) and magnetic resonance imaging (MRI) studies. Several MRS studies have found metabolic alterations consistent with neuronal injury and gliosis (decreased *N*-acetyl-aspartate/creatine and increased choline/creatine ratios) in the brains of HCV+/HIV- individuals with cognitive impairment but without hepatic failure (290, 294, 295) (303). Furthermore, hyperperfusion in the basal ganglia, suggestive of neuroinflammation, has been detected in HCV+ individuals by brain perfusion-weighted neuroimaging (303). An MRS study of 15 HCV+/HIV- individuals treated with pegylated interferon/ribavirin demonstrated decreased brain choline/creatine and myoinositol/creatine ratios in individuals with sustained HCV suppression, suggesting a potential brain neuroprotective/anti-inflammatory response with anti-HCV treatment (293). One structural brain MRI analysis of 251 HIV+ individuals without significant co-morbidities for cognitive impairment other than HIV infection demonstrated a greater loss of white matter volume in HCV+/HIV+ individuals in comparison with HCV-/HIV+ individuals (304). Notably, a significant correlation between plasma lipopolysaccharide levels and HAND was demonstrated in and HIV/HCV co-infected cohort, despite no significant correlation in HIV- or HCV- monoinfected sub-cohorts (305). These studies clearly demonstrate that HCV infection is associated with functionally significant injury to the brain that can potentially

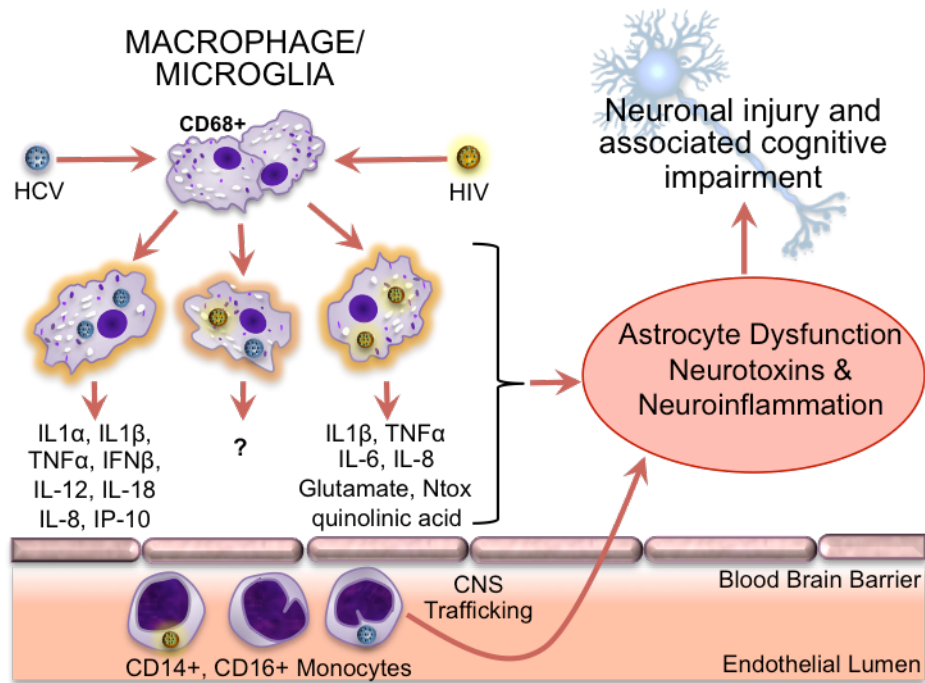

Figure 4.1 CNS inflammatory effects of HIV and HCV infection on monocytes, macrophages, and microglia. CD14+/CD16+ monocytes can be infected by HCV and HIV and migrate across the endothelial barrier into the brain. Macrophages and microglia within the brain can support productive infection with HIV and HCV, resulting in the production of pro-inflammatory cytokines and neurotoxins. Those associated with HCV infection are depicted in the left-most macrophage image, and those associated with HIV infection are depicted in the right-most macrophage image. Such pro-inflammatory cytokines and neurotoxins have been shown to induce neuronal injury through directed and indirect (astrocyte-mediated) mechanisms.

exacerbate the injurious effects of HIV infection, and they further suggest that induced neuroinflammation is a shared major contributor.

Although the association between HIV and HCV co-infection and worsened neurocognitive functioning has been observed in numerous studies, the relationship between active HCV replication (as indicated by detectable plasma HCV RNA) and worsening neurocognitive function has been questioned. A study of 24 HCV+ individuals with newly detectable plasma HCV RNA within 12 months of study showed worse neurocognitive performance in comparison with 57 individuals with HIV monoinfection (306). This was associated with MRS evidence of glial activation/inflammation in the basal ganglia. Contrasting results were seen when The AIDS Clinical Trials Group (ACTG) Longitudinal Linked Randomized Trials (ALLRT) study examined the relationship between HCV replication and neurocognitive performance in 517 HIV-infected individuals, of which 172 demonstrated detectable plasma HCV RNA (345 individuals had no detectable plasma HCV RNA). Although both groups performed below norms, there was no discordance in neurocognitive function between the two groups (307, 308), suggesting that active HCV replication, at least that outside of the CNS, does not drive neurocognitive dysfunction. Nonetheless, consistent with other studies of HCV seropositive (HCV+) patients, an earlier ACTG study confirmed that HCV infection, as indicated by HCV antibody detection (HCV seropositive) in HIV+ individuals is correlated with worse neurocognitive performance than that in HIV+ individuals not co-infected with HCV (309).

Thus, considerable evidence supports a significant negative impact of HCV infection on HAND and the high prevalence of HAND and HIV/HCV co-infection requires that effective suppression of both HIV and HCV be a high priority. The recent FDA approval (December 16, 2013) of the anti-HCV drug, Sofosbuvir, a nucleotide polymerase inhibitor, for HCV monoinfection and HCV/HIV co-infection represents a major step in the struggle to cure HCV infection (310). This approval could potentially represent a highly effective means of preventing neurocognitive deterioration in

HIV+ patients newly infected with HCV and it also raises the question of the possibility of improving cognitive performance in HAND individuals with co-infection. A therapeutic trial of Sofosbuvir as treatment for or prevention of neurocognitive impairment in HIV+/HCV+ individuals is clearly indicated.

4.3 Drugs of Abuse

Substance abuse often represents a co-morbid condition with HIV infection, and evidence supports additive or synergistic effects of substance abuse on the persistence and severity of neurocognitive dysfunction in patients with HAND (311) (summarized in Table 4.1). Under strict diagnostic criteria, a diagnosis of HAND requires the exclusion of other co-morbid conditions that may contribute to neurocognitive impairment, including drug abuse (180). However, drug abuse is common in HIV infected populations and is a major co-morbidity risk for neurocognitive impairment in HIV+ individuals (312-315). In the United States approximately one in four HIV+ individuals studied from 2005 to 2009 required treatment for alcohol or drug abuse (316). Thus, studying the interactions between drug abuse, HIV infection, and neurocognitive function is of high clinical importance. Although, the potential direct neurotoxic effects of drugs of abuse are not the focus of this section, we will focus on drug effects that may synergize with HIV-mediated neurocognitive impairment.

Numerous studies have implicated cocaine, methamphetamine (meth), and opioid use in exacerbating the risk for neuronal injury and neurocognitive impairment in HIV+ patients (311, 317-322). However, a recent large cohort study by Byrd et al. (2011) found that participants with histories of substance use (alcohol, cocaine, cannabis, opiates, methamphetamine) did not have higher rates of neurocognitive impairment or functional impairment in everyday life (321). Most of these participants were not current users and less than a third reported using illicit substances within the last year. The authors propose that sustained periods of drug abstinence may be

sufficient for full or partial reversal of substance use effects on neurocognition. These findings are consistent with another longitudinal study demonstrating improvement in neurocognitive function in long-term abstinent meth users (average of 13 months) compared to non-abstinent meth users (323). These results suggest that drugs of abuse may have a limited legacy effect on neurocognitive impairment in HIV+ individuals and that current and recent substance use may be more relevant to modulating HIV neuropathogenesis.

Cocaine, meth, and opioids have been shown to increase HIV infection/replication in primary human macrophages *in vitro* (312, 324-330), likely due at least in part to increases in HIV co-receptor (CCR5 and CXCR4) expression (331-333). Cocaine and opioids also increase HIV infection and replication in T-lymphocytes *in vitro* (334-337). The effects of meth on T-lymphocyte HIV replication remain controversial due to variations in models, viral strains, exposure time, and drug concentrations used (338, 339). Some studies suggest that dopamine, which is elevated within the CNS in response to these drugs of abuse, can enhance macrophage HIV infection and replication as well as alter macrophage cytokine production (340, 341). These findings are consistent with studies demonstrating that treatment of SIV-infected rhesus macaques with selegiline, an inhibitor of dopamine catabolism through inhibition of MAO activity, or L-DOPA, the precursor of dopamine, resulted in elevated brain viral loads (342, 343). In the SIV-macaque model, methamphetamine and opioid exposure increased both CSF/brain viral loads and macrophage influx into the CNS (344-346). In contrast, cocaine exposed SIV-infected macaques did not show elevated CNS viral replication or alterations in inflammatory markers; notably, the low dose cocaine-treated animals had significantly lower CSF viral RNA (347). The relative contribution of the direct drug effects or indirect dopamine effects on CNS viral loads and macrophage influx is not known. Taken together these data suggest that some drugs of abuse may increase HIV replication within CNS macrophage/microglia, which likely results in enhanced neuroinflammation, HIV-infected macrophage/microglia neurotoxin production, and associated neuronal dysfunction (42, 46, 312).

	Cocaine	Meth	Opioids	Dopamine
Risk of neurocognitive impairment in HIV+ individuals with current/recent use of selected drug	↑	↑	↑	N/A
HIV replication in human macrophages	↑/-	↑	↑	↑
Monocyte/macrophage CCR5 expression	↑	↑	↑	?
Monocyte/macrophage CXCR4 expression	↑	↑	↑/-	?
HIV replication in human T-lymphocytes	↑↑	↑/-	↑	↑
CSF/brain SIV viral load in macaque model	↓/-	↑	↑	↑
Pro-inflammatory cytokine release from macrophages/monocytes/microglia/astrocytes	↑	↑	↑	some ↑ some ↓
Anti-inflammatory cytokine release from macrophages/microglia/astrocytes	↑/-	?	↓/-	↓
Blood brain barrier breakdown following exposure in rodent models	↑	↑	↑ during withdrawal	?

Table 4.1 Effects of cocaine, methamphetamine (meth), opioids, and dopamine on HIV, SIV, and neuroinflammation. Symbols used: ↑ increased; ↓ decreased; ↑/- increased reported in some studies, but not others; ↓/- decrease reported in some studies, but not others; ? no current data; N/A not applicable.

Further supporting a role for drugs of abuse increasing neuroinflammation and associated neurodegeneration, the pathological diagnosis of HIV-encephalitis is more common in HIV+ individuals who abuse drugs compared to HIV+ controls (348-350). The relative additive and synergistic effects of drugs of abuse on neuroinflammation in HIV+ individuals is not known. Both *in vitro* and *in vivo* data suggest that cocaine, meth, and opioids promote increased proinflammatory cytokine release and activation of microglia, perivascular macrophages, and astrocytes (312, 351-354). Increased activation of these glial cells within the CNS drives oxidative stress, excitotoxicity, and inflammatory neuronal injury (355). Furthermore, distinct mechanisms have been identified for augmenting neurotoxin production by astrocytes. Exposure to opioids (morphine) or meth has been shown to inhibit astrocyte regulation of extracellular glutamate (356, 357), an excitotoxin strongly implicated in HAND (46, 358). Cocaine may potentiate astrocyte toxicity through apoptotic pathways involving reactive oxygen species generation, mitochondrial membrane potential loss, and activation of the inflammatory NF- κ B pathway (359). In conclusion, drugs of abuse may induce neuronal injury through potentiation of glia pro-inflammatory signaling and through perturbation of astrocyte homeostatic functioning; additionally, these insults may be further promoted through drug-induced increases in CNS HIV replication.

During HIV infection, both viral and host factors alter the stability and function of the blood brain barrier (BBB) and this is believed to be a critical driver of HIV neuroinflammation and neuropathogenesis (360). This effect can be exacerbated by drugs of abuse. Such drugs have been proposed to exacerbate neurocognitive impairment in HIV-infection through further disruption of the BBB, resulting in enhanced immune cell infiltration, elevated CNS inflammation, and alteration in cellular homeostasis. In rodent models, cocaine and meth exposure increase BBB breakdown (361-364). Cocaine and meth also alter tight junction and cell adhesion molecule expression, permeability, and immune cell migration across brain microvascular endothelial cells (BMECs) *in vitro* (365-370). These effects on BBB integrity may be synergistic, as co-treatment with the HIV envelope glycoprotein gp120 and meth increased permeability across BMECs and

decreased the expression of tight junction proteins (ZO-1, JAM-2, claudin-3, claudin-5) more than treatment with gp120 or methamphetamine alone (365). In contrast, chronic opioid (morphine) exposure did not significantly alter BBB integrity in rats (371); however, another study suggests that spontaneous morphine withdrawal in rats results in significant BBB breakdown in multiple brain regions, including the cerebral cortex, hypothalamus, hippocampus, and cerebellum (372). The HIV and drug-mediated BBB dysfunction promotes immune cell infiltration (HIV-infected and non-infected) into the CNS and promotes neuroinflammation, which in turn may drive further loss of BBB integrity.

Lastly, the treatment of drug abuse is likely to improve drug adherence to ART treatment, which remains the best currently available intervention for limiting the severity of neurocognitive impairment and associated neuroinflammation in HAND. Current drug use and alcohol abuse are associated with poorer adherence to ART regimens as well as a decreased or absent access and/or use of HIV care (373-376). These obstacles are an important barrier to appropriate treatment of HIV-infection and associated comorbidities, including neurocognitive impairment, in HIV+ drug users. Treating opioid addiction with methadone maintenance or buprenorphine has been shown to increase adherence to ART therapy and improve patient outcomes in HIV+ individuals with opioid abuse history (377). Another study observed a similar associative increase in ART adherence among drug users who were enrolled in non-medication drug abuse treatment programs (378), suggesting multiple modalities of drug abuse treatment may improve ART adherence in HIV+ individuals. The poor ART adherence among this vulnerable group of HIV+ drug abusers likely contributes to poor clinical outcomes. However, a review of 20 studies examining the effect of substance use on HIV disease progression found that drug use associated with more rapid HIV disease progression, even after controlling for ART adherence (379). Thus beyond the effects of drug abuse on ART adherence, drug abuse may affect HIV systemic and CNS disease progression, in part through the mechanisms outlined above.

Thus, drugs of abuse are strongly associated with worsening neuronal injury and neurocognitive impairment in HIV+ individuals. These drugs of abuse likely act through multiple mechanisms to promote neuronal dysfunction including i) increasing HIV infection and replication, ii) reducing BBB integrity, *iii*) stimulating neuroinflammation, iv) augmenting neurotoxin production and handling by astrocytes and macrophages, and v) decreasing ART regimen adherence. Effective treatment of neurological complications in the HIV+ population will require special clinical attention to drug use and abuse.

4.4 Aging

By 2015 more than 50% of the HIV+ population in the United States will be older than 50 years of age (380) and therefore at increased risk for neurocognitive dysfunction when compared with age-matched seronegative populations (288). As ART-treated patients age, they are at risk for associated CNS diseases and systemic diseases that can contribute to cognitive dysfunction, including renal failure and cardiovascular/atherosclerotic disease. Among the CNS diseases prevalent in aging, Alzheimer's disease (AD) and Parkinson's disease express some pathological features that have been seen in HIV+ brain tissue (380, 381). Thus, the brain in aging HIV+ individuals might be particularly vulnerable because of the combined effects of age-associated systemic diseases that indirectly affect the brain, and/or direct brain effects of HIV infection and aging (reviewed in (5)).

Neuropathological and biochemical changes in the aging HIV-infected brain

The neuropathological changes in the aging HIV+ brain and the relationship to neurocognitive dysfunction have received considerable attention but a consistent picture has not emerged. Demonstrations of AD- and PD-like brain neuropathology in ART-treated individuals (382, 383) include elevated levels of hyperphosphorylated Tau (p-Tau) in the hippocampus, elevated intra-

and extracellular beta-amyloid (A β) in the frontal cortex and hippocampus (219, 384-386), and elevated levels of alpha-synuclein in the substantia nigra (387) (383). Other studies have demonstrated elevated levels of amyloid precursor protein in damaged axons in brain specimens from ART-naive patients without elevated levels of p-Tau or neuritic plaque formation (388, 389). An association between the apolipoprotein E (APOE) e4 allele and increased diffuse b-amyloid plaques in HIV-infected brain was recently demonstrated in a study of 160 brains from HIV+ individuals (age range 27-67 years) (390). This study further demonstrated that age increased age also independently increased the likelihood of plaque deposition. A recent and much smaller brain autopsy study of ten ART-treated individuals (and ten seronegative controls; all patients between 28-58 years of age) showed that brain b-amyloid deposition was increased in HIV+ intravenous drug users, but this did not correlate with brain viral load (391). Correlations among lower expression of markers of autophagy, increased expression of markers of brain inflammation, reduction of the Beclin 1 protein that forms a critical core for the autophagosome, and older age in individuals with HIVE was demonstrated in a recent neuropathological study (392). Although b-amyloid deposition was not studied in those cases, the known association between Beclin 1 deficiency, low expression of autophagy markers, and increased risk for b-amyloid deposition in AD brain (393) suggests the possibility of similar associations in HIVE brain, but whether such associations exist in non-encephalitic HAND cases is not yet reported. Thus, the issue of aberrant processing of amyloid, synuclein, and tau proteins in the HIV-infected brain and the relationship to aging in ART-treated individuals remains unresolved and additional studies are needed to address the potential roles for such aberrant protein processing in HIV neuropathogenesis.

Neurocognitive testing in aging HIV+ cohorts

Determining whether effects of HIV and aging on neurocognitive functioning are truly independent or additive has been an priority of recent longitudinal neuropsychological and neuroimaging

studies. A study of 54 HIV+ and 30 HIV- individuals (40 – 74 years of age) assessed longitudinally over one year for performance on tests of verbal and visuospatial learning and memory (394). There were significant effect of age group and HIV x age group interactions on learning and memory performance between baseline and one year-follow up examination. The investigators concluded that a decline in performance in HIV+ individuals when compared with HIV- controls was enhanced through an additive age effect. Recently summarized data from the HIV Neurobehavioral Research Center in San Diego showed that global neurocognitive performance declined more rapidly with age in HIV+ individuals than in HIV- matched controls (288). The difference in rate of decline of performance vs. age (slope of regression line) indicated that the effects of aging on neurocognitive performance are amplified by HIV infection. The domains of performance that are particularly vulnerable include the speed of information processing and executive functioning.

Application of neuroimaging to brain effects of HIV and aging

Neuroimaging studies, including MRI, fMRI, MRS and DTI (Diffusion Tensor Imaging), have provided additional definitive evidence of enhanced vulnerability of the brain in HIV-infected individuals as they age (reviewed in (395)). The distinct advantages of applied neuroimaging are that individuals can be examined repeatedly under different conditions and compared in cross-sectional cohorts or in longitudinally-followed cohorts with complementary neuropsychological and biomarker testing.

Numerous neuroimaging studies of HIV+ individuals have demonstrated regional and global brain atrophy injury (grey and white matter), altered expression of cellular markers of neuronal integrity (N-acetyl aspartate) and glial activation (myoinositol), altered cerebral blood flow and physiological activation states, and microstructural white matter changes that can be attributed to HIV infection as well as aging. Furthermore, a recent CSF metabolomics analysis demonstrated

elevated levels of products of metabolic waste (phenylacetylglutamine, lactate, 3-hydroxybutyrate), glutamate, glial activation markers, and mitochondrial metabolites in HAND patients on ART, which suggests similar biochemical brain disturbances in both aging and HAND (396). Therefore, one can evaluate the natural history of HIV CNS infection, correlations between structural and functional brain disturbances and clinical performance, responses to therapy, and validity of biomarkers with neuroimaging techniques applied cross-sectionally and longitudinally in selected cohorts. Such studies can effectively complement neuropathological analyses to identify critical pathways of cellular injury and response that could potentially be targeted for therapeutics.

The effects of brain aging on functional physiological responses in HIV-infected brain have been recently explored with functional MRI (fMRI) techniques. Impairment of normal recruitment of brain regions for functional responses that can compensate for local brain dysfunction has been demonstrated in HIV infected individuals. Functional MRI was used in study of 122 individuals (59 seronegative, 29 HIV+/HAND, 37 HIV+/neurocognitive normal) to determine whether subject age affected brain activation during attention-requiring tasks independently from HIV infection (397). Strict HAND diagnostic criteria were used, and normalized NP data derived from a seronegative cohort of 342 individuals were adjusted for age and education. The study demonstrated that HAND patients demonstrate an age-dependent decline in functional brain activation in response to certain neuropsychological test demands, which indicates an inability to compensate for declining brain functioning. Another recent study of 52 HIV+ and 52 HIV- individuals using resting-state functional connectivity MRI showed that deficits in functional connectivity between different brain regions in HIV+ individuals resemble those affected in normal aging (398). These HIV and age effects were independent, which was interpreted as consistent with a premature brain aging effect of HIV.

These and other studies utilizing neuropsychological performance testing, neuroimaging, and neuropathological analyses strongly support a strong correlation between accelerated

neurocognitive decline driven by HIV infection in aging individuals, even those with what is considered 'effective' suppression of systemic HIV replication. These studies also further emphasize the need for developing new strategies, involving current ART and possibly adjunctive therapies, for protecting the brain against injury in the aging HIV+ population.

4.5 ART Neurotoxicity

Whether CNS-targeted therapy based upon putative level of CNS ART-penetrance (CNS Penetration-Effectiveness/CPE), antiviral activity, or even neurotoxicity of a particular drug class will prove effective in limiting HAND is unclear. Early studies of ART effects on neurocognitive test performance suggested that ART regimens containing drugs with relatively higher CPE could have increased benefit in protection against neurocognitive impairment (399, 400). Other studies have either no benefit to selected 'neuroactive' ART regimens or even neurotoxic effects. Two multi-center clinical trials (ACTG 5170, ACTG 736) have suggested possible neurotoxicity of ART, as reflected in improvement in neuropsychological test performance after ART interruption (ACTG 5170(401)) and poorer performance in patients on ART regimens with a higher CPE (ACTG 736) (402). A recent study showed that virologically suppressed patients (\geq one year on a stable regimen, undetectable viral loads) receiving protease-inhibitors (PIs) as 'boosted monotherapy' or as triple therapy with two nucleoside reverse transcriptase inhibitors showed similar patterns of neuropsychological test performance in 14 measures (403). These results were interpreted as evidence against the number of neuroactive drugs used in a regimen, rather than effective systemic viral load suppression, as an indicator or predictor of neuroprotection. Nonetheless, the issue of chronic ART neurotoxicity as a co-factor for exacerbating HAND remains as a critical and unsettled question in long-term management of HIV infection.

4.6 Conclusion

HIV associated neurocognitive disorders remain enigmatic despite intensive research aimed at understanding the factors and processes that contribute to their persistence in ART-treated individuals. Among the more significant discoveries in the last several years are the correlations between chronic, persistent inflammation and oxidative stress, systemic disease progression and HAND. These associations of inflammation, immune activation, and oxidative stress with disease progression in different body compartments suggests that shared immune-modulating and anti-oxidative processes should be therapeutically targeted to fully protect the individual from disease progression. Identifying such targets and testing currently available drugs, as well as continuing to develop new drugs, are worthy goals. However, full protection against neurocognitive decline in HIV+ ART-treated patients will also require effective targeting of the common co-morbid conditions that also affect such patients: co-infection with HCV, substance abuse, potential ART toxicity, and aging.

CHAPTER 5

HEME OXYGENASE-1 AND THE ENDOGENOUS ANTIOXIDANT RESPONSE

5.1 Introduction

The human genome encodes for a large number of inducible genes to protect against cellular and tissue injury. Many of these cytoprotective genes have a common promoter element, the antioxidant response element (ARE), which is regulated through the Keap1-Nrf2 pathway. Induction of the ARE induces the transcription and expression of a collation of more than 200 cytoprotective and detoxifying effector proteins (404). These Nrf2 target gene products are involved in numerous protective functions including metabolism, phase II detoxification, export of endo- and xenobiotics, glutathione biosynthesis (the principle endogenous small molecule antioxidant), peroxidation, heat shock protein responses, modulation of immune and inflammatory signaling, mitochondrial biogenesis, and tissue repair (reviewed in (405)).

One of the Nrf2/ARE driven genes is the highly inducible phase II detoxifying enzyme heme oxygenase-1 (protein HO-1; gene *HMOX1*). HO-1 is a sentinel cytoprotective enzyme that has emerged as a critical effector for limiting oxidative stress, inflammation, and cellular injury within the central nervous system (CNS) and other tissues in several disease states. The protective functions of HO-1 have been linked to its degradation of heme and the subsequent generation of carbon monoxide, biliverdin, and bilirubin, which have immunomodulatory and anti-oxidative properties (44). HO-1 is upregulated by multiple stimuli, including heme, oxidative stress (hydrogen peroxide, reactive oxygen species), nitric oxide, cytokines, endotoxin, heavy metals, ultraviolet radiation, shear stress, hyperoxia, and hypoxia (44). HO-1 is a type II transmembrane protein anchored to the endoplasmic reticulum (ER) by a hydrophobic C-terminus transmembrane domain with the enzymatically active portion facing the cytosol (406, 407). HO-1 can also be found anchored to the plasma membrane in caveolae as well as the mitochondrial inner membrane (408, 409), suggesting it may serve specific functions within particular cellular compartments. Additionally, upon certain cellular stressors HO-1 can be cleaved from its transmembrane domain and translocate to the nucleus, where it may have non-enzymatic

cytoprotective functions through activation of transcription factors (410, 411). A constitutively expressed heme oxygenase isoform, HO-2, catabolizes the same enzymatic reaction, although it is not regulated by the ARE, and, unlike HO-1, HO-2 is not considered to be a critical mediator of acute cellular injury responses. Likely due to these anti-inflammatory and cytoprotective roles of HO-1, numerous studies have demonstrated that inducing the HO-1 pathway and its products protects against a variety of conditions that are characterized by oxidative stress and inflammation (412-415). This identification of HO-1 as a drug target has led to fervent study of pharmacologic inducers of HO-1 for their potential as therapeutics (416-418).

5.2 Regulation of the Endogenous Antioxidant Response and HO-1

Keap1-Nrf2 pathway

All genes of the endogenous antioxidant response, including HO-1, have a common promoter element, the ARE, which is regulated by the Keap1-Nrf2 pathway. Keap1 (Kelch-like ECH associated protein 1) is a cysteine-rich protein that is the chemical sensor responsible for Nrf2 (nuclear factor erythroid 2-related factor 2) activation (405). Under baseline conditions, Keap1 forms a dimer and binds cytoplasmic actin and Nrf2 and targets Nrf2 for ubiquitination, thus both physically sequestering Nrf2 in the cytoplasm and targeting it for proteolytic degradation (405). These effects of Keap1 robustly prevent Nrf2 from entering the nucleus, binding the ARE, and driving transcription of target genes. In response to numerous cellular insults, particularly oxidative stress, Keap1 releases Nrf2, allowing Nrf2 to translocate to the nucleus, heterodimerize with other transcription factors including small Maf proteins, bind the ARE, and turn on the expression of target antioxidant response genes (405). Multiple mechanisms for the release of Nrf2 by Keap1 have been demonstrated; these include Keap1 conformational changes as a result Keap1 cysteine residues changing redox state in response to an oxidizing environment (419) and ubiquitination of Keap1 (420). Additionally there is strong evidence of Keap1-independent

mechanisms of Nrf2 activation, including the ability of Nrf2 to sense inducers directly (421), increased Nrf2 mRNA transcription (422), translational control through redox-sensitive internal ribosomal entry site in the 5'-UTR of Nrf2 mRNA (423), and phosphorylation of Nrf2 (424).

The multiple pathways for activation allow the Nrf2-driven ARE to respond to a broad range of cellular insults. There is strong evidence that different cell stressors and inducers of the Nrf2-dependent ARE utilize different combinations of these mechanisms described above to ultimately induce the transcription of antioxidant response genes. Endogenously the Nrf2/ARE pathway can be upregulated by oxidative stress (e.g. reactive oxygen species, electrophiles), shear stress, endoplasmic reticulum stress, infection, inflammation, mitochondrial dysfunction, etc. (405). Additionally, exogenous compounds from up to ten distinct chemical classes have been reported to induce the Nrf2/ARE (405), highlighting the potential for therapeutic targeting of the Nrf2/ARE pathway.

Transcriptional regulation of HO-1

In addition to Nrf2, several transcription factors bind the upstream promoter region and regulate expression of the HO-1 gene including hypoxia-inducible factor-1 (425), nuclear factor-kappa B (NF- κ B) (426), activator protein-1 (427), signal transducer and activator of transcription 3 (428, 429), and broad complex-tramtrack-bric-a-brac-domain (BTB) and cap'n'collar (CNC) homology 1 (BACH1) (430) (reviewed in (418)). The best studied of these regulatory transcription factors is BACH1, a potent transcriptional repressor of HO-1 in addition to some other, but not all, ARE genes (e.g. NQO1) (431). Under baseline conditions, BACH1 forms a heterodimer with small Maf proteins and can bind certain ARE promoter elements thus preventing Nrf2 binding and repressing transcription. In the presence of elevated intracellular heme levels or oxidative stress, BACH1 undergoes a conformation change and dissociates from the HO-1 promoter, allowing Nrf2 to bind and activate HO-1 gene expression (432, 433). Other pathways that have been implicated

in regulating HO-1 gene expression include p28 MAPK (434), phosphatidylinositol-3 kinase/Akt pathway (429, 435), and the IL-10 pathway (429, 436). The multiple identified transcription factors and signaling pathways that regulate HO-1 gene expression are one reason why HO-1 protein expression is induced in response to such a wide array of cellular insults (oxidative stress, heavy metals, ultraviolet light, inflammation, etc.) and other signals.

Micro-RNA regulation of HO-1

In addition to the multiple mechanisms of transcriptional control of HO-1, there is considerable research implicating an important role for microRNA (miR) regulation of HO-1 mRNA. MicroRNAs are small non-coding RNA molecules (~22 nucleotides) that post-transcriptionally silence specific mRNAs through base-pairing with complementary sequences in the 3' untranslated region. As a result of this complementary binding, mRNAs can be silenced through *i*) mRNA cleavage and degradation, *ii*) mRNA destabilization through shortening the poly(A) tail, and *iii*) less efficient translation (reviewed in (437)). Multiple miRs have been identified that downregulate HO-1 expression. These HO-1-downregulating miRs include those that target HO-1 mRNA directly (e.g. miR-155 (438, 439), miR-24-3p (440), miR-377 (441), miR-217 (441), miR-122 (442), miR-16-5p (443)) and those that target other genes involved in promoting HO-1 expression (e.g. miR-34a (444)). Additionally multiple miRs have been implicated in increasing HO-1 through targeting genes involved in repressing HO-1, such as BACH1 (miR196 (445), let7 (446), and miR-155 (447)). Thus, the multifaceted transcriptional regulation of HO-1 mRNA is further nuanced through microRNA mediated regulation directly of HO-1 mRNA and indirectly through associated genes.

Posttranslational regulation of HO-1

A few studies have also examined the posttranslational regulation of HO-1. HO-1 has been shown to be ubiquitinated and subsequently degraded in a proteasome-dependent manner

through the ER-associated degradation pathway (448). The E3-ubiquitin ligase, TRC8, has been demonstrated to target HO-1 for ubiquitination and subsequent degradation (449). Whether HO-1 is regulated significantly through changes in rate of degradation is currently unknown. In addition to changes in HO-1 protein levels, HO-1 activity reportedly can be regulated through post-translational phosphorylation. Specifically, HO-1 activity can be increased, albeit modestly, through phosphorylation at serine 188 by Akt/PKB (450). In summary, HO-1 expression and activity is tightly regulated through multiple mechanisms, which is likely responsible for HO-1's ability to be upregulated by a wide array of cellular signals and insults.

5.3 HO-1 and Heme/Hemoglobin Scavenging

As a degrader of heme, the major source of iron in the body, HO-1 plays a key role in iron recycling and homeostasis. Heme is a major component of a group of intracellular hemoproteins that include cytochromes, oxidase (e.g. NADPH oxidase), peroxidases, catalases, and synthases (e.g. nitric oxide synthase). HO-1 (and HO-2) degrades and thereby recycles free intracellular heme that is released when these hemoproteins are degraded. Additionally, heme has a significant and important role in binding and transporting oxygen from the respiratory organs to the rest of the body for aerobic respiration. Hemoglobin is the heme-containing oxygen-transport metalloprotein found abundantly in red blood cells. Intravascular hemolysis as a result of injury, disease (e.g. infections, autoimmune disorders, etc.), or toxins/drugs results in elevated plasma hemoglobin. Due to its heme moieties, free hemoglobin (or free heme itself) has damaging oxidative effects on tissues, relating in particular to the formation of oxygen radicals and the scavenging of nitric oxide (451).

To combat the potential hemoglobin toxicity during hemolysis, a potent hemoglobin scavenging system detoxifies and removes extracellular hemoglobin. The hemoglobin-binding protein haptoglobin is the first line of defense against hemoglobin toxicity. Haptoglobin, which is secreted

by hepatocytes, monocytes/macrophages, and other cell types (452), binds hemoglobin in an almost irreversible interaction and stabilizes the oxidative intermediate, thus preventing subsequent oxygen radical formation (453). This binding of haptoglobin to hemoglobin promotes CD163-mediated uptake of hemoglobin by cells of the macrophage/monocyte cell lineage (e.g. Kupffer cells, red pulp macrophages, alveolar macrophages, etc.) and the subsequent proteolytic degradation of hemoglobin and catabolism of the toxic heme moiety via the HO-1 (and HO-2) pathway (453). The presence of increased intracellular heme as a result of this CD163-mediated uptake of hemoglobin results in a potent and swift upregulation of HO-1 expression in order to rapidly detoxify the free heme. An additional back-up system exists to scavenge free extracellular heme that has disassociated from hemoglobin. The receptor CD91, which is abundant on macrophages and hepatocytes, can uptake heme when it is bound to the heme-scavenging protein hemopexin, where heme is again degraded through the heme oxygenase pathway (453). Thus, HO-1 plays a central and conserved role in protecting tissues from hemoglobin/heme oxidative damage as a result of intravascular hemolysis.

5.4 HO-1 as an Anti-Inflammatory and Anti-Oxidative Enzyme

Anti-oxidative and cytoprotective functions of HO-1

Despite HO-1's conserved and central role in detoxifying heme, numerous other cytoprotective roles for HO-1, have been described. HO-1 has been shown to be important in limiting cellular and tissue injury in response to non-heme oxidative stress. Adult HO-1 deficient mice have been shown to have elevated markers of oxidative stress, including oxidized proteins and lipid peroxidation (454, 455) and HO-1^{-/-} embryonic fibroblasts derived from these mice demonstrated elevated levels of reactive oxygen species (456). Multiple primary cell lineages (e.g. fibroblasts, vascular smooth muscle, astrocytes) derived from HO-1-deficient mice are more susceptible to oxidant-induced cell injury and death (456-458). Moreover, induction of HO-1 in vitro has been

demonstrated repeatedly to protect numerous cell types from oxidative stress (459-462), including cells of the CNS such as astrocytes (463, 464) and neurons (465, 466). These data identify HO-1 as a critical component of the cellular response to oxidative stress that protects against subsequent cellular and tissue injury.

Anti-inflammatory functions of HO-1

In addition to its role in limiting oxidative stress, HO-1 has been identified as a critical mediator of immune activation and inflammation. HO-1 deficient mice show signs of a progressive chronic inflammatory disease, as demonstrated by high peripheral white blood cell count, enlarged spleens and lymph nodes (extramedullary hematopoiesis and follicular hyperplasia), high CD4+:CD8+ T-lymphocyte ratios, elevated activated CD4+ T-lymphocytes, increased monocyte adhesion to vessel walls, increased baseline serum IgM, inflammatory cell tissue infiltrates (particularly in the liver), and elevated splenocyte secretion of pro-inflammatory cytokines in response to endotoxin or anti-CD3/anti-CD28 stimulation (455, 467). Consistent with this anti-inflammatory role of HO-1, the first identified human patient with HO-1 deficiency demonstrated enhanced systemic inflammatory reactions in addition to asplenia, intravascular hemolysis, and systemic vascular endothelial disturbance, among other symptoms (468, 469).

The anti-inflammatory and immunomodulatory functions of HO-1 have been shown to be particularly important within cells of the myeloid lineage (monocytes, macrophages, and dendritic cells). Induction of HO-1 has been shown to limit the expression of various pro-inflammatory factors including IL-6, TNF α , inducible nitric oxide synthase (iNOS), and cyclooxygenase-2 (COX-2) in macrophages and alter surface antigen expression in monocytes with reduction in human leukocyte antigen-DR, CD36, and CD11B (467, 470). Moreover, mice with genetic HO-1 deficiency restricted to cell of the myeloid lineage exhibited altered innate immune function in response to infections and experimental autoimmune encephalitis, potentially as a result of a

defect in the interferon- β signaling pathway (471). Additionally, human HO-1 deficiency has been associated with a disturbance in macrophage phagocytic function (468, 469). Further highlighting the importance of macrophage HO-1, transplant of wild-type macrophages into HO-1-deficient mice reversed many systemic disease parameters (anemia, blood chemistries, iron metabolism, renal damage) (472). HO-1 also regulates the maturation and proper functioning of dendritic cells (473). HO-1 has also been shown to have immunomodulatory effects on other cell lineages of the immune system, including T-lymphocytes. For example, HO-1 has been demonstrated to play an integral role in modulating T lymphocyte-mediated immunity (474), particularly with respect to the suppressive capacity of regulatory T cells (475). These data highlight the central role of HO-1 in downregulating and modulating inflammatory responses, particularly within the myeloid lineage.

Potential mechanism for anti-inflammatory and anti-oxidative effects of HO-1

The mechanisms by which HO-1 mediates its anti-inflammatory and anti-oxidative effects are not completely understood. However, these immunomodulatory and protective functions of HO-1 have been linked to both its degradation of free heme and the subsequent generation of the anti-inflammatory compounds carbon monoxide (CO), biliverdin, and bilirubin (44). Numerous cytoprotective and anti-inflammatory effects of HO-1 can be mimicked when CO or bilirubin are exogenously applied (454, 470, 476-478). HO-1 induction or inhaled CO have been shown to protect against lung ischemia/reperfusion injury, interstitial lung disease (fibrosis), acute lung injury, and pulmonary hypertension (479). Similarly, HO-1 induction or exogenous treatment with bilirubin can reduce i) superoxide production in vascular smooth muscle cells, ii) decrease reactive oxygen species in embryonic cells, iii) and lessen activation and dysfunction of vascular endothelial cells in response to proinflammatory stresses (457, 480, 481). One reported mechanism by which HO-1, perhaps through signaling by its enzymatic products, may downregulate inflammatory responses is by inhibiting the NF- κ B pathway. While HO-1 does not inhibit NF- κ B translocation to the nucleus or DNA binding, HO-1 reportedly inhibits the activating

phosphorylation of Ser276 on p65/RelA. Additionally, there is evidence that HO-1 may be cleaved from its transmembrane domain and translocate to the nucleus where it can alter transcription of other protective cellular genes (410). Thus, the cytoprotective effects of HO-1 in many model systems may be a result of protective effects and signaling through cleaved HO-1 and HO-1's enzymatic products CO, biliverdin, and bilirubin.

5.5 HO-1 in Diseases of Inflammation and Oxidative stress

HO-1 polymorphisms

Polymorphisms that exist at the human HO-1 locus have been associated with altered incidence and/or progression of various diseases (reviewed in (45)). There are currently three described polymorphism in the 5' flanking region of the HO-1 gene: two single nucleotide polymorphisms (SNP), G(-1135)A and T(-413)A, and a (GT)_n dinucleotide repeat polymorphism (482-484). The best characterized of these polymorphisms is the HO-1 promoter region (GT)_n dinucleotide repeat polymorphism. The length of the GT repeat varies from 12 to 40 repeats with a bimodal distribution with the most common alleles having 23 and 30 repeats in multiple populations studied (482, 483, 485-487). Using luciferase promoter constructs in cell lines, the length of the (GT)_n repeat has been demonstrated to modulate HO-1 transcription (485, 486). Specifically, shorter HO-1 promoter region (GT)_n repeat lengths increased HO-1 basal promoter activity and increased HO-1 induction in response to various stimuli. Additional studies have confirmed these findings using primary cells and lymphoblastoid cell lines established from subjects with known GT repeat lengths (488, 489). Furthermore, cells with short repeats are more resistant to oxidative stress induced apoptosis (488). Given the anti-inflammatory and cytoprotective functions of HO-1, a multitude of clinical studies have examined the HO-1 promoter region (GT)_n dinucleotide repeat polymorphism in patients with various diseases and medical conditions. Longer (GT)_n repeats, associated with lower HO-1 expression, have been associated with worse

Diseases with worse clinical outcome associated with longer HO-1 promoter region (GT)n repeats	Sample Size	Reference
<i>Pulmonary disease</i>		
Emphysema in smokers	201	(485)
Acute Chest Syndrome in Sickle Cell Disease	942	(502)
Lung function in smokers	749	(503)
<i>Cardiovascular disease</i>		
Coronary artery disease	577; 796; 259; 328; 2,298; 472	(504); (486); (483); (505); (506); (507)
Abdominal aortic aneurysms	271	(508)
Inflammation after balloon angioplasty	317	(509)
Restenosis after stenting or angioplasty	323; 381	(510);(511)
<i>Transplant disease</i>		
Kidney allograft function	101; 384	(487); (512)
<i>Obstetrics</i>		
Idiopathic recurrent miscarriage	291	(513)
<i>Gastrointestinal disease</i>		
Necrotizing acute pancreatitis	239	(514)
<i>Infectious disease</i>		
Sepsis	136	(515)
Pneumonia	200	(516)
<i>Neurological disease</i>		
Ischemic stroke	347	(517)
Cerebral aneurysm	69	(518)
<i>Immune disease</i>		
Rheumatoid arthritis	325; 1582	(519); (520)

Table 5.1 Studies that identified longer HO-1 promoter region (GT)n microsatellite polymorphisms as a risk factor for worse clinical outcomes in various disease states.

clinical disease in multiple disease states, many of which have inflammation and oxidative stress as a core component of the underlying pathology (see Table 5.1). The association of HO-1 promoter polymorphisms with the progression of these clinical diseases further highlights the broad role of HO-1 in modulating inflammation and oxidative stress across a variety of pathological conditions.

HO-1 and modulating disease outcomes

Using genetic approaches, several studies have demonstrated the ability of HO-1 to alter the pathologic outcome in experimental mouse models of disease. HO-1 knockout mice demonstrate exacerbation of disease in multiple animal models, including myocardial infarction and ischemia-reperfusion injury (490, 491), severe sepsis and endotoxin shock (456, 492, 493), autoimmune neuroinflammation (494), atherosclerosis (495), steatohepatitis (496), and mycobacterium infection (497). In support of the protective role of HO-1 in some of these diseases, BACH1 knockout mice (which have high levels of HO-1 expression) have reduced disease pathology in models of atherosclerosis (498), steatohepatitis (499), secondary injury after spinal cord injury (500), and colitis (501). These complimentary mouse genetic studies, similar to the clinical HO-1 promoter polymorphism studies in human disease populations, underscore the broad role of HO-1 in modulating pathological conditions, particularly those with inflammatory and oxidative stress pathology.

5.6 Conclusion

HO-1 is a critical member of a coalition of effector proteins of the Nrf2-driven antioxidant response. In addition to regulation by the ARE, HO-1 expression and activity is further modulated at the transcription level by multiple other transcription factors, at the mRNA level by various microRNAs, and at the post-translational level through phosphorylation and proteasome-

mediated degradation. Beyond its conserved role in the degradation of the pro-oxidant heme, HO-1 serves a vital and seemingly ubiquitous role in limiting oxidative stress, inflammation, and cellular injury within the CNS and other tissues. At least some of these protective effects of HO-1 can be linked to the enzyme's generation of the anti-inflammatory and anti-oxidative products, CO and bilirubin. Inducing and inhibiting HO-1 in animal disease models and studying HO-1 promoter polymorphisms in human disease cohorts have identified HO-1 as a modulator of disease progression and severity in multiple inflammatory and pro-oxidative disease states. The consistent ability of HO-1 induction to limit inflammation and oxidative stress in various disease models has spurred much study of potentially therapeutic HO-1 inducers and their ability to limit inflammation, oxidative stress, and disease pathology across multiple disciplines (416, 417, 521). Given these well-described protective functions of HO-1, the studies within this thesis explore the role for and the potential therapeutic targeting of HO-1 in HIV neuropathogenesis.

CHAPTER 6

MATERIALS AND METHODS

6.1 Material and Methods for Chapter 7

Study design and setting

We performed a retrospective cross-sectional study using data and biological samples (plasma, CSF) from 48 HIV-infected adults enrolled in the CNS HIV Anti-Retroviral Therapy Effects Research (CHARTER) cohort of the NIMH/NINDS/NIH. Characteristics of the CHARTER cohort are described elsewhere (10). CHARTER is an ongoing, observational cohort study of HIV-infected persons enrolled between 2003-2007 from six United States university-affiliated HIV treatment centers. Enrolling 1561 HIV+ subjects at baseline, the study was designed to assess the frequency and severity of HAND, and the specific contributions of HIV versus HIV-associated comorbidities to neurocognitive impairment. Inclusion criteria for the CHARTER study were broad, but individuals with severe comorbid psychiatric, medical, or neurological disorders deemed likely to adversely affect cognitive functioning were excluded, as were HIV-negative subjects. Our study used data and samples from 48 CHARTER subjects (15 each from ANI, and MND sub-groups, 3 HAD subjects, and 15 neurocognitively normal HIV-infected subjects). The cohort included men and women aged 18-65 years who were ART naïve or currently off of ART, and who underwent successful lumbar puncture, venipuncture, and neuropsychological testing. See Table 6.1 for cohort demographics. Subjects with a history of CNS opportunistic infection, trauma, epilepsy, MS, known causes of mental retardation, dementia, or active psychotic illness were excluded.

Data collection

Original data collection for the CHARTER cohort was approved by the Human Subjects Protection Committees of each participating institution. All subjects provided written consent to participate in the CHARTER study. Data were originally obtained through comprehensive

neuromedical, neurocognitive, psychiatric, and functional evaluations, and collection of blood and urine samples. Collection of CSF was through lumbar puncture (10). The de-identified data and biological samples for this substudy were obtained with permission of the CHARTER steering committee. Because the dataset and samples were de-identified and because our substudy did not involve patient contact, The Children's Hospital of Philadelphia institutional review board determined (November 21, 2012) that this study did not qualify as human subjects research.

Laboratory assessments

HIV infection was diagnosed by ELISA with Western blot confirmation. Clinical laboratory assessments, including complete blood counts, chemistry panels, rapid plasma regain (RPR), hepatitis C virus (HCV) antibody, and flow cytometry for CD4+ T-lymphocyte count) were performed at each CHARTER site's Clinical Laboratory Improvement Amendments (CLIA)-certified, or CLIA equivalent, medical center laboratory. Plasma HIV loads (viral loads) were quantified by real-time PCR ultrasensitive assay (nominal lower quantitation limit 50 copies per mL; Amplicor®, Roche Diagnostic Systems, Indianapolis, IN) in a central lab. (10).

Biomarkers were measured in triplicate by validated, commercially available 96-well plate ELISAs on stored, frozen samples (-80C). Paired CSF/plasma samples were assayed for NFL (Uman Diagnostics AB, limit of detection 31 ng/mL) and pNFH (Biovendor catalog number RD 191138300R, limit of detection 23.5 pg/mL); NFL and pNFH were detected only in CSF samples. sCD14 and sCD163 were assayed in paired CSF/plasma samples (R&D Systems, catalog number DC140, limit of detection 125 pg/mL sCD14 and Trillium Diagnostics, IQP-383, , limit of detection 0.23 ng/mL sCD163).

Characteristic	All, n=48	NCN, n=15	ANI, n=15	MND, n=15	HAD, n=3	p^b
Male sex	36 (75)	12 (80)	9 (60)	12 (80)	3 (100)	0.362
Black race	25 (53)	8 (57)	7 (47)	9 (60)	1 (33)	0.777
Age (years)	39.5 (36-47.5)	44 (36-49)	38 (31-40)	40 (25-48)	47 (38-50)	0.392
Duration of HIV (months)	98 (29-157)	131 (81-186)	99 (11-122)	98 (23-162)	34 (2-234)	0.616
Education (years)	12 (11-13)	13 (12-15)	11 (10-12)	12 (9-14)	12 (12-14)	0.102
HCV Positive	14 (31)	5 (33)	6 (40)	3 (20)	0 (0)	0.420
RPR Positive	5 (10)	1 (7)	1 (7)	3 (21)	0 (0)	0.538
CD4 nadir \leq 200	14 (29)	5 (33)	3 (20)	4 (27)	2 (67)	0.420
Plasma CD4 <50	5 (10)	1 (7)	1 (7)	1 (7)	2 (67)	0.046
50-199	5 (10)	1 (7)	2 (13)	2 (13)	0 (0)	-
200-349	7 (15)	0 (0)	3 (20)	3 (20)	1 (33)	-
\geq 350	31 (65)	13 (87)	9 (60)	9 (60)	0 (0)	-
Plasma HIV-1 RNA (log ₁₀ copies/mL)	4.34 (3.66-4.87)	3.83 (3.15-4.06)	4.68 (3.97-5.04)	4.54 (3.93-5.08)	5.53 (3.12-6.16)	0.038
CSF HIV-1 RNA (log ₁₀ copies/mL)	2.45 (1.70-3.20)	1.83 (1.70-3.20)	2.84 (1.70-3.20)	2.86 (2.01-3.41)	1.70 (1.70-2.35)	0.330

Table 6.1 Demographic and clinical characteristics of HIV autopsy cohort for study entitled "Central and Peripheral Markers of Neurodegeneration and Monocyte Activation in HAND" (Chapter 7).

^a Categorical variables are described using n (%). Continuous variables are described using median (IQR).

^b p values to compare characteristics among different subgroups of HAND were calculated using chi-square tests for categorical variables and Kruskal-Wallis tests for continuous variables.

Neurocognitive assessments

All CHARTER study subjects completed a comprehensive neuropsychological test battery assessing seven cognitive domains commonly affected in HIV infection (verbal fluency, executive functioning, speed of information processing, learning, recall, working memory, and motor skills). Raw test scores were converted to demographically adjusted T-scores using the best available normative data accounting for age, sex, ethnicity, and education. Functional impairment was assessed using the Patient's Assessment of Own Functioning Inventory (PAOFI) and an instrumental activities of daily living (IADL) questionnaire. (10). A global performance score was determined as previously described (522, 523). HAND status was classified according to Frascati criteria (180).

Data analysis and statistical methods

Data were analyzed using Stata version 12.1 (StataCorp, College Station, Texas, 2011). Continuous variables were described using median and interquartile range (IQR), and intergroup differences were evaluated using Kruskal-Wallis tests and Wilcoxon rank-sum tests. Categorical variables were described using counts and percents, and intergroup differences were compared using the Chi-square test. Spearman's correlation coefficients were used for correlations between biomarkers. Statistical significance was determined a priori as a two-tailed P-value < 0.05.

6.2 Material and Methods for Chapter 8

Subjects in DLDFC cohort

A cohort of 90 HIV-positive (HIV⁺) and 66 HIV-negative (HIV⁻) subjects was selected from the National NeuroAIDS Tissue Consortium (NNTC) (524) autopsy cohort for analysis of protein

expression within DLPFC tissue. This cohort was assembled by the Texas NeuroAIDS Research Center and has been described in a prior report (525). The 90 HIV⁺ cases included subjects who had pathologically confirmed encephalitis (HIVE⁺; n=14) and subjects who did not have HIVE (HIV⁺/HIVE⁻; n=76). Among the 76 HIV⁺/HIVE⁻ individuals were 37 confirmed cases of HAND, 6 cases confirmed as neurocognitively normal, and 33 cases with either no associated neurocognitive diagnosis or neurocognitive dysfunction in which factors other than HIV infection were not ruled out. Among the 14 HIVE⁺ cases, 9 were confirmed to have HAND (the other 5 had either no associated neurocognitive diagnosis or neurocognitive dysfunction in which factors other than HIV infection were not ruled out). Following administration of the neurocognitive test battery implemented by the NNTC (523), the neurocognitive diagnosis of HAND was assigned by the supervising neuropsychologist according to the Frascati Criteria (180) as reviewed by an experienced neurologist. NNTC site neuropathologists rendered nosological diagnoses of HIVE as guided by the criteria of Budka et al (526). Sixty-three percent of HIV⁺ subjects were ART-experienced. HIV⁻ subjects were significantly older than HIV⁺ subjects on average by 6.6 years, but did not significantly differ from HIV⁺ subjects in gender, ethnicity, race, or post-mortem interval. See Table 6.2 for summarized demographic and clinical data. Further details on the demographic and clinical data of this cohort were described previously (525).

Neurocognitive testing

The neurocognitive test battery implemented by the NNTC (Table 6.3 (523)) was used to evaluate 7 domains of cognitive functioning and to assign a diagnosis of HAND. Most HIV⁺ subjects (78%) underwent neurocognitive testing at 6-month intervals prior to death. Neurocognitive domain test results were assigned a T-score normalized for age, gender, ethnicity, and education-adjusted norms. A composite (Global) T-score for overall performance across all domains was calculated for subjects who completed at least 10 of 14 tests.

Characteristic	HIV-	HIV+ (no HIVE)	HIV+ HIVE	p-value
Number of subjects	66	76	14	-
Age at death	50.6 ± 16.6	44.4 ± 9.1	41.6 ± 7.1	0.005 ^a
Hours postmortem	14.8 ± 11.2	13.1 ± 14.1	19.7 ± 20.7	0.143 ^a
Male n (%)	49 (74%)	59 (78%)	14 (100%)	0.104 ^b
Race				
White	43 (65%)	48 (63%)	12 (86%)	0.143 ^b
Black	16 (24%)	22 (29%)	1 (7%)	
Other/Unknown	7 (10%)	6 (8%)	1 (7%)	
Hispanic	19 (29%)	12 (17%)	2 (14%)	0.195 ^b
Disease parameters				
Log ₁₀ plasma HIV RNA copies/mL	-	4.3 ± 1.4	5.2 ± 0.9	0.450 ^c
Log ₁₀ CSF HIV RNA copies/ml	-	3.8 ± 0.8	5.9 ± 1.4	<0.001 ^c
Log ₁₀ Brain HIV RNA copies/gram	-	2.8 ± 1.1	5.3 ± 1.5	< 0.001 ^c
CD4+ lymphocytes/mm ³	-	116 ± 169	49 ± 49	0.158 ^c
Neurocognitive impairment				
HAND	-	37 (49%)	9 (64%)	0.591 ^b
Neuropsych impairment other origin	-	22 (29%)	3 (21%)	
Neurocognitive normal	-	6 (8%)	0 (0%)	
No neurocognitive data	-	11 (14%)	2 (14%)	
ART treatment status				
ART-experienced	-	49 (65%)	8 (57%)	0.079 ^b
ART-naive	-	10 (13%)	5 (36%)	
Unknown ART	-	17 (22%)	1 (7%)	

Table 6.2 Demographic, clinical, and antiretroviral therapy data for DLPFC cohort for studies entitled Brain Heme Oxygenase-1 Deficiency Accompanies Neuropathogenesis of HIV-Associated Neurocognitive Disorders” (Chapter 8) and “HO-1 (GT)n Promoter Polymorphism Associates with HIV-Encephalitis” (Chapter 9). Categorical variables are described using n (%). Continuous variables are described using mean ± standard deviation. Abbreviations used: HIV encephalitis (HIVE), HIV-associated neurocognitive disorders (HAND), antiretroviral therapy (ART). Sample sizes of subgroups may be smaller than the overall group sample size due to the availability of demographic and clinical data.

^aAnalysis of variance p-value

^bChi-square test p value

^cStudent’s t-test p-value.

Domain	Primary Neuropsychological Test
Executive	Trail Making Test (TMT), Part B
	Wisconsin Card Sorting Test - 64 Card Version (WCST-64), Perseverative Responses
Speed of Information Processing	Trail Making Test (TMT), Part A
	Wechsler Adult Intelligence Scale - Third Edition (WAIS-III), Digit Symbol
	Wechsler Adult Intelligence Scale - Third Edition (WAIS-III), Symbol Search
Attention & Working Memory	Paced Auditory Serial Addition Test - 50 item version (PASAT-50)
	Wechsler Adult Intelligence Scale - Third Edition (WAIS-III), Letter-Number Sequencing
Learning	Brief Visuospatial Memory Test - Revised (BVM-T-R), total (trials 1-3)
	Hopkins Verbal Learning Test - Revised (HVMT-R), total (trials 1-3)
Memory	Brief Visuospatial Memory Test - Revised (BVM-T-R), Delayed Recall
	Hopkins Verbal Learning Test - Revised (HVMT-R), Delayed Recall
Verbal Fluency	Controlled Oral Word Association Test (COWAT-FAS)
Motor	Grooved Pegboard (most impaired hand)

Table 6.3 Primary neurocognitive test scores used to establish domain clinical T-scores. A Global T-score for overall performance across all domains was calculated for subjects who completed at least of 10 of 14 tests. See (523) for more details.

Subjects in regional analysis cohort

A cohort of 12 HIV-negative (HIV⁻), 12 HIV-positive with a diagnosis of HAND (HIV⁺/HAND), and 10 HIV-positive with HIVE (HIVE⁺) subjects was selected from the NNTC (524) for a regional brain analysis of protein expression within the striatum (head of caudate), occipital cortex, and cerebellum (anterior cerebellar cortex). This cohort was matched for age, post mortem interval, sex, race, and ethnicity (Table 6.4). Of the 34 cases in this regional analysis cohort, 16 were represented in the larger DLPFC cohort.

Brain dissection and extraction of protein and RNA

DLPFC was dissected from Brodmann areas 9 or 10. For protein extraction, fresh-frozen brain (30-500 mg) was homogenized by silica bead beating, sonicated, and solubilized (0.03% TX-100, 0.5 mM DTT, 5 mM MgCl₂, Tris 10 mM, pH 7.8). RNA was prepared using the RNeasy Lipid Tissue Mini Kit (Qiagen) as previously described (525, 527). Briefly, 100 mg of brain tissue from an adjacent region of protein extraction was dissected on dry ice and homogenized in a minibead beater. RNA was extracted with chloroform and centrifuged in RNeasy mini spin columns, washed, and eluted.

Quantification of viral loads and CD4 count

In the majority of cases, blood and CSF samples were obtained within 6 months of subject death and on the same day that neurocognitive domains were assessed. Plasma and CSF viral loads were determined with the Amplicor HIV-1 Monitor test v1.1 through v1.5 (Roche). Brain parenchyma HIV RNA was quantified from brain extracted RNA as previously described (525, 527). Briefly, 1µg microgram of brain RNA and 1µM of antisense primer 84R were used in 20µl reaction (iScript cDNA Synthesis Kit, Bio-Rad Laboratories). Four microliters of cDNA was used

Characteristic	HIV-	HIV+/HAND (no HIVE)	HIV+ HIVE	p-value
Number of subjects	12	12	10	-
Age at death	43.0 ± 4.5	41.9 ± 7.6	40.0 ± 5.7	0.518 ^a
Hours postmortem	24.4 ± 7.2	22.2 ± 17.7	26.2 ± 24.9	0.869 ^a
Male n (%)	9 (75%)	10 (83%)	9 (90%)	0.652 ^b
Race				
White	9 (75%)	9 (75%)	8 (80%)	
Black	2 (17%)	1 (8%)	1 (10%)	0.938 ^b
Other/Unknown	1 (8%)	2 (17%)	1 (10%)	
Hispanic	3 (25%)	1 (8%)	1 (10%)	0.454 ^b
Disease parameters				
Log ₁₀ plasma HIV RNA copies/mL	-	4.5 ± 1.5	5.2 ± 0.9	0.213 ^c
Log ₁₀ CSF HIV RNA copies/ml	-	2.8 ± 1.4	5.5 ± 1.4	<0.001 ^c
CD4+ lymphocytes/mm ³	-	50 ± 106	46 ± 30	0.158 ^c
Neurocognitive impairment				
HAND	-	12 (100%)	6 (60%)	
Neuropsych impairment other origin	-	0 (0%)	3 (30%)	0.052 ^b
No neurocognitive data	-	0 (0%)	1 (10%)	

Table 6.4 Demographic, clinical, and antiretroviral therapy data for brain regional analysis cohort for studies entitled “Brain Heme Oxygenase-1 Deficiency Accompanies Neuropathogenesis of HIV-Associated Neurocognitive Disorders” (Chapter 8). Categorical variables are described using n (%). Continuous variables are described using mean ± standard deviation. Abbreviations used: HIV encephalitis (HIVE), HIV-associated neurocognitive disorders (HAND), antiretroviral therapy (ART). Sample sizes of subgroups may be smaller than the overall group sample size due to the availability of demographic and clinical data.

^aAnalysis of variance p-value

^bChi-square test p value

^cStudent’s t-test p-value.

for 25 μ l quantitative real-time PCR (qPCR) by using JumpStart Taq ReadyMix for Quantitative PCR (Sigma) and SmartCycler (Cepheid). Results were standardized against a known brain secondary standard. CD4+ T-lymphocyte counts were determined by flow cytometry and performed at each NNTC site's Clinical Laboratory Improvement Amendments (CLIA)-certified, or CLIA equivalent, medical center laboratory.

Quantification of brain mRNAs

Expression of brain mRNAs was quantified after cDNA synthesis from mRNA samples using Taq-Man Universal PCR Master Mix (Applied Biosystems) by qPCR as previously described (527). Duplicate qPCR reactions were run and relative mRNA expression was calculated using the $\Delta\Delta C_t$ method (compared to GAPDH mRNA expression) using the primer and probe mixes listed in Table 6.5.

Western blot analysis

Cell cultures were rinsed with ice-cold PBS, lysed in 75mM Tris-HCL (pH 6.8) containing 15% glycerol, 3.75mM EDTA, and 3% SDS, and supplemented with Complete Protease Inhibitor Cocktail (Roche) and PhosSTOP phosphatase inhibitor mixture (Roche). Cell and DLPFC protein lysates were subjected to SDS-PAGE as previously described (46) using primary and secondary antibodies listed in Tables 6.6 and 6.7. For all autopsy cases, protein expression as determined by Western blotting was normalized to both β -tubulin and GAPDH expression.

Human Gene	Company	Primer and Probe Set Catalog #
CD163	Applied Biosystems	Hs01016661_m1
CD68	Applied Biosystems	Hs00154355_m1
CD8A	Applied Biosystems	Hs01555600_m1
GAPDH	Applied Biosystems	Hs99999905_m1
IRF1	Applied Biosystems	Hs00971959_m1
ISG15	Applied Biosystems	Hs00192713_m1
MX1	Applied Biosystems	Hs00182073_m1

Table 6.5 Quantitative real-time PCR primer and probe sets.

Protein Target	Host Species	Mono- or Polyclonal	Provider	Catalog #	Antibody Concentration	Band Size
β -tubulin	rabbit	monoclonal	Cell Signaling	2128	0.014 μ g/ml	55 kDa
FTH1	rabbit	polyclonal	Cell Signaling	3998	0.071 μ g/ml	21 kDa
GAPDH	mouse	monoclonal	Advanced Immunochemical	Mab 6C5	0.260 μ g/ml	35 kDa
GPX1	rabbit	monoclonal	Cell Signaling	3286	0.110 μ g/ml	21 kDa
GSTP1	mouse	monoclonal	Cell Signaling	3369	0.400 μ g/ml	23 kDa
HO-1*	rabbit	polyclonal	Enzo Life Sciences	SPA-895	2.0-4.0 μ g/ml	29 kDa
HO-1 [#]	rabbit	polyclonal	Enzo Life Sciences	SPA-896	2.0-4.0 μ g/ml	29 kDa
HO-2	rabbit	polyclonal	Enzo Life Sciences	SPA-897	2.0-4.0 μ g/ml	35 kDa
NQO1	mouse	monoclonal	Abcam	ab28947	1.0 μ g/ml	28 kDa
PRDX1	rabbit	polyclonal	Cell Signaling	8732	0.097 μ g/ml	21 kDa
SOD1	mouse	monoclonal	Cell Signaling	4266	0.250 μ g/ml	18 kDa
TRXR1	rabbit	polyclonal	Cell Signaling	6925	0.025 μ g/ml	55 kDa

Table 6.6 Primary antibodies for Western blotting.

*Antibody used for Western blot detection of HO-1 in human brain tissue.

[#]Antibody used for Western blot detection of HO-1 in all in vitro studies using primary cells.

Secondary Antibody	Host Species	Provider	Catalog #	Antibody Concentration
IRDye 680RD Goat Anti-Mouse IgG	goat	Licor	926-68070	0.050 µg/ml
IRDye 680RD Goat Anti-Rabbit IgG	goat	Licor	926-68071	0.050 µg/ml
IRDye 800RD Goat Anti-Mouse IgG	goat	Licor	926-32210	0.067 µg/ml
IRDye 800RD Goat Anti-Rabbit IgG	goat	Licor	926-32211	0.067 µg/ml
HRP-conjugated AffiniPure Goat Anti-Mouse IgG (H+L)	goat	Jackson Immunoresearch	115-035-003	0.160 µg/ml
HRP-conjugated AffiniPure Goat Anti-Rabbit IgG (H+L)	goat	Jackson Immunoresearch	111-035-003	0.160 µg/ml
HRP-conjugated Goat Anti-Rabbit IgG (H+L)	goat	Cell Signaling	7074	0.071 µg/ml
HRP-conjugated Goat Anti-Mouse IgG (H+L)	horse	Cell Signaling	7076	0.071 µg/ml

Table 6.7 Secondary antibodies for Western blotting. Signal intensity was analyzed using ImageJ for HRP-conjugated secondary antibodies and Image Studio (LiCor) for fluorescent secondary antibodies.

Statistics

All quantifications are expressed as mean \pm SEM. One-way ANOVA followed by a Holm-Sidak post-test were performed on indicated comparisons. Analyses of linear trends were performed by multivariate linear regression analysis where b is the slope of the line of association and p is the p -value versus the null hypothesis ($b = 0$). $\alpha = 0.05$ unless otherwise noted in order to correct for multiple comparisons. Statistical input support was provided by the Biostatics and Data Management Core, Center for AIDS Research, Perelman School of Medicine, University of Pennsylvania.

Study approval

All animal studies and protocols were carried out in accordance with the NIH Guidelines for the Care and Use of Laboratory Animals and approved by the University of Pennsylvania IACUC. All NNTC studies were conducted in accordance with human subject protection protocols at participating institutions. Written consent was obtained for subjects at four collection sites in the USA. The following offices maintained the IRBs that provided oversight for the protection of human subjects: 1) The University of Texas Medical Branch Office of Research Subject Protections; 2) Mount Sinai Medical Center Program for the Protection of Human Subjects; 3) University of California, San Diego Human Research Protections Program; 4) University of California, Los Angeles Office of the Human Research Protection Program.

6.3 Material and Methods for Chapter 9

Subjects in DLPFC cohort, Brain dissection and extraction of protein and RNA; Quantification of viral loads and CD4 count; Quantification of brain mRNAs; Western blot analysis; Neurocognitive testing

See section 6.2

DNA isolation and HO-1 promoter genotyping

DNA was isolated from the dorsolateral prefrontal cortex (DLPFC) using the DNA Extraction kit (Agilent Technologies, catalog #200600) according to the manufacturer's instruction, and each sample was standardized to a 20 ng/μl concentration. HO-1 microsatellite (GT repeat) genotyping was performed by the Penn Genomics Analysis Core (PGAC) in the Perelman School of Medicine at the University of Pennsylvania (Philadelphia, PA). The sequences of the primers were taken from Seu et al. (2011). The forward primer sequence, 'MS-Primer1' (as named in Seu et al., 2011), was labeled at the 5' end with 6-FAM: 5'-FAM-CCAGCTTTCTGGAACCTTCTG-3'. The reverse primer sequence, 'MS-Primer2,' was unlabeled: 5'-GAAACAAAGTCTGGCCATAGGA-3'. The samples were amplified using the Roche PCR Core Kit (Roche) on an thermocycler (GeneAmp PCR System 9700, Applied Biosystems) using a touchdown PCR protocol. Samples were initially heated to 95°C for 10 minutes, then cycled between 95°C (20 sec) for denaturing, 62°C (20 sec) for annealing, and 72°C (45 sec) for elongating. The touchdown protocol started the annealing temperature at 62°C and dropped 0.5°C during each subsequent cycle for the first 15 cycles. The remaining 35 cycles maintained the annealing temperature at 55°C, followed by a final hold of 72°C for 10 minutes. Two microliters (2 μl or approximately 40 ng) of DNA was used for each sample, and a final primer concentration of 250 nM for both forward and reverse primers was used. PCR products were run on a 2% agarose gel to ensure quality control of amplification of the target sequence. The resulting products were run on the 3130XL Capillary Sequencer (Applied Biosystems). Sizing was analyzed with GeneMapper (Applied Biosystems) and gated for products 200-300 basepairs in length. All samples were run twice independently to ensure accurate and reproducible sizing, and

were determined to be accurate within +/- 2 GT repeats, with a less than 5% chance of error based on reproducibility.

Statistics

Analyses of linear trends were performed by Spearman correlation where r is the Spearman's correlation coefficient and p is the p-value versus the null hypothesis (slope = 0). We used a statistical significant cut-off of $\alpha = 0.05$.

Study approval

All protocols were carried out in accordance with the NIH Guidelines for the Care and Use of Laboratory Animals and approved by the University of Pennsylvania IACUC. All human studies and protocols for monocyte isolation were reviewed and approved by the University of Pennsylvania and University of Texas IRBs and all participants provided written informed consent.

6.4 Material and Methods for Chapter 10

Isolation and culture of human monocyte-derived macrophages (MDM)

Human monocytes were isolated from healthy donors by Ficoll density gradient centrifugation as previously described (42). Monocytes were plated at 10.5×10^3 cells/cm² in Cell-Bind plates (Corning) and cultured in DMEM supplemented with 10% FBS (Thermo Scientific), 10% horse serum (Invitrogen), 1% nonessential amino acids (Invitrogen), 2mM glutamine (Invitrogen), and 50U/ml penicillin/streptomycin at 37°C, 6% CO₂. Cells were cultured for 7 days in vitro (DIV) and

visually inspected for MDM differentiation before use in HIV-infection experiments. MDM were cultured for 7-10 DIV before use in noninfectious experiments.

HIV infection of MDM

Differentiated MDM were exposed to 0.2-50ng of p24 of HIV per 10^6 cells for 24 hours. All HIV-1 virus stocks were prepared by the University of Pennsylvania Center for AIDS Research Virology Core (Table 6.8) through transfection of 293T cells for molecularly cloned viruses or by amplification in primary human peripheral blood mononuclear cells. HIV-1 89.6 accessory gene mutants have been described previously (528). HIV-2 CBL-20 virus stock was obtained from Dr. Robin Weiss through the NIH AIDS Reagent Program, Division of AIDS, NIAID, NIH. Supernatants from HIV-infected or noninfected (Mock) MDM were collected every 3 days through 12 days post-infection and stored at -80°C . Supernatants were monitored for HIV replication by quantifying cell associated HIV-1 p24 content, as analyzed by Western blot, or by viral reverse transcriptase (RT) activity, as analyzed by the amount of radiolabeled deoxythymidine incorporation (529). Briefly, 10 μl of MDM supernatant is incubated with 50 μl of RT cocktail (50 μM Tris pH 7.8, 75 μM KCl, 5 μM MgCl_2 , 0.05% NP-40, 2 μM DTT, 5 $\mu\text{g/ml}$, 1.6 mU *poly(rA):p(dT)*₁₂₋₁₈, and 10 $\mu\text{Ci/ml}$ dTTP [α - ^{32}P]) at 37°C overnight. 30 μl of sample is dotted onto DE81 Whatman ion exchange cellular chromatography paper (Fisher) and air dried for 30 minutes, washed four times with 2X UltraPure SCC (Invitrogen), washed once in absolute ethanol, and dried at 80 - 100°C for 30 minutes. Whatman paper is then placed in scintillation vial with 5ml of Scintiverse BD cocktail (Fisher) and counted for ^{32}P in a scintillation counter.

Donor/ Source ^a	Strain	Isolate Type	Co-receptor Usage	Tissue Isolated From	Clinical Diagnoses	Reference
A	Jago	Swarm	CCR5	CSF	AIDS Dementia Complex Stage 0.5	(530)
B	Doge	Swarm	CCR5	CSF	AIDS Dementia Complex Stage 1	(530)
C	TYBE	Swarm	CXCR4	CSF	CMV Encephalitis	(530, 531)
D	BR-2	Swarm	CCR5	Brain	Progressive Dementia	(532, 533)
D	CSF-2	Swarm	CCR5	CSF	Progressive Dementia	(532, 533)
E	BL-3	Swarm	CXCR4	PBMC		(534)
F	SF162	Swarm	CCR5	CSF	Toxoplasmosis, Acute Meningitis	(535, 536)
G	JR-FL	Swarm	CCR5	Frontal Lobe	AIDS Encephalopathy, Kaposi's Sarcoma	(537, 538)
G	JR-CSF	Swarm	CCR5	CSF	AIDS Encephalopathy, Kaposi's Sarcoma	(537, 538)
H	89.6	Clone	CCR5/ CXCR4	Blood	AIDS with no neurological disease	(538, 539)
I	NL43	Clone	CXCR4	Blood/ bone marrow	AIDS and non-AIDS	(540)
J	3B	Swarm	CXCR4	Blood/ bone marrow	AIDS and non-AIDS	(541, 542)
K	YU2	Clone	CCR5	Brain	HIV-1 Associated Encephalopathy	(543)
L	Bal-1	Swarm	CCR5	Lung	Pediatric patient with AIDS	(544)
M	ADA	Swarm	CCR5	Blood	Kaposi's Sarcoma	(545)

Table 6.8 Characteristics of select HIV-1 clade B strains prepared by the Center for AIDS Research Virology Core at the Perelman School of Medicine at the University of Pennsylvania, Philadelphia, PA, USA.

^aStrains with the same donor/source identifiers were isolated from the same individual

Western blot analysis

MDM cultures were rinsed with ice-cold PBS, lysed in 75mM Tris-HCL (pH 6.8) containing 15% glycerol, 3.75mM EDTA, and 3% SDS, and supplemented with Complete Protease Inhibitor Cocktail (Roche) and PhosSTOP phosphatase inhibitor mixture (Roche). MDM protein lysates were subjected to SDS-PAGE as previously described (46) using primary and secondary antibodies listed in Tables 6.6 and 6.7 Protein expression as determined by Western blotting was normalized to GAPDH expression.

RNA quantification and qPCR analysis

Cell cultures were rinsed in ice-cold PBS and RNA was isolated using RNeasy Kit (Qiagen) per manufactures instructions. RNA concentration and quality was analyzed by NanoDrop 2000c (Thermo Scientific). Following cDNA generation using Reverse Transcriptase Kit (Applied Biosciences), quantitative real-time PCR (qPCR) was performed using RealMasterMix (5Prime) on a MasterCycler RealPlex 2 (Eppendorf) with the primer sets listed in **Table S4** in the supplemental material.

MDM-mediated neurotoxicity and MDM extracellular glutamate

Rat cerebrocortical mixed neuroglial cultures (~80% neurons, 20% glia) were prepared from E17 embryos of Sprague-Dawley rats, as previously described (46). Cells were plated in tissue-culture plates pre-coated with poly-L-lysine (Peptides International) and maintained in neurobasal media plus B27 supplement (Invitrogen) at 37°C and 5% CO₂. After 7 DIV, approximately one-half volume of fresh media was added to the cells to replace evaporation losses. All cultures were used between days 14 and 17 DIV. Cell-based MAP2 ELISAs were performed on primary rat cerebrocortical cells plated at a density of 1×10^4 cells/well in 96-well plates as previously described (42, 46). Following a 24 hour exposure to HIV-MDM supernatant (n = 6 technical

replicates), neuronal cultures were fixed and fluorescently labeled using the following reagents: mouse anti-MAP2 (Covance), goat anti-mouse β -lactamase TEM-1 conjugate (Invitrogen), and Fluorocillin Green substrate (Invitrogen). Fluorescence intensity was measured using a fluorometric plate reader with a 480/520-nm filter set. MDM supernatant was applied at 1:10-1:60 dilution; the dilution that gave values within the linear range of the assay is presented. For uninfected MDM experiments pure neuronal cultures (~97-99% neurons, 5×10^4 cells/well) were used in order to detect lower levels of neurotoxicity. To obtain pure neuronal cultures cells were treated with $10 \mu\text{M}$ arabinosylcytosine 48 hours after plating and otherwise handled as described above. Neuronal survival was expressed as a percentage of untreated (UT) cultures. In previous publications we have demonstrated that this MAP-2 ELISA quantification robustly correlates with neuronal death as determined by hand counts of surviving MAP-2 stained neurons in this culture system (546, 547).

MDM extracellular glutamate

Glutamate concentration in MDM supernatant was assayed in triplicate using the Amplex Red Glutamic Acid/Glutamate Oxidase Assay Kit (Invitrogen) according to the manufacturer's directions.

ART preparation

Stock solutions of Tenofovir disoproxil fumarate, Efavirenz, Atazanavir sulfate, Ritonavir, and Raltegravir were prepared in DMSO and stock solution of Emtricitabine was prepared in H_2O and stored at -20°C until use. All ART drugs were provided by the NIH AIDS Research and Reference Reagent Program.

Statistics

All quantifications are expressed as mean \pm SEM. Two-tailed student's t-test or one-way ANOVA followed by a Holm-Sidak post-test were performed on indicated comparisons. $\alpha = 0.05$ unless otherwise noted in order to correct for multiple comparisons. Statistical input support was provided by the Biostatistics and Data Management Core, Center for AIDS Research, Perelman School of Medicine, University of Pennsylvania.

Study approval

All animal studies and protocols were carried out in accordance with the NIH Guidelines for the Care and Use of Laboratory Animals and approved by the University of Pennsylvania IACUC. All human studies and protocols for monocyte isolation were reviewed and approved by the University of Pennsylvania IRB and all participants provided written informed consent.

6.5 Material and Methods for Chapter 11

Isolation and culture of MDM; Western blot analysis; MDM-mediated neurotoxicity; MDM extracellular glutamate

See section 6.4

HIV infection of MDM

Differentiated MDM were exposed to 50-100ng of p24 of HIV-1 89.6 (R5/X4 strain) or Jago (R5 strain) per 10^6 cells for 24 hours. HIV-Jago is a macrophage-tropic CSF isolate from a patient

with confirmed HIV-associated dementia (530). Virus stocks were prepared by the University of Pennsylvania Center for AIDS Research Virology Core. Supernatants from HIV-infected or noninfected (mock) MDM were collected every 3 days and stored at -80°C. Supernatants were monitored for HIV replication by quantifying viral reverse transcriptase (RT) activity, as previously described (see section 6.4; (43)).

siRNA knockdown

Silencer® Select siRNAs (Ambion; Table 6.9) were transfected at a final concentration of 50nM using Lipofectamine RNAiMax (Invitrogen). Lipofectamine and siRNA were pre-incubated for 10 minutes in 50µl of Opti-Mem (Invitrogen) prior to treatment of MDM. All knockdown experiments were verified by Western blot. Transfection efficiency was evaluated using the BLOCK-IT™ Alexa Fluor® Red Fluorescent Oligo (Invitrogen).

Drugs and chemical preparations

Stock solutions of DMF, MMF, tBHQ, and camptothecin (Sigma-Aldrich) were prepared in DMSO and stored at -20°C until use. CoPP and SnMP (Frontier Scientific) were prepared in 1N NaOH and stored at -20°C until use. Stock solutions of mercaptosuccinic acid and dicoumarol (Sigma-Aldrich) and IFN γ , TNF α , and LPS (Peprotech) were prepared in PBS and stored at -20°C until use. Stock solutions of efavirenz (NIH AIDS Research and Reference Reagent Program) were prepared in DMSO and frozen at -80°C until use.

All human studies and protocols for monocyte isolation were reviewed and approved by the University of Pennsylvania IRB and all participants provided written informed consent.

Human Gene mRNA Targeted	Company	Product Line	siRNA ID Number
BACH1	Ambion (Life Technologies)	Silencer® Select	s1859
BACH1	Ambion (Life Technologies)	Silencer® Select	s1860
HO-1	Ambion (Life Technologies)	Silencer® Select	s6673*
HO-1	Ambion (Life Technologies)	Silencer® Select	s6674
HO-2	Ambion (Life Technologies)	Silencer® Select	s6675*
HO-2	Ambion (Life Technologies)	Silencer® Select	s6677
Scramble	Ambion (Life Technologies)	Silencer® Select	Catalog #: 4390846*

Table 6.9 Small interfering RNAs (siRNAs) used for knockdown experiments.

*siRNAs used in HIV-MDM experiments.

Statistics

All quantifications are expressed as mean \pm SEM. Two-tailed student's t-test or one-way ANOVA followed by a Holm-Sidak post-test were performed on indicated comparisons. $\alpha = 0.05$ unless otherwise noted in order to correct for multiple comparisons. Statistical input support was provided by the Biostatistics and Data Management Core, Center for AIDS Research, Perelman School of Medicine, University of Pennsylvania.

Study approval

All animal studies and protocols were carried out in accordance with the NIH Guidelines for the Care and Use of Laboratory Animals and approved by the University of Pennsylvania IACUC. All human studies and protocols for monocyte isolation were reviewed and approved by the University of Pennsylvania IRB and all participants provided written informed consent.

CHAPTER 7

CENTRAL AND PERIPHERAL MARKERS OF NEURODEGENERATION AND MONOCYTE ACTIVATION IN HAND

—

This work was originally published in *Journal of NeuroVirology*. McGuire JL, Gill AJ, Douglas SD, Kolson DL. Central and peripheral markers of neurodegeneration and monocyte activation in HIV-associated neurocognitive disorders. *J NeuroVirool.* 2015; 21(4):439-48. Copyright © 2015 Springer International Publishing AG

7.1 Abstract

HIV-associated neurocognitive disorders (HAND) affect up to 50% of HIV-infected adults, independently predict HIV morbidity/mortality, and are associated with neuronal damage and monocyte activation. Cerebrospinal fluid (CSF) neurofilament subunits (NFL, pNFH) are sensitive surrogate markers of neuronal damage in several neurodegenerative diseases. In HIV, CSF NFL is elevated in individuals with and without cognitive impairment, suggesting early/persistent neuronal injury during HIV infection. Although individuals with severe cognitive impairment (HIV-associated dementia (HAD)) express higher CSF NFL levels than cognitively normal HIV-infected individuals, the relationships between severity of cognitive impairment, monocyte activation, neurofilament expression, and systemic infection are unclear. We performed a retrospective cross-sectional study of 48 HIV-infected adults with varying levels of cognitive impairment, not receiving anti-retroviral therapy (ART), enrolled in the CNS Anti-Retroviral Therapy Effects Research (CHARTER) study. We quantified NFL, pNFH, and monocyte activation markers (sCD14/sCD163) in paired CSF/plasma samples. By examining subjects off ART, these correlations are not confounded by possible effects of ART on inflammation and neurodegeneration. We found that CSF NFL levels were elevated in individuals with HAD compared to cognitively normal or mildly impaired individuals with CD4+ T-lymphocyte nadirs ≤ 200 . In addition, CSF NFL levels were significantly positively correlated to plasma HIV-1 RNA viral load, and negatively correlated to plasma CD4+ T-lymphocyte count, suggesting a link between neuronal injury and systemic HIV infection. Finally, CSF NFL was significantly positively correlated with CSF pNFH, sCD163 and sCD14, demonstrating that monocyte activation within the CNS compartment is directly associated with neuronal injury at all stages of HAND.

7.2 Introduction

HIV-associated neurocognitive disorders (HAND) are a common complication of HIV infection in the era of combined antiretroviral therapy (cART) that independently predicts overall morbidity and mortality (548-551). The clinical sub-syndromes of HAND vary in severity of cognitive impairment and associated functioning, and include asymptomatic neurocognitive impairment (ANI), mild neurocognitive disorder (MND), and HIV-associated dementia (HAD) (180). Although HIV does not infect neurons, cognitive impairment in HIV is associated with pathological evidence of neuronal damage (synaptic loss, dendritic simplification), as well as infection and activation of central nervous system (CNS) infiltrating monocyte-derived macrophages (197, 548, 552). Up to 30% of HIV-infected individuals qualify for a diagnosis of ANI, 10-30% for MND, and 2-8% for HAD (548, 553); each diagnosis is based on neurocognitive testing and assessments of daily functioning in the absence of pre-existing or confounding diagnoses that may independently result in cognitive impairment. The temporal progression among these subtypes of HAND is not consistently linear, although they appear to be clinically and pathologically related (548, 553, 554). Individuals with ANI have an increased risk of progression to functional decline compared to neurocognitively normal HIV-infected individuals (548, 553, 555-557). In addition, mild, moderate, and severe cognitive impairment have been associated with synaptodendritic injury (197, 548, 553, 554), although the relationship between pathological abnormalities and severity of cognitive impairment has not been fully defined (558).

Neurofilaments (NFs) are structural proteins specific to neurons that are released into the cerebrospinal fluid (CSF) and blood following axonal disruption or degeneration (559-561). The neurofilament core chains are of low, medium or high molecular weight (NFL, NFM, NFH, respectively) with varying degrees of phosphorylation; these proteins are expressed in a stereotypic and phylogenetically conserved manner throughout neuronal development (562, 563). Elevations in CSF NFL are a sensitive surrogate marker of neuronal damage, as evidenced by pathological white matter changes, in several neurodegenerative diseases, including Alzheimer's disease, subcortical vascular dementia (564), amyotrophic lateral sclerosis (ALS) and multiple

sclerosis (MS) (565, 566). In HIV infection, CSF NFL levels are elevated both in early and later infection, in individuals with and without neurocognitive impairment (567, 568), although levels are highest in HAD (563, 569, 570). Moreover, CSF NFL levels increase with cART interruption, and decrease with cART initiation (569); neurocognitive performance improves in HAD in parallel with CSF NFL drop (563). Phosphorylated NFH (pNFH), a more protease resistant NF, has also been examined in multiple pathologies involving neuronal injury. Specifically, serum pNFH is elevated in amyotrophic lateral sclerosis (ALS) (571), optic neuritis (560) and following acute ischemic stroke (572). In addition, CSF and serum NFH concentrations correlate with each other in ALS (571). Neither CSF nor serum/plasma pNFH levels have been examined in HIV infection. In multiple sclerosis, CSF pNFH but not CSF NFL levels are higher in progressive patients compared with relapsing remitting patients. However, CSF NFL but not CSF pNFH levels predict early clinical disease progression from a first time demyelinating attack to relapsing/remitting disease (559, 573). Therefore, elevations in CSF NFL and pNFH, while both reflecting axonal damage, might have different associations with disease subtypes and/or disease progression, thus supporting separate investigation of each neurofilament subunit in HIV-infected individuals.

Positive correlations between CSF NFL and CSF neopterin (a marker of intrathecal monocyte/macrophage activation) have been described in individuals with HAD (563, 569), supporting previous evidence that axonal degeneration is associated with such activation (574). Although plasma sCD163 has been correlated with HAND subtype (575), the relationship between plasma monocyte activation markers, CSF NF isoforms, and HAND subtype has not been defined. Among the monocyte activation markers is membrane-bound CD14, a receptor for lipopolysaccharide. Activation of CD14 is associated with CD14 cleavage and release from the cell membrane in a soluble form (sCD14). Notably, plasma sCD14 levels independently predict mortality (574, 576) and impaired neurocognitive test performance in HIV-infected subjects (33). In addition, plasma sCD14 is elevated in HIV-infected subjects with cerebral atrophy compared to those without cerebral atrophy (574). Thus, sCD14 is an excellent candidate biomarker of

monocyte/macrophage activation associated with HIV-induced neurodegeneration. Similar to CD14, CD163, a monocyte-associated hemoglobin/haptoglobin complex scavenger receptor, is cleaved and shed from activated monocyte/macrophages in a soluble form, sCD163 in inflammatory states (577). Plasma sCD163 levels are elevated HIV-infected subjects, particularly those with cognitive impairment (35, 575), and plasma levels decrease with cART in parallel with HIV RNA (35). In addition, CD163+ monocyte/macrophages accumulate in perivascular brain regions in individuals with HIV encephalitis (101, 578). The number of perivascular CD163+ monocyte/macrophages is positively correlated with plasma HIV load (102), suggesting trafficking of peripherally activated monocytes to perivascular areas in the brain. Finally, elevated plasma sCD163 levels have been demonstrated in cognitively impaired HIV-infected individuals compared with non-impaired individuals (575), although whether such levels are correlated with expression of markers of neurodegeneration is not known.

To determine the relationship between neurodegeneration and monocyte/macrophage activation in HAND, as assessed by soluble biomarkers, we determined the correlations among levels of CSF neurofilament isoforms (NFL, pNFH), sCD14, and sCD163 across different stages of HAND and cognitively normal HIV-infected adult controls. We then examined associations of soluble biomarker levels with markers of systemic infection (plasma HIV-1 RNA viral load, CD4+ T-lymphocyte count), and with global and domain-specific cognitive impairment and HAND stage.

7.4 Results

To avoid any potential confounding effects of ART on expression of selected biomarkers of inflammation and neuronal injury, we selected a study cohort of individuals currently not receiving ART. Cohort demographics, medical, and laboratory characteristics are summarized in Table 6.1. Among the 48 subjects examined 75% were male, and 53% were African American. The median age was 39.5 (IQR 36-47.5, range 19-62). Only plasma CD4+ T-lymphocyte count and plasma

HIV-1 RNA differed across HAND subtypes: CD4+ T-lymphocyte count was lower and plasma HIV-1 RNA was higher in HAD when compared with ANI, MND and neurocognitively normal controls ($p=0.046$, $p=0.038$, respectively). Thus, as expected, our subjects with HAD demonstrated greater immune deficiency and poorer systemic viral control, than those without HAD as has been previously demonstrated in ART-naïve patients (553, 557). Finally, only one subject (ANI) was actively using illicit drugs (marijuana, opioids) during this study.

To determine the associations between neuronal injury, monocyte/macrophage activation and the severity of HAND, we first examined expression of neurofilament isoforms NFL and pNFH in CSF and expression of sCD163 and sCD14 in both CSF and plasma across the different sub-types of HAND. Among individuals with CD4+ T-lymphocyte nadirs ≤ 200 , CSF NFL levels were significantly elevated in individuals with HAD compared with neurocognitively normal subjects and those with MND (Figure 7.1A). There were no differences among HAND subtypes in levels of CSF NFL across all CD4+ T-lymphocyte nadirs (Figure 7.1B), CSF pNFH (Figure 7.1, C and D), CSF/plasma sCD14, or CSF/plasma CD163 (data not shown). In addition, CSF NFL levels did not significantly differ across HAND subtypes by current CD4+ T-lymphocyte count among neurocognitively normal subjects in contrast to another recent study (579). Finally, because our cohort did not include HIV-negative individuals, we compared absolute NFL levels with historical age-specific controls using the same NFL ELISA assay (Uman Diagnostics, AB) (567). Using these historical controls, we found that 10/15 neurocognitively normal, 11/15 ANI, 11/15 MND, and 2/3 HAD subjects demonstrated elevated CSF NFL levels, suggesting ongoing subclinical neuronal injury in HIV-infected individuals regardless of neurocognitive status.

Both CSF and plasma expression of sCD163 and sCD14 correlated within compartments (Figure 7.2, A and B), as did CSF NFL and pNFH (data not shown). These strong intra-compartment correlations among similar mechanistic biomarkers support the conclusion that these markers are predictably detecting monocyte/macrophage activation and neuronal injury in these subjects.

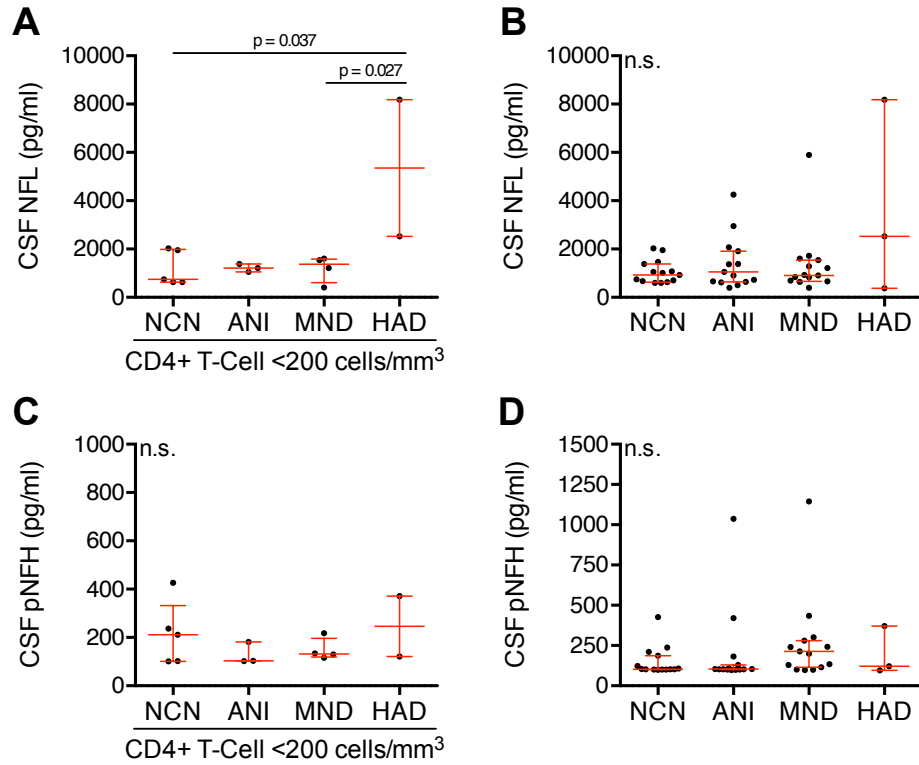

Figure 7.1 CSF NFL is elevated in individuals with HAD and a history of immunosuppression. NFL concentrations in the CSF of HIV+ **(A)** individuals with CD4 count nadir ≤ 200 and **(B)** individuals with any CD4 count nadir. pNFH concentrations in the CSF of HIV+ **(C)** individuals with CD4 count nadir ≤ 200 and **(D)** individuals with any CD4 count nadir. Data is presented as median and IQR with differences between groups evaluated using Kruskal-Wallis tests.

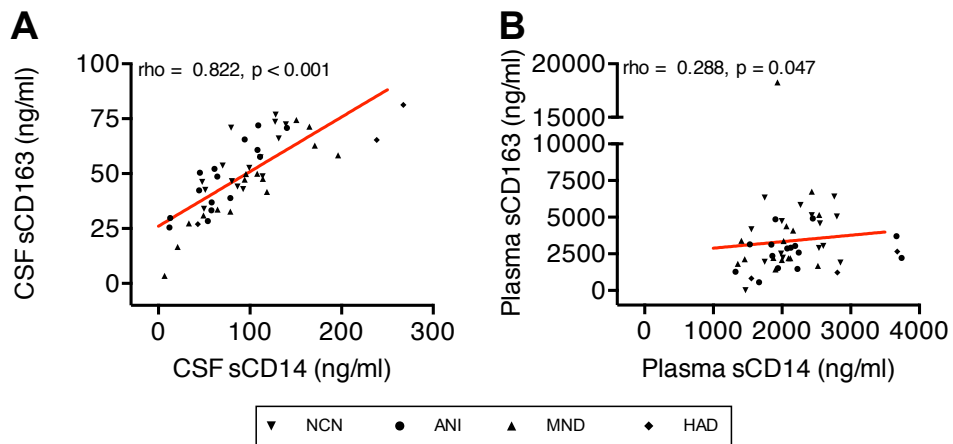

Figure 7.2 Monocyte activation markers intra-compartmentally correlate within the CSF and plasma. Correlations between the monocyte markers sCD163 and sCD14 within the (A) CSF and (B) plasma across all HIV-infected individuals with and without HAND. Correlations were analyzed using Spearman’s correlation coefficients.

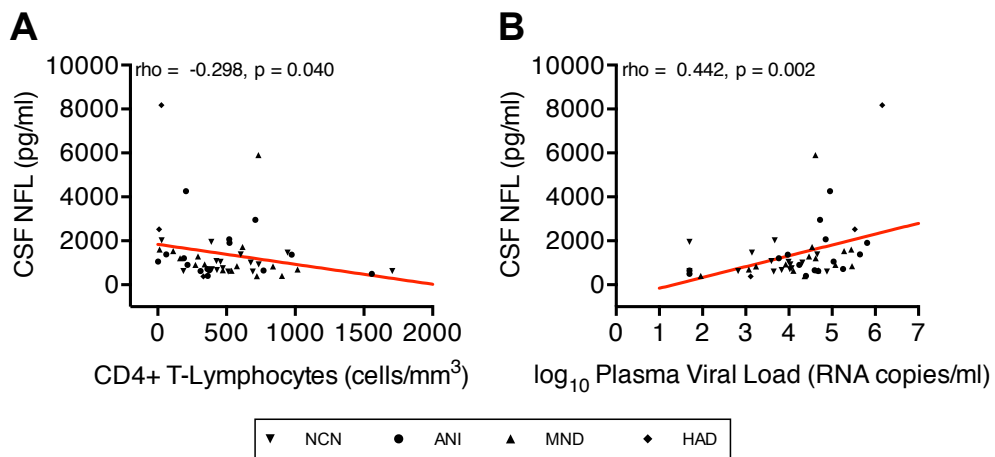

Figure 7.3 CSF NFL correlates negatively with plasma CD4+ T-lymphocyte count and positively with HIV-1 RNA load. Correlations between CSF NFL concentrations and plasma (A) CD4+ T-lymphocyte count and (B) HIV-1 RNA load in all HIV-infected individuals with and without HAND. Correlations were analyzed using Spearman’s correlation coefficients.

Next, to assess the relationship between CSF markers of neurodegeneration, monocyte activation, and systemic HIV infection, and to determine whether markers of monocyte/macrophage activation correlate with neuronal injury in HAND, each of the above candidate biomarkers was examined in association with each other and with plasma HIV-1 RNA viral load and CD4+ T-lymphocyte count in all subjects, regardless of cognitive impairment. Here, CSF NFL was negatively correlated with CD4+ T-lymphocyte count (Figure 7.3A) and positively correlated with plasma HIV-1 RNA viral load (Figure 7.3B), suggesting a relationship between neuronal damage and systemic HIV infection. CSF pNFH did not demonstrate the same correlations with markers of systemic HIV infection. Additionally, CSF NFL and pNFH levels correlated strongly and positively with CSF sCD163 (Figure 7.4, A and B) and CSF sCD14 (Figure 7.4, C and D), thus indicating that monocyte/macrophage activation within the CNS compartment is tightly linked to neuronal injury. In contrast to CSF expression, plasma expression of sCD14 and sCD163 did not correlate with CSF NFL or CSF pNFH. This suggests either no association between systemic monocyte/macrophage activation and CNS neuronal injury in this untreated cohort or a low level of sensitivity of plasma sCD14 and sCD163 detection as biomarkers for CNS neuronal injury in comparison with CSF sCD14 and sCD163.

Examination of biomarker associations with cognitive testing subdomain and global cognitive scores demonstrated that CSF pNFH was significantly higher in subjects with impaired speed of information processing (median CSF pNFH 103 pg/mL in unimpaired compared to 371 pg/mL in impaired subjects, total CSF pNFH range 96-1144 pg/mL, $p=0.018$) and memory (median CSF pNFH 103 pg/mL in unimpaired compared to 220 pg/mL in impaired subjects, $p=0.021$) compared to unimpaired subjects, although the magnitude of this effect was small. There were no significant correlations among NFL, plasma/CSF sCD14 or sCD163 and subdomain global deficit scores or impairment (data not shown).

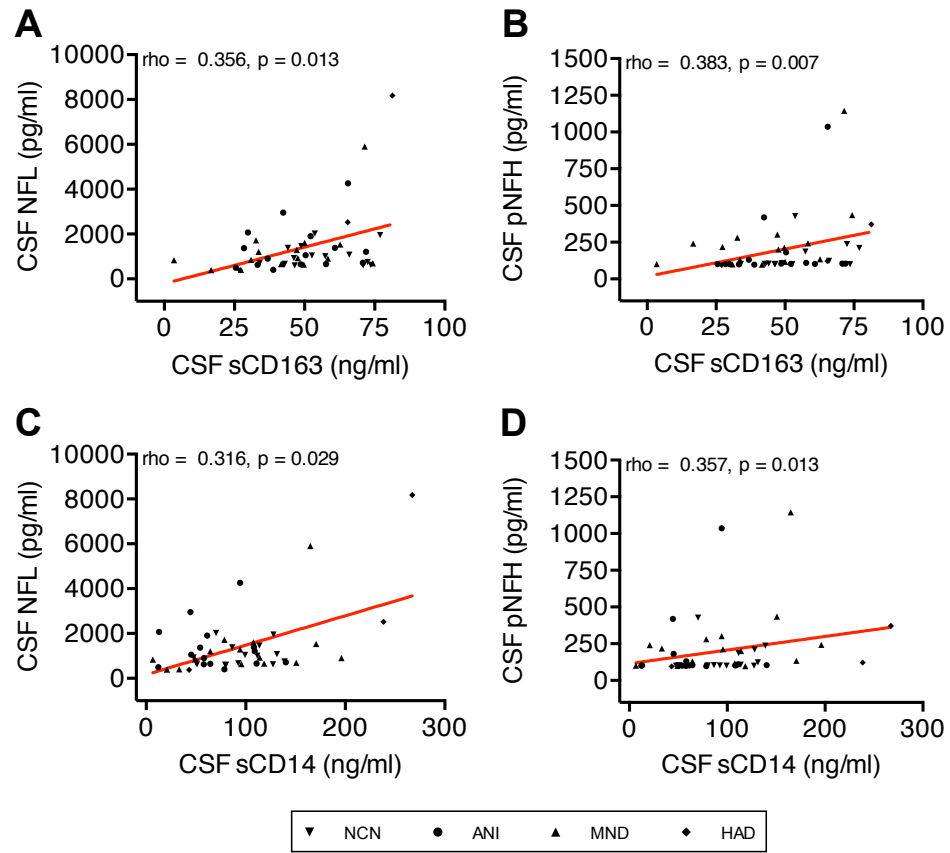

Figure 7.4 Neurofilament concentrations positively correlate with monocyte activation markers within the CSF. Correlations between sCD163 and (A) NFL and (B) pNFH and between sCD14 and (C) NFL and (D) pNFH within the CSF of all HIV-infected individuals with and without HAND. Correlations were analyzed using Spearman's correlation coefficients.

Finally, to investigate whether Hepatitis C virus (HCV) serostatus affected the relationships described above between the neurofilament isoforms, monocyte activation markers, and HAND subtypes, we performed an exploratory analysis examining concentrations of each of these markers across HAND for HCV+ and HCV- subjects separately. No statistically significant differences were found (data not shown). To determine whether a differential level of peripheral or central monocyte activation was present in HCV+ versus HCV- subjects, we then compared monocyte activation marker concentrations between these populations. After removing outlier values, none of the markers examined was significantly different between HCV+ and HCV- subjects (data not shown).

6.5 Discussion

We have demonstrated a strong correlation between CSF markers of neuronal damage (NFL, pNFH) and monocyte/macrophage activation (sCD14 and sCD163) in an unselected cohort of viremic HIV-infected individuals not receiving ART. No correlations between CSF NFL/pNFH and plasma sCD14 and sCD163 were demonstrated. In addition, plasma sCD163 did not vary significantly across different HAND subtypes, in contrast with a previous study of virologically-suppressed individuals on ART (575). However, plasma sCD163 levels in our cohort were higher than those observed in the previous study, which could reflect other factors contributing to monocyte/macrophage activation in this cohort, including perhaps uncontrolled peripheral HIV infection, co-infection with HCV, or syphilis in some individuals (Table 6.1). Nonetheless, our study clearly demonstrates that CNS monocyte/macrophage activation, as measured by CSF sCD163 and sCD14 is strongly correlated with neuronal injury, and based on our current understanding of HIV neuropathophysiology, this likely represents a causal association.

The possible association between CSF neurofilaments and severity of cognitive impairment in HIV infected individuals has not been fully described and involves complex and numerous

variables. Similar to others (563, 569, 570), we found that CSF NFL was significantly elevated in HAD subjects compared with those with milder (MND) or no cognitive dysfunction; this relationship was observed only in individuals with CD4 count nadirs ≤ 200 , which is strongly associated with an increased risk for HAND (10, 553, 557). Recent studies have demonstrated significant elevations in CSF NFL in individuals with acute HIV infection and in HIV-infected individuals without cognitive impairment (567, 568), although higher levels are observed in individuals with HAD, the most severe form of HAND. Elevated CSF NFL in acute HIV infection has also been associated with low N-acetylaspartate/creatine ratios (another indicator of neuronal injury) in cortex and white matter, as measured by brain magnetic resonance spectroscopy (568). In contrast, our study failed to demonstrate significant elevations of CSF NFL in ANI and MND individuals when compared with neurocognitively normal HIV-infected individuals, although we do not have a seronegative control group to determine whether CSF NFL is elevated in our seropositive neurocognitively normal control group. In examining previously published age-specific normative data from 107 HIV-uninfected subjects using the same ELISA platform (567), it does indeed appear that a significant proportion of our neurocognitively normal, ANI, and MND subjects had NFL elevations compared to uninfected controls. These data imply that many of our untreated subjects have ongoing subclinical CNS injury. But this conclusion is inherently limited by the use of historical controls. Thus, although CSF NFL can be considered to be sensitive marker of neuronal injury in the CNS in HIV infection, whether it reliably predicts or correlates with the severity of neuronal injury and neurocognitive impairment remains undefined. This is clearly an important gap in our understanding of the significance of the relative degree of neuronal injury in determining the presence and/or severity symptoms of cognitive dysfunction in HIV infection.

Our data suggest that CSF pNFH levels in individuals with HAND differ in comparison with CSF NFL levels. While CSF pNFH did not vary significantly across the different HAND sub-types, on cognitive testing subdomain assessment, we demonstrated significant associations with CSF pNFH and impaired speed of information processing and memory. However, the magnitude of

effect was small. Speed of information processing is dependent on multiple neurologic pathways, and therefore may be non-specifically affected compared to other, more localizable subdomains. In addition, CSF pNFH had an even stronger correlation with CSF markers of monocyte activation compared to CSF NFL, suggesting that these different neurofilament isoforms may represent distinct neuronal injury pathways with ultimately different clinical implications.

Our study showed no significant correlation between CSF NFL level and current CD4 count among neurocognitively normal HIV-infected subjects as demonstrated in previous studies (569, 579), perhaps reflecting a sample size too small to stratify into CD4 subgroup ranges. However, our data was significant for a negative correlation between CSF NFL and plasma CD4+ T-lymphocyte count across all strata of cognitive impairment, as well as a positive correlation between CSF NFL and plasma HIV-1 RNA viral load. Taken together, these data suggest more neuronal injury in more advanced (or poorly controlled) systemic infection, and may suggest a part of a mechanistic link to the clinical observation that low CD4+ T-lymphocyte count and high viral load are risk factors for HAD in untreated HIV infection. Notably, there was not a similar correlation between CSF pNFH and the same plasma markers of systemic HIV infection.

Because identifying a valid plasma biomarker for neuronal injury and/or HAND in HIV-infected individuals is still an unmet need, we considered the potential usefulness of neurofilament isoforms as such biomarkers. Published studies indicate that NFL is quickly proteolytically degraded in blood specimens, while pNFH is more protease-resistant (559). Based on prior investigations demonstrating serum pNFH elevation in other neurodegenerative diseases (560, 571, 572), serum pNFH could serve as a biomarker for neurodegeneration in the brain and/or spinal cord, each of which is affected in many individuals with HIV infection. Analyses of serum neurofilament isoforms in HIV infection have not been reported. However, despite demonstrating pNFH in CSF samples from our cohort, we failed to detect pNFH in matched plasma samples.

About one-third of our overall study population was Hepatitis C virus (HCV) positive, consistent with other estimates in adult HIV-infected populations (297, 302). However, HCV was not present in any subject with HAD. Prior literature suggests that individuals co-infected with both HIV and HCV have worsened cognitive impairment compared to HIV infection alone (306, 309). Mechanistically, HCV replicates in CD68+ macrophages of autopsied HIV-infected brain tissue (299), and is associated with increased macrophage expression of pro-inflammatory cytokines (300). Co-infection with HCV and HIV may therefore affect neurocognitive status via its effects on monocyte/macrophage activation (580). However, in this study we did not observe a difference in monocyte activation marker concentrations between all HCV+ and HCV- subjects, nor did we observe a difference in neurofilament isoforms concentrations or monocyte activation marker concentrations in HCV+ and HCV= subjects when analyzed across the spectrum of HAND. Whether these findings are truly representative of HIV/HCV co-infection neuropathology, or if they were limited by our sample size or other confounding factor not accounted for in these associations is unclear.

Our study had several limitations. First, because ART is now widely distributed, recruiting ART-free individuals is particularly difficult; our study therefore included a small cohort size (n=48) with few HAD subjects (n=3). Thus, sub-analyses with even smaller numbers (e.g. the relationship between HAND and CSF NFL among patients with CD4 count <200) may have limited potential biological significance. However, these data are consistent with other prior reports, and the possible effect of a history of profound immunosuppression on these relationships is thought provoking. Second, because this was a cross sectional correlation study, factors confounding the relationship between monocyte/macrophage activation and HAND status are not accounted for in statistical associations. However, relevant covariates were equivalent across the different subtypes of HAND, except for CD4+ T-lymphocyte count and viral load, which are known risk factors for HAD. In addition, causality cannot be inferred in a cross sectional study. Finally, by including only HIV-infected viremic subjects not receiving ART, we might obscure relevant

associations between plasma monocyte/macrophage activation and neurodegeneration because of high levels of plasma monocyte/macrophage activation in untreated, viremic subjects. Nonetheless, we have eliminated the possibility of unanticipated effects of ART on inflammation and neurodegeneration.

In summary, we have demonstrated a positive correlation between expression of CSF neurofilament isoforms and CSF sCD14 and sCD163 in viremic HIV-infected individuals not receiving ART, thus directly linking CNS monocyte/macrophage activation with neuronal injury. Future studies may examine if this relationship is specific to HIV neuropathogenesis, or if it is observed in other neuroinflammatory disorders as well. Furthermore, sCD14 and sCD163 levels are highly correlated in CSF and plasma, suggested that monocyte/macrophage activation can reliably be detected by ELISA in such stored tissue specimens. We have also confirmed that severe CD4 depletion (a risk factor for HAD) is associated with elevated CSF NFL levels at the time of diagnosis of HAD, and that elevated CSF NFL levels are highly correlated with low CD4+ T-lymphocyte counts and high plasma HIV-1 RNA viral load, suggesting a link between neuronal injury and systemic HIV infection. A previous study has suggested that CSF NFL can serve as a predictive biomarker for HAD in individuals not receiving ART (570). Whether CSF NFL is a sensitive predictor of risk for HAND subtypes, and whether sCD14 and sCD163 might also have predictive value on later development/progression of HAND in viremic versus aviremic ART-experienced individuals remains to be determined. Finally, we have demonstrated somewhat different correlations of NFL and pNFH with respect to cognitive measurements, suggesting that the different neurofilament isoforms may represent distinct neuronal injury pathways in HIV neuropathophysiology.

CHAPTER 8

BRAIN HEME OXYGENASE-1 DEFICIENCY ACCOMPANIES NEUROPATHOGENESIS OF HAND

Part of this work was originally published in *The Journal of Clinical Investigation*. Gill AJ, Kovacsics CE, Cross SA, Vance PJ, Kolson LL, Jordan-Sciutto KL, Gelman BB, Kolson DL. Heme oxygenase-1 deficiency accompanies neuropathogenesis of HIV-associated neurocognitive disorders. *J Clin Invest*. 2014; 124(10):4459-72. Copyright © 2014 American Society for Clinical Investigation.

8.1 Abstract

Heme oxygenase-1 (HO-1) is a highly inducible, detoxifying enzyme critical for limiting oxidative stress, inflammation, and cellular injury within the central nervous system (CNS) and other tissues. In several neurodegenerative diseases brain HO-1 expression is increased, presumably to protect against concurrent insults. Our analysis of HO-1 expression in the brain prefrontal cortex of HIV-infected individuals demonstrated a significant HO-1 protein deficiency, even in HIV-infected subjects treated with antiretroviral therapy (ART). This HO-1 deficiency was particularly striking in individuals with the pathological diagnosis of HIV-encephalitis (HIVE). This loss of HO-1 protein expression within the prefrontal cortex associated with cognitive dysfunction, CNS HIV replication, type I interferon responses, and macrophage activation. Additionally, we observed a reduction of HO-1 protein expression in the striatum of subjects with HIVE, although no alterations in HO-1 protein expression were seen in the occipital or cerebellar cortex. These findings identify HO-1 as a host factor that is deficient in the brains of HIV-infected individuals and suggest that loss of HO-1 and its protective functions may contribute to such HIV neuropathogenesis. Rescue of this deficiency through induction HO-1 in the CNS of HIV-infected antiretroviral therapy-treated patients could provide a novel approach for protection against neurodegeneration and associated cognitive dysfunction.

8.2 Introduction

HO-1 is a sentinel, detoxifying enzyme that is induced in response to numerous insults including inflammation and oxidative stress (581-583). The potent anti-inflammatory and cytoprotective actions of HO-1 have identified it as a potential therapeutic target in CNS inflammatory and neurodegenerative diseases (584, 585). Among these diseases, HIV infection is associated with neurodegeneration that is thought to result from effects of persistent inflammation and oxidative stress in both systemic and CNS compartments that persists in individuals on ART (93, 161, 258,

574). Within the CNS, such effects are driven by HIV infection of macrophages and microglia and contribute to the continued prevalence of cognitive, motor, and behavioral deficits collectively known as HIV-associated neurocognitive disorders (HAND) (180, 586), which affect up to 50% of HIV-infected ART-treated individuals (8, 10). This high prevalence of HAND strongly underscores the need for adjunctive therapies that target the neuropathological processes associated with persistent inflammation and oxidative stress in HIV-infected individuals. We have identified HO-1 as a potential targetable host factor that may contribute to HIV-associated neuropathological processes using human brain specimens from a large cohort of HIV-infected individuals.

Two heme oxygenase isoforms (HO-1 and HO-2) are expressed to varying levels in nearly all cell lineages, but only HO-1, the rapidly inducible isoform, is considered to be a critical mediator of the cellular response to injury (44). Elevated HO-1 expression has been observed in brain tissue from individuals with Alzheimer's disease, Parkinson's disease, and multiple sclerosis, perhaps reflecting a limited host protective response against ongoing injury (587-589). The protective functions of HO-1 have been linked to the enzyme's degradation of heme, a strong pro-oxidant, and the subsequent generation of the anti-inflammatory and anti-oxidative products, carbon monoxide, biliverdin, and bilirubin (44), although non-enzymatic cytoprotective functions of HO-1 through activation of oxidant-responsive transcription factors have also been proposed (410, 411). HO-1 catabolism of heme also releases free iron, which can contribute to cellular oxidative damage and toxicity. However, free iron rapidly induces expression of ferritin, a ubiquitous intracellular protein that binds and stores iron in a non-toxic form. Expression of HO-1 is regulated through the Nrf2-dependent antioxidant response element (ARE), which regulates the induction of a coalition of antioxidant and detoxifying effector proteins (404).

Through analysis of post-mortem brain tissue specimens from 156 individuals, we have demonstrated that HO-1 protein expression is deficient in the dorsolateral prefrontal cortex (DLPFC) of HIV-infected subjects and that this HO-1 deficiency is correlated with CNS viral load

and markers of immune activation. Additionally, we have shown that HIV-associated HO-1 deficiency also occurs within the striatum, but not in the occipital cortex or cerebellum. These findings suggest that HO-1 deficiency may contribute to HAND neuropathogenesis and that restoring CNS HO-1 expression may attenuate neurodegenerative processes and thereby reduce the persistent risk of HAND in ART-treated individuals

8.3 Results

HO-1 protein expression is reduced in the prefrontal cortex of HIV-infected subjects

To determine the expression of HO-1 in the brains of HIV-infected individuals, we used Western blotting to analyze the expression of HO-1, other canonical ARE effector proteins, and HO-2 in fresh-frozen autopsy specimens of DLPFC tissue from subjects enrolled in the National NeuroAIDS Tissue Consortium (NNTC). These included samples from HIV-negative subjects (HIV⁻, n=66), and HIV-positive subjects with and without HIV encephalitis (HIVE) (HIVE⁺, n=14 and HIV⁺/HIVE⁻, n=76, respectively) (see Table 6.2 for summary of cohort demographics and clinical data). To normalize the protein data, we quantified both β -tubulin and GAPDH expression and herein present all brain protein expression data normalized independently to both of these protein loading controls in consecutive figures. Using either loading control, there was a significant reduction in HO-1 protein expression in the DLPFC of HIV⁺/HIVE⁻ individuals in comparison with HIV⁻ controls, with the HIVE⁺ subgroup showing even greater HO-1 deficiency (Figure 8.1, A and B; Figure 8.2A). HO-1 expression did not correlate significantly with age or post-mortem autopsy interval within the full cohort or within the HIV⁻, HIV⁺/HIVE⁻, or HIVE⁺ subgroups (data not shown).

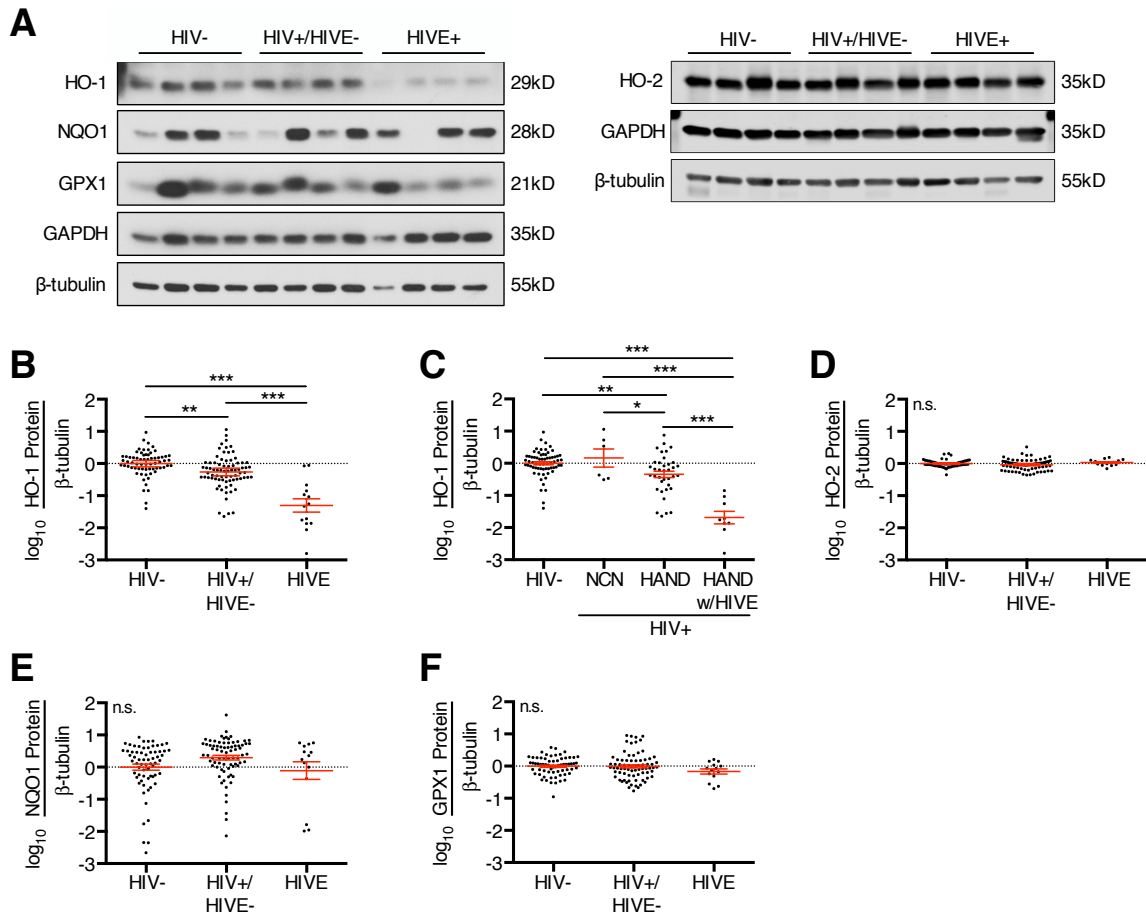

Figure 8.1 HO-1 protein expression is deficient in the DLPFC of HIV-infected subjects (β -tubulin). Protein expression in the DLPFC was assessed by Western blot in 66 HIV-negative (HIV⁻), 76 HIV-positive without HIVE (HIV⁺/HIVE⁻), and 14 HIV-positive with HIVE (HIVE⁺) post-mortem brain tissue samples. Of the 76 HIV⁺/HIVE⁻ subjects, 6 were neurocognitively normal (NCN) and 37 were diagnosed with HAND. **(A)** Representative Western blot of ARE and HO-2 proteins in the DLPFC of HIV⁻, HIV⁺/HIVE⁻, and HIVE⁺ subjects. Protein expression levels were quantified by densitometry analysis, normalized to β -tubulin, and log transformed for comparison between groups for **(B-C)** HO-1, **(D)** HO-2, **(E)** NQO1, and **(F)** GPX1. The mean HIV⁻ group protein expression was set to 0 (dotted line). Red lines indicate mean \pm SEM. Groups were analyzed by ANOVA with post hoc Holm-Sidak test. * $p < 0.05$, ** $p < 0.01$, *** $p < 0.001$.

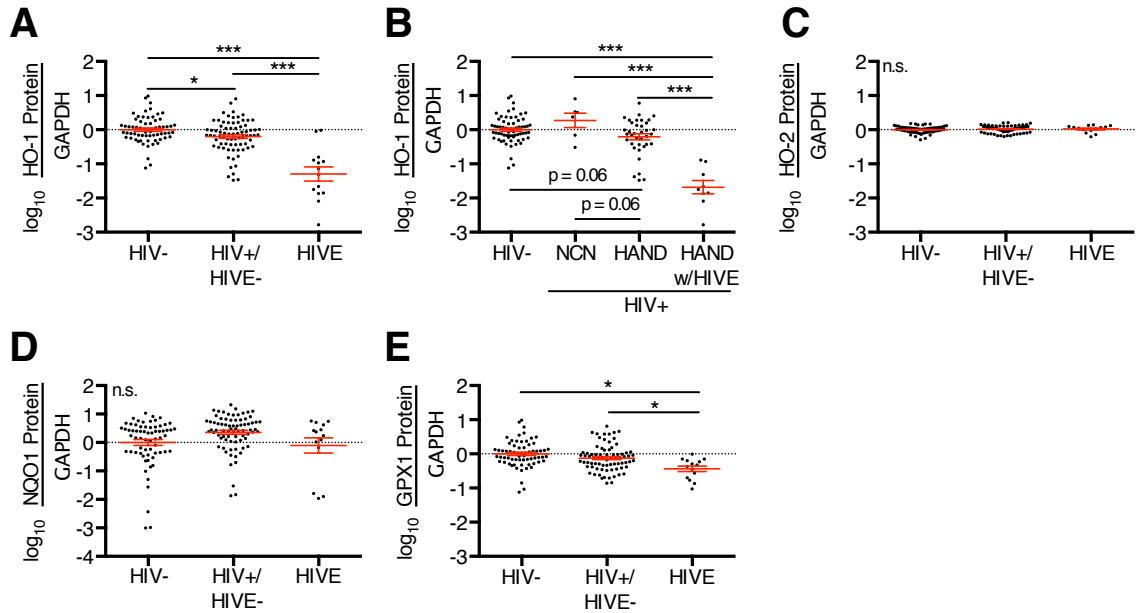

Figure 8.2 HO-1 protein expression is deficient in the DLPFC of HIV-infected subjects (GAPDH). ARE protein expression was assessed by Western blot in 66 HIV-negative (HIV⁻), 76 HIV-positive without HIVE (HIV⁺/HIVE⁻), and 14 HIV-positive with HIVE (HIVE⁺) post-mortem DLPFC tissue samples. Of the 76 HIV⁺/HIVE⁻ subjects, 6 were confirmed to be neurocognitively normal (NCN) and 37 were diagnosed with HAND. **(A)** Representative Western blot of ARE proteins in the DLPFC of HIV⁻, HIV⁺/HIVE⁻, and HIVE⁺ subjects. Protein expression levels were quantified by densitometry analysis, normalized to GAPDH, and log transformed for comparison between groups for **(B-C)** HO-1, **(D)** NQO1, and **(E)** GPX1. The mean HIV⁻ group protein expression was set to 0 (dotted line). Red lines indicate mean ± SEM. Groups were analyzed by ANOVA with post hoc Holm-Sidak test. *p < 0.05, **p < 0.01, ***p < 0.001.

Further subgroup analysis revealed that HO-1 expression was reduced in HIV⁺/HIVE⁻ subjects diagnosed with HAND compared to those diagnosed as neurocognitively normal when normalized to β -tubulin (Figure 8.1C), although this comparison was not significant when GAPDH expression was used to normalize (Figure 8.2B). Notably, the two HIVE⁺ subjects who did not demonstrate HO-1 deficiency (Figure 8.1B; Figure 8.2A) had neurocognitive impairment attributed to causes other than HAND. Use of ART was not associated with a significant difference in HO-1 expression levels in either HIV⁺/HIVE⁻ or HIVE⁺ subjects (Figure 8.3).

There were no significant differences in expression of either heme oxygenase-2 (HO-2), a ubiquitously-expressed heme oxygenase isoform (47% homology with HO-1) that is not regulated through the ARE, or the ARE effector protein NAD(P)H quinone oxidoreductase 1 (NQO1) among the HIV⁻, HIV⁺/HIVE⁻, and HIVE⁺ subgroups (Figure 8.1, D-E ; Figure 8.2, C-D). Similarly, expression of the ARE effector protein glutathione peroxidase 1 (GPX1) did not significantly differ among these groups when normalized to β -tubulin (Figure 8.1F), although GPX1 expression showed a significant decrease in HIVE⁺ subjects compared with HIV⁺/HIVE⁻ and HIV⁻ subjects when normalized to GAPDH (Figure 8.2E). We attempted to analyze Nrf2 (the major ARE transcriptional regulator) by Western blot in the DLPFC. Using an extended panel of commercially available Nrf2 antibodies, we were unable to reliably detect immunoreactivity consistent with Nrf2 protein expression, despite detecting transfected Nrf2 gene products in HEK cells (data not shown). We therefore cannot confirm Nrf2 protein expression levels in brain tissue; however, the lack of significant differences in the expression of the ARE proteins NQO1 and GPX1 in the DLPFC suggests that Nrf2-dependent ARE activity is not altered by HIV-infection.

Brain HO-1 protein deficiency in HIV-infection varies regionally

To determine whether brain HO-1 deficiency in HIV-infection is restricted to the DLPFC, we similarly analyzed HO-1 protein expression in the striatum (head of the caudate), occipital cortex

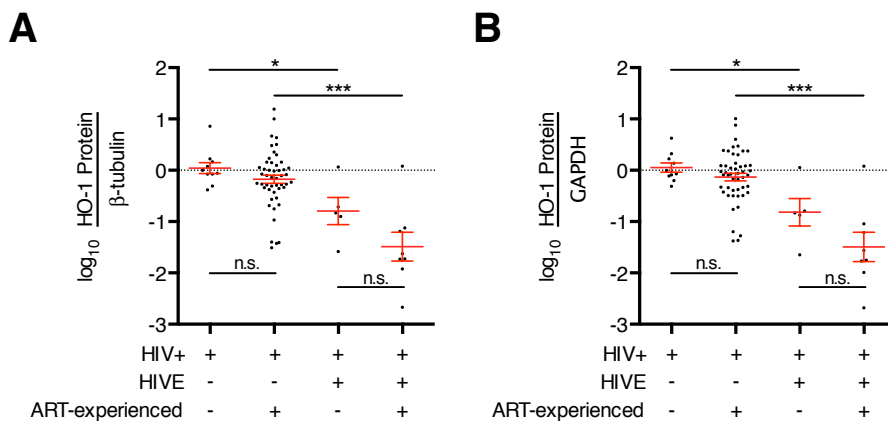

Figure 8.3 ART exposure is not associated with DLPFC HO-1 deficiency in HIV⁺ subjects with or without HIVE. HO-1 protein expression was assessed by Western blot and densitometry signal was normalized to (A) β -tubulin and (B) GAPDH in 10 ART-naive HIV⁺ subjects without HIVE, 49 ART-experienced HIV⁺ subjects without HIVE, 5 ART-naive subjects with HIVE, and 8 ART-experienced subjects with HIVE. No significant difference was observed in DLPFC HO-1 expression in ART-naive or ART experienced subjects in HIV⁺ subjects with or without HIVE. DLPFC HO-1 expression was significantly reduced in HIVE subjects compared with HIV⁺ subjects without HIVE in both the ART-naive and ART-experienced groups. The mean HIV⁻ protein expression was set to 0 (dotted line). Red lines indicate mean \pm SEM. Groups were analyzed by ANOVA with post hoc Holm-Sidak test. * $p < 0.05$, *** $p < 0.001$.

and cerebellum (anterior cerebellar cortex) in 12 HIV⁻, 12 HIV⁺/HIVE⁻, and 10 HIVE cases. This regional analysis cohort was matched for age, post mortem interval, sex, race, and ethnicity. We observed a significant reduction in HO-1 protein expression in the striatum of HIVE⁺ subjects compared to HIV⁻ and HIV⁺/HIVE⁻ subjects (Figure 8.4A; Figure 8.4A). However, we did not find any significant changes in HO-1 protein expression in the occipital cortex or cerebellum (Figure 8.4, B and C; Figure 8.5, B and C). In each of these regions, the expression of HO-2, NQO1, and GPX1 proteins in the HIV⁻ group did not significantly differ from either the HIV⁺/HIVE⁻ or HIVE⁺ groups. (Figure 8.4, D-F; Figure 8.5, D-F), a finding consistent with that in the DLPFC.

HO-1 deficiency in the prefrontal cortex of HIV-infected subjects correlates with neurocognitive dysfunction

The deficiency in prefrontal cortex HO-1 expression in HIV⁺/HIVE⁻ subjects with HAND compared with neurocognitively normal HIV⁺/HIVE⁻ subjects (Figure 8.1C) suggests that HO-1 deficiency may play a role in neurocognitive impairment in HAND. To determine whether specific deficits in neurocognitive functioning associate with HO-1 deficiency, we correlated HO-1 expression with normalized neurocognitive test T-scores covering 7 cognitive domains. Individual domain T-scores (and a Global T-score) were determined through a verified NNTC battery of neurocognitive tests (Table 6.3; (523)) in 69 HIV⁺ subjects who had undergone testing.

Although we did not detect any significant correlation between prefrontal cortex HO-1 expression and neurocognitive performance when all subjects were grouped as one group, significant correlations were observed when subjects were grouped as either self-identified white/Caucasian or black/African-American (Table 8.1). HO-1 expression in the white/Caucasian population was correlated positively with performance in the Speed of Information Processing and Executive Function domains, which are considered to be performance functions that are driven by output from the prefrontal cortex (590, 591). In contrast, within the black/African-American population,

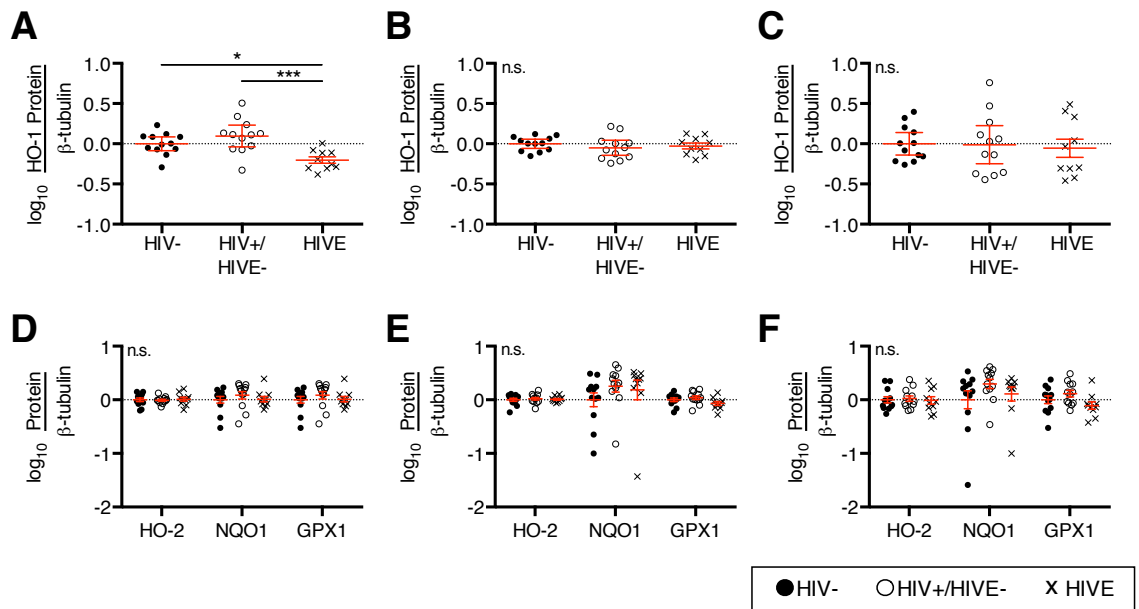

Figure 8.4 HO-1 is deficient in the striatum of HIV-infected subjects with HIVE (β-tubulin). HO-1 protein expression as determined by Western blot in the (A) striatum (head of caudate), (B) occipital cortex, and (C) anterior cerebellum of 12 HIV-, 12 HIV+/HIVE-, and 10 HIVE subjects. In the same cohort, HO-2, NQO1, and GPX1 protein expression was determined by Western blot in the (D) striatum, (E) occipital cortex, and (F) cerebellum. Protein expression levels were quantified by densitometry analysis, normalized to β-tubulin, and log transformed for comparison between groups. The mean HIV- group protein expression was set to 0 (dotted line). Red lines indicate mean ± SEM. Groups were analyzed by ANOVA with post hoc Holm-Sidak test. *P < 0.05; ***P < 0.001.

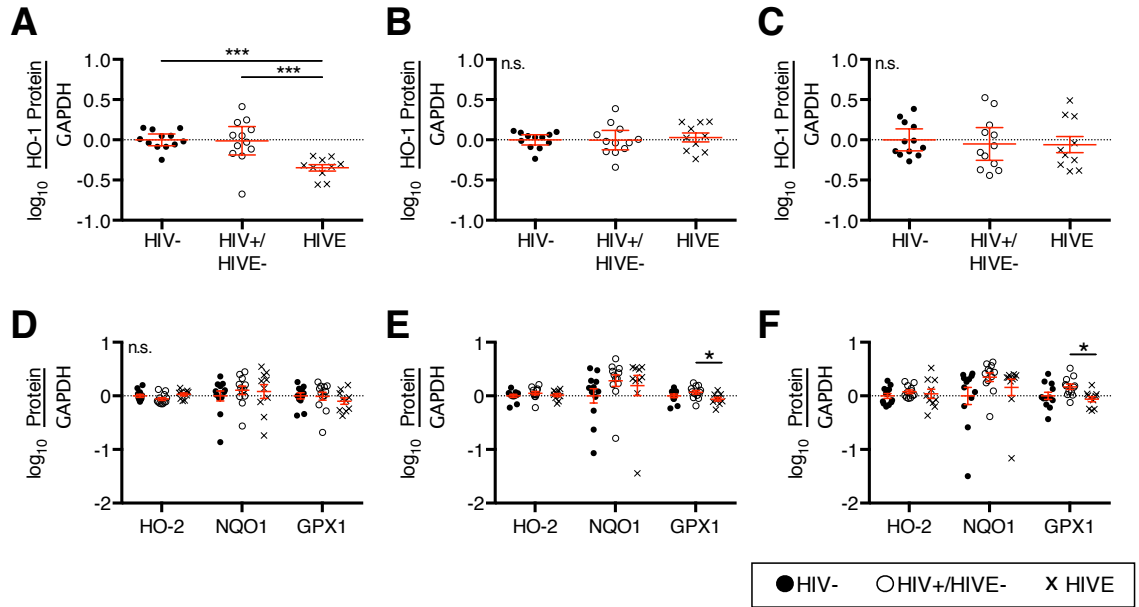

Figure 8.5 HO-1 is deficient in the striatum of HIV-infected subjects with HIVE (GAPDH). HO-1 protein expression as determined by Western blot in the (A) striatum (head of caudate), (B) occipital cortex, and (C) anterior cerebellum of 12 HIV-, 12 HIV+/HIVE-, and 10 HIVE subjects. In the same cohort, HO-2, NQO1, and GPX1 protein expression was determined by Western blot in the (D) striatum, (E) occipital cortex, and (F) cerebellum. Protein expression levels were quantified by densitometry analysis, normalized to GAPDH, and log transformed for comparison between groups. The mean HIV- group protein expression was set to 0 (dotted line). Red lines indicate mean \pm SEM. Groups were analyzed by ANOVA with post hoc Holm-Sidak test. *P < 0.05; ***P < 0.001.

Standardized Cognitive Domain T-Score	HO-1/ β -tubulin						HO-1/GAPDH					
	All		White		Black		All		White		Black	
	n = 63-69		n = 43-49		n = 15-16		n = 63-69		n = 43-49		n = 15-16	
	b	p	b	p	b	p	b	p	b	p	b	p
Global	0.79	0.63	3.68	0.05	-8.97	0.04[#]	2.65	0.10	5.29	0.004[#]	-7.55	0.099
Executive	2.15	0.30	6.52	0.01 [†]	-13.62	0.001[#]	4.71	0.02 [†]	8.61	<0.001[#]	-12.10	0.009[#]
Speed of Processing	1.98	0.29	5.60	0.007[#]	-10.95	0.11	3.47	0.06	6.37	0.002[#]	-6.89	0.34
Attention Working Memory	-0.12	0.95	2.47	0.31	-11.73	0.03 [†]	2.13	0.30	4.53	0.06	-10.91	0.05
Learning	0.11	0.96	2.63	0.24	-4.08	0.28	2.14	0.25	4.77	0.03 [†]	-5.51	0.14
Memory	2.07	0.32	4.35	0.09	-1.71	0.75	3.78	0.07	6.21	0.01 [†]	-3.74	0.49
Verbal Fluency	1.28	0.48	2.02	0.15	-1.37	0.86	1.91	0.30	3.33	0.11	0.24	0.98
Motor	0.62	0.77	4.59	0.05 [†]	13.26	0.04 [†]	2.16	0.31	5.38	0.02 [†]	-8.48	0.23

Table 8.1 DLPFC HO-1 expression in HIV+ subjects correlates differentially with neurocognitive domain T-scores in racial subpopulations. Correlations were determined between HO-1 expression as measured by Western blot (normalized to β -tubulin or GAPDH) in all HIV+ subjects with neurocognitive testing performed and in the self-identified White/Caucasian and Black/African American subpopulations. Correlations were determined from a multivariate linear regression where b is the slope of the line of association and p is the p-value versus the null hypothesis (b = 0). Analysis was corrected for years of education and age at time of neurocognitive testing as covariants. Sample size variations are due to availability of data; not all subjects completed the full battery of neurocognitive tests. To correct for multiple comparisons, domain T-scores $\alpha = 0.01$; Global T-score does not require correction, $\alpha = 0.05$.

[#]p < 0.05 and significant after adjusting for multiple comparisons

[†]p < 0.05 and not significant after adjusting for multiple comparisons

HO-1 expression was negatively correlated with performance in the Executive Function domain. HO-1 expression levels did not differ between these two populations, however (data not shown). Thus, these results suggest complex associations between brain HO-1 deficiency and cognitive performance that could be modulated by host factors differentially expressed in white/Caucasian and black/African American populations. Larger cohort studies are clearly needed to further define these relationships.

HO-1 prefrontal cortex deficiency correlates with CNS viral load, type I interferon response, and macrophage activation

We further sought to determine the relationships among HIV replication and associated markers of immune activation and HO-1 expression. In HIV⁺ subjects, prefrontal cortex HO-1 expression correlated negatively with both cerebrospinal fluid (CSF) and prefrontal cortex parenchyma HIV RNA load, but not with plasma viral load or CD4⁺ T-lymphocyte counts (Figure 8.6, A-D; Figure 8.7, A-D). This suggests that CNS HO-1 deficiency associates with ongoing HIV replication within the CNS compartment, but not with HIV replication in the periphery. As increased levels of markers of immune activation and the inflammatory type I interferon pathway are associated with the presence of HAND and high levels of brain parenchyma HIV RNA (527, 558), we assessed the mRNA expression of several markers of immune activation within our entire cohort. Expression of mRNA of the type I interferon-inducible genes *ISG15* and *MX1* correlated negatively with HO-1 expression (Figure 8.8, A and B; Figure 8.9, A and B), while no significant correlation with mRNA expression of *IRF1*, a predominantly type II interferon response gene (592), was observed (Figure 8.8C; Figure 8.9C). Expression of mRNA of the macrophage/microglia activation marker and haptoglobin-hemoglobin scavenging receptor *CD163* (593) correlated negatively with HO-1 expression (Figure 8.8D; Figure 8.9D). The link to *CD163*, which is expressed by perivascular macrophages as well as a unique subset of ramified grey matter microglia in HIV (101, 594), was relatively specific as the macrophage activation

marker *CD68* and the cytotoxic T-lymphocyte marker *CD8A* were not correlated significantly with HO-1 (Figure 8.8, E and F; Figure 8.9, E and F). These results suggest that prefrontal cortex HO-1 deficiency in HIV-infected individuals may be induced by CNS HIV replication and/or the associated innate immune activation of macrophages/microglia.

7.4 Discussion

The high prevalence of HAND in ART-treated HIV-infected individuals strongly emphasizes the need for adjunctive therapies that target the neuropathological processes that persist within the CNS despite the substantial benefit provided by ART (8, 10). These processes include inflammation and oxidative stress, which persist not only within the CNS but also within the systemic compartment in such individuals (93, 161, 258, 574). In our attempts to identify host factors that contribute to these processes, we have demonstrated a significant deficiency of the phase II detoxifying enzyme HO-1 in the prefrontal cortex of HIV-infected individuals with HAND and we have further shown that this deficiency is particularly severe in those subjects who also have HIV. This protein deficiency appears to be specific for HO-1 relative to other members of the ARE-driven gene family, as we saw no consistent changes in other ARE proteins or in the heme oxygenase isoform HO-2 in brain tissue. Prefrontal cortex HO-1 deficiency correlated with higher brain and CSF viral load and markers of immune activation and was associated with a clinical diagnosis of HAND. Notably, we observed no significant difference in the severity of brain HO-1 deficiency between ART-naïve and ART-experienced subpopulations, suggesting that conventional ART may not prevent or reverse this brain HO-1 deficiency and its associated cognitive dysfunction. However, we cannot rule out an influence of ART as ART-experienced decedents are often discontinued from therapy regimens near to the time of autopsy. We have thus linked brain HO-1 deficiency to HIV replication, immune activation, and clinically significant cognitive dysfunction (HAND) in ART-treated and non-treated subjects.

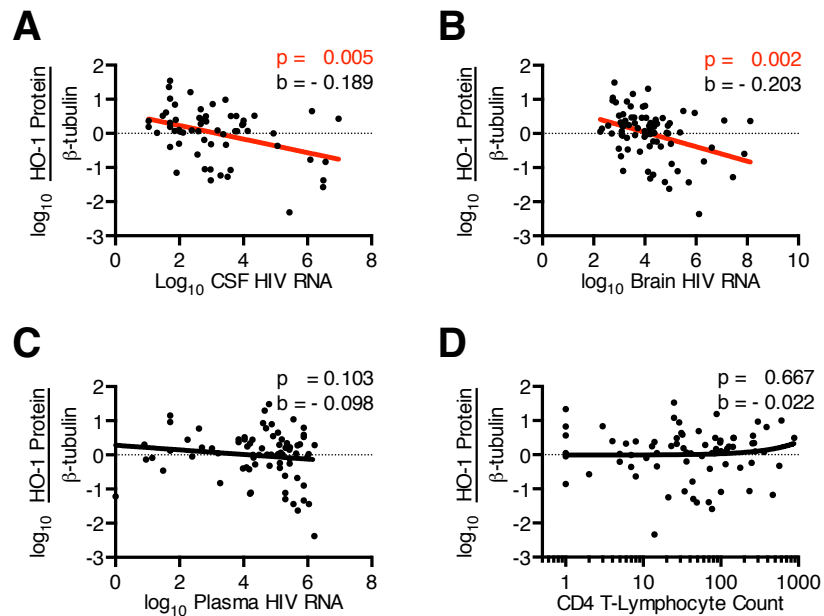

Figure 8.6 DLPFC HO-1 protein expression correlates with CSF and brain HIV RNA levels (β -tubulin). Samples were derived from the HIV+ cohort for all subjects with detectable viral loads. Correlations were determined between DLPFC HO-1 protein expression, as determined by Western blot and densitometry analysis normalized to β -tubulin, and HIV RNA in (A) CSF, (B) brain parenchyma, and (C) plasma, and (D) plasma CD4 T lymphocyte count in HIV+ subjects. Associations were determined by multivariate linear regression with $\alpha = 0.01$. Red regression lines denote significant trends.

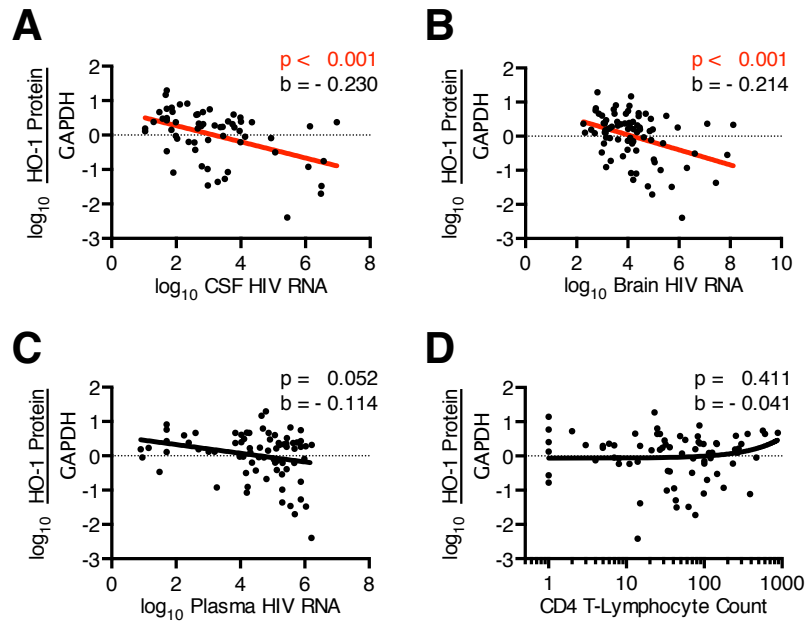

Figure 8.7 DLPFC HO-1 protein expression correlates with CSF and brain HIV RNA levels (GAPDH). Samples were derived from the HIV+ cohort for all subjects with detectable viral loads. Correlations were determined between DLPFC HO-1 protein expression, as determined by Western blot and densitometry analysis normalized to GAPDH, and HIV RNA in (A) CSF, (B) brain parenchyma, and (C) plasma, and (D) plasma CD4 T lymphocyte count in HIV+ subjects. Associations were determined by multivariate linear regression with $\alpha = 0.01$. Red regression lines denote significant trends.

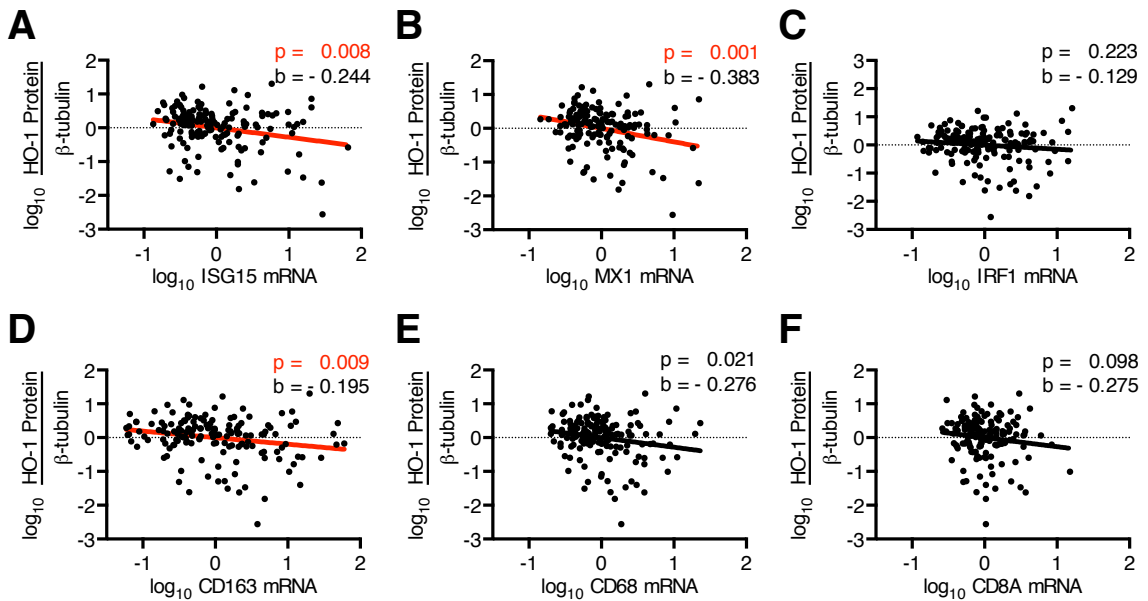

Figure 8.8 DLPFC HO-1 protein expression correlates with brain innate immune responses and macrophage markers (β -tubulin). Expression of mRNA within the DLPFC was determined by qPCR (see Methods). Correlations were determined between DLPFC HO-1 protein expression, as determined by Western blot and densitometry analysis normalized to β -tubulin, and (A) ISG15, (B) MX1, (C) IRF1, (D) CD163, (E) CD68, and (F) CD8A mRNA. Associations were determined by multivariate linear regression with $\alpha = 0.01$. Red regression lines denote significant trends.

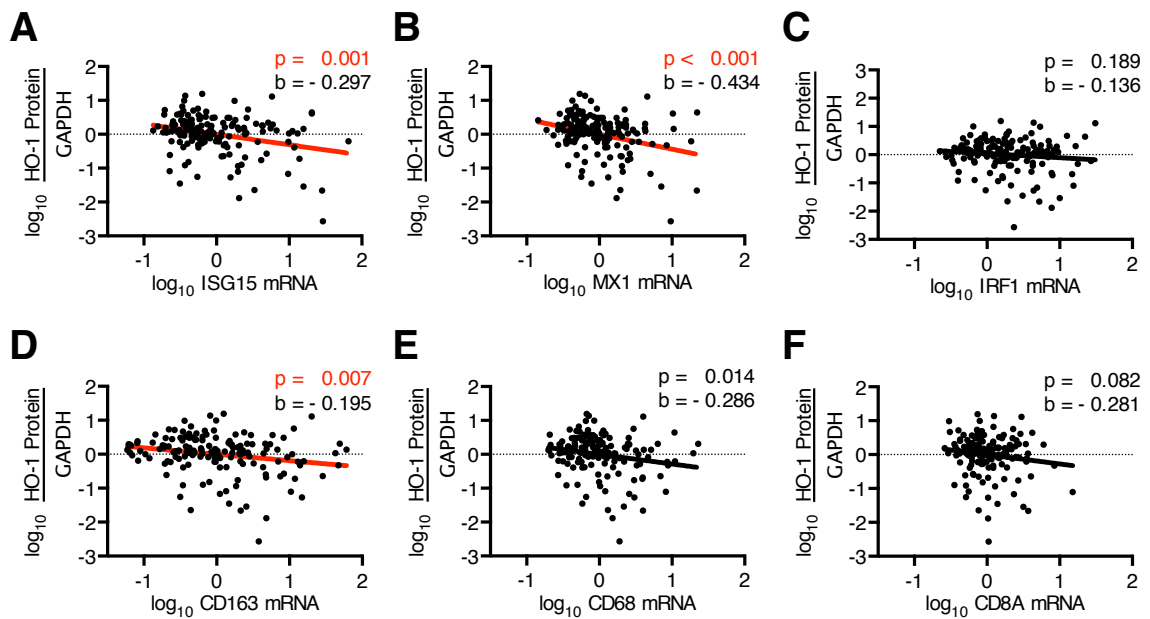

Figure 8.9 DLPFC HO-1 protein expression correlates with brain innate immune responses and macrophage markers (GAPDH). Expression of mRNA within the DLPFC was determined by qPCR (see Methods). Correlations were determined between DLPFC HO-1 protein expression, as determined by Western blot and densitometry analysis normalized to GAPDH, and (A) ISG15, (B) MX1, (C) IRF1, (D) CD163, (E) CD68, and (F) CD8A mRNA. Associations were determined by multivariate linear regression with $\alpha = 0.01$. Red regression lines denote significant trends.

In addition to demonstrating HO-1 deficiency in the prefrontal cortex of HIV+ patients with HAND, we also observed a significant reduction in HO-1 protein expression in the striatum of subjects with HIVE compared with HIV⁻ and HIV⁺/HIVE⁻ subjects in a smaller cohort. This finding provides evidence that HIV-associated HO-1 deficiency within the CNS is not restricted to the prefrontal cortex, but occurs in other brain regions. However, we did not observe altered HO-1 protein expression in the occipital or cerebellar cortex, indicating that the reduction of HO-1 in HIV-infection is not a global HIV effect in the brain. The pathological mechanism underlying the regional distribution of HO-1 protein deficiency in HIV-infected individuals is unclear. Notably, structural and functional imaging studies as well as neuropsychological testing studies suggest that the fronto-striatal circuitry may be particularly vulnerable to injury and dysfunction in HIV infection (595). Further analysis of regional expression of immune activation markers, viral load, and other proteins may elucidate common or unique associations with HO-1 expression.

Previous studies have associated CNS HIV replication with neurodegeneration, immune activation, and cognitive dysfunction, and have further shown that persistence of immune activation and oxidative stress in both systemic and CNS compartments are associated with disease progression within those compartments (93, 161, 258, 574). We demonstrated that prefrontal cortex HO-1 deficiency in HIV-infected subjects correlates significantly with increased brain parenchyma and CSF viral loads, but not with plasma viral load or CD4 T-cell count. This implicates the CNS viral reservoir as a driver of brain HO-1 deficiency independent of systemic HIV reservoirs, and it could identify one mechanism, loss of HO-1 enzymatic function, that contributes to persistent oxidative stress in HIV-infected brain. In addition to correlating with CNS viral replication, prefrontal cortex HO-1 deficiency also correlated with markers of innate immunity (type I interferon response genes *ISG15* and *MX1*) and macrophage and microglia activation (*CD163*). These data implicate the potential role for macrophage and microglia activation/infiltration in mediating brain HO-1 deficiency, although how this occurs is as yet unclear.

We believe that the deficiency of HO-1 expression in HAND brain might be unique among neurodegenerative diseases associated with CNS inflammation and oxidative stress. Alzheimer's disease, Parkinson's disease, and multiple sclerosis are also associated with CNS inflammation and oxidative stress (596), yet are not associated with decreased brain HO-1 expression. In contrast, these neurodegenerative diseases are all associated with increased brain HO-1 (587-589). For such CNS diseases, HO-1 induction in response to injury is considered to be a limited endogenous protective response and a potential therapeutic target for further protection against inflammation and oxidative stress (584). Why HO-1 expression is reduced in HIV infection of the brain, which is also associated with inflammation and oxidative stress, is unclear. Our preliminary studies of HO-1 mRNA expression in HIV-infected brain do not indicate transcriptional suppression of HO-1 (See section 11.4). Furthermore, other ARE-driven gene products, such as NQO1, GPX1 and others are expressed at normal levels in HIV-infected brain and in HIV-infected macrophages, which argues against transcriptional suppression of the ARE promoter as an explanation for HO-1 deficiency. The deficiency of HO-1 expression in both systems appears relatively specific for HO-1 among ARE proteins, and we suspect accelerated HO-1 degradation as the likely cause. We are currently investigating this enhanced HO-1 degradation hypothesis in various HIV-relevant models.

CHAPTER 9

HO-1 (GT)_N PROMOTER REGION MICROSATELLITE POLYMORPHISM ASSOCIATES WITH HIV-ENCEPHALITIS

9.1 Abstract

Heme oxygenase-1 (HO-1) is a ubiquitously expressed detoxifying enzyme with potent anti-oxidant, anti-inflammatory, and cytoprotective functions, and it is rapidly induced in response to cellular injury. Polymorphisms ((GT)_n dinucleotide repeat length variations) in the HO-1 promoter modulate the level of HO-1 expression, and greater promoter (GT)_n repeat length associates with poorer outcomes in individuals with certain cardiovascular, pulmonary, renal, infectious, and neurological diseases associated with oxidative stress and inflammation. In HIV-infected individuals, greater additive (GT)_n repeats associate with lower PBMC HO-1 expression, greater levels of systemic inflammation, and poorer control of HIV replication, suggesting a direct link between HO-1 expression and HIV disease progression. Furthermore, reduced brain expression of HO-1 in HIV-infected individuals is associated with HIV-associated neurocognitive disorders (HAND), HIV-encephalitis (HIVE), and elevated brain markers of macrophage activation. We therefore hypothesized that HO-1 promoter (GT)_n repeat length is a risk factor for HAND and/or HIVE and associated macrophage activation. Within an autopsy cohort of 68 HIV-infected subjects, homozygosity for a long (GT)_n repeat length (≥ 30 repeats) strongly correlated with a pathological diagnosis of HIVE. In HIV-negative subjects (n = 55) (GT)_n repeat length correlated with brain expression of the macrophage activation marker CD163. These data extend previous reports of an association between HO-1 promoter (GT)_n repeat length and systemic inflammation-associated diseases to an association with inflammation in the central nervous system, and a specific role in increasing risk for encephalitis in HIV infected individuals.

9.2 Introduction

Heme oxygenase-1 (HO-1) is a highly inducible, Nrf2-driven, detoxifying enzyme that is critical for limiting cellular injury from numerous insults, including inflammation and oxidative stress. Protective functions of HO-1 are linked to its rapid degradation of free heme, a major intra- and

extracellular byproduct of hemoglobin/myoglobin metabolism and a critical co-factor in various enzymatic pathways. The HO-1-mediated catabolism of free heme results in generation of the anti-inflammatory and antioxidation products, carbon monoxide, biliverdin, and bilirubin (44). We previously demonstrated that expression of HO-1 is reduced in brain prefrontal cortex of HIV-infected individuals with HIV-associated neurocognitive disorders (HAND), and that this deficiency associates with central nervous system (CNS) (489) viral load and markers of neuroinflammation, suggesting that HO-1 deficiency represents not only a potential biomarker for HAND but also a mediator of HIV Neuropathogenesis (43). We also demonstrated that HIV replication in macrophages, a major CNS HIV reservoir, markedly reduces HO-1 expression and that this triggers the release of neurotoxic levels of glutamate. Furthermore, correcting this HIV-induced macrophage HO-1 deficiency greatly attenuates glutamate release and associated neurotoxicity. Thus, regulating HO-1 expression in HIV-infected individuals could have a major beneficial impact on preventing or attenuating HIV-mediated neurodegeneration and HAND.

Transcriptional regulation of HO-1 expression is determined through sequence variation in the 5'-flanking region of the HO-1 promoter, which is driven by the transcriptional activator, Nrf2, and which contains a (GT)_n repeat sequence of varying length. Although estimated HO-1 promoter (GT)_n repeat lengths vary between 12 and 40, a bimodal distribution of short (23 repeats) and long (30 repeats) allele prevalence has been seen in several population studies (45). A long (GT)_n repeat length is associated with lower promoter responsiveness in transfected cell HO-1 promoter assays (485, 486, 517, 520, 597). Conversely, a shorter repeat length is associated with more robust HO-1 transcriptional induction. In line with the potent anti-inflammatory and anti-oxidative effects of HO-1 induction, many candidate gene studies have detected associations between the short HO-1 (GT)_n microsatellite variant and control of inflammatory and pro-oxidative disease states (485, 486, 517, 520, 597). A recent study of HIV-infected individuals demonstrated that a longer HO-1 promoter (GT)_n repeat length correlated with increased plasma sCD14 and viral load in HIV-infected African Americans, suggesting a promoter effect on systemic HIV

disease progression (489). Moreover, this study also demonstrated that primary immune cells (PBMC and CD14+ monocytes) derived from infected individuals having fewer (GT)_n repeats associated with greater HO-1 RNA and protein expression.

These observations, in conjunction with our previous observation of a correlation between HO-1 brain deficiency and HAND, with or without HIVE, prompted us to examine the association between the HO-1 promoter (GT)_n repeat length, the diagnosis of HAND, and the presence of HIVE in our autopsy cohort of HIV-infected and non-infected decedents. We found that *i*) HO-1 promoter (GT)_n repeat lengths in our cohort ranged from 20 to 36 with a bimodal peak distribution of 23 (short) and 30 (long) alleles, consistent with other cohort studies; *ii*) homozygosity for long (≥ 30 (GT)_n repeats) alleles correlated strongly with a post-mortem diagnosis of HIVE; and *iii*) total allele (GT)_n repeat length correlated strongly with brain CD163 mRNA expression level. These results suggest that HO-1 promoter (GT)_n repeat length is a determinant of an individual's vulnerability to developing HIV encephalitis. They further suggest that, even in the absence of HIV infection, a long repeat length associates with brain macrophage/monocyte activation, which might pre-dispose a newly-infected individual to develop HIV encephalitis. Identifying such host risk factors could guide the identification and application specifically-targeted therapies for neuroprotection against HIV.

9.3 Results

The distribution of the HO-1 promoter allele (GT)_n repeat lengths is bimodal (short allele, 23 repeats; long allele, 30 repeats) in our autopsy cohort study, similar to other cohorts studied

Previous studies have demonstrated a bimodal distribution of HO-1 allele promoter (GT)_n repeat lengths in cohorts of Caucasian individuals and a trimodal distribution in cohorts of African-American individuals (489). Our cohort consisted of decedent individuals enrolled in the National

NeuroAIDS Tissue Consortium (NNTC), which provided not only tissue-derived specimens (brain tissue) and genomic DNA, but also clinical, diagnostic and pathological data collected either pre- or post-mortem (43, 525) (Table 6.2). These data include assessments of neurocognitive status, markers of macrophage activation, and HIV RNA levels. Additionally, we determined HO-1 expression levels within brain tissue derived from the dorsolateral prefrontal cortex (DLPFC) and HO-1 promoter (GT)_n repeat lengths from banked genomic DNA samples in 55 HIV-negative subjects (HIV-) and 91 HIV-positive subjects (HIV+), including some with and without HIV-encephalitis (HIVE), as follows: (HIVE+, n = 14; HIV+/HIVE-, n = 77, respectively).

Within our cohort we observed an HO-1 promoter (GT)_n repeat length distribution with a range of 20 – 36 (GT)_n repeats and bimodal peaks at 23 and 30 (GT)_n repeats, with population peak frequencies of 19.9% and 65.1%, respectively, (Figure 9.1A), which is consistent with previous reports (489). In contrast with this previous report, we did not observe a significant difference in the allelic distribution between self-identifying Caucasians and African Americans in our cohort (Figure 9.1B; p = 0.0937). The distribution of total allele (diploid allele) (GT)_n repeat length per subject maintained a bimodal pattern with modes at 53 and 60 (GT)_n repeats (Figure 9.1C). Thus our cohort demonstrates a range and bimodal distribution of HO-1 promoter (GT)_n repeat lengths identified in other cohort studies, although we clearly cannot apply conclusions specifically to populations outside of the common bimodal distribution.

HO-1 promote region (GT)_n polymorphism repeat length does not correlate with HO-1 mRNA or protein expression within the prefrontal cortex

We observed no correlation between total HO-1 (GT)_n polymorphism length and DLPFC HO-1 mRNA or protein expression within the whole cohort (Figure 9.2, A and B) or within the HIV- and HIV+ cohort separately (data not shown). Our previous study (43) had demonstrated a significant deficiency of HO-1 protein expression and increased HO-1 mRNA expression in the brains of HIV-infected individuals, including those represented in this current study, The lack of correlation

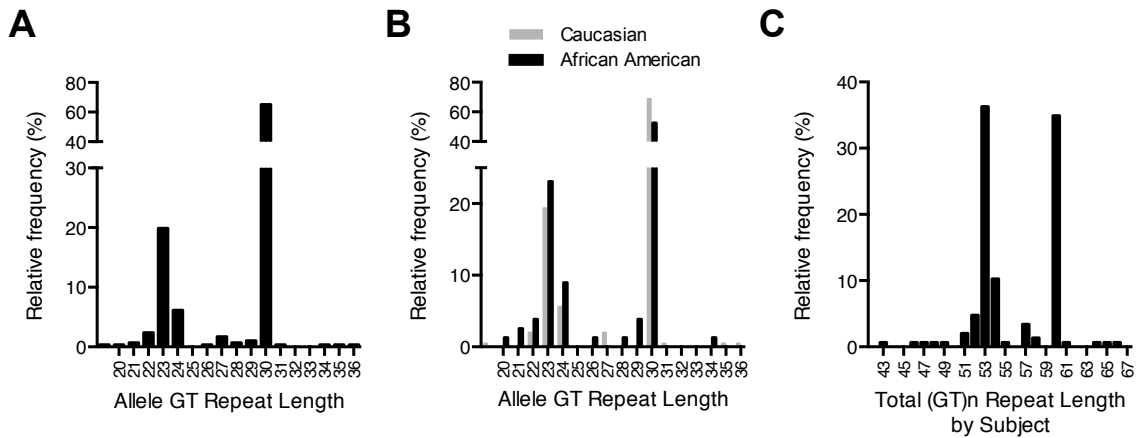

Figure 9.1 HO-1 promoter region (GT)_n polymorphism allele repeat length has a bimodal distribution. The allele repeat length of the HO-1 (GT)_n polymorphism was determined in 55-HIV negative and 91 HIV-positive subjects within our cohort. (A) Relative allele frequency of GT repeat lengths within the entire population, demonstrating a bimodal distribution with modes at 23 and 30. (B) Relative allele frequency of GT repeat lengths in self-identified Caucasians and African Americans demonstrating no significant difference in allele distribution between racial subpopulations ($p = 0.0937$, Kolmogorov-Smirnov test). (C) Relative frequency of total GT repeat length (allele 1 + allele 2) by individual subject, demonstrating a bimodal distribution with modes at 53 and 60.

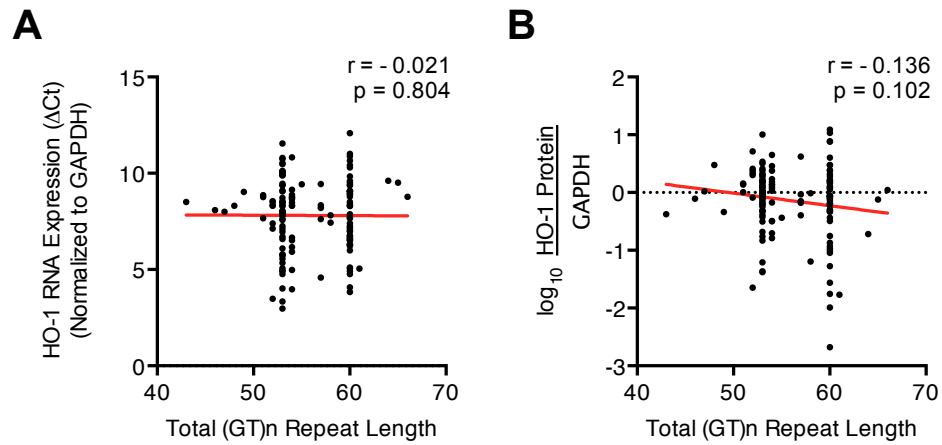

Figure 9.2 HO-1 (GT)n polymorphism repeat length does not correlate with prefrontal cortex HO1 mRNA nor protein. HO-1 RNA and protein expression in the DLPFC were quantified by qPCR and Western blot, respectively, in 55-HIV negative and 91 HIV-positive subjects within our cohort. Correlation between total HO-1 (GT)n polymorphism repeat length and DLPFC HO-1 **(A)** RNA and **(B)** protein expression. Correlations were assessed by Spearman's correlation with line of best fit determined by linear regression.

to post-mortem HO-1 expression is not wholly unexpected as HO-1 is a rapidly and highly inducible gene. Thus, potential inherent differences in CNS HO-1 inducibility between subjects as a result of the (GT)*n* promoter polymorphism may be masked by more acute responses that regulate HO-1, particularly within the HIV+ cohort where we know viral replication and inflammation associate with altered HO-1 expression (43).

*The HO-1 promoter allele (GT)*n* repeat length correlates with brain CD163 expression in HIV-negative subjects.*

To determine the relationship between brain macrophage activation and HO-1 promoter (GT)*n* repeat length, we correlated levels of CD163 and CD68 mRNA expression with HO-1 promoter (GT)*n* repeat length. Within the HIV-negative group (GT)*n* repeat length significantly correlated ($p=0.0091$) with brain CD163 mRNA levels (Figure 9.3A), suggesting an association between lower HO-1 promoter inducibility (greater HO-1 promoter (GT)*n* repeat length) and greater brain macrophage activation. We did not observe a significant correlation between HO-1 (GT)*n* polymorphism length and CD68 ($p=0.12$), although the trend was in the same direction as CD163 (Figure 9.3B).

*HO-1 promote region (GT)*n* polymorphism repeat length did not correlate with CNS viral replication or markers of macrophage activation within the brain of HIV+ subjects*

Within the HIV+ cohort, we did not observe a significant association between total HO-1(GT)*n* polymorphism repeat length and HIV-1 RNA in plasma (data not shown; $p = 0.26$) or CSF (Figure 9.4A, $p=0.34$), although there was a non-significant trend for longer (GT)*n* repeats to associate with higher DLPFC parenchymal HIV-1 RNA (Figure 9.4B; $p=0.06$). However, this trend is driven largely by three patients with short total (GT)*n* repeats and low viral load. Moreover, within the HIV+ cohort, we did not observe a correlation between total HO-1 (GT)*n* polymorphism length

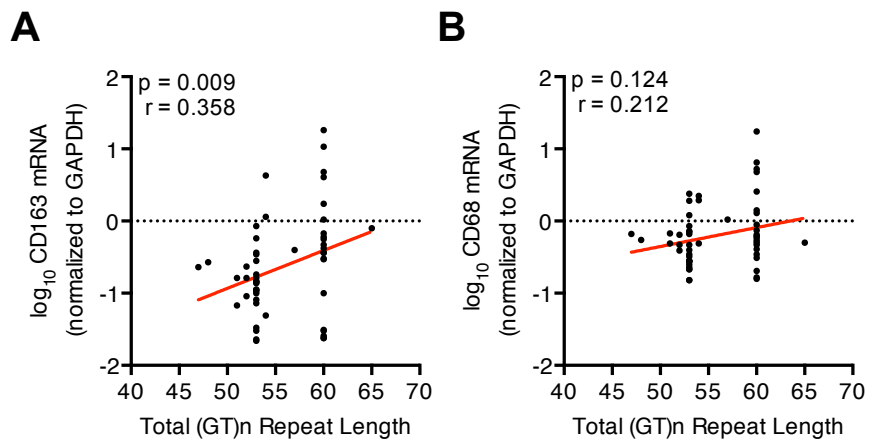

Figure 9.3 Longer HO-1 (GT)n polymorphism repeat length correlates with prefrontal cortex CD163 RNA. RNA expression of the macrophage markers CD163 and CD68 were quantified by qPCR in 55-HIV negative subjects within our cohort. Correlation between HO-1 (GT)n polymorphism repeat length and DLPFC **(A)** CD163 and **(B)** CD68 mRNA. Correlations were assessed by Spearman's correlation with line of best fit determined by linear regression.

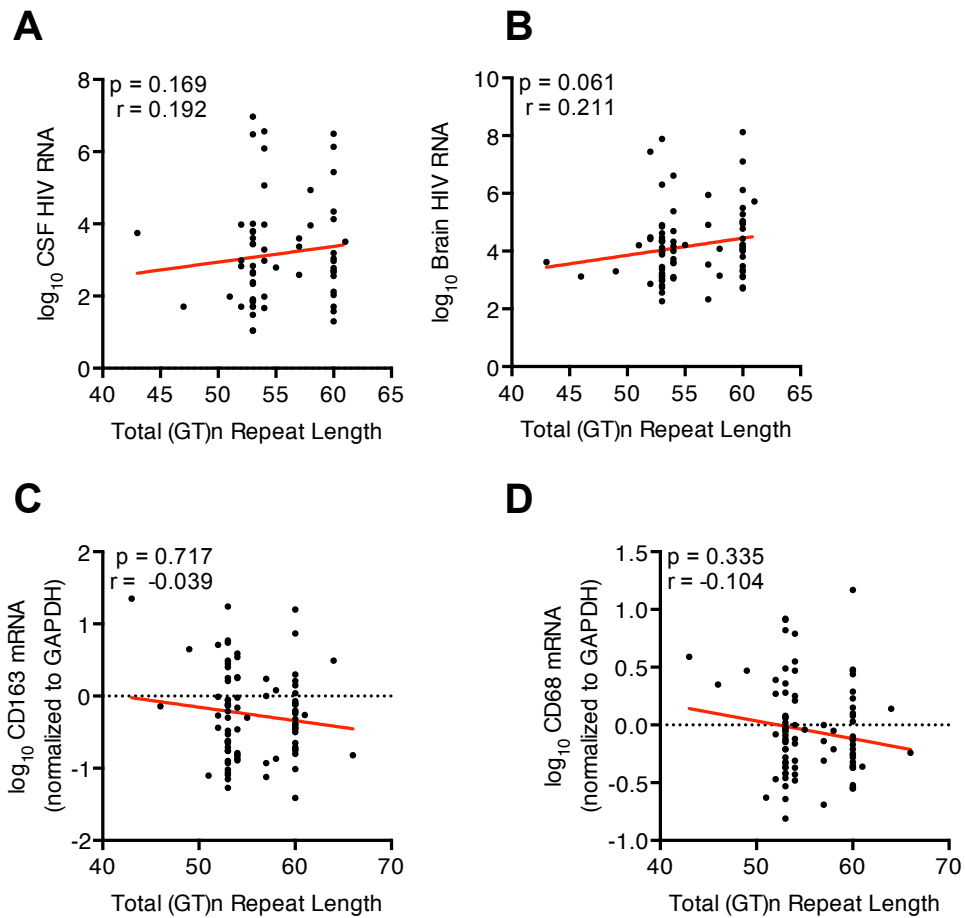

Figure 9.4 HO-1 (GT)n polymorphism repeat length did not correlate with CNS HIV replication or markers of macrophage activation within the prefrontal cortex of HIV+ subjects. CSF viral loads were determined with the Amplicor HIV-1 Monitor test v1.1 through v1.5 (*Roche*) for 61 of the 91 HIV-positive subjects. RNA expression of HIV-1 in the DLPFC was quantifiable by qPCR in 80 of the 91 HIV-positive subjects. RNA expression of the macrophage markers CD163 and CD68 were quantified by qPCR in 90 of the 91 HIV-positive subjects. Correlation between HO-1 (GT)n polymorphism repeat length and (A) CSF HIV-1 RNA, (B) DLPFC HIV-1 RNA, (C) DLPFC CD163 RNA, and (D) DLPFC CD68 RNA. Correlations were assessed by Spearman's correlation with line of best fit determined by linear regression.

and either CD163 or CD68 expression (Figure 9.4, C and D). This lack of association was expected as more acute factors such as CNS HIV-replication and clinical disease status are likely stronger drivers of HIV-associated inflammation and CNS macrophage activation than differences in HO-1 induction.

Longer HO-1 promote region (GT)n polymorphism repeat length associates with increased risk of HIV-encephalitis (HIVE)

HIVE is the post-mortem pathological diagnosis associated with profound neuroinflammation and fulminant HIV-infection of the CNS. To examine the association of the HO-1 (GT)_n polymorphism on HIVE-risk within our HIV+ cohort, we stratified (GT)_n allele lengths as short (S; < 30, the median) and long repeats (L; ≥ 30) and assessed the prevalence of HIVE diagnosis within each group. There was a significant difference in HIVE-prevalence between the genotype groups (Figure 9.5A; p=0.032), with HIV+ subjects with longer HO-1 (GT)_n polymorphism repeats having an increased prevalence of HIVE. This data suggests that patients with longer HO-1 (GT)_n polymorphisms have a higher risk of developing HIVE, suggesting that decreased HO-1 inducibility predisposes to a neuroinflammatory state in HIV-infected individuals potentially as a result of a loss of anti-inflammatory effects of HO-1.

In this cohort we found no association with HO-1 (GT)_n polymorphism genotype and HAND diagnosis (Figure 9.5B). While this cohort had 46 individuals that were diagnosed with HAND by neuropsychological testing, this analysis was extremely limited as this cohort only had 6 neurocognitively-normal controls. Larger cohort studies are needed to determine if HO-1 (GT)_n polymorphism modulates neurocognitive impairment in HIV-infected individuals.

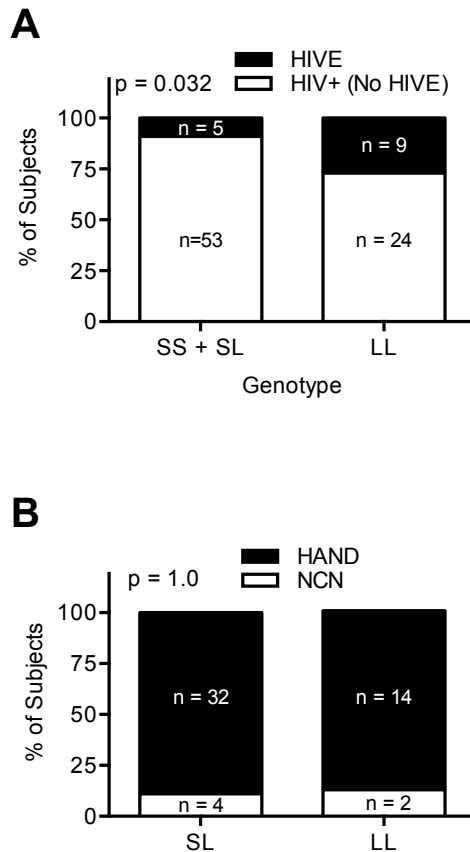

Figure 9.5 Longer HO-1 promote region (GT)_n polymorphism repeat length associates with increased risk of HIV-encephalitis (HIVE). HO-1 (GT)_n polymorphism allele repeat lengths were classified as short (S; < 30, the median) and long (L; ≥ 30). SS and SL genotype groups were combined for analysis as only 4 HIV-positive subjects had the SS genotype. All 91 HIV-positive subjects were pathologically diagnosed for HIVE and 43 subjects underwent neuropsychological testing to determine HAND status. Only 6 subjects were classified as neurocognitively normal (NCN). Frequency of **(A)** HIVE and **(B)** HAND stratified by subject HO-1 (GT)_n polymorphism genotype, SS+SL or LL. Statistical differences in distributions were analyzed by Fischer's Exact test.

9.4 Discussion

We have previously demonstrated a deficiency of HO-1 in the prefrontal cortex of HIV-infected individuals with HAND and that this deficiency associated with CNS viral load and markers of neuroinflammation (43). An earlier study by Seu et al. has shown that a (GT)_n repeat polymorphism within the HO-1 promoter region is associated with altered HO-1 inducibility in PBMCs from HIV-positive individuals (489). Specifically, longer (GT)_n repeat length associated with lower HO-1 induction, consistent with previous reports in cell lines (482, 485, 486, 488). Furthermore, longer (GT)_n repeat length in HIV-infected African Americans correlated with viral load and increased plasma levels of the macrophage activation marker sCD14, suggesting a link with systemic HIV disease progression (489). In this study, we examined a role of the HO-1 promoter region (GT)_n repeat polymorphism in CNS HIV disease progression using a well characterized cohort of HIV-infected and HIV-negative individuals.

Our analysis demonstrated a significant positive association between longer (GT)_n repeats (associated with lower HO-1 induction) and the risk of HIVE in our HIV+ cohort. Moreover, in the HIV-negative cohort, where HIV-driven neuroinflammation and immune activation is absent, we observed a significant correlation between longer (GT)_n repeats and higher RNA levels of the macrophage activation marker CD163, though not CD68. These results expand upon and strengthen our previous findings suggesting an association between HO-1 and HIV neurological disease progression and neuroinflammation (43) and are consistent with an anti-inflammatory role of HO-1. Specifically, these data link HO-1 with CNS macrophage activation and suggest that differences in HO-1 regulation may be capable of modulating HIV and other CNS inflammatory diseases, potentially through modulating inflammation within the CNS. Within this cohort, we did not observe significant correlations between HO-1 promoter (GT)_n polymorphism and a clinical diagnosis of HAND. However, this analysis was limited as our HIV+ cohort only had 6 neurocognitive-normal controls. Additional studies of the associations between HO-1

polymorphisms and risk for HIV disease progression, particularly neurocognitive impairment, in larger population cohorts are clearly needed.

CHAPTER 10

INDUCTION OF HO-1 DEFICIENCY AND ASSOCIATED GLUTAMATE-MEDIATED NEUROTOXICITY IS A HIGHLY CONSERVED PHENOTYPE OF CHRONIC MACROPHAGE INFECTION

Part of this work was originally published in *The Journal of Clinical Investigation* and *The Journal of Virology*. Gill AJ, Kovacsics CE, Cross SA, Vance PJ, Kolson LL, Jordan-Sciutto KL, Gelman BB, Kolson DL. Heme oxygenase-1 deficiency accompanies neuropathogenesis of HIV-associated neurocognitive disorders. *J Clin Invest*. 2014; 124(10):4459-72. Copyright © 2014 American Society for Clinical Investigation.

Gill AJ, Kovacsics CE, Vance PJ, Collman RG, Kolson DL. Induction of heme oxygenase-1 deficiency and associated glutamate-mediated neurotoxicity is a highly conserved HIV phenotype of chronic macrophage infection that is resistant to antiretroviral therapy. *J Virol*. 2015; (*In Press*) Copyright © 2015 American Society for Microbiology

10.1 Abstract

Expression of the cytoprotective enzyme heme oxygenase-1 (HO-1) is significantly reduced in brain prefrontal cortex of HIV-positive individuals with HIV-associated neurocognitive disorders (HAND). Furthermore, this HO-1 deficiency correlates with brain viral load, markers of macrophage activation, and type I interferon responses. Previously, we showed that HIV infection of monocyte-derived macrophages (MDM) reduces HO-1 protein expression in association with increased neurotoxin production. We now demonstrate that HIV-infection of MDM drives a time-dependent and progressive selective loss of HO-1 that occurs concomitantly with increased extracellular levels of glutamate, a HAND associated excitotoxin, and associated supernatant neurotoxicity. Moreover, this HIV-mediated macrophage HO-1 deficiency and associated glutamate release and neurotoxicity is a conserved feature of infection with macrophage-tropic HIV-1 strains that extends to HIV-2 infection. We further demonstrate that this HO-1 deficiency does not depend specifically upon the HIV-1 accessory genes *nef*, *vpr* or *vpu*, but rather on HIV replication, even when markedly limited. Finally, antiretroviral therapy (ART) applied to MDM after HIV infection is established does not prevent HO-1 loss and associated neurotoxin production. This work defines a predictable relationship between HIV replication, HO-1 loss, and glutamate-mediated neurotoxicity in MDM that likely reflects processes in place in the HIV-infected brain of individuals receiving ART. It further suggests that correcting this HO-1 deficiency in HIV-infected MDM could provide neuroprotection above that provided by current ART or proposed antiviral therapies directed at limiting Nef, Vpr or Vpu functions. The ability of HIV-2 to reduce HO-1 expression suggests that this is a conserved phenotype among macrophage-tropic human immunodeficiency viruses that could contribute to neuropathogenesis.

10.2 Introduction

Heme oxygenase-1 (HO-1) is a highly inducible phase II detoxifying enzyme that has emerged as a critical effector for limiting cellular injury associated with oxidative stress and inflammation within the central nervous system (CNS) and other tissues in several disease states, including HIV infection (42, 43, 585). It is a member of a family of antioxidant response element (ARE) promoter-driven genes that are induced by the transcriptional regulator Nrf2 in response to variety of cellular insults (404). The protective functions of HO-1 have been linked to its degradation of heme and the subsequent generation of carbon monoxide, biliverdin, and bilirubin, which have immunomodulatory and anti-oxidative properties (44). In addition, HO-1 has nonenzymatic cytoprotective functions through activation of transcription factors (410, 411). A constitutively expressed heme oxygenase isoform, HO-2, catabolizes the same enzymatic reaction, although it is not regulated by the ARE, and, unlike HO-1, HO-2 is not considered to be a critical mediator of acute cellular injury responses. Protective effects of HO-1 have been demonstrated *in vitro* and *in vivo* in animal models of oxidative, ischemic, and inflammatory diseases (412-415). Our *in vitro* studies have identified HO-1 as a potential protective host factor against HIV-associated excitotoxic injury and our analysis of autopsy brain specimens from a large cohort of HIV-infected decedents further demonstrated an association between brain HO-1 deficiency and cognitive impairment, thus suggesting a role for HO-1 deficiency in HIV neuropathogenesis (42, 585).

Because brain HO-1 deficiency is associated with cognitive impairment in HIV-infected individuals, we have proposed targeting HO-1 as a therapeutic target for neuroprotection against HIV as an adjunctive therapy to antiretroviral therapy (ART) for preventing pathogenic effects of HIV infection of the CNS (43, 585). HIV infection is associated with a syndrome of cognitive dysfunction (HIV-associated neurocognitive disorders (HAND)) in up to 50% of ART-treated HIV-infected individuals (180, 598, 599), which is thought to result in part from persistent inflammation and oxidative stress within both the CNS and systemic compartments (600). Within the CNS, such effects are driven largely by HIV infection of macrophages and microglia, long-lived HIV reservoirs that persist in ART-treated individuals (41).

The brain deficiency of HO-1 in HIV-infected individuals correlates with CNS HIV replication levels, immune activation markers, and the presence of HAND (43). In vitro, productive replication of HIV-1 in monocyte-derived macrophages (MDM) drastically reduces HO-1 protein and enhances supernatant neurotoxicity (42, 46). Together, these observations suggest a heretofore unknown neuropathological link between HIV replication in macrophages and a failure of a normal host cytoprotection surveillance response (HO-1 induction), which may promote neurodegeneration through inflammation-associated excitotoxic injury.

To further define this HIV-mediated macrophage HO-1 deficiency, we now determine the effects of HIV macrophage replication over the course of infection on the expression of HO-1, HO-2, and a panel of ARE proteins. In addition, we examined the association between HO-1 loss in HIV-MDM, supernatant neurotoxicity, and the release of the HAND relevant excitotoxin glutamate. Next we expanded our study to include an examination of a broader group of macrophage-tropic clade B HIV-1 strains (n = 13), a macrophage-tropic clinical HIV-2 isolate, and an examination of the potential roles for the HIV-1 accessory proteins Nef, Vpr, and Vpu in modulating HO-1 expression and associated neurotoxicity in infected MDM. Finally, to address the association between HIV replication and HO-1 deficiency in the setting of ART use, we determined the ability of clinically-relevant ART regimens applied pre- and post-infection to prevent HO-1 loss and associated neurotoxicity in HIV infected MDM. We found that induction of HO-1 loss in MDM was relatively selective; we observed no reduction in the expression of HO-2 or other ARE proteins in HIV-MDM. This loss of HO-1 was a consistent feature of macrophage-tropic HIV-1 strains and we observed a similar effect with HIV-2 infection. HIV replication levels correlated negatively with HO-1 protein expression and positively with culture supernatant glutamate levels and associated neurotoxicity. Induction of HO-1 deficiency did not require the HIV-1 accessory genes *nef*, *vpr*, or *vpu*. Finally, ART ameliorated the neurotoxic effects of HO-1 deficiency by prevention of HIV replication in newly-infected MDM, but no such protection was seen in MDM with established HIV

infection. These observations suggest that HO-1 deficiency in the pool of infected macrophages within the CNS of infected individuals may associate with macrophage neurotoxin production and represents a unique target for adjunctive therapies for neuroprotection in ART-treated individuals.

10.3 Results

HO-1 protein deficiency in HIV-infected macrophages occurs concomitantly with increased supernatant glutamate and neurotoxicity

Many published studies, including our own, have linked HIV-associated macrophage/microglial immune activation to neuronal injury and neurodegeneration in vitro and in vivo (33, 36, 42, 46, 530, 601). We therefore investigated the link between macrophage HIV infection, HO-1 expression, and associated neuronal injury in our in vitro HIV neurodegeneration model system of the course of infection. Analogous with the brain HO-1 deficiency that we observed in HIV⁺ individuals, HIV-infection of MDM in vitro drastically reduced HO-1 expression. This reduction in HIV-MDM HO-1 expression was progressive and time-dependent, typically showing a significant drop within 6-9 days after virus inoculation as replication approached its highest level (Figure 10.1, A and B). Furthermore, in contrast with this progressive HO-1 reduction, the expression of other ARE proteins (superoxide dismutase 1, SOD1; ferritin heavy chain 1, FTH1; peroxiredoxin1, PRDX1; glutathione S-transferase pi 1, GSTP1; thioredoxin reductase 1, TRXR1; NQO1; GPX1) was not consistently altered during infection (Figure 10.1C). Several of these proteins showed a transient increase from basal levels immediately after infection (day 0), but only HO-1 exhibited a progressive and persistent change from baseline over the course of infection. This suggests that the decrease in HO-1 protein expression in HIV-MDM is relatively specific and not a consequence of global suppression of ARE-driven gene expression. Finally, we did not observe a decrease in expression of HO-2, which further suggests that the decrease of the HO-1 isoform is relatively specific.

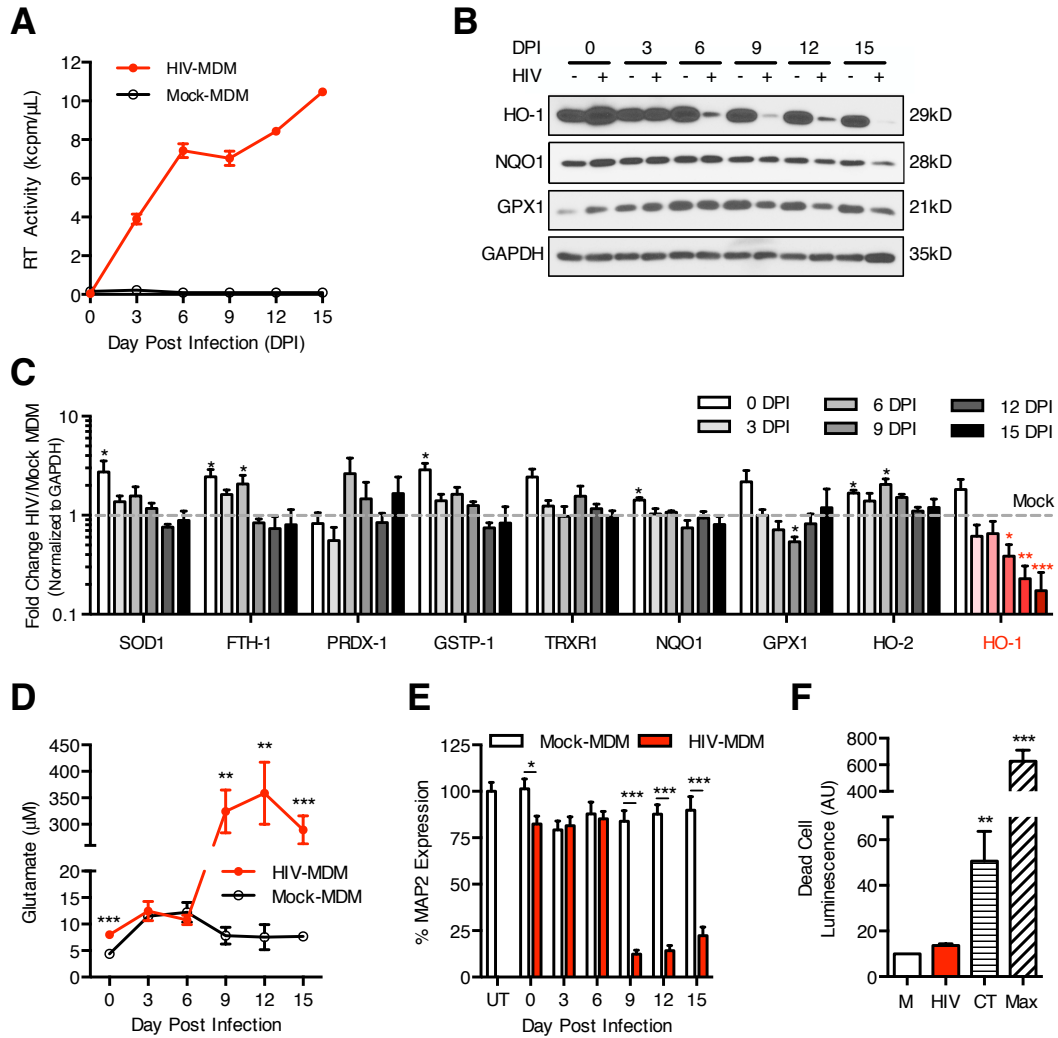

Figure 10.1 HIV infection of MDM reduces HO-1 protein expression and concomitantly increases supernatant glutamate levels and neurotoxicity. Infected (HIV-MDM) and mock-infected cultures (mock-MDM) were sampled and harvested every 3 days post infection (DPI) for analysis of supernatant glutamate content, supernatant neurotoxicity, and cellular protein expression. **(A)** Mean supernatant RT activity from representative HIV-infected and mock-infected cultures. **(B)** Western blot of selected ARE proteins (NQO1, HO-1, and GPX1) over the 15-day course of representative HIV-MDM infections. **(C)** Quantification of expression of canonical ARE proteins and HO-2 over the course of infection, as determined by Western blotting. Values represent mean \pm SEM ($n = 4$ different macrophage donor cultures) of the fold change in protein expression in HIV-infected versus mock-infected MDM. **(D)** Supernatant glutamate concentration and **(E)** supernatant neurotoxicity as measured by MAP2 expression in supernatant-exposed rat primary neuronal cultures) normalized to untreated (UT). RT, glutamate, and neurotoxicity data are representative of 4 independent experiments, with each replicate performed on MDM preparations from different donors. **(F)** Quantification of MDM cell death at 12 days after HIV infection. Results are averaged from 3 independent donors. Camptothecin (CT, 6 hour exposure) and complete cell lysis (max, maximum cytotoxicity) served as positive controls. All values represent mean \pm SEM. Statistical comparisons were made by paired Student's t test. * $P < 0.05$; ** $P < 0.01$; *** $P < 0.001$.

Suppression of HO-1 expression in human macrophages is a consistent phenotype of infection by macrophage-tropic HIV-1 strains

Our previous studies demonstrated the ability of several prototypic macrophage-tropic HIV-1 strains (89.6, Jago) to selectively reduce expression of the antioxidant response enzyme, HO-1, in human MDM, which is associated with a marked increase in MDM glutamate release and culture supernatant neurotoxicity (42, 43). This macrophage response suggests a plausible mechanism by which HIV-1 infection of brain macrophages could exacerbate oxidative stress and glutamate-induced neuronal injury, each of which is associated with neurocognitive dysfunction in infected individuals (174, 239). To determine whether this unique macrophage response to HIV is a consistent feature of macrophage-tropic HIV strains, we examined a broader panel of 13 clade B HIV-1 strains used to infect MDM derived from five independent human donors. All donors were confirmed negative for presence of the CCR5- Δ 32 allele, a deletion mutation resulting in a nonfunctional CCR5 receptor that prevents infection by CCR5 using strains.

Among these 13 HIV-1 strains we observed a ~3 log range of replication in MDM derived from the different human MDM donors (Figure 10.2 and 10.3). Two-way ANOVA analysis by viral strain and MDM donor demonstrated that the variability in HIV replication level as determined by supernatant reverse transcriptase (RT) activity (Figure 10.2, A and B) and cell-associated HIV-1 p24 antigen (Figure 10.2, C-E) was accounted for primarily by viral strain (75.3% for supernatant RT, $p < 0.001$; 86.9% for cell-associated p24, $p < 0.001$) and much less by donor (9.4% supernatant RT, $p < 0.001$; 1.2% cell-associated p24, $p < 0.05$). As predicted, supernatant RT activity strongly positively correlated with cell-associated p24 content (Figure 10.2F), suggesting proportional production of intracellular viral proteins and release of viral particles and consistency among MDM cultures. Thus, an HO-1 response associated with infection of MDM with these strains can be attributed to an HIV replication-dependent phenotype.

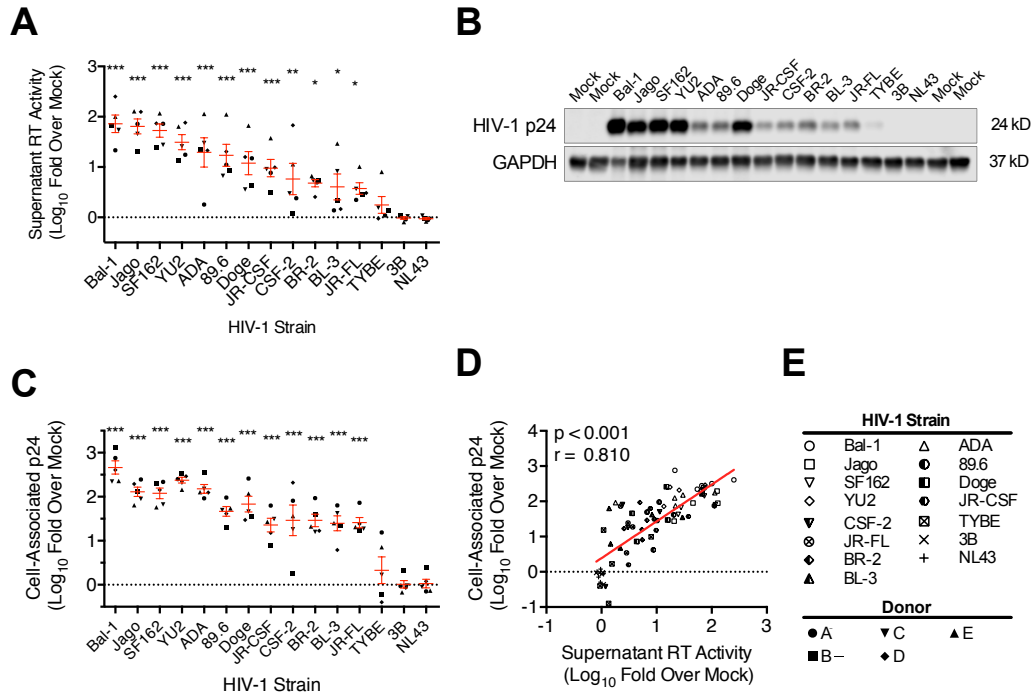

Figure 10.2 Supernatant reverse transcriptase activity and cell-associated HIV-1 p24 antigen content are highly correlated markers of HIV-1 replication in macrophages. MDM isolated from five healthy donors were infected with each of fifteen HIV-1 strains (inoculum of 25ng HIV-1 p24 content per 4×10^5 MDM). Replication was assessed on day 12 post infection by supernatant reverse transcriptase (RT) and by cell-associated HIV-1 p24 expression as quantified by Western blot. **(A)** Day 12 MDM supernatant RT activity (all 5 donors) stratified by strain normalized to uninfected/Mock-MDM. **(B)** Representative Western blot of cell-associated p24 on day 12 post infection from Donor A. **(C)** Densitometry analysis of cell-associated p24 expression (all 5 donors) stratified by strain and normalized to GAPDH and Mock-MDM background. **(D)** Correlation between supernatant RT activity and cell-associated p24 expression on day 12 post-infection. **(E)** Key for HIV strain and MDM donor symbols. RT and p24 values for Mock-MDM were set to 0 on a log scale (dotted line). Error bars indicate mean \pm SEM. Statistical comparisons to Mock-MDM were made by two-way ANOVA with Holm-Sidak post hoc test. Correlations were assessed by Pearson's correlation with line of best fit determined by linear regression. * $p < 0.05$, ** $p < 0.01$, *** $p < 0.001$.

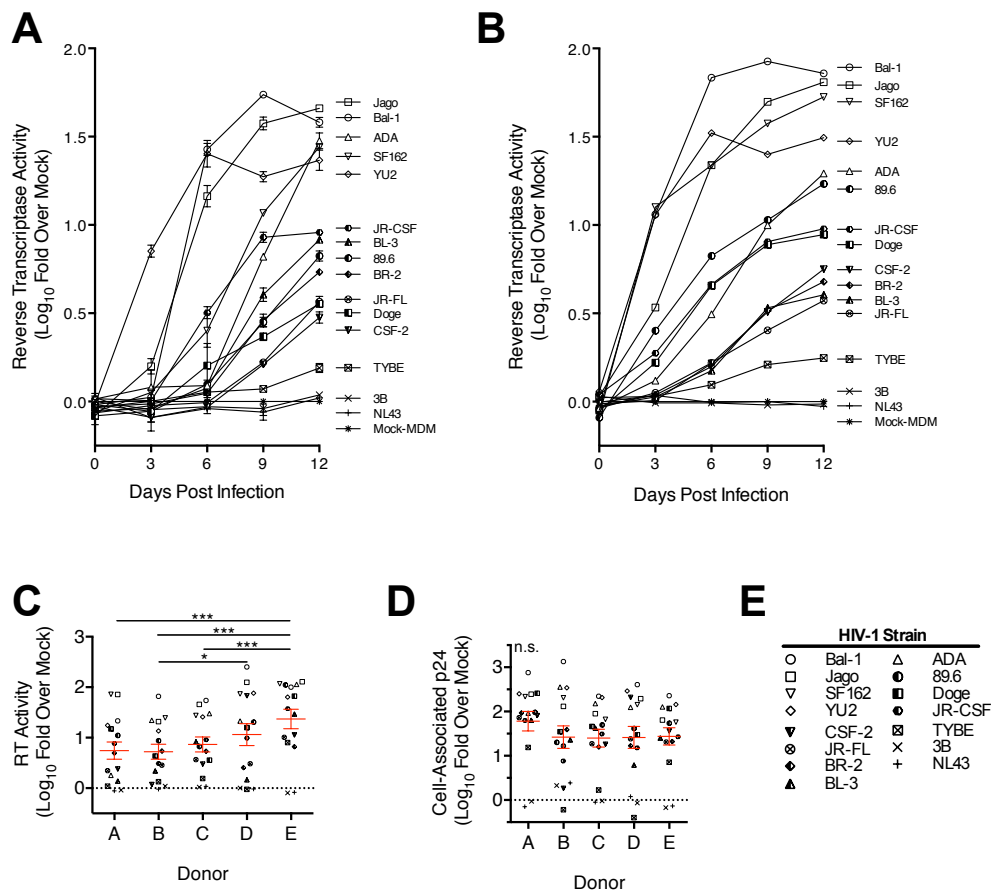

Figure 10.3 HIV-1 strain replication in primary human macrophages from different donors.

Replication of fifteen HIV-1 viral strains (inoculum 25ng p24 per 400,000 cells) in monocyte-derived macrophages (MDM) isolated from five healthy donors was assessed every 3 days over 12 days of infection by supernatant reverse transcriptase (RT) activity. **(A)** Supernatant RT activity in Donor C over the course of infection normalized to Mock-MDM background. Values represent mean \pm SEM. **(B)** Average supernatant RT activity in all five donors over the course of infection normalized to Mock-MDM background. Errors bars are not shown for clarity. **(C)** Day 12 supernatant RT activity in all 5 donors stratified by donor normalized to uninfected/Mock macrophages. **(D)** Day 12 HIV-MDM lysate p24 content in all five donors stratified by donor as assessed by Western blot. **(E)** Key for HIV strain symbols. Error bars indicate mean \pm SEM. Statistical comparisons to between donors were made by two-way ANOVA with Holm-Sidak post hoc test. * $p < 0.05$, *** $p < 0.001$

Productive infection of MDM with 11 of the 13 macrophage-tropic HIV-1 strains significantly decreased HO-1 protein expression (Figure 10.4, A and B), while infection with the two remaining strains (CSF-2, BR2) did not. Non-productive infection with the non-macrophage-tropic 3B swarm or the related NL43 strain also did not significantly reduce HO-1 expression. No effect on expression of the constitutive heme oxygenase isoform, HO-2, by any HIV strain was observed (Figure 10.4C), consistent with our previous observations of a selective suppression of HO-1 expression by the prototypic HIV-1 strains 89.6 and Jago. Expression of HO-1 correlated negatively with HIV replication level when analyzed across all five macrophage donors and all HIV strains (Figure 10.4, D and E), thus demonstrating consistency of this HO-1 deficiency with infection of macrophages by most, but not all, infecting strains. We confirmed the strong association between HIV replication level and HO-1 protein reduction seen among different HIV-1 strains by examining HO-1 reduction with different levels of replication by a single strain, 89.6 (Figure 10.5). Achieving increasing levels of replication in MDM by inoculating with increasing amounts of virus (Figure 10.5A), resulted in increasing HO-1 deficiency (Figure 10.5, B and C). This relationship was confirmed in each of three independent macrophage donors (Figure 10.5, D-F). This suggests that for individual macrophage-tropic strains, varying levels of replication would predictably decrease HO-1 expression. Notably, the decrease in HO-1 protein expression is associated with a highly significant and strongly correlated decrease in HO-1 RNA expression (Figure 10.6, A and B). Consistent with Western blot analysis of HO-2 protein expression, we did not observe any changes in HO-2 RNA expression in HIV-MDM with 89.6 infection (Figure 10.6C). Thus, varying levels of MDM infection by a viral swarm within an individual or among different individuals infected with genetically distinct macrophage-tropic HIV strains could be expected to result in varying, albeit significant, reduction in levels of HO-1 expression within the MDM compartment.

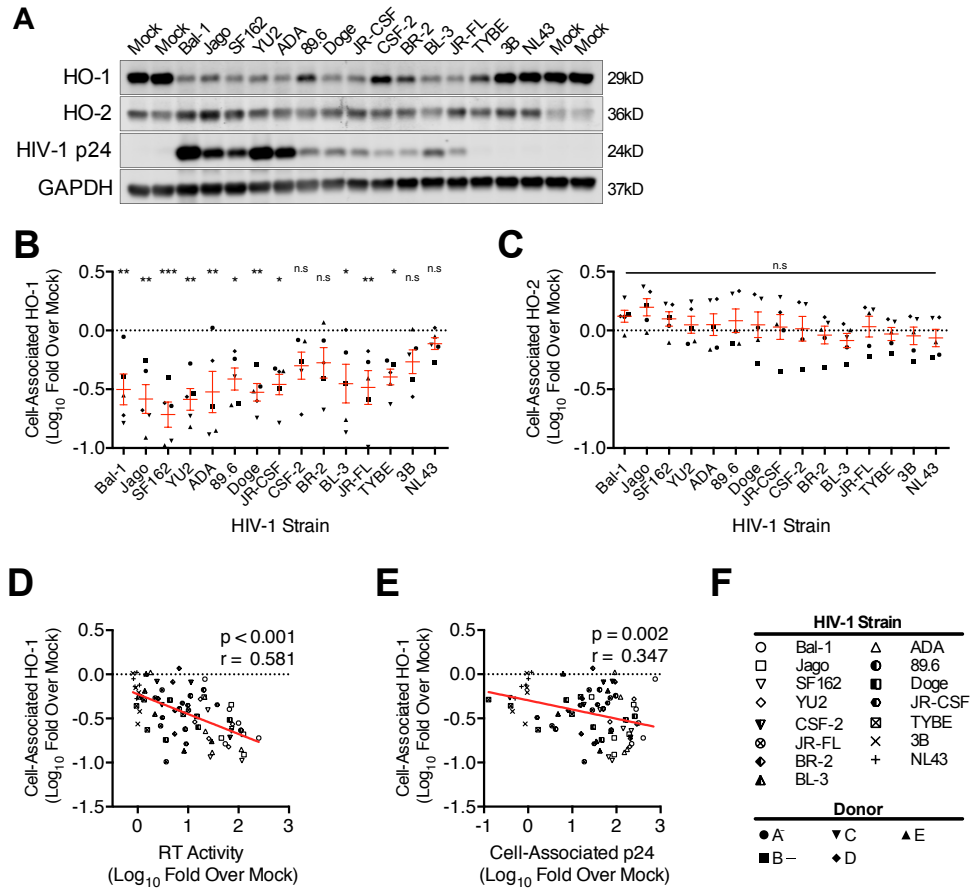

Figure 10.4 HIV-1 replication consistently induces HO-1 deficiency in macrophages. MDM isolated from five healthy donors were infected with each of fifteen HIV-1 viral strains (inoculum of 25ng HIV-1 p24 per 4×10^5 MDM). On day 12 post infection, MDM lysates were assessed for HO-1, HO-2, HIV-1 p24, and GAPDH protein expression by Western blot. Replication was assessed on day 12 post infection by supernatant RT activity and by cell-associated HIV-1 p24. **(A)** Representative Western blot of HO-1, HO-2, HIV-1 p24, and GAPDH in HIV-MDM from one donor. Densitometry analysis of **(B)** HO-1 and **(C)** HO-2 protein expression in HIV-MDM (all 5 donors) stratified by strain and normalized to GAPDH and presented as fold change from Mock-MDM. HO-1 and HO-2 expression levels in Mock-MDM were set to 0 on a log scale (dotted line). Error bars indicate mean \pm SEM. Correlation between macrophage HO-1 protein expression and **(D)** supernatant RT and **(E)** cell-associated HIV-1 p24. **(F)** Key for HIV strain and MDM donor symbols. Statistical comparisons to Mock-MDM were made by two-way ANOVA with Holm-Sidak post hoc test. Correlations were assessed by Pearson's correlation with line of best fit determined by linear regression. * $p < 0.05$, ** $p < 0.01$, *** $p < 0.001$.

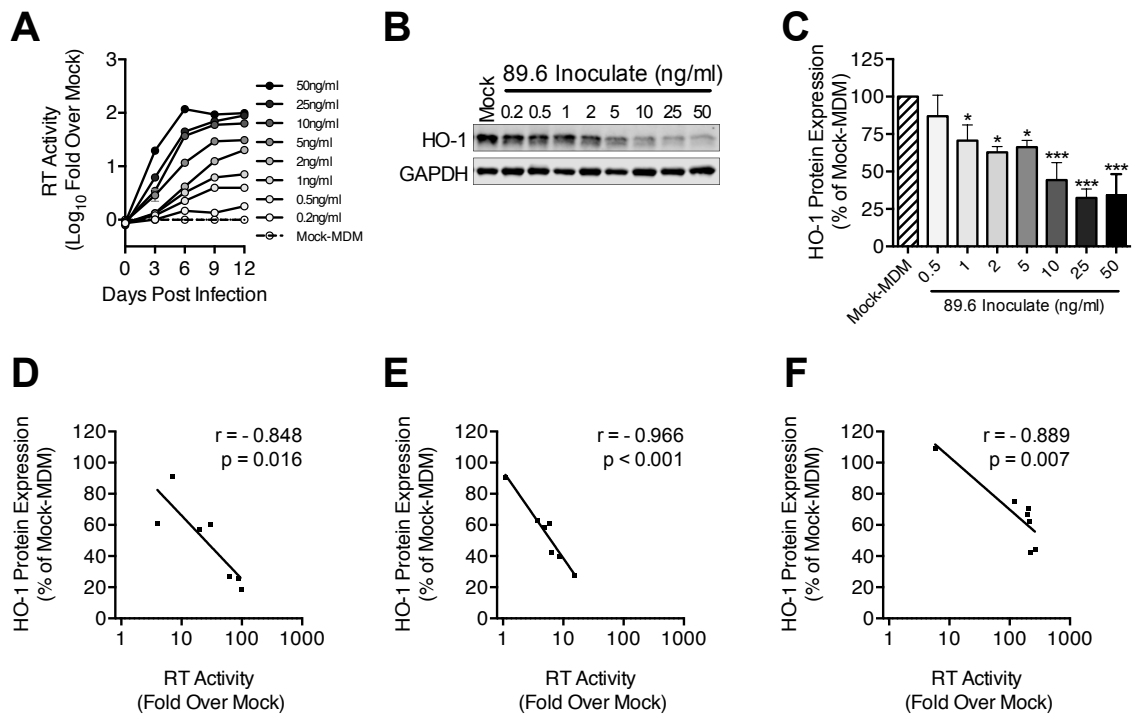

Figure 10.5 HIV-1 replication level predicts HO-1 loss within an HIV-MDM culture. MDM were infected with different inocula (0.2 to 50ng/ml HIV p24 per 4×10^5 cells) of HIV-1 89.6. Representative data from one MDM donor infection showing (A) HIV replication (n = 2 technical replicates) and (B) HO-1 and GAPDH protein Western blot (day 12 post infection) over the range of viral inocula tested. (C) Quantification of HO-1 protein expression normalized to GAPDH (n = 3 MDM donors). (D-F) Correlation between day 12 post infection HO-1 protein expression and RT activity for each individual donor. Error bars indicate mean \pm SEM. Statistical comparisons to Mock-MDM were made by one-way ANOVA with Holm-Sidak post hoc test. Correlations were assessed by Pearson's correlation with line of best fit determined by linear regression. * p < 0.05, ***p < 0.001

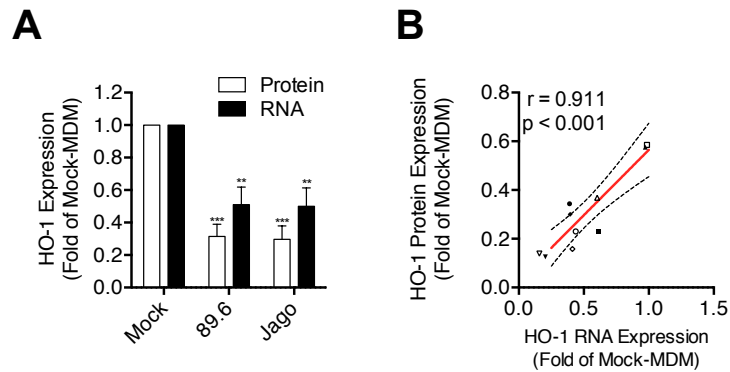

Figure 10.6 HIV-MDM HO-1 protein expression correlates with HO-1 RNA expression. Protein and RNA expression of HO-1 and GAPDH in HIV-MDM lysates were assessed by Western blot and qPCR, respectively, on day 12 post HIV infection (89.6 or Jago strains). **(A)** Protein and RNA expression of HO-1 normalized to GAPDH expression in HIV-MDM from 5-6 independent donors. **(B)** Correlation between HO-1 protein and RNA expression levels in HIV-MDM from 5 independent donors (distinguished by symbol shape) infected with HIV-1 strains 89.6 (closed shapes) or Jago (open shapes). Mock-MDM HO-1 protein and RNA expression was set to 1. Error bars indicate mean \pm SEM. Statistical comparisons to Mock-MDM were made by one-way ANOVA with Holm-Sidak post hoc test. Correlations were assessed by Pearson's correlation with line of best fit determined by linear regression. ** $p < 0.01$, *** $p < 0.001$.

HO-1 deficiency in HIV-MDM correlates with supernatant glutamate level and associated neurotoxicity

Previously, we demonstrated that modulating HO-1 in HIV-MDM modulates supernatant neurotoxicity (42, 43). Thus, we assessed the association between HIV-driven HO-1 reduction and neurotoxin production in our panel of HIV-1 strains. Replication in MDM by five of the six highest replicating viral strains (Bal-1, Jago, SF162, YU2, and 89.6) produced significant supernatant neurotoxicity in our neuronal/glial cell-based ELISA (Figure 10.7A). Notably, MDM derived from one of the five donors produced significantly higher levels of HIV-MDM supernatant neurotoxicity in comparison with the other donors (Figure 10.7B). A two-way ANOVA analysis demonstrated that while most supernatant neurotoxicity was accounted for by the viral strain (69.6%, $p < 0.001$), neurotoxicity variability could also be attributed to donor variability (16.0%, $p < 0.001$). These data suggest that host macrophage determinants that affect neurotoxic potential, potentially such as differential donor HO-1 inducibility or basal HO-1 expression, can play a significant role in determining neurotoxin output in response to HIV infection.

We and others previously identified glutamate as a major neurotoxin released from HIV-infected MDM and microglia (43, 46, 229, 602). The six most robustly replicating HIV strains (Bal-1, Jago, SF162, YU2, ADA, and 89.6) significantly increased MDM supernatant glutamate content (Figure 10.7C). Although there was significant variability in supernatant glutamate levels among different donors (Figure 10.7D), these differences were minimized when supernatant glutamate content was expressed as a fold-increase over matched Mock-MDM glutamate content (Figure 10.7E). Supernatant neurotoxicity positively correlated ($p < 0.001$) with supernatant glutamate content across all donors and strains (Figure 10.7F), which is consistent with glutamate toxicity being a primary component of HIV-MDM supernatant neurotoxicity (46, 229). These data suggest that while basal levels of glutamate production differ among donors the proportional HIV induction of MDM glutamate and associated neurotoxicity is similar among donors.

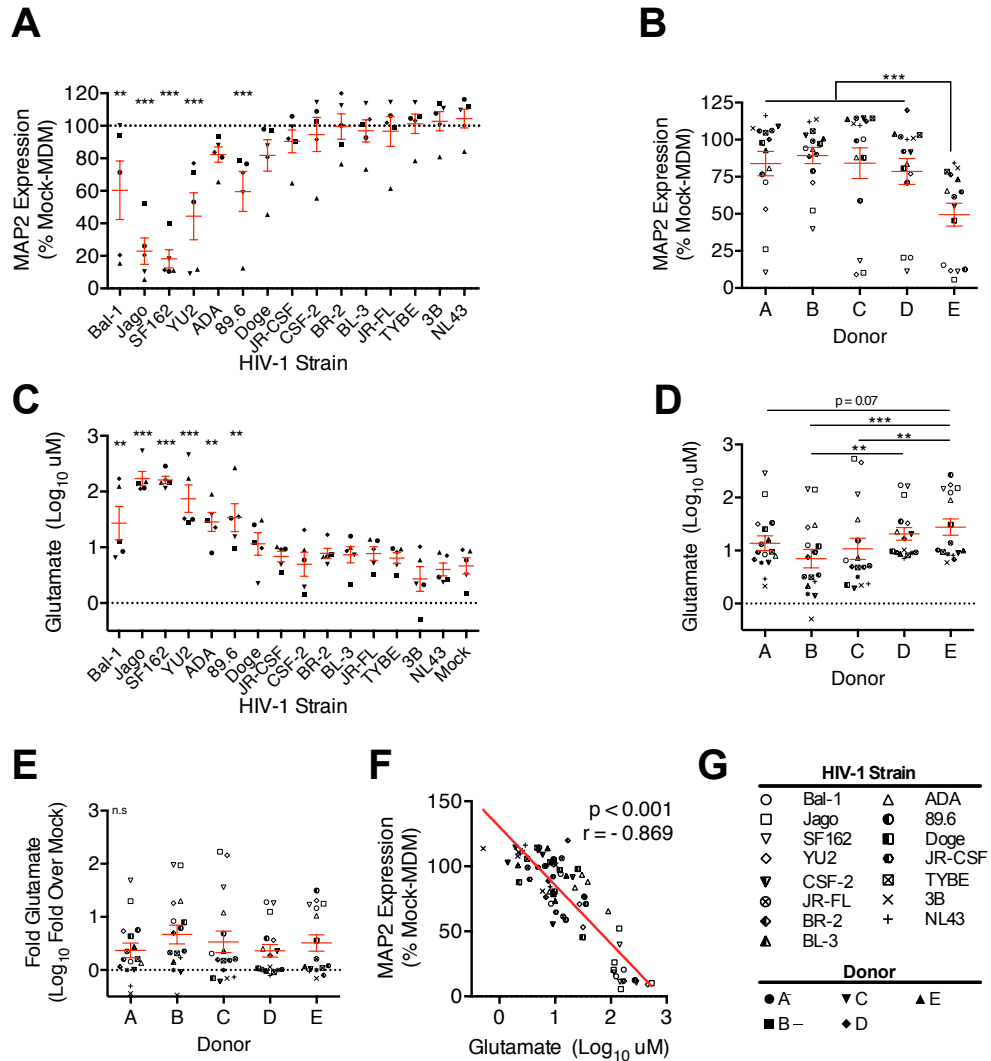

Figure 10.7 HIV-1 infection of MDM induces glutamate-associated supernatant neurotoxicity. Neurotoxicity of HIV-MDM supernatants was assessed by applying supernatants (day 12; 1:20 dilution) to primary rat neuroglial cultures for 24 hours, followed by quantification of culture MAP-2 content by ELISA. Supernatant glutamate content was quantified by Amplex Red Glutamate Assay. Supernatant neurotoxicity (loss of MAP2; Mock-MDM set to 100% expression of MAP2) stratified by (A) strain and (B) by MDM donor (n = 5). Supernatant glutamate concentrations stratified by (C) strain and by (D) MDM donor (n = 5). (E) Fold supernatant glutamate levels in all 5 donors stratified (E) by donor normalized to Mock-MDM supernatant glutamate. (F) Correlation between supernatant neurotoxicity and glutamate level across all five donors and all 15 HIV-1 strains. (G) Key for HIV strain and MDM donor symbols. Error bars indicate mean \pm SEM. Statistical comparisons to Mock-MDM or between donors were made by two-way ANOVA with Holm-Sidak post hoc test. Correlations were assessed by Pearson's correlation with line of best fit determined by linear regression. ** $p < 0.01$, *** $p < 0.001$.

Within our HIV-1 panel, HIV-MDM supernatant neurotoxicity and glutamate level correlated with HO-1 deficiency (Figure 10.8, A and B) and HIV strain replication (Figure 10.8, C-F) in the supplemental material), consistent with our previous studies (42, 43). Despite these correlations between HO-1 loss, neurotoxicity, and replication, however, several poorly replicating HIV-1 strains significantly reduced HO-1 protein expression without significantly increasing supernatant neurotoxicity or glutamate content. This suggests that a 'threshold' level of replication is necessary for increasing glutamate release from HIV-MDM in the context of HO-1 deficiency. Consistent with this, HO-1 reduction in MDM by siRNA knockdown in the absence of HIV infection did not increase supernatant glutamate content or supernatant neurotoxicity (Figure 10.9, A-C). Thus, HIV replication concomitant with HO-1 reduction appears necessary to increase glutamate release, suggesting critical virus-specific effects that create a permissive environment in MDM for enhanced glutamate release in a state of HO-1 deficiency.

Antiretroviral treatment of established HIV-MDM infection fails to limit HO-1 deficiency and associated neurotoxicity

Given the strong correlation between HIV replication and HO-1 loss, we determined the ability of ART treatment to prevent HO-1 loss and neurotoxicity associated with HIV-MDM. We utilized three ART regimens recommended for initial treatment in ART naïve patients (603). Each regimen included the two nucleoside reverse transcriptase inhibitors (NRTIs), tenofovir disoproxil fumarate (TDF, 20nM) and emtricitabine (FTC, 500nM), in addition to either *i*) efavirenz (EFZ, 40nM), a non-nucleoside reverse transcriptase inhibitor (NNRTI)-based regimen (regimen 1); *ii*) atazanavir boosted with ritonavir (ATV/r, 15nM/10nM), a protease-inhibitor (PI)-based regimen (regimen 2); or *iii*) raltegravir (RAL, 50nM), a integrase strand transfer inhibitor (INSTI)-based regimen (regimen 3). The chosen drug concentrations were based upon reported cerebrospinal fluid drug concentrations in ART-treated patients (189). To more effectively suppress HIV

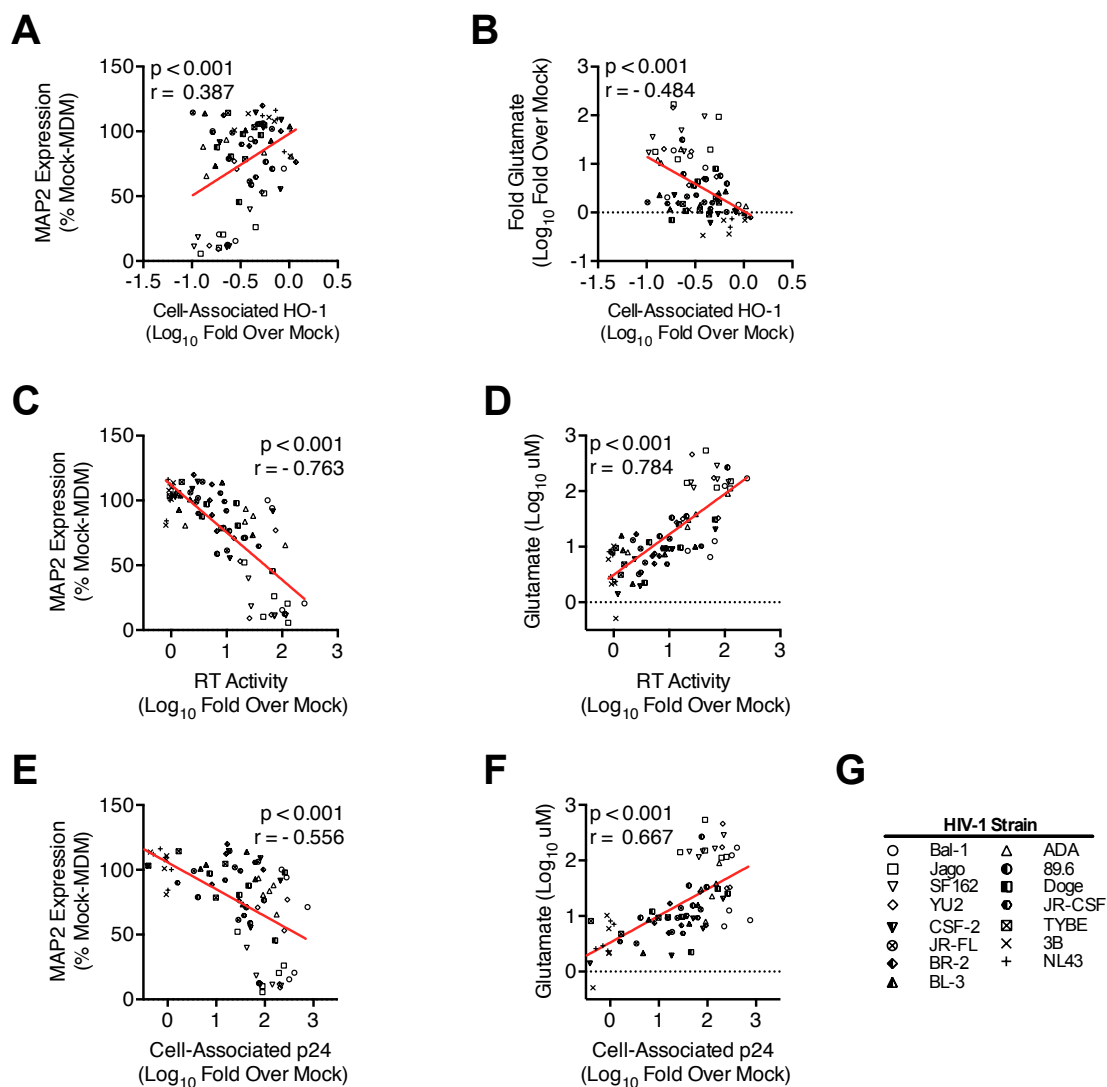

Figure 10.8 Supernatant neurotoxicity and glutamate levels correlate with HO-1 loss and replication in HIV-MDM. MDM isolated from five healthy donors were infected with each of fifteen HIV-1 viral strains (inoculum of 25ng HIV-1 p24 per 4×10^5 MDM). On day 12 post infection, MDM lysates were assessed for HO-1, HIV-1 p24, and GAPDH protein expression by Western blot. Replication was assessed on day 12 post infection by supernatant RT activity and by cell-associated HIV-1 p24. Correlation between macrophage HO-1 protein expression and supernatant (A) neurotoxicity and (B) glutamate concentration. Correlation between supernatant RT activity and supernatant (C) neurotoxicity and (D) glutamate concentration. Correlation between cell-associated HIV p24 protein expression and supernatant (E) neurotoxicity as measured by MAP2 ELISA and (F) glutamate concentration. (G) Key for HIV strain and MDM donor symbols. Correlations were assessed by Pearson's correlation with line of best fit determined by linear regression.

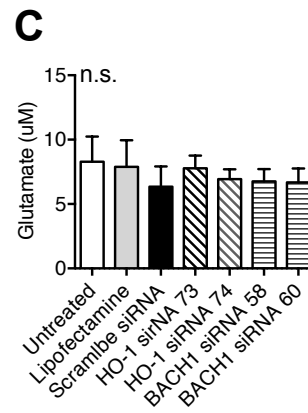
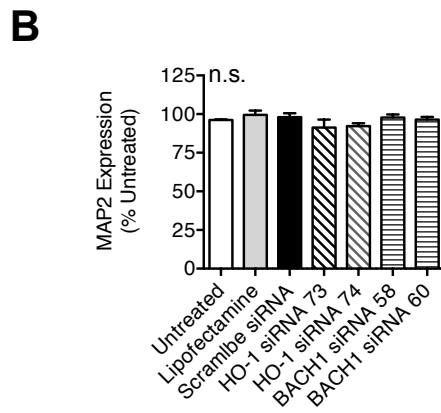
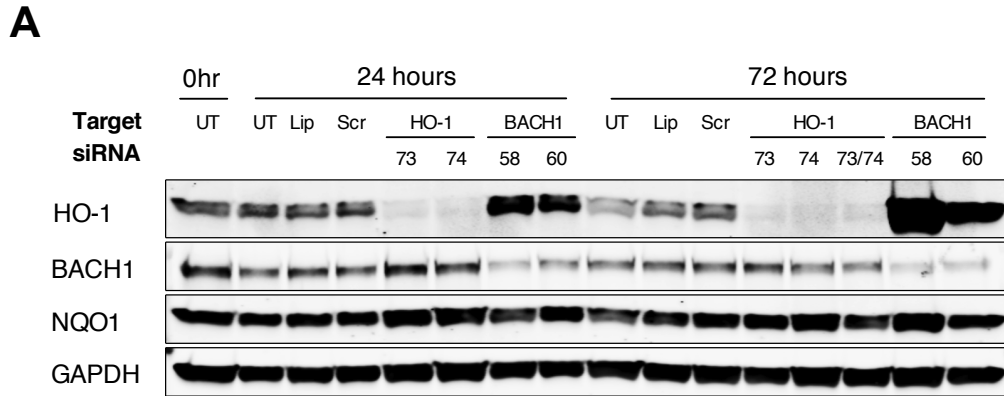

Figure 10.9 Targeted siRNA knockdown of HO-1 or the HO-1 repressor BACH1 in uninfected MDM does not alter supernatant neurotoxicity or glutamate content. MDM from 4 independent donors were transfected using Lipofectamine RNAiMax with 50nM of siRNA targeting either HO-1 or BACH1. Two distinct Silencer Select (Ambion) siRNAs targeting HO-1, s6673 (73) and s6674 (74), or BACH1, s1859 (59) and s1860 (60), were used independently to efficiently knockdown or derepress HO-1, respectively. Additional MDM were either left untreated (UT), exposed to lipofectamine (Lip), or transfected with scramble siRNA (Scr; #4390856 Ambion). **(A)** Representative Western blot for HO-1, BACH1, NQO1, and GAPDH at 24 hours and 72 hours post transfection with select siRNAs. MDM supernatant **(B)** neurotoxicity as measured by MAP2 ELISA and **(C)** glutamate content 72 hours post transfection. Errors bars indicate mean \pm SEM (n = 4). Statistical comparisons to Mock-MDM were made by one-way ANOVA with Holm-Sidak post hoc test. n.s. = not significant.

replication, we also used a high-dose PI-based regimen with five-fold higher ATV/r concentrations (75nM/50nM) and unchanged TDF and FTC concentrations (regimen 4).

To attempt to fully determine the effectiveness of ART in preventing HO-1 loss in HIV-MDM, we applied the treatment prior to and after establishing HIV infection in MDM. We pre-treated MDM with each ART regimen one hour prior to HIV infection and replenished all ART drugs with each media change. To model the ability of ART to impact already-infected macrophages, we also treated HIV-MDM with each ART regimen after HIV inoculation (beginning days 3 and 6 post-infection), and replenished all ART drugs with each media change. We analyzed HIV replication over the course of infection and we analyzed HO-1 expression and supernatant neurotoxicity from the last day of infection. Pre-treatment with each ART regimen resulted in no detectable viral replication or HO-1 loss, and dramatically reduced supernatant neurotoxicity (Figure 10.10, A-D). Notably, supernatants from ART pre-treated HIV-MDM showed a non-significant trend for enhanced neurotoxicity compared to Mock-MDM supernatants, although only those derived from MDM treated the NNRTI-based regimen (#1) reached statistical significance (Figure 10.10B).

Treatment of HIV-MDM on day 3 post-infection significantly reduced HIV replication, but only regimen 4 (high-dose PI) treatment significantly reduced HO-1 loss and supernatant neurotoxicity (Figure 10.10, A-D). No treatment regimen applied on day 6 post-infection reduced replication (Figure 10.10A), supernatant neurotoxicity (Figure 10.10B), or HO-1 loss (Figure 10.10, C and D). These data confirm the correlations between viral replication, HO-1 loss, and supernatant neurotoxicity in HIV-MDM. Furthermore, these findings strongly suggest that, although physiologically-relevant CNS concentrations of ART can protect against HO-1 loss by preventing HIV infection, they cannot prevent HO-1 loss and associated neurotoxicity from HIV-infected MDM. This ART failure to protect HIV-MDM from HO-1 loss and increased neurotoxicity underscores the potential importance of a persistently infected CNS macrophage reservoir in mediating neuronal injury even in ART-treated individuals.

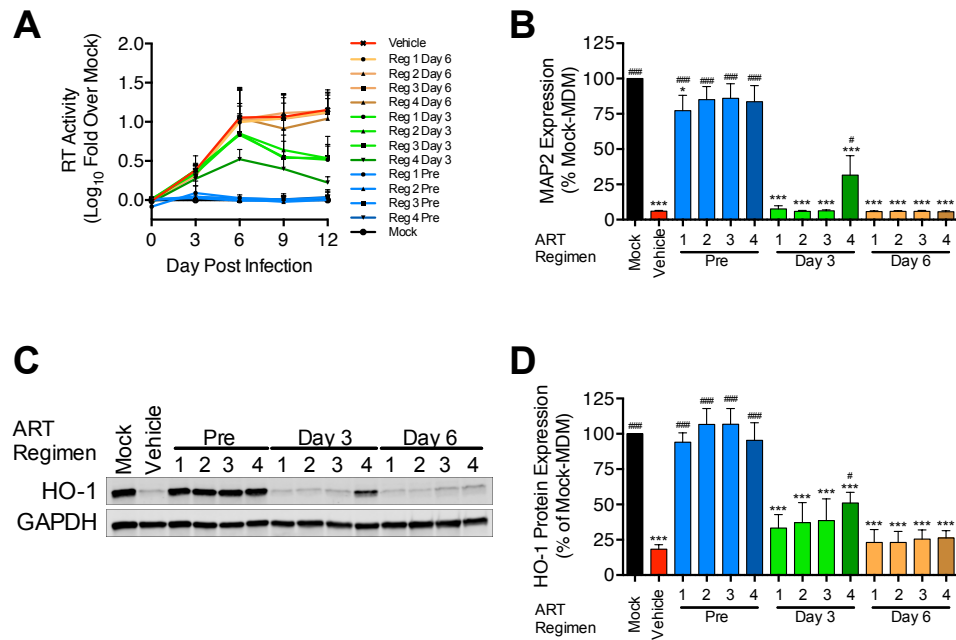

Figure 10.10 Antiretroviral drug treatment prior to, but not after, HIV-infection of MDM prevents HO-1 loss and associated neurotoxicity. MDM were treated with ART regimens either 1 hour prior to, 3 days after, or 6 days after HIV-1 (89.6) infection. ART drugs were replenished every 3 days with media changes. ART regimens were as follows: Regimen 1: 20nM TDF, 500nM FTC, and 40nM EFZ. Regimen 2: 20nM TDF, 500nM FTC, 15nM/10nM ATV/r. Regimen 3: 20nM TDF, 500nM FTC, and 50nM RAL. Regimen 4: 20nM TDF, 500nM FTC, and 75nM/50nM ATV/r. **(A)** HIV replication and **(B)** supernatant neurotoxicity in HIV-MDM (n=4). **(C)** Representative Western blot, and **(D)** densitometry quantification of HO-1 protein expression from last day of infection in all 4 donors. Error bars indicate mean \pm SEM. Statistical comparisons to Mock-MDM (*) and Vehicle (#) were made by one-way ANOVA with Holm-Sidak post hoc test. *,# p <0.05, ***,### p<0.001.

Accessory genes nef, vpr, and vpu are not required for HIV-1 mediated HO-1 reduction in infected macrophages

In addition to viral proteins required for genome replication and viral particle assembly, HIV-1 expresses several accessory proteins, Nef, Vpr, and Vpu, which can downregulate, degrade, or functionally inactivate certain host cell proteins, particularly viral restriction factors (604). To determine whether *nef*, *vpr*, or *vpu* might directly modulate HO-1 protein loss in HIV-MDM, we analyzed effects of infectious HIV mutant strains deficient in each (or all) of these accessory genes. We infected MDM with the wild-type (WT) molecular clone 89.6 or 89.6 clones deleted (Δ) individually for *nef*, *vpr*, or *vpu*, or the combination of all three (528).

The Δ *nef*, Δ *vpr*, and Δ *vpu* 89.6 mutants each replicated productively in MDM, albeit to different levels (Figure 10.11A). We found that 89.6 Δ *nef* and 89.6 Δ *vpu* replicated less robustly than WT 89.6, while 89.6 Δ *vpr* replicated to levels comparable to those of WT 89.6. As previously reported (528), 89.6 Δ *nef/vpr/vpu* did not replicate to detectable levels in MDM. Each replicating strain significantly reduced the MDM HO-1 expression (Figure 10.11, C and D) and increased associated supernatant neurotoxicity (Figure 10.11B), while the non-replicating 89.6 Δ *nef/vpr/vpu* did not. Furthermore, as predicted by our observations across all HIV-1 strains examined (Figure 10.4), the profile of HO-1 loss in infected MDM (Figure 10.11D) closely resembled the profile of neurotoxicity of the corresponding culture supernatants (Figure 10.11B). These data thus demonstrate that *nef*, *vpr*, and *vpu* accessory genes are not themselves directly required for HIV-1 mediated HO-1 loss in infected MDM, although their effects on HIV-1 replication do indeed modulate the level of HO-1 expression and associated supernatant neurotoxicity.

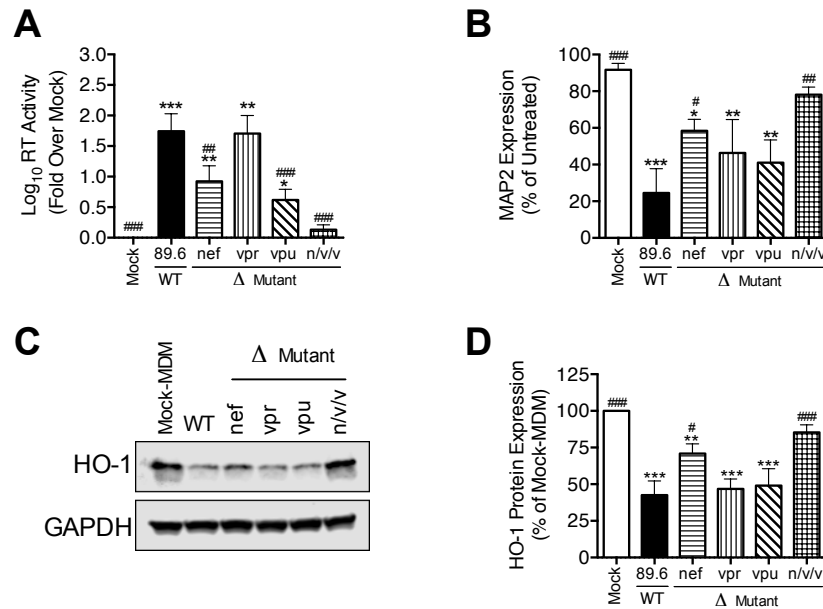

Figure 10.11 HIV-1 accessory genes *nef*, *vpr*, and *vpu* are not required for induction of HO-1 deficiency or associated neurotoxicity in HIV-MDM. MDM from 5 different donors were infected with wild-type (WT) 89.6 or mutant 89.6 lacking (Δ) *nef*, *vpr*, or *vpu* genes singularly or in combination (n/v/v). Supernatants (day 12 post infection) were analyzed for (A) HIV-replication and (B) supernatant neurotoxicity. (C) Representative Western blot and (D) summary densitometry analysis of HO-1 expression in HIV-MDM (day 12). Errors bars indicate mean \pm SEM (n = 5). Statistical comparisons to Mock-MDM (*) or WT 89.6 (#) were made by one-way ANOVA with Holm-Sidak post hoc test. *# p < 0.05, **.# p < 0.01, ***,### p < 0.001.

Macrophage tropic HIV-2 strain CBL-20 reduces HO-1 protein expression in infected MDM comparably to HIV-1 strain 89.6

The observation that 11 of 13 macrophage tropic HIV-1 strains tested significantly reduce HO-1 protein expression in MDM suggests that HO-1 loss is a highly conserved response to HIV-1 infection. This finding along with the lack of HIV-1 accessory gene requirement for HO-1 loss suggests that the other major human immunodeficiency virus group, HIV-2, which also causes immune deficiency, albeit less severely (605), might also induce HO-1 loss in MDM. We infected MDM derived from eight different human donors with HIV-2 CBL-20 (606) and HIV-1 89.6. While 89.6 replicated robustly and reduced MDM HO-1 protein expression in all donor cultures, HIV-2 CBL-20 replicated as robustly as 89.6 in MDM derived from only two of the eight donors (Figure 10.12A; Figure 10.13A). In these HIV-2-MDM cultures HO-1 protein expression was reduced similarly to that of 89.6-MDM, with comparable levels of supernatant neurotoxicity and glutamate content (Figure 10.12, B and C; Figure 10.13, B and C). Moreover, among all MDM donors, HO-1 protein loss in MDM correlated significantly with HIV-2 replication level (Figure 10.12D). Similar to HO-2-sparing effects of HIV-1 replication, we did not observe changes in HO-2 protein expression with HIV-2 replication (Figure 10.12B). These data suggest that HIV-driven HO-1 deficiency, glutamate release, and associated neurotoxicity are consistent features of HIV-1 and HIV-2 MDM infection.

10.4 Discussion

The continued prevalence of HAND and associated inflammation and oxidative stress in ART-treated HIV-infected individuals highlights the need for adjunctive therapies that target these neuropathological processes, which persist in both the CNS and systemic compartments. To this end, we have identified the anti-inflammatory and anti-oxidative enzyme HO-1 as a targetable host factor for adjunctive neuroprotective therapy for HAND. We previously demonstrated a

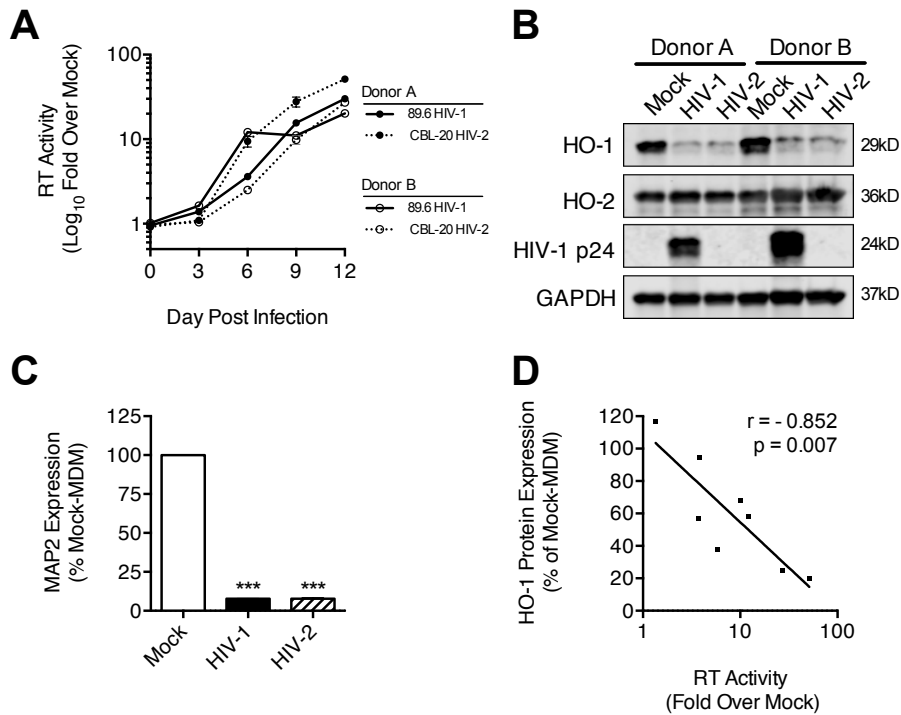

Figure 10.12 HIV-2 replication in MDM induces HO-1 deficiency and associated supernatant neurotoxicity. MDM (8 independent donors) were infected with HIV-2 CBL-20 and HIV-1 89.6. HIV-2 infection of MDM from 2 of 8 donors showed (A) replication levels comparable to those of HIV-1 89.6. (B) Western blot analysis of HO-1, HO-2, and HIV-1 p24, and (C) supernatant neurotoxicity in these representative infections. (D) Correlation between HO-1 protein expression and supernatant RT activity for HIV-2 MDM infections (all 8 donors). Errors bars indicate mean \pm SEM. Statistical comparisons to Mock-MDM were made by one-way ANOVA with Holm-Sidak post hoc test. Correlations were assessed by Pearson's correlation with line of best fit determined by linear regression. *** $p < 0.001$.

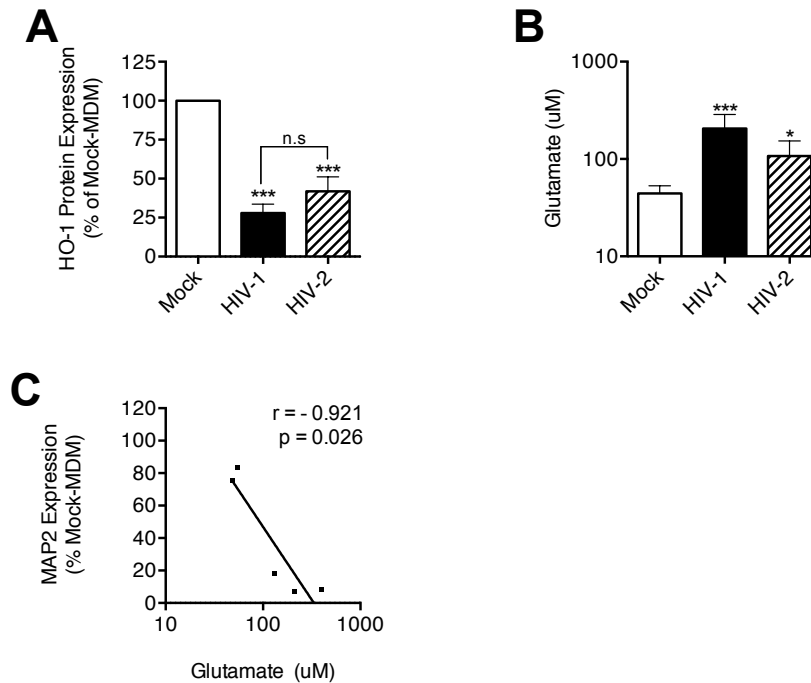

Figure 10.13 HIV-2 replication in MDM induces HO-1 deficiency and associated extracellular glutamate and supernatant neurotoxicity. MDM from 8 independent donors were infected with either HIV-2 CBL-20 or HIV-1 89.6. Supernatants and MDM lysates were analyzed from day 12 post infection. The 5 of the 8 donor MDM infections that demonstrated significant HIV-2 replication were analyzed. **(A)** HO-1 protein expression normalized to GAPDH as determined by Western blot densitometry analysis. **(B)** Supernatant glutamate content as determined by Amplex Red Assay. **(C)** Correlation between supernatant glutamate content and MAP2 ELISA neurotoxicity from day 12 post infection supernatants from HIV-2 infected MDM. Errors bars indicate mean \pm SEM ($n = 5$). Statistical comparisons to Mock-MDM were made by one-way ANOVA with Holm-Sidak post hoc test. Correlations were assessed by Pearson's correlation with line of best fit determined by linear regression. * $p < 0.05$, *** $p < 0.001$

significant deficiency of HO-1 protein within the brains of HIV-infected individuals with HAND and we further showed that this deficiency correlated with brain and CSF viral loads and markers of immune activation (43). Furthermore using two HIV-1 strains (Jago and 89.6), we demonstrated that HIV infection of macrophages reduces HO-1 protein expression in conjunction with neurotoxin production (42).

To expand on these initial observations, we examined the expression of HO-1, HO-2, and an expanded panel of ARE effector proteins over the course of HIV-MDM infection. These data demonstrated that HO-1 loss in HIV-MDM was progressive and time-dependent, typically showing a significant drop within 6-9 days after virus inoculation. This loss of HO-1 temporally associated with HIV-MDM glutamate release and supernatant neurotoxicity. The progressive deficiency of HO-1 was relatively specific, as other members of the ARE-driven gene family and the heme oxygenase isoform HO-2 were unaffected. To further define this neuropathological phenotype, we expanded these studies to examine a broader group of macrophage-tropic HIV-1 strains (n = 13). We demonstrated that most (11 of 13) clade B HIV-1 macrophage tropic strains induce a loss of HO-1 protein, in contrast to unaltered expression of HO-2 protein, and that loss of HO-1 protein in HIV-MDM correlates with decreased HO-1 RNA expression. We show that this loss of HO-1 expression in HIV-MDM associates significantly with viral replication and excitotoxic levels of supernatant glutamate. The HIV-1 accessory genes *nef*, *vpr*, or *vpu*, which are implicated in downregulating multiple host factors, are not required for this HO-1 deficiency phenotype, as mutant HIV-1 molecular clones lacking expression these accessory genes maintained the ability to reduce HO-1 protein expression and induce supernatant neurotoxicity in infected macrophages to an extent commensurate with their overall replication levels.

We further demonstrated that the other major human immunodeficiency virus, HIV-2, also reduces HO-1 protein expression and increases neurotoxin release in infected macrophages.

Although, HIV-1 and HIV-2 share many similarities including basic gene organization, replication pathways, and modes of transmission, HIV-2 shares only 50-60% nucleic acid homology with HIV-1 and it is more closely related to the simian-immunodeficiency virus (SIV). Compared to HIV-1, HIV-2 causes less severe disease as determined by lower plasma viral loads, less CD4+ T lymphocyte loss, reduced risk of progression to AIDS, and decreased mortality (605). Despite reduced pathogenic potential, HIV-2 infiltrates into the CNS and can cause neurological impairment and neuropathologic changes similar to those of HIV-1 (607). Our data suggest that this HO-1-deficient neurotoxic phenotype in macrophages is conserved across HIV-1 and HIV-2 strains and thus HO-1 loss may have a conserved role in neurological disease and neurocognitive impairment in both HIV-1 and HIV-2 infected individuals. In each of our HIV-1 and HIV-2 macrophage infection experiments, HO-1 deficiency correlated with viral replication. Despite this correlation, our data clearly demonstrate that even low-level HIV replication in macrophages can promote HO-1 loss. The conservation of this HO-1 deficiency phenotype across human immunodeficiency viruses suggests that reduction in HO-1 protein expression might provide a selective advantage for HIV survival in macrophages and ultimately therefore contribute to HIV pathogenesis.

A role for HO-1 in the pathogenesis of virus infections has been suggested not only for HIV-1, but also for other viruses. Induction of HO-1 expression in uninfected macrophages has been shown to reduce subsequent HIV-1 infection and replication (608, 609). An anti-viral effect of HO-1 induction has been observed in infection studies of hepatitis C (HCV) (610), hepatitis B (HBV) (611), ebola (612), enterovirus 71 (EV71) (613), vaccinia (614), and porcine reproductive and respiratory syndrome virus (615). Interestingly, HCV has been reported to downregulate HO-1 protein expression (616, 617), although contrasting studies report HO-1 induction by HCV (618, 619).

How HO-1 expresses antiviral effects is unknown. Recent work suggests that HO-1 expression in myeloid cells is required for induction of type I interferon expression and associated innate immune responses (471, 620). These effects might occur through signaling by biliverdin, an HO-1 enzymatic product (621). Thus, HO-1 might promote an interferon-mediated anti-viral state. Other proposed HO-1 antiviral effects include post-transcriptional destabilization of viral core proteins, as for HBV (611), and inhibition of viral enzymes, as for the HIV protease by biliverdin and bilirubin (622). The consistent ability of HIV to decrease HO-1 expression in macrophages suggests an adaptive benefit for the virus; however, the HIV-mediated loss of HO-1 in MDM seems unlikely to have a significant effect on HIV replication as HO-1 deficiency is not observed until 6-9 days post-infection, after robust infection is established (43). Although induction of HO-1 in macrophages prior to HIV infection has been reported to reduce subsequent HIV replication, enzymatic inhibition of target cell HO-1 prior to infection does not augment subsequent HIV replication (609). Moreover, we demonstrated that potent HO-1 knockdown, HO-1 enzymatic inhibition, or induction of HO-1 expression in macrophages in which productive HIV replication is established does not alter replication (43). Thus, a role for HO-1 in modulating HIV replication in macrophages has not been clearly established, in contrast to a clear role for HIV replication in macrophages in reducing HO-1 expression. The consequences and full effects of HIV-mediated HO-1 deficiency in macrophages clearly require further study.

To address the association between HIV replication and HO-1 deficiency in the context of ART use, we determined the ability of clinically-relevant ART regimens applied pre- and post-infection to prevent HO-1 loss and associated neurotoxicity in HIV-MDM. We demonstrated that ART exposure at CNS-relevant concentrations fails to prevent HO-1 loss and neurotoxicity in HIV-MDM once infection is already established. This suggests that long-lived CNS macrophage reservoirs in HIV-infected individuals, even those on suppressive ART, can maintain an HO-1 deficient, neurotoxic phenotype.

This inability for ART to attenuate this phenotype once established may be especially relevant given the recent evidence for plasma and CSF viral blipping (intermittent HIV replication) in ART-treated individuals and its association with immune activation. Recent studies suggest that despite apparently prolonged plasma HIV suppression by ART (< 50 HIV RNA copies/ml), intermittent viral replication is detectable in the plasma and/or cerebrospinal fluid (133). Moreover, CSF viral blipping, which can occur independently from plasma blipping, associates with monocyte activation (neopterin) and emergence of CNS-compartmentalized ART resistance mutations (134, 281). Intermittent viral replication within the CNS macrophage compartment could promote the persistence of an HO-1 deficient neurotoxic phenotype that is resistant to suppressive ART therapy. This suggests a plausible mechanism by which HIV infection of brain macrophages in ART-treated individuals could exacerbate oxidative stress and glutamate-induced neuronal injury, each of which is associated with neurocognitive dysfunction in infected individuals (174, 239).

The conservation of the ability to induce HO-1 deficiency and associated neurotoxin production across macrophage-tropic HIV strains and the association of brain HO-1 deficiency with neurocognitive impairment makes it an attractive therapeutic target in HIV-infected individuals with HAND (43). The failure of ART to prevent this HO-1 loss in established infection highlights the potential value of HO-1-inducing drugs as adjunctive therapy to ART. Our current findings suggest that induction of HO-1 deficiency associated with excess glutamate production and neurotoxicity is a highly conserved phenotype of macrophage-tropic HIV strains, which can persist in the macrophage compartment in the presence of ART. Our studies further suggest a role for HO-1 deficiency in ongoing neuronal injury in HAND, which is only partially prevented by ART. Therapies that target HO-1 deficiency in chronic HIV infection could provide additional neuroprotection to ART.

CHAPTER 11

HO-1 MODULATES NEUROTOXIN PRODUCTION FROM HIV-INFECTED MACROPHAGES

Part of this work was originally published in *The Journal of Clinical Investigation*. Gill AJ, Kovacsics CE, Cross SA, Vance PJ, Kolson LL, Jordan-Sciutto KL, Gelman BB, Kolson DL. Heme oxygenase-1 deficiency accompanies neuropathogenesis of HIV-associated neurocognitive disorders. *J Clin Invest*. 2014; 124(10):4459-72. Copyright © 2014 American Society for Clinical Investigation.

11.1 Abstract

Heme oxygenase-1 (HO-1) is an inducible, detoxifying enzyme critical for limiting oxidative stress, inflammation, and cellular injury within the CNS and other tissues. Our analysis of HO-1 expression in the brains of HIV-infected individuals demonstrated a significant HO-1 protein deficiency that correlated with cognitive dysfunction, CNS HIV replication, and neuroimmune activation. Furthermore, our in vitro analysis of HO-1 expression in HIV-infected macrophages, a primary CNS HIV reservoir along with microglia, demonstrated consistent and highly conserved HO-1 deficiency associated with increased culture supernatant glutamate and neurotoxicity, suggesting a link between HIV infection, macrophage HO-1 deficiency, and neurodegeneration. To determine a causative role for HO-1 in modulating macrophage neurotoxin production, we used pharmacologic and genetic approaches to manipulate HO-1 in HIV-infected macrophages. HO-1 siRNA knockdown and HO enzymatic inhibition in HIV-infected macrophages increased supernatant glutamate and neurotoxicity. In contrast, increasing HO-1 expression through siRNA derepression or with non-selective pharmacologic inducers, including the CNS-penetrating drug dimethyl fumarate (DMF), decreased supernatant glutamate and neurotoxicity. These findings identify HO-1 as a protective host factor against HIV-mediated neurodegeneration and further suggest that HO-1 deficiency contributes to such degeneration. Inducing HO-1 in the CNS of HIV-infected antiretroviral therapy-treated patients could provide a novel approach for protection against neurodegeneration and associated cognitive dysfunction.

11.2 Introduction

Through analysis of post-mortem brain tissue specimens, we have demonstrated that HO-1 protein expression is deficient in the dorsolateral prefrontal cortex (DLPFC) of HIV-infected subjects and that this HO-1 deficiency is correlated with CNS viral load and markers of immune activation (see Chapter 8). Using our in vitro model of HIV-mediated neurotoxicity, in which HIV

infection of monocyte-derived macrophages (HIV-MDM) induces release of soluble neurotoxins (46, 623), we have identified an association between HIV-driven HO-1 deficiency and a glutamate production and associated neurotoxicity (see Chapter 10). Overexpression of HO-1 has been shown to be protective in animal models of inflammatory diseases, including cardiac ischemia (412), pulmonary hypoxia and inflammation (413, 624), and stroke (414); such studies have promoted the study of pharmacological HO-1 inducers in human diseases (521). Among these HO-1 inducers are the fumaric acid esters, notably dimethyl fumarate (DMF) and its primary CNS-penetrating in vivo metabolite monomethyl fumarate (MMF). Both DMF and MMF induce expression of ARE-driven genes, including HO-1, and modulate immune responses in various cell lineages through inhibition of NF- κ B signaling, thereby promoting an anti-inflammatory and anti-oxidative cellular state (reviewed in (625)). Recently, an oral DMF preparation, Tecfidera™, received FDA approval for the treatment of multiple sclerosis, a disease characterized by recurrent neuroinflammation and oxidative stress.

To determine the role of HO-1 deficiency in modulating glutamate production and associated neurotoxicity in HIV-MDM, we utilized siRNA knockdown of HO-1 and pharmacologic HO enzymatic inhibition to further reduce HO-1 expression and enzymatic activity. Decreasing HO-1 expression or inhibiting enzymatic activity in HIV-MDM significantly augmented neurotoxin production. To determine the ability of HO-1 induction to ameliorate glutamate production and associated neurotoxicity in HIV-infected macrophages, we utilized siRNA depression and pharmacologic inducers of HO-1 to increase HO-1 expression. We demonstrated that induction of HO-1, including by DMF and MMF, can ameliorate HIV-MDM glutamate release and neurotoxicity. These findings suggest that HO-1 deficiency contributes significantly to HAND neuropathogenesis through modulation of neurotoxin production and that restoring CNS HO-1 expression could attenuate neurodegenerative processes and thereby reduce the persistent risk of HAND in ART-treated individuals.

11.4 Results

Pharmacologic inducer of HO-1 expression decreases HIV-MDM supernatant glutamate and neurotoxicity

Given the association between decreased HO-1 protein expression and glutamate production in HIV-MDM, we hypothesized that HO-1 modulates the release of glutamate from MDM and the associated neurotoxicity. To test this, we induced HO-1 expression in HIV-MDM with cobalt (III) protoporphyrin IX chloride (CoPP) and determined effects on supernatant glutamate and neurotoxicity (Figure 11.1). CoPP robustly induces HO-1 protein expression in MDM (~ 20-fold) with limited induction of other ARE proteins (NQO1 and TRXR1, ~1.5-2 fold) with no effect on HO-2, GPX1, or GSTP1 expression (Figure 11.2, A and B). We applied CoPP to HIV-MDM during days 6-15 of HIV infection, when glutamate production and supernatant neurotoxicity are generally robust (see Figure 10.1). The addition of CoPP profoundly increased HO-1 expression in HIV-MDM while modestly increasing expression of NQO1 (Figure 11.1B). No effect on HIV replication was observed (Figure 11.1A). However, CoPP treatment significantly reduced supernatant glutamate (Figure 11.1, C and E) and associated neurotoxicity (Figure 11.1, D and F). A similar reduction in supernatant glutamate and neurotoxicity was observed as expected when viral replication was inhibited via treatment of HIV-MDM with the reverse transcriptase inhibitor efavirenz. These data suggest that HO-1 induction may suppress HIV-mediated macrophage glutamate production and neurotoxicity independently of viral replication.

A pharmacologic inhibitor of HO enzymatic activity increases HIV-MDM supernatant glutamate and neurotoxicity

To further confirm the role for HO-1 in modulating macrophage glutamate production and neurotoxicity, we used tin (IV) mesoporphyrin IX dichloride (SnMP), a potent inhibitor of HO-1 and

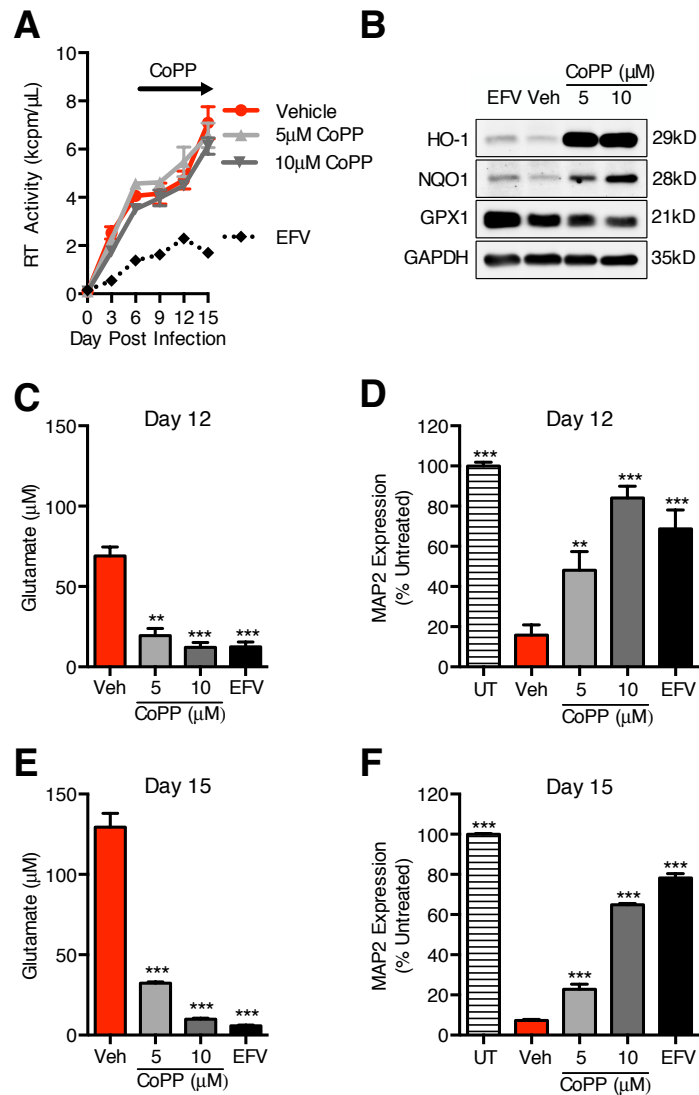

Figure 11.1 Inducers of HO-1 expression reduce HIV-MDM supernatant glutamate accumulation and neurotoxicity independently of HIV replication. CoPP, a potent inducer of HO-1, was added to HIV-MDM cultures on days 6, 9, and 12 post infection. Efavirenz (EFV) (20 nM) was added 1 hour prior to HIV inoculation and replenished with each medium exchange to suppress HIV replication. **(A)** HIV replication (supernatant RT activity). **(B)** Western blot of cell lysates (day 12) for detection of ARE proteins HO-1, NQO1, and GPX1. **(C)** Supernatant (day 12) glutamate concentration and **(D)** supernatant neurotoxicity. **(E)** Supernatant (day 15) glutamate concentration and **(F)** supernatant neurotoxicity. Values represent mean \pm SEM of technical replicates from a representative experiment of 3 independent experiments, with each biological replicate performed on MDM preparations from a different donor. Statistical comparisons were made by 1-way ANOVA plus Hold-Sidak post hoc test. ** $P < 0.01$; *** $P < 0.001$.

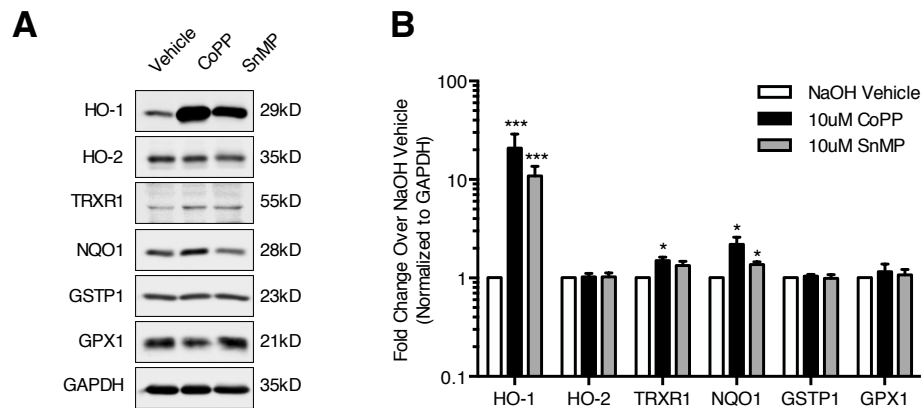

Figure 11.2 CoPP and SnMP induce HO-1, but not HO-2, protein expression in MDM.

Uninfected MDM were exposed to 10 μ M CoPP or SnMP for 24 hours and assessed for protein expression by Western blot. **(A)** Representative Western blot of HO-1, HO-2, TRXR1, NQO1, GSTP1, and GPX1 expression. **(B)** Quantification of Western blot expression by densitometry analysis. Data points represent mean \pm SEM from 6 different MDM donors. Statistical comparisons were made by one-way ANOVA plus Hold-Sidak post hoc test. * $p < 0.05$, *** $p < 0.001$.

HO-2 enzymatic activity (626), which also induces HO-1 expression, through derepression of the HO-1 promoter (627). As expected, the addition of SnMP to HIV-MDM cultures under conditions identical to those of the CoPP treatments did not alter HIV replication and did induce HO-1 protein expression (Figure 11.3, A and B). Strikingly, SnMP treatment dose-dependently increased supernatant glutamate (Figure 11.3, C and E) and neurotoxicity (Figure 11.3, D and F), suggesting that inhibition of heme oxygenase (HO-1 and/or HO-2) enzymatic activity enhances HIV-MDM glutamate production. Notably, SnMP also modestly increased NQO1 expression in MDM without altering HO-2, TRXR1, GSTP1, or GPX1 expression, similar to the effects of CoPP (Figure 11.2, A and B)). As both CoPP and SnMP have similar effects on ARE protein expression, but only SnMP inhibits HO-1 and HO-2 enzymatic activity, these data strongly suggest that heme oxygenase enzymatic activity mediates the effects on HIV-MDM glutamate production and neurotoxicity. Additionally, similar effects of SnMP were observed in uninfected MDM, with SnMP treatment dose-dependently increasing supernatant glutamate and neurotoxicity (Figure 11.4, A and B). Importantly, we did not observe SnMP cytotoxicity in MDM at the doses used (Figure 11.4, C and D). This further supports the hypothesis that deficiency of heme oxygenase enzymatic activity in MDM may induce glutamate release and neurotoxicity.

Finally, inhibitors of NQO1 (dicoumarol, DCM) and GPX1 (mercaptosuccinic acid, MSA) enzymatic activity did not increase MDM supernatant glutamate or neurotoxicity (Figure 11.4, A and B), further supporting the specificity of heme oxygenase effects. These results suggest that HO-1 modulates MDM glutamate production and neurotoxicity, and they further suggest that the brain HO-1 deficiency observed in HIV-infected individuals may directly contribute to HIV-mediated neurodegeneration.

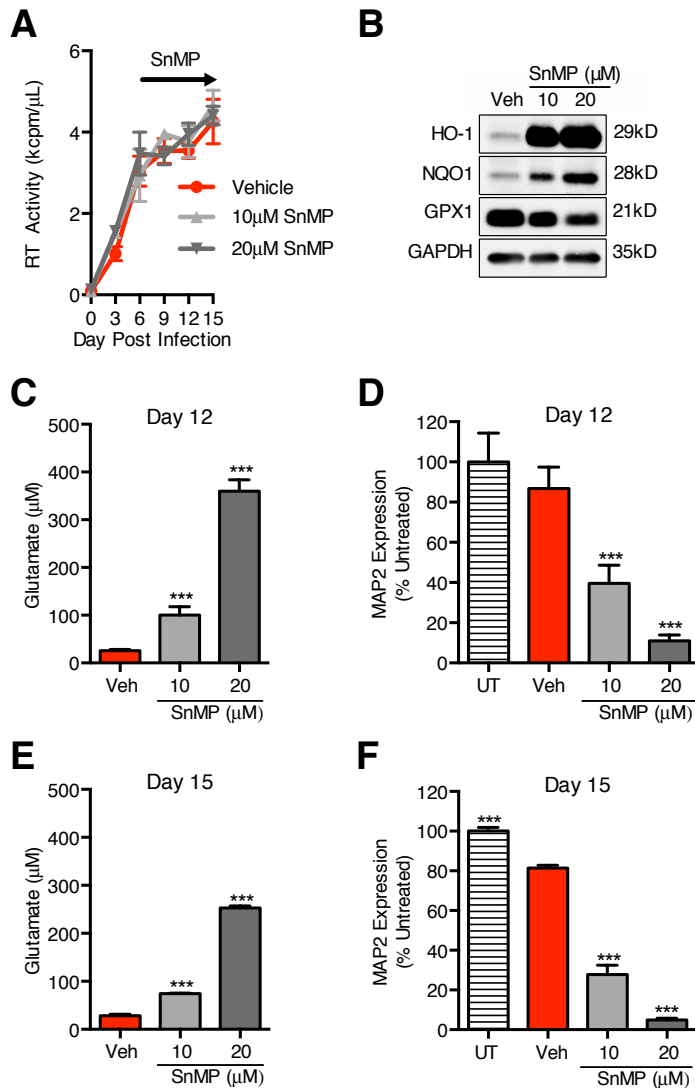

Figure 11.3 Exposure of HIV-MDM to an inhibitor of heme oxygenase enzymatic activity (SnMP) enhances glutamate release and supernatant neurotoxicity independently of HIV replication. SnMP, an inhibitor of heme oxygenase activity, was added to HIV-MDM cultures on days 6, 9, and 12 post infection. **(A)** HIV replication (supernatant RT activity). **(B)** Western blot of cell lysates (day 15) for detection of ARE proteins HO-1, NQO1, and GPX1. **(C)** Supernatant (day 12) glutamate concentration and **(D)** supernatant neurotoxicity. **(E)** Supernatant (day 15) glutamate concentration and **(F)** supernatant neurotoxicity. Values represent mean \pm SEM of technical replicates from a representative experiment of 3 independent experiments, with each biological replicate performed on MDM preparations from a different donor. Statistical comparisons were made by 1-way ANOVA plus Hold-Sidak post hoc test. *** $P < 0.001$

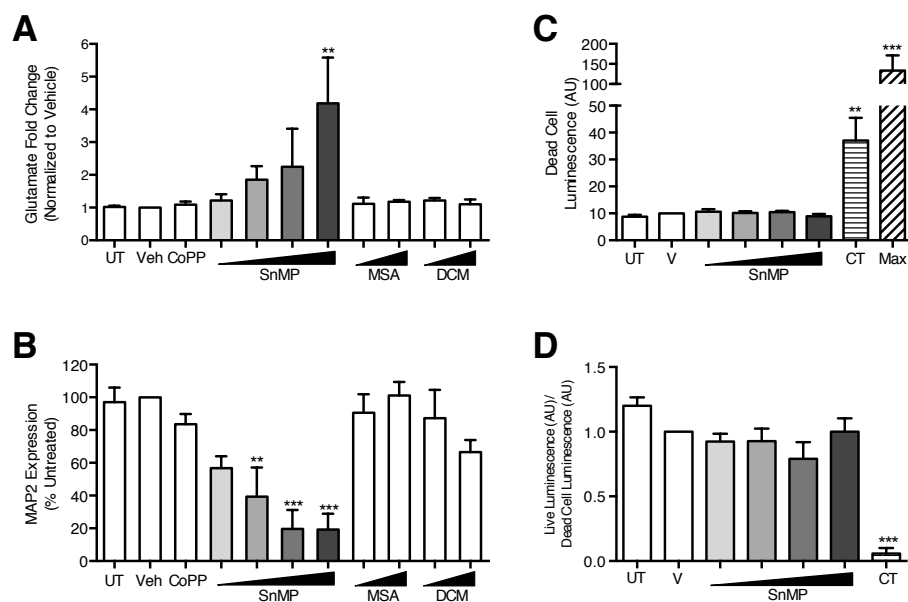

Figure 11.4 Exposure of non-infected MDM to an inhibitor of HO-1 and HO-2 enzymatic activity (SnMP) enhances supernatant glutamate and neurotoxicity. Uninfected MDM from 4 different donors were exposed (6 days) to Vehicle (Veh), the HO-1 inhibitor SnMP (1, 5, 10, 20μM), the HO-1 expression inducer CoPP (10μM), the GPX1 inhibitor MSA (100 and 1000μM), the NQO1 inhibitor DCM (1 and 10μM), or left untreated (UT) and culture supernatants were assayed for **(A)** glutamate concentration and **(B)** neurotoxicity normalized to Vehicle. SnMP induced toxicity was quantified by **(C)** total dead cell luminescence and **(D)** the live/dead cell ratio in MDM cultures from 3 different donors. Camptothecin (CT; 6 hour exposure) and complete cell lysis (maximum cytotoxicity, Max) served as a positive controls. Values represent mean ± SEM. Statistical comparisons were made by one-way ANOVA plus Hold-Sidak post hoc test. **p < 0.01, ***p < 0.001.

siRNA-mediated induction and inhibition of HO-1 expression modulate HIV-MDM supernatant glutamate and neurotoxicity

Given our evidence that pharmacologic modulations of HO-1 alter supernatant glutamate and neurotoxicity, we attempted to confirm the role of HO-1 in HIV-MDM neurotoxin production using an siRNA knockdown approach. We tested two siRNAs targeted against HO-1 and two siRNAs against BTB and CNC Homology 1 (BACH1) transcription factor, a robust negative transcriptional regulator of HO-1 (628). Transfection efficiency in four independent MDM donor cultures ranged from 84-96%, as determined by transfection of a fluorescent control RNA oligomer (Figure 11.5A). We confirmed that both siRNAs targeted against HO-1 reduced HO-1 protein expression by ~10 fold in MDM and HIV-MDM, while siRNAs targeting BACH1 were able to reduce BACH1 protein expression by ~ 3 fold (Figure 11.5, B-D). Associated with this BACH1 knockdown was a ~10 fold increase in HO-1 expression. Furthermore, neither the HO-1 nor BACH1 siRNAs altered HO-2 expression, in contrast to two siRNAs targeted to HO-2. Thus we were able to selectively modulate HO-1 expression by siRNA without altering HO-2 expression.

Therefore, to further confirm the role for HO-1 in regulating glutamate and neurotoxicity in HIV-MDM, we used siRNA targeting both HO-1 and BACH1 alone and in combination on day 6 post HIV infection of MDM. We transfected HIV-MDM with either scramble siRNA, HO-1 siRNA, BACH1 siRNA, BACH1 + scramble siRNA, or BACH1 + HO-1 siRNA and analyzed protein lysates and supernatants on day 12 post infection. Successful siRNA knockdown of HO-1 and BACH1 was confirmed by Western blot and neither knockdown altered HIV replication (Figure 11.6, A and B). Knockdown with BACH1 siRNA (or BACH1 siRNA + scramble siRNA) reduced extracellular glutamate and supernatant neurotoxicity, while knockdown of HO-1 increased extracellular glutamate and supernatant neurotoxicity (Figure 11.6, C and D). Furthermore, BACH1 + HO-1 knockdown partially reversed the reduced glutamate and neurotoxicity effects, suggesting that BACH1 siRNA modulation of glutamate and neurotoxicity is in part an effect of

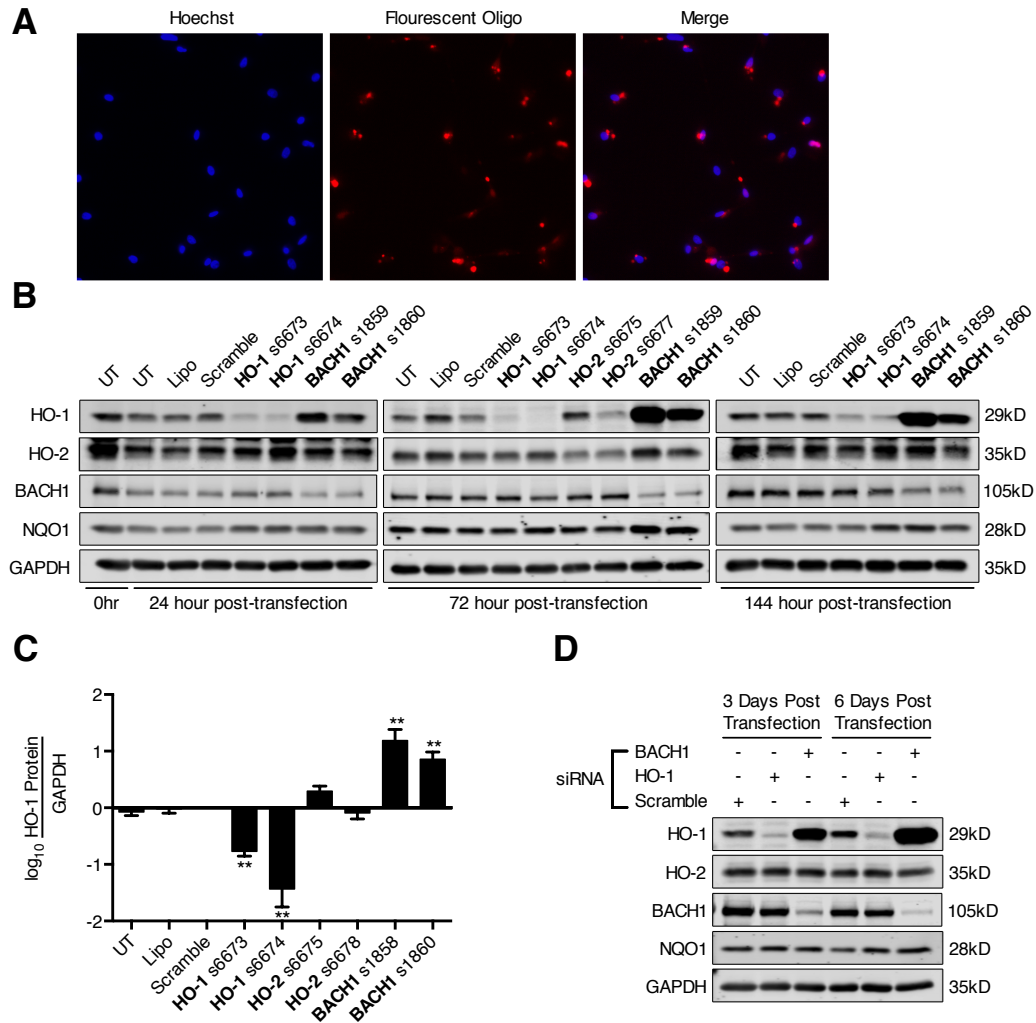

Figure 11.5 HO-1 and BACH1 siRNAs effectively knockdown and induce HO-1 expression, respectively, in uninfected and infected MDM. 50nM of each siRNA was transfected into MDM using Lipofectamine RNAiMax. **(A)** Representative fluorescent microscopy images of MDM 24 hours post-transfection with fluorescent oligos (BLOCK-IT™ Alexa Fluor® Red Fluorescent Oligo). **(B)** Representative Western blot for HO-1, HO-2, BACH1, NQO1, and GAPDH at 24 hours, 72 hours, and 144 hours post-transfection with siRNA targeting either HO-1, HO-2, or BACH1. **(C)** Densitometry analysis of HO-1 Western blot protein expression 72 hours post siRNA transfection. Values represent log mean \pm SEM of HO-1 expression normalized to GAPDH (Vehicle set to 0) from 4 different MDM donors. **(D)** Representative Western blot of HIV-infected MDM 3 days and 6 days post siRNA transfection. HIV-MDM were transfected with selected siRNA targeting HO-1 or BACH1 on day 6 post HIV infection. Protein lysates were either collected on day 9 post-infection (day 3 post transfection) or media was fully exchanged and protein lysates were collected on day 12 post-infection. Statistical comparisons were made by one-way ANOVA plus Hold-Sidak post hoc test. ** $p < 0.01$.

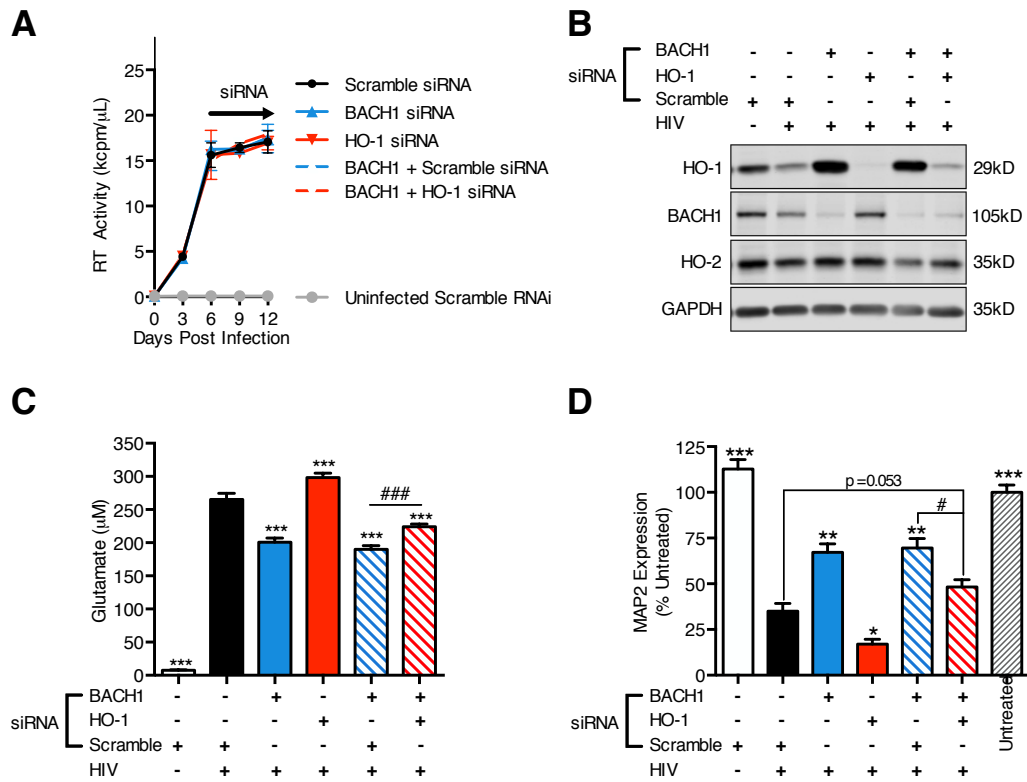

Figure 11.6 Knockdown of HO-1 and BACH1 by siRNA modulates extracellular glutamate and supernatant neurotoxicity in HIV-MDM independently of HIV replication. On day 6 post infection, siRNA targeting HO-1 or BACH1 or a scramble negative control siRNA were transfected into HIV-MDM alone or in combination using Lipofectamine RNAimax. On day 9, medium was fully exchanged without retransfection. Representative data from a single donor infection showing (A) HIV replication (supernatant RT activity), (B) Western blot of cell lysates (day 12) for detection of HO-1, BACH1, HO-2, and GAPDH, (C) supernatant (day 12) glutamate concentration, and (D) supernatant neurotoxicity. Values represent mean \pm SEM. Statistical comparisons were made by 1-way ANOVA plus Hold-Sidak post hoc test. * $P < 0.05$, ** $P < 0.01$, *** $P < 0.001$ versus HIV-MDM scramble siRNA; # $P < 0.05$, ### $P < 0.001$ for indicated comparison.

HO-1 protein induction (Figure 11.6, C and D). These siRNA mediated effects on glutamate levels were seen in 2 additional independent experiments from 2 additional MDM donors. Among these two replicate experiments, one donor failed to achieve a significant increase in neurotoxicity with HO-1 and BACH1 double knockdown compared to BACH1 + scramble, although HO-1 and BACH1 knockdown alone did increase and decrease neurotoxicity, respectively (data not shown). Overall, these siRNA knockdown data support the conclusion that HO-1 modulates supernatant neurotoxicity and glutamate in HIV-MDM independently of HO-2.

The therapeutic ARE- and HO-1-inducer, dimethyl fumarate, attenuates HIV-MDM supernatant glutamate and neurotoxicity

The potential benefit of therapeutic induction of HO-1 expression in the brains of HIV-infected individuals prompted us to examine the CNS-penetrating HO-1 inducer DMF for effects on MDM glutamate production and neurotoxicity. We previously showed that DMF and its primary in vivo metabolite, MMF, reduce neurotoxicity of HIV-MDM supernatants when applied to MDM cultures prior to inoculation with HIV (42). This effect was associated with both increased HO-1 expression and reduced HIV replication, both of which likely contributed to the reduction in neurotoxicity. We have now extended these studies to examine effects of DMF and MMF on glutamate production, HIV replication, and neurotoxicity when applied to MDM after HIV infection is established, as would reflect the state of the brain in HIV-infected individuals. Although less specific for HO-1 than CoPP, the ARE-inducers DMF, MMF, and tert-butylhydroquinone (tBHQ), nonetheless significantly induce the expression of HO-1, as well as other ARE proteins (Figure 11.7A). After exposure of MDM to each ARE-inducer, we observed a peak of HO-1 induction at 6-12 hours, with HO-1 levels returning to baseline by 48 hours (Figure 11.7, B-D).

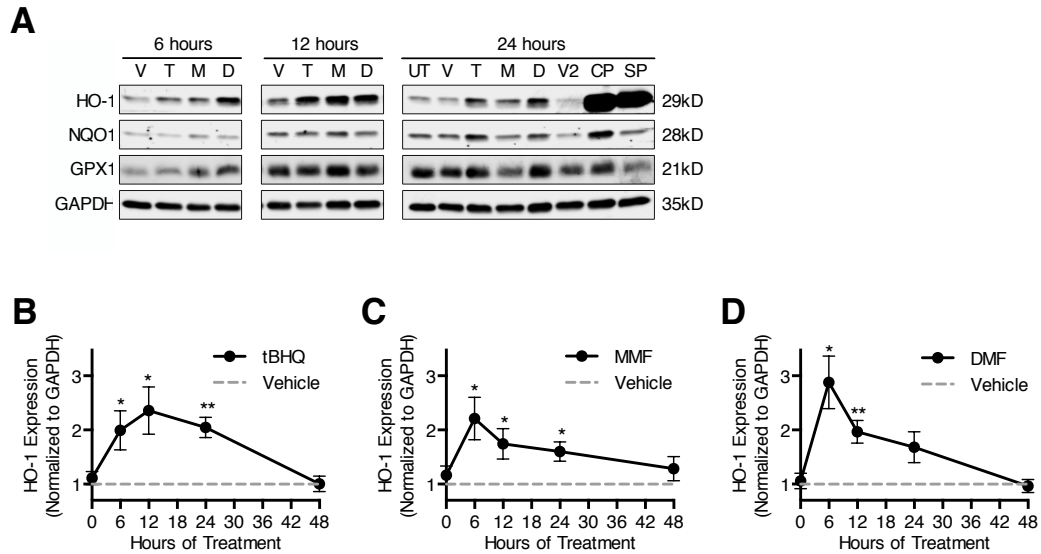

Figure 11.7 Time course of HO-1 induction in MDM by tBHQ, MMF, and DMF. Uninfected MDM were exposed to tBHQ (T, 10 μ M), MMF (M, 30 μ M), or DMF (D, 30 μ M) for 0, 6, 12, 24, and 48 hours and assessed for HO-1 expression by Western blot (V = vehicle for tBHQ, MMF, and DMF). For comparison, MDM were also treated with CoPP (CP, 10 μ M) and SnMP (SP, 10 μ M) for 24 hours (V2 = vehicle for SnMP and CoPP). (A) Representative Western blot of HO-1, NQO1, and GPX expression. Quantification of HO-1 Western blot expression by densitometry analysis normalized to GAPDH for (B) tBHQ, (C) MMF, and (D) DMF treatment. Data points represent mean \pm SEM from 6 different MDM donors. Statistical comparisons were made by Student's paired t-test. * $p < 0.05$, ** $p < 0.01$.

Because of this transient effect on HO-1 expression after single doses of DMF and MMF, we treated HIV-MDM cultures with multiple doses beginning on day 6 and again on day 9, and then quantified supernatant glutamate and neurotoxicity on day 12. Similar to previous HO-1 modulating treatments, we saw no effect of either DMF or MMF on HIV replication (Figure 11.8, A and D), yet we observed a significant reduction in supernatant glutamate (Figure 11.8, B and E) and supernatant neurotoxicity (Figure 11.8, C and F). We saw similar effects after treatment with tBHQ (Figure 11.8, G-I).

Notably, treatment of primary rat cortical neurons with DMF or MMF concurrently with HIV-infected macrophage supernatant did not prevent neuronal injury and death as measured by MAP2 ELISA (Figure 11.9, A and B), suggesting that DMF/MMF neuroprotection in this study is likely due to effects on macrophages, rather than effects of any un-metabolized DMF/MMF remaining in the macrophage supernatant used to treat neurons. These data demonstrate that ARE-inducers, including DMF and MMF, at concentrations consistent with CSF MMF concentrations in vivo (629), can ameliorate neurotoxin production in HIV-MDM independently of suppression of viral replication.

11.5 Discussion

HIV infection of macrophages markedly reduces HO-1 expression, and this HO-1 deficiency is linked to increased toxic levels of glutamate, a HAND-associated neurotoxin (229, 239, 602). Here we confirm a direct role for HIV-driven HO-1 loss in modulating neurotoxin production from HIV-MDM. The inhibition of heme oxygenase (HO-1 & HO-2) enzymatic activity and selective HO-1 knockdown increased glutamate and associated neurotoxicity in HIV-infected macrophages, which further implicates HO-1 in modulating macrophage-mediated neurotoxin production in HIV infection. This association between HO-1 deficiency and glutamate production suggests a potential therapeutic benefit of restoring HO-1 expression in HIV-infected brain macrophages.

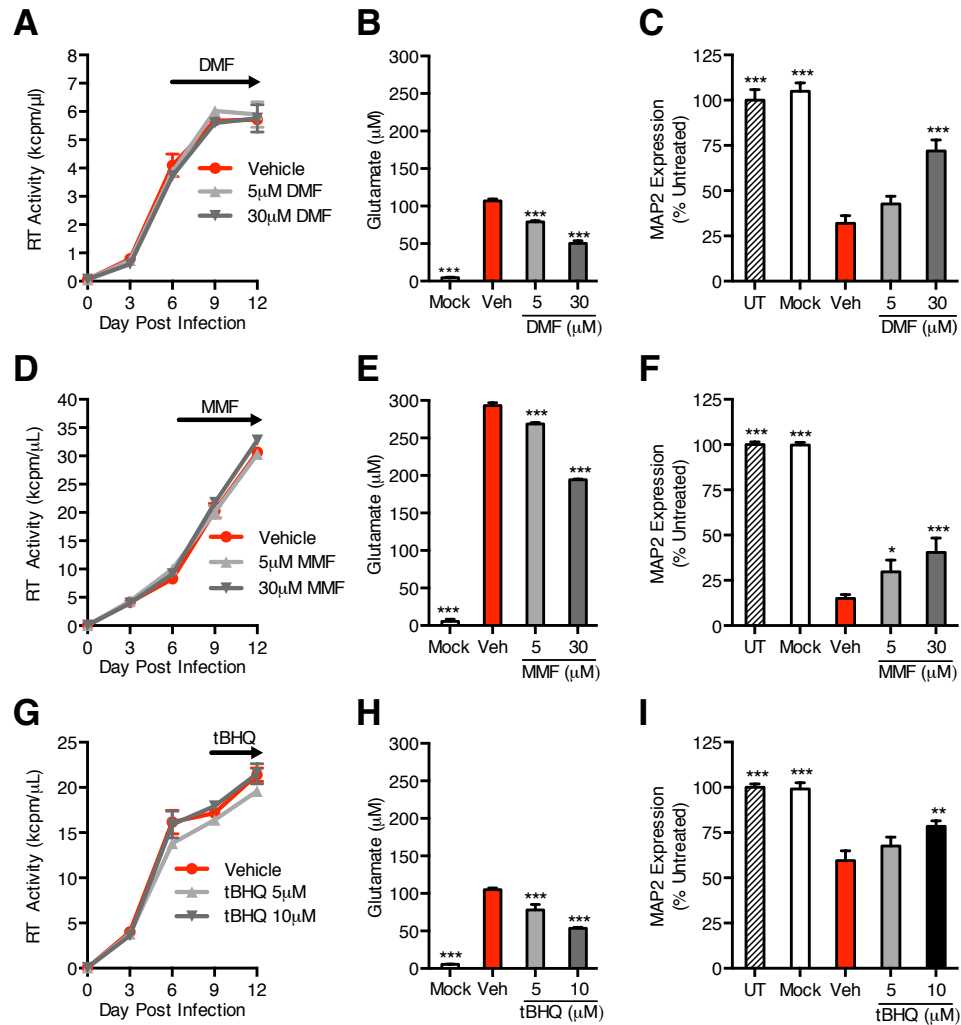

Figure 11.8 DMF and MMF reduce glutamate release and associated supernatant neurotoxicity in HIV-MDM independently of HIV replication. DMF and MMF were added to HIV-MDM on day 6 post infection and replenished on day 9 post infection. tBHQ was added on day 9 post infection and not replenished. Culture supernatants (day 12 post infection) were assayed for glutamate concentration and neurotoxicity normalized to untreated primary rat neuronal cultures (UT). (A) HIV replication (supernatant RT activity), (B) supernatant glutamate concentration, and (C) supernatant neurotoxicity in DMF-treated HIV-MDM. Similar effects of DMF treatment in HIV-MDM were observed in 4 of 5 independent experiments, with each replicate performed on MDM preparations from a different donor. (D) HIV replication (supernatant RT activity), (E) supernatant glutamate concentration, and (F) supernatant neurotoxicity in MMF-treated HIV-MDM. Similar effects of MMF treatment in HIV-MDM were observed in 3 of 4 independent experiments, with each replicate performed on MDM preparations from a different donor. (G) HIV replication (supernatant RT activity), (H) supernatant glutamate concentration, and (I) supernatant neurotoxicity in tBHQ-treated HIV-MDM. Similar effects of tBHQ treatment in HIV-MDM were observed in 3 of 3 independent experiments, with each replicate performed on MDM preparations from a different donor. Values represent mean \pm SEM. Statistical comparisons were made by 1-way ANOVA plus Hold-Sidak post hoc test. Veh, vehicle. * $P < 0.05$; ** $P < 0.01$; *** $P < 0.001$ versus vehicle.

A**B**

Figure 11.9 Concurrent treatment with DMF and MMF does not protect neurons in neuroglial cultures from HIV-MDM mediated neurotoxicity. Day 14 in vitro primary rat cerebrocortical neuroglial cultures were exposed to Mock-MDM or HIV-MDM supernatant from day 12 post infection at a 1:20 dilution. HIV-MDM exposed neuroglial cultures were co-treated with increasing doses of (A) DMF and (B) MMF. Positive control neuroglial cultures were pre-treated (5 minutes) with either MK801 (a nonselective noncompetitive antagonist of the NMDA receptor) or Ifenprodil (a selective noncompetitive antagonist of NR2B subunit-containing NMDA receptors). 24 hours after exposure neuroglial cultures were assessed for MAP2 expression by MAP2 ELISA. MAP2 expression was normalized to untreated neuroglial cultures. Values represent the mean \pm SEM from 3 experiments using supernatant from HIV-MDM infections from 3 independent donors. Statistical analysis comparing vehicle treated neuroglial cultures to all other groups were made by one-way ANOVA plus Hold-Sidak post hoc test. *** $p < 0.001$.

To this end, we have shown using both pharmacological and genetic approaches, that HO-1 induction decreased HIV-MDM glutamate production and associated neurotoxicity. However, the contribution of other ARE-induced genes (e.g. NQO1), which were induced to varying extents by these approaches, cannot be ruled out. Given that microglia can support robust HIV replication and that HIV-infection of microglia similarly enhances extracellular glutamate and associated neurotoxicity (602), we hypothesize that HIV reduces HO-1 expression and that HO-1 modulates neurotoxin production in HIV-infected microglia.

Our studies support a role for induction of HO-1 expression as a protective strategy against HIV disease progression, and they further suggest that drugs such as DMF could serve this therapeutic role. DMF and its primary metabolite monomethyl fumarate (MMF) are potent inducers of HO-1 expression and MMF is detectable within the CSF after oral delivery of DMF at concentrations (4.4 μ M) that effectively induce macrophage HO-1 expression and suppress production of neurotoxic levels of glutamate (629). Other effects of DMF and MMF (inhibition of HIV infection of macrophages, inhibition of macrophage NF- κ B nuclear translocation and TNF α release, and reduction of CCL2-mediated monocyte chemotaxis) could also have beneficial effects in ART-treated individuals (42), although whether these effects are related to HO-1 induction is not clear. Notably, HO-1 has been reported to inhibit NF- κ B through inhibition of phosphorylation of the p65 (NF- κ B subunit) at serine 276 (630), a mechanism of inhibition also reported in response to DMF treatment in dendritic cells (631). Thus, inhibition of NF- κ B signaling may play a role in the DMF/HO-1 mediated decrease in HIV-infected macrophage neurotoxin production. Considerable evidence therefore supports the testing of HO-1 inducers such as DMF as adjunctive therapy for prevention of both systemic and CNS complications of HIV infection in ART-treated subjects (reviewed in (625)) and additional studies of the role of HO-1 in HIV disease progression are needed.

CHAPTER 12

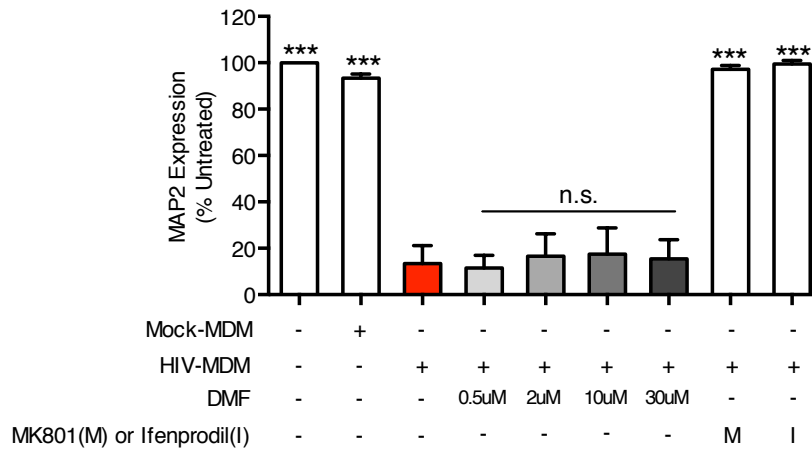
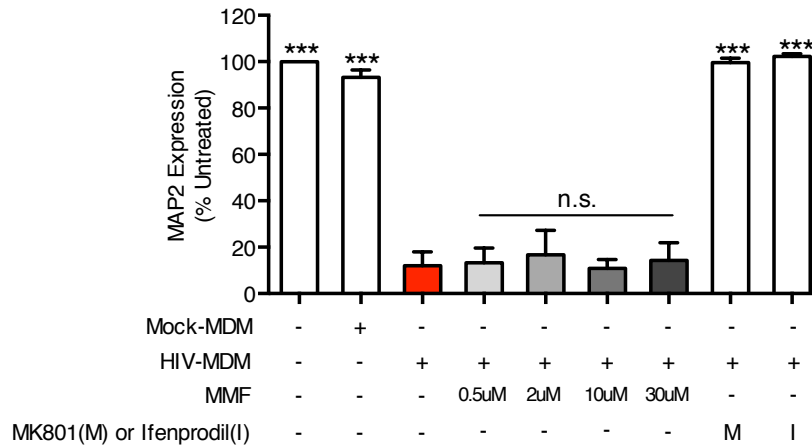
FUMARIC ACID ESTERS AS POTENTIAL ADJUNCTIVE THERAPY IN HIV INFECTION: TARGETING HO-1/ARE AND INFLAMMATION

Part of this work was originally published in *Critical Reviews in Immunology*. Gill AJ, Kolson DL. Dimethyl fumarate modulation of immune and antioxidant responses: application to HIV therapy. *Crit Rev Immunol*. 2013; 33(4):307-359. Copyright © 2013 Begell House Inc.

12.1 Abstract

The persistence of chronic immune activation and oxidative stress in human immunodeficiency virus (HIV)-infected, antiretroviral drug-treated individuals are major obstacles to fully preventing HIV disease progression. The immune modulator and antioxidant dimethyl fumarate (DMF) is effective in treating immune-mediated diseases and it also has potential applications to limiting HIV disease progression. Among the relevant effects of DMF and its active metabolite monomethyl fumarate (MMF) are induction of a Th1 → Th2 lymphocyte shift, inhibition of pro-inflammatory cytokine signaling, inhibition of NF-κB nuclear translocation, inhibition of dendritic cell maturation, suppression of lymphocyte and endothelial cell adhesion molecule expression, and induction of the Nrf2-dependent antioxidant response element (ARE) and effector genes. Associated with these effects are reduced lymphocyte and monocyte infiltration into psoriatic skin lesions in humans and immune-mediated demyelinating brain lesions in rodents, which confirms potent systemic and central nervous system (CNS) effects. In addition, DMF and MMF limit HIV infection in macrophages *in vitro*, albeit by unknown mechanisms. Finally, DMF and MMF also suppress neurotoxin production from HIV-infected macrophages, which drives CNS neurodegeneration. Thus, DMF might protect against systemic and CNS complications in HIV infection through its effective suppression of immune activation, oxidative stress, HIV replication, and macrophage-associated neuronal injury.

12.2 Introduction

Fumaric acid was initially proposed for treatment of psoriasis by the German chemist Walter Schweckendiek in 1959 (632). However, because fumaric acid is poorly absorbed after oral intake, developing a mixture of fumaric acid esters (FAEs) to achieve higher effective bioavailability after oral dosing was necessary. In 1994, an enteric-coated preparation of FAEs

containing 120 mg of dimethyl fumarate (DMF) and three salts of monoethyl fumarate (MEF) was licensed in Germany under the trade name Fumaderm® for the treatment of psoriasis. After positive results in psoriasis treatment trials, research into the therapeutic potential of FAEs has greatly accelerated. Most recently, a DMF-containing formulation, BG-12, showed marked efficacy in Phase III multiple sclerosis clinical trials (633, 634). Furthermore, additional *in vitro* and *in vivo* studies over the past decade have explored the therapeutic potential of FAEs for the treatment of other inflammatory diseases. With the recent FDA approval of BG-12 (brand name Tecfidera™) on March 27th, 2013 for the treatment of multiple sclerosis, the clinical application of FAEs for treating inflammatory diseases is likely to further rapidly expand. This review will assess the understanding of the mechanisms of FAEs in modulating immune responses and antioxidant responses and their potential application for treating disorders of inflammation and associated oxidative stress. Among the potential uses of FAEs is the treatment of HIV infection and its associated complications, as inflammation and oxidative stress are central to HIV pathogenesis. Notably, as DMF and MMF have been shown to effectively suppress inflammatory responses *in vivo* in both systemic and CNS compartments, DMF formulation therapy could offer adjunctive protection against both systemic and CNS complications of HIV infection.

12.3 Pharmacokinetics

Within minutes after oral intake, DMF is rapidly hydrolyzed by esterases within the small intestine to form its biologically active metabolite, monomethyl fumarate (MMF) (635). MMF, but not DMF, can be detected in serum after oral DMF ingestion. DMF is undetectable likely due its rapid hydrolysis. MMF is further metabolized through the tricarboxylic acid cycle to form H₂O and carbon dioxide, which is excreted through respiration. There is no evidence for cytochrome P450-dependent metabolism. Small amounts of non-metabolized MMF are detectable in the urine and feces.(636) In fasting healthy individuals, the half-life of MMF was estimated to be ~56 minutes and peak serum levels (mean 6 µM, range 3-10 µM) were observed at ~178 minutes (standard

deviation 39 minutes) after 120 mg of oral DMF (and 95 mg of MEF) (636). When these healthy individuals ingested DMF with meals, the peak MMF serum levels increased by more than 25% in 57% of the patients, but they decreased by an average of 69% in the remaining subjects; this demonstrates that food intake increases variability in serum MMF concentrations. In a smaller study of psoriasis patients, the average half-life of MMF was estimated to be ~47 minutes with peak serum levels of 12.5 μM observed at ~219 minutes post-intake (two tablets of Fumaderm®, 240 mg DMF and 190 mg MEF) (637). In both of these pharmacokinetic studies, DMF was not detected in serum ($<0.07 \mu\text{M}$ in healthy individuals). This suggests that MMF, but not DMF, is absorbed into the systemic circulation, and that MMF is the functional molecule *in vivo* that should be targeted for mechanistic studies *in vitro*. Nonetheless, Rostami-Yazdi et al. detected the mercapturic acid derivative of DMF in urine from individuals taking Fumaderm®, suggesting that DMF might indeed enter the circulation prior to being rapidly metabolized (638). Thus, DMF might express some biological activity *in vivo*, however transiently, and therefore defining the mechanisms of action of FAEs requires the study of both MMF and DMF to fully define the biological effects of oral DMF formulation therapy.

12.4 Mode of Action in Different Cell Lineages: Immunomodulation & Antioxidant Response

NF- κ B and the ARE

The effects of DMF and MMF on immune responses have thus far been only partially characterized. Several *in vitro* studies have demonstrated perturbation of nuclear factor κB (NF- κB) function through inhibition of NF- κB nuclear translocation and DNA binding (Figure 12.1). The NF- κB pathway plays a central role in regulating cytokine production, cellular activation, development, survival, and the innate and adaptive immune system among other roles (reviewed in (639)). NF- κB has been shown to induce TNF α , iNOS, IL-1, IL-2, IL-6, ICAM-1, and COX-2,

among others (640). DMF and MMF also induce the nuclear factor erythroid-2 related factor-2 (Nrf2)-dependent antioxidant response element (ARE) pathway (Figure 12.1). The ARE response is a ubiquitous cytoprotective cellular stress response involving induction of multiple genes that protect cells from many forms of intracellular oxidative stress and injury (reviewed in (641)). Generally, oxidative stress occurs when cells are unable to detoxify injurious agents or repair damage resulting from reactive oxygen species, hydrogen peroxide, hydroxyl radicals, and other mediators of oxidative stress. Oxidative stress induces the translocation of Nrf2 to the nucleus where it binds to the ARE promoter element and activates gene transcription (642-644) of hundreds of genes (643, 645, 646), including many antioxidant defense enzymes such as the sentinel cytoprotectant heme oxygenase-1 (HO-1) (647), NAD(P)H quinone oxidoreductase-1 (NQO1) (648), γ -glutamate cysteine ligase catalytic subunit (GCLC) (649), glutathione S-transferase (GST) (650), and the cysteine/glutamate transporter (xCT) (651).

Many studies have demonstrated complex regulatory interactions between the FAE-responsive Nrf2-dependent ARE and NF- κ B pathways. ARE induction can inhibit the NF- κ B pathway and thus indirectly modulate inflammatory cytokine and chemokine signaling (652). This inhibition of NF- κ B likely occurs through ARE-driven reduction in oxidative stress, which has been shown to activate the NF- κ B signaling pathway (653-656). Further supporting a role for Nrf2, several studies have demonstrated increased NF- κ B activation and dysregulation of cytokines and chemokines in Nrf2^{-/-} mice after inflammatory insults such as exposure to lipopolysaccharide (LPS) (657) or TNF α (657), after infection with respiratory syncytial virus (658), and after traumatic brain injury (659). Direct pharmacologic activators of Nrf2 such as tert-butylhydroquinone, sulforaphane, and phenethyl isothiocyanate also attenuate NF- κ B activation *in vitro* (660-663). Complicating the Nrf2 - NF- κ B regulation, a reciprocal effect of NF- κ B on Nrf2 function has been demonstrated (664). The NF- κ B p65 subunit has been shown to repress Nrf2 signaling at the transcriptional level, through competition with Nrf2 for transcription co-activator CREB binding protein (CBP) and through recruitment of histone deacetylase 3, resulting in local

hypocetylation of the ARE promoter element and the consequent suppression of Nrf2 signaling (664). Thus, the Nrf2 and NF- κ B pathways regulate each other through reciprocal inhibition (Figure 12.1). Additional studies are needed to further define the complex interactions between the NF- κ B and Nrf2 pathways believed to be responsible for the effects of DMF and MMF. Through a combination of ARE induction and NF- κ B signaling inhibition, and as yet undefined effects of other pathways, FAEs can promote an anti-inflammatory, anti-infiltrative, and anti-oxidative cellular state in multiple cell lineages, particularly immune cells. Notably, T-lymphocytes and cells of the monocyte lineage appear to be particularly sensitive to FAE exposure. The effects of DMF and MMF exposure on individual cell lineages is described in detail below.

Effect of FAE in T-lymphocytes

Early studies of Fumaderm® for psoriasis treatment demonstrated a significant decline (~30%) in lymphocytes, particularly T-lymphocytes, in 94% of treated patients (665). Similar results were observed in recent Phase III Multiple Sclerosis trials with the DMF formulation BG-12 (240 mg of DMF 2-3 times daily) (633, 634). However, the mechanism of DMF-induced lymphocytopenia is unknown. *In vitro* studies have demonstrated that DMF, but not MMF, induces apoptosis in human T-lymphocytes after 48 hours of exposure to a concentration of ~70 μ M, which is 10-fold higher than the MMF serum levels achieved with oral DMF dosing (666). This *in vitro* apoptotic effect of DMF was not seen at ~7 μ M, the physiologic concentration achieved by its primary *in vivo* metabolite MMF. Because DMF is not detectable *in vivo* after oral dosing, the contribution of direct DMF cytotoxicity to this lymphocytopenia is questionable. Thus further studies of the effects of long term exposure of MMF on T-lymphocyte viability and proliferation are needed.

Analyses of the immunomodulatory effects of FAEs on human T-lymphocytes demonstrated that FAEs alter cytokine production, cytokine and chemokine receptor expression, and adhesion molecule expression. Both DMF and MMF increased the production of multiple Th2 cytokines

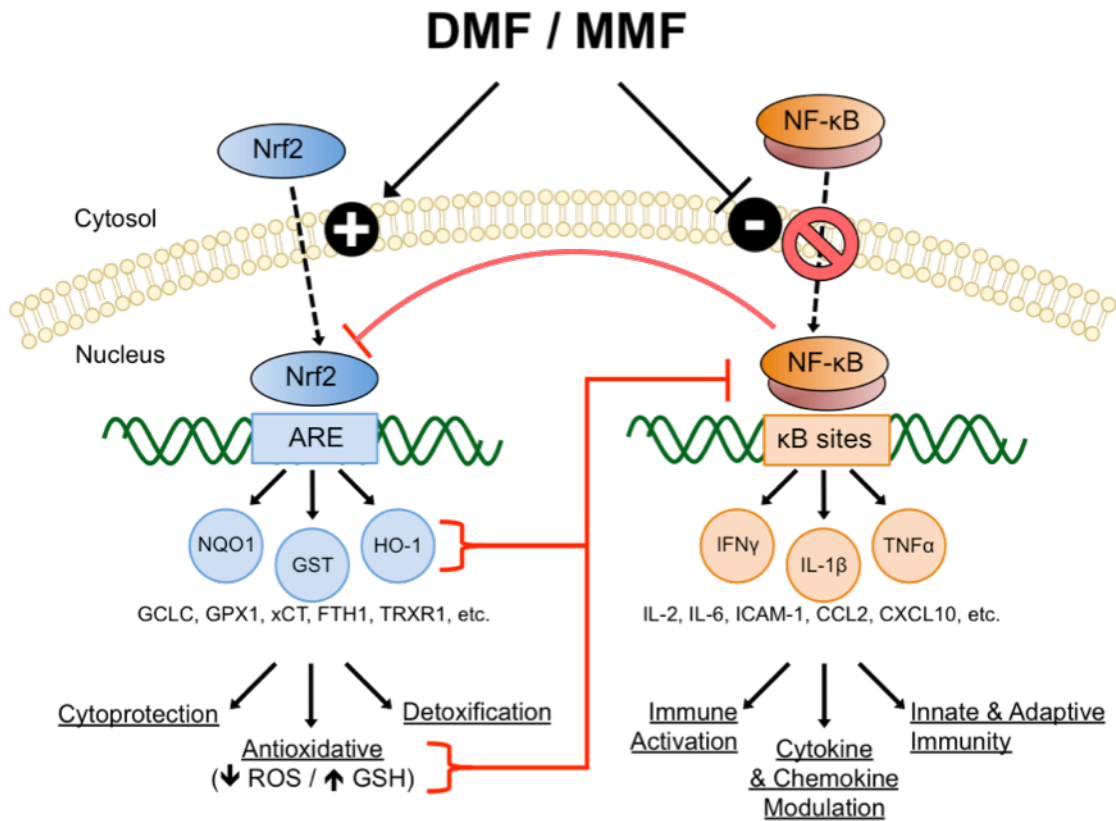

Figure 12.1 Effects of the fumaric acid esters (FAEs) DMF and MMF on the Nrf2-dependent antioxidant response and NF- κ B pathways. Flat head on a line instead of an arrow head indicates a negative or inhibitory relationship. Abbreviations used: antioxidant response element (ARE), CC chemokine ligand (CCL), CXC chemokine ligand (CXCL), cysteine/glutamate transporter (xCT), dimethyl fumarate (DMF), ferritin heavy chain 1 (FTH1), γ -glutamate cysteine ligase catalytic subunit (GCLC), glutathione (GSH), glutathione peroxidase-1 (GPX1), glutathione S-transferase (GST), heme oxygenase-1 (HO-1), intercellular adhesion molecule (ICAM), interferon (IFN), interleukin (IL), monomethyl fumarate (MMF), NAD(P)H quinone oxidoreductase-1 (NQO1), nuclear factor E2-related factor 2 (Nrf2), nuclear factor κ B (NF- κ B), reactive oxygen species (ROS), thioredoxin reductase 1 (TrxR1), tumor necrosis factor (TNF).

(IL-4, IL-10) (667-669) in T-lymphocytes. Furthermore, DMF, but not MMF, suppressed Th1 cytokine (IFN- γ) release and chemokine receptor (CXCR3) expression, as well as the skin-homing chemokine receptor CCR10 (670). In contrast, DMF exposure decreased release of IL-6 (670), a cytokine that inhibits Th1 polarization and promotes Th2 differentiation. The suppression of Th1 cytokine release and chemokine receptor expression is likely linked to DMF's ability to inhibit NF- κ B DNA binding in T-lymphocytes (671), an effect that is not induced by MMF *in vitro*. In line with these findings, DMF inhibited IFN- γ - and LPS-induced Th1 chemokine (CXCL9 and CXCL10) production in a dose dependent manner in human peripheral blood mononuclear cells (PBMC) (672). Furthermore, DMF was able to increase the expression of Th2 cytokines in lymphocytes in multiple sclerosis patients and mice with herpes stromal keratitis (see section V. FAEs In Inflammatory Diseases for further discussion), suggesting that DMF treatment maintains the Th1 to Th2 shift in the setting of superimposed infections and other inflammatory states. The persistence of this Th1 to Th2 shift after DMF therapy is stopped has not been reported.

DMF has also been shown to reduce adhesion molecule expression (CD25, HLA-DR, and cutaneous lymphocyte-associated antigen) in treated T-lymphocytes, which can explain the decreased binding of treated lymphocytes to E-selectin, P-selectin, and VCAM-1 (673). Such effects might also explain reduced leukocyte rolling and adhesion in DMF-treated mice (673). As many of these *in vitro* effects were either not studied or were not observed with MMF treatment, it is unknown if they occur *in vivo* in DMF-treated subjects. Furthermore, the roles for DMF and MMF in Nrf2-driven ARE activation in T-lymphocytes, beyond its associated NF- κ B modulation, have not been studied. Thus, although limited in scope, these *in vitro* studies suggest that DMF, and MMF in part, promote a shift from a pro-inflammatory, IFN- γ -driven Th1 T-lymphocyte profile to an anti-inflammatory, IL-10-driven Th2 T-lymphocyte profile. Such a shift from a Th1 response (autoimmune responses and the killing intracellular parasites) to a Th2 response associated with eosinophilic responses and counteraction against Th1 responses could result in decreased T-lymphocyte activation and tissue infiltration *in vivo*.

Effect of FAE in B-lymphocytes

Studies of the direct effects of FAE on B-Lymphocyte function have not been reported. However, there is evidence that disruption of NF- κ B signaling can interfere with B-lymphocyte development and survival (639), suggesting FAE-mediated NF- κ B modulation may alter B-lymphocyte function.

Effect of FAE in monocytes/macrophages/microglia

DMF and MMF express potent anti-inflammatory and antioxidant effects in monocytes, monocyte-derived macrophages, and microglia. In human macrophages, DMF and MMF decreased NF- κ B nuclear translocation and DNA binding in response to TNF α exposure and reduced TNF α secretion in response to phytohaemagglutinin, suggesting a decreased state of activation (42). Furthermore, DMF and MMF suppressed CCL2-induced chemotaxis of human monocytes (42), which would likely result in decreased infiltration across endothelial surfaces into tissue. In LPS-activated microglia, DMF has been shown to decrease release of the pro-inflammatory cytokines IL-1 β , IL-6, and TNF α (674), likely through decreased NF- κ B signaling. DMF- and MMF-induced expression of Nrf2-dependent ARE proteins, including the ubiquitous cytoprotectant enzyme HO-1, was also reported in macrophages and microglia (42, 675), suggesting that FAEs can modulate the oxidative state within these cells. However, DMF- and MMF-treated monocytes expressed higher levels of reactive oxygen intermediates in the respiratory burst (676), a rapid release of free radicals that is essential step in immunological defense, particularly against bacteria and fungi. In contrast, induction of HO-1 can also decrease expression of reactive nitrogen species, another principal component of the respiratory burst, through suppression of the inducible nitric oxide synthase (iNOS) expression and associated nitric oxide induction (677). Overall, these data suggest that DMF and MMF have potent anti-inflammatory and anti-oxidative effects in macrophages and microglia and this further suggests that DMF formulations could be effective in treating both systemic and CNS inflammatory diseases that involve

macrophage/microglial activation.

Effect of FAE in dendritic cells

Both DMF and MMF suppress monocyte-derived dendritic cell differentiation and cytokine production *in vitro* through suppression of both NF- κ B and extracellular signal-regulated kinase 1 and 2 (ERK1/2) signaling (631, 678). In addition, MMF decreased IL-12, IL-10, TNF α , and IFN- γ secretion from dendritic cells, which resulted in decreased dendritic cell effectiveness in stimulating Th1 cytokine production in T-lymphocytes (679, 680). DMF exposure to dendritic cells also decreased inflammatory cytokine production (IL-12, IL-23, and IL-6), dendritic cell maturation, and effectiveness in generating activated T-lymphocytes (631). These findings, coupled with reports demonstrating that DMF exposure increases the production of IL-10 by dendritic cells, suggest that DMF promotes the type II dendritic cell phenotype (681). In summary, FAE interference with dendritic cell differentiation and cytokine secretion further suppresses Th1 responses in addition to the direct effects of FAEs on T-lymphocytes and also promotes a type II dendritic cell response.

Effects of FAE in endothelial cells

Similar to DMF effects in T-lymphocytes, macrophages, and dendritic cells, DMF has been shown to decrease TNF α -induced NF- κ B activation and associated activation of vascular endothelial cells (682, 683). DMF also decreased the expression of the adhesion molecules E-selectin, VCAM-1, and ICAM-1 on endothelial cells, resulting in decreased leukocyte rolling, firm adhesion, and diapedesis *in vitro* (684, 685), perhaps through inhibition of NF- κ B activation. Notably, these effects were not seen with MMF, which might indicate that DMF formulations might not induce these effects after oral administration. Nonetheless, these results suggest a second mechanism (decreased adhesion and transendothelial migration) by which FAEs decrease immune cell

migration into tissues, in addition to direct effects on chemotaxis by exposed lymphocytes and mononuclear phagocytes, which could further limit tissue inflammation.

Effects of FAE in CNS cells

The effects of FAEs in the CNS could be expressed through modulation of macrophages, microglia, endothelial cells, astrocytes, neurons, oligodendrocytes, and choroid plexus cells. Among those cell types in which FAE effects have been examined are monocyte-derived macrophages, microglia, endothelial cells (previously discussed), astrocytes, neurons, and oligodendrocytes. No studies of DMF or MMF effects in choroid plexus-derived cells have been published. DMF has been shown to decrease IL-1 β , IL-6, and TNF α release from astrocytes and microglia (674, 686), which could contribute to an anti-inflammatory effect in the CNS compartment. Furthermore, DMF and MMF, through Nrf2 activation, induced the expression of ARE effector proteins, including NAD(P)H quinone oxidoreductase-1 and HO-1, in microglia, astrocytes, and neurons (674, 687, 688). Such induction of antioxidant enzymes in astrocytes and neurons was shown to protect against oxidative injury and glutamate toxicity (687-689). Despite this protection in astrocytes and neurons, DMF and MMF did not protect against oxidative injury in the oligodendrocyte CG4 cell line (690). These studies and those mentioned above suggest a role for FAEs as both indirect neuroprotectants through anti-inflammatory and anti-oxidative effects in macrophages, microglia, astrocytes, and endothelial cells, and as direct neuroprotectants through induction of the ARE in neurons.

12.5 FAEs in Inflammatory Disease

Psoriasis

Psoriasis is a common (1-3% of the worldwide population), systemic T-lymphocyte-mediated

chronic inflammatory skin disease characterized by cutaneous inflammation, increased epidermal proliferation, abnormal keratinization, and appearance of erythematous plaques (reviewed in (691)). Psoriasis is the disease for which FAEs have been most widely applied for therapeutic benefit. The efficacy of FAEs likely results from their potent anti-inflammatory and antioxidant effects.

Inflammation in psoriasis: Early reports demonstrated persistent Th1 T-lymphocyte activation within psoriatic plaques (692-694), although natural killer T-lymphocytes were also implicated (695-697). Recent work has shown a significantly complicated picture of the inflammatory milieu in psoriasis plaques. Current models now incorporate an inflammatory axis that balances the Th1, Th2, Th17, and T-regulatory type responses as well as contributions by dendritic cells, natural killer T-lymphocytes, and macrophages (reviewed in (698)). Underscoring this central role of inflammation in the pathogenesis of psoriasis, numerous immunomodulatory therapies have shown efficacy in treating psoriasis, including corticosteroids (699), tacrolimus (700), pimecrolimus (701), methotrexate (702), and the TNF α inhibiting therapies etanercept (703), infliximab (704), and adalimumab (705).

Oxidative stress in psoriasis: In addition to markers of immune activation, markers of oxidative stress are consistently elevated in psoriasis patients and coupled with antioxidant dysfunction. These patients have increased carbonylation (oxidative stress marker) of macromolecules in skin biopsies and cultured fibroblasts (706), increased plasma malondialdehyde (lipid peroxidation product) (707), increased urine 8-hydroxydeoxyguanosine (a marker of DNA oxidation) and nitrate (a product of nitric oxide) (708), increased lipid hydroperoxides (709), and lower serum antioxidants, including paraoxonase-1 and thiols (707, 709, 710). Furthermore, the 55 L/M allele of paraoxonase-1 (an antioxidant enzyme implicated in psoriasis that hydrolyses lipid peroxidases) is a risk factor for psoriasis and allele carriers have higher levels of oxidative stress and lower ARE activity (711). In summary, psoriasis is a chronic inflammatory skin diseases

involving numerous immune axes, particularly various arms of the T-lymphocyte axis, and elevated oxidative stress and impaired antioxidant responses.

Clinical trials of FAEs in psoriasis: Before the roles for immune activation and oxidative stress in psoriasis were identified, the German chemist Walter Schreckendiek empirically developed an FAE therapy for psoriasis (632). Although unknown at that time, the anti-inflammatory effects through suppression of NF- κ B activity and oxidative stress reducing effects through induction of the ARE suggest a role for FAEs in treating psoriasis. The first randomized, double-blind trial of FAE therapy for psoriasis was published by Nugteren-Huying et al. in 1990 (712). This trial demonstrated an average reduction in the psoriatic skin lesion area by 68% in 39 psoriasis patients treated with a combination of DMF and MEF for 4 months, an effect significantly different from the groups treated with an MEF/octylhydrogen-fumarate combination or with a placebo. Since that initial trial, other larger and longer-term clinical trials (up to 3 years) have affirmed the effectiveness and safety of FAE therapy for patients with severe psoriasis (713-719). Combining DMF with other FAEs including MEF (Fumaderm®) showed greater efficacy and patient adherence to FAE therapy than DMF monotherapy (713, 715). The mechanism for this synergistic effect is unknown, but likely could be due to competitive metabolism.

FAE effects on keratinocytes: role in psoriasis: The mechanisms of action of FAE therapy in effectively treating psoriasis likely represent both direct effects on keratinocytes and the aforementioned immunomodulatory and anti-oxidative properties of DMF and MMF on other cell types. Keratinocytes play a major role in the inflammatory response in psoriasis through expression of chemokines and cytokines (reviewed in (720)). DMF treatment in co-cultured keratinocytes and T-lymphocytes increased the Th2 cytokine IL-10, while decreasing IFN- γ , IL-6, and TGF α (668). Furthermore, DMF inhibited the expression of the chemokines CXCL1, CXCL8, CXCL9, CXCL10, and CXCL11 in primary human keratinocytes (672). These immunomodulatory effects on keratinocytes have not been tested with MMF. However, DMF and to a lesser extent

DMF have been shown to decrease keratinocyte proliferation (721, 722). In clinical studies, DMF treatment of psoriasis in patients resulted in improved epidermal hyperproliferation, epidermal thickness, and keratinocyte differentiation (718). Overall, these direct effects on keratinocytes suggest multiple mechanisms that modulate chemoattraction of macrophages, T-lymphocytes, and neutrophilic granulocytes and pathologic proliferation of keratinocytes.

FAEs reduce immune cell infiltration in psoriasis and other skin disorders: Psoriasis involves infiltration of the dermis by CD4⁺ T-lymphocytes and the epidermis by CD8⁺ T-lymphocytes, the majority of which are CD45RO⁺ (memory effector) (723-726). Clinical studies have demonstrated that DMF treatment of psoriasis patients for sixteen weeks decreases CD3⁺CD4⁺CD45RO⁺ T-lymphocytes in the dermis and CD3⁺ CD8⁺ CD45RO⁺ T-lymphocytes in the epidermis (718). This FAE effect of decreased immune cell infiltration is supported by the demonstrations of FAE efficacy in decreasing immune cell infiltration in other inflammatory skin diseases. These include disseminated granuloma annulare (727, 728) and recalcitrant cutaneous sarcoidosis (729), each of which involves large number of CD3⁺ lymphocytes and CD3⁺/CD68⁺ mononuclear phagocytes, each of which is suspected to result from unregulated Th1 reaction. These *in vivo* findings are consistent with *in vitro* studies of DMF that demonstrate decreased expression of adhesion molecules in endothelial cells (684, 685) and lymphocytes (673) and decreased CCL2-induced chemotaxis in macrophages (42), resulting in decreased immune cell tissue infiltration into tissues. Of note, DMF also decreased T-lymphocyte expression of the chemokine CCR10 (670), which is often expressed on skin-homing T-lymphocytes. In addition to decreased chemotaxis and homing in DMF-exposed macrophage and T-lymphocytes, induction of leukocytopenia and lymphocytopenia by DMF might also contribute to DMF efficacy in treating psoriasis (633, 634, 717, 730, 731).

Multiple sclerosis

Multiple sclerosis is the most common cause of neurological disability in young adults worldwide with approximately 2.1 million cases worldwide and 400,000 cases in the United States (322, 732, 733). Epidemiologic data suggest that multiple sclerosis pathogenesis involves environmental influences occurring on a background of genetic susceptibility (734). In most patients, multiple sclerosis presents as a relapsing-remitting disease characterized by dynamic inflammatory demyelinating lesions in the CNS that are associated with sensory (~30%) or motor (~13%) disturbance of the limbs, partial or complete visual loss (~16%) and other signs and symptoms (reviewed in (735)). Multiple sclerosis is the first CNS disease successfully treated with FAEs. The efficacy of FAEs in multiple sclerosis likely results from their potent anti-inflammatory and antioxidant effects within the CNS compartment.

Inflammation and degeneration in multiple sclerosis: Traditionally multiple sclerosis was considered to be an autoimmune, inflammatory disease of the CNS mediated by an aberrant T-lymphocyte attack against CNS elements, particularly myelin, resulting in degeneration of axons (736). This view was strongly supported by pathological, laboratory, radiological, genetic, epidemiological, and therapeutic data, all of which supported an autoimmune and inflammatory phenotype that is driven by Th1 type inflammation in the brain (reviewed in (736)). However, recently published studies have posited that multiple sclerosis is primarily a degenerative disorder, with a secondary immune response to myelin and other highly immunogenic debris (reviewed in (737)). Evidence for this includes reports demonstrating that myelin abnormalities might begin at the inner myelin sheath in areas outside focal inflammation (738, 739); patients in early stages of multiple sclerosis show little evidence of T-lymphocyte or B-lymphocyte infiltration in newly formed demyelinating lesions (although evidence of the innate immune response by macrophage infiltration and microglial activation is present, probably for clearing debris) (740, 741); and the ineffectiveness of autologous hematopoietic stem-cell transplantation to halt the

progression of demyelination, axonal degeneration, and brain atrophy despite reducing CNS inflammatory activity (742, 743). Regardless of the initial pathologic substrate, the inflammatory response present in relapsing-remitting multiple sclerosis plays a critical role in disease pathogenesis as evidenced by the success of numerous immune modulators, including interferon beta-1b (720) and beta-1a (744, 745), glatiramer acetate (746, 747), fingolimod (699, 748), and teriflunomide (749) among many others, in reducing and in some instances eliminating neuroinflammation and clinical relapses.

Clinical trials of FAEs for multiple sclerosis treatment: BG-12, an oral FAE formulation containing DMF, recently showed strong positive effects in two independent placebo-controlled phase III clinical trials (DEFINE and CONFIRM) involving more than 2600 relapsing-remitting multiple sclerosis patients (633, 634). Importantly, BG-12 improved clinical outcomes associated with suppression of brain inflammation in such patients when given twice daily or three times daily, likely due in part to the CNS penetrance of MMF (688). BG-12 therapy in both trials significantly reduced the proportion of patients who relapsed and the annualized relapse rate at 2 years by ~50%. Furthermore, BG-12 reduced the number of gadolinium-enhancing lesions (inflammation) and of new or enlarging T2-weighted hyperintense lesions (demyelination). In the DEFINE trial (633), BG-12 significantly reduced progression of disability by 38% with BG-12 twice daily and 34% with BG-12 thrice daily. In the CONFIRM trial (634), BG-12 also reduced progression of disability, but the trend was not significant. Given the positive results of these clinical trials BG-12 was approved for the treatment of multiple sclerosis by the FDA on March 27th, 2013 under the brand name Tecfidera™. These results show that the oral DMF formulation (BG-12/ Tecfidera™) is effective in modifying CNS inflammation and associated neurological dysfunction in treated patients and they suggest that DMF formulations should be considered for use in other neuroinflammatory diseases.

FAE immune modulation in multiple sclerosis: The balance between Th2 and Th1 responses

plays a key role in multiple sclerosis pathogenesis. Multiple sclerosis lesions contain activated CD4⁺ and CD8⁺ T-lymphocytes, mononuclear phagocytes, and high expression of IFN- γ , TNF α , IL-1, and leukocyte and vascular adhesion molecules(750-752). A shift from a Th1 towards a Th2 cytokine profile, as induced by FAEs in T-lymphocytes and PBMCs *in vitro* (667-670, 672), could have a beneficial effect on the clinical course of the disease. This is supported by a recent study that showed that BG-12-treated multiple sclerosis patients showed increased intracellular expression of the Th2 cytokine IL-10 in CD4⁺ peripheral lymphocytes, with no change in IFN- γ expression (753). It has also been proposed that the mild leukocytopenia and lymphocytopenia observed in BG-12 treated individuals could contribute to BG-12 efficacy by reducing the number of circulating immune cells (754). A possible complimentary mechanism for the efficacy of BG-12 in multiple sclerosis is the decreased expression of adhesion molecules on endothelial cells (684, 685) and lymphocytes (673) and decreased CCL2-induced chemotaxis in macrophages (42), resulting in decreased immune cell tissue infiltration into the brain. Each of these mechanisms is supported by studies of autoimmune encephalomyelitis (EAE), the murine model of multiple sclerosis. During chronic EAE, MMF significantly and DMF nonsignificantly reduced the infiltration of T-lymphocytes in the spinal cord. Additionally, MMF, and to a lesser degree DMF, significantly reduced the infiltration of macrophages into the spinal cord (755). Thus, although the major beneficial effects of BG-12/Tecfidera™ in treating multiple sclerosis are likely associated primarily with the ability to reduce CNS inflammation, the reduction of levels of circulating T lymphocytes and reduction of T-lymphocyte and monocyte/macrophage chemotaxis might also contribute to the beneficial effects in multiple sclerosis.

F AE antioxidant response induction in multiple sclerosis: The emerging and prominent role for oxidative stress in multiple sclerosis pathogenesis and the well studied protective effects of the ARE activation in cell of different lineages in the CNS highlight another probable mechanism of FAE efficacy in multiple sclerosis. Oxidative stress associated with mitochondrial dysfunction (756) and excessive release of free radicals(757) has been strongly associated with multiple

sclerosis pathogenesis, perhaps contributing to increased CNS leukocyte invasion and activation, neurodegeneration, and oligodendrocyte damage. Free radicals include reactive oxygen species, reactive nitrogen species, and nitric oxide, which are mainly produced by macrophages and microglia (758, 759). In addition, myeloperoxidase activity, which produces the cytotoxic oxidizer hypochlorous acid and tyrosyl radicals catalyzed from H₂O₂, is elevated in macrophages and microglia in actively demyelinating white matter and cortical lesions in multiple sclerosis (760). These data suggest that a reduction in oxidative stress might reduce neuroinflammation and associated CNS damage, each of which could be suppressed by BG-12.

BG-12 is the first multiple sclerosis therapy shown to activate the Nrf2-dependent ARE pathway and thus reduce oxidative stress. Previous studies have shown that FAE induction of the ARE and its effector proteins, including HO-1, prevented oxidative-stress induced astrocyte and neuronal injury (687, 688, 761), decreased microglia nitric oxide burst (690), and prevented myelin loss within the CNS (688). In EAE studies, DMF treatment attenuated axonal loss and reduced astrocyte activation in wild-type mice, but not in Nrf2^{-/-} knockout mice (688), strongly suggesting a role for Nrf2-dependent ARE activation in FAE-mediated neuroprotection. This finding is supported by *in vitro* data that demonstrated that Nrf2 knockdown removed the dose-dependent protective effect of DMF and MMF on astrocyte and neuron cell viability after toxic oxidative challenge (687). High concentrations (100 μM) of DMF and MMF have been shown to induce the ARE protein HO-1 in oligodendrocytes without evidence of drug cytotoxicity (11). However, whether FAEs are directly protective against oxidative injury or other insults in oligodendrocytes has not been reported. Despite this strong evidence linking ARE induction to protection during CNS oxidative and inflammatory injury in multiple sclerosis, the specific antioxidant pathways and effector proteins responsible for these protective effects are not known.

Other inflammatory diseases as targets for FAEs

Huntington's disease: FAEs have been studied preclinically in other diseases linked to inflammation and oxidative stress. Huntington's Disease (HD) is an autosomal dominant, progressive neurodegenerative genetic disorder, associated with an expanded trinucleotide (CAG)_n repeat encoding a polyglutamine stretch in the N-terminus of the huntingtin protein (762). Oxidative stress, mitochondrial dysfunction, and other metabolic deficits have been shown to play central roles in the pathogenesis of HD (763). Furthermore, symptomatic CNS disease staging in HD model mice was associated with increased levels of brain oxygen radicals (764). Treatment of these HD model mice with DMF prolonged survival and preserved motor functions and neuronal morphology within the striatum and motor cortex,⁶ likely through the induction of the ARE. These findings implicate a central role for oxidative stress in HD pathology and have led to multiple clinical trials studying the efficacy of various antioxidants and modulators of the Nrf-2/ARE pathway (765), though FAEs have not yet been studied clinically in HD. The efficacy of FAEs in this model and in multiple sclerosis suggests a broader applicability to CNS disease states with oxidative stress components, regardless of cause.

Herpes stromal keratitis: Herpes Stromal Keratitis (HSK), the leading cause of infectious blindness in developed nations (766), is a disease characterized by an immune-based pathological reaction that is triggered by herpes simplex virus (HSV) infection of the cornea. In HSK, CD4⁺ Th1 T-lymphocytes are believed to be the principal disease mediators, as the Th1 cytokines IFN- γ and IL-2 were highly expressed in the HSK cornea (767) and anti-IFN- γ and anti-IL-2 treatment decreased the incidence and severity of herpetic corneal disease (768, 769). Neutrophils and antigen-presenting cells may also play central roles in HSK pathogenesis (770, 771). In mice exposed to HSV after a corneal scratch, DMF therapy reduced corneal infiltration of lymphocytes, polymorphonuclear leukocytes (PMNs), and macrophages and decreased the severity and incidence of stromal keratitis (772, 773). Additional studies of these mice

demonstrated that DMF treatment increased the expression of Th2 cytokines IL-4 and IL-10 in lymphocytes cultured from the spleen, although no changes were seen in expression of the Th1 cytokines IFN- γ and IL-2 (773). Thus, while Th1 cytokines are associated with HSK progression, Th2 cytokines are consistently associated with improvement (773-775). Even though DMF treatment improved outcomes in these HSK mouse studies, DMF had no effect on viral titers, HSV antibody production, or HSV antigen-specific T cell proliferation (773). These data demonstrate that FAEs have therapeutic efficacy in treating virally-induced inflammation and immune cell infiltration, and that these effects likely result from direct modulation of the immune response rather than interference with virus replication.

12.6 FAEs as Candidate Adjunctive Therapy for Systemic HIV Disease

The FAEs, and specifically the oral DMF preparations (BG-12/Tecfidera™, Fumaderm®), are attractive candidates as adjunctive agents for suppressing chronic immune activation, oxidative stress, and associated HIV disease progression and comorbidities in antiretroviral therapy (ART)-treated individuals (reviewed in Figure 12.2). To date, no *in vivo* or clinical studies have examined the efficacy of FAE therapy in HIV infection, however the dual anti-inflammatory and anti-oxidative mechanisms of FAEs suggest potential potent systemic efficacy. FAEs have been studied in *in vitro* models of HIV macrophage-mediated neurotoxicity where they have shown promising results. The CNS penetrance of MMF and the demonstrable suppression of CNS inflammation in BG-12-treated multiple sclerosis patients are especially appealing for targeting persistent CNS inflammation and oxidative stress in such individuals (see section 12.7 HIV CNS Disease).

FAEs as suppressers of systemic immune activation in HIV/AIDS

Through inhibition of the NF- κ B signaling, which regulates cytokine and chemokine signaling, oral

DMF therapy might provide an additional suppressive effect on the chronic immune activation in ART-treated patients. This prediction is supported by the efficacy of oral DMF-formulations (BG-12/Tecfidera™ and Fumaderm®) in limiting inflammation and immune cell infiltration in multiple sclerosis and psoriasis (633, 634, 717, 723-726, 730, 731, 753). Suppression of chronic immune activation will likely improve long-term survival, lower risk of associated end-organ diseases, and improve quality of life in HIV-infected ART-treated individuals (111, 116). The glucocorticoid prednisolone, a potent immunosuppressant, lowered systemic immune activation in both untreated and ART-treated patients (776) and postponed CD4+ T-lymphocyte count decreases for a median of two years in untreated HIV-infected patients (777, 778). Prednisone, the precursor to prednisolone, inhibited monocyte TNF α production without affecting T-lymphocyte antigenic responses (779). However, the profound side effects of glucocorticoid therapy make its long-term use unattractive as adjunctive therapy. In a small retrospective study, addition of the immunosuppressant cyclosporine to ART therapy during primary HIV-1 infection restored CD4+ T-lymphocytes to normal levels (both percentage and absolute numbers) and adjunctively treated patients maintained higher CD4+ T-lymphocyte levels than those in patients taking ART alone (780). In this study, cyclosporine adjunctive therapy did not significantly affect virus-specific CD8+ or CD4+ T-lymphocyte responses or viral load (780). However, another study of the effects of cyclosporine treatment during acute and early HIV-infection in 48 subjects demonstrated no significant improvement in CD4+ T-lymphocyte counts or other markers of disease progression (781). Notably, cyclosporine has shown limited efficacy in multiple sclerosis (782-785), in direct contrast to the strong and consistent efficacy reported for the immune modulator BG-12/Tecfidera™ (633, 634), suggesting DMF therapy may similarly prove more effective in HIV-infection. The central role of chronic immune activation in disease progression in ART-treated individuals coupled with these promising findings demonstrating a delayed disease progression with suppression of immune activation strongly supports further exploration of immunomodulatory therapy for the treatment of HIV infection. The anti-inflammatory effects of DMF in cell lineages relevant to HIV-infection coupled with its effectiveness in the chronic inflammatory diseases

multiple sclerosis and psoriasis, makes it a promising adjunctive therapy for improving morbidity and mortality in ART-treated HIV-infected individuals.

FAEs as possible protectors of the intestinal mucosal barrier in HIV/AIDS

Chronic immune inflammation is believed to occur primarily as a result of microbial translocation across the damaged gastrointestinal tract (111), as described above. Beyond direct anti-inflammatory effects on immune cells, FAE therapy might ameliorate chronic immune activation through decreasing microbial translocation by several effects: *i)* reversing or halting the depletion of mucosal CD4⁺ T-lymphocytes, *ii)* limiting mucosal immune activation and inflammation, and *iii)* preventing structural damage to the intestinal epithelium. Through inhibition of NF- κ B activity in mucosal lymphocytes and other mucosal immune cells, FAEs could dampen mucosal immune cell activation thereby limiting mucosal inflammation. This decreased inflammation could reduce immune activation-induced T-lymphocyte apoptosis (786). Recent *in vitro* and *in vivo* mouse studies suggest that inducers of the Nrf2-dependent ARE can protect intestinal mucosa from inflammation-associated oxidative stress and injury and reduce the associated invasion of anaerobic bacteria into the mucosa (663, 787-791). Therefore, oral DMF through induction of the ARE might limit microbial translocation across the intestinal mucosa and through NF- κ B inhibition promote gut immunity, thereby preventing the primary cause of chronic systemic inflammation in HIV-infected individuals.

FAEs as suppressors of systemic HIV replication

The ability of DMF and MMF to modulate NF- κ B signaling and cellular pathways of cytokine production, particularly of TNF α , suggests the possibility of associated effects on replication of HIV in immune cells. Increased nuclear translocation of NF- κ B, through immune activation including TNF α stimulation (158, 792, 793), drives HIV gene expression from the HIV long

terminal repeat (LTR) (794, 795). Therefore, FAE-driven inhibition of NF- κ B nuclear translocation and DNA binding might further limit HIV-replication *in vivo*. Potent inhibition of HIV replication by DMF and MMF pre-treatment in primary human monocyte-derived macrophages has been demonstrated *in vitro* (42). The effect of FAEs on HIV replication in T-lymphocytes, the primary targets of HIV infection, has not been reported. In addition, modification of the oxidative state of immune cells such as increasing glutathione has been shown to interfere with HIV particle assembly, infectivity, and release (159, 796), which suggests another possible inhibitory effect of FAEs on the HIV life cycle.

FAEs as Suppressors of Oxidative Stress in HIV/AIDS: In addition to markers of immune activation, markers of oxidative stress are consistently elevated and associated with disease progression in HIV-infected patients. This role of oxidative stress and glutathione depletion in HIV systemic disease pathogenesis and mortality served as the rationale for treatment of HIV-infected patients with various direct antioxidants, including N-acetylcysteine (169, 797-800) and selenium (801-803). The largest selenium clinical trial was a randomized controlled trial of 262 HIV-infected patients (192 receiving ART) that reported that nine-months of selenium supplementation resulted in a significant increase in CD4+ T-lymphocyte count and a decrease in viral load (803). Similar effects on increasing CD4+ T-lymphocyte counts and decreased viral loads were seen in two of the N-acetylcysteine studies (799, 800). These trials suggest that antioxidant therapies have the potential to modulate HIV disease progression. However, numerous studies suggest that N-acetylcysteine (804-806), selenium (807), and other direct antioxidants (808-810) actually suppress the endogenous Nrf2-driven ARE (a pro-oxidative effect), likely due to their direct suppression of oxidative stress, which serves as the main inducer of the Nrf2 translocation and subsequent ARE induction. Furthermore complicating their clinical usefulness, direct antioxidants are expended to elicit their antioxidant effects and thus are often short-lived and need to be replenished frequently (811). Therapies that induce sustained activation of the endogenous ARE might provide greater protection against oxidative stress than direct antioxidants due to sustained

increased expression of multiple antioxidant effector proteins.

The monoamine oxidase B inhibitor selegiline, which had been shown decrease oxygen free radicals and enhance the expression of antioxidant enzymes superoxide dismutase and catalase (812-814), has been used to attempt to increase dopaminergic neurotransmission and reduce neuronal injury caused by oxidative stress in Parkinson's and Alzheimer's Disease (815, 816). In addition, selegiline has been shown to activate the Nrf2 pathway in neuronal cell lines (817). Despite the success of selegiline in other neurocognitive diseases and the evidence that selegiline may induce the ARE and limit oxidative stress, a 24-week clinical trial of transdermal selegiline therapy (two doses) with a 24-week open-label extension in HIV-infected patients failed to show neurocognitive improvement or positive changes in brain or CSF biomarkers of oxidative stress (818-820). The reasons for the failure of selegiline therapy to achieve positive outcomes in this trial are unclear. The 24-week treatment duration was relatively brief and each treatment arm, including placebo, showed no neurocognitive deterioration over 24 weeks of open-label follow-up. Some investigators have suggested that augmenting dopaminergic signaling could enhance HIV infection of macrophages and promote neuropathological disease progression in simian immunodeficiency virus (SIV)-infected macaques (341, 342).

Despite the clinical trial failure of transdermal selegiline, compelling evidence supports oxidative stress as a major driving force in HIV neuropathogenesis. Furthermore, the partial clinical efficacy of direct antioxidants (N-acetylcysteine, Selenium) strongly supports further study of ARE-inducing therapies such as DMF for disease suppression in HIV infected individuals.

Potential of FAEs in treating systemic HIV-associated comorbidities

Despite use of ART therapy, HIV-infected individuals have an increased risk of progressive dysfunction of major organs. Such HIV disease progression can involve the central nervous

system (brain/cognition, see section VI.B HIV CNS Disease; spinal cord/myelopathy), peripheral nerves (neuropathy), heart (atherosclerosis, heart failure), liver (cirrhosis, hepatocellular carcinoma), kidney (nephropathy, glomerulonephritis/sclerosis, tubulointerstitial nephritis), and bone (osteopenia, osteoporosis) (reviewed in (105, 821, 822)). In these comorbidities, inflammation and possibly the associated oxidative stress are thought to play a significant role.

Cardiovascular disease: HIV-infected patients have increased risk of atherosclerosis, myocardial infarction, heart failure, and other vascular diseases (823, 824). Increased serum levels of several markers of inflammation strongly predict cardiovascular disease and mortality (825-827). Although HIV-infected ART-treated individuals are at lower risk for cardiovascular disease than HIV-infected individuals not receiving ART, they are nonetheless at higher risk than the general population. Risk factors for cardiovascular disease in ART-treated individuals include low-level virus replication, chronic immune activation associated microbial translocation, monocyte activation, and oxidative stress (reviewed in (828)), each of which is a potential target of DMF therapy. Atherosclerosis in particular is driven by persistent inflammation, macrophage and T-lymphocyte infiltration, endothelial cell activation, and oxidative stress (829, 830). Furthermore, studies of transgenic mice expressing HIV Tat, gp120, and Nef suggest that expression of these HIV-1 proteins, independent of viral infection, can induce cardiac damage through oxidative stress (154). Such damage is associated with elevated cystine/cysteine ratios and altered glutathione metabolism in cardiac muscle (154). Similarly, cardiac tissue from Tat-expressing transgenic mice showed decreased glutathione levels, mitochondrial damage, and cardiomyopathy (831). Thus, the ability of DMF and MMF to decrease inflammation, immune cell activation and invasion, endothelial cell activation, and injury due to oxidative stress suggest that DMF formulations could decrease the elevated risk of cardiovascular events in ART-treated individuals.

Bone disease: Osteopenia and Osteoporosis: A recent meta-analysis showed that the prevalence

of osteopenia and osteoporosis in HIV-infected individuals was more than three times higher than that in uninfected controls (832). This could reflect effects of chronic inflammation and associated increased bone resorption (833) as well as HIV-driven (and potentially ART-driven) increases in osteoclast activity (834). DMF therapy, through limiting systemic inflammation and viral replication, could potentially reduce these pro-osteoclast signals. One such signal, NF- κ B activity, regulates osteoclast differentiation and the inflammatory cytokine TNF α that induces bone loss through stimulation of osteoclasts (835-837). Therefore, DMF therapy through inhibition of NF- κ B and TNF α release from immune cells could have further efficacy in decreasing osteoclast activity.

Hepatic and renal disease: HIV-infected individuals also have increased risk of both kidney (838-840) and liver (840-842) disease associated with viral replication, low peripheral CD4+ T-lymphocyte count, and the use of certain antiretroviral drugs (843-848). Given these correlations among renal and liver disease, viral replication (despite ART), and T-lymphocyte counts, DMF therapy could potentially ameliorate HIV-associated liver and kidney disease.

In summary, DMF therapy in HIV-infected patients could reduce disease progression by limiting systemic immune activation and associated oxidative stress. Through induction of the Nrf2/ARE and inhibition of NF- κ B, DMF therapy could systemically: *i*) reduce immune cell activation and cytokine release, *ii*) prevent leukocyte tissue infiltration; and *iii*) inhibit HIV infection and replication. Each of these effects has been demonstrated in published studies examining DMF. In addition, suggested possible effects of DMF therapy include the following: *i*) limiting intestinal mucosal barrier damage and associated microbial translocation, *ii*) reducing HIV-associated organ comorbidities, and *iii*) limiting oxidative stress (reviewed in Figure 12.2). Thus, there is much promise for the use of oral DMF formulations as adjunctive therapy for systemic disease progression and comorbidities in ART-treated HIV-infected individuals.

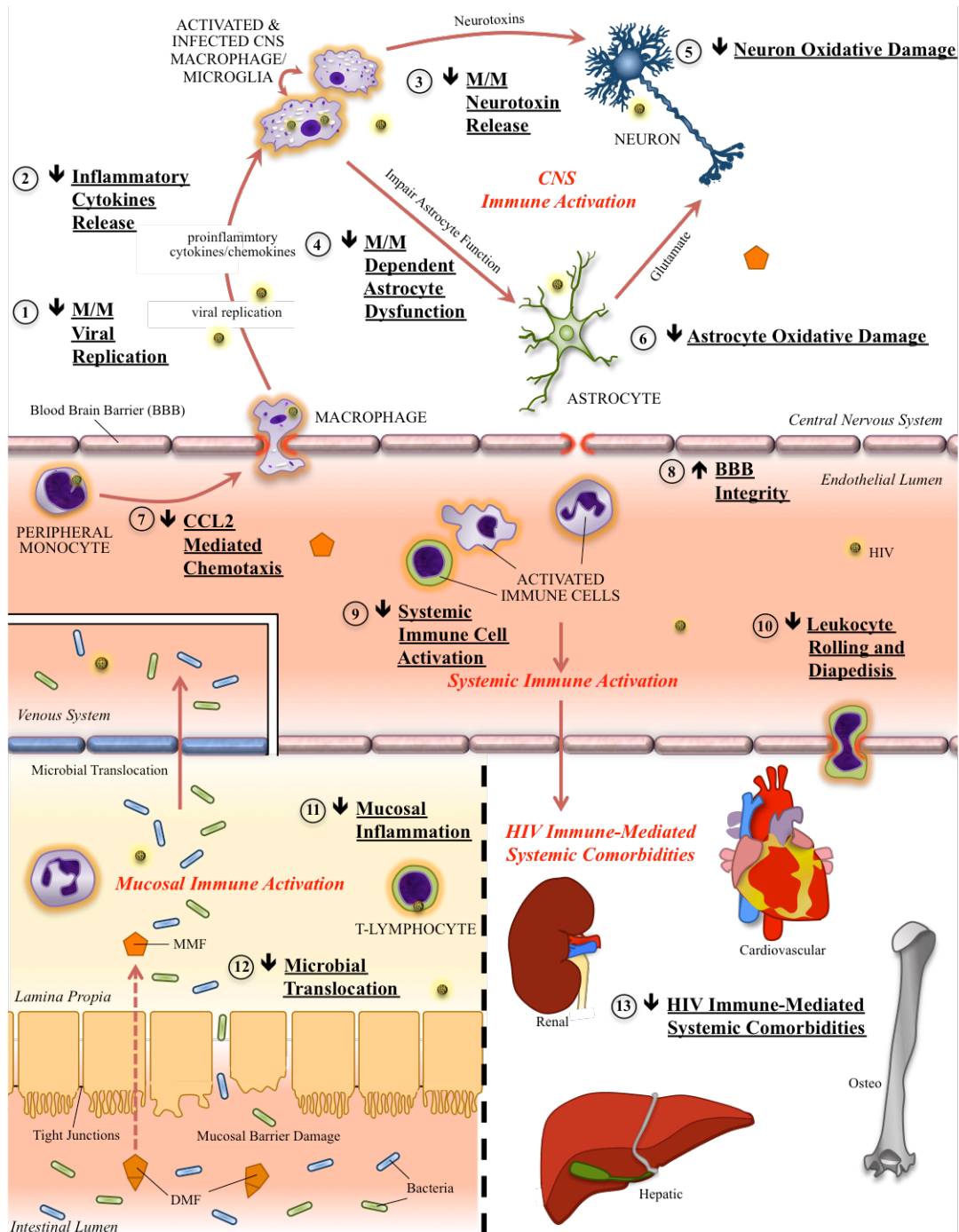

Figure 12.2 Potential effects of dimethyl fumarate (DMF) therapy on systemic and CNS HIV disease pathogenesis. Oral DMF, primarily through its active in vivo metabolite monomethyl fumarate (MMF), might have potent anti-inflammatory and anti-oxidative effects (marked by numbers 1–13 in figure) in HIV-infected cART-treated individuals thereby limiting both systemic and CNS chronic immune activation and oxidative stress. This could result in decreased HIV disease progression and associated comorbidities. Abbreviations used: monomethyl fumarate (MMF), dimethyl fumarate (DMF), blood-brain barrier (BBB), macrophage/microglia (M/M).

12.7 FAEs as Candidate Adjunctive Therapy for CNS HIV Disease

As discussed, the oral DMF formulation BG-12/Tecfidera™ decreased relapse rates and associated neuroinflammation in patients with multiple sclerosis in two independent Phase III clinical treatment trials (633, 634). These studies clearly demonstrate efficacy of oral DMF-treatment in the CNS and its efficacy against neuroinflammation and oxidative stress may provide important adjunctive therapy for HIV-infected patients to prevent and treat HAND.

FAEs as inhibitors of HIV viral infection in monocytes and macrophages

Pretreatment with DMF and MMF decreased HIV infection and TNF α secretion in HIV monocyte-derived macrophages (HIV-MDM), likely due in part to inhibition of NF- κ B nuclear translocation and DNA binding (42). It is well established that TNF α exposure increases HIV replication through increased nuclear translocation of NF- κ B (792, 793), which drives HIV gene expression from the HIV long terminal repeat (LTR) (794, 795). However, in addition to decreasing autocrine effects of TNF α secretion, there are other possible NF- κ B modulating effects of DMF and MMF associated with oxidative stress in HIV-MDM. Oxidative stress has been shown to drive HIV replication (158-160), likely through NF- κ B activation (653-656), and Nrf2 nuclear translocation and activation of the ARE have been shown to suppress NF- κ B (described above).

DMF and MMF induce activation of the ARE and suppress HIV infection at concentrations that are consistent with CSF MMF concentrations *in vivo* (4.4 μ M) (688). However, inhibition of NF- κ B may require higher DMF and MMF concentrations (>15 μ M) (42), which suggests other ARE-mediated, NF- κ B-independent effects of DMF and MMF on HIV infection. These effects could include suppression of HIV entry into monocytes and macrophages and disruption of virion assembly and release from infected cells. It has been reported that antioxidants can decrease the stability of CXCR4 and CCR5 mRNA transcripts in human monocytes (849). Because CCR5 and

CXCR4 are the major cellular co-receptors for HIV, such antioxidant effects of DMF and MMF could limit HIV entry into monocytes and macrophages. Furthermore high intracellular glutathione levels in macrophages were associated with defective HIV particle assembly and decreased virion infectivity and release (159). Thus, DMF and MMF activation of the ARE may limit HIV infection of monocytes and macrophages at several steps in the HIV life cycle (entry, replication, and particle assembly).

FAEs as inhibitors of macrophage neurotoxin release

One consequence of HIV infection and/or immune activation of macrophages and associated inflammation is the production and release of soluble neurotoxins. Beyond promoting HIV-replication, elevated TNF α levels associated with immune activation increase monocyte entry into the brain and drive associated inflammatory cascades; one consequence is the production and release of soluble neurotoxins from macrophages, microglia, and astrocytes (850). Activation of the ARE pathway decreases macrophage and microglia activation (42, 851-854), probably through ARE-mediated inhibition of NF- κ B signaling. Work from our laboratory demonstrated that DMF and MMF treatment reduces neurotoxin release from HIV-MDM and associated neuronal death in an HIV neurotoxicity model system, independent from viral replication (42, 43). We further demonstrated that the decrease in HIV-MDM neurotoxin release was partly dependent on the ability of DMF and MMF to induce the expression of the Nrf2/ARE effector and cytoprotective protein heme-oxygenase-1 (HO-1) (42). HO-1 is the inducible, rate-limiting enzyme that degrades pro-oxidative and cytotoxic heme to bilirubin and carbon monoxide, each of which has well-documented antioxidant and anti-inflammatory effects (42, 418, 855-857). We showed that HIV-infection of MDM in vitro drastically decreases HO-1 protein expression and that induction of HO-1 in HIV-MDM lowered neurotoxin production independent of viral replication ; in contrast, inhibition of HO-1 enzymatic activity in HIV-MDM increased neurotoxin production (42) (42, 43). These data strongly suggest that HO-1 suppression in HIV-MDM plays a pivotal role in

macrophage-mediated neurotoxin production during HIV infection and that rescuing this suppression with DMF or MMF might suppress neurodegeneration in HAND.

FAEs as modulators of immune cell CNS infiltration and blood brain barrier integrity

In addition to suppression of MDM activation and neurotoxin production, DMF and MMF reduced monocyte chemotaxis driven by CCL2 (42), thus potentially limiting transendothelial migration of monocytes into the CNS during HIV infection. Less monocyte trafficking into the CNS could limit HIV and inflammatory cell entry into the brain and subsequent neuroinflammation. Complementing this effect, DMF can decrease endothelial cell adhesion molecule (ICAM-1, VCAM-1, and E-selectin) expression, thereby decreasing leukocyte rolling and diapedesis (684, 685). This could potentially further limit immune cell trafficking into the CNS and its complications in HAND. HIV infection also impairs blood brain barrier (BBB) permeability, possibly through actions of released viral proteins, induction of oxidative stress, or induction of systemic inflammation (reviewed in (858)). Each of these can disrupt the structural integrity of the BBB in part through breakdown of tight junctions, thereby increasing microbial invasion and immune cell infiltration (858). Recent studies of post-traumatic brain injury (859) and subarachnoid hemorrhage (860) in mice suggested that activation of the Nrf2/ARE antioxidant and detoxifying enzymes preserve BBB and tight junction integrity. Moreover, Nrf2/ARE activation in choroid plexus cells preserved the blood-CSF barrier after oxidative stress injury (861). Therefore, DMF therapy could further protect the CNS compartment more globally from microbe and immune cell invasion and other systemic insults through direct protection of the BBB and blood-CSF barrier through its antioxidants effects.

FAEs as astrocyte and neuron protectants from inflammation and oxidative stress

In addition to macrophages and microglia, astrocytes and neurons are also possible CNS targets

for FAEs. DMF has been shown to decrease astrocyte activation and the release of inflammatory cytokines (687-689), which could further dampen CNS neuroinflammation. DMF treatment also decreased macrophage and microglia activation (674) and associated release of TNF α release (42) and likely other HIV-MDM factors (247-256) through ARE induction, which have been shown to impair astrocyte glutamate homeostasis and promote glutamate-mediated excitotoxicity. TNF α in particular can suppress astrocyte glutamate scavenging through impairment of their high affinity glutamate transporters, which are critical for regulation of extracellular glutamate levels (246, 862). Furthermore, TNF α released into supernatants of HIV-infected macrophage cultures can induce nitric oxide synthase and nitric oxide production and release by exposed astrocytes (863); such a process could amplify CNS oxidative stress and associated injury during HIV infection. Although such possible effects of DMF and MMF on HIV-MDM-mediated astrocyte dysfunction have not been studied, DMF treatment has been shown to directly protect both astrocytes and neurons from oxidative injury and glutamate toxicity through Nrf2/ARE induction (687-689). Because glutamate mediated excitotoxic injury has been implicated in the pathogenesis of HAND, these studies suggest DMF might protect neurons directly from HIV-mediated neurotoxicity as well as indirectly by preventing astrocyte dysfunction.

In summary, DMF therapy in HAND patients could have both direct and indirect neuroprotective effects through inhibition of NF- κ B activity and Nrf2/ARE induction in different CNS cell types (reviewed in Figure 12.2). Direct effects could occur through induction of neuronal cytoprotective antioxidant responses. Indirect effects could occur through DMF/MMF actions in macrophages/microglia, astrocytes, endothelial cells, and choroid plexus cells. Confirmed macrophage effects of DMF and MMF include (42): *i*) suppressing neurotoxin production; *ii*) limiting HIV infection; *iii*) impairing monocyte chemotaxis; *iv*) inhibiting TNF α release; and *v*) inhibiting NF- κ B nuclear translocation. Proposed astrocyte effects include: *i*) inhibiting release of TNF α and other proinflammatory cytokines; *ii*) preserving glutamate scavenging and glutamate homeostasis; *iii*) limiting production of nitric oxide and associated pro-oxidants. Additionally,

indirect neuroprotective effects of DMF and MMF could also occur through actions in endothelial cells, which maintain the BBB. Confirmed effects in endothelial cells include: *i*) reducing adhesion molecule expression; and *ii*) promoting BBB structural integrity. Finally, DMF therapy could preserve the blood-CSF barrier integrity through actions in choroid plexus cells. Thus, there is much supporting evidence for the study of DMF as an adjunctive therapy for neuroprotection against HAND in ART-treated HIV-infected individuals.

12.8 Safety of FAE Therapy

FAE therapy safety and adverse events

Oral DMF (240 mg taken 2-3 times daily) has been tested in several clinical trials in individuals with psoriasis (717, 730), multiple sclerosis (633, 634, 731), and other inflammatory diseases (727, 729). The recent phase III efficacy trials for multiple sclerosis demonstrated no increase rate of patient dropout in drug vs. placebo-treated patients, indicating excellent long-term tolerability (633, 634). The most common reported adverse events in these trials were flushing in ~33% of patients, gastrointestinal events (diarrhea, nausea, upper abdominal pain, and vomiting) in ~33% of patients, and pruritus and proteinuria in ~9% of patients. Flushing and gastrointestinal events decreased after the first month of therapy. Transient eosinophilia has also been reported in patients at 4-8 weeks post initiation of FAE therapy (716). DMF formulation treatment was associated with a persistent leukocytopenia (~11% reduction in white blood cell count) and particularly lymphocytopenia (~30% reduction in circulating T-lymphocytes). White-cell and lymphocyte counts decreased in patients over the first year of DMF therapy and eventually plateaued at a lower set-point, though the majority of patients' cell counts remained within the normal range. White-cell counts less than 3.0×10^9 per liter and lymphocyte counts of less than 0.5×10^9 per liter (corresponding to the National Cancer Institute Common Toxicity Criteria grade 2 or higher leukocytopenia and grade 3 or higher lymphocytopenia, respectively) were seen in

~4-7% of patients in the oral DMF groups versus ~1% in patients in the placebo group (633, 634).

Despite the reduced white blood cell and lymphocyte counts, an increase in risk for malignancy or infection, including opportunistic infections, has not been reported in any FAE clinical trials or retrospective studies during the 20 years of FAE use (730, 864). However, recent case reports of progressive multifocal leukoencephalopathy (PML) have been reported in patients taking combination formulations of DMF and other fumarate derivatives (Fumaderm® and Psorinovo) (865-868). Significant confounding risk factors for PML were present in some of these patients (including sarcoidosis, cancer, and efalizumab use) and so the true relative risk for FAE-associated PML is difficult to assess. Of the 135,000 patients with multiple sclerosis treated with the BG-12/Tecfidera™ oral DMF formulation (representing approximately 112,000 person-years of exposure as of December 21, 2014), there is only one case report of PML (869). Nonetheless, the rare case reports of PML suggest that vigilance in prescribers is critical. Prior to these reports, precautions for use such as monitoring blood lymphocyte levels had been suggested. A reduction of FAE dose or discontinuation was recommended if the white blood cell or lymphocyte counts fall below 3.0×10^9 or 0.5×10^9 cells per liter, respectively (870). This recommendation is especially prudent, in view of these recent PML case reports.

Safety of FAE immunomodulatory therapy in HIV-infected individuals

The clinical safety of long-term use of oral FAE therapy in humans is supported by a lack of clear evidence of serious adverse events after more than 17 years of its widespread use for the treatment of psoriasis, and its recent use in Phase III multiple sclerosis treatment trials involving more than 2600 patients (see section III. Safety and Adverse Events for long term clinical safety data and recent PML case reports). Nonetheless, its use in HIV-infected individuals has not been established, and the potential risks of this application must be considered. Among these concerns is the possibility that immunosuppressive FAE therapy in HIV-infected patients would increase

their risk for opportunistic infections, malignancy, acceleration of HIV infection, and mortality (871, 872). However, potent immunosuppressive therapy has been used successfully in HIV-infected individuals undergoing organ transplantation for nearly two decades, with no significant increase in risk for these complications in comparison with such complications in HIV-negative transplant recipients (873-876). Several studies have reported that HIV viral loads and CD4+ T-lymphocyte counts were well-maintained after kidney and liver transplantation in HIV-infected patients.(877-879) Moreover, the largest prospective study of ART-treated HIV-infected recipients of kidney transplantation (n = 150) receiving standard immunosuppressive therapy reported one and three year survival rates to be 94.6% and 88.2%(879), respectively, which is not significantly different from current kidney transplant survival rates as reported by the U.S. Scientific Registry of Transplant Recipients (880). Furthermore, the increased risk of *de novo* or recurrent malignancy in HIV-infected patients undergoing solid-organ transplantation and subsequent immunosuppressive therapy was low (881).

Other immunosuppressive drugs including prednisolone (776, 777) and cyclosporine (780, 781) have also been studied in clinical trials in ART-treated HIV-infected patients and these trials revealed no increased risk for opportunistic infections, increased viral load, or disease progression. These studies demonstrate that potent immunosuppressive regimens can be used safely in ART-treated HIV-infected individuals and they further suggest that DMF formulations could also be safely used in HIV-infected ART-treated individuals.

12.9 Conclusions

DMF formulation therapy reduces inflammation, immune activation, and oxidative stress in numerous cell lineages *in vitro*, particularly cells of the immune system, and such therapy has potent clinical efficacy in psoriasis and multiple sclerosis, likely through limiting inflammation and associated oxidative stress and immune cell infiltration in these diseases. Based on these effects,

this chapter proposes DMF as a potential adjunctive therapeutic in ART-treated HIV-infected individuals for improving morbidity and mortality by ameliorating immune activation and associated microbial translocation, systemic oxidative stress, and HIV-associated comorbidities, particularly HIV-associated neurocognitive disorder (HAND).

CHAPTER 13

WORK IN PROGRESS

13.1 Differences in Clade or Transmitted/Founder HO-1 Regulation

HIV-1 clades and transmitted/founder viruses

HIV-1 strains can be classified into four groups (M, N, O, and P), which may represent four distinct introductions of cross-species transmission of the simian immunodeficiency virus (SIV) in to humans. More than 90% of HIV-1 infections worldwide belonging to group M, which is further broken down into nine genetically distinct subtypes or clades (A, B, C, D, F, G, H, J, and K) (882). Group O is reportedly restricted to west-central Africa and Group N and P are extremely rare and found thus far only in Cameroon (882). The panel of viruses demonstrated in Chapter 10 to consistently reduce heme oxygenase-1 (HO-1) protein expression in HIX-MDM are all confirmed or presumed Clade B viruses, the most common subtype in Europe, the Americas, Japan, and Australia. Whether other HIV-1 clades similarly induce HO-1 protein loss and associated glutamate neurotoxicity is currently unknown.

Additionally, all viruses in the previously examined panel were clones or swarms derived from chronically infected individuals. Transmission and infection of HIV-1 at mucosal surfaces is characterized by a stringent population bottleneck such that clinical infection is established from the successful transmission and subsequent propagation of a single virus variant, termed the transmitted/founder (T/F) virus. After analysis of plasma viral sequences in subjects who recently were infected with HIV-1 (within 2-4 weeks), T/F sequences have been inferred using a model of early random virus evolution (52). Recent study of these T/F viruses has demonstrated that they are not the consequence of a random stochastic event, but have unique phenotypes distinct from viruses isolated chronically infected individuals. T/F viruses have been described to have differential utilization of CCR5, higher envelope content, enhanced cell-free infectivity, improved dendritic cell interaction, and relative interferon-alpha resistance (883, 884). While many T/F viruses are not macrophage tropic, Clade D T/F viruses may have a higher proportion of

macrophage-tropic viruses. Whether the HO-1 deficient neurotoxic phenotype is altered in T/F viruses is currently unknown.

Clade D transmitted/founder HIV-1 infection of macrophages does not induce HO-1 deficiency

We obtained five full length clones of previously characterized clade D T/F viruses (52) and quantified their ability to replicate in monocyte-derived macrophages (MDM) compared to the clade B clone 89.6 (Figure 13.1, A and B). While all clade D T/F viruses showed evidence of viral replication, two clones in particular (191859 & 191882) replicated to similar, if not higher, levels than 89.6. As expected, 89.6 infected MDM demonstrated significant reduction in HO-1 protein expression (Figure 13.2, A and B). However, all five clade D T/F viruses failed to significantly reduce HO-1 protein expression, even those clones that replicated similarly to 89.6. Similar to 89.6, clade D T/F viruses did not reduce NQO1, GPX1, or HO-2 protein expression (Figure 13.2, C-E). Despite the lack of significant HO-1 reduction in HIV-MDM with any individual clade T/F virus, there was a weak, but significant, trend for high replicating infections with clade D T/F to correlate with lower HO-1 expression (Figure 13.2 F) This data strongly suggest that clade D T/F viruses do not reduce HO-1 protein expression as efficiently as clade B viruses derived from chronic infection, and moreover may completely lack the ability to downregulate HO-1.

Clade D transmitted/founder HIV-1 infection of macrophages does induces non-glutamate mediated supernatant neurotoxicity

Consistent with our previous results, the HO-1 deficiency in HIV-MDM infected with 89.6 associated with a significant increase in supernatant glutamate and associated neurotoxicity (Figure 13.3, A-C). However, infection with clade D T/F viruses, which was not associated with HO-1 loss, did not increase supernatant glutamate content (Figure 13.3, A and B), although infection still increased supernatant neurotoxicity (Figure 13.3C). Moreover clade D T/F virus

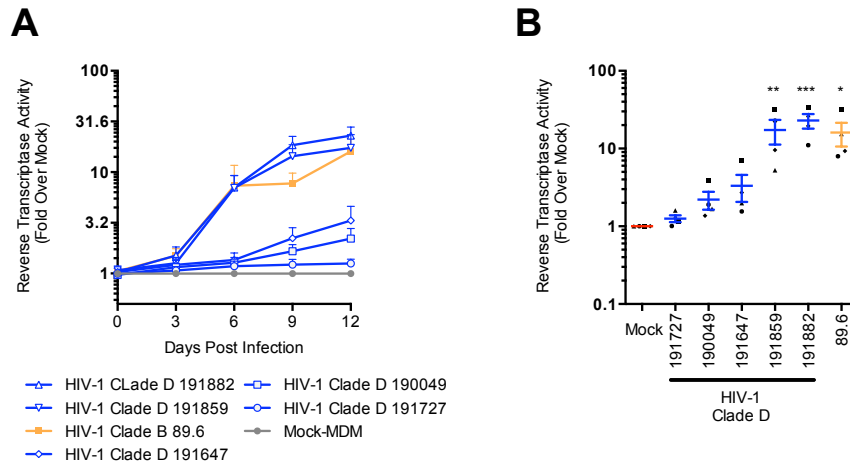

Figure 13.1 HIV-1 clade D transmitter/founder replication in macrophages. MDM were isolated and differentiated from 4 independent donors and infected with one of five clade D transmitter/founder (T/F) viruses or the clade B molecular clone 89.6. Supernatants were collected and media was changed every three days up to day 12 post-infection. HIV replication as measured by supernatant reverse transcriptase (RT) activity (**A**) over the course of infection and (**B**) on Day 12 post infection. A unique symbol shape distinguishes each individual MDM donor. Error bars indicate mean \pm standard error. Statistical comparisons versus Mock-MDM were made by one-way ANOVA with post Holm-Sidak test. * $p < 0.05$, *** $p < 0.001$.

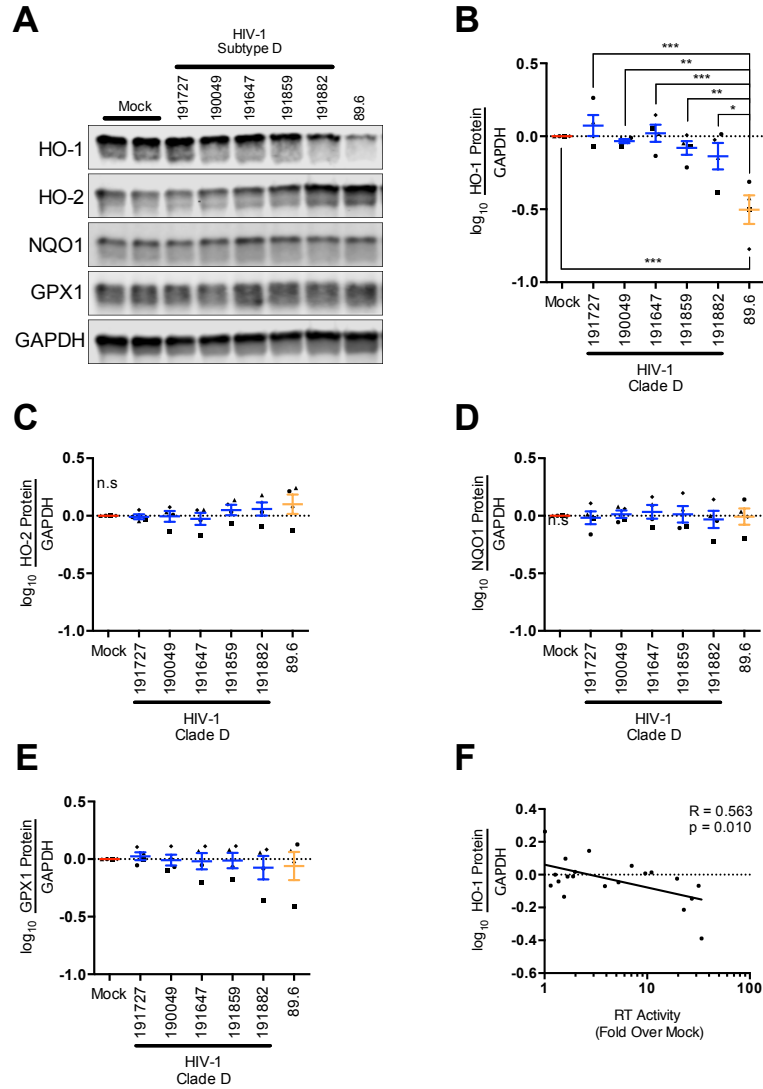

Figure 13.2 HIV-1 clade D transmitter/founder infection of MDM does not significantly reduce HO-1 protein expression despite efficient replication. MDM were isolated and differentiated from 4 independent donors and infected with one of five clade D transmitter/founder (T/F) viruses or the clade B molecular clone 89.6. MDM protein lysates from day 12 post infection were subsequently analyzed by Western blot/ (A) Representative Western blot for HO-1, HO-2, NQO1, GPX1, and GAPDH expression. Average protein expression of (B) HO-1, (C) HO-2, (D) NQO1, and (E) GPX1 expression in HIV-MDM as determined by Western blot (n = 4 donors). (F) Correlation between HO-1 protein expression and day 12 viral replication as determined by supernatant RT activity. A unique symbol shape distinguishes each individual MDM donor. Error bars indicate mean \pm standard error. Statistical comparisons versus Mock-MDM or identified comparisons were made by one-way ANOVA with post Holm-Sidak test. Correlations were assessed by Pearson's correlation with line of best fit determined by linear regression. * p < 0.05, **p > 0.01, ***p < 0.001.

replication did not correlate with extracellular glutamate concentration (Figure 13.3C), but did correlate with higher supernatant neurotoxicity (Figure 13.3D). Despite the lack of correlation with virus replication and extracellular glutamate, glutamate did correlate weakly with supernatant neurotoxicity (Figure 13.3F), suggesting that glutamate may still have a role, albeit a minor one, in neurotoxin production from MDM infected with clade D HIV-1. This data is consistent with our previous reports suggesting that HO-1 modulates glutamate release in HIV-MDM as the lack of HO-1 loss in clade D T/F infection occurs with a corresponding lack in elevated supernatant glutamate content.

Discussion and future directions

This data demonstrates for the first time a robust HIV-1 infection of MDM, in this case with clade D T/F clones, that does not induce HO-1 protein loss and associated increase in supernatant glutamate content similar to clade B viruses derived from chronically infected individuals. Whether clade D T/F fail to reduce HO-1 RNA, as would be predicted, is currently unknown. Whether this lack of the HO-1 deficient glutamate phenotype is a result of clade differences or a result of the T/F phenotype is as yet unknown. We propose to address this question by i) infecting MDM with macrophage-tropic viruses derived from chronically infected individuals from multiple HIV-1 clades (and groups) as well as ii) infecting MDM with macrophage-tropic T/F viruses from clade B, although they might be rare. We have shown that MDM infection with clade B HIV-1 takes 6-9 days to induce HO-1 protein loss (see Figure 10.1). Perhaps there are kinetic, but not magnitude, differences in the ability of T/F viruses or viruses from different clades to reduce HO-1 expression. Examining HO-1 expression over the course of extended HIV-MDM infections (up to 18 or 21 days post infection) will also be undertaken. These future experiments will further define the ability of clade D T/F virus to downregulate HO-1 in HIV-MDM.

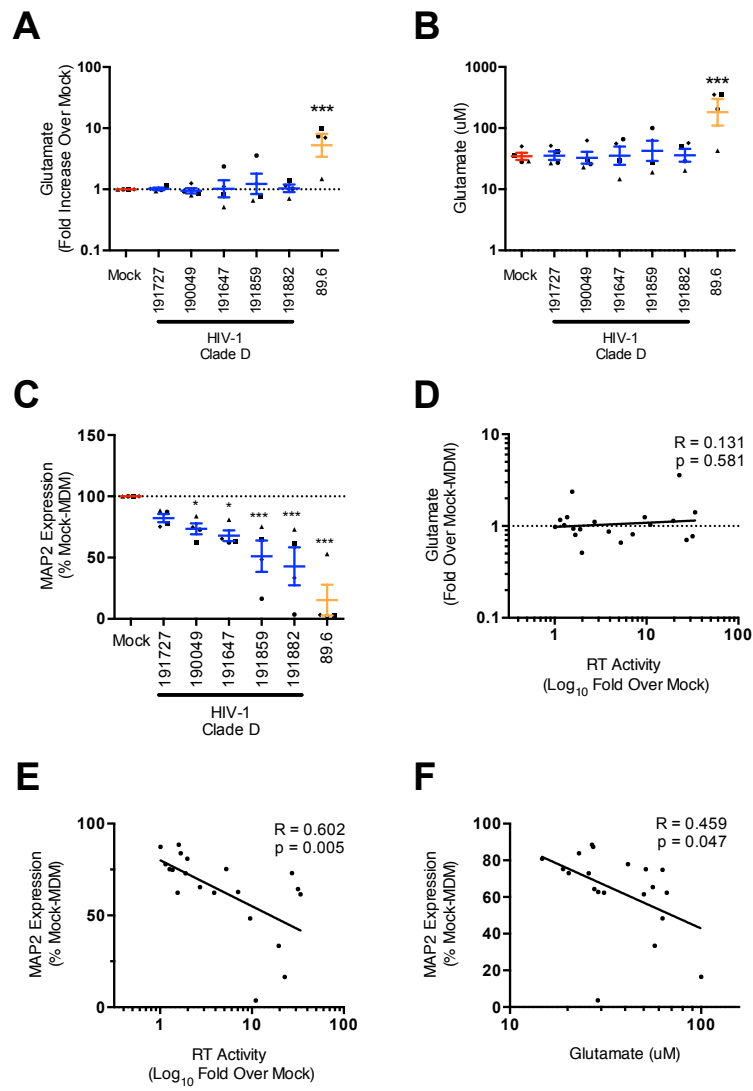

Figure 13.3 HIV-1 clade D transmitter/founder infection of MDM enhances supernatant neurotoxicity, but not extracellular glutamate. MDM were isolated and differentiated from 4 independent donors and infected with one of five clade D transmitter/founder (T/F) viruses or the clade B molecular clone 89.6. Day 12 post-infection supernatant (A) glutamate concentration, (B) fold increase in glutamate compared to Mock-MDM, and (C) supernatant neurotoxicity as measured by cell-based MAP2 ELISA (1:10 dilution). Correlations between viral replication (day 12 RT activity) and supernatant (D) glutamate and (E) neurotoxicity in clade D T/F MDM infections in all 4 donors (excludes 89.6 infection data). (F) Correlation between day 12 supernatant glutamate and neurotoxicity in clade D T/F MDM infections in all 4 donors (excludes 89.6 infection data). A unique symbol shape distinguishes each individual MDM donor. Error bars indicate mean \pm standard error. Statistical comparisons versus Mock-MDM were made by one-way ANOVA with post Holm-Sidak test. Correlations were assessed by Pearson's correlation with line of best fit determined by linear regression * $p < 0.05$, *** $p < 0.001$.

The presence of enhanced neurotoxicity in clade D T/F infections, despite no increased glutamate, demonstrates the presence of other neurotoxins present in the supernatant. The identify of these non-glutamate neurotoxins induced by clade D T/F are as of yet, unknown. It is possible that clade D T/F infection of MDM is inducing novel neurotoxins not elicited by 89.6 infection. Contrastingly, these non-glutamate neurotoxins may also be produced by 89.6 infection in addition to the predominant excitotoxin glutamate. Determining whether this clade D T/F neurotoxicity is a result of NMDA receptor activation, as it is with 89.6 and Jago (46), is an important initial step to understanding this new neurotoxicity profile. Further characterizing these non-glutamate neurotoxins is an important step in fully understanding this novel neurotoxic phenotype exhibited by clade D T/F viruses.

From these preliminary experiments we have identified two HIV-1 viral clones (191859 & 191882) that replicate efficiently in macrophages but not induce HO-1 loss. By creating recombinant viruses by swapping segments of the genome with clade B clones (89.6 and YU2) that do induce HO-1 loss, we may be able to determine the viral determinants of HO-1 loss. Specifically, we may be able to link the differences in the ability to effectively reduce HO-1 to a particular viral gene, allowing us to further elucidate the molecular mechanism by which HIV reduces HO-1 expression.

13.2 SIV Infection and HO-1

SIV infection of pigtail macaque MDM may induce HO-1 protein expression

Given the ability of multiple macrophage tropic HIV-1 clade B strains and a macrophage-tropic HIV-2 isolate to consistently reduce HO-1 protein expression in infected MDM, we wanted to determine whether this phenotype was conserved in SIV-infected macrophages. To this end, pigtail macaque (*Macaca nemestrina*) MDM were infected in vitro with a macrophage-tropic SIV-strain, SIV/17E-Fr and analyzed similar to HIV human MDM experiments. Despite significant, albeit limited, replication, SIV-MDM demonstrated an increase in HO-1 expression on each day

(3, 6, 9, 12, and 15) post infection with the induction of HO-1 being most pronounced on days 3 and 6 and subsequently waning over time (Figure 13.4, A and B). Notably, HO-1 expression in SIV-MDM from both pigtail donors was never lower than Mock-MDM at any time point analyzed. While these increases in HO-1 expression are not significant (due to the small sample size, $n = 2$), these preliminary results are in stark contrast to HIV-1 clade B and HIV-2 infected MDM, which predictably decrease HO-1 protein expression (and do not alter HO-1 expression in the case of HIV-1 clade D T/F viruses). Whether this induction of HO-1 by SIV-infection of MDM is a consistent phenotype of SIV-infection of simian macrophages is unknown. Potentially, this HO-1 induction response in this preliminary experiment may be relatively unique to the SIV/17E-Fr strain or may be a result of species differences in macrophages between pigtail macaques and humans.

Thus, in addition to repeating these SIV-MDM experiments to confirm this HO-1 inducing phenotype, we need to elucidate whether this phenotype is a conserved feature of SIV-infection (and thus a departure from the HIV phenotype), a unique feature of simian macrophage infection with the SIV/17-E-Fr strain, or a consequence of host differences in macrophage biology (pigtail macaque versus human). To accomplish this we could determine HO-1 expression profiles in pigtail MDM infected with additional, unique macrophage-tropic SIV strains and in SIV-MDM derived from other simian species, such as rhesus macaques. These experiments will more thoroughly define this observed HO-1 inducing phenotype. To further elucidate this phenotype, we could quantify the HO-1 protein response in human MDM infected with a chimera SIV virus containing a macrophage-tropic HIV envelope gene with an SIV backbone. Determining whether this HIV-mediated HO-1 response in macrophages is distinct in SIV-infected macrophages compared to HIV-infection is an important future direction; it would identify potential pathological differences between SIV and HIV infection that may effect neurological disease progression.

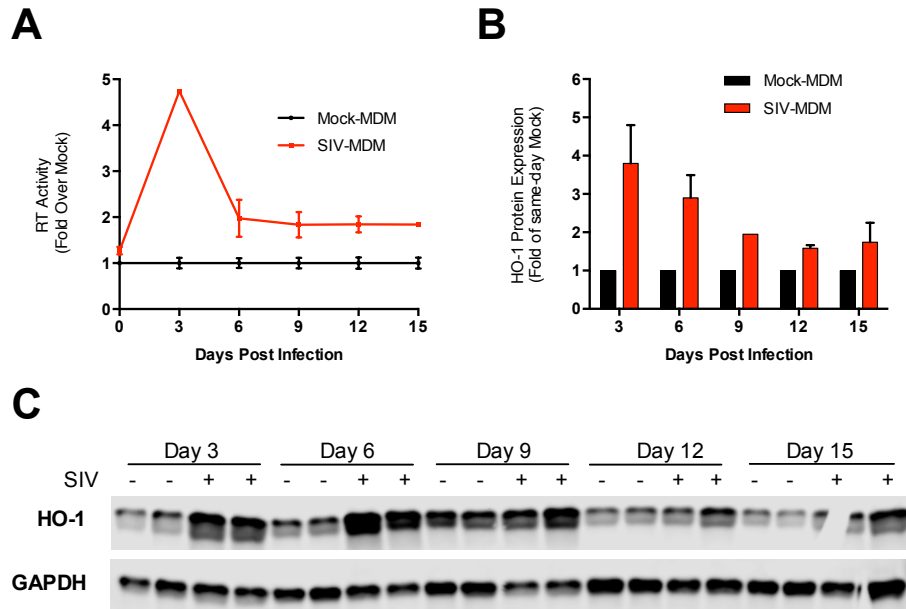

Figure 13.4 SIV/17E-Fr infection of pigtail macaque MDM does not decrease HO-1 protein expression. Monocytes were isolated from fresh whole blood from two healthy, adult, male pigtail macaques (*Macaca menestrina*) by Percoll density gradient and differentiated in vitro into MDM (in RPMI 1640 containing 10mM HEPES, 2mM L-glutamine, 20ug/ml gentamycin, 50ng/ml M-CSF, 2mM sodium pyruvate, and 20% human serum AB). After 7 days in vitro, pigtail MDM were infected with a macrophage-tropic SIV-strain, SIV/17E-Fr at 0.05 MOI for 24 hours and subsequently washed three times in RPMI and then returned to fresh pigtail MDM media (with only 10% human serum). MDM protein lysates and supernatants were collected from Mock-MDM and SIV-MDM in duplicate for each pigtail donor every 3 days over the course of a 15-day infection. **(A)** SIV replication as determined by supernatant RT activity for representative pigtail SIV-MDM infection. **(B)** Average protein expression of HO-1 normalized to GAPDH in SIV-MDM as determined by Western blot (n=2, except day 9 n = 1). **(C)** Representative Western blot of HO-1 and GAPDH over the course of a 15 day SIV-MDM infection. Due to limited sample size (n =2) no statistical analyses were performed.

13.3 Cytokine and Chemokine Regulation of HO-1 in Macrophages

Chronic immune stimulation with certain cytokines, chemokines, and immune modulators may reduce HO-1 expression in MDM

Classically, HO-1 is induced in response to inflammation and cell stress as a protective response and thus many studies have examined the ability of cytokines, chemokines, and other immune stimulation in inducing HO-1 expression. However, several studies have reported that some immune signals, including interferon-alpha (IFN α) (885), interferon-gamma (IFN γ) (886, 887), and lipopolysaccharide (LPS) (888) can decrease HO-1 protein expression. Thus, reduced HO-1 expression in brains from HIV-positive patients and in HIV-infected MDM may be a result of inflammatory signaling pathways triggered by HIV infection. To screen for the potential for immune signaling to modulate HO-1 expression in MDM, we exposed MDM from 5-6 independent donors to a panel of 20 immune modulators and determined HO-1 protein expression by Western blot. This panel of immune modulators consisted of cytokines, chemokines, and bacterial products (LPS) that have altered levels in HIV-infected individuals and/or known to modulate HIV-infection in vitro. We treated MDM with each immune modulator for either 9 days to represent chronic immune signaling or 24 hours to examine a more acute response. As this experiment was designed as an initial screen to identify candidate modulators of HO-1 expression in MDM, we analyzed our data using paired-t tests without correction to maximize candidates for further validation and follow up.

After 24 hours of exposure, only one cytokine (GM-CSF) significantly altered HO-1 protein expression, resulting in a 2-fold reduction in HO-1 levels (Figure 13.5A). However, after 9 days of exposure, six cytokines (IL-13, GM-CSF, IL-1 β , IL-23, IL-18, and TNF α) resulted in significant reduction in MDM HO-1 protein expression (Figure 13.5B). IL-13 and GM-CSF showed the greatest reduction in HO-1 protein expression (~4-fold; n = 6 MDM donors). Notably, only one

cytokine (IL-4) showed a statistically significant increase in HO-1 protein expression with chronic (9 day) exposure. This preliminary data suggests that chronic exposure to some cytokines and their subsequent signaling may be able to drive downregulation of HO-1 in macrophages. To confirm the ability of these candidate cytokines to decrease HO-1 in MDM, these experiments need to be repeated in MDM from additional donors. Initial future directions of this work include *i*) defining candidate cytokine effects on HO-1 RNA in MDM, *ii*) determining whether different combination of candidate cytokines provide synergistic effects on reducing HO-1 expression, and *iii*) determining whether pre-treatment with this candidate cytokines can blunt HO-1 induction, such as in response to oxidative stress or pharmacologic HO-1 inducers. This preliminary data proposes a potential mechanism whereby chronic inflammatory signaling driven by HIV-infection may be responsible for driving HO-1 loss in macrophages. Whether chronic inflammatory signaling can result HO-1 loss in other CNS cell types (astrocytes, microglia, oligodendrocytes, neurons) is a parallel future direction that we are actively pursuing.

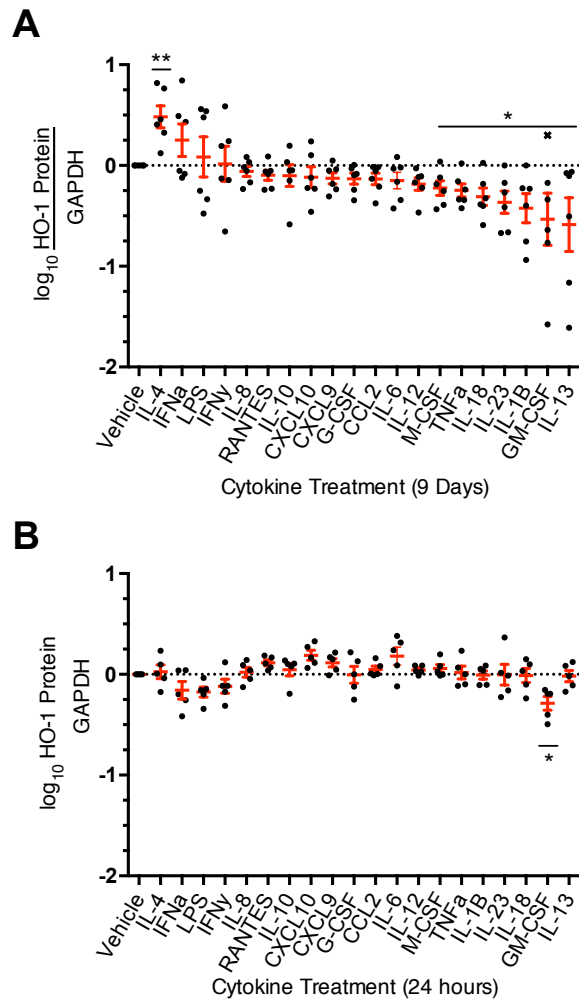

Figure 13.5 Chronic cytokine and chemokine exposure in macrophages may result in loss of HO-1 protein expression Uninfected MDM isolated from healthy donors were exposed to various cytokines, chemokines, or immune modulators for either 9 days (n=6) or 24 hours (n=5). For 9-day treatments, media was changed every three days and treatments were refreshed. At end of treatments, protein lysates were collected and HO-1 protein expression was analyzed by Western blot. Densitometry analysis of HO-1 protein expression normalized to GAPDH for (A) 9-day and (B) 24-hour treatments. Error bars indicate mean \pm SEM. Vehicle HO-1 expression was set to 0 (dotted line). One well treated with GM-CSF in the 9-day experiment had overt MDM death (data point marked by an X). Screening statistical comparisons to vehicle-treated MDM were made by uncorrected paired student's t-tests. * p < 0.05, **p < 0.01

CHAPTER 14

SUMMARY AND IMPLICATIONS

Discussion: Summary and Implications

The continued prevalence of HIV-associated neurocognitive disorders (HAND) in antiretroviral therapy (ART)-treated HIV-infected individuals strongly underscores the need for adjunctive therapies that target the neuropathological processes, including inflammation and oxidative stress, that persist within the CNS and systemic compartments. To this end, we have identified the sentinel, detoxifying enzyme heme oxygenase-1 (HO-1) as a targetable host factor for adjunctive neuroprotective therapy in HAND. HO-1 is a member of the antioxidant response element (ARE) pathway and is critical for limiting inflammation, oxidative stress, and cellular injury in physiological and disease states in both CNS and systemic tissues. This body of work suggests a plausible mechanism (HO-1 deficiency) by which HIV infection of brain macrophages in ART-treated individuals could exacerbate oxidative stress and glutamate-induced neuronal injury, each of which is associated with neurocognitive dysfunction in infected individuals. This work further suggests that reversal of this deficiency, particularly within the CNS macrophage compartment, may reduce HIV-mediated neuronal injury and associated neurocognitive impairment within ART-treated HIV-infected individuals.

Through examination of a post-mortem autopsy cohort, we have demonstrated a significant deficiency of HO-1 in the prefrontal cortex of HIV-infected individuals with HAND that is particularly severe in those subjects with HIV-encephalitis (HIVE). This loss of HO-1 within the prefrontal cortex was associated with higher brain and CSF viral load and markers of immune and macrophage activation. HO-1 deficiency was not restricted to the prefrontal cortex nor was it a global brain phenomenon; we observed a significant reduction in HO-1 protein expression in the striatum of subjects with HIVE, but altered HO-1 protein expression was not observed in the occipital or cerebellar cortex. This brain protein deficiency appears to be specific for HO-1 relative to other members of the ARE-driven gene family, as we saw no consistent changes in other ARE proteins or in the heme oxygenase isoform HO-2. We believe that the deficiency of HO-1

expression in HAND brain might be unique among neurodegenerative diseases associated with CNS inflammation and oxidative stress where increased brain HO-1 is often observed, likely as a protective response to injury.

To further explore the role of HO-1 in HIV neuropathology, we genotyped our HIV autopsy cohort for an HO-1 promoter region (GT)_n microsatellite polymorphism. Longer (GT)_n repeat lengths are associated with decreased HO-1 expression and inducibility and worse clinical outcomes in numerous inflammatory diseases. Our analysis demonstrated a significant positive correlation between longer (GT)_n repeats and the risk of HIVE in our HIV-positive cohort. Moreover, in the HIV-negative cohort, we observed a significant correlation between longer (GT)_n repeats and levels of the macrophage activation marker CD163. This data suggests that a lower inherent ability to induce a protective HO-1 response may promote neuroinflammatory processes, particularly macrophage activation, that are associated with the development of HIVE in HIV-infected individuals. While our cohort was underpowered to examine a role of this promoter polymorphism in HAND, these data linking HO-1 and neuroinflammation further corroborates our prefrontal cortex protein expression data, thus strengthening our hypothesis for a role for HO-1 in modulating HIV neuropathogenesis, macrophage activation, and associated cognitive impairment.

Previously, we have demonstrated that infection of monocyte-derived macrophages (MDM) with two HIV-1 viruses (Jago and 89.6) reduces HO-1 protein expression in conjunction with neurotoxin production. This work now expands on these initial observations to further characterize this neuropathological HIV-MDM phenotype. We showed that HO-1 loss in HIV-MDM was progressive and time-dependent, typically showing a significant drop within 6-9 days after virus inoculation and that this loss of HO-1 occurred concomitantly with elevated HIV-MDM supernatant neurotoxicity and glutamate, a HAND-associated neurotoxin. This loss of HO-1 protein tightly correlated with loss of HO-1 mRNA, suggesting at least part of the reduction in HO-

1 protein is occurring by a pre-translational mechanism. This deficiency of HO-1 was relatively specific, as other members of the ARE-driven gene family and the heme oxygenase isoform HO-2 were unaffected. We further demonstrated that this selective loss of HO-1 and associated glutamate release and neurotoxin production is a conserved feature of MDM infection with macrophage-tropic clade B HIV-1 strains that correlates closely with the extent of replication. This HIV-driven loss of HO-1 did not require the HIV-1 accessory genes *nef*, *vpr*, or *vpu*. Additionally, we demonstrated the ability of a macrophage-tropic HIV-2 strain to reduce HO-1 expression; this initially suggested this HO-1 deficient phenotype may be conserved among all macrophage-tropic human immunodeficiency viruses. However, preliminary data examining HIV-1 clade D transmitted/founder (T/F) viruses demonstrates that these isolates appear to replicate efficiently in MDM without reducing HO-1 protein expression. Whether this absence of decreasing HO-1 is associated with differences among HIV-1 clades or the T/F phenotype is currently an active area of investigation. Additional preliminary results suggest that simian immunodeficiency virus (SIV) infection of simian MDM may in further contrast induces HO-1 protein expression, highlighting potential neuropathologic differences between HIV and SIV, which is often used to study HIV disease in simian models.

Despite the correlation of HO-1 loss and viral replication, our data clearly demonstrate that even low-level HIV replication in macrophages can promote HO-1 loss, leading us to study the association between HIV replication and HO-1 deficiency in the context of clinically-relevant ART regimens. We demonstrated that ART exposure at CNS-relevant concentrations fails to prevent HO-1 loss and neurotoxicity in HIV-MDM once infection is already established. This suggests that long-lived CNS macrophage reservoirs in HIV-infected individuals, even those on suppressive ART, could maintain an HO-1 deficient, neurotoxic phenotype. Our current findings suggest that induction of HO-1 deficiency associated with excess glutamate production and neurotoxicity is a highly conserved phenotype of macrophage-tropic HIV strains, which can persist in the macrophage compartment in the presence of ART. The failure of ART to prevent this HO-1 loss in

established infection highlights the potential value of HO-1-inducing drugs as adjunctive therapy to ART.

Using pharmacologic and genetic approaches to modulate HO-1, we confirmed a direct role for HIV-driven HO-1 loss in modulating glutamate neurotoxicity from HIV-MDM. Pharmacologic inhibition of heme oxygenase (HO-1 and HO-2) enzymatic activity and selective HO-1 knockdown increased glutamate and associated neurotoxicity in HIV-MDM without altering viral replication. This enhanced neurotoxic phenotype in response to further HO-1 deficiency suggests a potential therapeutic benefit of restoring HO-1 in HIV-infected brain macrophages. Using both pharmacologic inducers and genetic derepression, we demonstrated that HO-1 induction decreased HIV-MDM glutamate production and associated neurotoxicity. However, the contribution of other protective ARE-induced genes (e.g. NQO1), which were induced to varying extents by these approaches, cannot be ruled out. Nonetheless, these data support a role for induction of HO-1 expression as a protective strategy against HIV disease progression.

From this work, we propose further study into testing HO-1 inducers as potential adjunctive therapy for prevention of HAND in ART-treated subjects. In March of 2013 an oral dimethyl fumarate preparation, Tecfidera™, received FDA approval for the treatment of multiple sclerosis, a CNS disease characterized by recurrent neuroinflammation and oxidative stress. DMF and its primary metabolite monomethyl fumarate (MMF) are potent inducers of HO-1 expression and MMF is detectable within the CSF after oral delivery of DMF at concentrations (4.4µM) that we have demonstrated effectively induce macrophage HO-1 expression and suppress production of neurotoxic levels of glutamate. In addition to DMF/MMF's induction of HO-1 expression and associated decrease in glutamate-associated neurotoxicity, DMF/MMF's other anti-inflammatory effects in macrophages (inhibition of NF-κB and reduction of CCL-2 mediated chemotaxis) may also have beneficial effects in HIV-infected ART-treated individuals. Thus, considerable evidence

therefore supports the testing of HO-1 inducers such as DMF as adjunctive therapy for prevention of HAND in HIV-infected individuals already virally suppressed on ART.

These data identify HO-1 deficiency as a plausible mechanism by which HIV infection of brain macrophages in ART-treated individuals could exacerbate oxidative stress and glutamate-induced neuronal injury, each of which is associated with neurocognitive dysfunction in infected individuals. The mechanism by which HIV drives HO-1 loss in infected macrophages and within the brain parenchyma is unclear and is an active area of investigation. Elucidating the mechanism of HO-1 downregulation by HIV in infected macrophages and the brain will further define this conserved HIV neuropathological phenotype and may provide additional insights into potential adjunctive therapies for preventing this loss. In addition to defining a pathologic role of HO-1 deficiency in HIV neurological disease, this work identifies induction of HO-1 as a potential therapeutic goal in HIV-individuals with HAND. Therapies, such as DMF, that induce HO-1 could ameliorate this brain HO-1 deficiency in chronic HIV infection and thereby provide additional neuroprotection to HIV-infected individuals already virally suppressed with ART. We have initiated studies to evaluate the efficacy of oral DMF therapy in limiting systemic and CNS inflammation and associated disease in the SIV rhesus macaque model. Moreover, we are exploring other candidate HO-1 inducing compounds as potential adjunctive therapeutics for individuals with HAND. This work supports the initiation of future translational studies to determine the safety and efficacy of DMF and other clinically relevant HO-1 inducing compounds in HIV-infected subjects in pilot clinical trials.

CHAPTER 15

BIBLIOGRAPHY

1. United Nations Programme on HIV/AIDS. UNAIDS Gap Report 2014. UNAIDS / JC2656. ISBN: 978-92-9253-062-4. World Health Organization Library. . Accessed June 25, 2015. Available at <http://www.unaids.org/en/resources>.
2. Broder S. The development of antiretroviral therapy and its impact on the HIV-1/AIDS pandemic. *Antiviral Res.* 2010;85(1):1-18.
3. Hunt PW. HIV and inflammation: mechanisms and consequences. *Curr HIV/AIDS Rep.* 2012;9(2):139-47.
4. Sharma B. Oxidative stress in HIV patients receiving antiretroviral therapy. *Curr HIV Res.* 2014;12(1):13-21.
5. Hearps AC, Martin GE, Rajasuriar R, and Crowe SM. Inflammatory co-morbidities in HIV+ individuals: learning lessons from healthy ageing. *Curr HIV/AIDS Rep.* 2014;11(1):20-34.
6. Robertson KR, Smurzynski M, Parsons TD, Wu K, Bosch RJ, Wu J, McArthur JC, Collier AC, Evans SR, and Ellis RJ. The prevalence and incidence of neurocognitive impairment in the HAART era. *AIDS.* 2007;21(14):1915-21.
7. Tozzi V, Balestra P, Bellagamba R, Corpolongo A, Salvatori MF, Visco-Comandini U, Vlassi C, Giulianelli M, Galgani S, Antinori A, et al. Persistence of neuropsychologic deficits despite long-term highly active antiretroviral therapy in patients with HIV-related neurocognitive impairment: prevalence and risk factors. *J Acquir Immune Defic Syndr.* 2007;45(2):174-82.
8. Simioni S, Cavassini M, Annoni JM, Rimbault Abraham A, Bourquin I, Schiffer V, Calmy A, Chave JP, Giacobini E, Hirschel B, et al. Cognitive dysfunction in HIV patients despite long-standing suppression of viremia. *AIDS.* 2010;24(9):1243-50.
9. Heaton RK, Franklin DR, Ellis RJ, McCutchan JA, Letendre SL, Leblanc S, Corkran SH, Duarte NA, Clifford DB, Woods SP, et al. HIV-associated neurocognitive disorders before and during the era of combination antiretroviral therapy: differences in rates, nature, and predictors. *J Neurovirol.* 2011;17(1):3-16.
10. Heaton RK, Clifford DB, Franklin DR, Jr., Woods SP, Ake C, Vaida F, Ellis RJ, Letendre SL, Marcotte TD, Atkinson JH, et al. HIV-associated neurocognitive disorders persist in the era of potent antiretroviral therapy: CHARTER Study. *Neurology.* 2010;75(23):2087-96.
11. Thiessen A, Schmidt MM, and Dringen R. Fumaric acid dialkyl esters deprive cultured rat oligodendroglial cells of glutathione and upregulate the expression of heme oxygenase 1. *Neurosci Lett.* 2010;475(1):56-60.
12. Mothobi NZ, and Brew BJ. Neurocognitive dysfunction in the highly active antiretroviral therapy era. *Curr Opin Infect Dis.* 2012;25(1):4-9.
13. Kusdra L, McGuire D, and Pulliam L. Changes in monocyte/macrophage neurotoxicity in the era of HAART: implications for HIV-associated dementia. *AIDS.* 2002;16(1):31-8.
14. Ances BM, and Ellis RJ. Dementia and neurocognitive disorders due to HIV-1 infection. *Semin Neurol.* 2007;27(1):86-92.
15. Cysique LA, and Brew BJ. Neuropsychological functioning and antiretroviral treatment in HIV/AIDS: a review. *Neuropsychol Rev.* 2009;19(2):169-85.

16. Joska JA, Gouse H, Paul RH, Stein DJ, and Flisher AJ. Does highly active antiretroviral therapy improve neurocognitive function? A systematic review. *J Neurovirol.* 2010;16(2):101-14.
17. Price RW, and Spudich S. Antiretroviral therapy and central nervous system HIV type 1 infection. *J Infect Dis.* 2008;197 Suppl 3(S294-306).
18. Bell JE. An update on the neuropathology of HIV in the HAART era. *Histopathology.* 2004;45(6):549-59.
19. Masliah E, DeTeresa RM, Mallory ME, and Hansen LA. Changes in pathological findings at autopsy in AIDS cases for the last 15 years. *AIDS.* 2000;14(1):69-74.
20. Morgello S, Mahboob R, Yakoushina T, Khan S, and Hague K. Autopsy findings in a human immunodeficiency virus-infected population over 2 decades: influences of gender, ethnicity, risk factors, and time. *Arch Pathol Lab Med.* 2002;126(2):182-90.
21. Langford TD, Letendre SL, Larrea GJ, and Masliah E. Changing patterns in the neuropathogenesis of HIV during the HAART era. *Brain Path.* 2003;13(2):195-210.
22. Anthony IC, and Bell JE. The Neuropathology of HIV/AIDS. *Int Rev Psychiatry.* 2008;20(1):15-24.
23. Anthony IC, Ramage SN, Carnie FW, Simmonds P, and Bell JE. Influence of HAART on HIV-related CNS disease and neuroinflammation. *J Neuropathol Exp Neurol.* 2005;64(6):529-36.
24. Silva AC, Rodrigues BS, Micheletti AM, Tostes S, Jr., Meneses AC, Silva-Vergara ML, and Adad SJ. Neuropathology of AIDS: An Autopsy Review of 284 Cases from Brazil Comparing the Findings Pre- and Post-HAART (Highly Active Antiretroviral Therapy) and Pre- and Postmortem Correlation. *AIDS Res Treat.* 2012;2012(186850).
25. Backe E, Schwarting R, Gerdes J, Ernst M, and Stein H. Ber-MAC3: new monoclonal antibody that defines human monocyte/macrophage differentiation antigen. *J Clin Pathol.* 1991;44(11):936-45.
26. Buechler C, Ritter M, Orso E, Langmann T, Klucken J, and Schmitz G. Regulation of scavenger receptor CD163 expression in human monocytes and macrophages by pro- and antiinflammatory stimuli. *J Leukoc Biol.* 2000;67(1):97-103.
27. Hintz KA, Rassias AJ, Wardwell K, Moss ML, Morganelli PM, Pioli PA, Givan AL, Wallace PK, Yeager MP, and Guyre PM. Endotoxin induces rapid metalloproteinase-mediated shedding followed by up-regulation of the monocyte hemoglobin scavenger receptor CD163. *J Leukoc Biol.* 2002;72(4):711-7.
28. Weaver LK, Pioli PA, Wardwell K, Vogel SN, and Guyre PM. Up-regulation of human monocyte CD163 upon activation of cell-surface Toll-like receptors. *J Leukoc Biol.* 2007;81(3):663-71.
29. Weaver LK, Hintz-Goldstein KA, Pioli PA, Wardwell K, Qureshi N, Vogel SN, and Guyre PM. Pivotal advance: activation of cell surface Toll-like receptors causes shedding of the hemoglobin scavenger receptor CD163. *J Leukoc Biol.* 2006;80(1):26-35.
30. Timmermann M, and Hogger P. Oxidative stress and 8-iso-prostaglandin F(2alpha) induce ectodomain shedding of CD163 and release of tumor necrosis factor-alpha from human monocytes. *Free Radic Biol Med.* 2005;39(1):98-107.

31. Neaton JD, Neuhaus J, and Emery S. Soluble biomarkers and morbidity and mortality among people infected with HIV: summary of published reports from 1997 to 2010. *Curr Opin HIV AIDS*. 2010;5(6):480-90.
32. Nixon DE, and Landay AL. Biomarkers of immune dysfunction in HIV. *Curr Opin HIV AIDS*. 2010;5(6):498-503.
33. Lyons JL, Uno H, Ancuta P, Kamat A, Moore DJ, Singer EJ, Morgello S, and Gabuzda D. Plasma sCD14 is a biomarker associated with impaired neurocognitive test performance in attention and learning domains in HIV infection. *J Acquir Immune Defic Syndr*. 2011;57(5):371-9.
34. Burdo TH, Lo J, Abbara S, Wei J, DeLelys ME, Preffer F, Rosenberg ES, Williams KC, and Grinspoon S. Soluble CD163, a novel marker of activated macrophages, is elevated and associated with noncalcified coronary plaque in HIV-infected patients. *J Infect Dis*. 2011;204(8):1227-36.
35. Burdo TH, Lentz MR, Autissier P, Krishnan A, Halpern E, Letendre S, Rosenberg ES, Ellis RJ, and Williams KC. Soluble CD163 made by monocyte/macrophages is a novel marker of HIV activity in early and chronic infection prior to and after anti-retroviral therapy. *J Infect Dis*. 2011;204(1):154-63.
36. Burdo TH, Soulas C, Orzechowski K, Button J, Krishnan A, Sugimoto C, Alvarez X, Kuroda MJ, and Williams KC. Increased monocyte turnover from bone marrow correlates with severity of SIV encephalitis and CD163 levels in plasma. *PLoS Pathog*. 2010;6(4):e1000842.
37. Burdo TW, A.; Woods, S.; Letendre, S.; Ellis, R.; Williams., K. . Elevated sCD163 is a Marker of Neurocognitive Impairment in HIV-infected Individuals on Effective ART. *AIDS*. 2013;27(9):1387-95.
38. Garvey LP, N.; Politis, M.; Ramlackhansingh, A.; Taylor-Robinson, S.; Brooks, D.; Winston, A. *Conference on Retroviruses and Opportunistic Infections* Seattle, WA.; 2012.
39. Kamat A, Lyons JL, Misra V, Uno H, Morgello S, Singer EJ, and Gabuzda D. Monocyte activation markers in cerebrospinal fluid associated with impaired neurocognitive testing in advanced HIV infection. *J Acquir Immune Defic Syndr*. 2012;60(3):234-43.
40. Nolting T, Lindecke A, Hartung HP, Koutsilieris E, Maschke M, Husstedt IW, Sopper S, Stuve O, Arendt G, and German Competence Network HA. Cytokine levels in CSF and neuropsychological performance in HIV patients. *J Neurovirol*. 2012;18(3):157-61.
41. Burdo TH, Lackner A, and Williams KC. Monocyte/macrophages and their role in HIV neuropathogenesis. *Immunol Rev*. 2013;254(1):102-13.
42. Cross SA, Cook DR, Chi AW, Vance PJ, Kolson LL, Wong BJ, Jordan-Sciutto KL, and Kolson DL. Dimethyl fumarate, an immune modulator and inducer of the antioxidant response, suppresses HIV replication and macrophage-mediated neurotoxicity: a novel candidate for HIV neuroprotection. *J Immunol*. 2011;187(10):5015-25.
43. Gill AJ, Kovacsics CE, Cross SA, Vance PJ, Kolson LL, Jordan-Sciutto KL, Gelman BB, and Kolson DL. Heme oxygenase-1 deficiency accompanies neuropathogenesis of HIV-associated neurocognitive disorders. *J Clin Invest*. 2014;124(10):4459-72.
44. Gozzelino R, Jeney V, and Soares MP. Mechanisms of cell protection by heme oxygenase-1. *Annu Rev Pharmacol Toxicol*. 2010;50(323-54).

45. Exner M, Minar E, Wagner O, and Schillinger M. The role of heme oxygenase-1 promoter polymorphisms in human disease. *Free Radic Biol Med.* 2004;37(8):1097-104.
46. O'Donnell LA, Agrawal A, Jordan-Sciutto KL, Dichter MA, Lynch DR, and Kolson DL. Human immunodeficiency virus (HIV)-induced neurotoxicity: roles for the NMDA receptor subtypes. *J Neurosci.* 2006;26(3):981-90.
47. Klatzmann D, Champagne E, Chamaret S, Gruest J, Guetard D, Hercend T, Gluckman JC, and Montagnier L. T-lymphocyte T4 molecule behaves as the receptor for human retrovirus LAV. *Nature.* 1984;312(5996):767-8.
48. Choe H, Farzan M, Sun Y, Sullivan N, Rollins B, Ponath PD, Wu L, Mackay CR, LaRosa G, Newman W, et al. The beta-chemokine receptors CCR3 and CCR5 facilitate infection by primary HIV-1 isolates. *Cell.* 1996;85(7):1135-48.
49. Feng Y, Broder CC, Kennedy PE, and Berger EA. HIV-1 entry cofactor: functional cDNA cloning of a seven-transmembrane, G protein-coupled receptor. *Science.* 1996;272(5263):872-7.
50. Deng H, Liu R, Ellmeier W, Choe S, Unutmaz D, Burkhart M, Di Marzio P, Marmon S, Sutton RE, Hill CM, et al. Identification of a major co-receptor for primary isolates of HIV-1. *Nature.* 1996;381(6584):661-6.
51. Dragic T, Litwin V, Allaway GP, Martin SR, Huang Y, Nagashima KA, Cayanan C, Maddon PJ, Koup RA, Moore JP, et al. HIV-1 entry into CD4+ cells is mediated by the chemokine receptor CC-CKR-5. *Nature.* 1996;381(6584):667-73.
52. Baalwa J, Wang S, Parrish NF, Decker JM, Keele BF, Learn GH, Yue L, Ruzagira E, Ssemwanga D, Kamali A, et al. Molecular identification, cloning and characterization of transmitted/founder HIV-1 subtype A, D and A/D infectious molecular clones. *Virology.* 2013;436(1):33-48.
53. Scarlatti G, Tresoldi E, Bjorndal A, Fredriksson R, Colognesi C, Deng HK, Malnati MS, Plebani A, Siccardi AG, Littman DR, et al. In vivo evolution of HIV-1 co-receptor usage and sensitivity to chemokine-mediated suppression. *Nat Med.* 1997;3(11):1259-65.
54. Connor RI, Sheridan KE, Ceradini D, Choe S, and Landau NR. Change in coreceptor use correlates with disease progression in HIV-1--infected individuals. *J Exp Med.* 1997;185(4):621-8.
55. Liu R, Paxton WA, Choe S, Ceradini D, Martin SR, Horuk R, MacDonald ME, Stuhlmann H, Koup RA, and Landau NR. Homozygous defect in HIV-1 coreceptor accounts for resistance of some multiply-exposed individuals to HIV-1 infection. *Cell.* 1996;86(3):367-77.
56. Zaitseva M, Blauvelt A, Lee S, Lapham CK, Klaus-Kovtun V, Mostowski H, Manischewitz J, and Golding H. Expression and function of CCR5 and CXCR4 on human Langerhans cells and macrophages: implications for HIV primary infection. *Nat Med.* 1997;3(12):1369-75.
57. Ghorpade A, Xia MQ, Hyman BT, Persidsky Y, Nukuna A, Bock P, Che M, Limoges J, Gendelman HE, and Mackay CR. Role of the beta-chemokine receptors CCR3 and CCR5 in human immunodeficiency virus type 1 infection of monocytes and microglia. *J Virol.* 1998;72(4):3351-61.

58. Lavi E, Kolson DL, Ulrich AM, Fu L, and Gonzalez-Scarano F. Chemokine receptors in the human brain and their relationship to HIV infection. *J Neurovirol.* 1998;4(3):301-11.
59. He J, Chen Y, Farzan M, Choe H, Ohagen A, Gartner S, Busciglio J, Yang X, Hofmann W, Newman W, et al. CCR3 and CCR5 are co-receptors for HIV-1 infection of microglia. *Nature.* 1997;385(6617):645-9.
60. Gabuzda D, and Wang J. Chemokine receptors and virus entry in the central nervous system. *J Neurovirol.* 1999;5(6):643-58.
61. Shieh JT, Albright AV, Sharron M, Gartner S, Strizki J, Doms RW, and Gonzalez-Scarano F. Chemokine receptor utilization by human immunodeficiency virus type 1 isolates that replicate in microglia. *J Virol.* 1998;72(5):4243-9.
62. Gorry PR, Bristol G, Zack JA, Ritola K, Swanstrom R, Birch CJ, Bell JE, Bannert N, Crawford K, Wang H, et al. Macrophage tropism of human immunodeficiency virus type 1 isolates from brain and lymphoid tissues predicts neurotropism independent of coreceptor specificity. *J Virol.* 2001;75(21):10073-89.
63. Platt EJ, Wehrly K, Kuhmann SE, Chesebro B, and Kabat D. Effects of CCR5 and CD4 cell surface concentrations on infections by macrophagetropic isolates of human immunodeficiency virus type 1. *J Virol.* 1998;72(4):2855-64.
64. Freed EO. HIV-1 replication. *Somat Cell Mol Genet.* 2001;26(1-6):13-33.
65. Fiorentini S, Marini E, Caracciolo S, and Caruso A. Functions of the HIV-1 matrix protein p17. *New Microbiol.* 2006;29(1):1-10.
66. Feng YX, Copeland TD, Henderson LE, Gorelick RJ, Bosche WJ, Levin JG, and Rein A. HIV-1 nucleocapsid protein induces "maturation" of dimeric retroviral RNA in vitro. *Proc Natl Acad Sci U S A.* 1996;93(15):7577-81.
67. Saah AJ, Farzadegan H, Fox R, Nishanian P, Rinaldo CR, Jr., Phair JP, Fahey JL, Lee TH, and Polk BF. Detection of early antibodies in human immunodeficiency virus infection by enzyme-linked immunosorbent assay, Western blot, and radioimmunoprecipitation. *J Clin Microbiol.* 1987;25(9):1605-10.
68. Hu WS, and Hughes SH. HIV-1 reverse transcription. *Cold Spring Harb Perspect Med.* 2012;2(10).
69. Van Maele B, and Debyser Z. HIV-1 integration: an interplay between HIV-1 integrase, cellular and viral proteins. *AIDS Rev.* 2005;7(1):26-43.
70. Lee SK, Potempa M, and Swanstrom R. The choreography of HIV-1 proteolytic processing and virion assembly. *J Biol Chem.* 2012;287(49):40867-74.
71. Checkley MA, Luttge BG, and Freed EO. HIV-1 envelope glycoprotein biosynthesis, trafficking, and incorporation. *J Mol Biol.* 2011;410(4):582-608.
72. Wilen CB, Tilton JC, and Doms RW. Molecular mechanisms of HIV entry. *Adv Exp Med Biol.* 2012;726(223-42).
73. Marcello A, Zoppe M, and Giacca M. Multiple modes of transcriptional regulation by the HIV-1 Tat transactivator. *IUBMB Life.* 2001;51(3):175-81.

74. Suhasini M, and Reddy TR. Cellular proteins and HIV-1 Rev function. *Curr HIV Res.* 2009;7(1):91-100.
75. Strebel K. HIV accessory proteins versus host restriction factors. *Curr Opin Virol.* 2013;3(6):692-9.
76. Foster JL, and Garcia JV. HIV-1 Nef: at the crossroads. *Retrovirology.* 2008;5(84).
77. Goila-Gaur R, and Strebel K. HIV-1 Vif, APOBEC, and intrinsic immunity. *Retrovirology.* 2008;5(51).
78. Huthoff H, and Towers GJ. Restriction of retroviral replication by APOBEC3G/F and TRIM5alpha. *Trends Microbiol.* 2008;16(12):612-9.
79. Kogan M, and Rappaport J. HIV-1 accessory protein Vpr: relevance in the pathogenesis of HIV and potential for therapeutic intervention. *Retrovirology.* 2011;8(25).
80. Dube M, Bego MG, Paquay C, and Cohen EA. Modulation of HIV-1-host interaction: role of the Vpu accessory protein. *Retrovirology.* 2010;7(114).
81. Van Der Graaf M, and Diepersloot RJ. Transmission of human immunodeficiency virus (HIV/HTLV-III/LAV): a review. *Infection.* 1986;14(5):203-11.
82. Scarlatti G. Mother-to-child transmission of HIV-1: advances and controversies of the twentieth centuries. *AIDS Rev.* 2004;6(2):67-78.
83. Wood LF, Chahroudi A, Chen HL, Jaspan HB, and Sodora DL. The oral mucosa immune environment and oral transmission of HIV/SIV. *Immunol Rev.* 2013;254(1):34-53.
84. Beltrami EM, Williams IT, Shapiro CN, and Chamberland ME. Risk and management of blood-borne infections in health care workers. *Clin Microbiol Rev.* 2000;13(3):385-407.
85. Cohen MS, Shaw GM, McMichael AJ, and Haynes BF. Acute HIV-1 Infection. *N Engl J Med.* 2011;364(20):1943-54.
86. CDC - Center for Disease Prevention. Monitoring selected national HIV prevention and care objectives by using HIV surveillance data - United States and 6 U.S. dependent areas - 2012. HIV Surveillance Supplemental Report 2014;19(No. 3). Accessed November 25, 2014. Available at <http://www.cdc.gov/hiv/library/reports>.
87. Llibre JM, Falco V, Tural C, Negredo E, Pineda JA, Munoz J, Ortega E, Videla S, Sirera G, Martinez E, et al. The changing face of HIV/AIDS in treated patients. *Curr HIV Res.* 2009;7(4):365-77.
88. Schuetz A, Deleage C, Sereti I, Rerknimitr R, Phanuphak N, Phuang-Ngern Y, Estes JD, Sandler NG, Sukhumvittaya S, Marovich M, et al. Initiation of ART during early acute HIV infection preserves mucosal Th17 function and reverses HIV-related immune activation. *PLoS Pathog.* 2014;10(12):e1004543.
89. Brenchley JM, Schacker TW, Ruff LE, Price DA, Taylor JH, Beilman GJ, Nguyen PL, Khoruts A, Larson M, Haase AT, et al. CD4+ T cell depletion during all stages of HIV disease occurs predominantly in the gastrointestinal tract. *J Exp Med.* 2004;200(6):749-59.
90. Brenchley JM, Price DA, and Douek DC. HIV disease: fallout from a mucosal catastrophe? *Nat Immunol.* 2006;7(3):235-9.

91. Brenchley JM, Price DA, Schacker TW, Asher TE, Silvestri G, Rao S, Kazzaz Z, Bornstein E, Lambotte O, Altmann D, et al. Microbial translocation is a cause of systemic immune activation in chronic HIV infection. *Nat Med*. 2006;12(12):1365-71.
92. Wallet MA, Rodriguez CA, Yin L, Saporta S, Chinratanapisit S, Hou W, Sleasman JW, and Goodenow MM. Microbial translocation induces persistent macrophage activation unrelated to HIV-1 levels or T-cell activation following therapy. *AIDS*. 2010;24(9):1281-90.
93. Eden A, Price RW, Spudich S, Fuchs D, Hagberg L, and Gisslen M. Immune activation of the central nervous system is still present after >4 years of effective highly active antiretroviral therapy. *J Infect Dis*. 2007;196(12):1779-83.
94. Marchetti G, Bellistri GM, Borghi E, Tincati C, Ferramosca S, La Francesca M, Morace G, Gori A, and Monforte AD. Microbial translocation is associated with sustained failure in CD4+ T-cell reconstitution in HIV-infected patients on long-term highly active antiretroviral therapy. *AIDS*. 2008;22(15):2035-8.
95. Jiang W, Lederman MM, Hunt P, Sieg SF, Haley K, Rodriguez B, Landay A, Martin J, Sinclair E, Asher AI, et al. Plasma levels of bacterial DNA correlate with immune activation and the magnitude of immune restoration in persons with antiretroviral-treated HIV infection. *J Infect Dis*. 2009;199(8):1177-85.
96. Pulliam L, Gascon R, Stubblebine M, McGuire D, and McGrath MS. Unique monocyte subset in patients with AIDS dementia. *Lancet*. 1997;349(9053):692-5.
97. Ancuta P, Kamat A, Kunstman KJ, Kim EY, Autissier P, Wurcel A, Zaman T, Stone D, Mefford M, Morgello S, et al. Microbial translocation is associated with increased monocyte activation and dementia in AIDS patients. *PLoS One*. 2008;3(6):e2516.
98. Reingold J, Wanke C, Kotler D, Lewis C, Tracy R, Heymsfield S, Tien P, Bacchetti P, Scherzer R, Grunfeld C, et al. Association of HIV infection and HIV/HCV coinfection with C-reactive protein levels: the fat redistribution and metabolic change in HIV infection (FRAM) study. *J Acquir Immune Defic Syndr*. 2008;48(2):142-8.
99. Neuhaus J, Jacobs DR, Jr., Baker JV, Calmy A, Duprez D, La Rosa A, Kuller LH, Pett SL, Ristola M, Ross MJ, et al. Markers of inflammation, coagulation, and renal function are elevated in adults with HIV infection. *J Infect Dis*. 2010;201(12):1788-95.
100. Roberts ES, Zandonatti MA, Watry DD, Madden LJ, Henriksen SJ, Taffe MA, and Fox HS. Induction of pathogenic sets of genes in macrophages and neurons in NeuroAIDS. *Am J Pathol*. 2003;162(6):2041-57.
101. Roberts ES, Masliah E, and Fox HS. CD163 identifies a unique population of ramified microglia in HIV encephalitis (HIVE). *J Neuropathol Exp Neurol*. 2004;63(12):1255-64.
102. Fischer-Smith T, Tedaldi EM, and Rappaport J. CD163/CD16 coexpression by circulating monocytes/macrophages in HIV: potential biomarkers for HIV infection and AIDS progression. *AIDS Res Hum Retroviruses*. 2008;24(3):417-21.
103. Hazenberg MD, Otto SA, van Benthem BH, Roos MT, Coutinho RA, Lange JM, Hamann D, Prins M, and Miedema F. Persistent immune activation in HIV-1 infection is associated with progression to AIDS. *AIDS*. 2003;17(13):1881-8.

104. Rajasuriar R, Khoury G, Kamarulzaman A, French MA, Cameron PU, and Lewin SR. Persistent immune activation in chronic HIV infection: do any interventions work? *AIDS*. 2013;27(8):1199-208.
105. Deeks SG. HIV infection, inflammation, immunosenescence, and aging. *Annu Rev Med*. 2011;62(141-55).
106. Bhaskaran K, Hamouda O, Sannes M, Boufassa F, Johnson AM, Lambert PC, and Porter K. Changes in the risk of death after HIV seroconversion compared with mortality in the general population. *JAMA*. 2008;300(1):51-9.
107. Losina E, Schackman BR, Sadownik SN, Gebo KA, Walensky RP, Chiosi JJ, Weinstein MC, Hicks PL, Aaronson WH, Moore RD, et al. Racial and sex disparities in life expectancy losses among HIV-infected persons in the united states: impact of risk behavior, late initiation, and early discontinuation of antiretroviral therapy. *Clin Infect Dis*. 2009;49(10):1570-8.
108. Collaboration ATC. Life expectancy of individuals on combination antiretroviral therapy in high-income countries: a collaborative analysis of 14 cohort studies. *Lancet*. 2008;372(9635):293-9.
109. Tien PC, Choi AI, Zolopa AR, Benson C, Tracy R, Scherzer R, Bacchetti P, Shlipak M, and Grunfeld C. Inflammation and Mortality in HIV-Infected Adults: Analysis of the FRAM Study Cohort. *J Acquir Immune Defic Syndr*. 2010;55(3):316-22.
110. Kuller LH, Tracy R, Bellosso W, De Wit S, Drummond F, Lane HC, Ledergerber B, Lundgren J, Neuhaus J, Nixon D, et al. Inflammatory and coagulation biomarkers and mortality in patients with HIV infection. *PLoS Med*. 2008;5(10):e203.
111. Marchetti G, Tincati C, and Silvestri G. Microbial Translocation in the Pathogenesis of HIV Infection and AIDS. *Clin Microbiol Rev*. 2013;26(1):2-18.
112. Mutlu EA, Keshavarzian A, Losurdo J, Swanson G, Siewe B, Forsyth C, French A, Demarais P, Sun Y, Koenig L, et al. A compositional look at the human gastrointestinal microbiome and immune activation parameters in HIV infected subjects. *PLoS Pathog*. 2014;10(2):e1003829.
113. Hamann L, Alexander C, Stamme C, Zahringer U, and Schumann RR. Acute-phase concentrations of lipopolysaccharide (LPS)-binding protein inhibit innate immune cell activation by different LPS chemotypes via different mechanisms. *Infect Immun*. 2005;73(1):193-200.
114. Freudenberg MA, Tchaptchet S, Keck S, Fejer G, Huber M, Schutze N, Beutler B, and Galanos C. Lipopolysaccharide sensing an important factor in the innate immune response to Gram-negative bacterial infections: benefits and hazards of LPS hypersensitivity. *Immunobiology*. 2008;213(3-4):193-203.
115. Funderburg N, Luciano AA, Jiang W, Rodriguez B, Sieg SF, and Lederman MM. Toll-like receptor ligands induce human T cell activation and death, a model for HIV pathogenesis. *PLoS One*. 2008;3(4):e1915.
116. Douek DC. Disrupting T-cell homeostasis: how HIV-1 infection causes disease. *AIDS Rev*. 2003;5(3):172-7.

117. Kovacs JA, Lempicki RA, Sidorov IA, Adelsberger JW, Herpin B, Metcalf JA, Sereti I, Polis MA, Davey RT, Tavel J, et al. Identification of dynamically distinct subpopulations of T lymphocytes that are differentially affected by HIV. *J Exp Med*. 2001;194(12):1731-41.
118. Sousa AE, Carneiro J, Meier-Schellersheim M, Grossman Z, and Victorino RM. CD4 T cell depletion is linked directly to immune activation in the pathogenesis of HIV-1 and HIV-2 but only indirectly to the viral load. *J Immunol*. 2002;169(6):3400-6.
119. Deeks SG, Kitchen CM, Liu L, Guo H, Gascon R, Narvaez AB, Hunt P, Martin JN, Kahn JO, Levy J, et al. Immune activation set point during early HIV infection predicts subsequent CD4+ T-cell changes independent of viral load. *Blood*. 2004;104(4):942-7.
120. Rychert J, Strick D, Bazner S, Robinson J, and Rosenberg E. Detection of HIV gp120 in Plasma During Early HIV Infection Is Associated with Increased Proinflammatory and Immunoregulatory Cytokines. *AIDS Res Hum Retroviruses*. 2010;26(10):1139-45.
121. Kong LY, Wilson BC, McMillian MK, Bing G, Hudson PM, and Hong JS. The effects of the HIV-1 envelope protein gp120 on the production of nitric oxide and proinflammatory cytokines in mixed glial cell cultures. *Cell Immunol*. 1996;172(1):77-83.
122. Herbein G, Gras G, Khan KA, and Abbas W. Macrophage signaling in HIV-1 infection. *Retrovirology*. 2010;7(34).
123. Molina JM, Schindler R, Ferriani R, Sakaguchi M, Vannier E, Dinarello CA, and Groopman JE. Production of cytokines by peripheral blood monocytes/macrophages infected with human immunodeficiency virus type 1 (HIV-1). *J Infect Dis*. 1990;161(5):888-93.
124. Finnegan A, Roebuck KA, Nakai BE, Gu DS, Rabbi MF, Song S, and Landay AL. IL-10 cooperates with TNF-alpha to activate HIV-1 from latently and acutely infected cells of monocyte/macrophage lineage. *J Immunol*. 1996;156(2):841-51.
125. Han J, Wang B, Han N, Zhao Y, Song C, Feng X, Mao Y, Zhang F, Zhao H, and Zeng H. CD14(high)CD16(+) rather than CD14(low)CD16(+) monocytes correlate with disease progression in chronic HIV-infected patients. *J Acquir Immune Defic Syndr*. 2009;52(5):553-9.
126. Ellery PJ, Tippet E, Chiu YL, Paukovics G, Cameron PU, Solomon A, Lewin SR, Gorry PR, Jaworowski A, Greene WC, et al. The CD16+ monocyte subset is more permissive to infection and preferentially harbors HIV-1 in vivo. *J Immunol*. 2007;178(10):6581-9.
127. Marchetti G, Gori A, Casabianca A, Magnani M, Franzetti F, Clerici M, Perno CF, Monforte A, Galli M, and Meroni L. Comparative analysis of T-cell turnover and homeostatic parameters in HIV-infected patients with discordant immune-virological responses to HAART. *AIDS*. 2006;20(13):1727-36.
128. Hunt PW, Martin JN, Sinclair E, Brecht B, Hagos E, Lampiris H, and Deeks SG. T cell activation is associated with lower CD4+ T cell gains in human immunodeficiency virus-infected patients with sustained viral suppression during antiretroviral therapy. *J Infect Dis*. 2003;187(10):1534-43.
129. Gazzola L, Tincati C, Bellistri GM, Monforte A, and Marchetti G. The absence of CD4+ T cell count recovery despite receipt of virologically suppressive highly active antiretroviral therapy: clinical risk, immunological gaps, and therapeutic options. *Clin Infect Dis*. 2009;48(3):328-37.

130. Gori A, Tincati C, Rizzardini G, Torti C, Quirino T, Haarman M, Ben Amor K, van Schaik J, Vriesema A, Knol J, et al. Early impairment of gut function and gut flora supporting a role for alteration of gastrointestinal mucosa in human immunodeficiency virus pathogenesis. *J Clin Microbiol.* 2008;46(2):757-8.
131. Tincati C, Biasin M, Bandera A, Violin M, Marchetti G, Piacentini L, Vago GL, Balotta C, Moroni M, Franzetti F, et al. Early initiation of highly active antiretroviral therapy fails to reverse immunovirological abnormalities in gut-associated lymphoid tissue induced by acute HIV infection. *Antivir Ther.* 2009;14(3):321-30.
132. Castro P, Plana M, Gonzalez R, Lopez A, Vilella A, Nicolas JM, Gallart T, Pumarola T, Bayas JM, Gatell JM, et al. Influence of episodes of intermittent viremia ("blips") on immune responses and viral load rebound in successfully treated HIV-infected patients. *AIDS Res Hum Retroviruses.* 2013;29(1):68-76.
133. Grennan JT, Loutfy MR, Su D, Harrigan PR, Cooper C, Klein M, Machouf N, Montaner JS, Rourke S, Tsoukas C, et al. Magnitude of virologic blips is associated with a higher risk for virologic rebound in HIV-infected individuals: a recurrent events analysis. *J Infect Dis.* 2012;205(8):1230-8.
134. Canestri A, Lescure FX, Jaureguiberry S, Moulignier A, Amiel C, Marcelin AG, Peytavin G, Tubiana R, Pialoux G, and Katlama C. Discordance between cerebral spinal fluid and plasma HIV replication in patients with neurological symptoms who are receiving suppressive antiretroviral therapy. *Clin Infect Dis.* 2010;50(5):773-8.
135. Perl A, and Banki K. Genetic and metabolic control of the mitochondrial transmembrane potential and reactive oxygen intermediate production in HIV disease. *Antioxid Redox Signal.* 2000;2(3):551-73.
136. Elbim C, Pillet S, Prevost MH, Preira A, Girard PM, Rogine N, Hakim J, Israel N, and Gougerot-Pocidalo MA. The role of phagocytes in HIV-related oxidative stress. *J Clin Virol.* 2001;20(3):99-109.
137. Allard JP, Aghdassi E, Chau J, Salit I, and Walmsley S. Oxidative stress and plasma antioxidant micronutrients in humans with HIV infection. *Am J Clin Nutr.* 1998;67(1):143-7.
138. Repetto M, Reides C, Gomez Carretero ML, Costa M, Griemberg G, and Llesuy S. Oxidative stress in blood of HIV infected patients. *Clin Chim Acta.* 1996;255(2):107-17.
139. Valcour V, and Shiramizu B. HIV-associated dementia, mitochondrial dysfunction, and oxidative stress. *Mitochondrion.* 2004;4(2-3):119-29.
140. Mollace V, Nottet HS, Clayette P, Turco MC, Muscoli C, Salvemini D, and Perno CF. Oxidative stress and neuroAIDS: triggers, modulators and novel antioxidants. *Trends Neurosci.* 2001;24(7):411-6.
141. Aukrust P, Svardal AM, Muller F, Lunden B, Berge RK, and Froland SS. Decreased levels of total and reduced glutathione in CD4+ lymphocytes in common variable immunodeficiency are associated with activation of the tumor necrosis factor system: possible immunopathogenic role of oxidative stress. *Blood.* 1995;86(4):1383-91.
142. Ronaldson PT, and Bendayan R. HIV-1 viral envelope glycoprotein gp120 produces oxidative stress and regulates the functional expression of multidrug resistance protein-1 (Mrp1) in glial cells. *J Neurochem.* 2008;106(3):1298-313.

143. Turchan-Cholewo J, Dimayuga FO, Gupta S, Keller JN, Knapp PE, Hauser KF, and Bruce-Keller AJ. Morphine and HIV-Tat increase microglial-free radical production and oxidative stress: possible role in cytokine regulation. *J Neurochem*. 2009;108(1):202-15.
144. Deshmane SL, Mukerjee R, Fan S, Del Valle L, Michiels C, Sweet T, Rom I, Khalili K, Rappaport J, Amini S, et al. Activation of the oxidative stress pathway by HIV-1 Vpr leads to induction of hypoxia-inducible factor 1alpha expression. *J Biol Chem*. 2009;284(17):11364-73.
145. Price TO, Ercal N, Nakaoke R, and Banks WA. HIV-1 viral proteins gp120 and Tat induce oxidative stress in brain endothelial cells. *Brain Res*. 2005;1045(1-2):57-63.
146. Eck HP, Gmunder H, Hartmann M, Petzoldt D, Daniel V, and Droge W. Low concentrations of acid-soluble thiol (cysteine) in the blood plasma of HIV-1-infected patients. *Biol Chem Hoppe Seyler*. 1989;370(2):101-8.
147. de Quay B, Malinverni R, and Lauterburg BH. Glutathione depletion in HIV-infected patients: role of cysteine deficiency and effect of oral N-acetylcysteine. *AIDS*. 1992;6(8):815-9.
148. Malvy DJ, Richard MJ, Arnaud J, Favier A, and Amedee-Manesme O. Relationship of plasma malondialdehyde, vitamin E and antioxidant micronutrients to human immunodeficiency virus-1 seropositivity. *Clin Chim Acta*. 1994;224(1):89-94.
149. Masutani H, Naito M, Takahashi K, Hattori T, Koito A, Takatsuki K, Go T, Nakamura H, Fujii S, Yoshida Y, et al. Dysregulation of adult T-cell leukemia-derived factor (ADF)/thioredoxin in HIV infection: loss of ADF high-producer cells in lymphoid tissues of AIDS patients. *AIDS Res Hum Retroviruses*. 1992;8(9):1707-15.
150. Sonnerborg A, Carlin G, Akerlund B, and Jarstrand C. Increased production of malondialdehyde in patients with HIV infection. *Scand J Infect Dis*. 1988;20(3):287-90.
151. Revillard JP, Vincent CM, Favier AE, Richard MJ, Zittoun M, and Kazatchkine MD. Lipid peroxidation in human immunodeficiency virus infection. *J Acquir Immune Defic Syndr*. 1992;5(6):637-8.
152. McLemore JL, Beeley P, Thorton K, Morrisroe K, Blackwell W, and Dasgupta A. Rapid automated determination of lipid hydroperoxide concentrations and total antioxidant status of serum samples from patients infected with HIV: elevated lipid hydroperoxide concentrations and depleted total antioxidant capacity of serum samples. *Am J Clin Pathol*. 1998;109(3):268-73.
153. Foga IO, Nath A, Hasinoff BB, and Geiger JD. Antioxidants and dipyrindamole inhibit HIV-1 gp120-induced free radical-based oxidative damage to human monocytoid cells. *J Acquir Immune Defic Syndr Hum Retrovirol*. 1997;16(4):223-9.
154. Otis JS, Ashikhmin YI, Brown LA, and Guidot DM. Effect of HIV-1-related protein expression on cardiac and skeletal muscles from transgenic rats. *AIDS Res Ther*. 2008;5(8).
155. Yu QR, Zhang ZP, Zhang H, Lin HT, Li XM, Bai L, and Cai WB. Inducible nitric oxide synthase is involved in the oxidation stress induced by HIV-1 gp120 in human retina pigment epithelial cells. *Chin Med J*. 2008;121(24):2578-83.

156. Radrizzani M, Accornero P, Delia D, Kurrle R, and Colombo MP. Apoptosis induced by HIV-gp120 in a Th1 clone involves the generation of reactive oxygen intermediates downstream CD95 triggering. *FEBS letters*. 1997;411(1):87-92.
157. Stromajer-Racz T, Gazdag Z, Belagyi J, Vagvolgyi C, Zhao RY, and Pesti M. Oxidative stress induced by HIV-1 F34IVpr in *Schizosaccharomyces pombe* is one of its multiple functions. *Exp Mol Pathol*. 2010;88(1):38-44.
158. Poli G, and Fauci AS. The effect of cytokines and pharmacologic agents on chronic HIV infection. *AIDS Res Hum Retroviruses*. 1992;8(2):191-7.
159. Palamara AT, Perno CF, Aquaro S, Bue MC, Dini L, and Garaci E. Glutathione inhibits HIV replication by acting at late stages of the virus life cycle. *AIDS Res Hum Retroviruses*. 1996;12(16):1537-41.
160. Israel N, and Gougerot-Pocidalo MA. Oxidative stress in human immunodeficiency virus infection. *Cell Mol Life Sci*. 1997;53(11-12):864-70.
161. Roc AC, Ances BM, Chawla S, Korczykowski M, Wolf RL, Kolson DL, Detre JA, and Poptani H. Detection of human immunodeficiency virus induced inflammation and oxidative stress in lenticular nuclei with magnetic resonance spectroscopy despite antiretroviral therapy. *Arch Neurol*. 2007;64(9):1249-57.
162. Reddy PV, Agudelo M, Atluri VS, and Nair MP. Inhibition of nuclear factor erythroid 2-related factor 2 exacerbates HIV-1 gp120-induced oxidative and inflammatory response: role in HIV associated neurocognitive disorder. *Neurochem Res*. 2012;37(8):1697-706.
163. Fuchs J, Oelke N, Imhof M, Ochsendorf F, Schofer H, Oromek G, Alaoui-Youssefi A, and Emerit I. Multiparameter analysis of clastogenic factors, pro-oxidant cytokines, and inflammatory markers in HIV-1-infected patients with asymptomatic disease, opportunistic infections, and malignancies. *Mol Med*. 1998;4(5):333-43.
164. Toborek M, Lee YW, Pu H, Malecki A, Flora G, Garrido R, Hennig B, Bauer HC, and Nath A. HIV-Tat protein induces oxidative and inflammatory pathways in brain endothelium. *J Neurochem*. 2003;84(1):169-79.
165. Driscoll KE. TNFalpha and MIP-2: role in particle-induced inflammation and regulation by oxidative stress. *Toxicol Lett*. 2000;112-113(177-83).
166. Wanchu A, Rana SV, Pallikkuth S, and Sachdeva RK. Short communication: oxidative stress in HIV-infected individuals: a cross-sectional study. *AIDS Res Hum Retroviruses*. 2009;25(12):1307-11.
167. Ibeh BO, and Emeka-Nwabunnia IK. Increased oxidative stress condition found in different stages of HIV disease in patients undergoing antiretroviral therapy in Umuahia (Nigeria). *Immunopharmacol Immunotoxicol*. 2012;34(6):1060-6.
168. Suresh DR, Annam V, Pratibha K, and Prasad BV. Total antioxidant capacity--a novel early bio-chemical marker of oxidative stress in HIV infected individuals. *J Biomed Sci*. 2009;16(61).
169. Herzenberg LA, De Rosa SC, Dubs JG, Roederer M, Anderson MT, Ela SW, and Deresinski SC. Glutathione deficiency is associated with impaired survival in HIV disease. *Proc Natl Acad Sci U S A*. 1997;94(5):1967-72.

170. Valcour V, Chalermchai T, Sailasuta N, Marovich M, Lerdlum S, Suttichom D, Suwanwela NC, Jagodzinski L, Michael N, Spudich S, et al. Central nervous system viral invasion and inflammation during acute HIV infection. *J Infect Dis.* 2012;206(2):275-82.
171. Manji H, Jager HR, and Winston A. HIV, dementia and antiretroviral drugs: 30 years of an epidemic. *J Neurol Neurosurg Psychiatry.* 2013;84(10):1126-37.
172. Clifford DB, and Ances BM. HIV-associated neurocognitive disorder. *Lancet Infect Dis.* 2013;13(11):976-86.
173. Yadav A, and Collman RG. CNS inflammation and macrophage/microglial biology associated with HIV-1 infection. *J Neuroimmune Pharmacol.* 2009;4(4):430-47.
174. Uzasci L, Nath A, and Cotter R. Oxidative stress and the HIV-infected brain proteome. *J Neuroimmune Pharmacol.* 2013;8(5):1167-80.
175. Price RW, Spudich SS, Peterson J, Joseph S, Fuchs D, Zetterberg H, Gisslen M, and Swanstrom R. Evolving Character of Chronic Central Nervous System HIV Infection. *Semin Neurol.* 2014;34(1):7-13.
176. Childers ME, Woods SP, Letendre S, McCutchan JA, Rosario D, Grant I, Mindt MR, and Ellis RJ. Cognitive functioning during highly active antiretroviral therapy interruption in human immunodeficiency virus type 1 infection. *J Neurovirol.* 2008:1-8.
177. Monteiro de Almeida S, Letendre S, Zimmerman J, Lazzaretto D, McCutchan A, and Ellis R. Dynamics of monocyte chemoattractant protein type one (MCP-1) and HIV viral load in human cerebrospinal fluid and plasma. *J Neuroimmunol.* 2005;169(1-2):144-52.
178. Gisslen M, Rosengren L, Hagberg L, Deeks SG, and Price RW. Cerebrospinal fluid signs of neuronal damage after antiretroviral treatment interruption in HIV-1 infection. *AIDS Res Ther.* 2005;2(6).
179. Stam AJ, Nijhuis M, van den Bergh WM, and Wensing AM. Differential genotypic evolution of HIV-1 quasispecies in cerebrospinal fluid and plasma: a systematic review. *AIDS Rev.* 2013;15(3):152-61.
180. Antinori A, Arendt G, Becker JT, Brew BJ, Byrd DA, Cherner M, Clifford DB, Cinque P, Epstein LG, Goodkin K, et al. Updated research nosology for HIV-associated neurocognitive disorders. *Neurology.* 2007;69(18):1789-99.
181. Grant I. Neurocognitive disturbances in HIV. *Int Rev Psychiatry.* 2008;20(1):33-47.
182. Gannon P, Khan MZ, and Kolson DL. Current understanding of HIV-associated neurocognitive disorders pathogenesis. *Curr Opin Neurol.* 2011;24(3):275-83.
183. Ellis RJ, Deutsch R, Heaton RK, Marcotte TD, McCutchan JA, Nelson JA, Abramson I, Thal LJ, Atkinson JH, Wallace MR, et al. Neurocognitive impairment is an independent risk factor for death in HIV infection. San Diego HIV Neurobehavioral Research Center Group. *Archives of neurology.* 1997;54(4):416-24.
184. Mayeux R, Stern Y, Tang MX, Todak G, Marder K, Sano M, Richards M, Stein Z, Ehrhardt AA, and Gorman JM. Mortality risks in gay men with human immunodeficiency virus infection and cognitive impairment. *Neurology.* 1993;43(1):176-82.

185. Mind Exchange Working G. Assessment, diagnosis, and treatment of HIV-associated neurocognitive disorder: a consensus report of the mind exchange program. *Clin Infect Dis*. 2013;56(7):1004-17.
186. Dore GJ, McDonald A, Li Y, Kaldor JM, and Brew BJ. Marked improvement in survival following AIDS dementia complex in the era of highly active antiretroviral therapy. *AIDS*. 2003;17(10):1539-45.
187. Sacktor N, McDermott MP, Marder K, Schifitto G, Selnes OA, McArthur JC, Stern Y, Albert S, Palumbo D, Kieburtz K, et al. HIV-associated cognitive impairment before and after the advent of combination therapy. *J Neurovirol*. 2002;8(2):136-42.
188. Letendre SL, Ellis RJ, Ances BM, and McCutchan JA. Neurologic complications of HIV disease and their treatment. *Top HIV Med*. 2010;18(2):45-55.
189. Calcagno A, Di Perri G, and Bonora S. Pharmacokinetics and pharmacodynamics of antiretrovirals in the central nervous system. *Clin Pharmacokinet*. 2014;53(10):891-906.
190. Morgello S, Estanislao L, Simpson D, Geraci A, DiRocco A, Gerits P, Ryan E, Yakoushina T, Khan S, Mahboob R, et al. HIV-associated distal sensory polyneuropathy in the era of highly active antiretroviral therapy: the Manhattan HIV Brain Bank. *Arch Neurol*. 2004;61(4):546-51.
191. Skopelitis EE, Kokotis PI, Kontos AN, Panayiotakopoulos GD, Konstantinou K, Kordossis T, and Karandreas N. Distal sensory polyneuropathy in HIV-positive patients in the HAART era: an entity underestimated by clinical examination. *Int J STD AIDS*. 2006;17(7):467-72.
192. Shurie JS, and Deribew A. Assessment of the prevalence of distal symmetrical polyneuropathy and its risk factors among HAART-treated and untreated HIV infected individuals. *Ethiop Med J*. 2010;48(2):85-93.
193. Bing EG, Burnam MA, Longshore D, Fleishman JA, Sherbourne CD, London AS, Turner BJ, Eggan F, Beckman R, Vitiello B, et al. Psychiatric disorders and drug use among human immunodeficiency virus-infected adults in the United States. *Arch Gen Psychiatry*. 2001;58(8):721-8.
194. Dube B, Benton T, Cruess DG, and Evans DL. Neuropsychiatric manifestations of HIV infection and AIDS. *J Psychiatry Neurosci*. 2005;30(4):237-46.
195. Nel A, and Kagee A. Common mental health problems and antiretroviral therapy adherence. *AIDS Care*. 2011;23(11):1360-5.
196. Masliah E, Ge N, Morey M, DeTeresa R, Terry RD, and Wiley CA. Cortical dendritic pathology in human immunodeficiency virus encephalitis. *Lab Invest*. 1992;66(3):285-91.
197. Masliah E, Heaton RK, Marcotte TD, Ellis RJ, Wiley CA, Mallory M, Achim CL, McCutchan JA, Nelson JA, Atkinson JH, et al. Dendritic injury is a pathological substrate for human immunodeficiency virus-related cognitive disorders. HNRC Group. The HIV Neurobehavioral Research Center. *Ann Neurol*. 1997;42(6):963-72.
198. Wiley CA, Masliah E, Morey M, Lemere C, DeTeresa R, Grafe M, Hansen L, and Terry R. Neocortical damage during HIV infection. *Ann Neurol*. 1991;29(6):651-7.
199. Kaul M, Zheng J, Okamoto S, Gendelman HE, and Lipton SA. HIV-1 infection and AIDS: consequences for the central nervous system. *Cell Death Differ*. 2005;12 Suppl 1(878-92).

200. Gelbard HA, James HJ, Sharer LR, Perry SW, Saito Y, Kazee AM, Blumberg BM, and Epstein LG. Apoptotic neurons in brains from paediatric patients with HIV-1 encephalitis and progressive encephalopathy. *Neuropathol Appl Neurobiol.* 1995;21(3):208-17.
201. Petit CK, and Roberts B. Evidence of apoptotic cell death in HIV encephalitis. *Am J Pathol.* 1995;146(5):1121-30.
202. Adamson DC, Dawson TM, Zink MC, Clements JE, and Dawson VL. Neurovirulent simian immunodeficiency virus infection induces neuronal, endothelial, and glial apoptosis. *Mol Med.* 1996;2(4):417-28.
203. Gelman BB, Soukup VM, Schuenke KW, Keherly MJ, Holzer C, 3rd, Richey FJ, and Lahart CJ. Acquired neuronal channelopathies in HIV-associated dementia. *J Neuroimmunol.* 2004;157(1-2):111-9.
204. Hu D, Liu J, and Xiong H. Enhancement of neuronal outward delayed rectifier K⁺ current by human monocyte-derived macrophages. *Glia.* 2009;57(14):1492-500.
205. Hu D, Liu J, Keblesh J, and Xiong H. Involvement of the 4-aminopyridine-sensitive transient A-type K⁺ current in macrophage-induced neuronal injury. *Eur J Neurosci.* 2010;31(2):214-22.
206. Xiong H, Zeng YC, Zheng J, Thylin M, and Gendelman HE. Soluble HIV-1 infected macrophage secretory products mediate blockade of long-term potentiation: a mechanism for cognitive dysfunction in HIV-1-associated dementia. *J Neurovirol.* 1999;5(5):519-28.
207. Dong J, and Xiong H. Human immunodeficiency virus type 1 gp120 inhibits long-term potentiation via chemokine receptor CXCR4 in rat hippocampal slices. *J Neurosci Res.* 2006;83(3):489-96.
208. Behnisch T, Francesconi W, and Sanna PP. HIV secreted protein Tat prevents long-term potentiation in the hippocampal CA1 region. *Brain Res.* 2004;1012(1-2):187-9.
209. Anderson ER, Boyle J, Zink WE, Persidsky Y, Gendelman HE, and Xiong H. Hippocampal synaptic dysfunction in a murine model of human immunodeficiency virus type 1 encephalitis. *Neuroscience.* 2003;118(2):359-69.
210. Gelman BB, and Nguyen TP. Synaptic proteins linked to HIV-1 infection and immunoproteasome induction: proteomic analysis of human synaptosomes. *J Neuroimmune Pharmacol.* 2010;5(1):92-102.
211. Ellis R, Langford D, and Masliah E. HIV and antiretroviral therapy in the brain: neuronal injury and repair. *Nature reviews Neuroscience.* 2007;8(1):33-44.
212. Valcour VG, Ananworanich J, Aagsalda M, Sailasuta N, Chalermchai T, Schuetz A, Shikuma C, Liang CY, Jirajariyavej S, Sithinamsuwan P, et al. HIV DNA reservoir increases risk for cognitive disorders in cART-naive patients. *PLoS One.* 2013;8(7):e70164.
213. Williams KC, Corey S, Westmoreland SV, Pauley D, Knight H, deBakker C, Alvarez X, and Lackner AA. Perivascular macrophages are the primary cell type productively infected by simian immunodeficiency virus in the brains of macaques: implications for the neuropathogenesis of AIDS. *J Exp Med.* 2001;193(8):905-15.

214. Gonzalez-Scarano F, and Martin-Garcia J. The neuropathogenesis of AIDS. *Nat Rev Immunol*. 2005;5(1):69-81.
215. Kaul M, Garden GA, and Lipton SA. Pathways to neuronal injury and apoptosis in HIV-associated dementia. *Nature*. 2001;410(6831):988-94.
216. Morner A, Thomas JA, Bjorling E, Munson PJ, Lucas SB, and McKnight A. Productive HIV-2 infection in the brain is restricted to macrophages/microglia. *AIDS*. 2003;17(10):1451-5.
217. Gelman BBM, D.J. . In: Gendelman HEG, I; Everall, I.P.; Fox, H.S.; Gelbard, H.A.; Lipton, S.A.; Swindells, S. ed. *The Neurology of AIDS*. New York: Oxford University Press; 2012:518-35.
218. Wiestler OD, Leib SL, Brustle O, Spiegel H, and Kleihues P. Neuropathology and pathogenesis of HIV encephalopathies. *Acta Histochem Suppl*. 1992;42(107-14).
219. Anthony IC, Ramage SN, Carnie FW, Simmonds P, and Bell JE. Accelerated Tau deposition in the brains of individuals infected with human immunodeficiency virus-1 before and after the advent of highly active anti-retroviral therapy. *Acta Neuropathol*. 2006;111(6):529-38.
220. Glass JD, Fedor H, Wesselingh SL, and McArthur JC. Immunocytochemical quantitation of human immunodeficiency virus in the brain: correlations with dementia. *Ann Neurol*. 1995;38(5):755-62.
221. Wesselingh SL, Takahashi K, Glass JD, McArthur JC, Griffin JW, and Griffin DE. Cellular localization of tumor necrosis factor mRNA in neurological tissue from HIV-infected patients by combined reverse transcriptase/polymerase chain reaction in situ hybridization and immunohistochemistry. *J Neuroimmunol*. 1997;74(1-2):1-8.
222. Deshpande M, Zheng J, Borgmann K, Persidsky R, Wu L, Schellpeper C, and Ghorpade A. Role of activated astrocytes in neuronal damage: potential links to HIV-1-associated dementia. *Neurotox Res*. 2005;7(3):183-92.
223. Li W, Galey D, Mattson MP, and Nath A. Molecular and cellular mechanisms of neuronal cell death in HIV dementia. *Neurotox Res*. 2005;8(1-2):119-34.
224. Cisneros IE, and Ghorpade A. HIV-1, methamphetamine and astrocyte glutamate regulation: combined excitotoxic implications for neuro-AIDS. *Current HIV research*. 2012;10(5):392-406.
225. Fan Y, Zou W, Green LA, Kim BO, and He JJ. Activation of Egr-1 expression in astrocytes by HIV-1 Tat: new insights into astrocyte-mediated Tat neurotoxicity. *J Neuroimmune Pharmacol*. 2011;6(1):121-9.
226. Toggas SM, Masliah E, and Mucke L. Prevention of HIV-1 gp120-induced neuronal damage in the central nervous system of transgenic mice by the NMDA receptor antagonist memantine. *Brain Res*. 1996;706(2):303-7.
227. Anderson ER, Gendelman HE, and Xiong H. Memantine protects hippocampal neuronal function in murine human immunodeficiency virus type 1 encephalitis. *J Neurosci*. 2004;24(32):7194-8.
228. Meisner F, Scheller C, Kneitz S, Sopper S, Neuen-Jacob E, Riederer P, ter Meulen V, and Koutsilieri E. Memantine upregulates BDNF and prevents dopamine deficits in SIV-

- infected macaques: a novel pharmacological action of memantine. *Neuropsychopharmacology*. 2008;33(9):2228-36.
229. Jiang ZG, Piggee C, Heyes MP, Murphy C, Quearry B, Bauer M, Zheng J, Gendelman HE, and Markey SP. Glutamate is a mediator of neurotoxicity in secretions of activated HIV-1-infected macrophages. *J Neuroimmunol*. 2001;117(1-2):97-107.
 230. Heyes MP, Jordan EK, Lee K, Saito K, Frank JA, Snoy PJ, Markey SP, and Gravel M. Relationship of neurologic status in macaques infected with the simian immunodeficiency virus to cerebrospinal fluid quinolinic acid and kynurenic acid. *Brain Res*. 1992;570(1-2):237-50.
 231. Heyes MP, Brew BJ, Martin A, Price RW, Salazar AM, Sidtis JJ, Yergey JA, Mouradian MM, Sadler AE, Keilp J, et al. Quinolinic acid in cerebrospinal fluid and serum in HIV-1 infection: relationship to clinical and neurological status. *Ann Neurol*. 1991;29(2):202-9.
 232. Giulian D, Yu J, Li X, Tom D, Li J, Wendt E, Lin SN, Schwarcz R, and Noonan C. Study of receptor-mediated neurotoxins released by HIV-1-infected mononuclear phagocytes found in human brain. *J Neurosci*. 1996;16(10):3139-53.
 233. Gelbard HA, Nottet HS, Swindells S, Jett M, Dzenko KA, Genis P, White R, Wang L, Choi YB, Zhang D, et al. Platelet-activating factor: a candidate human immunodeficiency virus type 1-induced neurotoxin. *J Virol*. 1994;68(7):4628-35.
 234. Achim CL, Heyes MP, and Wiley CA. Quantitation of human immunodeficiency virus, immune activation factors, and quinolinic acid in AIDS brains. *J Clin Invest*. 1993;91(6):2769-75.
 235. Pulliam L, West D, Haigwood N, and Swanson RA. HIV-1 envelope gp120 alters astrocytes in human brain cultures. *AIDS Res Hum Retroviruses*. 1993;9(5):439-44.
 236. Lipton SA. Requirement for macrophages in neuronal injury induced by HIV envelope protein gp120. *Neuroreport*. 1992;3(10):913-5.
 237. Nath A. Human immunodeficiency virus (HIV) proteins in neuropathogenesis of HIV dementia. *J Infect Dis*. 2002;186 Suppl 2(S193-8).
 238. Maragos WF, Tillman P, Jones M, Bruce-Keller AJ, Roth S, Bell JE, and Nath A. Neuronal injury in hippocampus with human immunodeficiency virus transactivating protein, Tat. *Neuroscience*. 2003;117(1):43-53.
 239. Ferrarese C, Aliprandi A, Tremolizzo L, Stanzani L, De Micheli A, Dolara A, and Frattola L. Increased glutamate in CSF and plasma of patients with HIV dementia. *Neurology*. 2001;57(4):671-5.
 240. Espey MG, Basile AS, Heaton RK, and Ellis RJ. Increased glutamate in CSF and plasma of patients with HIV dementia. *Neurology*. 2002;58(9):1439.
 241. Espey MG, Ellis RJ, Heaton RK, and Basile AS. Relevance of glutamate levels in the CSF of patients with HIV-1-associated dementia complex. *Neurology*. 1999;53(5):1144-5.
 242. Martin A, Heyes MP, Salazar AM, Kampen DL, Williams J, Law WA, Coats ME, and Markey SP. Progressive slowing of reaction time and increasing cerebrospinal fluid concentrations of quinolinic acid in HIV-infected individuals. *J Neuropsychiatry Clin Neurosci*. 1992;4(3):270-9.

243. Heyes MP, Brew BJ, Saito K, Quearry BJ, Price RW, Lee K, Bhalla RB, Der M, and Markey SP. Inter-relationships between quinolinic acid, neuroactive kynurenines, neopterin and beta 2-microglobulin in cerebrospinal fluid and serum of HIV-1-infected patients. *J Neuroimmunol.* 1992;40(1):71-80.
244. Ciardi M, Sharief MK, Thompson EJ, Salotti A, Vullo V, Sorice F, and Cirelli A. High cerebrospinal fluid and serum levels of tumor necrosis factor-alpha in asymptomatic HIV-1 seropositive individuals. Correlation with interleukin-2 and soluble IL-2 receptor. *J Neurol Sci.* 1994;125(2):175-9.
245. Schousboe A, and Waagepetersen HS. Role of astrocytes in glutamate homeostasis: implications for excitotoxicity. *Neurotox Res.* 2005;8(3-4):221-5.
246. Vesce S, Rossi D, Brambilla L, and Volterra A. Glutamate release from astrocytes in physiological conditions and in neurodegenerative disorders characterized by neuroinflammation. *Int Rev Neurobiol.* 2007;82(57-71).
247. Dreyer EB, and Lipton SA. The coat protein gp120 of HIV-1 inhibits astrocyte uptake of excitatory amino acids via macrophage arachidonic acid. *Eur J Neurosci.* 1995;7(12):2502-7.
248. Kort JJ. Impairment of excitatory amino acid transport in astroglial cells infected with the human immunodeficiency virus type 1. *AIDS Res Hum Retroviruses.* 1998;14(15):1329-39.
249. Vesce S, Bezzi P, Rossi D, Meldolesi J, and Volterra A. HIV-1 gp120 glycoprotein affects the astrocyte control of extracellular glutamate by both inhibiting the uptake and stimulating the release of the amino acid. *FEBS Lett.* 1997;411(1):107-9.
250. Visalli V, Muscoli C, Sacco I, Sculco F, Palma E, Costa N, Colica C, Rotiroti D, and Mollace V. N-acetylcysteine prevents HIV gp 120-related damage of human cultured astrocytes: correlation with glutamine synthase dysfunction. *BMC Neurosci.* 2007;8(106).
251. Fine SM, Angel RA, Perry SW, Epstein LG, Rothstein JD, Dewhurst S, and Gelbard HA. Tumor necrosis factor alpha inhibits glutamate uptake by primary human astrocytes. Implications for pathogenesis of HIV-1 dementia. *J Biol Chem.* 1996;271(26):15303-6.
252. Sitcheran R, Gupta P, Fisher PB, and Baldwin AS. Positive and negative regulation of EAAT2 by NF-kappaB: a role for N-myc in TNFalpha-controlled repression. *EMBO J.* 2005;24(3):510-20.
253. Cali C, and Bezzi P. CXCR4-mediated glutamate exocytosis from astrocytes. *J Neuroimmunol.* 2010;224(1-2):13-21.
254. Zou J, Wang YX, Dou FF, Lu HZ, Ma ZW, Lu PH, and Xu XM. Glutamine synthetase down-regulation reduces astrocyte protection against glutamate excitotoxicity to neurons. *Neurochem Int.* 2010;56(4):577-84.
255. Bezzi P, Carmignoto G, Pasti L, Vesce S, Rossi D, Rizzini BL, Pozzan T, and Volterra A. Prostaglandins stimulate calcium-dependent glutamate release in astrocytes. *Nature.* 1998;391(6664):281-5.
256. Sorg O, Horn TF, Yu N, Gruol DL, and Bloom FE. Inhibition of astrocyte glutamate uptake by reactive oxygen species: role of antioxidant enzymes. *Mol Med.* 1997;3(7):431-40.

257. Haughey NJ, Cutler RG, Tamara A, McArthur JC, Vargas DL, Pardo CA, Turchan J, Nath A, and Mattson MP. Perturbation of sphingolipid metabolism and ceramide production in HIV-dementia. *Ann Neurol*. 2004;55(2):257-67.
258. Bandaru VV, McArthur JC, Sacktor N, Cutler RG, Knapp EL, Mattson MP, and Haughey NJ. Associative and predictive biomarkers of dementia in HIV-1-infected patients. *Neurology*. 2007;68(18):1481-7.
259. Turchan J, Pocernich CB, Gairola C, Chauhan A, Schifitto G, Butterfield DA, Buch S, Narayan O, Sinai A, Geiger J, et al. Oxidative stress in HIV demented patients and protection ex vivo with novel antioxidants. *Neurology*. 2003;60(2):307-14.
260. Viviani B, Corsini E, Binaglia M, Galli CL, and Marinovich M. Reactive oxygen species generated by glia are responsible for neuron death induced by human immunodeficiency virus-glycoprotein 120 in vitro. *Neuroscience*. 2001;107(1):51-8.
261. Ferrucci A, Nonnemacher MR, Cohen EA, and Wigdahl B. Extracellular human immunodeficiency virus type 1 viral protein R causes reductions in astrocytic ATP and glutathione levels compromising the antioxidant reservoir. *Virus Res*. 2012;167(2):358-69.
262. Shi B, Raina J, Lorenzo A, Busciglio J, and Gabuzda D. Neuronal apoptosis induced by HIV-1 Tat protein and TNF-alpha: potentiation of neurotoxicity mediated by oxidative stress and implications for HIV-1 dementia. *J Neurovirol*. 1998;4(3):281-90.
263. Tian C, Sun L, Jia B, Ma K, Curthoys N, Ding J, and Zheng J. Mitochondrial glutaminase release contributes to glutamate-mediated neurotoxicity during human immunodeficiency virus-1 infection. *J Neuroimmunopharm*. 2012;7(3):619-28.
264. Velazquez I, Plaud M, Wojna V, Skolasky R, Laspiur JP, and Melendez LM. Antioxidant enzyme dysfunction in monocytes and CSF of Hispanic women with HIV-associated cognitive impairment. *J Neuroimmunol*. 2009;206(1-2):106-11.
265. Zhang Y, Wang M, Li H, Zhang H, Shi Y, Wei F, Liu D, Liu K, and Chen D. Accumulation of nuclear and mitochondrial DNA damage in the frontal cortex cells of patients with HIV-associated neurocognitive disorders. *Brain research*. 2012;1458(1-11).
266. Mattson MP, Haughey NJ, and Nath A. Cell death in HIV dementia. *Cell Death Differ*. 2005;12 Suppl 1(893-904).
267. Sacktor N, Haughey N, Cutler R, Tamara A, Turchan J, Pardo C, Vargas D, and Nath A. Novel markers of oxidative stress in actively progressive HIV dementia. *J Neuroimmunol*. 2004;157(1-2):176-84.
268. Van Muiswinkel FL, and Kuiperij HB. The Nrf2-ARE Signalling pathway: promising drug target to combat oxidative stress in neurodegenerative disorders. *Curr Drug Targets CNS Neurol Disord*. 2005;4(3):267-81.
269. Droge W, and Schipper HM. Oxidative stress and aberrant signaling in aging and cognitive decline. *Aging Cell*. 2007;6(3):361-70.
270. Mancuso M, Coppede F, Migliore L, Siciliano G, and Murri L. Mitochondrial dysfunction, oxidative stress and neurodegeneration. *J Alzheimers Dis*. 2006;10(1):59-73.
271. Halliwell B. Oxidative stress and neurodegeneration: where are we now? *J Neurochem*. 2006;97(6):1634-58.

272. Behl C. Oxidative stress in Alzheimer's disease: implications for prevention and therapy. *Subcell Biochem.* 2005;38(65-78).
273. Jenner P. Oxidative stress in Parkinson's disease. *Ann Neurol.* 2003;53 Suppl 3(S26-38).
274. Browne SE, and Beal MF. Oxidative damage in Huntington's disease pathogenesis. *Antioxid Redox Signal.* 2006;8(11-12):2061-73.
275. Laspiur JP, Anderson ER, Ciborowski P, Wojna V, Rozek W, Duan F, Mayo R, Rodriguez E, Plaud-Valentin M, Rodriguez-Orengo J, et al. CSF proteomic fingerprints for HIV-associated cognitive impairment. *J Neuroimmunol.* 2007;192(1-2):157-70.
276. Melendez LM, Colon K, Rivera L, Rodriguez-Franco E, and Toro-Nieves D. Proteomic analysis of HIV-infected macrophages. *J Neuroimmune Pharmacol.* 2011;6(1):89-106.
277. Schnell G, Joseph S, Spudich S, Price RW, and Swanstrom R. HIV-1 replication in the central nervous system occurs in two distinct cell types. *PLoS Pathog.* 2011;7(10):e1002286.
278. Joseph SB, Arrildt KT, Swanstrom AE, Schnell G, Lee B, Hoxie JA, and Swanstrom R. Quantification of entry phenotypes of macrophage-tropic HIV-1 across a wide range of CD4 densities. *J Virol.* 2014;88(4):1858-69.
279. Murray JM, Zaunders JJ, Koelsch KK, Natarajan V, Badralmaa Y, McBride K, Carrera A, Cooper DA, Emery S, and Kelleher AD. Short communication: HIV blips while on antiretroviral therapy can indicate consistently detectable viral levels due to assay underreporting. *AIDS Res Hum Retroviruses.* 2013;29(12):1621-5.
280. Benmarzouk-Hidalgo OJ, Torres-Cornejo A, Gutierrez-Valencia A, Ruiz-Valderas R, Viciano P, and Lopez-Cortes LF. Immune activation throughout a boosted darunavir monotherapy simplification strategy. *Clin Microbiol Infect.* 2013;20(12):1297-303.
281. Eden A, Fuchs D, Hagberg L, Nilsson S, Spudich S, Svennerholm B, Price RW, and Gisslen M. HIV-1 viral escape in cerebrospinal fluid of subjects on suppressive antiretroviral treatment. *J Infect Dis.* 2010;202(12):1819-25.
282. Khoury MN, Tan CS, Peaslee M, and Koranik IJ. CSF viral escape in a patient with HIV-associated neurocognitive disorder. *J Neurovirol.* 2013;19(4):402-5.
283. Zoufaly A, Kiepe J, Hertling S, Hufner A, Degen O, Feldt T, Schmiedel S, Kurowski M, and van Lunzen J. Immune activation despite suppressive highly active antiretroviral therapy is associated with higher risk of viral blips in HIV-1-infected individuals. *HIV Med.* 2014;15(8):449-57.
284. Taiwo B, and Bosch RJ. More reasons to reexamine the definition of viral blip during antiretroviral therapy. *J Infect Dis.* 2012;205(8):1189-91.
285. Eden A, Andersson L, Fuchs D, Hagberg L, Nilsson S, Svennerholm B, Yilmaz A, Zetterberg H, and Gisslen M. Cerebrospinal Fluid Viral Blips and Persistent Escape in HIV-Infected Patients On ART. Conference on Retroviruses and Opportunistic Infections. Abstract # 445. *Top Antivir Med.* 2014;22(e-1):210.
286. Pozniak A, Gupta RK, Pillay D, Arribas J, and Hill A. Causes and consequences of incomplete HIV RNA suppression in clinical trials. *HIV Clin Trials.* 2009;10(5):289-98.

287. Nightingale S, and Group PS. HIV-1 RNA Detection in CSF in ART-Treated Subjects With Incomplete Viral Suppression in Plasma. Conference on Retroviruses and Opportunistic Infections. Abstract #442. *Top Antivir Med.* 2014;22(e-1):209.
288. Canizares S, Cherner M, and Ellis RJ. HIV and Aging: Effects on the Central Nervous System. *Semin Neurol.* 2014;34(1):27-34.
289. Laskus T, Radkowski M, Adair DM, Wilkinson J, Scheck AC, and Rakela J. Emerging evidence of hepatitis C virus neuroinvasion. *AIDS.* 2005;19 Suppl 3(S140-4).
290. Forton DM, Allsop JM, Cox IJ, Hamilton G, Wesnes K, Thomas HC, and Taylor-Robinson SD. A review of cognitive impairment and cerebral metabolite abnormalities in patients with hepatitis C infection. *AIDS.* 2005;19 Suppl 3(S53-63).
291. Murray J, Fishman SL, Ryan E, Eng FJ, Walewski JL, Branch AD, and Morgello S. Clinicopathologic correlates of hepatitis C virus in brain: a pilot study. *J Neurovirol.* 2008;14(1):17-27.
292. Parikh N, Nonnemacher MR, Pirrone V, Block T, Mehta A, and Wigdahl B. Substance abuse, HIV-1 and hepatitis. *Curr HIV Res.* 2012;10(7):557-71.
293. Byrnes V, Miller A, Lowry D, Hill E, Weinstein C, Alsop D, Lenkinski R, and Afdhal NH. Effects of anti-viral therapy and HCV clearance on cerebral metabolism and cognition. *J Hepatol.* 2012;56(3):549-56.
294. Weissenborn K, Tryc AB, Heeren M, Worthmann H, Pflugrad H, Berding G, Bokemeyer M, Tillmann HL, and Goldbecker A. Hepatitis C virus infection and the brain. *Metab Brain Dis.* 2009;24(1):197-210.
295. Weissenborn K, Krause J, Bokemeyer M, Hecker H, Schuler A, Ennen JC, Ahl B, Manns MP, and Boker KW. Hepatitis C virus infection affects the brain-evidence from psychometric studies and magnetic resonance spectroscopy. *J Hepatol.* 2004;41(5):845-51.
296. Chak E, Talal AH, Sherman KE, Schiff ER, and Saab S. Hepatitis C virus infection in USA: an estimate of true prevalence. *Liver Int.* 2011;31(8):1090-101.
297. Sherman KE, Thomas D, and Chung RT. Human immunodeficiency virus and liver disease forum 2012. *Hepatology.* 2014;59(1):307-17.
298. Gupta P. Hepatitis C Virus and HIV Type 1 Co-Infection. *Infect Dis Rep.* 2013;5(Suppl 1):e7.
299. Wilkinson J, Radkowski M, and Laskus T. Hepatitis C virus neuroinvasion: identification of infected cells. *J Virol.* 2009;83(3):1312-9.
300. Wilkinson J, Radkowski M, Eschbacher JM, and Laskus T. Activation of brain macrophages/microglia cells in hepatitis C infection. *Gut.* 2010;59(10):1394-400.
301. Hinkin CH, Castellon SA, Levine AJ, Barclay TR, and Singer EJ. Neurocognition in individuals co-infected with HIV and hepatitis C. *J Addict Dis.* 2008;27(2):11-7.
302. Letendre SL, Cherner M, Ellis RJ, Marquie-Beck J, Gragg B, Marcotte T, Heaton RK, McCutchan JA, and Grant I. The effects of hepatitis C, HIV, and methamphetamine dependence on neuropsychological performance: biological correlates of disease. *AIDS.* 2005;19 Suppl 3(S72-8).

303. Bladowska J, Zimny A, Knysz B, Malyszczak K, Koltowska A, Szewczyk P, Gasiorowski J, Furdal M, and Sasiadek MJ. Evaluation of early cerebral metabolic, perfusion and microstructural changes in HCV-positive patients: a pilot study. *J Hepatol.* 2013;59(4):651-7.
304. Jernigan TL, Archibald SL, Fennema-Notestine C, Taylor MJ, Theilmann RJ, Julaton MD, Notestine RJ, Wolfson T, Letendre SL, Ellis RJ, et al. Clinical factors related to brain structure in HIV: the CHARTER study. *J Neurovirol.* 2011;17(3):248-57.
305. Vassallo M, Dunais B, Durant J, Carsenti-Dellamonica H, Harvey-Langton A, Cottalorda J, Ticchioni M, Laffon M, Lebrun-Frenay C, Dellamonica P, et al. Relevance of lipopolysaccharide levels in HIV-associated neurocognitive impairment: the Neuradapt study. *J Neurovirol.* 2013;19(4):376-82.
306. Garvey LJ, Pavese N, Ramlackhansingh A, Thomson E, Allsop JM, Politis M, Kulasegaram R, Main J, Brooks DJ, Taylor-Robinson SD, et al. Acute HCV/HIV coinfection is associated with cognitive dysfunction and cerebral metabolite disturbance, but not increased microglial cell activation. *PLoS One.* 2012;7(7):e38980.
307. Clifford DB, Smurzynski M, Park LS, Yeh TM, Zhao Y, Blair L, Arens M, and Evans SR. Effects of active HCV replication on neurologic status in HIV RNA virally suppressed patients. *Neurology.* 2009;73(4):309-14.
308. Garvey LJ, Pflugrad H, Thiyagarajan A, Grover VP, Taylor-Robinson SD, Winston A, Clifford DB, and Evans SR. Effects of active HCV replication on neurologic status in HIV RNA virally suppressed patients. *Neurology.* 2010;74(9):779-80.
309. Clifford DB, Evans SR, Yang Y, and Gulick RM. The neuropsychological and neurological impact of hepatitis C virus co-infection in HIV-infected subjects. *AIDS.* 2005;19 Suppl 3(S64-71).
310. Muir AJ. The Rapid Evolution of Treatment Strategies for Hepatitis C. *Am J Gastroenterol.* 2014;109(5):628-35.
311. Martin-Thormeyer EM, and Paul RH. Drug abuse and hepatitis C infection as comorbid features of HIV associated neurocognitive disorder: neurocognitive and neuroimaging features. *Neuropsychol Rev.* 2009;19(2):215-31.
312. Hauser KF, El-Hage N, Stiene-Martin A, Maragos WF, Nath A, Persidsky Y, Volsky DJ, and Knapp PE. HIV-1 neuropathogenesis: glial mechanisms revealed through substance abuse. *J Neurochem.* 2007;100(3):567-86.
313. Nath A. Human immunodeficiency virus-associated neurocognitive disorder: pathophysiology in relation to drug addiction. *Ann N Y Acad Sci.* 2010;1187(122-8).
314. Lucas GM. Substance abuse, adherence with antiretroviral therapy, and clinical outcomes among HIV-infected individuals. *Life Sci.* 2011;88(21-22):948-52.
315. Beyrer C, Wirtz AL, Baral S, Peryskina A, and Sifakis F. Epidemiologic links between drug use and HIV epidemics: an international perspective. *J Acquir Immune Defic Syndr.* 2010;55 Suppl 1(S10-6).
316. Department of Health and Human Services. Substance Abuse and Mental Health Services Administration (SAMHSA). Center for Behavioral Health Statistics and Quality. The National Survey on Drug use and Health (NSDUH) Report: HIV/AIDS and Substance Use, 2010. . Accessed June 15th, 2013. Available at <http://www.samhsa.gov>.

317. Chang L, Ernst T, Speck O, and Grob CS. Additive effects of HIV and chronic methamphetamine use on brain metabolite abnormalities. *Am J Psychiatry*. 2005;162(2):361-9.
318. Rippeth JD, Heaton RK, Carey CL, Marcotte TD, Moore DJ, Gonzalez R, Wolfson T, and Grant I. Methamphetamine dependence increases risk of neuropsychological impairment in HIV infected persons. *J Int Neuropsychol Soc*. 2004;10(1):1-14.
319. Nath A, Maragos WF, Avison MJ, Schmitt FA, and Berger JR. Acceleration of HIV dementia with methamphetamine and cocaine. *J Neurovirol*. 2001;7(1):66-71.
320. Dutta R, and Roy S. Mechanism(s) involved in opioid drug abuse modulation of HAND. *Curr HIV Res*. 2012;10(5):469-77.
321. Byrd DA, Fellows RP, Morgello S, Franklin D, Heaton RK, Deutsch R, Atkinson JH, Clifford DB, Collier AC, Marra CM, et al. Neurocognitive impact of substance use in HIV infection. *J Acquir Immune Defic Syndr*. 2011;58(2):154-62.
322. Banerjee A, Strazza M, Wigdahl B, Pirrone V, Meucci O, and Nonnemacher MR. Role of mu-opioids as cofactors in human immunodeficiency virus type 1 disease progression and neuropathogenesis. *J Clin Pathol*. 2011;17(4):291-302.
323. Iudicello JE, Woods SP, Vigil O, Scott JC, Cherner M, Heaton RK, Atkinson JH, and Grant I. Longer term improvement in neurocognitive functioning and affective distress among methamphetamine users who achieve stable abstinence. *J Clin Exp Neuropsychol*. 2010;32(7):704-18.
324. Liang H, Wang X, Chen H, Song L, Ye L, Wang SH, Wang YJ, Zhou L, and Ho WZ. Methamphetamine enhances HIV infection of macrophages. *Am J Pathol*. 2008;172(6):1617-24.
325. Wang X, Wang Y, Ye L, Li J, Zhou Y, Sakarcan S, and Ho W. Modulation of intracellular restriction factors contributes to methamphetamine-mediated enhancement of acquired immune deficiency syndrome virus infection of macrophages. *Curr HIV Res*. 2012;10(5):407-14.
326. Dhillon NK, Williams R, Peng F, Tsai YJ, Dhillon S, Nicolay B, Gadgil M, Kumar A, and Buch SJ. Cocaine-mediated enhancement of virus replication in macrophages: implications for human immunodeficiency virus-associated dementia. *J Neurovirol*. 2007;13(6):483-95.
327. Guo CJ, Li Y, Tian S, Wang X, Douglas SD, and Ho WZ. Morphine enhances HIV infection of human blood mononuclear phagocytes through modulation of beta-chemokines and CCR5 receptor. *J Investig Med*. 2002;50(6):435-42.
328. Reynolds JL, Law WC, Mahajan SD, Aalinkel R, Nair B, Sykes DE, Mammen MJ, Yong KT, Hui R, Prasad PN, et al. Morphine and galectin-1 modulate HIV-1 infection of human monocyte-derived macrophages. *J Immunol*. 2012;188(8):3757-65.
329. Ho WZ, Guo CJ, Yuan CS, Douglas SD, and Moss J. Methylnaltrexone antagonizes opioid-mediated enhancement of HIV infection of human blood mononuclear phagocytes. *J Pharmacol Exp Ther*. 2003;307(3):1158-62.
330. Dave RS, and Khalili K. Morphine treatment of human monocyte-derived macrophages induces differential miRNA and protein expression: impact on inflammation and oxidative stress in the central nervous system. *J Cell Biochem*. 2010;110(4):834-45.

331. Nair MP, Saiyed ZM, Nair N, Gandhi NH, Rodriguez JW, Boukli N, Provencio-Vasquez E, Malow RM, and Miguez-Burbano MJ. Methamphetamine enhances HIV-1 infectivity in monocyte derived dendritic cells. *J Neuroimmune Pharmacol.* 2009;4(1):129-39.
332. Roth MD, Whittaker KM, Choi R, Tashkin DP, and Baldwin GC. Cocaine and sigma-1 receptors modulate HIV infection, chemokine receptors, and the HPA axis in the huPBL-SCID model. *J Leukoc Biol.* 2005;78(6):1198-203.
333. Steele AD, Henderson EE, and Rogers TJ. Mu-opioid modulation of HIV-1 coreceptor expression and HIV-1 replication. *Virology.* 2003;309(1):99-107.
334. Mantri CK, Pandhare Dash J, Mantri JV, and Dash CC. Cocaine enhances HIV-1 replication in CD4+ T cells by down-regulating MiR-125b. *PLoS One.* 2012;7(12):e51387.
335. Kim SG, Jung JB, Dixit D, Rovner R, Jr., Zack JA, Baldwin GC, and Vatakis DN. Cocaine exposure enhances permissiveness of quiescent T cells to HIV infection. *J Leukoc Biol.* 2013;94(4):835-43.
336. Homan JW, Steele AD, Martinand-Mari C, Rogers TJ, Henderson EE, Charubala R, Pfeleiderer W, Reichenbach NL, and Suhadolnik RJ. Inhibition of morphine-potentiated HIV-1 replication in peripheral blood mononuclear cells with the nuclease-resistant 2-5A agonist analog, 2-5A(N6B). *J Acquir Immune Defic Syndr.* 2002;30(1):9-20.
337. Peterson PK, Gekker G, Hu S, Cabral G, and Lokensgard JR. Cannabinoids and morphine differentially affect HIV-1 expression in CD4(+) lymphocyte and microglial cell cultures. *J Neuroimmunol.* 2004;147(1-2):123-6.
338. Mantri CK, Mantri JV, Pandhare J, and Dash C. Methamphetamine inhibits HIV-1 replication in CD4+ T cells by modulating anti-HIV-1 miRNA expression. *Am J Pathol.* 2014;184(1):92-100.
339. Toussi SS, Joseph A, Zheng JH, Dutta M, Santambrogio L, and Goldstein H. Short communication: Methamphetamine treatment increases in vitro and in vivo HIV replication. *AIDS Res Hum Retroviruses.* 2009;25(11):1117-21.
340. Gaskill PJ, Calderon TM, Coley JS, and Berman JW. Drug induced increases in CNS dopamine alter monocyte, macrophage and T cell functions: implications for HAND. *J Neuroimmune Pharmacol.* 2013;8(3):621-42.
341. Gaskill PJ, Calderon TM, Luers AJ, Eugenin EA, Javitch JA, and Berman JW. Human immunodeficiency virus (HIV) infection of human macrophages is increased by dopamine: a bridge between HIV-associated neurologic disorders and drug abuse. *Am J Pathol.* 2009;175(3):1148-59.
342. Czub S, Koutsilieri E, Sopper S, Czub M, Stahl-Hennig C, Muller JG, Pedersen V, Gsell W, Heeney JL, Gerlach M, et al. Enhancement of central nervous system pathology in early simian immunodeficiency virus infection by dopaminergic drugs. *Acta Neuropathol.* 2001;101(2):85-91.
343. Czub S, Czub M, Koutsilieri E, Sopper S, Villinger F, Muller JG, Stahl-Hennig C, Riederer P, Ter Meulen V, and Gosztonyi G. Modulation of simian immunodeficiency virus neuropathology by dopaminergic drugs. *Acta Neuropathol.* 2004;107(3):216-26.
344. Marcondes MC, Flynn C, Watry DD, Zandonatti M, and Fox HS. Methamphetamine increases brain viral load and activates natural killer cells in simian immunodeficiency virus-infected monkeys. *Am J Pathol.* 2010;177(1):355-61.

345. Bokhari SM, Hegde R, Callen S, Yao H, Adany I, Li Q, Li Z, Pinson D, Yeh HW, Cheney PD, et al. Morphine potentiates neuropathogenesis of SIV infection in rhesus macaques. *J Neuroimmune Pharmacol.* 2011;6(4):626-39.
346. Kumar R, Torres C, Yamamura Y, Rodriguez I, Martinez M, Staprans S, Donahoe RM, Kraiselburd E, Stephens EB, and Kumar A. Modulation by morphine of viral set point in rhesus macaques infected with simian immunodeficiency virus and simian-human immunodeficiency virus. *J Virol.* 2004;78(20):11425-8.
347. Weed M, Adams RJ, Hienz RD, Meulendyke KA, Linde ME, Clements JE, Mankowski JL, and Zink MC. SIV/macaque model of HIV infection in cocaine users: minimal effects of cocaine on behavior, virus replication, and CNS inflammation. *J Neuroimmune Pharmacol.* 2012;7(2):401-11.
348. Bell JE, Arango JC, and Anthony IC. Neurobiology of multiple insults: HIV-1-associated brain disorders in those who use illicit drugs. *J Neuroimmune Pharmacol.* 2006;1(2):182-91.
349. Anthony IC, Arango JC, Stephens B, Simmonds P, and Bell JE. The effects of illicit drugs on the HIV infected brain. *Front Biosci.* 2008;13(1294-307).
350. Martinez AJ, Sell M, Mitrovics T, Stoltenburg-Didinger G, Iglesias-Rozas JR, Giraldo-Velasquez MA, Gosztanyi G, Schneider V, and Cervos-Navarro J. The neuropathology and epidemiology of AIDS. A Berlin experience. A review of 200 cases. *Pathol Res Pract.* 1995;191(5):427-43.
351. El-Hage N, Wu G, Wang J, Ambati J, Knapp PE, Reed JL, Bruce-Keller AJ, and Hauser KF. HIV-1 Tat and opiate-induced changes in astrocytes promote chemotaxis of microglia through the expression of MCP-1 and alternative chemokines. *Glia.* 2006;53(2):132-46.
352. Hauser KF, El-Hage N, Buch S, Berger JR, Tyor WR, Nath A, Bruce-Keller AJ, and Knapp PE. Molecular targets of opiate drug abuse in neuroAIDS. *Neurotox Res.* 2005;8(1-2):63-80.
353. Buch S, Yao H, Guo M, Mori T, Mathias-Costa B, Singh V, Seth P, Wang J, and Su TP. Cocaine and HIV-1 interplay in CNS: cellular and molecular mechanisms. *Curr HIV Res.* 2012;10(5):425-8.
354. Liu X, Silverstein PS, Singh V, Shah A, Qureshi N, and Kumar A. Methamphetamine increases LPS-mediated expression of IL-8, TNF-alpha and IL-1beta in human macrophages through common signaling pathways. *PLoS One.* 2012;7(3):e33822.
355. Zipp F, and Aktas O. The brain as a target of inflammation: common pathways link inflammatory and neurodegenerative diseases. *Trends Neurosci.* 2006;29(9):518-27.
356. Podhaizer EM, Zou S, Fitting S, Samano KL, El-Hage N, Knapp PE, and Hauser KF. Morphine and gp120 toxic interactions in striatal neurons are dependent on HIV-1 strain. *J Neuroimmune Pharmacol.* 2012;7(4):877-91.
357. Cisneros IE, and Ghorpade A. HIV-1, methamphetamine and astrocyte glutamate regulation: combined excitotoxic implications for neuro-AIDS. *Curr HIV Res.* 2012;10(5):392-406.
358. Potter MC, Figuera-Losada M, Rojas C, and Slusher BS. Targeting the glutamatergic system for the treatment of HIV-associated neurocognitive disorders. *J Neuroimmune Pharmacol.* 2013;8(3):594-607.

359. Yang Y, Yao H, Lu Y, Wang C, and Buch S. Cocaine potentiates astrocyte toxicity mediated by human immunodeficiency virus (HIV-1) protein gp120. *PLoS One*. 2010;5(10):e13427.
360. Strazza M, Pirrone V, Wigdahl B, and Nonnemacher MR. Breaking down the barrier: the effects of HIV-1 on the blood-brain barrier. *Brain Res*. 2011;1399(96-115).
361. Kousik SM, Graves SM, Napier TC, Zhao C, and Carvey PM. Methamphetamine-induced vascular changes lead to striatal hypoxia and dopamine reduction. *Neuroreport*. 2011;22(17):923-8.
362. Bowyer JF, and Ali S. High doses of methamphetamine that cause disruption of the blood-brain barrier in limbic regions produce extensive neuronal degeneration in mouse hippocampus. *Synapse*. 2006;60(7):521-32.
363. Martins T, Baptista S, Goncalves J, Leal E, Milhazes N, Borges F, Ribeiro CF, Quintela O, Lendoiro E, Lopez-Rivadulla M, et al. Methamphetamine transiently increases the blood-brain barrier permeability in the hippocampus: role of tight junction proteins and matrix metalloproteinase-9. *Brain Res*. 2011;1411(28-40).
364. Sharma HS, Muresanu D, Sharma A, and Patnaik R. Cocaine-induced breakdown of the blood-brain barrier and neurotoxicity. *Int Rev Neurobiol*. 2009;88(297-334).
365. Mahajan SD, Aalinkeel R, Sykes DE, Reynolds JL, Bindukumar B, Adal A, Qi M, Toh J, Xu G, Prasad PN, et al. Methamphetamine alters blood brain barrier permeability via the modulation of tight junction expression: Implication for HIV-1 neuropathogenesis in the context of drug abuse. *Brain Res*. 2008;1203(133-48).
366. Fiala M, Gan XH, Zhang L, House SD, Newton T, Graves MC, Shapshak P, Stins M, Kim KS, Witte M, et al. Cocaine enhances monocyte migration across the blood-brain barrier. Cocaine's connection to AIDS dementia and vasculitis? *Adv Exp Med Biol*. 1998;437(199-205).
367. Fiala M, Eshleman AJ, Cashman J, Lin J, Lossinsky AS, Suarez V, Yang W, Zhang J, Popik W, Singer E, et al. Cocaine increases human immunodeficiency virus type 1 neuroinvasion through remodeling brain microvascular endothelial cells. *J Neurovirol*. 2005;11(3):281-91.
368. Dhillon NK, Peng F, Bokhari S, Callen S, Shin SH, Zhu X, Kim KJ, and Buch SJ. Cocaine-mediated alteration in tight junction protein expression and modulation of CCL2/CCR2 axis across the blood-brain barrier: implications for HIV-dementia. *J Neuroimmune Pharmacol*. 2008;3(1):52-6.
369. Berger JR, and Avison M. The blood brain barrier in HIV infection. *Front Biosci*. 2004;9(2680-5).
370. Zhang L, Looney D, Taub D, Chang SL, Way D, Witte MH, Graves MC, and Fiala M. Cocaine opens the blood-brain barrier to HIV-1 invasion. *J Neurovirol*. 1998;4(6):619-26.
371. Yousif S, Saubamea B, Cisternino S, Marie-Claire C, Dauchy S, Scherrmann JM, and Decleves X. Effect of chronic exposure to morphine on the rat blood-brain barrier: focus on the P-glycoprotein. *J Neurochem*. 2008;107(3):647-57.
372. Sharma HS, and Ali SF. Alterations in blood-brain barrier function by morphine and methamphetamine. *Ann N Y Acad Sci*. 2006;1074(198-224).

373. Mellins CA, Havens JF, McDonnell C, Lichtenstein C, Uldall K, Chesney M, Santamaria EK, and Bell J. Adherence to antiretroviral medications and medical care in HIV-infected adults diagnosed with mental and substance abuse disorders. *AIDS Care*. 2009;21(2):168-77.
374. Lucas GM, Gebo KA, Chaisson RE, and Moore RD. Longitudinal assessment of the effects of drug and alcohol abuse on HIV-1 treatment outcomes in an urban clinic. *AIDS*. 2002;16(5):767-74.
375. Metsch LR, Bell C, Pereyra M, Cardenas G, Sullivan T, Rodriguez A, Gooden L, Khoury N, Kuper T, Brewer T, et al. Hospitalized HIV-infected patients in the era of highly active antiretroviral therapy. *Am J Public Health*. 2009;99(6):1045-9.
376. Bell C, Metsch LR, Vogenthaler N, Cardenas G, Rodriguez A, Locascio V, Kuper T, Scharf E, Marquez A, Yohannan M, et al. Never in care: characteristics of HIV-infected crack cocaine users in 2 US cities who have never been to outpatient HIV care. *J Acquir Immune Defic Syndr*. 2010;54(4):376-80.
377. Roux P, Carrieri MP, Villes V, Dellamonica P, Poizot-Martin I, Ravaux I, and Spire B. The impact of methadone or buprenorphine treatment and ongoing injection on highly active antiretroviral therapy (HAART) adherence: evidence from the MANIF2000 cohort study. *Addiction*. 2008;103(11):1828-36.
378. Kapadia F, Vlahov D, Wu Y, Cohen MH, Greenblatt RM, Howard AA, Cook JA, Goparaju L, Golub E, Richardson J, et al. Impact of drug abuse treatment modalities on adherence to ART/HAART among a cohort of HIV seropositive women. *Am J Drug Alcohol Abuse*. 2008;34(2):161-70.
379. Carrico AW. Substance use and HIV disease progression in the HAART era: implications for the primary prevention of HIV. *Life Sci*. 2011;88(21-22):940-7.
380. Deeks SG. Immune dysfunction, inflammation, and accelerated aging in patients on antiretroviral therapy. *Top HIV Med*. 2009;17(4):118-23.
381. Xu J, and Ikezu T. The comorbidity of HIV-associated neurocognitive disorders and Alzheimer's disease: a foreseeable medical challenge in post-HAART era. *J Neuroimmune Pharmacol*. 2009;4(2):200-12.
382. Anthony IC, and Bell J. In: al. RHPe ed. *HIV and the Brain*. Edinburgh: Humana Press; 2009:29-47.
383. Tisch S, and Brew B. Parkinsonism in hiv-infected patients on highly active antiretroviral therapy. *Neurology*. 2009;73(5):401-3.
384. Green DA, Masliah E, Vinters HV, Beizai P, Moore DJ, and Achim CL. Brain deposition of beta-amyloid is a common pathologic feature in HIV positive patients. *AIDS*. 2005;19(4):407-11.
385. Achim CL, Adame A, Dumaop W, Everall IP, and Masliah E. Increased accumulation of intraneuronal amyloid beta in HIV-infected patients. *J Neuroimmune Pharmacol*. 2009;4(2):190-9.
386. Brew BJ, Pemberton L, Blennow K, Wallin A, and Hagberg L. CSF amyloid beta42 and tau levels correlate with AIDS dementia complex. *Neurology*. 2005;65(9):1490-2.

387. Khanlou N, Moore DJ, Chana G, Cherner M, Lazzaretto D, Dawes S, Grant I, Masliah E, Everall IP, and Group H. Increased frequency of alpha-synuclein in the substantia nigra in human immunodeficiency virus infection. *J Neurovirol.* 2009;15(2):131-8.
388. Vehmas A, Lieu J, Pardo CA, McArthur JC, and Gartner S. Amyloid precursor protein expression in circulating monocytes and brain macrophages from patients with HIV-associated cognitive impairment. *J Neuroimmunol.* 2004;157(1-2):99-110.
389. Esiri MM, Biddolph SC, and Morris CS. Prevalence of Alzheimer plaques in AIDS. *J Neurol Neurosurg Psychiatry.* 1998;65(1):29-33.
390. Soontornniyomkij V, Moore DJ, Gouaux B, Soontornniyomkij B, Tatro ET, Umlauf A, Masliah E, Levine AJ, Singer EJ, Vinters HV, et al. Cerebral beta-amyloid deposition predicts HIV-associated neurocognitive disorders in APOE epsilon4 carriers. *AIDS.* 2012;26(18):2327-35.
391. Smith DB, Simmonds P, and Bell JE. Brain viral burden, neuroinflammation and neurodegeneration in HAART-treated HIV positive injecting drug users. *J Neurovirol.* 2014;20(1):28-38.
392. Fields J, Dumaop W, Rockenstein E, Mante M, Spencer B, Grant I, Ellis R, Letendre S, Patrick C, Adame A, et al. Age-dependent molecular alterations in the autophagy pathway in HIVE patients and in a gp120 tg mouse model: reversal with beclin-1 gene transfer. *J Neurovirol.* 2013;19(1):89-101.
393. Salminen A, Kaamiranta K, Kauppinen A, Ojala J, Haapasalo A, Soininen H, and Hiltunen M. Impaired autophagy and APP processing in Alzheimer's disease: The potential role of Beclin 1 interactome. *Prog Neurobiol.* 2013;106-107(33-54).
394. Seider TR, Luo X, Gongvatana A, Devlin KN, de la Monte SM, Chasman JD, Yan P, Tashima KT, Navia B, and Cohen RA. Verbal memory declines more rapidly with age in HIV infected versus uninfected adults. *J Clin Exp Neuropsychol.* 2014;36(4):356-67.
395. Holt JL, Kraft-Terry SD, and Chang L. Neuroimaging studies of the aging HIV-1-infected brain. *J Neurovirol.* 2012;18(4):291-302.
396. Cassol E, Misra V, Dutta A, Morgello S, and Gabuzda D. Cerebrospinal fluid metabolomics reveals altered waste clearance and accelerated aging in HIV patients with neurocognitive impairment. *AIDS.* 2014;28(11):1579-91.
397. Chang L, Holt JL, Yakupov R, Jiang CS, and Ernst T. Lower cognitive reserve in the aging human immunodeficiency virus-infected brain. *Neurobiol Aging.* 2013;34(4):1240-53.
398. Thomas JB, Brier MR, Snyder AZ, Vaida FF, and Ances BM. Pathways to neurodegeneration: effects of HIV and aging on resting-state functional connectivity. *Neurology.* 2013;80(13):1186-93.
399. Letendre SL, McCutchan JA, Childers ME, Woods SP, Lazzaretto D, Heaton RK, Grant I, and Ellis RJ. Enhancing antiretroviral therapy for human immunodeficiency virus cognitive disorders. *Ann Neurol.* 2004;56(3):416-23.
400. Letendre S, Marquie-Beck J, Capparelli E, Best B, Clifford D, Collier AC, Gelman BB, McArthur JC, McCutchan JA, Morgello S, et al. Validation of the CNS Penetration-Effectiveness rank for quantifying antiretroviral penetration into the central nervous system. *Arch Neurol.* 2008;65(1):65-70.

401. Robertson KR, Su Z, Margolis DM, Krambrink A, Havlir DV, Evans S, Skiest DJ, and Team AS. Neurocognitive effects of treatment interruption in stable HIV-positive patients in an observational cohort. *Neurology*. 2010;74(16):1260-6.
402. Marra CM, Zhao Y, Clifford DB, Letendre S, Evans S, Henry K, Ellis RJ, Rodriguez B, Coombs RW, Schifitto G, et al. Impact of combination antiretroviral therapy on cerebrospinal fluid HIV RNA and neurocognitive performance. *AIDS*. 2009;23(11):1359-66.
403. Perez-Valero I, Gonzalez-Baeza A, Estebanez M, Montes-Ramirez ML, Bayon C, Pulido F, Bernardino JI, Zamora FX, Monge S, Gaya F, et al. Neurocognitive impairment in patients treated with protease inhibitor monotherapy or triple drug antiretroviral therapy. *PLoS One*. 2013;8(7):e69493.
404. Ishii T, Itoh K, Takahashi S, Sato H, Yanagawa T, Katoh Y, Bannai S, and Yamamoto M. Transcription factor Nrf2 coordinately regulates a group of oxidative stress-inducible genes in macrophages. *J Biol Chem*. 2000;275(21):16023-9.
405. Baird L, and Dinkova-Kostova AT. The cytoprotective role of the Keap1-Nrf2 pathway. *Arch Toxicol*. 2011;85(4):241-72.
406. Shibahara S, Muller R, Taguchi H, and Yoshida T. Cloning and expression of cDNA for rat heme oxygenase. *Proc Natl Acad Sci U S A*. 1985;82(23):7865-9.
407. Gottlieb Y, Truman M, Cohen LA, Leichtmann-Bardoogo Y, and Meyron-Holtz EG. Endoplasmic reticulum anchored heme-oxygenase 1 faces the cytosol. *Haematologica*. 2012;97(10):1489-93.
408. Kim HP, Wang X, Galbiati F, Ryter SW, and Choi AM. Caveolae compartmentalization of heme oxygenase-1 in endothelial cells. *FASEB J*. 2004;18(10):1080-9.
409. Converso DP, Taille C, Carreras MC, Jaitovich A, Poderoso JJ, and Boczkowski J. HO-1 is located in liver mitochondria and modulates mitochondrial heme content and metabolism. *FASEB J*. 2006;20(8):1236-8.
410. Lin Q, Weis S, Yang G, Weng YH, Helston R, Rish K, Smith A, Bordner J, Polte T, Gaunitz F, et al. Heme oxygenase-1 protein localizes to the nucleus and activates transcription factors important in oxidative stress. *J Biol Chem*. 2007;282(28):20621-33.
411. Hori R, Kashiba M, Toma T, Yachie A, Goda N, Makino N, Soejima A, Nagasawa T, Nakabayashi K, and Suematsu M. Gene transfection of H25A mutant heme oxygenase-1 protects cells against hydroperoxide-induced cytotoxicity. *J Biol Chem*. 2002;277(12):10712-8.
412. Yet SF, Tian R, Layne MD, Wang ZY, Maemura K, Solovyeva M, Ith B, Melo LG, Zhang L, Ingwall JS, et al. Cardiac-specific expression of heme oxygenase-1 protects against ischemia and reperfusion injury in transgenic mice. *Circ Res*. 2001;89(2):168-73.
413. Otterbein LE, Kolls JK, Mantell LL, Cook JL, Alam J, and Choi AM. Exogenous administration of heme oxygenase-1 by gene transfer provides protection against hyperoxia-induced lung injury. *J Clin Invest*. 1999;103(7):1047-54.
414. Panahian N, Yoshiura M, and Maines MD. Overexpression of heme oxygenase-1 is neuroprotective in a model of permanent middle cerebral artery occlusion in transgenic mice. *J Neurochem*. 1999;72(3):1187-203.

415. Hashiba T, Suzuki M, Nagashima Y, Suzuki S, Inoue S, Tsuburai T, Matsuse T, and Ishigatubo Y. Adenovirus-mediated transfer of heme oxygenase-1 cDNA attenuates severe lung injury induced by the influenza virus in mice. *Gene Ther.* 2001;8(19):1499-507.
416. Motterlini R, and Foresti R. Heme oxygenase-1 as a target for drug discovery. *Antioxid Redox Signal.* 2014;20(11):1810-26.
417. Jazwa A, and Cuadrado A. Targeting heme oxygenase-1 for neuroprotection and neuroinflammation in neurodegenerative diseases. *Curr Drug Targets.* 2010;11(12):1517-31.
418. Paine A, Eiz-Vesper B, Blasczyk R, and Immenschuh S. Signaling to heme oxygenase-1 and its anti-inflammatory therapeutic potential. *Biochem Pharmacol.* 2010;80(12):1895-903.
419. Yamamoto T, Suzuki T, Kobayashi A, Wakabayashi J, Maher J, Motohashi H, and Yamamoto M. Physiological significance of reactive cysteine residues of Keap1 in determining Nrf2 activity. *Mol Cell Biol.* 2008;28(8):2758-70.
420. Hong F, Sekhar KR, Freeman ML, and Liebler DC. Specific patterns of electrophile adduction trigger Keap1 ubiquitination and Nrf2 activation. *J Biol Chem.* 2005;280(36):31768-75.
421. He X, and Ma Q. NRF2 cysteine residues are critical for oxidant/electrophile-sensing, Kelch-like ECH-associated protein-1-dependent ubiquitination-proteasomal degradation, and transcription activation. *Mol Pharmacol.* 2009;76(6):1265-78.
422. Ramos-Gomez M, Kwak MK, Dolan PM, Itoh K, Yamamoto M, Talalay P, and Kensler TW. Sensitivity to carcinogenesis is increased and chemoprotective efficacy of enzyme inducers is lost in nrf2 transcription factor-deficient mice. *Proc Natl Acad Sci U S A.* 2001;98(6):3410-5.
423. Li W, Thakor N, Xu EY, Huang Y, Chen C, Yu R, Holcik M, and Kong AN. An internal ribosomal entry site mediates redox-sensitive translation of Nrf2. *Nucleic Acids Res.* 2010;38(3):778-88.
424. Huang HC, Nguyen T, and Pickett CB. Phosphorylation of Nrf2 at Ser-40 by protein kinase C regulates antioxidant response element-mediated transcription. *J Biol Chem.* 2002;277(45):42769-74.
425. Lee PJ, Jiang BH, Chin BY, Iyer NV, Alam J, Semenza GL, and Choi AM. Hypoxia-inducible factor-1 mediates transcriptional activation of the heme oxygenase-1 gene in response to hypoxia. *J Biol Chem.* 1997;272(9):5375-81.
426. Naidu S, Wijayanti N, Santoso S, Kietzmann T, and Immenschuh S. An atypical NF-kappa B-regulated pathway mediates phorbol ester-dependent heme oxygenase-1 gene activation in monocytes. *J Immunol.* 2008;181(6):4113-23.
427. Lavrovsky Y, Schwartzman ML, Levere RD, Kappas A, and Abraham NG. Identification of binding sites for transcription factors NF-kappa B and AP-2 in the promoter region of the human heme oxygenase 1 gene. *Proc Natl Acad Sci U S A.* 1994;91(13):5987-91.
428. Weis N, Weigert A, von Knethen A, and Brune B. Heme oxygenase-1 contributes to an alternative macrophage activation profile induced by apoptotic cell supernatants. *Mol Biol Cell.* 2009;20(5):1280-8.

429. Ricchetti GA, Williams LM, and Foxwell BM. Heme oxygenase 1 expression induced by IL-10 requires STAT-3 and phosphoinositol-3 kinase and is inhibited by lipopolysaccharide. *J Leukoc Biol.* 2004;76(3):719-26.
430. Igarashi K, and Sun J. The heme-Bach1 pathway in the regulation of oxidative stress response and erythroid differentiation. *Antioxid Redox Signal.* 2006;8(1-2):107-18.
431. Dhakshinamoorthy S, Jain AK, Bloom DA, and Jaiswal AK. Bach1 competes with Nrf2 leading to negative regulation of the antioxidant response element (ARE)-mediated NAD(P)H:quinone oxidoreductase 1 gene expression and induction in response to antioxidants. *J Biol Chem.* 2005;280(17):16891-900.
432. Ogawa K, Sun J, Taketani S, Nakajima O, Nishitani C, Sassa S, Hayashi N, Yamamoto M, Shibahara S, Fujita H, et al. Heme mediates derepression of Maf recognition element through direct binding to transcription repressor Bach1. *EMBO J.* 2001;20(11):2835-43.
433. Ishikawa M, Numazawa S, and Yoshida T. Redox regulation of the transcriptional repressor Bach1. *Free Radic Biol Med.* 2005;38(10):1344-52.
434. Naidu S, Vijayan V, Santoso S, Kietzmann T, and Immenschuh S. Inhibition and genetic deficiency of p38 MAPK up-regulates heme oxygenase-1 gene expression via Nrf2. *J Immunol.* 2009;182(11):7048-57.
435. Martin D, Rojo AI, Salinas M, Diaz R, Gallardo G, Alam J, De Galarreta CM, and Cuadrado A. Regulation of heme oxygenase-1 expression through the phosphatidylinositol 3-kinase/Akt pathway and the Nrf2 transcription factor in response to the antioxidant phytochemical carnosol. *J Biol Chem.* 2004;279(10):8919-29.
436. Lee TS, and Chau LY. Heme oxygenase-1 mediates the anti-inflammatory effect of interleukin-10 in mice. *Nat Med.* 2002;8(3):240-6.
437. Bushati N, and Cohen SM. microRNA functions. *Annu Rev Cell Dev Biol.* 2007;23(175-205).
438. Zhang J, Vandevenne P, Hamdi H, Van Puyvelde M, Zucchi A, Bettonville M, Weatherly K, and Braun MY. Micro-RNA-155-mediated control of heme oxygenase 1 (HO-1) is required for restoring adaptively tolerant CD4+ T-cell function in rodents. *Eur J Immunol.* 2015;45(3):829-42.
439. Chang CL, Au LC, Huang SW, Fai Kwok C, Ho LT, and Juan CC. Insulin up-regulates heme oxygenase-1 expression in 3T3-L1 adipocytes via PI3-kinase- and PKC-dependent pathways and heme oxygenase-1-associated microRNA downregulation. *Endocrinology.* 2011;152(2):384-93.
440. Xiao S, Wang X, Ni H, Li N, Zhang A, Liu H, Pu F, Xu L, Gao J, Zhao Q, et al. MicroRNA miR-24-3p promotes porcine reproductive and respiratory syndrome virus replication through suppression of heme oxygenase-1 expression. *J Virol.* 2015;89(8):4494-503.
441. Beckman JD, Chen C, Nguyen J, Thayanithy V, Subramanian S, Steer CJ, and Vercellotti GM. Regulation of heme oxygenase-1 protein expression by miR-377 in combination with miR-217. *J Biol Chem.* 2011;286(5):3194-202.
442. Qiu L, Fan H, Jin W, Zhao B, Wang Y, Ju Y, Chen L, Chen Y, Duan Z, and Meng S. miR-122-induced down-regulation of HO-1 negatively affects miR-122-mediated suppression of HBV. *Biochem Biophys Res Commun.* 2010;398(4):771-7.

443. Selbach M, Schwanhauser B, Thierfelder N, Fang Z, Khanin R, and Rajewsky N. Widespread changes in protein synthesis induced by microRNAs. *Nature*. 2008;455(7209):58-63.
444. Do MT, Kim HG, Choi JH, and Jeong HG. Metformin induces microRNA-34a to downregulate the Sirt1/Pgc-1alpha/Nrf2 pathway, leading to increased susceptibility of wild-type p53 cancer cells to oxidative stress and therapeutic agents. *Free Radic Biol Med*. 2014;74(21-34).
445. Hou W, Tian Q, Zheng J, and Bonkovsky HL. MicroRNA-196 represses Bach1 protein and hepatitis C virus gene expression in human hepatoma cells expressing hepatitis C viral proteins. *Hepatology*. 2010;51(5):1494-504.
446. Hou W, Tian Q, Steuerwald NM, Schrum LW, and Bonkovsky HL. The let-7 microRNA enhances heme oxygenase-1 by suppressing Bach1 and attenuates oxidant injury in human hepatocytes. *Biochim Biophys Acta*. 2012;1819(11-12):1113-22.
447. Pulkkinen KH, Yla-Herttuala S, and Levonen AL. Heme oxygenase 1 is induced by miR-155 via reduced BACH1 translation in endothelial cells. *Free Radic Biol Med*. 2011;51(11):2124-31.
448. Lin PH, Chiang MT, and Chau LY. Ubiquitin-proteasome system mediates heme oxygenase-1 degradation through endoplasmic reticulum-associated degradation pathway. *Biochim Biophys Acta*. 2008;1783(10):1826-34.
449. Lin PH, Lan WM, and Chau LY. TRC8 suppresses tumorigenesis through targeting heme oxygenase-1 for ubiquitination and degradation. *Oncogene*. 2013;32(18):2325-34.
450. Salinas M, Wang J, Rosa de Sagarra M, Martin D, Rojo AI, Martin-Perez J, Ortiz de Montellano PR, and Cuadrado A. Protein kinase Akt/PKB phosphorylates heme oxygenase-1 in vitro and in vivo. *FEBS Lett*. 2004;578(1-2):90-4.
451. Belcher JD, Beckman JD, Balla G, Balla J, and Vercellotti G. Heme degradation and vascular injury. *Antioxid Redox Signal*. 2010;12(2):233-48.
452. Levy AP, Asleh R, Blum S, Levy NS, Miller-Lotan R, Kalet-Litman S, Anbinder Y, Lache O, Nakhoul FM, Asaf R, et al. Haptoglobin: basic and clinical aspects. *Antioxid Redox Signal*. 2010;12(2):293-304.
453. Thomsen JH, Etzerodt A, Svendsen P, and Moestrup SK. The haptoglobin-CD163-heme oxygenase-1 pathway for hemoglobin scavenging. *Oxid Med Cell Longev*. 2013;2013(523652).
454. Hayashi S, Takamiya R, Yamaguchi T, Matsumoto K, Tojo SJ, Tamatani T, Kitajima M, Makino N, Ishimura Y, and Suematsu M. Induction of heme oxygenase-1 suppresses venular leukocyte adhesion elicited by oxidative stress: role of bilirubin generated by the enzyme. *Circ Res*. 1999;85(8):663-71.
455. Poss KD, and Tonegawa S. Heme oxygenase 1 is required for mammalian iron reutilization. *Proc Natl Acad Sci U S A*. 1997;94(20):10919-24.
456. Poss KD, and Tonegawa S. Reduced stress defense in heme oxygenase 1-deficient cells. *Proc Natl Acad Sci U S A*. 1997;94(20):10925-30.

457. Datla SR, Dusting GJ, Mori TA, Taylor CJ, Croft KD, and Jiang F. Induction of heme oxygenase-1 in vivo suppresses NADPH oxidase derived oxidative stress. *Hypertension*. 2007;50(4):636-42.
458. Chen-Roetling J, Benvenisti-Zarom L, and Regan RF. Cultured astrocytes from heme oxygenase-1 knockout mice are more vulnerable to heme-mediated oxidative injury. *J Neurosci Res*. 2005;82(6):802-10.
459. Vile GF, Basu-Modak S, Waltner C, and Tyrrell RM. Heme oxygenase 1 mediates an adaptive response to oxidative stress in human skin fibroblasts. *Proc Natl Acad Sci U S A*. 1994;91(7):2607-10.
460. Balla G, Jacob HS, Balla J, Rosenberg M, Nath K, Apple F, Eaton JW, and Vercellotti GM. Ferritin: a cytoprotective antioxidant strategem of endothelium. *J Biol Chem*. 1992;267(25):18148-53.
461. Bhaskaran N, Shukla S, Kanwal R, Srivastava JK, and Gupta S. Induction of heme oxygenase-1 by chamomile protects murine macrophages against oxidative stress. *Life Sci*. 2012;90(25-26):1027-33.
462. Jian Z, Li K, Liu L, Zhang Y, Zhou Z, Li C, and Gao T. Heme oxygenase-1 protects human melanocytes from H₂O₂-induced oxidative stress via the Nrf2-ARE pathway. *J Invest Dermatol*. 2011;131(7):1420-7.
463. Teng ZP, Chen J, Chau LY, Galunic N, and Regan RF. Adenoviral transfer of the heme oxygenase-1 gene protects striatal astrocytes from heme-mediated oxidative injury. *Neurobiol Dis*. 2004;17(2):179-87.
464. Quincozes-Santos A, Bobermin LD, Latini A, Wajner M, Souza DO, Goncalves CA, and Gottfried C. Resveratrol protects C6 astrocyte cell line against hydrogen peroxide-induced oxidative stress through heme oxygenase 1. *PLoS One*. 2013;8(5):e64372.
465. Hung SY, Liou HC, Kang KH, Wu RM, Wen CC, and Fu WM. Overexpression of heme oxygenase-1 protects dopaminergic neurons against 1-methyl-4-phenylpyridinium-induced neurotoxicity. *Mol Pharmacol*. 2008;74(6):1564-75.
466. Chen K, Gunter K, and Maines MD. Neurons overexpressing heme oxygenase-1 resist oxidative stress-mediated cell death. *J Neurochem*. 2000;75(1):304-13.
467. Kapturczak MH, Wasserfall C, Brusko T, Campbell-Thompson M, Ellis TM, Atkinson MA, and Agarwal A. Heme oxygenase-1 modulates early inflammatory responses: evidence from the heme oxygenase-1-deficient mouse. *Am J Pathol*. 2004;165(3):1045-53.
468. Koizumi S. Human heme oxygenase-1 deficiency: a lesson on serendipity in the discovery of the novel disease. *Pediatr Int*. 2007;49(2):125-32.
469. Yachie A, Niida Y, Wada T, Igarashi N, Kaneda H, Toma T, Ohta K, Kasahara Y, and Koizumi S. Oxidative stress causes enhanced endothelial cell injury in human heme oxygenase-1 deficiency. *J Clin Invest*. 1999;103(1):129-35.
470. Otterbein LE, Bach FH, Alam J, Soares M, Tao Lu H, Wysk M, Davis RJ, Flavell RA, and Choi AM. Carbon monoxide has anti-inflammatory effects involving the mitogen-activated protein kinase pathway. *Nat Med*. 2000;6(4):422-8.

471. Tzima S, Victoratos P, Kranidioti K, Alexiou M, and Kollias G. Myeloid heme oxygenase-1 regulates innate immunity and autoimmunity by modulating IFN-beta production. *J Exp Med*. 2009;206(5):1167-79.
472. Kovtunovych G, Ghosh MC, Ollivierre W, Weitzel RP, Eckhaus MA, Tisdale JF, Yachie A, and Rouault TA. Wild-type macrophages reverse disease in heme oxygenase 1-deficient mice. *Blood*. 2014;124(9):1522-30.
473. Schumacher A, Wafula PO, Teles A, El-Mousleh T, Linzke N, Zenclussen ML, Langwisch S, Heinze K, Wollenberg I, Casalis PA, et al. Blockage of heme oxygenase-1 abrogates the protective effect of regulatory T cells on murine pregnancy and promotes the maturation of dendritic cells. *PLoS One*. 2012;7(8):e42301.
474. Xia ZW, Zhong WW, Meyrowitz JS, and Zhang ZL. The role of heme oxygenase-1 in T cell-mediated immunity: the all encompassing enzyme. *Curr Pharm Des*. 2008;14(5):454-64.
475. Brusko TM, Wasserfall CH, Agarwal A, Kapturczak MH, and Atkinson MA. An integral role for heme oxygenase-1 and carbon monoxide in maintaining peripheral tolerance by CD4+CD25+ regulatory T cells. *J Immunol*. 2005;174(9):5181-6.
476. Brouard S, Otterbein LE, Anrather J, Tobiasch E, Bach FH, Choi AM, and Soares MP. Carbon monoxide generated by heme oxygenase 1 suppresses endothelial cell apoptosis. *J Exp Med*. 2000;192(7):1015-26.
477. Sarady-Andrews JK, Liu F, Gallo D, Nakao A, Overhaus M, Ollinger R, Choi AM, and Otterbein LE. Biliverdin administration protects against endotoxin-induced acute lung injury in rats. *Am J Physiol Lung Cell Mol Physiol*. 2005;289(6):L1131-7.
478. Fondevila C, Shen XD, Tsuchiyashi S, Yamashita K, Csizmadia E, Lassman C, Busuttill RW, Kupiec-Weglinski JW, and Bach FH. Biliverdin therapy protects rat livers from ischemia and reperfusion injury. *Hepatology*. 2004;40(6):1333-41.
479. Ryter SW, Kim HP, Nakahira K, Zuckerbraun BS, Morse D, and Choi AM. Protective functions of heme oxygenase-1 and carbon monoxide in the respiratory system. *Antioxid Redox Signal*. 2007;9(12):2157-73.
480. Kawamura K, Ishikawa K, Wada Y, Kimura S, Matsumoto H, Kohro T, Itabe H, Kodama T, and Maruyama Y. Bilirubin from heme oxygenase-1 attenuates vascular endothelial activation and dysfunction. *Arterioscler Thromb Vasc Biol*. 2005;25(1):155-60.
481. Matsumoto H, Ishikawa K, Itabe H, and Maruyama Y. Carbon monoxide and bilirubin from heme oxygenase-1 suppresses reactive oxygen species generation and plasminogen activator inhibitor-1 induction. *Mol Cell Biochem*. 2006;291(1-2):21-8.
482. Ono K, Mannami T, and Iwai N. Association of a promoter variant of the haeme oxygenase-1 gene with hypertension in women. *J Hypertens*. 2003;21(8):1497-503.
483. Ono K, Goto Y, Takagi S, Baba S, Tago N, Nonogi H, and Iwai N. A promoter variant of the heme oxygenase-1 gene may reduce the incidence of ischemic heart disease in Japanese. *Atherosclerosis*. 2004;173(2):315-9.
484. Kimpara T, Takeda A, Watanabe K, Itoyama Y, Ikawa S, Watanabe M, Arai H, Sasaki H, Higuchi S, Okita N, et al. Microsatellite polymorphism in the human heme oxygenase-1 gene promoter and its application in association studies with Alzheimer and Parkinson disease. *Hum Genet*. 1997;100(1):145-7.

485. Yamada N, Yamaya M, Okinaga S, Nakayama K, Sekizawa K, Shibahara S, and Sasaki H. Microsatellite polymorphism in the heme oxygenase-1 gene promoter is associated with susceptibility to emphysema. *Am J Hum Genet.* 2000;66(1):187-95.
486. Chen YH, Lin SJ, Lin MW, Tsai HL, Kuo SS, Chen JW, Charng MJ, Wu TC, Chen LC, Ding YA, et al. Microsatellite polymorphism in promoter of heme oxygenase-1 gene is associated with susceptibility to coronary artery disease in type 2 diabetic patients. *Hum Genet.* 2002;111(1):1-8.
487. Exner M, Bohmig GA, Schillinger M, Regele H, Watschinger B, Horl WH, Raith M, Mannhalter C, and Wagner OF. Donor heme oxygenase-1 genotype is associated with renal allograft function. *Transplantation.* 2004;77(4):538-42.
488. Hirai H, Kubo H, Yamaya M, Nakayama K, Numasaki M, Kobayashi S, Suzuki S, Shibahara S, and Sasaki H. Microsatellite polymorphism in heme oxygenase-1 gene promoter is associated with susceptibility to oxidant-induced apoptosis in lymphoblastoid cell lines. *Blood.* 2003;102(5):1619-21.
489. Seu L, Burt TD, Witte JS, Martin JN, Deeks SG, and McCune JM. Variations in the heme oxygenase-1 microsatellite polymorphism are associated with plasma CD14 and viral load in HIV-infected African-Americans. *Genes Immun.* 2012;13(3):258-67.
490. Yet SF, Perrella MA, Layne MD, Hsieh CM, Maemura K, Kobzik L, Wiesel P, Christou H, Kourembanas S, and Lee ME. Hypoxia induces severe right ventricular dilatation and infarction in heme oxygenase-1 null mice. *J Clin Invest.* 1999;103(8):R23-9.
491. Liu X, Wei J, Peng DH, Layne MD, and Yet SF. Absence of heme oxygenase-1 exacerbates myocardial ischemia/reperfusion injury in diabetic mice. *Diabetes.* 2005;54(3):778-84.
492. Chung SW, Liu X, Macias AA, Baron RM, and Perrella MA. Heme oxygenase-1-derived carbon monoxide enhances the host defense response to microbial sepsis in mice. *J Clin Invest.* 2008;118(1):239-47.
493. Wiesel P, Patel AP, DiFonzo N, Marria PB, Sim CU, Pellacani A, Maemura K, LeBlanc BW, Marino K, Doerschuk CM, et al. Endotoxin-induced mortality is related to increased oxidative stress and end-organ dysfunction, not refractory hypotension, in heme oxygenase-1-deficient mice. *Circulation.* 2000;102(24):3015-22.
494. Chora AA, Fontoura P, Cunha A, Pais TF, Cardoso S, Ho PP, Lee LY, Sobel RA, Steinman L, and Soares MP. Heme oxygenase-1 and carbon monoxide suppress autoimmune neuroinflammation. *J Clin Invest.* 2007;117(2):438-47.
495. Yet SF, Layne MD, Liu X, Chen YH, Ith B, Sibinga NE, and Perrella MA. Absence of heme oxygenase-1 exacerbates atherosclerotic lesion formation and vascular remodeling. *FASEB J.* 2003;17(12):1759-61.
496. Yu J, Chu ES, Wang R, Wang S, Wu CW, Wong VW, Chan HL, Farrell GC, and Sung JJ. Heme oxygenase-1 protects against steatohepatitis in both cultured hepatocytes and mice. *Gastroenterology.* 2010;138(2):694-704.
497. Silva-Gomes S, Appelberg R, Larsen R, Soares MP, and Gomes MS. Heme catabolism by heme oxygenase-1 confers host resistance to Mycobacterium infection. *Infect Immun.* 2013;81(7):2536-45.

498. Watari Y, Yamamoto Y, Brydun A, Ishida T, Mito S, Yoshizumi M, Igarashi K, Chayama K, Ohshima T, and Ozono R. Ablation of the *bach1* gene leads to the suppression of atherosclerosis in *bach1* and apolipoprotein E double knockout mice. *Hypertens Res.* 2008;31(4):783-92.
499. Inoue M, Tazuma S, Kanno K, Hyogo H, Igarashi K, and Chayama K. *Bach1* gene ablation reduces steatohepatitis in mouse MCD diet model. *J Clin Biochem Nutr.* 2011;48(2):161-6.
500. Yamada K, Tanaka N, Nakanishi K, Kamei N, Ishikawa M, Mizuno T, Igarashi K, and Ochi M. Modulation of the secondary injury process after spinal cord injury in *Bach1*-deficient mice by heme oxygenase-1. *J Neurosurg Spine.* 2008;9(6):611-20.
501. Harusato A, Naito Y, Takagi T, Uchiyama K, Mizushima K, Hirai Y, Higashimura Y, Katada K, Handa O, Ishikawa T, et al. BTB and CNC homolog 1 (*Bach1*) deficiency ameliorates TNBS colitis in mice: role of M2 macrophages and heme oxygenase-1. *Inflamm Bowel Dis.* 2013;19(4):740-53.
502. Bean CJ, Boulet SL, Ellingsen D, Pyle ME, Barron-Casella EA, Casella JF, Payne AB, Driggers J, Trau HA, Yang G, et al. Heme oxygenase-1 gene promoter polymorphism is associated with reduced incidence of acute chest syndrome among children with sickle cell disease. *Blood.* 2012;120(18):3822-8.
503. Guenegou A, Leynaert B, Benessiano J, Pin I, Demoly P, Neukirch F, Boczkowski J, and Aubier M. Association of lung function decline with the heme oxygenase-1 gene promoter microsatellite polymorphism in a general population sample. Results from the European Community Respiratory Health Survey (ECRHS), France. *J Med Genet.* 2006;43(8):e43.
504. Kaneda H, Ohno M, Taguchi J, Togo M, Hashimoto H, Ogasawara K, Aizawa T, Ishizaka N, and Nagai R. Heme oxygenase-1 gene promoter polymorphism is associated with coronary artery disease in Japanese patients with coronary risk factors. *Arterioscler Thromb Vasc Biol.* 2002;22(10):1680-5.
505. Liang KW, Sheu WH, Lee WL, Lee IT, Lin SY, Ting CT, and Lee WJ. Shorter GT repeats in the heme oxygenase-1 gene promoter are associated with a lower severity score in coronary artery disease. *J Chin Med Assoc.* 2013;76(6):312-8.
506. Chen M, Zhou L, Ding H, Huang S, He M, Zhang X, Cheng L, Wang D, Hu FB, and Wu T. Short (GT) (n) repeats in heme oxygenase-1 gene promoter are associated with lower risk of coronary heart disease in subjects with high levels of oxidative stress. *Cell Stress Chaperones.* 2012;17(3):329-38.
507. Dick P, Schillinger M, Minar E, Mlekusch W, Amighi J, Sabeti S, Schlager O, Raith M, Endler G, Mannhalter C, et al. Haem oxygenase-1 genotype and cardiovascular adverse events in patients with peripheral artery disease. *Eur J Clin Invest.* 2005;35(12):731-7.
508. Schillinger M, Exner M, Mlekusch W, Domanovits H, Huber K, Mannhalter C, Wagner O, and Minar E. Heme oxygenase-1 gene promoter polymorphism is associated with abdominal aortic aneurysm. *Thromb Res.* 2002;106(2):131-6.
509. Schillinger M, Exner M, Mlekusch W, Ahmadi R, Rumpold H, Mannhalter C, Wagner O, and Minar E. Heme oxygenase-1 genotype is a vascular anti-inflammatory factor following balloon angioplasty. *J Endovasc Ther.* 2002;9(4):385-94.

510. Chen YH, Chau LY, Lin MW, Chen LC, Yo MH, Chen JW, and Lin SJ. Heme oxygenase-1 gene promoter microsatellite polymorphism is associated with angiographic restenosis after coronary stenting. *Eur Heart J.* 2004;25(1):39-47.
511. Schillinger M, Exner M, Minar E, Mlekusch W, Mullner M, Mannhalter C, Bach FH, and Wagner O. Heme oxygenase-1 genotype and restenosis after balloon angioplasty: a novel vascular protective factor. *J Am Coll Cardiol.* 2004;43(6):950-7.
512. Baan C, Peeters A, Lemos F, Uitterlinden A, Doxiadis I, Claas F, Ijzermans J, Roodnat J, and Weimar W. Fundamental role for HO-1 in the self-protection of renal allografts. *Am J Transplant.* 2004;4(5):811-8.
513. Denschlag D, Marculescu R, Unfried G, Hefler LA, Exner M, Hashemi A, Riener EK, Keck C, Tempfer CB, and Wagner O. The size of a microsatellite polymorphism of the haem oxygenase 1 gene is associated with idiopathic recurrent miscarriage. *Mol Hum Reprod.* 2004;10(3):211-4.
514. Gulla A, Evans BJ, Navenot JM, Pundzius J, Barauskas G, Gulbinas A, Dambrauskas Z, Arafat H, and Wang ZX. Heme oxygenase-1 gene promoter polymorphism is associated with the development of necrotizing acute pancreatitis. *Pancreas.* 2014;43(8):1271-6.
515. Vazquez-Armenta G, Gonzalez-Leal N, M JV-dIT, Munoz-Valle JF, Ramos-Marquez ME, Hernandez-Canaveral I, Plascencia-Hernandez A, and Siller-Lopez F. Short (GT)_n microsatellite repeats in the heme oxygenase-1 gene promoter are associated with antioxidant and anti-inflammatory status in Mexican pediatric patients with sepsis. *Tohoku J Exp Med.* 2013;231(3):201-9.
516. Yasuda H, Okinaga S, Yamaya M, Ohru T, Higuchi M, Shinkawa M, Itabashi S, Nakayama K, Asada M, Kikuchi A, et al. Association of susceptibility to the development of pneumonia in the older Japanese population with haem oxygenase-1 gene promoter polymorphism. *J Med Genet.* 2006;43(4):e17.
517. Bai CH, Chen JR, Chiu HC, Chou CC, Chau LY, and Pan WH. Shorter GT repeat polymorphism in the heme oxygenase-1 gene promoter has protective effect on ischemic stroke in dyslipidemia patients. *J Biomed Sci.* 2010;17(12).
518. Morgan L, Hawe E, Palmen J, Montgomery H, Humphries SE, and Kitchen N. Polymorphism of the heme oxygenase-1 gene and cerebral aneurysms. *Br J Neurosurg.* 2005;19(4):317-21.
519. Wagener FA, Toonen EJ, Wigman L, Fransen J, Creemers MC, Radstake TR, Coenen MJ, Barrera P, van Riel PL, and Russel FG. HMOX1 promoter polymorphism modulates the relationship between disease activity and joint damage in rheumatoid arthritis. *Arthritis Rheum.* 2008;58(11):3388-93.
520. Rueda B, Oliver J, Robledo G, Lopez-Nevot MA, Balsa A, Pascual-Salcedo D, Gonzalez-Gay MA, Gonzalez-Escribano MF, and Martin J. HO-1 promoter polymorphism associated with rheumatoid arthritis. *Arthritis Rheum.* 2007;56(12):3953-8.
521. Ferrandiz ML, and Devesa I. Inducers of heme oxygenase-1. *Curr Pharm Des.* 2008;14(5):473-86.
522. Carey CL, Woods SP, Gonzalez R, Conover E, Marcotte TD, Grant I, and Heaton RK. Predictive validity of global deficit scores in detecting neuropsychological impairment in HIV infection. *J Clin Exp Neuropsychol.* 2004;26(3):307-19.

523. Woods SP, Rippeth JD, Frol AB, Levy JK, Ryan E, Soukup VM, Hinkin CH, Lazzaretto D, Cherner M, Marcotte TD, et al. Interrater reliability of clinical ratings and neurocognitive diagnoses in HIV. *J Clin Exp Neuropsychol*. 2004;26(6):759-78.
524. Morgello S, Gelman BB, Kozlowski PB, Vinters HV, Masliah E, Cornford M, Cavert W, Marra C, Grant I, and Singer EJ. The National NeuroAIDS Tissue Consortium: a new paradigm in brain banking with an emphasis on infectious disease. *Neuropathol Appl Neurobiol*. 2001;27(4):326-35.
525. Nguyen TP, Soukup VM, and Gelman BB. Persistent hijacking of brain proteasomes in HIV-associated dementia. *Am J Pathol*. 2010;176(2):893-902.
526. Budka H, Wiley CA, Kleihues P, Artigas J, Asbury AK, Cho ES, Cornblath DR, Dal Canto MC, DeGirolami U, Dickson D, et al. HIV-associated disease of the nervous system: review of nomenclature and proposal for neuropathology-based terminology. *Brain Pathol*. 1991;1(3):143-52.
527. Gelman BB, Lisinicchia JG, Morgello S, Masliah E, Commins D, Achim CL, Fox HS, Kolson DL, Grant I, Singer E, et al. Neurovirological correlation with HIV-associated neurocognitive disorders and encephalitis in a HAART-era cohort. *J Acquir Immune Defic Syndr*. 2013;62(5):487-95.
528. Balliet JW, Kolson DL, Eiger G, Kim FM, McGann KA, Srinivasan A, and Collman R. Distinct effects in primary macrophages and lymphocytes of the human immunodeficiency virus type 1 accessory genes vpr, vpu, and nef: mutational analysis of a primary HIV-1 isolate. *Virology*. 1994;200(2):623-31.
529. Hoffman AD, Banapour B, and Levy JA. Characterization of the AIDS-associated retrovirus reverse transcriptase and optimal conditions for its detection in virions. *Virology*. 1985;147(2):326-35.
530. Chen W, Sulcove J, Frank I, Jaffer S, Ozdener H, and Kolson DL. Development of a human neuronal cell model for human immunodeficiency virus (HIV)-infected macrophage-induced neurotoxicity: apoptosis induced by HIV type 1 primary isolates and evidence for involvement of the Bcl-2/Bcl-xL-sensitive intrinsic apoptosis pathway. *J Virol*. 2002;76(18):9407-19.
531. Yi Y, Chen W, Frank I, Cutilli J, Singh A, Starr-Spires L, Sulcove J, Kolson DL, and Collman RG. An unusual syncytia-inducing human immunodeficiency virus type 1 primary isolate from the central nervous system that is restricted to CXCR4, replicates efficiently in macrophages, and induces neuronal apoptosis. *J Neurovirol*. 2003;9(4):432-41.
532. Mirra SS, Anand R, and Spira TJ. HTLV-III/LAV infection of the central nervous system in a 57-year-old man with progressive dementia of unknown cause. *N Engl J Med*. 1986;314(18):1191-2.
533. Anand R, Thayer R, Srinivasan A, Nayyar S, Gardner M, Luciw P, and Dandekar S. Biological and molecular characterization of human immunodeficiency virus (HIV-1BR) from the brain of a patient with progressive dementia. *Virology*. 1989;168(1):79-89.
534. Rana S, Besson G, Cook DG, Rucker J, Smyth RJ, Yi Y, Turner JD, Guo HH, Du JG, Peiper SC, et al. Role of CCR5 in infection of primary macrophages and lymphocytes by macrophage-tropic strains of human immunodeficiency virus: resistance to patient-derived and prototype isolates resulting from the delta ccr5 mutation. *J Virol*. 1997;71(4):3219-27.

535. Cheng-Mayer C, and Levy JA. Distinct biological and serological properties of human immunodeficiency viruses from the brain. *Ann Neurol.* 1988;23 Suppl(S58-61).
536. Hollander H, and Levy JA. Neurologic abnormalities and recovery of human immunodeficiency virus from cerebrospinal fluid. *Ann Intern Med.* 1987;106(5):692-5.
537. Koyanagi Y, Miles S, Mitsuyasu RT, Merrill JE, Vinters HV, and Chen IS. Dual infection of the central nervous system by AIDS viruses with distinct cellular tropisms. *Science.* 1987;236(4803):819-22.
538. Yi Y, Isaacs SN, Williams DA, Frank I, Schols D, De Clercq E, Kolson DL, and Collman RG. Role of CXCR4 in cell-cell fusion and infection of monocyte-derived macrophages by primary human immunodeficiency virus type 1 (HIV-1) strains: two distinct mechanisms of HIV-1 dual tropism. *J Virol.* 1999;73(9):7117-25.
539. Collman R, Balliet JW, Gregory SA, Friedman H, Kolson DL, Nathanson N, and Srinivasan A. An infectious molecular clone of an unusual macrophage-tropic and highly cytopathic strain of human immunodeficiency virus type 1. *J Virol.* 1992;66(12):7517-21.
540. Adachi A, Gendelman HE, Koenig S, Folks T, Willey R, Rabson A, and Martin MA. Production of acquired immunodeficiency syndrome-associated retrovirus in human and nonhuman cells transfected with an infectious molecular clone. *J Virol.* 1986;59(2):284-91.
541. Popovic M, Sarngadharan MG, Read E, and Gallo RC. Detection, isolation, and continuous production of cytopathic retroviruses (HTLV-III) from patients with AIDS and pre-AIDS. *Science.* 1984;224(4648):497-500.
542. Popovic M, Read-Connole E, and Gallo RC. T4 positive human neoplastic cell lines susceptible to and permissive for HTLV-III. *Lancet.* 1984;2(8417-8418):1472-3.
543. Li Y, Kappes JC, Conway JA, Price RW, Shaw GM, and Hahn BH. Molecular characterization of human immunodeficiency virus type 1 cloned directly from uncultured human brain tissue: identification of replication-competent and -defective viral genomes. *J Virol.* 1991;65(8):3973-85.
544. Gartner S, Markovits P, Markovitz DM, Kaplan MH, Gallo RC, and Popovic M. The role of mononuclear phagocytes in HTLV-III/LAV infection. *Science.* 1986;233(4760):215-9.
545. Gendelman HE, Orenstein JM, Martin MA, Ferrua C, Mitra R, Phipps T, Wahl LA, Lane HC, Fauci AS, Burke DS, et al. Efficient isolation and propagation of human immunodeficiency virus on recombinant colony-stimulating factor 1-treated monocytes. *J Exp Med.* 1988;167(4):1428-41.
546. Wang Y, White MG, Akay C, Chodroff RA, Robinson J, Lindl KA, Dichter MA, Qian Y, Mao Z, Kolson DL, et al. Activation of cyclin-dependent kinase 5 by calpains contributes to human immunodeficiency virus-induced neurotoxicity. *J Neurochem.* 2007;103(2):439-55.
547. White MG, Wang Y, Akay C, Lindl KA, Kolson DL, and Jordan-Sciutto KL. Parallel high throughput neuronal toxicity assays demonstrate uncoupling between loss of mitochondrial membrane potential and neuronal damage in a model of HIV-induced neurodegeneration. *Neurosci Res.* 2011;70(2):220-9.
548. Ellis R, Langford D, and Masliah E. HIV and antiretroviral therapy in the brain: neuronal injury and repair. *Nat Rev Neurosci.* 2007;8(1):33-44.

549. Ellis RJ, Deutsch R, Heaton RK, Marcotte TD, McCutchan JA, Nelson JA, Abramson I, Thal LJ, Atkinson JH, Wallace MR, et al. Neurocognitive impairment is an independent risk factor for death in HIV infection. San Diego HIV Neurobehavioral Research Center Group. *Arch Neurol*. 1997;54(4):416-24.
550. Valcour V, Paul R, Chiao S, Wendelken LA, and Miller B. Screening for cognitive impairment in human immunodeficiency virus. *Clin Infect Dis*. 2011;53(8):836-42.
551. Vivithanaporn P, Heo G, Gamble J, Krentz HB, Hoke A, Gill MJ, and Power C. Neurologic disease burden in treated HIV/AIDS predicts survival: a population-based study. *Neurology*. 2010;75(13):1150-8.
552. Cherner M, Masliah E, Ellis RJ, Marcotte TD, Moore DJ, Grant I, and Heaton RK. Neurocognitive dysfunction predicts postmortem findings of HIV encephalitis. *Neurology*. 2002;59(10):1563-7.
553. McArthur JC, Steiner J, Sacktor N, and Nath A. Human immunodeficiency virus-associated neurocognitive disorders: Mind the gap. *Ann Neurol*. 2010;67(6):699-714.
554. Tan IL, and McArthur JC. HIV-associated neurological disorders: a guide to pharmacotherapy. *CNS Drugs*. 2012;26(2):123-34.
555. Heaton R, Franklin D, Woods S, Marra C, Clifford D, Gelman B, McArthur J, Morgello S, McCutchan A, and Grant I. *19th Conference on Retroviruses and Opportunistic Infections (CROI)*. Seattle, WA; 2012.
556. Grant I, Franklin DR, Jr., Deutsch R, Woods SP, Vaida F, Ellis RJ, Letendre SL, Marcotte TD, Atkinson JH, Collier AC, et al. Asymptomatic HIV-associated neurocognitive impairment increases risk for symptomatic decline. *Neurology*. 2014;82(23):2055-62.
557. McArthur JC, and Brew BJ. HIV-associated neurocognitive disorders: is there a hidden epidemic? *AIDS*. 2010;24(9):1367-70.
558. Gelman BB, Chen T, Lisinicchia JG, Soukup VM, Carmical JR, Starkey JM, Masliah E, Commins DL, Brandt D, Grant I, et al. The National NeuroAIDS Tissue Consortium brain gene array: two types of HIV-associated neurocognitive impairment. *PLoS one*. 2012;7(9):e46178.
559. Gresle MM, Butzkueven H, and Shaw G. Neurofilament proteins as body fluid biomarkers of neurodegeneration in multiple sclerosis. *Mult Scler Int*. 2011;2011(315406).
560. Pasol J, Feuer W, Yang C, Shaw G, Kardon R, and Guy J. Phosphorylated neurofilament heavy chain correlations to visual function, optical coherence tomography, and treatment. *Mult Scler Int*. 2010;2010(542691).
561. Julien JP. Neurofilament functions in health and disease. *Curr Opin Neurobiol*. 1999;9(5):554-60.
562. Szaro BG, and Strong MJ. Post-transcriptional control of neurofilaments: New roles in development, regeneration and neurodegenerative disease. *Trends Neurosci*. 2010;33(1):27-37.
563. Mellgren A, Price RW, Hagberg L, Rosengren L, Brew BJ, and Gisslén M. Antiretroviral treatment reduces increased CSF neurofilament protein (NFL) in HIV-1 infection. *Neurology*. 2007;69(15):1536-41.

564. Norgren N, Rosengren L, and Stigbrand T. Elevated neurofilament levels in neurological diseases. *Brain Res.* 2003;987(1):25-31.
565. Rosengren LE, Karlsson JE, Karlsson JO, Persson LI, and Wikkelsø C. Patients with amyotrophic lateral sclerosis and other neurodegenerative diseases have increased levels of neurofilament protein in CSF. *J Neurochem.* 1996;67(5):2013-8.
566. Malmstrom C, Haghighi S, Rosengren L, Andersen O, and Lycke J. Neurofilament light protein and glial fibrillary acidic protein as biological markers in MS. *Neurology.* 2003;61(17):20-5.
567. Jessen Krut J, Mellberg T, Price RW, Hagberg L, Fuchs D, Rosengren L, Nilsson S, Zetterberg H, and Gisslen M. Biomarker evidence of axonal injury in neuroasymptomatic HIV-1 patients. *PLoS One.* 2014;9(2):e88591.
568. Peluso MJ, Meyerhoff DJ, Price RW, Peterson J, Lee E, Young AC, Walter R, Fuchs D, Brew BJ, Cinque P, et al. Cerebrospinal fluid and neuroimaging biomarker abnormalities suggest early neurological injury in a subset of individuals during primary HIV infection. *J Infect Dis.* 2013;207(11):1703-12.
569. Abdulle S, Mellgren A, Brew BJ, Cinque P, Hagberg L, Price RW, Rosengren L, and Gisslén M. CSF neurofilament protein (NFL) -- a marker of active HIV-related neurodegeneration. *J Neurol.* 2007;254(8):1026-32.
570. Gisslen M, Hagberg L, Brew BJ, Cinque P, Price RW, and Rosengren L. Elevated cerebrospinal fluid neurofilament light protein concentrations predict the development of AIDS dementia complex. *J Infect Dis.* 2007;195(12):1774-8.
571. Ganesalingam J, An J, Shaw CE, Shaw G, Lacomis D, and Bowser R. Combination of neurofilament heavy chain and complement C3 as CSF biomarkers for ALS. *J Neurochem.* 2011;117(3):528-37.
572. Sellner J, Patel A, Dassan P, Brown MM, and Petzold A. Hyperacute detection of neurofilament heavy chain in serum following stroke: a transient sign. *Neurochem Res.* 2011;36(12):2287-91.
573. Petzold A, Eikelenboom MJ, Keir G, Grant D, Lazeron RHC, Polman CH, Uitdehaag BMJ, Thompson EJ, and Giovannoni G. Axonal damage accumulates in the progressive phase of multiple sclerosis: three year follow up study. *J Neurol Neurosurg Psychiatry.* 2005;76(2):206-11.
574. Ryan LA, Zheng J, Brester M, Bohac D, Hahn F, Anderson J, Ratanasuwan W, Gendelman HE, and Swindells S. Plasma levels of soluble CD14 and tumor necrosis factor-alpha type II receptor correlate with cognitive dysfunction during human immunodeficiency virus type 1 infection. *J Infect Dis.* 2001;184(6):699-706.
575. Burdo TH, Weiffenbach A, Woods SP, Letendre S, Ellis RJ, and Williams KC. Elevated sCD163 is a marker of neurocognitive impairment in HIV infection. *AIDS.* 2013;27(9):1387-95.
576. Sandler NG, Wand H, Roque A, Law M, Nason MC, Nixon DE, Pedersen C, Ruxrungtham K, Lewin SR, Emery S, et al. Plasma levels of soluble CD14 independently predict mortality in HIV infection. *J Infect Dis.* 2011;203(6):780-90.
577. Møller HJ. Soluble CD163. *Scand J Clin Lab Invest.* 2012;72(1):1-13.

578. Fischer-Smith T, Bell C, Croul S, Lewis M, and Rappaport J. Monocyte/macrophage trafficking in acquired immunodeficiency syndrome encephalitis: lessons from human and nonhuman primate studies. *J Neurovirol.* 2008;14(4):318-26.
579. Peterson J, Zetterberg H, Hagberg L, Spudich S, Gisslen M, and Price R. *20th Conference on Retroviruses and Opportunistic Infections (CROI)*. Atlanta, GA; 2013.
580. Gill AJ, and Kolson DL. Chronic inflammation and the role for cofactors (hepatitis C, drug abuse, antiretroviral drug toxicity, aging) in HAND persistence. *Curr HIV/AIDS Rep.* 2014;11(3):325-35.
581. Keyse SM, and Tyrrell RM. Heme oxygenase is the major 32-kDa stress protein induced in human skin fibroblasts by UVA radiation, hydrogen peroxide, and sodium arsenite. *Proc Natl Acad Sci U S A.* 1989;86(1):99-103.
582. Camhi SL, Alam J, Otterbein L, Sylvester SL, and Choi AM. Induction of heme oxygenase-1 gene expression by lipopolysaccharide is mediated by AP-1 activation. *Am J Respir Cell Mol Biol.* 1995;13(4):387-98.
583. Rizzardini M, Terao M, Falciani F, and Cantoni L. Cytokine induction of haem oxygenase mRNA in mouse liver. Interleukin 1 transcriptionally activates the haem oxygenase gene. *Biochem J.* 1993;290(1):343-7.
584. Cuadrado A, and Rojo AI. Heme oxygenase-1 as a therapeutic target in neurodegenerative diseases and brain infections. *Curr Pharm Des.* 2008;14(5):429-42.
585. Ambegaokar SS, and Kolson DL. Heme Oxygenase-1 Dysregulation in the Brain: Implications for HIV-Associated Neurocognitive Disorders. *Curr HIV Res.* 2014;12(3):174-88.
586. Kraft-Terry SD, Buch SJ, Fox HS, and Gendelman HE. A coat of many colors: neuroimmune crosstalk in human immunodeficiency virus infection. *Neuron.* 2009;64(1):133-45.
587. Schipper HM, Liberman A, and Stopa EG. Neural heme oxygenase-1 expression in idiopathic Parkinson's disease. *Exp Neurol.* 1998;150(1):60-8.
588. Schipper HM, Cisse S, and Stopa EG. Expression of heme oxygenase-1 in the senescent and Alzheimer-diseased brain. *Ann Neurol.* 1995;37(6):758-68.
589. Mehindate K, Sahlas DJ, Frankel D, Mawal Y, Liberman A, Corcos J, Dion S, and Schipper HM. Proinflammatory cytokines promote glial heme oxygenase-1 expression and mitochondrial iron deposition: implications for multiple sclerosis. *J Neurochem.* 2001;77(5):1386-95.
590. Alvarez JA, and Emory E. Executive function and the frontal lobes: a meta-analytic review. *Neuropsychol Rev.* 2006;16(1):17-42.
591. Kochunov P, Coyle T, Lancaster J, Robin DA, Hardies J, Kochunov V, Bartzokis G, Stanley J, Royall D, Schlosser AE, et al. Processing speed is correlated with cerebral health markers in the frontal lobes as quantified by neuroimaging. *NeuroImage.* 2010;49(2):1190-9.
592. Horiuchi M, Itoh A, Pleasure D, Ozato K, and Itoh T. Cooperative contributions of interferon regulatory factor 1 (IRF1) and IRF8 to interferon-gamma-mediated cytotoxic effects on oligodendroglial progenitor cells. *J Neuroinflammation.* 2011;8(8):1-16.

593. Schaer DJ, Schaer CA, Buehler PW, Boykins RA, Schoedon G, Alayash AI, and Schaffner A. CD163 is the macrophage scavenger receptor for native and chemically modified hemoglobins in the absence of haptoglobin. *Blood*. 2006;107(1):373-80.
594. Kim WK, Alvarez X, Fisher J, Bronfin B, Westmoreland S, McLaurin J, and Williams K. CD163 identifies perivascular macrophages in normal and viral encephalitic brains and potential precursors to perivascular macrophages in blood. *Am J Pathol*. 2006;168(3):822-34.
595. Melrose RJ, Tinaz S, Castelo JM, Courtney MG, and Stern CE. Compromised fronto-striatal functioning in HIV: an fMRI investigation of semantic event sequencing. *Behav Brain Res*. 2008;188(2):337-47.
596. Reynolds A, Laurie C, Mosley RL, and Gendelman HE. Oxidative stress and the pathogenesis of neurodegenerative disorders. *Int Rev Neurobiol*. 2007;82(297-325).
597. Pechlaner R, Willeit P, Summerer M, Santer P, Egger G, Kronenberg F, Demetz E, Weiss G, Tsimikas S, Witztum JL, et al. Heme oxygenase-1 gene promoter microsatellite polymorphism is associated with progressive atherosclerosis and incident cardiovascular disease. *Arterioscler Thromb Vasc Biol*. 2015;35(1):229-36.
598. Heaton RK, Clifford DB, Franklin DR, Jr., Woods SP, Ake C, Vaida F, Ellis RJ, Letendre SL, Marcotte TD, Atkinson JH, et al. HIV-associated neurocognitive disorders persist in the era of potent antiretroviral therapy: CHARTER Study. *Neurology*. 2010;75(23):2087-96.
599. Nightingale S, Winston A, Letendre S, Michael BD, McArthur JC, Khoo S, and Solomon T. Controversies in HIV-associated neurocognitive disorders. *Lancet Neurol*. 2014;13(11):1139-51.
600. Chen MF, Gill AJ, and Kolson DL. Neuropathogenesis of HIV-associated neurocognitive disorders: roles for immune activation, HIV blipping and viral tropism. *Curr Opin HIV AIDS*. 2014;9(6):559-64.
601. Giulian D, Vaca K, and Noonan CA. Secretion of neurotoxins by mononuclear phagocytes infected with HIV-1. *Science*. 1990;250(4987):1593-6.
602. Huang Y, Zhao L, Jia B, Wu L, Li Y, Curthoys N, and Zheng JC. Glutaminase dysregulation in HIV-1-infected human microglia mediates neurotoxicity: relevant to HIV-1-associated neurocognitive disorders. *J Neurosci*. 2011;31(42):15195-204.
603. Department of Health and Human Services. Panel on Antiretroviral Guidelines for Adults and Adolescents. Guidelines for the use of antiretroviral agents in HIV-1-infected adults and adolescents, 2015. . Accessed November 20th 2014. Available at <http://aidsinfo.nih.gov/guidelines>.
604. Collins DR, and Collins KL. HIV-1 accessory proteins adapt cellular adaptors to facilitate immune evasion. *PLoS Pathog*. 2014;10(1):e1003851.
605. Nyamweya S, Hegedus A, Jaye A, Rowland-Jones S, Flanagan KL, and Macallan DC. Comparing HIV-1 and HIV-2 infection: Lessons for viral immunopathogenesis. *Rev Med Virol*. 2013;23(4):221-40.
606. Schulz TF, Whitby D, Hoad JG, Corrah T, Whittle H, and Weiss RA. Biological and molecular variability of human immunodeficiency virus type 2 isolates from The Gambia. *J Virol*. 1990;64(10):5177-82.

607. Choi Y, Townend J, Vincent T, Zaidi I, Sarge-Njie R, Jaye A, and Clifford DB. Neurologic manifestations of human immunodeficiency virus-2: dementia, myelopathy, and neuropathy in West Africa. *J Neurovirol.* 2011;17(2):166-75.
608. Devadas K, and Dhawan S. Hemin activation ameliorates HIV-1 infection via heme oxygenase-1 induction. *J Immunol.* 2006;176(7):4252-7.
609. Devadas K, Hewlett IK, and Dhawan S. Lipopolysaccharide suppresses HIV-1 replication in human monocytes by protein kinase C-dependent heme oxygenase-1 induction. *J Leukoc Biol.* 2010;87(5):915-24.
610. Zhu Z, Wilson AT, Mathahs MM, Wen F, Brown KE, Luxon BA, and Schmidt WN. Heme oxygenase-1 suppresses hepatitis C virus replication and increases resistance of hepatocytes to oxidant injury. *Hepatology.* 2008;48(5):1430-9.
611. Protzer U, Seyfried S, Quasdorff M, Sass G, Svorcova M, Webb D, Bohne F, Hosel M, Schirmacher P, and Tiegs G. Antiviral activity and hepatoprotection by heme oxygenase-1 in hepatitis B virus infection. *Gastroenterology.* 2007;133(4):1156-65.
612. Hill-Batorski L, Halfmann P, Neumann G, and Kawaoka Y. The cytoprotective enzyme heme oxygenase-1 suppresses Ebola virus replication. *J Virol.* 2013;87(24):13795-802.
613. Tung WH, Hsieh HL, Lee IT, and Yang CM. Enterovirus 71 induces integrin beta1/EGFR-Rac1-dependent oxidative stress in SK-N-SH cells: role of HO-1/CO in viral replication. *J Cell Physiol.* 2011;226(12):3316-29.
614. Meseda CA, Srinivasan K, Wise J, Catalano J, Yamada KM, and Dhawan S. Non-coding RNAs and heme oxygenase-1 in vaccinia virus infection. *Biochem Biophys Res Commun.* 2014;454(1):84-8.
615. Xiao S, Zhang A, Zhang C, Ni H, Gao J, Wang C, Zhao Q, Wang X, Wang X, Ma C, et al. Heme oxygenase-1 acts as an antiviral factor for porcine reproductive and respiratory syndrome virus infection and over-expression inhibits virus replication in vitro. *Antiviral Res.* 2014;110(60-9).
616. Abdalla MY, Britigan BE, Wen F, Icardi M, McCormick ML, LaBrecque DR, Voigt M, Brown KE, and Schmidt WN. Down-regulation of heme oxygenase-1 by hepatitis C virus infection in vivo and by the in vitro expression of hepatitis C core protein. *J Infect Dis.* 2004;190(6):1109-18.
617. Wen F, Brown KE, Britigan BE, and Schmidt WN. Hepatitis C core protein inhibits induction of heme oxygenase-1 and sensitizes hepatocytes to cytotoxicity. *Cell Biol Toxicol.* 2008;24(2):175-88.
618. Jablonowska E, Wojcik K, Szymanska B, Omulecka A, Cwiklinska H, and Piekarska A. Hepatic HMOX1 expression positively correlates with Bach-1 and miR-122 in patients with HCV mono and HIV/HCV coinfection. *PLoS One.* 2014;9(4):e95564.
619. Ghaziani T, Shan Y, Lambrecht RW, Donohue SE, Pietschmann T, Bartenschlager R, and Bonkovsky HL. HCV proteins increase expression of heme oxygenase-1 (HO-1) and decrease expression of Bach1 in human hepatoma cells. *J Hepatol.* 2006;45(1):5-12.
620. Koliaraki V, and Kollias G. A new role for myeloid HO-1 in the innate to adaptive crosstalk and immune homeostasis. *Adv Exp Med Biol.* 2011;780(101-11).

621. Lehmann E, El-Tantawy WH, Ocker M, Bartenschlager R, Lohmann V, Hashemolhosseini S, Tiegs G, and Sass G. The heme oxygenase 1 product biliverdin interferes with hepatitis C virus replication by increasing antiviral interferon response. *Hepatology*. 2010;51(2):398-404.
622. McPhee F, Caldera PS, Bemis GW, McDonagh AF, Kuntz ID, and Craik CS. Bile pigments as HIV-1 protease inhibitors and their effects on HIV-1 viral maturation and infectivity in vitro. *Biochem J*. 1996;320 (Pt 2)(681-6.
623. Cook DR, Gleichman AJ, Cross SA, Doshi S, Ho W, Jordan-Sciutto KL, Lynch DR, and Kolson DL. NMDA receptor modulation by the neuropeptide apelin: implications for excitotoxic injury. *J Neurochem*. 2011;118(6):1113-23.
624. Minamino T, Christou H, Hsieh CM, Liu Y, Dhawan V, Abraham NG, Perrella MA, Mitsialis SA, and Kourembanas S. Targeted expression of heme oxygenase-1 prevents the pulmonary inflammatory and vascular responses to hypoxia. *Proc Natl Acad Sci U S A*. 2001;98(15):8798-803.
625. Gill AJ, and Kolson DL. Dimethyl fumarate modulation of immune and antioxidant responses: application to HIV therapy. *Crit Rev Immunol*. 2013;33(4):307-59.
626. Drummond GS, Galbraith RA, Sardana MK, and Kappas A. Reduction of the C2 and C4 vinyl groups of Sn-protoporphyrin to form Sn-mesoporphyrin markedly enhances the ability of the metalloporphyrin to inhibit in vivo heme catabolism. *Arch Biochem Biophys*. 1987;255(1):64-74.
627. Abate A, Zhao H, Wong RJ, and Stevenson DK. The role of Bach1 in the induction of heme oxygenase by tin mesoporphyrin. *Biochem Biophys Res Commun*. 2007;354(3):757-63.
628. Sun J, Hoshino H, Takaku K, Nakajima O, Muto A, Suzuki H, Tashiro S, Takahashi S, Shibahara S, Alam J, et al. Hemoprotein Bach1 regulates enhancer availability of heme oxygenase-1 gene. *Embo J*. 2002;21(19):5216-24.
629. Linker RA, Lee DH, Ryan S, van Dam AM, Conrad R, Bista P, Zeng W, Hronowsky X, Buko A, Chollate S, et al. Fumaric acid esters exert neuroprotective effects in neuroinflammation via activation of the Nrf2 antioxidant pathway. *Brain*. 2011;134(3):678-92.
630. Seldon MP, Silva G, Pejanovic N, Larsen R, Gregoire IP, Filipe J, Anrather J, and Soares MP. Heme oxygenase-1 inhibits the expression of adhesion molecules associated with endothelial cell activation via inhibition of NF-kappaB RelA phosphorylation at serine 276. *J Immunol*. 2007;179(11):7840-51.
631. Peng H, Guerau-de-Arellano M, Mehta VB, Yang Y, Huss DJ, Papenfuss TL, Lovett-Racke AE, and Racke MK. Dimethyl fumarate inhibits dendritic cell maturation via nuclear factor kappaB (NF-kappaB) and extracellular signal-regulated kinase 1 and 2 (ERK1/2) and mitogen stress-activated kinase 1 (MSK1) signaling. *J Biol Chem*. 2012;287(33):28017-26.
632. Schweckendiek W. [Treatment of psoriasis vulgaris]. *Med Monatsschr*. 1959;13(2):103-4.
633. Gold R, Kappos L, Arnold DL, Bar-Or A, Giovannoni G, Selmaj K, Tornatore C, Sweetser MT, Yang M, Sheikh SI, et al. Placebo-controlled phase 3 study of oral BG-12 for relapsing multiple sclerosis. *N Engl J Med*. 2012;367(12):1098-107.

634. Fox RJ, Miller DH, Phillips JT, Hutchinson M, Havrdova E, Kita M, Yang M, Raghupathi K, Novas M, Sweetser MT, et al. Placebo-controlled phase 3 study of oral BG-12 or glatiramer in multiple sclerosis. *N Engl J Med*. 2012;367(12):1087-97.
635. Werdenberg D, Joshi R, Wolfram S, Merkle HP, and Langguth P. Presystemic metabolism and intestinal absorption of antipsoriatic fumaric acid esters. *Biopharm Drug Dispos*. 2003;24(6):259-73.
636. Litjens NH, Burggraaf J, van Strijen E, van Gulpen C, Mattie H, Schoemaker RC, van Dissel JT, Thio HB, and Nibbering PH. Pharmacokinetics of oral fumarates in healthy subjects. *Br J Clin Pharmacol*. 2004;58(4):429-32.
637. Rostami-Yazdi M, Clement B, and Mrowietz U. Pharmacokinetics of anti-psoriatic fumaric acid esters in psoriasis patients. *Arch Dermatol Res*. 2010;302(7):531-8.
638. Rostami-Yazdi M, Clement B, Schmidt TJ, Schinor D, and Mrowietz U. Detection of metabolites of fumaric acid esters in human urine: implications for their mode of action. *J Invest Dermatol*. 2009;129(1):231-4.
639. Hayden MS, and Ghosh S. NF-kappaB in immunobiology. *Cell Res*. 2011;21(2):223-44.
640. Pahl HL. Activators and target genes of Rel/NF-kappaB transcription factors. *Oncogene*. 1999;18(49):6853-66.
641. Singh S, Vrishni S, Singh BK, Rahman I, and Kakkar P. Nrf2-ARE stress response mechanism: a control point in oxidative stress-mediated dysfunctions and chronic inflammatory diseases. *Free Radic Res*. 2010;44(11):1267-88.
642. Itoh K, Wakabayashi N, Katoh Y, Ishii T, O'Connor T, and Yamamoto M. Keap1 regulates both cytoplasmic-nuclear shuttling and degradation of Nrf2 in response to electrophiles. *Genes Cells*. 2003;8(4):379-91.
643. Kobayashi M, and Yamamoto M. Nrf2-Keap1 regulation of cellular defense mechanisms against electrophiles and reactive oxygen species. *Adv Enzyme Regul*. 2006;46(113-40).
644. Itoh K, Tong KI, and Yamamoto M. Molecular mechanism activating Nrf2-Keap1 pathway in regulation of adaptive response to electrophiles. *Free Radic Biol Med*. 2004;36(10):1208-13.
645. Lee JM, Calkins MJ, Chan K, Kan YW, and Johnson JA. Identification of the NF-E2-related factor-2-dependent genes conferring protection against oxidative stress in primary cortical astrocytes using oligonucleotide microarray analysis. *J Biol Chem*. 2003;278(14):12029-38.
646. Fourtounis J, Wang IM, Mathieu MC, Claveau D, Loo T, Jackson AL, Peters MA, Therien AG, Boie Y, and Crackower MA. Gene expression profiling following NRF2 and KEAP1 siRNA knockdown in human lung fibroblasts identifies CCL11/Eotaxin-1 as a novel NRF2 regulated gene. *Respir Res*. 2012;13(92).
647. Alam J, Stewart D, Touchard C, Boinapally S, Choi AM, and Cook JL. Nrf2, a Cap'n'Collar transcription factor, regulates induction of the heme oxygenase-1 gene. *J Biol Chem*. 1999;274(37):26071-8.
648. Bloom DA, and Jaiswal AK. Phosphorylation of Nrf2 at Ser40 by protein kinase C in response to antioxidants leads to the release of Nrf2 from INrf2, but is not required for Nrf2 stabilization/accumulation in the nucleus and transcriptional activation of antioxidant

- response element-mediated NAD(P)H:quinone oxidoreductase-1 gene expression. *J Biol Chem*. 2003;278(45):44675-82.
649. Wild AC, Moinova HR, and Mulcahy RT. Regulation of gamma-glutamylcysteine synthetase subunit gene expression by the transcription factor Nrf2. *J Biol Chem*. 1999;274(47):33627-36.
650. Hayes JD, Chanas SA, Henderson CJ, McMahon M, Sun C, Moffat GJ, Wolf CR, and Yamamoto M. The Nrf2 transcription factor contributes both to the basal expression of glutathione S-transferases in mouse liver and to their induction by the chemopreventive synthetic antioxidants, butylated hydroxyanisole and ethoxyquin. *Biochem Soc Trans*. 2000;28(2):33-41.
651. Sasaki H, Sato H, Kuriyama-Matsumura K, Sato K, Maebara K, Wang H, Tamba M, Itoh K, Yamamoto M, and Bannai S. Electrophile response element-mediated induction of the cystine/glutamate exchange transporter gene expression. *J Biol Chem*. 2002;277(47):44765-71.
652. Wakabayashi N, Slocum SL, Skoko JJ, Shin S, and Kensler TW. When NRF2 talks, who's listening? *Antioxid Redox Signal*. 2010;13(11):1649-63.
653. Jin W, Wang H, Yan W, Xu L, Wang X, Zhao X, Yang X, Chen G, and Ji Y. Disruption of Nrf2 enhances upregulation of nuclear factor-kappaB activity, proinflammatory cytokines, and intercellular adhesion molecule-1 in the brain after traumatic brain injury. *Mediators Inflamm*. 2008;2008(725174).
654. Vollgraf U, Wegner M, and Richter-Landsberg C. Activation of AP-1 and nuclear factor-kappaB transcription factors is involved in hydrogen peroxide-induced apoptotic cell death of oligodendrocytes. *J Neurochem*. 1999;73(6):2501-9.
655. Rahman I, Gilmour PS, Jimenez LA, and MacNee W. Oxidative stress and TNF-alpha induce histone acetylation and NF-kappaB/AP-1 activation in alveolar epithelial cells: potential mechanism in gene transcription in lung inflammation. *Mol Cell Biochem*. 2002;234-235(1-2):239-48.
656. Bonello S, Zahringer C, BelAiba RS, Djordjevic T, Hess J, Michiels C, Kietzmann T, and Gorkach A. Reactive oxygen species activate the HIF-1alpha promoter via a functional NFkappaB site. *Arterioscler Thromb Vasc Biol*. 2007;27(4):755-61.
657. Thimmulappa RK, Lee H, Rangasamy T, Reddy SP, Yamamoto M, Kensler TW, and Biswal S. Nrf2 is a critical regulator of the innate immune response and survival during experimental sepsis. *J Clin Invest*. 2006;116(4):984-95.
658. Cho HY, Imani F, Miller-DeGraff L, Walters D, Melendi GA, Yamamoto M, Polack FP, and Kleeberger SR. Antiviral activity of Nrf2 in a murine model of respiratory syncytial virus disease. *Am J Respir Crit Care Med*. 2009;179(2):138-50.
659. Jin W, Zhu L, Guan Q, Chen G, Wang QF, Yin HX, Hang CH, Shi JX, and Wang HD. Influence of Nrf2 genotype on pulmonary NF-kappaB activity and inflammatory response after traumatic brain injury. *Ann Clin Lab Sci*. 2008;38(3):221-7.
660. Jeong WS, Kim IW, Hu R, and Kong AN. Modulatory properties of various natural chemopreventive agents on the activation of NF-kappaB signaling pathway. *Pharm Res*. 2004;21(4):661-70.

661. Xu C, Shen G, Chen C, Gelinas C, and Kong AN. Suppression of NF-kappaB and NF-kappaB-regulated gene expression by sulforaphane and PEITC through IkappaBalpha, IKK pathway in human prostate cancer PC-3 cells. *Oncogene*. 2005;24(28):4486-95.
662. Khodagholi F, and Tusi SK. Stabilization of Nrf2 by tBHQ prevents LPS-induced apoptosis in differentiated PC12 cells. *Mol Cell Biochem*. 2011;354(1-2):97-112.
663. Jin W, Ni H, Dai Y, Wang H, Lu T, Wu J, Jiang J, and Liang W. Effects of tert-butylhydroquinone on intestinal inflammatory response and apoptosis following traumatic brain injury in mice. *Mediators Inflamm*. 2010;2010(502564).
664. Liu GH, Qu J, and Shen X. NF-kappaB/p65 antagonizes Nrf2-ARE pathway by depriving CBP from Nrf2 and facilitating recruitment of HDAC3 to MafK. *Biochim Biophys Acta*. 2008;1783(5):713-27.
665. Altmeyer P, Hartwig R, and Matthes U. [Efficacy and safety profile of fumaric acid esters in oral long-term therapy with severe treatment refractory psoriasis vulgaris. A study of 83 patients]. *Hautarzt*. 1996;47(3):190-6.
666. Treumer F, Zhu K, Glaser R, and Mrowietz U. Dimethylfumarate is a potent inducer of apoptosis in human T cells. *J Invest Dermatol*. 2003;121(6):1383-8.
667. de Jong R, Bezemer AC, Zomerdijk TP, van de Pouw-Kraan T, Ottenhoff TH, and Nibbering PH. Selective stimulation of T helper 2 cytokine responses by the anti-psoriasis agent monomethylfumarate. *Eur J Immunol*. 1996;26(9):2067-74.
668. Ockenfels HM, Schultewolter T, Ockenfels G, Funk R, and Goos M. The antipsoriatic agent dimethylfumarate immunomodulates T-cell cytokine secretion and inhibits cytokines of the psoriatic cytokine network. *Br J Dermatol*. 1998;139(3):390-5.
669. Zoghi S, Amirghofran Z, Nikseresht A, Ashjzadeh N, Kamali-Sarvestani E, and Rezaei N. Cytokine secretion pattern in treatment of lymphocytes of multiple sclerosis patients with fumaric acid esters. *Immunol Invest*. 2011;40(6):581-96.
670. Moed H, Stoof TJ, Boorsma DM, von Blomberg BM, Gibbs S, Bruynzeel DP, Scheper RJ, and Rustemeyer T. Identification of anti-inflammatory drugs according to their capacity to suppress type-1 and type-2 T cell profiles. *Clin Exp Allergy*. 2004;34(12):1868-75.
671. Gerdes S, Shakery K, and Mrowietz U. Dimethylfumarate inhibits nuclear binding of nuclear factor kappaB but not of nuclear factor of activated T cells and CCAAT/enhancer binding protein beta in activated human T cells. *Br J Dermatol*. 2007;156(5):838-42.
672. Stoof TJ, Flier J, Sampat S, Nieboer C, Tensen CP, and Boorsma DM. The antipsoriatic drug dimethylfumarate strongly suppresses chemokine production in human keratinocytes and peripheral blood mononuclear cells. *Br J Dermatol*. 2001;144(6):1114-20.
673. Rubant SA, Ludwig RJ, Diehl S, Hardt K, Kaufmann R, Pfeilschifter JM, and Boehncke WH. Dimethylfumarate reduces leukocyte rolling in vivo through modulation of adhesion molecule expression. *J Invest Dermatol*. 2008;128(2):326-31.
674. Wilms H, Sievers J, Rickert U, Rostami-Yazdi M, Mrowietz U, and Lucius R. Dimethylfumarate inhibits microglial and astrocytic inflammation by suppressing the synthesis of nitric oxide, IL-1beta, TNF-alpha and IL-6 in an in-vitro model of brain inflammation. *J Neuroinflammation*. 2010;7(30).

675. Graber DJ, Hickey WF, Stommel EW, and Harris BT. Anti-inflammatory efficacy of dexamethasone and Nrf2 activators in the CNS using brain slices as a model of acute injury. *J Neuroimmune Pharmacol*. 2012;7(1):266-78.
676. Zhu K, and Mrowietz U. Enhancement of antibacterial superoxide-anion generation in human monocytes by fumaric acid esters. *Arch Dermatol Res*. 2005;297(4):170-6.
677. Srisook K, and Cha YN. Super-induction of HO-1 in macrophages stimulated with lipopolysaccharide by prior depletion of glutathione decreases iNOS expression and NO production. *Nitric Oxide*. 2005;12(2):70-9.
678. Zhu K, and Mrowietz U. Inhibition of dendritic cell differentiation by fumaric acid esters. *J Invest Dermatol*. 2001;116(2):203-8.
679. Litjens NH, Rademaker M, Ravensbergen B, Rea D, van der Plas MJ, Thio B, Walding A, van Dissel JT, and Nibbering PH. Monomethylfumarate affects polarization of monocyte-derived dendritic cells resulting in down-regulated Th1 lymphocyte responses. *Eur J Immunol*. 2004;34(2):565-75.
680. Litjens NH, Rademaker M, Ravensbergen B, Thio HB, van Dissel JT, and Nibbering PH. Effects of monomethylfumarate on dendritic cell differentiation. *Br J Dermatol*. 2006;154(2):211-7.
681. Ghoreschi K, Bruck J, Kellerer C, Deng C, Peng H, Rothfuss O, Hussain RZ, Gocke AR, Respa A, Glocova I, et al. Fumarates improve psoriasis and multiple sclerosis by inducing type II dendritic cells. *J Exp Med*. 2011;208(11):2291-303.
682. Loewe R, Pillinger M, de Martin R, Mrowietz U, Groger M, Holnthoner W, Wolff K, Wiegrebe W, Jirovsky D, and Petzelbauer P. Dimethylfumarate inhibits tumor-necrosis-factor-induced CD62E expression in an NF-kappa B-dependent manner. *J Invest Dermatol*. 2001;117(6):1363-8.
683. Loewe R, Holnthoner W, Groger M, Pillinger M, Gruber F, Mechtcheriakova D, Hofer E, Wolff K, and Petzelbauer P. Dimethylfumarate inhibits TNF-induced nuclear entry of NF-kappa B/p65 in human endothelial cells. *J Immunol*. 2002;168(9):4781-7.
684. Vandermeeren M, Janssens S, Borgers M, and Geysen J. Dimethylfumarate is an inhibitor of cytokine-induced E-selectin, VCAM-1, and ICAM-1 expression in human endothelial cells. *Biochem Biophys Res Commun*. 1997;234(1):19-23.
685. Wallbrecht K, Drick N, Hund AC, and Schon MP. Downregulation of endothelial adhesion molecules by dimethylfumarate, but not monomethylfumarate, and impairment of dynamic lymphocyte-endothelial cell interactions. *Exp Dermatol*. 2011;20(12):980-5.
686. Wierinckx A, Breve J, Mercier D, Schultzberg M, Drukarch B, and Van Dam AM. Detoxication enzyme inducers modify cytokine production in rat mixed glial cells. *J Neuroimmunol*. 2005;166(1-2):132-43.
687. Scannevin RH, Chollate S, Jung MY, Shackett M, Patel H, Bista P, Zeng W, Ryan S, Yamamoto M, Lukashev M, et al. Fumarates promote cytoprotection of central nervous system cells against oxidative stress via the nuclear factor (erythroid-derived 2)-like 2 pathway. *J Pharmacol Exp Ther*. 2012;341(1):274-84.
688. Linker RA, Lee DH, Ryan S, van Dam AM, Conrad R, Bista P, Zeng W, Hronowsky X, Buko A, Chollate S, et al. Fumaric acid esters exert neuroprotective effects in

- neuroinflammation via activation of the Nrf2 antioxidant pathway. *Brain : a journal of neurology*. 2011;134(Pt 3):678-92.
689. Albrecht P, Bouchachia I, Goebels N, Henke N, Hofstetter HH, Issberner A, Kovacs Z, Lewerenz J, Lisak D, Maher P, et al. Effects of dimethyl fumarate on neuroprotection and immunomodulation. *J Neuroinflammation*. 2012;9(163).
690. Moharreggh-Khiabani D, Blank A, Skripuletz T, Miller E, Kotsiari A, Gudi V, and Stangel M. Effects of fumaric acids on cuprizone induced central nervous system de- and remyelination in the mouse. *PloS One*. 2010;5(7):e11769.
691. Naldi L, and Gambini D. The clinical spectrum of psoriasis. *Clin Dermatol*. 2007;25(6):510-8.
692. Uyemura K, Yamamura M, Fivenson DF, Modlin RL, and Nickoloff BJ. The cytokine network in lesional and lesion-free psoriatic skin is characterized by a T-helper type 1 cell-mediated response. *J Invest Dermatol*. 1993;101(5):701-5.
693. Schlaak JF, Buslau M, Jochum W, Hermann E, Girndt M, Gallati H, Meyer zum Buschenfelde KH, and Fleischer B. T cells involved in psoriasis vulgaris belong to the Th1 subset. *J Invest Dermatol*. 1994;102(2):145-9.
694. Austin LM, Ozawa M, Kikuchi T, Walters IB, and Krueger JG. The majority of epidermal T cells in Psoriasis vulgaris lesions can produce type 1 cytokines, interferon-gamma, interleukin-2, and tumor necrosis factor-alpha, defining TC1 (cytotoxic T lymphocyte) and TH1 effector populations: a type 1 differentiation bias is also measured in circulating blood T cells in psoriatic patients. *J Invest Dermatol*. 1999;113(5):752-9.
695. Nickoloff BJ, Wrone-Smith T, Bonish B, and Porcelli SA. Response of murine and normal human skin to injection of allogeneic blood-derived psoriatic immunocytes: detection of T cells expressing receptors typically present on natural killer cells, including CD94, CD158, and CD161. *Arch Dermatol*. 1999;135(5):546-52.
696. Luszczek W, Manczak M, Cislo M, Nockowski P, Wisniewski A, Jasek M, and Kusnierczyk P. Gene for the activating natural killer cell receptor, KIR2DS1, is associated with susceptibility to psoriasis vulgaris. *Hum Immunol*. 2004;65(7):758-66.
697. Bonish B, Jullien D, Dutronc Y, Huang BB, Modlin R, Spada FM, Porcelli SA, and Nickoloff BJ. Overexpression of CD1d by keratinocytes in psoriasis and CD1d-dependent IFN-gamma production by NK-T cells. *J Immunol*. 2000;165(7):4076-85.
698. Nickoloff BJ, Qin JZ, and Nestle FO. Immunopathogenesis of psoriasis. *Clin Rev Allergy Immunol*. 2007;33(1-2):45-56.
699. Castela E, Archier E, Devaux S, Gallini A, Aractingi S, Cribier B, Jullien D, Aubin F, Bachelez H, Joly P, et al. Topical corticosteroids in plaque psoriasis: a systematic review of efficacy and treatment modalities. *J Eur Acad Dermatol Venereol*. 2012;26 Suppl 3(36-46).
700. Lebwohl M, Freeman AK, Chapman MS, Feldman SR, Hartle JE, and Henning A. Tacrolimus ointment is effective for facial and intertriginous psoriasis. *J Am Acad Dermatol*. 2004;51(5):723-30.
701. Gribetz C, Ling M, Lebwohl M, Pariser D, Draelos Z, Gottlieb AB, Zaias N, Chen DM, Parneix-Spake A, Hultsch T, et al. Pimecrolimus cream 1% in the treatment of

- intertriginous psoriasis: a double-blind, randomized study. *J Am Acad Dermatol*. 2004;51(5):731-8.
702. Gottlieb SL, Gilleaudeau P, Johnson R, Estes L, Woodworth TG, Gottlieb AB, and Krueger JG. Response of psoriasis to a lymphocyte-selective toxin (DAB389IL-2) suggests a primary immune, but not keratinocyte, pathogenic basis. *Nat Med*. 1995;1(5):442-7.
703. Leonardi CL, Powers JL, Matheson RT, Goffe BS, Zitnik R, Wang A, and Gottlieb AB. Etanercept as monotherapy in patients with psoriasis. *N Engl J Med*. 2003;349(21):2014-22.
704. Reich K, Nestle FO, Papp K, Ortonne JP, Evans R, Guzzo C, Li S, Dooley LT, and Griffiths CE. Infliximab induction and maintenance therapy for moderate-to-severe psoriasis: a phase III, multicentre, double-blind trial. *Lancet*. 2005;366(9494):1367-74.
705. Leonardi C, Langley RG, Papp K, Tying SK, Wasel N, Vender R, Unnebrink K, Gupta SR, Valdecantos WC, and Bagel J. Adalimumab for treatment of moderate to severe chronic plaque psoriasis of the hands and feet: efficacy and safety results from REACH, a randomized, placebo-controlled, double-blind trial. *Arch Dermatol*. 2011;147(4):429-36.
706. Dimon-Gadal S, Gerbaud P, Therond P, Guibourdenche J, Anderson WB, Evain-Brion D, and Raynaud F. Increased oxidative damage to fibroblasts in skin with and without lesions in psoriasis. *J Invest Dermatol*. 2000;114(5):984-9.
707. Relhan V, Gupta SK, Dayal S, Pandey R, and Lal H. Blood thiols and malondialdehyde levels in psoriasis. *J Dermatol*. 2002;29(7):399-403.
708. Nakai K, Yoneda K, Maeda R, Munehiro A, Fujita N, Yokoi I, Moriue J, Moriue T, Kosaka H, and Kubota Y. Urinary biomarker of oxidative stress in patients with psoriasis vulgaris and atopic dermatitis. *J Eur Acad Dermatol Venereol*. 2009;23(12):1405-8.
709. Ferretti G, Bacchetti T, Campanati A, Simonetti O, Liberati G, and Offidani A. Correlation between lipoprotein(a) and lipid peroxidation in psoriasis: role of the enzyme paraoxonase-1. *Br J Dermatol*. 2012;166(1):204-7.
710. Coaccioli S, Panaccione A, Biondi R, Sabatini C, Landucci P, Del Giorno R, Fantera M, Monno Mondo A, Di Cato L, Paladini A, et al. Evaluation of oxidative stress in rheumatoid and psoriatic arthritis and psoriasis. *Clin Ter*. 2009;160(6):467-72.
711. Asefi M, Vaisi-Raygani A, Bahrehmand F, Kiani A, Rahimi Z, Nomani H, Ebrahimi A, Tavilani H, and Pourmotabbed T. Paraoxonase 1 (PON1) 55 polymorphism, lipid profiles and psoriasis. *Br J Dermatol*. 2012;167(6):1279-86.
712. Nugteren-Huying WM, van der Schroeff JG, Hermans J, and Suurmond D. Fumaric acid therapy for psoriasis: a randomized, double-blind, placebo-controlled study. *J Am Acad Dermatol*. 1990;22(2 Pt 1):311-2.
713. Kolbach DN, and Nieboer C. Fumaric acid therapy in psoriasis: results and side effects of 2 years of treatment. *J Am Acad Dermatol*. 1992;27(5 Pt 1):769-71.
714. Altmeyer PJ, Matthes U, Pawlak F, Hoffmann K, Frosch PJ, Ruppert P, Wassilew SW, Horn T, Kreysel HW, Lutz G, et al. Antipsoriatic effect of fumaric acid derivatives. Results of a multicenter double-blind study in 100 patients. *J Am Acad Dermatol*. 1994;30(6):977-81.

715. Nieboer C, de Hoop D, Langendijk PN, van Loenen AC, and Gubbels J. Fumaric acid therapy in psoriasis: a double-blind comparison between fumaric acid compound therapy and monotherapy with dimethylfumaric acid ester. *Dermatologica*. 1990;181(1):33-7.
716. Mrowietz U, Christophers E, and Altmeyer P. Treatment of psoriasis with fumaric acid esters: results of a prospective multicentre study. German Multicentre Study. *Br J Dermatol*. 1998;138(3):456-60.
717. Reich K, Thaci D, Mrowietz U, Kamps A, Neureither M, and Luger T. Efficacy and safety of fumaric acid esters in the long-term treatment of psoriasis--a retrospective study (FUTURE). *J Dtsch Dermatol Ges*. 2009;7(7):603-11.
718. Bovenschen HJ, Langewouters AM, and van de Kerkhof PC. Dimethylfumarate for psoriasis: Pronounced effects on lesional T-cell subsets, epidermal proliferation and differentiation, but not on natural killer T cells in immunohistochemical study. *Am J Clin Dermatol*. 2010;11(5):343-50.
719. Wain EM, Darling MI, Pleass RD, Barker JN, and Smith CH. Treatment of severe, recalcitrant, chronic plaque psoriasis with fumaric acid esters: a prospective study. *Br J Dermatol*. 2010;162(2):427-34.
720. Homey B, and Meller S. Chemokines and other mediators as therapeutic targets in psoriasis vulgaris. *Clin Dermatol*. 2008;26(5):539-45.
721. Thio HB, Zomerdijk TP, Oudshoorn C, Kempenaar J, Nibbering PH, van der Schroeff JG, and Ponc M. Fumaric acid derivatives evoke a transient increase in intracellular free calcium concentration and inhibit the proliferation of human keratinocytes. *Br J Dermatol*. 1994;131(6):856-61.
722. Sebok B, Bonnekoh B, Geisel J, and Mahrle G. Antiproliferative and cytotoxic profiles of antipsoriatic fumaric acid derivatives in keratinocyte cultures. *Eur J Pharmacol*. 1994;270(1):79-87.
723. Paukkonen K, Naukkarinen A, and Horsmanheimo M. The development of manifest psoriatic lesions is linked with the invasion of CD8 + T cells and CD11c + macrophages into the epidermis. *Arch Dermatol Res*. 1992;284(7):375-9.
724. Cabrijan L, Lipozencic J, Batinac T, Peternel S, and Pastar Z. The role of CD4 and CD8 lymphocytes and macrophages in psoriasis vulgaris. *Acta Dermatovenerol Croat*. 2009;17(3):162-5.
725. Ramirez-Bosca A, Martinez-Ojeda L, Valcuende-Cavero F, and Castells-Rodellas A. A study of local immunity in psoriasis. *Br J Dermatol*. 1988;119(5):587-95.
726. Bovenschen HJ, Seyger MM, and Van de Kerkhof PC. Plaque psoriasis vs. atopic dermatitis and lichen planus: a comparison for lesional T-cell subsets, epidermal proliferation and differentiation. *Br J Dermatol*. 2005;153(1):72-8.
727. Weber HO, Borelli C, Rocken M, and Schaller M. Treatment of disseminated granuloma annulare with low-dose fumaric acid. *Acta Derm Venereol*. 2009;89(3):295-8.
728. Eberlein-Konig B, Mempel M, Stahlecker J, Forer I, Ring J, and Abeck D. Disseminated granuloma annulare--treatment with fumaric acid esters. *Dermatology*. 2005;210(3):223-6.

729. Nowack U, Gambichler T, Hanefeld C, Kastner U, and Altmeyer P. Successful treatment of recalcitrant cutaneous sarcoidosis with fumaric acid esters. *BMC Dermatol.* 2002;2(15).
730. Hoefnagel JJ, Thio HB, Willemze R, and Bouwes Bavinck JN. Long-term safety aspects of systemic therapy with fumaric acid esters in severe psoriasis. *Br J Dermatol.* 2003;149(2):363-9.
731. Kappos L, Gold R, Miller DH, Macmanus DG, Havrdova E, Limmroth V, Polman CH, Schmierer K, Yousry TA, Yang M, et al. Efficacy and safety of oral fumarate in patients with relapsing-remitting multiple sclerosis: a multicentre, randomised, double-blind, placebo-controlled phase IIb study. *Lancet.* 2008;372(9648):1463-72.
732. Rosati G. The prevalence of multiple sclerosis in the world: an update. *Neurol Sci.* 2001;22(2):117-39.
733. Pugliatti M, Sotgiu S, and Rosati G. The worldwide prevalence of multiple sclerosis. *Clin Neurol Neurosurg.* 2002;104(3):182-91.
734. Hogancamp WE, Rodriguez M, and Weinshenker BG. The epidemiology of multiple sclerosis. *Mayo Clin Proc.* 1997;72(9):871-8.
735. Stüve O, and Oksenberg J. In: Pagon R, Bird T, Dolan C, and al. e eds. *GeneReviews™ [Internet]*. Seattle (WA): University of Washington, Seattle; 2006 Jan 10 (Updated 2010 May 11).
736. Weiner HL. Multiple sclerosis is an inflammatory T-cell-mediated autoimmune disease. *Arch Neurol.* 2004;61(10):1613-5.
737. Stys PK, Zamponi GW, van Minnen J, and Geurts JJ. Will the real multiple sclerosis please stand up? *Nat Rev Neurosci.* 2012;13(7):507-14.
738. Rodriguez M, and Scheithauer B. Ultrastructure of multiple sclerosis. *Ultrastruct Pathol.* 1994;18(1-2):3-13.
739. Aboul-Enein F, Rauschka H, Kornek B, Stadelmann C, Stefferl A, Bruck W, Lucchinetti C, Schmidbauer M, Jellinger K, and Lassmann H. Preferential loss of myelin-associated glycoprotein reflects hypoxia-like white matter damage in stroke and inflammatory brain diseases. *J Neuropathol Exp Neurol.* 2003;62(1):25-33.
740. Barnett MH, and Prineas JW. Relapsing and remitting multiple sclerosis: pathology of the newly forming lesion. *Ann Neurol.* 2004;55(4):458-68.
741. Henderson AP, Barnett MH, Parratt JD, and Prineas JW. Multiple sclerosis: distribution of inflammatory cells in newly forming lesions. *Ann Neurol.* 2009;66(6):739-53.
742. Inglese M, Mancardi GL, Pagani E, Rocca MA, Murialdo A, Saccardi R, Comi G, and Filippi M. Brain tissue loss occurs after suppression of enhancement in patients with multiple sclerosis treated with autologous haematopoietic stem cell transplantation. *J Neurol Neurosurg Psychiatry.* 2004;75(4):643-4.
743. Metz I, Lucchinetti CF, Openshaw H, Garcia-Merino A, Lassmann H, Freedman MS, Atkins HL, Azzarelli B, Kolar OJ, and Bruck W. Autologous haematopoietic stem cell transplantation fails to stop demyelination and neurodegeneration in multiple sclerosis. *Brain.* 2007;130(Pt 5):1254-62.

744. Jacobs LD, Cookfair DL, Rudick RA, Herndon RM, Richert JR, Salazar AM, Fischer JS, Goodkin DE, Granger CV, Simon JH, et al. Intramuscular interferon beta-1a for disease progression in relapsing multiple sclerosis. The Multiple Sclerosis Collaborative Research Group (MSCRG). *Ann Neurol*. 1996;39(3):285-94.
745. Reichard O, Norkrans G, Fryden A, Braconier JH, Sonnerborg A, and Weiland O. Randomised, double-blind, placebo-controlled trial of interferon alpha-2b with and without ribavirin for chronic hepatitis C. The Swedish Study Group. *Lancet*. 1998;351(9096):83-7.
746. Johnson KP, Brooks BR, Cohen JA, Ford CC, Goldstein J, Lisak RP, Myers LW, Panitch HS, Rose JW, and Schiffer RB. Copolymer 1 reduces relapse rate and improves disability in relapsing-remitting multiple sclerosis: results of a phase III multicenter, double-blind placebo-controlled trial. The Copolymer 1 Multiple Sclerosis Study Group. *Neurology*. 1995;45(7):1268-76.
747. Comi G, Filippi M, and Wolinsky JS. European/Canadian multicenter, double-blind, randomized, placebo-controlled study of the effects of glatiramer acetate on magnetic resonance imaging--measured disease activity and burden in patients with relapsing multiple sclerosis. European/Canadian Glatiramer Acetate Study Group. *Ann Neurol*. 2001;49(3):290-7.
748. Cohen JA, Barkhof F, Comi G, Hartung HP, Khatri BO, Montalban X, Pelletier J, Capra R, Gallo P, Izquierdo G, et al. Oral fingolimod or intramuscular interferon for relapsing multiple sclerosis. *N Engl J Med*. 2010;362(5):402-15.
749. O'Connor P, Wolinsky JS, Confavreux C, Comi G, Kappos L, Olsson TP, Benzerdjeb H, Truffinet P, Wang L, Miller A, et al. Randomized trial of oral teriflunomide for relapsing multiple sclerosis. *N Engl J Med*. 2011;365(14):1293-303.
750. Lassmann H, and Ransohoff RM. The CD4-Th1 model for multiple sclerosis: a critical [correction of crucial] re-appraisal. *Trends Immunol*. 2004;25(3):132-7.
751. Ffrench-Constant C. Pathogenesis of multiple sclerosis. *Lancet*. 1994;343(8892):271-5.
752. Nylander A, and Hafler DA. Multiple sclerosis. *J Clin Invest*. 2012;122(4):1180-8.
753. Schimrigk S, Brune N, Hellwig K, Lukas C, Bellenberg B, Rieks M, Hoffmann V, Pohlau D, and Przuntek H. Oral fumaric acid esters for the treatment of active multiple sclerosis: an open-label, baseline-controlled pilot study. *Eur J Neurol*. 2006;13(6):604-10.
754. Confavreux C, and Vukusic S. Non-specific immunosuppressants in the treatment of multiple sclerosis. *Clin Neurol Neurosurg*. 2004;106(3):263-9.
755. Schilling S, Goelz S, Linker R, Luehder F, and Gold R. Fumaric acid esters are effective in chronic experimental autoimmune encephalomyelitis and suppress macrophage infiltration. *Clin Exp Immunol*. 2006;145(1):101-7.
756. Witte ME, Bo L, Rodenburg RJ, Belien JA, Musters R, Hazes T, Wintjes LT, Smeitink JA, Geurts JJ, De Vries HE, et al. Enhanced number and activity of mitochondria in multiple sclerosis lesions. *J Pathol*. 2009;219(2):193-204.
757. Van Horssen J, Witte ME, Schreibelt G, and de Vries HE. Radical changes in multiple sclerosis pathogenesis. *Biochim Biophys Acta*. 2011;1812(2):141-50.
758. Bedard K, and Krause KH. The NOX family of ROS-generating NADPH oxidases: physiology and pathophysiology. *Physiol Rev*. 2007;87(1):245-313.

759. Liu JS, Zhao ML, Brosnan CF, and Lee SC. Expression of inducible nitric oxide synthase and nitrotyrosine in multiple sclerosis lesions. *Am J Pathol.* 2001;158(6):2057-66.
760. Gray E, Thomas TL, Betmouni S, Scolding N, and Love S. Elevated myeloperoxidase activity in white matter in multiple sclerosis. *Neurosci Lett.* 2008;444(2):195-8.
761. Lin SX, Lisi L, Dello Russo C, Polak PE, Sharp A, Weinberg G, Kalinin S, and Feinstein DL. The anti-inflammatory effects of dimethyl fumarate in astrocytes involve glutathione and haem oxygenase-1. *ASN Neuro.* 2011;3(2):e00055.
762. Ross CA, and Tabrizi SJ. Huntington's disease: from molecular pathogenesis to clinical treatment. *Lancet Neurol.* 2011;10(1):83-98.
763. Chen CM. Mitochondrial dysfunction, metabolic deficits, and increased oxidative stress in Huntington's disease. *Chang Gung Med J.* 2011;34(2):135-52.
764. Ellrichmann G, Petrasch-Parwez E, Lee DH, Reick C, Arning L, Saft C, Gold R, and Linker RA. Efficacy of fumaric acid esters in the R6/2 and YAC128 models of Huntington's disease. *PLoS One.* 2011;6(1):e16172.
765. Johri A, and Beal MF. Antioxidants in Huntington's disease. *Biochim Biophys Acta.* 2012;1822(5):664-74.
766. Farooq AV, and Shukla D. Herpes simplex epithelial and stromal keratitis: an epidemiologic update. *Surv Ophthalmol.* 2012;57(5):448-62.
767. Niemieltowski MG, and Rouse BT. Predominance of Th1 cells in ocular tissues during herpetic stromal keratitis. *J Immunol.* 1992;149(9):3035-9.
768. Hendricks RL, Tumpey TM, and Finnegan A. IFN-gamma and IL-2 are protective in the skin but pathologic in the corneas of HSV-1-infected mice. *J Immunol.* 1992;149(9):3023-8.
769. Tang Q, Chen W, and Hendricks RL. Proinflammatory functions of IL-2 in herpes simplex virus corneal infection. *J Immunol.* 1997;158(3):1275-83.
770. Inoue Y. Immunological aspects of herpetic stromal keratitis. *Semin Ophthalmol.* 2008;23(4):221-7.
771. Hawthorne KM, Dana R, and Chodosh J. Delayed type hypersensitivity in the pathogenesis of recurrent herpes stromal keratitis. *Semin Ophthalmol.* 2011;26(4-5):246-50.
772. Heiligenhaus A, Li H, Wasmuth S, and Bauer D. Influence of dimethylfumarate on experimental HSV-1 necrotizing keratitis. *Graefes Arch Clin Exp Ophthalmol.* 2004;42(10):870-7.
773. Heiligenhaus A, Li H, Schmitz A, Wasmuth S, and Bauer D. Improvement of herpetic stromal keratitis with fumaric acid derivative is associated with systemic induction of T helper 2 cytokines. *Clin Exp Immunol.* 2005;142(1):180-7.
774. Heiligenhaus A, Bauer D, Zheng M, Mrzyk S, and Steuhl KP. CD4+ T-cell type 1 and type 2 cytokines in the HSV-1 infected cornea. *Graefes Arch Clin Exp Ophthalmol.* 1999;37(5):399-406.

775. Heiligenhaus A, Jayaraman S, Soukiasian S, Dorf M, and Foster CS. [Glycoprotein D (5-23) specific Th2-T-cell line induces HSV-1 keratitis]. *Ophthalmologie*. 1995;92(4):484-91.
776. Kasang C, Ulmer A, Donhauser N, Schmidt B, Stich A, Klinker H, Kalluvya S, Koutsilier E, Rethwilm A, and Scheller C. HIV patients treated with low-dose prednisolone exhibit lower immune activation than untreated patients. *BMC Infect Dis*. 2012;12(14).
777. Andrieu JM, and Lu W. Long-term clinical, immunologic and virologic impact of glucocorticoids on the chronic phase of HIV infection. *BMC Med*. 2004;2(17).
778. Andrieu JM, Lu W, and Levy R. Sustained increases in CD4 cell counts in asymptomatic human immunodeficiency virus type 1-seropositive patients treated with prednisolone for 1 year. *J Infect Dis*. 1995;171(3):523-30.
779. Wallis RS, Kalayjian R, Jacobson JM, Fox L, Purdue L, Shikuma CM, Arakaki R, Snyder S, Coombs RW, Bosch RJ, et al. A study of the immunology, virology, and safety of prednisone in HIV-1-infected subjects with CD4 cell counts of 200 to 700 mm⁻³. *J Acquir Immune Defic Syndr*. 2003;32(3):281-6.
780. Rizzardì GP, Harari A, Capiluppi B, Tambussi G, Ellefsen K, Ciuffreda D, Champagne P, Bart PA, Chave JP, Lazzarin A, et al. Treatment of primary HIV-1 infection with cyclosporin A coupled with highly active antiretroviral therapy. *J Clin Invest*. 2002;109(5):681-8.
781. Markowitz M, Vaida F, Hare CB, Boden D, Mohri H, Hecht FM, Kalayjian RC, Conrad A, Mildvan D, Aberg J, et al. The virologic and immunologic effects of cyclosporine as an adjunct to antiretroviral therapy in patients treated during acute and early HIV-1 infection. *J Infect Dis*. 2010;201(9):1298-302.
782. Zhao GJ, Li DK, Wolinsky JS, Koopmans RA, Mielowski W, Redekop WK, Riddehough A, Cover K, and Paty DW. Clinical and magnetic resonance imaging changes correlate in a clinical trial monitoring cyclosporine therapy for multiple sclerosis. The MS Study Group. *J Neuroimaging*. 1997;7(1):1-7.
783. Group TMSS. Efficacy and toxicity of cyclosporine in chronic progressive multiple sclerosis: a randomized, double-blinded, placebo-controlled clinical trial. *Ann Neurol*. 1990;27(6):591-605.
784. Steck AJ, Regli F, Ochsner F, and Gauthier G. Cyclosporine versus azathioprine in the treatment of multiple sclerosis: 12-month clinical and immunological evaluation. *Eur Neurol*. 1990;30(4):224-8.
785. Rudge P, Koetsier JC, Mertin J, Mispelblom Beyer JO, Van Walbeek HK, Clifford Jones R, Harrison J, Robinson K, Mellein B, Poole T, et al. Randomised double blind controlled trial of cyclosporin in multiple sclerosis. *J Neurol Neurosurg Psychiatry*. 1989;52(5):559-65.
786. Cummins NW, and Badley AD. Mechanisms of HIV-associated lymphocyte apoptosis: 2010. *Cell Death Dis*. 2010;1(e99).
787. Theiss AL, Vijay-Kumar M, Obertone TS, Jones DP, Hansen JM, Gewirtz AT, Merlin D, and Sitaraman SV. Prohibitin is a novel regulator of antioxidant response that attenuates colonic inflammation in mice. *Gastroenterology*. 2009;137(1):199-208.
788. Yanaka A, Sato J, and Ohmori S. Sulforaphane protects small intestinal mucosa from aspirin/NSAID-induced injury by enhancing host defense systems against oxidative

- stress and by inhibiting mucosal invasion of anaerobic enterobacteria. *Curr Pharm Des.* 2013;19(1):157-62.
789. Yeh CT, Chiu HF, and Yen GC. Protective effect of sulforaphane on indomethacin-induced cytotoxicity via heme oxygenase-1 expression in human intestinal Int 407 cells. *Mol Nutr Food Res.* 2009;53(9):1166-76.
790. Cheng YT, Wu CH, Ho CY, and Yen GC. Catechin protects against ketoprofen-induced oxidative damage of the gastric mucosa by up-regulating Nrf2 in vitro and in vivo. *J Nutr Biochem.* 2013;24(2):475-83.
791. Jin W, Wang HD, Hu ZG, Yan W, Chen G, and Yin HX. Transcription factor Nrf2 plays a pivotal role in protection against traumatic brain injury-induced acute intestinal mucosal injury in mice. *J Surg Res.* 2009;157(2):251-60.
792. Poli G, Kinter A, Justement JS, Kehrl JH, Bressler P, Stanley S, and Fauci AS. Tumor necrosis factor alpha functions in an autocrine manner in the induction of human immunodeficiency virus expression. *Proc Natl Acad Sci U S A.* 1990;87(2):782-5.
793. Butera ST, Roberts BD, and Folks TM. Regulation of HIV-1 expression by cytokine networks in a CD4+ model of chronic infection. *J Immunol.* 1993;150(2):625-34.
794. Gatignol A, Buckler-White A, Berkhout B, and Jeang KT. Characterization of a human TAR RNA-binding protein that activates the HIV-1 LTR. *Science.* 1991;251(5001):1597-600.
795. Duh EJ, Maury WJ, Folks TM, Fauci AS, and Rabson AB. Tumor necrosis factor alpha activates human immunodeficiency virus type 1 through induction of nuclear factor binding to the NF-kappa B sites in the long terminal repeat. *Proc Natl Acad Sci U S A.* 1989;86(15):5974-8.
796. Davis DA, Yusa K, Gillim LA, Newcomb FM, Mitsuya H, and Yarchoan R. Conserved cysteines of the human immunodeficiency virus type 1 protease are involved in regulation of polyprotein processing and viral maturation of immature virions. *J Virol.* 1999;73(2):1156-64.
797. Look MP, Rockstroh JK, Rao GS, Barton S, Lemoch H, Kaiser R, Kupfer B, Sudhop T, Spengler U, and Sauerbruch T. Sodium selenite and N-acetylcysteine in antiretroviral-naive HIV-1-infected patients: a randomized, controlled pilot study. *Eur J Clin Invest.* 1998;28(5):389-97.
798. De Rosa SC, Zaretsky MD, Dubs JG, Roederer M, Anderson M, Green A, Mitra D, Watanabe N, Nakamura H, Tjioe I, et al. N-acetylcysteine replenishes glutathione in HIV infection. *Eur J Clin Invest.* 2000;30(10):915-29.
799. Treitinger A, Spada C, Masokawa IY, Verdi JC, Van Der Sander Silveira M, Luis MC, Reis M, Ferreira SI, and Abdalla DS. Effect of N-acetyl-L-cysteine on lymphocyte apoptosis, lymphocyte viability, TNF-alpha and IL-8 in HIV-infected patients undergoing anti-retroviral treatment. *Braz J Infect Dis.* 2004;8(5):363-71.
800. Spada C, Treitinger A, Reis M, Masokawa IY, Verdi JC, Luiz MC, Silveira MV, Michelon CM, Avila-Junior S, Gil I D, et al. The effect of N-acetylcysteine supplementation upon viral load, CD4, CD8, total lymphocyte count and hematocrit in individuals undergoing antiretroviral treatment. *Clin Chem Lab Med.* 2002;40(5):452-5.

801. Constans J, Delmas-Beauvieux MC, Sergeant C, Peuchant E, Pellegrin JL, Pellegrin I, Clerc M, Fleury H, Simonoff M, Leng B, et al. One-year antioxidant supplementation with beta-carotene or selenium for patients infected with human immunodeficiency virus: a pilot study. *Clin Infect Dis*. 1996;23(3):654-6.
802. Burbano X, Miguez-Burbano MJ, McCollister K, Zhang G, Rodriguez A, Ruiz P, Lecusay R, and Shor-Posner G. Impact of a selenium chemoprevention clinical trial on hospital admissions of HIV-infected participants. *HIV Clin Trials*. 2002;3(6):483-91.
803. Hurwitz BE, Klaus JR, Llabre MM, Gonzalez A, Lawrence PJ, Maher KJ, Greeson JM, Baum MK, Shor-Posner G, Skyler JS, et al. Suppression of human immunodeficiency virus type 1 viral load with selenium supplementation: a randomized controlled trial. *Arch Intern Med*. 2007;167(2):148-54.
804. Yi JH, and Hazell AS. N-acetylcysteine attenuates early induction of heme oxygenase-1 following traumatic brain injury. *Brain Res*. 2005;1033(1):13-9.
805. Romanque P, Cornejo P, Valdes S, and Videla LA. Thyroid hormone administration induces rat liver Nrf2 activation: suppression by N-acetylcysteine pretreatment. *Thyroid*. 2011;21(6):655-62.
806. Chen F, Lewis W, Hollander JM, Baseler W, and Finkel MS. N-acetylcysteine reverses cardiac myocyte dysfunction in HIV-Tat proteinopathy. *J Appl Physiol*. 2012;113(1):105-13.
807. Burk RF, Hill KE, Nakayama A, Mostert V, Levander XA, Motley AK, Johnson DA, Johnson JA, Freeman ML, and Austin LM. Selenium deficiency activates mouse liver Nrf2-ARE but vitamin E deficiency does not. *Free Radic Biol Med*. 2008;44(8):1617-23.
808. Wagner AE, Boesch-Saadatmandi C, Breckwoldt D, Schrader C, Schmelzer C, Doring F, Hashida K, Hori O, Matsugo S, and Rimbach G. Ascorbic acid partly antagonizes resveratrol mediated heme oxygenase-1 but not paraoxonase-1 induction in cultured hepatocytes - role of the redox-regulated transcription factor Nrf2. *BMC Complement Altern Med*. 2011;11(1).
809. Tarumoto T, Nagai T, Ohmine K, Miyoshi T, Nakamura M, Kondo T, Mitsugi K, Nakano S, Muroi K, Komatsu N, et al. Ascorbic acid restores sensitivity to imatinib via suppression of Nrf2-dependent gene expression in the imatinib-resistant cell line. *Exp Hematol*. 2004;32(4):375-81.
810. Yubero-Serrano EM, Gonzalez-Guardia L, Rangel-Zuniga O, Delgado-Casado N, Delgado-Lista J, Perez-Martinez P, Garcia-Rios A, Caballero J, Marin C, Gutierrez-Mariscal FM, et al. Postprandial antioxidant gene expression is modified by Mediterranean diet supplemented with coenzyme Q(10) in elderly men and women. *Age*. 2013;35(1):159-70.
811. Dinkova-Kostova AT, Cheah J, Samouilov A, Zweier JL, Bozak RE, Hicks RJ, and Talalay P. Phenolic Michael reaction acceptors: combined direct and indirect antioxidant defenses against electrophiles and oxidants. *Med Chem*. 2007;3(3):261-8.
812. Carrillo MC, Kitani K, Kanai S, Sato Y, Miyasaka K, and Ivy GO. (-)-deprenyl increases activities of superoxide dismutase and catalase in certain brain regions in old male mice. *Life Sci*. 1994;54(14):975-81.

813. Matsui Y, and Kumagae Y. Monoamine oxidase inhibitors prevent striatal neuronal necrosis induced by transient forebrain ischemia. *Neurosci Lett*. 1991;126(2):175-8.
814. Ansari KS, Yu PH, Kruck TP, and Tatton WG. Rescue of axotomized immature rat facial motoneurons by R(-)-deprenyl: stereospecificity and independence from monoamine oxidase inhibition. *J Neurosci*. 1993;13(9):4042-53.
815. Palhagen S, Heinonen E, Hagglund J, Kaugesaar T, Maki-Ikola O, and Palm R. Selegiline slows the progression of the symptoms of Parkinson disease. *Neurology*. 2006;66(8):1200-6.
816. Sano M, Ernesto C, Thomas RG, Klauber MR, Schafer K, Grundman M, Woodbury P, Growdon J, Cotman CW, Pfeiffer E, et al. A controlled trial of selegiline, alpha-tocopherol, or both as treatment for Alzheimer's disease. The Alzheimer's Disease Cooperative Study. *N Engl J Med*. 1997;336(17):1216-22.
817. Nakaso K, Nakamura C, Sato H, Imamura K, Takeshima T, and Nakashima K. Novel cytoprotective mechanism of anti-parkinsonian drug deprenyl: PI3K and Nrf2-derived induction of antioxidative proteins. *Biochem Biophys Res Commun*. 2006;339(3):915-22.
818. Schifitto G, Yiannoutsos CT, Ernst T, Navia BA, Nath A, Sacktor N, Anderson C, Marra CM, and Clifford DB. Selegiline and oxidative stress in HIV-associated cognitive impairment. *Neurology*. 2009;73(23):1975-81.
819. Schifitto G, Zhang J, Evans SR, Sacktor N, Simpson D, Millar LL, Hung VL, Miller EN, Smith E, Ellis RJ, et al. A multicenter trial of selegiline transdermal system for HIV-associated cognitive impairment. *Neurology*. 2007;69(13):1314-21.
820. Evans SR, Yeh TM, Sacktor N, Clifford DB, Simpson D, Miller EN, Ellis RJ, Valcour V, Marra CM, Millar L, et al. Selegiline transdermal system (STS) for HIV-associated cognitive impairment: open-label report of ACTG 5090. *HIV Clin Trials*. 2007;8(6):437-46.
821. Phillips AN, Neaton J, and Lundgren JD. The role of HIV in serious diseases other than AIDS. *AIDS*. 2008;22(18):2409-18.
822. Deeks SG, and Phillips AN. HIV infection, antiretroviral treatment, ageing, and non-AIDS related morbidity. *BMJ*. 2009;338(a3172).
823. Triant VA, Lee H, Hadigan C, and Grinspoon SK. Increased acute myocardial infarction rates and cardiovascular risk factors among patients with human immunodeficiency virus disease. *J Clin Endocrinol Metab*. 2007;92(7):2506-12.
824. Currier JS, Taylor A, Boyd F, Dezii CM, Kawabata H, Burtcel B, Maa JF, and Hodder S. Coronary heart disease in HIV-infected individuals. *J Acquir Immune Defic Syndr*. 2003;33(4):506-12.
825. Ridker PM, Cushman M, Stampfer MJ, Tracy RP, and Hennekens CH. Inflammation, aspirin, and the risk of cardiovascular disease in apparently healthy men. *N Engl J Med*. 1997;336(14):973-9.
826. Ridker PM, Hennekens CH, Buring JE, and Rifai N. C-reactive protein and other markers of inflammation in the prediction of cardiovascular disease in women. *N Engl J Med*. 2000;342(12):836-43.

827. Pai JK, Pischon T, Ma J, Manson JE, Hankinson SE, Joshipura K, Curhan GC, Rifai N, Cannuscio CC, Stampfer MJ, et al. Inflammatory markers and the risk of coronary heart disease in men and women. *N Engl J Med*. 2004;351(25):2599-610.
828. Hsue PY, Deeks SG, and Hunt PW. Immunologic basis of cardiovascular disease in HIV-infected adults. *J Infect Dis*. 2012;205 Suppl 3(S375-82).
829. Hulsmans M, and Holvoet P. The vicious circle between oxidative stress and inflammation in atherosclerosis. *J Cell Mol Med*. 2010;14(1-2):70-8.
830. Hansson GK. Inflammation, atherosclerosis, and coronary artery disease. *N Engl J Med*. 2005;352(16):1685-95.
831. Raidel SM, Haase C, Jansen NR, Russ RB, Sutliff RL, Velsor LW, Day BJ, Hoit BD, Samarel AM, and Lewis W. Targeted myocardial transgenic expression of HIV Tat causes cardiomyopathy and mitochondrial damage. *Am J Physiol Heart Circ Physiol*. 2002;282(5):H1672-8.
832. Brown TT, and Qaqish RB. Antiretroviral therapy and the prevalence of osteopenia and osteoporosis: a meta-analytic review. *AIDS*. 2006;20(17):2165-74.
833. Aukrust P, Haug CJ, Ueland T, Lien E, Muller F, Espevik T, Bollerslev J, and Froland SS. Decreased bone formative and enhanced resorptive markers in human immunodeficiency virus infection: indication of normalization of the bone-remodeling process during highly active antiretroviral therapy. *J Clin Endocrinol Metab*. 1999;84(1):145-50.
834. Fakruddin JM, and Laurence J. HIV envelope gp120-mediated regulation of osteoclastogenesis via receptor activator of nuclear factor kappa B ligand (RANKL) secretion and its modulation by certain HIV protease inhibitors through interferon-gamma/RANKL cross-talk. *J Biol Chem*. 2003;278(48):48251-8.
835. Lam J, Abu-Amer Y, Nelson CA, Fremont DH, Ross FP, and Teitelbaum SL. Tumour necrosis factor superfamily cytokines and the pathogenesis of inflammatory osteolysis. *Ann Rheum Dis*. 2002;61 Suppl 2(ii82-3).
836. Romas E, Gillespie MT, and Martin TJ. Involvement of receptor activator of NFkappaB ligand and tumor necrosis factor-alpha in bone destruction in rheumatoid arthritis. *Bone*. 2002;30(2):340-6.
837. Boyle WJ, Simonet WS, and Lacey DL. Osteoclast differentiation and activation. *Nature*. 2003;423(6937):337-42.
838. Islam FM, Wu J, Jansson J, and Wilson DP. Relative risk of renal disease among people living with HIV: a systematic review and meta-analysis. *BMC Public Health*. 2012;12(234).
839. Maggi P, Bartolozzi D, Bonfanti P, Calza L, Cherubini C, Di Biagio A, Marcotullio S, Montella F, Montinaro V, Mussini C, et al. Renal complications in HIV disease: between present and future. *AIDS Rev*. 2012;14(1):37-53.
840. Mocroft A, Reiss P, Gasiorowski J, Ledergerber B, Kowalska J, Chiesi A, Gatell J, Rakhmanova A, Johnson M, Kirk O, et al. Serious fatal and nonfatal non-AIDS-defining illnesses in Europe. *J Acquir Immune Defic Syndr*. 2010;55(2):262-70.
841. Smit C, Geskus R, Walker S, Sabin C, Coutinho R, Porter K, and Prins M. Effective therapy has altered the spectrum of cause-specific mortality following HIV seroconversion. *AIDS*. 2006;20(5):741-9.

842. Palella FJ, Jr., Baker RK, Moorman AC, Chmiel JS, Wood KC, Brooks JT, and Holmberg SD. Mortality in the highly active antiretroviral therapy era: changing causes of death and disease in the HIV outpatient study. *J Acquir Immune Defic Syndr*. 2006;43(1):27-34.
843. Kalayjian RC, Franceschini N, Gupta SK, Szczech LA, Mupere E, Bosch RJ, Smurzynski M, and Albert JM. Suppression of HIV-1 replication by antiretroviral therapy improves renal function in persons with low CD4 cell counts and chronic kidney disease. *AIDS*. 2008;22(4):481-7.
844. Kalayjian RC, Lau B, Mehekano RN, Crane HM, Rodriguez B, Salata RA, Krishnasami Z, Willig JH, Martin JN, Moore RD, et al. Risk factors for chronic kidney disease in a large cohort of HIV-1 infected individuals initiating antiretroviral therapy in routine care. *AIDS*. 2012;26(15):1907-15.
845. Flandre P, Pugliese P, Cuzin L, Bagnis CI, Tack I, Cabie A, Poizot-Martin I, Katlama C, Brunet-Francois C, Yazdanpanah Y, et al. Risk factors of chronic kidney disease in HIV-infected patients. *Clin J Am Soc Nephrol*. 2011;6(7):1700-7.
846. El-Sadr WM, Lundgren J, Neaton JD, Gordin F, Abrams D, Arduino RC, Babiker A, Burman W, Clumeck N, Cohen CJ, et al. CD4+ count-guided interruption of antiretroviral treatment. *N Engl J Med*. 2006;355(22):2283-96.
847. Weber R, Sabin CA, Friis-Moller N, Reiss P, El-Sadr WM, Kirk O, Dabis F, Law MG, Pradier C, De Wit S, et al. Liver-related deaths in persons infected with the human immunodeficiency virus: the D:A:D study. *Arch Intern Med*. 2006;166(15):1632-41.
848. Forrester JE, Rhee MS, McGovern BH, Sterling RK, Knox TA, and Terrin N. The association of HIV viral load with indirect markers of liver injury. *J Viral Hepat*. 2012;19(2):e202-11.
849. Saccani A, Saccani S, Orlando S, Sironi M, Bernasconi S, Ghezzi P, Mantovani A, and Sica A. Redox regulation of chemokine receptor expression. *Proc Natl Acad Sci U S A*. 2000;97(6):2761-6.
850. Fiala M, Looney DJ, Stins M, Way DD, Zhang L, Gan X, Chiappelli F, Schweitzer ES, Shapshak P, Weinand M, et al. TNF-alpha opens a paracellular route for HIV-1 invasion across the blood-brain barrier. *Mol Med*. 1997;3(8):553-64.
851. Koh K, Kim J, Jang YJ, Yoon K, Cha Y, Lee HJ, and Kim J. Transcription factor Nrf2 suppresses LPS-induced hyperactivation of BV-2 microglial cells. *J Neuroimmunol*. 2011;233(1-2):160-7.
852. Brandenburg LO, Kipp M, Lucius R, Pufe T, and Wruck CJ. Sulforaphane suppresses LPS-induced inflammation in primary rat microglia. *Inflamm Res*. 2010;59(6):443-50.
853. Kuhn AM, Tzieply N, Schmidt MV, von Knethen A, Namgaladze D, Yamamoto M, and Brune B. Antioxidant signaling via Nrf2 counteracts lipopolysaccharide-mediated inflammatory responses in foam cell macrophages. *Free Radic Biol Med*. 2011;50(10):1382-91.
854. Rojo AI, Innamorato NG, Martin-Moreno AM, De Ceballos ML, Yamamoto M, and Cuadrado A. Nrf2 regulates microglial dynamics and neuroinflammation in experimental Parkinson's disease. *Glia*. 2010;58(5):588-98.
855. Nath KA. Heme oxygenase-1: a provenance for cytoprotective pathways in the kidney and other tissues. *Kidney Int*. 2006;70(3):432-43.

856. Pae HO, Lee YC, and Chung HT. Heme oxygenase-1 and carbon monoxide: emerging therapeutic targets in inflammation and allergy. *Recent Pat Inflamm Allergy Drug Discov.* 2008;2(3):159-65.
857. An L, Liu CT, Yu MJ, Chen ZH, Guo XG, Peng W, Wang JF, Fang XQ, Gao YH, and Yu SY. Heme oxygenase-1 system, inflammation and ventilator-induced lung injury. *Eur J Pharmacol.* 2012;677(1-3):1-4.
858. Spindler KR, and Hsu TH. Viral disruption of the blood-brain barrier. *Trends Microbiol.* 2012;20(6):282-90.
859. Zhao J, Moore AN, Redell JB, and Dash PK. Enhancing expression of Nrf2-driven genes protects the blood brain barrier after brain injury. *J Neurosci.* 2007;27(38):10240-8.
860. Wang Z, Ma C, Meng CJ, Zhu GQ, Sun XB, Huo L, Zhang J, Liu HX, He WC, Shen XM, et al. Melatonin activates the Nrf2-ARE pathway when it protects against early brain injury in a subarachnoid hemorrhage model. *J Pineal Res.* 2012;53(2):129-37.
861. Xiang J, Alesi GN, Zhou N, and Keep RF. Protective effects of isothiocyanates on blood-CSF barrier disruption induced by oxidative stress. *Am J Physiol Regul Integr Comp Physiol.* 2012;303(1):R1-7.
862. Rossi D, and Volterra A. Astrocytic dysfunction: insights on the role in neurodegeneration. *Brain Res Bull.* 2009;80(4-5):224-32.
863. Hori K, Burd PR, Furuke K, Kutza J, Weih KA, and Clouse KA. Human immunodeficiency virus-1-infected macrophages induce inducible nitric oxide synthase and nitric oxide (NO) production in astrocytes: astrocytic NO as a possible mediator of neural damage in acquired immunodeficiency syndrome. *Blood.* 1999;93(6):1843-50.
864. Mrowietz U, Christophers E, and Altmeyer P. Treatment of severe psoriasis with fumaric acid esters: scientific background and guidelines for therapeutic use. The German Fumaric Acid Ester Consensus Conference. *Br J Dermatol.* 1999;141(3):424-9.
865. Van Oosten BW, Killestein J, Barkhof F, Polman CH, and Wattjes MP. PML in a patient treated with dimethyl fumarate from a compounding pharmacy. *N Engl J Med.* 2013;368(17):1658-9.
866. Ermis U, Weis J, and Schulz JB. PML in a patient treated with fumaric acid. *N Engl J Med.* 2013;368(17):1657-8.
867. Sweetser MT, Dawson KT, and Bozic C. Manufacturer's response to case reports of PML. *N Engl J Med.* 2013;368(17):1659-61.
868. Nieuwkamp DJ, Murk JL, van Oosten BW, Cremers CH, Killestein J, Viveen MC, Van Hecke W, Frijlink DW, Wattjes MP, and Consortium PMLiDMP. PML in a patient without severe lymphocytopenia receiving dimethyl fumarate. *N Engl J Med.* 2015;372(15):1474-6.
869. Rosenkranz T, Novas M, and Terborg C. PML in a patient with lymphocytopenia treated with dimethyl fumarate. *N Engl J Med.* 2015;372(15):1476-8.
870. Mrowietz U, Altmeyer P, Bieber T, Rocken M, Schopf RE, and Sterry W. Treatment of psoriasis with fumaric acid esters (Fumaderm). *J Dtsch Dermatol Ges.* 2007;5(8):716-7.

871. Carlson L. Clinical management of the HIV-positive kidney transplant recipient. *Nephrol Nurs J*. 2008;35(6):559-67.
872. Rubin RH, and Tolkoff-Rubin NE. The problem of human immunodeficiency virus (HIV) infection and transplantation. *Transpl Int*. 1988;1(1):36-42.
873. Huprikar S. Solid organ transplantation in HIV-infected individuals: an update. *Rev Med Virol*. 2009;19(6):317-23.
874. Norman SP, Kommareddi M, and Kaul DR. Update on kidney transplantation in HIV-infected recipients. *AIDS reviews*. 2012;14(3):195-207.
875. Qiu J, Terasaki PI, Waki K, Cai J, and Gjertson DW. HIV-positive renal recipients can achieve survival rates similar to those of HIV-negative patients. *Transplantation*. 2006;81(12):1658-61.
876. Locke JE, Montgomery RA, Warren DS, Subramanian A, and Segev DL. Renal transplant in HIV-positive patients: long-term outcomes and risk factors for graft loss. *Arch Surg*. 2009;144(1):83-6.
877. Ontario HQ. Kidney and liver organ transplantation in persons with human immunodeficiency virus: An Evidence-Based Analysis. *Ont Health Technol Assess Ser*. 2010;10(4):1-56.
878. Roland ME, Barin B, Carlson L, Frassetto LA, Terrault NA, Hirose R, Freise CE, Benet LZ, Ascher NL, Roberts JP, et al. HIV-infected liver and kidney transplant recipients: 1- and 3-year outcomes. *Am J Transplant*. 2008;8(2):355-65.
879. Stock PG, Barin B, Murphy B, Hanto D, Diego JM, Light J, Davis C, Blumberg E, Simon D, Subramanian A, et al. Outcomes of kidney transplantation in HIV-infected recipients. *N Engl J Med*. 2010;363(21):2004-14.
880. Department of Health and Human Services, 2010 Annual Data Report. Health Resources and Services Administration, Healthcare Systems Bureau, Division of Transplantation. Organ Procurement and Transplantation Network (OPTN) and Scientific Registry of Transplant Recipients (SRTR). OPTN / SRTR. Accessed June 15, 2015. Available at <http://srtr.transplant.hrsa.gov/>.
881. Nissen NN, Barin B, and Stock PG. Malignancy in the HIV-infected patients undergoing liver and kidney transplantation. *Curr Opin Oncol*. 2012;24(5):517-21.
882. Lihana RW, Ssemwanga D, Abimiku A, and Ndemi N. Update on HIV-1 diversity in Africa: a decade in review. *AIDS Rev*. 2012;14(2):83-100.
883. Parker ZF, Iyer SS, Wilen CB, Parrish NF, Chikere KC, Lee FH, Didigu CA, Berro R, Klasse PJ, Lee B, et al. Transmitted/founder and chronic HIV-1 envelope proteins are distinguished by differential utilization of CCR5. *J Virol*. 2013;87(5):2401-11.
884. Parrish NF, Gao F, Li H, Giorgi EE, Barbian HJ, Parrish EH, Zajic L, Iyer SS, Decker JM, Kumar A, et al. Phenotypic properties of transmitted founder HIV-1. *Proc Natl Acad Sci U S A*. 2013;110(17):6626-33.
885. Lu DY, Leung YM, and Su KP. Interferon-alpha induces nitric oxide synthase expression and haem oxygenase-1 down-regulation in microglia: implications of cellular mechanism of IFN-alpha-induced depression. *Int J Neuropsychopharmacol*. 2013;16(2):433-44.

886. Takahashi K, Nakayama M, Takeda K, Fujia H, and Shibahara S. Suppression of heme oxygenase-1 mRNA expression by interferon-gamma in human glioblastoma cells. *J Neurochem*. 1999;72(6):2356-61.
887. Udono-Fujimori R, Takahashi K, Takeda K, Furuyama K, Kaneko K, Takahashi S, Tamai M, and Shibahara S. Expression of heme oxygenase-1 is repressed by interferon-gamma and induced by hypoxia in human retinal pigment epithelial cells. *Eur J Biochem*. 2004;271(14):3076-84.
888. Dorresteijn MJ, Paine A, Zilian E, Fenten MG, Frenzel E, Janciauskiene S, Figueiredo C, Eiz-Vesper B, Blasczyk R, Dekker D, et al. Cell-type-specific downregulation of heme oxygenase-1 by lipopolysaccharide via Bach1 in primary human mononuclear cells. *Free Radic Biol Med*. 2015;78(224-32).