



5-4-2015

# 1,3-Propanediol from Crude Glycerol

Evans Molel  
*University of Pennsylvania*

Hannah Phillips  
*University of Pennsylvania*

Alexander Smith  
*University of Pennsylvania*

Follow this and additional works at: [http://repository.upenn.edu/cbe\\_sdr](http://repository.upenn.edu/cbe_sdr)

 Part of the [Biochemical and Biomolecular Engineering Commons](#)

Molel, Evans; Phillips, Hannah; and Smith, Alexander, "1,3-Propanediol from Crude Glycerol" (2015). *Senior Design Reports (CBE)*.  
74.

[http://repository.upenn.edu/cbe\\_sdr/74](http://repository.upenn.edu/cbe_sdr/74)

This paper is posted at ScholarlyCommons. [http://repository.upenn.edu/cbe\\_sdr/74](http://repository.upenn.edu/cbe_sdr/74)  
For more information, please contact [libraryrepository@pobox.upenn.edu](mailto:libraryrepository@pobox.upenn.edu).

---

# 1,3-Propanediol from Crude Glycerol

## **Abstract**

As a result of the rapid increase in biodiesel production, there is excess supply of crude glycerol, a byproduct of the transesterification process. Prices are depressed and expected to remain low for the foreseeable future, making it a very good time to enter the glycerol market. The proposed design is for 1,3-propanediol from crude glycerol. The plant has a capacity of 100 MM lb/year and will be located in Southeast Asia. It has an estimated IRR of 16.76% and an NPV of \$46,963,200. The process begins with an aerobic fermentation section, consisting of lab scale fermenters, seven seed fermenters, and 14 production fermenters. *Klebsiella pneumoniae*, a genetically engineered, PDO producing microbe is used. In order to produce polymer grade PDO, a separation section is needed following fermentation. Separation operations include filtration, ion exchange, evaporation, hydrogenation, and distillation. The final product is 99.98% pure, by mass.

## **Disciplines**

Biochemical and Biomolecular Engineering | Chemical Engineering | Engineering

University of Pennsylvania  
Department of Chemical and Biomolecular Engineering  
220 South 33<sup>rd</sup> Street  
Philadelphia, PA 19104



April 14, 2014

Dear Dr. Holleran and Professor Fabiano,

Enclosed you will find the solution to the design problem presented by Dr. Richard Bockrath. The proposed process design is for the industrial production of polymer grade 1,3-propanediol (PDO) from crude glycerol. *Klebsiella pneumoniae*, a genetically engineered microbe, is used in fed-batch fermentation. The fermentation broth is filtered in microfiltration, ultrafiltration and nanofiltration. The filtrate from the nanofiltration step is ion-exchanged to remove most of the salts before evaporation. The concentrated product from the evaporators is then taken to a mixed bed polish, which removes any remaining salts in the product. From here, the contents are taken through two distillation towers, a hydrogenation reactor bed, and lastly through another pair of distillation towers. The proposed plant will be located in Southeast Asia and has the capacity to produce 100MM lb/year of polymer grade 1,3-propanediol.

This report contains detailed process design, economic analysis, and conclusions and recommendations for the implementation of the plant. The proposed plant is found to be economically feasible. It has an estimated IRR of 16.76% with a total NPV of \$46,963,200. Most of the continuous operations in this process were modeled using Aspen Plus v8.6. Cost estimates for the equipment were obtained using the equations contained in *Process Design Principles, 3<sup>rd</sup> Edition*, by Seider, Seader, Lewin and Widagdo.

Thank you for the assistance afforded to us during this project.

Sincerely,

---

Evans Molel

---

Hannah Phillips

---

Alexander Smith



Evans Molel | Hannah Phillips | Alexander Smith

# **1,3-Propanediol from Crude Glycerol**

Senior Design Project, CBE 459

Project submitted to: Dr. Sean Holleran  
Prof. Leonard Fabiano  
Project proposed by: Dr. Richard Bockrath

Dept. of Chemical and Biomolecular Engineering

School of Engineering and Applied Science

University of Pennsylvania

April 14, 2015

## Table of Contents

Abstract.....	7
Introduction .....	8
Objective Time Chart .....	10
Market and Competitive Analysis.....	11
Glycerol Market.....	11
PDO Market.....	11
Preliminary Process Synthesis .....	13
Assembly of Database .....	15
Input Costs .....	15
Aspen Simulation Specifications.....	16
Process Flow Diagrams and Material Balance.....	18
Process Description.....	27
Energy Balance and Utility Requirements .....	30
Equipment List and Unit Descriptions .....	35
Seed Fermenter .....	35
Production Fermenter.....	35
Air Compressor.....	36
Microfiltration.....	36
Ultrafiltration.....	37
Nanofiltration .....	37
Strong Acid Cation Ion Exchange Columns .....	38
Weak Base Anion Ion Exchange Columns.....	38
Triple Effect Evaporator Unit.....	39
Mixed Bed Polish Ion Exchange Column.....	40
Distillation Column 1.....	40
Distillation Column 2.....	41
Hydrogenation Reactor.....	41
Distillation Columns 3 and 4 .....	42
Vacuum Systems.....	42
Heat Exchangers.....	43
Storage Vessels.....	44
Autoclaves.....	45
Pumps .....	45

Unit Specification Sheets.....	46
Seed Fermenters .....	46
Production Fermenters.....	47
Compressors for Fermentation Air Feed.....	48
Filtration Units.....	49
Ion Exchange Units .....	52
Triple Effect Evaporation Unit.....	55
Distillation Columns .....	56
Hydrogenation Reactor.....	58
Vacuum System Unit .....	59
Heat Exchangers.....	62
Storage Tanks.....	78
Autoclave Unit.....	87
Pumps .....	88
Equipment Cost Summary .....	112
Operating Cost-Cost of Manufacture .....	116
Other Important Considerations .....	119
Plant Location, Layout and Startup .....	119
Fouling in Heat Exchangers.....	120
Water Management.....	120
Environmental Considerations .....	121
Process Controllability .....	121
Economic Analysis.....	123
Conclusions and Recommendations.....	131
Acknowledgements .....	132
References.....	133
Appendix A: Sample Calculations.....	135
Fermenter Calculations.....	135
Air Compressor Calculations.....	135
Filtration Calculations .....	136
Batch to Continuous Transition Calculation .....	136
Ion Exchange Calculations.....	137
Distillation Calculations.....	137
Pump Calculations .....	138

Vacuum System Calculations.....	138
Evaporator Sample Calculations.....	139
Appendix B: Aspen Plus Input Summary, Block Report, and Stream Reports.....	140
Evaporator Flowsheet .....	140
Evaporator Input Summary .....	141
Evaporator Block Report .....	145
Distillation Flowsheet .....	168
Distillation Input Summary.....	169
Distillation Block Report .....	171
Heat Integration Flowsheet .....	183
Heat Integration Block Report .....	184
Appendix C: Material Safety Data Sheets .....	206
Appendix D: Vendor Specification Sheets.....	224



## Abstract

As a result of the rapid increase in biodiesel production, there is excess supply of crude glycerol, a byproduct of the transesterification process. Prices are depressed and expected to remain low for the foreseeable future, making it a very good time to enter the glycerol market.

The proposed design is for 1,3-propanediol from crude glycerol. The plant has a capacity of 100 MM lb/year and will be located in Southeast Asia. It has an estimated IRR of 16.76% and an NPV of \$46,963,200.

The process begins with an aerobic fermentation section, consisting of lab scale fermenters, seven seed fermenters, and 14 production fermenters. *Klebsiella pneumoniae*, a genetically engineered, PDO producing microbe is used. In order to produce polymer grade PDO, a separation section is needed following fermentation. Separation operations include filtration, ion exchange, evaporation, hydrogenation, and distillation. The final product is 99.98% pure, by mass.

## Introduction

As demand increases for 1,3-propanediol (PDO), an intermediate to fibers and resins, there has been significant research on alternatives to the conventional chemical synthesis. PDO is traditionally produced by reacting ethylene oxide over a catalyst in the presence of phosphine, water, carbon monoxide, hydrogen, and an acid, or catalytic solution phase hydration of acrolein followed by reduction (Adkesson, et al). The chemical synthesis of PDO has numerous disadvantages, including many byproducts, poor selectivity, high temperature and pressures required for operation, and expensive catalysts (Liu, et al). In 2006, the joint venture between DuPont and Tate & Lyle commercialized the first large-scale industrial fermentation to produce bio-based PDO. Unlike the chemical route, the process uses a renewable source, corn glucose, as a feedstock. DuPont Tate & Lyle's bio-based PDO process consumes 40 percent less energy than petroleum-based PDO processes. The biological process reduces greenhouse gas emissions by 40 percent compared to petroleum-based PDO production. Furthermore, it is a renewably sourced monomer for otherwise petroleum-based polymers ("Our Process").

This project proposes a fermentation process to produce bio-based PDO using crude glycerol as a feedstock. A low-end byproduct of biodiesel production, crude glycerol contains many impurities that need to be removed in order to produce a high quality polymer grade product. However, an overpowering advantage of crude glycerol is the excess supply and relatively low demand. The price is very depressed and expected to remain low, making it an ideal feedstock for the proposed process (Ciriminna, et al).

The process begins with an aerobic fermentation section, consisting of lab scale fermenters, seven seed fermenters, and 14 production fermenters. *Klebsiella pneumoniae*, a

genetically engineered, PDO producing microbe, displays a high yield and selectivity. Fermentation takes about three days and crude glycerol is fed without purification.

In order to achieve the desired product purity, a separation section is required following fermentation. Separation operations include filtration, ion exchange, evaporation, hydrogenation, and distillation. The final product is of higher purity than petroleum-based PDO and is sold at a price competitive with DuPont Tate & Lyle.

The proposed plant will be located in Southeast Asia and will produce 100 million pounds per year of PDO. This location was chosen due to both its proximity to biodiesel plants, which produce crude glycerol, and to polytrimethylene terephthalate (PTT) plants, which consume PDO.

## Objective Time Chart

Project Name	1,3-Propanediol from Crude Glycerol
Project Champions	Dr. Richard Bockrath, Dr. Sean Holleran, Professor Leonard Fabiano
Project Leaders	Evans Molel, Hannah Phillips, Alexander Smith
Specific Goals	Develop a bio-based PDO plant with a capacity of 100 MM lb/yr using crude glycerol as a feedstock.
Project Scope	<p>In-scope:</p> <ul style="list-style-type: none"><li>· Lab-scale cell growth</li><li>· Sterilization of media and water for fermentation as well as of fermenters between batches</li><li>· Deactivation and disposal of genetically engineered microbe</li><li>· Design of fed-batch fermentation process</li><li>· Design of continuous separation process to achieve 99.98 wt% purity on a dry basis.</li><li>· Market and profitability analysis</li><li>· Determination of plant location</li></ul> <p>Out-of-scope:</p> <ul style="list-style-type: none"><li>· Procurement of genetically engineered microbes</li><li>· Packaging and distribution of final PDO product</li></ul>
Deliverables	<p>Business Opportunity Assessment:</p> <ul style="list-style-type: none"><li>· What is the market for PDO?</li><li>· What competitors currently produce PDO?</li></ul> <p>Manufacturing Capability Assessment:</p> <ul style="list-style-type: none"><li>· Can the plant be built with a reasonable capital investment?</li></ul>
Timeline	Complete design and economic analysis by April 14, 2015.

## Market and Competitive Analysis

### Glycerol Market

Concerns of global warming and energy security have caused major progress in the field of alternative sources of energy. Biodiesel is one of the fastest growing alternative fuels in the world. In 2013, global biodiesel production reached 7 billion gallons, an increase of 17 percent from 2012 (Esterly and Gelman). While the United States, Germany, and Brazil are the world's largest biodiesel manufacturers, many countries in Southeast Asia have also become major producers. Palm oil, which is widely cultivated in Indonesia, Malaysia, and Thailand, has a higher yield than other oil crops as well as lower production costs, making it a promising feedstock for biodiesel production. In 2011, Indonesia exported over 300 million gallons of biodiesel, 117 percent more than in 2010 (Mukherjee and Sovacool).

A result of the rapid increase in biodiesel production has been an abundance of crude glycerol, a byproduct of the transesterification process. For every 10 pounds of biodiesel produced, one pound of crude glycerol is formed (Xiu and Zeng). At \$0.11 per pound, the price of crude glycerol is very depressed due to the excess supply. According to an article in the European Journal of Lipid Science and Technology, even if all major industrial plants using crude glycerol as raw material operated at full capacity, less than 20 percent of the crude glycerol generated in 2014 would be used. This excess supply should keep the price low for the foreseeable future, making it a very good time to enter the glycerol market.

### PDO Market

In 2014, the PDO market was worth \$310.5MM. Market research reports that the PDO market will grow at a compound annual growth rate of 10.4 percent and will be worth \$621MM by 2021 (Markets and Markets). Currently, DuPont Tate & Lyle is the market leader. However,

as their Loudon plant has a capacity of 140 million pounds per year, which is not enough to keep up with demand, it can be assumed that new producers will enter the market (“FAQs”). Approximately 90 percent of the total market is the production of polytrimethylene terephthalate, or PTT. A polyester traditionally used in textiles, PTT has expanded in recent years to other industries, including consumer products, electronics, and the automotive industry. Other polymers produced from PDO include polytrimethylene naphthalate (PTN), polytrimethylene isophthalate (PTI), and thermoplastic polyester elastomer. Companies in Asia are increasing PDO production and it is predicted that in 2019, China will become the largest producer and exporter of PDO (“1,3-Propanediol Market”). PDO currently sells for \$1.00 per pound.

## Preliminary Process Synthesis

Many alternatives were considered before choosing the final design of this process. An important decision was using crude glycerol as a feedstock instead of purifying it to a higher quality before fermentation. As a result of biodiesel production, crude glycerol contains methanol, fatty acids, salts, and water. These impurities contribute to an undesirable brown color and odor in the product if they are not removed. Table 1 compares the compositions of crude and purified glycerol from the Renewable Energy Group. The impurities in crude glycerol do not inhibit cell growth or have significant effects on product yield (Yang, Hanna and Sun). They do, however, need to be removed from the final product. Purification before fermentation was considered, but research suggests that the membranes necessary for this separation are not economical and it is hard to run both processes simultaneously (Liu, et al).

**Table 1:** Composition by mass of Crude and Technical Grade (Purified) Glycerol

<b>Property</b>	<b>Crude</b>	<b>Technical Grade</b>
Glycerol	82.00%	98.00%
Moisture	11.00%	0.80%
Ash	6.00%	0.01%
Methanol	0.05%	0.03%
Fatty Acid	0.20%	0.00%

One of the main decisions in the batch section of the process was how to minimize cost by finding the optimal number and size of the fermenters. Productivity rate, final PDO concentration in the fermentation broth, ease of oxygenation, target production of 100 MMlb/year of PDO, and capital cost requirements were all determining factors. Due to economies of scale, large fermenters are more cost-effective than numerous small fermenters. According to Dr. Bockrath, current manufacturing technology limits the size of these vessels to 18 feet in diameter and a maximum aspect ratio of 6:1. It was concluded that the optimal

combination was 14 production fermenters, each with a diameter of 17.5 feet and an aspect ratio of 5:1, for a total volume of 600,000 L. Due to the large fermenter size, the size and power of the agitator required to disperse air was not economical. Since fermentation is micro-aerobic, with low oxygen transfer rate, low viscosity, and a large volume, bubble column fermenters were chosen (Benz).

In order to optimize the number of pre-production fermenters, the impacts of contamination, localized failures, and vessel cost were considered. While exponential cell growth could allow three production fermenters to be fed by one seed fermenter, any disruption in the seed fermenter would be catastrophic. We minimized cost but ensured process robustness by assigning one seed fermenter to two production fermenters. The volume of each of our 7 seed fermenters is 10% of the volume of a production fermenter, which is a standard industry practice. The smaller size allows for mechanical agitation.

Another major consideration in designing the process was determining when to transition from batch to continuous operation to minimize PDO loss. Half of the PDO in filtration retentate can be recovered by dilution and recycle. In order to maintain a reasonable and economical size of our filtration units, batch filtration was selected. All following separation operations are optimized as continuous processes.



## Assembly of Database

### Input Costs

The cost of medium pressure steam and cooling water was taken directly out of the Aspen Plus simulation utilities report. These costs were reported in terms of dollars per heating value. To get cost estimates per pound of utility, the cost per heating value was multiplied by the heating value per pound. Using this process, the cost of medium pressure steam was found to be \$2.00 per Mlb, while the cost of cooling water was found to be \$2.01 per MMBb.

The costs of process water, electricity and chilled water were obtained from Dr. Seider's profitability analysis lecture notes from CBE459. A value of \$2.00 per Mgal was used for the costing of our process water. A value of \$0.07 per kWh of electricity was used. A value of \$5.208 per MMBTU was reported for the cost of chilled water. It is important to note that chilled water enters at 43 °F and exits at 54 °F.

The price of crude glycerol was obtained from ICIS Chemical Business Byline by Alexis Gan. The article reports a trend in the values of crude glycerol. We assumed a value of \$235 per ton, which is equivalent to \$0.11 per pound.

Because we were unable to obtain a price quote for the fermentation media salts, we assumed an annual value of \$2MM. This value was suggested by Dr. Bockrath and is typical for the concentration of media salts in our fermentation. This translates to roughly \$0.18 per pound of media powder.

A price estimate of \$0.32 per pound of hydrogen was used. This value was obtained from an average of vendors on [www.alibaba.com](http://www.alibaba.com).

Glucose was priced at \$0.20 per pound. We obtained this value from [www.alibaba.com](http://www.alibaba.com), where glucose is sold as dextrose monohydrate and priced at \$450 per ton (f.o.b. price).

The selling price for 1,3-propanediol final products was contained in our problem statement.

### Aspen Simulation Specifications

Aspen Plus v8.6 was used in the simulation of many of our continuous processes. These processes include evaporation, distillation and heat exchange via heat exchangers or heat exchanger networks. The solutions in this process form ideal mixtures. We therefore used WILSON as the property method. All of our heat exchangers were modeled using HEATX.

To properly model the distillation process, DSTWU was used alongside industry-wide heuristics pertaining to the reflux ratio in relation to minimum reflux ratio. The actual reflux ratio was obtained by the DSTWU model using the Winn-Underwood-Gilliland shortcut method. From DSTWU, we also gathered the number of stages, the optimum feed location, and the boil-up rate. Information from DSTWU was incorporated in the more rigorous RADFRAC model. In the RADFRAC model, temperature and pressure profiles for each stage were obtained and the number of stages and feed location were optimized. Here, design specifications were added to manipulate the boil-up ratio to satisfy temperature restrictions in the reboilers. The reflux ratios were also manipulated to ensure desired composition of the distillates, while minimizing loss of PDO. One implementation was a design specification to ensure less than 1000 ppm water in the bottoms of the first distillation tower.

The triple effect evaporation unit was modeled as three heat exchangers (one for each effect). A constraint on the maximum temperature in the first effect and a trade-off between deep vacuum operation and a small minimum approach temperature were considered in the design. Operation at a minimum approach temperature of 10 °F was found to be optimal despite large heat exchanger sizes. Since there is no actual model for the evaporators in Aspen Plus, exit cold

stream from the heat exchangers were separated in a FLASH2. Since our calculated duty was different from the actual heat duty needed, it was important to use design specifications and sensitivity analysis among other Aspen Plus features to get the heat duty that would ensure evaporation of the correct amount of water with acceptable loss of PDO product.

## Process Flow Diagrams and Material Balance

Process flow diagrams are presented in Figures 1-4. Figure 1 shows the media sterilization process. Figure 2 shows a closeup of a single fermentation train, including all equipment required for a single seed fermenter and pair of production fermenters. The full fermentation design and all batch operations are shown in Figure 3. Intermediate pumps for fermentation are not shown in the overall diagram, but can be referenced in detail in Figure 2. All continuous processes are presented in Figure 4. Some streams appear in multiple figures to show the path of heat integration across the batch and continuous processes.

Component flows and select physical properties are presented for major process streams in Tables 2 and 3. Streams that contain significant amounts of PDO or are critical for heat integration are included.

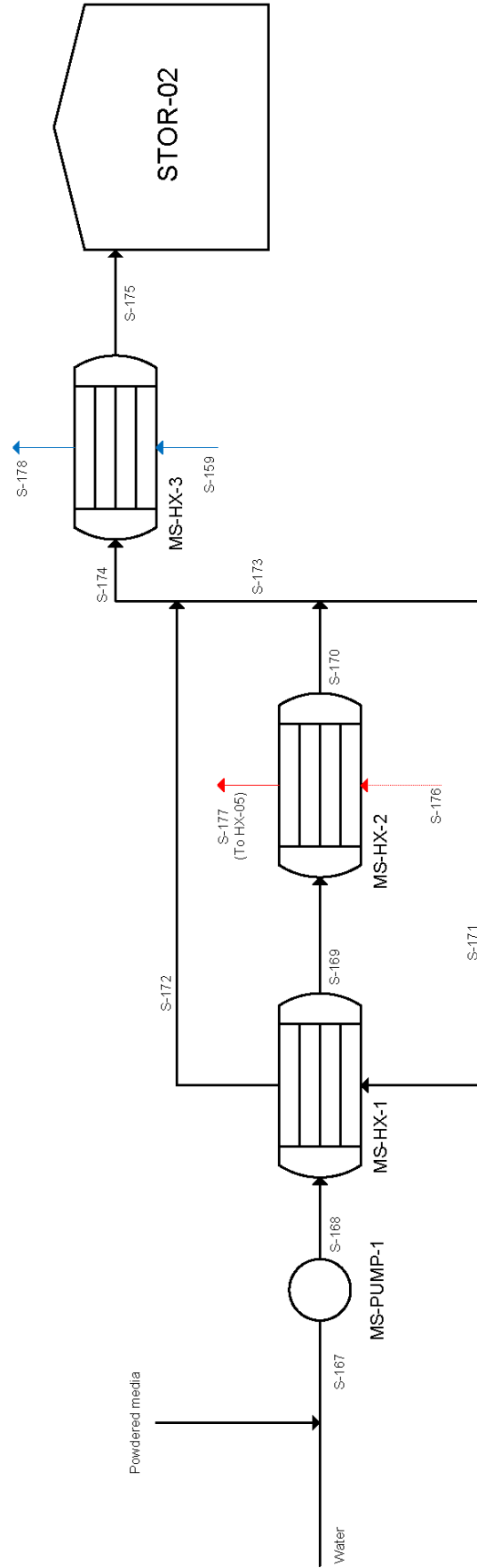

**Figure 1:** Process flow diagram for media sterilization. Red streams indicate streams used for heating. Blue streams indicate streams used for cooling.

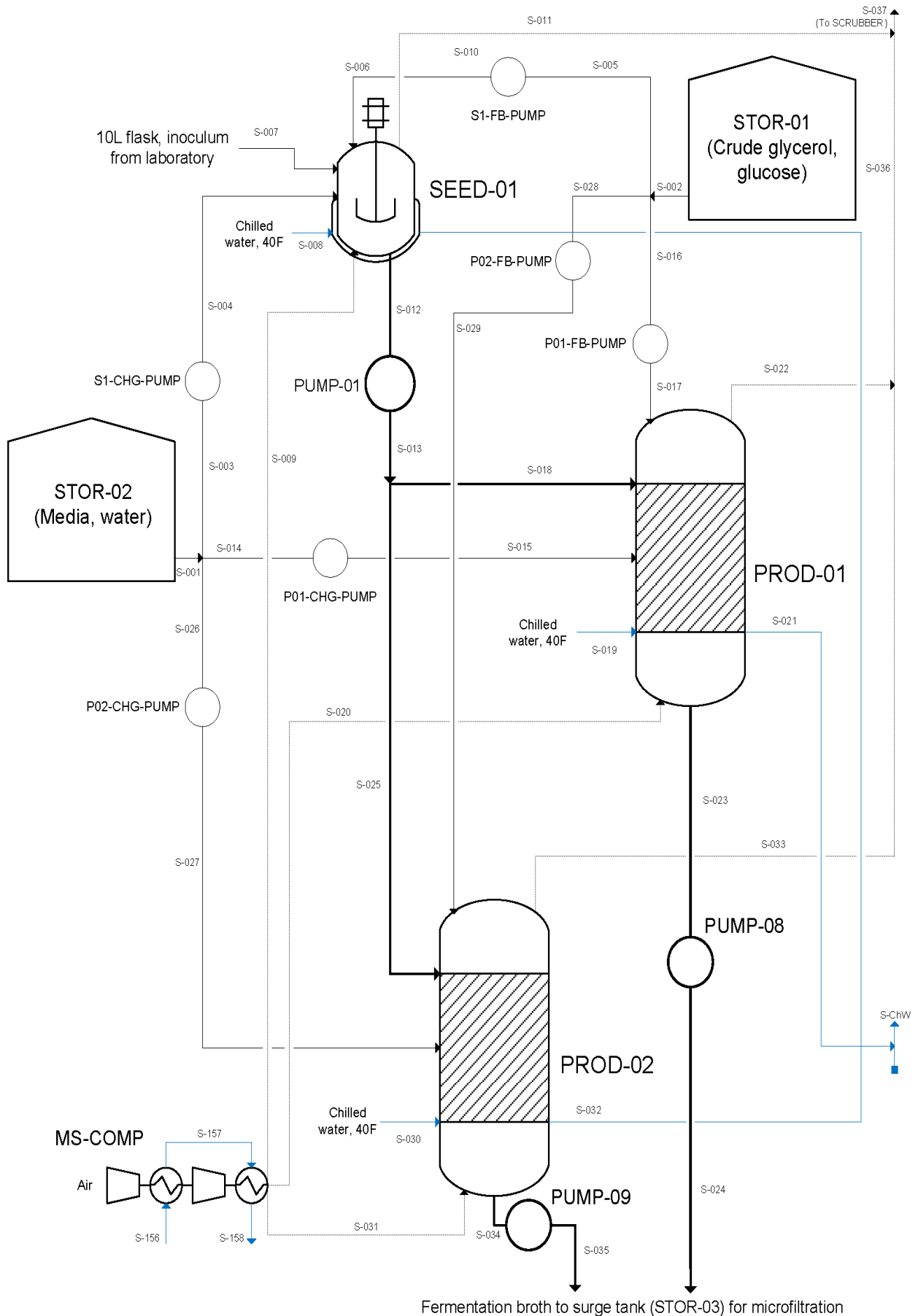

**Figure 2:** Process flow diagram for a single fermentation train (SEED-01, PROD-01, PROD-02). Includes all equipment required, including that shared among the seven trains. Bold streams contain PDO product. Red indicates streams used for heating. Blue indicates streams used for cooling. Square terminals indicate streams for disposal.

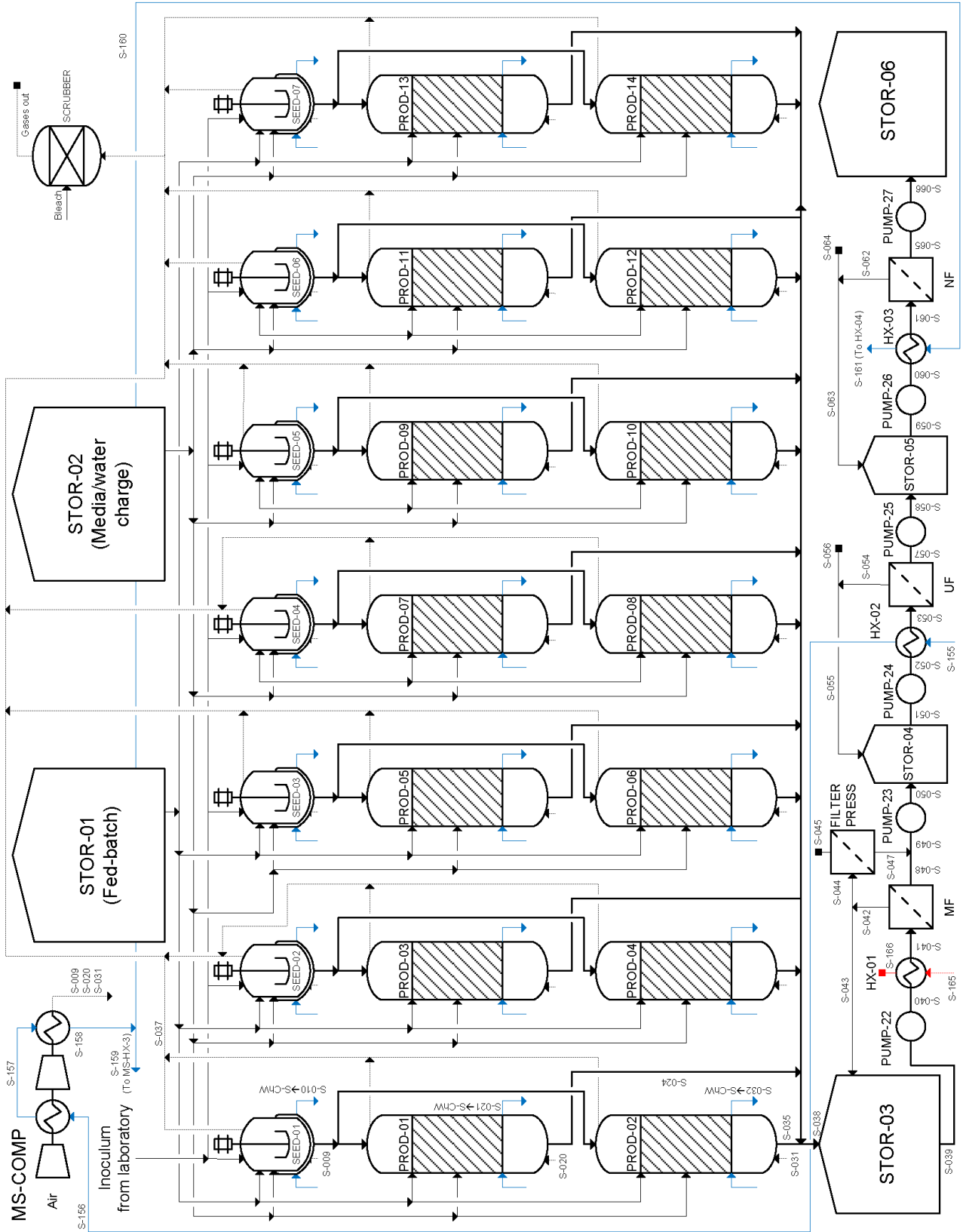

**Figure 3:** Process flow diagram for all batch operations, including fermentation, filtration, and all associated pumps, heat exchangers, and storage tanks. Intermediate fermentation equipment shown in Figure 2 is not shown here for each fermentation train. Bold streams contain PDO product. Red indicates streams used for heating. Blue indicates streams used for cooling. Square terminals indicate disposal.

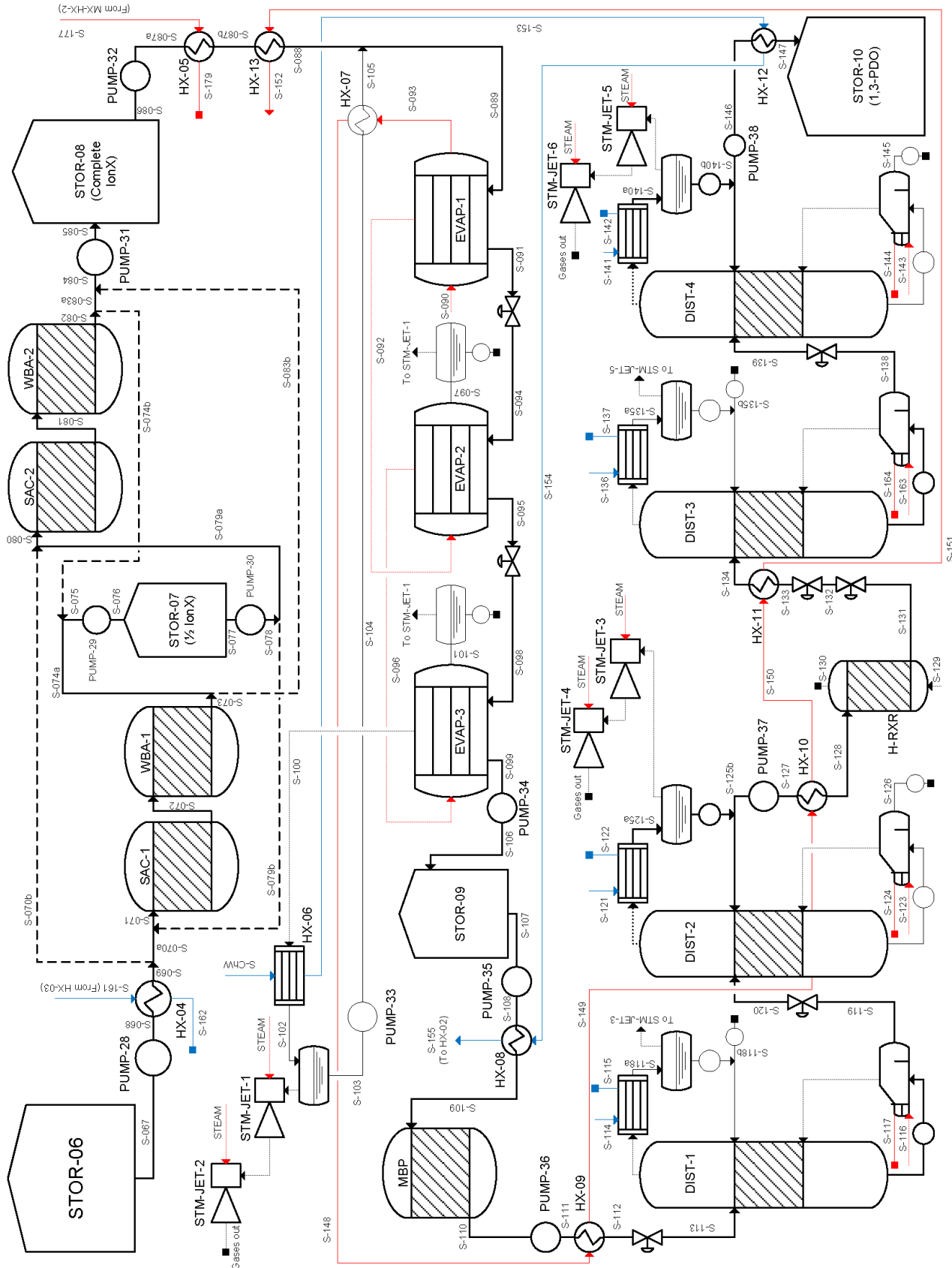

**Figure 4:** Process flow diagram for all continuous operations, including ion exchange, evaporation, distillation, and hydrogenation, with all associated streams, heat exchangers, storage vessels, and vacuum systems. Bold streams contain PDO product. Red indicates streams used for heating. Blue indicates streams used for cooling. Square terminals indicate disposal.



Table 2: Batch Section PDO Process Stream Reports

STREAM ID:	S-012	S-013	S-018	S-023	S-024	S-038	S-039	S-040	S-041	S-049	S-050
Temperature (F)	98	98	98	98	98	98	98	98	98	165	165
Pressure (psia)	29	80	16	31	68	68	28	110	80	15	68
Total (lb/batch)	112543	112543	56271	1106308	1106313	2212616	2212626	2212626	2212626	2405616	2405823
Components Flow (lb/batch)											
Glycerol	2233	2233	1117	21918	21918	43835	43835	43835	43835	40183	40183
Glucose	207	207	103	2025	2025	4051	4051	4051	4051	3713	3713
Water	101959	101959	50980	1002699	1002699	2005397	2005397	2005397	2005397	2207036	2207036
PDO	7832	7832	3916	76560	76560	153120	153120	153120	153120	149694	149694
Methanol	11	11	6	103	103	206	206	206	206	189	189
Salts	297	297	149	2959	2959	5918	5918	5918	5918	4722	4722
Oleic Acid	2	2	1	22	22	44	44	44	44	40	40
Palmitic Acid	2	2	1	22	22	44	44	44	44	40	40
Biomass	409	409	205	4033	4033	8065	8065	8065	8065	0	0

STREAM ID:	S-051	S-052	S-053	S-057	S-058	S-059	S-060	S-061	S-065	S-066
Temperature (F)	160	160	140	140	140	140	140	140	120	120
Pressure (psia)	28	110	80	15	68	28	250	220	15	68
Total (lb/batch)	2405823	2405823	2405823	2602442	2602636	2602636	2602636	2602636	2488429	2488613
Components Flow (lb/batch)										
Glycerol	40183	40183	40183	37504	37504	37504	37504	37504	35629	35629
Glucose	3713	3713	3713	3206	3206	3206	3206	3206	801	801
Water	2207036	2207036	2207036	2411384	2411384	2411384	2411384	2411384	2305460	2305460
PDO	149694	149694	149694	145702	145702	145702	145702	145702	142788	142788
Methanol	189	189	189	176	176	176	176	176	167	167
Salts	4722	4722	4722	4395	4395	4395	4395	4395	3585	3585
Oleic Acid	40	40	40	38	38	38	38	38	0	0
Palmitic Acid	40	40	40	38	38	38	38	38	0	0
Biomass	0	0	0	0	0	0	0	0	0	0

Table 3: Continuous Section PDO Process Stream Report

STREAM ID:	S-ChW	S-040	S-041	S-052	S-053	S-067	S-068	S-069	S-070a	S-071	S-072	S-073	S-074a	S-075
Temperature (F)	54	99	165	160	140	120	120	109	109	109	109	109	109	109
Pressure (psia)	14.70	44	44	80	75	28	67	27	27	27	20	16	16	16
Vapor fraction	0.00	0	0	0	0		0	0	0	0	0	0	0	0
Total Flow (lb/hr)	7748460	176482	176482	212768	212768	271824	271801	271801	271801	271801	271643	271496	271496	271496
Component Flow (lb/hr)														
Glycerol	0	0	0	3858	3858	3423	3423	3423	3423	3423	3423	3423	3423	3423
Glucose	0	0	0	357	357	77	77	77	77	77	77	77	77	77
Water	7748460	176482	176482	194182	194182	254235	254235	254235	254235	254235	254235	254235	254235	254235
PDO	0	0	0	14372	14372	13719	13719	13719	13719	13719	13719	13719	13719	13719
Methanol	0	0	0	0	0	25	25	25	25	25	25	25	25	25
Salts	0	0	0	0	0	344	344	344	344	344	164	17	17	17

STREAM ID:	S-076	S-077	S-078	S-079a	S-080	S-081	S-082	S-083a	S-084	S-085	S-086	S-087a	S-087b	S-088
Temperature (F)	109	109	109	109	109	109	109	109	109	109	109	109	124	189.5
Pressure (psia)	41	22	62	62	27	20	16	16	16	55	22	40	35	30
Vapor fraction		0	0	0	0	0	0	0	0	0	0	0	0	0
Total Flow (lb/hr)	271496	271473	271473	271473	271473	271473	271473	271473	271473	271473	271473	271473	271473	271473
Component Flow (lb/hr)														
Glycerol	3423	3423	3423	3423	3423	3423	3423	3423	3423	3423	3423	3423	3423	3423
Glucose	77	77	77	77	77	77	77	77	77	77	77	77	77	77
Water	254235	254235	254235	254235	254235	254235	254235	254235	254235	254235	254235	254235	254235	254235
PDO	13719	13719	13719	13719	13719	13719	13719	13719	13719	13719	13719	13719	13719	13719
Methanol	25	25	25	25	25	25	25	25	25	25	25	25	25	25
Salts	17	17	17	17	17	17	17	17	17	17	17	17	17	17

<b>STREAM ID:</b>	<b>S-089</b>	<b>S-091</b>	<b>S-092</b>	<b>S-093</b>	<b>S-094</b>	<b>S-095</b>	<b>S-096</b>	<b>S-097</b>	<b>S-098</b>	<b>S-099</b>	<b>S-100</b>	<b>S-101</b>
Temperature (F)	190	190	190	345	171	172	172	189	127	152	152	170
Pressure (psia)	9.20	9.20	9.20	126.32	6.05	6.05	6.05	9.20	2.00	2.00	2.00	6.05
Vapor fraction	0.00	0.00	1.00	0.00	0.02	0.00	1.00	0.00	0.05	0.00	1.00	0.04
Total Flow (lb/hr)	396163	272999	123164	138600	272999	145972	127027	123164	145972	21289	124683	127027
Component Flow (lb/hr)												
Glycerol	3428	3428	0	0	3428	3427	0	0	3427	3423	5	0
Glucose	77	77	0	0	77	77	0	0	77	77	0	0
Water	376581	253508	123074	138600	253508	126601	126907	123074	126601	4255	122346	126907
PDO	16051	15981	69	0	15981	15866	115	69	15866	13534	2332	115
Methanol	26	5	21	0	5	1	5	21	1	0	1	5
Salts	17	0	0	0	0	0	0	0	0	0	0	0

<b>STREAM ID:</b>	<b>S-102</b>	<b>S-103</b>	<b>S-104</b>	<b>S-105</b>	<b>S-108</b>	<b>S-109</b>	<b>S-113</b>	<b>S-118b</b>	<b>S-119</b>	<b>S-120</b>	<b>S-125b</b>	<b>S-126</b>
Temperature (F)	126	126	126	190	154	117	120	104	283	283	229	303
Pressure (psia)	2.00	2.00	9.21	9.21	32	27	1.1	1.1	1.1	0.4	0.4	0.5
Vapor fraction	0.00	0.00	0.00	0.00	0	0	0	0	0	0	0	0
Total Flow (lb/hr)	124683	124683	124683	124683	21289	21289	21158	4109	17049	17049	12738	4311
Component Flow (lb/hr)												
Glycerol	5	5	5	5	3423	3423	3423	0	3423	3423	37	3386
Glucose	0	0	0	0	77	77	77	0	77	77	0	77
Water	122346	122346	122346	122346	4255	4255	4125	4108	18	18	18	0
PDO	2332	2332	2332	2332	13534	13534	13533	1	13532	13532	12683	848
Methanol	1	1	1	1	0	0	0	0	0	0	0	0
Salts	0	0	0	0	0	0	0	0	0	0	0	0

<b>STREAM ID:</b>	<b>S-146</b>	<b>S-147</b>	<b>S-148</b>	<b>S-153</b>	<b>S-154</b>	<b>S-155</b>	<b>S-156</b>	<b>S-167</b>	<b>S-168</b>	<b>S-169</b>	<b>S-170</b>	<b>S-171</b>
Temperature (F)	229	75	298	70	71	71	72	68	68	190	250	250
Pressure (psia)	0.39	0.39	126.32	14.70	14.70	15	15	15	44	39	34	34
Vapor fraction	0.00	0.00	0.00	0.00	0.00	0	0	0	0	0	0	0
Total Flow (lb/hr)	12738	12738	138600	7748460	7748460	7748460	7748460	216548	216548	216548	216548	168354
Component Flow (lb/hr)												
Glycerol	37	37	0	0	0	0	0	24089	24089	24089	24089	18728
Glucose	0	0	0	0	0	0	0	2409	2409	2409	2409	1873
Water	18	18	138600	7748460	7748460	7748460	7748460	190050	190050	190050	190050	147754
PDO	12684	12684	0	0	0	0	0	0	0	0	0	0
Methanol	0	0	0	0	0	0	0	0	0	0	0	0
Salts	0	0	0	0	0	0	0	0	0	0	0	0

<b>STREAM ID:</b>	<b>S-172</b>	<b>S-173</b>	<b>S-174</b>	<b>S-175</b>
Temperature (F)	99	250	134	99
Pressure (psia)	34	34	34	29
Vapor fraction	0	0	0	0
Total Flow (lb/hr)	168354	48194	216548	216548
Component Flow (lb/hr)				
Glycerol	18728	5361	24089	24089
Glucose	1873	536	2409	2409
Water	147754	42297	190050	190050
PDO	0	0	0	0
Methanol	0	0	0	0
Salts	0	0	0	0

## Process Description

The first section of this process is aerobic fermentation of *Klebsiella Pneumoniae*. Starting with 10 mg of the organism, the cells are grown for 48 hours in the lab. They are then transferred into seven 60,000-liter seed fermenters (SEED-01 to -07), where the reaction proceeds for 68.5 hours. Glycerol and glucose are added in a mass ratio of 10:1 and air is added at 0.5 vvm. The fermentation is exothermic. Chilled water is used to maintain the temperature of the fermenters at 37 °C and ammonia solution is added to maintain the pH at 6.8. Final PDO concentration in each fermenter is 70 g/L at the end of the fermentation period (Cheng, et al).

Each seed fermenter feeds two 600,000-liter production fermenters (PROD-01 to -14). Due to the low oxygen transfer rate in the reaction, bubble columns were determined to be the most economical choice for the production fermenters. The reaction takes place for 64.4 hours and temperature and pH are again maintained at 99 °F and 6.8 respectively. During the fermentation period, the concentration of glycerol is maintained at 20 g/L by feedings glycerol and glucose in a 10:1 mass ratio and air is added at 0.8 vvm. Final PDO concentration in each of the 14 fermenters is 70 g/L, and the molar yield of PDO is 0.6 mol PDO per mol of glycerol.

The batch time for the fermentation is 138.4 hours, with a cycle time of 73 hours, allowing for 107 batches per year. Each of the pre-production fermenters is staggered by 10.4 hours. See page 135 in Appendix A for stagger time calculations. The stagger time is the only unique aspect of scheduling this process. There are no bottlenecks as the fermentation time is similar in the seed and production fermenters. Any Gantt chart for the process would provide no new information and is not included as part of this report.

After fermentation, the production fermenters are emptied into a storage tank (STOR-03). Due to the staggered start times, only two production fermenters are emptied at the same time.

This tank is drained to a microfiltration unit (MF) where biomass is removed. The retentate is diluted with recycled process water and is recycled through the filter for ten hours. The permeate is transferred to an intermediate storage tank (STOR-04). The biomass in the retentate is sterilized and safely discarded. The contents from the storage tank are pumped to the ultrafiltration unit (UF), and then the nanofiltration unit (NF), both of which are batch processes with intermediate storage tanks. Recycled process water from the evaporator dilutes the retentate, which is recycled through the filtration units, minimizing the PDO loss. After nanofiltration, the contents are transferred into another storage tank (STOR-06) where the transition to continuous flow occurs.

Material is pumped from the storage tank to the following sequence of strong acid cation and weak base anion exchange columns: SAC-1, WBA-1, SAC-2, WBA-2, followed by a mixed bed polish (MBP). Between the final WBA and MBP exchanger columns, water is removed with a triple-effect evaporator. Each column has a cycle time of 24 hours before regeneration. When the first two columns become exhausted, they are regenerated and the feed is switched to the second pair in series. Once regeneration is complete, product that has passed through the second pair of columns is finished in the first, regenerated pair. During regeneration, continuous operation is maintained by holdup in a surge tank (STOR-07). Depending on regeneration scheduling, product may take either the solid path or the dotted path between HX-04 and PUMP-31 to STOR-08 (see Figure 4).

The triple-effect evaporator is run under vacuum conditions due to the temperature sensitivity of the product. When the product is heated to above the maximum temperature of 190 °F, UV absorbers will form, lessening the quality of the final product. The evaporator reduces moisture content from 90% to 20% and the condensate streams are recycled back into the system

and later cooled, sterilized, and fed back into the fermentation process. A two-stage steam-jet ejector is used for the vacuum system. After evaporation, additional purification is achieved in a 24 hour cycle in a mixed bed polish column. Following the mixed bed polish, the impurities that remain are water, glycerol, glucose, and other low and high-boilers. Four packed distillation columns are used to reach the desired purity. To keep temperatures below 338 °F, as specified in the problem statement, the columns must be run under vacuum. A two-stage steam-jet ejector vacuum system is used. The first distillation column reduces the water in the bottoms to 1000 ppm. The distillate of the second column is 99.95% PDO. During separation, it is likely that some of the product reacted and formed double bonds. A hydrogenation reactor follows the second distillation to saturate these compounds and minimize color-forming alkenes in the product. The catalyst used is Raney Nickel. After hydrogenation, which is a high pressure reaction, the product goes through two more distillation columns under vacuum. The vacuum is again maintained by a two-stage steam-jet ejector system. These columns are necessary to remove the low and high-boilers formed during hydrogenation. The final product is 99.98% PDO on a dry basis and contains less than 500 ppm water.

## Energy Balance and Utility Requirements

The main utility needs for this process include chilled water for the fermentation vessels, cooling water for condensers, electricity for operation of pumps and compressors, medium pressure steam for first effect of evaporator and distillation reboilers.

It was estimated that the seed fermenters and production fermenters consume 5,940 and 55,000 lb O<sub>2</sub> per batch, respectively. Using correlations in Shuler, the rate of heat generation was found to be  $6.0 \times 10^5$  BTU/hr in the seed fermenters and  $6.0 \times 10^6$  BTU/hr in the production fermenters. Defining an overall heat transfer efficiency of 70% between submerged coils and the fermentation broth, we conservatively estimated a chilled water cooling requirement for each of the fermenters.

Although the process is micro-aerobic, the sheer size of the bubble column fermenters and large aspect ratio (L:D) of 5 demands the air feed be compressed to 3.5 bar. At this pressure and maximum aeration rates of 0.8 vvm, the most economical configuration was found to be two parallel two-stage compressors with inter-stage cooling. Rather than buying cooling water for this process, we utilized the recycled chilled water to cool the air after each compression stage.

The separation steps of this process require many process units that operate at varying temperatures, thus cooling or heating is necessary in most of the transfer streams. To make effective use of our process streams, intensive heat integration was performed to ensure most heat sources or sinks are utilized. It was convenient to use minimum utility requirements for heat integration. As the process streams were at varying temperatures, in most cases we were not constrained by the minimum approach temperature of 10 °F that we had placed on the heat exchangers. In such situations, adding more heat exchangers for single process streams was



found to minimize the cost of utilities. To minimize our utility needs, medium pressure steam condensate from heat exchangers was reused to heat or preheat process streams.

While heat integration was performed within a single process unit, there was also a need to use process streams to heat or cool process stream within other process units. For example, chilled water from cooling production fermenters is used for condensation of vapor from the third effect of the triple effect evaporators unit. The exit cold stream from that heat exchanger has enough cooling value to be able to cool the final product from 229 °F to 75 °F before storage. Condensation of the vapor stream from the third effect allows it to be pumped from 2.0 psia to 9.2 psia. The steam condensate from the first effect is used to reheat the condensed vapor at 9.2 psia to its bubble point before it is mixed with fresh feed into the evaporators. This process saves us capital cost that would have otherwise been needed to buy equipment to compress the vapor from 2.0 psia to 9.2 psia.

The exit hot stream from reheating the evaporation recycle stream is then transferred to the network of heat exchangers. This stream is used to heat process streams to the various exit temperatures. Our most ideal configuration includes this hot exit stream heating:

1. Transfer stream from mixed bed polish to the first distillation tower, from 117 to 120 °F
2. Transfer stream from second distillation tower to hydrogenation bed, from 230 to 248 °F
3. Transfer stream from hydrogenation bed to third distillation tower, from 248 to 279 °F

In the process of heating the three streams in three separate heat exchangers, the hot stream cools from 298 to 291 °F. At this temperature and pressure, this stream does not have enough heating value to completely heat the feed to the evaporation unit. To ensure maximal utilization of the stream enthalpy, the steam condensate from MS-HX-2 is used to heat the feed

to the evaporation unit from 109 to 131 °F. The exit hot stream from heating transfer stream to third distillation tower is then used to heat the feed to the evaporation unit from 131 to 190 °F.

The above arrangement of heat exchangers in this network gives the minimum utility needs, as found from pinch analysis, given our minimum temperature of approach of 10 °F.

Each of the evaporation effects had a duty of 121 MMBTU/hr. Our design was efficient, with one pound of medium pressure steam effectively vaporizing 2.7 pounds of water. Theoretically, we expect one pound of steam to vaporize three pounds of water. Adding more effects would have led to better utilization of steam at the expense of greater capital cost to purchase more heat exchangers. Furthermore, each additional effect would have required deeper vacuum operation. Using three effects with forward feed arrangement was therefore found to be optimal.

Detailed block reports with energy balances have been attached where they are available and can be found in Appendix B. Table 4 shows a summary of utility requirements for the process.

Our design decisions were not always concerned with minimizing cost of utilities. For example, our initial decision to include multi-stage air compressors for each fermenter led to a massive capital cost estimate of \$38MM. For the same aeration needs, the number of multi-stage compressors could be reduced to two, which leads to a reduction of \$16MM in capital needed for the compressors. Though this decision results in less efficient air compressors, it is favorable, as further savings are made in the form of reduced number of heat exchangers for inter-stage cooling. Thus, fewer large, multi-stage compressors were chosen over many, smaller compressors and heat exchangers.

**Table 4:** Utility Summary by Equipment Item

<i>Utility Name</i>	<i>Process Unit</i>	<i>Quantity (tonnes/yr)</i>
Chilled Water	SEED-01 to 07	2,176,020
	PROD-01 to 14	42,956,760
	<b>Total</b>	<b>45,132,780</b>

<i>Utility Name</i>	<i>Process Unit</i>	<i>Quantity (lb/yr)</i>
Cooling Water	MSU HX-103	6,392,152,800
Cooling water	D2-COND101	4,648,564,800
Cooling water	D3-COND-101	4,648,564,800
Cooling water	D4-COND-101	4,648,564,800
Cooling water	D1-COND-101	4,216,845,600
	<b>Total</b>	<b>24,554,692,800</b>

<i>Utility Name</i>	<i>Process Unit</i>	<i>Quantity (kWh/yr)</i>
Electricity	PUMP-01 to 07	1,985,761
Electricity	PUMP-08 to 21	5,485,946
Electricity	PUMP-22	352,222
Electricity	PUMP-23	229,296
Electricity	PUMP-24	354,240
Electricity	PUMP-25	232,948
Electricity	PUMP-26	971,349
Electricity	PUMP-27	292,686
Electricity	PUMP-28	104,271
Electricity	PUMP-29	66,330
Electricity	PUMP-30	106,128
Electricity	PUMP-31	104,111
Electricity	PUMP-32	46,431
Electricity	PUMP-34	6,988
Electricity	PUMP-35	5,610
Electricity	PUMP-36	2,675
Electricity	PUMP-37	49,694
Electricity	PUMP-38	5,661
Electricity	MS-PUMP-1	86,902
Electricity	PUMP-33	14,343
Electricity	P01-FB-PUMP	1,426,936
Electricity	S01-FB-PUMP	129,214
Electricity	P01-CHG-PUMP	697,618
Electricity	S01-CHG-PUMP	73,221
Electricity	MS-COMP-1	52,385,714
Electricity	MS-COMP-2	52,385,714
	<b>Total</b>	<b>117,602,009</b>

<i>Utility Name</i>	<i>Process Unit</i>	<i>Quantity (lb/yr)</i>
Medium Steam	EVAP-1	1,097,712,000
Medium Steam	MSU HX-102	121,191,840
Medium Steam	D2-REB-101	44,248,057
Medium Steam	D3-REB-101	44,249,040
Medium Steam	D4-REB-101	44,249,040
Medium Steam	AUTOCLAVE	1,044,670
Medium Steam	STM-JET-1 to 6	108,702,317
Medium Steam	HX-01	107,917,920
Medium Steam	D1-REB-101	57,066,366
	<b>Total</b>	<b>1,626,381,249</b>

Table 5 shows utility needs per pound of product, found from optimizing capital cost versus utility requirements.

**Table 5:** Utility Cost Summary

<b>Utility</b>	<b>Unit</b>	<b>Ratio (per lb of PDO)</b>	<b>Utility Cost (\$ per Unit)</b>
Chilled Water	BTU	6800	$5.2 \times 10^{-6}$
Cooling Water	lb	200	$2.0 \times 10^{-6}$
Electricity	kWh	1.2	0.07
Medium Pressure Steam	1000 lb	0.02	2.0
Process Water	gal	0.32	$2.0 \times 10^{-3}$
<b>Total Weighted Average Utility Cost</b>			<b>\$0.15/lb PDO</b>

## Equipment List and Unit Descriptions

### Seed Fermenter

Each of the seven seed fermenters is 60,000 L with an initial working volume of 44,000 L. Inoculum, glycerol, glucose, and media are initially charged to the fermenter. During fed-batch fermentation, which is 68.5 hours, glycerol and glucose are fed in a mass ratio of 10:1 to maintain the glycerol concentration at 20 g/L. The fermenter is aerated at 0.5 vvm and non-dissolved gases exit through a vent. Ammonia solution is added to maintain the pH at 6.8 and the temperature is maintained at 98.6 °F with 942 tons/day chilled water at 40 °F. The molar yield of PDO is 0.6 and the productivity is 1.1 g/L-h. The concentration of PDO in the broth after fermentation is 70 g/L. The final working volume is 51,000 L. The seed fermenter is 27 feet tall and has a diameter of 10 ft. It is constructed from carbon steel and has a stainless steel 316 lining to prevent rust and corrosion. The total bare module cost of the fermenter, including the agitator and chilled water coils, is \$722,000. The combined total bare module cost for all seed fermenters is \$5MM.

### Production Fermenter

Each seed fermenter feeds into two 600,000 L production fermenters with initial working volumes of 430,000 L. During fed-batch fermentation, which is 64.5 hours, glycerol and glucose are fed in a mass ratio of 10:1 to maintain the glycerol concentration at 20 g/L. The fermenter is aerated at 0.8 vvm and non-dissolved gases exit through a vent. Ammonia solution is added to maintain the pH at 6.8 and the temperature is maintained at 98.6 °F with 9,300 tons/day of chilled water. The molar yield of PDO is 0.6 and the productivity is 1.1 g/Lh. The concentration of PDO in the broth after fermentation is 70 g/L. The final working volume is 500,000 L. The production fermenter is 88 feet tall with a diameter of 17.5 feet. It is constructed from carbon

steel and has a stainless steel 316 lining to prevent rust and corrosion. Bubble columns are used and therefore agitators are not required. The total bare module cost of the production fermenter, including chilled water coils, is \$2.2MM. The combined total bare module cost for all production fermenters is \$31MM.

### Air Compressor

The air compressor is required to feed air to the seed fermenters at 1.9 bar and production fermenters at 3.5 bar absolute. Piping, fittings, control valves, HEPA filters, and air spargers accumulate 1 bar of pressure drop between the compressor and fermenter, leading to a compressor requirement of 4.5 bar. A single compression system with two parallel multistage compressors was designed to satisfy the needs of the 7 seed and 14 production fermenters. Each compressor is two stages with inter-stage cooling, and was designed to accommodate 50% of air compression requirement for the plant. The first stage, with a brake horsepower of 4350 hp, compresses air from ambient temperature and pressure to 227 °F and 2.1 bar. A stream of used chilled water is used to cool the air stream isobarically to 98.6 °F. The second stage, with a brake horsepower of 4520 hp, compresses the air to 254 °F and 4.5 bar. The outlet cold water stream from the first stage is used to isobarically cool the exiting air stream to 98.6 °F. The total bare module cost of the two-stage compressor, including inter-stage coolers, is \$8MM. The combined total bare module cost for both compressors is \$16MM.

### Microfiltration

The purpose of microfiltration is to remove the biomass and insoluble materials from the fermentation broth. In each batch, the contents of two production fermenters are re-circulated through the filter for 10 hours, with sufficient time for maintenance between each batch. The permeate is continuously sent to an intermediate storage tank while the retentate is diluted with

recycled process water and sent back to the microfiltration feed tank. The stream is pre-heated to 165 °F and 65 psig before microfiltration to allow for a high flux rate through the membrane. The transmembrane pressure is 65 psi. The volumetric concentration ratio (VCR) is maintained at 12. The ceramic filter elements are purchased from Novasep. The microfiltration unit consists of 3 skids with 16 modules each. The modules have 104 elements, for a total of 4992 filter elements. The final retentate is heated to kill cells and a filter press is used to recover 85% of the PDO in the stream. Overall, there is 2% PDO loss in microfiltration. The total bare module cost of the microfiltration unit, including filter press, is \$60,000.

### Ultrafiltration

Ultrafiltration removes impurities with molecular weights exceeding 5000 Daltons and ensures that nanofiltration will be efficient. It operates similarly to microfiltration, with recycle and dilution of the retentate, but with no filter press. The feed is maintained at 140 °F and 60 psig. The transmembrane pressure is 60 psi. The VCR in ultrafiltration is 15. The 193 polyethersulfone filter elements are purchased from Koch. Ultrafiltration rejects 9% of the ammonia cations and 7% of the glucose in the stream. There is a 3% PDO loss in ultrafiltration. The unit has a total bare module cost of \$160,000.

### Nanofiltration

The purpose of nanofiltration is to remove any remaining impurities before distillation, including residual saccharides, proteins, salts from media and crude glycerol as well as UV absorbers. In order for nanofiltration to be effective, a high feed pressure must be used. The feed is pre-heated to 120 °F and maintained at 205 psig. The transmembrane pressure is 205 psi. The VCR is 20. The 101 polyamide elements are purchased from Koch. Nanofiltration rejects 7% of

the glucose and significant amounts of weak ions. There is an overall PDO loss of 2% in nanofiltration. The total bare module cost of the unit is \$110,000.

#### Strong Acid Cation Ion Exchange Columns

Both of the strong acid cation ion exchange columns are designed to handle the 16.34 meq/L of anions in the broth coming from the storage tank. The DowEx Marathon C Ion Exchange Resin was chosen due to its high capacity and its small uniform bead size, resulting in a durable resin and a long life. The resin bed height is 13 feet, and the vessel is 23 feet to account for 60% backwash expansion. The resin has a total exchange capacity of 1.8 eq/L and the particles swell 8%. Every 24 hours, the resin needs to be backwash expanded for 20 minutes and regenerated with 1.9 ft<sup>3</sup> 1-8% H<sub>2</sub>SO<sub>4</sub> for 40 minutes, the equivalent of two bed volumes. Pressure drop across the column is 7.4 psi, well below the recommended upper limit of 14.7 psi. Since ion exchange does not depend on temperature, this separation is done at relatively low temperature so that fiber-reinforced plastic can be used, significantly reducing the cost of the large vessel. The total installed cost of the ion exchange column, including resin, is \$670,000.

#### Weak Base Anion Ion Exchange Columns

Both of the weak base anion ion exchange columns are designed to handle the 23.23 meq/L of cations in the broth coming from the storage tank. See feed salinity calculations on page 137. Similarly to the strong acid cation resin, the DowEx Marathon WBA Ion Exchange Resin was chosen due to its small uniform bead size. The resin bed height is 10 feet and the vessel is 24 feet to account for 100% backwash expansion and 20% swelling when exhausted. This resin has a total exchange capacity of 1.3 eq/L. Every 24 hours, the resin needs to be backwash expanded for 20 minutes and regenerated with 3.7 ft<sup>3</sup> of 2-5% NaOH for 45 minutes, the equivalent of two bed volumes. Pressure drop across the column is 3.8 psi. Again,



temperature is 109 °F so that fiber-reinforced plastic can be used for construction. The total installed cost of the weak base anion ion exchange column, including resin, is \$660,000.

### Triple Effect Evaporator Unit

The product from the ion exchange columns contains 94 wt% water. To minimize the size of our distillation towers, it was necessary to concentrate the product to 20 wt% water. This was done with a triple effect falling film evaporator with forward feed arrangement. The feed to the evaporators unit is at 190 °F and 9.2 psia and is mixed with the recycle stream (vapor from the third effect). Recycling the vapor from the third effect was necessary to minimize loss of PDO. Medium pressure steam is used to evaporate 123,000 lb/hr of water from the first effect operating at 9.2 psia. Vapor from the first effect is used to evaporate 127,000 lb/hr of water from the second effect. For this vapor to achieve evaporation in the second effect, it was necessary to reduce the pressure of the liquid feed to the second effect from 9.2 psia to 6.1 psia. The vapor from the second effect is used to vaporize 125,000 lb/hr of water from the third effect. To achieve this evaporation, it was necessary to lower the pressure of liquid feed to the third effect from 6.1 psia to 2.0 psia. The temperatures of feeds are 190 °F, 172 °F and 152 °F for the first, second and third effects respectively.

The vapor from the third effect is recycled and needs to be at similar temperature and pressure to the feed. Use of compressors was found to be too demanding in terms of capital cost, and utility requirements (both electricity and cooling water). A better alternative was to condense the vapor at 2.0 psia. This was then pumped to 9.2 psia, before being heated to bubble point (190 °F) at this pressure.

Use of falling film evaporators was suggested since our product is heat sensitive and to avoid side reactions that might lead to formation of UV absorbers. Polymer grade PDO needs to

be colorless and of ultra-high purity. The strict requirements of purity of final product necessitated use of the otherwise expensive falling film evaporators network.

The total bare module cost of the triple-effect evaporator unit is \$14.6MM.

#### Mixed Bed Polish Ion Exchange Column

Although the strong acid cation and weak base anion ion exchange columns are able to remove more than 95% of the salts, the evaporation unit concentrates the stream and a mixed bed polish ion exchange column is preferred to remove the remaining salts. The DowEx Marathon MR-3 resin, premixed with half strong acid cation and half strong base anion resins, is used. The resin bed height is 3 feet and the vessel is 7.5 feet to account for backwash expansion. Every 24 hours, the resin needs to be backwash expanded for 20 minutes and regenerated for 12 minutes. Temperature is 117 °F and fiber-reinforced plastic is used for construction. The total installed cost of the mixed bed polish ion exchange column is \$280,000.

#### Distillation Column 1

The purpose of the first distillation column is to remove as much remaining water as possible. It reduces the water in the bottoms product to 1000 ppm. The column is operated under vacuum conditions to keep temperatures below 338 °F. Pressure at the top is maintained at 1.1 psia. Flexipac-HC structured packing from Koch was chosen due to its low pressure drop and cost. The tower has six stages, with the feed entering on the third stage, and a packing height of 5.5 feet. The tangent-to-tangent height is 19.5 feet and the diameter is 2.5 feet. It is constructed from carbon steel but is lined with stainless steel 304 to prevent rust. The total installed cost of the tower, including ladders, packing, and associated heat exchangers and pumps is \$610,000.

## Distillation Column 2

The purpose of the second distillation column is to remove glycerol, glucose, and other impurities from fermentation. The purity of PDO in the overhead is 99.6% and 85% of the sulfur from the crude glycerol is removed. This is especially important because significant amounts of sulfur can hinder the hydrogenation reaction that follows. The column is also operated under vacuum conditions, with pressure at the top maintained at 0.39 psia. Flexipac-HC structured packing was again chosen to minimize pressure drop and cost. The tower is six stages, with the feed entering on the third stage, and a packing height of 5.5 feet. The tangent-to-tangent height is 19.5 feet and the diameter is 2.5 feet. Since all water has been removed from the process stream, this column is constructed from carbon steel, which is significantly cheaper than stainless steel. The total installed cost of the tower including ladders, packing, and associated heat exchangers and pumps is \$370,000.

## Hydrogenation Reactor

To ensure the purity and quality of the product, the stream is contacted with hydrogen in a reactor packed with Raney Nickel catalyst. This chemical reduction step breaks any double bonded compounds that may be in the stream, including color-forming compounds. The residence time in the reactor is 0.25 hours and hydrogen is fed at 9,000 L/h. The bare module cost of the hydrogenation reactor is \$120,000.

In determining our hydrogen needs, we were faced with the challenge of limited information on how much UV absorbers are actually formed. To get started on the amount of hydrogen needed, we assumed that 5 mol% of distillate from second distillation towers are UV absorbers. Using this information, the stoichiometric amount needed was calculated. Actual operation was then assumed at 5 times stoichiometric equivalent. We understand that this

number might be on the higher side. Any excess hydrogen in actual operations could be recycled back into the hydrogenation reactor.

Our configuration for the hydrogenation reactor between the second and third distillation towers was optimal, given our fermentation process. We expected any sulfur compounds—which act as a hydrogenation catalyst poison—would be eliminated either as low boilers in the first distillation tower or high boilers in the second distillation tower. This configuration eliminates concerns of sulfur poisoning and catalyst deactivation.

#### Distillation Columns 3 and 4

The evaporation and distillation processes can form olefins and the hydrogenation step breaks the double bonds, creating more impurities. These new impurities must be separated. Distillation column 3 distills off more water and light impurities while distillation column 4 removes heavy impurities in the bottoms. Due to lack of information on the exact impurities hydrogenated, a rigorous design could not be performed for these columns. It was assumed that they would have the same packing, size, and cost as distillation column 2. The final PDO product, the vapor of column 4, is 99.98% pure on a dry basis and is clear in color. The bare module cost of each of the distillation columns is \$370,000.

#### Vacuum Systems

The three vacuum systems in the process are each two-stage steam-jet ejectors. The evaporator vacuum system is based on a vacuum pressure of 2 psia in the third effect (lowest pressure in the system). Following the condenser HX-06, liquid enters the vacuum drum where any air and vapors leaked into the system separate. Condensed water and PDO is pumped to 9 psia, reheated, and recycled to effect 1. Drums also exist for the condensate from each effects 2 and 3. Liquid is pumped from each of these drums at 9 and 6 psia to atmospheric pressure for

disposal. Air and vapors that separate in each of the three drums are fed to the first stage of the steam jet ejector, STM-JET-1. The estimated volume based on cylindrical shell and tube heat exchangers for each effect is 315 ft<sup>3</sup>, with a total air leakage rate of 26 lb/hr. The first stage, STM-JET-1, requires 525 lb/hr MP steam to remove the air. The second stage, STM-JET-2, requires 5,800 lb/hr MP steam to remove the air and steam from stage one. The total bare module cost, including the two-stage ejector, associated drums, and pumps, is \$471,000.

The vacuum system for distillation columns 1 and 2 is based on an operating pressure of 0.45 psia in column 2. Air and vapors in the reflux accumulators of both columns are fed to the first stage of the steam-jet ejector, STM-JET-3. Associated pumps on the distillate from column 1 and the bottoms from column 2 pump low pressure waste streams to atmospheric pressure for disposal. The estimated volume of the distillation pair is 190 ft<sup>3</sup>, with an air leakage rate of 15 lb/hr. The first stage, STM-JET-3, requires 310 lb/hr MP steam, and the second stage, STM-JET-4, requires 3,400 lb/hr MP steam. The total bare module cost, including the two-stage ejector and associated pumps, is \$31,000.

The vacuum system for distillation columns 3 and 4 is based on an operating pressure of 0.68 psia in column 4. Air and vapors in the reflux accumulators of both columns are fed to the first stage of the steam-jet ejector, STM-JET-5. Associated pumps on the distillate from column 3 and the bottoms from column 4 pump low pressure waste streams to atmospheric pressure for disposal. Operating specifications are comparable to the previous vacuum system; the change in operating pressure is negligible. The total bare module cost is \$30,000.

### Heat Exchangers

There are 16 heat exchangers in the design of this process, excluding condensers and reboilers associated with the distillation columns. Since all involve water or steam, they are

constructed from stainless steel to prevent rust. Three of the heat exchangers have utility requirements and the rest use integrated heat from elsewhere in the process. Due to an abundance of used chilled water, the cold-side flow rate is much greater than the hot-side, and thus has a very small change in temperature. The combined bare module cost of the heat exchangers is \$3.2MM.

### Storage Vessels

Surge tanks are installed between any two batch processes. In addition, we have storage tanks for all of the major raw materials and for the final product. Our decisions for the volumes of the storage vessels for the raw materials and for the final product were informed by how many days of storage we needed. To account for variations in supply of the raw materials and demand of the final product, two weeks was assumed to be an acceptable length of storage.

Sizing of the storage tank between batch and continuous processes was based on the mean residence time in the vessel. For storage vessels between two batch operations, our decision of the volume was based on the maximum working volume for the tank. Since fermentation times are staggered, it was especially important to anticipate the maximum working volume and purchase storage tanks large enough to handle the volume input.

It was optimal and necessary to include storage tanks for raw materials, fermentation broth before filtration, filtrate from microfiltration, contents from ion exchange columns during regeneration, concentrate from evaporators before mixed bed polish, polished concentrate to distillation tower, and final product. The combined bare module cost of the storage tanks is \$2.1MM.

### Autoclaves

Although the genetically engineered strain of *Klebsiella pneumoniae* used in our fermentation process is non-pathogenic, precautions were taken to sterilize the biomass before disposal using an autoclave. To minimize the size of the sterilizer and reduce capital cost requirements, only the cake out of the filter press is sterilized. The autoclave is heated using medium pressure steam, and has an installed cost of \$280,000.

### Pumps

There are 43 centrifugal pumps in the design of this process. It was assumed that there was a 25 psi loss in pipe flow and a 5 psi loss through heat exchangers. The calculation of the pump outlet pressures takes these losses, as well as any elevation, into account. The pumps are constructed from cast iron, which is resistant to rust. Motors use totally enclosed fan cooled motor enclosures for protection against corrosive vapors, dust, dirt, and moisture that could be present in the ambient air in our plant (Seider, et al). The combined bare module cost of the pumps is \$1.6MM.

# Unit Specification Sheets

## Seed Fermenters

<b>SEED FERMENTER</b>		
<b>Identification:</b>	Item	<i>Vertical Vessel</i>
	Item No.	SEED-01 (02-07)
	No. Required	7
<b>Function:</b>	Production of PDO from <i>Klebsiella Pneumoniae</i> Cells	
<b>Operation:</b>	Batch	
<b>Type:</b>	N/A	
	<b>Inlet</b>	<b>Outlet</b>
<b>Temperature (°F)</b>	97	97
<b>Composition (lb/batch)</b>		
PDO	0	7832
Water	97007	101959
Glycerol	17259	2233
Glucose	1727	207
Methanol	11	11
Oleic Acid	2	2
Palmitic Acid	2	2
Biomass	0	409
Salts	1058	297
<b>Design Data:</b>	Material of Construction:	Carbon Steel and Stainless Steel
	Vessel Diameter (ft):	316
	Vessel Height (ft):	10
	Final working volume (ft <sup>3</sup> ):	27
	Pressure at base of vessel (psia):	1790
		28
<b>Cost of utilities/year:</b>	3.1 x 10 <sup>5</sup> tons chilled water	\$ 24,000.00
<b>Purchase Cost:</b>		\$ 137,000.00
<b>Bare Module Cost:</b>		\$ 632,000.00
<b>Associated Costs:</b>	Agitator:	\$ 60,000.00
	Chilled water coils:	\$ 8,000.00
<b>Total Bare Module Cost:</b>		\$ 700,000.00
<b>Comments:</b>	Salts are from both media and crude glycerol Carbon Steel and Stainless Steel prices were averaged to estimate the price of a Carbon Steel vessel lined with Stainless Steel SEED-01 to 07 are identical	



Production Fermenters

<b>PRODUCTION FERMENTER</b>		
<b>Identification:</b>	Item	<i>Vertical Vessel</i>
	Item No.	PROD-01(02-14)
	No. Required	14
<b>Function:</b>	Production of PDO from <i>Klebsiella Pneumoniae</i> Cells	
<b>Operation:</b>	Batch	
<b>Type:</b>	N/A	
<b>Temperature (°F)</b>	<b>Inlet</b> 97	<b>Outlet</b> 97
<b>Composition (lb/batch)</b>		
PDO	3916	76560
Water	956727	1002698.532
Glycerol	161341.4	21917.742
Glucose	16125.67	2025
Methanol	108.24	108.24
Oleic Acid	22	22
Palmitic Acid	22	22
Biomass	205	4033
Salts	10112	2959.2156
<b>Design Data:</b>	Material of Construction:	Carbon Steel and Stainless Steel 316
	Vessel Diameter (ft):	17.5
	Vessel Height (ft):	88
	Final working volume (ft <sup>3</sup> ):	17591
	Pressure at base of vessel (psia):	47
<b>Cost of utilities/year:</b>	3.1 x 10 <sup>6</sup> tons chilled water	\$ 241,000.00
<b>Purchase Cost:</b>		\$ 455,000.00
<b>Bare Module Cost:</b>		\$ 2,123,000.00
<b>Associated Costs:</b>	Chilled water coils:	\$ 77,000.00
<b>Total Bare Module Cost:</b>		\$ 2,200,000.00
<b>Comments:</b>	Salts are from both media and crude glycerol Carbon Steel and Stainless Steel prices were averaged to estimate the price of a Carbon Steel vessel lined with Stainless Steel PROD-01 to14 are identical	

Compressors for Fermentation Air Feed

<b>AIR COMPRESSION SYSTEM</b>		
<b>Identification:</b>	Item	<i>Multi-stage compressor</i>
	Item No.	MS-COMP
	No. Required	2
<b>Function:</b>	Compress air for seed and production fermenters	
<b>Operation:</b>	Continuous	
<b>Type:</b>	2-Stage Centrifugal	
<b>Stream ID</b>	<b>Stream In</b>	<b>Stream Out</b>
<b>Air Flow rate (lb/hr)</b>	301718	301718
<b>Temperature (°F)</b>	77	98.6
<b>Pressure (psia)</b>	14.7	65.1
<b>Design Data:</b>	Construction Material:	Cast Iron/Carbon Steel/SS304
	Consumed Power (Hp)	8870
	Drive Type:	Electric
	Total Cooling Duty (BTU/hr):	20.66 x 10 <sup>6</sup>
<b>Cost of utilities/year:</b>	5.24 x 10 <sup>7</sup> kw-hr electricity	\$ 3,667,000.00
<b>Associated costs:</b>	HEPA filters, yearly	\$ 500,000.00
<b>Purchase Cost:</b>		\$ 3,240,000.00
<b>Bare Module Cost:</b>		\$ 8,000,000.00
<b>Comments:</b>	BM cost includes interstage coolers using recycled chilled water.	

Filtration Units

<b>MICROFILTRATION</b>			
<b>Identification:</b>	Item	<i>Multi-skid microfiltration unit</i>	
	Item No.	MF	
	No. Required	1	
<b>Function:</b>	Remove biomass, dirt, and large sugars and proteins from fermentation broth		
<b>Operation:</b>	Batch with recycle and dilution		
<b>Type:</b>	N/A		
<b>Stream ID</b>	<b>Feed S-041</b>	<b>Final Retentate S-045</b>	<b>Final Permeate S-049</b>
<b>Flow rate (lb/hr)</b>	443930	39960	444200
<b>Temperature (°F)</b>	165	165	165
<b>Pressure (psia)</b>	79.7	14.7	14.7
<b>Mass fraction</b>			
PDO	0.069	0.017	0.067
Water	0.903	0.920	0.911
Biomass	0.004	0.040	0.000
Glycerol	0.020	0.018	0.018
Glucose	0.002	0.002	0.002
Methanol	0.000	0.000	0.000
Oleic Acid	0.000	0.000	0.000
Palmitic Acid	0.000	0.000	0.000
Salts	0.002	0.002	0.002
<b>Design Data:</b>	Filter elements:	Kerasep BH	
	Filter material:	Ceramic	
	Pore size:	0.1 µm	
	Filtration area per element:	0.34 m <sup>2</sup>	
	Vendor:	Novasep	
	Number of skids:	3	
	Number of modules per skid:	16	
	Number of elements per module:	104	
	Total number of filter elements:	4992	
<b>Purchase Cost:</b>		\$	17,000.00
<b>Bare Module Cost:</b>		\$	19,000.00
<b>Associated Costs:</b>	Filter press	\$	32,000.00
<b>Total Bare Module Cost:</b>		\$	51,000.00
<b>Comments:</b>	Feed flow rate does not equal the sum of final retentate and permeate due to fed-batch diluent water.		

<b>ULTRAFILTRATION</b>			
<b>Identification:</b>	Item Item No. No. Required	<i>Ultrafiltration unit</i> UF 1	
<b>Function:</b>	Remove insoluble material and contaminants of fairly high molecular weight		
<b>Operation:</b>	Batch with recycle and dilution		
<b>Type:</b>	N/A		
<b>Stream ID</b>	<b>Feed S-053</b>	<b>Final Retentate S-056</b>	<b>Final Permeate S-057</b>
<b>Flow rate (lb/hr)</b>	444200	30980	450880
<b>Temperature (°F)</b>	140	140	140
<b>Pressure (psia)</b>	79.7	14.7	14.7
<b>Mass fraction</b>			
PDO	0.067	0.026	0.065
Water	0.911	0.952	0.915
Biomass	0.000	0.000	0.000
Glycerol	0.018	0.017	0.017
Glucose	0.002	0.003	0.001
Methanol	0.000	0.000	0.000
Oleic Acid	0.000	0.000	0.000
Palmitic Acid	0.000	0.000	0.000
Salts	0.002	0.002	0.002
<b>Design Data:</b>	Filter elements: Filter material: Pore specificity: Filtration area per element: Vendor: Total number of filter elements:	8338 HFK-328 Polyethersulfone Molecular weight < 5,000 kDa 37.6 m <sup>2</sup> Koch 193	
<b>Purchase Cost:</b>		\$	140,000.00
<b>Bare Module Cost:</b>		\$	160,000.00
<b>Comments:</b>	Feed flow rate does not equal the sum of final retentate and permeate due to fed-batch diluent water.		

<b>NANOFILTRATION</b>			
<b>Identification:</b>	Item Item No. No. Required	<i>Nanofiltration unit</i> NF 1	
<b>Function:</b>	Remove some salts, residual saccharides, proteins, and large contaminants		
<b>Operation:</b>	Batch with recycle and dilution		
<b>Type:</b>	N/A		
<b>Stream ID</b>	<b>Feed S-061</b>	<b>Final Retentate S-064</b>	<b>Final Permeate S-065</b>
<b>Flow rate (lb/hr)</b>	450880	22570	464170
<b>Temperature (°F)</b>	120	120	120
<b>Pressure (psia)</b>	219.7	14.7	14.7
<b>Mass fraction</b>			
PDO	0.065	0.026	0.062
Water	0.915	0.929	0.921
Biomass	0.000	0.000	0.000
Glycerol	0.017	0.017	0.015
Glucose	0.001	0.021	0.000
Methanol	0.000	0.000	0.000
Oleic Acid	0.000	0.000	0.000
Palmitic Acid	0.000	0.000	0.000
Salts	0.002	0.007	0.002
<b>Design Data:</b>	Filter elements: Filter material: Pore specificity: Filtration area per element: Vendor: Total number of filter elements:	8040 SR100-400 Polyamide Molecular weight < 200 Da 37.2 m <sup>2</sup> Koch 101	
<b>Purchase Cost:</b>		\$	94,000.00
<b>Bare Module Cost:</b>		\$	106,000.00
<b>Comments:</b>	Feed flow rate does not equal the sum of final retentate and permeate due to fed-batch diluent water.		

Ion Exchange Units

<b>WEAK BASE ANION ION EXCHANGE COLUMN</b>		
<b>Identification:</b>	Item	<i>Ion Exchange</i>
	Item No.	WBA-1 (2)
	No. Required	2
<b>Function:</b>	Remove anions from the product stream	
<b>Operation:</b>	Continuous	
<b>Type:</b>	N/A	
<b>Design Data:</b>	Volumetric Flow Rate (ft <sup>3</sup> /hr):	4322
	Cycle time(hr):	24
	Resin and Vendor:	Marathon WBA by Dow
	Total Capacity (eq/L):	1.3
	Volume of Resin (ft <sup>3</sup> ):	1854
	Bed Height (ft):	10
	Vessel Height (ft):	24
	Pressure Drop (psia):	3.8
	Temperature (F):	109
	Regeneration/backwash time (hr):	1.1
	Material of Construction:	Fiber-reinforced Plastic
<b>Purchase Cost:</b>		\$ 100,000.00
<b>Bare Module Cost:</b>		\$ 430,000.00
<b>Associated Costs:</b>	Resin:	\$ 235,000.00
<b>Total Bare Module Cost:</b>		\$ 665,000.00
<b>Comments:</b>	Material Factor is assumed to be .7 WBA-2 is identical	

<b>STRONG ACID CATION ION EXCHANGE COLUMN</b>		
<b>Identification:</b>	Item	<i>Ion Exchange</i>
	Item No.	SAC-1 (2)
	No. Required	2
<b>Function:</b>	Remove cations from the product stream	
<b>Operation:</b>	Continuous	
<b>Type:</b>	N/A	
<b>Design Data:</b>	Volumetric Flow Rate (ft <sup>3</sup> /hr):	4322
	Cycle time(hr):	24
	Resin and Vendor:	Marathon C by Dow
	Total Capacity (eq/L):	1.8
	Volume of Resin (ft <sup>3</sup> ):	941
	Bed Height (ft):	13
	Vessel Height (ft):	23
	Pressure Drop (psia):	7.4
	Temperature (F):	109
	Regeneration/backwash time (hr):	0.9
	Material of Construction:	Fiber-reinforced Plastic
<b>Purchase Cost:</b>	\$	67,000.00
	\$	
<b>Bare Module Cost:</b>		278,000.00
		\$
<b>Associated Costs:</b>	Resin:	389,000.00
<b>Total Bare Module Cost:</b>		\$
		667,000.00
<b>Comments:</b>	Material Factor is assumed to be .7 SAC-2 is identical	

<b>MIXED BED POLISH ION EXCHANGE COLUMN</b>			
<b>Identification:</b>	Item		<i>Ion Exchange</i>
	Item No.		MBP
	No. Required		1
<b>Function:</b>	Remove any remaining ions from the product stream		
<b>Operation:</b>	Continuous		
<b>Type:</b>	N/A		
<b>Design Data:</b>	Volumetric Flow Rate (ft <sup>3</sup> /hr):	292	
	Cycle time(hr):	24	
	Resin and Vendor:	DowEx Marathon MR by Dow	
	Total Capacity (eq/L):	1.45	
	Volume of Resin (ft <sup>3</sup> ):	8	
	Bed Height (ft):	3	
	Vessel Height (ft):	7.5	
	Pressure Drop (psia):	3.5	
	Temperature (F):	117	
	Regeneration/backwash time (hr):	0.5	
	Material of Construction:	Fiber-reinforced Plastic	
<b>Purchase Cost:</b>	\$	63,000.00	
<b>Bare Module Cost:</b>	\$	263,000.00	
<b>Associated Costs:</b>	Resin:	\$	13,000.00
<b>Total Bare Module Cost:</b>	\$	276,000.00	
<b>Comments:</b>	Material Factor is assumed to be .7		



Triple Effect Evaporation Unit

<b>Triple Effect Evaporator Unit</b>			
<b>Identification:</b>	Item	<i>Falling film evaporator</i>	
	Item No.	EVAP-1,2,3	
	No. Required	1	
<b>Function:</b>	Concentrate filtered fermentation broth to 20 wt% water		
<b>Operation:</b>	Continuous		
<b>Type:</b>	Shell-and-tube floating head		
<b>Duty per Effect (MMBTU/HR)</b>			121.35
<b>Flow rate into effect 1 (lb/hr)</b>			396,163
<b>Inlet Temperature (°F)</b>			190
<b>Outlet Temperature (°F)</b>			152
<b>Mass Evaporated Effect 1 (lb/hr)</b>			123,164
<b>Mass Evaporated Effect 2 (lb/hr)</b>			127,027
<b>Mass Evaporated Effect 3 (lb/hr)</b>			124,683
<b>Design Data:</b>			
<b>Effect 1</b>	Temperature (°F)		190
	Pressure (psia)		9.2
	Area(ft <sup>2</sup> )		1196
<b>Effect 2</b>	Temperature (°F)		172
	Pressure (psia)		6.1
	Area (ft <sup>2</sup> )		11137
<b>Effect 3</b>	Temperature (°F)		152
	Pressure (psia)		2.0
	Area (ft <sup>2</sup> )		7358
	Construction Materials	Stainless Steel/Stainless Steel	
<b>Cost of utilities/year:</b>	MP Steam	\$	2,456,621.00
<b>Purchase Cost:</b>		\$	5,964,323.00
<b>Bare Module Cost:</b>		\$	14,612,590.00
<b>Comments:</b>	Falling evaporator chosen to avoid colorformers and reactions		

Distillation Columns

<b>DISTILLATION COLUMN 1</b>			
<b>Identification:</b>	Item <i>Distillation Column</i>		
	Item No.	DIST-1	
	No. Required	1	
<b>Function:</b>	Reduce water content in bottoms to 1000 ppm		
<b>Operation:</b>	Continuous		
<b>Type:</b>	N/A		
<b>Stream ID</b>	<b>Feed</b>	<b>Bottoms</b>	<b>Overhead</b>
	S-113	S-119	S-118
<b>Flow rate (lb/hr)</b>	21158	17049	4109
<b>Temperature (°F)</b>	120	283	104
<b>Pressure (psia)</b>	1.07	1.10	1.06
<b>Mass fraction</b>			
PDO	0.64	0.79	0.00
Water	0.20	0.00	1.00
Glycerol	0.16	0.20	0.00
Glucose	0.00	0.01	0.00
Methanol	0.00	0.00	0.00
Oleic Acid	0.00	0.00	0.00
Palmitic Acid	0.00	0.00	0.00
Salts	0.00	0.00	0.00
<b>Design Data:</b>	Packing Type: Flexipac-HC Packing Material: Metal Packing Size: 2YHC Vendor: KOCH Packing Height (ft): 5.5 Column Diameter (ft): 2.5 Tangent to Tangent Height (ft): 19.5 Material of Construction: Carbon Steel and Stainless Steel Number of Stages: 6 Feed Stage: 3 Reflux Ratio: 0.12 Boilup Ratio: 0.87		
<b>Cost of utilities/year:</b>	5.7 x 10 <sup>7</sup> lb MP Steam	\$	114,000.00
	4.2 x 10 <sup>9</sup> lb cooling water	\$	8,446.20
<b>Purchase Cost:</b>		\$	40,000.00
<b>Bare Module Cost:</b>		\$	239,000.00
<b>Associated Costs:</b>	Packing:	\$	7,000.00
	Condenser:	\$	120,000.00
	Reboiler:	\$	175,000.00
	Reboiler Pump:	\$	12,000.00
	Reflux Accumulator:	\$	43,000.00
	Reflux Pump:	\$	14,000.00
<b>Total Bare Module Cost:</b>		\$	610,000.00
<b>Comments:</b>	Carbon Steel and Stainless Steel prices were averaged to estimate the price of a Carbon Steel tower lined with Stainless Steel		

<b>DISTILLATION COLUMN 2</b>			
<b>Identification:</b>	Item	<i>Distillation Column</i>	
	Item No.	DIST-2 (3,4)	
	No. Required	1	
<b>Function:</b>	Achieve >99% purity PDO in overhead		
<b>Operation:</b>	Continuous		
<b>Type:</b>	N/A		
<b>Stream ID</b>	<b>Feed</b>	<b>Bottoms</b>	<b>Overhead</b>
	S-120	S-126	S-125
<b>Flow rate (lb/hr)</b>	17049	4311	12738
<b>Temperature (°F)</b>	283	302	229
<b>Pressure (psia)</b>	0.40	0.46	0.39
<b>Mass fraction</b>			
PDO	0.79	0.20	1.00
Water	0.00	0.00	0.00
Glycerol	0.20	0.79	0.00
Glucose	0.01	0.02	0.00
Methanol	0.00	0.00	0.00
Oleic Acid	0.00	0.00	0.00
Palmitic Acid	0.00	0.00	0.00
Salts	0.00	0.00	0.00
<b>Design Data:</b>	Packing Type:	Flexipac-HC	
	Packing Material:	Metal	
	Packing Size:	2YHC	
	Vendor:	KOCH	
	Packing Height (ft):	5.5	
	Column Diameter (ft):	2.5	
	Tangent to Tangent Height (ft):	19.5	
	Material of Construction:	Carbon Steel	
	Number of Stages:	6	
	Feed Stage:	3	
	Reflux Ratio:	0.074	
	Boilup Ratio:	3.24	
<b>Cost of utilities/year:</b>	4.4 x 10 <sup>7</sup> lb MP Steam	\$	88,000.00
	4.65 x 10 <sup>9</sup> lb cooling water	\$	9,351.15
<b>Purchase Cost:</b>		\$	31,000.00
<b>Bare Module Cost:</b>		\$	170,000.00
<b>Associated Costs:</b>	Packing:	\$	7,000.00
	Condenser:	\$	34,000.00
	Reboiler:	\$	88,000.00
	Reboiler Pump:	\$	11,000.00
	Reflux Accumulator:	\$	47,000.00
	Reflux Pump:	\$	13,000.00
<b>Total Bare Module Cost:</b>		\$	370,000.00

Hydrogenation Reactor

<b>HYDROGENATION REACTOR</b>		
<b>Identification:</b>	Item	<i>Horizontal Vessel</i>
	Item No.	H-RXR
	No. Required	1
<b>Function:</b>	Chemical reduction of contaminants	
<b>Operation:</b>	Continuous	
<b>Type:</b>	N/A	
<b>Hydrogen Flow Rate (L/h)</b>		600
<b>Temperature (°F)</b>		248
<b>Pressure (psia)</b>		418
<b>Design Data:</b>	Material of Construction:	Carbon Steel
	Catalyst:	Raney Nickel
	Length (ft):	9
	Diameter (ft):	4
<b>Purchase Cost:</b>	\$	35,000.00
<b>Bare Module Cost:</b>	\$	120,000.00

Vacuum System Unit

<b>EVAPORATOR VACUUM SYSTEM</b>			
<b>Identification:</b>	Item	<i>Steam Jet Ejector</i>	
	Item No.	STM-JET-1, STM-JET-2	
	No. Required	1	
<b>Function:</b>	Maintain vacuum pressure across evaporator effects		
<b>Operation:</b>	Continuous		
<b>Type:</b>	2-stage		
<b>Stream ID</b>	<b>Liquid 1 to vacuum</b> <b>S-102</b>	<b>Liquid 2 to vacuum</b> <b>S-101</b>	<b>Liquid 3 to vacuum</b> <b>S-097</b>
<b>Temperature (°F)</b>	126.2	170.4	189.3
<b>Pressure (psia)</b>	2.0	6.1	9.2
<b>Design Data:</b>	Operating pressure, effect 1:		9.2 psia
	Operating pressure, effect 2:		6.1 psia
	Operating pressure, effect 3:		2.0 psia
	Total air leakage rate:		52.5 lb/hr
	Vacuum flow / suction P:		0.51 lb/hr / mmHg
<b>Cost of utilities/year:</b>	5.0 x 10 <sup>7</sup> lb/yr medium-pressure steam		\$ 250,000.00
<b>Purchase Cost:</b>			\$ 2,300.00
<b>Bare Module Cost:</b>			\$ 59,000.00
<b>Associated Costs:</b>	Vacuum Drum		\$ 150,000.00
	Drum for S-101		\$ 120,000.00
	Drum for S-097		\$ 120,000.00
	Pump for S-101		\$ 11,000.00
	Pump for S-097		\$ 11,000.00
<b>Total Bare Module Cost</b>			<b>\$ 471,000.00</b>
<b>Comments:</b>	Total air leakage rate includes an overdesign factor of 2 to account for volume of additional equipment.		

<b>DISTILLATION VACUUM SYSTEM, COLUMNS 1 &amp; 2</b>			
<b>Identification:</b>	Item	<i>Steam Jet Ejector</i>	
	Item No.	STM-JET-3, STM-JET-4	
	No. Required	1	
<b>Function:</b>	Maintain vacuum pressure across DIST-1, DIST-2		
<b>Operation:</b>	Continuous		
<b>Type:</b>	2-stage		
<b>Stream ID</b>	<b>Liquid 1 to vacuum S-125a</b>	<b>Liquid 2 to vacuum S-126</b>	<b>Liquid 3 to vacuum S-118a</b>
<b>Temperature (°F)</b>	229.1	302.6	103.8
<b>Pressure (psia)</b>	0.4	0.5	1.1
<b>Design Data:</b>	Operating pressure, column 1:		1.1 psia
	Operating pressure, column 2:		0.5 psia
	Total air leakage rate:		30.8 lb/hr
	Vacuum flow / suction P:		1.31 lb/hr / mmHg
<b>Cost of utilities/year:</b>	2.9 x 10 <sup>7</sup> lb/yr medium-pressure steam		\$ 150,000.00
<b>Purchase Cost:</b>			\$ 3,400.00
<b>Bare Module Cost:</b>			\$ 7,000.00
<b>Associated Costs:</b>	Pump for S-118		\$ 12,000.00
	Pump for S-126		\$ 12,000.00
<b>Total Bare Module Cost:</b>			\$ 31,000.00
<b>Comments:</b>	Total air leakage rate includes an oversize factor of 2 to account for volume of additional equipment.		

**DISTILLATION VACUUM SYSTEM, COLUMNS 3 & 4**

<b>Identification:</b>	Item Item No. No. Required	<i>Steam Jet Ejector</i> STM-JET-5, STM-JET-6 1	
<b>Function:</b>	Maintain vacuum pressure across DIST-3, DIST-4		
<b>Operation:</b>	Continuous		
<b>Type:</b>	2-stage		
<b>Stream ID</b>	<b>Liquid 1 to vacuum S-140a</b>	<b>Liquid 2 to vacuum S-145</b>	<b>Liquid 3 to vacuum S-135a</b>
<b>Temperature (°F)</b>	229.1	302.6	229.1
<b>Pressure (psia)</b>	0.7	0.7	0.9
<b>Design Data:</b>	Operating pressure, column 3:	0.9	psia
	Operating pressure, column 4:	0.7	psia
	Total air leakage rate:	31.0	lb/hr
	Vacuum flow / suction P:	0.89	lb/hr / mmHg
<b>Cost of utilities/year:</b>	3.0 x 10 <sup>7</sup> lb/yr medium-pressure steam	\$	150,000.00
<b>Purchase Cost:</b>		\$	2,900.00
<b>Bare Module Cost:</b>		\$	6,000.00
<b>Associated Costs:</b>	Pump for S-135	\$	12,000.00
	Pump for S-145	\$	12,000.00
<b>Total Bare Module Cost:</b>		\$	30,000.00
<b>Comments:</b>	Total air leakage rate includes an oversize factor of 2 to account for volume of additional equipment.		

Heat Exchangers

<b>HEAT EXCHANGER</b>			
<b>Identification:</b>	Item	<i>Heat Exchanger</i>	
	Item No.	HX-01	
	No. Required	1	
<b>Function:</b>	Cools feed to ultrafiltration		
<b>Operation:</b>	Continuous		
<b>Type:</b>	Floating head, Shell and Tube		
<b>Stream ID</b>	<b>Tube Side</b>	<b>Shell Side</b>	
<b>Stream In</b>	S-165	S-040	
<b>Stream Out</b>	S-166	S-041	
<b>Flow rate (lb/hr)</b>	13626	176482	
<b>Inlet Temperature (°F)</b>	347	98.6	
<b>Outlet Temperature (°F)</b>	345.2	165	
<b>Design Data:</b>	Surface Area (ft <sup>2</sup> )	374	
	LMTD (°F)	212.67	
	Heat Duty (MMBTU/HR)	11.92	
	Construction Materials	Stainless Steel/Stainless Steel	
<b>Cost of Utilities/year:</b>	1 x 10 <sup>8</sup> lb MP Steam	\$	200,000.00
<b>Purchase Cost:</b>		\$	20,000.00
<b>Bare Module Cost:</b>		\$	157,000.00



<b>HEAT EXCHANGER</b>		
<b>Identification:</b>	Item	<i>Heat Exchanger</i>
	Item No.	HX-02
	No. Required	1
<b>Function:</b>	Cools feed to ultrafiltration	
<b>Operation:</b>	Continuous	
<b>Type:</b>	Floating head, Shell and Tube	
<b>Stream ID</b>	<b>Tube Side</b>	<b>Shell Side</b>
<b>Stream In</b>	S-052	S-155
<b>Stream Out</b>	S-053	S-156
<b>Flow rate (lb/hr)</b>	212768	$7.7 \times 10^6$
<b>Inlet Temperature (°F)</b>	160	71
<b>Outlet Temperature (°F)</b>	140	72
<b>Design Data:</b>	Surface Area (ft <sup>2</sup> )	359
	LMTD (°F)	78.25
	Heat Duty (MMBTU/HR)	4.2
	Construction Materials	Stainless Steel/Stainless Steel
<b>Utilities:</b>	N/A	
<b>Purchase Cost:</b>	\$	20,000.00
<b>Bare Module Cost:</b>	\$	140,000.00
<b>Comments:</b>		

<b>HEAT EXCHANGER</b>		
<b>Identification:</b>	Item	<i>Heat Exchanger</i>
	Item No.	HX-03
	No. Required	1
<b>Function:</b>	Cools feed to nanofiltration	
<b>Operation:</b>	Continuous	
<b>Type:</b>	Floating head, Shell and Tube	
<b>Stream ID</b>	<b>Tube Side</b>	<b>Shell Side</b>
<b>Stream In</b>	S-060	S-161
<b>Stream Out</b>	S-061	S-160
<b>Flow rate (lb/hr)</b>	450938	$7.7 \times 10^6$
<b>Inlet Temperature (°F)</b>	140	74
<b>Outlet Temperature (°F)</b>	120	75
<b>Design Data:</b>	Surface Area (ft <sup>2</sup> )	1108
	LMTD (°F)	53.1
	Heat Duty (MMBTU/HR)	23.48
	Construction Materials	Stainless Steel/Stainless Steel
<b>Utilities:</b>	N/A	
<b>Purchase Cost:</b>	\$	28,000.00
<b>Bare Module Cost:</b>	\$	220,000.00
<b>Comments:</b>	Uses recycled chilled water	

<b>HEAT EXCHANGER</b>		
<b>Identification:</b>	Item	<i>Heat Exchanger</i>
	Item No.	HX-04
	No. Required	1
<b>Function:</b>	Cools feed to ion exchange	
<b>Operation:</b>	Continuous	
<b>Type:</b>	Floating head, Shell and Tube	
<b>Stream ID</b>	<b>Tube Side</b>	<b>Shell Side</b>
<b>Stream In</b>	S-068	S-161
<b>Stream Out</b>	S-069	S-162
<b>Flow rate (lb/hr)</b>	464424	$7.7 \times 10^6$
<b>Inlet Temperature (°F)</b>	120	75
<b>Outlet Temperature (°F)</b>	109	76
<b>Design Data:</b>	Surface Area (ft <sup>2</sup> )	888.85
	LMTD (°F)	35.84
	Heat Duty (MMBTU/HR)	4.7689
	Construction Materials	Stainless Steel/Stainless Steel
<b>Utilities:</b>	N/A	
<b>Purchase Cost:</b>	\$	25,000.00
<b>Bare Module Cost:</b>	\$	200,000.00
<b>Comments:</b>	Uses recycled chilled water	

<b>HEAT EXCHANGER</b>		
<b>Identification:</b>	Item	<i>Heat Exchanger</i>
	Item No.	HX-05
	No. Required	1
<b>Function:</b>	Preheats evaporator feed	
<b>Operation:</b>	Continuous	
<b>Type:</b>	Floating head, Shell and Tube	
<b>Stream ID</b>	<b>Tube Side</b>	<b>Shell Side</b>
<b>Stream In</b>	S-177	S-087a
<b>Stream Out</b>	S-179	S-087b
<b>Flow rate (lb/hr)</b>	15302	271481
<b>Inlet Temperature (°F)</b>	345	109
<b>Outlet Temperature (°F)</b>	120	124
<b>Design Data:</b>	Surface Area (ft <sup>2</sup> )	373.42
	LMTD (°F)	69.35
	Heat Duty (MMBTU/HR)	3.88
	Construction Materials	Stainless Steel/Stainless Steel
<b>Utilities:</b>	N/A	
<b>Purchase Cost:</b>	\$	20,000.00
<b>Bare Module Cost:</b>	\$	160,000.00
<b>Comments:</b>	Uses condensed steam from media sterilization	

<b>HEAT EXCHANGER</b>		
<b>Identification:</b>	Item	<i>Heat Exchanger</i>
	Item No.	HX-06
	No. Required	1
<b>Function:</b>	Condenses evaporator recycle	
<b>Operation:</b>	Continuous	
<b>Type:</b>	Floating head, Shell and Tube	
<b>Stream ID</b>	<b>Tube Side</b>	<b>Shell Side</b>
<b>Stream In</b>	S-100	S-ChW
<b>Stream Out</b>	S-102	S-153
<b>Flow rate (lb/hr)</b>	124683	$7.7 \times 10^6$
<b>Inlet Temperature (°F)</b>	152	54
<b>Outlet Temperature (°F)</b>	126	70
<b>Design Data:</b>	Surface Area (ft <sup>2</sup> )	11058.97
	LMTD (°F)	77
	Heat Duty (MMBTU/HR)	127.47
	Construction Materials	Stainless Steel/Stainless Steel
<b>Utilities:</b>	N/A	
<b>Purchase Cost:</b>	\$	110,000.00
<b>Bare Module Cost:</b>	\$	900,000.00
<b>Comments:</b>	Uses recycled chilled water	

<b>HEAT EXCHANGER</b>		
<b>Identification:</b>	Item	<i>Heat Exchanger</i>
	Item No.	HX-07
	No. Required	1
<b>Function:</b>	Heat evaporator recycle to bubble point	
<b>Operation:</b>	Continuous	
<b>Type:</b>	Shell-and-tube floating head	
<b>Stream ID</b>	<b>Tube Side</b>	<b>Shell Side</b>
<b>Stream In</b>	S-093	S-104
<b>Stream Out</b>	S-148	S-105
<b>Flow rate (lb/hr)</b>	138600	124683
<b>Inlet Temperature (°F)</b>	345	126
<b>Outlet Temperature (°F)</b>	298	190
<b>Design Data:</b>	Surface Area (ft <sup>2</sup> )	332
	LMTD (°F)	164
	Heat Duty (MMBTU/HR)	8.12
	Construction Materials	Stainless Steel/Stainless Steel
<b>Utilities:</b>	N/A	
<b>Purchase Cost:</b>	\$	20,000.00
<b>Bare Module Cost:</b>	\$	150,000.00
<b>Comments:</b>	Uses condensed steam from effect 1 of evaporator	

<b>HEAT EXCHANGER</b>		
<b>Identification:</b>	Item	<i>Heat Exchanger</i>
	Item No.	HX-08
	No. Required	1
<b>Function:</b>	Cools feed to mixed bed polish	
<b>Operation:</b>	Continuous	
<b>Type:</b>	Double Pipe	
<b>Stream ID</b>	<b>Tube Side</b>	<b>Shell Side</b>
<b>Stream In</b>	S-108	S-154
<b>Stream Out</b>	S-109	S-155
<b>Flow rate (lb/hr)</b>	21289	$7.7 \times 10^6$
<b>Inlet Temperature (°F)</b>	153.6	71.0
<b>Outlet Temperature (°F)</b>	116.6	71.1
<b>Design Data:</b>	Surface Area (ft <sup>2</sup> )	54
	LMTD (°F)	62.3
	Heat Duty (BTU/HR)	504997
	Construction Materials	Stainless Steel/Stainless Steel
<b>Utilities:</b>	N/A	
<b>Purchase Cost:</b>	\$	2,400.00
<b>Bare Module Cost:</b>	\$	9,000.00
<b>Comments:</b>	Uses recycled chilled water	

<b>HEAT EXCHANGER</b>		
<b>Identification:</b>	Item	<i>Heat Exchanger</i>
	Item No.	HX-09
	No. Required	1
<b>Function:</b>	Heats feed to DIST-1	
<b>Operation:</b>	Continuous	
<b>Type:</b>	Double Pipe	
<b>Stream ID</b>	<b>Tube Side</b>	<b>Shell Side</b>
<b>Stream In</b>	S-148	S-111
<b>Stream Out</b>	S-149	S-112
<b>Flow rate (lb/hr)</b>	138600	21289
<b>Inlet Temperature (°F)</b>	298.3	116.6
<b>Outlet Temperature (°F)</b>	298.0	120.0
<b>Design Data:</b>	Surface Area (ft <sup>2</sup> )	2
	LMTD (°F)	180
	Heat Duty (BTU/HR)	45746
	Construction Materials	Stainless Steel/Stainless Steel
<b>Utilities:</b>	N/A	
<b>Purchase Cost:</b>	\$	1,400.00
<b>Bare Module Cost:</b>	\$	6,000.00
<b>Comments:</b>	Uses condensed steam from effect 1 of evaporator	



<b>HEAT EXCHANGER</b>		
<b>Identification:</b>	Item	<i>Heat Exchanger</i>
	Item No.	HX-10
	No. Required	1
<b>Function:</b>	Heats feed to H-RXR	
<b>Operation:</b>	Continuous	
<b>Type:</b>	Double Pipe	
<b>Stream ID</b>	<b>Tube Side</b>	<b>Shell Side</b>
<b>Stream In</b>	S-149	S-127
<b>Stream Out</b>	S-150	S-128
<b>Flow rate (lb/hr)</b>	138600	12738
<b>Inlet Temperature (°F)</b>	298	230
<b>Outlet Temperature (°F)</b>	297	248
<b>Design Data:</b>	Surface Area (ft <sup>2</sup> )	16.31
	LMTD (°F)	58.22
	Heat Duty (MMBTU/HR)	0.142
	Construction Materials	Stainless Steel/Stainless Steel
<b>Utilities:</b>	N/A	
<b>Purchase Cost:</b>	\$	2,000.00
<b>Bare Module Cost:</b>	\$	8,600.00
<b>Comments:</b>	Uses condensed steam from effect 1 of evaporator	

<b>HEAT EXCHANGER</b>		
<b>Identification:</b>	Item	<i>Heat Exchanger</i>
	Item No.	HX-11
	No. Required	1
<b>Function:</b>	Heats feed to DIST-3	
<b>Operation:</b>	Continuous	
<b>Type:</b>	Double Pipe	
<b>Stream ID</b>	<b>Tube Side</b>	<b>Shell Side</b>
<b>Stream In</b>	S-150	S-133
<b>Stream Out</b>	S-151	S-134
<b>Flow rate (lb/hr)</b>	138600	12738
<b>Inlet Temperature (°F)</b>	297	248
<b>Outlet Temperature (°F)</b>	295	279
<b>Design Data:</b>	Surface Area (ft <sup>2</sup> )	124
	LMTD (°F)	19.99
	Heat Duty (MMBTU/HR)	0.372
	Construction Materials	Stainless Steel/Stainless Steel
<b>Utilities:</b>	N/A	
<b>Purchase Cost:</b>	\$	3,000.00
<b>Bare Module Cost:</b>	\$	12,000.00
<b>Comments:</b>	Uses condensed steam from effect 1 of evaporator	

<b>HEAT EXCHANGER</b>		
<b>Identification:</b>	Item	<i>Heat Exchanger</i>
	Item No.	HX-12
	No. Required	1
<b>Function:</b>	Cools final product for storage	
<b>Operation:</b>	Continuous	
<b>Type:</b>	Floating Head, Shell and Tube	
<b>Stream ID</b>	<b>Tube Side</b>	<b>Shell Side</b>
<b>Stream In</b>	S-146	S-153
<b>Stream Out</b>	S-147	S-154
<b>Flow rate (lb/hr)</b>	12738.27	$7.7 \times 10^6$
<b>Inlet Temperature (°F)</b>	229	70
<b>Outlet Temperature (°F)</b>	75	71
<b>Design Data:</b>	Surface Area (ft <sup>2</sup> )	169.7329
	LMTD (°F)	43.4
	Heat Duty (MMBTU/HR)	1.1
	Construction Materials	Stainless Steel/Stainless Steel
<b>Utilities:</b>	N/A	
<b>Purchase Cost:</b>	\$	3,000.00
<b>Bare Module Cost:</b>	\$	12,000.00
<b>Comments:</b>	Uses recycled chilled water	

<b>HEAT EXCHANGER</b>		
<b>Identification:</b>	Item	<i>Shell and tube heat exchanger</i>
	Item No.	HX-13
	No. Required	1
<b>Function:</b>	Heats feed to evaporators to 190 F	
<b>Operation:</b>	Continuous	
<b>Type:</b>	Floating head	
<b>Stream ID</b>	<b>Tube Side</b>	<b>Shell Side</b>
<b>Stream In</b>	S-151	S-087b
<b>Stream Out</b>	S-152	S-088
<b>Flow rate (lb/hr)</b>	138600	271481
<b>Inlet Temperature (°F)</b>	295	124
<b>Outlet Temperature (°F)</b>	141	190
<b>Design Data:</b>	Surface Area (ft <sup>2</sup> )	3593
	Tube Pitch (in)	1.25
	LMTD (°F)	43.66
	Heat Duty (MMBTU/HR)	23.48
	Construction Materials	Stainless Steel/Stainless Steel
<b>Utilities:</b>	N/A	
<b>Purchase Cost:</b>	\$	50,000.00
<b>Bare Module Cost:</b>	\$	400,000.00
<b>Comments:</b>	Uses condensed steam from effect 1 of evaporator	

<b>HEAT EXCHANGER</b>		
<b>Identification:</b>	Item	<i>Shell and tube heat exchanger</i>
	Item No.	MS-HX-1
	No. Required	1
<b>Function:</b>	Preheat unsterilized media to 190 F	
<b>Operation:</b>	Continuous	
<b>Type:</b>	Shell-and-tube floating head	
<b>Stream ID</b>	<b>Tube Side</b>	<b>Shell Side</b>
<b>Stream In</b>	S-171	S-168
<b>Stream Out</b>	S-172	S-169
<b>Flow rate (lb/hr)</b>	168354	216548
<b>Inlet Temperature (°F)</b>	250	68
<b>Outlet Temperature (°F)</b>	99	190
<b>Design Data:</b>	Surface Area (ft <sup>2</sup> )	3886
	LMTD (°F)	43.5
	Heat Duty (MMBTU/HR)	25.3
	Construction Materials	Stainless Steel/Stainless Steel
<b>Purchase Cost:</b>	\$	52,000.00
<b>Bare Module Cost:</b>	\$	420,000.00

<b>HEAT EXCHANGER</b>		
<b>Identification:</b>	Item	<i>Heat Exchanger</i>
	Item No.	MS-HX-2
	No. Required	1
<b>Function:</b>	Heat unsterilized media from 190 to 250 F	
<b>Operation:</b>	Continuous	
<b>Type:</b>	Shell-and-tube floating head	
<b>Stream ID</b>	<b>Tube Side</b>	<b>Shell Side</b>
<b>Stream In</b>	S-176	S-169
<b>Stream Out</b>	S-177	S-170
<b>Flow rate (lb/hr)</b>	15302	216548
<b>Inlet Temperature (°F)</b>	347	190
<b>Outlet Temperature (°F)</b>	345.2	250
<b>Design Data:</b>	Surface Area (ft <sup>2</sup> )	721
	LMTD (°F)	124
	Heat Duty (MMBTU/HR)	13.4
	Construction Materials	Stainless Steel/Stainless Steel
<b>Cost of utilities (per yr):</b>	1.2 x 10 <sup>8</sup> MP Steam	\$ 250,000.00
<b>Purchase Cost:</b>		\$ 24,000.00
<b>Bare Module Cost:</b>		\$ 188,000.00

<b>HEAT EXCHANGER</b>		
<b>Identification:</b>	Item	<i>Heat Exchanger</i>
	Item No.	MS-HX-3
	No. Required	1
<b>Function:</b>	Cool sterilized media to 96 F	
<b>Operation:</b>	Continuous	
<b>Type:</b>	Floating Head, Shell and Tube	
<b>Stream ID</b>	<b>Tube Side</b>	<b>Shell Side</b>
<b>Stream In</b>	S-174	S-159
<b>Stream Out</b>	S-175	S-178
<b>Flow rate (lb/hr)</b>	216548	807090
<b>Inlet Temperature (°F)</b>	134	68
<b>Outlet Temperature (°F)</b>	99	77
<b>Design Data:</b>	Surface Area (ft <sup>2</sup> )	1141.68
	LMTD (°F)	42.38
	Heat Duty (MMBTU/HR)	7.24
	Construction Materials	Stainless Steel/Stainless Steel
<b>Cost of utilities/year:</b>	6.4 x 10 <sup>9</sup> lb cooling water	\$ 13,000.00
<b>Purchase Cost:</b>		\$ 28,000.00
<b>Bare Module Cost:</b>		\$ 220,000.00

Storage Tanks

<b>STERILIZED MEDIA STORAGE TANK</b>		
<b>Identification:</b>	Item	<i>Storage Tank</i>
	Item No.	STOR-02
	No. Required	1
<b>Function:</b>	Holds sterilized media before being charged to fermenters	
<b>Operation:</b>	Batch	
<b>Type:</b>	Cone Roof	
<b>Stream ID</b>	<b>Stream In S-175</b>	<b>Stream Out S-001</b>
<b>Temperature (°F)</b>	98.6	
<b>Mass fraction</b>		
PDO	0.00	
Water	>0.96	
Glycerol	0.02	
Glucose	0.00	
Methanol	0.00	
Oleic Acid	0.00	
Palmitic Acid	0.00	
Salts	<0.01	
<b>Temperature (°F)</b>	75	
<b>Design Data:</b>	Material of Construction:	Stainless Steel 316
	Max working volume (gal) per tank:	720000
	Days of storage(max):	1
<b>Purchase Cost:</b>		\$ 260,000
<b>Bare Module Cost:</b>		\$ 290,000



<b>CRUDE GLYCEROL STORAGE TANK</b>		
<b>Identification:</b>	Item	<i>Storage Tank</i>
	Item No.	STOR-01
	No. Required	1
<b>Function:</b>	Holds crude glycerol and glucose before being charged to fermenters	
<b>Operation:</b>	Batch	
<b>Type:</b>	Cone Roof	
<b>Stream ID</b>	<b>Stream Out</b>	
	<b>S-002</b>	
<b>Temperature (°F)</b>	98.6	
<b>Mass fraction</b>		
PDO	0.000	
Water	0.105	
Glycerol	0.745	
Glucose	0.086	
Methanol	0.000	
Oleic Acid	0.001	
Palmitic Acid	0.001	
Salts	0.009	
Ash	0.052	
<b>Design Data:</b>	Material of Construction:	Stainless Steel 316
	Max working volume (gal) per tank:	22000
	Days of storage(max):	14
<b>Purchase Cost:</b>	\$ 340,000.00	
<b>Bare Module Cost:</b>	\$ 380,000.00	

<b>MICROFILTRATION STORAGE TANK</b>		
<b>Identification:</b>	Item	<i>Storage Tank</i>
	Item No.	STOR-03
	No. Required	1
<b>Function:</b>	Hold contents from fermenter and transfer to microfiltration	
<b>Operation:</b>	Batch	
<b>Type:</b>	Cone Roof	
<b>Stream ID</b>	<b>Stream In S-038</b>	<b>Stream Out S-039</b>
<b>Temperature (°F)</b>	98.6	
<b>Composition (lb/batch)</b>		
PDO	153000	
Water	2010000	
Glycerol	44000	
Glucose	4100	
Methanol	27	
Oleic Acid	5	
Palmitic Acid	5	
Salts	5200	
<b>Design Data:</b>	Material of Construction:	Stainless Steel 316
	Max working volume (gal):	330000
	Hours of storage:	10
<b>Purchase Cost:</b>		\$ 190,000.00
<b>Bare Module Cost:</b>		\$ 240,000.00

<b>ULTRAFILTRATION STORAGE TANK</b>		
<b>Identification:</b>	Item	<i>Storage Tank</i>
	Item No.	STOR-04
	No. Required	1
<b>Function:</b>	Hold contents from microfiltration and transfer to ultrafiltration	
<b>Operation:</b>	Batch	
<b>Type:</b>	Cone Roof	
<b>Stream ID</b>	<b>Stream In S-050</b>	<b>Stream Out S-051</b>
<b>Temperature (°F)</b>	165	
<b>Composition (lb/batch)</b>		
PDO	150000	
Water	2210000	
Glycerol	40200	
Glucose	3700	
Methanol	25	
Oleic Acid	5	
Palmitic Acid	5	
Salts	4700	
<b>Design Data:</b>	Material of Construction:	Stainless Steel 316
	Max working volume (gal):	330000
	Hours of storage:	10
<b>Purchase Cost:</b>	\$	190,000.00
<b>Bare Module Cost:</b>	\$	240,000.00

<b>NANOFILTRATION STORAGE TANK</b>		
<b>Identification:</b>	Item	<i>Storage Tank</i>
	Item No.	STOR-05
	No. Required	1
<b>Function:</b>	Hold contents from ultrafiltration and transfer to nanofiltration	
<b>Operation:</b>	Batch	
<b>Type:</b>	Cone Roof	
<b>Stream ID</b>	<b>Stream In S-058</b>	<b>Stream Out S-059</b>
<b>Temperature (°F)</b>	140	
<b>Composition (lb/batch)</b>		
PDO	146000	
Water	2410000	
Glycerol	37500	
Glucose	3200	
Methanol	23	
Oleic Acid	5	
Palmitic Acid	5	
Salts	4400	
<b>Design Data:</b>	Material of Construction:	Stainless Steel 316
	Max working volume (gal):	330000
	Hours of storage:	10
<b>Purchase Cost:</b>	\$	190,000.00
<b>Bare Module Cost:</b>	\$	240,000.00

<b>BATCH TO CONTINUOUS STORAGE TANK</b>			
<b>Identification:</b>	Item	<i>Storage Tank</i>	
	Item No.	STOR-06	
	No. Required	1	
<b>Function:</b>	Transition from batch to continuous		
<b>Operation:</b>	Batch in and continuous out		
<b>Type:</b>	Cone Roof		
<b>Stream ID</b>	<b>Stream In</b> <b>S-066</b>		<b>Stream Out</b> <b>S-067</b>
<b>Temperature (°F)</b>	120	<b>Temperature (°F)</b>	120
<b>Composition (lb/batch)</b>		<b>Flow rate (lb/hr)</b>	272000
		<b>Mass fraction</b>	
PDO	143000	PDO	0.049
Water	265000	Water	0.937
Glycerol	36000	Glycerol	0.013
Glucose	800	Glucose	0.000
Methanol	22	Methanol	0.000
Oleic Acid	0	Oleic Acid	0.000
Palmitic Acid	0	Palmitic Acid	0.000
Salts	3600	Salts	0.001
<b>Design Data:</b>	Material of Construction:	Stainless Steel 316	
	Max working volume (gal):	330000	
	Hours of storage:	10	
<b>Purchase Cost:</b>		\$	190,000.00
<b>Bare Module Cost:</b>		\$	240,000.00

<b>ION EXCHANGE STORAGE TANK</b>		
<b>Identification:</b>	Item	<i>Storage Tank</i>
	Item No.	STOR-07 (STOR-08)
	No. Required	2
<b>Function:</b>	Hold contents of ion exchange during regeneration	
<b>Operation:</b>	Continuous	
<b>Type:</b>	Cone Roof	
<b>Stream ID</b>	<b>Stream In S-076</b>	<b>Stream Out S-077</b>
<b>Temperature (°F)</b>		109
<b>Flow rate (lb/hr)</b>		272000
<b>Mass fraction</b>		
PDO		0.051
Water		0.936
Glycerol		0.013
Glucose		0.000
Methanol		0.000
Oleic Acid		0.000
Palmitic Acid		0.000
Salts		0.000
<b>Design Data:</b>	Material of Construction:	Stainless Steel 316
	Max working volume (gal):	65000
	Hours of storage(max):	1.5
<b>Purchase Cost:</b>		\$ 83,000.00
<b>Bare Module Cost:</b>		\$ 100,000.00
<b>Comments:</b>	STOR-08 is identical	

<b>MIXED BED POLISH STORAGE TANK</b>		
<b>Identification:</b>	Item	<i>Storage Tank</i>
	Item No.	STOR-09
	No. Required	1
<b>Function:</b>	Hold contents of mixed bed polish during regeneration	
<b>Operation:</b>	Batch	
<b>Type:</b>	Cone Roof	
<b>Stream ID</b>	<b>Stream In S-106</b>	<b>Stream Out S-107</b>
<b>Temperature (°F)</b>		152
<b>Flow rate (lb/hr)</b>		20900
<b>Mass fraction</b>		
PDO		0.640
Water		0.195
Glycerol		0.162
Glucose		0.004
Methanol		0.000
Oleic Acid		0.000
Palmitic Acid		0.000
Salts		0.000
<b>Design Data:</b>	Material of Construction:	Stainless Steel 316
	Max working volume (gal):	1900
	Hours of storage(max):	0.85
<b>Purchase Cost:</b>		\$ 4,000.00
<b>Bare Module Cost:</b>		\$ 17,000.00

<b>PDO PRODUCT STORAGE TANK</b>		
<b>Identification:</b>	Item	<i>Storage Tank</i>
	Item No.	STOR-10
	No. Required	1
<b>Function:</b>	Holds product before shipment for sale	
<b>Operation:</b>	Batch	
<b>Type:</b>	Cone Roof	
<b>Stream ID</b>	<b>Stream In</b> <b>S-147</b>	
<b>Temperature (°F)</b>	75	
<b>Flow rate (lb/hr)</b>	12738	
<b>Mass fraction</b>		
PDO	0.999	
Water	0.000	
Glycerol	0.000	
Glucose	0.000	
Methanol	0.000	
Oleic Acid	0.000	
Palmitic Acid	0.000	
Salts	0.000	
<b>Design Data:</b>	Material of Construction:	Stainless Steel 316
	Max working volume (gal):	552000
	Days of storage(max):	14
<b>Purchase Cost:</b>	\$ 225,000.00	
<b>Bare Module Cost:</b>	\$ 255,000.00	



Autoclave Unit

<b>Autoclaves</b>		
<b>Identification:</b>	Item	<i>Storage Tank</i>
	Item No.	
	No. Required	2
<b>Function:</b>	Sterilizes Biomass Cake from Filter Press	
<b>Operation:</b>	Batch	
<b>Type:</b>	N/A	
<b>Contents</b>	Biomass	
<b>Temperature (°F)</b>	250	
<b>Pressure (psia)</b>	29.4	
<b>Design Data:</b>	Material of Construction:	Stainless Steel 316
	Volume (gal)	1,264
<b>Total Purchase Cost:</b>	\$ 125,000	
<b>Total Bare Module Cost:</b>	\$ 141,000	

Pumps

<b>PUMP-01</b>		
<b>Identification:</b>	Item	<i>Pump</i>
	Item No.	PUMP-01 (02-07)
	No. Required	7
<b>Function:</b>	Pump contents of seed fermenter to production fermenters	
<b>Operation:</b>	Continuous	
<b>Type:</b>	Centrifugal, 3600 RPM, VSC 75 Hp	
<b>Stream ID</b>	<b>Stream In</b>	<b>Stream Out</b>
	S-012	S-013
<b>Pressure (psia)</b>	29	80
<b>Design Data:</b>	Flow Rate (gpm):	1130
	Pump Head (ft):	117
	Brake Horsepower (Hp):	48
	Construction Material:	Cast Iron
<b>Cost of utilities/year:</b>	28 x 10 <sup>4</sup> kWh electricity	\$ 20,000
<b>Purchase Cost:</b>		\$ 5,700
<b>Bare Module Cost:</b>		\$ 28,000
<b>Associated Costs:</b>	Motor	\$ 14,000
<b>Total Bare Module Cost:</b>		\$ 42,000
<b>Comments:</b>	Totally enclosed, fan-cooled motor enclosure used PUMP-01 through PUMP-07 are identical	

<b>PUMP-08</b>		
<b>Identification:</b>	Item	<i>Pump</i>
	Item No.	PUMP-08 (09-21)
	No. Required	14
<b>Function:</b>	Pump contents of production fermenter into storage tank	
<b>Operation:</b>	Continuous	
<b>Type:</b>	Centrifugal, 1800 RPM, VSC, 200 Hp	
<b>Stream ID</b>	<b>Stream In</b>	<b>Stream Out</b>
	S-023	S-024
<b>Pressure (psia)</b>	31	68
<b>Design Data:</b>	Flow Rate (gpm):	21512
	Pump Head (ft):	84
	Brake Horsepower (hP):	66
	Construction Material:	Cast Iron
<b>Cost of utilities/year:</b>	39 x 10 <sup>4</sup> kWh electricity	\$ 27,000
<b>Purchase Cost:</b>		\$ 7,000
<b>Bare Module Cost:</b>		\$ 34,600
<b>Associated Costs:</b>	Motor	\$ 19,000
<b>Total Bare Module Cost:</b>		\$ 53,600
<b>Comments:</b>	Totally enclosed, fan-cooled motor enclosure used PUMP-08 through PUMP-21 are identical	

<b>PUMP-22</b>		
<b>Identification:</b>	Item Item No. No. Required	<i>Pump</i> PUMP-22 1
<b>Function:</b>	Pump contents into microfiltration	
<b>Operation:</b>	Continuous	
<b>Type:</b>	Centrifugal, 3600 RPM, VSC, 75 Hp	
<b>Stream ID</b>	<b>Stream In</b>	<b>Stream Out</b>
	S-039	S-040
<b>Pressure (psia)</b>	28	110
<b>Design Data:</b>	Flow Rate (gpm):	875
	Pump Head (ft):	187
	Brake Horsepower (hP):	60
	Construction Material:	Cast Iron
<b>Cost of utilities/year:</b>	35 x 10 <sup>4</sup> kWh electricity	\$ 25,000
<b>Purchase Cost:</b>		\$ 5,700
<b>Bare Module Cost:</b>		\$ 23,900
<b>Associated Costs:</b>	Motor	\$ 17,100
<b>Total Bare Module Cost:</b>		\$ 41,000
<b>Comments:</b>	Totally enclosed, fan-cooled motor enclosure used	

<b>PUMP-23</b>		
<b>Identification:</b>	Item Item No. No. Required	<i>Pump</i> PUMP-23 1
<b>Function:</b>	Pump contents from microfiltration into storage tank	
<b>Operation:</b>	Continuous	
<b>Type:</b>	Centrifugal, 3600 RPM, VSC, 75 Hp	
<b>Stream ID</b>	<b>Stream In</b> S-049	<b>Stream Out</b> S-050
<b>Pressure (psia)</b>	15	68
<b>Design Data:</b>	Flow Rate (gpm):	879
	Pump Head (ft):	121
	Brake Horsepower (hP):	39
	Construction Material:	Cast Iron
<b>Cost of utilities/year:</b>	23 x 10 <sup>4</sup> kWh electricity	\$ 16,000
<b>Purchase Cost:</b>		\$ 5,000
<b>Bare Module Cost:</b>		\$ 21,000
<b>Associated Costs:</b>	Motor	\$ 11,000
<b>Total Bare Module Cost:</b>		\$ 32,000
<b>Comments:</b>	Totally enclosed, fan-cooled motor enclosure used	

<b>PUMP-24</b>		
<b>Identification:</b>	Item Item No. No. Required	<i>Pump</i> PUMP-24 1
<b>Function:</b>	Pump contents into ultrafiltration	
<b>Operation:</b>	Continuous	
<b>Type:</b>	Centrifugal, 3600 RPM, VSC, 75 Hp	
<b>Stream ID</b>	<b>Stream In</b>	<b>Stream Out</b>
	S-051	S-052
<b>Pressure (psia)</b>	28	110
<b>Design Data:</b>	Flow Rate (gpm):	879
	Pump Head (ft):	187
	Brake Horsepower (hP):	60
	Construction Material:	Cast Iron
<b>Cost of utilities/year:</b>	35 x 10 <sup>4</sup> kWh electricity	\$ 25,000
<b>Purchase Cost:</b>		\$ 6,000
<b>Bare Module Cost:</b>		\$ 24,000
<b>Associated Costs:</b>	Motor	\$ 17,000
<b>Total Bare Module Cost:</b>		\$ 41,000
<b>Comments:</b>	Totally enclosed, fan-cooled motor enclosure used	

<b>PUMP-25</b>			
<b>Identification:</b>	Item	<i>Pump</i>	
	Item No.	PUMP-25	
	No. Required	1	
<b>Function:</b>	Pump contents from ultrafiltration into storage tank		
<b>Operation:</b>	Continuous		
<b>Type:</b>	Centrifugal, 3600 RPM, VSC, 75 Hp		
<b>Stream ID</b>	<b>Stream In</b>	<b>Stream Out</b>	
	S-057	S-058	
<b>Pressure (psia)</b>	15	68	
<b>Design Data:</b>	Flow Rate (gpm):	893	
	Pump Head (ft):	121	
	Brake Horsepower (hP):	60	
	Construction Material:	Cast Iron	
<b>Cost of utilities/year:</b>	23 x 10 <sup>4</sup> kWh electricity	\$	16,000
<b>Purchase Cost:</b>		\$	5,300
<b>Bare Module Cost:</b>		\$	21,500
<b>Associated Costs:</b>	Motor	\$	11,000
<b>Total Bare Module Cost:</b>		\$	32,500
<b>Comments:</b>	Totally enclosed, fan-cooled motor enclosure used		

<b>PUMP-26</b>		
<b>Identification:</b>	Item Item No. No. Required	<i>Pump</i> PUMP-26 1
<b>Function:</b>	Pump contents into nanofiltration	
<b>Operation:</b>	Continuous	
<b>Type:</b>	Centrifugal, 1800 RPM, VSC, 200 Hp	
<b>Stream ID</b>	<b>Stream In</b>	<b>Stream Out</b>
	S-059	S-060
<b>Pressure (psia)</b>	28	250
<b>Design Data:</b>	Flow Rate (gpm):	893
	Pump Head (ft):	508
	Brake Horsepower (hP):	181
	Construction Material:	Cast Iron
<b>Cost of utilities/year:</b>	11 x 10 <sup>5</sup> kWh electricity	\$ 75,000
<b>Purchase Cost:</b>		\$ 7,000
<b>Bare Module Cost:</b>		\$ 38,000
<b>Associated Costs:</b>	Motor	\$ 50,000
<b>Total Bare Module Cost:</b>		\$ 88,000
<b>Comments:</b>	Totally enclosed, fan-cooled motor enclosure used	



<b>PUMP-27</b>		
<b>Identification:</b>	Item Item No. No. Required	<i>Pump</i> PUMP-27 1
<b>Function:</b>	Pump contents from nanofiltration into storage tank	
<b>Operation:</b>	Continuous	
<b>Type:</b>	Centrifugal, 3600 RPM, VSC, 75 Hp	
<b>Stream ID</b>	<b>Stream In</b>	<b>Stream Out</b>
	S-065	S-066
<b>Pressure (psia)</b>	15	68
<b>Design Data:</b>	Flow Rate (gpm):	1124
	Pump Head (ft):	121
	Brake Horsepower (hP):	50
	Construction Material:	Cast Iron
<b>Cost of utilities/year:</b>	29 x 10 <sup>4</sup> kWh electricity	\$ 20,000
<b>Purchase Cost:</b>		\$ 6,000
<b>Bare Module Cost:</b>		\$ 23,500
<b>Associated Costs:</b>	Motor	\$ 14,000
<b>Total Bare Module Cost:</b>		\$ 37,500
<b>Comments:</b>	Totally enclosed, fan-cooled motor enclosure used	

<b>PUMP-28</b>		
<b>Identification:</b>	Item	<i>Pump</i>
	Item No.	PUMP-28
	No. Required	1
<b>Function:</b>	Pump contents into ion exchange	
<b>Operation:</b>	Continuous	
<b>Type:</b>	Centrifugal, 3600 RPM, VSC, 75 Hp	
<b>Stream ID</b>	<b>Stream In</b>	<b>Stream Out</b>
	S-067	S-068
<b>Pressure (psia)</b>	28	67
<b>Design Data:</b>	Flow Rate (gpm):	539
	Pump Head (ft):	90
	Brake Horsepower (hP):	18
	Construction Material:	Cast Iron
<b>Cost of utilities/year:</b>	11 x 10 <sup>4</sup> kWh electricity	\$ 7,300
<b>Purchase Cost:</b>		\$ 4,000
<b>Bare Module Cost:</b>		\$ 16,000
<b>Associated Costs:</b>	Motor	\$ 6,000
<b>Total Bare Module Cost:</b>		\$ 22,000
<b>Comments:</b>	Totally enclosed, fan-cooled motor enclosure used	

<b>PUMP-29</b>			
<b>Identification:</b>	Item	<i>Pump</i>	
	Item No.	PUMP-29	
	No. Required	1	
<b>Function:</b>	Pump contents from ion exchange into storage tank		
<b>Operation:</b>	Continuous		
<b>Type:</b>	Centrifugal, 3600 RPM, VSC, 75 Hp		
<b>Stream ID</b>	<b>Stream In</b>	<b>Stream Out</b>	
	S-075	S-076	
<b>Pressure (psia)</b>	16	41	
<b>Design Data:</b>	Flow Rate (gpm):	539	
	Pump Head (ft):	58	
	Brake Horsepower (hP):	11	
	Construction Material:	Cast Iron	
<b>Cost of utilities/year:</b>	7 x 10 <sup>4</sup> kWh electricity	\$	4,600
<b>Purchase Cost:</b>		\$	4,000
<b>Bare Module Cost:</b>		\$	15,500
<b>Associated Costs:</b>	Motor	\$	4,000
<b>Total Bare Module Cost:</b>		\$	19,500
<b>Comments:</b>	Totally enclosed, fan-cooled motor enclosure used		

<b>PUMP-30</b>		
<b>Identification:</b>	Item	<i>Pump</i>
	Item No.	PUMP-30
	No. Required	1
<b>Function:</b>	Pump contents into ion exchange	
<b>Operation:</b>	Continuous	
<b>Type:</b>	Centrifugal, 3600 RPM, VSC, 75 Hp	
<b>Stream ID</b>	<b>Stream In</b>	<b>Stream Out</b>
	S-077	S-078
<b>Pressure (psia)</b>	22	62
<b>Design Data:</b>	Flow Rate (gpm):	539
	Pump Head (ft):	93
	Brake Horsepower (hP):	18
	Construction Material:	Cast Iron
<b>Cost of utilities/year:</b>	11 x 10 <sup>4</sup> kWh electricity	\$ 7,400
<b>Purchase Cost:</b>		\$ 4,000
<b>Bare Module Cost:</b>		\$ 16,800
<b>Associated Costs:</b>	Motor	\$ 5,600
<b>Total Bare Module Cost:</b>		\$ 22,400
<b>Comments:</b>	Totally enclosed, fan-cooled motor enclosure used	

<b>PUMP-31</b>			
<b>Identification:</b>	Item	<i>Pump</i>	
	Item No.	PUMP-31	
	No. Required	1	
<b>Function:</b>	Pump Contents from ion exchange into storage tank		
<b>Operation:</b>	Continuous		
<b>Type:</b>	Centrifugal, 3600 RPM, VSC, 75 Hp		
<b>Stream ID</b>	<b>Stream In</b>	<b>Stream Out</b>	
	S-084	S-085	
<b>Pressure (psia)</b>	16	55	
<b>Design Data:</b>	Flow Rate (gpm):	539	
	Pump Head (ft):	96	
	Brake Horsepower (hP):	18	
	Construction Material:	Cast Iron	
<b>Cost of utilities/year:</b>	10 x 10 <sup>4</sup> kWh electricity	\$	7,000
<b>Purchase Cost:</b>		\$	4,300
<b>Bare Module Cost:</b>		\$	16,900
<b>Associated Costs:</b>	Motor	\$	5,500
<b>Total Bare Module Cost:</b>		\$	22,400
<b>Comments:</b>	Totally enclosed, fan-cooled motor enclosure used		

<b>PUMP-32</b>			
<b>Identification:</b>	Item	<i>Pump</i>	
	Item No.	PUMP-32	
	No. Required	1	
<b>Function:</b>	Pump Contents into the evaporator		
<b>Operation:</b>	Continuous		
<b>Type:</b>	Centrifugal, 3600 RPM, VSC, 75 Hp		
<b>Stream ID</b>	<b>Stream In</b>	<b>Stream Out</b>	
	S-086	S-087a	
<b>Pressure (psia)</b>	22	40	
<b>Design Data:</b>	Flow Rate (gpm):	539	
	Pump Head (ft):	43	
	Brake Horsepower (hP):	8	
	Construction Material:	Cast Iron	
<b>Cost of utilities/year:</b>	5 x 10 <sup>4</sup> kWh electricity	\$	3,000
<b>Purchase Cost:</b>		\$	4,000
<b>Bare Module Cost:</b>		\$	16,000
<b>Associated Costs:</b>	Motor	\$	2,000
<b>Total Bare Module Cost:</b>		\$	18,000
<b>Comments:</b>	Totally enclosed, fan-cooled motor enclosure used		

<b>PUMP-33</b>		
<b>Identification:</b>	Item	<i>Centrifugal pump</i>
	Item No.	PUMP-33
	No. Required	1
<b>Function:</b>	To pump recycled vapor from effect 3 of evaporator	
<b>Operation:</b>	Continuous	
<b>Type:</b>	Centrifugal, 3600 RPM, VSC, 75 Hp	
<b>Stream ID</b>	<b>Stream In</b>	<b>Stream Out</b>
	<b>S-103</b>	<b>S-104</b>
<b>Pressure (psia)</b>	2	40
<b>Design Data:</b>	Flow Rate (gpm):	256
	Pump Head (ft)	17.1
	Brake Power (hp)	1.7
	Construction Material	Cast Iron
<b>Cost of utilities/year:</b>	14 x 10 <sup>3</sup> kWh electricity	\$ 1,000
<b>Purchase Cost:</b>		\$ 3,000
<b>Bare Module Cost:</b>		\$ 11,500
<b>Associated Costs</b>	Motor	\$ 2,000
<b>Total Bare Module Costs</b>		\$ 13,500
<b>Comments:</b>	Totally enclosed, fan-cooled motor enclosure used	

<b>PUMP-34</b>		
<b>Identification:</b>	Item	<i>Pump</i>
	Item No.	PUMP-34
	No. Required	1
<b>Function:</b>	Pump Contents into storage tank while mixed bed polish during regeneration	
<b>Operation:</b>	Continuous	
<b>Type:</b>	Centrifugal, 3600 RPM, VSC, 75 Hp	
<b>Stream ID</b>	<b>Stream In</b>	<b>Stream Out</b>
	S-099	S-106
<b>Pressure (psia)</b>	2	41
<b>Design Data:</b>	Flow Rate (gpm):	36
	Pump Head (ft):	80
	Brake Horsepower (hP):	1.2
	Construction Material:	Cast Iron
<b>Cost of utilities/year:</b>	7 x 10 <sup>3</sup> kWh electricity	\$ 500
<b>Purchase Cost:</b>		\$ 3,000
<b>Bare Module Cost:</b>		\$ 11,100
<b>Associated Costs:</b>	Motor	\$ 1,600
<b>Total Bare Module Cost:</b>		\$ 12,700
<b>Comments:</b>	Totally enclosed, fan-cooled motor enclosure used	



<b>PUMP-35</b>		
<b>Identification:</b>	Item Item No. No. Required	<i>Pump</i> PUMP-35 1
<b>Function:</b>	Pump Contents into mixed bed polish	
<b>Operation:</b>	Continuous	
<b>Type:</b>	Centrifugal, 3600 RPM, VSC, 75 Hp	
<b>Stream ID</b>	<b>Stream In</b> S-107	<b>Stream Out</b> S-108
<b>Pressure (psia)</b>	18	49
<b>Design Data:</b>	Flow Rate (gpm):	36
	Pump Head (ft):	64
	Brake Horsepower (hP):	1
	Construction Material:	Cast Iron
<b>Cost of utilities/year:</b>	6 x 10 <sup>3</sup> kWh electricity	\$ 400
<b>Purchase Cost:</b>		\$ 3,000
<b>Bare Module Cost:</b>		\$ 11,000
<b>Associated Costs:</b>	Motor	\$ 1,600
<b>Total Bare Module Cost:</b>		\$ 12,600
<b>Comments:</b>	Totally enclosed, fan-cooled motor enclosure used	

<b>PUMP-36</b>		
<b>Identification:</b>	Item Item No. No. Required	<i>Pump</i> PUMP-36 1
<b>Function:</b>	Pump Contents into distillation	
<b>Operation:</b>	Continuous	
<b>Type:</b>	Centrifugal, 3600 RPM, VSC, 75 Hp	
<b>Stream ID</b>	<b>Stream In</b> S-110	<b>Stream Out</b> S-111
<b>Pressure (psia)</b>	16	31
<b>Design Data:</b>	Flow Rate (gpm):	36
	Pump Head (ft):	30
	Brake Horsepower (hP):	0.5
	Construction Material:	Cast Iron
<b>Cost of utilities/year:</b>	3 x 10 <sup>3</sup> kWh electricity	\$ 200
<b>Purchase Cost:</b>		\$ 3,000
<b>Bare Module Cost:</b>		\$ 11,100
<b>Associated Costs:</b>	Motor	\$ 1,500
<b>Total Bare Module Cost:</b>		\$ 12,600
<b>Comments:</b>	Totally enclosed, fan-cooled motor enclosure used	

<b>PUMP-37</b>			
<b>Identification:</b>	Item	<i>Pump</i>	
	Item No.	PUMP-37	
	No. Required	1	
<b>Function:</b>	Pump Contents into hydrogenation		
<b>Operation:</b>	Continuous		
<b>Type:</b>	Centrifugal, 3600 RPM, VSC, 75 Hp		
<b>Stream ID</b>	<b>Stream In</b>	<b>Stream Out</b>	
	S-125b	S-127	
<b>Pressure (psia)</b>	0	365	
<b>Design Data:</b>	Flow Rate (gpm):	26	
	Pump Head (ft):	917	
	Brake Horsepower (hP):	9	
	Construction Material:	Cast Iron	
<b>Cost of utilities/year:</b>	5 x 10 <sup>4</sup> kWh electricity	\$	3,500
<b>Purchase Cost:</b>		\$	3,000
<b>Bare Module Cost:</b>		\$	11,800
<b>Associated Costs:</b>	Motor	\$	3,200
<b>Total Bare Module Cost:</b>		\$	15,000
<b>Comments:</b>	Totally enclosed, fan-cooled motor enclosure used		

<b>PUMP-38</b>			
<b>Identification:</b>	Item	<i>Pump</i>	
	Item No.	PUMP-38	
	No. Required	1	
<b>Function:</b>	Pump Contents into product storage tank		
<b>Operation:</b>	Continuous		
<b>Type:</b>	Centrifugal, 3600 RPM, VSC, 75 Hp		
<b>Stream ID</b>	<b>Stream In</b>	<b>Stream Out</b>	
	S-140b	S-146	
<b>Pressure (psia)</b>	0.4	15	
<b>Design Data:</b>	Flow Rate (gpm):	26	
	Pump Head (ft):	107	
	Brake Horsepower (hP):	1	
	Construction Material:	Cast Iron	
<b>Cost of utilities/year:</b>	6 x 10 <sup>3</sup> kWh electricity	\$	400
<b>Purchase Cost:</b>		\$	3,000
<b>Bare Module Cost:</b>		\$	11,000
<b>Associated Costs:</b>	Motor	\$	1,600
<b>Total Bare Module Cost:</b>		\$	12,600
<b>Comments:</b>	Totally enclosed, fan-cooled motor enclosure used		

<b>PUMP GLYCEROL TO PRODUCTION FERMENTER</b>		
<b>Identification:</b>	Item	<i>Pump</i>
	Item No.	P01-FB-PUMP
	No. Required	14
<b>Function:</b>	Pump Glycerol and Glucose into production fermenter	
<b>Operation:</b>	Continuous	
<b>Type:</b>	Centrifugal, 3600 RPM, VSC, 75 Hp	
<b>Stream ID</b>	<b>Stream In</b>	<b>Stream Out</b>
	<b>S-016</b>	<b>S-017</b>
<b>Pressure (psia)</b>	31	69
<b>Design Data:</b>	Flow Rate (gpm):	357
	Pump Head (ft):	106
	Brake Horsepower (hP):	17
	Construction Material:	Cast Iron
<b>Cost of utilities/year:</b>	10 x 10 <sup>4</sup> kWh electricity	\$ 7,000
<b>Purchase Cost:</b>		\$ 4,000
<b>Bare Module Cost:</b>		\$ 12,900
<b>Associated Costs:</b>	Motor	\$ 5,400
<b>Total Bare Module Cost:</b>		\$ 18,300
<b>Comments:</b>	Totally enclosed, fan-cooled motor enclosure used	

<b>PUMP GLYCEROL TO SEED FERMENTER</b>			
<b>Identification:</b>	Item	<i>Pump</i>	
	Item No.	S01-FB-PUMP	
	No. Required	7	
<b>Function:</b>	Pump Glycerol and Glucose into seed fermenter		
<b>Operation:</b>	Continuous		
<b>Type:</b>	Centrifugal, 3600 RPM, VSC, 75 Hp		
<b>Stream ID</b>	<b>Stream In</b>	<b>Stream Out</b>	
	<b>S-005</b>	<b>S-006</b>	
<b>Pressure (psia)</b>	31	68	
<b>Design Data:</b>	Flow Rate (gpm):	150	
	Pump Head (ft):	46	
	Brake Horsepower (hP):	3	
	Construction Material:	Cast Iron	
<b>Cost of utilities/year:</b>	2 x 10 <sup>4</sup> kWh electricity	\$	1,300
<b>Purchase Cost:</b>		\$	3,100
<b>Bare Module Cost:</b>		\$	10,200
<b>Associated Costs:</b>	Motor	\$	2,000
<b>Total Bare Module Cost:</b>		\$	12,200
<b>Comments:</b>	Totally enclosed, fan-cooled motor enclosure used		

<b>PUMP MEDIA TO PRODUCTION FERMENTER</b>			
<b>Identification:</b>	Item	<i>Pump</i>	
	Item No.	P01-CHG-PUMP	
	No. Required	14	
<b>Function:</b>	Pump media into production fermenter		
<b>Operation:</b>	Continuous		
<b>Type:</b>	Centrifugal, 3600 RPM, VSC, 75 Hp		
<b>Stream ID</b>	<b>Stream In</b>	<b>Stream Out</b>	
	<b>S-014</b>	<b>S-015</b>	
<b>Pressure (psia)</b>	26	64	
<b>Design Data:</b>	Flow Rate (gpm):	191	
	Pump Head (ft):	122	
	Brake Horsepower (hP):	8	
	Construction Material:	Cast Iron	
<b>Cost of utilities/year:</b>	5 x 10 <sup>4</sup> kWh electricity	\$	3,500
<b>Purchase Cost:</b>		\$	3,500
<b>Bare Module Cost:</b>		\$	11,800
<b>Associated Costs:</b>	Motor	\$	3,200
<b>Total Bare Module Cost:</b>		\$	15,000
<b>Comments:</b>	Totally enclosed, fan-cooled motor enclosure used		

<b>PUMP MEDIA TO SEED FERMENTER</b>		
<b>Identification:</b>	Item	<i>Pump</i>
	Item No.	S01-CHG-PUMP
	No. Required	7
<b>Function:</b>	Pump media into seed fermenter	
<b>Operation:</b>	Continuous	
<b>Type:</b>	Centrifugal, 3600 RPM, VSC, 75 Hp	
<b>Stream ID</b>	<b>Stream In</b>	<b>Stream Out</b>
	<b>S-003</b>	<b>S-004</b>
<b>Pressure (psia)</b>	28	65
<b>Design Data:</b>	Flow Rate (gpm):	85
	Pump Head (ft):	58
	Brake Horsepower (hP):	2
	Construction Material:	Cast Iron
<b>Cost of utilities/year:</b>	1 x 10 <sup>4</sup> kWh electricity	\$ 700
<b>Purchase Cost:</b>		\$ 3,000
<b>Bare Module Cost:</b>		\$ 14,000
<b>Associated Costs:</b>	Motor	\$ 5,000
<b>Total Bare Module Cost:</b>		\$ 19,000
<b>Comments:</b>	Totally enclosed, fan-cooled motor enclosure used	



<b>MEDIA PUMP</b>		
<b>Identification:</b>	Item	<i>Centrifugal pump</i>
	Item No.	MS-PUMP-1
	No. Required	1
<b>Function:</b>	To pump unsterilized media to heat exchanger	
<b>Operation:</b>	Continuous	
<b>Type:</b>	Centrifugal, 3600 RPM, VSC, 75 Hp	
<b>Stream ID</b>	<b>Stream In</b>	<b>Stream Out</b>
	<b>S-167</b>	<b>S-168</b>
<b>Pressure (psia)</b>	14.7	44.1
<b>Design Data:</b>	Flow Rate (gpm):	7.5
	Pump Head (ft):	65.7
	Brake Power (hp):	10.3
	Construction Material:	Cast Iron
<b>Cost of utilities/year:</b>	86 x 10 <sup>3</sup> kWh electricity	\$ 6,000
<b>Purchase Cost:</b>		\$ 4,000
<b>Bare Module Cost:</b>		\$ 14,000
<b>Associated Costs</b>	Motor	\$ 5,000
<b>Total Bare Module Costs</b>		\$ 19,000
<b>Comments:</b>	Totally enclosed, fan-cooled motor enclosure used	

## Equipment Cost Summary

The summary of all equipment purchase and bare module costs is presented in Table 6. The total cost for plant equipment is \$79.8MM, 40% of which is attributed to the 14 production fermenters. This was anticipated to be the greatest cost in the process, due to requirements for stainless steel construction and massive fermentation volume to meet production goals.

The triple-effect evaporator is the most expensive single unit, accounting for 18% of total equipment costs (\$14.6MM). A discussion of the evaporator modeling and its effect on costing is found in the economic analysis section, page 129.

HX-06, evaporator recycle condenser, was the most expensive heat exchanger in the process, accounting for 28% of the total heat exchanger costs. This is because of the massive heat exchange area required.

**Table 6:** Equipment Cost Summary

Unit Name	C <sub>P</sub>	F <sub>BM</sub>	Associated Costs	C <sub>BM</sub>	Quantity	Total C <sub>BM</sub>
<b>Fermenters</b>						
SEED-01 to 07	\$136,860.57	4.16	\$67,741.85	\$722,450.81	7	\$5,057,155.65
PROD-01 to 14	\$454,975.03	4.16	\$77,043.20	\$2,233,684.37	14	\$31,271,581.13
<i>Subtotal</i>						\$36,328,736.77
<b>Filtration Units</b>						
MF	\$16,931.00	1	\$0.00	\$19,199.75	1	\$19,199.75
UF	\$144,823.00	1	\$0.00	\$164,229.28	1	\$164,229.28
NF	\$93,665.00	1	\$0.00	\$106,216.11	1	\$106,216.11
FILTER PRESS	\$28,218.33	1	\$0.00	\$31,999.59	1	\$31,999.59
<i>Subtotal</i>						\$321,644.73
<b>Ion Exchange</b>						
SAC-1,2	\$66,849.42	4.16	\$388,163.04	\$666,256.64	2	\$1,332,513.28
WBA-1,2	\$103,138.85	4.16	\$234,649.83	\$663,707.43	2	\$1,327,414.86
MBP	\$63,274.72	4.16	\$13,298.86	\$276,409.39	1	\$276,409.39
<i>Subtotal</i>						\$2,936,337.53
<b>Evaporation</b>						
EVAP-1	\$675,262.63	2.45	\$0.00	\$1,876,182.17	1	\$1,876,182.17
EVAP-2	\$2,575,698.09	2.45	\$0.00	\$7,156,062.00	1	\$7,156,062.00
EVAP-3	\$2,008,583.31	2.45	\$0.00	\$5,580,447.00	1	\$5,580,447.00
<i>Subtotal</i>						\$14,612,691.17
<b>Hydrogenation</b>						
H-RXR	\$35,461.63	3.05		\$122,651.13	1	\$122,651.13

Unit Name	C <sub>P</sub>	F <sub>BM</sub>	Associated Costs	C <sub>BM</sub>	Quantity	Total C <sub>BM</sub>
<b>Distillation Columns</b>						
DIST-1	\$39,849.46	4.16	\$370,652.02	\$608,306.82	1	\$608,306.82
DIST-2,3,4	\$31,025.49	4.16	\$199,125.36	\$372,169.05	3	\$1,116,507.14
<i>Subtotal</i>						\$1,724,813.97
<b>Pumps</b>						
PUMP-01 to 07	\$ 5,701.75	3.3	\$13,715.08	\$41,852.09	7	\$292,964.66
PUMP-08 to 21	\$ 6,915.57	3.3	\$19,094.86	\$53,551.51	14	\$749,721.16
PUMP-22	\$ 5,659.85	3.3	\$17,098.92	\$40,570.46	1	\$40,570.46
PUMP-23	\$ 5,240.62	3.3	\$11,107.62	\$32,207.48	1	\$32,207.48
PUMP-24	\$ 5,671.28	3.3	\$17,199.92	\$40,727.79	1	\$40,727.79
PUMP-25	\$ 5,269.79	3.3	\$11,280.22	\$32,512.36	1	\$32,512.36
PUMP-26	\$ 6,967.29	3.3	\$49,365.50	\$88,116.96	1	\$88,116.96
PUMP-27	\$ 5,731.50	3.3	\$14,154.03	\$37,499.10	1	\$37,499.10
PUMP-28	\$ 4,280.48	3.3	\$5,478.06	\$22,230.54	1	\$22,230.54
PUMP-29	\$ 4,029.59	3.3	\$3,901.38	\$19,503.71	1	\$19,503.71
PUMP-30	\$ 4,301.56	3.3	\$5,557.04	\$22,398.98	1	\$22,398.98
PUMP-31	\$ 4,318.08	3.3	\$5,471.29	\$22,363.56	1	\$22,363.56
PUMP-32	\$ 3,877.95	3.3	\$3,103.92	\$18,031.90	1	\$18,031.90
PUMP-33	\$ 3,110.95	3.3	\$1,867.99	\$13,509.81	1	\$13,509.81
PUMP-34	\$ 2,898.66	3.3	\$1,603.66	\$12,665.92	1	\$12,665.92
PUMP-35	\$ 2,900.97	3.3	\$1,555.68	\$12,620.15	1	\$12,620.15
PUMP-36	\$ 2,936.93	3.3	\$1,436.53	\$12,619.61	1	\$12,619.61
PUMP-37	\$ 3,010.52	3.3	\$3,233.26	\$14,932.48	1	\$14,932.48
PUMP-38	\$ 2,905.83	3.3	\$1,557.47	\$12,640.36	1	\$12,640.36
P01-FB-PUMP	\$3,923.79	3.3	\$5,378.50	\$18,327.01	1	\$18,327.01
S01-FB-PUMP	\$3,095.90	3.3	\$2,021.48	\$12,237.95	1	\$12,237.95
P01-CHG-PUMP	\$3,465.83	3.3	\$3,238.64	\$14,675.88	1	\$14,675.88
S01-CHG-PUMP	\$2,967.84	3.3	\$1,726.38	\$11,520.23	1	\$11,520.23
MS-PUMP-1	\$3,851.83	3.3	\$4,747.41	\$19,161.73	1	\$19,161.73
<i>Subtotal</i>						\$1,573,759.79

Unit Name	C <sub>P</sub>	F <sub>BM</sub>	Associated Costs	C <sub>BM</sub>	Quantity	Total C <sub>BM</sub>
<b>Heat Exchangers</b>						
HX-12	\$2,885.57	3.17	\$0.00	\$12,434.48	1	\$12,434.48
MS-HX-2	\$23,716.26	3.17	\$0.00	\$187,733.60	1	\$187,733.60
MS-HX-1	\$51,981.32	3.17	\$0.00	\$422,059.91	1	\$422,059.91
MS-HX-3	\$27,922.50	3.17	\$0.00	\$222,513.45	1	\$222,513.45
HX-09	\$1,381.47	3.17	\$0.00	\$5,953.01	1	\$5,953.01
HX-10	\$1,983.63	3.17	\$0.00	\$8,547.86	1	\$8,547.86
HX-11	\$2,744.94	3.17	\$0.00	\$11,828.51	1	\$11,828.51
HX-05a	\$20,048.89	3.17	\$0.00	\$157,233.02	1	\$157,233.02
HX-05b	\$49,548.86	3.17	\$0.00	\$401,812.47	1	\$401,812.47
HX-04	\$25,423.72	3.17	\$0.00	\$201,858.46	1	\$201,858.46
HX-03	\$27,594.70	3.17	\$0.00	\$219,804.13	1	\$219,804.13
HX-08	\$2,402.43	3.17	\$0.00	\$9,129.25	1	\$9,129.25
HX-02	\$19,897.68	3.17	\$0.00	\$137,532.67	1	\$137,532.67
HX-06	\$109,437.35	3.17	\$0.00	\$903,794.96	1	\$903,794.96
HX-07	\$19,617.09	3.17	\$0.00	\$153,597.00	1	\$153,597.00
HX-01	\$20,059.49	3.17	\$0.00	\$157,322.08	1	\$157,322.08
<i>Subtotal</i>				\$3,213,154.86		\$3,213,154.86
<b>Autoclave</b>						
AUTOCLAVE	\$124645.94	1	\$0.00	\$141,348.50	2	\$282,697.00
<b>Storage Tanks</b>						
STOR-02	\$256,687.00	1	\$0.00	\$291,083.00	1	\$291,083.00
STOR-01	\$337,052.52	1	\$0.00	\$382,217.00	1	\$382,217.00
STOR-03,04,05,06	\$189,443.19	1	\$0.00	\$236,310.86	4	\$945,243.43
STOR-07,08	\$82,626.82	1	\$0.00	\$103,068.69	2	\$206,137.39
STOR-09	\$3,377.23	1	\$0.00	\$16,686.75	1	\$16,686.75
STOR-10	\$224,667.00	1	\$0.00	\$254,773.00	1	\$254,773.00
<i>Subtotal</i>				\$2,096,140.57		\$2,096,140.57
<b>Vacuum System</b>						
STM-JET-1,2	\$2,300.00	1	\$412,909.20	\$470,847.23	1	\$470,847.23
STM-JET-3,4	\$3,398.00	1	\$24,077.13	\$31,156.80	1	\$31,156.80
STM-JET-5,6	\$2,900.00	1	\$24,077.13	\$30,592.07	1	\$30,592.07
<i>Subtotal</i>				\$532,596.10		\$532,596.10
<b>Air Compressors</b>						
MS-COMP	\$3,242,796.00		\$0.00	\$8,033,198.17	2	\$16,066,396.33
<b>Total</b>						\$79,811,619.94

## Operating Cost-Cost of Manufacture

Our variable costs are broken down into raw materials, utility costs, labor costs, and other general expenses that scale with production. The general summary of all costs and investments is shown in Table 7.

**Table 7: Cost and Investment Summary**

<u>Variable Cost Summary</u>		
<u>Variable Costs at 100% Capacity:</u>		
<u>General Expenses</u>		
Selling / Transfer Expenses:	\$	3,000,000
Direct Research:	\$	4,800,000
Allocated Research:	\$	500,000
Administrative Expense:	\$	2,000,000
Management Incentive Compensation:	\$	1,250,000
<b>Total General Expenses</b>	<b>\$</b>	<b>11,550,000</b>
<u>Raw Materials</u>	\$0.267507 per lb of PDO	\$26,750,683
<u>Byproducts</u>	\$0.000000 per lb of PDO	\$0
<u>Utilities</u>	\$0.150230 per lb of PDO	\$15,023,005
<b>Total Variable Costs</b>	<b>\$</b>	<b>53,323,687</b>
<u>Fixed Cost Summary</u>		
<u>Operations</u>		
Direct Wages and Benefits	\$	416,000
Direct Salaries and Benefits	\$	62,400
Operating Supplies and Services	\$	24,960
Technical Assistance to Manufacturing	\$	300,000
Control Laboratory	\$	325,000
<b>Total Operations</b>	<b>\$</b>	<b>1,128,360</b>
<u>Maintenance</u>		
Wages and Benefits	\$	4,661,797
Salaries and Benefits	\$	1,165,449
Materials and Services	\$	4,661,797
Maintenance Overhead	\$	233,090
<b>Total Maintenance</b>	<b>\$</b>	<b>10,722,132</b>
<u>Operating Overhead</u>		
General Plant Overhead:	\$	447,701
Mechanical Department Services:	\$	151,336
Employee Relations Department:	\$	372,033
Business Services:	\$	466,618
<b>Total Operating Overhead</b>	<b>\$</b>	<b>1,437,687</b>
<u>Property Taxes and Insurance</u>		
Property Taxes and Insurance:	\$	2,071,910
<u>Other Annual Expenses</u>		
Rental Fees (Office and Laboratory Space):	\$	-
Licensing Fees:	\$	-
Miscellaneous:	\$	-
<b>Total Other Annual Expenses</b>	<b>\$</b>	<b>-</b>
<b>Total Fixed Costs</b>	<b>\$</b>	<b>15,360,089</b>

---

**Investment Summary**

---

**Total Bare Module Costs:**

Fabricated Equipment	\$	1,573,760	
Process Machinery	\$	78,237,860	
Spares	\$	-	
Storage	\$	-	
Other Equipment	\$	-	
Catalysts	\$	-	
Computers, Software, Etc.	\$	-	
<b>Total Bare Module Costs:</b>			<b>\$ 79,811,620</b>

**Direct Permanent Investment**

Cost of Site Preparations:	\$	3,990,581	
Cost of Service Facilities:	\$	3,990,581	
Allocated Costs for utility plants and related facilities:	\$	-	
<b>Direct Permanent Investment</b>			<b>\$ 87,992,782</b>

**Total Depreciable Capital**

Cost of Contingencies & Contractor Fees	\$	15,802,701	
<b>Total Depreciable Capital</b>			<b>\$ 103,595,483</b>

**Total Permanent Investment**

Cost of Land:	\$	2,071,910	
Cost of Royalties:	\$	-	
Cost of Plant Start-Up:	\$	10,359,548	
<b>Total Permanent Investment - Unadjusted</b>			<b>\$ 116,026,941</b>
Site Factor			0.80
<b>Total Permanent Investment</b>			<b>\$ 92,821,553</b>

---

**Working Capital**

---

	<u>2017</u>	<u>2018</u>	<u>2019</u>
Accounts Receivable	\$ 3,698,630	\$ 1,849,315	\$ 1,849,315
Cash Reserves	\$ 1,123,758	\$ 561,879	\$ 561,879
Accounts Payable	\$ (1,545,054)	\$ (772,527)	\$ (772,527)
PDO Inventory	\$ 493,151	\$ 246,575	\$ 246,575
Raw Materials	\$ 65,961	\$ 32,980	\$ 32,980
<b>Total</b>	<b>\$ 3,836,445</b>	<b>\$ 1,918,223</b>	<b>\$ 1,918,223</b>
<i>Present Value at 10%</i>	\$ 3,487,678	\$ 1,585,308	\$ 1,441,189
<b>Total Capital Investment</b>			<b>\$ 99,335,727</b>



## Other Important Considerations

### Plant Location, Layout and Startup

There is a glycerol glut in Asia due to the manufacture of biodiesel, where it is estimated that 10 lb of crude glycerol is formed per 100 lb of biodiesel manufactured. The feedstock for the manufacture of biodiesel is palm oil. To minimize the cost of transportation of crude glycerol, we thought it economically sound to locate the plant in Southeast Asia.

In regards to the plant layout, one must consider the separation units: filtration, ion exchange, evaporation, mixed bed polish, distillation and a hydrogenation bed. To minimize risks in case of implosion, special attention should be given to the location of the triple effect evaporator and distillation towers, which operate at sub-atmospheric pressures. In addition, the hydrogenation reactor should be far away from storage tanks to prevent runaway scenarios in case of an explosion.

This process has significant heat integration and recycle operations. For example, evaporated water from the triple effect evaporation unit and the first distillation tower is recycled back into the fermenters. We therefore expect the startup costs to be considerable and the percentage allocated in the profitability analysis, as based from Seider, et al, to be on the lower side. It was not within the scope of this project to rigorously estimate plant startup costs, so at this point we do not have a basis for setting the cap for the cost of this. Still, we do not expect the startup costs to have a significant impact on the profitability of our process.

Other considerations need to be made to minimize risk of accidents, to facilitate heat integration and to minimize length of piping pressure drop. If this is done well, pump size might be reduced and the electricity needs would simultaneously go down.

### Fouling in Heat Exchangers

In designing the heat exchanger for preheating the fermentation broth, we did not take into account any fouling that might result. The heat exchanger has an area of 374 ft<sup>2</sup>, and costs \$157,000. We understand that fouling may reduce the effective heat transfer coefficient, however, we do not anticipate the size and cost of the heat exchanger will increase dramatically. As our actual operation includes equipment costs in excess of \$80MM, this would not have a significant impact on our project cost.

### Water Management

At a concentration of 70 g PDO per liter in the fermentation broth, we would need roughly 13.5 pounds of water per pound of product without water recycle. The evaporated water from effects 1 and 2 of the triple effect evaporation unit and distillate from the first distillation tower can be reused. To minimize product loss, a small fraction of the evaporated water is recycled and used to dilute the retentate before it passes through the microfiltration, ultrafiltration and nanofiltration units. Excluding this portion, the overall amount of water available to be reused in fermentation is 81% of the annual water charged into the fermenters. This recycling process reduced the net water needed to 2.68 pounds per pound of product.

At this point, we have assumed negligible impact from the trace methanol found in the system. We have not found alternatives to eliminate methanol and attempts to separate the methanol from water via distillation proved too costly. The utility needs were found to be 5 times the opportunity cost of not recycling water. Since dumping the water is not environmentally friendly and purifying the water comes at too steep a price, we suggest that the water should only be dumped when the methanol concentration in the vapors from the evaporators reaches a yet unknown critical value. This value or range of values could be found by studies on the impact of

methanol on the fermentation process. Since the concentration of methanol in the crude glycerol feed is low, buildup of methanol is expected to also be low.

### Environmental Considerations

The strain of *Klebsiella pneumoniae* used in our fermentation process is attenuated and non-pathogenic. However, to reduce risk, a scrubber unit is installed for the fermentation vent gases. Additionally, biomass from the filter press is sterilized in an autoclave. Our project author, Dr. Bockrath, suggested that we dump the biomass in a landfill. Alternatively, it can be sold as compost. If the study of the effects reveal that the genetically engineered strain of *Klebsiella pneumoniae* has high tolerance levels for methanol, then at one point in the production cycle, disposal (or treatment) of water containing methanol would need to be considered.

### Process Controllability

Temperature control in the fermenters is very important because the fermentation process is aerobic and exothermic. Temperatures in the fermenters have to be maintained between 86 and 99 °F using chilled water to ensure microbes are not denatured, resulting in a lower productivity. Additionally, for the same reasons, the pH has to be maintained between 6.8 and 8 using ammonia solution. Since there is no mention of carboxylic byproducts of fermentation, we do not expect the pH drops to be significant. Additionally, glucose and glycerol in this fed-batch fermentation are fed in a mass ratio of 10 to 1 to regulate formation of carboxylic acids during fermentation.

Other important process control decisions that have to be made pertain to both pressure and temperature regulation in the evaporation and distillation units. PDO is heat sensitive. Since we are targeting manufacture of polymer grade PDO, it is important that the temperatures be kept below 338 °F throughout the entire process. Sub-atmospheric operation has been chosen to

maintain temperatures within the defined limits. It is therefore important to ensure that the vacuum operations are maintained and there is proper control of the vacuum systems.

Lastly, there is a need to control the temperature of other heat exchangers in the process. Due to massive heat integration, the design of the controllers for temperatures is expected to be non-trivial.

## Economic Analysis

The economic analysis of this project is summarized in Tables 8-10. Based on the norm in the commodity chemicals industry, a conservative plant life of 20 years was chosen. For design and construction in the years 2016-2017, cash flow becomes positive in 2018 and cumulative net present value is expected to become positive in 2026.

**Table 8:** General Information and Plant Economic Specifications

<b>General Information</b>					
Process Title: <b>Crude Glycerol to 1,3-propanediol</b>					
Product: <b>PDO</b>					
Plant Site Location: <b>Asia</b>					
Site Factor: <b>0.80</b>					
Operating Hours per Year: <b>7919</b>					
Operating Days Per Year: <b>330</b>					
Operating Factor: <b>0.9040</b>					
<b>Product Information</b>					
This Process will Yield					
<b>12,628</b> lb of PDO per hour					
<b>303,067</b> lb of PDO per day					
<b>100,000,000</b> lb of PDO per year					
Price	<b>\$1.00 /lb</b>				
<b>Chronology</b>					
<u>Year</u>	<u>Action</u>	<u>Distribution of Permanent Investment</u>	<u>Production Capacity</u>	<u>Depreciation 10 year MACRS</u>	<u>Product Price</u>
2016	Design		0.0%		
2017	Construction	100%	0.0%		
2018	Production	0%	45.0%	10.00%	\$1.00
2019	Production	0%	67.5%	18.00%	\$1.00
2020	Production	0%	90.0%	14.40%	\$1.00
2021	Production		90.0%	11.52%	\$1.00
2022	Production		90.0%	9.22%	\$1.00
2023	Production		90.0%	7.37%	\$1.00
2024	Production		90.0%	6.55%	\$1.00
2025	Production		90.0%	6.55%	\$1.00
2026	Production		90.0%	6.56%	\$1.00
2027	Production		90.0%	6.55%	\$1.00
2028	Production		90.0%	3.28%	\$1.00
2029	Production		90.0%		\$1.00
2030	Production		90.0%		\$1.00
2031	Production		90.0%		\$1.00
2032	Production		90.0%		\$1.00
2033	Production		90.0%		\$1.00
2034	Production		90.0%		\$1.00
2035	Production		90.0%		\$1.00
2036	Production		90.0%		\$1.00
2037	Production		90.0%		\$1.00

---

**Equipment Costs**

---

<u>Equipment Description</u>		<u>Bare Module Cost</u>
Seed Fermenters	Process Machinery	\$5,057,156
Production Fermenters	Process Machinery	\$31,271,581
Filtration Units	Process Machinery	\$289,645
Filter Press	Process Machinery	\$32,000
Ion Exchange	Process Machinery	\$2,936,338
Evaporator	Process Machinery	\$14,612,691
Hydrogenation Bed	Process Machinery	\$122,651
Distillation Units	Process Machinery	\$1,724,814
Pumps	Fabricated Equipment	\$1,573,760
Heat Exchangers	Process Machinery	\$3,213,155
Autoclaves	Process Machinery	\$282,697
Storage Tanks	Process Machinery	\$2,096,141
Vacuum Systems	Process Machinery	\$532,596
Air Compressors	Process Machinery	\$16,066,396
<b>Total</b>		<b><u>\$79,811,620</u></b>

---

**Raw Materials**

---

<u>Raw Material:</u>	<u>Unit:</u>	<u>Required Ratio:</u>	<u>Cost of Raw Material:</u>
1 Crude Glycerol	lb	1.82 lb per lb of PDO	\$0.110 per lb
2 Media	lb	0.10922 lb per lb of PDO	\$0.18 per lb
3 Glucose	lb	0.22143 lb per lb of PDO	\$0.20 per lb
4 Hydrogen	lb	0.006655 lb per lb of PDO	\$0.32 per lb
Total Weighted Average:			\$0.268 per lb of PDO

---

**Utilities**

---

<u>Utility:</u>	<u>Unit:</u>	<u>Required Ratio</u>	<u>Utility Cost</u>
1 Medium Pressure steam	1000 lb	0.0156931 1000 lb per lb of PDO	\$2.000 per 1000 lb
2 Cooling water	lb	203.38 lb per lb of PDO	\$2.011E-06 per lb
3 Process Water	gal	0.3223 gal per lb of PDO	\$2.000E-03 per gal
4 Electricity	kWh	1.17602 kWh per lb of PDO	\$0.070 per kWh
5 Chilled water	Btu	6810 Btu per lb of PDO	\$5.208E-06 per Btu
Total Weighted Average:			\$0.150 per lb of PDO

---

**Variable Costs**

---

**General Expenses:**

Selling / Transfer Expenses:	<b>3.00% of Sales</b>
Direct Research:	<b>4.80% of Sales</b>
Allocated Research:	<b>0.50% of Sales</b>
Administrative Expense:	<b>2.00% of Sales</b>
Management Incentive Compensation:	<b>1.25% of Sales</b>

---

---

**Working Capital**

---

Accounts Receivable	⇒	30	Days
Cash Reserves (excluding Raw Materials)	⇒	30	Days
Accounts Payable	⇒	30	Days
PDO Inventory	⇒	4	Days
Raw Materials	⇒	2	Days

---

**Total Permanent Investment**

---

Cost of Site Preparations:	5.00% of Total Bare Module Costs
Cost of Service Facilities:	5.00% of Total Bare Module Costs
Allocated Costs for utility plants and related facilities:	\$0
Cost of Contingencies and Contractor Fees:	18.00% of Direct Permanent Investment
Cost of Land:	2.00% of Total Depreciable Capital
Cost of Royalties:	\$0
Cost of Plant Start-Up:	10.00% of Total Depreciable Capital

---

**Fixed Costs**

---

**Operations**

Operators per Shift:	1 (assuming 5 shifts)
Direct Wages and Benefits:	\$40 /operator hour
Direct Salaries and Benefits:	15% of Direct Wages and Benefits
Operating Supplies and Services:	6% of Direct Wages and Benefits
Technical Assistance to Manufacturing:	\$60,000.00 per year, for each Operator per Shift
Control Laboratory:	\$65,000.00 per year, for each Operator per Shift

**Maintenance**

Wages and Benefits:	4.50% of Total Depreciable Capital
Salaries and Benefits:	25% of Maintenance Wages and Benefits
Materials and Services:	100% of Maintenance Wages and Benefits
Maintenance Overhead:	5% of Maintenance Wages and Benefits

**Operating Overhead**

General Plant Overhead:	7.10% of Maintenance and Operations Wages and Benefits
Mechanical Department Services:	2.40% of Maintenance and Operations Wages and Benefits
Employee Relations Department:	5.90% of Maintenance and Operations Wages and Benefits
Business Services:	7.40% of Maintenance and Operations Wages and Benefits

**Property Taxes and Insurance**

Property Taxes and Insurance:	2% of Total Depreciable Capital
-------------------------------	---------------------------------

**Straight Line Depreciation**

Direct Plant	8.00% of Total Depreciable Capital, less 1.18 times the Allocated Costs for Utility Plants and Related Facilities
Allocated Plant	6.00% of 1.18 times the Allocated Costs for Utility Plants and Related Facilities

**Other Annual Expenses**

Rental Fees (Office and Laboratory Space):	\$0
Licensing Fees:	\$0
Miscellaneous:	\$0

**Depletion Allowance**

Annual Depletion Allowance:	\$0
-----------------------------	-----

---



**Table 9:** Cash Flow Summary

Year	Design Capacity	Percentage of Design Capacity	Product Unit Price	Sales	Capital Costs	Working Capital	Var Costs	Fixed Costs	Depreciation	Taxable Income	Taxes	Net Earnings	Cash Flow	Cumulative Net Present Value at 10%
2016	0%			-	(92,821,600)	(3,836,400)	-	-	-	-	-	-	(96,658,000)	(87,870,900)
2017	0%		\$1.00	45,000,000	-	(1,918,200)	(23,995,700)	(15,360,100)	(10,359,500)	(4,715,300)	1,744,700	(2,970,600)	5,470,700	(83,349,700)
2018	45%		\$1.00	67,500,000	-	(1,918,200)	(35,993,500)	(15,360,100)	(18,647,200)	(2,500,800)	925,300	(1,575,500)	15,153,500	(71,964,600)
2019	68%		\$1.00	90,000,000	-	-	(47,991,300)	(15,360,100)	(14,917,700)	11,730,800	(4,340,400)	7,390,400	22,308,200	(56,727,900)
2020	90%		\$1.00	90,000,000	-	-	(47,991,300)	(15,360,100)	(11,934,200)	14,714,400	(5,444,300)	9,270,100	21,204,300	(43,561,700)
2021	90%		\$1.00	90,000,000	-	-	(47,991,300)	(15,360,100)	(9,551,500)	17,097,100	(6,325,900)	10,771,200	20,322,700	(32,090,100)
2022	90%		\$1.00	90,000,000	-	-	(47,991,300)	(15,360,100)	(7,635,000)	19,013,600	(7,035,000)	11,978,600	19,613,600	(22,025,200)
2023	90%		\$1.00	90,000,000	-	-	(47,991,300)	(15,360,100)	(6,785,500)	19,863,100	(7,349,300)	12,513,700	19,299,200	(13,022,000)
2024	90%		\$1.00	90,000,000	-	-	(47,991,300)	(15,360,100)	(6,785,500)	19,863,100	(7,349,300)	12,513,700	19,299,200	(4,837,200)
2025	90%		\$1.00	90,000,000	-	-	(47,991,300)	(15,360,100)	(6,795,900)	19,852,700	(7,345,500)	12,507,200	19,303,100	2,605,000
2026	90%		\$1.00	90,000,000	-	-	(47,991,300)	(15,360,100)	(6,785,500)	19,863,100	(7,349,300)	12,513,700	19,299,200	9,369,300
2027	90%		\$1.00	90,000,000	-	-	(47,991,300)	(15,360,100)	(3,397,900)	23,250,700	(8,602,700)	14,647,900	18,045,800	15,119,200
2028	90%		\$1.00	90,000,000	-	-	(47,991,300)	(15,360,100)	-	26,648,600	(9,860,000)	16,788,600	16,788,600	19,982,300
2029	90%		\$1.00	90,000,000	-	-	(47,991,300)	(15,360,100)	-	26,648,600	(9,860,000)	16,788,600	16,788,600	24,403,200
2030	90%		\$1.00	90,000,000	-	-	(47,991,300)	(15,360,100)	-	26,648,600	(9,860,000)	16,788,600	16,788,600	28,422,300
2031	90%		\$1.00	90,000,000	-	-	(47,991,300)	(15,360,100)	-	26,648,600	(9,860,000)	16,788,600	16,788,600	32,076,000
2032	90%		\$1.00	90,000,000	-	-	(47,991,300)	(15,360,100)	-	26,648,600	(9,860,000)	16,788,600	16,788,600	35,397,500
2033	90%		\$1.00	90,000,000	-	-	(47,991,300)	(15,360,100)	-	26,648,600	(9,860,000)	16,788,600	16,788,600	38,417,100
2034	90%		\$1.00	90,000,000	-	-	(47,991,300)	(15,360,100)	-	26,648,600	(9,860,000)	16,788,600	16,788,600	41,162,200
2035	90%		\$1.00	90,000,000	-	-	(47,991,300)	(15,360,100)	-	26,648,600	(9,860,000)	16,788,600	16,788,600	43,657,700
2036	90%		\$1.00	90,000,000	-	-	(47,991,300)	(15,360,100)	-	26,648,600	(9,860,000)	16,788,600	16,788,600	46,963,200
2037	90%		\$1.00	90,000,000	-	7,672,900	(47,991,300)	(15,360,100)	-	26,648,600	(9,860,000)	16,788,600	24,461,500	

**Table 10:** Profitability Measures

<b>The Internal Rate of Return (IRR) for this project is</b>	16.76%
<b>The Net Present Value (NPV) of this project in 2016 is</b>	\$ 46,963,200
<b>ROI Analysis (Third Production Year)</b>	
<b>Annual Sales</b>	90,000,000
<b>Annual Costs</b>	(63,351,408)
<b>Depreciation</b>	(7,425,724)
<b>Income Tax</b>	(7,112,461)
<b>Net Earnings</b>	12,110,407
<b>Total Capital Investment</b>	100,494,444
<b>ROI</b>	12.05%

With an IRR of 16.76% and a NPV of \$46,963,200, the proposed design is expected to be a profitable endeavor. Market research shows that glycerol prices will most likely remain depressed and the price of PDO will increase due to increased demand. However, to be conservative, a sensitivity analysis was performed for increased glycerol pricing. Figure 5 shows that the price of crude glycerol needs to rise from \$0.11 per lb to greater than \$0.177 per lb while the price of PDO remains constant before the project becomes unprofitable. It is our assumption that the price of glycerol and PDO are correlated. Therefore, a 60% increase in the price of crude glycerol without the price of PDO also rising is highly unlikely. If the price of crude glycerol remains constant, the market price of PDO would have to fall from \$1.00 per lb to \$0.87 per lb before the process has an NPV of 0.

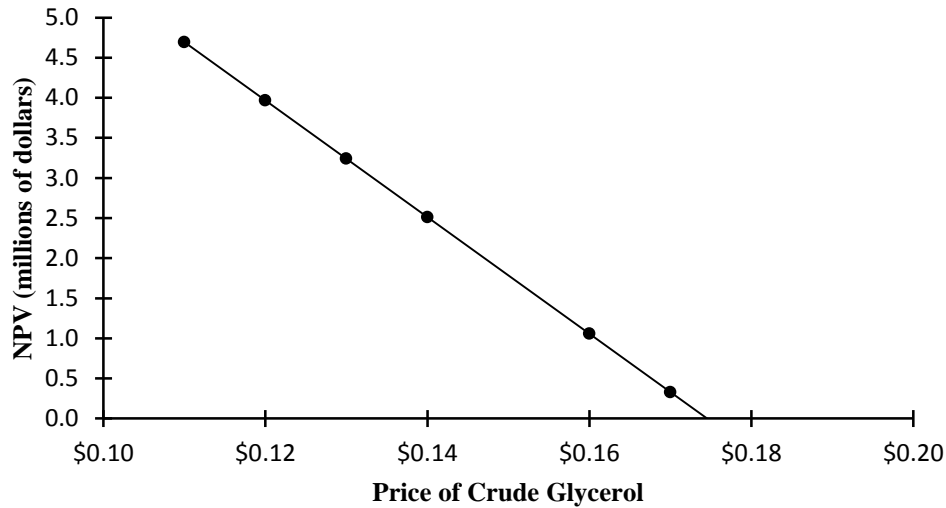

**Figure 5:** NPV vs. Price of Crude Glycerol

The analysis was performed at a discount rate of 10%. In January 2015, DuPont issued bonds with a coupon of 3.25% (“Domestic Bonds”). While our company is not as established as DuPont, the project is comparable. Using a more optimistic discount rate of 3.25%, if the cost of PDO remains constant, the price of glycerol can double before the NPV becomes 0. Although the bonds issued by DuPont have lower beta values (risk premium) than we expect for our company, we do not expect cost of capital for our company to be more than the 10% used in profitability analysis.

In addition to using a conservative discount rate, estimates for equipment costs were also conservative. One of the most expensive pieces of equipment was the evaporator. Simulation of the evaporation was done in Aspen Plus as three separate heat exchangers. Costing was based on inflation adjusted cost correlations found in Seider, et al. Actual purchase costs from vendors are expected to be much lower because the evaporator is sold as a single unit instead of three heat exchangers. In the absence of vendor cost information, we chose to use the values obtained from costing the three separated heat exchangers. Actual profitability position and cash flows are expected to improve when vendor installed costs are used.

**Table 11: Sensitivity Analyses for IRR with varying product price and (a) TPI, (b) Variable Costs, (c) Fixed Costs**

Product Price	Total Permanent Investment										
	\$46,410,776	\$55,692,932	\$64,975,087	\$74,257,242	\$83,539,397	\$92,827,553	\$102,103,708	\$111,385,863	\$120,668,018	\$129,950,174	\$139,232,329
0.5	Negative IRR	Negative IRR	Negative IRR	Negative IRR	Negative IRR	Negative IRR	Negative IRR	Negative IRR	Negative IRR	Negative IRR	Negative IRR
0.6	Negative IRR	Negative IRR	Negative IRR	Negative IRR	Negative IRR	Negative IRR	Negative IRR	Negative IRR	Negative IRR	Negative IRR	Negative IRR
0.7	17.33%	9.94%	4.18%	-0.78%	-5.53%	-10.86%	-18.94%	-2.00%	-4.67%	-7.30%	-10.03%
0.8	33.67%	23.88%	16.92%	11.65%	7.44%	3.90%	0.81%	5.05%	2.59%	0.38%	-1.65%
0.9	47.36%	34.93%	26.29%	19.93%	15.04%	11.11%	7.85%	10.05%	7.44%	5.15%	3.11%
<b>\$7.00</b>	59.75%	44.81%	34.47%	26.95%	21.25%	16.76%	13.11%	14.22%	11.37%	8.91%	6.76%
\$11.10	71.27%	53.96%	41.99%	33.32%	26.79%	21.70%	17.60%	17.94%	14.82%	12.16%	9.85%
\$12.20	82.12%	62.58%	49.06%	39.27%	31.92%	26.21%	21.66%	21.36%	17.96%	15.09%	12.61%
\$13.30	92.44%	70.79%	55.78%	44.91%	36.76%	30.45%	25.44%	24.57%	20.90%	17.80%	15.14%
\$14.40	102.30%	78.65%	62.22%	50.31%	41.38%	34.48%	29.01%	27.63%	23.68%	20.35%	17.51%
\$15.50	111.76%	86.21%	68.42%	55.52%	45.83%	38.35%	32.43%				

Product Price	Variable Costs										
	\$26,661,844	\$31,994,212	\$37,326,581	\$42,658,950	\$47,991,318	\$53,323,687	\$58,656,056	\$63,988,425	\$69,320,793	\$74,653,162	\$79,985,531
0.5	Negative IRR	Negative IRR	Negative IRR	Negative IRR	Negative IRR	Negative IRR	Negative IRR	Negative IRR	Negative IRR	Negative IRR	Negative IRR
0.6	Negative IRR	Negative IRR	Negative IRR	Negative IRR	Negative IRR	Negative IRR	Negative IRR	Negative IRR	Negative IRR	Negative IRR	Negative IRR
0.7	15.27%	12.13%	8.63%	4.52%	-0.85%	-10.86%	-1.66%	-12.71%	-2.50%	-14.80%	-3.37%
0.8	20.46%	17.71%	14.78%	11.62%	8.08%	3.90%	1.11%	10.60%	6.98%	2.63%	6.42%
0.9	25.14%	22.62%	19.99%	17.23%	14.30%	11.11%	7.53%	16.29%	13.33%	10.09%	12.84%
1	29.51%	27.13%	24.68%	22.16%	19.52%	16.76%	13.81%	23.77%	21.24%	18.60%	18.14%
\$1.10	33.65%	31.37%	29.05%	26.67%	24.23%	21.70%	19.06%	28.76%	26.32%	23.32%	22.87%
\$1.20	37.60%	35.41%	33.18%	30.91%	28.59%	26.21%	23.77%	30.00%	27.68%	25.31%	24.87%
\$1.30	41.42%	39.29%	37.13%	34.95%	32.72%	30.45%	28.14%	34.02%	31.81%	29.55%	27.24%
\$1.40	45.11%	43.04%	40.94%	38.82%	36.67%	34.48%	32.26%				
\$1.50	48.69%	46.67%	44.62%	42.56%	40.47%	38.35%	36.20%				

Product Price	Fixed Costs										
	\$7,680,045	\$9,216,054	\$10,752,063	\$12,288,072	\$13,824,080	\$15,360,089	\$16,896,098	\$18,432,107	\$19,968,116	\$21,504,125	\$23,040,134
0.5	Negative IRR	Negative IRR	Negative IRR	Negative IRR	Negative IRR	Negative IRR	Negative IRR	Negative IRR	Negative IRR	Negative IRR	Negative IRR
0.6	Negative IRR	Negative IRR	Negative IRR	Negative IRR	Negative IRR	Negative IRR	Negative IRR	Negative IRR	Negative IRR	Negative IRR	Negative IRR
0.7	3.01%	1.18%	-0.88%	-3.32%	-6.39%	-10.86%	2.26%	0.44%	-1.61%	-4.03%	-7.09%
0.8	10.75%	9.50%	8.20%	6.85%	5.42%	3.90%	2.26%	8.70%	7.42%	6.09%	4.68%
0.9	16.64%	15.57%	14.49%	13.39%	12.26%	11.11%	9.92%	14.69%	13.63%	12.55%	11.44%
<b>\$7.00</b>	21.73%	20.75%	19.77%	18.78%	17.77%	16.76%	15.73%	19.79%	18.83%	17.86%	16.87%
\$11.10	26.37%	25.44%	24.51%	23.58%	22.64%	21.70%	20.75%	24.40%	23.49%	22.56%	21.66%
\$12.20	30.71%	29.81%	28.92%	28.02%	27.12%	26.21%	25.31%	28.70%	27.92%	26.95%	26.07%
\$13.30	34.83%	33.95%	33.08%	32.20%	31.33%	30.45%	29.58%	32.77%	31.92%	31.06%	30.21%
\$14.40	38.77%	37.91%	37.05%	36.20%	35.34%	34.48%	33.63%	36.67%	35.83%	34.99%	34.16%
\$15.50	42.57%	41.72%	40.88%	40.03%	39.19%	38.35%	37.51%				

## Conclusions and Recommendations

One major factor that affects the degree of profitability of this process is the high cost of equipment for the fermentation section. This is primarily due to our assumption of productivity and PDO concentration in the fermentation broth. Using a conservative estimate for productivity of 1.1 g/L-h reported by DuPont, the fermentation time is large. However, there is literature published that reports productivity rates of up to 2.2 g/L-h and product concentration in the fermentation broth of up to 94.6 g/L. With an increased productivity, less capital would have to be invested for fermenters, improving the cash position.

We believe capital costs could also be cut significantly if a corrosion study was conducted. In the absence of this information, stainless steel 316 was used prior to ion exchange. Stainless steel 316 is more corrosion resistant than stainless steel 304, but also more expensive. There is potential for using stainless steel 304 instead.

The design and profitability analysis for the process to manufacture 100MM lb/year of polymer-grade 1,3-propanediol from crude glycerol has been presented. For the prevailing economic conditions, the process has an estimated NPV of \$46,963,200 and an IRR of 16.76%. It has also been shown that the process has a positive NPV under various economic scenarios. We recommend conducting research on various ways to reduce costs further.

## Acknowledgements

We would like to thank Dr. Sean Holleran and Professor Fabiano for the help and guidance they have provided us in completing this project. We would also like to thank Dr. Richard Bockrath, the project author, for providing us with invaluable information and for cheerfully pointing out different alternatives that we needed to consider.

We would also like to thank Mr. Adam Brostow of Air Products, Mr. Stephen Tieri of DuPont, Mr. Bruce Vrana of DuPont and Mr. Gary Sawyer (formerly ARCO, Lyondell-Basell) for all their guidance during weekly design meetings. Each of these consultants provided vital insights and information. Additionally, we would like to thank Dr. Miriam Wattenbarger for her input regarding the fermentation process. Her help at the beginning of this project is especially appreciated.

## References

- "1,3-Propanediol (PDO) Market By Applications (PTT [Polytrimethylene Terephthalate], Polyurethane, Cosmetic, Personal Care & Home Cleaning & Other Applications) & Geography - Global Market Trends & Forecasts to 2019." Research and Markets. Research and Markets, Dec. 2012. Web. 05 Apr. 2015.  
<<http://www.researchandmarkets.com/research/zx7hb6/13propanediol>>.
- Adkesson, et al. Purification of Biologically Produced 1,3-Propanediol. E.I. Du Pont De Nemours and Company, Tate & Lyle Ingredients Americas LLC, assignee. Patent US 8,183,417 B2. 22 May 2012. Print.
- Benz, Gregory T. "Large Scale Microbial Production of Advanced Biofuels: How Big Can We Go?" *Biofuels Digest*. N.p., n.d. Web. 05 Apr. 2015.  
<<http://www.biofuelsdigest.com/bdigest/2014/12/07/large-scale-microbial-production-of-advanced-biofuels-how-big-can-we-go/>>.
- Cheng, Ke-Ke, et al. "1, 3-Propanediol production by *Klebsiella pneumoniae* under different aeration strategies." *Biotechnology letters* 26.11 (2004): 911-915.
- Ciriminna, Rosaria, et al. "Understanding the glycerol market." *European Journal of Lipid Science and Technology* 116.10 (2014): 1432-1439.
- "Dextrose Monohydrate." *Dextrose Monohydrate, Dextrose Monohydrate Suppliers and Manufacturers at Alibaba.com*. Alibaba, n.d. Web. 06 Apr. 2015.  
<<http://www.alibaba.com/showroom/dextrose-monohydrate.html>>.
- "Domestic Bonds: DuPont, 3.25% 15jan2015." *Cbonds*. N.p., 15 Jan. 2015. Web. 5 Apr. 2015.  
<<http://www.cbonds.com/emissions/issue/54299>>.
- Esterly, Sean, and Rachel Gelman. 2013 Renewable Energy Data Book. Rep. U.S. Department of Energy, 2014. Web. <<http://www.nrel.gov/docs/fy15osti/62580.pdf>>.
- "FAQS." DuPont Tate and Lyle Bio Products. N.p., 03 Aug. 2012. Web. 05 Apr. 2015.  
<<http://www.duponttateandlyle.com/faqs>>.
- Gan, Alexis. "Asia Glycerine Market Poised to Firm on Tight Supply." Asia Glycerine Market Poised to Firm on Tight Supply. ICIS, n.d. Web. 06 Apr. 2015.  
<<http://www.icis.com/resources/news/2015/01/22/9854502/asia-glycerine-market-poised-to-firm-on-tight-supply/>>.
- Liu, Dehua, et al. "Via fermentation; 1, 3-propanediol is important chemical raw material for things such as polytrimethylene terephthalate." U.S. Patent No. 8,486,673. 16 Jul. 2013.
- Markets and Markets. 1,3-Propanediol Market worth \$621.2 Million by 2021. Markets and Markets. Markets and Markets, n.d. Web. 05 Apr. 2015.  
<<http://www.marketsandmarkets.com/PressReleases/1-3-propanediol-pdo.asp>>.

- Mukherjee, Ishani, and Benjamin K. Sovacool. "Palm oil-based biofuels and sustainability in southeast Asia: A review of Indonesia, Malaysia, and Thailand." *Renewable and Sustainable Energy Reviews* 37 (2014): 1-12.
- "Our Process." *DuPont Tate and Lyle Bio Products*. N.p., 03 Aug. 2012. Web. 05 Apr. 2015. <[http://www.duponttateandlyle.com/our\\_process](http://www.duponttateandlyle.com/our_process)>.
- "Pure Hydrogen Suppliers - Reliable Pure Hydrogen Suppliers and Manufacturers at Alibaba.com." *Pure Hydrogen Suppliers - Reliable Pure Hydrogen Suppliers and Manufacturers at Alibaba.com*. Alibaba, n.d. Web. 06 Apr. 2015. <[http://www.alibaba.com/corporations/pure\\_hydrogen.html](http://www.alibaba.com/corporations/pure_hydrogen.html)>.
- Renewable Energy Group. *REG Glycerin Product Lineup*. N.p.: Renewable Energy Group, n.d. *Regfuel.com*. Web. 6 Apr. 2015. <[http://www.regfuel.com/sites/default/files/REG\\_Glycerin\\_Technical%20Sheet.pdf](http://www.regfuel.com/sites/default/files/REG_Glycerin_Technical%20Sheet.pdf)>.
- Seider, Warren D., J. D. Seader, and Daniel R. Lewin. *Product and Process Design Principles Synthesis, Analysis, and Evaluation*. New York: Wiley, 2009.
- Shuler, Michael L., and Fikret Kargi. *Bioprocess engineering*. New York: Prentice Hall, 2002.
- "Steps to Design an Ion Exchange Resin System." Dow Water and Process. Dow Chemicals, n.d. Web. 12 Apr. 2015.
- Xiu, Zhi-Long, and An-Ping Zeng. "Present state and perspective of downstream processing of biologically produced 1, 3-propanediol and 2, 3-butanediol." *Applied microbiology and biotechnology* 78.6 (2008): 917-926.
- Yang, Fangxia, Milford A. Hanna, and Runcang Sun. "Value-added uses for crude glycerol-a byproduct of biodiesel production." *Biotechnol Biofuels* 5.13 (2012): 1-10.



## Appendix A: Sample Calculations

### Fermenter Calculations

Using an element balance, the following chemical reactions were derived and used for material balances. The composition of biomass is 50% C, 20% O, 14% N, 8% H, 3% P and 5% salts.

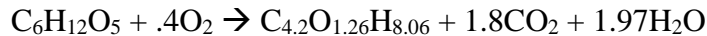
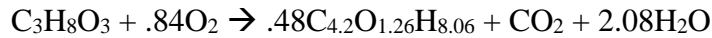
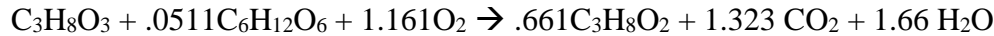

The patent by DuPont cites the productivity of *Klebsiella pneumoniae* to be 1.1 g PDO/L-hour and reaction stoichiometry gives the amount of PDO formed in the fermentation. The following was used to calculate the fermentation times:

$$\frac{3560 \times 10^3 \text{ g PDO produced in seed fermenter}}{\left(1.1 \text{ g} \frac{\text{PDO}}{\text{L} \cdot \text{hour}}\right) * (47249 \text{ L on average in seed fermenter})} = 68.5 \text{ hours}$$

The stagger time is defined by the cycle time (sum of fermentation time, clean-in-place, steam-in-place, charge, etc.) and number of fermentation trains:

$$\frac{73.01 \text{ hours}}{7 \text{ fermentation trains}} = 10.43 \text{ hours}$$

Reaction stoichiometry gives the amount of Oxygen consumed during the reaction. This can be used to calculate the heat generated in the reaction (Shuler).

$$.12 * \frac{8.52 \times 10^7 \text{ mmol O}_2 \text{ consumed in seed fermenter}}{(68.5 \text{ hours})} = 1.49 \times 10^5 \frac{\text{kcal}}{\text{hr}}$$

Assuming 70% heat transfer efficiency and that the chilled water is cooled 6 degrees, the chilled water requirement can be calculated.

$$\frac{1.49 \times 10^5 \frac{\text{kcal}}{\text{hr}}}{.9981 \frac{\text{kcal}}{\text{kg}^\circ\text{C}} * 6^\circ\text{C}} = 35599 \frac{\text{kg}}{\text{hr}} \text{ chilled water for the seed fermenter}$$

### Air Compressor Calculations

Compressor requirements were evaluated using the air flow rate from the fermentation mass balance and the pressure at the base of the production fermenter (air sparger location). Pressure

in the head space of the fermenters is maintained at 1.25 bar. Pressure at the bottom of the fluid in the vessel was calculated as follows:

$$\frac{\text{maximum working volume}}{\pi * \text{vessel diameter}^2/4} * g * \rho_{\text{fluid}} + 1.25 \text{ bar} = \text{Pressure at sparger}$$

$$\frac{500 \text{ m}^3}{\pi * (5.33 \text{ m})^2/4} * 9.81 \frac{\text{m}}{\text{s}^2} * 1000 \frac{\text{kg}}{\text{m}^3} + 1.25 \text{ bar} = 3.5 \text{ bar}$$

Accounting for pressure losses in pipes, fittings, HEPA filters, etc., the compressor specification:

$$\text{Pressure outlet from compressor} = 3.5 \text{ bar} + 1 \text{ bar} = \mathbf{4.5 \text{ bar}}$$

### Filtration Calculations

Sizing the filtration units required the flow rate, filtration area per membrane, and average flux through the membrane. For the microfiltration setup, the flow rate was determined from the mass balance to be 183 m<sup>3</sup>/hr. The documented average flux was 108 L/m<sup>2</sup>-hr and Novasep Kerasep BH ceramic MF elements have a filtration area of 0.34 m<sup>2</sup> apiece. The number of filters required was calculated as follows:

$$\frac{\text{Design flow rate}}{\text{Average flux}} = \text{Filtration area required} = \frac{183000 \frac{\text{L}}{\text{hr}}}{108 \frac{\text{L}}{\text{m}^2\text{hr}}} = 1700 \text{ m}^2$$

$$\frac{\text{Area required}}{\text{Area per element}} = \text{Filtration elements required} = \frac{1700 \text{ m}^2}{0.34 \text{ m}^2} = 4980$$

These 4980 modules would fit in a configuration of 3 parallel jumbo skids of 16 modules each, produced by Novasep. Each of the modules would contain a bundle of at least 104 filtration elements.

### Batch to Continuous Transition Calculation

Each staggered section of the batch process, 2 production fermenters, is 1.3MM L. During the 10.43 hours, it is flowing at an average of 255,373 L/hr. Using this information, a factor was found to relate the non-continuous flow rate into STOR-06 to the continuous flow rate out of the storage tank to ensure it never emptied completely.

$$\frac{1,276,862.62 \frac{\text{L}}{\text{batch}}}{255,373 \frac{\text{L}}{\text{hr}} * 10.43 \frac{\text{hr}}{\text{batch}}} = .48$$

$$255,373 \frac{\text{L}}{\text{hr}} \text{ into STOR06} * .48 = 122,422.11 \frac{\text{L}}{\text{hr}} \text{ out of STOR06}$$

### Ion Exchange Calculations

First, the feed salinity needed to be determined in meq/L. For example, for K<sup>+</sup>:

$$\frac{Valence}{MW} = \frac{1}{39} = .0256$$
$$79.59 \frac{mg}{L} * .0256 = 2.04 \frac{meq}{L}$$

This was repeated for each anion and cation and summed to find the total feed salinity.

Since the volumetric flow rate going into ion exchange is known and a typical cycle time of 24 hours is chosen, throughput could be calculated.

$$122.42 \frac{m^3}{hr} * 24 hr = 2938.13 m^3$$

From the throughput, feed salinity, and the total capacity given in the Dow ion exchange resin specification sheet, the volume of resin could be calculated.

$$\frac{2938.13 m^3 * 16.34 \frac{eq}{m^3}}{1.8 \frac{eq}{L} * 1000 \frac{L}{m^3}} = 26.66 m^3 \text{ strong acid cation resin}$$

From the bed volume, vessel height and diameter were determined with a recommended aspect ratio of 2/3 to 3/2 ("Steps to Design an Ion Exchange Resin System").

### Distillation Calculations

Reflux Accumulator

$$volume \text{ into accumulator} = (1 + R) * distillate \text{ flow rate} = 1.123 * 65.121 \frac{ft^3}{hr} = 73.13 \frac{ft^3}{hr}$$

Assuming a residence time of 5 minutes at half full,

$$volume = 73.13 \frac{ft^3}{hr} * \left( 5 \frac{min}{60 \frac{min}{hr}} \right) * 2 = 12.19 ft^3$$

Reboiler

$$reboiler \text{ duty from Aspen} = 6.23 \times 10^6 \frac{BTU}{hr}$$

Assuming a heat flux of 12,000 BTU/hr-ft<sup>2</sup>

$$A_R = \frac{6.23 \times 10^6 \frac{BTU}{hr}}{12,000 \frac{Btu}{hr ft^2}} = 520 ft^2$$

Condenser

$$\text{condenser duty from Aspen} = 4.63 \times 10^6 \frac{BTU}{hr} \text{ and } \Delta T_{lm} = 27.22$$

Assuming a heat transfer coefficient of 100 BTU/hr-ft<sup>2</sup>-°F

$$A_C = \frac{4.63 \times 10^6 \frac{BTU}{hr}}{100 \frac{Btu}{hr ft^2 \cdot ^\circ F} * 27.22 \text{ } ^\circ F} = 1700 ft^2$$

### Pump Calculations

For PUMP-23, Pin=0 psig and Pout=1.25 psig after pipe and elevation pressure losses. The storage tank is 61 feet tall.

$$\Delta P = P_{out} - P_{in} + P_{lost \text{ in pipe}} + P_{elevation}$$

$$\Delta P = 1.25 - 0 + 25 + \frac{61 ft * 63 \frac{lb}{ft^3}}{144 \frac{in^2}{ft^2}} = 53 \frac{lb}{in^2}$$

$$\frac{53 \frac{lb}{in^2} * 144 \frac{in^2}{ft^2}}{163 \frac{lb}{ft^3}} = 121 ft \text{ head}$$

$$\frac{878.91 gpm * 53 \frac{lb}{in^2}}{1714} = \frac{27 hp \text{ theoretical}}{.7 \text{ efficiency}} = 39 Hp$$

### Vacuum System Calculations

For the steam-jet ejector system for the first distillation pair (DIST-1, -2), the volumes were approximated as cylinders to calculate air leakage rate, W. The suction pressure of the system is designed as the lowest pressure in the pair, with some inefficiency. The suction pressure was set at 23.5 mmHg (DIST-2 pressure). The air leakage rates were calculated from correlations as follows:

$$5 + (0.0298 + 0.03088 \ln(P_{D-1}) - 0.0005733 \ln(P_{D-1})^2) * \left( \frac{\pi D_{D-1}^2 h_{D-1}}{4} \right)^{0.66} = W_{D-1}$$

$$= 5 + (0.0298 + 0.03088 \ln(56.6 \text{ mmHg}) - 0.0005733 \ln(56.6 \text{ mmHg})^2)$$

$$* \left( \frac{\pi (2.5 \text{ ft})^2 * 19.5 \text{ ft}}{4} \right)^{0.66} = 8.0 \frac{\text{lb}}{\text{hr}}$$

$$W_{D-2} = 7.5 \frac{\text{lb}}{\text{hr}}$$

*Design air leakage rate, W = oversize factor \* (W<sub>D-1</sub> + W<sub>D-2</sub>)*

$$= 2 * \left( 8.0 \frac{\text{lb}}{\text{hr}} + 7.5 \frac{\text{lb}}{\text{hr}} \right) = \mathbf{30.8 \frac{\text{lb}}{\text{hr}}}$$

$$\frac{\text{Vacuum flow rate}}{\text{Suction pressure}} = \frac{30.8 \frac{\text{lb}}{\text{hr}}}{23.5 \text{ mmHg}} = \mathbf{1.31}$$

This factor of 1.31 is used to define the steam-jet ejector in costing equations by Seider, et al. The steam requirement for the ejector, is 10x the amount of vapor that the ejector is trying to remove, which in these cases is the leaked air. The second stage must remove the air and—with no interstage condenser—all of the steam used in stage 1.

$$\text{Steam requirement, stage 1} = 10 * W = 10 * 30.8 = \mathbf{308 \frac{\text{lb}}{\text{hr}}}$$

$$\text{Steam requirement, stage 2} = 10 * (30.8 + 308) = \mathbf{3390 \frac{\text{lb}}{\text{hr}}}$$

### Evaporator Sample Calculations

$\dot{m} \equiv$  Evaporation rate

$H_v \equiv$  Latent heat of vaporization of water

$\dot{Q}_{tot} \equiv$  Total heat duty

$\dot{Q}_{tot} = \dot{m} \times H_v$

$\dot{Q}_{ef} \equiv$  Duty per effect

For triple effect evaporation;

$$\dot{Q}_{ef} = \frac{\dot{Q}_{tot}}{3}$$

For our evaporator,

$$\dot{m} = 374,874.25 \text{ lb} \cdot \text{hr}^{-1}$$

$$H_v = 970.4 \text{ Btu} \cdot \text{lb}^{-1}$$

$$\dot{Q}_{tot} = 374,874.25 \times 970.4 \text{ Btu} \cdot \text{hr}^{-1}$$

$$= 363,778,000 \text{ Btu} \cdot \text{hr}^{-1}$$

$$\dot{Q}_{ef} = \frac{363,778,000 \text{ Btu} \cdot \text{hr}^{-1}}{3}$$

$$= 121,259,300 \text{ Btu} \cdot \text{hr}^{-1}$$

$$\text{Actual duty per effect} = 121,350,000 \text{ Btu} \cdot \text{hr}^{-1}$$

The difference between the calculated duty per evaporator effect and the actual duty per evaporator effect can be explained by the possibility of bubble point elevation because the liquid feed gets concentrated from one effect to another. The calculated heat duty was used as the initial value while performing the simulation in ASPEN PLUS.

# Appendix B: Aspen Plus Input Summary, Block Report, and Stream Reports

## Evaporator Flowsheet

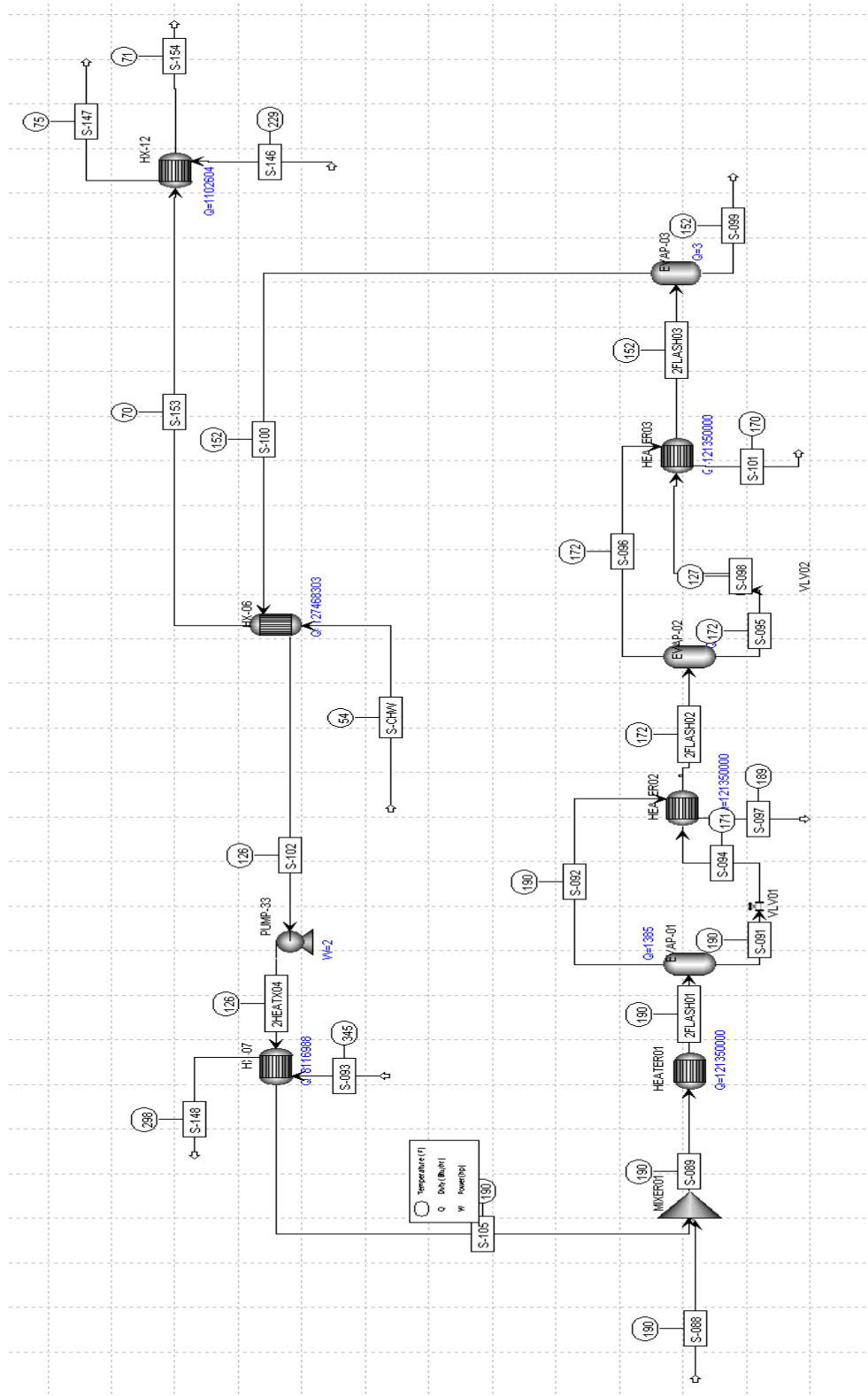

## Evaporator Input Summary

```
;  
;Input Summary created by Aspen Plus Rel. 32.0 at 16:00:10 Sun Apr 12, 2015  
;Directory S:\Desktop\Senior Design\Final Pass\150412 Evaporator Filename  
C:\Users\molele\AppData\Local\Temp\~apd47c.txt  
;
```

DYNAMICS

DYNAMICS RESULTS=ON

IN-UNITS ENG

DEF-STREAMS CONVEN ALL

MODEL-OPTION

DATABANKS 'APV86 PURE32' / 'APV86 AQUEOUS' / 'APV86 SOLIDS' / &  
'APV86 INORGANIC' / NOASPENPCD

PROP-SOURCES 'APV86 PURE32' / 'APV86 AQUEOUS' / 'APV86 SOLIDS' &  
/ 'APV86 INORGANIC'

COMPONENTS

WATER H2O /  
DEXTR-01 C6H12O6 /  
1:3-P-01 C3H8O2-3 /  
GLYCE-01 C3H8O3 /  
METHA-01 CH4O /  
N-HEX-01 C16H32O2 /  
OLEIC-01 C18H34O2

SOLVE

RUN-MODE MODE=SIM

FLOWSHEET

BLOCK HEATER01 IN=S-089 OUT=2FLASH01  
BLOCK EVAP-01 IN=2FLASH01 OUT=S-092 S-091  
BLOCK MIXER01 IN=S-088 S-105 OUT=S-089  
BLOCK HEATER02 IN=S-092 S-094 OUT=S-097 2FLASH02  
BLOCK EVAP-02 IN=2FLASH02 OUT=VAP02 S-095  
BLOCK VLV02 IN=S-095 OUT=S-098  
BLOCK HEATER03 IN=VAP02 S-098 OUT=S-101 2FLASH03  
BLOCK EVAP-03 IN=2FLASH03 OUT=S-100 S-099  
BLOCK VLV01 IN=S-091 OUT=S-094  
BLOCK HX-06 IN=S-100 S-CHW OUT=S-102 S-153  
BLOCK PUMP-33 IN=S-102 OUT=S-104  
BLOCK HX-07 IN=S-093 S-104 OUT=S-148 S-105  
BLOCK HX-12 IN=S-146 S-153 OUT=S-147 S-154

PROPERTIES WILSON FREE-WATER=STEAMNBS

PROPERTIES SRK

PROP-DATA WILSON-1

IN-UNITS ENG  
PROP-LIST WILSON  
BPVAL WATER GLYCE-01 .6429000000 -236.2611600 0.0 0.0 &  
77.00000000 554.0000000 0.0  
BPVAL GLYCE-01 WATER 1.176600000 -475.6645800 0.0 0.0 &  
77.00000000 554.0000000 0.0  
BPVAL WATER METHA-01 .0490000000 -39.55392000 0.0 0.0 &  
76.98200000 212.0000000 0.0

BPVAL METHA-01 WATER -2.030200000 807.6218400 0.0 0.0 &  
 76.98200000 212.0000000 0.0  
 BPVAL GLYCE-01 METHA-01 0.0 -814.7795400 0.0 0.0 &  
 77.00000000 144.5000000 0.0  
 BPVAL METHA-01 GLYCE-01 0.0 218.2307400 0.0 0.0 &  
 77.00000000 144.5000000 0.0

STREAM S-088  
 SUBSTREAM MIXED TEMP=190. VFRAC=0. MASS-FLOW=123141. <kg/hr>  
 MASS-FLOW WATER 115319.25 <kg/hr> / DEXTR-01 34.93 <kg/hr> / &  
 1:3-P-01 6222.79 <kg/hr> / GLYCE-01 1552.71 <kg/hr> / &  
 METHA-01 11.5 <kg/hr> / N-HEX-01 0. <kg/hr> / OLEIC-01 &  
 0. <kg/hr>

STREAM S-093  
 SUBSTREAM MIXED TEMP=345.2 PRES=126.324315 MASS-FLOW=138600.  
 MASS-FRAC WATER 1. / DEXTR-01 0. / 1:3-P-01 0. / &  
 GLYCE-01 0. / METHA-01 0. / N-HEX-01 0. / OLEIC-01 &  
 0.

STREAM S-146  
 SUBSTREAM MIXED TEMP=229.0768 PRES=0.3867355 &  
 MOLE-FLOW=168.0608  
 MASS-FRAC WATER 0.00138279 / DEXTR-01 5.0735E-012 / &  
 1:3-P-01 0.9957154 / GLYCE-01 0.00290177 / METHA-01 &  
 0. / N-HEX-01 0. / OLEIC-01 0.

STREAM S-CHW  
 SUBSTREAM MIXED TEMP=12. <C> PRES=14.7 &  
 MASS-FLOW=3514644. <kg/hr>  
 MASS-FRAC WATER 1. / DEXTR-01 0. / 1:3-P-01 0. / &  
 GLYCE-01 0. / METHA-01 0. / N-HEX-01 0. / OLEIC-01 &  
 0.

BLOCK MIXER01 MIXER  
 PARAM

BLOCK EVAP-01 FLASH2  
 PARAM TEMP=190.542 PRES=9.20067

BLOCK EVAP-02 FLASH2  
 PARAM TEMP=173.6633 PRES=6.

BLOCK EVAP-03 FLASH2  
 PARAM TEMP=113.1827 PRES=2.

BLOCK HEATER01 HEATX  
 PARAM DUTY=121.35 <MMBtu/hr> CALC-TYPE=DESIGN &  
 PRES-COLD=0. MIN-TAPP=10. U-OPTION=CONSTANT &  
 F-OPTION=CONSTANT CALC-METHOD=SHORTCUT  
 FEEDS COLD=S-089  
 OUTLETS-COLD 2FLASH01  
 HEAT-TR-COEF U=650. <Btu/hr-sqft-F>  
 TUBES  
 HOT-SIDE DP-OPTION=CONSTANT  
 COLD-SIDE DP-OPTION=CONSTANT  
 TQ-PARAM CURVE=YES  
 REFERENCE HOT-UTIL=MPSTEAM

BLOCK HEATER02 HEATX  
 PARAM DUTY=121.35 <MMBtu/hr> PRES-COLD=0. MIN-TAPP=10. &  
 U-OPTION=CONSTANT  
 FEEDS HOT=S-092 COLD=S-094



OUTLETS-HOT S-097  
OUTLETS-COLD 2FLASH02  
HEAT-TR-COEF U=600. <Btu/hr-sqft-F>  
TQ-PARAM CURVE=YES

BLOCK HEATER03 HEATX

PARAM DUTY=121.35 <MMBtu/hr> PRES-HOT=0. MIN-TAPP=10. &  
U-OPTION=CONSTANT  
FEEDS HOT=VAP02 COLD=S-098  
OUTLETS-HOT S-101  
OUTLETS-COLD 2FLASH03  
HEAT-TR-COEF U=550. <Btu/hr-sqft-F>  
PROPERTIES WILSON FREE-WATER=STEAM-TA SOLU-WATER=3 &  
TRUE-COMPS=YES / WILSON FREE-WATER=STEAMNBS SOLU-WATER=3 &  
TRUE-COMPS=YES  
FLASH-SPECS S-101 NPHASE=2 FREE-WATER=NO MAXIT=30 &  
TOL=0.0001  
TQ-PARAM CURVE=YES  
EO-OPTIONS CHECK-FREE-W=YES NEG-COMP-CHK=-1E-008 &  
NEG-FLOW-CHK=0. ALWAYS-INST=NO FLASH-FORM=PML &  
PRES-TOL=1.45037738E-4 MIN-PRES=YES COMP-TOL=1E-015 &  
CHEM-METHOD=YES AUTO-COMPS-T=0. AUTO-PHASE=YES &  
AUTO-PHASE-T=0.1 TEMP-TOL=0.0018  
BLOCK-OPTION SIM-LEVEL=4 PROP-LEVEL=4 STREAM-LEVEL=4 &  
TERM-LEVEL=4 RESTART=YES ENERGY-BAL=YES  
REPORT REPORT NONEWPAGE TOTBAL INPUT NOCOMPBAL RESULTS

BLOCK HX-06 HEATX

PARAM VFRAC-HOT=0. MIN-TAPP=10.  
FEEDS HOT=S-100 COLD=S-CHW  
OUTLETS-HOT S-102  
OUTLETS-COLD S-153  
TQ-PARAM CURVE=YES

BLOCK HX-07 HEATX

PARAM VFRAC-COLD=0.  
FEEDS HOT=S-093 COLD=S-104  
OUTLETS-HOT S-148  
OUTLETS-COLD S-105  
TQ-PARAM CURVE=YES

BLOCK HX-12 HEATX

PARAM T-HOT=75. CALC-TYPE=DESIGN PRES-HOT=0.3867355 &  
U-OPTION=PHASE F-OPTION=CONSTANT CALC-METHOD=SHORTCUT  
FEEDS HOT=S-146 COLD=S-153  
OUTLETS-HOT S-147  
OUTLETS-COLD S-154  
PROPERTIES WILSON FREE-WATER=STEAM-TA SOLU-WATER=3 &  
TRUE-COMPS=YES / WILSON FREE-WATER=STEAMNBS SOLU-WATER=3 &  
TRUE-COMPS=YES  
FLASH-SPECS S-147 NPHASE=2 FREE-WATER=NO MAXIT=30 &  
TOL=0.0001  
HOT-SIDE DP-OPTION=CONSTANT  
COLD-SIDE DP-OPTION=CONSTANT  
TQ-PARAM CURVE=YES  
EO-OPTIONS CHECK-FREE-W=YES NEG-COMP-CHK=-1E-008 &  
NEG-FLOW-CHK=0. ALWAYS-INST=NO FLASH-FORM=PML &  
PRES-TOL=1.45037738E-4 MIN-PRES=YES COMP-TOL=1E-015 &  
CHEM-METHOD=YES AUTO-COMPS-T=0. AUTO-PHASE=YES &  
AUTO-PHASE-T=0.1 TEMP-TOL=0.0018  
BLOCK-OPTION SIM-LEVEL=4 PROP-LEVEL=4 STREAM-LEVEL=4 &  
TERM-LEVEL=4 RESTART=YES ENERGY-BAL=YES  
REPORT REPORT NONEWPAGE TOTBAL INPUT NOCOMPBAL RESULTS

```

BLOCK PUMP-33 PUMP
  PARAM PRES=9.205266

BLOCK VLV01 VALVE
  PARAM P-OUT=6.05

BLOCK VLV02 VALVE
  PARAM P-OUT=2.

UTILITY CW GENERAL
  DESCRIPTION "Cooling Water, Inlet Temp=20 C, Outlet Temp=25 C"
  COST ENERGY-PRICE=2.12E-007 <$/kJ>
  PARAM UTILITY-TYPE=WATER PRES=1. <atm> PRES-OUT=1. <atm> &
    TIN=20. <C> TOUT=25. <C> CALOPT=FLASH MIN-TAPP=5. <C> &
    HTC=0.0135 <GJ/hr-sqm-C>

UTILITY MPSTEAM GENERAL
  DESCRIPTION &
    "Medium Pressure Steam, Inlet Temp=175 C, Outlet Temp=174 C, Pres=127 psia"
  COST ENERGY-PRICE=2.2E-006 <$/kJ>
  PARAM UTILITY-TYPE=STEAM TIN=175. <C> TOUT=174. <C> VFRAC=1. &
    VFR-OUT=0. CALOPT=FLASH MIN-TAPP=10. CALCCO2=YES &
    FACTORSOURCE="US-EPA-Rule-E9-5711" FUELSOURCE="Natural_gas" &
    CO2FACTOR=1.30000000E-4 EFFICIENCY=0.85 &
    HTC=0.0216 <GJ/hr-sqm-C>

EO-CONV-OPTI

TRANSFER T-1
  SET BLOCK-VAR BLOCK=EVAP-01 VARIABLE=TEMP SENTENCE=PARAM &
    UOM="F"
  EQUAL-TO STREAM-VAR STREAM=2FLASH01 SUBSTREAM=MIXED &
    VARIABLE=TEMP UOM="F"

TRANSFER T-2
  SET BLOCK-VAR BLOCK=EVAP-02 VARIABLE=TEMP SENTENCE=PARAM &
    UOM="F"
  EQUAL-TO STREAM-VAR STREAM=2FLASH02 SUBSTREAM=MIXED &
    VARIABLE=TEMP UOM="F"

TRANSFER T-3
  SET BLOCK-VAR BLOCK=EVAP-03 VARIABLE=TEMP SENTENCE=PARAM &
    UOM="F"
  EQUAL-TO STREAM-VAR STREAM=2FLASH03 SUBSTREAM=MIXED &
    VARIABLE=TEMP UOM="F"

TRANSFER T-4
  SET BLOCK-VAR BLOCK=EVAP-02 VARIABLE=PRES SENTENCE=PARAM &
    UOM="psia"
  EQUAL-TO BLOCK-VAR BLOCK=VLV01 VARIABLE=P-OUT SENTENCE=PARAM &
    UOM="psia"

TRANSFER T-5
  SET BLOCK-VAR BLOCK=EVAP-03 VARIABLE=PRES SENTENCE=PARAM &
    UOM="psia"
  EQUAL-TO BLOCK-VAR BLOCK=VLV02 VARIABLE=P-OUT SENTENCE=PARAM &
    UOM="psia"

SENSITIVITY S-1
  DEFINE HOHFRAC MASS-FRAC STREAM=S-099 SUBSTREAM=MIXED &
    COMPONENT=WATER
  TABULATE 1 "HOHFRAC"

```

VARY BLOCK-VAR BLOCK=VLV01 VARIABLE=P-OUT SENTENCE=PARAM &  
 UOM="psia"  
 RANGE LOWER="5.5" UPPER="7" INCR="0.05"

TEAR  
 TEAR S-100

BLOCK-REPORT NEWPAGE

STREAM-REPOR MOLEFLOW MASSFLOW MOLEFRAC MASSFRAC

## Evaporator Block Report

BLOCK: EVAP-01 MODEL: FLASH2

-----  
 INLET STREAM: 2FLASH01  
 OUTLET VAPOR STREAM: S-092  
 OUTLET LIQUID STREAM: S-091  
 PROPERTY OPTION SET: WILSON WILSON / IDEAL GAS

*** MASS AND ENERGY BALANCE ***			
	IN	OUT	RELATIVE DIFF.
TOTAL BALANCE			
MOLE (LBMOL/HR)	21152.8	21152.8	0.00000
MASS (LB/HR )	396163.	396163.	0.146929E-15
ENTHALPY (BTU/HR )	-0.245709E+10	-0.245709E+10	-0.563792E-06

*** CO2 EQUIVALENT SUMMARY ***		
FEED STREAMS CO2E	0.00000	LB/HR
PRODUCT STREAMS CO2E	0.00000	LB/HR
NET STREAMS CO2E PRODUCTION	0.00000	LB/HR
UTILITIES CO2E PRODUCTION	0.00000	LB/HR
TOTAL CO2E PRODUCTION	0.00000	LB/HR

*** INPUT DATA ***	
TWO PHASE TP FLASH	
SPECIFIED TEMPERATURE F	190.113
SPECIFIED PRESSURE PSIA	9.20067
MAXIMUM NO. ITERATIONS	30
CONVERGENCE TOLERANCE	0.000100000

*** RESULTS ***	
OUTLET TEMPERATURE F	190.11
OUTLET PRESSURE PSIA	9.2007
HEAT DUTY BTU/HR	1385.3
VAPOR FRACTION	0.32304

V-L PHASE EQUILIBRIUM :

COMP	F(I)	X(I)	Y(I)	K(I)
WATER	0.98821	0.98269	0.99977	1.0174
DEXTR-01	0.20207E-04	0.29850E-04	0.16601E-12	0.55613E-08
1:3-P-01	0.99715E-02	0.14666E-01	0.13316E-03	0.90791E-02
GLYCE-01	0.17596E-02	0.25991E-02	0.19828E-06	0.76287E-04
METHA-01	0.38270E-04	0.11567E-04	0.94227E-04	8.1461

BLOCK: EVAP-02 MODEL: FLASH2

-----  
 INLET STREAM: 2FLASH02

OUTLET VAPOR STREAM: S-096  
 OUTLET LIQUID STREAM: S-095  
 PROPERTY OPTION SET: WILSON WILSON / IDEAL GAS

*** MASS AND ENERGY BALANCE ***			
	IN	OUT	RELATIVE DIFF.
TOTAL BALANCE			
MOLE (LBMOL/HR)	14319.7	14319.7	0.00000
MASS (LB/HR )	272999.	272999.	0.426431E-15
ENTHALPY (BTU/HR )	-0.163152E+10	-0.163152E+10	-0.421941E-09

*** CO2 EQUIVALENT SUMMARY ***			
FEED STREAMS CO2E	0.00000	LB/HR	
PRODUCT STREAMS CO2E	0.00000	LB/HR	
NET STREAMS CO2E PRODUCTION	0.00000	LB/HR	
UTILITIES CO2E PRODUCTION	0.00000	LB/HR	
TOTAL CO2E PRODUCTION	0.00000	LB/HR	

*** INPUT DATA ***			
TWO PHASE TP FLASH			
SPECIFIED TEMPERATURE F			171.901
SPECIFIED PRESSURE PSIA			6.05000
MAXIMUM NO. ITERATIONS			30
CONVERGENCE TOLERANCE			0.000100000

*** RESULTS ***			
OUTLET TEMPERATURE F			171.90
OUTLET PRESSURE PSIA			6.0500
HEAT DUTY BTU/HR			0.68840
VAPOR FRACTION			0.49206

V-L PHASE EQUILIBRIUM :

COMP	F(I)	X(I)	Y(I)	K(I)
WATER	0.98269	0.96616	0.99976	1.0348
DEXTR-01	0.29850E-04	0.58767E-04	0.11345E-12	0.19305E-08
1:3-P-01	0.14666E-01	0.28665E-01	0.21541E-03	0.75147E-02
GLYCE-01	0.25991E-02	0.51167E-02	0.27503E-06	0.53752E-04
METHA-01	0.11567E-04	0.25263E-05	0.20900E-04	8.2730

BLOCK: EVAP-03 MODEL: FLASH2

-----  
 INLET STREAM: 2FLASH03  
 OUTLET VAPOR STREAM: S-100  
 OUTLET LIQUID STREAM: S-099  
 PROPERTY OPTION SET: WILSON WILSON / IDEAL GAS

*** MASS AND ENERGY BALANCE ***			
	IN	OUT	RELATIVE DIFF.
TOTAL BALANCE			
MOLE (LBMOL/HR)	7273.59	7273.59	-0.249279E-06
MASS (LB/HR )	145972.	145972.	-0.602489E-07
ENTHALPY (BTU/HR )	-0.782917E+09	-0.782917E+09	0.230180E-06

*** CO2 EQUIVALENT SUMMARY ***			
FEED STREAMS CO2E	0.00000	LB/HR	
PRODUCT STREAMS CO2E	0.00000	LB/HR	
NET STREAMS CO2E PRODUCTION	0.00000	LB/HR	
UTILITIES CO2E PRODUCTION	0.00000	LB/HR	
TOTAL CO2E PRODUCTION	0.00000	LB/HR	

\*\*\* INPUT DATA \*\*\*

TWO PHASE TP FLASH  
 SPECIFIED TEMPERATURE F 152.014  
 SPECIFIED PRESSURE PSIA 2.00000  
 MAXIMUM NO. ITERATIONS 30  
 CONVERGENCE TOLERANCE 0.000100000

\*\*\* RESULTS \*\*\*

OUTLET TEMPERATURE F 152.01  
 OUTLET PRESSURE PSIA 2.0000  
 HEAT DUTY BTU/HR 3.0412  
 VAPOR FRACTION 0.93791

V-L PHASE EQUILIBRIUM :

COMP	F(I)	X(I)	Y(I)	K(I)
WATER	0.96616	0.52295	0.99550	1.9036
DEXTR-01	0.58767E-04	0.94645E-03	0.10204E-11	0.10782E-08
1:3-P-01	0.28665E-01	0.39381	0.44916E-02	0.11405E-01
GLYCE-01	0.51167E-02	0.82294E-01	0.73482E-05	0.89291E-04
METHA-01	0.25263E-05	0.23686E-06	0.26779E-05	11.306

BLOCK: HEATER01 MODEL: HEATX

-----  
 HOT SIDE:  
 -----

INLET UTILITY: MPSTEAM  
 OUTLET UTILITY: MPSTEAM  
 PROPERTY OPTION SET: WILSON WILSON / IDEAL GAS  
 COLD SIDE:  
 -----

INLET STREAM: S-089  
 OUTLET STREAM: 2FLASH01  
 PROPERTY OPTION SET: WILSON WILSON / IDEAL GAS

\*\*\* MASS AND ENERGY BALANCE \*\*\*

	IN	OUT	RELATIVE DIFF.
TOTAL BALANCE			
MOLE (LBMOL/HR)	21152.8	21152.8	0.00000
MASS (LB/HR )	396163.	396163.	0.00000
ENTHALPY (BTU/HR )	-0.257844E+10	-0.245709E+10	-0.470634E-01

\*\*\* CO2 EQUIVALENT SUMMARY \*\*\*

FEED STREAMS CO2E	0.00000	LB/HR
PRODUCT STREAMS CO2E	0.00000	LB/HR
NET STREAMS CO2E PRODUCTION	0.00000	LB/HR
UTILITIES CO2E PRODUCTION	18559.4	LB/HR
TOTAL CO2E PRODUCTION	18559.4	LB/HR

FLASH SPECS FOR COLD SIDE:

TWO PHASE FLASH  
 MAXIMUM NO. ITERATIONS 30  
 CONVERGENCE TOLERANCE 0.000100000

FLOW DIRECTION AND SPECIFICATION:

COUNTERCURRENT HEAT EXCHANGER  
 SPECIFIED EXCHANGER DUTY  
 SPECIFIED VALUE BTU/HR 121350000.0000  
 LMTD CORRECTION FACTOR 1.00000

PRESSURE SPECIFICATION:

HOT SIDE OUTLET PRESSURE PSIA 126.3243  
 COLD SIDE PRESSURE DROP PSI 0.0000

HEAT TRANSFER COEFFICIENT SPECIFICATION:  
 OVERALL COEFFICIENT BTU/HR-SQFT-R 650.0000

\*\*\* OVERALL RESULTS \*\*\*

STREAMS:

```

-----|-----|-----
MPSTEAM  ----->|             HOT             |-----> MPSTEAM
T=  3.4700D+02 |             |             |             T=  3.4520D+02
P=  1.2935D+02 |             |             |             P=  1.2632D+02
V=  1.0000D+00 |             |             |             V=  0.0000D+00
|             |             |             |
2FLASH01 <-----|             COLD             |<----- S-089
T=  1.9011D+02 |             |             |             T=  1.8984D+02
P=  9.2007D+00 |             |             |             P=  9.2007D+00
V=  3.2303D-01 |             |             |             V=  1.0469D-05
-----|-----|-----

```

DUTY AND AREA:

CALCULATED HEAT DUTY BTU/HR 121350000.0000  
 CALCULATED (REQUIRED) AREA SQFT 1195.8195  
 ACTUAL EXCHANGER AREA SQFT 1195.8195  
 PER CENT OVER-DESIGN 0.0000

HEAT TRANSFER COEFFICIENT:

AVERAGE COEFFICIENT (DIRTY) BTU/HR-SQFT-R 650.0000  
 UA (DIRTY) BTU/HR-R 777282.6848

LOG-MEAN TEMPERATURE DIFFERENCE:

LMTD CORRECTION FACTOR 1.0000  
 LMTD (CORRECTED) F 156.1208  
 NUMBER OF SHELLS IN SERIES 1

PRESSURE DROP:

HOTSIDE, TOTAL PSI 3.0211  
 COLD SIDE, TOTAL PSI 0.0000

\*\*\* ASSOCIATED UTILITIES \*\*\*

UTILITY ID FOR STEAM MPSTEAM  
 RATE OF CONSUMPTION 1.3860+05 LB/HR  
 COST 281.6683 \$/HR  
 CO2 EQUIVALENT EMISSIONS 1.8559+04 LB/HR

HEATX COLD-TQCU HEATER01 TQCURV INLET

-----  
 PRESSURE PROFILE: CONSTANT2  
 PRESSURE DROP: 0.0 PSI  
 PROPERTY OPTION SET: WILSON WILSON / IDEAL GAS

```

-----|-----|-----|-----|-----
!  DUTY      !  PRES    !  TEMP    !  VFRAC   !
!           !          !          !          !
!           !          !          !          !
!           !          !          !          !
!  BTU/HR   !  PSIA    !  F       !          !
!           !          !          !          !
!=====|=====|=====|=====|
!  0.0     !  9.2007 !  190.1133 !  0.3230 !

```

!	5.7786+06	!	9.2007	!	190.0952	!	0.3077	!
!	1.1557+07	!	9.2007	!	190.0952	!	0.3077	!
!	1.7336+07	!	9.2007	!	190.0778	!	0.2923	!
!	2.3114+07	!	9.2007	!	190.0612	!	0.2769	!
-----								
!	2.8893+07	!	9.2007	!	190.0452	!	0.2615	!
!	3.4671+07	!	9.2007	!	190.0299	!	0.2461	!
!	4.0450+07	!	9.2007	!	190.0151	!	0.2308	!
!	4.6229+07	!	9.2007	!	190.0009	!	0.2154	!
!	5.2007+07	!	9.2007	!	189.9873	!	0.2000	!
-----								
!	5.7786+07	!	9.2007	!	189.9741	!	0.1846	!
!	6.3564+07	!	9.2007	!	189.9613	!	0.1692	!
!	6.9343+07	!	9.2007	!	189.9490	!	0.1538	!
!	7.5121+07	!	9.2007	!	189.9371	!	0.1385	!
!	8.0900+07	!	9.2007	!	189.9256	!	0.1231	!
-----								
!	8.6679+07	!	9.2007	!	189.9143	!	0.1077	!
!	9.2457+07	!	9.2007	!	189.9034	!	9.2312-02	!
!	9.8236+07	!	9.2007	!	189.8928	!	7.6929-02	!
!	1.0401+08	!	9.2007	!	189.8825	!	6.1545-02	!
!	1.0979+08	!	9.2007	!	189.8723	!	4.6161-02	!
-----								
!	1.1557+08	!	9.2007	!	189.8623	!	3.0778-02	!
!	1.2109+08	!	9.2007	!	189.8430	!	7.0763-04	!
!	1.2135+08	!	9.2007	!	189.8524	!	1.5394-02	!

HEATX HOT-TQCUR HEATER01 TQCURV INLET

-----  
 PRESSURE PROFILE:            CONSTANT2  
 PRESSURE DROP:                0.0            PSI  
 PROPERTY OPTION SET:        STEAMNBS   NBS STEAM TABLE EQUATION OF STATE

!	DUTY	!	PRES	!	TEMP	!	VFRAC	!
!		!		!		!		!
!	BTU/HR	!	PSIA	!	F	!		!
!		!		!		!		!
!	0.0	!	129.3454	!	347.0000	!	1.0000	!
!	5.7786+06	!	129.3454	!	347.0000	!	0.9523	!
!	1.1557+07	!	129.3454	!	347.0000	!	0.9046	!
!	1.7336+07	!	129.3454	!	347.0000	!	0.8568	!
!	2.3114+07	!	129.3454	!	347.0000	!	0.8091	!
-----								
!	2.8893+07	!	129.3454	!	347.0000	!	0.7614	!
!	3.4671+07	!	129.3454	!	347.0000	!	0.7137	!
!	4.0450+07	!	129.3454	!	347.0000	!	0.6659	!
!	4.6229+07	!	129.3454	!	347.0000	!	0.6182	!
!	5.2007+07	!	129.3454	!	347.0000	!	0.5705	!
-----								
!	5.7786+07	!	129.3454	!	347.0000	!	0.5228	!
!	6.3564+07	!	129.3454	!	347.0000	!	0.4751	!
!	6.9343+07	!	129.3454	!	347.0000	!	0.4273	!
!	7.5121+07	!	129.3454	!	347.0000	!	0.3796	!
!	8.0900+07	!	129.3454	!	347.0000	!	0.3319	!
-----								
!	8.6679+07	!	129.3454	!	347.0000	!	0.2842	!
!	9.2457+07	!	129.3454	!	347.0000	!	0.2364	!
!	9.8236+07	!	129.3454	!	347.0000	!	0.1887	!

```

! 1.0401+08 ! 129.3454 ! 347.0000 ! 0.1410 !
! 1.0979+08 ! 129.3454 ! 347.0000 ! 9.3281-02 !
!-----+-----+-----+-----!
! 1.1557+08 ! 129.3454 ! 347.0000 ! 4.5559-02 !
! 1.2109+08 ! 129.3454 ! 347.0000 ! BUB>0.0 !
! 1.2135+08 ! 129.3454 ! 345.1955 ! 0.0 !
-----

```

BLOCK: HEATER02 MODEL: HEATX  
-----

HOT SIDE:  
-----

INLET STREAM: S-092  
OUTLET STREAM: S-097  
PROPERTY OPTION SET: WILSON WILSON / IDEAL GAS  
COLD SIDE:  
-----

INLET STREAM: S-094  
OUTLET STREAM: 2FLASH02  
PROPERTY OPTION SET: WILSON WILSON / IDEAL GAS

*** MASS AND ENERGY BALANCE ***			
	IN	OUT	RELATIVE DIFF.
TOTAL BALANCE			
MOLE (LBMOL/HR)	21152.8	21152.8	0.00000
MASS (LB/HR )	396163.	396163.	0.00000
ENTHALPY (BTU/HR )	-0.245709E+10	-0.245709E+10	0.194066E-15

*** CO2 EQUIVALENT SUMMARY ***		
FEED STREAMS CO2E	0.00000	LB/HR
PRODUCT STREAMS CO2E	0.00000	LB/HR
NET STREAMS CO2E PRODUCTION	0.00000	LB/HR
UTILITIES CO2E PRODUCTION	0.00000	LB/HR
TOTAL CO2E PRODUCTION	0.00000	LB/HR

\*\*\* INPUT DATA \*\*\*

FLASH SPECS FOR HOT SIDE:  
TWO PHASE FLASH  
MAXIMUM NO. ITERATIONS 30  
CONVERGENCE TOLERANCE 0.000100000

FLASH SPECS FOR COLD SIDE:  
TWO PHASE FLASH  
MAXIMUM NO. ITERATIONS 30  
CONVERGENCE TOLERANCE 0.000100000

FLOW DIRECTION AND SPECIFICATION:  
COUNTERCURRENT HEAT EXCHANGER  
SPECIFIED EXCHANGER DUTY  
SPECIFIED VALUE BTU/HR 121350000.0000  
LMTD CORRECTION FACTOR 1.00000

PRESSURE SPECIFICATION:  
HOT SIDE PRESSURE DROP PSI 0.0000  
COLD SIDE PRESSURE DROP PSI 0.0000

HEAT TRANSFER COEFFICIENT SPECIFICATION:  
OVERALL COEFFICIENT BTU/HR-SQFT-R 600.0000

\*\*\* OVERALL RESULTS \*\*\*

STREAMS:



```

-----
S-092 -----> |                HOT                | -----> S-097
T= 1.9011D+02 |                |                | T= 1.8928D+02
P= 9.2007D+00 |                |                | P= 9.2007D+00
V= 1.0000D+00 |                |                | V= 2.4677D-05

2FLASH02 <-----|                COLD                |<----- S-094
T= 1.7190D+02 |                |                | T= 1.7117D+02
P= 6.0500D+00 |                |                | P= 6.0500D+00
V= 4.9206D-01 |                |                | V= 2.0557D-02
-----

```

DUTY AND AREA:

CALCULATED HEAT DUTY	BTU/HR	121350000.0000
CALCULATED (REQUIRED) AREA	SQFT	11136.4598
ACTUAL EXCHANGER AREA	SQFT	11136.4598
PER CENT OVER-DESIGN		0.0000

HEAT TRANSFER COEFFICIENT:

AVERAGE COEFFICIENT (DIRTY)	BTU/HR-SQFT-R	600.0000
UA (DIRTY)	BTU/HR-R	6681875.8643

LOG-MEAN TEMPERATURE DIFFERENCE:

LMTD CORRECTION FACTOR		1.0000
LMTD (CORRECTED)	F	18.1611
NUMBER OF SHELLS IN SERIES		1

PRESSURE DROP:

HOTSIDE, TOTAL	PSI	0.0000
COLD SIDE, TOTAL	PSI	0.0000

HEATX COLD-TQCU HEATER02 TQCURV INLET

```

-----
PRESSURE PROFILE:      CONSTANT2
PRESSURE DROP:         0.0      PSI
PROPERTY OPTION SET:   WILSON   WILSON / IDEAL GAS
-----

```

```

-----
!  DUTY      !  PRES      !  TEMP      !  VFRAC      !
!           !           !           !           !
!           !           !           !           !
!  BTU/HR    !  PSIA      !  F         !           !
!           !           !           !           !
!=====!=====!=====!=====!
!   0.0      !   6.0500   !  171.9006  !   0.4921   !
!  5.7786+06 !   6.0500   !  171.8365  !   0.4696   !
!  1.1557+07 !   6.0500   !  171.8365  !   0.4696   !
!  1.7336+07 !   6.0500   !  171.7776  !   0.4472   !
!  2.3114+07 !   6.0500   !  171.7234  !   0.4247   !
!-----+-----+-----+-----!
!  2.8893+07 !   6.0500   !  171.6732  !   0.4023   !
!  3.4671+07 !   6.0500   !  171.6267  !   0.3799   !
!  4.0450+07 !   6.0500   !  171.5834  !   0.3574   !
!  4.6229+07 !   6.0500   !  171.5431  !   0.3350   !
!  5.2007+07 !   6.0500   !  171.5054  !   0.3125   !
!-----+-----+-----+-----!
!  5.7786+07 !   6.0500   !  171.4701  !   0.2901   !
!  6.3564+07 !   6.0500   !  171.4370  !   0.2676   !
!  6.9343+07 !   6.0500   !  171.4059  !   0.2451   !
!  7.5121+07 !   6.0500   !  171.3765  !   0.2227   !
!  8.0900+07 !   6.0500   !  171.3488  !   0.2002   !
-----

```

```

!-----+-----+-----+-----!
! 8.6679+07 !      6.0500 !   171.3226 !    0.1778 !
! 9.2457+07 !      6.0500 !   171.2978 !    0.1553 !
! 9.8236+07 !      6.0500 !   171.2742 !    0.1329 !
! 1.0401+08 !      6.0500 !   171.2518 !    0.1104 !
! 1.0979+08 !      6.0500 !   171.2305 !   8.7940-02 !
!-----+-----+-----+-----!
! 1.1557+08 !      6.0500 !   171.2101 !   6.5480-02 !
! 1.2135+08 !      6.0500 !   171.1906 !   4.3019-02 !
!-----+-----+-----+-----!

```

HEATX HOT-TQCUR HEATER02 TQCURV INLET

```

-----
PRESSURE PROFILE:      CONSTANT2
PRESSURE DROP:        0.0      PSI
PROPERTY OPTION SET:  WILSON    WILSON / IDEAL GAS

```

```

-----
! DUTY      ! PRES      ! TEMP      ! VFRAC     !
!           !           !           !           !
!           !           !           !           !
! BTU/HR    ! PSIA      ! F         !           !
!           !           !           !           !
!=====+=====+=====+=====!
! 0.0       ! 9.2007   ! 190.1133 ! 1.0000 !
! 5.7786+06 ! 9.2007   ! 189.4137 ! 0.9528 !
! 1.1557+07 ! 9.2007   ! 189.3626 ! 0.9051 !
! 1.7336+07 ! 9.2007   ! 189.3436 ! 0.8575 !
! 2.3114+07 ! 9.2007   ! 189.3335 ! 0.8099 !
!-----+-----+-----+-----!
! 2.8893+07 ! 9.2007   ! 189.3272 ! 0.7622 !
! 3.4671+07 ! 9.2007   ! 189.3229 ! 0.7146 !
! 4.0450+07 ! 9.2007   ! 189.3196 ! 0.6670 !
! 4.6229+07 ! 9.2007   ! 189.3170 ! 0.6193 !
! 5.2007+07 ! 9.2007   ! 189.3149 ! 0.5717 !
!-----+-----+-----+-----!
! 5.7786+07 ! 9.2007   ! 189.3131 ! 0.5240 !
! 6.3564+07 ! 9.2007   ! 189.3114 ! 0.4764 !
! 6.9343+07 ! 9.2007   ! 189.3098 ! 0.4288 !
! 7.5121+07 ! 9.2007   ! 189.3083 ! 0.3811 !
! 8.0900+07 ! 9.2007   ! 189.3068 ! 0.3335 !
!-----+-----+-----+-----!
! 8.6679+07 ! 9.2007   ! 189.3051 ! 0.2858 !
! 9.2457+07 ! 9.2007   ! 189.3033 ! 0.2382 !
! 9.8236+07 ! 9.2007   ! 189.3011 ! 0.1906 !
! 1.0401+08 ! 9.2007   ! 189.2985 ! 0.1429 !
! 1.0979+08 ! 9.2007   ! 189.2949 ! 9.5295-02 !
!-----+-----+-----+-----!
! 1.1557+08 ! 9.2007   ! 189.2898 ! 4.7658-02 !
! 1.2135+08 ! 9.2007   ! 189.2815 ! 2.4677-05 !
!-----+-----+-----+-----!

```

BLOCK: HEATER03 MODEL: HEATX

```

-----
HOT SIDE:
-----
INLET STREAM:          S-096
OUTLET STREAM:         S-101
PROPERTY OPTION SET:  WILSON    WILSON / IDEAL GAS
COLD SIDE:
-----
INLET STREAM:          S-098

```

OUTLET STREAM: 2FLASH03  
 PROPERTY OPTION SET: WILSON WILSON / IDEAL GAS

\*\*\* MASS AND ENERGY BALANCE \*\*\*

	IN	OUT	RELATIVE DIFF.
TOTAL BALANCE			
MOLE (LBMOL/HR)	14319.7	14319.7	0.00000
MASS (LB/HR )	272999.	272999.	-0.213216E-15
ENTHALPY (BTU/HR )	-0.163152E+10	-0.163152E+10	0.00000

\*\*\* CO2 EQUIVALENT SUMMARY \*\*\*

FEED STREAMS CO2E	0.00000	LB/HR
PRODUCT STREAMS CO2E	0.00000	LB/HR
NET STREAMS CO2E PRODUCTION	0.00000	LB/HR
UTILITIES CO2E PRODUCTION	0.00000	LB/HR
TOTAL CO2E PRODUCTION	0.00000	LB/HR

\*\*\* INPUT DATA \*\*\*

FLASH SPECS FOR HOT SIDE:  
 TWO PHASE FLASH  
 MAXIMUM NO. ITERATIONS 30  
 CONVERGENCE TOLERANCE 0.000100000

FLASH SPECS FOR COLD SIDE:  
 TWO PHASE FLASH  
 MAXIMUM NO. ITERATIONS 30  
 CONVERGENCE TOLERANCE 0.000100000

FLOW DIRECTION AND SPECIFICATION:  
 COUNTERCURRENT HEAT EXCHANGER  
 SPECIFIED EXCHANGER DUTY  
 SPECIFIED VALUE BTU/HR 121350000.0000  
 LMTD CORRECTION FACTOR 1.00000

PRESSURE SPECIFICATION:  
 HOT SIDE PRESSURE DROP PSI 0.0000  
 COLD SIDE PRESSURE DROP PSI 0.0000

HEAT TRANSFER COEFFICIENT SPECIFICATION:  
 OVERALL COEFFICIENT BTU/HR-SQFT-R 550.0000

\*\*\* OVERALL RESULTS \*\*\*

STREAMS:

Stream	Phase	Temp (T)	Pressure (P)	Volume (V)
S-096	HOT	1.7190D+02	6.0500D+00	1.0000D+00
S-101	HOT	1.7041D+02	6.0500D+00	4.1747D-02
2FLASH03	COLD	1.5201D+02	2.0000D+00	9.3791D-01
S-098	COLD	1.2736D+02	2.0000D+00	4.6949D-02

DUTY AND AREA:

CALCULATED HEAT DUTY	BTU/HR	121350000.0000
CALCULATED (REQUIRED) AREA	SQFT	7357.2505
ACTUAL EXCHANGER AREA	SQFT	7357.2505
PER CENT OVER-DESIGN		0.0000

HEAT TRANSFER COEFFICIENT:  
 AVERAGE COEFFICIENT (DIRTY) BTU/HR-SQFT-R 550.0000  
 UA (DIRTY) BTU/HR-R 4046487.7954

LOG-MEAN TEMPERATURE DIFFERENCE:  
 LMTD CORRECTION FACTOR 1.0000  
 LMTD (CORRECTED) F 29.9890  
 NUMBER OF SHELLS IN SERIES 1

PRESSURE DROP:  
 HOTSIDE, TOTAL PSI 0.0000  
 COLDSIDE, TOTAL PSI 0.0000

HEATX COLD-TQCU HEATER03 TQCURV INLET

-----  
 PRESSURE PROFILE: CONSTANT2  
 PRESSURE DROP: 0.0 PSI  
 PROPERTY OPTION SET: WILSON WILSON / IDEAL GAS

```

-----
! DUTY      ! PRES      ! TEMP      ! VFRAC     !
!           !           !           !           !
!           !           !           !           !
! BTU/HR    ! PSIA      ! F         !           !
!           !           !           !           !
!=====!=====!=====!=====!
! 0.0       ! 2.0000    ! 152.0144 ! 0.9379 !
! 5.7786+06 ! 2.0000    ! 141.2787 ! 0.9015 !
! 1.1557+07 ! 2.0000    ! 141.2787 ! 0.9015 !
! 1.7336+07 ! 2.0000    ! 136.3302 ! 0.8613 !
! 2.3114+07 ! 2.0000    ! 133.7150 ! 0.8197 !
!-----+-----+-----+-----!
! 2.8893+07 ! 2.0000    ! 132.1350 ! 0.7774 !
! 3.4671+07 ! 2.0000    ! 131.0856 ! 0.7349 !
! 4.0450+07 ! 2.0000    ! 130.3408 ! 0.6922 !
! 4.6229+07 ! 2.0000    ! 129.7856 ! 0.6494 !
! 5.2007+07 ! 2.0000    ! 129.3562 ! 0.6065 !
!-----+-----+-----+-----!
! 5.7786+07 ! 2.0000    ! 129.0145 ! 0.5636 !
! 6.3564+07 ! 2.0000    ! 128.7361 ! 0.5206 !
! 6.9343+07 ! 2.0000    ! 128.5050 ! 0.4776 !
! 7.5121+07 ! 2.0000    ! 128.3102 ! 0.4346 !
! 8.0900+07 ! 2.0000    ! 128.1437 ! 0.3915 !
!-----+-----+-----+-----!
! 8.6679+07 ! 2.0000    ! 127.9998 ! 0.3485 !
! 9.2457+07 ! 2.0000    ! 127.8741 ! 0.3054 !
! 9.8236+07 ! 2.0000    ! 127.7635 ! 0.2624 !
! 1.0401+08 ! 2.0000    ! 127.6654 ! 0.2193 !
! 1.0979+08 ! 2.0000    ! 127.5777 ! 0.1762 !
!-----+-----+-----+-----!
! 1.1557+08 ! 2.0000    ! 127.4989 ! 0.1331 !
! 1.2135+08 ! 2.0000    ! 127.4277 ! 9.0040-02 !
-----

```

HEATX HOT-TQCUR HEATER03 TQCURV INLET

-----  
 PRESSURE PROFILE: CONSTANT2  
 PRESSURE DROP: 0.0 PSI  
 PROPERTY OPTION SET: WILSON WILSON / IDEAL GAS

DUTY	PRES	TEMP	VFRAC
BTU/HR	PSIA	F	
0.0	6.0500	171.9006	1.0000
5.7786+06	6.0500	170.5808	0.9550
1.1557+07	6.0500	170.4963	0.9094
1.7336+07	6.0500	170.4656	0.8638
2.3114+07	6.0500	170.4497	0.8181
2.8893+07	6.0500	170.4400	0.7724
3.4671+07	6.0500	170.4334	0.7268
4.0450+07	6.0500	170.4286	0.6811
4.6229+07	6.0500	170.4250	0.6354
5.2007+07	6.0500	170.4222	0.5898
5.7786+07	6.0500	170.4199	0.5441
6.3564+07	6.0500	170.4179	0.4984
6.9343+07	6.0500	170.4163	0.4528
7.5121+07	6.0500	170.4149	0.4071
8.0900+07	6.0500	170.4136	0.3614
8.6679+07	6.0500	170.4125	0.3158
9.2457+07	6.0500	170.4114	0.2701
9.8236+07	6.0500	170.4104	0.2244
1.0401+08	6.0500	170.4094	0.1788
1.0979+08	6.0500	170.4083	0.1331
1.1557+08	6.0500	170.4071	8.7416-02
1.2135+08	6.0500	170.4055	4.1747-02

BLOCK: HX-06      MODEL: HEATX

HOT SIDE:

INLET STREAM:            S-100  
 OUTLET STREAM:           S-102  
 PROPERTY OPTION SET:    WILSON      WILSON / IDEAL GAS

COLD SIDE:

INLET STREAM:            S-CHW  
 OUTLET STREAM:           S-153  
 PROPERTY OPTION SET:    WILSON      WILSON / IDEAL GAS

\*\*\* MASS AND ENERGY BALANCE \*\*\*

TOTAL BALANCE	IN	OUT	RELATIVE DIFF.
MOLE (LBMOL/HR)	436927.	436927.	0.00000
MASS (LB/HR )	0.787315E+07	0.787315E+07	0.00000
ENTHALPY (BTU/HR )	-0.537326E+11	-0.537326E+11	0.00000

\*\*\* CO2 EQUIVALENT SUMMARY \*\*\*

FEED STREAMS CO2E	0.00000	LB/HR
PRODUCT STREAMS CO2E	0.00000	LB/HR
NET STREAMS CO2E PRODUCTION	0.00000	LB/HR
UTILITIES CO2E PRODUCTION	0.00000	LB/HR
TOTAL CO2E PRODUCTION	0.00000	LB/HR

\*\*\* INPUT DATA \*\*\*

FLASH SPECS FOR HOT SIDE:

TWO PHASE FLASH	
MAXIMUM NO. ITERATIONS	30
CONVERGENCE TOLERANCE	0.000100000

FLASH SPECS FOR COLD SIDE:

TWO PHASE FLASH	
MAXIMUM NO. ITERATIONS	30
CONVERGENCE TOLERANCE	0.000100000

FLOW DIRECTION AND SPECIFICATION:

COUNTERCURRENT HEAT EXCHANGER	
SPECIFIED HOT VAPOR FRACTION	
SPECIFIED VALUE	0.0000
LMTD CORRECTION FACTOR	1.00000

PRESSURE SPECIFICATION:

HOT SIDE PRESSURE DROP	PSI	0.0000
COLD SIDE PRESSURE DROP	PSI	0.0000

HEAT TRANSFER COEFFICIENT SPECIFICATION:

HOT LIQUID	COLD LIQUID	BTU/HR-SQFT-R	149.6937
HOT 2-PHASE	COLD LIQUID	BTU/HR-SQFT-R	149.6937
HOT VAPOR	COLD LIQUID	BTU/HR-SQFT-R	149.6937
HOT LIQUID	COLD 2-PHASE	BTU/HR-SQFT-R	149.6937
HOT 2-PHASE	COLD 2-PHASE	BTU/HR-SQFT-R	149.6937
HOT VAPOR	COLD 2-PHASE	BTU/HR-SQFT-R	149.6937
HOT LIQUID	COLD VAPOR	BTU/HR-SQFT-R	149.6937
HOT 2-PHASE	COLD VAPOR	BTU/HR-SQFT-R	149.6937
HOT VAPOR	COLD VAPOR	BTU/HR-SQFT-R	149.6937

\*\*\* OVERALL RESULTS \*\*\*

STREAMS:

```

-----
S-100  -----> |                HOT                | -----> S-102
T= 1.5201D+02 |                |                T= 1.2619D+02
P= 2.0000D+00 |                |                P= 2.0000D+00
V= 1.0000D+00 |                |                V= 0.0000D+00
                |                |                |
S-153  <----- |                COLD                | <----- S-CHW
T= 7.0434D+01 |                |                T= 5.3600D+01
P= 1.4700D+01 |                |                P= 1.4700D+01
V= 0.0000D+00 |                |                V= 0.0000D+00
-----

```

DUTY AND AREA:

CALCULATED HEAT DUTY	BTU/HR	127468303.2272
CALCULATED (REQUIRED) AREA	SQFT	11058.9713
ACTUAL EXCHANGER AREA	SQFT	11058.9713
PER CENT OVER-DESIGN		0.0000

HEAT TRANSFER COEFFICIENT:

AVERAGE COEFFICIENT (DIRTY)	BTU/HR-SQFT-R	149.6937
UA (DIRTY)	BTU/HR-R	1655457.8488

LOG-MEAN TEMPERATURE DIFFERENCE:

LMTD CORRECTION FACTOR		1.0000
LMTD (CORRECTED)	F	76.9988
NUMBER OF SHELLS IN SERIES		1

PRESSURE DROP:  
 HOTSIDE, TOTAL                   PSI                   0.0000  
 COLD SIDE, TOTAL                PSI                   0.0000

\*\*\* ZONE RESULTS \*\*\*

TEMPERATURE LEAVING EACH ZONE:

```

                                HOT
-----
HOT IN  |          COND          |  HOT OUT
-----> |                          | ----->
  152.0 |                          |   126.2
        |                          |
COLDOUT |          LIQ            |  COLDIN
<----- |                          | <-----
   70.4 |                          |   53.6
        |                          |
-----
                                COLD
  
```

ZONE HEAT TRANSFER AND AREA:

ZONE	HEAT DUTY BTU/HR	AREA SQFT	LMTD F	AVERAGE U BTU/HR-SQFT-R	UA BTU/HR-R
1	127468303.227	11058.9713	76.9988	149.6937	1655457.8488

HEATX COLD-TQCU HX-06      TQCURV INLET

-----  
 PRESSURE PROFILE:           CONSTANT2  
 PRESSURE DROP:            0.0           PSI  
 PROPERTY OPTION SET:   WILSON      WILSON / IDEAL GAS

```

-----
!  DUTY      !  PRES      !  TEMP      !  VFRAC     !
!           !           !           !           !
!           !           !           !           !
!  BTU/HR   !  PSIA      !  F         !           !
!           !           !           !           !
!===== !===== !===== !===== !
!   0.0     !  14.7000  !  70.4342  !  0.0       !
! 6.0699+06 !  14.7000  !  69.6354  !  0.0       !
! 1.2140+07 !  14.7000  !  69.6354  !  0.0       !
! 1.8210+07 !  14.7000  !  68.8363  !  0.0       !
! 2.4280+07 !  14.7000  !  68.0369  !  0.0       !
!-----+-----+-----+-----+
! 3.0350+07 !  14.7000  !  67.2373  !  0.0       !
! 3.6420+07 !  14.7000  !  66.4373  !  0.0       !
! 4.2489+07 !  14.7000  !  65.6371  !  0.0       !
! 4.8559+07 !  14.7000  !  64.8366  !  0.0       !
! 5.4629+07 !  14.7000  !  64.0357  !  0.0       !
!-----+-----+-----+-----+
! 6.0699+07 !  14.7000  !  63.2347  !  0.0       !
! 6.6769+07 !  14.7000  !  62.4333  !  0.0       !
! 7.2839+07 !  14.7000  !  61.6316  !  0.0       !
! 7.8909+07 !  14.7000  !  60.8297  !  0.0       !
! 8.4979+07 !  14.7000  !  60.0275  !  0.0       !
!-----+-----+-----+-----+
! 9.1049+07 !  14.7000  !  59.2250  !  0.0       !
! 9.7119+07 !  14.7000  !  58.4222  !  0.0       !
! 1.0319+08 !  14.7000  !  57.6192  !  0.0       !
  
```

```

! 1.0926+08 ! 14.7000 ! 56.8159 ! 0.0 !
! 1.1533+08 ! 14.7000 ! 56.0123 ! 0.0 !
!-----+-----+-----+-----!
! 1.2140+08 ! 14.7000 ! 55.2085 ! 0.0 !
! 1.2747+08 ! 14.7000 ! 54.4044 ! 0.0 !
!-----+-----+-----+-----!

```

HEATX HOT-TQCUR HX-06 TQCURV INLET

```

-----
PRESSURE PROFILE: CONSTANT2
PRESSURE DROP: 0.0 PSI
PROPERTY OPTION SET: WILSON WILSON / IDEAL GAS

```

```

-----
! DUTY ! PRES ! TEMP ! VFRAC !
! ! ! ! !
! ! ! ! !
! BTU/HR ! PSIA ! F ! !
! ! ! ! !
!=====!=====!=====!=====!
! 0.0 ! 2.0000 ! 152.0139 ! 1.0000 !
! 6.0699+06 ! 2.0000 ! 130.3564 ! 0.9638 !
! 1.2140+07 ! 2.0000 ! 127.9803 ! 0.9168 !
! 1.8210+07 ! 2.0000 ! 127.2771 ! 0.8688 !
! 2.4280+07 ! 2.0000 ! 126.9449 ! 0.8207 !
!-----+-----+-----+-----!
! 3.0350+07 ! 2.0000 ! 126.7520 ! 0.7725 !
! 3.6420+07 ! 2.0000 ! 126.6260 ! 0.7243 !
! 4.2489+07 ! 2.0000 ! 126.5374 ! 0.6760 !
! 4.8559+07 ! 2.0000 ! 126.4715 ! 0.6277 !
! 5.4629+07 ! 2.0000 ! 126.4208 ! 0.5795 !
!-----+-----+-----+-----!
! 6.0699+07 ! 2.0000 ! 126.3804 ! 0.5312 !
! 6.6769+07 ! 2.0000 ! 126.3475 ! 0.4829 !
! 7.2839+07 ! 2.0000 ! 126.3203 ! 0.4346 !
! 7.8909+07 ! 2.0000 ! 126.2973 ! 0.3863 !
! 8.4979+07 ! 2.0000 ! 126.2776 ! 0.3380 !
!-----+-----+-----+-----!
! 9.1049+07 ! 2.0000 ! 126.2607 ! 0.2898 !
! 9.7119+07 ! 2.0000 ! 126.2458 ! 0.2415 !
! 1.0319+08 ! 2.0000 ! 126.2327 ! 0.1932 !
! 1.0926+08 ! 2.0000 ! 126.2211 ! 0.1449 !
! 1.1533+08 ! 2.0000 ! 126.2107 ! 9.6589-02 !
!-----+-----+-----+-----!
! 1.2140+08 ! 2.0000 ! 126.2013 ! 4.8294-02 !
! 1.2747+08 ! 2.0000 ! 126.1927 ! 1.0348-09 !
!-----+-----+-----+-----!

```

BLOCK: HX-07 MODEL: HEATX

HOT SIDE:

```

-----
INLET STREAM: S-093
OUTLET STREAM: S-148
PROPERTY OPTION SET: WILSON WILSON / IDEAL GAS
COLD SIDE:

```

```

-----
INLET STREAM: 2HEATX04
OUTLET STREAM: S-105
PROPERTY OPTION SET: WILSON WILSON / IDEAL GAS

```

\*\*\* MASS AND ENERGY BALANCE \*\*\*



	IN	OUT	RELATIVE DIFF.
TOTAL BALANCE			
MOLE (LBMOL/HR)	14515.4	14515.4	0.00000
MASS (LB/HR )	263283.	263283.	0.00000
ENTHALPY (BTU/HR )	-0.173900E+10	-0.173900E+10	0.00000

\*\*\* CO2 EQUIVALENT SUMMARY \*\*\*

FEED STREAMS CO2E	0.00000	LB/HR
PRODUCT STREAMS CO2E	0.00000	LB/HR
NET STREAMS CO2E PRODUCTION	0.00000	LB/HR
UTILITIES CO2E PRODUCTION	0.00000	LB/HR
TOTAL CO2E PRODUCTION	0.00000	LB/HR

\*\*\* INPUT DATA \*\*\*

FLASH SPECS FOR HOT SIDE:

TWO PHASE FLASH	
MAXIMUM NO. ITERATIONS	30
CONVERGENCE TOLERANCE	0.000100000

FLASH SPECS FOR COLD SIDE:

TWO PHASE FLASH	
MAXIMUM NO. ITERATIONS	30
CONVERGENCE TOLERANCE	0.000100000

FLOW DIRECTION AND SPECIFICATION:

COUNTERCURRENT HEAT EXCHANGER	
SPECIFIED COLD VAPOR FRACTION	
SPECIFIED VALUE	0.0000
LMTD CORRECTION FACTOR	1.00000

PRESSURE SPECIFICATION:

HOT SIDE PRESSURE DROP	PSI	0.0000
COLD SIDE PRESSURE DROP	PSI	0.0000

HEAT TRANSFER COEFFICIENT SPECIFICATION:

HOT LIQUID	COLD LIQUID	BTU/HR-SQFT-R	149.6937
HOT 2-PHASE	COLD LIQUID	BTU/HR-SQFT-R	149.6937
HOT VAPOR	COLD LIQUID	BTU/HR-SQFT-R	149.6937
HOT LIQUID	COLD 2-PHASE	BTU/HR-SQFT-R	149.6937
HOT 2-PHASE	COLD 2-PHASE	BTU/HR-SQFT-R	149.6937
HOT VAPOR	COLD 2-PHASE	BTU/HR-SQFT-R	149.6937
HOT LIQUID	COLD VAPOR	BTU/HR-SQFT-R	149.6937
HOT 2-PHASE	COLD VAPOR	BTU/HR-SQFT-R	149.6937
HOT VAPOR	COLD VAPOR	BTU/HR-SQFT-R	149.6937

\*\*\* OVERALL RESULTS \*\*\*

STREAMS:

S-093	----->	HOT	----->	S-148
T=	3.4520D+02			T= 2.9828D+02
P=	1.2632D+02			P= 1.2632D+02
V=	0.0000D+00			V= 0.0000D+00
S-105	<-----	COLD	<-----	2HEATX04
T=	1.8954D+02			T= 1.2623D+02
P=	9.2053D+00			P= 9.2053D+00
V=	0.0000D+00			V= 0.0000D+00

DUTY AND AREA:

CALCULATED HEAT DUTY	BTU/HR	8116987.5622
CALCULATED (REQUIRED) AREA	SQFT	331.0835
ACTUAL EXCHANGER AREA	SQFT	331.0835
PER CENT OVER-DESIGN		0.0000

HEAT TRANSFER COEFFICIENT:		
AVERAGE COEFFICIENT (DIRTY)	BTU/HR-SQFT-R	149.6937
UA (DIRTY)	BTU/HR-R	49561.1037

LOG-MEAN TEMPERATURE DIFFERENCE:		
LMTD CORRECTION FACTOR		1.0000
LMTD (CORRECTED)	F	163.7774
NUMBER OF SHELLS IN SERIES		1

PRESSURE DROP:		
HOTSIDE, TOTAL	PSI	0.0000
COLD SIDE, TOTAL	PSI	0.0000

\*\*\* ZONE RESULTS \*\*\*

TEMPERATURE LEAVING EACH ZONE:

	HOT		
	-----		
HOT IN	LIQ		HOT OUT
----->			----->
345.2			298.3
COLDOUT	LIQ		COLDIN
<-----			<-----
189.5			126.2
	COLD		
	-----		

ZONE HEAT TRANSFER AND AREA:

ZONE	HEAT DUTY BTU/HR	AREA SQFT	LMTD F	AVERAGE U BTU/HR-SQFT-R	UA BTU/HR-R
1	8116987.562	331.0835	163.7774	149.6937	49561.1037

HEATX COLD-TQCU HX-07 TQCURV INLET

PRESSURE PROFILE: CONSTANT2  
 PRESSURE DROP: 0.0 PSI  
 PROPERTY OPTION SET: WILSON WILSON / IDEAL GAS

! DUTY	! PRES	! TEMP	! VFRAC	!
! BTU/HR	! PSIA	! F	!	!
! 0.0	! 9.2053	! 189.5379	! 0.0	!
! 3.8652+05	! 9.2053	! 186.5979	! 0.0	!
! 7.7305+05	! 9.2053	! 183.6501	! 0.0	!
! 1.1596+06	! 9.2053	! 180.6944	! 0.0	!
! 1.5461+06	! 9.2053	! 177.7309	! 0.0	!
! 1.9326+06	! 9.2053	! 174.7597	! 0.0	!

! 2.3191+06 !	9.2053 !	171.7809 !	0.0 !
! 2.7057+06 !	9.2053 !	168.7945 !	0.0 !
! 3.0922+06 !	9.2053 !	165.8005 !	0.0 !
! 3.4787+06 !	9.2053 !	162.7991 !	0.0 !
-----			
! 3.8652+06 !	9.2053 !	159.7903 !	0.0 !
! 4.2518+06 !	9.2053 !	156.7741 !	0.0 !
! 4.6383+06 !	9.2053 !	153.7508 !	0.0 !
! 5.0248+06 !	9.2053 !	150.7202 !	0.0 !
! 5.4113+06 !	9.2053 !	147.6825 !	0.0 !
-----			
! 5.7978+06 !	9.2053 !	144.6379 !	0.0 !
! 6.1844+06 !	9.2053 !	141.5862 !	0.0 !
! 6.5709+06 !	9.2053 !	138.5277 !	0.0 !
! 6.9574+06 !	9.2053 !	135.4624 !	0.0 !
! 7.3439+06 !	9.2053 !	132.3904 !	0.0 !
-----			
! 7.7305+06 !	9.2053 !	129.3117 !	0.0 !
! 8.1170+06 !	9.2053 !	126.2265 !	0.0 !
-----			

HEATX HOT-TQCUR HX-07 TQCURV INLET

-----  
 PRESSURE PROFILE: CONSTANT2  
 PRESSURE DROP: 0.0 PSI  
 PROPERTY OPTION SET: WILSON WILSON / IDEAL GAS

! DUTY !	! PRES !	! TEMP !	! VFRAC !
! BTU/HR !	! PSIA !	! F !	! !
=====			
! 0.0 !	! 126.3243 !	! 345.2000 !	! 0.0 !
! 3.8652+05 !	! 126.3243 !	! 343.0402 !	! 0.0 !
! 7.7305+05 !	! 126.3243 !	! 340.8730 !	! 0.0 !
! 1.1596+06 !	! 126.3243 !	! 338.6983 !	! 0.0 !
! 1.5461+06 !	! 126.3243 !	! 336.5162 !	! 0.0 !
-----			
! 1.9326+06 !	! 126.3243 !	! 334.3266 !	! 0.0 !
! 2.3191+06 !	! 126.3243 !	! 332.1296 !	! 0.0 !
! 2.7057+06 !	! 126.3243 !	! 329.9252 !	! 0.0 !
! 3.0922+06 !	! 126.3243 !	! 327.7133 !	! 0.0 !
! 3.4787+06 !	! 126.3243 !	! 325.4940 !	! 0.0 !
-----			
! 3.8652+06 !	! 126.3243 !	! 323.2673 !	! 0.0 !
! 4.2518+06 !	! 126.3243 !	! 321.0331 !	! 0.0 !
! 4.6383+06 !	! 126.3243 !	! 318.7915 !	! 0.0 !
! 5.0248+06 !	! 126.3243 !	! 316.5424 !	! 0.0 !
! 5.4113+06 !	! 126.3243 !	! 314.2860 !	! 0.0 !
-----			
! 5.7978+06 !	! 126.3243 !	! 312.0221 !	! 0.0 !
! 6.1844+06 !	! 126.3243 !	! 309.7508 !	! 0.0 !
! 6.5709+06 !	! 126.3243 !	! 307.4721 !	! 0.0 !
! 6.9574+06 !	! 126.3243 !	! 305.1861 !	! 0.0 !
! 7.3439+06 !	! 126.3243 !	! 302.8926 !	! 0.0 !
-----			
! 7.7305+06 !	! 126.3243 !	! 300.5917 !	! 0.0 !
! 8.1170+06 !	! 126.3243 !	! 298.2834 !	! 0.0 !
-----			



```

-----|-----
S-146  ----->|          HOT          |-----> S-147
T=  2.2908D+02 |          |          |          T=  7.5000D+01
P=  3.8674D-01 |          |          |          P=  3.8674D-01
V=  3.8607D-07 |          |          |          V=  0.0000D+00
          |          |          |
S-154  <-----|          COLD          |<----- S-153
T=  7.0579D+01 |          |          |          T=  7.0434D+01
P=  1.4700D+01 |          |          |          P=  1.4700D+01
V=  0.0000D+00 |          |          |          V=  0.0000D+00
-----|-----

```

DUTY AND AREA:

CALCULATED HEAT DUTY	BTU/HR	1102603.5928
CALCULATED (REQUIRED) AREA	SQFT	169.7329
ACTUAL EXCHANGER AREA	SQFT	169.7329
PER CENT OVER-DESIGN		0.0000

HEAT TRANSFER COEFFICIENT:

AVERAGE COEFFICIENT (DIRTY)	BTU/HR-SQFT-R	149.6937
UA (DIRTY)	BTU/HR-R	25407.9404

LOG-MEAN TEMPERATURE DIFFERENCE:

LMTD CORRECTION FACTOR		1.0000
LMTD (CORRECTED)	F	43.3960
NUMBER OF SHELLS IN SERIES		1

PRESSURE DROP:

HOTSIDE, TOTAL	PSI	0.0000
COLD SIDE, TOTAL	PSI	0.0000

\*\*\* ZONE RESULTS \*\*\*

TEMPERATURE LEAVING EACH ZONE:

```

                                HOT
-----|-----
HOT IN  |          LIQ          | HOT OUT
----->|          |          |----->
  229.1 |          |          |    75.0
          |          |          |
COLDOUT |          LIQ          | COLDIN
<-----|          |          |<-----
   70.6 |          |          |    70.4
          |          |          |
-----|-----
                                COLD

```

ZONE HEAT TRANSFER AND AREA:

ZONE	HEAT DUTY BTU/HR	AREA SQFT	LMTD F	AVERAGE U BTU/HR-SQFT-R	UA BTU/HR-R
1	1102603.593	169.7329	43.3960	149.6937	25407.9404

HEATX COLD-TQCU HX-12 TQCURV INLET

```

-----|-----
PRESSURE PROFILE:  CONSTANT2
PRESSURE DROP:    0.0      PSI
PROPERTY OPTION SET: WILSON  WILSON / IDEAL GAS
-----|-----

```

DUTY	PRES	TEMP	VFRAC
BTU/HR	PSIA	F	
0.0	14.7000	70.5792	0.0
5.2505+04	14.7000	70.5723	0.0
1.0501+05	14.7000	70.5723	0.0
1.5751+05	14.7000	70.5654	0.0
2.1002+05	14.7000	70.5585	0.0
2.6252+05	14.7000	70.5516	0.0
3.1503+05	14.7000	70.5447	0.0
3.6753+05	14.7000	70.5378	0.0
4.2004+05	14.7000	70.5309	0.0
4.7254+05	14.7000	70.5240	0.0
5.2505+05	14.7000	70.5171	0.0
5.7755+05	14.7000	70.5102	0.0
6.3006+05	14.7000	70.5033	0.0
6.8256+05	14.7000	70.4963	0.0
7.3507+05	14.7000	70.4894	0.0
7.8757+05	14.7000	70.4825	0.0
8.4008+05	14.7000	70.4756	0.0
8.9258+05	14.7000	70.4687	0.0
9.4509+05	14.7000	70.4618	0.0
9.9759+05	14.7000	70.4549	0.0
1.0501+06	14.7000	70.4480	0.0
1.1026+06	14.7000	70.4411	0.0

HEATX HOT-TQCUR HX-12 TQCURV INLET

PRESSURE PROFILE: CONSTANT2  
PRESSURE DROP: 0.0 PSI  
PROPERTY OPTION SET: WILSON WILSON / IDEAL GAS

DUTY	PRES	TEMP	VFRAC
BTU/HR	PSIA	F	
0.0	0.3867	229.0768	3.8616-07
5.2505+04	0.3867	222.2813	0.0
1.0501+05	0.3867	215.4354	0.0
1.5751+05	0.3867	208.5385	0.0
2.1002+05	0.3867	201.5897	0.0
2.6252+05	0.3867	194.5885	0.0
3.1503+05	0.3867	187.5340	0.0
3.6753+05	0.3867	180.4255	0.0
4.2004+05	0.3867	173.2625	0.0
4.7254+05	0.3867	166.0442	0.0
5.2505+05	0.3867	158.7701	0.0
5.7755+05	0.3867	151.4396	0.0

```

! 6.3006+05 !      0.3867 !    144.0524 !      0.0 !
! 6.8256+05 !      0.3867 !    136.6080 !      0.0 !
! 7.3507+05 !      0.3867 !    129.1063 !      0.0 !
!-----+-----+-----+-----+-----!
! 7.8757+05 !      0.3867 !    121.5471 !      0.0 !
! 8.4008+05 !      0.3867 !    113.9305 !      0.0 !
! 8.9258+05 !      0.3867 !    106.2566 !      0.0 !
! 9.4509+05 !      0.3867 !     98.5259 !      0.0 !
! 9.9759+05 !      0.3867 !     90.7389 !      0.0 !
!-----+-----+-----+-----+-----!
! 1.0501+06 !      0.3867 !     82.8966 !      0.0 !
! 1.1026+06 !      0.3867 !     75.0000 !      0.0 !
!-----+-----+-----+-----+-----!

```

BLOCK: MIXER01 MODEL: MIXER

```

-----
INLET STREAMS:      S-088      S-105
OUTLET STREAM:      S-089
PROPERTY OPTION SET: WILSON    WILSON / IDEAL GAS

```

\*\*\* MASS AND ENERGY BALANCE \*\*\*

	IN	OUT	RELATIVE DIFF.
--	----	-----	----------------

TOTAL BALANCE	IN	OUT	RELATIVE DIFF.
MOLE (LBMOL/HR)	21152.8	21152.8	0.00000
MASS (LB/HR )	396163.	396163.	-0.146929E-15
ENTHALPY (BTU/HR )	-0.257844E+10	-0.257844E+10	-0.151645E-13

\*\*\* CO2 EQUIVALENT SUMMARY \*\*\*

FEED STREAMS CO2E	0.00000	LB/HR
PRODUCT STREAMS CO2E	0.00000	LB/HR
NET STREAMS CO2E PRODUCTION	0.00000	LB/HR
UTILITIES CO2E PRODUCTION	0.00000	LB/HR
TOTAL CO2E PRODUCTION	0.00000	LB/HR

\*\*\* INPUT DATA \*\*\*

```

TWO PHASE FLASH
MAXIMUM NO. ITERATIONS 30
CONVERGENCE TOLERANCE 0.000100000
OUTLET PRESSURE: MINIMUM OF INLET STREAM PRESSURES

```

BLOCK: PUMP-33 MODEL: PUMP

```

-----
INLET STREAM:      S-102
OUTLET STREAM:      2HEATX04
PROPERTY OPTION SET: WILSON    WILSON / IDEAL GAS

```

\*\*\* MASS AND ENERGY BALANCE \*\*\*

	IN	OUT	RELATIVE DIFF.
--	----	-----	----------------

TOTAL BALANCE	IN	OUT	RELATIVE DIFF.
MOLE (LBMOL/HR)	6821.96	6821.96	0.00000
MASS (LB/HR )	124683.	124683.	0.00000
ENTHALPY (BTU/HR )	-0.834741E+09	-0.834737E+09	-0.507479E-05

\*\*\* CO2 EQUIVALENT SUMMARY \*\*\*

FEED STREAMS CO2E	0.00000	LB/HR
PRODUCT STREAMS CO2E	0.00000	LB/HR
NET STREAMS CO2E PRODUCTION	0.00000	LB/HR
UTILITIES CO2E PRODUCTION	0.00000	LB/HR
TOTAL CO2E PRODUCTION	0.00000	LB/HR

\*\*\* INPUT DATA \*\*\*

```

OUTLET PRESSURE PSIA 9.20527
DRIVER EFFICIENCY 1.00000

```

FLASH SPECIFICATIONS:

LIQUID PHASE CALCULATION

NO FLASH PERFORMED

MAXIMUM NUMBER OF ITERATIONS

30

TOLERANCE

0.000100000

\*\*\* RESULTS \*\*\*

VOLUMETRIC FLOW RATE	CUFT/HR	2,055.21
PRESSURE CHANGE	PSI	7.20527
NPSH AVAILABLE	FT-LBF/LB	0.0
FLUID POWER	HP	1.07697
BRAKE POWER	HP	1.66486
ELECTRICITY	KW	1.24149
PUMP EFFICIENCY USED		0.64688
NET WORK REQUIRED	HP	1.66486
HEAD DEVELOPED	FT-LBF/LB	17.1026

BLOCK: VLV01 MODEL: VALVE

-----  
 INLET STREAM: S-091  
 OUTLET STREAM: S-094  
 PROPERTY OPTION SET: WILSON WILSON / IDEAL GAS

\*\*\* MASS AND ENERGY BALANCE \*\*\*

	IN	OUT	RELATIVE DIFF.
TOTAL BALANCE			
MOLE (LBMOL/HR)	14319.7	14319.7	0.00000
MASS (LB/HR )	272999.	272999.	0.00000
ENTHALPY (BTU/HR )	-0.175287E+10	-0.175287E+10	0.00000

\*\*\* CO2 EQUIVALENT SUMMARY \*\*\*

FEED STREAMS CO2E	0.00000	LB/HR
PRODUCT STREAMS CO2E	0.00000	LB/HR
NET STREAMS CO2E PRODUCTION	0.00000	LB/HR
UTILITIES CO2E PRODUCTION	0.00000	LB/HR
TOTAL CO2E PRODUCTION	0.00000	LB/HR

\*\*\* INPUT DATA \*\*\*

VALVE OUTLET PRESSURE PSIA 6.05000  
 VALVE FLOW COEF CALC. NO

FLASH SPECIFICATIONS:

NPHASE 2  
 MAX NUMBER OF ITERATIONS 30  
 CONVERGENCE TOLERANCE 0.000100000

\*\*\* RESULTS \*\*\*

VALVE PRESSURE DROP PSI 3.15067

BLOCK: VLV02 MODEL: VALVE

-----  
 INLET STREAM: S-095  
 OUTLET STREAM: S-098  
 PROPERTY OPTION SET: WILSON WILSON / IDEAL GAS

\*\*\* MASS AND ENERGY BALANCE \*\*\*

	IN	OUT	RELATIVE DIFF.
TOTAL BALANCE			
MOLE (LBMOL/HR)	7273.59	7273.59	0.00000
MASS (LB/HR )	145972.	145972.	0.00000



ENTHALPY (BTU/HR )            -0.904267E+09    -0.904267E+09            0.00000

\*\*\* CO2 EQUIVALENT SUMMARY \*\*\*

FEED STREAMS CO2E	0.00000	LB/HR
PRODUCT STREAMS CO2E	0.00000	LB/HR
NET STREAMS CO2E PRODUCTION	0.00000	LB/HR
UTILITIES CO2E PRODUCTION	0.00000	LB/HR
TOTAL CO2E PRODUCTION	0.00000	LB/HR

\*\*\* INPUT DATA \*\*\*

VALVE OUTLET PRESSURE	PSIA	2.00000
VALVE FLOW COEF CALC.		NO

FLASH SPECIFICATIONS:

NPHASE		2
MAX NUMBER OF ITERATIONS		30
CONVERGENCE TOLERANCE		0.000100000

\*\*\* RESULTS \*\*\*

VALVE PRESSURE DROP	PSI	4.05000
---------------------	-----	---------

# Distillation Flowsheet

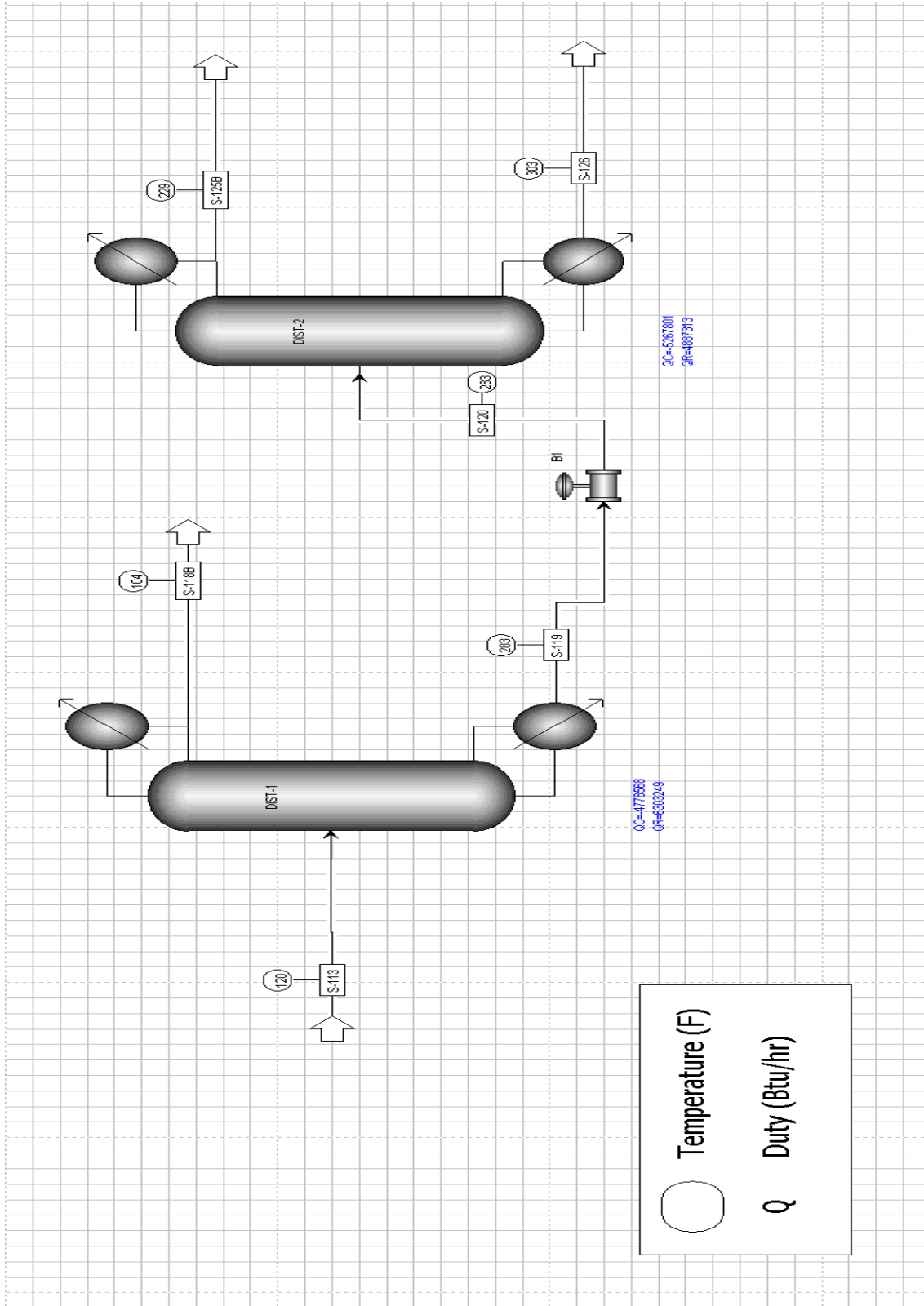

## Distillation Input Summary

```
;  
;Input Summary created by Aspen Plus Rel. 32.0 at 16:03:51 Sun Apr 12, 2015  
;Directory S:\Desktop\Senior Design\Final Pass\150412 Final Pass Distillation  
Filename C:\Users\molele\AppData\Local\Temp\~ap36d4.txt  
;
```

DYNAMICS

DYNAMICS RESULTS=ON

IN-UNITS ENG

DEF-STREAMS CONVEN ALL

SIM-OPTIONS MASS-BAL-CHE=YES UTL-REQD=YES

MODEL-OPTION

DATABANKS 'APV86 PURE32' / 'APV86 AQUEOUS' / 'APV86 SOLIDS' / &  
'APV86 INORGANIC' / NOASPENPCD

PROP-SOURCES 'APV86 PURE32' / 'APV86 AQUEOUS' / 'APV86 SOLIDS' &  
/ 'APV86 INORGANIC'

COMPONENTS

GLYCE-01 C3H8O3 /  
1:3-P-01 C3H8O2-3 /  
WATER H2O /  
DEXTR-01 C6H12O6 /  
OLEIC-01 C18H34O2 /  
N-HEX-01 C16H32O2 /  
METHA-01 CH4O

SOLVE

RUN-MODE MODE=SIM

FLOWSHEET

BLOCK DIST-1 IN=S-113 OUT=S-118B S-119  
BLOCK DIST-2 IN=S-120 OUT=S-125B S-126  
BLOCK B1 IN=S-119 OUT=S-120

PROPERTIES WILSON

PROP-DATA WILSON-1

IN-UNITS MET PRESSURE=bar TEMPERATURE=C DELTA-T=C PDROP=bar &  
INVERSE-PRES='1/bar'

PROP-LIST WILSON

BPVAL GLYCE-01 WATER 1.176600000 -264.2581000 0.0 0.0 &  
25.00000000 290.0000000 0.0  
BPVAL WATER GLYCE-01 .6429000000 -131.2562000 0.0 0.0 &  
25.00000000 290.0000000 0.0  
BPVAL GLYCE-01 METHA-01 0.0 -452.6553000 0.0 0.0 &  
25.00000000 62.50000000 0.0  
BPVAL METHA-01 GLYCE-01 0.0 121.2393000 0.0 0.0 &  
25.00000000 62.50000000 0.0  
BPVAL WATER METHA-01 .0490000000 -21.97440000 0.0 0.0 &  
24.99000000 100.0000000 0.0  
BPVAL METHA-01 WATER -2.030200000 448.6788000 0.0 0.0 &  
24.99000000 100.0000000 0.0

STREAM S-113

SUBSTREAM MIXED TEMP=120. PRES=1.0695 MOLE-FLOW=444.428  
MOLE-FLOW GLYCE-01 37.1664 / 1:3-P-01 177.844 / WATER &  
228.99 / DEXTR-01 0.4274444 / OLEIC-01 0. / N-HEX-01 &  
0. / METHA-01 0.00010405

BLOCK DIST-1 RADFRAC

PARAM NSTAGE=6 ALGORITHM=STANDARD MAXOL=25 DAMPING=NONE &  
P-UPDATE=YES  
COL-CONFIG CONDENSER=TOTAL REBOILER=KETTLE  
FEEDS S-113 3  
PRODUCTS S-119 6 L / S-118B 1 L  
P-SPEC 1 1.063522609  
COL-SPECS DP-COL=.0116020648 MASS-RR=0.1233 MASS-BR=1.15  
PACK-SIZE 1 2 5 FLEXIPACHC VENDOR=KOCH PACK-MAT=METAL &  
PACK-SIZE="2YHC" HETP=16. <in> DPMETH=STICHLM &  
P-UPDATE=YES  
UTILITIES COND-UTIL=CW REB-UTIL=MPSTEAM

BLOCK DIST-2 RADFRAC

PARAM NSTAGE=6 ALGORITHM=STANDARD MAXOL=25 DAMPING=NONE &  
P-UPDATE=YES  
COL-CONFIG CONDENSER=TOTAL  
FEEDS S-120 3  
PRODUCTS S-126 6 L / S-125B 1 L  
P-SPEC 1 .3867354941  
COL-SPECS DP-STAGE=1.93367747E-3 MASS-RR=0.074435 &  
MASS-BR=2.845  
PACK-SIZE 2 2 5 FLEXIPACHC VENDOR=KOCH PACK-MAT=METAL &  
PACK-SIZE="2YHC" HETP=16. <in> DPMETH=STICHLM &  
P-UPDATE=YES  
UTILITIES COND-UTIL=CW REB-UTIL=MPSTEAM

BLOCK B1 VALVE

PARAM P-OUT=0.4 NPHASE=1 PHASE=L  
BLOCK-OPTION FREE-WATER=NO

UTILITY CW GENERAL

DESCRIPTION "Cooling Water, Inlet Temp=20 C, Outlet Temp=25 C"  
COST ENERGY-PRICE=2.12E-007 <\$/kJ>  
PARAM UTILITY-TYPE=WATER PRES=1. <atm> PRES-OUT=1. <atm> &  
TIN=20. <C> TOUT=25. <C> CALOPT=FLASH MIN-TAPP=5. <C> &  
HTC=0.0135 <GJ/hr-sqm-C>

UTILITY MPSTEAM GENERAL

DESCRIPTION &  
"Medium Pressure Steam, Inlet Temp=175 C, Outlet Temp=174 C, Pres=127 psia"  
COST ENERGY-PRICE=2.2E-006 <\$/kJ>  
PARAM UTILITY-TYPE=STEAM TIN=175. <C> TOUT=174. <C> VFRAC=1. &  
VFR-OUT=0. CALOPT=FLASH MIN-TAPP=10. <C> CALCCO2=YES &  
FACTORSOURCE="US-EPA-Rule-E9-5711" FUELSOURCE="Natural\_gas" &  
CO2FACTOR=1.30000000E-4 EFFICIENCY=0.85 &  
HTC=0.0216 <GJ/hr-sqm-C>

DESIGN-SPEC HOHBOT01

DEFINE HOHBOT01 MASS-FRAC STREAM=S-119 SUBSTREAM=MIXED &  
COMPONENT=WATER  
SPEC "HOHBOT01" TO "0.00099"  
TOL-SPEC "0.0001"  
VARY BLOCK-VAR BLOCK=DIST-1 VARIABLE=MASS-BR &  
SENTENCE=COL-SPECS  
LIMITS "0.001" "3"

DESIGN-SPEC TOW02BR

```

DEFINE PDOBOT02 MOLE-FLOW STREAM=S-126 SUBSTREAM=MIXED &
    COMPONENT=1:3-P-01 UOM="kmol/hr"
SPEC "PDOBOT02" TO "0.05"
TOL-SPEC "0.001"
VARY BLOCK-VAR BLOCK=DIST-2 VARIABLE=MASS-BR &
    SENTENCE=COL-SPECS
LIMITS "0.001" " 4"

```

EO-CONV-OPTI

STREAM-REPOR MOLEFLOW MASSFLOW MOLEFRAC MASSFRAC

DISABLE

DESIGN-SPEC TOW02BR

```

;
;
;
;
;

```

## Distillation Block Report

BLOCK: B1 MODEL: VALVE

```

-----
INLET STREAM:          S-119
OUTLET STREAM:         S-120
PROPERTY OPTION SET:   WILSON      WILSON / IDEAL GAS

```

*** MASS AND ENERGY BALANCE ***			
TOTAL BALANCE	IN	OUT	RELATIVE DIFF.
MOLE (LBMOL/HR)	216.396	216.396	0.00000
MASS (LB/HR )	17049.1	17049.1	0.00000
ENTHALPY (BTU/HR )	-0.457663E+08	-0.457663E+08	0.00000

*** CO2 EQUIVALENT SUMMARY ***		
FEED STREAMS CO2E	0.00000	LB/HR
PRODUCT STREAMS CO2E	0.00000	LB/HR
NET STREAMS CO2E PRODUCTION	0.00000	LB/HR
UTILITIES CO2E PRODUCTION	0.00000	LB/HR
TOTAL CO2E PRODUCTION	0.00000	LB/HR

\*\*\* INPUT DATA \*\*\*

VALVE OUTLET PRESSURE PSIA 0.40000  
 VALVE FLOW COEF CALC. NO

FLASH SPECIFICATIONS:  
 PHASE LIQUID  
 MAX NUMBER OF ITERATIONS 30  
 CONVERGENCE TOLERANCE 0.000100000

\*\*\* RESULTS \*\*\*

VALVE PRESSURE DROP PSI 0.69551

BLOCK: DIST-1 MODEL: RADFRAC

```

-----
INLETS   - S-113   STAGE   3
OUTLETS  - S-118B  STAGE   1

```

S-119 STAGE 6  
 PROPERTY OPTION SET: WILSON WILSON / IDEAL GAS

```

*** MASS AND ENERGY BALANCE ***
                                IN          OUT          RELATIVE DIFF.
TOTAL BALANCE
MOLE (LBMOL/HR)                444.428      444.428      0.00000
MASS (LB/HR )                  21158.3      21158.3     -0.189135E-14
ENTHALPY (BTU/HR )             -0.752024E+08 -0.736778E+08 -0.202734E-01
  
```

```

*** CO2 EQUIVALENT SUMMARY ***
FEED STREAMS CO2E              0.00000      LB/HR
PRODUCT STREAMS CO2E           0.00000      LB/HR
NET STREAMS CO2E PRODUCTION    0.00000      LB/HR
UTILITIES CO2E PRODUCTION      964.026      LB/HR
TOTAL CO2E PRODUCTION          964.026      LB/HR
  
```

\*\*\*\*\*  
 \*\*\*\* INPUT DATA \*\*\*\*  
 \*\*\*\*\*

\*\*\*\* INPUT PARAMETERS \*\*\*\*

```

NUMBER OF STAGES                6
ALGORITHM OPTION                STANDARD
ABSORBER OPTION                 NO
INITIALIZATION OPTION          STANDARD
HYDRAULIC PARAMETER CALCULATIONS NO
INSIDE LOOP CONVERGENCE METHOD  BROYDEN
DESIGN SPECIFICATION METHOD     NESTED
MAXIMUM NO. OF OUTSIDE LOOP ITERATIONS 25
MAXIMUM NO. OF INSIDE LOOP ITERATIONS 10
MAXIMUM NUMBER OF FLASH ITERATIONS 30
FLASH TOLERANCE                 0.000100000
OUTSIDE LOOP CONVERGENCE TOLERANCE 0.000100000
  
```

\*\*\*\* COL-SPECS \*\*\*\*

```

MOLAR VAPOR DIST / TOTAL DIST  0.0
MASS REFLUX RATIO              0.12330
MASS BOILUP RATIO              0.72635
  
```

\*\*\*\* PROFILES \*\*\*\*

```

P-SPEC      STAGE  1  PRES, PSIA      1.06352
  
```

\*\*\*\*\*  
 \*\*\*\* RESULTS \*\*\*\*  
 \*\*\*\*\*

\*\*\* COMPONENT SPLIT FRACTIONS \*\*\*

```

                                OUTLET STREAMS
                                -----
                                S-118B      S-119
COMPONENT:
GLYCE-01      .21106E-08  1.0000
1:3-P-01      .10789E-03  .99989
WATER         .99573      .42659E-02
DEXTR-01      0.0000      1.0000
  
```

METHA-01 .99999 .65525E-05

\*\*\* SUMMARY OF KEY RESULTS \*\*\*

TOP STAGE TEMPERATURE	F	103.757
BOTTOM STAGE TEMPERATURE	F	283.073
TOP STAGE LIQUID FLOW	LBMOL/HR	28.1164
BOTTOM STAGE LIQUID FLOW	LBMOL/HR	216.396
TOP STAGE VAPOR FLOW	LBMOL/HR	0.0
BOILUP VAPOR FLOW	LBMOL/HR	187.771
MOLAR REFLUX RATIO		0.12330
MOLAR BOILUP RATIO		0.86772
CONDENSER DUTY (W/O SUBCOOL)	BTU/HR	-4,778,580.
REBOILER DUTY	BTU/HR	6,303,250.

\*\*\*\* MAXIMUM FINAL RELATIVE ERRORS \*\*\*\*

DEW POINT	0.49445E-03	STAGE= 4
BUBBLE POINT	0.66229E-04	STAGE= 3
COMPONENT MASS BALANCE	0.43832E-06	STAGE= 5 COMP=DEXTR-01
ENERGY BALANCE	0.26181E-03	STAGE= 5

\*\*\*\* PROFILES \*\*\*\*

\*\*NOTE\*\* REPORTED VALUES FOR STAGE LIQUID AND VAPOR RATES ARE THE FLOWS FROM THE STAGE INCLUDING ANY SIDE PRODUCT.

STAGE	TEMPERATURE F	PRESSURE PSIA	ENTHALPY BTU/LBMOL		HEAT DUTY BTU/HR
			LIQUID	VAPOR	
1	103.76	1.0635	-0.12240E+06	-0.10375E+06	-.47786+07
2	104.79	1.0658	-0.12473E+06	-0.10375E+06	
3	126.10	1.0679	-0.16627E+06	-0.10377E+06	
4	131.51	1.0732	-0.17212E+06	-0.10382E+06	
5	203.77	1.0798	-0.20244E+06	-0.10976E+06	
6	283.07	1.0955	-0.21149E+06	-0.15844E+06	.63032+07

STAGE	FLOW RATE LBMOL/HR		FEED RATE LBMOL/HR			PRODUCT RATE LBMOL/HR	
	LIQUID	VAPOR	LIQUID	VAPOR	MIXED	LIQUID	VAPOR
1	256.1	0.000				228.0324	
2	25.33	256.1					
3	474.1	253.4	444.4280				
4	454.1	257.7					
5	404.2	237.7					
6	216.4	187.8				216.3955	

\*\*\*\* MASS FLOW PROFILES \*\*\*\*

STAGE	FLOW RATE LB/HR		FEED RATE LB/HR			PRODUCT RATE LB/HR	
	LIQUID	VAPOR	LIQUID	VAPOR	MIXED	LIQUID	VAPOR
1	4616.	0.000				4109.1847	
2	498.0	4616.					
3	0.2176E+05	4607.	.21158+05				
4	0.2269E+05	4706.					
5	0.2943E+05	5640.					
6	0.1705E+05	0.1238E+05				.17049+05	

\*\*\*\* MOLE-X-PROFILE \*\*\*\*

STAGE	GLYCE-01	1:3-P-01	WATER	DEXTR-01	METHA-01
1	0.34400E-09	0.84145E-04	0.99992	0.33516E-22	0.45629E-06
2	0.34126E-04	0.28224E-01	0.97174	0.16260E-11	0.51140E-07
3	0.78392E-01	0.37735	0.54335	0.90155E-03	0.35611E-07
4	0.81958E-01	0.44291	0.47419	0.94127E-03	0.51642E-08
5	0.95328E-01	0.81912	0.84492E-01	0.10576E-02	0.22200E-09
6	0.17175	0.82176	0.45142E-02	0.19753E-02	0.31507E-11

\*\*\*\* MOLE-Y-PROFILE \*\*\*\*

STAGE	GLYCE-01	1:3-P-01	WATER	DEXTR-01	METHA-01
1	0.32241E-14	0.23988E-06	1.0000	0.62125E-33	0.40554E-05
2	0.34400E-09	0.84145E-04	0.99992	0.33516E-22	0.45629E-06
3	0.34124E-05	0.28977E-02	0.99710	0.16257E-12	0.41578E-06
4	0.49419E-05	0.42174E-02	0.99578	0.28366E-12	0.65509E-07
5	0.21893E-03	0.98045E-01	0.90174	0.14473E-09	0.98623E-08
6	0.72544E-02	0.81608	0.17666	0.56527E-07	0.47420E-09

\*\*\*\* K-VALUES \*\*\*\*

STAGE	GLYCE-01	1:3-P-01	WATER	DEXTR-01	METHA-01
1	0.93726E-05	0.28508E-02	1.0001	0.18536E-10	8.8876
2	0.10082E-04	0.29815E-02	1.0290	0.20619E-10	8.9216
3	0.43599E-04	0.76840E-02	1.8350	0.18089E-09	11.670
4	0.60414E-04	0.95298E-02	2.0998	0.30253E-09	12.679
5	0.22972E-02	0.11971	10.673	0.13693E-06	44.426
6	0.42233E-01	0.99310	39.140	0.28601E-04	150.53

\*\*\*\* MASS-X-PROFILE \*\*\*\*

STAGE	GLYCE-01	1:3-P-01	WATER	DEXTR-01	METHA-01
1	0.17580E-08	0.35533E-03	0.99964	0.33508E-21	0.81134E-06
2	0.15988E-03	0.10926	0.89058	0.14902E-10	0.83361E-07
3	0.15734	0.62579	0.21333	0.35397E-02	0.24868E-07
4	0.15107	0.67456	0.17098	0.33940E-02	0.33119E-08
5	0.12056	0.85593	0.20902E-01	0.26165E-02	0.97678E-10
6	0.20076	0.79369	0.10322E-02	0.45168E-02	0.12814E-11

\*\*\*\* MASS-Y-PROFILE \*\*\*\*

STAGE	GLYCE-01	1:3-P-01	WATER	DEXTR-01	METHA-01
1	0.16482E-13	0.10132E-05	0.99999	0.62127E-32	0.72129E-05
2	0.17580E-08	0.35533E-03	0.99964	0.33508E-21	0.81134E-06
3	0.17282E-04	0.12126E-01	0.98786	0.16107E-11	0.73266E-06
4	0.24924E-04	0.17575E-01	0.98240	0.27985E-11	0.11495E-06
5	0.84979E-03	0.31446	0.68469	0.10990E-08	0.13319E-07
6	0.10130E-01	0.94161	0.48257E-01	0.15441E-06	0.23039E-09

\*\*\*\*\*  
 \*\*\*\*\* HYDRAULIC PARAMETERS \*\*\*\*\*  
 \*\*\*\*\*

\*\*\* DEFINITIONS \*\*\*

MARANGONI INDEX = SIGMA - SIGMATO  
 FLOW PARAM = (ML/MV)\*SQRT(RHOV/RHOL)  
 QR = QV\*SQRT(RHOV/(RHOL-RHOV))  
 F FACTOR = QV\*SQRT(RHOV)

WHERE:

SIGMA IS THE SURFACE TENSION OF LIQUID FROM THE STAGE  
 SIGMATO IS THE SURFACE TENSION OF LIQUID TO THE STAGE  
 ML IS THE MASS FLOW OF LIQUID FROM THE STAGE  
 MV IS THE MASS FLOW OF VAPOR TO THE STAGE



RHOL IS THE MASS DENSITY OF LIQUID FROM THE STAGE  
 RHOV IS THE MASS DENSITY OF VAPOR TO THE STAGE  
 QV IS THE VOLUMETRIC FLOW RATE OF VAPOR TO THE STAGE

TEMPERATURE F		
STAGE	LIQUID FROM	VAPOR TO
1	103.76	104.79
2	104.79	126.10
3	126.10	131.51
4	131.51	203.77
5	203.77	283.07
6	283.07	283.07

STAGE	MASS FLOW LB/HR		VOLUME FLOW CUFT/HR		MOLECULAR WEIGHT	
	LIQUID FROM	VAPOR TO	LIQUID FROM	VAPOR TO	LIQUID FROM	VAPOR TO
1	4615.8	4615.8	75.479	0.14558E+07	18.020	18.020
2	497.96	4607.1	7.9238	0.14914E+07	19.657	18.184
3	21755.	4706.3	305.37	0.15236E+07	45.885	18.261
4	22689.	5640.1	320.55	0.15674E+07	49.964	23.726
5	29433.	12384.	456.88	0.13662E+07	72.823	65.951
6	17049.	0.0000	275.99	0.0000	78.787	

STAGE	DENSITY LB/CUFT		VISCOSITY CP		SURFACE TENSION DYNE/CM	
	LIQUID FROM	VAPOR TO	LIQUID FROM	VAPOR TO	LIQUID FROM	
1	61.154	0.31707E-02	0.67302	0.10359E-01	69.785	
2	62.844	0.30891E-02	0.72617	0.10793E-01	68.955	
3	71.242	0.30889E-02	2.5502	0.10903E-01	57.651	
4	70.783	0.35984E-02	2.9158	0.12194E-01	55.602	
5	64.421	0.90644E-02	3.1243	0.10967E-01	42.299	
6	61.774		1.6155		37.950	

STAGE	MARANGONI INDEX DYNE/CM	FLOW PARAM	QR CUFT/HR	REDUCED F-FACTOR (LB-CUFT)**.5/HR
1		0.72006E-02	10483.	81973.
2	-.82957	0.75778E-03	10457.	82893.
3	-.47765	0.30438E-01	10033.	84679.
4	-2.0485	0.28683E-01	11176.	94023.
5	-13.303	0.28193E-01	16207.	0.13007E+06
6	-4.3490		0.0000	0.0000

\*\*\*\*\*  
 \*\*\*\*\* PACKING SIZING CALCULATIONS \*\*\*\*\*  
 \*\*\*\*\*

\*\*\*\*\*  
 \*\*\* SECTION 1 \*\*\*  
 \*\*\*\*\*

STARTING STAGE NUMBER	2
ENDING STAGE NUMBER	5
CAPACITY CALCULATION METHOD	STICHL
PRESSURE DROP CALCULATION METHOD	STICHL

LIQUID HOLDUP CALCULATION METHOD  
 PRESSURE PROFILE UPDATED

STICHL  
 YES

DESIGN PARAMETERS

OVERDESIGN FACTOR		1.00000
SYSTEM FOAMING FACTOR		1.00000
FRAC. APP. TO MAXIMUM CAPACITY		0.62000
MAXIMUM CAPACITY FACTOR	FT/SEC	MISSING
DESIGN CAPACITY FACTOR	FT/SEC	MISSING
PRESSURE DROP FOR THE SECTION	PSI	MISSING
PRESSURE DROP PER UNIT HEIGHT	IN-WATER/FT	MISSING

PACKING SPECIFICATIONS

PACKING TYPE		FLEXIPAC-HC
PACKING MATERIAL		METAL
PACKING SIZE		2YHC
VENDOR		KOCH
PACKING FACTOR	1/FT	23.7531
PACKING SURFACE AREA	SQFT/CUF	68.5800
PACKING VOID FRACTION		0.97000
FIRST STICHLMAIR CONSTANT		0.083300
SECOND STICHLMAIR CONSTANT		-0.0099000
THIRD STICHLMAIR CONSTANT		0.016100
HETP	FT	1.33333
PACKING HEIGHT	FT	5.33333

\*\*\*\*\* SIZING RESULTS \*\*\*\*\*

COLUMN DIAMETER	FT	2.15797
MAXIMUM FRACTIONAL CAPACITY		0.62000
MAXIMUM CAPACITY FACTOR	FT/SEC	1.23088
PRESSURE DROP FOR THE SECTION	PSI	0.029662
AVERAGE PRESSURE DROP/HEIGHT	IN-WATER/FT	0.15395
MAXIMUM LIQUID HOLDUP/STAGE	CUFT	0.39386
MAX LIQ SUPERFICIAL VELOCITY	FT/SEC	0.034700

\*\*\*\* RATING PROFILES AT MAXIMUM COLUMN DIAMETER \*\*\*\*

STAGE	HEIGHT FROM TOP OF SECTION FT	FRACTIONAL CAPACITY	PRESSURE DROP PSI	PRESSURE DROP/HEIGHT IN-WATER/FT	LIQUID HOLDUP CUFT	HETP FT
2	0.000	0.1592	0.20455E-02	0.42464E-01	0.2603E-01	1.333
3	1.333	0.3935	0.52621E-02	0.10924	0.2973	1.333
4	2.667	0.4296	0.66523E-02	0.13810	0.3074	1.333
5	4.000	0.6200	0.15702E-01	0.32598	0.3939	1.333

STAGE	LIQUID SUPERFICIAL VELOCITY FT/SEC
2	0.6018E-03
3	0.2319E-01
4	0.2434E-01
5	0.3470E-01

\*\*\* ASSOCIATED UTILITIES \*\*\*

UTILITY USAGE: CW (WATER)

```

-----
CONDENSER                5.3243+05                1.0688
-----
TOTAL:                    5.3243+05  LB/HR        1.0688  $/HR
=====
UTILITY USAGE:  MPSTEAM  (STEAM)
-----
REBOILER                7205.4747                14.6306
964.0259
-----
TOTAL:                    7205.4747  LB/HR        14.6306  $/HR
964.0259 CO2 LB/HR
=====

```

BLOCK: DIST-2 MODEL: RADFRAC

```

-----
INLETS   - S-120   STAGE   3
OUTLETS  - S-125B  STAGE   1
          S-126    STAGE   6
PROPERTY OPTION SET:  WILSON  WILSON / IDEAL GAS

```

```

***  MASS AND ENERGY BALANCE  ***
              IN              OUT              RELATIVE DIFF.
TOTAL BALANCE
MOLE (LBMOL/HR)          216.396          216.396          0.131341E-15
MASS (LB/HR )            17049.1          17049.1          0.712272E-12
ENTHALPY (BTU/HR )      -0.457663E+08      -0.461469E+08      0.824753E-02

```

```

***  CO2 EQUIVALENT SUMMARY  ***
FEED STREAMS CO2E          0.00000          LB/HR
PRODUCT STREAMS CO2E       0.00000          LB/HR
NET STREAMS CO2E PRODUCTION 0.00000          LB/HR
UTILITIES CO2E PRODUCTION  747.470          LB/HR
TOTAL CO2E PRODUCTION      747.470          LB/HR

```

```

*****
****  INPUT DATA  ****
*****

```

\*\*\*\* INPUT PARAMETERS \*\*\*\*

```

NUMBER OF STAGES                6
ALGORITHM OPTION                 STANDARD
ABSORBER OPTION                  NO
INITIALIZATION OPTION           STANDARD
HYDRAULIC PARAMETER CALCULATIONS NO
INSIDE LOOP CONVERGENCE METHOD   BROYDEN
DESIGN SPECIFICATION METHOD      NESTED
MAXIMUM NO. OF OUTSIDE LOOP ITERATIONS 25
MAXIMUM NO. OF INSIDE LOOP ITERATIONS 10
MAXIMUM NUMBER OF FLASH ITERATIONS 30
FLASH TOLERANCE                  0.000100000
OUTSIDE LOOP CONVERGENCE TOLERANCE 0.000100000

```

\*\*\*\* COL-SPECS \*\*\*\*

```

MOLAR VAPOR DIST / TOTAL DIST  0.0
MASS REFLUX RATIO               0.074435
MASS BOILUP RATIO               2.84500

```



2	11.59	180.6		13.2147
3	215.1	166.4	203.1808	
4	214.5	166.8		
5	204.9	166.1		
6	48.34	156.5		48.3383

\*\*\*\* MASS FLOW PROFILES \*\*\*\*

STAGE	FLOW RATE		FEED RATE			PRODUCT RATE	
	LB/HR		LB/HR			LB/HR	
	LIQUID	VAPOR	LIQUID	VAPOR	MIXED	LIQUID	VAPOR
1	0.1369E+05	0.000				.12738+05	
2	895.6	0.1369E+05		961.7785			
3	0.1702E+05	0.1267E+05	.16087+05				
4	0.1699E+05	0.1271E+05					
5	0.1658E+05	0.1268E+05					
6	4311.	0.1226E+05				4311.0217	

\*\*\*\* MOLE-X-PROFILE \*\*\*\*

STAGE	GLYCE-01	1:3-P-01	WATER	DEXTR-01	METHA-01
1	0.23882E-02	0.99180	0.58126E-02	0.21345E-11	0.40569E-11
2	0.72398E-01	0.92751	0.89514E-04	0.30464E-06	0.17521E-13
3	0.17661	0.82139	0.19106E-04	0.19872E-02	0.94529E-15
4	0.18225	0.81575	0.39978E-06	0.19932E-02	0.48525E-17
5	0.28690	0.71101	0.86759E-08	0.20877E-02	0.22648E-19
6	0.76058	0.23058	0.16863E-09	0.88428E-02	0.50594E-22

\*\*\*\* MOLE-Y-PROFILE \*\*\*\*

STAGE	GLYCE-01	1:3-P-01	WATER	DEXTR-01	METHA-01
1	0.44296E-04	0.69392	0.30604	0.51324E-17	0.71954E-09
2	0.23882E-02	0.99180	0.58126E-02	0.21345E-11	0.40569E-11
3	0.69248E-02	0.99188	0.11984E-02	0.19763E-07	0.24067E-12
4	0.73378E-02	0.99264	0.24645E-04	0.21734E-07	0.12193E-14
5	0.13965E-01	0.98603	0.51606E-06	0.33859E-07	0.62646E-17
6	0.14064	0.85936	0.11303E-07	0.19103E-05	0.29625E-19

\*\*\*\* K-VALUES \*\*\*\*

STAGE	GLYCE-01	1:3-P-01	WATER	DEXTR-01	METHA-01
1	0.18550E-01	0.69966	52.646	0.24045E-05	177.36
2	0.32988E-01	1.0693	64.934	0.70076E-05	231.54
3	0.39211E-01	1.2076	62.721	0.99464E-05	254.59
4	0.40261E-01	1.2168	61.644	0.10904E-04	251.27
5	0.48687E-01	1.3869	59.461	0.16229E-04	276.61
6	0.18505	3.7280	66.977	0.21659E-03	585.46

\*\*\*\* MASS-X-PROFILE \*\*\*\*

STAGE	GLYCE-01	1:3-P-01	WATER	DEXTR-01	METHA-01
1	0.29017E-02	0.99572	0.13815E-02	0.50734E-11	0.17150E-11
2	0.86312E-01	0.91367	0.20876E-04	0.71047E-06	0.72677E-14
3	0.20555	0.78992	0.43501E-05	0.45245E-02	0.38280E-15
4	0.21188	0.78359	0.90914E-07	0.45329E-02	0.19627E-17
5	0.32659	0.66876	0.19319E-08	0.46489E-02	0.89699E-20
6	0.78540	0.19674	0.34064E-10	0.17863E-01	0.18177E-22

\*\*\*\* MASS-Y-PROFILE \*\*\*\*

STAGE	GLYCE-01	1:3-P-01	WATER	DEXTR-01	METHA-01
1	0.69947E-04	0.90540	0.94534E-01	0.15854E-16	0.39532E-09
2	0.29017E-02	0.99572	0.13815E-02	0.50734E-11	0.17150E-11
3	0.83762E-02	0.99134	0.28356E-03	0.46765E-07	0.10128E-12
4	0.88671E-02	0.99113	0.58256E-05	0.51378E-07	0.51264E-15
5	0.16852E-01	0.98315	0.12182E-06	0.79928E-07	0.26302E-17
6	0.16532	0.83467	0.25990E-08	0.43929E-05	0.12116E-19

\*\*\*\*\*  
 \*\*\*\*\* HYDRAULIC PARAMETERS \*\*\*\*\*  
 \*\*\*\*\*

\*\*\* DEFINITIONS \*\*\*

MARANGONI INDEX = SIGMA - SIGMATO  
 FLOW PARAM = (ML/MV)\*SQRT(RHOV/RHOL)  
 QR = QV\*SQRT(RHOV/(RHOL-RHOV))  
 F FACTOR = QV\*SQRT(RHOV)

WHERE:

SIGMA IS THE SURFACE TENSION OF LIQUID FROM THE STAGE  
 SIGMATO IS THE SURFACE TENSION OF LIQUID TO THE STAGE  
 ML IS THE MASS FLOW OF LIQUID FROM THE STAGE  
 MV IS THE MASS FLOW OF VAPOR TO THE STAGE  
 RHOL IS THE MASS DENSITY OF LIQUID FROM THE STAGE  
 RHOV IS THE MASS DENSITY OF VAPOR TO THE STAGE  
 QV IS THE VOLUMETRIC FLOW RATE OF VAPOR TO THE STAGE

TEMPERATURE  
 F

STAGE	LIQUID FROM	VAPOR TO
1	229.09	244.73
2	244.73	250.29
3	250.42	252.54
4	252.54	259.33
5	259.33	302.60
6	302.60	302.60

STAGE	MASS FLOW LB/HR		VOLUME FLOW CUFT/HR		MOLECULAR WEIGHT	
	LIQUID FROM	VAPOR TO	LIQUID FROM	VAPOR TO	LIQUID FROM	VAPOR TO
1	13686.	13686.	220.92	0.35118E+07	75.796	75.796
2	895.61	13634.	14.462	0.35216E+07	77.248	75.890
3	17020.	12709.	271.66	0.30374E+07	79.127	76.211
4	16988.	12677.	271.19	0.29239E+07	79.219	76.319
5	16576.	12265.	261.18	0.28119E+07	80.903	78.346
6	4311.0	0.0000	62.697	0.0000	89.184	

STAGE	DENSITY LB/CUFT		VISCOSITY CP		SURFACE TENSION DYNE/CM
	LIQUID FROM	VAPOR TO	LIQUID FROM	VAPOR TO	LIQUID FROM
1	61.951	0.38972E-02	2.3186	0.98632E-02	37.682
2	61.928	0.38715E-02	2.1659	0.99371E-02	38.069
3	62.653	0.41843E-02	2.3921	0.99530E-02	39.654
4	62.645	0.43358E-02	2.3505	0.10043E-01	39.648
5	63.465	0.43617E-02	2.5139	0.10518E-01	41.209
6	68.760		2.9173		47.171

STAGE	MARANGONI INDEX DYNE/CM	FLOW PARAM	QR CUFT/HR	REDUCED F-FACTOR (LB-CUFT)**.5/HR
1		0.79314E-02	27855.	0.21923E+06
2	0.38712	0.51940E-03	27845.	0.21912E+06
3	-.12642	0.10944E-01	24823.	0.19648E+06
4	-.64461E-02	0.11148E-01	24326.	0.19253E+06

5	1.5618	0.11204E-01	23312.	0.18571E+06
6	5.9617		0.0000	0.0000

\*\*\*\*\*  
 \*\*\*\*\* PACKING SIZING CALCULATIONS \*\*\*\*\*  
 \*\*\*\*\*

\*\*\*\*\*  
 \*\*\* SECTION 2 \*\*\*  
 \*\*\*\*\*

STARTING STAGE NUMBER	2
ENDING STAGE NUMBER	5
CAPACITY CALCULATION METHOD	STICHL
PRESSURE DROP CALCULATION METHOD	STICHL
LIQUID HOLDUP CALCULATION METHOD	STICHL
PRESSURE PROFILE UPDATED	YES

DESIGN PARAMETERS

OVERDESIGN FACTOR		1.00000
SYSTEM FOAMING FACTOR		1.00000
FRAC. APP. TO MAXIMUM CAPACITY		0.62000
MAXIMUM CAPACITY FACTOR	FT/SEC	MISSING
DESIGN CAPACITY FACTOR	FT/SEC	MISSING
PRESSURE DROP FOR THE SECTION	PSI	MISSING
PRESSURE DROP PER UNIT HEIGHT	IN-WATER/FT	MISSING

PACKING SPECIFICATIONS

PACKING TYPE		FLEXIPAC-HC
PACKING MATERIAL		METAL
PACKING SIZE		2YHC
VENDOR		KOCH
PACKING FACTOR	1/FT	23.7531
PACKING SURFACE AREA	SQFT/CUF	68.5800
PACKING VOID FRACTION		0.97000
FIRST STICHLMAIR CONSTANT		0.083300
SECOND STICHLMAIR CONSTANT		-0.0099000
THIRD STICHLMAIR CONSTANT		0.016100
HETP	FT	1.33333
PACKING HEIGHT	FT	5.33333

\*\*\*\*\* SIZING RESULTS \*\*\*\*\*

COLUMN DIAMETER	FT	2.30697
MAXIMUM FRACTIONAL CAPACITY		0.62000
MAXIMUM CAPACITY FACTOR	FT/SEC	1.85042
PRESSURE DROP FOR THE SECTION	PSI	0.066748
AVERAGE PRESSURE DROP/HEIGHT	IN-WATER/FT	0.34642
MAXIMUM LIQUID HOLDUP/STAGE	CUFT	0.29370
MAX LIQ SUPERFICIAL VELOCITY	FT/SEC	0.018053

\*\*\*\* RATING PROFILES AT MAXIMUM COLUMN DIAMETER \*\*\*\*

HEIGHT				
FROM TOP	FRACTIONAL	PRESSURE	PRESSURE	LIQUID

STAGE	OF SECTION FT	CAPACITY	DROP PSI	DROP/HEIGHT IN-WATER/FT	HOLDUP CUFT	HETP FT
2	0.000	0.3452	0.11425E-01	0.23719	0.4097E-01	1.333
3	1.333	0.6200	0.19535E-01	0.40554	0.2937	1.333
4	2.667	0.6108	0.18719E-01	0.38860	0.2928	1.333
5	4.000	0.5862	0.17069E-01	0.35436	0.2845	1.333

LIQUID  
SUPERFICIAL

STAGE	VELOCITY FT/SEC
2	0.9611E-03
3	0.1805E-01
4	0.1802E-01
5	0.1736E-01

\*\*\* ASSOCIATED UTILITIES \*\*\*

UTILITY USAGE: CW (WATER)

CONDENSER	5.8694+05		1.1783
TOTAL:	5.8694+05	LB/HR	1.1783 \$/HR

UTILITY USAGE: MPSTEAM (STEAM)

REBOILER	5586.8549		11.3440
747.4696			
TOTAL:	5586.8549	LB/HR	11.3440 \$/HR
747.4696 CO2		LB/HR	



# Heat Integration Flowsheet

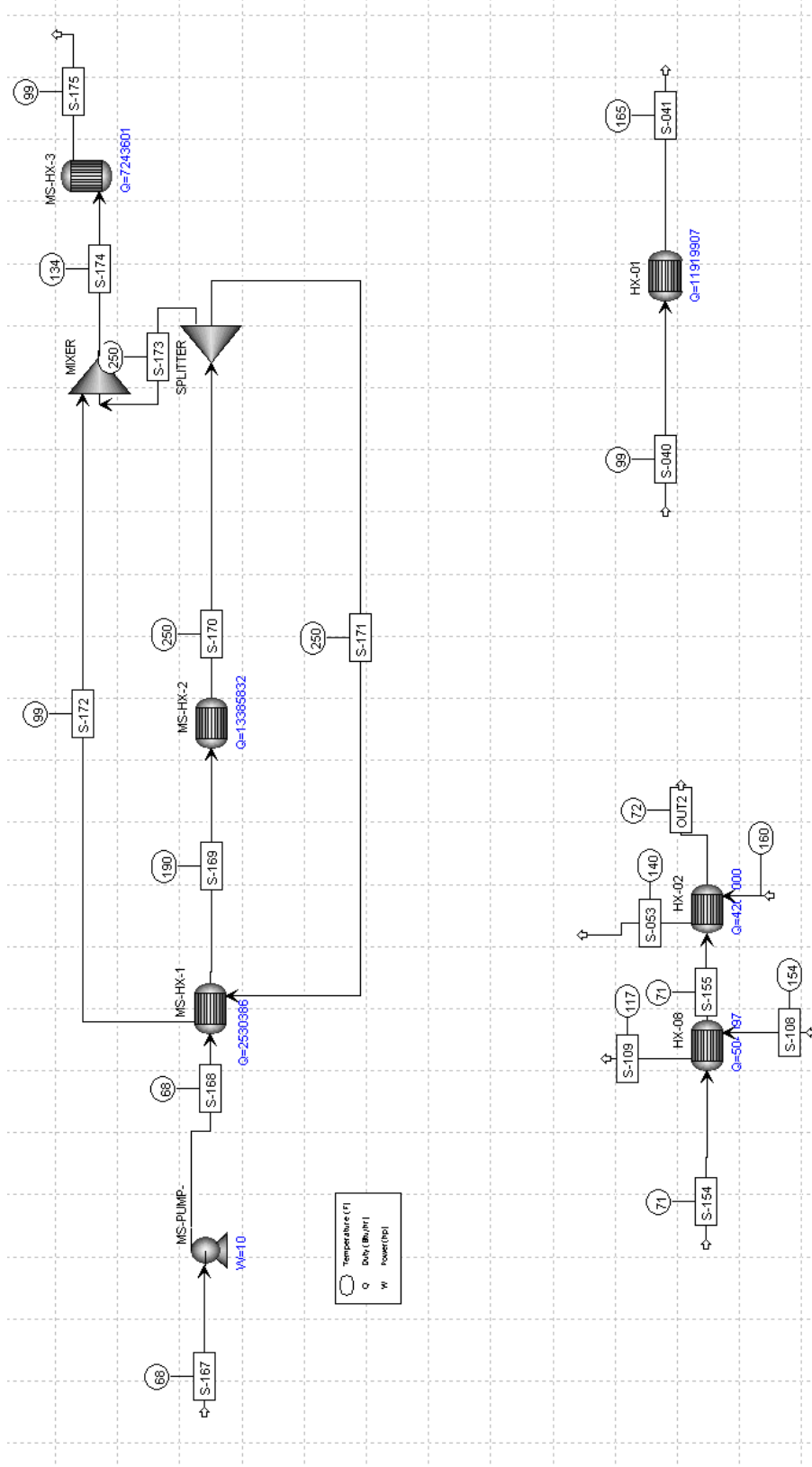

# Heat Integration Block Report

BLOCK: HX-01      MODEL: HEATX

-----  
HOT SIDE:

-----  
INLET UTILITY:            MPSTEAM  
OUTLET UTILITY:         MPSTEAM  
PROPERTY OPTION SET:   WILSON      WILSON / IDEAL GAS  
COLD SIDE:

-----  
INLET STREAM:            S-040  
OUTLET STREAM:          S-041  
PROPERTY OPTION SET:   WILSON      WILSON / IDEAL GAS

\*\*\* MASS AND ENERGY BALANCE \*\*\*

	IN	OUT	RELATIVE DIFF.
TOTAL BALANCE			
MOLE (LBMOL/HR)	9796.25	9796.25	0.00000
MASS (LB/HR )	176482.	176482.	0.00000
ENTHALPY (BTU/HR )	-0.119991E+10	-0.118799E+10	-0.993399E-02

\*\*\* CO2 EQUIVALENT SUMMARY \*\*\*

FEED STREAMS CO2E	0.00000	LB/HR
PRODUCT STREAMS CO2E	0.00000	LB/HR
NET STREAMS CO2E PRODUCTION	0.00000	LB/HR
UTILITIES CO2E PRODUCTION	1823.05	LB/HR
TOTAL CO2E PRODUCTION	1823.05	LB/HR

FLASH SPECS FOR COLD SIDE:

TWO PHASE FLASH	
MAXIMUM NO. ITERATIONS	30
CONVERGENCE TOLERANCE	0.000100000

FLOW DIRECTION AND SPECIFICATION:

COUNTERCURRENT HEAT EXCHANGER	
SPECIFIED COLD OUTLET TEMP	
SPECIFIED VALUE	F      165.0000
LMTD CORRECTION FACTOR	1.00000

PRESSURE SPECIFICATION:

HOT SIDE OUTLET PRESSURE	PSIA	126.4289
COLD SIDE PRESSURE DROP	PSI	0.0000

HEAT TRANSFER COEFFICIENT SPECIFICATION:

HOT LIQUID	COLD LIQUID	BTU/HR-SQFT-R	149.6937
HOT 2-PHASE	COLD LIQUID	BTU/HR-SQFT-R	149.6937
HOT VAPOR	COLD LIQUID	BTU/HR-SQFT-R	149.6937
HOT LIQUID	COLD 2-PHASE	BTU/HR-SQFT-R	149.6937
HOT 2-PHASE	COLD 2-PHASE	BTU/HR-SQFT-R	149.6937
HOT VAPOR	COLD 2-PHASE	BTU/HR-SQFT-R	149.6937
HOT LIQUID	COLD VAPOR	BTU/HR-SQFT-R	149.6937
HOT 2-PHASE	COLD VAPOR	BTU/HR-SQFT-R	149.6937
HOT VAPOR	COLD VAPOR	BTU/HR-SQFT-R	149.6937

\*\*\* OVERALL RESULTS \*\*\*

STREAMS:

HOT		COLD	
MPSTEAM	----->	S-041	<-----
T=	3.4700D+02	T=	1.6500D+02
P=	1.2945D+02	P=	4.3511D+01
V=	1.0000D+00	V=	0.0000D+00
MPSTEAM	----->	S-040	<-----
T=	3.4520D+02	T=	9.8600D+01
P=	1.2643D+02	P=	4.3511D+01
V=	0.0000D+00	V=	0.0000D+00

DUTY AND AREA:

CALCULATED HEAT DUTY	BTU/HR	11919920.2058
CALCULATED (REQUIRED) AREA	SQFT	374.4288
ACTUAL EXCHANGER AREA	SQFT	374.4288
PER CENT OVER-DESIGN		0.0000

HEAT TRANSFER COEFFICIENT:

AVERAGE COEFFICIENT (DIRTY)	BTU/HR-SQFT-R	149.6937
UA (DIRTY)	BTU/HR-R	56049.6181

LOG-MEAN TEMPERATURE DIFFERENCE:

LMTD CORRECTION FACTOR		1.0000
LMTD (CORRECTED)	F	212.6673
NUMBER OF SHELLS IN SERIES		1

PRESSURE DROP:

HOTSIDE, TOTAL	PSI	3.0230
COLD SIDE, TOTAL	PSI	0.0000

\*\*\* ASSOCIATED UTILITIES \*\*\*

UTILITY ID FOR STEAM	MPSTEAM	
RATE OF CONSUMPTION	1.3626+04	LB/HR
COST	27.6676	\$/HR
CO2 EQUIVALENT EMISSIONS	1823.0466	LB/HR

\*\*\* ZONE RESULTS \*\*\*

TEMPERATURE LEAVING EACH ZONE:

HOT		COLD	
HOT IN	----->	HOT OUT	----->
347.0		345.2	
COLDOUT	<-----	COLDIN	<-----
165.0		98.6	

ZONE HEAT TRANSFER AND AREA:

ZONE	HEAT DUTY	AREA	LMTD	AVERAGE U	UA
------	-----------	------	------	-----------	----

BTU/HR                    SQFT                    F                    BTU/HR-SQFT-R                    BTU/HR-R  
 1    11919920.206                    374.4288                    212.6673                    149.6937                    56049.6181

HEATX COLD-TQCU HX-01                    TQCURV INLET

-----  
 PRESSURE PROFILE:                    CONSTANT2  
 PRESSURE DROP:                    0.0                    PSI  
 PROPERTY OPTION SET:                    WILSON                    WILSON / IDEAL GAS

! DUTY	! PRES	! TEMP	! VFRAC	!
! BTU/HR	! PSIA	! F	!	!
! 0.0	! 43.5113	! 165.0000	! 0.0	!
! 5.6762+05	! 43.5113	! 161.9105	! 0.0	!
! 1.1352+06	! 43.5113	! 158.8132	! 0.0	!
! 1.7028+06	! 43.5113	! 155.7082	! 0.0	!
! 2.2705+06	! 43.5113	! 152.5956	! 0.0	!
! 2.8381+06	! 43.5113	! 149.4755	! 0.0	!
! 3.4057+06	! 43.5113	! 146.3479	! 0.0	!
! 3.9733+06	! 43.5113	! 143.2130	! 0.0	!
! 4.5409+06	! 43.5113	! 140.0707	! 0.0	!
! 5.1085+06	! 43.5113	! 136.9213	! 0.0	!
! 5.6762+06	! 43.5113	! 133.7647	! 0.0	!
! 6.2438+06	! 43.5113	! 130.6012	! 0.0	!
! 6.8114+06	! 43.5113	! 127.4307	! 0.0	!
! 7.3790+06	! 43.5113	! 124.2533	! 0.0	!
! 7.9466+06	! 43.5113	! 121.0692	! 0.0	!
! 8.5142+06	! 43.5113	! 117.8785	! 0.0	!
! 9.0818+06	! 43.5113	! 114.6812	! 0.0	!
! 9.6495+06	! 43.5113	! 111.4775	! 0.0	!
! 1.0217+07	! 43.5113	! 108.2674	! 0.0	!
! 1.0785+07	! 43.5113	! 105.0511	! 0.0	!
! 1.1352+07	! 43.5113	! 101.8286	! 0.0	!
! 1.1894+07	! 43.5113	! 98.7466	! 0.0	!
! 1.1920+07	! 43.5113	! 98.6000	! 0.0	!

HEATX HOT-TQCUR HX-01                    TQCURV INLET

-----  
 PRESSURE PROFILE:                    CONSTANT2  
 PRESSURE DROP:                    0.0                    PSI  
 PROPERTY OPTION SET:                    SYSOP12                    ASME STEAM TABLE EQUATION OF STATE

! DUTY	! PRES	! TEMP	! VFRAC	!
! BTU/HR	! PSIA	! F	!	!
! 0.0	! 129.4519	! 347.0001	! 1.0000	!
! 5.6762+05	! 129.4519	! 347.0001	! 0.9523	!
! 1.1352+06	! 129.4519	! 347.0001	! 0.9046	!

```

! 1.7028+06 ! 129.4519 ! 347.0001 ! 0.8568 !
! 2.2705+06 ! 129.4519 ! 347.0001 ! 0.8091 !
!-----+-----+-----+-----!
! 2.8381+06 ! 129.4519 ! 347.0001 ! 0.7614 !
! 3.4057+06 ! 129.4519 ! 347.0001 ! 0.7137 !
! 3.9733+06 ! 129.4519 ! 347.0001 ! 0.6659 !
! 4.5409+06 ! 129.4519 ! 347.0001 ! 0.6182 !
! 5.1085+06 ! 129.4519 ! 347.0001 ! 0.5705 !
!-----+-----+-----+-----!
! 5.6762+06 ! 129.4519 ! 347.0001 ! 0.5228 !
! 6.2438+06 ! 129.4519 ! 347.0001 ! 0.4751 !
! 6.8114+06 ! 129.4519 ! 347.0001 ! 0.4273 !
! 7.3790+06 ! 129.4519 ! 347.0001 ! 0.3796 !
! 7.9466+06 ! 129.4519 ! 347.0001 ! 0.3319 !
!-----+-----+-----+-----!
! 8.5142+06 ! 129.4519 ! 347.0001 ! 0.2842 !
! 9.0818+06 ! 129.4519 ! 347.0001 ! 0.2364 !
! 9.6495+06 ! 129.4519 ! 347.0001 ! 0.1887 !
! 1.0217+07 ! 129.4519 ! 347.0001 ! 0.1410 !
! 1.0785+07 ! 129.4519 ! 347.0001 ! 9.3280-02 !
!-----+-----+-----+-----!
! 1.1352+07 ! 129.4519 ! 347.0001 ! 4.5558-02 !
! 1.1894+07 ! 129.4519 ! 347.0001 ! BUB>0.0 !
! 1.1920+07 ! 129.4519 ! 345.1954 ! 0.0 !
!-----+-----+-----+-----!

```

BLOCK: HX-02 MODEL: HEATX

HOT SIDE:

```

-----
INLET STREAM:          S-052
OUTLET STREAM:         S-053
PROPERTY OPTION SET:   WILSON    WILSON / IDEAL GAS
COLD SIDE:
-----

```

```

INLET STREAM:          S-155
OUTLET STREAM:         OUT2
PROPERTY OPTION SET:   WILSON    WILSON / IDEAL GAS

```

```

*** MASS AND ENERGY BALANCE ***
                                IN          OUT          RELATIVE DIFF.
TOTAL BALANCE
MOLE (LBMOL/HR)                441116.        441116.        0.00000
MASS (LB/HR )                   0.796123E+07   0.796123E+07   0.00000
ENTHALPY (BTU/HR )              -0.542524E+11  -0.542524E+11  0.140628E-15

```

```

*** CO2 EQUIVALENT SUMMARY ***
FEED STREAMS CO2E                0.00000        LB/HR
PRODUCT STREAMS CO2E             0.00000        LB/HR
NET STREAMS CO2E PRODUCTION      0.00000        LB/HR
UTILITIES CO2E PRODUCTION        0.00000        LB/HR
TOTAL CO2E PRODUCTION            0.00000        LB/HR

```

\*\*\* INPUT DATA \*\*\*

FLASH SPECS FOR HOT SIDE:

```

TWO PHASE FLASH
MAXIMUM NO. ITERATIONS          30
CONVERGENCE TOLERANCE          0.000100000

```

FLASH SPECS FOR COLD SIDE:

```

TWO PHASE FLASH
MAXIMUM NO. ITERATIONS          30

```

CONVERGENCE TOLERANCE 0.00010000

FLOW DIRECTION AND SPECIFICATION:  
COUNTERCURRENT HEAT EXCHANGER  
SPECIFIED HOT OUTLET TEMP

SPECIFIED VALUE F 140.0000  
LMTD CORRECTION FACTOR 1.00000

PRESSURE SPECIFICATION:

HOT SIDE PRESSURE DROP PSI 5.0000  
COLD SIDE PRESSURE DROP PSI 0.0000

HEAT TRANSFER COEFFICIENT SPECIFICATION:

HOT LIQUID COLD LIQUID BTU/HR-SQFT-R 149.6937  
HOT 2-PHASE COLD LIQUID BTU/HR-SQFT-R 149.6937  
HOT VAPOR COLD LIQUID BTU/HR-SQFT-R 149.6937  
HOT LIQUID COLD 2-PHASE BTU/HR-SQFT-R 149.6937  
HOT 2-PHASE COLD 2-PHASE BTU/HR-SQFT-R 149.6937  
HOT VAPOR COLD 2-PHASE BTU/HR-SQFT-R 149.6937  
HOT LIQUID COLD VAPOR BTU/HR-SQFT-R 149.6937  
HOT 2-PHASE COLD VAPOR BTU/HR-SQFT-R 149.6937  
HOT VAPOR COLD VAPOR BTU/HR-SQFT-R 149.6937

\*\*\* OVERALL RESULTS \*\*\*

STREAMS:

```
----->|
S-052      |          HOT          |-----> S-053
T= 1.6000D+02 |          |          T= 1.4000D+02
P= 7.9700D+01 |          |          P= 7.4700D+01
V= 0.0000D+00 |          |          V= 0.0000D+00
|          |          |
OUT2      <-----|          COLD          |<----- S-155
T= 7.1620D+01 |          |          T= 7.1066D+01
P= 1.4700D+01 |          |          P= 1.4700D+01
V= 0.0000D+00 |          |          V= 0.0000D+00
----->|
```

DUTY AND AREA:

CALCULATED HEAT DUTY BTU/HR 4206997.0290  
CALCULATED (REQUIRED) AREA SQFT 359.1358  
ACTUAL EXCHANGER AREA SQFT 359.1358  
PER CENT OVER-DESIGN 0.0000

HEAT TRANSFER COEFFICIENT:

AVERAGE COEFFICIENT (DIRTY) BTU/HR-SQFT-R 149.6937  
UA (DIRTY) BTU/HR-R 53760.3460

LOG-MEAN TEMPERATURE DIFFERENCE:

LMTD CORRECTION FACTOR 1.0000  
LMTD (CORRECTED) F 78.2546  
NUMBER OF SHELLS IN SERIES 1

PRESSURE DROP:

HOT SIDE, TOTAL PSI 5.0000  
COLD SIDE, TOTAL PSI 0.0000

\*\*\* ZONE RESULTS \*\*\*

TEMPERATURE LEAVING EACH ZONE:

HOT

```

-----
HOT IN |          LIQ          | HOT OUT
-----> |          | ----->
160.0  |          | 140.0
      |          |
COLDOUT |          LIQ          | COLDIN
<----- |          | <-----
71.6    |          | 71.1
      |          |
-----
                COLD

```

ZONE HEAT TRANSFER AND AREA:

ZONE	HEAT DUTY BTU/HR	AREA SQFT	LMTD F	AVERAGE U BTU/HR-SQFT-R	UA BTU/HR-R
1	4206997.029	359.1358	78.2546	149.6937	53760.3460

HEATX COLD-TQCU HX-02 TQCURV INLET

```

-----
PRESSURE PROFILE:  CONSTANT2
PRESSURE DROP:    0.0      PSI
PROPERTY OPTION SET:  WILSON  WILSON / IDEAL GAS

```

```

-----
!  DUTY      !  PRES      !  TEMP      !  VFRAC     !
!           !           !           !           !
!           !           !           !           !
!  BTU/HR   !  PSIA      !  F         !           !
!           !           !           !           !
!=====!=====!=====!=====!
!   0.0     !  14.7000  !  71.6197  !  0.0       !
! 2.0033+05 !  14.7000  !  71.5934  !  0.0       !
! 4.0067+05 !  14.7000  !  71.5670  !  0.0       !
! 6.0100+05 !  14.7000  !  71.5407  !  0.0       !
! 8.0133+05 !  14.7000  !  71.5143  !  0.0       !
!-----+-----+-----+-----!
! 1.0017+06 !  14.7000  !  71.4880  !  0.0       !
! 1.2020+06 !  14.7000  !  71.4617  !  0.0       !
! 1.4023+06 !  14.7000  !  71.4353  !  0.0       !
! 1.6027+06 !  14.7000  !  71.4090  !  0.0       !
! 1.8030+06 !  14.7000  !  71.3826  !  0.0       !
!-----+-----+-----+-----!
! 2.0033+06 !  14.7000  !  71.3563  !  0.0       !
! 2.2037+06 !  14.7000  !  71.3299  !  0.0       !
! 2.4040+06 !  14.7000  !  71.3036  !  0.0       !
! 2.6043+06 !  14.7000  !  71.2772  !  0.0       !
! 2.8047+06 !  14.7000  !  71.2509  !  0.0       !
!-----+-----+-----+-----!
! 3.0050+06 !  14.7000  !  71.2245  !  0.0       !
! 3.2053+06 !  14.7000  !  71.1982  !  0.0       !
! 3.4057+06 !  14.7000  !  71.1718  !  0.0       !
! 3.6060+06 !  14.7000  !  71.1455  !  0.0       !
! 3.8063+06 !  14.7000  !  71.1191  !  0.0       !
!-----+-----+-----+-----!
! 4.0067+06 !  14.7000  !  71.0928  !  0.0       !
! 4.2070+06 !  14.7000  !  71.0664  !  0.0       !
!-----

```

HEATX HOT-TQCUR HX-02 TQCURV INLET

PRESSURE PROFILE: CONSTANT2  
 PRESSURE DROP: 0.0 PSI  
 PROPERTY OPTION SET: WILSON WILSON / IDEAL GAS

```

-----
! DUTY      ! PRES      ! TEMP      ! VFRAC     !
!           !           !           !           !
!           !           !           !           !
! BTU/HR    ! PSIA      ! F         !           !
!           !           !           !           !
!===== !===== !===== !===== !
! 0.0       ! 79.7000  ! 160.0000 ! 0.0       !
! 2.0033+05 ! 79.7000  ! 159.0547 ! 0.0       !
! 4.0067+05 ! 79.7000  ! 158.1087 ! 0.0       !
! 6.0100+05 ! 79.7000  ! 157.1620 ! 0.0       !
! 8.0133+05 ! 79.7000  ! 156.2145 ! 0.0       !
!-----+-----+-----+-----+
! 1.0017+06 ! 79.7000  ! 155.2664 ! 0.0       !
! 1.2020+06 ! 79.7000  ! 154.3175 ! 0.0       !
! 1.4023+06 ! 79.7000  ! 153.3679 ! 0.0       !
! 1.6027+06 ! 79.7000  ! 152.4176 ! 0.0       !
! 1.8030+06 ! 79.7000  ! 151.4666 ! 0.0       !
!-----+-----+-----+-----+
! 2.0033+06 ! 79.7000  ! 150.5149 ! 0.0       !
! 2.2037+06 ! 79.7000  ! 149.5625 ! 0.0       !
! 2.4040+06 ! 79.7000  ! 148.6093 ! 0.0       !
! 2.6043+06 ! 79.7000  ! 147.6555 ! 0.0       !
! 2.8047+06 ! 79.7000  ! 146.7010 ! 0.0       !
!-----+-----+-----+-----+
! 3.0050+06 ! 79.7000  ! 145.7458 ! 0.0       !
! 3.2053+06 ! 79.7000  ! 144.7899 ! 0.0       !
! 3.4057+06 ! 79.7000  ! 143.8333 ! 0.0       !
! 3.6060+06 ! 79.7000  ! 142.8760 ! 0.0       !
! 3.8063+06 ! 79.7000  ! 141.9180 ! 0.0       !
!-----+-----+-----+-----+
! 4.0067+06 ! 79.7000  ! 140.9593 ! 0.0       !
! 4.2070+06 ! 79.7000  ! 140.0000 ! 0.0       !
-----

```

BLOCK: HX-08 MODEL: HEATX

HOT SIDE:

```

-----
INLET STREAM:      S-108
OUTLET STREAM:     S-109
PROPERTY OPTION SET: WILSON WILSON / IDEAL GAS
COLD SIDE:
-----

```

```

INLET STREAM:      S-154
OUTLET STREAM:     S-155
PROPERTY OPTION SET: WILSON WILSON / IDEAL GAS

```

\*\*\* MASS AND ENERGY BALANCE \*\*\*

	IN	OUT	RELATIVE DIFF.
--	----	-----	----------------

TOTAL BALANCE	IN	OUT	RELATIVE DIFF.
MOLE (LBMOL/HR)	430557.	430557.	0.00000
MASS (LB/HR )	0.776975E+07	0.776975E+07	0.00000
ENTHALPY (BTU/HR )	-0.529691E+11	-0.529691E+11	0.00000

\*\*\* CO2 EQUIVALENT SUMMARY \*\*\*

FEED STREAMS CO2E	0.00000	LB/HR
PRODUCT STREAMS CO2E	0.00000	LB/HR



NET STREAMS CO2E PRODUCTION 0.00000 LB/HR  
 UTILITIES CO2E PRODUCTION 0.00000 LB/HR  
 TOTAL CO2E PRODUCTION 0.00000 LB/HR

\*\*\* INPUT DATA \*\*\*

FLASH SPECS FOR HOT SIDE:

TWO PHASE FLASH  
 MAXIMUM NO. ITERATIONS 30  
 CONVERGENCE TOLERANCE 0.000100000

FLASH SPECS FOR COLD SIDE:

TWO PHASE FLASH  
 MAXIMUM NO. ITERATIONS 30  
 CONVERGENCE TOLERANCE 0.000100000

FLOW DIRECTION AND SPECIFICATION:

COUNTERCURRENT HEAT EXCHANGER  
 SPECIFIED HOT OUTLET TEMP  
 SPECIFIED VALUE F 116.6000  
 LMTD CORRECTION FACTOR 1.00000

PRESSURE SPECIFICATION:

HOT SIDE PRESSURE DROP PSI 5.0000  
 COLD SIDE PRESSURE DROP PSI 0.0000

HEAT TRANSFER COEFFICIENT SPECIFICATION:

HOT LIQUID	COLD LIQUID	BTU/HR-SQFT-R	149.6937
HOT 2-PHASE	COLD LIQUID	BTU/HR-SQFT-R	149.6937
HOT VAPOR	COLD LIQUID	BTU/HR-SQFT-R	149.6937
HOT LIQUID	COLD 2-PHASE	BTU/HR-SQFT-R	149.6937
HOT 2-PHASE	COLD 2-PHASE	BTU/HR-SQFT-R	149.6937
HOT VAPOR	COLD 2-PHASE	BTU/HR-SQFT-R	149.6937
HOT LIQUID	COLD VAPOR	BTU/HR-SQFT-R	149.6937
HOT 2-PHASE	COLD VAPOR	BTU/HR-SQFT-R	149.6937
HOT VAPOR	COLD VAPOR	BTU/HR-SQFT-R	149.6937

\*\*\* OVERALL RESULTS \*\*\*

STREAMS:

```

-----|----->
S-108      |          HOT          |-----> S-109
T= 1.5360D+02 |          |          T= 1.1660D+02
P= 3.2100D+01 |          |          P= 2.7100D+01
V= 0.0000D+00 |          |          V= 0.0000D+00
          |          |
S-155      |          COLD          |<----- S-154
T= 7.1066D+01 |          |          T= 7.1000D+01
P= 1.4700D+01 |          |          P= 1.4700D+01
V= 0.0000D+00 |          |          V= 0.0000D+00
-----|-----

```

DUTY AND AREA:

CALCULATED HEAT DUTY	BTU/HR	504997.2552
CALCULATED (REQUIRED) AREA	SQFT	54.1922
ACTUAL EXCHANGER AREA	SQFT	54.1922
PER CENT OVER-DESIGN		0.0000

HEAT TRANSFER COEFFICIENT:

AVERAGE COEFFICIENT (DIRTY)	BTU/HR-SQFT-R	149.6937
UA (DIRTY)	BTU/HR-R	8112.2294

LOG-MEAN TEMPERATURE DIFFERENCE:  
 LMTD CORRECTION FACTOR 1.0000  
 LMTD (CORRECTED) F 62.2514  
 NUMBER OF SHELLS IN SERIES 1

PRESSURE DROP:  
 HOTSIDE, TOTAL PSI 5.0000  
 COLDSIDE, TOTAL PSI 0.0000

PRESSURE DROP PARAMETER:  
 HOT SIDE: 0.54422E+07

\*\*\* ZONE RESULTS \*\*\*

TEMPERATURE LEAVING EACH ZONE:

		HOT			
HOT IN		LIQ		HOT OUT	
----->				----->	
153.6				116.6	
COLDOUT		LIQ		COLDIN	
<-----				<-----	
71.1				71.0	
		COLD			

ZONE HEAT TRANSFER AND AREA:

ZONE	HEAT DUTY BTU/HR	AREA SQFT	LMTD F	AVERAGE U BTU/HR-SQFT-R	UA BTU/HR-R
1	504997.255	54.1922	62.2514	149.6937	8112.2294

HEATX COLD-TQCU HX-08 TQCURV INLET

PRESSURE PROFILE: CONSTANT2  
 PRESSURE DROP: 0.0 PSI  
 PROPERTY OPTION SET: WILSON WILSON / IDEAL GAS

DUTY	PRES	TEMP	VFRAC
BTU/HR	PSIA	F	
0.0	14.7000	71.0664	0.0
2.4047+04	14.7000	71.0633	0.0
4.8095+04	14.7000	71.0601	0.0
7.2142+04	14.7000	71.0569	0.0
9.6190+04	14.7000	71.0538	0.0
1.2024+05	14.7000	71.0506	0.0
1.4428+05	14.7000	71.0475	0.0
1.6833+05	14.7000	71.0443	0.0
1.9238+05	14.7000	71.0411	0.0
2.1643+05	14.7000	71.0380	0.0
2.4047+05	14.7000	71.0348	0.0

!	2.6452+05	!	14.7000	!	71.0316	!	0.0	!
!	2.8857+05	!	14.7000	!	71.0285	!	0.0	!
!	3.1262+05	!	14.7000	!	71.0253	!	0.0	!
!	3.3666+05	!	14.7000	!	71.0222	!	0.0	!
-----								
!	3.6071+05	!	14.7000	!	71.0190	!	0.0	!
!	3.8476+05	!	14.7000	!	71.0158	!	0.0	!
!	4.0881+05	!	14.7000	!	71.0127	!	0.0	!
!	4.3285+05	!	14.7000	!	71.0095	!	0.0	!
!	4.5690+05	!	14.7000	!	71.0063	!	0.0	!
-----								
!	4.8095+05	!	14.7000	!	71.0032	!	0.0	!
!	5.0500+05	!	14.7000	!	71.0000	!	0.0	!
-----								

HEATX HOT-TQCUR HX-08      TQCURV INLET

PRESSURE PROFILE:      CONSTANT2  
 PRESSURE DROP:        0.0            PSI  
 PROPERTY OPTION SET:   WILSON      WILSON / IDEAL GAS

!	DUTY	!	PRES	!	TEMP	!	VFRAC	!
!		!		!		!		!
!	BTU/HR	!	PSIA	!	F	!		!
!		!		!		!		!
!	0.0	!	32.1000	!	153.6000	!	0.0	!
!	2.4047+04	!	32.1000	!	151.8650	!	0.0	!
!	4.8095+04	!	32.1000	!	150.1273	!	0.0	!
!	7.2142+04	!	32.1000	!	148.3869	!	0.0	!
!	9.6190+04	!	32.1000	!	146.6438	!	0.0	!
-----								
!	1.2024+05	!	32.1000	!	144.8980	!	0.0	!
!	1.4428+05	!	32.1000	!	143.1495	!	0.0	!
!	1.6833+05	!	32.1000	!	141.3982	!	0.0	!
!	1.9238+05	!	32.1000	!	139.6443	!	0.0	!
!	2.1643+05	!	32.1000	!	137.8876	!	0.0	!
-----								
!	2.4047+05	!	32.1000	!	136.1283	!	0.0	!
!	2.6452+05	!	32.1000	!	134.3663	!	0.0	!
!	2.8857+05	!	32.1000	!	132.6016	!	0.0	!
!	3.1262+05	!	32.1000	!	130.8343	!	0.0	!
!	3.3666+05	!	32.1000	!	129.0642	!	0.0	!
-----								
!	3.6071+05	!	32.1000	!	127.2916	!	0.0	!
!	3.8476+05	!	32.1000	!	125.5162	!	0.0	!
!	4.0881+05	!	32.1000	!	123.7382	!	0.0	!
!	4.3285+05	!	32.1000	!	121.9576	!	0.0	!
!	4.5690+05	!	32.1000	!	120.1744	!	0.0	!
-----								
!	4.8095+05	!	32.1000	!	118.3885	!	0.0	!
!	5.0500+05	!	32.1000	!	116.6000	!	0.0	!
-----								

BLOCK: MIXER      MODEL: MIXER

INLET STREAMS:        S-172        S-173  
 OUTLET STREAM:       S-174  
 PROPERTY OPTION SET:   WILSON      WILSON / IDEAL GAS

```

*** MASS AND ENERGY BALANCE ***
                                IN          OUT          RELATIVE DIFF.
TOTAL BALANCE
MOLE (LBMOL/HR)                10824.3        10824.3        0.00000
MASS (LB/HR )                   216548.         216548.         0.00000
ENTHALPY (BTU/HR )              -0.136661E+10  -0.136661E+10  0.00000

```

```

*** CO2 EQUIVALENT SUMMARY ***
FEED STREAMS CO2E                0.00000        LB/HR
PRODUCT STREAMS CO2E             0.00000        LB/HR
NET STREAMS CO2E PRODUCTION      0.00000        LB/HR
UTILITIES CO2E PRODUCTION        0.00000        LB/HR
TOTAL CO2E PRODUCTION            0.00000        LB/HR

```

```

*** INPUT DATA ***
TWO PHASE FLASH
MAXIMUM NO. ITERATIONS           30
CONVERGENCE TOLERANCE           0.000100000
OUTLET PRESSURE: MINIMUM OF INLET STREAM PRESSURES

```

BLOCK: MS-HX-1 MODEL: HEATX

```

-----
HOT SIDE:
-----
INLET STREAM:                    S-171
OUTLET STREAM:                   S-172
PROPERTY OPTION SET: WILSON      WILSON / IDEAL GAS
COLD SIDE:
-----
INLET STREAM:                    S-168
OUTLET STREAM:                   S-169
PROPERTY OPTION SET: WILSON      WILSON / IDEAL GAS

```

```

*** MASS AND ENERGY BALANCE ***
                                IN          OUT          RELATIVE DIFF.
TOTAL BALANCE
MOLE (LBMOL/HR)                19239.7        19239.7        0.00000
MASS (LB/HR )                   384903.         384903.         0.00000
ENTHALPY (BTU/HR )              -0.242280E+10  -0.242280E+10  0.196813E-15

```

```

*** CO2 EQUIVALENT SUMMARY ***
FEED STREAMS CO2E                0.00000        LB/HR
PRODUCT STREAMS CO2E             0.00000        LB/HR
NET STREAMS CO2E PRODUCTION      0.00000        LB/HR
UTILITIES CO2E PRODUCTION        0.00000        LB/HR
TOTAL CO2E PRODUCTION            0.00000        LB/HR

```

```

*** INPUT DATA ***
FLASH SPECS FOR HOT SIDE:
TWO PHASE FLASH
MAXIMUM NO. ITERATIONS           30
CONVERGENCE TOLERANCE           0.000100000

```

```

FLASH SPECS FOR COLD SIDE:
TWO PHASE FLASH
MAXIMUM NO. ITERATIONS           30
CONVERGENCE TOLERANCE           0.000100000

```

```

FLOW DIRECTION AND SPECIFICATION:
COUNTERCURRENT HEAT EXCHANGER
SPECIFIED COLD OUTLET TEMP
SPECIFIED VALUE                   F           190.0000

```

LMTD CORRECTION FACTOR 1.00000

PRESSURE SPECIFICATION:

HOT SIDE PRESSURE DROP PSI 0.0000  
COLD SIDE PRESSURE DROP PSI 5.0000

HEAT TRANSFER COEFFICIENT SPECIFICATION:

HOT LIQUID COLD LIQUID BTU/HR-SQFT-R 149.6937  
HOT 2-PHASE COLD LIQUID BTU/HR-SQFT-R 149.6937  
HOT VAPOR COLD LIQUID BTU/HR-SQFT-R 149.6937  
HOT LIQUID COLD 2-PHASE BTU/HR-SQFT-R 149.6937  
HOT 2-PHASE COLD 2-PHASE BTU/HR-SQFT-R 149.6937  
HOT VAPOR COLD 2-PHASE BTU/HR-SQFT-R 149.6937  
HOT LIQUID COLD VAPOR BTU/HR-SQFT-R 149.6937  
HOT 2-PHASE COLD VAPOR BTU/HR-SQFT-R 149.6937  
HOT VAPOR COLD VAPOR BTU/HR-SQFT-R 149.6937

\*\*\* OVERALL RESULTS \*\*\*

STREAMS:

```
-----> S-171 HOT -----> S-172
T= 2.4980D+02 | T= 9.8600D+01
P= 3.4088D+01 | P= 3.4088D+01
V= 0.0000D+00 | V= 0.0000D+00
<----- S-169 COLD <----- S-168
T= 1.9000D+02 | T= 6.8131D+01
P= 3.9088D+01 | P= 4.4088D+01
V= 0.0000D+00 | V= 0.0000D+00
-----
```

DUTY AND AREA:

CALCULATED HEAT DUTY BTU/HR 25303874.6276  
CALCULATED (REQUIRED) AREA SQFT 3886.0465  
ACTUAL EXCHANGER AREA SQFT 3886.0465  
PER CENT OVER-DESIGN 0.0000

HEAT TRANSFER COEFFICIENT:

AVERAGE COEFFICIENT (DIRTY) BTU/HR-SQFT-R 149.6937  
UA (DIRTY) BTU/HR-R 581716.5031

LOG-MEAN TEMPERATURE DIFFERENCE:

LMTD CORRECTION FACTOR 1.0000  
LMTD (CORRECTED) F 43.4986  
NUMBER OF SHELLS IN SERIES 1

PRESSURE DROP:

HOT SIDE, TOTAL PSI 0.0000  
COLD SIDE, TOTAL PSI 5.0000

PRESSURE DROP PARAMETER:

COLD SIDE: 46130.

\*\*\* ZONE RESULTS \*\*\*

TEMPERATURE LEAVING EACH ZONE:

HOT	
HOT IN	LIQ
----->	----->
249.8	98.6
COLDOUT	LIQ
<-----	<-----
190.0	68.1

COLD

ZONE HEAT TRANSFER AND AREA:

ZONE	HEAT DUTY BTU/HR	AREA SQFT	LMTD F	AVERAGE U BTU/HR-SQFT-R	UA BTU/HR-R
1	25303874.628	3886.0465	43.4986	149.6937	581716.5031

HEATX COLD-TQCU MS-HX-1 TQCURV INLET

PRESSURE PROFILE: CONSTANT2  
 PRESSURE DROP: -5.0000 PSI  
 PROPERTY OPTION SET: WILSON WILSON / IDEAL GAS

DUTY	PRES	TEMP	VFRAC
BTU/HR	PSIA	F	
0.0	44.0878	190.0000	0.0
1.2049+06	44.0878	184.4417	0.0
2.4099+06	44.0878	178.8559	0.0
3.6148+06	44.0878	173.2430	0.0
4.8198+06	44.0878	167.6035	0.0
6.0247+06	44.0878	161.9377	0.0
7.2297+06	44.0878	156.2461	0.0
8.4346+06	44.0878	150.5292	0.0
9.6396+06	44.0878	144.7874	0.0
1.0845+07	44.0878	139.0213	0.0
1.2049+07	44.0878	133.2313	0.0
1.3254+07	44.0878	127.4181	0.0
1.4459+07	44.0878	121.5820	0.0
1.5664+07	44.0878	115.7238	0.0
1.6869+07	44.0878	109.8439	0.0
1.8074+07	44.0878	103.9430	0.0
1.9279+07	44.0878	98.0217	0.0
2.0484+07	44.0878	92.0806	0.0
2.1689+07	44.0878	86.1203	0.0
2.2894+07	44.0878	80.1415	0.0
2.4099+07	44.0878	74.1449	0.0

! 2.5304+07 ! 44.0878 ! 68.1312 ! 0.0 !

HEATX HOT-TQCUR MS-HX-1 TQCURV INLET

PRESSURE PROFILE: CONSTANT2  
 PRESSURE DROP: 0.0 PSI  
 PROPERTY OPTION SET: WILSON WILSON / IDEAL GAS

DUTY	PRES	TEMP	VFRAC
BTU/HR	PSIA	F	
0.0	34.0878	249.8000	0.0
1.2049+06	34.0878	243.0656	0.0
2.4099+06	34.0878	236.2804	0.0
3.6148+06	34.0878	229.4448	0.0
4.8198+06	34.0878	222.5593	0.0
6.0247+06	34.0878	215.6247	0.0
7.2297+06	34.0878	208.6413	0.0
8.4346+06	34.0878	201.6099	0.0
9.6396+06	34.0878	194.5312	0.0
1.0845+07	34.0878	187.4060	0.0
1.2049+07	34.0878	180.2349	0.0
1.3254+07	34.0878	173.0189	0.0
1.4459+07	34.0878	165.7587	0.0
1.5664+07	34.0878	158.4554	0.0
1.6869+07	34.0878	151.1099	0.0
1.8074+07	34.0878	143.7231	0.0
1.9279+07	34.0878	136.2963	0.0
2.0484+07	34.0878	128.8304	0.0
2.1689+07	34.0878	121.3266	0.0
2.2894+07	34.0878	113.7861	0.0
2.4099+07	34.0878	106.2102	0.0
2.5304+07	34.0878	98.6001	0.0

BLOCK: MS-HX-2 MODEL: HEATX

HOT SIDE:

INLET UTILITY: MPSTEAM  
 OUTLET UTILITY: MPSTEAM  
 PROPERTY OPTION SET: WILSON WILSON / IDEAL GAS

COLD SIDE:  
 INLET STREAM: S-169  
 OUTLET STREAM: S-170  
 PROPERTY OPTION SET: WILSON WILSON / IDEAL GAS

TOTAL BALANCE	*** MASS AND ENERGY BALANCE ***		RELATIVE DIFF.
	IN	OUT	
MOLE (LBMOL/HR)	10824.3	10824.3	0.00000
MASS (LB/HR )	216548.	216548.	0.00000

ENTHALPY (BTU/HR )            -0.135470E+10    -0.134131E+10    -0.988104E-02

\*\*\* CO2 EQUIVALENT SUMMARY \*\*\*

FEED STREAMS CO2E	0.00000	LB/HR
PRODUCT STREAMS CO2E	0.00000	LB/HR
NET STREAMS CO2E PRODUCTION	0.00000	LB/HR
UTILITIES CO2E PRODUCTION	2047.24	LB/HR
TOTAL CO2E PRODUCTION	2047.24	LB/HR

FLASH SPECS FOR COLD SIDE:

TWO PHASE FLASH	
MAXIMUM NO. ITERATIONS	30
CONVERGENCE TOLERANCE	0.000100000

FLOW DIRECTION AND SPECIFICATION:

COUNTERCURRENT HEAT EXCHANGER	
SPECIFIED COLD OUTLET TEMP	
SPECIFIED VALUE	F            249.8000
LMTD CORRECTION FACTOR	1.00000

PRESSURE SPECIFICATION:

HOT SIDE OUTLET PRESSURE	PSIA	126.4289
COLD SIDE PRESSURE DROP	PSI	5.0000

HEAT TRANSFER COEFFICIENT SPECIFICATION:

HOT LIQUID	COLD LIQUID	BTU/HR-SQFT-R	149.6937
HOT 2-PHASE	COLD LIQUID	BTU/HR-SQFT-R	149.6937
HOT VAPOR	COLD LIQUID	BTU/HR-SQFT-R	149.6937
HOT LIQUID	COLD 2-PHASE	BTU/HR-SQFT-R	149.6937
HOT 2-PHASE	COLD 2-PHASE	BTU/HR-SQFT-R	149.6937
HOT VAPOR	COLD 2-PHASE	BTU/HR-SQFT-R	149.6937
HOT LIQUID	COLD VAPOR	BTU/HR-SQFT-R	149.6937
HOT 2-PHASE	COLD VAPOR	BTU/HR-SQFT-R	149.6937
HOT VAPOR	COLD VAPOR	BTU/HR-SQFT-R	149.6937

\*\*\* OVERALL RESULTS \*\*\*

STREAMS:

MPSTEAM	----->	HOT		-----> MPSTEAM
T=	3.4700D+02			T= 3.4520D+02
P=	1.2945D+02			P= 1.2643D+02
V=	1.0000D+00			V= 0.0000D+00
S-170	<-----	COLD		<----- S-169
T=	2.4980D+02			T= 1.9000D+02
P=	3.4088D+01			P= 3.9088D+01
V=	0.0000D+00			V= 0.0000D+00

DUTY AND AREA:

CALCULATED HEAT DUTY	BTU/HR	13385819.1942
CALCULATED (REQUIRED) AREA	SQFT	721.4513
ACTUAL EXCHANGER AREA	SQFT	721.4513
PER CENT OVER-DESIGN		0.0000

HEAT TRANSFER COEFFICIENT:

AVERAGE COEFFICIENT (DIRTY)	BTU/HR-SQFT-R	149.6937
UA (DIRTY)	BTU/HR-R	107996.6875

LOG-MEAN TEMPERATURE DIFFERENCE:

LMTD CORRECTION FACTOR	1.0000
------------------------	--------



LMTD (CORRECTED) F 123.9466  
 NUMBER OF SHELLS IN SERIES 1

PRESSURE DROP:  
 HOTSIDE, TOTAL PSI 3.0230  
 COLD SIDE, TOTAL PSI 5.0000

\*\*\* ASSOCIATED UTILITIES \*\*\*

UTILITY ID FOR STEAM MPSTEAM  
 RATE OF CONSUMPTION 1.5302+04 LB/HR  
 COST 31.0701 \$/HR  
 CO2 EQUIVALENT EMISSIONS 2047.2429 LB/HR

\*\*\* ZONE RESULTS \*\*\*

TEMPERATURE LEAVING EACH ZONE:

```

                                HOT
-----
HOT IN | | COND | | HOT OUT
-----> | | | | ----->
  347.0 | | | | 345.2
| | | | |
COLDOUT | | LIQ | | COLDIN
<----- | | | | <-----
  249.8 | | | | 190.0
| | | | |
-----
                                COLD
  
```

ZONE HEAT TRANSFER AND AREA:

ZONE	HEAT DUTY BTU/HR	AREA SQFT	LMTD F	AVERAGE U BTU/HR-SQFT-R	UA BTU/HR-R
1	13385819.194	721.4513	123.9466	149.6937	107996.6875

HEATX COLD-TQCU MS-HX-2 TQCURV INLET

PRESSURE PROFILE: CONSTANT2  
 PRESSURE DROP: -5.0000 PSI  
 PROPERTY OPTION SET: WILSON WILSON / IDEAL GAS

```

-----
! DUTY      ! PRES      ! TEMP      ! VFRAC     !
!          !          !          !          !
!          !          !          !          !
!          !          !          !          !
! BTU/HR    ! PSIA      ! F         !           !
!          !          !          !          !
!===== !===== !===== !===== !
! 0.0       ! 39.0878   ! 249.8000  ! 0.0       !
! 6.3742+05 ! 39.0878   ! 247.0365  ! 0.0       !
! 1.2748+06 ! 39.0878   ! 244.2644  ! 0.0       !
! 1.9123+06 ! 39.0878   ! 241.4837  ! 0.0       !
! 2.5497+06 ! 39.0878   ! 238.6943  ! 0.0       !
!-----+-----+-----+-----+
! 3.1871+06 ! 39.0878   ! 235.8965  ! 0.0       !
! 3.8245+06 ! 39.0878   ! 233.0901  ! 0.0       !
! 4.4619+06 ! 39.0878   ! 230.2752  ! 0.0       !
! 5.0994+06 ! 39.0878   ! 227.4519  ! 0.0       !
! 5.7368+06 ! 39.0878   ! 224.6203  ! 0.0       !
  
```

6.3742+06	39.0878	221.7802	0.0
7.0116+06	39.0878	218.9318	0.0
7.6490+06	39.0878	216.0751	0.0
8.2865+06	39.0878	213.2102	0.0
8.9239+06	39.0878	210.3371	0.0
9.5613+06	39.0878	207.4559	0.0
1.0199+07	39.0878	204.5666	0.0
1.0836+07	39.0878	201.6692	0.0
1.1474+07	39.0878	198.7637	0.0
1.2111+07	39.0878	195.8504	0.0
1.2748+07	39.0878	192.9291	0.0
1.3357+07	39.0878	190.1330	0.0
1.3386+07	39.0878	190.0000	0.0

HEATX HOT-TQCUR MS-HX-2 TQCURV INLET

PRESSURE PROFILE: CONSTANT2  
 PRESSURE DROP: 0.0 PSI  
 PROPERTY OPTION SET: SYSOP12 ASME STEAM TABLE EQUATION OF STATE

DUTY	PRES	TEMP	VFRAC
BTU/HR	PSIA	F	
0.0	129.4519	347.0001	1.0000
6.3742+05	129.4519	347.0001	0.9523
1.2748+06	129.4519	347.0001	0.9046
1.9123+06	129.4519	347.0001	0.8568
2.5497+06	129.4519	347.0001	0.8091
3.1871+06	129.4519	347.0001	0.7614
3.8245+06	129.4519	347.0001	0.7137
4.4619+06	129.4519	347.0001	0.6659
5.0994+06	129.4519	347.0001	0.6182
5.7368+06	129.4519	347.0001	0.5705
6.3742+06	129.4519	347.0001	0.5228
7.0116+06	129.4519	347.0001	0.4751
7.6490+06	129.4519	347.0001	0.4273
8.2865+06	129.4519	347.0001	0.3796
8.9239+06	129.4519	347.0001	0.3319
9.5613+06	129.4519	347.0001	0.2842
1.0199+07	129.4519	347.0001	0.2364
1.0836+07	129.4519	347.0001	0.1887
1.1474+07	129.4519	347.0001	0.1410
1.2111+07	129.4519	347.0001	9.3280-02
1.2748+07	129.4519	347.0001	4.5558-02
1.3357+07	129.4519	347.0001	BUB>0.0
1.3386+07	129.4519	345.1954	0.0

BLOCK: MS-HX-3 MODEL: HEATX

HOT SIDE:

-----

INLET STREAM: S-174  
OUTLET STREAM: S-175  
PROPERTY OPTION SET: WILSON WILSON / IDEAL GAS  
COLD SIDE:

-----

INLET UTILITY: CW  
OUTLET UTILITY: CW  
PROPERTY OPTION SET: WILSON WILSON / IDEAL GAS

\*\*\* MASS AND ENERGY BALANCE \*\*\*

	IN	OUT	RELATIVE DIFF.
TOTAL BALANCE			
MOLE (LBMOL/HR)	10824.3	10824.3	0.00000
MASS (LB/HR )	216548.	216548.	0.00000
ENTHALPY (BTU/HR )	-0.136661E+10	-0.137386E+10	0.527244E-02

\*\*\* CO2 EQUIVALENT SUMMARY \*\*\*

FEED STREAMS CO2E	0.00000	LB/HR
PRODUCT STREAMS CO2E	0.00000	LB/HR
NET STREAMS CO2E PRODUCTION	0.00000	LB/HR
UTILITIES CO2E PRODUCTION	0.00000	LB/HR
TOTAL CO2E PRODUCTION	0.00000	LB/HR

\*\*\* INPUT DATA \*\*\*

FLASH SPECS FOR HOT SIDE:

TWO PHASE FLASH  
MAXIMUM NO. ITERATIONS 30  
CONVERGENCE TOLERANCE 0.000100000

FLOW DIRECTION AND SPECIFICATION:

COUNTERCURRENT HEAT EXCHANGER  
SPECIFIED HOT OUTLET TEMP  
SPECIFIED VALUE F 98.6000  
LMTD CORRECTION FACTOR 1.00000

PRESSURE SPECIFICATION:

HOT SIDE PRESSURE DROP PSI 5.0000  
COLD SIDE OUTLET PRESSURE PSIA 14.6959

HEAT TRANSFER COEFFICIENT SPECIFICATION:

HOT LIQUID	COLD LIQUID	BTU/HR-SQFT-R	149.6937
HOT 2-PHASE	COLD LIQUID	BTU/HR-SQFT-R	149.6937
HOT VAPOR	COLD LIQUID	BTU/HR-SQFT-R	149.6937
HOT LIQUID	COLD 2-PHASE	BTU/HR-SQFT-R	149.6937
HOT 2-PHASE	COLD 2-PHASE	BTU/HR-SQFT-R	149.6937
HOT VAPOR	COLD 2-PHASE	BTU/HR-SQFT-R	149.6937
HOT LIQUID	COLD VAPOR	BTU/HR-SQFT-R	149.6937
HOT 2-PHASE	COLD VAPOR	BTU/HR-SQFT-R	149.6937
HOT VAPOR	COLD VAPOR	BTU/HR-SQFT-R	149.6937

\*\*\* OVERALL RESULTS \*\*\*

STREAMS:

S-174		HOT		S-175	
T=	1.3386D+02			T=	9.8600D+01
P=	3.4088D+01			P=	2.9088D+01
V=	0.0000D+00			V=	0.0000D+00
CW		COLD		CW	
T=	7.7000D+01			T=	6.8000D+01
P=	1.4696D+01			P=	1.4696D+01
V=	0.0000D+00			V=	0.0000D+00

DUTY AND AREA:

CALCULATED HEAT DUTY	BTU/HR	7243585.0693
CALCULATED (REQUIRED) AREA	SQFT	1141.6809
ACTUAL EXCHANGER AREA	SQFT	1141.6809
PER CENT OVER-DESIGN		0.0000

HEAT TRANSFER COEFFICIENT:

AVERAGE COEFFICIENT (DIRTY)	BTU/HR-SQFT-R	149.6937
UA (DIRTY)	BTU/HR-R	170902.3912

LOG-MEAN TEMPERATURE DIFFERENCE:

LMTD CORRECTION FACTOR		1.0000
LMTD (CORRECTED)	F	42.3843
NUMBER OF SHELLS IN SERIES		1

PRESSURE DROP:

HOT SIDE, TOTAL	PSI	5.0000
COLD SIDE, TOTAL	PSI	0.0000

\*\*\* ASSOCIATED UTILITIES \*\*\*

UTILITY ID FOR WATER	CW	
RATE OF CONSUMPTION	8.0709+05	LB/HR
COST	1.6202	\$/HR

\*\*\* ZONE RESULTS \*\*\*

TEMPERATURE LEAVING EACH ZONE:

HOT		
HOT IN	LIQ	HOT OUT
----->		----->
133.9		98.6
COLDOUT	LIQ	COLDIN
<-----		<-----
77.0		68.0
COLD		

ZONE HEAT TRANSFER AND AREA:

ZONE	HEAT DUTY BTU/HR	AREA SQFT	LMTD F	AVERAGE U BTU/HR-SQFT-R	UA BTU/HR-R

1 7243585.069 1141.6809 42.3843 149.6937 170902.3912

HEATX COLD-TQCU MS-HX-3 TQCURV INLET

-----  
 PRESSURE PROFILE: CONSTANT2  
 PRESSURE DROP: 0.0 PSI  
 PROPERTY OPTION SET: SYSOP12 ASME STEAM TABLE EQUATION OF STATE

```

-----
! DUTY      ! PRES      ! TEMP      ! VFRAC     !
!           !           !           !           !
!           !           !           !           !
! BTU/HR    ! PSIA      ! F         !           !
!           !           !           !           !
!=====!=====!=====!=====!
! 0.0       ! 14.6959   ! 77.0000   ! 0.0       !
! 3.4493+05 ! 14.6959   ! 76.5713   ! 0.0       !
! 6.8987+05 ! 14.6959   ! 76.1426   ! 0.0       !
! 1.0348+06 ! 14.6959   ! 75.7140   ! 0.0       !
! 1.3797+06 ! 14.6959   ! 75.2853   ! 0.0       !
!-----!-----!-----!-----!
! 1.7247+06 ! 14.6959   ! 74.8567   ! 0.0       !
! 2.0696+06 ! 14.6959   ! 74.4280   ! 0.0       !
! 2.4145+06 ! 14.6959   ! 73.9994   ! 0.0       !
! 2.7595+06 ! 14.6959   ! 73.5708   ! 0.0       !
! 3.1044+06 ! 14.6959   ! 73.1422   ! 0.0       !
!-----!-----!-----!-----!
! 3.4493+06 ! 14.6959   ! 72.7136   ! 0.0       !
! 3.7943+06 ! 14.6959   ! 72.2850   ! 0.0       !
! 4.1392+06 ! 14.6959   ! 71.8564   ! 0.0       !
! 4.4841+06 ! 14.6959   ! 71.4279   ! 0.0       !
! 4.8291+06 ! 14.6959   ! 70.9994   ! 0.0       !
!-----!-----!-----!-----!
! 5.1740+06 ! 14.6959   ! 70.5708   ! 0.0       !
! 5.5189+06 ! 14.6959   ! 70.1423   ! 0.0       !
! 5.8639+06 ! 14.6959   ! 69.7138   ! 0.0       !
! 6.2088+06 ! 14.6959   ! 69.2853   ! 0.0       !
! 6.5537+06 ! 14.6959   ! 68.8569   ! 0.0       !
!-----!-----!-----!-----!
! 6.8987+06 ! 14.6959   ! 68.4284   ! 0.0       !
! 7.2436+06 ! 14.6959   ! 68.0000   ! 0.0       !
-----
  
```

HEATX HOT-TQCUR MS-HX-3 TQCURV INLET

-----  
 PRESSURE PROFILE: CONSTANT2  
 PRESSURE DROP: 0.0 PSI  
 PROPERTY OPTION SET: WILSON WILSON / IDEAL GAS

```

-----
! DUTY      ! PRES      ! TEMP      ! VFRAC     !
!           !           !           !           !
!           !           !           !           !
! BTU/HR    ! PSIA      ! F         !           !
!           !           !           !           !
!=====!=====!=====!=====!
! 0.0       ! 34.0878   ! 133.8639   ! 0.0       !
! 3.4493+05 ! 34.0878   ! 132.2029   ! 0.0       !
! 6.8987+05 ! 34.0878   ! 130.5399   ! 0.0       !
! 1.0348+06 ! 34.0878   ! 128.8751   ! 0.0       !
! 1.3797+06 ! 34.0878   ! 127.2084   ! 0.0       !
-----
  
```

1.7247+06	34.0878	125.5398	0.0
2.0696+06	34.0878	123.8694	0.0
2.4145+06	34.0878	122.1971	0.0
2.7595+06	34.0878	120.5230	0.0
3.1044+06	34.0878	118.8471	0.0
3.4493+06	34.0878	117.1694	0.0
3.7943+06	34.0878	115.4899	0.0
4.1392+06	34.0878	113.8087	0.0
4.4841+06	34.0878	112.1256	0.0
4.8291+06	34.0878	110.4409	0.0
5.1740+06	34.0878	108.7544	0.0
5.5189+06	34.0878	107.0662	0.0
5.8639+06	34.0878	105.3763	0.0
6.2088+06	34.0878	103.6847	0.0
6.5537+06	34.0878	101.9915	0.0
6.8987+06	34.0878	100.2966	0.0
7.2436+06	34.0878	98.6000	0.0

BLOCK: MS-PUMP- MODEL: PUMP

INLET STREAM: S-167  
 OUTLET STREAM: S-168  
 PROPERTY OPTION SET: WILSON WILSON / IDEAL GAS

*** MASS AND ENERGY BALANCE ***			
	IN	OUT	RELATIVE DIFF.
TOTAL BALANCE			
MOLE (LBMOL/HR)	10824.3	10824.3	0.00000
MASS (LB/HR )	216548.	216548.	0.00000
ENTHALPY (BTU/HR )	-0.138003E+10	-0.138000E+10	-0.190188E-04

*** CO2 EQUIVALENT SUMMARY ***		
FEED STREAMS CO2E	0.00000	LB/HR
PRODUCT STREAMS CO2E	0.00000	LB/HR
NET STREAMS CO2E PRODUCTION	0.00000	LB/HR
UTILITIES CO2E PRODUCTION	0.00000	LB/HR
TOTAL CO2E PRODUCTION	0.00000	LB/HR

*** INPUT DATA ***	
OUTLET PRESSURE PSIA	44.0878
DRIVER EFFICIENCY	1.00000

FLASH SPECIFICATIONS:  
 LIQUID PHASE CALCULATION  
 NO FLASH PERFORMED  
 MAXIMUM NUMBER OF ITERATIONS 30  
 TOLERANCE 0.000100000

*** RESULTS ***	
VOLUMETRIC FLOW RATE CUFT/HR	3,362.08
PRESSURE CHANGE PSI	29.3919
NPSH AVAILABLE FT-LBF/LB	32.1169
FLUID POWER HP	7.18676
BRAKE POWER HP	10.3153
ELECTRICITY KW	7.69209
PUMP EFFICIENCY USED	0.69671
NET WORK REQUIRED HP	10.3153
HEAD DEVELOPED FT-LBF/LB	65.7119

BLOCK: SPLITTER MODEL: FSPLIT

-----  
INLET STREAM: S-170  
OUTLET STREAMS: S-171 S-173  
PROPERTY OPTION SET: WILSON WILSON / IDEAL GAS

\*\*\* MASS AND ENERGY BALANCE \*\*\*  
IN OUT RELATIVE DIFF.  
TOTAL BALANCE  
MOLE (LBMOL/HR) 10824.3 10824.3 0.00000  
MASS (LB/HR ) 216548. 216548. 0.00000  
ENTHALPY (BTU/HR ) -0.134131E+10 -0.134131E+10 -0.177750E-15

\*\*\* CO2 EQUIVALENT SUMMARY \*\*\*  
FEED STREAMS CO2E 0.00000 LB/HR  
PRODUCT STREAMS CO2E 0.00000 LB/HR  
NET STREAMS CO2E PRODUCTION 0.00000 LB/HR  
UTILITIES CO2E PRODUCTION 0.00000 LB/HR  
TOTAL CO2E PRODUCTION 0.00000 LB/HR

\*\*\* INPUT DATA \*\*\*  
FRACTION OF FLOW STRM=S-171 FRAC= 0.77745

\*\*\* RESULTS \*\*\*  
STREAM= S-171 SPLIT= 0.77745 KEY= 0 STREAM-ORDER= 1  
S-173 0.22255 0 2

## Appendix C: Material Safety Data Sheets

This appendix contains MSDS forms for all major materials in our process. They are in the following order:

1,3-propanediol

Glycerol

Glucose

Hydrogen

Nickel





Health	2
Fire	2
Reactivity	0
Personal Protection	J

## Material Safety Data Sheet 1,3-Propanediol MSDS

### Section 1: Chemical Product and Company Identification

Product Name: 1,3-Propanediol  
 Catalog Codes: SLP5347  
 CAS#: 504-63-2  
 RTECS: TY2010000  
 TSCA: TSCA 8(b) inventory; No products were found.  
 CBI: Not available.  
 Synonym:  
 Chemical Name: Not available.  
 Chemical Formula: Not available.

Contact Information:  
 ScienceLab.com, Inc.  
 14025 Smith Rd.  
 Houston, Texas 77396  
 US Sales: 1.800.904.7247  
 International Sales: 1.281.441.4400  
 Order Online: ScienceLab.com

CHEMTREC (24HR Emergency Telephone), call:  
 1-800-424-9300  
 International CHEMTREC, call: 1-703-527-3887  
 For non-emergency assistance, call: 1-281-441-4400

### Section 2: Composition and Information on Ingredients

Composition:		
Name	CAS #	% by Weight
{1,3-Propanediol	504-63-2	100

Toxicological Data on Ingredients: 1,3-Propanediol LD50: Not available. LC50: Not available.

### Section 3: Hazards Identification

**Potential Acute Health Effects:**  
 Hazardous in case of skin contact (irritant), of eye contact (irritant). Slightly hazardous in case of skin contact (sensitizer, permeator).

**Potential Chronic Health Effects:**  
 CARCINOGENIC EFFECTS: Not available. MUTAGENIC EFFECTS: Not available. TERATOGENIC EFFECTS: Not available. DEVELOPMENTAL TOXICITY: Not available. Repeated or prolonged exposure is not known to aggravate medical condition.

### Section 4: First Aid Measures

**Eye Contact:**  
 Check for and remove any contact lenses. Immediately flush eyes with running water for at least 15 minutes, keeping eyelids open. Cold water may be used. Do not use an eye ointment. Seek medical attention.

**Skin Contact:**  
 After contact with skin, wash immediately with plenty of water. Gently and thoroughly wash the contaminated skin with running water and non-abrasive soap. Be particularly careful to clean folds, creases, and groin. Cold water may be used.  
 Cover the irritated skin with an emollient. If irritation persists, seek medical attention. Wash contaminated clothing before reusing.

**Serious Skin Contact:**  
 Wash with a disinfectant soap and cover the contaminated skin with an anti-bacterial cream. Seek medical attention.

**Inhalation:** Allow the victim to rest in a well ventilated area. Seek immediate medical attention.

**Serious Inhalation:** Not available.

**Ingestion:**  
 Do not induce vomiting. Loosen tight clothing such as a collar, tie, belt or waistband. If the victim is not breathing, perform mouth-to-mouth resuscitation. Seek immediate medical attention.

**Serious Ingestion:** Not available.

### Section 5: Fire and Explosion Data

**Flammability of the Product:** Combustible.

**Auto-Ignition Temperature:** Not available.

**Flash Points:** CLOSED CUP: 79°C (174.2°F).

**Flammable Limits:** Not available.

**Products of Combustion:** Not available.

**Fire Hazards in Presence of Various Substances:** Not available.

**Explosion Hazards in Presence of Various Substances:**  
 Risks of explosion of the product in presence of mechanical impact: Not available. Risks of explosion of the product in presence of static discharge: Not available.

**Fire Fighting Media and Instructions:**

**SMALL FIRE:** Use DRY chemical powder. **LARGE FIRE:** Use water spray, fog or foam. Do not use water jet.

**Special Remarks on Fire Hazards:** Not available.

**Special Remarks on Explosion Hazards:** Not available.

### Section 6: Accidental Release Measures

**Small Spill:**  
 Dilute with water and mop up, or absorb with an inert dry material and place in an appropriate waste disposal container. Finish cleaning by spreading water on the contaminated surface and dispose of according to local and regional authority requirements.

**Large Spill:**  
 Combustible material. Keep away from heat. Keep away from sources of ignition. Stop leak if without risk. Finish cleaning by spreading water on the contaminated surface and allow to evacuate through the sanitary system.

### Section 7: Handling and Storage

**Precautions:**  
 Keep away from heat. Keep away from sources of ignition. Ground all equipment containing material. Do not breathe gas/fumes/vapour/spray. Wear suitable protective clothing if you feel unwell, seek medical attention and show the label when possible. Avoid contact with skin and eyes.

<p><b>Storage:</b> Flammable materials should be stored in a separate safety storage cabinet or room. Keep away from heat. Keep away from sources of ignition. Keep container tightly closed. Keep in a cool, well-ventilated place. Ground all equipment containing material. Keep container dry. Keep in a cool place.</p>
<p><b>Section 8: Exposure Controls/Personal Protection</b></p>
<p><b>Engineering Controls:</b> Provide exhaust ventilation or other engineering controls to keep the airborne concentrations of vapors below their respective threshold limit value. Ensure that eyewash stations and safety showers are proximal to the work-station location.</p> <p><b>Personal Protection:</b> Splash goggles. Lab coat. Gloves.</p> <p><b>Personal Protection in Case of a Large Spill:</b> Splash goggles. Full suit. Boots. Gloves. Suggested protective clothing might not be sufficient; consult a specialist BEFORE handling this product.</p> <p><b>Exposure Limits:</b> Not available.</p>
<p><b>Section 9: Physical and Chemical Properties</b></p>
<p><b>Physical state and appearance:</b> Liquid.</p> <p><b>Odor:</b> Not available.</p> <p><b>Taste:</b> Not available.</p> <p><b>Molecular Weight:</b> 76.1 g/mole</p> <p><b>Color:</b> Colorless to light yellow.</p> <p><b>pH (1% soln/water):</b> Not available.</p> <p><b>Boiling Point:</b> Decomposes.</p> <p><b>Melting Point:</b> -27°C (-16.6°F)</p> <p><b>Critical Temperature:</b> Not available.</p> <p><b>Specific Gravity:</b> 1.0597 (Water = 1)</p> <p><b>Vapor Pressure:</b> Not available.</p> <p><b>Vapor Density:</b> 2.62 (Air = 1)</p> <p><b>Volatility:</b> Not available.</p> <p><b>Odor Threshold:</b> Not available.</p> <p><b>Water/Oil Dist. Coeff.:</b> Not available.</p> <p><b>Ionicity (in Water):</b> Not available.</p> <p><b>Dispersion Properties:</b> See solubility in water.</p> <p><b>Solubility:</b> Easily soluble in cold water.</p>
<p><b>Section 10: Stability and Reactivity Data</b></p>
<p><b>Stability:</b> The product is stable.</p> <p><b>Instability Temperature:</b> Not available.</p> <p><b>Conditions of Instability:</b> Not available.</p>

<p><b>Incompatibility with various substances:</b> Not available.</p> <p><b>Corrosivity:</b> Non-corrosive in presence of glass.</p> <p><b>Special Remarks on Reactivity:</b> Not available.</p> <p><b>Special Remarks on Corrosivity:</b> Not available.</p> <p><b>Polymerization:</b> No.</p>
<p><b>Section 11: Toxicological Information</b></p>
<p><b>Routes of Entry:</b> Eye contact.</p> <p><b>Toxicity to Animals:</b> LD50: Not available. LC50: Not available.</p> <p><b>Chronic Effects on Humans:</b> Not available.</p> <p><b>Other Toxic Effects on Humans:</b> Hazardous in case of skin contact (irritant). Slightly hazardous in case of skin contact (sensitizer, permeator).</p> <p><b>Special Remarks on Toxicity to Animals:</b> Not available.</p> <p><b>Special Remarks on Chronic Effects on Humans:</b> Not available.</p> <p><b>Special Remarks on other Toxic Effects on Humans:</b> Not available.</p>
<p><b>Section 12: Ecological Information</b></p>
<p><b>Ecotoxicity:</b> Not available.</p> <p><b>BOD5 and COD:</b> Not available.</p> <p><b>Products of Biodegradation:</b> Possibly hazardous short term degradation products are not likely. However, long term degradation products may arise.</p> <p><b>Toxicity of the Products of Biodegradation:</b> The products of degradation are more toxic.</p> <p><b>Special Remarks on the Products of Biodegradation:</b> Not available.</p>
<p><b>Section 13: Disposal Considerations</b></p>
<p><b>Waste Disposal:</b></p>
<p><b>Section 14: Transport Information</b></p>
<p><b>DOT Classification:</b> Not a DOT controlled material (United States).</p> <p><b>Identification:</b> Not applicable.</p> <p><b>Special Provisions for Transport:</b> Not applicable.</p>
<p><b>Section 15: Other Regulatory Information</b></p>
<p><b>Federal and State Regulations:</b> Connecticut carcinogen reporting list.: 1,3-Propanediol</p> <p><b>Other Regulations:</b></p>

<p>OSHA: Hazardous by definition of Hazard Communication Standard (29 CFR 1910.1200). EINECS: This product is on the European Inventory of Existing Commercial Chemical Substances.</p> <p><b>Other Classifications:</b></p> <p>WHMIS (Canada): CLASS B-3: Combustible liquid with a flash point between 37.8°C (100°F) and 93.3°C (200°F).</p> <p>DSCCL (EEC): R36/38- Irritating to eyes and skin.</p> <p>HMS (U.S.A.):</p> <p>Health Hazard: 2</p> <p>Fire Hazard: 2</p> <p>Reactivity: 0</p> <p>Personal Protection: j</p> <p>National Fire Protection Association (U.S.A.):</p> <p>Health: 2</p> <p>Flammability: 2</p> <p>Reactivity: 0</p> <p><b>Specific hazard:</b></p> <p>Protective Equipment: Gloves. Lab coat. Wear appropriate respirator when ventilation is inadequate. Splash goggles.</p>
<p><b>Section 16: Other Information</b></p> <p>References: Not available.</p> <p>Other Special Considerations: Not available.</p> <p>Created: 10/09/2005 06:12 PM</p> <p>Last Updated: 05/21/2013 12:00 PM</p> <p><i>The information above is believed to be accurate and represents the best information currently available to us. However, we make no warranty of merchantability or any other warranty, express or implied, with respect to such information, and we assume no liability resulting from its use. Users should make their own investigations to determine the suitability of the information for their particular purposes. In no event shall ScienceLab.com be liable for any claims, losses, or damages of any third party or for lost profits or any special, indirect, incidental, consequential or exemplary damages, howsoever arising, even if ScienceLab.com has been advised of the possibility of such damages.</i></p>

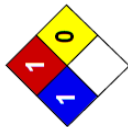

Health	1
Fire	1
Reactivity	0
Personal Protection	G

## Material Safety Data Sheet Glycerin MSDS

### Section 1: Chemical Product and Company Identification

**Product Name:** Glycerin  
**Catalog Codes:** SLG1171, SLG1894, SLG1111, SLG1615  
**CAS#:** 56-81-5  
**RTECS:** MA8050000  
**TSCA:** TSCA 8(b) inventory; Glycerin  
**Chemical Name:** Glycerin  
**Chemical Formula:** C<sub>3</sub>H<sub>5</sub>(OH)<sub>3</sub>

**Contact Information:**  
**Sciencelab.com, Inc.**  
 14025 Smith Rd.  
 Houston, Texas 77396  
**US Sales:** 1-800-301-7247  
**International Sales:** 1-281-441-4400  
**Order Online:** [Sciencelab.com](http://Sciencelab.com)  
**CHEMTREC (24HR Emergency Telephone), call:**  
 1-800-424-9300  
**International CHEMTREC, call:** 1-703-527-3887  
**For non-emergency assistance, call:** 1-281-441-4400

### Section 2: Composition and Information on Ingredients

Name	CAS #	% by Weight
Glycerin	56-81-5	100

**Toxicological Data on Ingredients:** Glycerin (LD50): Acute: 12600 mg/kg [Rat]. 4090 mg/kg [Mouse]. DERMAL (LD50): Acute: 10000 mg/kg [Rabbit]. MIST(LC50): Acute: >gt;570 mg/m<sup>3</sup> 1 hours [Rat].

### Section 3: Hazards Identification

**Potential Acute Health Effects:** Slightly hazardous in case of skin contact (irritant, permeator), of eye contact (irritant), of ingestion, or inhalation.

**Potential Chronic Health Effects:**  
**CARCINOGENIC EFFECTS:** Not available. **MUTAGENIC EFFECTS:** Not available. **TERATOGENIC EFFECTS:** Not available. **DEVELOPMENTAL TOXICITY:** Not available. The substance may be toxic to kidneys. Repeated or prolonged exposure to the substance can produce target organs damage.

### Section 4: First Aid Measures

**Eye Contact:**  
 Check for and remove any contact lenses. In case of contact, immediately flush eyes with plenty of water for at least 15 minutes. Cold water may be used. Get medical attention if irritation occurs.

**Skin Contact:**  
 Wash with soap and water. Cover the irritated skin with an emollient. Get medical attention if irritation develops. Cold water may be used.

**Serious Skin Contact:** Not available.

**Inhalation:**  
 If inhaled, remove to fresh air. If not breathing, give artificial respiration. If breathing is difficult, give oxygen. Get medical attention immediately.

**Serious Inhalation:** Not available.

**Ingestion:**  
 Do NOT induce vomiting unless directed to do so by medical personnel. Never give anything by mouth to an unconscious person. Loosen tight clothing such as a collar, tie, belt or waistband. Get medical attention if symptoms appear.

**Serious Ingestion:** Not available.

### Section 5: Fire and Explosion Data

**Flammability of the Product:** May be combustible at high temperature.

**Auto-Ignition Temperature:**  
 370°C (688°F) (NFPA Fire Protection Guide to Hazardous Materials, 13th ed., 2002; NIOSH ICSC, 2001; CHRIS, 2001) 392 C (739 F) (Lewis, 1997)

**Flash Points:**  
 CLOSED CUP: 160°C (320°F). (Chemical Hazard Response Information System, 2001; Lewis, 1997) OPEN CUP: 177°C (350.6°F) (Budavari, 2000; Chemical Response Information System, 2001; NIOSH ICSC, 2001) OPEN CUP: 199 C (390 F) (National Fire Protection Association, Fire Protection Guide to Hazardous Materials, 13 ed., 2002)

**Flammable Limits:** LOWER: 0.9%

**Products of Combustion:** These products are carbon oxides (CO, CO<sub>2</sub>), irritating and toxic fumes.

**Fire Hazards in Presence of Various Substances:**

Slightly flammable to flammable in presence of open flames and sparks, of heat, of oxidizing materials. Non-flammable in presence of shocks.

**Explosion Hazards in Presence of Various Substances:**

Risks of explosion of the product in presence of mechanical impact: Not available. Risks of explosion of the product in presence of static discharge: Not available. Explosive in presence of oxidizing materials.

**Fire Fighting Media and Instructions:**

SMALL FIRE: Use DRY chemical powder. LARGE FIRE: Use water spray, fog or foam. Do not use water jet.

**Special Remarks on Fire Hazards:** Not available.

**Special Remarks on Explosion Hazards:**

Glycerin is incompatible with strong oxidizers such as chromium trioxide, potassium chlorate, or potassium permanganate and may explode on contact with these compounds. Explosive glyceryl nitrate is formed from a mixture of glycerin and nitric and sulfuric acids. Perchloric acid + lead oxide + glycerin form perchloric esters which may be explosive. Glycerin and chlorine may explode if heated and confined.

### Section 6: Accidental Release Measures

**Small Spill:**  
 Dilute with water and mop up, or absorb with an inert dry material and place in an appropriate waste disposal container. Finish cleaning by spreading water on the contaminated surface and dispose of according to local and regional authority requirements.

**Large Spill:**

Stop leak if without risk. If the product is in its solid form: Use a shovel to put the material into a convenient waste disposal container. If the product is in its liquid form: Do not get water inside container. Absorb with an inert material and put the spilled material in an appropriate waste disposal. Do not touch spilled material. Use water spray to reduce vapors. Prevent entry into sewers, basements or confined areas, dike if needed. Eliminate all ignition sources. Call for assistance on disposal. Finish cleaning by spreading water on the contaminated surface and allow to evacuate through the sanitary system. Be careful that the product is not present at a concentration level above TLV. Check TLV on the MSDS and with local authorities.

#### Section 7: Handling and Storage

**Precautions:**  
Keep away from heat. Keep away from sources of ignition. Ground all equipment containing material. Do not ingest. Do not breathe gas/fumes/vapors/spray. Wear suitable protective clothing. If ingested, seek medical advice immediately and show the container or the label. Keep away from incompatibles such as oxidizing agents.

**Storage:** Keep container tightly closed. Keep container in a cool, well-ventilated area. Hygroscopic

#### Section 8: Exposure Controls/Personal Protection

**Engineering Controls:**  
Provide exhaust ventilation or other engineering controls to keep the airborne concentrations of vapors below their respective threshold limit value. Ensure that eyewash stations and safety showers are proximal to the work-station location.

**Personal Protection:**  
Safety glasses. Lab coat. Vapor respirator. Be sure to use an approved/certified respirator or equivalent. Gloves.

**Personal Protection in Case of a Large Spill:**  
Splash goggles. Full suit. Vapor respirator. Boots. Gloves. A self contained breathing apparatus should be used to avoid inhalation of the product. Suggested protective clothing might not be sufficient; consult a specialist BEFORE handling this product.

**Exposure Limits:**  
TWA: 10 (mg/m3) from ACGIH (TLV) [United States] [1999] Inhalation Total. TWA: 15 (mg/m3) from OSHA (PEL) [United States] Inhalation Total. TWA: 10 STEL: 20 (mg/m3) [Canada] TWA: 5 (mg/m3) from OSHA (PEL) [United States] Inhalation Respirable. Consult local authorities for acceptable exposure limits.

#### Section 9: Physical and Chemical Properties

**Physical state and appearance:** Liquid. (Viscous (Syrupy) liquid.)

**Odor:** Mild

**Taste:** Sweet.

**Molecular Weight:** 92.09 g/mole

**Color:** Clear Colorless.

**pH (1% soln/water):** Not available.

**Boiling Point:** 290°C (554°F)

**Melting Point:** 19°C (66.2°F)

**Critical Temperature:** Not available.

**Specific Gravity:** 1.2636 (Water = 1)

**Vapor Pressure:** 0 kPa (@ 20°C)

**Vapor Density:** 3.17 (Air = 1)

**Volatility:** Not available.

**Odor Threshold:** Not available.

**Water/Oil Dist. Coeff.:** The product is more soluble in water; log(oil/water) = -1.8

**Ioncity (in Water):** Not available.

**Dispersion Properties:** See solubility in water, acetone.

**Solubility:**

Miscible in cold water, hot water and alcohol. Partially soluble in acetone. Very slightly soluble in diethyl ether (ethyl ether). Limited solubility in ethyl acetate. Insoluble in carbon tetrachloride, benzene, chloroform, petroleum ethers, and oils

#### Section 10: Stability and Reactivity Data

**Stability:** The product is stable.

**Instability Temperature:** Not available.

**Conditions of Instability:** Avoid contact with incompatible materials, excess heat and ignition, sources, moisture.

**Incompatibility with various substances:** Highly reactive with oxidizing agents.

**Corrosivity:** Non-corrosive in presence of glass.

**Special Remarks on Reactivity:**

Hygroscopic. Glycerin is incompatible with strong oxidizers such as chromium trioxide, potassium chlorate, or potassium permanganate. Glycerin may react violently with acetic anhydride, aniline and nitrobenzene, chromic oxide, lead oxide and fluome, phosphorous trioxide, ethylene oxide and heat, silver perchlorate, sodium peroxide, sodium hydride.

**Special Remarks on Corrosivity:** Not available.

**Polymerization:** Will not occur.

#### Section 11: Toxicological Information

**Routes of Entry:** Absorbed through skin. Eye contact.

**Toxicity to Animals:**

**WARNING: THE LC50 VALUES HEREUNDER ARE ESTIMATED ON THE BASIS OF A 4-HOUR EXPOSURE. Acute oral toxicity (LD50): 4090 mg/kg [Mouse]. Acute dermal toxicity (LD50): 10000 mg/kg [Rabbit]. Acute toxicity of the mist (LC50): >570 mg/m<sup>3</sup> 1 hours [Rat].**

**Chronic Effects on Humans:** May cause damage to the following organs: kidneys.

**Other Toxic Effects on Humans:** Slightly hazardous in case of skin contact (irritant), of ingestion, of inhalation.

**Special Remarks on Toxicity to Animals:**

**TDL (rat) - Route:** Oral; Dose: 100 mg/kg 1 day prior to mating. **TDL (human) - Route:** Oral; Dose: 1428 mg/kg

**Special Remarks on Chronic Effects on Humans:**

Glycerin is transferred across the placenta in small amounts. May cause adverse reproductive effects based on animal data (Paternal Effects (Rat): Spermatogenesis (including genetic material, sperm morphology, motility, and count), Testes, epididymis, sperm duct). May affect genetic material.

**Special Remarks on other Toxic Effects on Humans:**

**Acute Potential Health Effects:** Low hazard for normal industrial handling or normal workplace conditions. Skin: May cause skin irritation. May be absorbed through skin. Eyes: May cause eye irritation with stinging, redness, burning sensation, and tearing, but no eye injury. Ingestion: Low toxicity except with very large doses. When large doses are ingested, it can cause gastrointestinal tract irritation with thirst (dehydration), nausea or vomiting diarrhea. It may also affect behavior/central nervous system/nervous system (central nervous system depression, general anesthetic, headache, dizziness, confusion, insomnia, toxic psychosis, muscle weakness, paralysis/convolutions), urinary system/kidneys(renal failure,

hemoglobinuria), cardiovascular system (cardiac arrhythmias), liver. It may also cause elevated blood sugar. Inhalation: Due to low vapor pressure, inhalation of the vapors at room temperature is unlikely. Inhalation of mist may cause respiratory tract irritation. Chronic Potential Health Effects: Ingestion: Prolonged or repeated ingestion may affect the blood/hemolysis, changes in white blood cell count), endocrine system (changes in adrenal weight), respiratory system, and may cause kidney injury.

#### Section 12: Ecological Information

**Ecotoxicity:** Ecotoxicity in water (LC50): 58.5 ppm 96 hours [Trout].  
**BOD5 and COD:** Not available.

**Products of Biodegradation:**  
Possibly hazardous short-term degradation products are not likely. However, long-term degradation products may arise.  
**Toxicity of the Products of Biodegradation:** The products of degradation are less toxic than the product itself.

**Special Remarks on the Products of Biodegradation:** Not available.

#### Section 13: Disposal Considerations

**Waste Disposal:**  
Waste must be disposed of in accordance with federal, state and local environmental control regulations.

#### Section 14: Transport Information

**DOT Classification:** Not a DOT controlled material (United States).  
**Identification:** Not applicable.

**Special Provisions for Transport:** Not applicable.

#### Section 15: Other Regulatory Information

**Federal and State Regulations:**  
Illinois toxic substances disclosure to employee act: Glycerin Rhode Island RTK hazardous substances: Glycerin Pennsylvania RTK: Glycerin Minnesota: Glycerin Massachusetts RTK: Glycerin Tennessee - Hazardous Right to Know: Glycerin TSCA 8(b) inventory: Glycerin

**Other Regulations:**  
OSHA: Hazardous by definition of Hazard Communication Standard (29 CFR 1910.1200). EINECS: This product is on the European Inventory of Existing Commercial Chemical Substances.

**Other Classifications:**

**WHMIS (Canada):** Not controlled under WHMIS (Canada).

**DSDL (EEC):**  
Not available S24/25. Avoid contact with skin and eyes.

**HMS (U.S.A.):**

**Health Hazard:** 1

**Fire Hazard:** 1

**Reactivity:** 0

**Personal Protection:** g

**National Fire Protection Association (U.S.A.):**

**Health:** 1

**Flammability:** 1

**Reactivity:** 0

**Specific hazard:**

**Protective Equipment:**  
Gloves. Lab coat. Vapor respirator. Be sure to use an approved/certified respirator or equivalent. Wear appropriate respirator when ventilation is inadequate. Safety glasses.

#### Section 16: Other Information

**References:** Not available.

**Other Special Considerations:** Not available.

**Created:** 10/10/2005 08:38 PM

**Last Updated:** 05/21/2013 12:00 PM

*The information above is believed to be accurate and represents the best information currently available to us. However, we make no warranty of merchantability or any other warranty, express or implied, with respect to such information, and we assume no liability resulting from its use. Users should make their own investigations to determine the suitability of the information for their particular purposes. In no event shall ScienceLab.com be liable for any claims, losses, or damages of any third party or for lost profits or any special, indirect, incidental, consequential or exemplary damages, howsoever arising, even if ScienceLab.com has been advised of the possibility of such damages.*

# Material Safety Data Sheet



Revision date: 09/18/2009  
Print Date: 09/18/2009  
Version: 0

## I. IDENTIFICATION OF THE SUBSTANCE/PREPARATION AND THE COMPANY UNDERTAKING

**Product name:** Glucose HK liquid, GLUC2  
**Product number:** Correlated Diagnostics  
**Product line:** Cobas  
**Supplier:** Roche Diagnostics Corporation  
11115 Haggie Road (U.S. or Canada)  
11115 Haggie Road (U.S. or Canada)  
1-700-527-3887 (international)  
**Emergency telephone number:**  
CHEMTREC: 1-800-424-9300 (U.S. or Canada)  
1-700-527-3887 (international)  
**Site Phone Number:** 1-800-428-5074

## 6. ACCIDENTAL RELEASE MEASURES

**Personal precautions:** Evacuate personnel to safe areas.  
**Methods for cleaning up:** Sweep up or vacuum (if powder) or soak up with inert absorbent material (if liquid), then place into a suitable clean, dry, closed container, and label for disposal.

## 7. HANDLING AND STORAGE

**Handling:** Protect from contamination. Wear personal protective equipment.  
**Storage:** No special precautions required.

## 8. EXPOSURE CONTROLS / PERSONAL PROTECTION

**Engineering measures:** Ensure adequate ventilation, especially in confined areas.

**Personal Protective Equipment**

**Respiratory protection:** Respiratory protection is not required under normal use of this product. If respiratory protection is needed, follow the OSHA regulation, 29CFR1910.134. Always use a NIOSH approved respirator when necessary.

**Hand protection:** Wear appropriate protective gloves to prevent skin contact. Replace torn or punctured gloves promptly.

**Skin and body protection:** Wear appropriate body protection to prevent skin contact.

**Eye protection:** Wear appropriate eye protection to prevent eye contact.

**Hygiene measures:** Avoid contact with skin, eyes and clothing.

## 9. PHYSICAL AND CHEMICAL PROPERTIES

**pH:** 7.0-7.8  
**Physical state:** Liquid.

## 10. STABILITY AND REACTIVITY

**Stability:** Stable under recommended storage conditions.  
**Reactivity:** No reaction with oxidizing agents.  
**Hazardous decomposition products:** Carbon oxides.  
**Materials to avoid:** Strong acids and strong bases. Strong oxidising agents.

## 11. TOXICOLOGICAL INFORMATION

Components	NIOSH - Selected LD50s and LC50s:	NIOSH Pocket Guide - Target Organs:
Sodium azide	=20 mg/kg Dermal LD50 Rabbit	eyes skin CNS OVS kidneys
Sodium sulfate anhydrous	>10000 mg/kg Oral LD50 Rat	

**Inhalation:** No additional data available.  
**Skin:** No additional data available.  
**Acute toxicity:** No data is available on the product itself.  
**Mutagenic effects:** No data is available on the product itself.  
**Reproductive toxicity:** No data is available on the product itself.

## 12. ECOLOGICAL INFORMATION

**Bioaccumulation:** Not determined.  
**Aquatic toxicity:** No data is available on the product itself.  
**Ecotoxicity effects:** No data is available on the product itself.  
**Product number:** 04657527190  
**Product name:** Glucose HK liquid, GLUC2

## 2. COMPOSITION/INFORMATION ON INGREDIENTS

Description 1: R1 and R2 (only R2 contains the sodium sulfate anhydrous)

Components	CAS Number	Weight %	OSHA PEL	OSHA STEL	ACGIH TLV	ACGIH STEL	ACGIH TLV
Sodium azide	20628-22-8	0.01-0.1	NA	NA	NA	0.11 ppm Ceiling	NA
Sodium sulfate anhydrous	7787-82-6	1-5	NA	NA	NA	0.25 mg/m <sup>3</sup> Ceiling	NA

## 3. HAZARDS IDENTIFICATION

**Emergency Overview**  
**MSD Ratings:** Health: 1 Flammability: 0 Reactivity: 0 Special: 1  
**Environmental:** Light Stable Non-flammable Non-toxic  
**Physical:** Non-combustible Non-flammable H-Harmful Irritant Ox-Oxidizer PB-Potential Biohazard  
**Reproductive:** S-Sensitizer T-Toxic T+Highly Toxic W-Water Reactive

**Principle routes of exposure:** Ingestion, inhalation, skin and/or eye contact.

**Inhalation:** May cause irritation of respiratory tract.

**Ingestion:** Ingestion may cause gastrointestinal irritation, nausea, vomiting and diarrhea.

**Skin contact:** May cause irritation in contact with skin.

**Eye contact:** Avoid contact with eyes. Contact with eyes may cause irritation.

**Sensitization or Odor threshold:** The following chemical(s) may cause sensitization, be absorbed via skin, and/or has an odor threshold for detection:

**Medical conditions aggravated by exposure:** None known

**Additional information:** None

## 4. FIRST AID MEASURES

**Inhalation:** Consult a physician. Move to fresh air. If not breathing, give artificial respiration. If breathing is difficult, give oxygen.

**Skin contact:** Rinse with plenty of water. If skin irritation persists, call a physician. Remove and wash contaminated clothing before reuse.

**Ingestion:** Consult a physician. Do not induce vomiting without medical advice.

**Eye contact:** In the case of contact with eyes, rinse immediately with plenty of water and seek medical advice.

**Notes to physician:** None determined

## 5. FIRE-FIGHTING MEASURES

**Suitable extinguishing media:** Use dry chemical, CO2, water spray or 'alcohol' foam

**U.S. EPA, RCRA, CERCLA, SARA, or DSG information on persistent, bioaccumulative, and toxic chemicals (PBTs):**  
The following chemicals are listed under the U.S. EPA regulations of RCRA, CERCLA, SARA, or DGC:

**13. DISPOSAL CONSIDERATIONS**

**Waste from residues / unused products:** Waste disposal must be in accordance with appropriate Federal, State, and local regulations. This product, if unaltered by use, may be disposed of by treatment at a permitted facility or as advised by your local hazardous waste regulatory authority. Residue from files extinguished with this material may be hazardous.

**14. TRANSPORT INFORMATION**

Is product hazardous to ship? No  
DOT:

**Proper shipping name:** None  
**UN Number:** Not applicable  
**Hazard class:** Not applicable  
**Subsidiary risk:** Not applicable  
**Packing group:** Not applicable

ICAO/IATA

**Proper shipping names:** None  
**UN Number:** Not applicable  
**Hazard class:** Not applicable  
**Subsidiary risk:** Not applicable  
**Packing group:** Not applicable

**15. REGULATORY INFORMATION**

U.S. Regulations:

**U.S. CERCLA/SARA/TSCA Regulatory Information:** The following chemicals are listed under the following TSCA/SARA/CERCLA lists. Refer to TSCA regulation if you need a definition for acronyms that may be shown in the TSCA Inventory field in the table below.

Components	CERCLA/SARA 302 RCRA TPO (40 CFR 302.41)	CERCLA/SARA 304 RCRA TPO (40 CFR 304.202.4)	SARA 313 Emission reporting	TSCA Inventory
Sodium azide	~500 lb TPO This material is a reactive solid. The TPO does not default to 1000 pounds for non-solution form.	~454 kg final RCQ	Listed	Present
Sodium sulfate anhydrous				Present

**U.S. Clean Water Act (CWA)/ California Proposition 65:** The following chemicals are listed under the CWA and/or California Proposition 65:

Canadian Regulations:

This product has been classified in accordance with the hazard criteria of the Controlled Products Regulations and the MSDS contains all the information required by the Controlled Products Regulations.

Components	Canada - WHMIS: Classifications of Substances:
Sodium azide	D1A
Sodium sulfate anhydrous	Uncontrolled product according to WHMIS classification criteria

**16. OTHER INFORMATION**

**Reason for revision:** Not applicable  
**References:** None  
**Additional advice:** None

**Prepared by:** Roche Diagnostics, Health & Safety Department, MSDS Contact: 317-521-7425 or 317-521-7505  
The information, data and recommendations contained herein are based upon information believed by Roche Diagnostics Operations after reasonable investigation and research, to be accurate; however, Roche Diagnostics Operations does not warrant the accuracy of this information. All materials and mixtures may present unknown hazards and should be used with caution. When necessary or appropriate, independent opinions regarding the risk of handling or exposure should be obtained from trained professionals. Roche Diagnostics Operations disclaims any warranty, express or implied, regarding the implied warranty of merchantability and fitness for a particular purpose. Roche Diagnostics Operations shall be liable for incidental or consequential damages, including lost profits, in no case shall Roche Diagnostics Operations be liable for incidental or consequential damages, including lost profits.

Product number: 04657527190

Product name: Glucose HK liquid, GLUC2

Product number: 04657527190

Product name: Glucose HK liquid, GLUC2



2.3. Other hazards : None.  
 Other hazards not contributing to the classification.

2.4. Unknown acute toxicity (GHS-US) : No data available

**SECTION 3: Composition/information on ingredients**

3.1. Substance	Product identifier (GHS No)	%
Hydrogen, compressed (non-oxidizing)	1333-74-0	100

3.2. Mixture : Not applicable

**SECTION 4: First aid measures**

4.1. Description of first aid measures : Remove victim to uncontaminated area wearing self contained breathing apparatus. Keep victim warm and rested. Call a doctor. Apply artificial respiration if breathing stopped.

First-aid measures after inhalation : Adverse effects not expected from this product.

First-aid measures after skin contact : Immediately flush eyes thoroughly with water for at least 15 minutes. Hold the eyelids open and away from the eyeballs to ensure that all surfaces are flushed thoroughly. Get immediate medical attention.

First-aid measures after eye contact : Ingestion is not considered a potential route of exposure.

4.2. Most important symptoms and effects, both acute and delayed : No additional information available

4.3. Indication of any immediate medical attention and special treatment needed : None.

**SECTION 5: Firefighting measures**

5.1. Extinguishing media : Suitable extinguishing media : Carbon dioxide, dry chemical powder, water spray, fog.

5.2. Special hazards arising from the substance or mixture : FIRE HAZARD : EXTREMELY FLAMMABLE GAS. The hydrogen flame is nearly invisible. Hydrogen has a low ignition energy; escaping hydrogen gas may ignite spontaneously. A fireball forms if the gas cloud ignites immediately after release. Hydrogen forms explosive mixtures with air and oxidizing agents.

Fire hazard : EXTREMELY FLAMMABLE GAS. Forms explosive mixtures with air and oxidizing agents.

Explosion hazard : No reactivity hazard other than the effects described in sub-sections below.

Reactivity : None.

5.3. Advice for firefighters : Evacuate all personnel from the danger area. Use self-contained breathing apparatus (SCBA) and protective clothing. Immediately cool containers with water from maximum distance. Stop leaking if safe to do so. Remove containers from area of fire if safe to do so. On-site fire brigades must comply with OSHA 29 CFR 1910.156 and applicable standards under 29 CFR 1910 Subpart L—Fire Protection.

Firefighting instructions : If venting or leaking gas catches fire, do not extinguish flames. Flammable vapors may spread from leak, creating an explosive ignition hazard. Vapors can be ignited by pilot lights, other flames, smoking, sparks, heaters, electrical equipment, static discharge, or other ignition sources at locations distant from product handling point. Explosive atmospheres may linger, entering an area, especially a confined area. Check the atmosphere with an appropriate device.

Special protective equipment for fire fighters : Standard protective clothing and equipment (Self Contained Breathing Apparatus) for fire fighters.

Prevention during firefighting : Evacuate all personnel from the danger area. Use self-contained breathing apparatus (SCBA) and protective clothing. Immediately cool containers with water from maximum distance. Stop leaking if safe to do so. Remove containers from area of fire if safe to do so. On-site fire brigades must comply with OSHA 29 CFR 1910.156 and applicable standards under 29 CFR 1910 Subpart L—Fire Protection.

EN (English US) SDS ID: P-4604 2/9

This document is only controlled while on the Praxair, Inc. website and a copy of this controlled version is available for download. Praxair cannot assure the integrity or accuracy of any version of this document after it has been downloaded or removed from our website.

**SECTION 1: Product and company identification**

1.1. Product identifier : Substance : Hydrogen, compressed  
 Name : Hydrogen, compressed  
 CAS No : 1333-74-0  
 Formula : H<sub>2</sub>

Other means of identification : Dihydrogen, parahydrogen, refrigerant gas R702, water gas

1.2. Relevant identified uses of the substance or mixture and uses advised against : Industrial use. Use as directed.

1.3. Details of the supplier of the safety data sheet : Praxair, Inc.  
 30 Old Ridgebury Road  
 Danbury, CT 06810-5113 - USA  
 T 1-800-772-9247 (1-800-PRAXAIR) - F 1-716-879-2146  
[www.praxair.com](http://www.praxair.com)

1.4. Emergency telephone number : Onsite Emergency, 1-800-645-4633

CHEMREC, 24hr/day 7days/week — Within USA, 1-800-424-9300, Outside USA, 001-703-527-3887 (collect calls accepted, Contract 17729)

**SECTION 2: Hazards identification**

2.1. Classification of the substance or mixture : Classification (GHS-US)  
 Flam. Gas 1 H220  
 Compressed gas H280  
 Full text of H-phrases: see section 16

2.2. Label elements : GHS-US labelling  
 Hazard pictograms (GHS-US)



Signal word (GHS-US) : Danger  
 Hazard statements (GHS-US) : H220 - EXTREMELY FLAMMABLE GAS. Gases may explode if heated.  
 H280 - CONTAINS PRESSURIZED GAS. MAY EXPLODE IF HEATED.  
 OSHA-H01 - MAY DISPLACE OXYGEN AND CAUSE RAPID SUFFOCATION.  
 CGA-H04 - MAY FORM EXPLOSIVE MIXTURES WITH AIR.  
 CGA-H08 - BURNS WITH INVISIBLE FLAME.  
 P202 - Do not handle until all safety precautions have been read and understood  
 P271-H280 - Use and store only outdoors or in a well-ventilated place.  
 P377 - Leaking gas fire: Do not extinguish, unless leak can be stopped safely  
 P501 - Dispose of contents and container in accordance with local regulations.  
 CGA-PG05 - Use a back flow preventer in the piping.  
 CGA-PG10 - Use only with equipment rated for cylinder pressure.  
 CGA-PG06 - Close valve after each use and when empty.  
 CGA-PG02 - Protect from sunlight when ambient temperature exceeds 52°C (125°F).

EN (English US) SDS ID: P-4604 1/9

**PRAXAIR**  
*Making our planet more productive™*

**Hydrogen, compressed**  
 Safety Data Sheet P-4604

according to U.S. Code of Federal Regulations 29 CFR 1910.1200, Hazard Communication.  
 Date of issue: 01/10/1980 Revision date: 01/13/2015 Supersedes: 03/01/2012

according to U.S. Code of Federal Regulations 29 CFR 1910.1200, Hazard Communication.  
 Date of issue: 01/10/1980 Revision date: 01/13/2015 Supersedes: 03/01/2012

**Specific methods**

: Use fire control measures appropriate for the surrounding fire. Exposed to fire and heat radiation may cause gas containers to rupture. Cool endangered containers with water spray jet from a protected position. Prevent water used in emergency cases from entering sewers and drainage systems. Stop flow of product if safe to do so. Use water spray or fog to knock down fire flames if possible.

**SECTION 6: Accidental release measures**

**6.1. Personal precautions, protective equipment and emergency procedures**

**General measures**  
 : EXTREMELY FLAMMABLE GAS. Forms explosive mixtures with air and oxidizing agents. See section 5. Evacuate personnel to a safe area. Appropriate self-contained breathing apparatus must be worn. Do not breathe vapors or gas. Avoid contact with skin and eyes. If safe to do so, ventilate area or move container to a well-ventilated area. Flammable gas may spread from leak. Before entering the area, especially a confined area, check the atmosphere with an appropriate device.

6.1.1. For non-emergency personnel

No additional information available

6.1.2. For emergency responders

No additional information available

6.2. Environmental precautions

Try to stop release.

6.3. Methods and material for containment and cleaning up

No additional information available

6.4. Reference to other sections

See also sections 8 and 13.

**SECTION 7: Handling and storage**

**7.1. Precautions for safe handling**

**Precautions for safe handling**  
 : Keep away from heat, hot surfaces, sparks, open flames and other ignition sources. No smoking. Use only non-sparking tools. Use only explosion-proof equipment.  
 Wear leather safety gloves and safety shoes when handling cylinders. Protect cylinders from physical damage; do not drag, roll, slide or drop. While moving cylinder, always keep in place removable valve cover. Never attempt to fit a cylinder by its cap; the cap is intended solely to protect the valve. When moving cylinders, even for short distances, use a cart (trolley, hand truck) or a cylinder cart. Do not use a crane or hoist to move cylinders. Do not use a pry bar into cap openings; doing so may damage the valve and cause a leak. Use an adjustable strap wrench to remove over-tight or rusted caps. Slowly open the valve. If the valve is hard to open, discontinue use and contact your supplier. Close the container valve after each use; keep closed even when empty. Never apply flame or localized heat directly to any part of the container. High temperatures may damage the container and/or cause the contents to leak. Do not use repair devices to fail unsafely, venting the container contents. For other precautions in using this product, see section 16.

**7.2. Conditions for safe storage, including any incompatibilities**

**Storage conditions**  
 : Store only where temperature will not exceed 129°F (52°C). Post "No Smoking or Open Flames" signs in storage and use areas. There must be no sources of ignition. Separate storage and use areas must be provided for compressed gases. Store in accordance with coded and marked products (e.g. NFPA 30, NFPA 55, NFPA 59, NFPA 70, and/or NFPA 221 in the U.S.) or according to requirements determined by the Authority Having Jurisdiction (AHJ). Always secure containers upright to keep them from falling or being knocked over. Install valve protection caps, if provided, firmly in place by hand when the container is not in use. Store full and empty containers separately. Use a first-in, first-out inventory system to prevent storing full containers for long periods. For other precautions in using this product, see section 16.

**OTHER PRECAUTIONS FOR HANDLING, STORAGE, AND USE:** When handling product under pressure, use piping and equipment adequately designed to withstand the pressures to be encountered. Never work on a pressurized system. Use a back flow preventive device in any piping system. If a leak occurs, close the container valve and blow down the system with adequate ventilation. If a leak occurs, close the container valve and blow down the system in a safe and environmentally correct manner in compliance with all international, federal/national, state/provincial, and local laws; then repair the leak. Never place a container where it may become part of an electrical circuit.

7.3. Specific end use(s)

None.

**SECTION 8: Exposure controls/personal protection**

**8.1. Control parameters**

Hydrogen, compressed (1333-74-9)	Not established
ACGIH	Not established
USA OSHA	Not established

**8.2. Exposure controls**

**Appropriate engineering controls**  
 : An explosion-proof local exhaust system is acceptable. Local exhaust and general ventilation must be adequate to meet exposure standards. Mechanic (general) engineering controls: Use only in a closed system. Closed system, ventilation, explosion-proof electrical equipment and lighting.

**Eye protection**

: Wear safety glasses with side shields.

**Respiratory protection**

: An air-supplied respirator must be used while working with this product in confined spaces. The respiratory protection used must conform with OSHA rules as specified in 29 CFR 1910.134. Select per OSHA 29 CFR 1910.134 and ANSI Z89.2.

**Thermal hazard protection**

: None necessary.

**Other information**

: Consider the use of flame resistant anti-static safety clothing. Wear safety shoes while handling containers.

**SECTION 9: Physical and chemical properties**

**9.1. Information on basic physical and chemical properties**

Physical state	: Gas
Appearance	: Colorless gas.
Molecular mass	: 2 g/mol
Color	: Colorless.
Odor	: No data available
Odor threshold	: No data available
pH	: Not applicable.
Relative evaporation rate (butyl acetate=1)	: No data available
Relative evaporation rate (ether=1)	: Not applicable.
Melting point	: -259 °C
Freezing point	: No data available
Boiling point	: -252.9 °C
Flash point	: No data available

EN (English US)

SDS ID: P-4604

419

EN (English US) SDS ID: P-4604 319

This document is only controlled while on the Praxair, Inc. website and a copy of this controlled version is available for download. Praxair cannot assure the integrity or accuracy of any version of this document after it has been downloaded or removed from our website.

**PRAXAIR**  
*Making our planet more productive*

**Hydrogen, compressed**  
 Safety Data Sheet P-4604  
 according to U.S. Code of Federal Regulations 29 CFR 1910.1200, Hazard Communication.  
 Date of issue: 01/01/1980 Revision date: 01/13/2015 Supersedes: 03/01/2012

Critical temperature : -230.9 °C  
 Auto-ignition temperature : 566 °C  
 Decomposition temperature : No data available  
 Flammability (solid, gas) : 4 - 75 vol %  
 Vapor pressure : Not applicable.  
 Critical pressure : 1293 kPa  
 Relative vapor density at 20 °C : No data available  
 Relative density : 0.07  
 Solubility : 0.07  
 Stability : Water: 1.6 mg/l  
 Log Pow : Not applicable.  
 Viscosity, kinematic : Not applicable.  
 Viscosity, dynamic : Not applicable.  
 Explosive properties : Not applicable.  
 Oxidizing properties : None.  
 Explosive limits : No data available

9.2. Other information  
 Gas group : Compressed gas  
 Additional information : BURNS WITH INVISIBLE FLAME.

**SECTION 10: Stability and reactivity**

10.1. Reactivity  
 No reactivity hazard other than the effects described in sub-sections below.

10.2. Chemical stability  
 Stable under normal conditions.

10.3. Possibility of hazardous reactions  
 Can form explosive mixture with air. May react violently with oxidants.

10.4. Conditions to avoid  
 Keep away from heat/sparks/open flames/hot surfaces. - No smoking.

10.5. Incompatible materials  
 Air, Oxidizer.

10.6. Hazardous decomposition products  
 Under normal conditions of storage and use, hazardous decomposition products should not be produced.

**SECTION 11: Toxicological information**

11.1. Information on toxicological effects

Acute toxicity : Not classified

Hydrogen, compressed (if 1333-74-0)  
 LC50 inhalation rat (ppm) : > 15000 ppm/h

Skin corrosion/irritation : Not classified  
 pH: Not applicable.

Serious eye damage/irritation : Not classified  
 pH: Not applicable.

Respiratory or skin sensitization : Not classified

Germ cell mutagenicity : Not classified

EN (English US) SDS ID: P-4604 59  
 This document is only controlled while on the Praxair, Inc. website and a copy of this controlled version is available for download.  
 Praxair cannot assure the integrity or accuracy of any version of this document after it has been downloaded or removed from our website.

**PRAXAIR**  
*Making our planet more productive*

**Hydrogen, compressed**  
 Safety Data Sheet P-4604  
 according to U.S. Code of Federal Regulations 29 CFR 1910.1200, Hazard Communication.  
 Date of issue: 01/01/1980 Revision date: 01/13/2015 Supersedes: 03/01/2012

Carcinogenicity : Not classified  
 Reproductive toxicity : Not classified  
 Specific target organ toxicity (single exposure) : Not classified  
 Specific target organ toxicity (repeated exposure) : Not classified  
 No known effects from this product.  
 Aspiration hazard : Not classified  
 Not applicable.

**SECTION 12: Ecological information**

12.1. Toxicity  
 Ecology - general : No ecological damage caused by this product.

12.2. Persistence and degradability  
 Hydrogen, compressed (1333-74-0)  
 Persistence and degradability : No ecological damage caused by this product.

12.3. Bioaccumulative potential  
 Hydrogen, compressed (1333-74-0)  
 BCF fish 1 : (no bioaccumulation expected)  
 Log Pow : Not applicable.  
 Log Kow : Not applicable.  
 Bioaccumulative potential : No ecological damage caused by this product.

12.4. Mobility in soil  
 Hydrogen, compressed (1333-74-0)  
 Mobility in soil : No data available.  
 Ecology - soil : No ecological damage caused by this product.

12.5. Other adverse effects  
 Effect on ozone layer : None.  
 Effect on the global warming : No known effects from this product.

**SECTION 13: Disposal considerations**

13.1. Waste treatment methods  
 Waste disposal recommendations : Dispose of contents/container in accordance with local/regional/national/international regulations. Contact supplier for any special requirements.

**SECTION 14: Transport information**

In accordance with DOT  
 Transport document description : UN1049 Hydrogen, compressed, 2.1  
 UN-No.(DOT) : UN1049  
 Proper Shipping Name (DOT) : Hydrogen, compressed  
 Department of Transportation (DOT) Hazard Classes : 2.1 - Class 2.1 - Flammable gas 49 CFR 173.115  
 Hazard labels (DOT) : 2.1 - Flammable gas



DOT Special Provisions (49 CFR 172.102) : N89 -When steel UN pressure receptacles are used, only those bearing the "H" mark are authorized.

EN (English US) SDS ID: P-4604 69  
 This document is only controlled while on the Praxair, Inc. website and a copy of this controlled version is available for download.  
 Praxair cannot assure the integrity or accuracy of any version of this document after it has been downloaded or removed from our website.

**PRAXAIR** **Hydrogen, compressed**  
**Safety Data Sheet P-4604**

Making our planet more productive® according to U.S. Code of Federal Regulations 29 CFR 1910.1200, Hazard Communication.  
 Date of issue: 01/07/1980 Revision date: 01/13/2015 Supersedes: 03/07/2012

**Additional information**

Emergency Response Guide (ERG) Number : 115 (UN1049)

Other information : No supplementary information available.

**Special transport precautions**

- Avoid transport on vehicles where the load space is not separated from the driver's compartment. Ensure vehicle driver is aware of the potential hazards of the load and knows what to do in an emergency.
- Ensure the vehicle is properly secured.
- Ensure there is adequate ventilation.
- Ensure that containers are firmly closed.
- Ensure valve is closed and not leaking.
- Ensure valve outlet cap nut or plug (where provided) is correctly fitted.
- Ensure valve protection device (where provided) is correctly fitted.

**Transport by sea**

UN-No. (IMDG) : 1049  
 Proper Shipping Name (IMDG) : HYDROGEN, COMPRESSED  
 Class (IMDG) : 2 - Gases  
 MFAG-No : 115

**Air transport**

UN-No (IATA) : 1049  
 Proper Shipping Name (IATA) : Hydrogen, compressed  
 Class (IATA) : 2  
 Civil Aeronautics Law : Gases under pressure/Gases flammable under pressure

**SECTION 15: Regulatory information**

**15.1. US Federal regulations**

**Hydrogen, compressed (1333-74-4)**  
 Listed on the United States TSCA (Toxic Substances Control Act) Inventory  
 Sudden release of pressure hazard  
 SARA Section 311/312 Hazard Classes  
 Fire hazard

**15.2. International regulations**

**CANADA**

**Hydrogen, compressed (1333-74-4)**  
 Listed on the Canadian DSL (Domestic Substances List)  
 WHMIS Classification  
 Class A - Compressed Gas  
 Class B Division 1 - Flammable Gas

**EU-Regulations**

**Hydrogen, compressed (1333-74-4)**  
 Listed on the EEC inventory EINECS (European Inventory of Existing Commercial Chemical Substances)  
 Flam. Gas 1 H220  
 Compressed gas H280  
 Classification according to Regulation (EC) No. 1272/2008 [CLP]  
 Full text of H-phrases: see section 16

**15.2.2. National regulations**

**Hydrogen, compressed (1333-74-4)**  
 Listed on the AICS (Australian Inventory of Chemical Substances)  
 Listed on the ECSC (Inventory of Existing Chemical Substances Produced or Imported in China)  
 Listed on NZCIC (New Zealand Inventory of Chemicals)  
 Listed on PICCS (Philippines Inventory of Chemicals and Chemical Substances)

EN (English US)

SDS ID: P-4604

7/9

This document is only controlled while on the Praxair, Inc. website and a copy of this controlled version is available for download. Praxair cannot assure the integrity or accuracy of any version of this document after it has been downloaded or removed from our website.

**PRAXAIR** **Hydrogen, compressed**  
**Safety Data Sheet P-4604**

Making our planet more productive® according to U.S. Code of Federal Regulations 29 CFR 1910.1200, Hazard Communication.  
 Date of issue: 01/07/1980 Revision date: 01/13/2015 Supersedes: 03/07/2012

**15.3. US State regulations**

<b>Hydrogen, compressed(1333-74-4)</b>	
U.S. - California - Proposition 65 - Carcinogens List	No
U.S. - California - Proposition 65 - Developmental Toxicity	No
U.S. - California - Proposition 65 - Reproductive Toxicity - Female	No
U.S. - California - Proposition 65 - Reproductive Toxicity - Male	No
State or local regulations	U.S. - Massachusetts - Right To Know List U.S. - Massachusetts - Right To Know List U.S. - Pennsylvania - RTK (Right to Know) List

**SECTION 16: Other information**

Revision date : 1/13/2015 12:00:00 AM

**Other information**

: When you mix two or more chemicals, you can create additional, unexpected hazards. Obtain and evaluate the safety information for each component before you produce the mixture. Consult an industrial hygienist or other trained person when you evaluate the end product. Before using any plastics, confirm their compatibility with the product.

Praxair asks users of this product to study this SDS and become aware of the product hazards and safety information. To promote safe use of this product, a user should (1) notify employees, agents, and contractors of the information in this SDS and of any other known product hazards and safety information, (2) furnish this information to each purchaser of the product, and (3) advise each purchaser to notify its employees and customers of the product hazards and safety information.

The opinions expressed herein are those of qualified experts within Praxair, Inc. We believe that the information contained herein is current as of the date of this Safety Data Sheet. Since the information is subject to change, Praxair, Inc. does not assume any liability for the use of this information. It is the user's obligation to determine the conditions of safe use of the product.

Praxair SDSs are furnished on sale or delivery by Praxair or the independent distributors and suppliers who package and sell our products. To obtain current SDSs for these products, contact your Praxair representative, local distributor, supplier, or retailer. Praxair SDSs are prepared from the most current information available. If you have any questions, please contact your Praxair representative, phone number and date of the latest SDS, or would like the names of the Praxair suppliers in your area, please contact the Praxair Call Center (Phone: 1-800-PRAXAIR/1-800-772-9247; Address: Praxair Call Center, Praxair, Inc., P.O. Box 44, Tonawanda, NY 14151-0044).

PRAXAIR and the Flowing Achrom design are trademarks or registered trademarks of Praxair Technology, Inc. in the United States and/or other countries.

**Full text of H-phrases:**

Compressed gas	Gases under pressure Compressed gas
Flam. Gas 1	Flammable gases Category 1
H220	EXTREMELY FLAMMABLE GAS
H280	CONTAINS GAS UNDER PRESSURE. MAY EXPLODE IF HEATED

**NFPA health hazard**

: 0 - Exposure under fire conditions would offer no hazard beyond that of ordinary combustible materials.

: 4 - Will rapidly or completely vaporize at normal pressure and temperature, or is readily dispersed in air and will burn readily.

**NFPA fire hazard**

: 0 - Normally stable, even under fire exposure conditions, and are not reactive with water.

**NFPA reactivity**

: 0 - Normally stable, even under fire exposure conditions, and are not reactive with water.

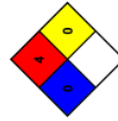

EN (English US)

SDS ID: P-4604

8/9

This document is only controlled while on the Praxair, Inc. website and a copy of this controlled version is available for download. Praxair cannot assure the integrity or accuracy of any version of this document after it has been downloaded or removed from our website.

**Hydrogen, compressed**



Safety Data Sheet P-4604  
according to U.S. Code of Federal Regulations 29 CFR 1910.1200, Hazard Communication.  
Date of issue: 01/01/1980    Revision date: 01/13/2015    Supersedes: 03/01/2012

HMIS III Rating  
Health : 0 Minimal Hazard - No significant risk to health  
Flammability : 4 Severe Hazard  
Physical : 3 Serious Hazard

SDS US (GHS HazCom 2012) - Praxair  
This information is based on our current knowledge and is provided to describe the product for the purposes of health, safety and environmental requirements only. It should not therefore be construed as guaranteeing any specific property of the product.

EN (English US)

SDS ID: P-4604

9/9

This document is only controlled while on the Praxair, Inc. website and a copy of this controlled version is available for download. Praxair cannot assure the integrity or accuracy of any version of this document after it has been downloaded or removed from our website.



# SAFETY DATA SHEET

Creation Date 24-Nov-2010

Revision Date 10-Feb-2015

Revision Number 1

## 1. Identification

**Product Name** Raney Nickel®, activated catalyst, 50% slurry in water

**Cat No. :** AC395920000; AC395921000; AC395925000

**Synonyms** Catalyst for hydrogenation.

**Recommended Use** Laboratory chemicals.

**Uses advised against** No information available

**Details of the supplier of the safety data sheet.**

**Company** Entity / Business Name

Fisher Scientific  
Acros Organics  
One Reagent Lane  
Fair Lawn, NJ 07410  
Tel: (201) 796-7100

**Emergency Telephone Number**  
For information US call: 001-800-ACROS-01  
/ Europe call: +32 14 57 52 11  
Emergency Number US:001-201-796-7100 /  
Europe: +32 14 57 52 99  
CHEMTREC Tel. No US:001-800-424-9300 /  
Europe:001-703-527-3887

## 2. Hazard(s) Identification

**Classification**  
This chemical is considered hazardous by the 2012 OSHA Hazard Communication Standard (29 CFR 1910.1200)

Substances/mixtures which, in contact with water, emit flammable gases  
Skin Sensitization  
Carcinogenicity  
Specific target organ toxicity - (repeated exposure)

Category 2  
Category 1  
Category 1B  
Category 1

### Label Elements

**Signal Word**

Danger

### Hazard Statements

In contact with water releases flammable gas  
May cause an allergic skin reaction  
May cause cancer  
Causes damage to organs through prolonged or repeated exposure



Raney Nickel®, activated catalyst, 50% slurry in water

Revision Date 10-Feb-2015

## Precautionary Statements

### Prevention

Obtain special instructions before use  
Do not handle until all safety precautions have been read and understood  
Use personal protective equipment as required  
Contaminated work clothing should not be allowed out of the workplace  
Wear protective gloves

Do not breathe dust/fume/gas/mist/vapors/spray.  
Avoid breathing any vapors that may be evolved.  
Do not eat, drink or smoke while using this product.  
Keep away from any possible contact with water, because of violent reaction and possible flash fire  
Handle under inert gas. Protect from moisture

### Response

IF exposed or concerned: Get medical attention/advice

### Skin

IF ON SKIN: Wash with plenty of soap and water  
If skin irritation or rash occurs: Get medical advice/attention  
Wash contaminated clothing before reuse

### Fire

Brush off loose particles from skin. Immerse in cool water/wrap with wet bandages  
In case of fire: Use CO2, dry chemical, or foam for extinction

### Storage

Store locked up  
Store in dry place. Store in a closed container

### Disposal

Dispose of contents/container to an approved waste disposal plant  
**Hazards not otherwise classified (HNOC)**

### None identified

### Unknown Acute Toxicity

? % of the mixture consists of ingredients of unknown toxicity.

## 3. Composition / Information on ingredients

Component	CAS-No	Weight %
Nickel	7440-02-0	46-49
Water	7732-18-5	39.5
Aluminium powder	7429-90-5	1-4

## 4. First-aid measures

### Eye Contact

Rinse immediately with plenty of water, also under the eyelids, for at least 15 minutes.  
Obtain medical attention.

### Skin Contact

Wash off immediately with soap and plenty of water while removing all contaminated clothes and shoes. Obtain medical attention.

### Inhalation

Remove from exposure. Lie down. Move to fresh air. If breathing is difficult, give oxygen. If not breathing, give artificial respiration. Immediate medical attention is required.

### Ingestion

Clean mouth with water. Get medical attention.

### Most important symptoms/effects

May cause allergic skin reaction. Symptoms of allergic reaction may include rash, itching, swelling, trouble breathing, tingling of the hands and feet, dizziness, lightheadedness, chest pain, muscle pain or flushing  
Treat symptomatically

### Notes to Physician

<b>5. Fire-fighting measures</b>	
<b>Suitable Extinguishing Media</b>	Water spray, Carbon dioxide (CO <sub>2</sub> ), Dry chemical. Use water spray to cool unopened containers, chemical foam.
<b>Unsuitable Extinguishing Media</b>	No information available
<b>Flash Point Method</b>	No information available
<b>Autoignition Temperature</b>	No information available
<b>Explosion Limits</b>	No information available
<b>Upper</b>	No data available
<b>Lower</b>	No data available
<b>Sensitivity to Mechanical Impact</b>	No information available
<b>Sensitivity to Static Discharge</b>	No information available

**Specific Hazards Arising from the Chemical**  
Explosive properties. Self-heating; exposure to air may cause substance to self-heat without an energy supply.

**Hazardous Combustion Products**  
Burning produces obnoxious and toxic fumes  
**Protective Equipment and Precautions for Firefighters**  
As in any fire, wear self-contained breathing apparatus pressure-demand, MSHA/NIOSH (approved or equivalent) and full protective gear.

**NFPA** · Health 3 · Flammability 2 · Instability 0 · Physical hazards W

<b>6. Accidental release measures</b>	
<b>Personal Precautions</b>	Ensure adequate ventilation. Use personal protective equipment.
<b>Environmental Precautions</b>	Do not flush into surface water or sanitary sewer system. See Section 12 for additional ecological information.

**Methods for Containment and Clean Up**  
Soak up with inert absorbent material (e.g. sand, silica gel, acid binder, universal binder, sawdust). Keep in suitable, closed containers for disposal. Remove all sources of ignition. Use spark-proof tools and explosion-proof equipment. Do not flush into surface water or sanitary sewer system.

<b>7. Handling and storage</b>	
<b>Handling</b>	Do not breathe dust. Do not breathe vapors or spray mist. Do not get in eyes, on skin, or on clothing. Take precautionary measures against static discharges. Use only in area provided with appropriate exhaust ventilation. Use explosion-proof equipment. Use only non-sparking tools. Minimize dust generation and accumulation.
<b>Storage</b>	Keep in a dry, cool and well-ventilated place. Keep container tightly closed. Keep away from heat and sources of ignition. Flammable area. Material can explode if dry. Keep at temperatures below 40°C. Do not freeze.

<b>8. Exposure controls / personal protection</b>	
<b>Exposure Guidelines</b>	

<b>Component</b>	<b>ACGIH TLV</b>	<b>OSHA PEL</b>	<b>NIOSH IDLH</b>
Nickel	TWA: 1.5 mg/m <sup>3</sup>	(Vacated) TWA: 1 mg/m <sup>3</sup> TWA: 1 mg/m <sup>3</sup>	IDLH: 10 mg/m <sup>3</sup> TWA: 0.015 mg/m <sup>3</sup>
Aluminium powder	TWA: 1 mg/m <sup>3</sup>	(Vacated) TWA: 15 mg/m <sup>3</sup> (Vacated) TWA: 15 mg/m <sup>3</sup> TWA: 5 mg/m <sup>3</sup>	TWA: 10 mg/m <sup>3</sup> TWA: 5 mg/m <sup>3</sup>
<b>Component</b>	<b>Quebec</b>	<b>Mexico OEL (TWA)</b>	<b>Ontario TWA/VEV</b>
Nickel	TWA: 1 mg/m <sup>3</sup>	TWA: 1 mg/m <sup>3</sup>	TWA: 1 mg/m <sup>3</sup>
Aluminium powder	TWA: 10 mg/m <sup>3</sup> TWA: 5 mg/m <sup>3</sup>	TWA: 10 mg/m <sup>3</sup> TWA: 5 mg/m <sup>3</sup>	TWA: 1 mg/m <sup>3</sup>

*Legend*  
ACGIH - American Conference of Governmental Industrial Hygienists  
OSHA - Occupational Safety and Health  
NIOSH IDLH - The National Institute for Occupational Safety and Health Immediately Dangerous to Life or Health

**Engineering Measures**  
Use explosion-proof electrical/ventilating/lighting/equipment. Ensure that eyewash stations and safety showers are close to the workstation location.

**Personal Protective Equipment**  
**Eyeface Protection**  
Wear appropriate protective eyeglasses or chemical safety goggles as described by OSHA eye and face protection regulations in 29 CFR 1910.133 or European Standard EN166.

**Skin and body protection**  
Wear appropriate protective gloves and clothing to prevent skin exposure.  
**Respiratory Protection**  
Follow the OSHA respirator regulations found in 29 CFR 1910.134 or European Standard EN 149. Use a NIOSH/MSHA or European Standard EN 149 approved respirator if exposure limits are exceeded or if irritation or other symptoms are experienced.

**Hygiene Measures**  
Handle in accordance with good industrial hygiene and safety practice.

<b>9. Physical and chemical properties</b>	
<b>Physical State</b>	Slurry/Liquid
<b>Appearance</b>	Dark grey
<b>Odor</b>	Odorless
<b>Odor Threshold</b>	No information available
<b>pH</b>	No information available
<b>Melting Point/Range</b>	10-11 1500 g/L aq.sol
<b>Boiling Point/Range</b>	No data available
<b>Flash Point</b>	No information available
<b>Evaporation Rate</b>	No information available
<b>Flammability (solid,gas)</b>	No information available
<b>Flammability or explosive limits</b>	Not applicable
<b>Upper</b>	No data available
<b>Lower</b>	No data available
<b>Vapor Pressure</b>	23.5 mbar @ 20 °C
<b>Vapor Density</b>	No information available
<b>Relative Density</b>	No information available
<b>Solubility</b>	No information available
<b>Partition coefficient; n-octanol/water</b>	No data available
<b>Autoignition Temperature</b>	No information available
<b>Decomposition Temperature</b>	> 100°C
<b>Viscosity</b>	No information available
<b>Molecular Formula</b>	N <sub>2</sub>
<b>Molecular Weight</b>	58.69

**10. Stability and reactivity**

**Reactive Hazard** Yes

**Stability** Stable.

**Conditions to Avoid** Heat, flames and sparks. Keep away from open flames, hot surfaces and sources of ignition. Exposure to air. Incompatible products.

**Incompatible Materials** Acids, Ammonia, Ammonium nitrate; fertilizers capable of self-sustaining decomposition, Halogens, Fluorine, Organic materials, nitrites

**Hazardous Decomposition Products** Burning products obnoxious and toxic fumes

**Hazardous Polymerization** Hazardous polymerization does not occur.

**Hazardous Reactions** None under normal processing.

**11. Toxicological information**

**Acute Toxicity**

**Product Information**  
 Oral LD50 9000 mg/kg. (Rat.)  
 Dermal LD50 No information available  
 Vapor LC50 No information available

**Component Information**

Component	LD50 Oral	LD50 Dermal	LC50 Inhalation
Nickel	9000 mg/kg. (Rat.)	Not listed	Not listed

**Toxicologically Synergistic Products** No information available

**Delayed and immediate effects as well as chronic effects from short and long-term exposure.**

**Irritation** No information available

**Sensitization** No information available

**Carcinogenicity** The table below indicates whether each agency has listed any ingredient as a carcinogen.

Component	CAS-No	IARC	NTP	ACGIH	OSHA	Mexico
Nickel	7440-02-0	Group 2B	Reasonably Anticipated	Not listed	X	Not listed
Water	7732-18-5	Not listed	Not listed	Not listed	Not listed	Not listed
Aluminum powder	7429-90-5	Not listed	Not listed	Not listed	Not listed	Not listed

**Mutagenic Effects** No information available

**Reproductive Effects** No information available.

**Developmental Effects** No information available.

**Teratogenicity** No information available.

**STOT - single exposure** None known

**STOT - repeated exposure** None known

**Aspiration hazard** No information available

**Symptoms / effects both acute and chronic** Symptoms of allergic reaction may include rash, itching, swelling, trouble breathing, tingling of the hands and feet, dizziness, lightheadedness, chest pain, muscle pain or flu-like symptoms.

**Endocrine Disruptor Information** No information available

**12. Ecological information**

**Other Adverse Effects** The toxicological properties have not been fully investigated. See actual entry in RTECS for complete information.

**Ecotoxicity**  
 Do not flush into surface water or sanitary sewer system. Do not allow material to contaminate ground water system. Do not empty into drains. The product contains following substances which are hazardous for the environment. Toxic to aquatic organisms, may cause long-term adverse effects in the aquatic environment. Very toxic to aquatic organisms, may cause long-term adverse effects in the aquatic environment.

Component	Freshwater Algae	Freshwater Fish	Microtox	Water Flea
Nickel	EC50 = 0.11 mg/L 72h EC50 = 0.18 mg/L 72h	10.4 mg/L LC50 96 h 1.3 mg/L LC50 96 h 100 mg/L LC50 96 h.	Not listed	EC50 = 510 µg/L 96h

**Persistence and Degradability** Insoluble in water

**Bioaccumulation/ Accumulation** No information available.

**Mobility** . Is not likely mobile in the environment due its low water solubility.

**13. Disposal considerations**

**Waste Disposal Methods** Chemical waste generators must determine whether a discarded chemical is classified as a hazardous waste. Chemical waste generators must also consult local, regional, and national hazardous waste regulations to ensure complete and accurate classification.

**14. Transport information**

**DOT**

UN-No UN1378

Hazard Class 4.2

Packing Group II

**TDG**

UN-No UN1378

Hazard Class 4.2

Packing Group II

**IATA**

UN-No 1378

Proper Shipping Name METAL CATALYST, WETTED

Hazard Class 4.2

Packing Group II

**IMDG/IMCO**

UN-No 1378

Proper Shipping Name METAL CATALYST, WETTED

Hazard Class 4.2

Packing Group II

**15. Regulatory information**

**International Inventories**

Component	TSCA	DSL	NDSL	EINECS	ELINCS	NLP	PICCS	ENCS	AICS	IECSC	KECL
Nickel	X	X	-	231-111-4	-	-	X	-	X	X	X
Water	X	X	-	231-791-2	-	-	X	-	X	X	X
Aluminum powder	X	X	-	231-072-3	-	-	X	-	X	X	X

**Legend:**  
 X - Listed  
 E - Indicates a substance that is the subject of a Section 5(f) Consent order under TSCA.  
 F - Indicates a substance that is the subject of a Section 5(f) Rule under TSCA.  
 P - Indicates a polymer made with any free-radical initiator regardless of the amount used.  
 P - Indicates a commenced PMN substance



This product contains the following DHS chemicals:  
**Other International Regulations**  
 Mexico - Grade No information available  
**Canada**  
 This product has been classified in accordance with the hazard criteria of the Controlled Products Regulations (CPR) and the MSDS contains all the information required by the CPR  
**WHMIS Hazard Class**  
 65: Reactive flammable material  
 D2A: Very toxic materials



**16. Other Information**  
 Prepared By Regulatory Affairs  
 Thermo Fisher Scientific  
 Email: EMSDS.RA@thermofisher.com  
 Creation Date 24-Nov-2010  
 Revision Date 10-Feb-2015  
 Print Date 10-Feb-2015  
 Revision Summary This document has been updated to comply with the US OSHA HazCom 2012 Standard replacing the current legislation under 29 CFR 1910.1200 to align with the Globally Harmonized System of Classification and Labeling of Chemicals (GHS)

**Disclaimer**  
 The information provided on this Safety Data Sheet is correct to the best of our knowledge, information and belief at the date of its publication. The information given is designed only as a guide for safe handling, use, processing, storage, transportation, disposal and release and is not to be considered as a warranty or quality specification. The information relates only to the specific material designated and may not be valid for such material used in combination with any other material or in any process, unless specified in the text.

**End of SDS**

**R** - Indicates a substance that is the subject of a Section 6 risk management rule under TSCA.  
**S** - Indicates a substance that is identified in a proposed or final Significant New Use Rule.  
**T** - Indicates a substance that is the subject of a Section 4 test rule under TSCA.  
**XU** - Indicates a substance exempt from reporting under the Inventory Update Rule, i.e. Partial Updating or the TSCA Inventory Data Base.  
**Y1** - Indicates an exempt polymer that has a number-average molecular weight of 1,000 or greater.  
**Y2** - Indicates an exempt polymer that is a polyester and is made only from reactants included in a specified list of low concern reactants that comprises one of the eligibility criteria for the exemption rule.

**U.S. Federal Regulations**  
 TSCA 12(b) Not applicable

SARA 313	Component	CAS-No	Weight %	SARA 313 - Threshold Values %
	Nickel	7440-02-0	46-49	0.1
	Aluminium powder	7429-90-5	1-4	1.0

**SARA 311/312 Hazardous Categorization**  
 Acute Health Hazard Yes  
 Chronic Health Hazard Yes  
 Fire Hazard No  
 Sudden Release of Pressure Hazard No  
 Reactive Hazard Yes

Clean Water Act	CWA - Hazardous Substances	CWA - Reportable Quantities	CWA - Toxic Pollutants	CWA - Priority Pollutants
Nickel	-	-	X	X

Clean Air Act	HAPS Data	Class 1 Ozone Depleters	Class 2 Ozone Depleters
Nickel	X	-	-

**OSHA Occupational Safety and Health Administration**  
 Not applicable

**CERCLA**  
 This material, as supplied, contains one or more substances regulated as a hazardous substance under the Comprehensive Environmental Response Compensation and Liability Act (CERCLA) (40 CFR 302)

Component	Hazardous Substances RQs	CERCLA EHS RQs
Nickel	100 lb	-

**California Proposition 65**  
 This product contains the following Proposition 65 chemicals:

Component	CAS-No	California Prop. 65	Prop 65 NSRL	Category
Nickel	7440-02-0	Carcinogen	-	Carcinogen
<b>State Right-to-Know Component</b>				
Nickel	X	New Jersey	Pennsylvania	Illinois
Water	-	-	X	-
Aluminium powder	X	X	X	-
				Rhode Island
				X

**U.S. Department of Transportation**  
 Reportable Quantity (RQ):  
 DOT Marine Pollutant N  
 DOT Severe Marine Pollutant N  
**U.S. Department of Homeland Security**

## Appendix D: Vendor Specification Sheets

Vendor specification sheets used for calculations are presented here in the following order:

Kerasep Novasep BH ceramic microfiltration elements

Koch 8338 HFK-328 ultrafiltration elements

Koch 8040-SR100-400 nanofiltration elements

DowEx Marathon WBA ion exchange resin

DowEx Marathon C ion exchange resin

DowEx Marathon MR-3 mixed ion exchange resin

Flexipac HC structured column packing

# Diamond II Ceramic Membranes

The premium membrane for CFF operations



- A premium membrane with ultra-long lifetime and excellent in-process performance
- Our process development experience to increase efficiency of your CFF unit
- A premium package of services in order to better serve you and your production

The Kerasep® Diamond II membranes are the result of our excellence in ceramic materials processing combined with 25 years of experience in developing high-performance CFF systems. A premium product, the Diamond II is designed for users looking for unrivaled durability, with up to a 6-year guarantee.

## Ultra-long durability and resistance

The Diamond II pushes abrasion resistance a step ahead thanks to high-quality ceramic materials, individually engineered layers and an exceptional sintering process. With a longer lifetime than market standards, the Diamond II has a direct impact on your operational expenses by limiting maintenance costs and production shutdowns.

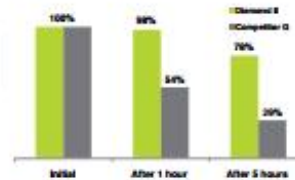

Figure 1: Remaining active layer after an abrasion resistance test for two membranes (0.1µm)

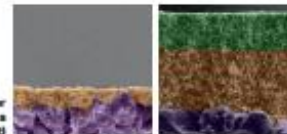





Figure 2: Microscope sectional view of the Diamond II (right) and a competitor (left) after 18 months purifying a broth under industrial conditions (Green: active layer, orange: sub-layer, purple: support)

				
<b>Geometry</b>	BX	BE	BW	BH
<b>Number of channels</b>	7	8	19	31
<b>Hydraulic diameter (mm)</b>	6	4.8	3.5	2.9
<b>Filtration area/monolith (m²)</b>	0.15	0.21	0.25	0.34
<b>Cut offs</b>	300 kD and 0.1 µm			
<b>Support/Layers</b>	Monolithic TiO <sub>2</sub> -Al <sub>2</sub> O <sub>3</sub> / ZrO <sub>2</sub> -TiO <sub>2</sub>			
<b>Ext. Diameter/Length (mm)</b>	25 / 1178			
<b>Bursting Pressure (bar)</b>	>80			
<b>Chemical resistance</b>	pH: 0-14 ; all organic solvents: ethanol, methanol, phenols, etc.			
<b>Sterilization / CIP conditions</b>	High pressure, hot water up to 121°C / NaOH, HNO <sub>3</sub> , O <sub>3</sub> , NaClO			
<b>Standard process temperature</b>	Up to 80°C			



## Get access to the backpulse

Thanks to a highly resistant monolith, combined to the engineered sub- and active-layers, the Diamond II can endure important mechanical constraints. As a result, you can use the backpulse in order to remove clogging matters from the membrane, optimizing flux, cycle time and chemicals consumption. As part of the premium services package we can also help you implementing and optimizing the backpulse step in your unit.

## The Kerasep® benefit: a high permeability

Thanks to our optimized manufacturing process, the Kerasep® Diamond II membranes conserve a high permeability compared to current market standards with an average of +30% permeability gain in industrial conditions for the purification of a fermentation broth.

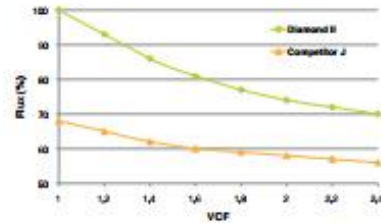

Figure 3: Permeability law of the Diamond II and a competitor for a fermentation broth

## Premium product, premium services

The Kerasep® Diamond II membranes are a premium product combined with a premium services package. With more than 25 years of experience in membrane design and process development, Novasep's experts and customer service teams are ready to serve you, providing support upon request.

This premium package of services includes:

**At least one visit from our technicians every year** to perform periodic audits of your CFF unit and to check the evolution of your membranes. We produce a full report for you with suggestions on what actions should be considered. The technician may also suggest improvements to your process or operating conditions.

The customer service team can assist you in **troubleshooting your CFF units**, defining the best maintenance and preventive practices.

With our **membrane expertise**, we can perform detailed membrane analysis anticipating any deviation compared to the specifications (for example due to membrane ageing under very harsh conditions). We will provide guidance on what preventive or corrective actions should be taken to optimally run your CFF unit.

Our process development experts can propose customized solutions to optimize your overall process.



Kerasep® Diamond membrane



Left: Novasep scanning electron microscope  
Right: Filling a Kerasep® module



Services and technologies  
for the life science industries

[www.novasep.com](http://www.novasep.com)  
[novasep@novasep.com](mailto:novasep@novasep.com)

**EUROPE**  
Novasep  
Phone: +33 4 72 01 27 27  
[industrialbiotech@novasep.com](mailto:industrialbiotech@novasep.com)

**NORTH AMERICA**  
Novasep Inc.  
Phone: +1 610 494 0447  
[industrialbiotech.north-am@novasep.com](mailto:industrialbiotech.north-am@novasep.com)

**ASIA**  
Novasep Asia  
Phone: +86 21 6045 1600  
[industrialbiotech.asia@novasep.com](mailto:industrialbiotech.asia@novasep.com)

**JAPAN**  
Novasep Japan K.K.  
Phone: +81 [0]3 3221 1960  
[japan@novasep.com](mailto:japan@novasep.com)

**INDIA**  
Novasep India  
Phone: +91 900 84 77 311  
[industrialbiotech.india@novasep.com](mailto:industrialbiotech.india@novasep.com)

**RUSSIA**  
Novasep Russia  
Phone: +7 (8652) 316 645  
[industrialbiotech.russia@novasep.com](mailto:industrialbiotech.russia@novasep.com)

**REST OF THE WORLD**  
Novasep  
Phone: +33 4 72 01 27 27  
[industrialbiotech@novasep.com](mailto:industrialbiotech@novasep.com)

© 2014 Groupe Novasep SAS. Groupe Novasep SAS and/or its affiliates (hereafter Groupe Novasep) own or license the copyrights, trademarks, names, logos, and other rights to the information in this brochure. No right or license is granted to any other party. Any unauthorized use without the express prior written consent of Groupe Novasep is prohibited. Disclaimers: The information contained on this brochure are provided "as is", for informational purposes only, without any representation or warranty of accuracy or completeness. In no event will Groupe Novasep be liable to any party for any damages or any other losses from access or reliance upon any information contained in this brochure. 033-0128



## HFK-328 FOOD & DAIRY UF ELEMENTS

### Ultrafiltration 4", 6" and 8" Spiral Element Series

#### PRODUCT DESCRIPTION

Membrane Chemistry: Proprietary semi-permeable polyethersulfone (PES)  
 Membrane Type: HFK-328 with observed separation range of 5,000 Daltons  
 Construction: Sanitary spiral wound element with net outer wrap  
 Regulatory Status: Compliant with US FDA CFR Title 21, EC Reg. No. 1935/2004, and EU Reg. No. 10/2011. Halal-certified by the Islamic Food and Nutrition Council of America (IFANCA)  
 Options:  
 Diameter: 3.8", 4.3", 6.3", 6.4", 7.8, 8.0", or 8.3"  
 Length: 33", 35.5", or 38"  
 Feed Spacer: N (31 mil), V (46 mil), H (62 mil), or F (80 mil)  
 Outer wrap: Controlled (e.g. NYV) or trimmable (e.g. NYT)

#### SPECIFICATIONS

Model	Active Membrane Area			
	NYVIT Spacer (31 mil)	VYVIT Spacer (46 mil)	HYVIT Spacer (62 mil)	FYVIT Spacer (80 mil)
	ft <sup>2</sup> (m <sup>2</sup> )	ft <sup>2</sup> (m <sup>2</sup> )	ft <sup>2</sup> (m <sup>2</sup> )	ft <sup>2</sup> (m <sup>2</sup> )
3838 HFK-328	76 (7.1)	60 (5.6)	46 (4.3)	-
4336 HFK-328	-	82 (7.6)	-	50 (4.6)
4338 HFK-328	107 (9.9)	83 (7.7)	-	-
6338 HFK-328	237 (22.0)	186 (17.5)	143 (13.3)	117 (10.9)
6438 HFK-328	237 (22.0)	186 (17.5)	143 (13.3)	117 (10.9)
7838 HFK-328	-	278 (25.8)	-	-
8038 HFK-328	370 (34.4)	293 (27.2)	220 (20.4)	-
8338 HFK-328	405 (37.6)	320 (29.7)	260 (24.1)	-

Not all combinations are available.  
 6438 and 788 elements are only available in controlled configuration. 6338 elements are only available in trimmable configuration

#### OPERATING AND DESIGN INFORMATION\*

Typical Operating Pressure: 30 - 120 psi (2.1 - 8.3 bar)  
 Maximum Operating Pressure: 140 psi (9.7 bar)  
 Operating Temperature Range: 41 - 131°F (5 - 55°C)  
 Cleaning Temperature Range: 105 - 122°F (40 - 50°C)  
 Allowable pH - Continuous Operation: 2.0 - 10.0  
 Allowable pH - Clean-In-Place (CIP): 1.8 - 11.0  
 Design Pressure Drop Per Element:  
 N spacer: 12-15 psi (0.8-1.0 bar)  
 V spacer: 15-20 psi (1.0-1.4 bar)  
 H or F spacer: 15-25 psi (1.0-1.7 bar)  
 Design Pressure Drop Per Vessel (3 in series):  
 N spacer: 36-45 psi (2.5-3.1 bar)  
 V spacer: 45-60 psi (3.1-4.1 bar)  
 H or F spacer: 45-75 psi (3.1-5.2 bar)  
 Design Pressure Drop Per Vessel (4 in series):  
 N spacer: 48-60 psi (3.3-4.1 bar)  
 V spacer: 60-68 psi (4.1-4.7 bar)

\* Consult KMS Process Technology Group for specific applications.

#### NOMINAL DIMENSIONS

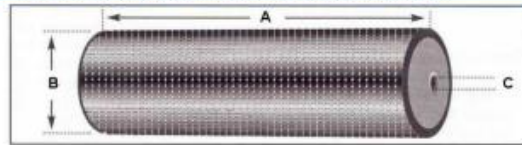

Model	A inches (mm)	B inches (mm)	C inches (mm)
3838 HFK-328	38.0 (965)	3.8 (96)	0.831 (21.1)
4336 HFK-328	35.5 (902)	4.3 (109)	0.831 (21.1)
4338 HFK-328	38.0 (965)	4.3 (109)	0.831 (21.1)
6338 HFK-328	38.0 (965)	6.3 (160)	1.138 (28.9)
6438 HFK-328	38.0 (965)	6.4 (162)	1.138 (28.9)
7838 HFK-328	38.0 (965)	7.7 (197)	1.138 (28.9)
8038 HFK-328	38.0 (965)	7.9 (201)	1.138 (28.9)
8338 HFK-328	38.0 (965)	8.3 (211)	1.138 (28.9)

Note: Not all combinations are available.

## HFK-328 FOOD & DAIRY UF SPIRAL ELEMENTS

### Membrane Characteristics:

- The membrane used in these modules consists of a semipermeable polyethersulfone (PES) layer on a polyester backing material.
- Pure water flux of these PES HFK-328 membranes is 1.0-2.2 gfd/psi (24-53 l/m<sup>2</sup>/h/bar) at 77°F (25°C).

### Operating Limits:

- **Operating Pressure:** Maximum operating pressure is 140 psi (9.7 bar).
- **Permeate Pressure:** Permeate pressure should not exceed baseline (concentrate) pressure at any time (including on-line, off-line and during transition). Reverse pressure will damage the membrane.
- **Differential Pressure:** The maximum differential pressures per element are listed on the front of this document, including design values for multi-element housings.
- **Temperature:** Maximum operating temperature is 131°F (55°C). Maximum cleaning temperature is 122°F (50°C).
- **pH:** Allowable range for continuous operation is 2.0 to 10.0. Allowable pH range for cleaning is 1.8 to 11.0.

### Water Quality for Cleaning & Diafiltration:

- **Turbidity and SDI:** Maximum feed turbidity is 1 NTU. Maximum feed SDI is 5.0 (15-minute test).
- **Guidelines:** Please refer to the KMS "Water Quality Guidelines for CIP and Diafiltration" for more detailed information.

### Chlorine and Chemical Exposure:

- Adherence to cleaning and sanitizing procedures including chemical concentrations, pH, temperature, and exposure time is necessary to achieve maximum useful element life. Accurate records should be maintained.
- KMS standard cleaning procedures for dairy applications should be followed. Recommended chlorine exposure time at the defined conditions is 30 minutes per day.
- Residual chlorine concentration during cleaning cycle (CIP) should be 150 ppm @ pH 10.5 or higher. Chlorine concentration should never exceed 200 ppm.

- Chlorine should only be added to the cleaning solution after the pH has been adjusted to 10.5 or higher.
- Iron or other catalyzing metals in the presence of free chlorine or hydrogen peroxide will accelerate membrane degradation.
- Sanitizing should be done only after a complete cleaning cycle and with water of acceptable quality. Refer to cleaning instructions and feedwater quality technical bulletins.

### Cationic Polymers and Surfactants:

HFK-328 membranes may be irreversibly fouled if exposed to cationic (positively charged) polymers or surfactants. Exposure to these chemicals during operation or cleaning is not recommended and will void the warranty.

### Lubricants:

For element installation, use only water or glycerin to lubricate seals. The use of petroleum or vegetable-based oils or solvents may damage the element and will void the warranty.

### Supplemental Technical Bulletins:

- UF Element Cleaning Procedures
- Water Quality Guidelines for CIP and Diafiltration

### Service and Ongoing Technical Support:

KMS has an experienced staff available to assist end-users and OEM's for optimization of existing systems and development of new applications. KMS also offers a complete line of KOCHKLEEN® membrane pretreatment, cleaning, and maintenance chemicals.

### KMS Capability

KMS is the leader in crossflow membrane technology, manufacturing reverse osmosis, nanofiltration, microfiltration, and ultrafiltration membranes and membrane systems. The industries we serve include food, dairy and beverage, semiconductors, automotive, water and wastewater, chemical and general manufacturing. KMS adds value by providing top quality membrane products and by sharing our experience in the design and supply of thousands of crossflow membrane systems worldwide.

The information contained in this publication is believed to be accurate and reliable, but is not to be construed as implying any warranty or guarantee of performance. We assume no responsibility, obligation or liability for results obtained or damages incurred through the application of the information contained herein. Refer to Standard Terms and Conditions of Sale and Performance Warranty documentation for additional information.

Koch Membrane Systems, Inc., [www.kochmembrane.com](http://www.kochmembrane.com)

Corporate Headquarters: 850 Main Street, Wilmington, Massachusetts 01887-3388, US, Tel. Toll Free: 1-888-677-5624, Telephone: 1-978-694-7000, Fax: 1-978-657-5208  
European Headquarters: Koch Chemical Technology Group Ltd., Units 3-6, Frank Foley Way, Stafford ST16 2ST, GB, Telephone: +44-178-527-2500, Fax: +44-178-522-3149

• Aachen DE • Lyon FR • Madrid ES • Milan IT • Wijnegem BE • Beijing & Shanghai CN • Mumbai & New Delhi IN • Melbourne & Sydney AU • Singapore • Sao Paulo BR • Dubai UAE •

For related trademark information, visit [www.kochmembrane.com](http://www.kochmembrane.com)

Koch Membrane Systems, Inc. is a Koch Chemical Technology Group, LLC company.  
© 2015 Koch Membrane Systems, Inc. All rights reserved worldwide.

01/15 Rev 15-1



# FLUID SYSTEMS® TFC® - SR™ 100 8" ELEMENT

*Low Pressure, Selective Rejection Nanofiltration Elements*

<b>PRODUCT DESCRIPTION</b>	<b>Membrane Chemistry:</b>	Proprietary TFC® polyamide
	<b>Membrane Type:</b>	SR™100 – selective rejection nanofiltration membrane
	<b>Construction:</b>	Spiral wound with fiberglass outerwrap
	<b>Applications:</b>	Sulfate and hardness removal from seawater, removal of color and organics from ground water, softening and de-ashing.

<b>SPECIFICATIONS</b>	Part Number	Model	Nominal Permeate Flow gpd (m <sup>3</sup> /d)	Rejection percent	Active Membrane Area ft <sup>2</sup> (m <sup>2</sup> )	Feed Spacer mil (mm)
		8872202	8040-SR100-400	6,200 (23.5)	> 99.0	400 (37.2)

Test Conditions: 5,000 mg/l MgSO<sub>4</sub> in deionized water at 95 psi (655 kPa) applied pressure, 15% recovery, 77°F (25°C), pH 7.5

<b>OPERATING AND DESIGN INFORMATION*</b>	<b>Typical Operating Pressure:</b>	200 - 600 psi (1,380 - 4,140 kPa)
	<b>Maximum Operating Pressure:</b>	600 psi (4,140 kPa)
	<b>Maximum Operating Temperature:</b>	122°F (50°C)
	<b>Maximum Cleaning Temperature:</b>	113°F (45°C)
	<b>Maximum Continuous Free Chlorine:</b>	<0.1 mg/l
	<b>Allowable pH – Continuous Operation:</b>	4 - 10
	<b>Allowable pH – Short Term Cleaning:</b>	1.7 – 11.5
	<b>Maximum Differential Pressure Per Element:</b>	10 psi (69 kPa)
	<b>Maximum Differential Pressure Per Vessel:</b>	60 psi (414 kPa)
<b>Maximum Feed Turbidity:</b>	1 NTU	
<b>Maximum Feed SDI (15 minute test):</b>	5	

\* Consult Process Technology Group for specific information.

**NOMINAL DIMENSIONS AND WEIGHT\***

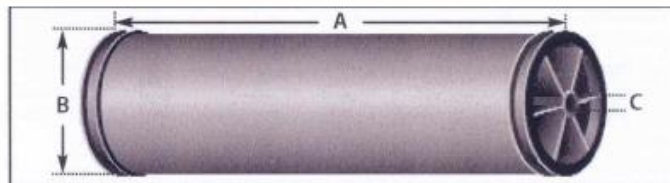

Model	A	B	C	Weight lbs (kg)	Part Numbers		
	inches (mm)	inches (mm)	inches (mm)		Interconnector	O-ring	Brine Seal
8040-SR100-400	40 (1,016)	8 (203)	1.125 (29)	44 (20)	0035260	0035464	0035705

\* Dimensions are provided for reference only and should not be interpreted as accurate specifications.

## TFC® – SR®100 8" ELEMENT

### Performance:

Performance specifications shown on the front side of this document are nominal values. Individual element permeate flows may vary +20/-15% from the values shown.

Selective Rejection (SR™100) nanofiltration membrane performance is highly dependent on water chemistry, temperature, pH, and solution concentration. Performance can only be accurately known through pilot study. KMS strongly recommends that the appropriate pilot studies be conducted to determine suitability for a given application.

System operating data should be normalized and key performance parameters tracked using KMS NORMPRO® software.

### Operating Limits:

- **Operating Pressure:** Maximum operating pressure is 600 psi (4,140 kPa). Typical operating pressure for TFC®-SR100 systems is in the range of 150 psi (1,035 kPa) to 250 psi (1,725 kPa). Actual operating pressure is dependent upon system flux rate (appropriate for feed source) as well as feed salinity, recovery and temperature conditions.
- **Permeate Pressure:** Permeate pressure should not exceed feed-concentrate pressure by more than 5 psi (34 kPa) at any time (on-line, off-line and during transition).
- **Differential Pressure:** Maximum differential pressure limits are 10 psi (69 kPa) per element. Maximum differential pressure for pressure vessel is 60 psi (414 kPa).
- **Temperature:** Maximum operating temperature is 122°F (50°C). Maximum cleaning temperature is 113°F (45°C).
- **pH:** Allowable range for continuous operation is pH 4-10. Allowable range for short term cleaning is pH 1.7-11.5. It is recommended to limit the exposure of the TFC-SR100 membrane to the extended pH range to 4 hours, once per month.
- **Turbidity and SDI:** Maximum feed turbidity is 1 NTU. Maximum feed Silt Density Index (SDI) is 5.0 (15 minute test). Experience has shown that feedwater with turbidity greater than 0.2 NTU generally results in frequent cleanings.

- **Recovery:** Maximum recovery is site and application specific. In general, single element recovery is approximately 15% per element.

### Chemical Tolerance:

- **Chlorine:** Exposure of TFC-SR100 membrane to free chlorine or other oxidizing agents such as permanganate, ozone, bromine and iodine is not recommended. TFC-SR100 membrane has a free chlorine tolerance of approximately 2,000 ppm-hours based on testing at 77°F (25°C), pH 8. This tolerance may be significantly reduced if catalyzing metals such as iron are present or if the pH and/or temperature are different. Sodium metabisulfite (without catalysts such as cobalt) is the preferred reducing agent. TFC-SR100 membrane has a chloramine tolerance of approximately 60,000 ppm-hours in the absence of free chlorine based on testing at 77°F (25°C), pH 8.
- **Cationic (Positively Charged) Polymers and Surfactants:** TFC-SR100 membrane may be irreversibly fouled if exposed to cationic (positively charged) polymers or surfactants. Exposure to these chemicals during operation or cleaning is not recommended.

### Lubricants:

For element loading, use only the recommended silicone lubricant (or approved equivalent), water or glycerin to lubricate O-rings and brine seals. The use of petroleum based lubricants or vegetable based oils may damage the element and void the warranty.

### Service and Ongoing Technical Support:

KMS has an experienced staff of professionals available to assist end users and OEM's for optimization of existing systems and support with the development of new applications. Along with the availability of supplemental technical bulletins, KMS also offers a complete line of KOCHTREAT® and KOCHKLEEN® RO pretreatment and maintenance chemicals.

*The information contained in this publication is believed to be accurate and reliable, but is not to be construed as implying any warranty or guarantee of performance. We assume no responsibility, obligation or liability for results obtained or damages incurred through the application of the information contained herein. Refer to Standard Terms and Conditions of Sale and Performance Warranty documentation for additional information.*

Koch Membrane Systems, Inc., [www.kochmembrane.com](http://www.kochmembrane.com)

Corporate Headquarters: 850 Main Street, Wilmington, Massachusetts 01887-3388, US, Tel. Toll Free: 1-888-677-5624, Telephone: 1-978-694-7000, Fax: 1-978-657-5208  
European Headquarters: Koch Chemical Technology Group Ltd., Units 3-6, Frank Foley Way, Stafford ST16 2ST, GB, Telephone: +44-178-527-2500, Fax: +44-178-522-3149

• San Diego US • Aachen DE • Lyon FR • Madrid ES • Milan IT • Wijnegem BE • Beijing & Shanghai CN • Mumbai & Chennai IN • Melbourne & Sydney AU • Singapore • Sao Paulo BR • Manama BH •

The FLOW LINES DESIGN, FLUID SYSTEMS, TFC, SR, NORMPRO, KOCHKLEEN and KOCHTREAT are registered trademarks of Koch Membrane Systems, Inc. in the US and other countries.

The STYLIZED K is a registered trademark of Koch Industries, Inc. in the US and other countries.

Koch Membrane Systems, Inc. is a Koch Chemical Technology Group, LLC company.

© 2012 Koch Membrane Systems, Inc. All rights reserved worldwide.

2/12 Rev 2012-2



Dow  
Liquid Separations



# **DOWEX**

# **MARATHON WBA**

## **Ion Exchange Resin**

**ENGINEERING INFORMATION**

Specifications	FB (free base) form	
Total exchange capacity, min.	eq/l	1.3
	kgr/ft <sup>3</sup> as CaCO <sub>3</sub>	28.4
Water content	%	50 - 60
Uniformity coefficient, max.		1.1

Typical Physical and Chemical Properties	FB (free base) form	
Mean particle size <sup>†</sup>	μm	525 ± 50
Whole beads	%	95 - 100
Total swelling (FB ♦ HCl)	%	20
Particle density	g/ml	1.04
Shipping weight	g/l	640
	lbs/ft <sup>3</sup>	40

Recommended Operating Conditions	
Maximum operating temperature	100°C (212°F)
pH range	0-7
Bed depth, min.	800 mm (2.6 ft)
Flow rates:	
Service/fast rinse	5-60 m/h (2-24 gpm/ft <sup>2</sup> )
Backwash	See figure 1
Co-current regeneration/displacement rinse	1-10 m/h (0.4-4 gpm/ft <sup>2</sup> )
Counter-current regeneration/displacement rinse	5-20 m/h (2-8 gpm/ft <sup>2</sup> )
Total rinse requirement	2-4 Bed volumes
Regenerant	2-5% NaOH

<sup>†</sup>For additional particle size information, please refer to the Particle Size Distribution Cross Reference Chart (Form No. 177-01775).

## Hydraulic Characteristics

### Backwash Expansion

Backwash expansion of the resin to accomplish reclassification of the bed and removal of accumulated fine particles should be done at flowrates sufficient to expand the bed between 50 and 100% of its original height in the free base form. Figure 1 details percent bed expansion for DOWEX MARATHON WBA resin when backwashed at various flowrates. It includes data for two different bases:

- 1) Regenerated - The percent expansion is determined relative to the bed depth in the regenerated (free base) form. This is the data to use for backwashing new or completely regenerated resin.
- 2) Exhausted - Resin in the exhausted form swells by up to 20% of its original volume. This is the data to use for backwashing completely exhausted resin relative to the bed depth in the free base form.

### Example

Resin depth is 1.5 m (5 ft) in the free form. The goal is to expand the bed to 3.0 m (9.9 ft) during backwash. Bed depth in the exhausted form is 1.8 m (5.9 ft). Temperature of the backwash water is 15°C (60°F).

The target expansion of the exhausted resin is 100% relative to the free base form bed depth.  
 $\{(3.0\text{m} - 1.5\text{m})/1.5\text{m}\} \times 100 = 100\%$ .  
 Using Figure 1, the flowrate required for 100% expansion in the regenerated form is determined to be 9.0 m/h (3.7 gpm/ft<sup>2</sup>) at 25°C (77°F). The temperature correction factor is then applied to determine the required flowrate at 15°C (60°F).  
 $9.0 \text{ m/h} [1 + 0.008 \{(1.8 \times 15) - 45\}]$   
 $= 7.7 \text{ m/h} (3.1 \text{ gpm/ft}^2)$ .

Figure 1. Backwash expansion vs. flow rate

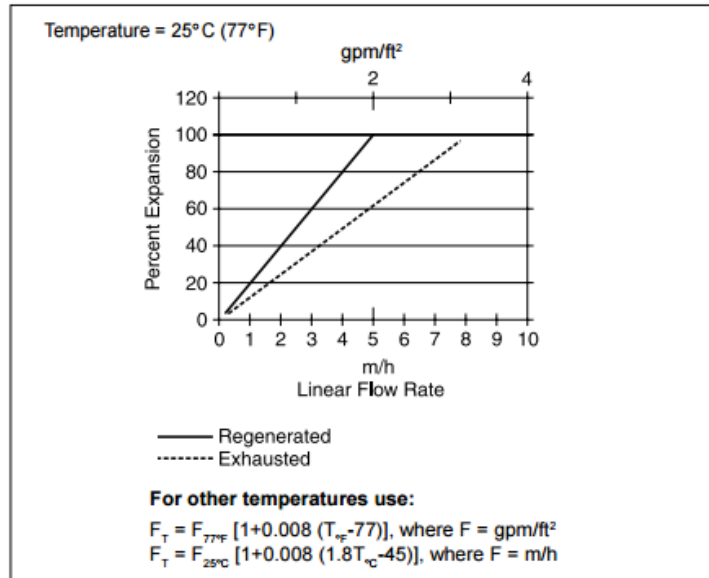

### Pressure Drop Data

The pressure drop across a resin bed can vary depending on a number of factors. These include resin type, bead size, interstitial space (bed voidage), flow rate, temperature and degree of bed contamination. The presence of smaller beads in conventional resins results in filling of the interstitial spaces between the larger beads, thereby increasing the head loss. Compared to conventional resins, uniform beads have a higher bed voidage which compensates for the smaller mean bead diameter, resulting in similar head loss characteristics to the conventional resins.

The data in Figure 2 shows the pressure drop per unit bed depth as a function of both flow velocity and water temperature for the resin. These figures refer to a new resin bed at the beginning of the operational cycle with the resin in the free amine form (i.e. regenerated) in a backwashed, settled condition and should be considered indicative. The total head loss of a unit in operation will also depend on the design, in addition to other factors such as level of fines and suspended solids. Vessel geometry is also an important consideration, as in very small diameter units, particularly with deep beds, bed compaction may occur which could substantially increase the head loss.

### Operating Characteristics

#### General

DOWEX MARATHON WBA resin removes free mineral acidity (FMA) from the cation effluent but, apart from a short period at the beginning of the operational cycle, will not remove carbon dioxide or silica. It therefore provides a highly efficient partial demineralization. The capacity of the resin is higher if carbon

Figure 2. Pressure drop

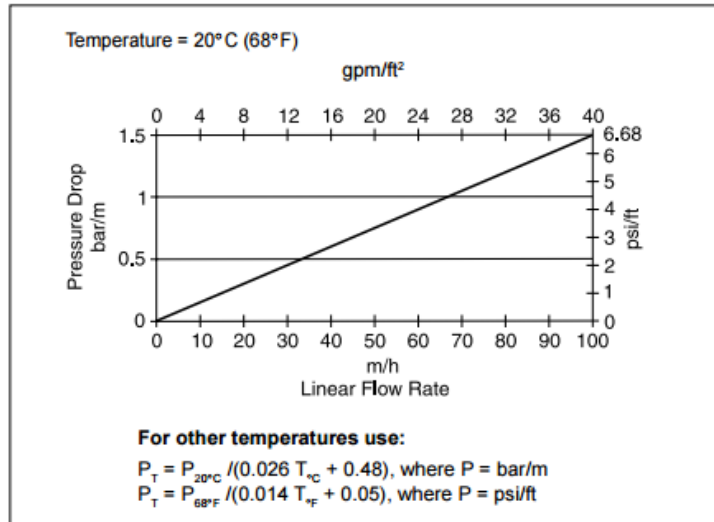

dioxide is present in the water, thus the logical location of a degassing tower would be after the weak base anion resin. The chemical efficiency remains the same, however, so the position of the degasser can be selected according to the overall chemical engineering.

#### Chemical Efficiency

DOWEX MARATHON WBA resin regenerates extremely efficiently, leading to lower operating costs and reduced waste disposal. Figure 3 shows the amount of caustic soda normally required based on a

consumption of 130% of the stoichiometric chemical equivalent. This is a typical figure. If the water is free from organic matter, 5-10% less chemical may be used. A water with a high organic content may need 10% more. If caustic soda is very expensive, it may be economical to use less caustic soda and heat to 40°C (104°F). The capacity of the resin to an end point of 30 µS/cm should not be affected by the regeneration level, always provided it exceeds the chemical equivalent of the work done.

Dow  
Liquid Separations

# **DOWEX MARATHON C**

## **Ion Exchange Resin**

**ENGINEERING INFORMATION**

# DOWEX MARATHON C Strong Acid Cation Exchange Resin

## General Information

DOWEX® MARATHON® C resin is a high capacity, gel strong acid cation exchange resin of uniform bead size distribution. It is based on a styrene-divinyl benzene copolymer matrix with sulfonate functional groups. DOWEX MARATHON C resin is specifically designed to give high throughput and economical operation in both water and non-water applications. Because of its uniform particle size, this resin offers

a number of advantages compared to conventional (polydispersed) resins. The small uniform bead size of DOWEX MARATHON C resin results in rapid exchange kinetics during operation, more complete regeneration of the resin, and faster, more thorough rinse following regeneration. Its high mechanical and osmotic strength due to its specially designed structure and small bead size gives it outstanding resistance to bead breakage.

This brochure relates to water demineralization, using HCl or H<sub>2</sub>SO<sub>4</sub> as regenerant in co-current or counter-current operation. The presented data allows the calculation of operational capacities and sodium leakages for different water qualities at different temperatures and levels of regeneration. Separate information is available on its use in softening applications. The resin is normally delivered in the hydrogen form but is also available in the sodium form.

Guaranteed Sales Specifications		Na <sup>+</sup> form	H <sup>+</sup> form
Total exchange capacity, min.	eq/l	2.0	1.8
	kgr/ft <sup>3</sup> as CaCO <sub>3</sub>	43.7	39.3
Water content	%	42 - 48	50 - 56
Uniformity coefficient, max.		1.1	1.1

Typical Physical and Chemical Properties		Na <sup>+</sup> form	H <sup>+</sup> form
Mean particle size†	µm	585 ± 50	600 ± 50
Whole uncracked beads	%	95 - 100	95 - 100
Total swelling (Na <sup>+</sup> + H <sup>+</sup> )	%	8	8
Particle density	g/ml	1.28	1.20
Shipping weight	g/l	820	800
	lbs/ft <sup>3</sup>	51	50

Recommended Operating Conditions	
Maximum operating temperature:	120°C (250°F)
pH range	0-14
Bed depth, min.	800 mm (2.6 ft)
Flow rates:	
Service/fast rinse	5-60 m/h (2-24 gpm/ft <sup>2</sup> )
Backwash	See figure 1
Co-current regeneration/displacement rinse	1-10 m/h (0.4-4 gpm/ft <sup>2</sup> )
Counter-current regeneration/displacement rinse	5-20 m/h (2-8 gpm/ft <sup>2</sup> )
Total rinse requirement	2-5 Bed volumes
Regenerant	1-8% H <sub>2</sub> SO <sub>4</sub> , 4-8% HCl or 8-12% NaCl

†For additional particle size information, please refer to the Particle Size Distribution Cross Reference Chart (Form No. 177-01775/CH 171-476-E).

### Bed Expansion

A uniform bead resin requires less flow to expand to the same height as a conventional polydispersed resin. DOWEX MARATHON C resin has a smaller mean size, thereby reducing the backwash flow rate required even further. Backwash expansion characteristics for MARATHON C resin are displayed in Figure 1. Backwash expansion reclassifies the resin, removes any accumulated fines, and prevents channeling during the subsequent service cycle. An expansion of 60–80% for 20 minutes is normally recommended to remove particulate matter from the resin bed.

In co-current operation the resin is backwashed before every regeneration. Occasionally, extended backwash may be needed to fully remove contaminants. In counter-current operation, the strainers are cleaned by the regenerant flow. To retain the advantages of counter-current operation, it is essential not to disturb the resin. Backwashing is only desirable if accumulated debris causes an excessive increase in pressure drop or to decompact the bed. Usually, a backwash is performed every 15 to 30 cycles in conventional "blocked" counter-current regeneration systems.

### Pressure Drop Data

The pressure drop across a resin bed can vary depending on a number of factors. These include resin type, bead size, interstitial space (void volume), flow rate, and temperature. The presence of smaller beads in conventional polydispersed resins can result in filling of the interstitial spaces between the larger beads, thereby increasing the head loss pressure drop. Compared to conventional resins, uniform beads have a higher void volume which compensates for the smaller mean bead diameter, resulting in similar head loss characteristics to the conventional resins.

Figure 1. Backwash expansion vs. flow rate

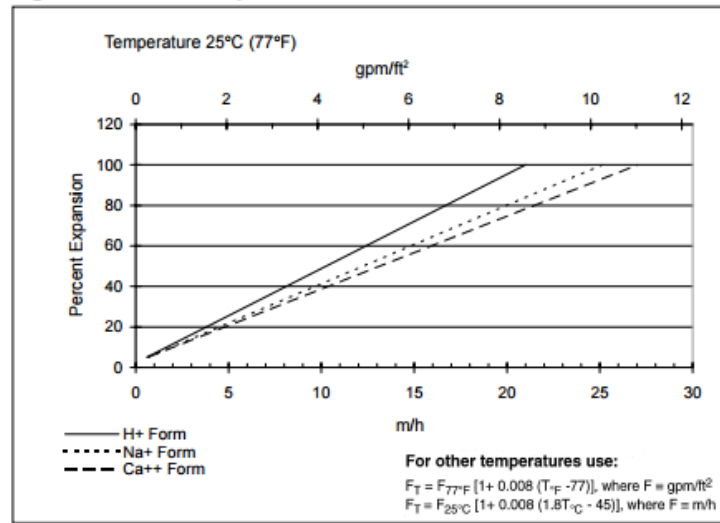
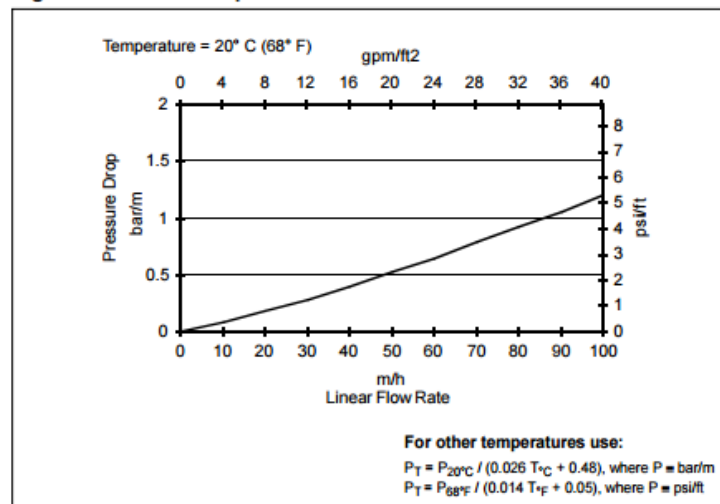

Figure 2. Pressure drop vs. flow rate



The data in Figure 2 shows the pressure drop per unit bed depth as a function of flow velocity. These figures are based on new resin which has been backwashed and settled and must be considered representative only. The total head

loss of a unit in operation will also depend on the design, in addition to other factors such as level of fines and suspended solids. It is substantially affected by the contribution of the strainers surrounded by resin.



## DOWEX™ MARATHON™ MR-3

Uniform Particle Size, High Capacity, Mixed Ion Exchange Resin for Demineralization

Product	Type	Matrix	Functional group
DOWEX™ MARATHON™ MR-3	1:1 by equivalents cation:anion	Styrene-DVB, gel	Sulfonic acid Quaternary amine

Guaranteed Sales Specifications		OH <sup>-</sup> form	H <sup>+</sup> form
Total exchange capacity, min.	eq/L	1.0	1.9
	kg/ft <sup>3</sup> as CaCO <sub>3</sub>	21.9	41.5
Water content	%	60 - 72	46 - 51
Uniformity coefficient, max.		1.1	1.1
Whole uncracked beads, min.	%	90	90

Typical Physical and Chemical Properties		OH <sup>-</sup> form	H <sup>+</sup> form
Mean particle size <sup>1</sup>	μm	610 ± 50	760 ± 50
Particle density	g/mL	1.06	1.22
Shipping weight	g/L		672
	lbs/ft <sup>3</sup>		42

### Recommended Operating Conditions

- Maximum operating temperature 60°C (140°F)
- pH range 0 - 14
- Bed depth, min. 800 mm (2.6 ft)

<sup>1</sup> For additional particle size information, please refer to Particle Size Distribution Cross Reference Chart (Form No. 177-01775)



**Typical properties and applications**

DOWEX™ MARATHON™ MR-3 ion exchange resin is a 1:1 equivalent mixture of DOWEX MARATHON A (OH) anion and DOWEX MARATHON C-10 (H) cation resins. This product is a ready-to-use regenerable uniform particle size mixed resin for demineralization.

**Packaging**

25 liter bags or 5 cubic foot fiber drums

**Figure 1. Pressure Drop Data**

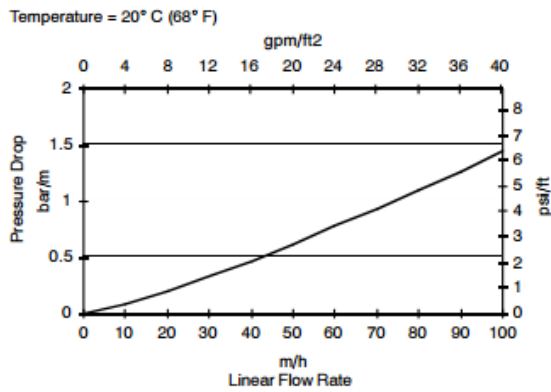

**For other temperatures use:**

$$P_T = P_{20^\circ C} / (0.026 T_C + 0.48), \text{ where } P = \text{bar/m}$$

$$P_T = P_{68^\circ F} / (0.014 T_F + 0.05), \text{ where } P = \text{psi/ft}$$

# FLEXIPAC® HC® High Capacity Structured Packing

Since its introduction in 1997, FLEXIPAC HC structured packing has been used in hundreds of columns to increase capacity and reduce pressure drop both in new construction and for replacing standard sheet metal structured packings, conventional random packings and trays. Combining excellent capacity and efficiency characteristics along with a lower pressure drop per theoretical stage, it is the preferred packing for use in vacuum distillation applications.

FLEXIPAC HC is similar in construction to standard FLEXIPAC packing, except for a subtle modification in the geometry of the corrugation at the top and bottom of each packing layer. This relatively small change in geometry eliminates the abrupt change in flow direction of the liquid and vapor phases at the packing layer interface.

Conventional structured packing capacity is limited by flow interaction at the layer interface where the abrupt directional change limits the amount of counter-flowing liquid and vapor. As the liquid flow becomes restricted by the upward-flowing vapor, the liquid begins to build up at the layer interface which increases the pressure drop and may ultimately lead to flooding. The geometry of FLEXIPAC HC packing relieves this restriction. Since the premature build-up of liquid is eliminated, the low pressure drop characteristics of structured packing are better maintained throughout the efficient operating

range of the packing. The advantages of FLEXIPAC HC packing are particularly strong for smaller corrugation crimp size, higher surface area packings.



FLEXIPAC® HC® Structured Packing with a perforated and textured surface showing corrugation configuration at layer interface

Please refer to page 5 for recommended application guidelines and efficiency values.

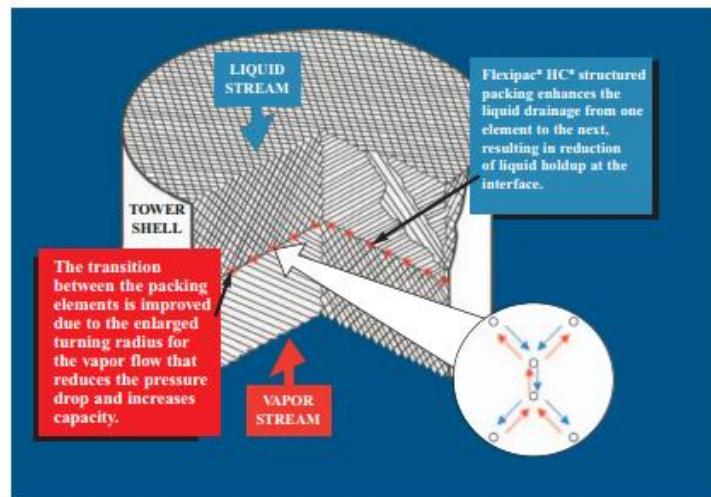

FLEXIPAC® HC® Structured Packing		2Y	250Y	1.6Y	1.4Y/350Y	1Y	500Y	700
Surface Area	ft <sup>2</sup> /ft <sup>2</sup>	68	77	90	106	129	152	220
	m <sup>2</sup> /m <sup>2</sup>	225	250	295	350	420	500	725

# Choice and Application of Koch-Glitsch High Capacity Structured Packings

Each type of Koch-Glitsch structured packing has strong performance characteristics. Under certain conditions or in specific applications, each has a particular strength which may make one style more desirable. Considerations in choosing a specific structured packing type are:

- To meet specific process requirements
- As a direct replacement of an existing packing
- Familiarity with the packing type and its performance
- Past experience of using a specific packing type in a particular application
- Specified for use in a licensed process

With more than thirty years of history, FLEXIPAC structured packing continues to be a strong performer in applications where the incremental capacity increase of high performance structured packing is not required.

When choosing a high capacity structured packing, FLEXIPAC HC and INTALOX structured packings each offer distinct advantages, depending upon the application. Through its wetting and liquid handling characteristics, the patented, aggressive surface texture of the INTALOX structured packing offers extremely efficient use of the available packing surface. For the larger corrugation size packings, INTALOX structured packing provides a better efficiency than other structured packings with similar surface area.

FLEXIPAC HC structured packing uses a less aggressive, perforated and textured surface style to provide excellent surface area utilization. This surface, along with the smooth channel transition at the layer interface, provides a less restricted flow channel and results in lower pressure drop as the packing reaches the loading region. This is particularly true for the smaller corrugation packing sizes. The table below provides guidance in choosing the recommended high capacity packing.

		← Increasing Capacity				Increasing Efficiency →					
INTALOX® Structured Packing		5T	4T	3T	2T	1.5T	1T				
FLEXIPAC® HC® Structured Packing					2Y	250Y	1.6Y	1.4Y	1Y	500Y	700Y
Approximate HETP*											
	inches	30	24	18	16	14	12.5	11	10	9	7.5
	mm	762	610	457	406	356	318	279	254	229	191

\* HETP values are typical for total reflux distillation of low-alpha systems with good liquid and vapor distribution at moderate vacuum to moderate pressure in the typical design range of 50% to 80% of flood

All Applications
Aqueous Service, High Pressure or High Liquid Rate
Low Pressure Drop Requirement

## Special Purpose Structured Packings

### INTALOX® Structured Packing 5TX

As the only high capacity, high efficiency packing available in the "X" (60°) corrugation configuration, INTALOX structured packing 5TX offers grid type packing capacity with good efficiency. INTALOX 5TX structured packing should be considered whenever fractionation or excellent heat transfer is required at the absolute maximum throughput.

### FLEXIPAC® S, FLEXIGRID® and GLITSCH-GRID® Structured Packings

FLEXIPAC® S packing is similar in construction to FLEXIPAC packing but has a smooth surface and can be manufactured using thicker material. The smooth surface enables the packing to be used in moderately fouling systems while the thicker material gauge gives it greater mechanical strength and provides increased corrosion resistance. FLEXIPAC S packing is available in various sizes and in both the X (45°) and Y (60°)

corrugation configurations. Applications include top pumparound zones of Refinery Fractionators as well as Ethylene Water Quench Columns.

FLEXIGRID® and GLITSCH-GRID® structured packings are the packings of choice for applications in severe services subject to fouling, coking, erosion and high solids content, while providing a robust mechanical structure to resist damage during upsets. FLEXIGRID and GLITSCH-GRID structured packings are available in a wide variety of materials. Applications for these packings include Crude Atmospheric and Crude Vacuum Towers, FCC Main Fractionators, Coker Fractionators as well as Ethylene Plant Oil and Water Quench Columns. For further information on FLEXIGRID, GLITSCH-GRID and FLEXIPAC S packings for use in severe service, please ask for brochure KGSS-1.