



Aalborg Universitet

AALBORG UNIVERSITY
DENMARK

Analysis and distributed control of power flow in DC microgrids to improve system efficiency

Chen, Fang; Burgos, Rolando; Boroyevich, Dushan; Diaz, Enrique Rodriguez; Meng, Lexuan; Quintero, Juan Carlos Vasquez; Guerrero, Josep M.

Published in:

Proceedings of IEEE 2016 4th International Symposium on Environment Friendly Energies and Applications (EFEA)

DOI (link to publication from Publisher):

[10.1109/EFEA.2016.7748774](https://doi.org/10.1109/EFEA.2016.7748774)

Publication date:

2016

Document Version

Early version, also known as pre-print

[Link to publication from Aalborg University](#)

Citation for published version (APA):

Chen, F., Burgos, R., Boroyevich, D., Diaz, E. R., Meng, L., Quintero, J. C. V., & Guerrero, J. M. (2016). Analysis and distributed control of power flow in DC microgrids to improve system efficiency. In *Proceedings of IEEE 2016 4th International Symposium on Environment Friendly Energies and Applications (EFEA)* IEEE Press. <https://doi.org/10.1109/EFEA.2016.7748774>

General rights

Copyright and moral rights for the publications made accessible in the public portal are retained by the authors and/or other copyright owners and it is a condition of accessing publications that users recognise and abide by the legal requirements associated with these rights.

- ? Users may download and print one copy of any publication from the public portal for the purpose of private study or research.
- ? You may not further distribute the material or use it for any profit-making activity or commercial gain
- ? You may freely distribute the URL identifying the publication in the public portal ?

Take down policy

If you believe that this document breaches copyright please contact us at vbn@aub.aau.dk providing details, and we will remove access to the work immediately and investigate your claim.

Power Flow Analysis and Control for DC Microgrid to Improve System Efficiency

Fang Chen, Rolando Burgos, Dushan Boroyevich
Center for Power Electronics Systems (CPES)
Virginia Polytechnic Institute & State University
Blacksburg, VA, US
fangchen@vt.edu

Enrique Rodriguez-Diaz, Juan C. Vasquez,
Josep M. Guerrero
Department of Energy Technology
Aalborg University, Aalborg, Denmark
www.microgrids.et.aau.dk

Abstract—DC Microgrid attains popularity in integrating renewable energy sources and batteries. It also has the potential to achieve higher efficiency than ac power grid under the condition of optimized power flow. In this paper, a general dc microgrid is modeled based on a cluster of general dc nodes, which includes constant power renewables generation, droop-controlled voltage source and different kinds of load. Then the dc power flow is solved for optimization. A voltage restoration method based on consensus communication is used to restore the voltage deviation from droop characteristic. An enhanced current regulator is adopted to guarantee the accurate load sharing considering the impact from sensor error and line resistance. A tie line power flow control method is proposed to regulate the tie line power and increase the system efficiency at light load. All the considered methods only need the local information and the information from its nearest neighbor thus the system expendability is guaranteed. Simulation and experiment results are provided to validate the proposed methods.

Keywords—dc microgrid; power flow; efficiency

I. INTRODUCTION

DC microgrid gains more and more attention because of the ease to integrate different renewable sources and energy storage, no frequency issue and the possibility to achieve higher efficiency [1]. To coordinate multiple sources in a dc grid that are paralleled to a common bus, droop control is broadly used [2]–[4]. By introducing a virtual output resistance to each source, the circulating current is suppressed and load sharing among sources is realized.

Though the droop principle is used in many applications, how to analyze and optimize power flow in a dc grid that consists of multiple power nodes is seldom analyzed. In [5], the steady-state performance and sensitivity in a dc microgrid are analyzed. But it only considered the droop-controlled voltage source and constant current load. In [6], the droop voltage range design and the cable's impact on system performance are analyzed quantitatively, but the analyzed system is small and only has a limited number of sources. In [7]–[10], different secondary control methods were proposed to restore the dc bus voltage deviation from droop control and ensure a proportional load sharing. However, all of them rely on dedicated communication links, which reduces system reliability and expendability. What is more, though these methods improve the bus voltage regulation and proportional load sharing, the

outcomes and benefits of these improvement is still unclear. In [11], a hierarchical control structure was used to optimize the efficiency of a dc microgrid. It was reported that, to improve the overall system efficiency, uneven load sharing is better at light load condition while proportional load sharing is better at heavy load. But the proposed algorithm is very complicate and was only demonstrated for a two-source system where source efficiency curves are already known.

To save the dedicated communication link in distributed control, consensus based control method was introduced to the field of microgrid from multi-agent systems in [12]–[17]. It enables the bus voltage restoration and load sharing with communications between only adjacent nodes. It also enables an opportunity to achieve other optimization without dedicated communication.

In this paper, the analytical solution for the power flow in a general dc grid is derived, which reveals the impact from cable resistance and voltage sensor error. Then a secondary level voltage restoration based on consensus communication is applied. Two power flow control methods are considered and compared for the sake of efficiency. All the control methods are based on the nearest nodes communication in which one node only talks to its nearest neighbors.

II. POWER FLOW ANALYSIS FOR A GENERAL DC GRID

To get a generalized power flow solution for optimization, a general dc grid needs modeling. Consider a general dc microgrid as shown in Fig. 1. It can include many dc nodes which have different structure and are geographically distributed. In the figure, five nodes are drawn as an example. Every dc node has its different local power generation (e.g. solar and wind), energy storage and loads. The nodes can even be another dc or ac system. All the nodes are connected to a common dc bus through power converters.

For the modeling, the sources and loads are categorized into following types.

- 1) constant power source (CPS), which is usually the distributed renewable energy generation (photovoltaic and wind) working at maximum power point tracking (MPPT) mode. It can be either one source or a combination of multiple CPSs. This kind of sources inject a constant power no matter the dc bus voltage.

2) droop controlled voltage regulators (VR), which buffers the intermittent power from renewable sources and regulates the dc bus voltage. Battery is a good candidate for this purpose because of its bidirectional power capability. In some case, it can be also a bidirectional ac-dc converter interfaced to the ac utility. The injected power from this source to the dc bus changes with different bus voltage.

3) constant power load (CPL) and constant resistive load (CRL). Nowadays, most loads like consumer electronics, LEDs, microwaves, washing machines are all constant power style. But some old lighting bulbs and oven can be still resistive.

Consider the span of a real distribution system, the distance between different nodes cannot be omitted.

Similar to the power flow analysis in ac system, we define the system to include N power nodes and the corresponding admittance matrix $Y_{N \times N}$. Its elements y_{ij} is the line admittance between node i and node j . The self admittance y_{ii} is defined as the sum of all branch admittance connecting to node i . Obviously, the admittance matrix is symmetric and usually sparse.

For certain node i , suppose the total generation of CPS is P_{CPSi} and total CPL consumption is P_{CPLi} . The VR follows the droop output characteristic in (1) to share the load, where v_i is the bus voltage of node i and v_i^* is the voltage set point of the droop for node i . r_d is the droop resistance and i_o is the output current of VR.

$$v_i = v_i^* - r_d i_o \quad (1)$$

Then the injected power from VR is

$$P_{VRI} = v_i i_o = \frac{v_i^* - v_i}{r_d} v_i \quad (2)$$

The power consumed on CRL is

$$P_{CRLi} = \frac{v_i^2}{R_{CRLi}} \quad (3)$$

The power injected into node i is in (4). If there is no connection between node i and j , then y_{ij} equals to zero.

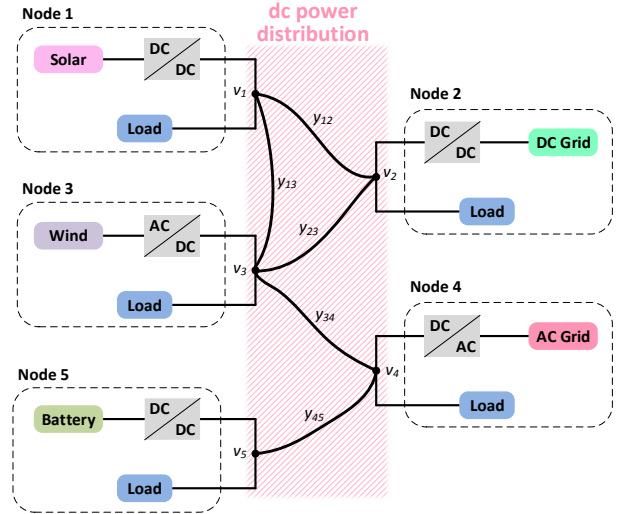

Fig. 1. A general dc microgrid.

$$P_{INi} = \sum_{j=1, j \neq i}^N v_j (v_j - v_i) y_{ij} \quad (4)$$

Due to power balance, for every node i , (5) needs to be satisfied.

$$P_{CPSi} + P_{VRI} - P_{CPLi} - P_{CRLi} + P_{INi} = 0 \quad (5)$$

If we put it in a matrix form, then the system power description can be expressed in (6).

In this equation, the node voltage v_1 to v_n are unknowns. The P_{CPSi} and P_{CPLi} are usually unadjustable. But the droop voltage set point v_i^* and droop resistance r_{di} are controllable. They can be finely programmed to control the power flow between different nodes and enable the optimized power flow. Since the droop resistance is usually programmed inverse proportional to the source rating. In the following section, the voltage set point is used as the control variable to achieve different optimization targets.

III. POWER FLOW CONTROL AND OPTIMIZATION

In order to maximize the system efficiency, the system loss needs to be analyzed and minimized. In practical, the system loss are mainly from the power conversion loss generated by power converters and transmission loss consumed on power cables. In this section, two different power control methods are

$$\begin{bmatrix} P_{CPS1} \\ P_{CPS2} \\ \vdots \\ P_{CPSn} \end{bmatrix} - \begin{bmatrix} P_{CPL1} \\ P_{CPL2} \\ \vdots \\ P_{CPLn} \end{bmatrix} + \begin{bmatrix} v_1 & 0 & 0 & 0 \\ 0 & v_2 & 0 & 0 \\ 0 & 0 & \ddots & 0 \\ 0 & 0 & 0 & v_n \end{bmatrix} \begin{bmatrix} v_1^* / r_{d1} \\ v_2^* / r_{d2} \\ \vdots \\ v_n^* / r_{dn} \end{bmatrix} + \begin{bmatrix} v_1 & 0 & 0 & 0 \\ 0 & v_2 & 0 & 0 \\ 0 & 0 & \ddots & 0 \\ 0 & 0 & 0 & v_n \end{bmatrix} \begin{bmatrix} -y_{11} - 1/r_{d1} - 1/R_{CRL1} & y_{12} & \cdots & y_{1n} \\ y_{21} & -y_{22} - 1/r_{d2} - 1/R_{CRL2} & \cdots & y_{2n} \\ \vdots & \vdots & \ddots & \vdots \\ y_{n1} & y_{n2} & \cdots & -y_{nn} - 1/r_{dn} - 1/R_{CRLn} \end{bmatrix} \begin{bmatrix} v_1 \\ v_2 \\ \vdots \\ v_n \end{bmatrix} = 0 \quad (6)$$

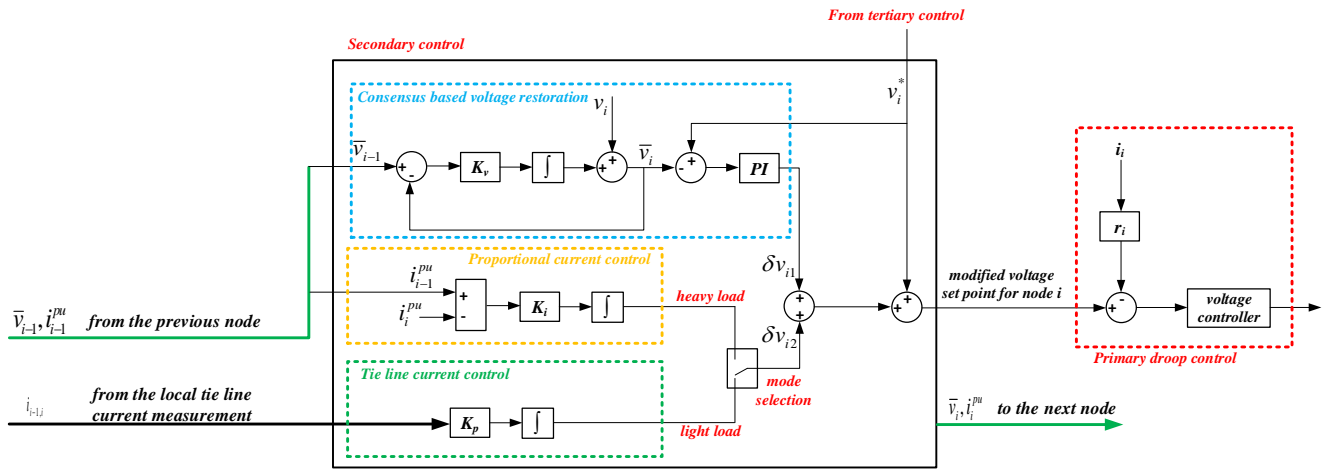

Fig. 2. Consensus based optimized power flow controller.

discussed by using only the communication between nearest nodes. One is accurate load sharing control among different nodes according to their power rating. When the load is heavy, the conversion loss dominates. The proportional load sharing can minimize the conversion loss by distributing the load. However, when the load is light, instead of distributing the load, it is better to let local source provides the local power consumption. It has two benefits. Firstly, according to [11], at light load condition, unevenly distributing the load at light load condition achieves lower overall conversion loss. Secondly, since the loads are fed by their local sources, the transmission loss is eliminated. In order to directly control the power flow on the tie lines, it requires additional measurement to measure the current on the tie lines. But the cost is considered reasonable to achieve the direct power flow control target. In this case, under normal load condition, the tie line current can be controlled to be zero. The transmission loss on the lines is completely eliminated. At heavy load condition, the control can switch to the proportional sharing mode to guarantee the system availability.

Because of the droop characteristic of VRs, the steady state bus voltage will be lower than the nominal voltage which can deteriorate the system performance and lower the system efficiency. For both control method, a consensus based voltage restoration is applied to compensate the steady state error. Again, this only requires the communication between adjacent nodes.

The controller structure for each node is shown in Fig. 2. This paper focuses on the secondary level control, which consists of three paralleled parts: 1) consensus based voltage restoration. 2) proportional current control and 3) tie line current control. It is worth mentioning that the communication can be bidirectional or unidirectional. In this paper, to show the simpleness of the proposed method, only unidirectional communication is used. It means the information can only be passed from node $i-1$ to node i , and then to node $i+1$, but not in the reversed direction.

The function of the voltage restoration controller is to generate a compensation voltage offset to cancel the voltage drift caused by the primary droop control. In order to generate this restoration signal, each node needs to estimate the bus

voltage by comparing the local voltage estimation \bar{v}_i with the estimation \bar{v}_{i-1} received from the previous node. The error is passed through a gain of K_v and an integrator. The result is added to the current local voltage measurement result v_i to update the local estimation \bar{v}_i . The estimation of bus voltage is then compared with the voltage set point v_i^* . The error is compensated by a PI controller. This part will restore the voltage deviation caused by droop characteristic and cable voltage drop. The local bus voltage estimation is also passed to the next node for its calculation.

The proportional current control part and tie line current control part are for different load condition. Though the droop resistance is designed for the proportional load sharing between different sources without communication, the ratio is never accurate in real case because of sensor discrepancy and cable resistance. The proportional current control part is designed for this. A new term called “pu current” is defined. It is the percentage of local current compared to its rated current. So when the local VR current is 0 then the pu current is also 0. When the local current is maximized at its rating, the pu current is 1. By such definition, different sources can compare their output current directly without any transformation. In this part, the local controller receives the pu current from previous node and compare it with the local pu current. Based on the difference, a second adjustment part for local voltage reference is generated. Because this is a closed loop compensation with an integrator, the steady state error is eliminated. Accurate load distribution is achieved for heavy load condition.

At light load condition, it is not preferred to have even load sharing. In this case, the tie line current control part is used. It directly senses the current of transmission line which is connected to the local node and compare it with the reference. In this case, we want to stop transmitting power from other nodes, then the current reference is zero. In fact, this reference can be set to other desired non-zero values to achieve other optimization target.

It is worth mentioning that the proportional load sharing and tie line current control can be contradictory with each other, so it is preferred to choose one for a certain load condition. But the

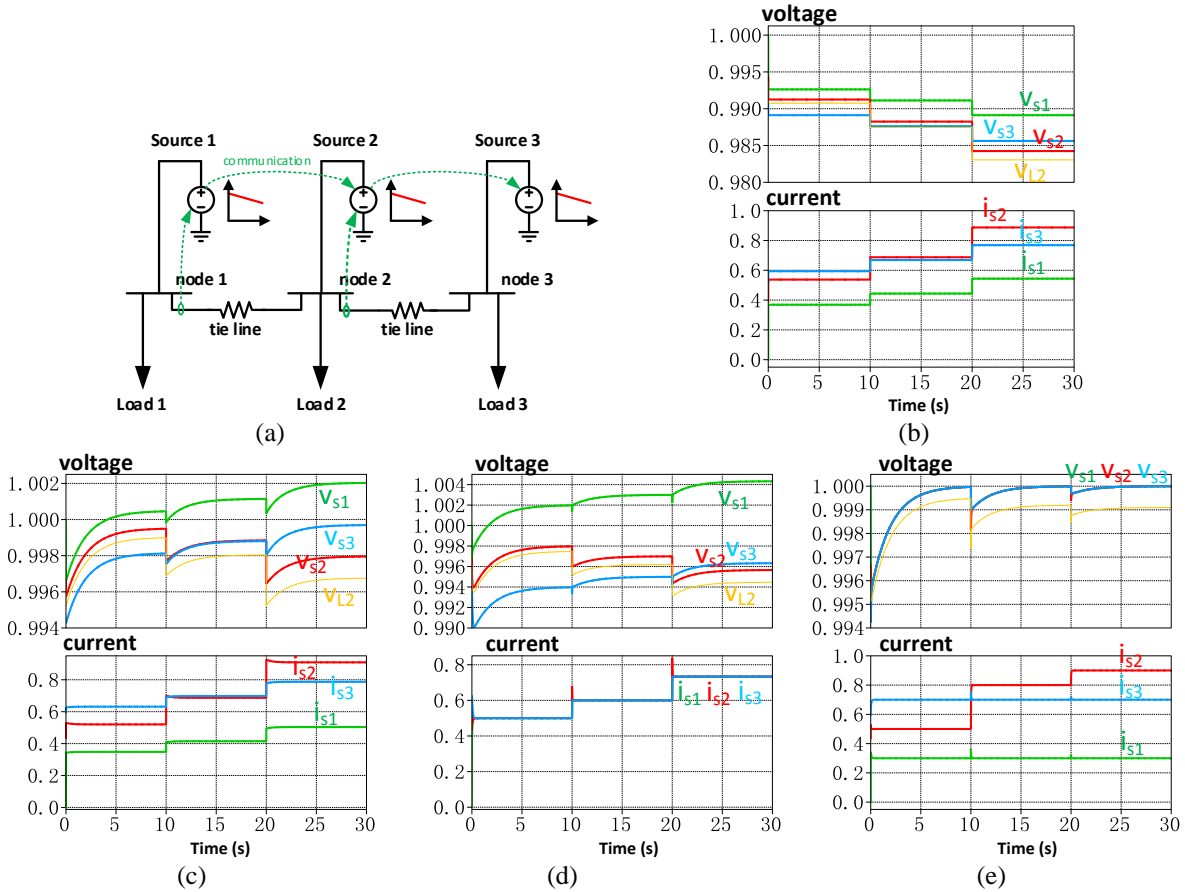

Fig. 3. System structure and simulation results.

(a) simulated three-source three-load dc distribution system. (b) voltage and current without secondary control (c) with voltage restoration (d) with both voltage restoration and current sharing control (e) with tie line current control

voltage restoration can work with both since it adjusts all the node voltage in the same manner.

IV. SIMULATION AND EXPERIMENT VERIFICATION

A three-node system is constructed to simulate and validate the effectiveness of the proposed control strategy. The system structure and load profile is shown in Fig. 3. Three VR nodes are connected through two segments of tie lines. Each tie line has different resistance. There is also sensor discrepancy for different VRs, i.e. VR₁ has accurate sensing while VR₂ and VR₃ have 0.2% and 0.1% drift. So without compensation, the load sharing will be inaccurate. The load at each node is expressed as load 1 to load 3. In the simulation, loads at node 1 and 3 are fixed at 0.3 pu and 0.7 pu. Load at node 2 steps up at 10 second and 20 second to demonstrate the performance. The communication is only between the nearest nodes and unidirectional. Node 1 sends its pu current and voltage estimation to node 2. The same from node 2 to node 3. Each node also senses its local tie line current for direct power flow control. To make the conclusion more general, the nominal bus voltage is 1 p.u.. The current rating for each source is also 1 p.u..

Fig. 3 (b)-(e) show the simulation results. In (b), no secondary control is enabled. The system can still work with the primary droop control. But the load is not evenly shared among sources. Also, the bus voltage drops as the load current increases

at 10 second and 20 second. In (c), the voltage restoration loop is enabled. The current sharing is the same as in (a). But the voltage is lifted up. At the heaviest load condition, the load node voltage is 0.983 p.u., which is much higher than the value of 0.983 p.u. in (b). In (d), both the voltage restoration and current sharing control are enabled. In this case, the three source current are always the same, even with the realistic line resistance and sensor drift. The effectiveness of the current sharing control is proved. In (e), the tie line current control is enabled. We can observe the source current of node 1 and node 3 are constant and equal to their individual fixed load. Current from source 2 tightly follows the load step at node 2. The current flow through tie lines are zero.

The proposal was also verified by hardware experiment. Fig. 4 shows a picture of the experiment setup. Three three-phase ac-dc converters are placed in a cabinet to mimic the operation of three distributed sources. The converters are connected through adjustable cable emulator. So the resistance of each cable can be accurately controlled. A dSpace control system is used to fulfill the converter control and higher level optimization. It also works as the monitoring system to observe the interested waveforms in real time. It makes it convenient to start and stop each control function so the effect of each control loop can be identified. Constant resistive and constant power loads are connected along the bus to typify the distributed load.

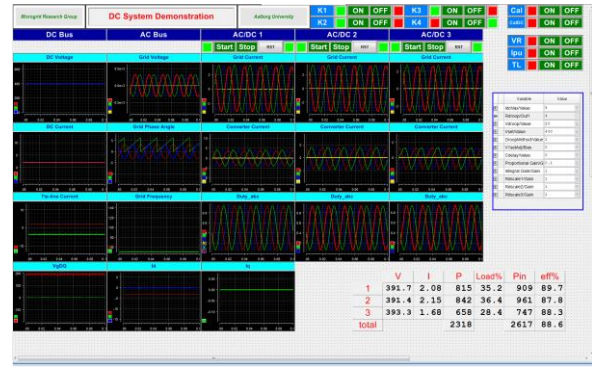
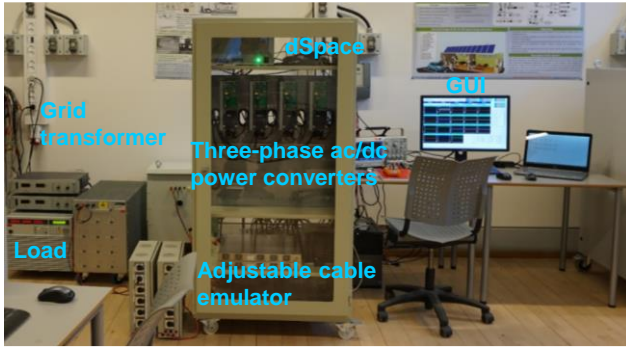

(a) (b) Fig. 4. Experiment set up and monitoring user interface

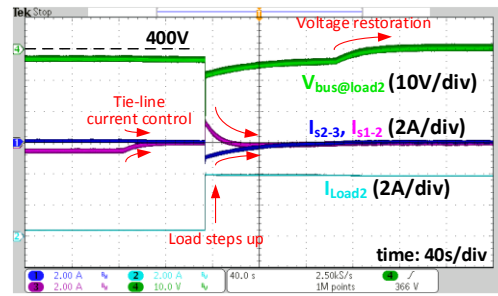
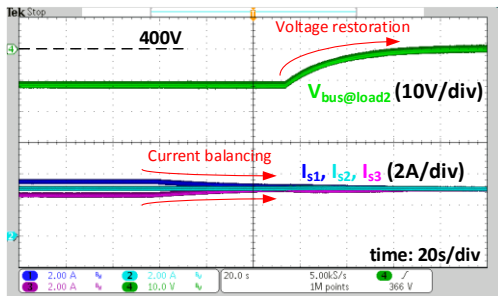
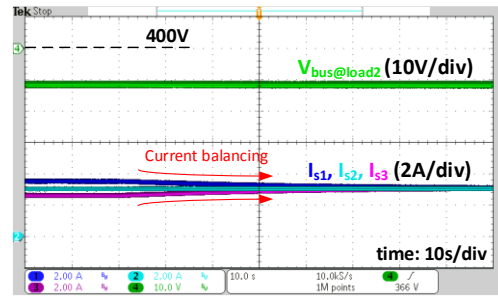
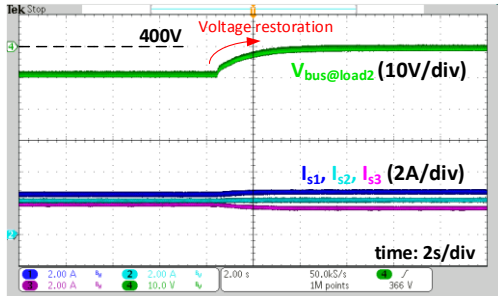

(a) (b) (c) (d) Fig. 5. Experiment results.

(a) with voltage restoration (b) with proportional load sharing control (c) with both voltage restoration and current balancing (d) direct tie line current control with load step up

Fig. 5 shows the experiment waveforms measured by the oscilloscope. In the experiment, the nominal bus voltage is set at 400 V. The current and power rating of each source is 5 A and 2 kW. The droop resistance for all the sources is the same, i.e. 5 Ω . In Fig. 5(a), when the output current of the sources is around 2 A, the bus voltage has 10 V deviation. After enabling the voltage restoration, the bus voltage which is measured at load 2, goes back to the nominal voltage at 400 V. But the load current is not evenly distributed. In fact, after enabling the voltage restoration, the sharing is becoming worse.

In Fig. 5(b), the proportional load sharing control is enabled. The current from the three sources are identical because all the sources have the same power rating and droop resistance. In Fig. 5(c), besides the current balancing, the voltage restoration is also enabled later. It can be observed that the bus voltage deviation is eliminated while the load sharing is even.

In Fig. 5(d), the performance of the tie line current control is tested. When the tie line current control is enabled, after some

transient time, the tie line current becomes zero. When load step happens, the tie line current will have some instant value to supply the transient power. But after some time, the tie line current will become zero again. Also, the voltage restoration works well with the tie line current control.

V. CONCLUSION

In this paper, the analytical solution for power flow in a generalized dc system is derived. Based on it, the power flow optimization can be realized. This paper focuses on the secondary control to improve system efficiency, which prefers even load sharing at heavy load and uneven load sharing at light load. A voltage restoration method based on consensus communication is used to restore the voltage deviation from droop characteristic. A proportional current regulator is adopted to accurately control the load sharing with realistic sensor drift and line resistance. A tie line power flow control method is proposed to regulate tie line current and increase the system efficiency at light load. All the considered methods only need

the local measurement and the information from its nearest neighbor thus system expendability is guaranteed.

REFERENCES

- [1] D. Boroyevich, I. Cvetković, D. Dong, R. Burgos, F. Wang, and F. Lee, "Future electronic power distribution systems a contemplative view," in *Optimization of Electrical and Electronic Equipment (OPTIM), 2010 12th International Conference on*, 2010, pp. 1369–1380.
- [2] S. Luo, Z. Ye, R.-L. Lin, and F. C. Lee, "A classification and evaluation of paralleling methods for power supply modules," in *Power Electronics Specialists Conference, 1999. PESC 99. 30th Annual IEEE*, 1999, vol. 2, pp. 901–908.
- [3] J. Schonbergerschonberger, R. Duke, and S. D. Round, "DC-Bus Signaling: A Distributed Control Strategy for a Hybrid Renewable Nanogrid," *IEEE Trans. Ind. Electron.*, vol. 53, no. 5, pp. 1453–1460, Oct. 2006.
- [4] X. Lu, J. M. Guerrero, K. Sun, and J. C. Vasquez, "An Improved Droop Control Method for DC Microgrids Based on Low Bandwidth Communication With DC Bus Voltage Restoration and Enhanced Current Sharing Accuracy," *IEEE Trans. Power Electron.*, vol. 29, no. 4, pp. 1800–1812, Apr. 2014.
- [5] S. Anand and B. G. Fernandes, "Steady state performance analysis for load sharing in DC distributed generation system," in *Environment and Electrical Engineering (EEEIC), 2011 10th International Conference on*, 2011, pp. 1–4.
- [6] F. Chen, W. Zhang, R. Burgos, and D. Boroyevich, "Droop voltage range design in DC micro-grids considering cable resistance," in *Energy Conversion Congress and Exposition (ECCE), 2014 IEEE*, 2014, pp. 770–777.
- [7] S. Anand, B. G. Fernandes, and J. Guerrero, "Distributed Control to Ensure Proportional Load Sharing and Improve Voltage Regulation in Low-Voltage DC Microgrids," *IEEE Trans. Power Electron.*, vol. 28, no. 4, pp. 1900–1913, Apr. 2013.
- [8] X. Lu, J. M. Guerrero, K. Sun, and J. C. Vasquez, "An Improved Droop Control Method for DC Microgrids Based on Low Bandwidth Communication With DC Bus Voltage Restoration and Enhanced Current Sharing Accuracy," *IEEE Trans. Power Electron.*, vol. 29, no. 4, pp. 1800–1812, Apr. 2014.
- [9] P.-H. Huang, P.-C. Liu, W. Xiao, and M. S. El Moursi, "A Novel Droop-Based Average Voltage Sharing Control Strategy for DC Microgrids," *IEEE Trans. Smart Grid*, vol. 6, no. 3, pp. 1096–1106, May 2015.
- [10] P. Wang, X. Lu, X. Yang, W. Wang, and D. Xu, "An Improved Distributed Secondary Control Method for DC Microgrids With Enhanced Dynamic Current Sharing Performance," *IEEE Trans. Power Electron.*, vol. 31, no. 9, pp. 6658–6673, Sep. 2016.
- [11] L. Meng, T. Dragicevic, J. C. Vasquez, and J. M. Guerrero, "Tertiary and Secondary Control Levels for Efficiency Optimization and System Damping in Droop Controlled DC–DC Converters," *IEEE Trans. Smart Grid*, vol. 6, no. 6, pp. 2615–2626, Nov. 2015.
- [12] R. Olfati-Saber and R. M. Murray, "Consensus problems in networks of agents with switching topology and time-delays," *IEEE Trans. Autom. Control*, vol. 49, no. 9, pp. 1520–1533, Sep. 2004.
- [13] R. Olfati-Saber, J. A. Fax, and R. M. Murray, "Consensus and Cooperation in Networked Multi-Agent Systems," *Proc. IEEE*, vol. 95, no. 1, pp. 215–233, Jan. 2007.
- [14] V. Nasirian, A. Davoudi, F. L. Lewis, and J. M. Guerrero, "Distributed Adaptive Droop Control for DC Distribution Systems," *IEEE Trans. Energy Convers.*, vol. 29, no. 4, pp. 944–956, Dec. 2014.
- [15] F. Guo, C. Wen, J. Mao, and Y.-D. Song, "Distributed Secondary Voltage and Frequency Restoration Control of Droop-Controlled Inverter-Based Microgrids," *IEEE Trans. Ind. Electron.*, vol. 62, no. 7, pp. 4355–4364, Jul. 2015.
- [16] L. Meng, T. Dragicevic, J. Roldan-Perez, J. C. Vasquez, and J. M. Guerrero, "Modeling and Sensitivity Study of Consensus Algorithm-Based Distributed Hierarchical Control for DC Microgrids," *IEEE Trans. Smart Grid*, vol. 7, no. 3, pp. 1504–1515, May 2016.
- [17] V. Nasirian, Q. Shafiee, J. M. Guerrero, F. L. Lewis, and A. Davoudi, "Droop-Free Distributed Control for AC Microgrids," *IEEE Trans. Power Electron.*, vol. 31, no. 2, pp. 1600–1617, Feb. 2016.