

International Energy Agency, EBC Annex 58

Reliable building energy performance characterisation based on full scale dynamic measurements

Report of Subtask 3, part 2: Thermal performance characterisation using time series data – statistical guidelines

Henrik Madsen, Peder Bacher, Geert Bauwens, An-Heleen Deconinck, Glenn Reynders, Staf Roels, Eline Himpe, Guillaume Lethé



International Energy Agency, EBC Annex 58

Reliable building energy performance characterisation based on full scale dynamic measurements

Report of Subtask 3, part 2: Thermal performance characterisation using time series data – statistical guidelines

Authors

DTU, Lyngby, Denmark (www.imm.dtu.dk)

Henrik Madsen, Peder Bacher

KU Leuven, Leuven, Belgium (www.kuleuven.be/bwf)

Geert Bauwens, An-Heleen Deconinck, Glenn Reynders, Staf Roels

UGent, Ghent, Belgium (www.architectuur.ugent.be/bouwfysica)

Eline Himpe

BBRI, Limelette, Belgium (www.wtcb.be)

Guillaume Lethé

Reviewed by:

Søren Ostergaard Jensen (DTI, Denmark)

Maria José Jiménez (CIEMAT, Spain)

© Copyright KU Leuven, Belgium 2016

All property rights, including copyright, are vested in KU Leuven, Belgium, Operating Agent for EBC Annex 58, on behalf of the Contracting Parties of the International Energy Agency Implementing Agreement for a Programme of Research and Development on Energy in Buildings and Communities. In particular, no part of this publication may be reproduced, stored in a retrieval system or transmitted in any form or by any means, electronic, mechanical, photocopying, recording or otherwise, without the prior written permission of KU Leuven.

Published by KU Leuven, Belgium

Disclaimer Notice: This publication has been compiled with reasonable skill and care. However, neither KU Leuven nor the EBC Contracting Parties (of the International Energy Agency Implementing Agreement for a Programme of Research and Development on Energy in Buildings and Communities) make any representation as to the adequacy or accuracy of the information contained herein, or as to its suitability for any particular application, and accept no responsibility or liability arising out of the use of this publication. The information contained herein does not supersede the requirements given in any national codes, regulations or standards, and should not be regarded as a substitute for the need to obtain specific professional advice for any particular application.

ISBN: 9789460189869

Participating countries in EBC:

Australia, Austria, Belgium, Canada, P.R. China, Czech Republic, Denmark, Finland, France, Germany, Greece, Ireland, Italy, Japan, Republic of Korea, the Netherlands, New Zealand, Norway, Poland, Portugal, Spain, Sweden, Switzerland, Turkey, United Kingdom and the United States of America.

Additional copies of this report may be obtained from:

www.iea-ebc.org

essu@iea-ebc.org

cover picture: Tailored heating experiment performed for one of the industrial partners of the Annex 58-project to determine the overall heat loss coefficient of a newly built dwelling based on on-site measured data. (source: Geert Bauwens, KU Leuven)

Preface

The International Energy Agency

The International Energy Agency (IEA) was established in 1974 within the framework of the Organisation for Economic Co-operation and Development (OECD) to implement an international energy programme. A basic aim of the IEA is to foster international co-operation among the 29 IEA participating countries and to increase energy security through energy research, development and demonstration in the fields of technologies for energy efficiency and renewable energy sources.

The IEA Energy in Buildings and Communities Programme

The IEA co-ordinates international energy research and development (R&D) activities through a comprehensive portfolio of Technology Collaboration Programmes. The mission of the Energy in Buildings and Communities (EBC) Programme is to develop and facilitate the integration of technologies and processes for energy efficiency and conservation into healthy, low emission, and sustainable buildings and communities, through innovation and research. (Until March 2013, the IEA-EBC Programme was known as the Energy in Buildings and Community Systems Programme, ECBCS.)

The research and development strategies of the IEA-EBC Programme are derived from research drivers, national programmes within IEA countries, and the IEA Future Buildings Forum Think Tank Workshops. The research and development (R&D) strategies of IEA-EBC aim to exploit technological opportunities to save energy in the buildings sector, and to remove technical obstacles to market penetration of new energy efficient technologies. The R&D strategies apply to residential, commercial, office buildings and community systems, and will impact the building industry in five focus areas for R&D activities:

- Integrated planning and building design
- Building energy systems
- Building envelope
- Community scale methods
- Real building energy use

The Executive Committee

Overall control of the IEA-EBC Programme is maintained by an Executive Committee, which not only monitors existing projects, but also identifies new strategic areas in which collaborative efforts may be beneficial. As the Programme is based on a contract with the IEA, the projects are legally established as Annexes to the IEA-EBC Implementing Agreement. At the present time, the following projects have been initiated by the IEA-EBC Executive Committee, with completed projects identified by (*):

- Annex 1: Load Energy Determination of Buildings (*)
- Annex 2: Ekistics and Advanced Community Energy Systems (*)
- Annex 3: Energy Conservation in Residential Buildings (*)
- Annex 4: Glasgow Commercial Building Monitoring (*)
- Annex 5: Air Infiltration and Ventilation Centre
- Annex 6: Energy Systems and Design of Communities (*)
- Annex 7: Local Government Energy Planning (*)
- Annex 8: Inhabitants Behaviour with Regard to Ventilation (*)
- Annex 9: Minimum Ventilation Rates (*)
- Annex 10: Building HVAC System Simulation (*)
- Annex 11: Energy Auditing (*)
- Annex 12: Windows and Fenestration (*)
- Annex 13: Energy Management in Hospitals (*)
- Annex 14: Condensation and Energy (*)
- Annex 15: Energy Efficiency in Schools (*)

Annex 16:	BEMS 1- User Interfaces and System Integration (*)
Annex 17:	BEMS 2- Evaluation and Emulation Techniques (*)
Annex 18:	Demand Controlled Ventilation Systems (*)
Annex 19:	Low Slope Roof Systems (*)
Annex 20:	Air Flow Patterns within Buildings (*)
Annex 21:	Thermal Modelling (*)
Annex 22:	Energy Efficient Communities (*)
Annex 23:	Multi Zone Air Flow Modelling (COMIS) (*)
Annex 24:	Heat, Air and Moisture Transfer in Envelopes (*)
Annex 25:	Real time HVAC Simulation (*)
Annex 26:	Energy Efficient Ventilation of Large Enclosures (*)
Annex 27:	Evaluation and Demonstration of Domestic Ventilation Systems (*)
Annex 28:	Low Energy Cooling Systems (*)
Annex 29:	Daylight in Buildings (*)
Annex 30:	Bringing Simulation to Application (*)
Annex 31:	Energy-Related Environmental Impact of Buildings (*)
Annex 32:	Integral Building Envelope Performance Assessment (*)
Annex 33:	Advanced Local Energy Planning (*)
Annex 34:	Computer-Aided Evaluation of HVAC System Performance (*)
Annex 35:	Design of Energy Efficient Hybrid Ventilation (HYBVENT) (*)
Annex 36:	Retrofitting of Educational Buildings (*)
Annex 37:	Low Exergy Systems for Heating and Cooling of Buildings (LowEx) (*)
Annex 38:	Solar Sustainable Housing (*)
Annex 39:	High Performance Insulation Systems (*)
Annex 40:	Building Commissioning to Improve Energy Performance (*)
Annex 41:	Whole Building Heat, Air and Moisture Response (MOIST-ENG) (*)
Annex 42:	The Simulation of Building-Integrated Fuel Cell and Other Cogeneration Systems (FC+COGEN-SIM) (*)
Annex 43:	Testing and Validation of Building Energy Simulation Tools (*)
Annex 44:	Integrating Environmentally Responsive Elements in Buildings (*)
Annex 45:	Energy Efficient Electric Lighting for Buildings (*)
Annex 46:	Holistic Assessment Tool-kit on Energy Efficient Retrofit Measures for Government Buildings (EnERGo) (*)
Annex 47:	Cost-Effective Commissioning for Existing and Low Energy Buildings (*)
Annex 48:	Heat Pumping and Reversible Air Conditioning (*)
Annex 49:	Low Exergy Systems for High Performance Buildings and Communities (*)
Annex 50:	Prefabricated Systems for Low Energy Renovation of Residential Buildings (*)
Annex 51:	Energy Efficient Communities (*)
Annex 52:	Towards Net Zero Energy Solar Buildings (*)
Annex 53:	Total Energy Use in Buildings: Analysis & Evaluation Methods (*)
Annex 54:	Integration of Micro-Generation & Related Energy Technologies in Buildings (*)
Annex 55:	Reliability of Energy Efficient Building Retrofitting - Probability Assessment of Performance & Cost (RAP-RETRO) (*)
Annex 56:	Cost Effective Energy & CO2 Emissions Optimization in Building Renovation
Annex 57:	Evaluation of Embodied Energy & CO2 Equivalent Emissions for Building Construction
Annex 58:	Reliable Building Energy Performance Characterisation Based on Full Scale Dynamic Measurements
Annex 59:	High Temperature Cooling & Low Temperature Heating in Buildings
Annex 60:	New Generation Computational Tools for Building & Community Energy Systems
Annex 61:	Business and Technical Concepts for Deep Energy Retrofit of Public Buildings
Annex 62:	Ventilative Cooling
Annex 63:	Implementation of Energy Strategies in Communities
Annex 64:	LowEx Communities - Optimised Performance of Energy Supply Systems with Exergy Principles
Annex 65:	Long Term Performance of Super-Insulating Materials in Building Components and Systems
Annex 66:	Definition and Simulation of Occupant Behavior Simulation
Annex 67:	Energy Flexible Buildings
Annex 68:	Design and Operational Strategies for High IAQ in Low Energy Buildings

Annex 69: Strategy and Practice of Adaptive Thermal Comfort in Low Energy Buildings
Annex 70: Energy Epidemiology: Analysis of Real Building Energy Use at Scale

Working Group - Energy Efficiency in Educational Buildings (*)
Working Group - Indicators of Energy Efficiency in Cold Climate Buildings (*)
Working Group - Annex 36 Extension: The Energy Concept Adviser (*)

IEA EBC Annex 58: Reliable Building energy performance characterisation based on full scale dynamic measurements

Annex 58 in general

To reduce the energy use of buildings and communities, many industrialised countries have imposed more and more stringent requirements in the last decades. In most cases, evaluation and labelling of the energy performance of buildings are carried out during the design phase. Several studies have shown, however, that the actual performance after construction may deviate significantly from this theoretically designed performance. As a result, there is growing interest in full scale testing of components and whole buildings to characterise their actual thermal performance and energy efficiency. This full scale testing approach is not only of interest to study building (component) performance under actual conditions, but is also a valuable and necessary tool to deduce simplified models for advanced components and systems to integrate them into building energy simulation models. The same is true to identify suitable models to describe the thermal dynamics of whole buildings including their energy systems, for example when optimising energy grids for building and communities.

It is clear that quantifying the actual performance of buildings, verifying calculation models and integrating new advanced energy solutions for nearly zero or positive energy buildings can only be effectively realised by in situ testing and dynamic data analysis. But, practice shows that the outcome of many on site activities can be questioned in terms of accuracy and reliability. Full scale testing requires a high quality approach during all stages of research, starting with the test environment, such as test cells or real buildings, accuracy of sensors and correct installation, data acquisition software, and so on. It is crucial that the experimental setup (for example the test layout or boundary conditions imposed during testing) is correctly designed, and produces reliable data. These outputs can then be used in dynamic data analysis based on advanced statistical methods to provide accurate characteristics for reliable final application. If the required quality is not achieved at any of the stages, the results become inconclusive or possibly even useless. The IEA EBC Annex 58-project arose from the need to develop the necessary knowledge, tools and networks to achieve reliable in situ dynamic testing and data analysis methods that can be used to characterise the actual energy performance of building components and whole buildings. As such, the outcome of the project is not only of interest for the building community, but is also valuable for policy and decision makers, as it provides opportunities to make the step from (stringent) requirements on paper towards actual energy performance assessment and quality checking. Furthermore, with the developed methodology it is possible to characterise the dynamic behaviour of buildings, which is a prerequisite for optimising smart energy and thermal grids. Finally, the project developed a dataset to validate numerical Building Energy Simulation programs.

Structure of the project

Successful full scale dynamic testing requires quality over the whole process chain of full scale testing and dynamic data analysis: a good test infrastructure, a good experimental set-up, a reliable dynamic data analysis and appropriate use of the results. Therefore, the annex-project was organised around this process chain, and the following subtasks were defined:

Subtask 1 made an inventory of full scale test facilities available all over the world and described the common methods with their advantages and drawbacks for analysing the obtained dynamic data. This subtask produced an overview of the current state of the art on full scale testing and dynamic data analysis and highlighted the necessary skills.

Subtask 2 developed a roadmap on how to realise a good test environment and test set-up to measure the actual thermal performance of building components and whole buildings in situ. Since there are many different objectives when measuring the thermal performance of buildings or building components, the best way to treat this variety has

been identified as constructing a decision tree. With a clear idea of the test objective, the decision tree will give the information of a test procedure or a standard where this type of test is explained in detail.

Subtask 3 focused on quality procedures for full scale dynamic data analysis and on how to characterise building components and whole buildings starting from full scale dynamic data sets. The report of subtask 3 provides a methodology for dynamic data analysis, taking into account the purpose of the in situ testing, the existence of prior physical knowledge, the available data and statistical tools,... The methodologies have been tested and validated within different common exercises, in a way that quality procedures and guidelines could be developed.

Subtask 4 produced examples of the application of the developed concepts and showed the applicability and importance of full scale dynamic testing for different issues with respect to energy conservation in buildings and community systems, such as the verification of common BES-models, the characterisation of buildings based on in situ testing and smart meter readings and the application of dynamic building characterisation for optimising smart grids.

Subtask 5 established a network of excellence on ‘in situ testing and dynamic data analysis’ for dissemination, knowledge exchange and guidelines on testing.

Overview of the working meetings

The preparation and working phase of the project encompassed 8 working meetings:

Meeting	Place, date	Attended by
Kick off meeting	Leuven (BE), September 2011	45 participants
Second preparation meeting	Bilbao (SP), April 2012	46 participants
First working meeting	Leeds (UK), September 2012	44 participants
Second working meeting	Munich (GE), April 2013	53 participants
Third working meeting	Hong-Kong (CH), September 2013	26 participants
Fourth working meeting	Gent (BE), April 2014	49 participants
Fifth working meeting	Berkeley (USA), September 2014	37 participants
Sixth working meeting	Prague (CZ), April 2015	39 participants

During these meetings, working papers on different subjects related to full scale testing and data analysis were presented and discussed. Over the course of the Annex, a Round Robin experiment on characterising a test box was undertaken, and several common exercises on data analysis methods were introduced and solved.

Outcome of the project

The IEA EBC Annex 58-project worked closely together with the Dynastee-network (www.dynastee.info). Enhancing this network and promoting actual building performance characterization based on full scale measurements and the appropriate data analysis techniques via this network is one of the deliverables of the Annex-project. This network of excellence on full scale testing and dynamic data analysis organizes on a regular basis events such as international workshops, annual training,... and will be of help for organisations interested in full scale testing campaigns.

In addition to the network of excellence, the outcome of the Annex 58-project has been described in a set of reports, including:

Report of Subtask 1A: Inventory of full scale test facilities for evaluation of building energy performances.

Report of Subtask 1B: Overview of methods to analyse dynamic data

Report of Subtask 2: Logic and use of the decision tree for optimizing full scale dynamic testing.

Report of Subtask 3 part 1: Thermal performance characterization based on full scale testing: physical guidelines and description of the common exercises

Report of Subtask 3 part 2: Thermal performance characterization using time series data – statistical guidelines.

Report of Subtask 4A: Empirical validation of common building energy simulation models based on in situ dynamic data.

Report of Subtask 4B: Towards a characterization of buildings based on in situ testing and smart meter readings and potential for applications in smart grids

IEA EBC Annex 58 project summary report

Participants

In total 49 institutes from 17 countries participated in Annex 58. The different participants are listed below:

Austria	Gabriel Rojas-Kopeinig, Universität Innsbruck Susanne Metzger, Vienna University of Technology
Belgium	Gilles Flamant, Belgian Building Research Institute Guillaume Lethé, Belgian Building Research Institute Luk Vandaele, Belgian Building Research Institute (subtask 5 co-leader) Paul Steskens, Belgian Building Research Institute Gabrielle Masy, Haute Ecole de la Province de Liège An-Heleen Deconinck, Katholieke Universiteit Leuven Dirk Saelens, KU Leuven (subtask 4 co-leader) Geert Bauwens, KU Leuven (secretary) Glenn Reynders, KU Leuven Ruben Baetens, KU Leuven Roel De Coninck, KU Leuven Staf Roels, KU Leuven (operating agent) Frédéric Delcuve, Knauf Insulation Philippe André, Université de Liège Arnold Janssens, Universiteit Gent (subtask 1 leader) Eline Himpe, Universiteit Gent
China	Gongshen Huang, City University of Hong Kong Tin-Tai Chow, City University of Hong Kong Linda Xiao Fu, The Hong Kong Polytechnic University Shengwei Wang, The Hong Kong Polytechnic University (subtask 4 co-leader) Xue Xue, The Hong Kong Polytechnic University
Czech Republic	Kamil Stanek, Czech Technical University Prague Pavel Kopecký, Czech Technical University Prague
Denmark	Christian Holm Christiansen, Danish Technological Institute Søren Østergaard Jensen, Danish Technological Institute Henrik Madsen, Technical University of Denmark (subtask 3 co-leader) Kyung Hun (Peter) Woo, Technical University of Denmark Peder Bacher, Technical University of Denmark
France	Bouchie Remi, Centre Scientifique et Technique du Bâtiment Pierre Boisson, Centre Scientifique et Technique du Bâtiment Mohamed El Mankibi, Ecole Nationale des Travaux Publics de l'Etat Christian Ghiaus, INSA de Lyon Ibán Naveros, INSA de Lyon Guillaume Pandraud, Isover Saint-Gobain Simon Rouchier, Université de Savoie
Germany	Franz Feldmeier, Fachhochschule Rosenheim Lucia Bauer, Fachhochschule Rosenheim Herbert Sinnesbichler, Fraunhofer-Institut für Bauphysik Ingo Heusler, Fraunhofer-Institut für Bauphysik Matthias Kersken, Fraunhofer-Institut für Bauphysik Soeren Peper, Passive House Institute
Italy	Fabio Moretti, ENEA Hans Bloem, European Commission - DG JRC (subtask 5 co-leader) Lorenzo Pagliano, Politecnico di Milano Giuseppina Alcamo, Università degli Studi di Firenze
The Netherlands	A.W.M. van Schijndel, Technische Universiteit Eindhoven Rick Kramer, Technische Universiteit Eindhoven
Norway	Nathalie Labonnote, Norges teknisk-naturvitenskapelige universitet
Spain	Gerard Mor-Lleida, Centro Internacional de Métodos Numéricos en Ingeniería Xavi Cipriano, Centro Internacional de Métodos Numéricos en Ingeniería Aitor Erkoreka, Escuela Técnica Superior de Ingeniería Bilbao (subtask 2 co-leader) Koldo Martin Escudero, Escuela Técnica Superior de Ingeniería Bilbao

Roberto Garay Martinez, Tecnalia Research & Innovation
Luis Castillo López, CIEMAT
Maria José Jiménez Taboada, CIEMAT (subtask 3 co-leader)
Ricardo Enríquez Miranda, CIEMAT
United Kingdom Richard Fritton, Salford University
Chris Gorse, Leeds Beckett University (subtask 2 co-leader)
Martin Fletcher, Leeds Beckett University
Samuel Stamp, University College London
Filippo Monari, University of Strathclyde
United States **Paul A. Strachan, University of Strathclyde (subtask 4 co-leader)**
Stephen Selkowitz, Lawrence Berkeley National Laboratory

IEA, EBC Annex 58, Report of Subtask 3, part 2

Thermal performance characterisation using time series data – statistical guidelines

Henrik Madsen, Peder Bacher, Geert Bauwens, An-Heleen Deconinck, Glenn Reynders, Staf Roels, Eline Himpe, Guillaume Lethé

December 2015

TABLE OF CONTENTS

1.	Introduction.....	6
2.	Data description.....	10
3.	Statistical descriptive analysis and pre-processing of the data.....	11
3.1	Particular aspects to be aware of.....	11
3.2	Averaging and filtering.....	12
3.3	Aliasing.....	12
4.	Models for estimation of building thermal performance parameters.....	13
4.1	Steady state methods.....	13
4.1.1	<i>Linear steady state models</i>	13
4.2	Linear dynamics input-output models (ARX models).....	16
4.3	Grey-box models.....	21
4.3.1	<i>Introduction</i>	21
4.3.2	<i>Linear (RC-network) models</i>	22

4.3.3	<i>Nonlinear and non-stationary models</i>	26
5.	Model selection and validation.....	29
5.1	Basic model selection (identification) techniques.....	30
5.2	Basic model validation procedure.....	31
A.	Introduction to time series modelling.....	33
A.1	Heat dynamics of a building.....	33
A.2	Introduction to time series models.....	34
A.3	Input-output (transfer function) models.....	35
A.4	State-space models.....	36
B.	Introduction to grey-box models and noise processes.....	37
B.1	ODE formulation of the system equations.....	37
B.1.1	<i>Characterisation of the ODE's</i>	38
B.2	SDE formulation of the system equations	38
B.2.1	<i>Characterisation of the SDE's</i>	39
B.2.2	<i>The grey-box model</i>	39
B.3	Example: RC model for the heat dynamics of a building.....	40
C.	The family of linear models and their characteristics.....	42
C.1	Discrete time models in state space form.....	42
C.2	The transfer function form.....	43
C.3	Impulse and response function models.....	45
C.4	The linear regression models.....	45
D.	Calculation of the HLC, gA-value and their uncertainties.....	47
D.1	For models with heating power as output.....	47
D.1.1	<i>Linear minimum variance weighting for estimation of the HLC</i>	47
D.1.2	<i>gA-value</i>	50
D.2	For models with internal temperature as output.....	51
E.	Experimental design; basic principles.....	53

E.1	Experimental design considerations.....	53
E.2	PRBS-signals.....	55
F.	Multiple sensors; how to use all the information.....	57
G.	Example: steady state model for the RRTB.....	60
H.	Example: linear dynamics input-output ARX-model for the RRTB.....	65
I.	Example: grey-box model for the IDEE house.....	73
	Acronyms.....	80
	Bibliography.....	81

Summary

Within Subtask 3 of the IEA EBC Annex 58-project, guidelines for dynamic data analysis for energy performance assessment of buildings and building components have been elaborated. These guidelines build on experiences gained in former EU projects and on the lessons learned from common exercises and other activities carried out in the framework of Annex 58. They comprise two parts: one relates to physical aspects and the other to statistical aspects of data analysis. Both parts must be considered as complementary in a multidisciplinary context. The first part, dealing with physical aspects, can be found in the last chapter of the '*Report of Subtask 3, part 1 – Thermal performance characterisation based on full scale testing: description of the common exercises and physical guidelines*'.

This document deals with the second part: the statistical aspects. It presents guidelines for using time series analysis methods, models and tools for estimating the thermal performance of buildings and building components. The thermal performance can be derived from estimated parameters of a model. A special focus will be on estimating the Heat Loss Coefficient (HLC) and gA-value. Provided in the guidelines are modelling procedures with which consistent results for estimation of energy performance of buildings and building components can be achieved.

These guidelines start with simple (non-dynamical) **steady state models** where the parameters are found using classical methods for linear regression. Such steady state techniques provide sub-optimal use of the information embedded in the data and provides information only about the HLC and gA-values.

Next the guidelines consider **dynamical models**. Firstly, **linear input-output models** are considered. More specifically we will consider the class of Autoregressive with exogenous input (ARX) (p) models. These models provide information about the HLC and gA-values, and information about the dynamics (most frequently described as time-constants for the system).

Finally, **grey-box models** are considered. This class of models is formulated as state space models which are able to provide rather detailed information about the internal physical parameters of a construction. This class of models bridges the gap between physical and statistical modelling. A grey-box model describes, in continuous time, the states of the system and describes how the actual measurements are linked to these states. Frequently, so-called RC-network models are used. They belong to the class of linear grey-box models. However, advanced constructions, e.g. a wall with PV-integration or a complex building with a lot of glass, often call for models that explicitly describe nonlinear phenomena. Here, non-linear grey-box models can be used.

It is assumed that data is available as time series of measurements. Hence it should be noticed that the important steps of experimental design and setting up the experiment have been conducted.

Acknowledgement

Thanks go to Søren Østergaard, who thoroughly evaluated and commented the guidelines. Further thanks go to Pierre Vogler-Finch, Hans Bloem, Maria Jose Jimenez, Simon Rouchier for valuable input. The work was financed by Danish research program EUDP and under CITIES financed by the Danish Strategic Research Council.

1. Introduction

The goal of these guidelines is to describe modelling procedures with which an experienced or trained user can obtain consistent results by using the dynamical approaches for estimation of building energy performance. The document is formulated as a part of IEA EBC Annex 58.

Required basic knowledge

Please note, that these guidelines requires some level of statistical knowledge. Apart from basic statistical terms (e.g. normal distribution, confidence interval, p -value) the reader is also required to be familiar with basic concepts from time series analysis (e.g. autocorrelation function, regression with autocorrelated residuals, transfer function, white noise). The concepts needed are introduced in the book on time series analysis by [Madsen \(2008\)](#), which also is referenced to where appropriate. The notation used is also aligned with ([Madsen, 2008](#)). However, numerous books provide an introduction to most of the concepts needed. A few other examples are ([Box and Jenkins, 1970/1976](#)), ([Chatfield, 2003](#)) and ([Harvey, 1990](#)).

In Appendix A a short introduction to the time series models used in the guidelines is provided. The introduction focus on the context of buildings thermal performance, hence if the reader needs an overview of time series models it can be a good idea to read, as well as Appendix A in which an introduction to the applied grey-box models is provided.

This version of the guidelines will be rather strict and focus on the RRTB and the IDEE ([Lethé et al., 2014](#)) experiments. However, we aim at providing a set of guidelines such that they ultimately can be used for different types of dynamical tests for estimating the thermal performance of many types of buildings and building components. We shall assume that data is available as time series of measurements obtained in dynamical test conditions. Consequently the methods can be used for outdoor testing, and ultimately for occupied buildings.

Traditionally, the so-called steady state methods like those described in ISO 9251 (1987) have been used. These methods assume that the considered system is in steady state, and consequently that the variables are constant in time. Obviously methods relying on steady state analysis are not suitable for outdoor and real life testing. Consequently, we shall focus on time series originating from dynamical testing where e.g. the input variables are excited such that also the dynamical properties of the component or building can be identified.

The thermal performance is obtained based in estimated parameters of a model. A special focus will be on the HLC and gA-value, which, by using the proposed techniques, can be estimated also in dynamical and real life conditions. Furthermore, the dynamical procedures will lead to more efficient use of the data, and typically the experimental time for obtaining a certain accuracy of e.g. the HLC is an order of magnitude smaller for dynamical test procedures than for steady state procedures.

The guidelines assume that data is available as time series of measurements; i.e. the important steps of experimental design, setup and conduction have been carried out. The purpose of these guidelines is to describe successive steps for pre-processing the data, model selection or formulation, parameter estimation, and model validation. In practice this implies that we might end up concluding that new experiments are needed in order to achieve the wanted results.

Noticed that e.g. the definition of an HLC relies on an assumption of steady state, and some of the classical used terms for characterizing the thermal performance of buildings and building components might need to be reformulated. Hence for more complicated building components or more advanced studies the fundamental equations for heat conduction, convection and radiative transfer must be considered.

In some cases it is important to be able to describe **nonlinear phenomena** like the heat transfer by radiation, wind speed driven convection, influence of solar radiation, etc. Likewise it is sometimes essential to be able to describe **time-varying/nonstationary phenomena** like changes caused by a varying amount of moisture in a wall.

It must be emphasized that parameters are related to a model. This also implies that simple models (like linear regression models) only provide rather limited information about the thermal characteristics, and, as the other extreme, the grey-box models typically contain a lot of information about the internal physical parameters of the system.

Terms like linearity and stationarity will be used. The reason being that if the model can be considered both stationary and linear, then more simple approaches, like those related to ARX models, can be used, whereas, on the other hand, grey-box models are able to describe both nonlinear and nonstationary systems.

First, however, the guidelines will start with some sections describing the initial model formulation and the pre-processing of the data. These sections are common for all models. Subsequently guidelines related to a number of different models will be described. We shall consider the following models

- **The linear regression model (non-dynamical/steady state approach).**
- **The linear dynamic (ARX) model (dynamical, linear, and stationary approach).**
- **The grey-box model (dynamical, linear or nonlinear, stationary or non-stationary (time-varying) approach).**

As indicated, these guidelines start with simple (non-dynamical) **steady state models** where the parameters are found using classical methods for linear regression. Such steady state techniques provide sub-optimal use of the information embedded in the data and provides information only about the HLC and gA-values. The concepts of linear regression are described in detail in Chapter 3 of (Madsen, 2008).

Next the guidelines consider **dynamical models**. Firstly, **linear input-output models** are considered; see Chapter 8 in (Madsen, 2008) further details about univariate input-output models and Chapter 9 for multivariate input-output models. More specifically we will here consider the class of ARX (p) models. **These models provide information about the HLC and gA-values** as well as crude information about the dynamics (most frequently described as time-constants for the system). The linear input-output models are often labelled as **an external model** since they describe only the relation between the input and output signal (and not the details of the physical processes).

Finally, **grey-box models** are considered. This class of models bridges the gap between physical and statistical modelling. The grey-box models main strength is their ability to couple detailed physical models to data and thereby **providing an insight into the detailed physics and dynamics of the building**. A grey-box model is formulated a continuous time model for the states of the system, together with a discrete set of equations describing how the measurements are linked to the states. This is often called a continuous-discrete time **state space model**; see Chapter 10 in (Madsen, 2008) for further details about state space models. The continuous time formulation of the dynamics ensures that prior physical known relations, which typically are given as differential equations, can be used as a part of the model formulation. This class of models are often labelled as **an internal model** since they provide a possibility for describing the internal physical processes.

Most often the so-called **RC-network models** are considered for buildings. These models belong to the class of **linear grey-box models**, which is the classical dynamical model most frequently used for buildings and building components. However, modern buildings (e.g. buildings with a lot of glass or natural ventilation) and advanced walls (e.g. walls with PV-integrated panels) contains non-linear phenomena like those related to radiative heat transfer, free convection, etc. For such more complicated phenomena the class of **non-linear grey-box models** must be considered.

These guidelines also includes a series of appendices. Appendix A introduces very shortly statistical time series models. Appendix B describes the physical arguments for using stochastic model formulations. Furthermore, the relationship between the models is outlined in Appendix C. A special attention is put on how the noise enters the models, and the relation between parameters in the various models. For the state space models both continuous and discrete time versions of the models are considered. Finally, some detailed calculations are described in Appendix D, and in the last two Appendices examples of how the guidelines can be applied are presented.

Most of the methods and models were initially developed during a number of European Research projects focusing on outdoor testing under real weather conditions; the first being the PASSYS project (Cools and Gicquel, 1989), which also

inspired by the early work by Sonderegger (1978). Some of the approaches have been further developed and presented in (Madsen and Schultz, 1993), (Bloem, 1994), (Madsen and Holst, 1995), (Andersen et al., 2000), (Bloem, 2007), (Jiménez and Madsen, 2008), (Jiménez et al., 2008a), (Jiménez et al., 2008b) and (Bacher and Madsen, 2011).

2. Data description

The data and notation symbols must be described and defined. It is here recommended to follow a current ISO standard related to energy in buildings, in this document the notation follows EN ISO 13790:2008 Energy performance of buildings - Calculation of energy use for space heating and cooling.

The variables and their units must be specified, as well as how they were measured and sampled. Preferably a list of the variables is provided, with their: symbols, units, sampling resolution (e.g. number of digits) and sampling time, as well as a short description of each including potential preprocessing.

A description of the experimental setup, e.g. measuring equipment such as sensors, setup, and measuring period, should preferably be another document, which is written before the experiments are carried out.

Furthermore, it is to notice the units, and ensure that the signals are measured using directly related physical units.

Finally, some signals appears as a cumulated signal, and the original signal must then be found using an appropriate difference operator.

The data description is an important interface between the experimental design and conduction phase, presented in the physical guidelines and the modelling guidelines presented in this document.

3. Statistical descriptive analysis and pre-processing of the data

This analysis is common for all methods, and contains of the following items:

- Plot the data as a function of time on 2 to 3 different zoom levels (e.g. the entire period and a couple of days).
- Check the data for outliers, missing data and other irregularities. Here simple basic time series plot and e.g. box-plots are useful tools, see ([Brockhoff et al., 2015](#)) and [Madsen \(2008\)](#) for more details.
- Calculate the average and quantiles for the data. It might be useful to calculate the average e.g. for each hour in the diurnal cycle, each month in the annual cycle, etc.

These steps may point out unusual phenomena, which could potentially give rise to difficulties in the subsequent modelling. The issues are often introduced either in the experiment setup, the measuring equipment, or the data handling.

3.1 Particular aspects to be aware of

Often encountered phenomena found in data which can introduce problems such as non-linearities and outliers in the modelling and estimation step:

- Experimental setup:
 - Overheating in thermostatic controlled experiments. In experiments where the internal temperature is thermostatic controlled, hence should be constant, overheating resulting in increased temperature often occur. This is mostly caused by too high level of solar radiation entering the building. Overheating can result in biased and increased uncertainty of the estimates.
 - Solar radiation striking directly on the temperature sensors.
 - Shadowing on solar radiation sensors from surrounding buildings, trees, poles, etc. Especially a problem in the early and late hours of the day when the sun elevation is low.

- Measuring equipment:
 - Saturation or clipping in the sensor or sensor electronics.
 - Low resolution. The required resolution will always be relative to the experiment, sampling time resolution etc.
 - Too sparse sampling time can give rise to inaccurate sampling. One particular example is when a flow (e.g. the heating power) is measured as point values at a too low sampling time resolution, where it would be more accurate to measure the accumulated flow, i.e. with an energy meter, such that the averaged flow values are obtained.
 - Some signals appear as a cumulated signal, and this often implies that the resolution of the original signal (which is obtained using a difference operator) is rather poor.
- Data preprocessing:
 - Time synchronization can be an issue if multiple acquisition systems have been used during the experiment.
 - Time zone needs to be checked when external data and derived quantities are used in the data analysis. For example when positions of the sun are derived and used in the models. Plotting measured solar radiation together with the calculated sun elevation can easily reveal synchronization errors.
 - Averaging a signal with large high frequency variation like a PRBS signal must be done carefully. If the averaging contains averages over a period with both signals with low and high values, this often creates problems (e.g. large residuals) in the subsequent modelling. Try to perform the averaging such that they don't consider a mixture of high and low values, but synchronized such that only either low or high values are forming the averages.

3.2 Averaging and filtering

If the data is sub-sampled by averaging or filtering, then it is important that the same method (e.g. filter) is used for all the signals. Alternatively, the input-output model found will be corrupted by the difference in the filters used for the various signals.

3.3 Aliasing

It must also be noticed that subsampling - and to some degree also averaging - can lead to the so-called **aliasing problem**, which arises from the fact that a significant variation at a high frequency in the original signal will appear as a faulty significant variation at a lower frequency if the aliasing problem or sampling is not treated carefully, see ([Madsen, 2008](#)) p. 78-80 for further details.

4. Models for estimation of building thermal performance parameters

This is the main chapter of this document and describes various models and the model specific guidelines.

4.1 Steady state models

This class of models is useful for describing *linear and stationary steady state (i.e. non-dynamical)* relations between input and output time series of data. However, in some cases a nonlinear dependency of input data can be described simply by a nonlinear transformation of the data.

Since this class of models does not offer a dynamical description the time series data must be sub-sampled e.g. by averaging the data over a sufficiently long period of time. The length of this time period must be so large that the values of the autocorrelation of the residuals is basically zero (use the standard white noise test, e.g. the test in the autocorrelation function, found in (Madsen, 2008) page 175).

4.1.1 Linear steady state models

Based on the steady state energy balance, linear static models are formulated. Such models can be applied to estimate thermal performance of a building in different settings. Note that in this simple setup the effect of wind is not taken into account.

As a starting point for the models consider the steady state energy balance

$$\Phi_h = H_{\text{tot}}(T_i - T_e) + gA_{\text{sol}}I_{\text{sol}} \quad (4.1)$$

where the output and inputs of the model are:

- Φ_h Heating power of the heating system (plus other sources: electrical appliances, etc.) inside the building (W)
- T_i Internal temperature (°C)
- T_e External temperature (°C)

- I_{sol} Solar irradiation received by the building (W m^{-2})

the *parameters* of the model are

- H_{tot} the overall heat loss coefficient (HLC). This is thus a measure which include both the transmission losses and ventilation losses, hence a sum of the UA-value (W/K) and ventilation losses.
- gA_{sol} is a parameter which is the product of: g solar transmittance of the transparent elements and A_{sol} the effective collecting area (solar aperture) (m^2)

The symbols and definitions are taken as much as possible from the ISO 13790 standard, see the nomenclature in the end of the document, which the symbols are linked to (click the symbol to take the link and depending on the editor go back by "Alt-Left").

For this guideline the *observations are time series*, which implies that an index t will be introduced in the following to denote time. For that reason we shall use a slightly different notation in what follows.

The *observations* will be denoted as time series: Φ_t^h , T_t^i , T_t^e and I_t^{sol} . Hence the observation at time t . When average values are used then the time point t is set to the end of the averaging interval, e.g. for the average over the hour from 10:00 to 11:00 the time point t is set to 11:00.

In order to formulate and estimate the thermal performance of a building based on the energy balance above, the following steps should be followed:

1. **Sampling time (used in the averaging).** When applying a steady state model the dynamical effects must be filtered out by low pass filtering the time series; typically by averaging over periods with length of the *sampling time*. The appropriate sampling time depends on how fast the system responds: for standard insulated buildings one or two days averages are usually appropriate, whereas for high performance (very well insulated or heavy) buildings a higher sampling time can be needed. For smaller or very poorly insulated buildings lower sampling time could be appropriate, e.g. for the RRTB 6 hour averages has proven to be a good choice, however care should be taken due to the diurnal periodicity of the signals, especially the cross-correlation between the residuals and solar radiation should be watched.

A procedure for selection of an appropriate sampling time is:

- Start with a short sampling time, which results in correlated (non-white noise) residuals (as analysed in the model validation step below using the AutoCorrelation Function (ACF), see also p. 31).
- Increase the sampling time until white noise residuals are obtained.
- Check that the cross-correlation to the inputs, especially to solar radiation, is not significant.

In this way a good balance between a too short sampling time: resulting in biased estimates and too narrow CIs (correlated residuals indicate too many observations compared to the available information in data), and a too long sampling time: resulting in too wide CIs (too few observations compared to the available information in data).

2. **Model parametrization.** In order to estimate the thermal performance the energy balance above it is used to parameterize a linear regression model

$$\Phi_t^h = \omega_i T_t^i + \omega_e T_t^e + \omega_{\text{sol}} I_t^{\text{sol}} + \varepsilon_t \quad (4.2)$$

where the residual error ε_t is assumed to be i.i.d.¹ random variables following a normal distribution with mean zero and variance σ^2 , written as $N(0, \sigma)$. A time series of such random variables is called a *white noise* signal. In (4.2) the parameters which can be estimated represents:

- ω_i : the HLC (i.e. H_{tot}), which includes ventilation.
 - ω_e : the negative HLC (i.e. H_{tot}), which includes ventilation. Note that two estimates of the HLC is obtained and in order to find the best single estimate a linear minimum variance weighting used is as described in Appendix D .
 - ω_{sol} : a measure of the solar absorption of the building based on the available measurements, usually global radiation (i.e. measured horizontal radiation) or south-faced vertical radiation. Therefore, since the incoming radiation onto the building is not equal to the available measured radiation, care must be taken when interpreting and comparing the estimated value with the building solar absorption properties, i.e. gA_{sol} .
3. **Model validation.** The model must be validated using the techniques described in Section 5.
 4. **Calculation of HLC and gA-values (simple setup).** Based on the estimated parameters in the model estimates of the HLC and the gA-value are calculated as described in details in Appendix D.1.1. To summarize, the following steps for the HLC is carried out:

- The coefficients for the internal and external temperature

$$H_i = \omega_i \quad (4.3)$$

$$H_e = -\omega_e \quad (4.4)$$

are both representing an estimate of the HLC.

- Make a linear weighting

$$H_{\text{tot}} = \lambda H_i + (1 - \lambda) H_e \quad (4.5)$$

to find the estimator for the HLC. The value of λ is found such that the variance of H_{tot} is minimized, see Appendix D for details.

- Calculate the estimated variance of the HLC denoted $\sigma_{H_{\text{tot}}}^2$.

¹i.i.d. means independently and identically distributed

For this simple setup the gA-value is simply the estimated coefficient $-\omega_{\text{sol}}$ with standard deviation estimate $\sigma_{gA_{\text{sol}}}$, which can be directly read from the linear regression results. However it is again noted that this interpretation should be considered in the light of which measurements was used to represent the incoming solar radiation.

Notice that *it is very important to state both the estimates and the standard error of the estimates*, since without knowing the uncertainty of the estimates we have serious issues in comparing the results with physical judged parameters, other estimates, etc.

4.2 Linear dynamics input-output models (ARX models)

This class of models can be used for **linear and stationary (e.g. not time-varying) dynamical** systems. Consequently, if it has been concluded that the system is either nonlinear or nonstationary, then typically the concept of grey-box models, as described in Section 4.3, must be used. However, in some cases a nonlinear transformation of the input signals might be sufficient. Also if the data is sample at non-equidistant time intervals, then the continuous time approach as used for the grey-box approach should be used.

The most important difference from the steady-state models considered in the previous section is that now **dynamical** properties are described. Depending on the application and the properties of the building (or building component an appropriate sampling time range from, say, five minutes to an hour. Also since the model describes the dynamics of the system, then data sampled at rather frequent sample points can often be used directly or a simple low-pass filtering (averaging) can be applied.

Also since the model describe the dynamics of the system, then data sampled at rather frequent sample points can often be used directly.

This class of models provides HLC and gA-values, and the time constants of the system. We shall focus on ARX models, however, a close relation to e.g. ARMAX and Box-Jenkins models exists - please see Appendix C. The models might be very useful for forecasting and control.

Since only the input-output relations are described this model belongs to the class of **external models** since they only provide information about the so-called external relations between the input and output variables. They do not provide information of the internal physical parameters like thermal resistances and heat capacities. If these parameters are essential then the grey-box approach should be considered instead.

We will restrict our attention to multiple-input, single-output (MISO) models here, but in Chapter 10 of (Madsen, 2008) this is generalized to multiple-input, multiple-output (MIMO) models, which naturally extents to build a framework for handling a wider range of applications.

In the following a set of guidelines related to estimating HLC and gA-values as well as the time constants using ARX models are provided:

1. **Sampling time.** Since we will consider a dynamical model the selected sampling time T_s should reflect the use of the model. In general it can be said that *faster dynamics are averaged out as the sampling time increase*, hence the sampling period should be set depending on the required level of details. If the focus is entirely on the HLC and gA-values, which are steady state related parameters, the sampling time could be relatively long, say: between 1 and 6 hours for regular sized buildings, but could be even longer for very well insulated buildings. For the RRTB a reasonable sampling time is around 1 hour or shorter. If the focus is on control then an appropriate sampling time might be shorter; depending on the importance of influences from e.g. solar radiation and occupancy behavior.

From experience it is found that an appropriate sampling time, in the case where only the steady state thermal performance is needed (i.e. HLC and gA), is to select the sampling time such that a second order model is suitable.

2. **Model parameterization (simple setup).** Two simple model setups are included here:

- Heating power as model output. Internal temperature, external temperature and solar radiation as model inputs. This is the type of model, which is suited for constant thermostatic controlled internal temperature experiments, where the heating power thus becomes the dependent variable, similarly as for the steady state model presented in Section 4.1.1.
- Internal temperature as model output. External temperature, heating power and solar radiation as model inputs. This is the type of model, which is suited for controlled heating experiments (using a PRBS or ROLBS sequence).

The symbols used for the variables are in both cases the same as explained on page 14.

Heating power as model output. In this simple setup we will assume a parameterization using the following ARX model

$$\phi(B)\Phi_t^h = \omega_i(B)T_t^i + \omega_e(B)T_t^e + \omega_{\text{sol}}(B)I_t^{\text{sol}} + \varepsilon_t \quad (4.6)$$

where $\phi(B)$ is an output (or AR) polynomial of order p in the backshift operator B , and similarly the input polynomials $\omega_i(B)$, $\omega_e(B)$ and $\omega_{\text{sol}}(B)$ are polynomials of order $s_i = 0$ (explanation below), s_e and s_{sol} . Appendix A contains a short introduction to this notation, but for a further description we refer to (Madsen, 2008).

Note that when the internal temperature is thermostatic controlled it must be kept constant and if changed the transient periods must be removed, since in these periods the system is operating in a non-linear mode. Therefore, since the input is constant, hence a the values of lagged signals are constant, the order of the internal temperature polynomial is set to zero ($s_i = 0$).

The inputs and output are derived similarly as for the steady state models described in Section 4.1.1. However, it is very important to notice that for ARX models a much lower sampling time is possible, and this implies that the information in the data is used much better for ARX models than for the steady state (linear regression) models.

In the simple setup the orders of the input polynomials are set equal by $s_e = s_{sol} = p - 1$ and for the special case $p = 0$: $s_i = s_e = s_{sol} = p$, i.e. in the latter case a linear steady state model as defined in Eq. (4.2) is obtained. Consequently, only a single parameter, namely p , needs to be set to fix the model order. In a more advanced setup (see later on) we will allow for different orders of the polynomials, but the above approach has proven to be useful.

Internal temperature as model output. In this simple setup we will assume a parameterization using the following ARX model

$$\phi(B)T_t^i = \omega_h(B)\Phi_t^h + \omega_e(B)T_t^e + \omega_{sol}(B)I_t^{sol} + \varepsilon_t \quad (4.7)$$

where $\phi(B)$ is an output (or AR) polynomial of order p in the backshift operator B , and similarly the input polynomials $\omega_h(B)$, $\omega_e(B)$ and $\omega_{sol}(B)$ are polynomials of order s_h , s_e and s_{sol} . In this simple setup we will assume that the order of the input polynomials are $s_h = s_e = s_{sol} = p - 1$. Consequently, only a single parameter, namely p , needs to be set to fix the model order. The same considerations for advanced setup as the heating power setup above should be taken into account.

3. **Model order selection (simple setup).** The model order p needs to be set appropriately for a given set of data (based on a given sampling time. Please notice that e.g. a lower sampling time (higher sampling rate) typically will call for a higher model order).
 - (a) Set the model order to $p = 0$.
 - (b) Estimate the model parameters using for instance the `lm()` procedure in [R Core Team \(2015\)](#).
 - (c) Evaluate for white noise residuals using the ACF and Partial AutoCorrelation Function (PACF) functions ([Madsen, 2008](#)).
 - (d) If the ACF and PACF indicate that the residuals are still autocorrelated then increase the model order by one, i.e. $p_{new} = p_{old} + 1$ and goto (B). If, on the other hand, the residuals can be assumed to be white noise the model order is found to be p .

When the assumed conditions are met, i.e. when the model validation step leads to the conclusion that the residuals are white noise, then we are ready to calculate the thermal characteristics.

4. **Model validation.** The model must be validated using the techniques described in Section 5. It is important to notice that if it is an experiment with heat consumption as output and constant (controlled) indoor air temperature, then large residuals indicates *overheating* and the corresponding part of the time series should be removed.

5. **Calculation of HLC, gA-values and time constants (simple setup).** Based on the estimated parameters in the ARX model estimates of the HLC and the gA-value are calculated, see the details in Appendix D.1.1.

The calculations differs between the two simple setups, however one important point is emphasized here: Notice that *it is very important to state both the estimates and the standard error of the estimates*, since without knowing the uncertainty of the estimates we have serious issues in comparing the results with physical judged parameters, other estimates, etc.

Heating power as model output: Calculated similarly as for the linear steady state model, described on page 15, except that the steady state gains of the estimated transfer functions are used for the two HLC estimates, i.e.

$$H_i = \frac{\omega_i(1)}{\phi(1)} \quad (4.8)$$

$$H_e = \frac{-\omega_e(1)}{\phi(1)} \quad (4.9)$$

Similarly the estimate for the gA-value is the steady state gain from the radiation input

$$gA_{\text{sol}} = \frac{\omega_{\text{sol}}(1)}{\phi(1)} \quad (4.10)$$

and its variance estimator $\sigma_{gA_{\text{sol}}}^2$, see Appendix D.1.2 for a detailed description.

Internal temperature as model output: The calculation of the HLC and gA-value is in this setup slightly different. Using the steady state gains of the estimated transfer functions the HLC is found by

$$H_{\text{tot}} = \frac{1}{\frac{\omega_h(1)}{\phi(1)}} \quad (4.11)$$

and the gA-value by

$$gA_{\text{sol}} = \frac{\omega_{\text{sol}}(1)}{\omega_h(1)} \quad (4.12)$$

see the details of how to calculate the HLC and the gA-value as well as estimation of uncertainty in Section D.2.

Calculation of time constants: Finally, the time constants of the system can be calculated by

$$\tau_i = -\Delta t_{\text{smp}} \frac{1}{\ln(p_i)} \quad (4.13)$$

where p_i is the i 'th non-negative real pole in the transfer function, found as the roots in the characteristic equation, see page 122 in (Madsen, 2008). Δt_{smp} is the sampling time. Furthermore, the step response for each input can be calculated, simply by simulation of the output when applying a step as the input.

6. Model selection (advanced setup).

There exists, of course, several possibilities for a more advanced model. Here we shall only briefly mention these possibilities, and provide references for further guidance or reading.

Possibilities for an advanced setup:

- **Separate model orders.** In time series analysis various methods exist for determining different model orders for the individual polynomials – see (Madsen, 2008) Chapter 8. It might be crucial to consider such alternative methods for model order selection; one example is in the case of a time-delay between input and output variables.
- **Moving Average terms.** We could extend the model with a Moving Average (MA) term, i.e. include historical values of the residuals. Including an MA term in the model can take into account systematic errors, for example originating from deviations in inputs or in the model, which result in correlated errors. Procedures for this is also described in (Madsen, 2008).
- **Additional input variables.** There are several possible candidates for additional input variables like the long wave radiation, wind speed, wind speed multiplied with temperature differences, precipitation, transformed input variables (like T^4 for radiative transfer - or other transformation for free convective transfer).

Cross-correlation functions between the residuals and various candidate input variables are useful for identifying important extra input variables. Methods like pre-whitening and ridge regression should be considered here; see e.g. (Madsen, 2008) page. 224-228.

- **Transformation of solar radiation and semi-parametric models.** Modelling of the solar radiation effect in the simple setup can often be improved. The gA-value is not constant but rather a function (gA-curve) of the sun position, which can be parameterized by the sun elevation and azimuth angles or for shorter periods simply by the time of day in combination with transformation of solar radiation. Several aspects can be taken into account for advanced solar radiation modelling:
 - Schemes for splitting the total solar radiation into direct and diffuse radiation.
 - Transformation of the radiation onto the plane normal to the direct solar radiation.
 - Transformation of the radiation onto the surfaces of the building. This requires knowledge about the building topology.
 - Semi-parametric models in which the gA-curve are modelled by a spline function. With such models for example a gA-curve as a function of the time of day can be estimated without any knowledge about the building typology.

4.3 Grey-box models

Grey-box models are useful for identifying the **internal dynamical characteristics** of buildings or building components. The concept belongs to **the class of internal models**, which contains a description of the **internal physical parameterization** of the model. This implies that the parameters in most cases have a direct physical interpretation, which enables a possibility for using any prior physical knowledge of parameters or model structure. Obviously this class of models will provide much more information about the system than the previously considered input-output (transfer function or external) models. However, if the purpose of an experiment and the subsequent modelling is to provide only the stationary parameters, for instance the HLC, then it might be overkill to consider the grey-box models over the input-output models.

Compared to the previously considered models classes grey-box models can describe rather complex phenomena and data structures. As an important example grey-box models facilitates a possibility of describing both **nonlinear and non-stationary systems**. For buildings the effect of wind speed (and other sources of convective heat transfer) typically gives rise to the need for a nonlinear components, and varying moisture in the construction may give rise to a change in time of the 'thermal mass' and hence a need for being able to describe (or track) the changing features of the systems. These are only one example of each of these more complex phenomena that often is seen for newer buildings, complex walls, and advanced glazing. As an example models for green houses calls for a description of the moisture as a part of the models, and hence these models often becomes rather complex, see e.g. (Nielsen and Madsen, 1995) and (Nielsen and Madsen, 1998).

Since grey-box models are formulated in continuous time the data sampling time can be non-equidistant. In the design of a test it is actually advantageous to vary the sampling time during the experiment.

For stiff systems, like most buildings, it will be advantageous to vary both the excitation of the system and the sampling time such that some periods zoom in on the low frequency part of the model and other periods zoom in on the high frequency parts - see (Sadegh et al., 1995).

4.3.1 Introduction

The concept of grey-box models is introduced in more detail in Appendix B, and we shall here assume that the concept is known to the reader. In particular we will not focus on the noise or the stochastic formulation in these conceptual part of the guidelines, but for advanced modelling this stochastic part of the model may become essential. For a more elaborated description of grey-box models and the related modelling concept we refer to (Madsen et al., 2007).

Most importantly grey-box models are continuous-discrete time state-space models, where the dynamics of all the states of the system are described in continuous

time by a set of (stochastic) differential equations. These models also describe how the observations, which are given as time series (i.e. in discrete time), are linked to the states of the model.

In the most general case the grey-box model is given as the continuous-discrete time state space model:

$$dT_t = f(T_t, \mathbf{U}_t, t)dt + G(T_t, \mathbf{U}_t)dW_t \quad (4.14)$$

$$Y_{t_k} = h(T_{t_k}, \mathbf{U}_{t_k}) + e_{t_k} \quad (4.15)$$

where the vector T contains the states (typically temperatures) of the system. For a further introduction to the equations we refer to (B.5)-(B.6).

The model is a so-called **lumped model** since all the temperatures in the wall or the building are described by only a low number of temperatures. Conceptually this implies that the thermal mass is lumped into a finite number of states, and typically this number is rather low. The number of states is **the model order** and for linear systems this is equal to the number of time-constants. For nonlinear systems the concept of time constants does not exist. As described in Appendix B the number of states for a linear and stationary model corresponds to the order of the auto-regressive part of the ARX model, and the ARX model is the equivalent input-output or transfer function of the model. For nonlinear models the concept of a transfer function representation does not exist.

4.3.2 Linear (RC-network) models

The thermal characteristics of buildings and building components is frequently approximated by a simple network with resistors and capacitances, see for instance (Sonderregger, 1978). This, so-called **RC network model**, is in fact just one (important) example of a linear and stationary (time-invariant) grey-box model.

The linear and time-invariant grey-box model is written

$$dT_t = (AT_t + BU_t)dt + dW_t \quad (4.16)$$

$$Y_{t_k} = CT_{t_k} + e_{t_k} \quad (4.17)$$

Where A , B , and C are matrices where the elements are functions of the physical parameters - see the simple example below.

Example of a two state RC-network model

Let us consider a simple single zone RC-network model for a building with the thermal mass divided between the inside of the building and the walls. The thermal RC-network model is shown in Figure 4.1. The states of this second order model are given by the temperature T_w of the large heat accumulating part of the wall with the heat capacity C_w , and by the temperature T_i of the room air and possibly the inner part of the walls with the capacity C_i . R_{iw} is the thermal resistance for heat transfer between the room air and the heat accumulating part of the wall,

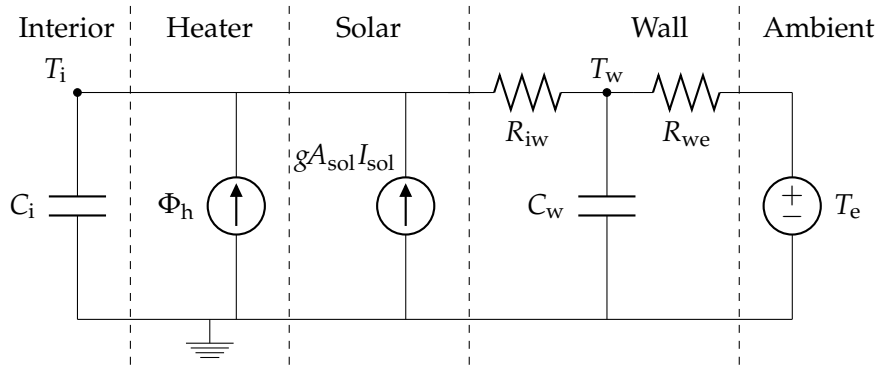

Figure 4.1: A two state RC-network model of a building.

while R_{we} is the thermal resistance against heat transfer from the wall part to the ambient air with the temperature T_e (the thermal resistances include ventilation losses). The input heating power to the building is denoted by Φ_h .

Hence, the model for the state variables are

$$dT_i = \frac{1}{C_i} \left(\frac{1}{R_{iw}} (T_w - T_i) + gA_{sol} I_{sol} + \Phi_h \right) dt + \sigma_i d\omega_i(t) \quad (4.18)$$

$$dT_w = \frac{1}{C_w} \left(\frac{1}{R_{iw}} (T_i - T_w) + \frac{1}{R_{we}} (T_e - T_w) \right) dt + \sigma_w d\omega_w(t) \quad (4.19)$$

which, since it is a linear model, can also be written on matrix form

$$\begin{bmatrix} dT_i \\ dT_w \end{bmatrix} = \begin{bmatrix} \frac{-1}{C_i R_{iw}} & \frac{1}{C_i R_{iw}} \\ \frac{1}{C_w R_{iw}} & -\left(\frac{1}{C_w R_{iw}} + \frac{1}{C_w R_{we}} \right) \end{bmatrix} \begin{bmatrix} T_i \\ T_w \end{bmatrix} dt + \begin{bmatrix} 0 & \frac{1}{C_i} & \frac{gA_{sol}}{C_i} \\ \frac{1}{C_w R_{we}} & 0 & 0 \end{bmatrix} \begin{bmatrix} T_e \\ \Phi_h \\ I_{sol} \end{bmatrix} dt + \begin{bmatrix} \sigma_i d\omega_i(t) \\ \sigma_w d\omega_w(t) \end{bmatrix} \quad (4.20)$$

The model (B.3) describes the evolution of both states of the system. However, let us assume that only the indoor air temperature is measured. If T_r is introduced to denote the measured or recorded variables we can write

$$T_{r,t_k} = [1 \ 0] \begin{bmatrix} T_i(t_k) \\ T_w(t_k) \end{bmatrix} + e_{t_k} \quad (4.21)$$

where e_{t_k} is the measurement error at time t_k , which accompany the measurement of the indoor air temperature.

The example in Appendix B describes how a grey-box is formulated for a simple low-energy test building.

Guidelines for grey-box modelling

In the following guidelines a stepwise procedure which is equivalent to the procedure for ARX models, see Section 4.2, is presented. However, due to the internal

description the physical considerations are here very important to consider, compared the ARX models procedure.

- **Sampling time:** Grey-box models for buildings use temperatures as the states, and for instance the indoor air temperature is most often an observed state of the system. Since the indoor air temperature often contains significant high frequency variation, the aliasing problem could be a serious issue, see also Chapter 3. Consequently, in order to describe the high frequency variation by the proper physical states, the sampling time should ideally be kept rather low (in most cases lower than one hour).
- **Values and physical units:** First of all the physical units for all the variables must be equivalent, note the unit of the time (dt) must be correct according to units of the other variables. Secondly, the modelling is numerically most robust if the units (e.g. W, kW, MW or GW) are selected in such a way that the range of the values of the variables are equivalent (in particular we should avoid that, for instance, some of the variables are measured such that the numbers for some variables are, say, on the order of 10^8 and other variables are on the order of 10^{-8}).
- **Initial identification of the states:** The states, e.g. how to lump the thermal mass, must be selected in accordance with the physical characteristics. For instance for a house the main thermal mass might most appropriately be put 'inside' the building if, for instance, the building has concrete floors (and light walls). However, for other buildings this main thermal mass should be allocated to walls, which by the way implies that the transfer of heat from the inside to the outside is via this thermal mass.

In order to describe the variation of the indoor air temperature a state representing this variable should be defined. However, typically the estimated thermal mass related to this state will account also for e.g. a part of the furnitures, etc.

Attention must also be on heat losses through boundaries not related to the climate, e.g. adjacent zones (rooms), as well as the ground. It should be considered to include such boundary conditions depending on the magnitude of the heat transfer, e.g. temperature differences over the boundary and degree of insulation. Furthermore, identifiability issues becomes very important to consider. For example, usually it will not be possible to identify thermal resistances related to more than one adjacent zone with constant temperature.

- **Initial system equations:** Using the well-know equations for mechanisms for heat transfer the heat balance for all the states, i.e. the systems equations, must be written down. Add noise to the system equations. *In general it is recommended to start with a simple model, which is then stepwise extended until it is found suitable with model validation.*
- **Initial measurement equations:** Write down how the measurements relates to the states of the system. Most frequently only a subset of the states is measured. Some measurements might be functions of some states, and this has to be written down as well using the measurement equation.

- **Model estimation:** The parameters of the model are estimated using some software for grey-box model estimation like CTSM-R². Notice that, as also mentioned in the Users Guide for CTSM-R (Team, 2015), it is advisable to transform some of the parameters to ensure that the transformed parameter can take all values (from $-\infty$ to ∞). For instance for a variance, which should be non-negative, it is preferable to estimate $\log \sigma^2$ instead of just estimating σ^2 . Please consult the CTSM-R user guides for more practical hints.
- **Model validation:** In this step validation of the estimated model is carried out. The validation follows the steps presented in detail in Section 5. Below are additional points to be aware of related to grey-box model validation:
 - **Plot of residuals:** The time series of residuals must show a reasonable stationary behavior. If, for instance, the residuals are relatively very high when the heat is turned on, then this part of the model must be revised. In advanced approaches when the stochastic part is also in focus, this part of the model can be used to describe that the uncertainty is higher for large solar radiation. The structure describing the uncertainty should (in the optimal situation) be built into the model.
 - **Check if all parameters are significant:** If any parameter is not significant (consult the t -test values), then this parameter must be removed and the model reduced accordingly.
 - **Check if serious correlations exist between estimated parameters:** Use the correlation matrix of the parameter estimates to see if any correlation coefficient is close to 1 or -1 . If this is the case it indicates that the two parameters are strongly linked, and the problem can typically be solved either using for instance the restriction that the parameters are equal, or by freezing one of the parameters to a physical reasonable value.
 - **Check if residuals are white noise:** If the ACF and/or the Accumulated Periodogram tests indicates that the residuals are still autocorrelated, then the model should be extended to obtain a more detailed description of the system. This is typically achieved by increasing the model order, which for a state-space model implies that another state must be introduced, or by introducing additional or transformed inputs.
 - **Check if the residuals are uncorrelated with all potential input variables:** In the case of such a significant cross-correlation between the residuals and an input variable this input variable must be introduced in the model. Here both physical and statistical approaches can be used, see also (Kristensen et al., 2003).
- **Model comparison:** Models can be compared using statistical tests depending on their relation.
 - **Nested models:** Models are nested when a smaller model is a sub-model of a larger model. Two nested models can be compared directly using the likelihood values provided by CTSM-R and the Likelihood Ratio Test, see (Madsen and Thyregod, 2011). For a grey-box model selection procedure for buildings based on a forward selection approach

²The estimation method used in CTSM-R is described in (Kristensen et al., 2004)

(stepwise extension of a simple model) using likelihood ratio tests see (Bacher and Madsen, 2011).

- **Non-nested models:** Two non-nested models can be compared by using the information criteria. If the model is going to be used for forecasting or control, the Akaike Information Criterion (AIC) criterion is reasonable, but if the model is used for identifying the physical parameters, then the BIC criterion is best.
- **Model selection choice:** Depending on the outcome of the model validation and optionally a model comparison it should be decided to either keep, reduce or extend the model. A model is found *suitable* when the model validation is successful, if however the model validation reveals that the model needs to be reduced or extended, a new model should be formulated. It is recommended to reduce or extend only one part of the model in each step. Thereafter the procedure should be repeated from the model estimation step with the re-formulated model.

Calculation of HLC and C values: The overall HLC value is calculated using the well-know rules for calculating the total resistance in electrical circuits. For a multi-room model several HLC values can be calculated following these rules.

The total heat capacity is calculated by adding the relevant individual capacities. Here it should, however, be noticed that the lumped model is an approximation of a distributed system, and (Goodson, 1970) has shown that in this case the approximation is only reasonable if a large number of capacitances is used. Hence, for determining the total capacity for instance for a thick homogenous wall, it is advisable to use a rather large number of R-C components in series, and in order to limit the number of free parameters the same value for R and C can be used for all the lumped states through the wall. See (Sonderegger, 1978) or (Goodson, 1970) for more information.

4.3.3 Nonlinear and nonstationary models

The basic steps needed for nonlinear and nonstationary modelling are the same as for linear modelling. However, now the nonlinear and nonstationary formulation, as defined by (4.14)-(4.15), are considered, and, for instance, nonlinear phenomena can now be described. This includes infrared radiation, convection, absorption of solar radiation, etc.

Instead of almost listing the steps from the linear case, we shall consider a simple example.

Example - Nonlinear grey-box model

In the example we shall consider the modeling the thermal dynamics of a PV test reference module mounted in a test reference environment.

The test reference environment is designed for testing PV modules under specific conditions under which the modules can be applied when integrated as a cladding device into the building environment. The test environment is constructed in such a way that the thermal energy obtained by convection and radiation exchanges at the rear of the PV module can be measured accurately. As indicated on Figure 4.2 the test environment box is composed of an insulated cavity of 10 cm with an air in- and outlet placed at the back of the box. Considering the long wave radiative transfer it was decided to have the cavity painted in defined colors. The box is equipped with a number of air and surface temperature sensors, making data available for modelling work.

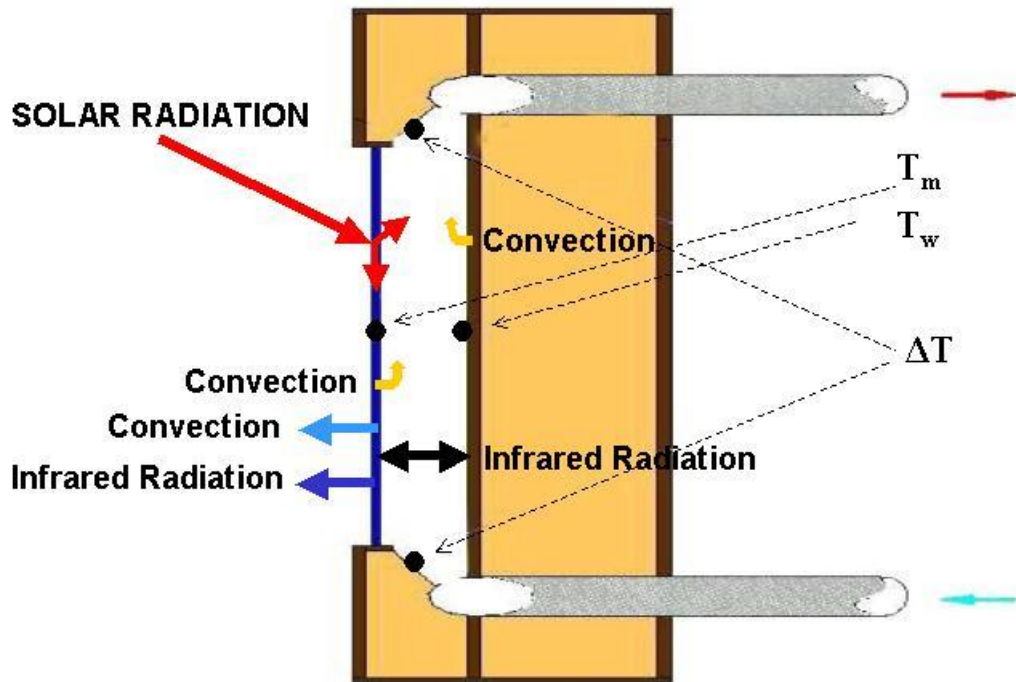

Figure 4.2: View of vertical cross section of PV-element. Main sources for energy transfer and measurement points are indicated.

The modelling is described in detail in (Friling et al., 2009).

For the final model the long wave radiation to the surroundings are relative to some mean radiant temperature (T_{rad}). In the model the mean radiant temperature is treated as a parameter. Furthermore we will introduce a non-linear description of the radiative transfer between the PV module and the pack-panel of wood. Finally it is also assumed that the absorptivity depends on the wind speed. The model is

$$dT = k_0(T_{rad}^4 - T^4)dt + k_1W^{k_2}(T_a - T)dt \quad (4.22)$$

$$+ k_3\Delta Tdt + k_4(T_w^4 - T^4)dt \quad (4.23)$$

$$+ k_5W^{k_6}I_0dt + dw \quad (4.24)$$

$$T_m = T + e \quad (4.25)$$

Note that the absolute temperature has to be used.

It is clear that nonlinear and nonstationary models call for more advanced procedures for structure identification and modelling. Here we will briefly give a few hints and reference on such advanced procedures.

- Autocorrelation functions are only able to measure linear lag-dependencies. An extension to identification of nonlinear methods for measuring or identifying the lag-dependencies are the family of Lag-Dependent-Functions (LDFs). These functions are described by [Nielsen and Madsen \(2001\)](#)
- Identification of nonlinear and nonstationary relation using non-parametric or semi-parametric methods, see [Madsen et al. \(2007\)](#)
- Validation of grey-box models using posterior odds, etc.
- Use a priori information

5. Model selection and validation

In this section techniques which must be applied for model selection and validation are presented. If these techniques are applied appropriately, then it can be ensured that the identified model is suitable and thus that the estimated performance measures can be trusted.

It is assumed that the important steps of *Experimental Design* and *Data Collection* have been conducted, and consequently that time series of good quality data are given. Here it should be noticed that a bad experimental setup might lead to a situation where the model is NOT *identifiable* - see (Madsen et al., 2007) for a discussion on identifiability issues. As an example a control of the indoor air temperature might lead to a situation where the internal thermal mass can not be identified.

Model building is an iterative procedure, which consists of the following steps:

1. **Selection/Identification (of model structure and order)**
2. **Estimation (of model parameters)**
3. **Validation (of the model)**

If the model validation fails, the model structure has to be revised.

In this guide we will consider only rather simple models, and the model selection procedure is then greatly simplified compared to procedures normally used in time series analysis; see e.g. (Madsen, 2008) Chapter 6, 7, 8 and 9 for more advanced methods for model selection.

Basically the two main categories of problems related to the order of the model are:

1. **Model too simple:** A common problem is that *the residuals* for a given model are *autocorrelated*. In this case the model needs to be extended (for greybox models more states are needed). Another common problem is that the residuals are *cross-correlated* with some explanatory variables (e.g. large residuals for large wind speeds). In this case this (or these) explanatory variable needs to be included into the model.
2. **Model too large:** A common problem is that some of the *parameters* are *insignificant*. In order to ensure a reliable estimation of the performance parameters the model must then be reduced by putting insignificant parameters to zero (removing the parameters).

In this section we shall describe some of the basic techniques for model selection and validation.

5.1 Basic model selection (identification) techniques

The following methodologies can be used in relation to model selection:

1. **Test for white noise residuals.** Typically the autocorrelation function (ACF) of the residuals is used here. If a test for white noise residuals fails, see the section below on validation, then the model must be extended by extending the model order (for ARX models) or by extending the number of states (for grey-box models).
2. **Test for cross-correlation with inputs.** If the cross-correlation function (Cross-Correlation Function (CCF)) between the residuals of a given model and input variables are significant, see (Madsen, 2008) p. 230, then this input variable has to be introduced in the model.
3. **Test for parameter significance.** See the next section on model validation. Here it is mentioned that if a parameter is found to be insignificant, then in general this parameter should be removed from the model, and the parameters of the reduced model estimated.
4. **Check for correlation between parameters.** Most software for parameter estimation provides a correlation matrix of the estimated parameters. A numerically very high (say larger than .98) correlation between two parameter estimates indicates that one of these two parameters should be either excluded from the model or fixed to some physically assumed values.
5. **Test between (nested) models.** If two models are nested, i.e. the smaller model (B) can be found just by removing parts of a larger model (A), then the *Likelihood Ratio Test (LRT)* is very useful.

The LRT value is given as $D = 2 \cdot (\log L_A - \log L_B)$, where $\log L_A$ is the logarithm of the likelihood function for model A. Given that the model can be reduced to model B the quantity D is $\chi^2(k - m)$ distributed, where k and m are the number of parameters in model A and B, respectively. For large values of D (use the χ^2 test) it is concluded that the best model is the larger model.

In CTSM the value $\log L$ is found using `summary()`.

6. **Comparison between (non-nested) models.** If two models are non-nested, then use methods based on *Information criteria* can be used - see page 174 in (Madsen, 2008).

All the methods described here are so-called *in-sample* methods for model selection. They are characterized by the fact that the model complexity is evaluated using the same observations as those used for estimating the parameters of the

model. For the in-sample methods statistical tests are used to assess the significance of extra parameters, etc., and when the improvement is small (in some sense), the parameters are considered to be statistically insignificant.

In *data-rich* situations, the performance can be evaluated by splitting the total set of observations in three parts: A *training set* used for estimating the parameters, a validation test (used for *out-of-sample* model selection), and a *test set* used measuring the performance on an independent data set. See e.g. (Hastie et al., 2001) and (Madsen and Thyregod, 2011) p. 32 for more information on these procedures.

5.2 Basic model validation procedure

The following procedure should as a minimum be carried out to validate the identified model:

1. **Time series plots.** Time series plots of residuals and the inputs, as well as measured and predicted output, should be inspected, to see if any clear patterns are present. This is also often a simple and effective way to find model deficiencies and thus to suggest improvements to the model. The variability of the residuals should be almost the same at all time periods. See the examples in Appendix G and H.
2. **Test for parameter significance.** A model parameter is significant if it can be tested to be significantly different from zero. Most often this done by a *t*-test and in most statistical software the *p*-value is directly printed with the model fit results, e.g. in R `summary()` on an `lm()` fit prints out the *p*-value (in the column `Pr(>|t|)`) and indicates the level with stars. See p. 172-173 in (Madsen, 2008).

Related specifically to ARX models selected using the procedure in Section 4.2 the following two conditions should be met:

- (a) At least one coefficient is significant for each input. If for one input all the coefficients are not significant, then: remove the input from the model and restart the modeling procedure.
 - (b) If the highest order AR coefficient (i.e. ϕ_p) estimate is not significant, then it is recommended to reduce the model order *p* by one. It is left as a recommendation, as it might also be an indication of non-linear or time dependent systematic effects, which could lead to an advanced model setup.
3. **Tests for white noise residuals.** This test should preferably be carried out both in the time domain using the ACF in the frequency domain using the Cumulated Periodogram.
 - **Test using the ACF**
This is a test in the time domain. The ACF of the residuals should be insignificant – or more specifically the residuals are not significantly different from white noise. This means that there must be no systematic pattern in the ACF, hence the following conditions should be fulfilled

- Not more than 5-10% of the lag correlations should be above the 95% confidence bands for white noise.
- The correlation for the shorter lags should be insignificant. Typically an exponential decaying pattern from lag 1 is found, indicating that a higher order model should be applied.
- Lag correlations around the 24 hours lag should be insignificant. Significant 24 hours lag correlation indicates a daily pattern in the residuals, which is related to a model deficiency occurring at a particular time of the day, e.g. the effect of solar radiation is systematically too low in morning.

For a more detailed description of the ACF test see p. 103-108 in (Madsen, 2008).

- **Test using the Accumulated Periodogram**

This is a test in the frequency domain. For a description of the procedure we refer to (Madsen, 2008) page 176. The accumulated periodogram is useful to detect cyclic behavior in the residuals. Very often a significant cyclic behavior is seen corresponding to the 24 hour period. This problem might reflect a problem with a description of how the solar radiation influences the building.

4. **Physical considerations.** Clearly, the estimated performance measures must be evaluated from a physical point of view to verify that they are in within reasonable ranges from a physical view point.

The model validation are included in the model procedures presented in Section 4. Both partly in the model identification and as a final step for validation of the identified model.

A. Introduction to time series modelling

Very often the correlation of data in time is disregarded. For instance in regression analysis the assumption about serial uncorrelated residuals is often violated in practice. However, it is crucial to take this autocorrelation into account in the modeling procedure. This autocorrelation can be taking into account by using time series models, like the ARX, Box-Jenkins, and State-space models, see (Madsen, 2008).

A.1 Heat dynamics of a building

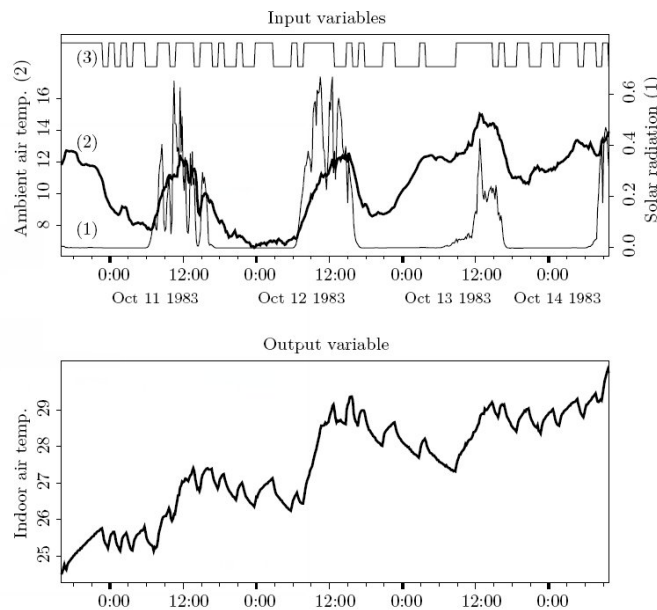

Figure A.1: Measurements from an unoccupied test building. The input variables are (1) solar radiation, (2) external air temperature, and (3) heat input. The output variable is the indoor air temperature.

Now let us consider a more technical example. Figure A.1 shows measurements from an unoccupied test building. The data on the lower plot show the indoor air temperature, while on the upper plot the external air temperature, the heat supply, and the solar radiation are shown.

For this example it might be interesting to characterize the thermal behavior of the building. As a part of that the so-called resistance against heat flux from in-

side to outside can be estimated. The resistance characterizes the insulation of the building. It might also be useful to establish a dynamic model for the building and to estimate the time constants. Knowledge of the time constants can be used for designing optimal controllers for the heat supply.

For this case methods for transfer function modeling as described by ARX or Box-Jenkins models, where the input (explanatory) variables are the solar radiation, heat input, and outdoor air temperature, while the output (dependent) variable is the indoor air temperature. For transfer function models it is crucial that all the signals can be classified as either input or output series related to the system considered.

A.2 Introduction to time series models

Let us introduce some of the most important concepts of time series analysis by considering an example where we look for simple models for predicting diurnal measurements of heat consumption.

In the following, let Φ_t denote the heat consumption (the heat load) at time (day) t . The first naive guess would be to say that the heat consumption the next day is the same as today. Hence, the *predictor* is

$$\widehat{\Phi}_{t+1|t} = \Phi_t \quad (\text{A.1})$$

This predictor is called the *naive predictor* or the *persistent predictor*. The syntax used is short for a prediction (or estimate) of Φ_{t+1} given the observations $\Phi_t, \Phi_{t-1}, \dots$

Next day, i.e., at time $t + 1$, the actual heat consumption is Φ_{t+1} . This means that the *prediction error* or *innovation* may be computed as

$$\varepsilon_{t+1} = \Phi_{t+1} - \widehat{\Phi}_{t+1|t} \quad (\text{A.2})$$

By combining Equations (A.1) and (A.2) we obtain the *stochastic model* for the heat load

$$\Phi_t = \Phi_{t-1} + \varepsilon_t \quad (\text{A.3})$$

If $\{\varepsilon_t\}$ is a sequence of uncorrelated zero mean random variables (*white noise*), the process (A.3) is called a *random walk*. The random walk model is very often seen in finance and econometrics. For this model the optimal predictor is the naive predictor (A.1).

However, it is obvious to try to consider the more general model

$$\Phi_t = \varphi \Phi_{t-1} + \varepsilon_t \quad (\text{A.4})$$

called the *AR(1) model* (the autoregressive first order model). Notice that the random walk is obtained for $\varphi = 1$.

By introducing the *backward shift operator* B by

$$B^k \Phi_t = \Phi_{t-k} \quad (\text{A.5})$$

the models can be written in a more compact form. The $AR(1)$ model can be written as

$$(1 - \varphi B)\Phi_t = \varepsilon_t \quad (\text{A.6})$$

Given a *time series* of observed heat load, $\Phi_1, \Phi_2, \dots, \Phi_N$, the *model structure* can be identified, and, for a given model, the time series can be used for *parameter estimation*.

The *model identification* is most often based on the estimated autocorrelation function, see (Madsen, 2008).

The autocorrelation function shows how the heat load now is correlated to previous values for the heat load; more specifically the autocorrelation in lag k , called $\rho(k)$, is simply the correlation between Φ_t and Φ_{t-k} for stationary processes.

A.3 Input-output (transfer function) models

Let us now introduce the so-called *transfer function models* or *input-output models*. This class of models describes the relation between a input series $\{U_t\}$ and an output series $\{Y_t\}$. Basically the models can be written

$$Y_t = \sum_{k=0}^{\infty} h_k U_{t-k} + N_t \quad (\text{A.7})$$

where $\{N_t\}$ is a correlated noise process,

This gives rise to the so-called *Box-Jenkins transfer function model*, and the *ARX model*:

$$\phi(B)Y_t = \omega(B)U_t + \varepsilon_t \quad (\text{A.8})$$

where ϕ , ω , and θ are polynomials in B .

An important assumption related to the Box-Jenkins transfer function and ARX models is that the output process does not influence the input process. Hence for the heat dynamics of a building example in Section A.1, a transfer function model for the relation between the outdoor air temperature and the indoor air temperature can be formulated. This model can be extended to also include the solar radiation and the heat supply (provided that no feedback exists from the indoor air temperature to the heat supply).

In the case of multiple processes with no obvious split in input and output processes, a multivariate approach must be considered. Alternatively, if for instance the indoor air temperature is controlled, then the input and output time series must be altered. In this case the output is typically the heat consumption.

A.4 State-space models

Until now all the models can be considered as input-output models. The purpose of the modeling procedure is simply to find an appropriate model which relates the output to the input process, which in many cases is simply the white noise process. An important class of models which not only focuses on the input-output relations, but also on the internal state of the system, is the class of *state space models*.

A state space model in discrete time is formulated using a first order (multivariate) difference equation describing the dynamics of the *state vector*, which we shall denote \mathbf{X}_t , and a static relation between the state vector and the (multivariate) observation \mathbf{Y}_t . More specifically the *linear state space model* consists of the *system equation*

$$\mathbf{X}_t = \mathbf{A}\mathbf{X}_{t-1} + \mathbf{B}\mathbf{u}_{t-1} + \mathbf{e}_{1,t} \quad (\text{A.9})$$

and the *measurement equation*

$$\mathbf{Y}_t = \mathbf{C}\mathbf{X}_t + \mathbf{e}_{2,t} \quad (\text{A.10})$$

where \mathbf{X}_t is the m -dimensional, latent (not directly observable), random *state vector*. Furthermore \mathbf{u}_t is a deterministic *input vector*, \mathbf{Y}_t is a vector of observable (measurable) stochastic output, and \mathbf{A} , \mathbf{B} , and \mathbf{C} are known matrices of suitable dimensions. Finally, $\{\mathbf{e}_{1,t}\}$ and $\{\mathbf{e}_{2,t}\}$ are vector white noise processes.

For linear state space models the *Kalman filter* is used to estimate the latent state vector and for providing predictions. The *Kalman smoother* can be used to estimate the values of the latent state vector, given all N values of the time series, for \mathbf{Y}_t .

To illustrate an example of application of the state space model, consider again the heat dynamics of the test building in Section A.1. [Madsen and Holst \(1995\)](#) shows that a second order system is needed to describe the dynamics. Furthermore it is suggested to define the two elements of the state vector as the indoor air temperature and the temperature of the heat accumulating concrete floor. The input vector \mathbf{u}_t consists of the external air temperature, the solar radiation, and the heat input. Only the indoor air temperature is observed, and hence, \mathbf{Y}_t is the measured indoor air temperature. Using the state space approach gives us a possibility of estimating the temperature of heat accumulating in the concrete floor using the so-called Kalman filter technique, see ([Madsen, 2008](#)).

B. Introduction to grey-box models and noise processes

The purpose of this Appendix is to introduce the concept of grey-box models and to describe the physical reasons for the presence of both system and measurement noise. Let us consider the continuous time formulation, where the stochastic model in state space form is formulated as an extension of the ordinary formulated deterministic lumped model. This gives rise to the so-called *Grey-box model* formulation.

Let us first focus on how to describe the dynamics of a physical systems, and we will first consider the classical ODE description, and subsequently the formulation using Stochastic Differential Equations (SDEs).

Then the grey-box model is more formally introduced. The grey-box model uses SDEs to describe the dynamics of the states of the system in continuous time. This part of the model is called **the system equations**. The relations between the discrete time observations and the states are described by **the measurement equations**.

B.1 ODE formulation of the system equations

Very often a lumped description of dynamical systems is used. This holds also for the heat dynamics of buildings which frequently are described by a system of linear differential equations, and in a very useful matrix notation the equations can be parameterized by *the deterministic linear model in continuous time of the states X of the system*:

$$\frac{d\mathbf{X}}{dt} = \mathbf{A}\mathbf{X} + \mathbf{B}\mathbf{U} \quad (\text{B.1})$$

where \mathbf{X} is the state-vector and \mathbf{U} is the input vector. The dynamical behaviour of the system is characterized by the matrix \mathbf{A} , and \mathbf{B} is a matrix, which specify how the input signals (outdoor air temperature, solar radiation, heat supply, etc.) enter the system. Such linear (often called RC formulation) are often used for modelling the thermal performance of buildings.

B.1.1 Characterization of ODEs

Let us generalize to the nonlinear ODE's in this paragraph, and briefly mention how ODEs can be characterized:

- Ordinary Differential Equations (ODE's) provide deterministic description of a system:

$$d\mathbf{X}_t = \mathbf{f}(\mathbf{X}_t, \mathbf{u}_t, t)dt \quad t \geq 0 \quad (\text{B.2})$$

where \mathbf{f} is a deterministic function of the time t and the state \mathbf{X} .

- The solution to an ODE is a (deterministic) function of time.
- For systems described by ODEs future states of the system can be predicted without any error!
- Parameters can be calibrated using curve fitting methods (... but please check for uncorrelated residuals if you call it an estimate, if you are using statistical tests, or if you provide confidence intervals!).
- Consequently Maximum Likelihood Estimation (MLE) and Prediction Error Methods are seldom the best methods for 'tuning the parameters'.

B.2 SDE formulation of the system equations

Let us again first consider the linear state space formulation. For most real life systems, the states can not be predicted exactly, i.e. Equation B.1 is not able to exactly predict the future behaviour of the states. To describe the deviation between B.1 and the true variation of the states an additive noise term is introduced. Then the model of the heat dynamics is described by the stochastic differential equation

$$d\mathbf{X} = \mathbf{A}\mathbf{X}dt + \mathbf{B}\mathbf{U}dt + d\mathbf{w}(t) \quad (\text{B.3})$$

where the n 'th dimensional stochastic process $\mathbf{w}(t)$ often is assumed to be a process with independent increments. $\mathbf{B.3}$ is *the system equations of a stochastic linear state space model in continuous time*, i.e. a system of stochastic differential equations.

There are many reasons for introducing such a noise term:

- Lack of the model. For instance the dynamic, as described by the matrix \mathbf{A} in B.3 might be an approximation to the true system.
- Unrecognized inputs. Some variables, which are not considered, may affect the system.
- Measurements of the input are noise corrupted. In this cases the measured input is regarded as the actual input to the system, and the deviation from the true input is described by $\mathbf{w}(t)$.

B.2.1 Characterization of SDEs

Let us again, for a moment, generalize to the class of nonlinear models, and then focus on the characterization of models described by SDEs.

- To describe the deviation between the ODE and the true variation of the states a system noise term is introduced, i.e.

$$d\mathbf{X}_t = \mathbf{f}(\mathbf{X}_t, \mathbf{u}_t, t)dt + \mathbf{G}(\mathbf{X}_t, \mathbf{u}_t)d\mathbf{W}_t \quad (\text{B.4})$$

- Reasons for including the system noise:
 1. Modelling approximations.
 2. Unrecognized inputs.
 3. Measurements of the input are noise corrupted.
- For an SDE's the solutions is a stochastic processes
- This implies that the future values are not know exactly (the outcomes are described a probability density function).
- Here proper statistical methods like MLE and Prediction Error Methods are appropriate for estimating the parameters – and we can easily test for hypothesis using statistical tests.

B.2.2 The grey-box model

We are now ready to provide a more formel introduction to the grey-box model.

The grey-box model is formulated as a continuous-discrete time state space model, which, as previous explained, consists of the system equations formulated in continuous time, and the measurement equations formulated in discrete time.

The dynamics of the system is described in continuous time using a set SDEs; one for each of the states of the system. The **systems equations**¹ are:

$$d\mathbf{X}_t = \mathbf{f}(\mathbf{X}_t, \mathbf{U}_t, t)dt + \mathbf{G}(\mathbf{X}_t, \mathbf{U}_t)d\mathbf{W}_t \quad (\text{B.5})$$

where:

$\mathbf{X}_t \in \mathbb{R}^n$ is the n -dimensional state vector,

$\mathbf{U}_t \in \mathbb{R}^r$ is a r -dimensional known input vector,

\mathbf{f} is the drift term,

\mathbf{G} is the diffusion term,

\mathbf{W}_t is a Wiener process of dimension with incremental covariance \mathbf{Q}_t

¹Please notice that, since in this document the states are most often a temperature (of a wall, indoor air, etc.) we shall most often use T_t to denote the state vector

The discrete time observations are functions of states, inputs and are subject to noise, as described by the discrete time **measurement equations**:

$$\mathbf{Y}_{t_k} = h(\mathbf{X}_{t_k}, \mathbf{U}_{t_k}) + \mathbf{e}_{t_k} \quad (\text{B.6})$$

where:

$\mathbf{Y}_{t_k} \in \mathbb{R}^m$ is the m -dimensional vector of measurements at time t_k

h is the measurement function

$\mathbf{e}_{t_k} \in \mathbb{R}^m$ is a Gaussian white noise with covariance Σ_{t_k}

It is assumed that in total N observations are available at the time points:

$$t_1 < \dots < t_k < \dots < t_N$$

Finally, it is assumed that $\mathbf{X}_0, \mathbf{W}_t, \mathbf{e}_{t_k}$ are independent for all $(t, t_k), t \neq t_k$.

Let us consider an example:

B.3 Example: RC model for the heat dynamics of a building

As an example of a model in the class described by B.3 consider the following example from (Madsen and Holst, 1995), which is a proposed model for a very tight low energy test building situated at the campus of the Technical University of Denmark, as illustrated on Figure B.1. Note, that the notation symbols used in this example differs slightly from elsewhere in the document. For the consid-

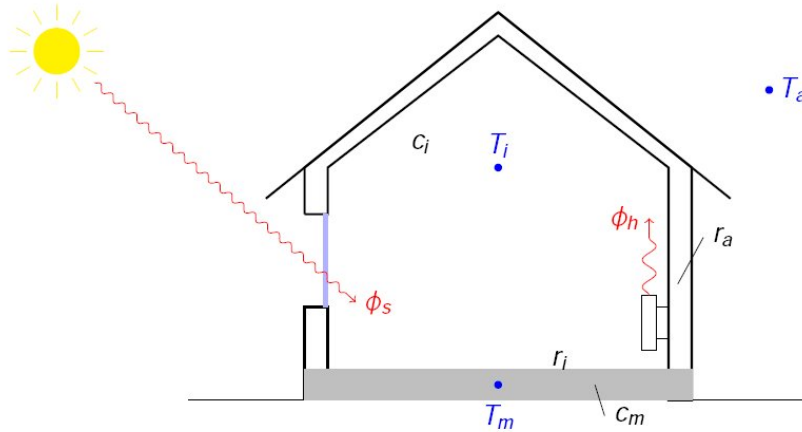

Figure B.1: The states and input of a low energy test building.

ered building it is reasonable to assume that all the heat accumulating medium is situated inside the building. The lumped model is

$$\begin{bmatrix} dT_m \\ dT_i \end{bmatrix} = \begin{bmatrix} \frac{-1}{r_i c_m} & \frac{1}{r_i c_m} \\ \frac{1}{r_i c_i} & -\left(\frac{1}{r_a c_i} + \frac{1}{r_i c_i}\right) \end{bmatrix} \begin{bmatrix} T_m \\ T_i \end{bmatrix} dt + \begin{bmatrix} 0 & 0 & A_w p / c_m \\ 1 / (r_a c_i) & 1 / c_i & A_w (1 - p) / c_i \end{bmatrix} \begin{bmatrix} T_a \\ \phi_h \\ \phi_s \end{bmatrix} dt + \begin{bmatrix} dw_m(t) \\ dw_i(t) \end{bmatrix} \quad (\text{B.7})$$

where the states of the model are the temperature of the T_i of the room air (and the inner part of the walls), and the temperature T_m of the large heat accumulating medium. The constants c_m, c_i, r_a, r_i, A_w and p are equivalent thermal parameters, which describes the dynamical behaviour of the building. A_w and p are the effective window area, and the percentage of the heat which is transferred to the heat accumulating medium, respectively.

Equation B.3 describes the transfer of all the states of the system; but it is most likely that only some of the states are measured. If we for instance consider the state space model in B.7 it is reasonable to assume that the temperature of the indoor air is measured; but not the temperature of the large heat accumulating medium (it might also be difficult to find a reasonable temperature to measure in order to represent the temperature of the heat accumulating part of the wall and floors).

In the general linear case we assume that only a linear combination of the states are measured, and if we introduce T_r to denote the measured or recorded variables we can write

$$T_{r,t_k} = CT_{i,t_k} + e_{t_k} \quad (\text{B.8})$$

where C is a constant matrix, which specifies which linear combination of the states that actually are measured. The equation is for obvious reasons called **the measurement equation**. In practice, however, C most frequently acts only as a matrix which picks out the actual measured states.

The term e_{t_k} is the measurement error. The sensors that measure the output signals are subject to noise and drift.

Often it is assumed that e_{t_k} is white noise with zero mean and variance R_2 . Furthermore it is assumed that $\omega(t)$ and e_{t_k} are mutually independent, which seems to be quit reasonable. However, the measurement error may consist of both a **systematic error** and a **random error**. In statistical modelling the random error can be accounted for by extending the length of the experiment. The systematic error, on the other hand, is more complicated. Ideally, the experiment should be repeated with randomly picked and individually calibrated experiments, and then the total sequence of experiments can be estimated as described in (Kristensen et al., 2004).

As an example consider the system described by B.7, and assume that only the indoor air temperature is measured. Then the measurement equation simply becomes

$$T_{r,t_k} = [0 \ 1] \begin{bmatrix} T_m(t_k) \\ T_i(t_k) \end{bmatrix} + e_{t_k} \quad (\text{B.9})$$

where e_{t_k} is the measurement error, which accomplish the measurement of the indoor air temperature.

C. The family of linear models and their characteristics

Let us consider the linear grey-box model formulated in the previous appendix. This model is formulated a linear model in continuous time and the model is formulated in continuous time as a set of coupled stochastic differential equations.

C.1 Discrete time models in state space form

Frequently, the method of finite differences is used for transforming differential equations into difference equations. This is, however, very often a crude approximation, and more adequate techniques are preferred, see for instance (Kristensen and Madsen, 2003). In the present situation, where the system is assumed to be described by the stochastic differential equation B.3, it is possible analytical to perform an integration, which under some assumptions exactly specifies the system equation in discrete time.

For the continuous time model B.3 the corresponding discrete time model is obtained by integrating the differential equation through the sample interval $[t, t + \tau]$. Thus the sampled version of B.3 can be written as

$$T(t + \tau) = e^{A(t+\tau-t)}T(t) + \int_t^{t+\tau} e^{A(t+\tau-s)}BU(s)ds + \int_t^{t+\tau} e^{A(t+\tau-s)}dw(s) \quad (\text{C.1})$$

Under the assumption that $U(t)$ is constant in the sample interval the sampled version can be written as the following *discrete time model in state space form*

$$T(t + \tau) = \phi(\tau)T(t) + \Gamma(\tau)U(t) + v(t; \tau) \quad (\text{C.2})$$

where

$$\phi(\tau) = e^{A\tau}; \Gamma(\tau) = \int_0^\tau e^{As}Bds \quad (\text{C.3})$$

$$v(t; \tau) = \int_t^{t+\tau} e^{A(t+\tau-s)}dw(s) \quad (\text{C.4})$$

If the input is not constant in the sample interval other methods exists – see for instance (Kristensen and Madsen, 2003).

On the assumption that $w(t)$ is a Wiener process, $v(t; \tau)$ becomes normal distributed white noise with zero mean and covariance

$$R_1(\tau) = E [v(t; \tau)v(t; \tau)'] = \int_0^\tau \phi(s)R_1'\phi(s)'ds \quad (\text{C.5})$$

The total state space form most frequently include the measurement equation, which in this case is unchanged from the continuous time case, i.e.:

$$T_r(t) = CT(t) + e(t) \quad (\text{C.6})$$

If the sampling time is constant (equally spaced observations), the stochastic difference equation can be written

$$T(t+1) = \phi T(t) + \Gamma U(t) + v(t) \quad (\text{C.7})$$

where the time scale now is transformed such that the sampling time becomes equal to one time unit.

Notice that compared to the continuous time model we observe that:

- Equidistant data is assumed and hence the possibility of time-varying sampling times is lost.
- Furthermore, the direct physical interpretation of the parameters is lost.
- Finally, a much higher number of parameters is typically needed which implies lower efficiency and a lower robustness.

C.2 The transfer function form

The (discrete time) transfer functions form is also frequently called the Box-Jenkins transfer functions, since (Box and Jenkins, 1970/1976) are responsible for the great popularity of this class of models – see also (Madsen, 2008).

Let us introduce the transfer function form by showing how the transfer function form is obtained by the state space form. Consider the following discrete time state space model:

$$T(t+1) = \phi T(t) + \Gamma U(t) + v(t) \quad (\text{C.8})$$

$$Y(t) = CT(t) + e(t) \quad (\text{C.9})$$

where $\{v(t)\}$ and $\{e(t)\}$ are mutual uncorrelated white noise processes with variance R_1 and R_2 , respectively.

By using the z-transform the state space form is written

$$zT(z) = \phi T(z) + \Gamma U(z) + v(z) \quad (\text{C.10})$$

$$Y(z) = CT(z) + e(z) \quad (\text{C.11})$$

By eliminating $T(z)$ in C.10 - C.11 we obtain

$$Y(z) = C(zI - \phi)^{-1}\Gamma U(z) + C(zI - \phi)^{-1}v(z) + e(z) \quad (\text{C.12})$$

Note that rational polynomials in z are found ahead of $U(z)$ and $v(z)$. Another possibility, which will be demonstrated later on, is first to obtain the innovation form, which is obtained directly from using a Kalman filter on the discrete time model.

If $\{Y_t\}$ is a stationary process (the matrix A is stable) then the noise processes in C.12 can be concentrated in only one stationary noise process. Following [Madsen \(2008\)](#) we write

$$Y(z) = C(zI - \phi)^{-1}\Gamma U(z) + [C(zI - \phi)^{-1}K + I]\epsilon(z) \quad (\text{C.13})$$

or alternatively in *the transfer function form, the Box-Jenkins transfer function form or the input-output form*:

$$Y(z) = H_1(z)U(z) + H_2(z)\epsilon(z) \quad (\text{C.14})$$

where $\{\epsilon_t\}$ is white noise with variance R , and $H_1(z)$ and $H_2(z)$ are rational polynomials in z :

$$H_1(z) = C(zI - \phi)^{-1}\Gamma \quad (\text{C.15})$$

$$H_2(z) = C(zI - \phi)^{-1}K + I \quad (\text{C.16})$$

The matrix K is the stationary Kalman gain. R is determined from the values of R_1 , R_2 , ϕ and C , since we have

$$K = \phi PC^T (CPC^T + R_2)^{-1} \quad (\text{C.17})$$

$$R = CPC^T + R_2 \quad (\text{C.18})$$

where P is determined by the stationary Ricatti equation

$$P = \phi P \phi^T + R_1 - \phi PC (CPC^T + R_2) CP \phi^T \quad (\text{C.19})$$

The ARMAX class of models obtain in cases where the denominators in (C.14) for H_1 and H_2 are equal, hence the models is written:

$$\phi(z)Y(z) = \omega(z)U(z) + \theta(z)\epsilon(z) \quad (\text{C.20})$$

where ϕ , ω , and θ are polynomials in z .

As shown above a transfer function can be found from the state space form by simply eliminating the state vector. To go from a transfer function to a state space form is more difficult, since for a given transfer function model, there in fact exists a whole continuum of state space models. The most frequently used solution is to choose a canonical state space model - see e.g. (Madsen, 2008), or to use some physical knowledge to write down a proper connection between desirable state variables, which have to be introduced for the state space form.

Notice that compared to the discrete time state space model we observe that:

- The decomposition of the noise into system and measurement noise is lost.
- The state variable is lost, i.e. the possibility for physical interpretation is further reduced.

C.3 Impulse and response function models

A non-parametric description of the linear system is obtained by polynomial division, i.e.

$$Y(t) = \sum_{i=0}^{\infty} h_i U(t-i) + N(t) \quad (\text{C.21})$$

where N_i is a correlated noise sequence. The sequence $\{h_i\}$ is the *impulse response (matrix) function*.

In the frequency (or z-) domain:

$$Y(z) = H(z)U(z) + N(z) \quad (\text{C.22})$$

where $H(z)$ is the transfer function, and for $z = e^{i\omega}$ we obtain the *frequency response function (gain and phase)*.

Notice that compared to the transfer function models we now observed that:

- The description of the noise process is lost.
- The non-parametric model hides the number of time constants, etc.

C.4 The linear regression model

The linear regression model, which describes the stationary situation, can be obtained directly from the state space models by using the fact that, in the stationary situation, $dT/dt = 0$ - or from the state space model in discrete form by using, $T(t+1) = T(t)$.

Hence it follows that *the steady state equation or regression model*, which expresses the stationary relationship between the influences U and the recorded temperature T_r , is given by (from the continuous time model)

$$T_r = -CA^{-1}BU \quad (\text{C.23})$$

or (from the discrete time model)

$$T_r = C(I - \Phi)^{-1}\Gamma U \quad (\text{C.24})$$

Alternatively, the stationary equation is obtained from the (discrete time) transfer function model by putting $z = 1$.

Notice, that now also a description of the dynamics is lost.

D. Calculation of the HLC, gA-value and their uncertainties

When a model includes two estimates of the heat loss coefficient H_{tot} , then a linear weighting of the two estimates can be applied to find the single minimum variance estimate. In this section it is described how weighting is carried out.

D.1 For models with heating power as output

D.1.1 Linear minimum variance weighting for estimation of the HLC

The models which is covered by the derivation presented in this section have the heating power as output

$$\phi(B)\Phi_t^h = \omega_i(B)T_t^i + \omega_e(B)T_t^e + \dots + \varepsilon_t \quad (\text{D.1})$$

where \dots represent other inputs to the model and B is the backward shift operator ($B^k Y_t = Y_{t-k}$). The included polynomials to be considered are

$$\phi(B) = 1 + \phi_1 B^1 + \phi_2 B^2 + \dots + \phi_{n_\phi} B^{n_\phi} \quad (\text{D.2})$$

$$\omega_i(B) = \omega_{i,0} + \omega_{i,1} B^1 + \dots + \omega_{i,n_i} B^{n_i} \quad (\text{D.3})$$

$$\omega_e(B) = \omega_{e,0} + \omega_{e,1} B^1 + \dots + \omega_{e,n_e} B^{n_e} \quad (\text{D.4})$$

To obtain the steady state gain (i.e. the infinite response from a step in an input) the inputs are set to one, hence $B = 1$, and the polynomials become

$$\phi(1) = 1 + \phi_1 + \phi_2 + \dots + \phi_{n_\phi} \quad (\text{D.5})$$

$$\omega_i(1) = \omega_{i,0} + \omega_{i,1} + \dots + \omega_{i,n_i} \quad (\text{D.6})$$

$$\omega_e(1) = \omega_{e,0} + \omega_{e,1} + \dots + \omega_{e,n_e} \quad (\text{D.7})$$

Two estimates of the heat loss coefficient H_{tot} (here shortened to H) can be calculated with the model: one related to T_i and one to T_e . They are found by (Note: the sign for $\omega_e(1)$, which comes from the energy balance $\Phi_h = H(T_i - T_e)$, hence an

opposite sign for T_e)

$$H_i = \frac{\omega_i(1)}{\phi(1)} \quad (\text{D.8})$$

$$H_e = \frac{-\omega_e(1)}{\phi(1)} \quad (\text{D.9})$$

The minimum variance estimate of the total H is found with the Lagrange weighting (linear interpolation of the two H)

$$H = \lambda H_i + (1 - \lambda) H_e \quad (\text{D.10})$$

and by finding its variance by (Note: H_i and H_e are stochastic variables, use the rule: $\text{Var}(aX + bY) = a^2\text{Var}(X) + b^2\text{Var}(Y) + 2ab\text{Cov}(X, Y)$)

$$\text{Var}(\lambda H_i + (1 - \lambda) H_e) = \lambda^2 \text{Var}(H_i) + (1 - \lambda)^2 \text{Var}(H_e) + 2\lambda(1 - \lambda) \text{Cov}(H_i, H_e) \quad (\text{D.11})$$

differentiate Equation (D.11) and set it to zero in order to calculate the value of λ that minimize the variance

$$\frac{d\text{Var}(\lambda H_i + (1 - \lambda) H_e)}{d\lambda} = 0 \Leftrightarrow \quad (\text{D.12})$$

$$\lambda = \frac{\text{Var}(H_e) - \text{Cov}(H_i, H_e)}{\text{Var}(H_i) + \text{Var}(H_e) - 2\text{Cov}(H_i, H_e)} \quad (\text{D.13})$$

Hence we need to calculate the variance of H_i and H_e and their covariance, which is carried out in the following.

The parameter estimates are set into a single vector

$$\theta = (\phi_0, \phi_1, \dots, \phi_{n_\phi}, \omega_{i,0}, \omega_{i,1}, \dots, \omega_{i,n_i}, \omega_{e,0}, \omega_{e,1}, \dots, \omega_{e,n_e}) \quad (\text{D.14})$$

It has the covariance matrix $V(\theta)$, which is estimated when the model is fitted.

The H -values are parameterized as functions of the parameters (i.e. $H_i = H_i(\theta)$ and $H_e = H_e(\theta)$) and to calculate the needed variance and covariance we can use the error propagation formula

$$V[H_i(\theta), H_e(\theta)] = \begin{pmatrix} V[H_i(\theta)] & \text{Cov}[H_i(\theta), H_e(\theta)] \\ \text{Cov}[H_i(\theta), H_e(\theta)] & V[H_e(\theta)] \end{pmatrix} \quad (\text{D.15})$$

$$= \begin{pmatrix} d \begin{pmatrix} H_i(\theta) \\ H_e(\theta) \end{pmatrix} \\ d\theta \end{pmatrix} V(\theta) \begin{pmatrix} d \begin{pmatrix} H_i(\theta) \\ H_e(\theta) \end{pmatrix} \\ d\theta \end{pmatrix}^T \quad (\text{D.16})$$

where the Jacobian can be calculated

$$\frac{d \begin{pmatrix} H_i(\theta) \\ H_e(\theta) \end{pmatrix}}{d\theta} = \begin{pmatrix} \frac{dH_i(\theta)}{d\phi_1} & \frac{dH_i(\theta)}{d\phi_2} & \dots & \frac{dH_i(\theta)}{d\phi_{n_\phi}} & \frac{dH_i(\theta)}{d\omega_{i,0}} & \frac{dH_i(\theta)}{d\omega_{i,1}} & \dots & \frac{dH_i(\theta)}{d\omega_{i,n_i}} & \frac{dH_i(\theta)}{d\omega_{e,0}} & \frac{dH_i(\theta)}{d\omega_{e,1}} & \dots & \frac{dH_i(\theta)}{d\omega_{e,n_e}} \\ \frac{dH_e(\theta)}{d\phi_1} & \frac{dH_e(\theta)}{d\phi_2} & \dots & \frac{dH_e(\theta)}{d\phi_{n_\phi}} & \frac{dH_e(\theta)}{d\omega_{i,0}} & \frac{dH_e(\theta)}{d\omega_{i,1}} & \dots & \frac{dH_e(\theta)}{d\omega_{i,n_i}} & \frac{dH_e(\theta)}{d\omega_{e,0}} & \frac{dH_e(\theta)}{d\omega_{e,1}} & \dots & \frac{dH_e(\theta)}{d\omega_{e,n_e}} \end{pmatrix} \quad (\text{D.17})$$

Hence each element in this matrix needs to be calculated, which is luckily not too difficult!

By using the differentiation rule

$$\left(\frac{f}{g}\right)' = \frac{f'g - fg'}{g^2} \quad (\text{D.18})$$

the first element becomes

$$\begin{aligned} \frac{dH_i(\theta)}{d\phi_1} &= \frac{d\left(\frac{\omega_i(1)}{\phi(1)}\right)}{d\phi_1} = \frac{\left(\frac{d\omega_i(1)}{d\phi_1}\right)\phi(1) - \omega_i(1)\left(\frac{d\phi(1)}{d\phi_1}\right)}{\phi(1)^2} = \frac{0 - \omega_i(1)\left(\frac{d(1+\phi_1+\phi_2+\dots+\phi_{n_\phi})}{d\phi_1}\right)}{\phi(1)^2} \\ &= \frac{-\omega_i(1)}{\phi(1)^2} \end{aligned} \quad (\text{D.19})$$

Watching the steps above it becomes clear that for all the elements with ϕ_i the result is the same, i.e.

$$\frac{dH_i(\theta)}{d\phi_i} = \frac{-\omega_i(1)}{\phi(1)^2} \quad \text{for } i = 1, \dots, n_\phi \quad (\text{D.20})$$

The next elements are with respect to $\omega_{i,j}$ and here the differentiation is

$$\begin{aligned} \frac{dH_i(\theta)}{d\omega_{i,0}} &= \frac{d\left(\frac{\omega_i(1)}{\phi(1)}\right)}{d\omega_{i,0}} = \frac{\left(\frac{d\omega_i(1)}{d\omega_{i,0}}\right)\phi(1) - \omega_i(1)\left(\frac{d\phi(1)}{d\omega_{i,0}}\right)}{\phi(1)^2} = \frac{\left(\frac{d(\omega_{i,0}+\omega_{i,1}+\dots+\omega_{i,n_i})}{d\omega_{i,0}}\right)\phi(1)}{\phi(1)^2} \\ &= \frac{\phi(1)}{\phi(1)^2} = \frac{1}{\phi(1)} \end{aligned} \quad (\text{D.21})$$

and again by watching the steps it is clear that

$$\frac{dH_i(\theta)}{d\omega_{i,j}} = \frac{1}{\phi(1)} \quad \text{for } i = 0, \dots, n_i \quad (\text{D.22})$$

The elements where $H_i(\theta)$ is differenced with respect to $\omega_{e,i}$ are zero.

Now comes the elements in the second row where $H_e(\theta)$ is differenced, starting with

$$\frac{dH_e(\theta)}{d\phi_i} = \frac{d\left(\frac{-\omega_e(1)}{\phi(1)}\right)}{d\phi_i} = \frac{\omega_e(1)}{\phi(1)^2} \quad \text{for } i = 1, \dots, n_\phi \quad (\text{D.23})$$

since the same calculations as in Eq. (D.19) just replacing $\omega_i(1)$ with $-\omega_e(1)$ are carried out.

The elements where $H_e(\theta)$ are differenced with respect to $\omega_{i,j}$ are zero.

The elements where $H_e(\theta)$ are differenced with respect to $\omega_{e,i}$ are calculated the same way as in Eq. (D.21) where $\omega_i(1)$ is replaced with $-\omega_e(1)$ giving

$$\frac{dH_e(\theta)}{d\omega_{e,i}} = \frac{-1}{\phi(1)} \quad \text{for } i = 0, \dots, n_e \quad (\text{D.24})$$

Finally we have all variables needed to calculate the Jacobian

$$\frac{df(\theta)}{d\theta} = \begin{pmatrix} \frac{-\omega_i(1)}{\phi(1)^2} & \frac{-\omega_i(1)}{\phi(1)^2} & \cdots & \frac{-\omega_i(1)}{\phi(1)^2} & \frac{1}{\phi(1)} & \frac{1}{\phi(1)} & \cdots & \frac{1}{\phi(1)} & 0 & 0 & \cdots & 0 \\ \frac{\omega_e(1)}{\phi(1)^2} & \frac{\omega_e(1)}{\phi(1)^2} & \cdots & \frac{\omega_e(1)}{\phi(1)^2} & 0 & 0 & \cdots & 0 & \frac{-1}{\phi(1)} & \frac{-1}{\phi(1)} & \cdots & \frac{-1}{\phi(1)} \end{pmatrix} \quad (\text{D.25})$$

The estimate of the variance of the heat loss coefficient H_{tot} is finally calculated using Equation (D.11)

$$\sigma_{H_{\text{tot}}}^2 = \text{Var}(\lambda H_i + (1 - \lambda) H_e) \quad (\text{D.26})$$

One important point is when the H_{tot} is estimated using an ARX model, then sign of the estimated coefficients of the AR polynomial is flipped, such that

$$\phi_1 = -\phi_{\text{lm},1} \quad (\text{D.27})$$

$$\phi_2 = -\phi_{\text{lm},2} \quad (\text{D.28})$$

\vdots

$$\phi_{n_\phi} = -\phi_{\text{lm},n_\phi} \quad (\text{D.29})$$

and the sign of the covariances in $V(\theta)$ involving the AR coefficients must also be flipped.

D.1.2 gA-value

The models which is covered by the derivation presented in this section have the heating power Φ_h as output

$$\phi(B)\Phi_t^h = \omega_{\text{sol}}(B)I_t^{\text{sol}} + \dots + \varepsilon_t \quad (\text{D.30})$$

where \dots represent other inputs to the model and B is the backward shift operator ($B^k Y_t = Y_{t-k}$) and the included polynomials are

$$\phi(B) = 1 + \phi_1 B^1 + \phi_2 B^2 + \dots + \phi_{n_\phi} B^{n_\phi} \quad (\text{D.31})$$

$$\omega_{\text{sol}}(B) = \omega_{\text{sol},0} + \omega_{\text{sol},1} B^1 + \dots + \omega_{\text{sol},n_s} B^{n_s} \quad (\text{D.32})$$

The gA-value is the stationary gain of the transfer function from the solar radiation input

$$gA_{\text{sol}} = \frac{\omega_{\text{sol}}(1)}{\phi(1)} \quad (\text{D.33})$$

and can therefore be directly calculated with the estimated coefficients.

The uncertainty of the gA-value can be calculated similarly as for the HLC using the first order error propagation approximation, see from Equation (D.15).

D.2 For models with internal temperature as output

In this section the calculation of the HLC and gA-value for models with internal temperature as output are presented. A simple first order ODE RC-model is rewritten into transfer functions, such that it is elucidated which physical parameters are represented by the transfer functions of an linear input-output model. The first-order RC state-space model presented in Equation (4.7), which is equivalent to the simple setup ARX model, is

$$dT_i = \left(\frac{1}{RC}(T_e - T_i) + \frac{1}{C}\Phi_h + \frac{gA_{\text{sol}}}{C}I_{\text{sol}} \right) dt + \sigma\omega(t) \quad (\text{D.34})$$

$$T_{r,t_k} = T_i(t_k) + e_{t_k} \quad (\text{D.35})$$

where T_i is the internal temperature, T_e is the external temperature, I_{sol} is the incoming solar radiation, Φ_h is the heating power, R_{ie} is the thermal resistance between internal and external, C_i is the heat capacity, gA_{sol} is the gA-value and finally the model output T_r is the recorded internal temperature.

Now Equation (C.12) with out the stochastic and noise part gives the transfer function form in the frequency domain

$$Y(s) = C(sI - A)^{-1}BU(s) \quad (\text{D.36})$$

where the input vector is

$$\mathbf{u} = [T_e \quad \Phi_h \quad I_{\text{sol}}] \quad (\text{D.37})$$

Hence the transfer function is

$$\mathbf{H}(s) = C(sI - A)^{-1}\mathbf{B} \quad (\text{D.38})$$

and the matrices are

$$\mathbf{A} = \frac{-1}{R_{ie}C_i} \quad (\text{D.39})$$

$$\mathbf{B} = \left[\begin{array}{ccc} \frac{1}{R_{ie}C_i} & \frac{1}{C_i} & \frac{gA_{\text{sol}}}{C_i} \end{array} \right] \quad (\text{D.40})$$

$$\mathbf{C} = 1 \quad (\text{D.41})$$

which is inserted results in the transfer function

$$\mathbf{H}(s) = \left(s\mathbf{I} + \frac{1}{R_{ie}C_i} \right)^{-1} \left[\begin{array}{ccc} \frac{1}{R_{ie}C_i} & \frac{1}{C_i} & \frac{gA_{\text{sol}}}{C_i} \end{array} \right] \quad (\text{D.42})$$

$$= \left[\begin{array}{ccc} \frac{1}{s\mathbf{I} + \frac{1}{R_{ie}C_i}} & \frac{1}{s\mathbf{I} + \frac{1}{R_{ie}C_i}} & \frac{gA_{\text{sol}}}{s\mathbf{I} + \frac{1}{R_{ie}C_i}} \end{array} \right] \quad (\text{D.43})$$

$$= \left[\begin{array}{ccc} \frac{1}{sR_{ie}C_i + 1} & \frac{1}{sC_i + \frac{1}{R_{ie}}} & \frac{gA_{\text{sol}}}{sC_i + \frac{1}{R_{ie}}} \end{array} \right] \quad (\text{D.44})$$

The steady state gain is obtained by setting $s = 0$

$$\mathbf{H}(0) = [1 \quad R_{ie} \quad gA_{\text{sol}}R_{ie}] \quad (\text{D.45})$$

and thus the HLC estimate is

$$H_{\text{tot}} = \frac{1}{\frac{\omega_h(1)}{\phi(1)}} \quad (\text{D.46})$$

where $\frac{\omega_h(1)}{\phi(1)}$ is the steady state gain of the estimated transfer function for the heating power in (4.7). The gA-value is similarly obtained by

$$gA_{\text{sol}} = \frac{\frac{\omega_{\text{sol}}(1)}{\phi(1)}}{\frac{\omega_h(1)}{\phi(1)}} = \frac{\omega_{\text{sol}}(1)}{\omega_h(1)} \quad (\text{D.47})$$

The uncertainties are estimated by either the error propagation formula (linear approximation) or a simulation approach.

E. Experimental design; basic principles

This section describes briefly the experimental design related to test performed in a PASSYS test cell at the Technical University of Denmark (PASSYS is a project funded by the European Community for testing of PAssive Solar SYStems). For a more elaborated description we refer to (Madsen and Schultz, 1993). The test cell has a simple geometry, a simpler window arrangement, an high insulation level, and a very well defined construction with respect to the used materials and their thermal properties. Furthermore, the south wall in the test cells can easily be exchanged with a different type of wall construction leading to a different mathematical model for estimation. Besides, a comprehensive set of sensors for measurement of air and surface temperatures as well as climatic data is available, which ensures that even rather complicated models can be identified. For instance for the measuring the indoor air temperature seven sensors are used, and these sensors are placed all over the volume of the room.

The aim is to optimize the input signal (mainly frequency, power level and duration) in order being able to carry out experiments for estimating the thermal characteristics of the test cell. We will use the tool CTSM to estimate these characteristics using a grey-box model.

There are a number of benefits by using a continuous time model: The continuous time formulation ensures that the parameters are easily interpreted as equivalent thermal parameters, and the methods allow for changes in the sampling time, which ensures that a **stiff system** like a house, with both short and long time constants, can be identified.

E.1 Experimental design considerations

The experimental design is a very important part of an experiment. Furthermore, it is well known that the design procedure is partly iterative, since results from any experiment can be used for an improved design of future experiments.

Let us first briefly summarize some important aspects of the experimental design with a focus on how to design the input signal (the heating) in order to ensure reasonable conditions for estimation of the parameters in a **linear model**:

- The system should be excited near the dynamics or time constants of interests.
- For a linear system an optimal signal shifts between minimum and maximum power in a random (or pseudo random) manner.
- The range defined by the minimum and maximum power should ensure that the temperatures stays within reasonable values (for a building that might be between 12 and 35 degrees).
- If the system is stiff (a large difference between the time constants) then it appropriate to design a signal which for some part focus on the short time constants and for other part the focus should be on the long time constants.
- Theoretically, see e.g. (Madsen et al., 2007) or (Goodwin and Payne, 1977) it can be shown that for linear systems the optimal test signal could be either a white noise signal (or Pseudo Random Binary Signal - PRBS) or a harmonic signal.
- It is very important to construct the test signal is such a way that there is no (or minor) cross-correlation between the test signal and other input variables. For instance it is important to avoid a 24 hour variation in the test signal (since this period is normally seen for solar radiation and outdoor air temperature).
- If several input signals have to be selected then they must be constructed such that there is no cross-correlation between these signals.

For a **nonlinear model** it is important to ensure that basically all possible input power levels are used - and not only the minimum and maximum values as for linear systems.

The first design of the experiment is based on a knowledge of the physical properties of the test building. The PASSYS test cell consists of a heavily insulated test room and an adjacent service room holding measuring equipment and a cooling system. The two rooms are separated by a well insulated door. The wall, roof and floor are made of a rigid steel frame insulated with mineral wool - the outside is covered with sheets of stainless steel. On the inside 400 mm of polystyrene is glued to a chipboard screwed to the steel frame. Thus the construction has no thermal bridges. On the inside, the polystyrene is covered with a layer of chipboard to which the final cover of 2 mm galvanized steel plates is screwed. The large insulation thickness and the steel plates give the test cells relatively large time constants.

As a goal for the experiment it was decided to try to estimate simultaneously both the short time and the long time dynamics of the test cell. As a starting point for the experimental design we expect a short time constant around 10 minutes, and a long time constant in the interval 38–100 hours.

E.2 PRBS signals

In order to ensure a reasonable information for an identification of the dynamics, the system has to be excited in both the short time and the long time part of the frequency scale of variations. This is ensured by controlling the heat input by a **Pseudo Random Binary Sequence (PRBS-signal)**, which can be chosen to excite the system in desired intervals of the frequency scale of variations.

The PRBS-signal is a deterministic signal shifting between two constant levels. The signal may switch from one value to the other only at certain intervals of time, $t = 0, T, 2T, \dots, nT$. The levels are here used to control the heat supply (on - off). This signal contains some very attractive properties, e.g. the signal is uncorrelated with other external signals (meteorological data), and it is possible, by selecting the time period, T , and the order of the signal, n , to excite the system in the areas of the scale of variations where interesting parameters are expected to be located. See (Godfrey, 1980) for further information about PRBS-signals.

The time period, T , and the order of the PRBS-signal, n , are determined by the expected time constants in the system. If only one PRBS-signal is used, the period T is of an order of magnitude as the smallest time constant, and n may be selected such that nT is of the order of magnitude as the largest time constant.

However, in order to excite a stiff system like a building in each part of the frequency scale of variations, two different PRBS-signals are used in a single experiment. In order to identify the short time constant a PRBS-signal with $T=20$ minutes and $n=6$ has been selected. The PRBS-signal is periodic with a period of $(2^n - 1)T = 21$ hours. In our experiment this PRBS-signal has been used in two periods, i.e. 42 hours. This procedure yields good possibilities to estimate time constants between 5 minutes and 4 hours.

In order to search for the long time constant a PRBS-signal with $T=20$ hours and $n=4$ was used. This corresponds to a test period of 300 hours. This PRBS-signal forms a good basis for estimating time constants between 10 hours and 160 hours.

Hence the total experiment consists of an entrance period of 6 periods using the PRBS-signal corresponding to the short time constant - $(T,n) = (20 \text{ min.}, 6)$. This period contains the transient part of the experiment, and ensures variations around stationary values for the rest of the experiment. Then follows a period of 42 hours using the same PRBS-signal. In this period the relevant data are measured with a sampling time of 5 minutes. The PRBS-signal is then changed to $(T,n) = (20 \text{ hours}, 4)$. The sampling time is still 5 minutes. After a single period of this signal (300 hours), the PRBS-signal is changed to the first one, $(T,n) = (20 \text{ min.}, 6)$, for 42 hours. Hence, data are collected with a sampling time of 5 minutes in a total period of $(42+300+42)$ hours. In Fig. 2 the total experiment is illustrated by the PRBS-signals.

The heating system in the test room consists of four 75 W electric bulbs. The total energy consumption in the bulbs is measured with an electricity meter. The accuracy is about 0.05 kWh. The electric power, when the bulbs are turned on, is found as a mean value over the total experiment by dividing the total consumption by the total number of hours the bulbs have been turned on. In the service room we use

three 500 W electric heaters, that can be controlled by the Data Acquisition System. This means that we can control the temperature in the service room within 0.5°C. The heating equipment is indicated on Figure 1.

Several experiments have been carried out. However, the results shown originate from a single experiment, where the heat loss through the partitioning wall has been eliminated by ensuring that the temperature in the service room is equal (within 0.5°C) to the temperature inside the test cell.

In each test cell 7 sensors for measuring the air temperature and 16 sensors for measuring the surface temperature have been used. In Appendix F we will describe how Principal Component Analysis (PCA) is used to find a representative indoor air temperature based on the values from all 7 sensors.

As an alternative to use a sequence of PRBS signals with different values of the smallest period with constant input (i.e. T) the so-called Random Ordered Logarithmic Binary Signal (ROLBS) is sometimes used.

It should be noticed it is well known that an optimal input signal for modelling linear dynamical systems consists of a finite number (often a rather low number) linear of harmonic functions – see (Goodwin and Payne, 1977) and (Madsen et al., 2007). For this reason harmonic functions are attractive alternatives to ROLBS and PRBS signals.

F. Multiple sensors; how to use all the information

Very often many sensors are used to measure e.g. the indoor air temperature in a room. The advantage of this approach is that if some sensors show abnormal values (e.g. if the sensor is exposed to direct solar radiation) then this can be detected and the actual sensor can be disregarded. Another advantage is by using some appropriate statistical approaches, then the measurement error of the concentrated information (often similar to the mean of all sensors) is dramatically reduced compared to the error of a single sensor. The techniques also often solve the problem of finding a **single value** which can represent e.g. the indoor air temperature.

This appendix shows how relevant information from all sensors can be concentrated in so-called **principal components**. By using this method we are able to find the most reasonable linear combination of all the measurements for representing the indoor air temperature or the surface temperature. If, for instance, a single sensor is placed unsuccessfully for measuring the indoor air temperature, the principal component will pick up this measurement as non-representative for the indoor air temperature.

In this section the principal components for the air temperature will be considered for illustration purposes only. It is well known from multivariate statistics that the principal components correspond to an eigenvalue analysis of the covariance matrix for the vector containing the measurements of the indoor air temperature.

Consider a the stochastic vector

$$X_t = (X_{1t}, X_{2t}, \dots, X_{7t}) \quad (\text{F.1})$$

which contains the seven measurements at time t of the indoor air temperature. Based on time series of measurements of the indoor air temperature, the mean value vector and the covariance matrix Σ , associated with this stochastic vector, are readily calculated.

The eigenvalues of Σ is then calculated and ordered in decreasing order

$$\lambda_1 \geq \lambda_2 \geq \dots \geq \lambda_7 \quad (\text{F.2})$$

and the associated eigenvectors are

$$p_1, p_2, \dots, p_7 \quad (\text{F.3})$$

The i 'th principal component is then defined as

$$Y_{it} = p_i' X_t \quad (\text{F.4})$$

Hence, the first eigenvector defines the linear combination of the measurements, which accounts for most of the variation of the measurements of indoor air temperature. How much of the total variation, that is described by the first principal component, is determined by the first eigenvalue.

For an ordinary and well planned experiment, the first principal component is representative for the indoor air temperature, and it contains information from all (in this case) seven measurements, see for example Appendix E or (Madsen and Schultz, 1993) for more information about the considered experiment. So apart from the fact that the analysis will pick up unsuccessful measurements it will also reduce the measurement error, since information from several sensors is contained in the first principal component.

Based on the estimated covariance matrix for the indoor air temperature we found the following values of the first three principal components p_1 , p_2 and p_3 :

$$p_1 = (0.3781, 0.3785, 0.3784, 0.3787, 0.3780, 0.3771, 0.3758)' \quad (\text{F.5})$$

$$p_2 = (-0.547, 0.266, -0.105, -0.232, 0.011, -0.130, 0.740)' \quad (\text{F.6})$$

$$p_3 = (-0.583, -0.377, 0.391, 0.037, 0.073, 0.586, -0.126)' \quad (\text{F.7})$$

The associated eigenvalues explain 99.9948 %, 0.0042 % and 0.0003 %, respectively, of the variations of the indoor air temperature.

It is seen that **the first principal component**, determined by p_1 and defined though Eq. (F.4), is seen to put equal weight on all seven measurements, and consequently this component will be the best representation for the indoor air temperature. Corresponding to a single measurement the measurement error for this component is approximately $1/\sqrt{7}$ times the original measurement error.

Likewise it is seen that **the second principal component** is seen to be approximately the difference between X_7 and X_1 . Notice that X_7 is the measurement near the wall to the service room, which is heated in such a way that no heat loss takes place through this wall. X_1 is the measurement near the floor of the test cell. Hence, the second principal component measures a difference between the temperature near the wall to the service room and the temperature near the floor (which is the coldest).

It can be seen that this component behaves very much like the PRBS-signal! Hence, it is reasonable to conclude that when the heating system is turned on, there are differences between measurements, which are not present when the heating system is turned off. This agrees very well with the fact that the electric bulbs positioned on the floor were shielded with cylinders of aluminium foil with openings in the top and bottom. When the heat was on (i.e. the bulbs are turned on) the stack effect of the cylinders will force a warm air stream towards the ceiling of the test cell. In case of no heating a more uniform temperature distribution in the test room will occur.

Also **the third principal component** is interesting. A further analysis has shown that it measures some transient behaviour of the temperatures. The third principal component happens to be large just after the heating system is turned on and small just after it is turned off. For the higher order principal components no interesting behaviour is found.

For the surface temperature a similar principal component analysis was carried out. Also in this case the first principal component happens to be the best representative for the surface temperature.

G. Example: steady state model for the RRTB

In this section an example of identifying and validating a linear steady state model for the Annex 58 test box is presented. The guidelines used are found in: Section 4.1.1 for identification, and in Section 5 for validation, of the model.

The model has the heating power from the heating system as output and climate variables as input. During the example helping functions are used, they are all found in the folder functions in files named as the function, e.g. the function `readSeries()` is defined in the file `functions/readSeries.R`.

1. **Sampling time.** In the first chunk the data is read into a data.frame `X` and resampled to six hours values, which based on experience removes all dynamics in the series

```
## Load the helping functions
source("sourceFunctions.R")
## Read the data from the 3rd common exercise as 6 hours
## average values
X <- readSeries("ce3b25C", Ts = 6 * 3600, selNames = c("t", "Ph",
  "Ti", "Te", "Isol"))
## Remove beginning such that the same period is always
## removed independent of the sample period
X <- X[asP("2013-01-29 12:00") < X$t, ]
```

Then the series are plotted

```
setpar(mfrow = c(3, 1))
plot(X$t, X$Ph, type = "b", xlab = "", ylab = "$\\Phi_\\mathrm{h}$ (W)")
plot(X$t, X$Ti, type = "b", ylim = range(X$Ti, X$Te), xlab = "",
  ylab = "Temperature ( $^\\circ$ C)")
lines(X$t, X$Te, type = "b", col = 2)
legend("right", c("Internal", "External"), col = 1:2, lty = 1)
plot(X$t, X$Isol, ylab = "$I_\\mathrm{sol} = G_\\mathrm{vs}$ (W/m$^2$)",
  xlab = "", type = "b")
axis.POSIXct(1, X$t, xaxt = "s")
```

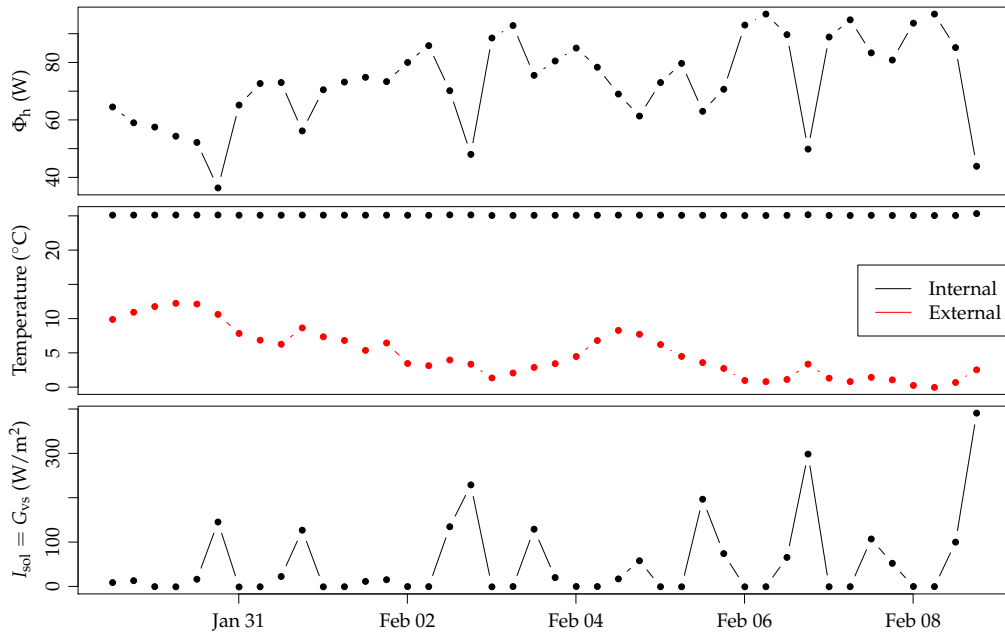

From the plots it is clearly seen that the heat heating power varies and downward peaks coincide with the global radiation. It is seen that the internal temperature is almost constant around 25 C over the entire period.

- 2. Model parametrization.** First the full steady state linear model is estimated and the summary is printed

```
## Fit a linear steady-state model
fit <- lm(Ph ~ 0 + Ti + Te + Isol, data = X)
## See the result
summary(fit)

##
## Call:
## lm(formula = Ph ~ 0 + Ti + Te + Isol, data = X)
##
## Residuals:
##      Min       1Q   Median       3Q      Max
## -9.7640 -1.7888  0.2384  3.0137  5.2304
##
## Coefficients:
##           Estimate Std. Error t value Pr(>|t|)
## Ti      3.844442    0.042140   91.23  <2e-16 ***
## Te     -3.441565    0.159629  -21.56  <2e-16 ***
## Isol  -0.119634    0.006424  -18.62  <2e-16 ***
## ---
## Signif. codes:  0 '***' 0.001 '**' 0.01 '*' 0.05 '.' 0.1 ' ' 1
##
## Residual standard error: 3.627 on 39 degrees of freedom
## Multiple R-squared:  0.9978, Adjusted R-squared:  0.9977
## F-statistic: 5956 on 3 and 39 DF, p-value: < 2.2e-16
```

- 3. Model validation.** By inspecting the $P(>|t|)$ values it is seen that the coefficient for all inputs the coefficients are estimated to be significant and the

model is now validated by investigating if the residuals are significantly different from white noise. The residuals ACF and CCF to the inputs are plotted using a helping function

```
## Plot ACF and CCF to inputs (wrapped in the function
## acfccf())
acfccf(fit, X)
```

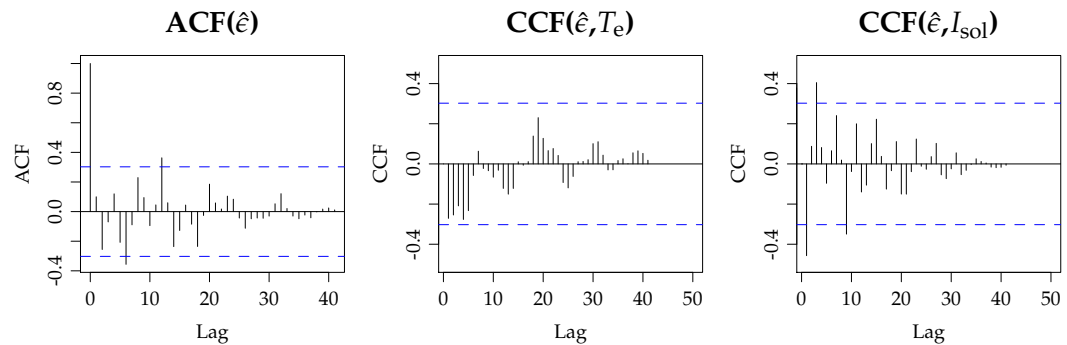

No significant auto-correlation is left in the residuals and they are not significantly correlated to inputs. The residuals are plotted as time series along side with the inputs and outputs

```
tsPlotResiduals(fit, X, type = "b")
```

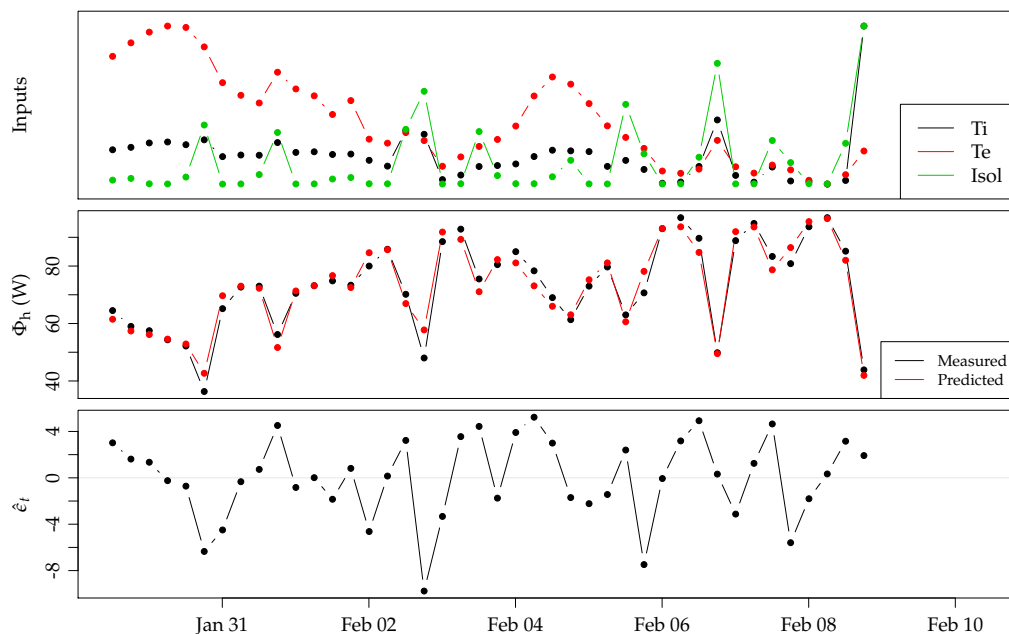

No clear patterns are seen in the residuals and the model is thereby validated.

4. **Calculation of HLC and gA-values (simple setup).** Finally the HLC is calculated as described in Section using a helping function which carries out the linear minimum variance weighting and furthermore estimates the standard deviation of the HLC

```
## Calculate the HLC using minimum variance linear weighting
HLCPhAsOutput(fit)
```



```
## $Hi
## [1] 3.844442
##
## $He
## [1] 3.441565
##
## $H
## [1] 3.929419
##
## $sdH
## [1] 0.0321569
##
## $VarHs
##           [,1]      [,2]
## [1,] 0.001775803 0.00529240
## [2,] 0.005292400 0.02548129
```

and the g_A -value is calculated as the stationary gain of the transfer function from the solar radiation input, together with its estimated standard deviation σ_{gA}

```
## Calculate the gA value and its uncertainty
gAPhAsOutput(fit)

## $gA
## [1] 0.1196339
##
## $sdgA
##           [,1]
## [1,] 0.006424267
```

Finally, it is shown how the linear steady state model can also be fitted using ΔT as input. First the ΔT is calculated

```
## Calculate the delta T
X$deltaT <- X$Ti - X$Te
```

and then the model is fitted

```
## Fit a linear steady-state model
fitDeltaT <- lm(Ph ~ 0 + deltaT + Isol, data = X)
```

and the HLC and g_A -value estimates can then be directly read from the fitted coefficients

```
## See the result
summary(fitDeltaT)

...
## Coefficients:
##           Estimate Std. Error t value Pr(>|t|)
## deltaT  3.929419    0.035495  110.70 <2e-16 ***
## Isol   -0.120567    0.007083  -17.02 <2e-16 ***
## ---
...

```

The HLC is exactly the same and the g_A -value is only slightly different, the same goes for the estimated uncertainties.

H. Example: Linear dynamics input-output ARX model for RRTB

In this section an example of identifying and validating an ARX model for the Annex 58 RRTB is presented. The guidelines used are found in: Section 4.1.1 for identification, and in Section 5 for validation, of the model.

The model has the heating power from the heating system as output and climate variables as input. During the example helping functions are used, they are all found in the folder functions in files named as the function, e.g. the function `readSeries()` is defined in the file `functions/readSeries.R`.

1. **Sampling time.** From previous experience with the RRTB a sampling time around 60 minutes was found appropriate (this results in a model order of 2 as outlined in the following).

First, the helping functions are loaded, and the data is read and resampled to 1 hour average values with the function `readSeries()`

```
## Load the helping functions
source("sourceFunctions.R")
## Read the data
selNames <- c("Ph", "Ti", "Te", "Isol")
## The sampling time in seconds, use 1 hour average values
Ts <- 3600
## The 3rd common exercise with 25 C constant internal
## temperature
X <- readSeries("ce3b25C", Ts = 3600, selNames)
## See the first six rows of X
head(X)

##           t Ph      Ti      Te      Isol
## 1 2013-01-29 01:05:00 75 25.10942 7.764750 -0.7065730
## 2 2013-01-29 02:05:00 75 25.10904 8.551083 -0.5355782
## 3 2013-01-29 03:05:00 72 25.10096 8.895000 -0.8273256
## 4 2013-01-29 04:05:00 72 25.09975 8.588333 -0.4694283
## 5 2013-01-29 05:05:00 70 25.12138 8.961333 -0.2687661
## 6 2013-01-29 06:05:00 68 25.09758 9.394750 -0.2859173
```

Lagged series are added to X. Notice the naming convention that `name.lk` is the k lagged series

```

## Make lagged series
X <- makeLagged(X, selNames, nlags = 4)
## Remove beginning such that the same period is always
## removed independent of the sample period
X <- X[asP("2013-01-29 12:00") < X$t, ]
## See the column names
names(X)

## [1] "t"      "Ph"     "Ti"     "Te"     "Isol"   "Ph.10"  "Ph.11"
## [8] "Ph.12" "Ph.13" "Ph.14" "Ti.10"  "Ti.11"  "Ti.12"  "Ti.13"
## [15] "Ti.14" "Te.10"  "Te.11"  "Te.12"  "Te.13"  "Te.14"  "Isol.10"
## [22] "Isol.11" "Isol.12" "Isol.13" "Isol.14"

## Now see the first six rows of X for lagged Ti
head(X[, grep("^Ti.1", names(X))])

##      Ti.10  Ti.11  Ti.12  Ti.13  Ti.14
## 12 25.11225 25.10558 25.10496 25.11729 25.11454
## 13 25.10358 25.11225 25.10558 25.10496 25.11729
## 14 25.09746 25.10358 25.11225 25.10558 25.10496
## 15 25.11962 25.09746 25.10358 25.11225 25.10558
## 16 25.12037 25.11962 25.09746 25.10358 25.11225
## 17 25.12758 25.12037 25.11962 25.09746 25.10358

```

Then time series are plotted

```

setpar(mfrow = c(3, 1))
plot(X$t, X$Ph, type = "b", xlab = "", ylab = "\\Phi_t$ (W)")
plot(X$t, X$Ti, type = "b", ylim = range(X$Ti, X$Te), xlab = "",
     ylab = "Temperature (C)")
lines(X$t, X$Te, type = "b", col = 2)
legend("right", c("Internal", "External"), col = 1:2, lty = 1)
plot(X$t, X$Isol, ylab = "\\I_{\\mathrm{sol}} = G_{\\mathrm{vs}}$ (W/m^2)",
     xlab = "", type = "b")
axis.POSIXct(1, X$t, xaxt = "s")

```

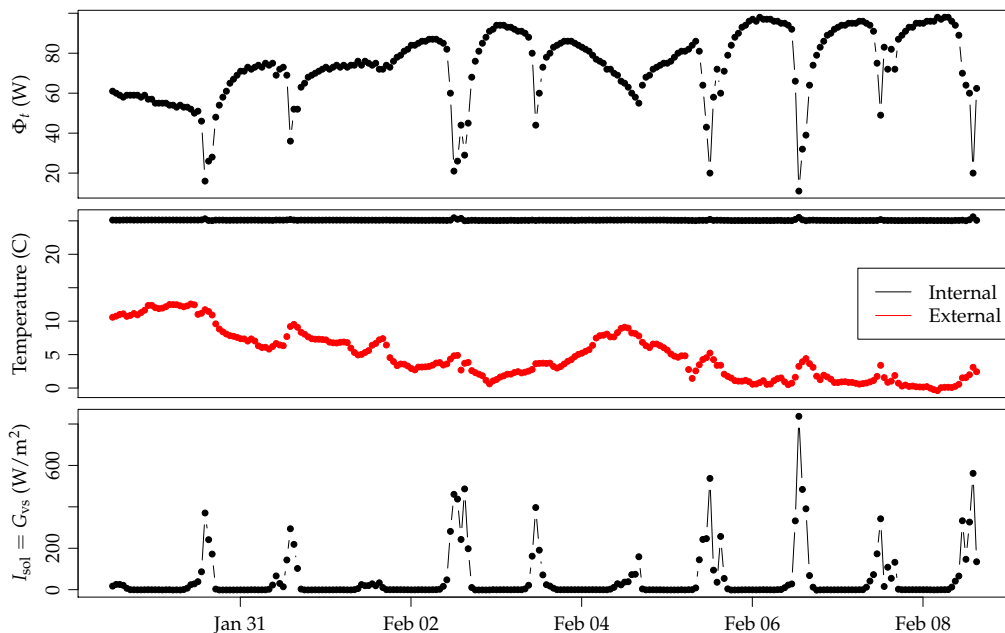

It is clearly seen how the heating power is decreased, when the solar radiation is high during the day, and that the heating power increase when the external temperature decreases.

2. **Model parametrization.** The model parametrization is as described in Section 4.2 Eq. (4.6), with: the heating power as output, and the internal and external temperature, and the global vertical south faced radiation, as input.
3. **Model order selection (simple setup).** Now a model of $p = 0$ order is fitted, i.e. a steady state linear model, and the residuals ACF and CCF to the inputs are plotted

```
## Fit a linear steady-state model
fit0 <- lm(Ph ~ 0 + Ti + Te + Isol, X)
## The ACF and CCF
acfccf(fit0, X)
```

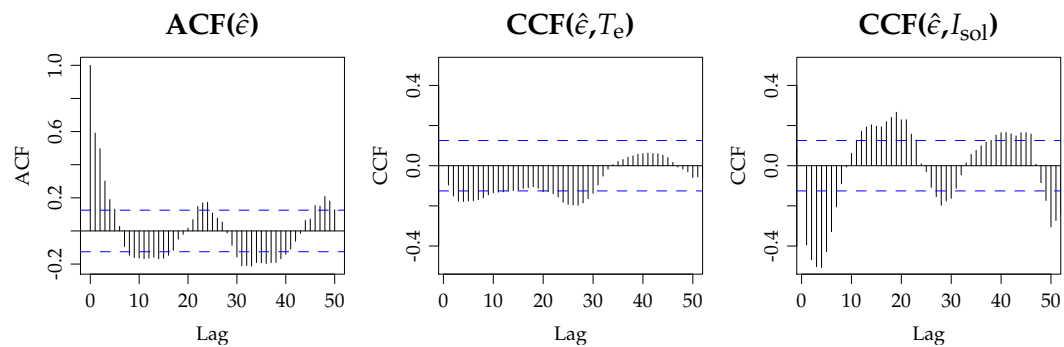

Clearly, the residuals are not white noise, hence the model order is increased to $p = 1$, thus an ARX model is applied.

A helping function is available for generating the formula needed to define an ARX model to be fitted, here demonstrated by defining an ARX model with order $p = 1$

```
(frml <- frmlARX(outName = "Ph", inNames = c("Te", "Isol"), p = 1,
  inNonLagNames = "Ti"))
## [1] "Ph.l0~Ph.l1+Te.l0+Isol.l0+Ti.l0+0"
```

The formula is then used to fit the model and the residuals ACF and CCF are plotted

```
## Fit a linear steady-state model
fit1 <- lm(frml, X)
## The ACF and CCF
acfccf(fit1, X)
```

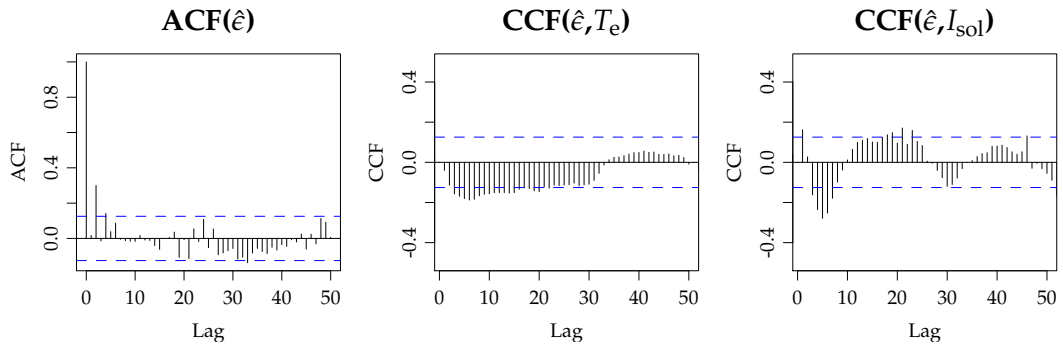

Still the residuals are correlated in time and to the inputs, hence the model order is increased to $p = 2$, which is fitted and residuals ACF and CCF plotted

```
fit2 <- lm(frmlARX(outName = "Ph", inNames = c("Te", "Isol"),
  p = 2, inNonLagNames = "Ti"), X)
## The ACF and CCF
acfccf(fit2, X)
```

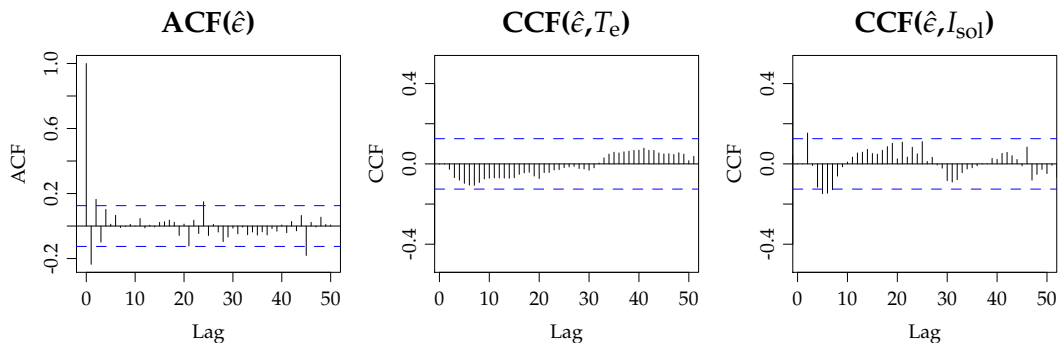

where now only very little significant correlation is left, however it is tried to increase the model order to $p = 3$

```
fit3 <- lm(frmlARX(outName = "Ph", inNames = c("Te", "Isol"),
  p = 3, inNonLagNames = "Ti"), X)
## The ACF and CCF
acfccf(fit3, X)
```

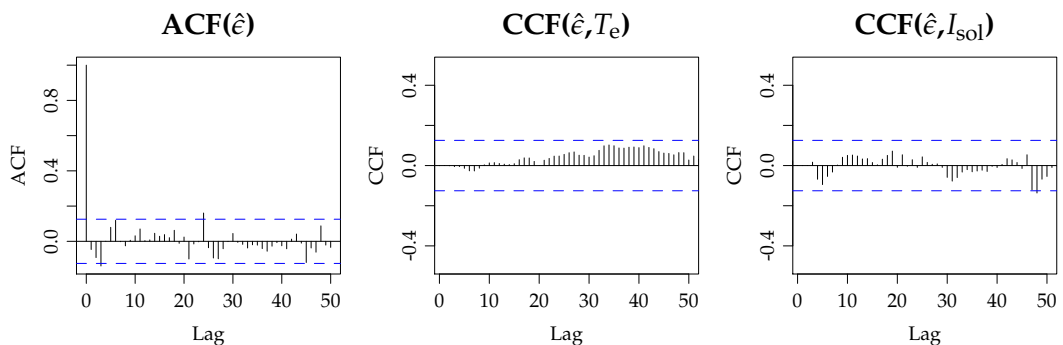

and the ACf and CCF now shows no significant correlation of the residuals in time and to the inputs.

- 4. Model validation.** Now we carry out the model validation, as described on page 31. First the estimated coefficients are checked by writing out the summary of the $p = 3$ fit

```
summary(fit3)

...
## Coefficients:
##           Estimate Std. Error t value Pr(>|t|)
## Ph.11    0.1145141  0.0582653   1.965  0.05055 .
## Ph.12    0.3330523  0.0556390   5.986 8.02e-09 ***
## Ph.13    0.0007389  0.0245478   0.030  0.97601
## Te.10   -0.5010150  0.3890118  -1.288  0.19905
## Te.11   -0.3110348  0.6329659  -0.491  0.62361
## Te.12   -1.1852874  0.4554511  -2.602  0.00985 **
## Isol.10 -0.0961939  0.0022995 -41.832 < 2e-16 ***
## Isol.11 -0.0139482  0.0062612  -2.228  0.02685 *
## Isol.12  0.0308220  0.0047747   6.455 6.16e-10 ***
## Ti.10    2.1672014  0.1950562  11.111 < 2e-16 ***
## ---
...

```

At least one of the coefficients are significant for each input, hence they should be kept in the model. However the AR coefficients (Ph.11, Ph.12 and Ph.12) are not all significant. The highest order AR coefficient is not significant, which leads to conclude that the model order should be decreased by one.

Thus the fit for model order $p = 2$ is checked and the coefficient estimates are printed

```
summary(fit2)

...
## Coefficients:
##           Estimate Std. Error t value Pr(>|t|)
## Ph.11    0.326806  0.057849   5.649 4.6e-08 ***
## Ph.12    0.092018  0.026599   3.459 0.000642 ***
## Te.10   -0.163963  0.428933  -0.382 0.702612
## Te.11   -1.892024  0.488180  -3.876 0.000138 ***
## Isol.10 -0.097482  0.002552 -38.204 < 2e-16 ***
## Isol.11  0.017459  0.005311   3.287 0.001164 **
## Ti.10    2.264867  0.160558  14.106 < 2e-16 ***
## ---
...

```

The highest order AR coefficient is now significant, thus the model order $p = 2$ is selected as the most suitable model order.

See above for the residuals ACF and CCF for the $p = 2$ fit, where only very little correlation was seen. A further check of for white noise residuals is carried out by plotting the cumulated periodogram (CPGRAM)

```
par(mar = c(3.5, 3.5, 1.5, 0.5), cex = 0.75)
cpgram(fit2$residuals, main = "Residuals CPGRAM for $p=2$")

```

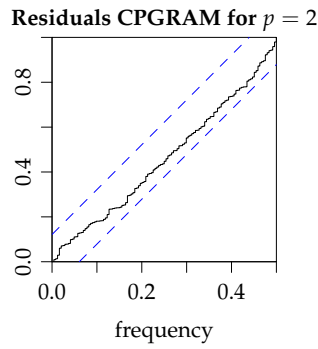

which shows that the residuals cannot be tested significantly different from white noise, since the CPGRAM stays within the two blue lines marking the 95% confidence band for the CPGRAM of white noise.

Furthermore the residuals are plotted over time along with the inputs and the output (both predicted and measured)

```
tsPlotResiduals(fit2, X, type = "b")
```

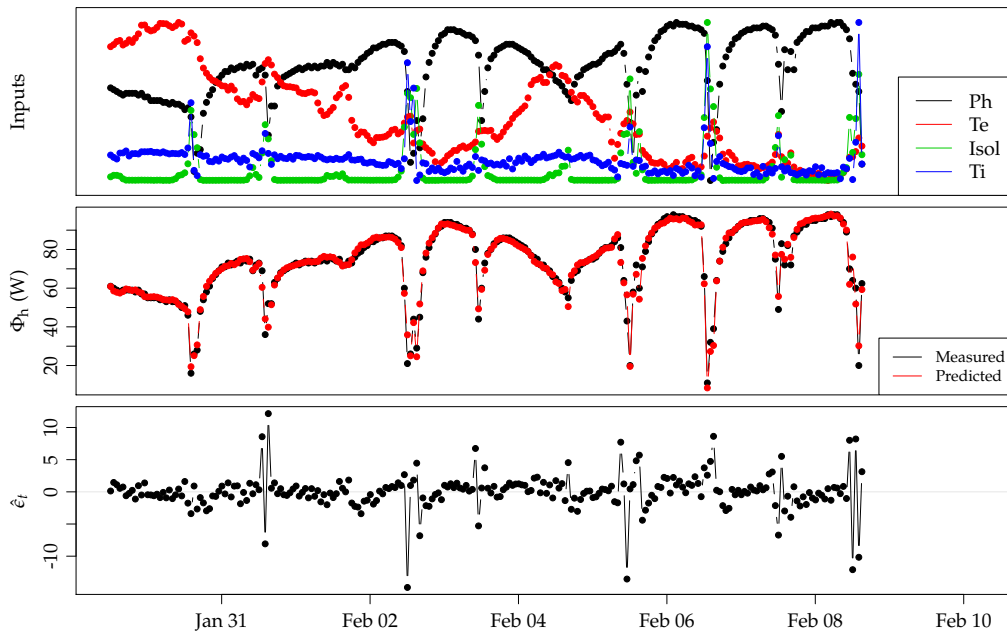

No clear repeating patterns are seen in the residuals, except from the apparent higher level occurring 7-8 times related to high levels of solar radiation. This could be due to only using the south faced vertical radiation as input to the model, which thus can be seen as an oversimplification of the model part related to the incoming solar radiation and this could be more elaborated. However for the simple setup this is accepted. However, accepting the simplified setup the model can now be applied to calculate the thermal performance, as described in the next step.

5. **Calculation of HLC, gA-values and time constants (simple setup).** The estimated HLC and its standard deviation is calculated

```
HLCPhAsOutput(fit2)
```



```
## $Hi
## [1] 3.897044
##
## $He
## [1] 3.537635
##
## $H
## [1] 3.969638
##
## $sdH
## [1] 0.0178928
##
## $VarHs
##           [,1]      [,2]
## [1,] 0.0005365911 0.001608164
## [2,] 0.0016081640 0.007985014
```

the latter matrix VarHs is the covariance matrix of the two HLCs. Similarly the gA-value and its standard deviation is calculated

```
gAPhAsOutput(fit2)
```

```
## $gA
## [1] 0.137691
##
## $sdgA
##           [,1]
## [1,] 0.003832191
```

Finally, the time constants are calculated in seconds

```
timeConstantsPhAsOutput(fit2, Ts)
```

```
## $timeConstants
## [1] 2107.216 5314.791
```

and the step responses for the external temperature and the vertical south faced global radiation are calculated and plotted

```
par(mfrow = c(2, 1), mar = c(3.5, 3.5, 1.5, 0.5), cex = 0.8)
stepResponsePhAsOutput(fit2, Ts, inName = "Te")
stepResponsePhAsOutput(fit2, Ts, inName = "Isol")
```

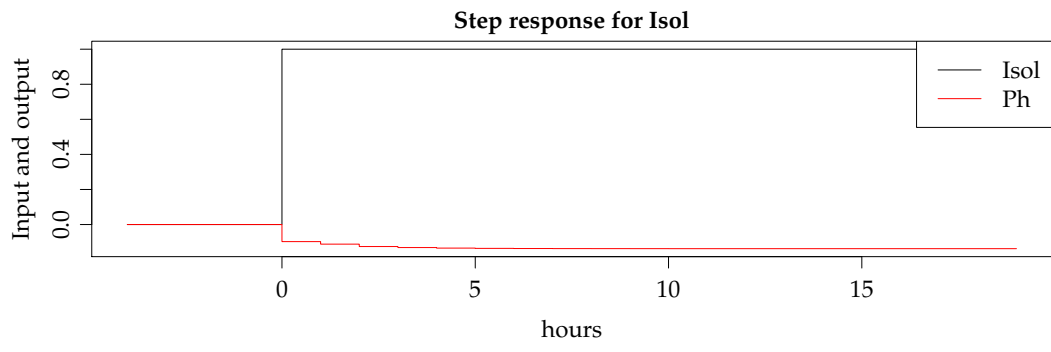
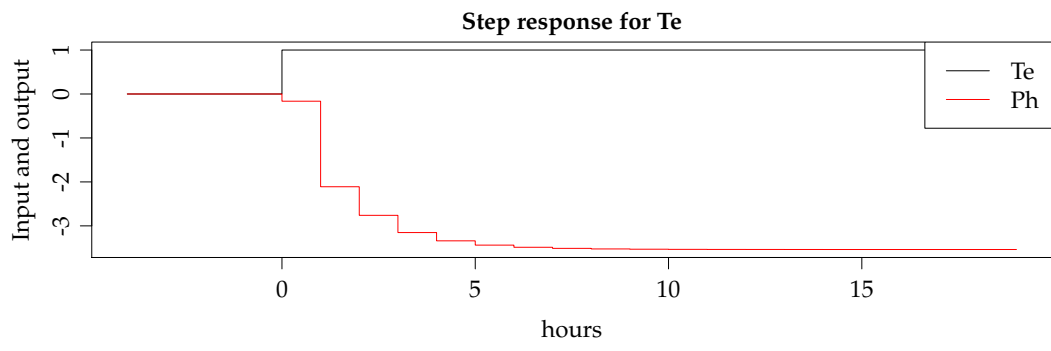

I. Example: Grey-box model for the IDEE house

In this section an example of selection of a suitable grey-box model for the IDEE house is presented. The data originates from a series of experiments carry out in the IDEE test house located at BBRI in Belgium. For details of the building and the experiments, see (Lethé et al., 2014). The grey-box model selection procedure presented in Section 4.3 is used and only linear RC-models are applied. The R code for this example is not included, however it can be found in the file `greyboxForIDEE.R`.

For the example an experiment in which the heating power is controlled with a PRBS is used. First the entire series are plotted:

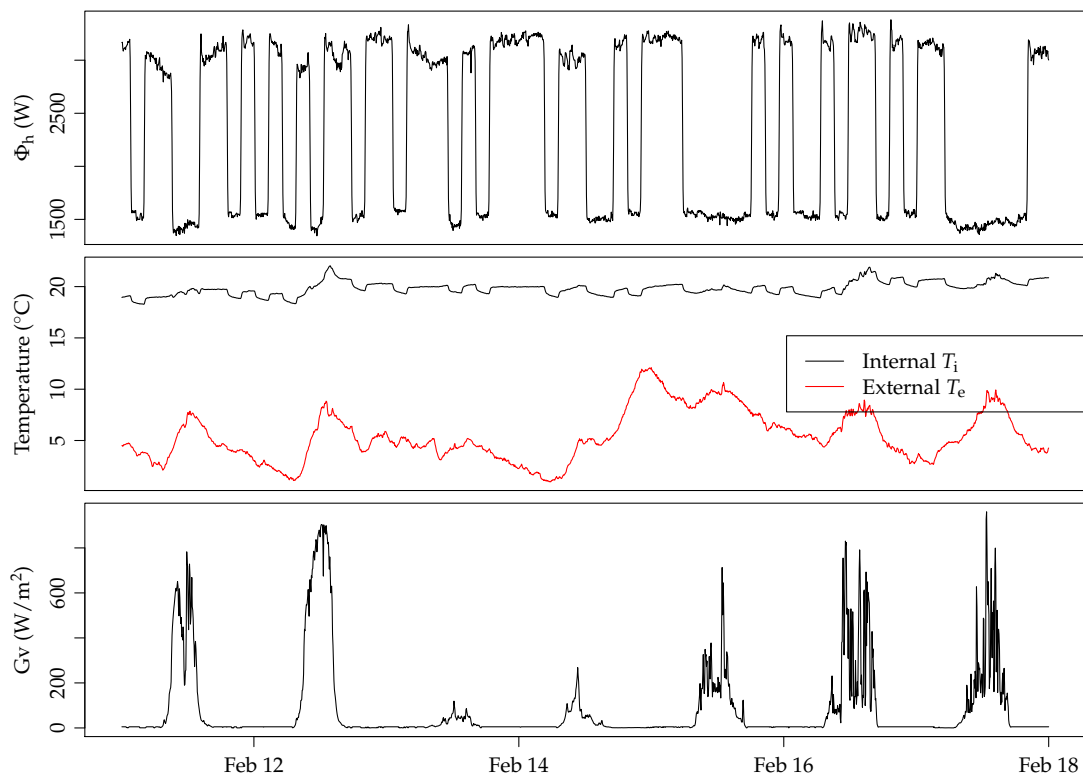

It is seen that there are measurements from ten days in the winter period. In the upper plot the heating power (Φ_h) is seen as controlled with a PRBS between appr. 1500 W and 3200 W. The middle plot shows the internal temperature around 20 $^{\circ}\text{C}$ and it can be seen that it reacts to the heating power, as the external temperature

and global radiation, the latter is plotted in the lower plot.

A similar plot of the series zooming on a single day is generated:

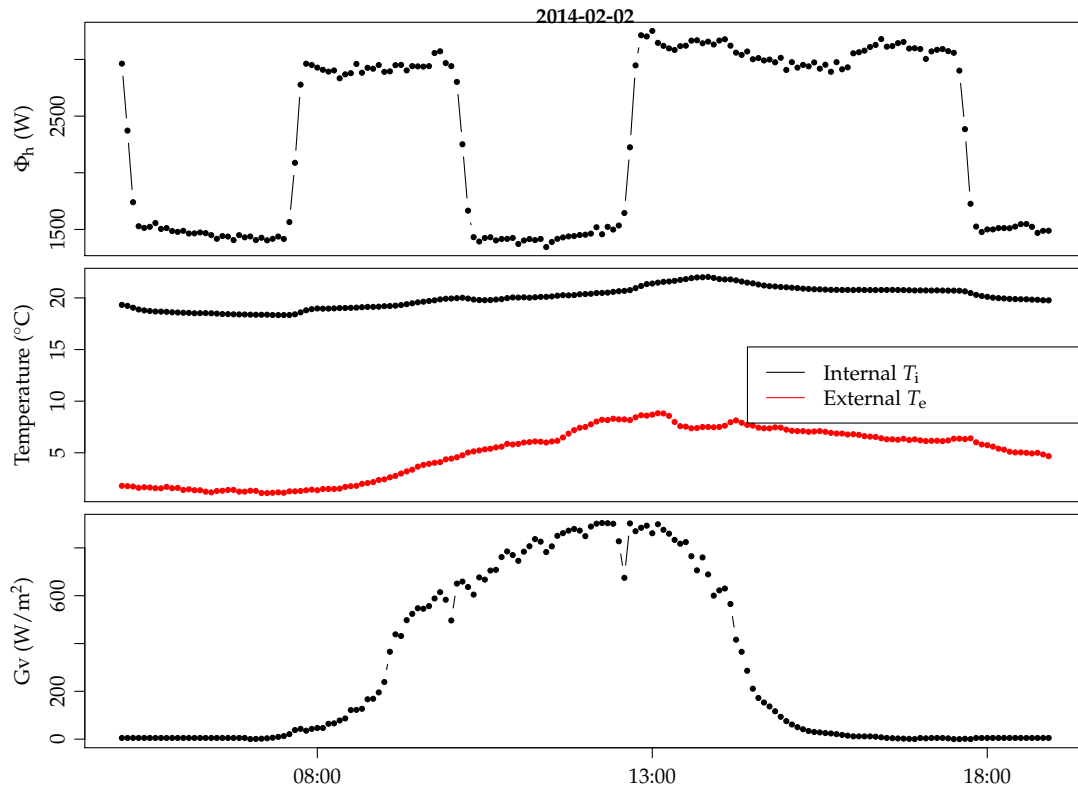

It is seen that the transients of heating power signal are slightly smoothed. Furthermore, that the global radiation in the early morning is quite low and suddenly steps up around 09:30, which is most likely caused by shadowing from trees etc. in the surroundings.

First the simplest feasible model is fitted. This model is denoted with $Model_{T_i}$. It has a single state and system equation

$$dT_i = \frac{1}{10^9 C_i} \left(\frac{1}{R_{ie}} (T_e - T_i) + g A_{sol} I_{sol} + \Phi_h \right) dt + \sigma_i d\omega_i(t) \quad (I.1)$$

and the measurement equation

$$T_{r,t_i} = T_{i,t_i} + \epsilon_{t_i} \quad (I.2)$$

It is illustrated with the RC-diagram:

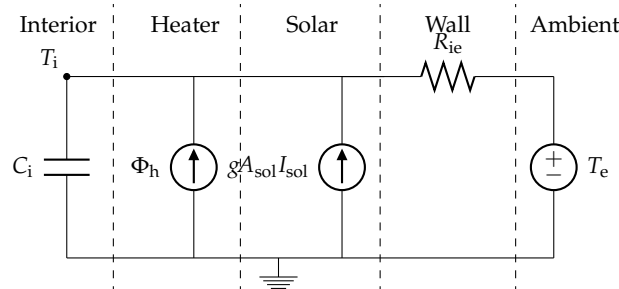

In order to fit the model to the data the following is executed in R. Note that the definition of the model and initial values can be found in the file `verb+functions/sdeTi.R+`:

Now the model fit is validated, first by plotting the input series with the one-step ahead residuals:

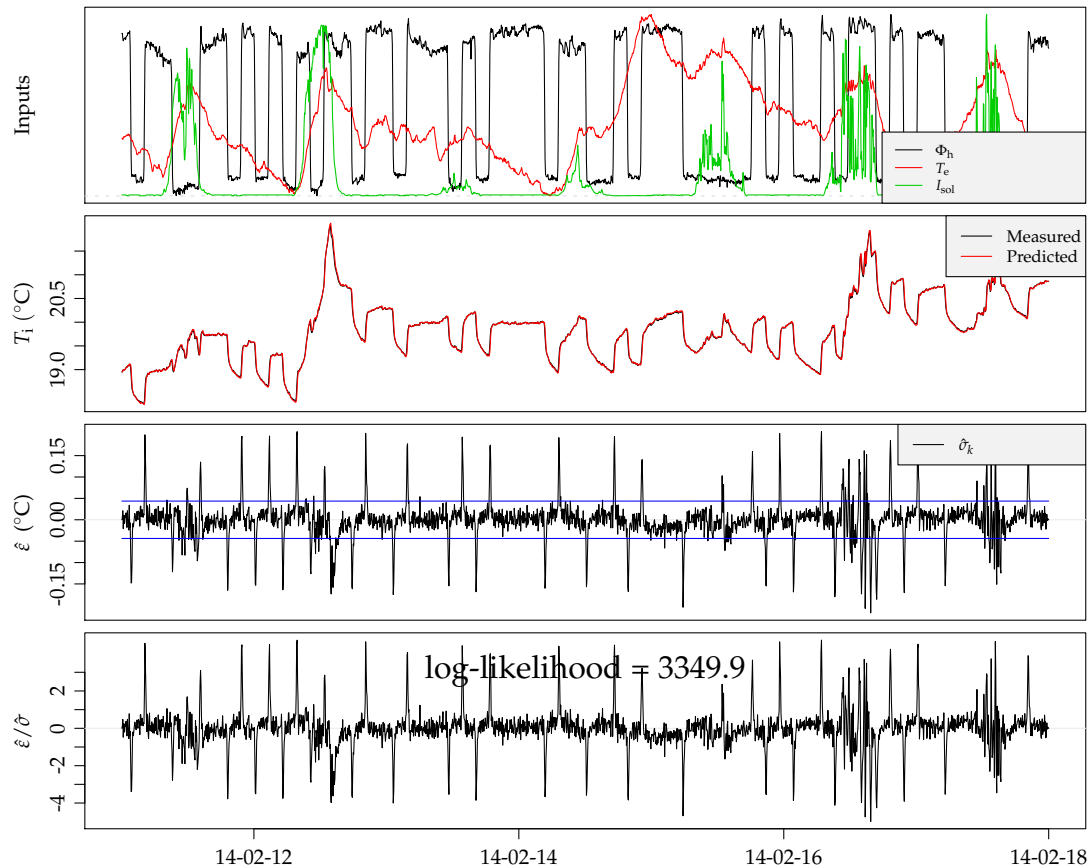

It is clearly seen that the residuals are not white noise, due to the high spikes occurring at the shifts of the PRBS of the heating power. This is a clear indication that the model should be extended with a temperature state in order to describe the faster dynamics.

The ACF and CPGRAM clearly reveals that the residuals are significantly different from white noise:

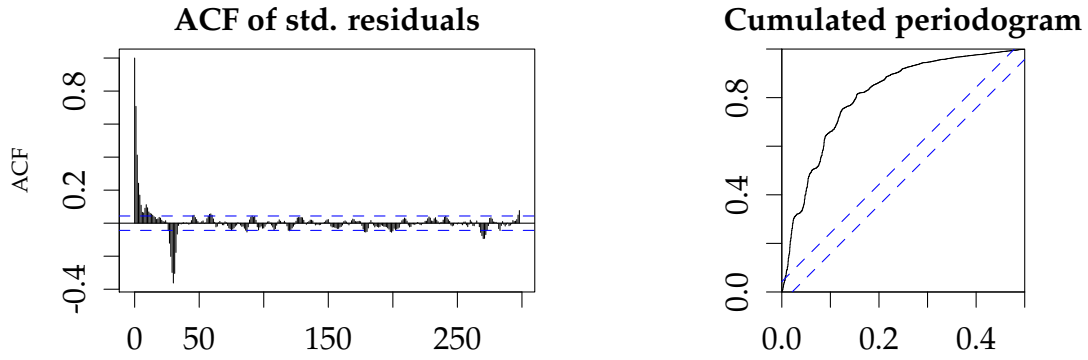

Thus a state representing the temperature in the walls of the building is added to extend the model. Thus the two-state model $Model_{T_i T_w}$

$$dT_i = \frac{1}{10^9 C_i} \left(\frac{1}{R_{ia}} (T_w - T_i) + g A_{sol} I_{sol} + \Phi_h \right) dt + \sigma_i d\omega_i(t) \quad (I.3)$$

$$dT_w = \frac{1}{10^9 C_w} \left(\frac{1}{R_{iw}} (T_i - T_w) + \frac{1}{R_{we}} (T_e - T_w) \right) dt + \sigma_w d\omega_w(t) \quad (I.4)$$

The RC-diagram representing the model

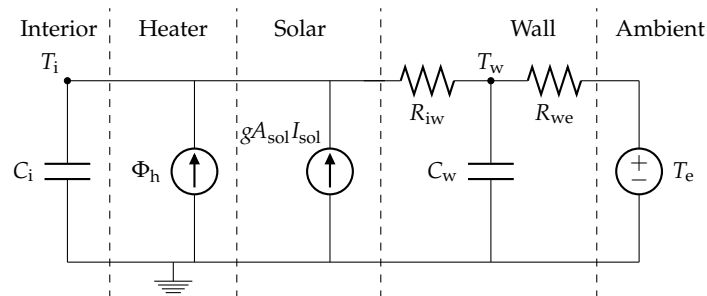

First the model is fitted to the 5 minutes data.

and the input series are plotted with the residuals:

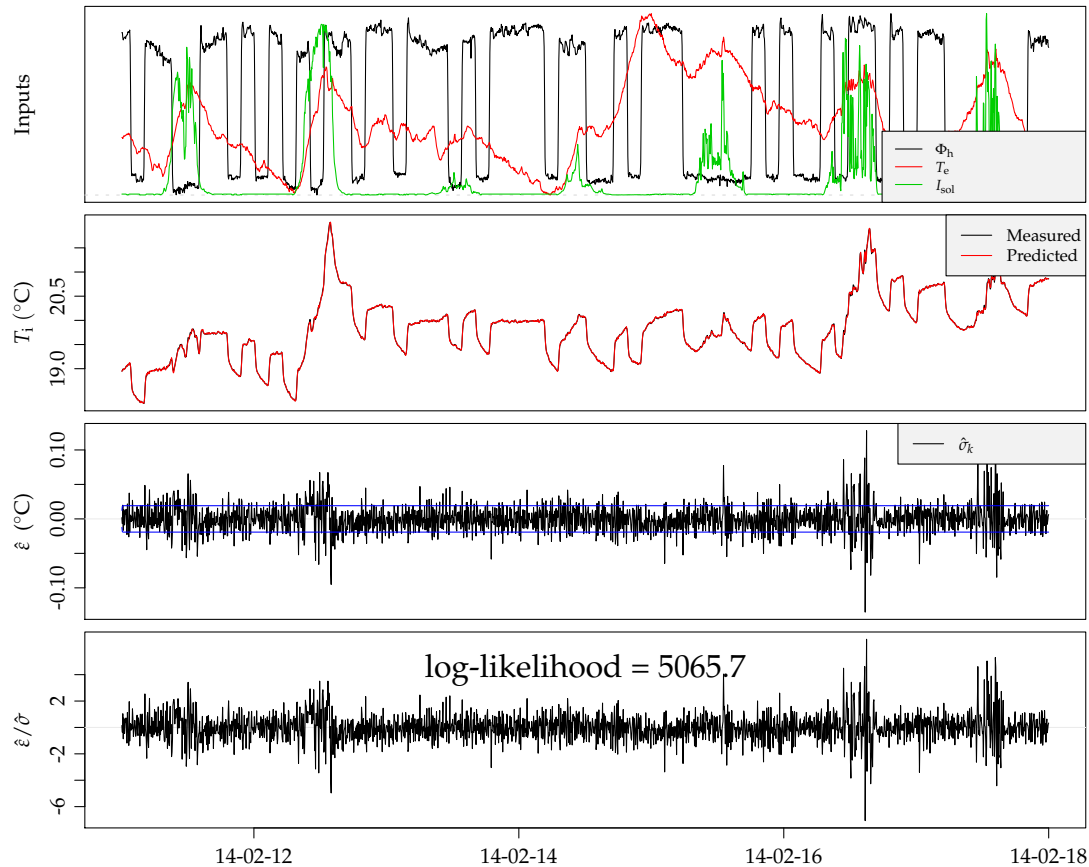

Clearly now the spikes in the residuals at the shifts of the PRBS are gone. Some periods with a higher level of the residuals are seen coinciding with fluctuations of the solar radiation.

The ACF and CPGRAM of the residuals are plotted:

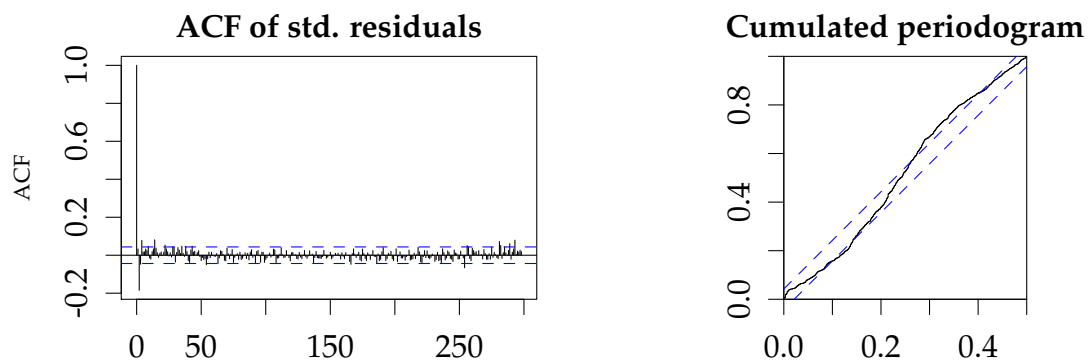

The residuals are now much closer to white noise, than for the single-state model. However still the first two lags are significantly correlated. The best way of dealing with this, when sticking to linear models, is to resample to a lower sampling time.

Since two lags were significant this leads to generating 15 minutes average values,

which the two-state model is fitted to.

The input series and the residuals are plotted:

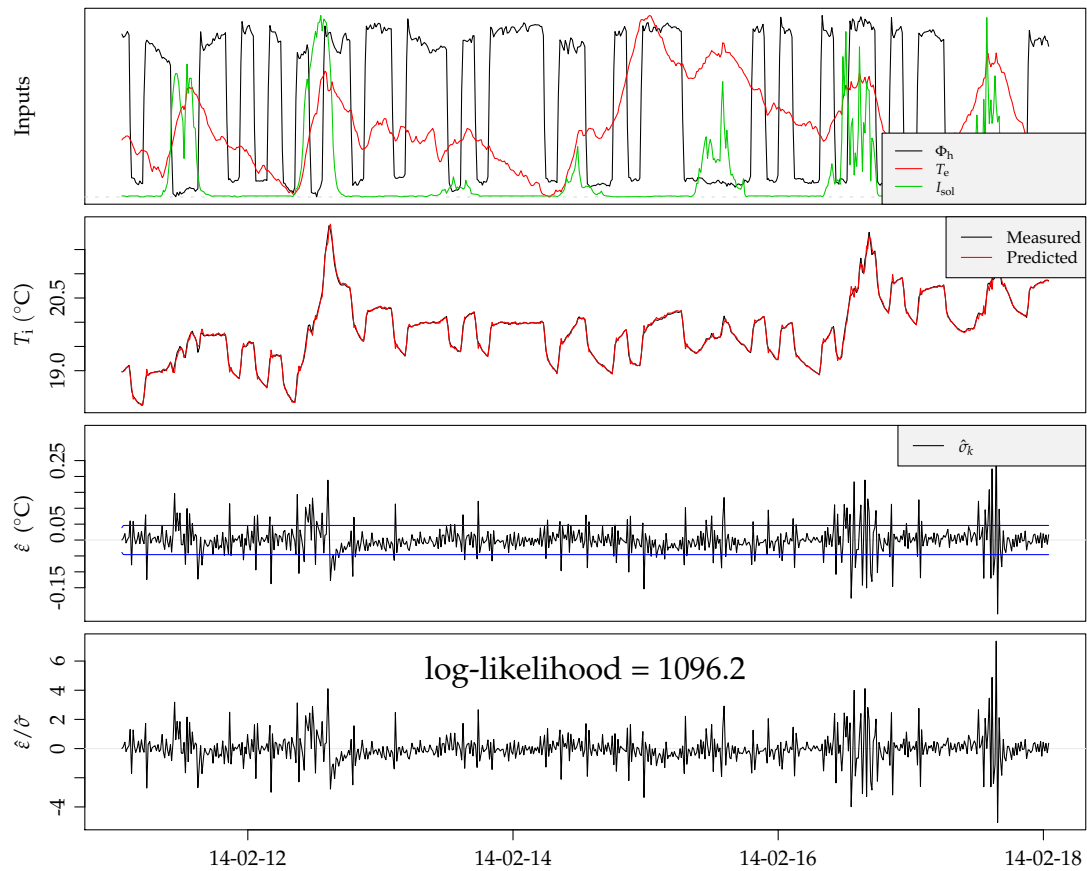

Apparently, the resampling removed high frequency noise (averaging a simple low-pass filter) revealing some patterns in the residuals, both the previous seen higher level related to fluctuations in the solar radiation, but also some systematic deviations in the morning of clear-sky days after the step up in solar radiation already pointed out from the second plot in this section.

The ACF and CPGRAM of the residuals are plotted.

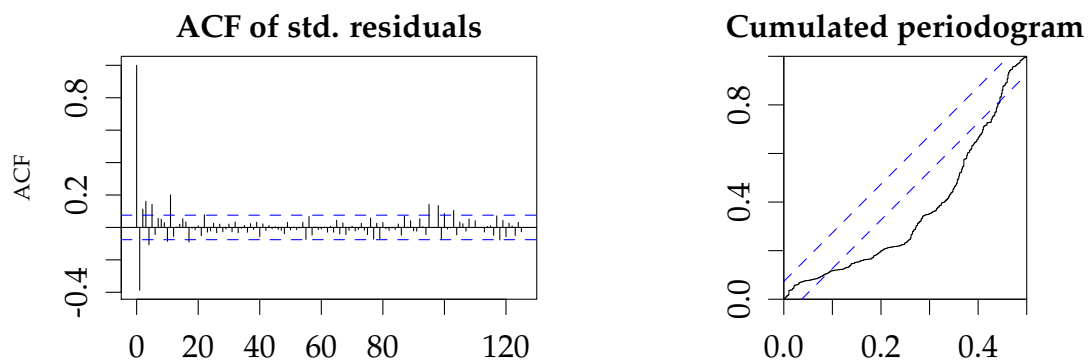

Now the residuals are quite close to white noise and the model are thus selected as a suitable model.

The estimated parameters can now be printed together with estimated standard deviation (Std. Error), p -values (Pr(>|t|)) and the correlation matrix:

```
## Coefficients:
##      Estimate Std. Error  t value  Pr(>|t|)    dF/dPar dPen/dPar
## Ti0  1.8976e+01 3.8322e-02  4.9517e+02 0.0000e+00 3.2619e-05 -1e-04
## Tw0  1.7503e+01 9.4142e-02  1.8593e+02 0.0000e+00 8.2689e-05  1e-04
## Ci   1.2572e-03 4.1884e-05  3.0017e+01 0.0000e+00 -2.1775e-05  0e+00
## Cw   3.0933e-02 2.7010e-03  1.1453e+01 0.0000e+00 -1.6224e-04  0e+00
## e11 -2.4989e+01 6.7368e-01 -3.7094e+01 0.0000e+00 2.8666e-04  2e-04
## gA   2.3608e+00 1.2365e-01  1.9093e+01 0.0000e+00 -1.7242e-06  0e+00
## p11 -2.7208e+01 4.9594e-01 -5.4861e+01 0.0000e+00 2.4221e-04  2e-04
## p22 -6.0007e+00 3.1303e-02 -1.9170e+02 0.0000e+00 2.8364e-04  0e+00
## Riw  4.6954e-04 1.2470e-05  3.7655e+01 0.0000e+00 6.2487e-05  0e+00
## Rwe  5.3696e-03 2.1111e-04  2.5435e+01 0.0000e+00 4.1010e-05  0e+00
##
## Correlation of coefficients:
##      Ti0  Tw0  Ci  Cw  e11  gA  p11  p22  Riw
## Tw0  0.68
## Ci   0.01  0.07
## Cw  -0.08 -0.03  0.20
## e11  0.10  0.02 -0.31 -0.77
## gA  -0.03  0.07  0.38 -0.01  0.00
## p11  0.10  0.04 -0.28 -0.68  0.85 -0.01
## p22  0.06 -0.08  0.37  0.12 -0.30  0.09 -0.26
## Riw  0.00 -0.42 -0.13 -0.04  0.12 -0.23  0.10  0.30
## Rwe -0.02 -0.03  0.01  0.00  0.15 -0.10  0.11  0.04 -0.02
##
## [1] "Loglikelihood 1096"
## [1] "HLC: 171"
## [1] "HLC 95% confidence band: 159 to 183"
## [1] "gA: 2.4"
## [1] "gA 95% confidence band: 2.1 to 2.6"
```

All p -values indicate that the estimated parameters are significantly different from zero and no high correlation are found. Hence this validates further the results and finally the total HLC from the internal to the external is printed together with its estimated 95% confidence interval, and similarly for the gA value.

Missing a physical validation of the estimated parameters according to some simple calculations of the properties of the building.

If this model should be further improved it is suggested to include non-linear parts, such as for instance

Acronyms

ACF AutoCorrelation Function. 14, 18, 25, 30–32, 62, 67–69

AIC Akaike Information Criterion. 26

ARX AutoRegressive with eXogenous input. 4, 7, 8, 16–19, 22–24, 30, 31, 33–35, 50, 51, 65, 67

CCF Cross-Correlation Function. 30, 62, 67–69

HLC Heat Loss Coefficient. 4, 7, 8, 14–17, 19, 21, 50–52, 62–64, 70, 71, 80, 82,
Glossary: Heat Loss Coefficient

PACF Partial AutoCorrelation Function. 18

Bibliography

- K. Andersen, H. Madsen, and L. Hansen. Modelling the heat dynamics of a building using stochastic differential equations. *Energy and Buildings*, 31:13–34, 2000.
- P. Bacher and H. Madsen. Identifying suitable models for the heat dynamics of buildings. *Energy and Buildings*, 43(7):1511–1522, 2011.
- J. Bloem, editor. *System Identification applied to building performance data*. Commission of the European Communities, Luxembourg, 1994.
- J. Bloem. Dynamic analysis methods and modelling. application to energy performance assessment. In *2nd PALENC Conference*, pages 132–136, Grete Island, September 2007.
- G. E. P. Box and G. M. Jenkins. *Time Series Analysis, Forecasting and Control*. Holden-Day, San Francisco, 1970/1976.
- P. Brockhoff, J. Møller, E. Andersen, P. Bacher, and L. Christiansen. *Introduction to Statistics - eNotes*. 2015. URL <http://introstat.compute.dtu.dk/enote/>.
- C. Chatfield. *The Analysis of Time Series: An Introduction*. Chapman and Hall, New York, 6 edition, 2003.
- C. Cools and R. Gicquel. The passys project, final reports phase 1 1986-89. Technical report, Office of the Official Publications of EU, Luxembourg, 1989.
- N. Friling, M. Jiménez, H. Bloem, and H. Madsen. Modelling the heat dynamics of building integrated and ventilated photovoltaic models. *Energy and Building*, 41:1051–1057, 2009.
- K. Godfrey. Correlation methods. *Automatica*, 16:527–534, 1980.
- R. Goodson. Distributed system simulation using infinite product expansions. *Simulation*, 15:255–263, 1970.
- C. G. Goodwin and R. L. Payne. *Dynamic System Identification: Experimental Design and Data Analysis*. Academic Press, New York, 1977.
- A. C. Harvey. *The econometric analysis of time series*. Mit Press, 1990.
- T. Hastie, R. Tibshirani, and J. Friedman. *The Elements of Statistical Learning; Data Mining, Inference and Prediction*. Springer, New York, 2001.
- M. Jiménez and H. Madsen. Models for describing the thermal characteristics of building components. *Building and Environment*, 43:152–162, 2008.

- M. Jiménez, H. Madsen, and K. Andersen. Identification of the main thermal characteristics of building components using matlab. *Building and Energy*, 43:170–180, 2008a.
- M. Jiménez, H. Madsen, H. Bloem, and B. Dammann. Estimation of nonlinear continuous time models for the heat dynamics of building integrated photovoltaic modules. *Energy and Buildings*, 40:157–167, 2008b.
- N. Kristensen and H. Madsen. *Continuous Time Stochastic Modelling – CTSM 2.3 Mathematics Guide*. Technical University of Denmark, Lyngby, Denmark, 2003.
- N. Kristensen, H. Madsen, and S. Jørgensen. A unified framework for systematic model improvement. *Process Systems Engineering*, 15:1292–1297, 2003.
- N. R. Kristensen, H. Madsen, and S. B. Jørgensen. Parameter estimation in stochastic grey-box models. *Automatica*, 40:225–237, 2004.
- G. Lethé, P. Steskens, G. Flamant, and B. Meurisse. An adapted co-heating test and experimental infrastructure for thermal dynamic response and performance identification of residential buildings. In *9th SSB Conference, 10-12 December 2014, Liège*, 2014.
- H. Madsen. *Time Series Analysis*. Chapman and Hall, 2008.
- H. Madsen and J. Holst. Estimation of continuous-time models for the heat dynamics of a building. *Energy and Building*, 22:67–79, 1995.
- H. Madsen and J. Schultz. Short time determination of the heat dynamics of buildings. Technical Report 243, DTU, Laboratoriet for Varmeisolering, DTU Byg, 1993.
- H. Madsen and P. Thyregod. *An introduction to general and generalized linear models*. Chapman and Hall, New York, 2011.
- H. Madsen, J. Holst, and E. Lindström. *Modelling Non-linear and Non-stationary Time Series*. IMM, DTU, Lyngby, Denmark, 2007.
- B. Nielsen and H. Madsen. Identification of transfer functions for control of greenhouse air temperature. *Journal Agricultural Engineering Research*, 60:25–34, 1995.
- B. Nielsen and H. Madsen. Identification of a continuous time linear model of the heat dynamics in a greenhouse. *Journal Agricultural Engineering Research*, 71:249–256, 1998.
- H. A. Nielsen and H. Madsen. A generalization of some classical time series tools. *Computational Statistics and Data Analysis*, 37:13–31, 2001.
- R Core Team. *R: A Language and Environment for Statistical Computing*. R Foundation for Statistical Computing, Vienna, Austria, 2015. URL <https://www.R-project.org/>.
- P. Sadegh, J. Holst, H. Madsen, and H. Melgaard. Experiment design for grey-box identification. *International Journal for Adaptive Control and Signal Processing*, 9:491–507, 1995.

- R. Sonderegger. Diagnostic tests to determine the thermal response of a house. *ASHRAE Transactions*, 91, 1978.
- C.-R. D. Team. *Continuous Time Stochastic Modeling in R User's Guide and Reference Manual*. Technical University of Denmark, Lyngby, Denmark, 2015.