



SAPIENZA
UNIVERSITÀ DI ROMA

“Spontaneous generation of RNA”

Tutore

Prof. Ernesto Di Mauro

Coordinatore

Prof. Marco Tripodi

Dottoranda

Samanta Pino

XXII CICLO

Director of doctoral program:

Prof. Marco Tripodi (professor of Molecular Genetics)
Dipartimento di Biotecnologie Cellulari ed Ematologia
Università “Sapienza” di Roma

Scientific Tutor:

Prof. Ernesto Di Mauro (professor of Molecular Genetics)
Dipartimento di Genetica e Biologia Molecolare
Università “Sapienza” di Roma

Board of examiners:

Prof. ssa Manuela Helmer Citterich, Dipartimento di Biologia,
Università degli Studi di Roma “Tor Vergata”

Prof. Elias Maccioni, Dipartimento Chimico Farmaceutico Tecnologico,
Università degli Studi di Cagliari

Prof. Giuseppe Giannini, Dipartimento di Medicina Sperimentale,
“Sapienza” Università di Roma

Publications	6
Introduction	7
DEFINING “LIFE”	7
DOES A TRANSITION FROM INANIMATE TO ANIMATE MATTER EXIST?	10
NATURE’S DRIVE TOWARDS STABLE SYSTEMS	11
LIVING SYSTEMS AS A KINETIC STATE OF MATTER	13
PREBIOTIC CHEMISTRY	14
WHEN DID THE TEMPERATURE OF UNIVERSE PERMIT THE INGREDIENTS OF LIFE TO EXIST?	15
FROM ORGANIC MOLECULES TO PROTOCELLS	19
THE HYPOTHESIS OF AN RNA WORLD	21
WHY RNA?	22
RECREATING AN RNA WORLD	23
MY STARTING POINT: FROM FORMAMIDE TO NUCLEOTIDES	27
Purpose of the work	33
Results	35
The solvent	35
Water as the solvent	37
GENERATION OF LONG RNA CHAINS IN WATER	39
How RNA polymerization was started?	39
Syntheses from cyclic nucleotides. 3',5'-cGMP	39
3',5'-cAMP	41
RNase analyses of the neo-formed bonds	44

Mechanism of polymerization	44
The problem of the precursors in nonenzymatic polymerization	46
RNA chain extension	47
RNA extension: characterization of the neo-formed bonds	57
Polymerization as the way-out from degradation	58
A role for stacking interactions	59
NONENZYMATIC RNA LIGATION IN WATER	62
Cofactors	65
The effect of fragment size	65
Ligation of oligomers with different lengths	68
Ligation as a function of pH	71
The plausible mechanism for the formation of dimers and tetramers	72
The importance of stacking interactions in nonenzymatic ligations	75
The possible evolutionary meaning of nonenzymatic ligations	77
MOLECULAR PHENOTYPE FAVOURS THE EVOLUTION OF RIBOPOLYMERS	77
The 3' phosphoester bond in 3'AMP and 3'CMP	78
Kinetics of RNA hydrolysis	80
PolyA ₂₄	81
PolyA ₁₂ C ₁₂	83
Mixed-sequence RNA	86
The hydrolytic degradation of RNA in water is preceded by a lag period	87
The half-life of the 3'phosphoester bond: monomers versus polymers.	
Temperature effects	89
The lag period and the pH effect	91
Conclusion	94
Experimental procedures	98
MATERIALS	98

METHODS	98
Polymerization protocols and analysis	98
Acrylamide gel electrophoresis	99
Reference ladders	99
Terminal labelling of the material polymerized from unlabeled cyclic nucleotides	99
RNase analyses	100
RNA labeling and handling	100
The ribo-oligonucleotide ligation protocols and analyses	101
Fragment size determination	101
Half-lives of the 3'phosphoester bond in 3'AMP	101
Ribonucleotide degradation protocols and analyses	102
Half-lives of the bonds in the ribooligonucleotide	103
Bibliography	104

Publications

- F. Ciciriello, G. Costanzo, S. Pino, C. Crestini, R. Saladino, E. Di Mauro
Molecular complexity favors the evolution of ribopolymers
Biochemistry .47, 2732-2742 (2008)
- S. Pino, F. Ciciriello, G. Costanzo, E. Di Mauro
Nonenzymatic RNA ligation in water
J. Biol. Chem. 283, 36494-36503 (2008)
- Ciciriello F, Costanzo G, Pino S, Di Mauro E. Spontaneous generation revisited at the molecular level. P. Pontarotti (ed), Evolutionary Biology: Concept, modelling, and application, Springer (2009)
- Saladino R, Crestini C, Ciciriello F, Pino S, Costanzo G, Di Mauro E. From formamide to RNA: The roles of formamide and water in the evolution of chemical information. Res. Mic. 160, 441 (2009)
- Costanzo G, Pino S, Ciciriello F, Di Mauro E. Generation of long RNA chains in water. J.Biol. Chem. 284, 33206-33216 (2009)

INTRODUCTION

DEFINING “LIFE”

Different viewpoints, many with deep philosophical and historical roots, have shaped the scientific study of the origin of life.

No broadly accepted definition of “life” is available, yet. Suggested definitions face problems, often in the form of robust counter-examples. A list of failed attempts, including physiological, metabolic, biochemical, genetic and thermodynamic definitions of life was catalogued by Sagan in 1970 (Chyba & Hang 2005), all of which include some imperfections. A metabolic definition, for example, finds it hard to exclude fire (which grows and reproduces via chemical reactions), a biochemical definition does not exclude enzymes, while a thermodynamic definition cannot exclude mineral crystals. It is evident that the question “What is life?” is an extremely difficult question which requires a scientific theory rather than a definition.

Onsager, Morowitz and Lehn , among others, made important contributions to find the solution of significant questions regarding the emergence and function of complex biological living matter (Folsome 1979, Eigen 1971, 1996, Yates 1987, Lehn 2002a,b, 2003).

Onsager and Morowitz attempted to provide a unified description of living matter and their definition reads : “Life is that property of matter that results in the cycling of bioelements in aqueous solution, ultimately driven by radiant energy to attain maximum complexity” (Folsome 1979). This particularly fascinating definition of life implies that coupled cycles involving homogeneous and/or heterogeneous chemical reactions of bioelements (i.e. prebiotic material and building blocks of biomolecules) in water result in the organization of complex matter through the acquisition and disposal of radiant energy. Nevertheless this definition bypasses the characterization of complex biological matter and how it differs from chemical matter, considered not to be alive (Kadanoff 1993).

Eigen, on the contrary, addressed the basic differences between a chemically coupled system and a living system (Eigen 1971, 1996). He affirmed that all reactions in living systems follow a controlled program, whose aim is the self-reproduction of the program itself and he also supported the idea that all living entities need some essential characteristics which are : self-reproduction (without which information would be lost); mutations (which allow evolution) and metabolism (which allows an optimal choice of a system for a certain function) (Eigen 1971, 1996).

In this context the concept of self-organization (self-assembly) was developed (Lehn 2002a,b, 2003, Heckl 2004).

Eigen, Lehn and Heckl proposed that, prior to the biological evolution, the chemical evolution took place, performing a selection on molecular diversity and leading to the embedment of structural information in chemical entities.

Molecular structure formation of living and non-living matter is driven by molecular interactions such as H-bonding, van der Waals interactions and charge transfer in donor-acceptor sequences. Self-organization of matter involves selection in addition to design at the supramolecular level and leads to biologically active substances (Lehn 2003).

A heuristic, highly speculative, partial scheme for the emergence of living matter could be as shown in figure 1.

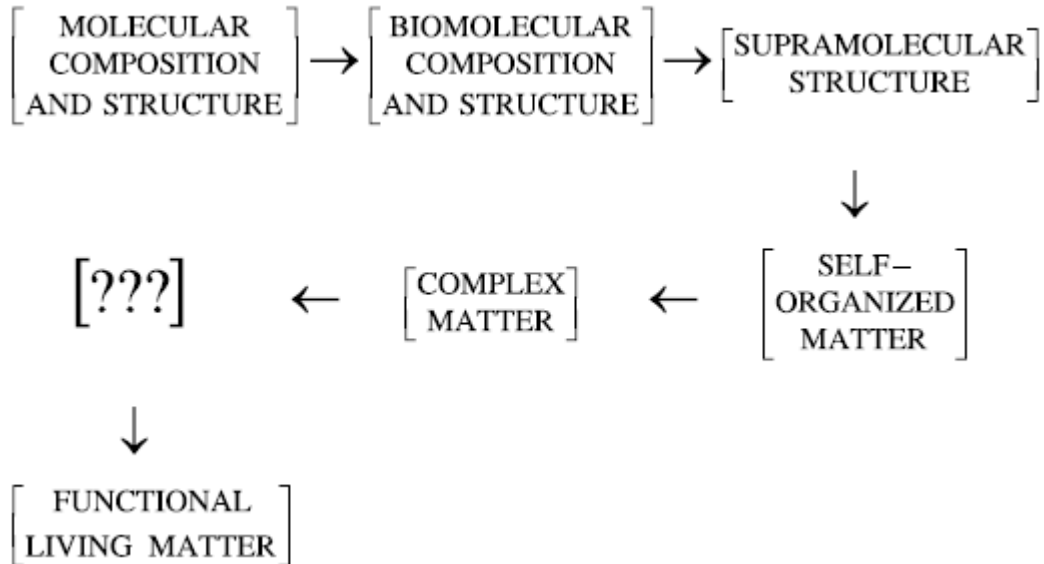

Figure 1: scheme for the emergence of living matter in the ‘parameter space’ of increasing complexity. The attributes marked by [???] are unknown, being the most fascinating (Jortner 2006).

Many gaps are present in this conceptual framework. In particular, the mechanistic aspects of information-driven self-organization remain to be elucidated.

One definition of life that has become increasingly accepted within the origin-of-life community is : “ Life is a self-sustained chemical system capable of undergoing Darwinian evolution” (Joyce 1994a,b).

This definition is presently used by the Exobiology Program within the National Aeronautics and Space Agency as a general working definition of life and I consider it a careful formulation shaping not only our ideas of what life is, but also of what we recognize as its origin.

However, problems remain which are related to the Darwinian aspects present in the definition of life. It is conceivable that early cellular life on Earth passed through a period of reproduction without replication, during which Darwinian evolution was not yet established (Dyson 1985). If such organisms were to be discovered, we would be unlikely to declare them not to be alive by definition. Another concern with the Darwinian definition is that living sterile organism such as mules cannot reproduce, so they are not 'capable' of Darwinian evolution (Cleland 2002).

It is evident that current attempts to define 'life' face many quandaries. Consequently, we need a theoretical framework for biology that will support a deeper understanding of life that can be provided by the features that we currently use to recognize it on Earth.

How far can we reduce life and still call it life? Is DNA alive? Where is the line between chemistry and life? (Rollins 2006)

DOES A TRANSITION FROM INANIMATE TO ANIMATE MATTER EXIST?

Matter manifests itself in a variety of forms: solid, liquid and gas. These three states differ dramatically in their physical characteristics. Nevertheless, the rules that govern the interconversion of one state to another are well understood. Then there are the living systems. The relationship between living systems and the traditional states of matter remains confused and a subject of endless controversy.

Pross assumed that : first, animate and inanimate matter are related in some manner, based on the conviction that animate matter emerged from inanimate through a physical-chemical process on the primordial Earth after its formation (Pross 2005). The second assumption pertains to the existing laws of physics and chemistry. These explain the process of increasing complexity by which the inanimate matter generates chemical systems with specific characteristics (Pross 2005).

Third, the transition from inanimate to animate matter must have followed some particular mechanistic pathway.

The physical-chemical principles that could explain the process of biological complexification should not be associated with just that single chemical system following that particular mechanistic path. In other words we could presume that there were appropriate conditions and other chemical systems that, at least in principle, allowed the special kinds of increasing complexity we associate with living systems (Pross 2005).

NATURE'S DRIVE TOWARD STABLE SYSTEMS

Survival of the most stable is a fundamental law of nature that we can apply to both the biological and the broader physical-chemical world. The universe tends to be populated by stable things, where the term “stable” is used in the sense of persistent, unchanging with time. In this context Dawkins (1989) points out that the Darwinian principle, *survival of the fittest*, becomes a special case of that broader law. The fit individuals and the fit species are more likely to survive and therefore to persist (Dawkins 1989).

Within the inanimate world *survival of the most stable* is a general principle that expresses what is generally considered to be one of the most fundamental laws of physics and chemistry: the Second Law of Thermodynamics.

The second law states that any isolated physical-chemical system is driven toward its lowest Gibbs energy (equilibrium) state. In order to relate animate and inanimate systems, we can point out a common feature: both animate and inanimate worlds have a drive toward greater stability but the nature of stability within an inanimate physical-chemical context is quite distinct from the one that generally applies within the biological world.

A biological system, though stable in the sense that it maintains itself over time, is actually unstable from a thermodynamic point of view in that it must tap into a constant source of energy, either chemical or photochemical, in order to maintain that state far from equilibrium, which is essential to all biological functions. Clearly, the stability that living systems exhibit is not thermodynamic and is only reflected in their persistent nature. Therefore, different kinds of stability in nature exist, and each kind of stability, whether biological or chemical, requires a specific defined physical-chemical characterization.

In a physical-chemical context, however, stability is more explicitly defined and we distinguish between two kinds of stability: kinetic and thermodynamic.

Consider, for example, the exergonic reaction of hydrogen and oxygen gases to yield water. Since that reaction is spontaneous but the reverse reaction is not, we state that H_2O is thermodynamically stable while the $\text{H}_2 - \text{O}_2$ gas mixture is thermodynamically unstable. However, the system comprising a $\text{H}_2 - \text{O}_2$ mixture can be extremely stable in the sense that it can be extremely persistent but only under appropriate conditions.

In order for a reaction to take place, some form of activation is necessary. So, we term a $\text{H}_2 - \text{O}_2$ mixture as kinetically stable because it is the high kinetic barrier to reaction that prevents the chemical reaction from taking place. The kinetic stability, in contrast to the thermodynamic stability, is a property of the system and of its immediate environment.

It also depends not just on the system itself but on factors extraneous to the system. For this reason, kinetic stability cannot be classified as a state function, in contrast to thermodynamic stability.

LIVING SYSTEMS AS A KINETIC STATE OF MATTER

All living systems, from the simpler prokaryotes through complex multicellular plants and animals, but also including parasitic species such as viruses and phages, may be thought of as manifesting a kinetic state of matter. Thus, the term “kinetic state of matter” highlights the fact that replicating systems, animate or inanimate, by the very fact of being replicative, have the potential to access non thermodynamic, kinetic steady states, resulting in the formation of aggregates that are stable, though the stability is kinetic in nature. A stability therefore exists in nature that is quite different from the conventional chemical stability we normally associate with an inherent lack of reactivity. For replicating systems, the stability is of a dynamic kinetic kind which derives from the special kinetic character of the replicative process. It is the immense kinetic power of autocatalysis inherent in all replicating process that is the ultimate driving force for the generation of the complex physicochemical pattern that we label as “life”.

Thus, according to the “kinetic state of matter model of living systems” we could suggest that biological *natural selection* is a particular case of *kinetic selection*, that the concept of the *fitness* is a particular case of *kinetic stability* and that *survival of the fittest* is a particular case of *kinetic selection of the kinetically more stable* (Pross 2005).

PREBIOTIC CHEMISTRY

The fundamental structures and processes that constitute life rely on a relatively small number of molecules. Formulating hypotheses about the origin of life requires a basic understanding of the role that these molecules play in modern life, as well as how they may have formed or appeared in the prebiotic conditions of early Earth.

The biochemical complexity of even the simplest organisms makes it difficult to conceive a less complicated ancestor. Nonetheless, attempts to understand how life originated on a prebiotic Earth are extremely important for understanding both the evolution and the definition of life.

“Prebiotic chemistry” investigates how synthesis of biomolecules may have occurred prior to the beginning of life as we know it. Abiotic synthesis of amino acids was demonstrated, in 1953, by the use of an electrical discharge under reducing conditions (Miller 1953). Today, most scientists agree that the atmosphere of the primitive Earth was never as strongly reducing as investigators then suspected, but early experiments showed that common biomolecules could be synthesized. The plausibility of an RNA world in origin-of-life scenarios crucially depends on finding probable prebiotic conditions that, in the absence of any biological catalyst, could have produced pools of random RNA molecules, the starting scenario for an RNA world. One hypothesis concerning the formation of nucleotides suggests that precursors (e. g., ribose, nitrogenous bases) originated on the early Earth (endogenous formation), either in the subsurface in volcanic aquifers or on the surface of metal-sulfide minerals (Zubay 1998, Orgel 2004).

Still, while several abiotic mechanisms have been proposed, they are difficult to demonstrate. Alternatively, nucleotide precursors and, potentially, nucleotides may have formed exogenously (elsewhere) and then been transported to Earth. Such material may have arrived via a class of meteorites known as carbonaceous chondrites (Cooper *et al.* 2001). Carbonaceous chondrites are over 3% carbon, often in the form of organic material, including amino acids, polycyclic aromatic hydrocarbons, and carboxylic acids (Jenniskens *et al.* 1998).

While the ability of this material to withstand passage through the Earth's atmosphere and planetary impact is debated, most scientists agree that meteorites, as well as comets and interstellar dust, must have contributed in part to the buildup of organic matter on the prebiotic Earth (Maurette 1998).

Then, it is obvious that the delivery of biogenic compounds from the outer space played a role at that stage, while its relative contribution mainly depended on the local production, which can only be deduced from hypothetical models of the early atmosphere. A recent model of the evolution of atmosphere supports a hydrogen escape that could have been much slower than previously believed (Tian *et al.* 2005), so that the amount of organic matter produced on Earth could have been sufficient for the emergence of life. It has also been proposed that the hydrothermal synthesis by which organic molecules could have been synthesized by heating taking advantage of the presence of mineral (Russel & Martin 2004), may have contributed to endogenous production. The catalogue of molecules produced includes high-energy biogenic basic species such as HCN, cyanate, formaldehyde and other aldehydes (Miller 1998). These simple molecules can undergo different processes under conditions simulating the primitive Earth capable of yielding the building blocks of biochemistry: amino acids (Strecker reaction of aldehydes), nucleic bases and sugars (formose reaction from formaldehyde). However, it is more difficult to define a scenario of chemical evolution by which the system became more complex allowing the formation of macromolecular and supramolecular components of life and their combination into metabolic processes.

WHEN DID THE TEMPERATURE OF UNIVERSE PERMIT THE INGREDIENTS OF LIFE TO EXIST?

The very early universe was filled with radiation at arbitrarily high temperature. At 10^{-33} seconds after the Big Bang, the universe cooled enough to allow matter to aggregate. At 10^{-4} seconds after the Big Bang the thermal energy of the universe

was low enough to allow the hot soup of quarks to condense and to form, under the influence of the strong nuclear force, protons and neutrons.

The thermal energy of the universe decreased allowing protons and neutrons to bind together under the residual nuclear force to form the nuclei of the lightest elements: ^1H , ^2H , ^3H , ^4He , ^7Li .

For the first 400,000 years after the big bang all the matters was in thermal equilibrium with the sea photons (cosmic microwave background: CMB) that filled the universe. Then, when the thermal energy of CMB fell beneath the ionization energy of hydrogen, the hydrogen atoms were formed and in the densest part of the universe paired up to form the first molecules: H_2 . The universe continued to expand and cool and when the clouds of hydrogen cooled beneath 100K the thermal energy decreased enough to form massive stars (Lineweaver & Schwartzman 2004).

The Earth was formed from a molten ball at 2000K about 4.56Gyr ago (Allègre *et al.* 1995). In that period the surface of the Earth was exposed to heavy bombardment and was periodically vaporized and covered with a 2000K rock vapor atmosphere (Hartman *et al.* 2000).

This conditions were probably inadequate for the earliest life forms or more generally frustrating for the evolution of life. A steadily decreasing heavy bombardment continued until 3.8 Gyr ago.

Events on Mercury, Venus and Mars were similar: an initial period of heavy bombardment abated as planetesimals were swept up. There are probably the temperature constraints that any life in the universe has to begin with if it is to come into existence. (Lineweaver & Schwartzman 2004).

The hyperthermophilic monopoly on the deepest roots of the phylogenetic tree of terrestrial life (Figure 2) suggest that temperature played a dominant role in biogenesis and dominated the selection pressure on the earliest forms of life. This suggests the more general idea that wherever biogenesis occurs in the universe, temperature will play a dominant role non only in setting the stage with stars, planets and the building blocks of life but also in determining, restricting and constraining the earliest and simplest forms of life.

By identifying the oldest features in extant life we can get an idea of what the thermal constraints on the earliest life were. Molecular biologists have been able to construct phylogenies based on protein similarities, DNA and RNA sequences. The phylogenetic tree of life in Fig. 2 is based on 16S rRNA (Pace 1997). Life can be usefully classified into three domains : Bacteria, Archea and Eukarya (Woese *et al.* 1990). The position of the root of the tree is estimated from ancient gene duplications (Gogarten-Boekels *et al.* 1995; Grimaldo & Cammarano 1998). Only autotrophic hyperthermophiles from hot springs and hydrothermal vents are found near the root. This suggests that the last common ancestor (LCA) lived in similarly hot environments (Di Giulio 2000).

The distance from the root to the tip of any branch is proportional to the number of changes per site. Hyperthermophiles are living fossils and have a monopoly on the root. All the organisms that cannot tolerate heat are only found far from the root suggesting that we can use this phylogenetic tree as a crude thermometer.

The color-code of the tree, which defines three temperatures, is derived from values of maximum growth temperature (T_{max}) of extant organisms.

The simple picture that emerges from this analysis is that of mesophiles evolving from hyperthermophiles and gradually adapting to cool environments.

The transition from hot to cool was an essential stage for the emergence of life. Life emerges as soon as it can, probably needing an environment that is still hot and compatible with liquid water. The connections between temperature and life are so fundamental that we can use them as guides in our estimates of what life forms we can reasonably expect to exist beyond the Earth.

Extant life is no longer a passive inhabitant of a given ambient temperature. The relation between life and temperature has become a quasi-deterministic one in the sense that although temperature has played a dominant role in constraining life, life has also been able to modify the temperature within the limits set by the deterministic processes of planet formation (Schwartzman 1999).

FROM ORGANIC MOLECULES TO PROTOCELLS

The question “How do simple organic molecules form a protocell?” is largely unanswered. Numerous hypotheses were formulated. Some of these postulate the early appearance of nucleic acids (“gene-first”) whereas others postulate the evolution of biochemical reactions and pathways first (“metabolism-first”).

Recently, trends are emerging to create hybrid models that combine aspects of both. The gene-first model suggests that relatively short RNA molecules could have spontaneously formed and were capable of catalyzing their own continuing replication. Factors supportive of an important role for RNA in early life include its ability to replicate; its ability to act both to store information and catalyze chemical reactions (as a ribozyme); its many important roles as an intermediate in the expression and maintenance of genetic information (in form of DNA) in modern organisms and the ease of chemical synthesis of at least the components of the first molecules under prebiotic conditions. A number of problems with the gene-first theory remain, particularly the instability of RNA when exposed to ultraviolet light, the difficulty of activating and ligating nucleotides and the lack of available phosphate in solution required to constitute the nucleic acids backbone.

Several models reject the idea of self-replication of a “naked-gene” and postulate the emergence of a primitive metabolism which could provide an environment for the later emergence of RNA replication. One of the stronger supporter of this idea was Alexander Oparin (Oparin 1938, 1961). Subsequently, Gunter Wächtershäuser introduced some variants in Oparin’s theory and proposed an autotrophic origin of life in which an energy flux provided by chemical reactions at liquid-solid interfaces was used for carbon fixation (Wächtershäuser 1988, 2006).

More abstract and theoretical arguments for the plausibility of the emergence of metabolism without the presence of genes include a mathematical model introduced by Freeman Dyson in the early 1980s. Although the autotrophic model (metabolism-first) for the origin of life are in theory experimentally realizable in toto (Huber & Wächtershäuser 2006), experimental programs to test these theories have succeeded

up to now in producing early simple organic molecules (from C₂ to C₄), insufficient to start real chemical evolution (Orgel 2000).

The controversy between these two theories remains lively. However, there is now a general agreement on the idea that minerals may have catalyzed prebiotic reactions such as clays, important source of electrons for the reduction of organic compounds (Bada & Lazcano 2002) and volcanic minerals, important for the production of phosphoric compounds that are essential for life (Yamagata *et al.* 1991, Schwartz 2006). In this scenario the first organics useful for life were concentrated at mineral-water interfaces or into porous minerals (Schwartz 2006).

Some authors suggest that organic molecules, concentrated on mineral surface, were in competition to one another and subjected to Darwinian selection prior to the existence of cellular entities (Russel & Hall 1997, Wächtershäuser 2006).

Probably, the early formation of “protocells” was essential in order to ensure the stability and evolution of RNA replicators and for the establishment of any sustained energy-driven protometabolism. In other words, the appearance of lipid bilayers was a fundamental step for : keeping together RNA replicators, excluding external parasitic RNAs and preventing the dilution of macromolecules.

Noteworthy, lipid vesicles are rather easy to synthesize prebiotically and could have been abundant on early Earth (Muller 2006). Moreover, mineral surfaces, such as montmorillonite, stimulate the formation of lipid vesicles (Hanczyc *et al.* 2007).

Recently, Szostak and coworkers have shown that vesicles encapsulating RNA grow preferentially by lipid capture at the expense of empty vesicles (Chen & Szostak 2004). This result suggests that natural selection can discriminate between competing protocells, thus allowing the survival of only those protocells which contain more efficient RNA replicators (Chen *et al.* 2004).

THE HYPOTHESIS OF AN RNA WORLD

The time necessary to go from an habitable Earth to a protocell-like prokaryote can be divided in three periods. During the first period molecular organic sources, from which building blocks of life could have appeared, accumulated on the early Earth. The next period led to macromolecular synthesis from small monomers and to the first metabolic steps including the formation of the first replicating polymers. Subsequently, a scenario can be described for the development from random polymers to a replicative system, capable of evolving by mutation and natural selection.

This last period, called the *RNA world period*, would have opened the door to evolutionary biology as we know it today, leading to organized and complex systems (Pascal *et al.* 2006). The RNA world hypothesis is supported by its ability to explain a variety of observations in present life forms (Popper 1963).

First, DNA replication requires protein catalysis, and protein synthesis requires that the amino acids sequence be encoded in a DNA sequence. The RNA world hypothesis explains how this interdependent situation could originate from a much simpler situation, from a world without DNA or proteins: RNA was first, serving both as genome and as catalyst, later passing on its genomic role to DNA and most of its catalytic roles to proteins. Second, the hypothesis explains a number of biochemical observations: the ribosome and RNaseP are ribozymes (Guerrier-Takada *et al.* 1983, Steitz & Moore 2003), nucleotide cofactor are conserved throughout biology (White 1976, Benner *et al.* 1989), DNA replication requires RNA primers (Itoh & Tomizawa 1980) and DNA is synthesized from RNA precursors (Lazcano *et al.* 1988).

These biochemical findings are explained as molecular fossils of an earlier RNA world (White 1976).

WHY RNA?

RNAs occupy a pivotal role in the cell metabolism of all living organisms. For instance, throughout its life cycle, the cell produces the deoxyribonucleotides required for the synthesis of DNA from the ribonucleotides, the monomers of RNA. Thymine, a base specific of DNA, is obtained by transformation (methylation) of uracil, a base specific of RNA, and RNAs serve as obligatory primers during DNA synthesis. Finally, the demonstration that RNAs act as catalysts is an additional argument in favour of the presence during evolution of RNAs before DNA. Therefore it seems highly likely that RNA arose before DNA during biochemical evolution. For this reason DNA is considered as a modified RNA better suited for the conservation of genetic information.

The idea of an *RNA world* rests primarily on three fundamental hypotheses developed by Joyce and Orgel (1999):

- during a certain period in evolution, genetic continuity was assured by RNA replication;
- replication was based on Watson-Crick type base pairing;
- early catalysis was performed by small non genetically coded peptides and by ribozymes.

Until 20 years ago it was firmly believed that proteins were the only catalytic macromolecules in biology. However, this conception was overturned with the discovery of the first catalytic RNA molecules (Chech *et al.* 1981, Guerrier-Takada *et al.* 1983). The discovery of RNA catalysis provided a paradigm shift in biology, insight into the evolution of life on the planet and a challenge to understand its mechanistic origins. RNA has limited catalytic resources that must be used to maximal effect. Consequently, RNA catalysis tends to be multifactorial, with several processes contributing to an overall significant enhancement of reaction rate.

These include general acid-base catalysis, electrostatic effects, and substrate orientation and proximity. The main players are the RNA nucleobases and bound metal ions (Lilley 2003). Ribozymes might have played a key role in the development of life on this planet. There is clearly a fundamental “chicken and egg” problem in imagining how life came into being in anything like its present form.

Even the simplest translation system would surely be too complex to exist at any early stage. This problem can be circumvented if primitive life passed through a stage at which RNA was both the informational and the catalytic macromolecule (Woese 1967; Crick 1968). The ribosome, perhaps RNaseP too, probably represents a molecular fossil from this period and still existing inside all cells (Lilley 2003).

RECREATING AN RNA WORLD

The synthesis in the laboratory of a self-replicating system based on catalytic RNAs would be a milestone in the search for the origin of life itself. Recent progresses are made in this sector but several obstacles remain to be overcome.

Orgel and his coworkers showed that starting from activated monomers, it is possible in certain conditions to copy a large number of oligonucleotide sequences in the absence of enzyme (Joyce & Orgel 1986, Orgel 1992, Hill *et al.* 1993).

On the other hand, Ferris and his coworkers studied the assembly of RNA oligomers on the surface of montmorillonite (Ferris 1987, Ferris & Ertem 1992). Thus, experimental results demonstrated that minerals which serve as adsorbing surface and as catalysts (Paecht-Horowitz *et al.* 1970, Ferris *et al.* 1996) can lead to accumulation of long oligonucleotides, if activated monomers are provided. One can thus envisage that activated mononucleotides assembled into oligomers on the montmorillonite surface or on an equivalent mineral surface. The longest strands, serving as templates, direct the synthesis of complementary strands starting from monomers or short oligomers, leading double-stranded RNA molecules to accumulate.

Finally, a double RNA helix, of which one strand is endowed with RNA polymerase activity, would dissociate to copy the complementary strand and to produce a second polymerase that would copy the first to produce a second complementary strand, and so forth. The RNA world would thus have emerged from a mixture of activated nucleotides. However, a mixture of activated nucleotides would need to have been available.

A certain number of difficulties are encountered in the abiotic formation of sugars (Sutherland & Whitfield 1997). Synthesis of sugars from formaldehyde produces a complex mixture in which ribose is in low amounts. Moreover, production of a nucleoside from a base and a sugar leads to numerous isomers and, finally, phosphorylation of nucleosides also tends to produce complex mixtures (Ferris 1987). Eschenmoser succeeded in producing 2,4-diphosphate ribose during a potentially prebiotic reaction between glycol aldehyde monophosphate and formaldehyde (Eschenmoser 1999).

It is thus possible that direct prebiotic nucleotide synthesis occurred by an alternative chemical pathway. Nevertheless, it is more likely that a certain organized form of chemistry preceded the RNA world. Since the ribose-phosphate skeleton is theoretically not indispensable for the transfer of genetic information, it is logical to propose that a simpler replication system would have appeared before the RNA molecule (Figure 3).

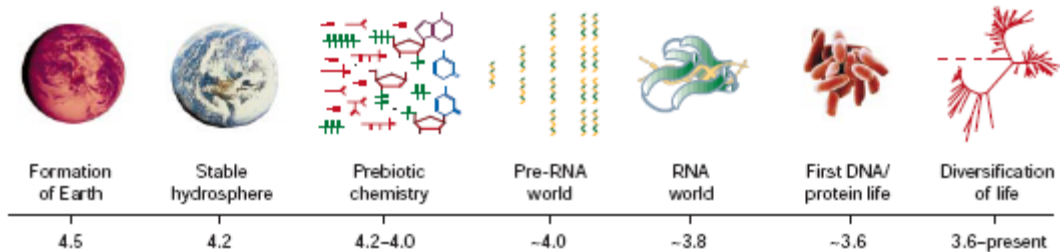

Figure 3: Timeline of events pertaining to the early history of life on Earth, with approximate dates in billions of years before the present (Joyce 2002).

Moreover, the inability of researchers to find a prebiotic synthesis for RNA has led many to conclude that life today descended from an organism that used an alternative genetic polymer, or proto-RNA (Joyce & Orgel 2006). Despite the lack of guidance from known metabolic pathways in biology regarding the chemical nature of a precursor to RNA, a systematic investigation of potentially natural nucleic acid analogues was made in recent years.

Most notable is the threose nucleic acid (TNA) (see Figure 4a) analogue based on α -L-threofuranosyl units joined by 3',2'-phosphodiester linkage (Schoning *et al.* 2000). TNA can form a double helix with RNA and is also capable of antiparallel Watson-Crick pairing with complementary DNA, RNA and TNA oligonucleotides. From the point of view of overcoming the clutter of prebiotic chemistry, TNA is more advantageous than RNA because of its relative chemical simplicity. There are other interesting candidates for a potential predecessor to RNA. Peptide nucleic acid (PNA) (Fig. 4b) consists of a peptide-like-backbone of N-(2-aminoethyl)glycine units with the bases attached through a methylenecarbonyl group (Nielsen *et al.* 1991). PNAs form very stable double helices with an RNA or a complementary DNA (Egholm *et al.* 1993) and can serve as template for the synthesis of RNA, or vice versa (Schmidt *et al.* 1997).

The transition to RNA from whatever might have preceded it would have had a very different character depending on whether the predecessor was a nucleic acid-like molecule. If the predecessor was able to cross-pair with RNA, then the transition may have been a gradual one. Genetic information could have been preserved by transcription of the pre-RNA to RNA, conferring selective advantage based on the function of the transcribed molecules. Once the RNA became self-replicating, it could have usurped the role of genetic material and the pre-RNA world have become expendable. If the predecessor was not a nucleic acid-like molecule, the appearance of RNA might have involved either a “translation” process, adapting pre-RNA-based information, or a “genetic takeover” (Cairns-Smith & Davies 1977) in which none of the genetic information in pre-RNA was passed on to RNA.

The catalytic potential of TNA, PNA and other proposed precursors to RNA has not yet been explored, but any cogent hypothesis regarding pre-RNA life must consider whether the genetic system under consideration could have facilitated the appearance of RNA.

MY STARTING POINT

The origin of informational polymers is not known. The great complexity of extant nucleic acids and the difficulty of following a top-down approach suggests that the genetic mechanisms onto which relies “life” as we know it today are elaborated.

We started from the consideration that life is a robust phenomenon and that its origin is presumably based on simple robust chemistry. We asked the question: does a unitary and simple physical-chemical frame exist in which nucleic bases may form and evolve to their open and closed nucleoside forms, and in which nucleosides may be phosphorylated, oligomerize and possibly ligate to yield larger oligonucleotide fragments? Our previous studies focused on the study of Formamide (HCONH_2) which provides a chemical frame potentially affording all monomeric components necessary for the formation of nucleic polymers.

In my work I have focused on two particular aspects: the RNA chain polymerization from precursors and the study of intrinsic endurance properties of RNA when brought in water solution.

FROM FORMAMIDE TO NUCLEOTIDES

The bottom-up prebiotic process to informational polymers

The steps leading from any putative simple-molecule precursor to an extant-type nucleic informational polymer are: 1) condensation into nucleic bases; 2) formation of nucleosides thereof; 3) phosphorylation of nucleosides; 4) chain-wise linear polymerization; and 5) survival of the formed polymer for a period long enough to allow replication.

Formamide as a multifunctional prebiotic precursor

Formamide plays a positive role in most of these steps. In recent years, formamide received particular attention due to its unique property to condense in purine and pyrimidine nucleic bases, simply by heating the compound at 110°-160° in the presence of metal oxides and mineral largely diffused in the Universe (Saladino *et al.* 2004). These inorganic compounds catalyze the thermal condensation of formamide and, at the same time, its partial degradation to low molecular weight derivatives, including HCN, formaldehyde (HCOH), formic acid (HCOOH), carbon oxides (CO_x) and ammonia (NH₃). Moreover, during the process of condensation of formamide in the presence of mineral phosphates, glycine, the simplest α -amino acid, was recovered in appreciable yields, in addition to cytosine, uracil, adenine and hypoxanthine (Saladino *et al.* 2006). For this reason, formamide behaves as a multifunctional prebiotic precursor whereby selectivity of transformation depends on the physical and chemical properties of the mineral used.

Noteworthy is the reaction of formamide in the presence of titanium dioxide (TiO₂) which produces purine acyclonucleosides composed by a sugar moiety directly linked on the nucleic base. The mixture of NHCHO and formaldehyde (products heating formamide on the presence of titanium dioxide) is responsible for the formation of this particular molecules, probably by a formose-like condensation of an activated formaldehyde on the exocyclic formyl moiety of newly synthesized formylpurine and adenine derivatives. Under formose condensation formaldehyde is converted into a mixture of monosaccharides by aldol-like reaction. Several sugars, including ribose and deoxyribose, may be formed by the action of ultraviolet. This observation is of particular prebiotic relevance because of the known difficulty of building under prebiotic conditions the β -glycosidic bond between separately synthesized nucleobases and sugars (Fuller *et al.* 1972).

Abiotic nucleoside phosphorylation

The phosphorylation of biological molecules has been explored through several different routes. Phosphonic acids have been proposed as a source of biophosphates (De Graaf *et al.* 1997). For the phosphorylation of nucleosides, two early reports described the preparation of uridine phosphate by heating uridine with inorganic phosphates in an aqueous environment (Beck *et al.* 1967) and the effects of condensing agents on this reaction (Lohrmann & Orgel 1968). However, the inefficiency of the system due to the competition of water with the nucleoside was pointed out by the authors. The alternative offered by phosphorylation in organic solvents, notably in formamide, was described in a series of pioneering studies by Schoffstall (Schoffstall 1976, Shoffstall *et al.* 1982, Shoffstall & Liang 1985, Shoffstall & Mahone 1988). Building on these latter observations and on the large availability of phosphates in mineral form, we reported the efficient phosphorylation of nucleosides occurring in formamide on numerous phosphate minerals. In the presence of formamide, crystal phosphate minerals may act as phosphate donors to nucleosides which are phosphorylated in different positions.

The acceptor nucleoside was alternately phosphorylated in 5'-, 3'-, 2'-, or 2',3'-cyclic positions; the 3',5'-cyclic form was not detected due to limitation in assay resolution (Costanzo *et al.* 2007). We also recently observed monophosphorylation of nucleosides (adenosine) in water in every possible position (Saladino *et al.* 2009). The products formed are 2'AMP, 3'AMP, 5'AMP and the cyclic forms 2',3'-cAMP and 3',5'-cAMP. We also noticed a relatively short half-life of the open forms 2'AMP, 3'AMP and 5'AMP, under the same conditions, cyclic forms 2',3'-cAMP and 3',5'-cAMP are more stable. This differential stability causes the accumulation of the cyclic forms, as already noted for the same type of nucleoside reactions when carried out in formamide (Costanzo *et al.* 2007). In summary, adenosine was phosphorylated in formamide at 100-150° and in water in the presence of a phosphate source at 90°. The reaction was faster and more efficient in formamide than in water. However, the very fact that nucleoside phosphorylation may take place in water in non-enzymatic abiotic conditions make this observation relevant for an understanding of spontaneous origin of genetic polymers.

Oligomerization

The first attempts of prebiotic synthesis of oligonucleotides were mainly directed to design the optimal conditions for the formation of the phosphate ester bond between preformed nucleotide derivatives. The Gibbs free-energy problem, critically evaluated by van Holde (van Holde 1980), and the intrinsic instability of nucleic polymers set strict limits to the possibility of formation and endurance of long polymers in aqueous environments. Specific catalysts and favourable physico-chemical setting were likely to be needed in prebiotic environments to provide a way out from otherwise prohibitive thermodynamic conditions. In principle the prebiotic synthesis of the oligonucleotide chains were performed in the presence of a template. The presence of a template represents an advantage for the reaction because the processes of molecular recognition between complementary nucleobases

can direct the monomer in the correct spatial position to form the phosphodiester bonds with low energy requirement. Sulston and co-workers described how 1-ethyl-3-[3-(dimethylamino)propyl]carbodiimide hydrochloride brings about formation of oligoadenylic acids from adenylic acid on polyuridylic template (Sulston *et al.* 1968). Based on this model, Orgel described the first selective polymerization of adenosine-5'-monophosphate (5'AMP) and guanosine-5'-monophosphate (5'GMP) in the presence of complementary oligonucleotides as a template (polyuridylic and polycytidylic acids, respectively) using different condensing agents (Schneider-Bernloehr *et al.* 1968, Orgel 1968), 2',5'-phosphodiester linkages were predominantly formed. Another example is the synthesis of dodecamer (A)₅A(2'-5')A₅Ap, which was formed by incubation of (A)₅A>p with two equivalents of polyU in ethylenediamine buffer at pH 8, at 0°C. The reaction appeared to occur within triple stranded complex (Ax2U), the geometry of which was favourable for in-line displacement with the release of 3'hydroxyl and 2',5'-linkage formation (Usher *et al.* 1976). These experiments marked an important advancement in the prebiotic synthesis of oligonucleotides, introducing the use of activated nucleotides, mainly on the 5'-position of the sugar, for the polymerization process. In the 1970s, Orgel described the first example of an efficient prebiotic synthesis of oligonucleotides using together the template and the activated nucleotides approaches (Ostenberg *et al.* 1973). Non-enzymatic, template-directed RNA polymerization reactions have been extensively studied over the past 30 years. Much of this work has focused on the template-directed polymerization of mononucleotides activated with imidazole and carbodiimide derivatives (Smith *et al.* 1958, Joyce 1987). A non-enzymatic replication scheme that has been less thoroughly investigated involves the template-directed ligation of short 3'-5'-linked oligomers rather than monomers. Rohatgi and co-workers have recently described the detection of a non-enzymatic ligation of two oligonucleotides aligned on a template RNA in which the 3'-hydroxyl of one oligonucleotide attacks the 5'-triphosphate of the other oligonucleotide, displacing pyrophosphate with the concomitant formation of a 3'-5'phosphodiester bond (Rohatgi *et al.* 1996).

The phosphate activating group, that was usually a good leaving group such as imidazole and 2-methylimidazole, played a relevant role in driving the polymerization toward longer oligomers (Weimann *et al.* 1968).

Noteworthy, the prebiotic synthesis of oligonucleotides in the presence of a template can be selectively catalyzed by minerals which were widely diffused on the primitive Earth, such as montmorillonite clays (Ferris *et al.* 1984). Ferris and co-workers have importantly shown that drying the chemically activated nucleoside 5'phosphoroimidazolide-adenosine (ImpA) or 5'phosphoroimidazolide-cytidine (ImpC) on the surface of a montmorillonite clays leads to the synthesis of oligonucleotides (Ferris *et al.* 1996, Prabahaar & Ferris 1997).

Although activated mononucleotides spontaneously form oligonucleotides on existing nucleic acid templates, or when dried on certain mineral surfaces (Prabahaar & Ferris 1997, Ertem & Ferris 1998), chemically activated nucleotides are of questionable relevance to the origin-of-life, as their synthesis by a plausible prebiotic chemistry was not corroborated (Hill *et al.* 1993, Orgel 2004). For these reasons the conclusion is that an different and efficient strategy must have been necessarily involved in the origin of polynucleotide replication.

The prebiotic synthesis of polynucleotide chains and the formation of the phosphodiester bonds between monomers is a process termodinamicly uphill. Thus, an efficient and robust catalytic mechanism for the activation (possibly phosphorylation) of nucleosides was probably involved.

We have observed that phosphorylation of nucleosides readily occurs in formamide or in water in the presence of a phosphate donor. We have observed 5 different phosphorylated forms and so we have tested their capacity to undergo spontaneous polymerization. Polymerization was verified in the same conditions in which phosphorylation was observed. The results showed that no oligomerization was observed for open forms such as 2'AMP, 3'AMP and 5'AMP, while both 2,3'-cAMP and 3',5'-cAMP underwent polymerization events.

PURPOSE OF THE WORK

Self organization and endurance of informational polymers entail the simultaneous presence of robust chemical frame and favourable thermodynamic conditions.

This truism led us to investigate the role of formamide in the origin of genetic information. Formamide chemistry provides a novel scenario for the origin of biomolecules under plausible prebiotic conditions. Selectivity in the condensation process of formamide strictly depends on the physical and chemical properties of the minerals or metal oxides used as catalysts in transformation. Formamide also works well in the presence of non-terrestrial minerals such as cosmic dust analogues (CDAs) of olivines, further expanding the potentiality of this chemical precursors as a building block for construction of biologically important molecules (Saladino *et al.* 2005). Indeed, all the nucleic acid base components of extant DNA and RNA can be synthesized by thermal condensation of formamide. Quite interestingly the formation of purine acyclonucleosides is obtained by the reaction between formamide and TiO₂ (Saladino *et al.* 2003).

In specific conditions, acyclonucleosides could produce nucleosides.

This observation is of particular prebiotic relevance because of the known difficulty of building, under abiotic conditions, the β -glycosidic bond between separately synthesized nucleobases and sugars (Fuller *et al.* 1972).

We also recently observed that monophosphorylation of nucleosides (adenosine) in formamide or in water is possible in every positions (Saladino *et al.* 2009).

The products formed are : 2'AMP, 3'AMP, 5'AMP and the cyclic forms 2',3'-cAMP and 3',5'-cAMP.

Even if the phosphorylation reaction was faster and more efficient in formamide than in water, the prebiotic relevance of a reaction occurring in water is higher than that occurring in organic solvents or in dry-state chemistry (Ferris & Ertem 1993).

Having obtained the indication that nucleoside phosphorylation can occur under simple conditions I have focused my work on the process of oligomerization starting from 3',5'-cAMP or 3',5'-cGMP.

Cyclic nucleotides are stable compounds and also hold sufficient energy to overcome the energetic barrier in the oligomerization reactions. The synthesis of RNA chains from 3',5'-cAMP and 3',5'-cGMP, in the same conditions of phosphorylation, is discussed.

The polymerizations are based on two reactions not previously described : 1) oligomerization of 3',5'-cGMP to □ 25 nucleotides-long RNA molecules and of 3',5'-cAMP to 4 - to - 8 nucleotides-long molecules. Oligo As further yield RNA molecules up to more than 120 nucleotides-long. 2) Chain extension by terminal ligation of newly polymerized products of 3',5'-cGMP on preformed oligonucleotides. We also have previously described the nonenzymatic ligation of RNA oligomers in water. Dimers and tetramers are formed in time-, pH-, and temperature dependent reaction. Ligation efficiently depends on oligonucleotides length and sequence and is strongly enhanced by adenine-based nucleotide cofactors.

The founding basic property of a polymer is to maintain its polymeric form, its endurance as a polymer that, for the largest part, corresponds to its resistance to the hydrolysis of phosphoester bonds. For this reason I have finally explored the stability of selected ribooligomers in water. The physical-chemical conditions in which the key 3'-phosphoester bond is more stable when embedded in the polymer than when present in the monomer were determined. A narrow pH range was identified in which complex sequences resist degradation markedly more than monotonous ones, thus potentially favouring the evolution of sequence-based genetic information.

RESULTS

The solvent

A liquid phase facilitates chemical reactions, which is something known empirically since centuries. As a solvent, a liquid allows dissolved reactants to encounter each other at rates higher than the rates of encounter between species in a solid. Chemical reactions can take place in the gas and solid phases as well, of course. But each of these has disadvantages relative to the liquid phase. In the gas phase, chemistry is limited to molecules that are sufficiently volatile to deliver adequate amounts of material to the gas phase at moderate temperature and to molecules sufficiently stable to survive higher temperatures where the vapor pressures are higher. It is even conceivable that in the vacuum of interstellar space, life exists through molecules at high dilution reacting in the gas phase. The possible disadvantage of this environment are the difficulties in holding together the components of the interstellar life form.

Likewise, species can diffuse through solids to give chemical reactions (Huang & Walsh 1998). However, solid-phase diffusion is slow. Nevertheless, given cosmic lengths of time, and input of energy via high energy particles, a biochemistry able to support Darwinian evolution can be conceived (Goldanskii 1996).

The reactions in liquid-phase present numerous advantages compared to other reactions in solid or gas-phase. Several studies were conducted in order to understand the behaviour of particular solvents for life in alternative to water.

Liquid ammonia is considered to be a possible solvent for life because it has some characteristics very similar to water. Ammonia is liquid over a wide range of temperatures (195-240 K at 1 atm) and the liquid range is even broader at higher pressure. Ammonia, like water, dissolves many organic compounds, but the increased ability of ammonia to dissolve hydrophobic organic molecules suggests an increased difficulty in using the hydrophobic effect to generate

compartmentalization in ammonia, relative to water. This implies that liposomes, a compartment that works in water, generally will not work in liquid ammonia.

Ammonia is not the only polar solvent that might serve as an alternative to water.

For example, sulphuric acid is a reasonably good solvent that supports chemical reactivity (Olah *et al.* 1978). Sulphuric acid is known to be common in Venus (Kolodner & Steffes 1998). Many authors have discussed the possibility of life on Venus in its acidic environments (Colin & Kasting 1992, Cockell 1999), replacing earlier views that Venus might be covered by swamps (Arrhenius 1918) or by hot seas at the poles (Seckbach & Libby 1970).

Formamide is the third solvent of biological interest. Formamide is formed by the reaction of hydrogen cyanide with water, and is polar like water. In formamide, however, many species that are thermodynamically unstable in water with respect to hydrolysis, are spontaneously synthesized. These include ATP (from ADP and inorganic phosphates), nucleosides (Saladino *et al.* 2003, Ricardo *et al.* 2004), peptides from amino acids, and even oligoribonucleotides (Schoffstall 1976, Schoffstall & Liang 1985). The fact that formamide provides a simple-chemical frame into which all the steps from the one-carbon atom compound (H_2NCOH) to activated nucleotides have been described, suggested to investigate the process of self-polymerization between cyclic nucleotides in pure formamide at high temperature. According to previous studies (Verlander *et al.* 1973), we have started with 2',3'-cyclic nucleotides because they have an energetic advantage and at the same time they are the major chemical end-products produced in RNA degradation. We have characterized the self-polymerization of adenosine cyclic 2'-3' phosphate in our conditions (fig 30 HPLC), providing the proof of principle for the plausibility of this general mechanism. Even if the ΔG° is the major obstacle for liquid-phase polymerizations in prebiotic conditions (van Holde 1980), we have found that in formamide adenosine cyclic 2'-3' phosphate, also in the presence of mineral phosphate, could spontaneously polymerize affording ribooligomers of 5-6 residues. However, extant organisms live in water, not in formamide. And the structure and properties of nucleic acids strongly hint that interactions with water is one of their

most intimate properties. At what stage could the passage from a formamide environment to water have occurred?

Water as the solvent

Water certainly appears to be required for Terran life, which appears to live only under conditions where water is a liquid. Thus, the extremophiles that live above 373K on the ocean floor do so only because high pressures there keep water liquid. Bacteria in the Antarctic ice pack presumably require melting to grow (Laybourn-Parry 2002, Junge *et al.* 2004). Virtually every environment on Earth that has been examined, from deep in mine shafts to deep in oceans, seems to hold life that has evolved from the universal ancestor of all life on Earth. As long as water is available, life finds a way to exploit whatever thermodynamic disequilibria exists (Gold 1992, Stevens 1997). This experience suggests that Terran life needs water. Most of the literature in this area comments on properties of water that make it well suited for life.

Water, for example, expands when it freezes. This is useful to process rocks to make soils. This expansion also means that ice floats, permitting surface ice to insulate liquid water beneath, which can harbor life on an otherwise freezing planet.

Another feature of liquid water is the hydrophobic effect. This is a manifestation of the fact that water forms stronger hydrogen bonds to other water molecules than to oily molecules. The hydrophobic effect is key to the formation of membranes, which in turn support isolation strategies in Terran life. Likewise, when proteins fold, they put their amino acids inside, away from water.

On the other hand, water engages in undesired reactions as well. Thus, cytidine hydrolytically deaminates to give uridine with a half life of ca. 70 years in water at 300K (Frick *et al.* 1987). Adenosine hydrolytically deaminates to inosine and guanosine hydrolytically deaminates to xanthosine at only slightly slower rates. As a consequence, Terran DNA in water must be continuously repaired.

In order to perform all reactions, many biomolecules must be soluble in water. This is the simplest explanation for the prevalence of hydroxyl groups in organic molecules central to biological metabolism. Charge also helps dissolution in water. Many intermediates in Terran metabolism are phosphorylated, giving them charges that increase solubility in water.

DNA, the molecule at the center of Darwinian evolution on Earth, shows the importance of being soluble (Westheimer 1987). The DNA duplex, where polyanion binds another polyanion, appears to disregard Coulomb's law (Linkletter *et al.* 2001, Reddy & Bruice 2003). Many efforts have been made to create non-ionic analogs of DNA and RNA. However, the results suggest three hypotheses in order to explain why charged phosphate linkage are important to molecular recognition in DNA. First, the repeating charges in the backbone force inter-strand interactions away from the backbone, causing the strands to contact at the Watson-Crick edge of the heterocycles. Without the polyanionic backbone, inter-strand contacts can be anywhere (Steinbeck & Richert 1998). Further, the repeating charges in the backbone keep DNA strands from folding. Last, the repeating backbone charges allow DNA to support Darwinian evolution. The polyanionic backbone dominates the physical properties of DNA. In replication process, replacing one nucleobase by another has only a minimal impact on the physical behaviour of the molecule. This allows nucleobases to be replaced during Darwinian evolution without losing properties essential for replication. For this reason, a repeating charge may be a universal structure of any genetic molecule that supports Darwinian evolution in water (Benner & Hutter 2002).

GENERATION OF LONG RNA CHAINS IN WATER

How RNA polymerization was started?

The solution of the ribose stability problem (Ricardo *et al.*, 2004), the in vitro functional evolution of RNA (Lincoln & Joyce 2009), and the template-directed synthesis of a genetic polymer in model protocells (Mansy *et al.* 2008), embody the coming of age of the reconstruction of life bound processes and of *ab initio* synthetic biology. A key initial step missing is an abiotically plausible synthesis of RNA. In order to fill this gap, the robust synthesis and the simultaneous presence of all the necessary nucleic acid precursors (Saladino *et al.* 2008), an abiotic procedure for their activation, and a thermodynamically sound polymerization mechanism are needed. The simpler are the precursor molecules and the processes involved, the higher is the probability that prebiotic polymerization might have actually taken place in that context. Thus, we have asked the question: does a unitary simple physical-chemical frame exist in which nucleosides may phosphorylate, oligomerize and possibly ligate to yield larger oligonucleotide fragments? In this logic we have analyzed nucleotide oligomerization in the simple environment: water at moderate temperature. In spite of the limits set by the standard state Gibbs free energy change problem (van Holde 1980, Alberty 2006), we have observed that the process does actually take place.

Syntheses from cyclic nucleotides. 3',5'-cGMP

The first aim of our work is to produce RNA chains from monomers in simple abiotic conditions. We started from 3',5'-cGMP in solution and we have observed the formation of oligomers. Figure 1 shows the products of polymerization obtained by treating 3',5'-cGMP in water. It is evident that cyclic-GMP have the ability to polymerize into RNA chains that reached a size of at least 25 nucleotides, the

predominant oligomer being the 8mer. Fig 1, Panel A, reports the synthesis obtained at 85°C as a function of the 3',5'-cGMP concentration, showing that above the optimal concentration of 1 mM, chain elongation is impaired and the preferentially formed 8mer accumulates. Fig. 1, Panels B and C, show the syntheses obtained at the optimal 1 mM and at the highest possible, before aggregation, 100 mM concentration as a function of the temperature. In both cases the highest temperature tested was the most favourable for chain extension. Below 60°C the reaction rate dropped rapidly (data not shown). The oligomers shown are the products of synthetic reactions lasting 1 hour. In kinetic analyses it was observed that at the optimal concentration (1 mM) synthesis was fast, a *N_{avg}* of 11.8 being reached during handling time (< 1 min), followed by slow stepwise further growth. The kinetic constant of this further growth was determined by measuring the *N_{avg}* of the oligo G chains formed as a function of time at 85°C with 1 mM 3',5'-cGMP and was 0.4 x h⁻¹.

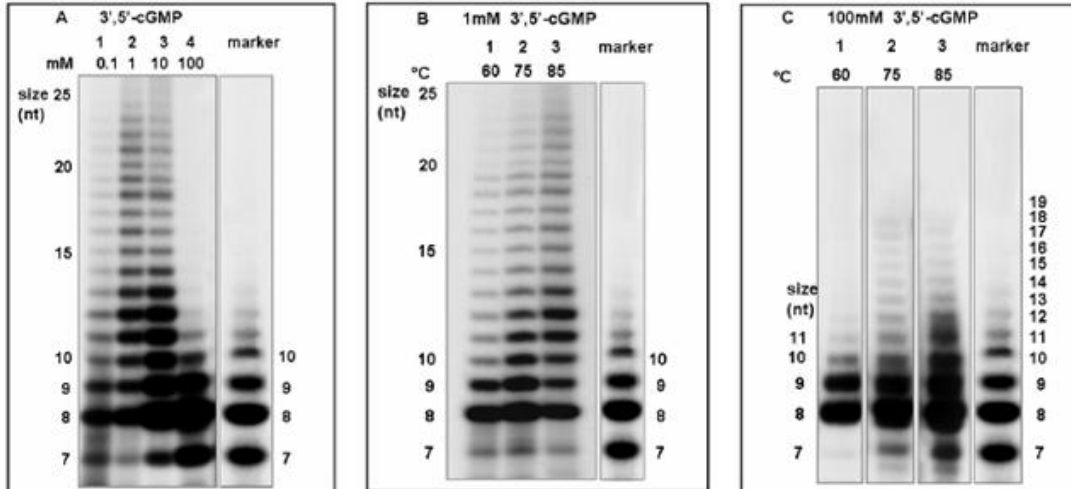

Fig. 1: Nonenzymatic polymerization of 3',5'-cGMP in water. Panel A, 3',5'-cGMP reacted at 0.1 (lane 1), 1 (lane 2), 10 (lane 3) or 100 (lane 4) mM concentration at 85°C for 1h in Tris HCl-buffered water, pH 8.2. Panel B and Panel C, nonenzymatic polymerization of 3',5'-cGMP at 60°C (lane 1), 75 (lane 2), or 85°C (lane 3) for 1h in Tris HCl-buffered water, pH 8.2 , 1 mM 3',5'-cGMP and 100 mM respectively (Costanzo *et al.* 2009).

3',5'-cAMP

Under the same conditions of the 3',5'-cGMP polymerization, 3',5'-cAMP polymerized by a two-steps mechanism. Figure 2 shows (lane1) that at the beginning of the reaction a family of short oligomers was synthesized rapidly. The steady-state N_{avg} of 5.32 was reached by 60 min (50% of molecules formed in 20 min). The kinetic constant of the reaction leading to the formation of the short Oligo A molecules (N_{avg} of 5.32) was determined at 85°C and was $2 \times h^{-1}$.

The short oligomers did not continue growing by ladder-wise addition, as for 3',5'-cGMP, but extended their size forming a heterogeneous population (Fig. 2, lane 2)

in which a rapidly formed 16mer was prominent. Sequence extension lasted 200 hours, forming molecules > 100 nucleotides long (Fig. 2, lane 4). The oligomers growth was size-discontinuous (see the numbering at the side of lane 4), comprising a complex series of fragments. Such heterogeneous numerical distribution is best interpreted as the result of ligation of short pieces. A model study (Pino *et al.* 2008) showed that mixing a limited number of different RNA oligomers in water yields a complex population of differently sized RNA fragments by nonenzymatic ligation. Polymerization of 3',5'-cUMP and 3',5'-cCMP yielded only short fragments (*N_{avg}* of 5.49 and 5.45 respectively) at 85°C, which did not grow further.

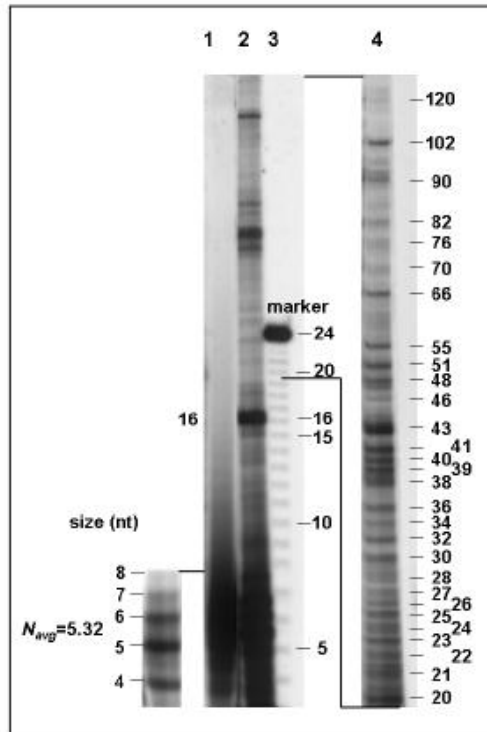

Fig. 2: Nonenzymatic polymerization of 3',5'-cAMP in water. 3',5'-cAMP reacted in water (85°C) for 30 min (lane 1) or 3 h (lane 2). Marker: hydrolyzed 24mer Poly(A). Lane 4, blow-up analysis of the population of fragments encompassed between 20 and > 120 nucleotides, 2×10^2 h of reaction (Costanzo *et al.* 2009).

The choice of using cyclic nucleotides in polymerization reactions is not casual. Cyclic nucleotides monophosphate were suggested as possible prebiotic compounds (Renz *et al.* 1971, Usher & McHale 1976), the driving force for polymerization being their high reactivity and the large negative standard enthalpy of hydrolysis.

The prebiotic relevance of these polymerizations was questioned because efficient synthesis was observed with 2',3'- but not with 3',5'-cyclic forms.

Cyclic monophosphate nucleosides are obtained abiotically and their stability is the main characteristic that they need to conserve. A possible solution is provided by the observation that in monophosphate ribonucleotides the 3' phosphate bond, the weakest bond in water, is stabilized upon polymerization (Saladino *et al.* 2006).

This property may endow the polymer with an evolutionary edge over the monomer, allowing accumulation of complex chemical information.

RNase analyses of the neo-formed bonds

The type of phosphate bond formed in the polymers derived from 3',5'-cGMP and 3',5'-cAMP was analyzed by enzymatic digestion with Snake Venom Phosphodiesterase I, a 5'-exonuclease cleaving 3',5' and 2',5' phosphodiester bonds, and with P1 endonuclease which is a 3',5'-specific ribonuclease.

Treatment of the products of polymerization with 1mU of SVPD I or of P1 for 20 min at 37°C completely converted the oligos into monomers, showing that the bonds formed are canonical 3',5' phosphodiester bonds.

Mechanism of polymerization

The RNase digestion mentioned above shows that the bonds formed by polymerization of 3',5'-cyclic nucleosides are standard 3'-5' phosphodiester bonds. The combined SVPD I and P1 RNase analyses rule out the formation of 2'-5' bonds, of pyrophosphate bonds, or more complex alternatives.

3',5'-cyclic nucleoside monophosphate hydrolyze in water yielding (in the temperature and pH conditions in which polymerization occurs) a mixture of 5' and 3' monophosphates, as verified by HPLC (data not shown), and as originally reported by Smith and coworkers (Smith *et al.* 1960).

Thus, the polymerization could occur according to two different alternative models as shown in Figure 3.

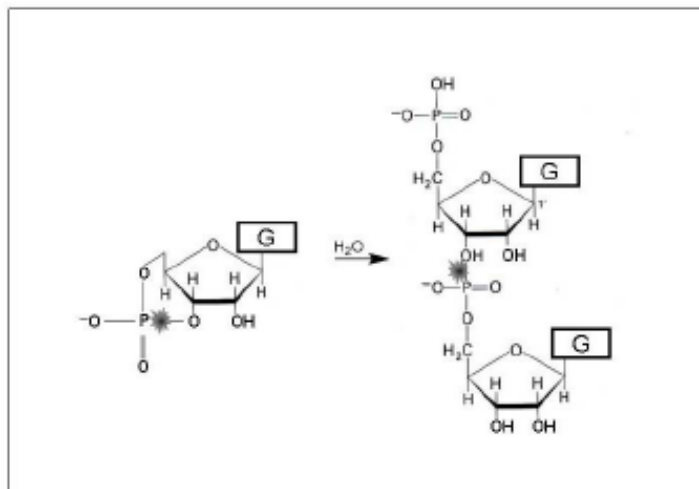

Fig. 3: A simple model for the polymerization of 3',5'-cGMP (Costanzo *et al.* 2009).

- A) model A: the reactive species is a 5'XMP afforded by the opening of the 3' phosphoester bond of the cyclic nucleotide. In this case, the polymerization would occur via the 5' phosphate reacting with the 3' OH of another 5'XMP, as indicated by the spark symbol in Fig. 3.
- B) model B: the reactive species is a 3'XMP and the polymerization occurs via the 3' phosphate reacting with the unphosphorylated 5' extremity of another 3'XMP molecule (model B not shown).

The bias would be solved in favor of model A for two reasons:

- 1) the enthalpy of hydrolysis of the 3' bond of guanosine 3',5'-monophosphate is indication of a high energy bond, being -10,500 cal per mole. The enthalpy of the same bond of adenosine 3',5'-monophosphate is -14,100 cal per mole (Greengard *et al.* 1969). These energy values imply that the 3' bonds are easily broken in water leading the phosphate group on the top of sugar molecule.
- 2) Neo-formed oligo G, obtained as described in Fig. 1, can ligate to the 3' non-phosphorylated extremity of an acceptor oligo through 3'-5' phosphodiester bonds (as schematically described in Fig. 5). The experiments reported below (Fig. 4-6) show that the neo-formed oligo G ligated with 3'-5' bonds to the 3' OH extremity of a 5'C₂₄3' and of a 5'A₁₂C₁₂3' oligomer. Thus, model A applies.

The problem of the precursors in nonenzymatic polymerization

Nonenzymatic polymerizations require pre-activated monomers (van Holde 1980, Alberty 2006). The results obtained with the phosphoramidated nucleotides commonly used (Lohrmann 1977, Ferris *et al.* 2004, Mansy *et al.* 2008) show that the accumulation of polymerized forms is possible once suitable activated monomers are available. Although these studies provide useful data on the formation and properties of RNA oligomers formed by chemical synthesis, their prebiotic relevance was questioned (Orgel 1998, 2004).

An innovative nonenzymatic polymerization system was recently reported describing the lipid-assisted synthesis of RNA-like polymers from mononucleotides (Rajamani *et al.* 2008). In this system the synthesis of phosphodiester bonds was

driven by the chemical potential of fluctuating anhydrous and hydrated conditions, with heat providing the activation energy. However, chemical complexity prevented the full analysis of the RNA-like products of this otherwise promising system.

In the possibly simplest activation system so far described, the phosphorylation of nucleosides by free phosphates or phosphate mineral was observed both in formamide (Costanzo *et al.*, 2007) and in water (Saladino *et al.* 2008).

The treatment of adenosine in water with 1M KH_2PO_4 afforded 2'AMP, 3'AMP, 5'AMP, 2',3'cAMP and 3',5'cAMP providing prebiotically plausible precursors to polymerization. A high concentration of phosphate donor is necessary and in optimized conditions (16 hrs, 1M KH_2PO_4 , 90°C, pH 6.1) the total amount of phosphorylated products reaches only the 7.3% of the input of adenosine. In these conditions the half-lives of the open phosphorylated forms 2'AMP, 3'AMP, 5'AMP are 15, 23, and 35 hours, respectively, while the 2',3'- and 3',5'-cAMP cyclic forms have half-lives of 165 and 450 hours. Adenosine half-life in the same environments is 450 hours. Thus, although not efficiently, the formation of cyclic nucleotides also occurs in water. Furthermore cyclic monophosphate nucleosides can be synthesized abiotically by a two stage nucleobase assembly process on a sugar-phosphate scaffold, as shown for cytidine-2',3'-cyclic phosphate (Powner *et al.* 2009).

These observations highlight the possibility that nucleoside phosphorylation does occur in water, albeit in conditions that do not allow their survival for a long time, thus preventing their accumulation. Protective conditions like micelles, interaction with mineral surface (Ciciriello *et al.* 2007) or inner strata [i.e. in clays (Bernal 1949, Cairns-Smith 1966)], cycles of displacement into cooler surroundings, might have played an important role in the formation and accumulation of activated precursors.

RNA chain extension.

The oligomerization capacity of cyclic nucleotides was further analyzed. We have tried to answer the question: do cyclic nucleotides polymerize in the presence of preformed oligonucleotides? The answer is positive.

The following oligonucleotides were tested : 5'³²P-A₂₄3', 5'³²P-C₂₄3', 5'³²P-A₁₂C₁₂3', 5'³²P-A₁₂U₁₂3', 5'³²P-U₂₄3', 5'³²P-G₂₄3'. Each of these oligos was reacted with 3',5'-cAMP, 3',5'-cGMP, 3',5'-cCMP, 3',5'-cUMP.

Fig. 4 Panel A shows the results of the reaction of 5'-labelled 5'³²P-C₂₄3' with different concentration of unlabelled 3',5'-cAMP, 3',5'-cGMP, 3',5'-cCMP, 3',5'-cUMP, as indicated.

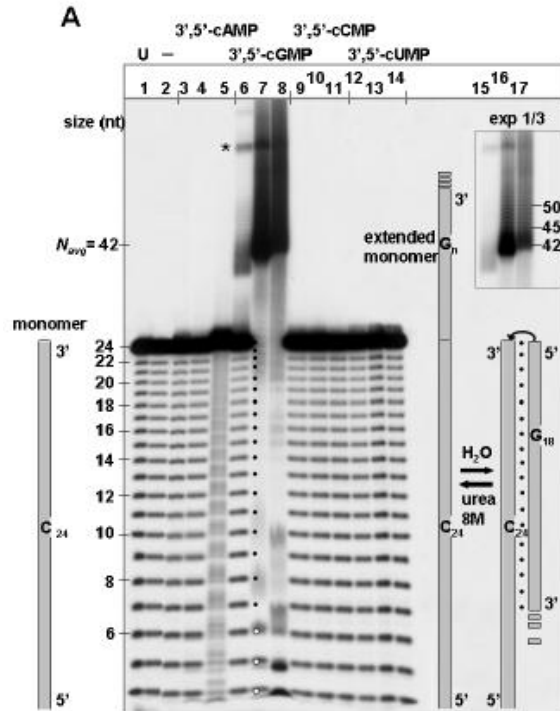

Fig. 4A: RNA-chain extension by 3',5'-cGMP-fed polymerization. 5'-labeled 5'C₂₄3' reacted with 3',5'-cAMP (lanes 3-5), 3',5'-cGMP (lanes 6-8), 3',5'-cCMP (lanes 9-11), or 3',5'-cUMP (lanes 12-14). Each group of three lanes contained 0.1, 1.0, or 10 mM nucleotide, respectively. The reaction was in Tris-HCl- buffered water (pH 5.4) at 60°C for 6h. Lane 1:U, untreated; lane2: no nucleotide. Inset: one-third autoradiographic exposure of the corresponding part of the gel. The model interprets the structure of the polymer in denaturing (left) and water condition (right) . The polymer indicated by the asterisk is formed only in the presence of 3',5'-cGMP. This multimer is interpreted as a dimeric form of the extended monomer, possibly caused by oligonucleotide G-oligonucleotide G ligation (Costanzo *et al.* 2009).

The key observation is that 3',5'-cGMP actively reacted with the preformed oligo, affording longer fragments. In particular: a group of molecules with a number average (N_{avg}) of 42 formed in the presence of 3',5'-cGMP (lanes 6-8), that grew up to an observed length of > 50 nt in the presence of the higher concentration of cyclic nucleotide (as counted in the right corner inset, showing a lower exposure of the relevant gel position). A slower migration band is also observed in the upper part of the lanes 6-8 (asterisk), probably representing a dimeric form of the extended sequence. The N_{avg} was calculated from graphical extrapolation of gel positions in the appropriate autoradiographic exposure. All the 5'C₂₄3' fragments covalently reacted with oligo G (lanes 7 and 8) and formed a new population reaching an average length of 42. This entails that in the solution in which the reaction takes place Oligo Cs and Oligo Gs interact, presumably by base-pairing, to form a double-strand. Double-strands withstand hydrolysis more than single strands. If this occurs also in our conditions and sequence setup, a circa 18 base-long footprint should be produced, which is actually observed (Fig. 4A, dots in lane 7; scheme on the right side). The open dots at the bottom of the lane indicate where the footprint is not observed. The following is also noted: the treatment of 5'C₂₄3' with 3',5'-cAMP does not support polymerization growing on the 3' extremity nor supports multimerization by ligation as observed for 5'A₂₄3' oligos (Pino *et al.* 2008). However 3',5'-cAMP, at 10 mM concentration, only enhances the hydrolytic degradation of the 5'C₂₄3' oligonucleotide (lane 5).

3',5'-cCMP and 3',5'-cUMP are inert. Thus, only the reaction of oligo C with 3',5'-cGMP was explored further.

Fig. 4 Panel B shows the RNA chain extension of 5'C₂₄3' by 3',5'-cGMP as a function of cyclic nucleotide concentration.

We can notice in the figure that the production of polymeric forms are dependent on the ratio between preformed oligo 5'C₂₄3' and the amount of 3',5'-cGMP in the reaction. The low doses of 3',5'-cGMP can stimulate the formation of the polymers only marginally (Fig. 4, Panel B lanes 3-4) but at higher amount of cyclic nucleotide the amount of polymers formed is massive and every molecule of preformed oligos in solution can react (Fig. 4, Panel B lane 7-8).

However, the band compression effect characteristic of the C residues prevents a better resolution of high molecular weight oligomers and a more precise evaluation of fragment lengths. For this reason the system was further explored with higher precision in 5'A₁₂C₁₂3' polymers. Fig. 4 Panel C shows selected example of the same reaction on 5'A₁₂C₁₂3'.

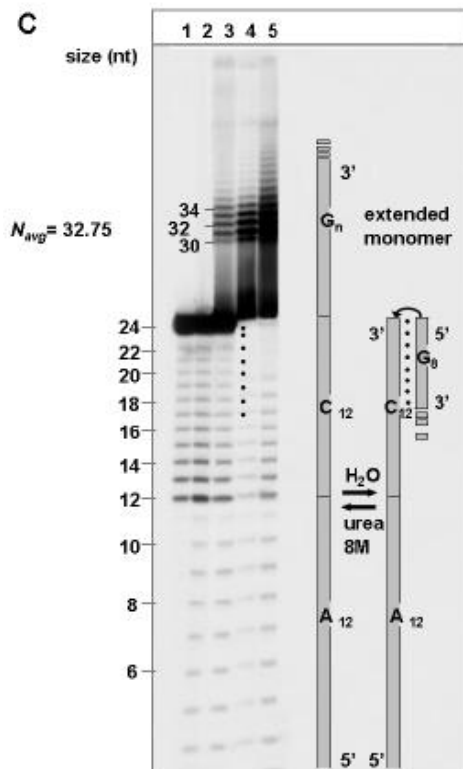

Fig. 4C: 5'-labeled 5'A₁₂C₁₂3' reacted with 3',5'-cGMP. Lane 1: untreated; lane 2: 6h, Tris-HCl-buffered water pH5.4, 60°C. The C₁₂ segment undergoes hydrolysis faster than the A₁₂ segment. Lanes 3-5: as in lane 2, in the presence of 0.1, 0.4, and 2 mM 3',5'-cGMP, respectively. The fragment sizes of the G-encompassing fragments were determined by top-down band counting starting from the 48-mer dimer (24 x 2) in overexposed gel images (Costanzo *et al.* 2009).

Consistent with the calculated N_{avg} of the Oligo G polymerized from 3',5'-cGMP reported in Fig. 1 (in synthesis reactions in which the 8mer was prevailing), the family of Oligo Gs that polymerize from 3',5'-cGMP in the presence of the 5'A₁₂C₁₂3' 24mer and that ligated to its 3' C-extremity had a N_{avg} of 8.75 (Fig. 4 Panel C). This N_{avg} value was determined from the N_{avg} calculated from the fragment sizes observed in the gel migration ladder (N_{avg} = 32.75) subtracting 24 (that is the size of the acceptor 24mer oligo). The following is also noted: the footprint on the C₁₂ moiety is shorter relative to the one on the C₂₄ oligo, as shorter are the chains produced (N_{avg} = 32.75, corresponding to an extension of 8.75 on the 24mer and to a footprint \geq 8 residues, as indicated by dots) and as predicted in a model based on the PolyC - PolyG base pairing in water.

3',5'-cAMP, 3',5'-cCMP, and 3',5'-cUMP did not support chain extension on the 5'A₁₂C₁₂3' (nor on the 5'C₂₄3' - data not shown).

The pre-synthesized Oligo G did not bind to (nor 3',5'-cGMP-fed polymerization occurred on) pre-synthesized PolyA oligos (data not shown), thus excluding that the 5'A extremity of the 5'A₁₂C₁₂3' molecule supported RNA chain extension on the PolyC oligonucleotides. The fact that a footprint is observed starting from the position in which sequence extension begins (i.e. , the 3' extremity) and is oriented in the specular direction , provides an assay for the presence of newly formed complementary sequences. No footprint is observed on the 5'extremity, indicating that sequence extension only occurs on the 3'-OH extremity based on the 5' P-group from the incoming molecule, and not *viceversa*.

A quantitative evaluation of the RNA chain extension occurring on 5'C₂₄3' and on 5'A₁₂C₁₂3' as a function of the cyclic nucleotide concentration is reported in Fig.4 Panel D.

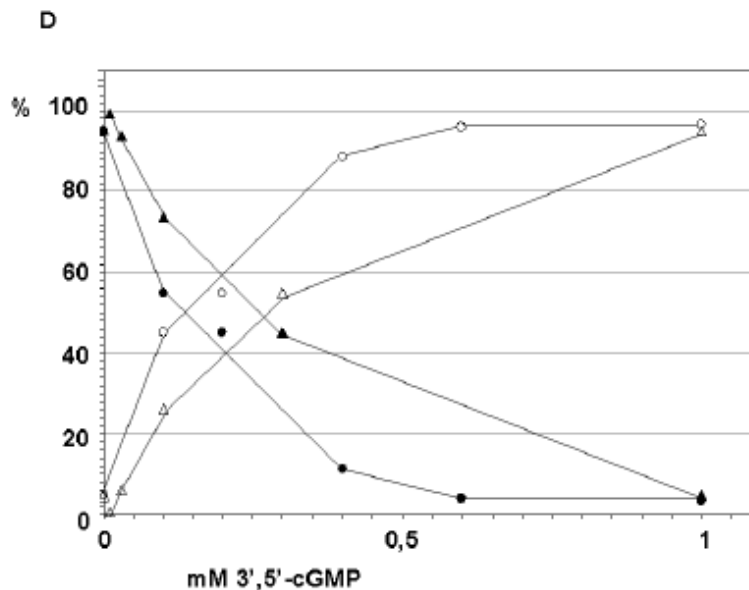

Fig.4D: chain extension of 5'C₂₄3' and of a 5'A₁₂C₁₂3' as a function of 3',5'-cGMP concentration. The data points show the % of full sized monomer molecules (filled symbols: ▲, 5'C₂₄3'; ●, 5'A₁₂C₁₂3') and of the extended molecules (open symbols, Δ and O) as a function of the 3',5'-cGMP concentration indicated on the abscissa. Data are from the experiments reported in Fig. 4B (Costanzo *et al.* 2009).

The plot shows that the growth of short segments occurring on 5'A₁₂C₁₂3' ($N_{avg}=8.75$) levels off a lower concentration of 3',5'-cGMP, relative to the growth on 5'C₂₄3' ($N_{avg}=18$). The kinetic constant of the reactions leading to the formation of the extended monomers could not be determined because the reaction was too fast even at the lowest concentration tested (200 nM 5'C₂₄3' and 1μM 3',5'-cGMP), at

40°C. In conclusion, 3',5'-cGMP efficiently polymerizes in the presence of PolyC and is covalently bound to its 3' extremity. Given that the 3' extremity of 5'A₁₂C₁₂3' oligo bears no phosphate but ends by OH in 3', and given that the ligation occurred via 3'-5' phosphodiester bonds the observed chain extension necessarily occurred by ligation through the 5' phosphate group carried by the neo-polymerized Oligo G, as shown in Fig. 5.

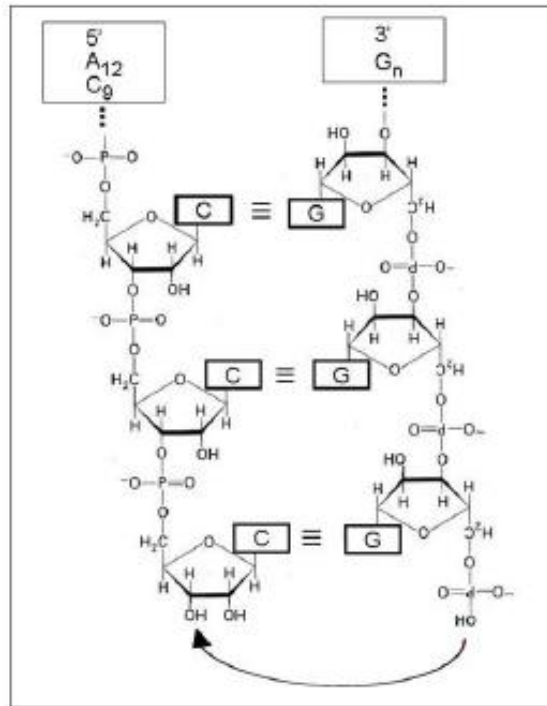

Fig. 5: The 5'A₁₂C₁₂3' oligonucleotide (schematically shown in its 3'-extremity (left) ligates to a neo-synthesized base-paired oligonucleotide G segment (right) through a standard 3'-5' phosphodiester bond (Costanzo *et al.* 2009).

RNA extension: characterization of the neo-formed bonds

In order to investigate the kind of bonds in neo-formed RNA chains the 5'A₁₂C₁₂3' oligo was reacted with 3',5'-cGMP (60°C, 6 hrs, 400 μM 3',5'-cGMP) and then treated with T1 or SVPD I ribonucleases. RNase T1 is a 3',5'-specific ribonuclease, it cleaves at the 3'-end of G residues whilst SVPD I is a 5'-exonuclease that cleaves both 2',5'- and 3',5'-phosphodiester linkages.

Figure 6 shows that the 5'A₁₂C₁₂G_{8.75}3' is sensitive to the two nucleases, thus confirming the 3'-5' nature of the phosphodiester bonds formed, both in the Oligo G and between the Oligo G and the 5'A₁₂C₁₂3' oligomer.

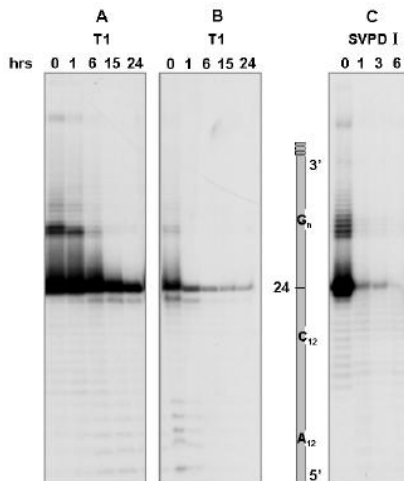

Fig. 6: T1 and SVPD I ribonuclease treatment of the 5'A₁₂C₁₂G_{8.75}3' RNA, synthesized as in Fig. 4C.A, treatment of the 5'-labeled RNA with 40 units of T1 for the indicated times. B, 400 units.C, SVPD I treatment with 330 μU for the indicated times (Costanzo *et al.* 2009).

A vast literature has accumulated on the preferential formation of the 3'-5' over the 2'-5' phosphodiester linkages or (more often) its contrary, in oligomerizations entailing nucleoside-5'-phosphorimidazolides and related phosphorimidates, or in carbodiimide-mediated ligations (Orgel 2004). The syntheses may preferentially form one type of linkage (i.e., the 2'-3' linkage) (Lutay *et al.* 2006) or the other (Rohatgi *et al.* 1996), or both (Sawai *et al.* 2006). The summary of our RNases analyses is that: in the oligomers formed from 3',5'-cGMP and 3',5'-cAMP the linkage is 3'-5'. The discrepancy with the fact that the 2'-3' is the most commonly observed linkage in abiotic polymerizations from preactivated compounds may be explained simply by the fact that none of the previously reported syntheses was performed with 3'-5' cyclic nucleotides in water, as in our case.

Polymerization as the way-out from degradation

It was reported that in the ribo system the weakest bond, the 3' phosphoester bond, is more stable in the polymer than in the precursor monomers (Saladino *et al.* 2006 a). This effect can be further enhanced by the presence of small external molecules (i.e., free phosphates) (Saladino *et al.* 2006 b) and is larger at defined pH values (Ciciriello *et al.* 2008). Higher stability of the polymeric form entails its accumulation. Thus, if phosphorylated nucleosides polymerized spontaneously, they could have accumulated in the form of polymers, and this would have occurred in the same environment of their phosphorylation. Consequently, the observation of nonenzymatically polymerized RNA would sketch a plausible thermodynamic scenario for the origin of informational polymers. The observed polymerization only occur with cyclic nucleotides and do not take place with open nucleotide forms. Sizeable polymerization is observed only with 3',5'cyclic nucleotides while the 2',3'cyclic ones only afford very short chain. These facts help to focus on the possible mechanism, based on the formation of the internucleotide bonds requiring the opening of the cyclic phosphate bridge .

Renz and coworkers reported the nonenzymatic joining of oligoadenilates on a polyuridylic acid template (Renz *et al.* 1971). They showed that 3',5'-linked hexadenilic acid with a 2',3'-cyclic phosphate terminus was able to couple on a polyuridylic acid template in the presence of ethylenediamine, yielding mostly a dodecamer. Before that, syntheses of oligomers were obtained from 2',3'-cyclic AMP (Usher & McHale 1976) upon polymerization on a PolyU or from 2',3'-cyclic AMP evaporated from solution in the presence of catalysts such as aliphatic diamines (Verlander *et al.* 1973). The self-polymerization afforded oligonucleotides of chain length up to at least 6. In both reported reactions the opening of the phosphate cyclic bridge supposedly provided the necessary activation energy. Nonenzymatic template-directed ligation of terminally pre-activated oligonucleotides was extensively studied (Rohatgi *et al.* 1996, Joyce 2004, Sawai *et al.* 2006, Mansy *et al.* 2008). In these works the formation of the internal phosphodiester bond is attributed to the template-mediated proximity of the reactive groups. At the contrary of these systems, our syntheses require no special preactivation, no catalysts and no dry-chemistry, polymerization spontaneously occurring in water.

A role for stacking interactions

The explanation for the formation of ribooligomers, starting from the simple interaction of 3',5'-cyclic nucleotides, is quite difficult. The possible catalytic role in oligomerization by minerals that act as catalysts for the synthesis of nucleic bases (Saladino *et al.* 2006 b) and, in several instance, also for the their phosphorylation was disproved. Different kinds of minerals, such as hydroxylapatite, libethenite, ludjibaite, reichenbachite, montmorillonite clays, TiO₂ and olivine were tested in syntheses reactions, all with negative results. Thus, the system described here seems not to depend on surface interaction.

How the template- and mineral-independent polymer formation in water is possibly justified? The enthalpies of hydrolysis of acyclic, monocyclic and glycoside cyclic phosphate diesters are described in detail (Gerlt *et al.* 1975). While five-membered cyclic phosphate as 2',3'-cyclic nucleotides are strained and do actually undergo polymerization (Usher & McHale 1976, Verlander *et al.* 1973), it was recognized that a six-membered cyclic phosphate (Gerlt *et al.* 1975) is not subjected to excessive strain, and maybe difficult to polymerize. Nevertheless, polymerization of cyclic phosphate has been achieved with aminoacid acyl cyclic-3',5' nucleotides (Aylward & Bofinger 2007). In this latter case polymerization was explained by the fact that the molecule acts as its own catalyst in that the protonated amino group forms a strong hydrogen bond to one of the oxygen atoms attached to phosphorus in a six-membered ring, thus allowing quasi-stacking of the nucleotide bases, followed by polymerization. Starting from our observation that 3',5'-cyclic nucleotides actually polymerize, the question thus pertains in the first place to the conditions allowing stacking of nucleoside monophosphates solution. The phenomenon of base stacking is not yet completely understood. The three-dimensional structure of DNA and RNA are to a large extent determined by base stacking. In contrast to the hydrogen bonding responsible for base pairing, stacking interactions are critically dependent on the aromatic base sequence. Semi-empirical calculations, molecular mechanics, molecular dynamics simulations, and free energy perturbation methods have been used to investigate base stacking (Aida 1988, Cieplak & Kollman 1988). Most of these theoretical studies of base stacking have focused on the base-base interactions and have highlighted that different forces, such as hydrophobic effects or direct electrostatic interactions between the bases, have been suggested as responsible of the dominant contribution to the stabilization of base stacks (Newcomb & Gellman 1994). The driving force for the stacking interaction is that the stacked conformation is most favored in aqueous solvent (Norberg & Nilson 2002). The induced dipole interactions between the pi electron clouds of stacked bases was also pointed out as stacking agent (Cantor & Schimmel 1980).

Aqueous media bias nucleic acids towards ordered conformation, one possibility being provided by the fact that water has a relatively high surface tension (Sinanoglou & Abdulnur 1964). However, thermodynamic studies of complex formation between actinomycin and deoxyguanosine in a series of solvent mixtures (Crothers & Ratner 1968) favor the standard view of hydrophobic effects as arising from an ordering of solvent molecules around the solute over the description in terms of varying solvent surface tension. Other solvents (methanol, glycol, formamide, glycerol, ethanol, *n*-propanol, *n*-butanol and DMSO) have lower dielectric constant and increase the electronic destabilization of a nucleic acid helix (Wacker 1968). Stacking free energy profiles for all 16 natural ribonucleoside monophosphates in aqueous solution were reported (Olson 1975, Norberg & Nilsson 1995). The potential of mean force calculations showed that the free energy profiles displayed the deepest minima and the highest barriers, and therefore the highest stacking abilities, for purine-purine dimers, especially for ApA and GpG.

The free energy of stabilizing the stacked state were 2-6 Kcal/mol higher for purine-purine dimers than for pyrimidine-pyrimidine dimers. The explanation for the formation of oligonucleotides in solution thus relies on stacking for the passage from monomer to short oligonucleotides, and on the ability of RNA to interact with itself, not only by sequence-determined hydrogen bonding but also by stacking.

The explanation for the formation of long sequences by terminal ligation relies in the studies by Holcomb and Tinoco (Holcomb & Tinoco 1965) and by Brahms et al (Brahms *et al.* 1966) who first described the double-strand formation by ribo PolyA and the relationship between PolyA length and strand coupling (Brahms *et al.* 1966). The study of the free energy profiles of stacking for all 16 natural ribonucleoside monophosphates based on potential of mean force calculations shows that many different conformations, with different degrees of stacking are possible, revealing the gradual nature of the stacking phenomenon (Norberg & Nilsson 1995).

This explains the variation in equilibrium constants and fraction stacked of ribonucleoside monophosphates reported in the literature (Brahms *et al.* 1967,

Davis & Tinoco 1968, Ezra *et al.* 1977, Frechet *et al.* 1979, Kang *et al.* 1992) and predicts that various degrees of stacking may occur also in suboptimal conditions. Hence, we hypothesize that the oligomerization reactions from 3',5'-cGMP and from 3',5'-cAMP described in Fig. 1 and 2 rely on the stacking interaction of the purine moieties of the cyclic nucleotides, followed by the opening of the phosphodiester cyclic bond and the consequent formation of the inter-nucleotide phosphodiester bridge. However, the sequence extension due to the terminal ligation reaction of PolyG on PolyC described in Fig. 4 (Panels A, B, C) and Fig. 5 occur on antiparallel hydrogen-bonded base-paired double strands. The versatility of the set of nonenzymatic polymerization reactions leading to longer sequences is possibly the most relevant property of these self-polymerizing systems. However, these neo-formed polymers should be stable molecules in order to keep their characteristics and ensure their survival through replication and evolution. In the present analysis, the products of polymerization from 3',5'-cGMP and 3',5'-cAMP showed unexpectedly high $t_{1/2}$ values. It was found that the increased life span of the oligos in water is induced by the presence of the free cyclic nucleotide, presumably due to interference with the hydrolytic degradation process by stacking interaction.

NONENZYMATIC RNA LIGATION IN WATER

Having characterized the phenomenon of RNA elongation in water, we have also identified another mechanism which provide the accumulation of sufficiently long and (pre)genetically meaningful oligomers.

Multimerization was observed by simply leaving pre-synthesized ribo-oligonucleotides in water in the presence of an adenine-based nucleotide cofactor. The reaction is dependent upon time, type of cofactor, oligonucleotide length and sequence, temperature and pH. Figure 7 shows the kinetic of formation of dimer- and tetramer-sized multimers from both a 24-mer ribo-oligonucleotide (5'A₂₃U3');

first five lanes on the left) and from a 23-mer ($5'A_{23}3'$; three rightmost lanes) as a function of increasing treatment periods.

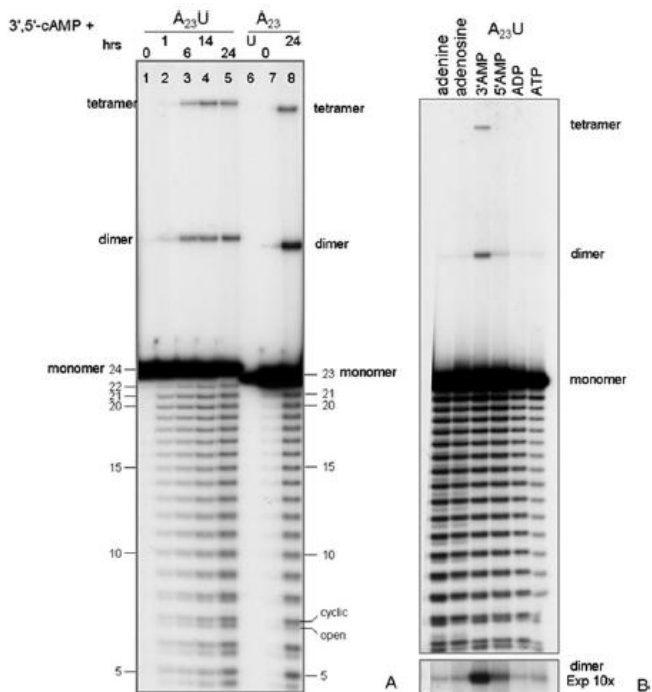

Fig. 7: A, gel electrophoretic images of the reaction products of a 5'-labeled $5'A_{23}U3'$ (lanes 1-5) and of a $5'A_{23}3'$ (lane 6-8) oligomer, as indicated. The monomeric oligonucleotides were treated in water, for the periods of time indicated (hours) on top of each lane. The samples were then treated and analyzed as described under "experimental procedures". During the permanence in water, the oligomers undergo hydrolysis affording the ladder of decreasing fragment lengths and ligation affording the indicated multimers. B, the oligonucleotide A_{23} was reacted in water for 6 h at 60°C in the presence of adenine or of the adenosine-based compound indicated on top of the appropriate lane (final concentration, 10 mM). The lowest part of the Panel is an overexposure (10X) of the section of the image containing the dimer (Pino *et al.* 2008).

RNA oligomers were reacted in Tris-HCl-buffered water at 60°C at pH 6.2. As shown in Fig. 7A the formation of only even-numbered multimers was observed and the formation of dimers precedes in time that of the tetramer. Furthermore, the formation of multimers requires the presence of a cofactor, as detailed in Fig. 7B. In the experiment reported in Fig. 7A, 3',5'-cAMP was present. We also noticed the dependence of ligation upon the concentration of cofactors (data not shown). Poly(A) oligomers ending with a terminal uridine were routinely studied in parallel to the homogeneous Poly(A)s to verify whether two terminal purine bases are a prerequisite for the ligation events to occur. The results show that this is not the case and the ligation occurs for both types of extremities, even though, a relatively higher efficiency was observed for the homogeneous A-stretch (compare in Fig. 7A, lanes 1-5 versus lanes 6-8). In addition to ligation, during the treatment in water, the oligomers also undergo hydrolytic degradation, as shown by the ladder of bands below the monomer-sized 24-mer fragment. The mechanism of RNA hydrolysis is fully characterized (Morrow *et al.* 1995, Soukup & Breaker 1999). The cleavage of phosphoester chain normally requires participation of the 2'-OH group as an internal nucleophile (Soukup & Breaker 1999) in two “nucleophilic cleavage” events: the transesterification and hydrolysis reactions. During transesterification, the 2'-OH nucleophile attacks the tetrahedral phosphorus to afford a 2',3'-cyclic monophosphate. This species is then hydrolyzed into a mixture of 3'- and 2'-phosphate monoesters. Both steps are catalyzed by protons, hydroxide, nitrogen derivatives, and metal ions. The degradation profile characteristically yields a double-banded profile, because of a first cleavage of the 5' phosphodiester bond leaving a 2',3'-cyclic phosphate extremity, which is successively opened resulting in a 2' or 3' phosphate extremity as indicated in the right side of Fig. 7A. Ligation and hydrolytic degradation occur simultaneously. However, no indication of reciprocal interference by the two reactions was observed, aside from the fact that hydrolysis slowly depletes the pool of full-length molecules undergoing ligation.

Cofactors

The nature of the cofactor favoring ligation was explored (Fig. 7B). In addition to 3',5'-cAMP (Fig. 7A), adenine, adenosine 5'-monophosphate, 2',3'-cAMP, ADP, and ATP were analyzed in the same conditions. Active ligation was favored by 2'-AMP (not shown), 3'-AMP, and 5'-AMP. Adenine, adenosine, ADP, and ATP only showed minor stimulation of the reaction. 2',3'-cAMP was not active at all (not shown). Treatment for longer periods did not modify the pattern. In the moderate reaction conditions used (6h, 60°C, pH 6.2), the nucleoside and nucleotide forms are stable, and no transphosphorylation occurs (Saladino *et al.* 2006 a, Costanzo *et al.* 2007). Thus, the observed effect can be attributed to the primary chemical forms tested, excluding the involvement of molecular species deriving from degradation or transphosphorylation.

The effect of fragment size

The spontaneous ligation of preformed polyriboadenylate in water is completed in 14 h in the conditions analyzed here. We have subsequently demonstrated that the dimeric and tetrameric molecules were afforded with a yield that directly depends on the length of the starting oligonucleotides.

Figure 8 shows the results of the same analysis performed on similar but shorter oligomers: 5'A₉U3' and 5'A₁₄U3'.

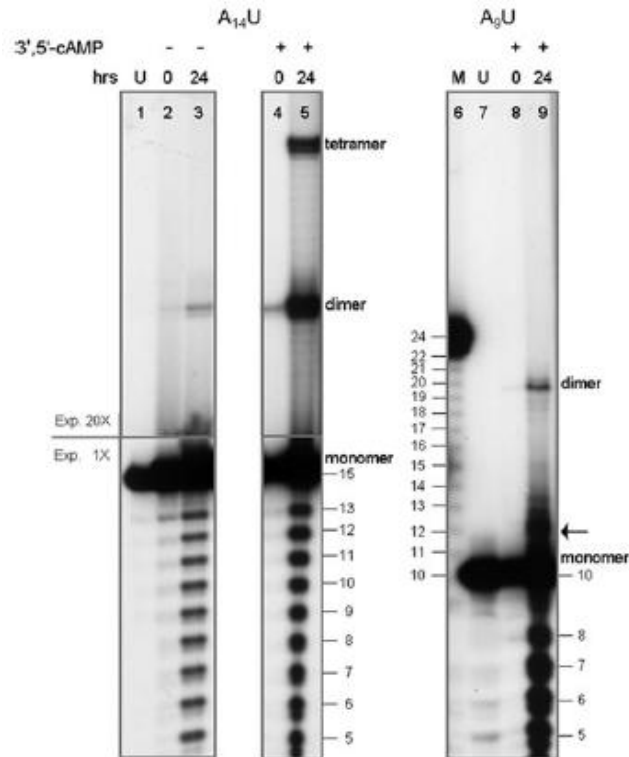

Fig. 8: The ligation reaction was carried out with the 5'A₁₄U3' (lane 1-5) and the 5'A₉U3' (lane 6-9) oligomers in the same conditions described for Fig. 8. The reactions were carried out in the absence (lane 2 and 3) and in the presence (lane 4, 5, 8, 9) of 10 mM 3',5'-cAMP. To show clearly the difference in abundance of the resulting products, the experiment carried on the the 5'A₁₄U3' 15-mer is shown at two different exposure of the autoradiograms: 20X and 1X. U, untreated; M, marker lane, fragments obtained by hydrolysis of 5'-labeled the A₂₃U molecules. The arrow on the right side of the lane 9 points to the presumptive circularization product (Pino *et al.* 2008).

The behavior of the 15-mer (Fig 8, lanes 1-5) is similar to that of the 24-mer (Fig. 7A). The formation of dimers still take place with the 10-mer, although at reduced rate (lane 9). This behavior is consistent with the observation that fragment size is the limiting factor for the formation of multimers. The ligation of 5'A₁₄U3' 15-mer was tested in the absence and in the presence of 3',5'-cAMP as shown in Fig. 8: lanes 2 and 3 and lanes 4 and 5, respectively. In the absence of the cofactor, the ligation of the monomer to yield dimer is marginal and tetramer is not formed at all. However, the very fact that ligation may occur in the absence of an externally added molecular species is in principle relevant per se. The 5'A₉U3' 10-mer undergoes less efficient dimerization in water (Fig. 8, lane 9) and no ligation is evident in the absence of the cofactor (not shown). Molecular forms with molecular size slightly higher than the monomer size are also formed (arrow on the right side of lane 9). One form is particularly evident that is presumably the product of self-ligation leading to a presumptive circular molecule. Despite the strong increase in the multimerization efficiency brought about by a cofactor (3',5'-cAMP or 2'-AMP), the products formed in its absence are of identical size (Fig. 8, lanes 1-5). In the 10-mer the size of the dimer formed is exactly 20, as shown by its correspondence (Fig. 8, lane 9) with the 20-mer in a degradation ladder obtained by hydrolysis of a 24-mer (Fig. 8, lane 6 versus lane 9). This shows that 3',5'-cAMP is not retained in the final product and its function is that of a typical catalysis cofactor, favoring a reaction that would occur anyway. In this respect, it is worth mentioning that adenine dependent self-association of hairpin ribozymes was described (Li *et al.* 2008), not followed by covalent linking. The report dealt with ribozymes that are dependent on adenine for their reversible self-cleavage (Meli *et al.* 2002, Meli *et al.* 2003). The present findings are in agreement with the observation that RNA can use exogenous reactive molecules to enhance its own catalytic activity. In summary, RNA oligomers in water undergo dimerization and tetramerization. The order of increasing efficiency is 10-mer < 15-mer < 23-mer < 24-mer. Cofactors such as : 3',5'-cAMP, 2'-AMP, and 3'-AMP stimulate the reaction by at least 2 orders of magnitude. Tetramerization only occurs with the 15-mer and 23- or 24-mer.

Ligation of oligomers with different lengths

The results reported in Fig. 9 show that the same reaction of ligation can also occur between oligomers with different lengths.

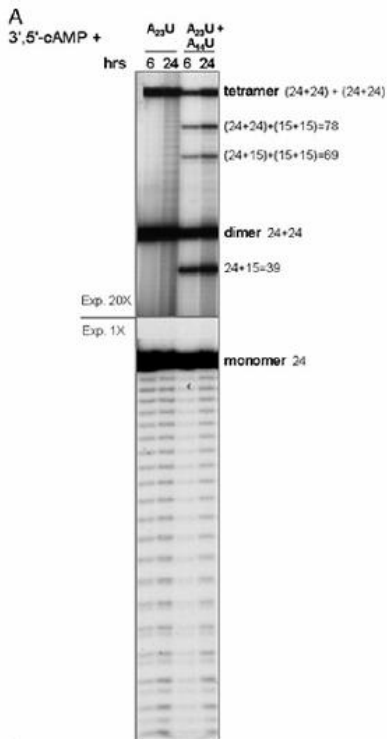

Fig. 9: The 5'-labeled 5' $A_{23}U$ 3' 24-mer was treated in the usual conditions (60°C, Tris-HCL-buffered water at pH 6.2) for 6 h and 24 h (first and second lanes) in the presence of 10 mM 3',5'-cAMP. The reaction was also carried out in the additional presence of unlabeled 5'-labeled 5' $A_{14}U$ 3' 15-mer (third and fourth lanes). The upper part of the autoradiogram shows the exposure 20X (Pino *et al.* 2008).

In Fig. 9 the products of multimerization starting from 5'A₂₃U3' and 5'A₁₄U3' are shown. The two oligonucleotides were present in water at the same concentration (3.5 pmol each in 15 µl), with only the 5'A₂₃U3' 24-mer being labeled at the 5' extremity. The two lanes on the left of the figure show the ligation reaction of the 5'A₂₃U3' 24-mer when present alone, resulting in the formation the dimer and of the tetramers. When unlabeled 5'A₁₄U3' 15-mer is included (two lanes on the right), additional fragments are observed, corresponding to the combinations expected in the case of heterogeneous ligation events. Successively, a ligation assay was performed on a mixture of four different oligomers. The 5'-labeled 5'A₂₃U3' 24-mer was added with equal amounts of unlabeled 5'A₁₄U3' 15-mer + 5'A₉U3' 10-mer + mixed sequence P1 20-mer. The result revealed that a complex ensemble of ligation events take place. The scanning profile of the relevant samples are given in Fig. 10, showing that the efficiency of the ligation events pertaining to the shortest oligonucleotide (10-mer) is low (trace 2); that the ligation with the 15-mer is markedly higher (trace 3); that when present together, the 10-mer partially competes off the 15-mer (trace 4); that heterogeneous P1 sequence does not participate in the ligation events (traces 5-7); and that a complex mixture of fragments is actually obtained (trace 8).



Fig. 10: Scanning profiles of an autoradiogram in which the following ligation reactions were analyzed: Lane 1, $5^3\text{A}_{23}\text{U}3'$ 24-mer ($5'$ -labeled); lane 2, 24-mer + $5^3\text{A}_9\text{U}3'$ 10-mer; lane 3, 24-mer + $5^3\text{A}_{14}\text{U}3'$ 15-mer; lane 4, 24-mer + 10-mer + 15-mer; lane 5, 24-mer + P1 20-mer; lane 6, 24-mer + 10-mer + 20-mer; lane 7, 24-mer + 15-mer + 20-mer; lane 8, 24-mer + 10-mer + 15-mer + 20-mer. All the unlabeled oligonucleotides were added at the same concentration as the labeled 24-mer, namely 3.5 pmol in 15 μl (Pino *et al.* 2008).

Ligation as a function of pH

Poly(A) was the focus of intense studies, several properties and molecular characteristics in aqueous solution are known. The single-strand helix of stacked bases is the stable form of Poly(A) at neutral pH and room temperature and also at acidic pH and higher temperature. The conformation of Poly(A) at low temperature and acidic pH is a double-strand helix. The equilibrium between the two helical forms is established by modifying temperature, pH, and fragment size (T'so *et al.* 1962, Holcomb & Tinoco 1965, Brahms *et al.* 1966, Finch & Klug 1969). For this reason we tested whether the ligation reaction depends on the pH values indicated by these early studies as discriminatory between the single- and double-stranded forms.

Fig 11 shows the products of ligation (dimers and tetramers) as a function of different pH values (between 2.46 and 8.36), furthermore the ligation reactions were carried out at 45, 60, and 75°C. The result is in agreement with the data previously described (T'so *et al.* 1962, Holcomb & Tinoco 1965, Brahms *et al.* 1966, Finch & Klug 1969). Above the pH value 6.10 ligation occurs at the lower temperature but not at the higher one (see arrows in Fig 4. 11, B and C).

At these pH value at 60°C, single strands prevail as described Holcomb and Tinoco (Holcomb & Tinoco 1965). The need for a careful control on the pH in this experimental set-up is evident.

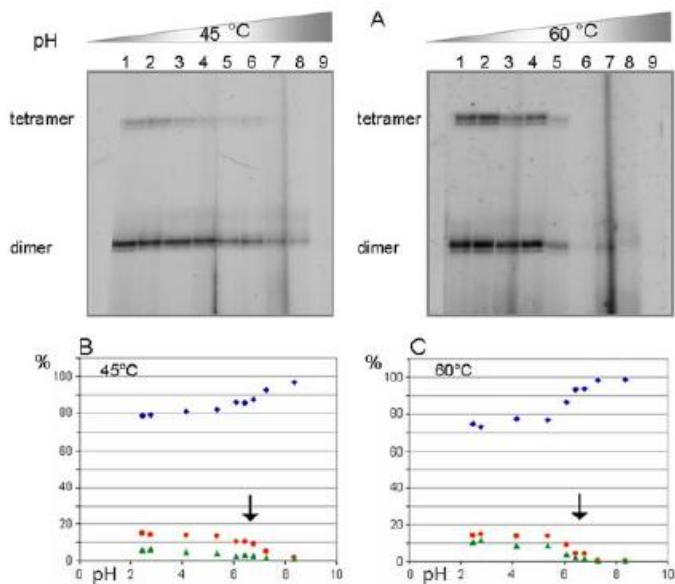

Fig. 11: Ligation as a function of pH. A shows the yield of the dimers and tetramers of the 5'A₁₄U3' 15-mer as a function of the pH values 2.46 (lane 1), 2.77 (lane 2), 4.16 (lane 3), 5.36 (lane 4), 6.10 (lane 5), 6.43 (lane 6), 6.78 (lane 7), 7.29 (lane 8), 8.36 (lane 9). The reactions were carried out at 45, 60, 75°C (data not shown) for 24 h. The yields were quantified by scanning densitometry relative to the unreacted monomer and are reported as percentages values in B (reactions at 45°C) and C (reactions at 60°C). The arrow localizes the pH values at which ligations occur at 45 but not at 60°C (Pino *et al.* 2008).

The plausible mechanism for the formation of dimers and tetramers

The formation of dimers and tetramers but not of trimers and pentamers entails a ligation preceded by the coupling of the reacting molecules two by two and excludes a tandem wise polymerization mechanism. The two coupled molecules may undergo

covalent linking only if the reacting phosphate and hydroxyl groups are in the necessary close proximity and in the appropriate relative position.

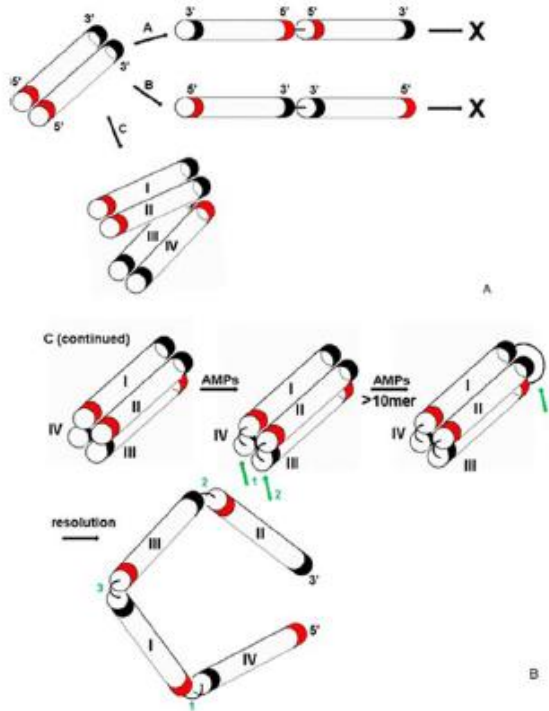

Fig. 12: A model explaining for the observed directionality of the ligation events. Oligomers are idealized as rods whose 5' (red) and 3' (black) extremities are indicated throughout by this color – code. Arrow A, 5' to 5' ligation bring to the impossibility (X) of continuing the reaction to form the tetramer. Arrow B, 3' to 3' ligation: same. Arrow C, the antiparallel interaction of two parallel PolyA double helices would bring the reactive 5' phosphate and 3' hydroxyl group in the correct positioning (Pino *et al.* 2008).

Nonenzymatically driven formation of phosphoester bonds may occur in numerous orientations. A vast literature, pioneered by decades of studies by Korana and co-workers (Dekker & Korana 1954, Gilham & Korana 1958, Fritz *et al.* 1978), has detailed the versatility of phosphate ester bonds chemistry. In Fig. 12 we have schematically shown the alternatives that may be conceived in our system. Starting from the consideration that Poly(A) forms parallel-stranded double helices, the two strands might connect through their 5' extremities (Fig 12, arrow A) or their 3' extremity (Fig 12, arrow B). In addition, ligation could occur between the 5' and 3' extremities of two stacked double helices (Fig 12, arrow C). However, the first two possibilities are unlikely.

In the first case (Fig 12, arrow A) two oligomers might react through their phosphates in 5' position and ligate with a 5'P-P5' diphosphoester bond resulting in a divergently oriented molecule. In the second case (Fig 12, arrow B) the ligation could occur at the 3'-OH extremities resulting in the also divergently molecule. Furthermore, in this case the absence of a phosphate at the 3' positions makes this alternative highly improbable. Both models can be discarded for the reason that the formation of divergent molecules, not capable to form additional bonds, can not explain the formation of tetramers.

The asymmetric 3' to 5' ligation between two pairs of overlapping parallel molecules remains the only plausible alternative (Fig 12, arrow C). In this case the appropriate antiparallel orientation between two double strands coupled ensure the proximity of the reactive phosphate and hydroxyl groups at the extremity position of the two macromolecules. The high temperature provides the energy necessary for the bond formation and thus the three 3'-5' phosphodiester bonds formed (green arrows in Fig. 12, B) would yield a linear tetramer-sized molecule.

Two Poly(A) oligomers are easily fully matched. In the case of equal sized molecules both extremities will coincide, whereas only one extremity will do so in the case of different length molecules. The observed absence of trimers excludes the head-to-tail interaction of a third molecule at one of the two available extremities of the double strand or the formation of triple strand.

Tetramer are at the contrary efficiently formed (Figs 7, 8, 9, 11). For their formation side-by-side columnar interaction of two double strands is necessary, followed by ligation. This type of interaction has been recently described for DNA double strands (Nakata *et al.*, 2007; Baldwin *et al.*, 2008) but for RNA not yet. A similar type of interaction for double-stranded RNA, given its helical configuration in solution (Olson 1975), could be considered.

The importance of stacking interactions in non-enzymatic ligations

Stacking interactions are of fundamental importance to explain the process leading the oligomers to its terminal intermolecular ligation.

The stacked states were found to have 2-6 Kcal/mol lower free energy than the unstacked states for purine dimers; for pyrimidine-pyrimidine dimers no barrier or a very small one was obtained (Norberg & Nilsson 1995 a).

The stacking-unstacking process has also been shown to be temperature-dependent, at the transition barrier was shown to be lower at higher temperature (Norberg & Nilsson 1995 b). Although vertical stacking of bases, or of mononucleotides, in aqueous solution seems to be non-cooperative (Norberg & Nilsson 1996) clear cooperativity was reported for the formation of double helices. Furthermore, cooperativity depends on pH, length of the oligomer, ionic environment and temperature (Holcomb & Tinoco 1965, Brahms *et al.* 1966, Norberg & Nilsson 1995 b). In particular, it was shown that although at neutral pH, Poly(A) and oligonucleotide A exist in a single-strand conformation stabilized by base stacking, at pH levels lower than 5, a double-strand conformation is assumed by oligomers larger than the heptamer (Brahms *et al.* 1966). These observation are in agreement with the analysis by Holcomb and Tinoco, who established the correlation between the transition of the single- to double-stranded form in RNA and pH/temperature of the system (Holcomb & Tinoco 1965). Similar plot was presented by T'so *et al.*, who also found a linear relationship of the same slope but displaced to lower pH at

higher salt concentration (T'so *et al.* 1962). The formation of two helical forms of polyriboadenilic acid and the pH-dependent transition between them was also shown by crystallographic analysis and vibrational circular dichroism (Finch & Klug 1969, Petrovic & Polavarupu 2005). The chains on the double helix formed at pH levels between 5 and 6, consistent in with a protonated state of the adenine residue. To obtain information of the type of phosphate bond formed we have performed enzymatic analyses with snake venom phosphodiesterase I and with P1 endonuclease. Snake venom phosphodiesterase is a 5'-exonuclease cleaving 3'-5' and 2'-5' phosphodiester bonds from the 3' extremity in a non-processive manner. Treatment of a sample of A₂₃U 24-mer containing dimers and tetramers with 1 milliunit of SVDP in the appropriate buffer for 20 min at 37°C showed that the multimeric forms are completely susceptible to digestion by the enzyme (data not shown). Thus, the bonds formed are canonical phosphodiesteric bonds of the 3'-5' or 2'-5' species. This result excludes the possibility that bonds other than ester bonds were involved in the ligation reaction. The regioselectivity (2'-5' or 3'-5') of the phosphodiester bonds was determined by P1 nuclease treatment of an RNA population that had undergone ligation in the standard conditions (18h, 60°C, Poly(A)₂₃U). P1 nuclease is a 3'-5'- specific riboendonuclease. The amount of the digestion resistant label-containing dinucleotides remaining upon extensive treatment with P1 determines the amount of 2'-5' (resistant) relative to that of 3'-5' (sensitive) bond. In our case the result of the quantitative analysis of the amount of dinucleotides versus the amount of mononucleotides, after extensive enzymatic assay, indicates that 66.5% of the bonds formed in the ligation reaction are of the 3'-5' type.

The possible evolutionary meaning of nonenzymatic ligations

The ligation reaction described has remarkable potential in prebiotic terms: it helps to solve the problem of the thermodynamically uphill one-by-one polymerization needed to reach a (pre)genetic meaningful size.

It has the intrinsic potential of favoring the evolution of complex sequences. If we suppose the insertion of bases different from As in the oligonucleotides just described, the molecules with matching complementarities could use not only base stacking but also base pairing as means to favor dimerization. This would widen the range of temperatures in which ligation could occur, and at higher temperature ligation would be faster. An experimentally verifiable positive Darwinian cycle would thus be allowed.

This system is fit for evolution. The transmission of genetic information is done by two strands through a pairing mechanism. Strand pairing by stacking can be obtained with a number of sequence combinations and allows for internal sequence defects.

As long as the two reactive extremities are matched in the correct reacting position, the strands could evolve into the appropriate although different sequence combinations. In summary, the process described here is base-on-base stacking rather than base pairing. Stacking is notoriously a less sequence-dependent mechanism. The suggestion that the initial replicatory events were based on stacking is tempting.

MOLECULAR PHENOTYPE FAVOURS THE EVOLUTION OF RIBOPOLYMERS

At the molecular level, in a prebiotic acellular context the founding phenotype of the developing system of informational molecules is stability. Along with the ability to

reproduce, selection necessarily favored molecules able to keep for a longer time their macromolecular information.

Considering this assumption we have explored the stability of selected ribo-oligomers in water and have determined the physical-chemical conditions in which the key 3' phosphoester bond is more stable when embedded in the polymer than when present in the monomer. A narrow pH range was identified in which complex sequences resist degradation markedly more than monotonous one, thus potentially favoring the evolution of sequence-based genetic information. Based on this assumption we have analyzed the stability of ribo-oligomers and compared it with that of the constituent monomers.

The 3' phosphoester bond in 3'AMP and 3' CMP

The cleavage rate of the 3' phosphoester bond of 3'AMP and 3' CMP was determined by incubation in water at 90°C at the Tris HCl-buffered pH values of 3.37, 3.72, 4.31, 4.98, 5.26, 5.34, 5.60, 5.92, 6.48, 7.21, 7.69, 8.25, 8.57, 8.73, 9.02. The treatment lasted for 92 hrs and the products were analyzed by HPLC analysis at the time intervals. The figure 13 (which shows selected examples of the large data) illustrates the degradation of 3'AMP (% , ordinate) as a function of time (abscissa) and of the pH (indicated in the central upper part of each panel). The upper panel on the right side provides the interpretation key. The results show that 3'AMP in water at 90°C has a $t_{1/2} \sim 0.3 \times 10^3$ min. This value is only marginally pH-dependent between $\text{pH} < 3.37$ and > 8.73 , as show in Fig. 13. The degradation of 3'AMP occurs by cleavage of the β -glycosidic and/or the 3' phosphoester bonds. The first cleavage results in the production of adenine (green), the latter in the production of adenosine (red). Stability of adenosine was measured separately in a similar set of analyses (not detailed) showing that in the whole range of pH values analyzed adenosine was only marginally degraded. Thus, in the degradation of 3'AMP in water at 90°C adenine is mostly produced by depurination of the nucleotide form, not from the adenosine moiety deriving from its dephosphorylation.

Following depurination, the phosphoester bond connecting the ribose and phosphate moieties (which in this analytical set up are not visible) is cleaved by a well characterized β -elimination mechanism (Lindhal 1993). Fig. 1 shows that adenosine depurination is faster between $\text{pH} > 3.72$ and < 4.98 . At pH values higher than 7.21 (Fig. 13) little adenine is formed, showing that in alkaline conditions the β -glycosidic bond is protected and that degradation of the nucleotide mostly occurs by high pH -enhanced dephosphorylation. The increase of adenine after 48 hrs is given by the sum of adenine formed previously plus the adenine being produced from adenosine till its consumption. Formation of a discrete amount of *bona-fide* 3'-5' cyclic AMP is also observed (magenta). In conclusion, the degradation of 3'AMP is largely a pH -independent process between pH 3 and 7. In this range of values the contribution of depurination is higher between pH 3.7 and 5.0. The half-life of 3'AMP was also determined as a function of temperature at pH 5.5 in water, showing its steady temperature-dependent increase. The cleavage rates of the 3'-phosphoester bond of 3'CMP were determined by a similar set of analyses for the same range of pH values. The results showed that the degradation of 3'CMP is an essentially pH -independent process and that the cleavage of the β -glycosidic bond resulting in the production of cytosine is faster than the cleavage of the 3'-phosphoester bond yielding cytidine.

In spite of this kinetic difference, the quantitative relevance of the two cleavages is roughly equivalent. Both cytosine and cytidine are stable in these experimental conditions.

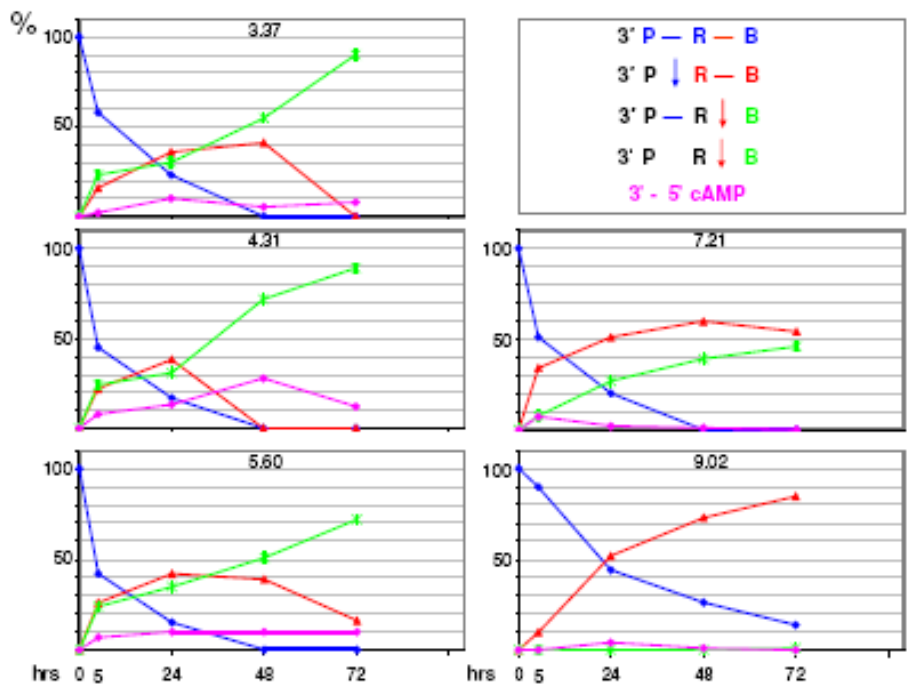

Fig. 13: Degradation kinetics of 3'AMP as a function of the pH indicated in each panel, HPLC analysis. Blue, nucleotide; red, nucleoside; green, base. The ribose and the ribose-phosphate moieties are not detected in the HPLC analysis and are indicated in black. The line connecting the experimental points, here and in the following plots, has no mathematical meaning. It is given only to facilitate identification (Ciciriello *et al.* 2008).

Kinetics of RNA hydrolysis

In order to study the stability of the 3'-phosphoester bond in ribo-oligomers we performed the simple test of measuring the kinetics of degradation of a 5' labelled

RNA in water at various temperatures on the three following oligos: PolyA₂₄ , PolyA₁₂ C₁₂ , mixed sequence oligo P1, respectively, treated at 90°C as a function of time.

PolyA₂₄

The pattern of hydrolytic degradation of the PolyA₂₄ at 90°C (Fig. 14) shows that the 24-mer was regularly hit by hydrolytic events along its whole length, as shown by the appearance of the ladder-like degradation profiles. After about 6 hrs of permanence of RNA in water, degradation started. The relatively high stability of the PolyA sequence in aqueous solution is well established (Smith & Allen 1953, Lane & Butler 1959, Kaukinen *et al.* 2002). The stability of RNA phosphodiester bonds has repeatedly been associated with the stacking interaction between adjacent bases (Li & Breaker 1999, Bibillo *et al.* 1999, Kierzek 1992). Nucleic acid base stacking is at present an essentially well understood phenomenon (Norberg & Nilson 1995a and b, 1996a and b, 1998) (Luo *et al.* 1998, Newcomb & Gellman 1994, Friedman & Honig 1995, Pohorille *et al.* 1984). The possibility that the initial stability of the PolyA oligo towards hydrolysis is a base stacking-related effect is discussed below. The upper panel shows the degradation observed in water at pH 5.5 (90°C). The bottom panel shows the disappearance of full-length molecules of the same oligo at pH 6.2 (90°C).

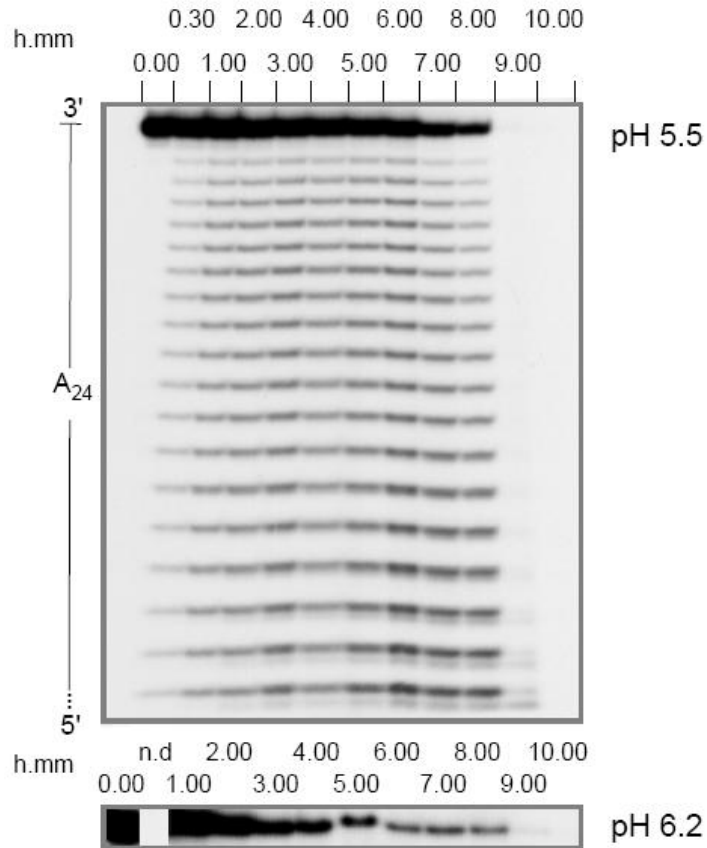

Fig. 14: Kinetics of degradation of PolyA₂₄ in water at pH 5.5 and 6.2, 90°C. The upper panel shows both the full-length molecules and the degradation ladder of the sample treated in water at pH 5.5. After a lag period lasting for the first 6 hours, rapid degradation started (see points at 7 and 8 hours). Samples at 9 were more than 90% degraded. The lower panel shows only the full-length molecules of the sample treated in water at pH 6.2 (Ciciriello *et al.* 2008).

PolyA₁₂ C₁₂

The cleavage profile of PolyA₁₂ C₁₂ (Fig. 15) showed that the bipartite oligo molecule behaved towards degradation as two separate entities: the C-stretch and the A-stretch. The two sequence components did not appreciably affect each other.

In this experimental conditions (water pH 5.5, 90°C), the C-stretch component was rather unstable, its depolymerization already starting during the handling of the sample (i.e. , see the T₀ sample, first lane). The cleavage pattern depicts the progressively decreasing size of the homogeneous sequence stretch and is compatible both with a multiple independent-hits kinetics and/or with a cooperative cleavage mechanism. Conformation and thermodynamic properties of oligocytidylic acids are known (Brahms *et al.* 1967). The standard state free energy change obtained at 0°C is only about 1 Kcal/mole in favor of stacking, thus allowing reversible formation of an ordered helical chain which may easily be disordered at higher temperature or at constant temperature under influence of external factor.

Two functionally distinct sub-populations of molecules were observed (Fig. 15): one that was very sensitive to hydrolysis and was repeatedly cleaved to its consumption (indicated by the empty arrow in Fig. 15), the other that followed a slower kinetics (filled arrow). This behavior is compatible with the following mechanism : all the molecules have similar conformation and accessibility but, once cleaved by a first-hit event, the hit molecule is rapidly cleaved to completion. This behavior could be explained by faster unstacking in the early part of the kinetics in shorter segments and/or faster processive hydrolysis from the induced extremities. In spite of early reports (Brahms *et al.* 1967, 1966, Van Holde *et al.* 1965, Kaukinen *et al.* 2003) describing that the loss of the helical structure with increase in temperature is not dependent on chain length, thus essentially being a non-cooperative process, evidence for cooperative stacking/unstacking effects was later reported (Kaukinen *et al.* 2003).

An alternative less likely interpretation of cleavage pattern is that the CpC step become more cleavable as they get closer to the A-stretch due to context effects.

Ascertaining the mechanism(s) responsible for the higher sensitivity of the CpC steps closer to the A-stretch will require further analyses. Whichever the mechanism leading to the rapid degradation of the PolyC stretch after initial cleavages, the half life of the bi-composite oligo analyzed here is determined by its first-hit kinetics. This is safely calculated from the disappearance of the full-length molecules. In these experimental conditions, the A-stretch component was more stable. The T_0 sample showed no sign of cleavages in this sequence portion (Fig. 15, first lane). The degradation pattern of the first time point (T_0) showed that the cleavage kinetics of the two sequence stretches (A-stretch vs C-stretch) were largely independent, that the cleavage of the As was not progressive (in agreement with Leng & Fenselfeld 1966), that a “first-hit kinetics” condition applied. Values of 8 and 10 Kcal/mole in favor of stacking were reported (Brahms *et al.* 1966, Leng & Fenselfeld 1966, respectively) indicating the higher tendency of the PolyA sequence to maintain an ordered stacked structure at least in the early moments of the treatment at 90°C. The PolyA₁₂ C₁₂ sequence is composed of eleven 5'ApA3', one 5'ApC3', eleven 5'CpC3' steps. The 5'ApC3' step was cleaved less than both 5'CpC3' and 5'ApA3'.

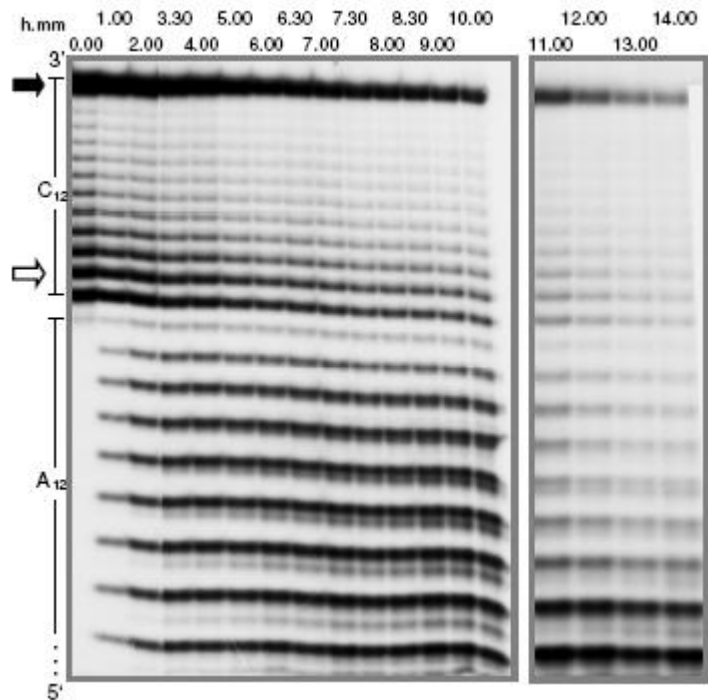

Fig. 15: Kinetics of degradation of PolyA₁₂ C₁₂ in water, pH 5.5, 90°C. Experimental procedure and representation as for the PolyA analysis reported in Fig. 14. The C₁₂ and A₁₂ moieties of the oligo are indicated (left, upper panel) (Ciciriello *et al.* 2008).

Mixed-sequence RNA (5'-GGAAACGUACCUUUGGGAG-3')

This sequence (dubbed “P1”, La Neve *et al.* 2003) contains the highly scissile base step 5'UpA3' and, out of the 16 possible combinations, only 5'GpC3' and 5'CpA3' (the other highly scissile step) are missing. This sequence was selected in order to have the highest possible number of sequence combinations and only one highly scissile site. The 5'GpC3' step was not introduced in order to avoid sequence combinations that would lead to stable intrastrand structure (not detailed).

As it is, this sequence lacks noticeable stable intrastrand structures, as determined by the standard Zuker analysis (Zuker 1989).

With the exception of the cleavage of the 5'UpA3' bond (indicated by an arrow on the left side of fig. 16) the overall cleavage profile was rather homogeneous and only slight preference was shown for the centrally located cluster of pyrimidine steps 5'UpC3', 5'CpC3', 5'CpU3' (Fig. 16). The double bands appearing in correspondence of cleavages at advanced stages of the degradation process (indicated on the right side of fig. 16) are due to successive steps of the hydrolytic process (Soukup & Breaker 1999, Kuusela & Lonberg 1994). The cleavage of a 3' phosphoester bond first results in the production of a 3'-2' phosphate cyclic extremity (upper band in a 5' labeled oligomers), followed by the opening of the cyclic bond, yielding a non-resolved mixture of 2'- and 3'- monophosphate extremities (lower bands).

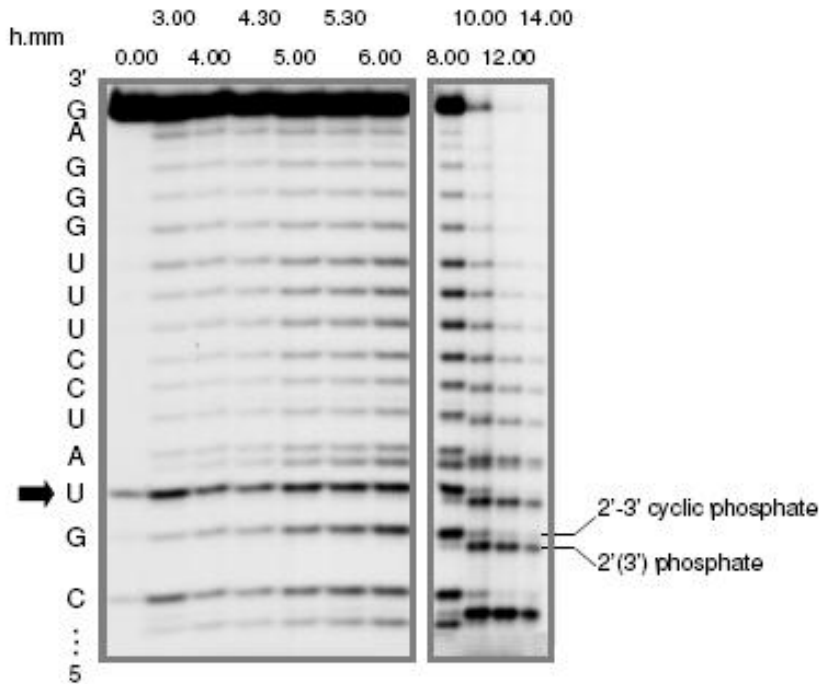

Fig . 16: Kinetics of degradation of P1 in water, pH 5.5, 90°C. The arrow (left) points to the 5'UpA3' labile step. The bands representing the 2'-3' cyclic phosphate and 2' or 3' free phosphate extremities are indicated (right, bottom) (Ciciriello *et al.* 2008).

The hydrolytic degradation of RNA in water is preceded by a lag period

The average half-life of the 3' phosphoester bonds was calculated (see Methods) based on the disappearance of the full length molecules, and on the principle that

this is a measure of independent first-hit events. In homogeneous-sequence molecules (as in PolyA₂₄) the calculated t_{1/2} value corresponds to the half-life of homogeneously cleaved (see Fig. 14) 3' phosphoester bonds. The degradation kinetics of the PolyA₂₄ oligo at pH 5.5 and pH 6.2 are shown. The lag period is only observed for pH 5.5. In spite of the relatively small acidity difference, at pH 6.2 the lag period is lost. The two sequence blocks composing the PolyA₁₂ C₁₂ oligo were cleaved with different kinetics, faster for the stretch of Cs, slower for the stretch of As (Fig. 15). In this case the disappearance of the full-length molecules due to first-hit events were therefore mostly caused by cleavages of one of the relatively weaker 5'CpC3' steps.

For the heterogeneous sequence 5'--GGAAACGUACCUUUGGGAG-3' the cleavage pattern did not show strong sequence-related cleavage biases (Fig. 16).

Such cleavage homogeneity is not *a priori* expected but is *a posteriori* justified by the relevance of sequence-context effects (Kaukinen *et al.* 2002) averaging out potential local cleavage differences, as confirmed by the inspection of the relatively homogeneous cleavage pattern (Fig. 16). The kinetics of disappearance of the full-length molecules as a function of time at 90°C revealed a lag of about 6 hours before the onset of rapid degradation. During this period the RNA oligo polymers remained as intact full-length molecules. Operationally, the lag period was defined as the period during which 90% of the molecules remain full-length.

In conclusion, RNA in water at pH 5.5 (90°C) is resistant to hydrolysis for a defined period, after which it undergoes rapid degradation. This behavior is largely sequence-independent.

Irreversibility: The lag resistance is not a reversible phenomenon. An RNA sample (conserved in water at -20°C) was defrozen and treated for 6 hrs at 90°C, then re-frozen at -20°C for 12 hrs. The sample was then re-heated at 90°C and the kinetics of hydrolysis was analyzed with the standard procedure. The results showed that the molecules are in this case hydrolyzed with a rapid-start kinetics, not undergoing again to the pre-hydrolysis lag period. A dehydration step was introduced in a variant of this assay. After the 6 hrs treatment at 90°C, RNA was alcohol

precipitated, then frozen and treated as previously described. Also in this case the pre-hydrolysis lag was not observed. Hysteresis effects in RNA conformation have been previously observed and their basis analyzed (Revzin *et al.* 1973, Pinder *et al.* 1974). RNA meta-stability is based on acquired structures, from base stacking to complex folding. In sequences which do not fold, as in our case, persistence of base stacking might contribute to stability for a certain period of time. However, the experiments described showed that stability, once lost, was not re-attained and is only explained by a persistent, conceivably covalent modification.

pH: The analysis of the pH-dependence of RNA stability was performed by measuring the residual amount of the full-length molecules (% , ordinate) after 4 hrs in water at 90°C at the indicated pH (abscissa). Fig. 18 compares the three profiles. A well defined, often sharp dependence of RNA oligo stability on pH was observed which locally varied as a function of the sequence composition.

The half-life of the 3' phosphoester bond: monomer versus polymers. Temperature effects

The kinetics of hydrolysis in water was analyzed in detail as a function temperature in the mixed sequence P1 oligo at 20, 30, 40, 50, 60, 70, 80, 90°C. The half-life values of the P1 RNA, calculated as described for the experiments reported in Fig. 16, are shown for the whole range of temperature in Fig. 17.

The figure compares the half-life of the 3'-phosphoester bond in the 3'AMP monomer (filled squares) with the half-life of the same bond in the P1 oligo (filled dots). The error bar for the 80°C temperature point is the average of 6 measurements, that for the 90°C point of 4 measurements.

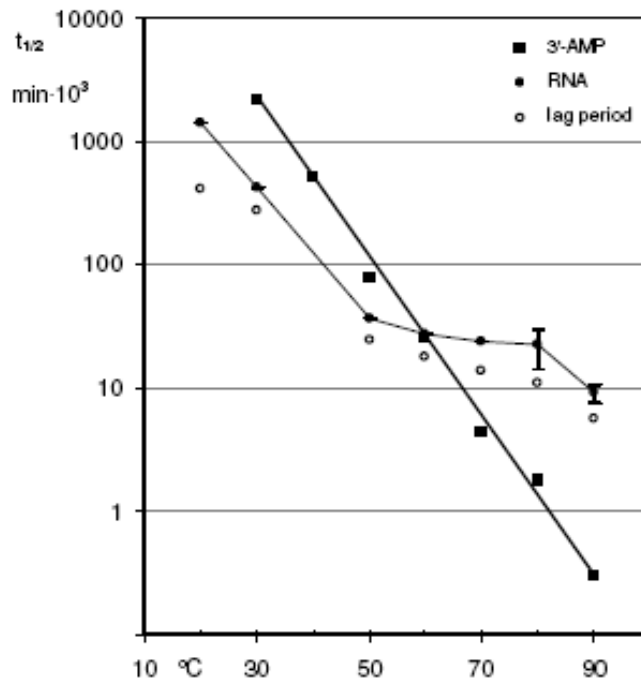

Fig. 17: The stability of the 3' phosphoester bond when present in 3'AMP (filled squares) and in the oligomer P1 (filled dots). In the oligomer data set, each point represent the half-life (ordinate) calculated in degradation analyses, performed at the indicated temperature (abscissa). Open dots indicated the duration of the lag period at the specified temperature (Ciciriello *et al.* 2008).

All the other points were measured once. The open dots indicate the duration of the lag period at each temperature. The comparison shows that at lower temperature (up to 50°C) the 3'-phosphoester bond was more stable in the monomer, while above 60°C the stability of this bond was markedly higher when embedded in the polymer.

As evident, the difference is largely due to the lag period preceding the onset of hydrolytic degradation.

The lag period and the pH effect

The kinetics of degradation of the three oligos tested is peculiar: a lag period during which the RNA backbone length does not change, which is similar for the three sequences, followed by rapid degradation. The lag lasts for several hours at 90°C and is lost at pH < 4 and > 6.

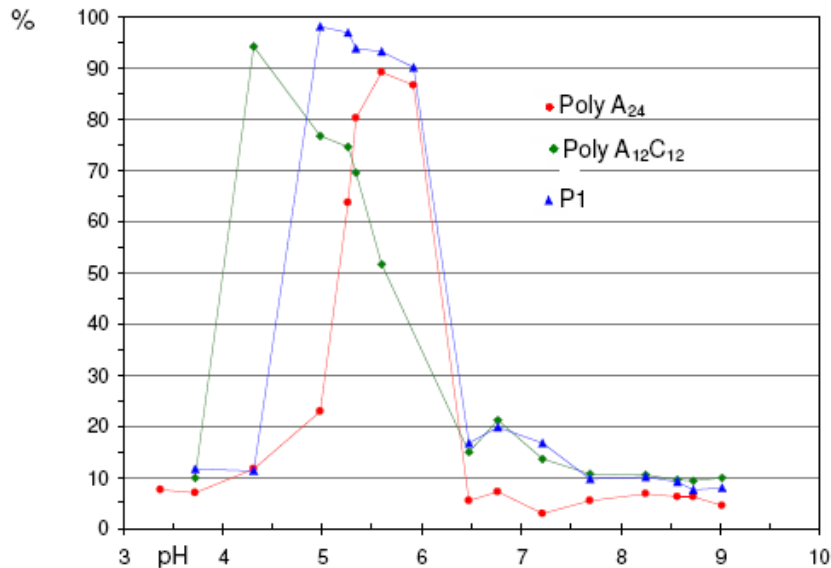

Fig. 18: Stability of different RNAs as a function of the pH (Ciciriello *et al.* 2008).

Given the inconsistency of the occurrence of first-hit events at 90°C after several hours being due to the persistence of a protective stacked conformation, the existence and the characteristics of the lag period can be explained more mechanistically by default reasoning: the kinetics and mechanisms for the cleavage and isomerization of the phosphoester bonds of RNA by Bronsted acids and bases were thoroughly analyzed and reviewed (Oivanen *et al.* 1998).

The pH rate profiles for trans-esterifications have been determined over a wide range of acidity, extending from concentrate acid solutions to concentrated aqueous alkalines. Under neutral or alkaline pH conditions, the dominant pathway for RNA degradation is an internal phosphoester transfer reaction that is promoted by specific base catalysis (Li & Breaker 1999). In most instances the identities of the nucleotide bases that flank the target RNA linkage have a negligible effect on the pKa of the nucleophilic 2'-hydroxyl group, and only have a minor effect on the maximal rate constant for the transesterification reaction (as determined and reviewed in Li & Breaker 1999). Alkaline conditions favor specific base catalysis, in which the 2' hydroxyl group is deprotonated by hydroxide to generate the more nucleophilic 2' oxyanion group. The ensuing reaction is the primary pathways for the uncatalyzed degradation of RNA polymerase under typical cellular conditions (Jarvinen *et al.* 1991). Facile transesterification also occurs under strong acid conditions (Oivanen *et al.* 1998). With reaction conditions below pH 6, specific base catalysis becomes a minor mechanism relative to the competing mechanism of specific acid catalysis for RNA transesterification (Oivanen *et al.* 1998).

A bell-shaped pH-rate profile was reported, with the minimum reactivity centering at pH 5 (Oivanen *et al.* 1998). This shape was interpreted to indicate involvement of four kinetically distinct terms in the cleavage reaction, the monoanionic phosphodiester being largely predominant at pH 4 to 6. As pointed out (Li & Breaker 1999), around these pH values both specific base catalysis and specific acid catalysis are near a minimum (Oivanen *et al.* 1998) and cleavage by a depurination/ β -elimination mechanism (Smith & Allen 1953) becomes increasingly significant.

One is therefore left with a chemical environment encompassed between pH 4 and 6 in which the onset or the absence of depurination or of other reactions leading to base degradation or removal become relevant. In our experimental setup at 90°C depurination of 3'AMP levels off after 0.3×10^3 min (Fig. 4) being more prominent between pH 3.37 and 5.24. Loss of the pyrimidine base cytosine or of the corresponding nucleoside cytidine from 3'CMP (data not shown) is not dependent and occurs in $\square 1 \times 10^3$ min. The average duration of the lag period (Figs 14-16) corresponds to the time required for depurination and depyrimidination (Fig. 13 for depurination). β -elimination follows. Thus, by default a limited area of pH values is left in which nor specific base nor specific acid catalysis occur and RNA resists degradation. On the acidic side, above pH 3.37 and below 5.24, depurination further limits pure-purine RNA stability, as seen in PolyA₂₄.

A pH-determined niche is thus defined in which RNA stability strictly depends on its sequence. The results showed that at well defined pH and temperature conditions, polymers are favored. We hypothesize that this property conferred to the polymer a sufficient Darwinian edge over its constituent monomers not only to allow its very survival in the polymeric form but also to provide a phenotype for evolution. Complex sequences resist more, in terms of time and in wider environmental conditions, thus being favored.

CONCLUSIONS

In pursuing the origin of informational polymers, we followed the assumption that their spontaneous formation could only have occurred:

1. If all the components were present at the same site and in the same reaction
2. If the thermodynamics of the processes involved favored a polymerized over a monomeric state of the precursors.

A plausible scenario satisfying both assumptions is provided. We reasoned that for a pre-enzymatic polymerization to occur the solution must have relied on a simple and robust process. Ideally, such a process should have been based on compounds that were reactive yet relatively stable, chemically not too elaborate in order to allow their efficient production, and not too dissimilar from the products of their polymerization in order to minimize the chemical cost of the process. It was observed phosphorylation of nucleosides occurs in formamide simply in the presence of a source of organic or inorganic phosphate at temperatures at which both the reactants and the products are stable (Costanzo *et al.* 2007). Phosphorylation occurs in every possible position of the nucleoside sugar moiety resulting, both for purine and pyrimidine nucleosides, in the production of 2', 3', 5', 2',3'-cyclic and 3',5'-cyclic XMPs (Costanzo *et al.* 2007). The phosphorylation reaction is faster for the open than for the cyclic forms, while higher stability for the cyclic forms at higher temperature favors their accumulation. Coupled with the facile synthesis of all the nucleic bases from formamide (Saladino *et al.* 2007) and with the formation of acyclonucleosides by TiO₂-catalyzed formamide photochemistry (Saladino *et al.* 2003), the nonenzymatic phosphorylation of nucleosides (Costanzo *et al.* 2007) shows that the formation of cyclic monophosphate nucleosides is chemically simple and prebiotically plausible. The formation of both 2',3' and 3',5'-cyclic XMPs in water starting from nucleosides and an inorganic source was also observed (Saladino *et al.* 2009). The unsophisticated chemistry required for the formation of both open and cyclic nucleotides prompted us to investigate the possibility of their spontaneous

polymerization. If so, nonenzymatic (pre)genetic polymerization could have taken place in “warm little pond” conditions, close to those imagined by Darwin (Darwin 1888).

We describe three mechanisms for nonenzymatic RNA generation:

1. RNA polymerization from monomers
2. RNA ligation
3. RNA extension by polymerization on pre-existing oligomers and ligation.

Having obtained the indication that nucleoside phosphorylation can occur under simple, possibly prebiotic conditions, we tested the capacity of the 3',5'-cyclicGMP and 3',5'-cyclicAMP to undergo spontaneous polymerization. We hypothesize that the oligomerization reactions from 3',5'-cGMP and from 3',5'-cAMP described in Figs 1 and 2 rely on the stacking interaction of the purine moieties of the cyclic nucleosides, followed by the opening of the phosphodiester cyclic bond and the consequent formation of the inter-nucleotide phosphodiester bridge. The sequence extension due to the terminal ligation reaction of PolyG on PolyC described in Figs 4A and 4B needs not to be different from this type of ligation. Moreover, we described a mechanism of RNA ligation starting from homogeneous oligomers. The PolyA ligation occurred in water solution in the presence of 3',5'-cAMP. The PolyA polymerization took place through two steps. The first step is the formation of parallel-oriented RNA double strands. In the second step, the antiparallel interaction of two parallel PolyA double helices would bring the reactive 5' phosphate and 3' hydroxyl groups in the position allowing ligation (see Figs 7-12). Condensation reactions are not thermodynamically spontaneous in dilute aqueous solution or even at moderate water activity (van Holde 1980). The problem can be alleviated by high concentrations of the reactants, by concentration in organic solvent or in dry state, by pre-activated precursors. The latter is the solution adopted by extant organisms through the use of triphosphate forms, which are outside the category of prebiotic compounds. However, we showed that the syntheses require no special preactivation, no catalyst and no dry-chemistry, polymerization spontaneously

occurring in our system. The versatility of the set of nonenzymatic polymerization reactions leading to longer sequences is possibly the most relevant property. However, the first property of a polymer is to maintain its polymeric form. Finally we have explored the stability of selected ribo oligomers in water and have determined the physical-chemical condition in which the key 3'-phosphoester bond is more stable when embedded in the polymer than when present in the monomer. In these conditions, the spontaneous formation and the survival of ribo polymers are potentially favored. A narrow pH range was identified in which complex sequences resist degradation markedly more than monotonous ones, thus potentially favoring the evolution of sequence-based genetic information. In light of these suggestions we could consider a prebiotic scenario in which all conditions that favor the RNA polymerization are present. Abiotically formed cyclic precursors may actually have started their evolution towards complexity in a "warm little pond" as first conceived by Darwin (see Fig. 19).

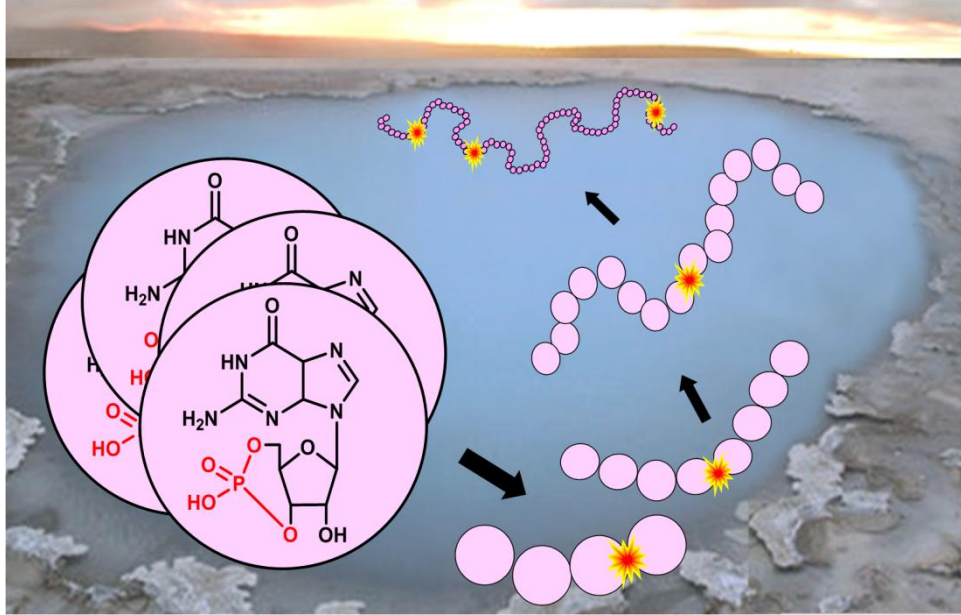

Fig. 19. The “warm little pond”: hypothetical scenario in which the RNA oligomers could have been formed (Costanzo *et al.* 2009).

Experimental Procedures

MATERIALS

Adenine, adenosine, adenosine 2'-monophosphate (2'-AMP), adenosine 3'-monophosphate (3'-AMP), adenosine 5'-monophosphate (5'-AMP), adenosine 2',3'-cyclic monophosphate (2',3'-cAMP), adenosine 3',5'-cyclic monophosphate (3',5'-cAMP), adenosine 5'-diphosphate (ADP), adenosine 5'-triphosphate (ATP), guanosine 3',5'-cyclic monophosphate (3',5'-cGMP), cytosine, cytidine, cytosine 3'-monophosphate (3'-CMP), cytosine 2'-monophosphate (2'-CMP), cytosine 5'-monophosphate (5'-CMP), cytosine 3',5'-cyclic monophosphate (3',5'-cCMP), uridine 3',5'-cyclic monophosphate (3',5'-cUMP), ribose, ribose 5'-monophosphate were from Sigma-Aldrich and were analytical grade.

RNA Oligonucleotides: The oligonucleotides 5'A₂₄3', 5'A₂₃3', 5'A₂₃U3', 5'A₁₄3', 5'A₁₄U3', 5'A₉U3', 5'C₂₄3', 5'A₁₂C₁₂3', 5'G₂₄3' and P1 RNA. P1 is an oligonucleotide with the sequence 5'-GGAAACGUAUCCUUUGGGAG-3'. The oligonucleotides were all purchased from Dharmacon and provided in the standard lyophilized form.

METHODS

Polymerization Protocol and Analysis: Concentrated solution of the appropriate nucleotide (2'-AMP, 3'-AMP, 5'-AMP, 2',3'-cAMP, 3',5'-cAMP, 3',5'-cGMP, 3',5'-cUMP, 3',5'-cCMP) were diluted in water to the desired final concentration. Concentration between 1 μ M and 0.1M were analyzed. Temperatures between 25 and 90°C and pH values 3.2, 3.7, 5.0, 5.4, 6.1, 8.0, 8.2, and 8.4, obtained by Tris-HCl buffering of bidistilled deionized MilliQ water, were tested. After terminal labeling the samples were analyzed by gel electrophoresis.

Acrylamide Gel Electrophoresis: Standard methodologies were used, with the following specifications 1) 12% polyacrylamide was used in analyses encompassing the whole product of the polymerization reaction, from the ^{32}P -labeled monomer to highest molecular weight fragments (>100 units), or 2) longer runs on 16% polyacrylamide gels were used for the analysis of low molecular weight polymers. With sequences allowing good resolution, the average chain length (N_{avg}) of the oligomers was determined by the equation $N_{\text{avg}} = \sum_i n_i N_i / \sum_i n_i$, where n_i is the number of chain (in %) and N_i is the length of RNA chains in nucleotides.

Reference Ladders: The nucleotide ladders used as standard in the gel-electrophoretic analyses of the polymerization products consisted of partially hydrolyzed 24-mer PolyG or PolyA (Dharmacon), as appropriate. Products of combinatorial ligation of preformed oligonucleotides were also used as markers, obtained as detailed in a previous study (Pino *et al.* 2008).

Terminal labeling of the material polymerized from unlabeled cyclic nucleotides:

The products of the polymerization reactions from cyclic nucleotides were ethanol-precipitated and dissolved in 44 μl of water. For de-phosphorylation, 1 μl of shrimp alkaline phosphatase (1 unit/ μl , MBI Fermentas) was added along with 5 μl of 10X shrimp phosphatase buffer, and the reaction was incubated at 37°C for 30 min, followed by phenol extraction and ethanol precipitation. RNA was pelleted by centrifugation, then dissolved in 16 μl of water and labeled at the 5' termini with ^{32}P . Phosphorylation was carried out by adding 1 μl of T4 Polynucleotide Kinase (T4 PNK, 10 unit/ μl , New England Biolabs), 2 μl of 10X PNK buffer and 0.5 μl of [γ - ^{32}P]ATP, followed by incubation at 37°C for 30 min. For gel electrophoresis, 10 μl aliquots of the RNA samples were resuspended in 100% formamide and separated by electrophoresis on 12 or 16 % polyacrylamide gels containing 7M urea, along with the indicated markers.

RNase Analyses: Phosphodiesterase I from *Crotalus adamanteus* venom (I. U.B. 3.1.4.1., snake venom phosphodiesterase I (SVPD I) from Sigma (in vials \geq 0.4 unit, purified, catalog number P3243) is a 5'-exonuclease that hydrolyzes 5'-mononucleotides from 3'-hydroxy-terminated ribo-oligonucleotides. It cleaves both 2',5'- and 3',5'-phosphodiester linkages, and it was here typically used at 1 milliunit/assay in 40 mM Tris-HCl, pH 8.4, and 10 mM MgCl₂ in 20 μ l assays. One unit hydrolyzes 1.0 μ mol of bis-(*p*-nitrophenyl)phosphate per minute at pH 8.8 at 37°C. Nuclease P1 from *Penicillium citrinum* (I.U.B. 3. 1. 30. 1) is from Sigma (Cat N8630), specific activity of 200 units/mg of protein. It catalyzes the sequence non-specific endonucleolytic cleavage of single-stranded RNA to yield nucleoside 5'-phosphates and 5'-phospho-oligonucleotides. Specific for 3',5'-phosphodiester linkages, it is here typically used at 20 units/sample in 40mM Tris-HCl, pH 5.4, 5mM NaCl, 0.5 mM MgCl₂, in 20 μ l assays. One unit liberates 1.0 μ mol of acid-soluble nucleotides from RNA per minute at pH 5.3 at 37°C.

T1 from *Aspergillus oryzae* (EC 3. 1. 27. 3.) is a 3',5'-specific ribonuclease. It cleaves with high preference at the 3'-end of G residues but at high concentration or at longer time will cleave also at other residues. One unit produces acid-soluble oligonucleotides equivalent to a ΔA_{260} of 1.0 in 15 min at pH 7.5 at 37°C in a reaction volume of 1ml.

RNA labeling and handling: RNA 5' labeling 300 pmol of the oligonucleotide RNA were labeled with [γ -³²P]ATP using polynucleotide kinase (Roche Applied Science). The oligonucleotide was then purified on a 16% denaturing acrylamide (19:1 acrylamide/bisacrylamide, 8M urea) gel. After elution, the residual polyacrylamide was removed by a NuncTrap Probe purification column (Stratagene). Subsequently the RNA, suspended in STE buffer (100mM NaCl, 20mM Tris-HCl, pH 7.5, 10mM EDTA) was precipitated by the addition of glycogen (20 μ g/ μ l of bidistilled sterile water) and 3 volumes of ethanol, kept overnight at -20°C, centrifuged, washed once with 70% ethanol/water, and dehydrated (Savant, 13.000 rpm, 10 min, room temperature, environmental atmospheric pressure). The pellet was suspended in

water, distributed in aliquots, immediately frozen, and conserved at -20°C . Typically one aliquot was used for each experiment. Each experimental point consisted of 2-4 pmol of RNA (typically 15,000 cpm/pmol).

The ribo-oligonucleotide ligation protocols and analyses: The basic ligation protocol consisted of the following steps: 20 pmol of 5'-labeled RNA (6×10^5 cpm) were resuspended in 45 μl of Tris-HCl- buffered water at the appropriate pH. This amount of RNA was normally used for six experimental points. A Tris-HCl- buffered solution of 20 mM 3',5'-cAMP was added to reach a final volume of 90 μl . The sample was divided in six 15 μl aliquots and treated as appropriate for each experimental variable. A sample was immediately precipitated by the addition of 25 μl of MilliQ water, 50 μl of sodium pyrophosphate, 10 μl of 3 M sodium acetate, pH 7.5, 300 μl of 96% ethanol, 1 μl of 20 $\mu\text{g}/\mu\text{l}$ glycogen. Before the addition of alcohol, the sample was thoroughly vortexed. The other samples were precipitated similarly after the appropriate treatments. Variants were tested of this basic protocol, and the oligonucleotides were treated at the temperature, time, and solution conditions indicated where appropriate. After precipitation the sample were suspended in 5 μl of formamide buffer, heated for 3 min at 65°C , and loaded on a 16% denaturing polyacrylamide gel. Densitometric analysis was performed with Epson expression 1640 XL Kodak imaging software, and quantification was by OptiQuant 3.10.

Fragment size determination: Given the known difficulty of obtaining precise size markers for large RNA molecules, the determination of the fragment lengths was verified by the linearity of their migration in semi-log plots.

Half-lives of the 3'-phosphoester bond in 3'-AMP: The half-lives of the 3'-phosphoester bond in 3'-AMP and 3'-CMP was calculated at the pH and temperature conditions indicated. Commercial distilled water was further purified by tridistillation-deionization with a MilliQ Advantage A10 or with a Sartorius ARIUM

611 VF apparatus. Pure or 10 mM Tris-HCl- buffered water were pretreated for two hours at the temperature of the assay to be performed, a period of time sufficient to reach and maintain the temperature-specific pH. The temperature-stabilized pH values (determined on a Beckman Ø 40 pHmeter) are given throughout.

Samples were resuspended at the final concentration of 1mg/ml in water or in the appropriate formamide reaction medium (usually in 0.5-1.0 ml) and incubated at various temperature (20, 30, 50, 60, 70, 80, or 90°C) at the indicated pH values for the appropriate periods of time. 10 µl aliquots were diluted to a final concentration of 50% formamide in a final volume of 20 µl and injected into a Supelcosil™ LC-18-S 5- µm HPLC column (Supelco) 15 cm x 4.6 mm. elution was performed at a flow rate of 2 ml/min at room temperature with methanol: 30 mM ammonium phosphate, pH 5.3 (2.5:97.5), UV 254 nm, pressure 1.5 atmosphere, on a HPLC Beckman System Gold instrument. Identification of the peaks was performed by comparison with real samples. Half-lives were determined by standard graphical procedure.

Ribooligonucleotide degradation protocols and analyses: The 5'-labeled oligonucleotide was treated under the time, temperature, and solution conditions indicated where appropriate. To stop the reactions carried out in water (pH 5.5 at 90°C) the sample (typically 15 µl) was diluted and precipitated with 3 vol of ethanol 96%, sodium acetate 0.3 M final concentration, pH 7.5, 20 µg glycogen. To stop the reaction carried out in formamide a solution of 5×10^{-4} M (final concentration) of tetrasodium pyrophosphate (Sigma) dissolved in water, pH 7.5, was added to a final volume of 40 µl. The samples were vortexed for 1 min and then centrifuged at 13000 rpm for 20 min. This procedure was performed twice. The supernatant was ethanol precipitated, resuspended in 5 µl of formamide buffer, heated for 2 min at 65°C, and loaded on a 16% denaturing polyacrylamide gel (19:1 acrylamide/bisacrylamide).

Half-lives of the bonds in the ribooligonucleotide: For oligonucleotides, the half-lives of the phosphoester bonds were determined from the rate of disappearance of the band representing the intact 20- or 24-mer molecule. The cleavage of RNA normally requires participation of the 2'-OH group as an internal nucleophile by two "nucleophilic cleavage" events: the transesterification and hydrolysis reactions. During the transesterification, the 2'-OH nucleophile attacks on tetrahedral phosphorus, affording a 2'-3'-cyclic monophosphate, which in turn is hydrolyzed to a mixture of 3'- and 2'-phosphate monoesters. On the basis of this known mechanism and of common experimental experience, we assumed that the cleavage of the 3'-phosphoester bond is largely more effective than the cleavage of the 5' one and that, for practical calculation purposes, the 5'-phosphoester bond is not cleaved. The half-lives of the oligonucleotide was determined with a standard graphical procedure from plots of the percent disappearance of the intact full-length molecules, the half-life value corresponding to the time value at which 50% of the full-length molecules had disappeared. Given that one disappearing molecule *a priori* represent one cleavage, the half-life of a 3'-phosphoester bond in the ribo oligonucleotide is given by the half-life of the oligonucleotide x 19 (that is, the number of the 3'-phosphoester bonds in the P1 20-mer) or x 23 (that is, the number of the 3'-phosphoester bonds in the PolyA₂₄ and PolyA₁₂C₁₂ 24-mer oligos), respectively.

Bibliography

Aida, M. 1988. An ab initio molecular orbital study on the sequence-dependency of DNA conformation: an evaluation of intra- and inter-strand stacking interaction energy. *J. Theor. Biol.* 130: 327-335.

Allègre, C. J., Manhès, G., Gopel, C. 1995. The age of the Earth. *Geochim. Cosmochim. Acta.* 59: 1445-1456.

Alberty, R.A. 2006. Thermodynamic properties of enzyme-catalyzed reactions involving guanine, xanthine, and their nucleosides and nucleotides. *Biophysical Chemistry.* 121: 157-162.

Arrhenius, S. 1918. *The destinies of the stars.* NY Putnam.

Aylward, N., Bofinger, N. 2007. Intramolecular interactions in aminoacyl cyclic-3',5'-nucleotides. *J. Theor. Biol.* 244: 258-274.

Bada, J.L., Lazcano, A. 2002. Origin of life. Some like it hot, but not the first biomolecules. *Science.* 296: 1982-1983.

Baldwin, G.S., Brooks, N.J., Robson, R.E., Wynveen, A., Goldar, A., Leikin, S., Seddon, J.M., Kornyshev, A.A. 2008. DNA double helices recognize mutual sequence homology in a protein free environment. *J. Phys. Chem. B.* 112: 1060-1064.

Beck, A., Lohrmann, R., Orgel, L.E. 1967. Phosphorylation with inorganic phosphates at moderate temperatures. *Science.* 157: 952.

Benner, S.A., Ellington, A.D., Tower, A. 1989. Modern metabolism as a palimpsest of the RNA world. *Proc. Natl. Acad. Sci. USA* 86: 7054-7058.

Benner, S.A., Huttler, D. 2002. Phosphates, DNA, and the search for nonterran life. A second generation model for genetic molecules. *Bioorg. Chem.* 30: 62-80.

Bernal, J.D. 1949. The physical basis of life. *Proc. Phys. Soc.* 62: 537-558.

Brahms, J., Michelson, A.M. and van Holde, K.E. 1966. Adenylate oligomers in single and double-strand conformation. *J. Mol. Biol.* 15: 467-488.

Brahms, J., Maurizot, J.C., Michelson, A.M. 1967. Conformation and thermodynamic properties of oligocytidylic acids. *J. Mol. Biol.* 25: 481-495.

Bibillo, A., Figlerowicz, M., Kierzek, R. 1999. The non-enzymatic hydrolysis of oligoribonucleotides. VI. The role of biogenic polyamines. *Nucleic Acid Res.* 27: 3931-3937.

Cairns-Smith, A.G. 1966. The origin of life and the nature of the primitive gene. *J. Theor. Biol.* 10, 53-88.

Cairns-Smith, A.G., Davies, C.J. 1977. The design of novel replicating polymers. *Encyclopaedia of Ignorance* (eds Duncan, R. & Weston-Smith, M. 391-403. Pergamon Oxford.

Cantor, R.C., Schimmel, P.R. 1980. *Biophysical Chemistry*. W.H. Freeman San Francisco, CA. p. 335.

Chaput J. and Switzer C. 2000. Nonenzymatic oligomerization on templates containing phosphoester linked acyclic glycerol nucleic acid analogues. *J. Mol. Evol.* 51: 464-470.

Chech, T.R., Zaug, A.J., Grabowski, P.J. 1981. In vitro splicing of the ribosomal RNA precursor of *Tetrahymena*: involvement of a guanosine nucleotide in the excision of the intervening sequence. *Cell.* 27: 487-496.

Chen, I.A., Roberts, R. W., Szostak, J.W. 2004. The emergence of competition between model protocells. *Science.* 305: 1474-1476.

Chen, I.A., Szostak, J.W. 2004. Membrane growth can generate a transmembrane pH gradient in fatty acid vesicles. *Proc. Natl. Acad. Sci. USA.* 101: 7965-7970.

Chyba, C. F., Hang, K. P. 2005. Astrobiology: the study of the living universe. *Annu. Rev. Astron. Astrophys.* 43: 31-74.

Ciciriello, F., Costanzo, G., Crestini, C., Saladino, R., Di Mauro, E. 2007. Origin of informational polymers and the search for non-terran life: protection of the polymeric state of DNA by phosphate minerals. *Astrobiology.* 7: 616-630.

Ciciriello, F., Costanzo, G., Pino, S., Crestini, C., Saladino, R., Di Mauro E. 2008. Molecular complexity favors the evolution of ribopolymers. *Biochemistry.* 47: 2732-2742.

Cieplak, P., Kollman, P.A. 1988. Calculation of the free energy of association of nucleic acid bases in vacuo and water solution. *J. Am. Chem. Soc.* 110: 3734-3739.

Cleland, C. E., Chyba, C. 2002. Defining 'life'. *Orig. Life. Evol. Biosph.* 32: 387-393.

- Cockell, C.S. 1999. Life on Venus. *Planetary Space Sci.* 47: 1487-1501.
- Colin, J., Kasting, J.F. 1992. Venus. A search for clues to early biological possibilities. In *exobiology in the Solar System*. NASA Technical Pub. 512.
- Cooper, G., Kimmich, N., Belisle, W., Sarinan, J., Brabbam, J., Garrel, L. 2001. Carbonaceous meteorites as a source of sugar-related compounds for the early Earth. *Nature*. 414: 879-883.
- Costanzo, G., Saladino, R., Crestini, C., Ciciriello, F., Di Mauro, E. 2007. Nucleoside phosphorylation by phosphate minerals. *J. Biol. Chem.* 282: 16729-16735.
- Crick, F.H.C. 1968. The origin of the genetic code. *J. Mol. Biol.* 38: 367-379.
- Crothers, D.M., Ratner, D.I. 1968. Thermodynamic studies of a model system for hydrophobic bonding. *Biochemistry*. 7: 1823-1827.
- Davis, R.C., Tinoco, I. 1968. Temperature-dependent properties of dinucleoside phosphates. *Biopolymers*. 6: 223-242.
- Dawkins, R. 1989. *The selfish Gene*. p. 12, Oxford University Press. Oxford
- De Graaf, R.M., Visscher, J., Schwartz, A.W. 1997. Reactive phosphonic acids as a prebiotic carriers of phosphorous. *J. Mol. Evol.* 44: 237-241.
- Dekker, C.A., Korana, H.G. 1954. Carbodiimides. VI. The Reaction of Dicyclohexylcarbodiimide with Yeast Adenylic Acid. A New Method for the Preparation of Monoesters of Ribonucleoside 2'- and 3'-Phosphates

J. Am. Chem. Soc. 76: 3522-3527.

Di Giulio, M. 2000. The universal ancestor lived in a thermophilic or hyperthermophilic environment. J. Theor. Biol. 203: 203-213.

Dyson, F. 1985. Origin of life (Cambridge U. Press).

Egholm, M., Buchardt, O., Christensen, L., Beherens, C., Freier, S., Driver, D.A., Berg, R.H., Kim, S.K., Norden, B., Nielsen, P.E. 1993. PNA hybridizes to complementary oligonucleotides obeying the Watson-Crick hydrogen-bonding rules Nature 365: 566-568.

Eigen, M. 1971. Self-organization of matter and the evolution of biological molecules. Naturwissenschaften. 58: 465-523.

Eigen, M. 1996. Steps towards life. Oxford, UK: Oxford University Press.

Ertem, G., Ferris, J.P. 1998. Formation of RNA oligomers on montmorillonite: site of catalysis. Origins Life Evol. Biosphere. 28: 485.

Eschenmoser, A. 1999. Chemical etiology of nucleic acid structure. Science. 284: 2118-2124.

Ezra, F.S., Lee, C.H., Kondo, N.S., Danvluk, S.S., Sarma, R.H. 1977. Conformational properties of purine-pyrimidine and pyrimidine-purine dinucleoside monophosphates. Biopolymers. 16: 1977-1987.

Ferris, J.P., Hagan, W.J., 1984. HCN and chemical evolution: the possible role of cyano compounds in prebiotic synthesis. Tetrahedron 40: 1093-1120.

Ferris , J.P. 1987. Prebiotic synthesis: problems and challenger. Cold Spring Harbor Symp. LII: 29-39.

Ferris, J.P., Ertem, G. 1992. Oligomerization of ribonucleotides on montmorillonite: reaction of the 5'-phosphorimidazolide of adenosine. Science. 257: 1387-1389.

Ferris, J.P., Ertem, G. 1993. Montmorillonite catalysis of RNA oligomer formation in aqueous solution. A model for the prebiotic formation of RNA. J. Am. Chem. Soc. 115: 12270-12275.

Ferris , J.P., Hill, A., Liu, R., Orgel, L.E. 1996. Synthesis of long prebiotic oligomers on mineral surfaces. Nature. 381: 59-61.

Ferris , J.P., Joshi, P.C., Wang, K.J., Miyakawa, S., Huang, W. 2004. Catalysis in prebiotic chemistry: application to the synthesis of RNA oligomers. Adv. Space Res. 33: 100-105.

Finch, J.T., Klug, A. 1969. Two double helical forms of polyriboadenylic acid and the pH-dependent transition between them. J. Mol. Biol. 46: 597-598.

Folsome, C. E. 1979. The Origin of Life. San Francisco, CA: Freeman and Co.

Frechet, D., Ehrlich, R., Remy, P., Gabarro-Arpa, J. 1979. Thermal perturbation differential spectra of ribonucleic acids. II. Nearest neighbor interactions. Nucleic Acids Res. 7: 1981-2001.

Frick, L., Mac Neela, J.P., Wolfender, R. 1987. Transition state stabilization by deaminases: rates of nonenzymic hydrolysis of adenosine and cytidine. Bioorg. Chem. 15: 100-108.

Friedman, R.A., Honig, B. 1995. A free energy analysis of nucleic acid base stacking in aqueous solution. *Biophys. J.* 69: 1528-1535.

Fritz, H.J., Belagaje, R., Brown, E.L., Fritz, R.H., Jones, R.A., Lees, R.G., Korana, H.G. 1978. High-pressure liquid chromatography in polynucleotide synthesis. *Biochemistry.* 17: 1257-1267.

Fuller, W.D., Sanchez, R.A., Orgel, L.E. 1972. Studies in prebiotic synthesis. VI. Synthesis of purine nucleosides. *J. Mol. Biol.* 67: 25-33.

Gerlt, J.A., Westheimer, F.H., Sturtevant, J.M. 1975. The enthalpies of hydrolysis of acyclic, monocyclic, and glycoside cyclic phosphate diesters. *J. Biol. Chem.* 250: 5059-5067.

Gilham, P.T., Korana, H.G. 1958. Studies on Polynucleotides. I. A New and General Method for the Chemical Synthesis of the C₅'-C₃' Internucleotidic Linkage. Syntheses of Deoxyribo-dinucleotides. *J. Am. Chem. Soc.* 80: 6212-6222.

Gogarten-Boekels, M., Hilario, E., Gogarten, J. P. (1995) The effects of heavy meteorite bombardment on the early evolution-the emergence of the three domains of life. *Orig. Life Evol. Biosph.* 25: 251-264.

Gold, T. 1992. The deep hot biosphere. *Proc Natl Acad Sci USA.* 89: 6045-6049.

Goldanskii VI. 1996. Nontraditional mechanism of solid-phase astrochemical reactions. *Kinetic and Catalysis.* 37: 608-614.

Greengard, P., Rudolph, S.A., Sturtevant, J.M. 1969. Enthalpy of hydrolysis of the 3' bond of adenosine 3',5'-monophosphate and guanosine 3',5'-monophosphate. *J. Biol. Chem.* 244: 4798.

Grimaldo, S., Cammarano, P. 1998. The root of the universal tree inferred from anciently duplicated genes encoding components of the protein-targeting machinery. *J. Mol. Evol.* 47: 508-516.

Guerrier-Takada, C., Gardiner, K., Marsh, T., Pace, N., Altman, S. 1983. The RNA moiety of ribonuclease P is the catalytic subunit of the enzyme. *Cell.* 35: 849-857.

Hanczyc, M., Mansy, S., Szostak, J.W. 2007. Mineral surface directed membrane assembly. *Orig. Life. Evol. Biosph.* 37: 67-82.

Hartmann, W. K., Ryder, G., Dones, L., Grinspoon, D. 2000. The time-dependent intense bombardment of the primordial Earth/Moon system. In: R. M. Canup and K. Righter (eds.) *Origin of the Earth and moon* university of Arizona Press, Tucson, pp. 493-512.

Hill, A.R., Orgel, L.E., Wu, T. 1993. The limits of template-directed synthesis with nucleoside-5'-phosphoro(2-methyl)imidazolides. *Orig. Life Evol. Biosphere.* 23: 285-290.

Heckl, W. M. 2004. Molecular self-assembly and nanomanipulation-two key technologies in nanoscience and templating. *Adv. Eng. Mater.* 6: 843-847.

Holcomb, D.N., Tinoco I. 1965. Conformation of polyriboadenylic acid: pH and temperature dependence. *Biopolymers.* 3: 121-133.

Huber, C., Wachtershauser, G. 2006. Alpha-hydroxy and alpha-amino acids under possible Hadean, volcanic origin of life conditions. *Science.* 314: 630-632.

- Huang, B., Walsh, J.J. 1998. Solid-phase polymerization mechanism of poly(ethyleneterephthalate) affected by gas flow velocity and particle size. *Polym.* 39: 6991-6999.
- Itoh, T., Tomizawa, J. 1980. Formation of an RNA primer for initiation of replication of ColE1 DNA by ribonuclease H. *Proc. Natl. Acad. Sci. USA* 77: 2450-2454.
- Jarvinen, P., Oivanen, M., Lonnberg, H. 1991. Interconversion and phosphoester hydrolysis of 2',5'- and 3',5'-dinucleoside monophosphates: kinetics and mechanisms. *J. Org. Chem.* 56: 5396-5401.
- Jenniskens, P., Wilson, M.A., Packan, D., Laux, C.O., Kruger, C.H., Boyd, I.D., Popova, O.P., Fonda, M. 1998. Meteors: a delivery mechanism of organic matter to the early Earth. *Earth Moon Planets.* 82-3, 57-70.
- Joyce, G. F., Orgel, L.E. 1986. Non-enzymic template-directed synthesis on RNA random copolymers. Poly(C, G) templates. *J. Mol. Biol.* 188: 433-441.
- Joyce, G. F. 1987. Nonenzymatic Template-directed Synthesis of Informational Macromolecules. *Cold Spring Harbor Symp. Quant. Biol.* 52: 41-51.
- Joyce, G. F. 1994a, forward, in D. W. Deamer, G. R. Fleischaker (eds), *Origins of life : the central concepts* (Jones & Bartlett, Boston), pp. xi-xii.
- Joyce, G. F. 1994b. *The RNA world : life before DNA and protein*, in *Extraterrestrial Where are they? II*, ed. B. Zuckerman, M. Hart. Cambridge : Cambridge U. Press.

Joyce, G. F., Orgel, L.E. 1999, in R. F. Gesteland, T. R. Cech and J. F. Atkins (eds.). The RNA world. Cold Spring Harbor Laboratory Press, Cold Spring Harbor NY, pp. 49-77.

Joyce, G. F. 2002. The antiquity of RNA-based evolution. *Nature*. 418: 214-221.

Joyce, G. F. 2004. Directed evolution of nucleic acid enzymes. *Annual Review of Biochemistry*. 73: 791-836.

Joyce, G. F., Orgel, L.E. 2006. Progress towards understanding the origin of the RNA world, in *The RNA World*, third edition: The nature of modern RNA suggests a prebiotic RNA world (Gesteland, R.F. and Atkins, J.F. Eds.) pp 23-56, Cold Spring Harbor Laboratory Press, Cold Spring Harbor, NY.

Junge, K., Eicken, H., Deming, J.W. 2004. Bacterial activity at -2 to -20 degrees C in Arctic wintertime sea ice. *Appl. Environ. Microbiol.* 70: 550-557.

Kadanoff, L. P. 1993. *From order to chaos*. Singapore, Singapore: World Scientific.

Kang, H., Chou, P.J., Johnson, W.C., Weller, D., Huang, S.B., Summerton, J.E. 1992. Stacking interactions of ApA analogues with modified backbones. *Biopolymers*. 32: 1351-1363.

Kaukinen, U., Lyyticainen, S., Mikkola, S, Lonnberg, H. 2002. The reactivity of phosphodiester bonds within linear single-stranded oligoribonucleotides strongly dependent on the base sequence. *Nucleic Acid Res.* 30: 467-468.

Kaukinen, U., Venalainen, T., Lonnberg, H., Perakyla, M. 2003. The base sequence dependent flexibility of linear single-stranded oligoribonucleotides correlates with the reactivity of the phosphodiester bond. *Org. Biomol. Chem.* 1: 2439-2447.

- Kierzek, R. 1992. Nonenzymatic hydrolysis of oligoribonucleotides. *Nucleic Acid Res.* 20: 5079-5084.
- Kolodner, M.A., Steffes, P.G. 1998. The microwave absorption and abundance of sulphuric acid vapour in the Venus atmosphere based on new laboratory measurement. *Icarus.* 132: 151-169.
- Koppitz, M., Nielsen, P.E., Orgel, L.E. 1998. Formation of oligonucleotide-PNA-chimeras by template-directed ligation. *J. Am. Chem. Soc.* 120: 4563-4569.
- Kuusela, S., Lonnberg, H. 1994. Metal-ion-promoted hydrolysis of polyuridylic acid. *J. Chem. Soc. Perkin Trans. 2:* 2301.
- La Neve, P., Altieri, F., Fiori, M. E., Scaloni, A., Bozzoni, I., Caffarelli, E. 2003. Purification, cloning, and characterization of XendoU, a novel endoribonuclease involved in processing of intron-encoded small nucleolar RNAs in *Xenopus Laevis*. *J. Biol. Chem.* 278: 13026-13032.
- Lane, B.G., Butler, G.C. 1959. The exceptional resistance of certain oligoribonucleotides to alkaline degradation. *Biochim. Biophys. Acta.* 33: 281-283.
- Laybourn-Parry, J. 2002. Survival mechanism in antarctic lakes. *Philos. Trans. R. Soc. Lond. B Biol. Sci.* 357: 863-869.
- Lazcano, A., Guerrero, R., Margulis, L., Oro, J. 1988. The evolutionary transition from RNA to DNA in early cells. *J. Mol. Evol.* 27: 283-290.

- Lehn, J. M. 2002a. Supramolecular chemistry and self-assembly special feature towards complex matter: supramolecular chemistry and self-organization. *Proc. Natl. Acad. Sci. USA.* 99: 4763-4768.
- Lehn, J. M. 2002b. Towards self-organization and complex matter. *Science.* 295: 2400-2403.
- Lehn, J. M. 2003. The Einstein lecture. Albert Einstein Memorial Lecture, Jerusalem. Jerusalem, Israel: The Israel Academy of Sciences.
- Leng, M., Fensfeld, G. 1996. A study of polyadenilic acid at neutral pH. *J. Mol. Biol.* 15: 455-466.
- Li, Y., Breaker, R.R. 1999. Kinetics of RNA degradation by specific base catalysis of transesterification involving the 2'-hydroxyl group. *J. Am. Chem. Soc.* 121: 5364-5372.
- Li, Y.L., Maurel, M.C., Ebel, C., Vergne, J., Pipich, V., Zaccai, J. 2008. Self-association of adenine-dependent hairpin ribozymes. *Eur. Biophys. J.* 37: 173-182.
- Lineweaver, C.H., Schwartzman, D. 2004. *Cosmic Thermobiology. Genesis, Evolution and Diversity of Life*, edited by J. Seckbach, Kluwer
- Lindhall, T. 1993. Instability and decay of the primary structure of DNA. *Nature.* 362: 709-715.
- Linkletter, B.A., Szabo, I.E., Bruice, T.C. 2001. Solid-phase synthesis of oligopurine deoxynucleic guanidine (DNG) and analysis of binding with DNA oligomers. *Nucleic Acid Res.* 29: 2370-2376.

- Lineweaver, C. H., Schwartzman, D. 2003. Thermal constraints on the origin and evolution of life in the universe. *Cosmic Thermobiology* pp 1-14.
- Lilley, D.M.J. 2003. The origins of RNA catalysis in ribozymes. *Trends Biochem. Sci.* 28: 495-501.
- Lincoln, T.A., Joyce, G.F. 2009. Self-Sustained Replication of an RNA Enzyme. *Science.* 232: 1229-1232.
- Lohrmann, R., Orgel, L.E. 1968. Prebiotic synthesis: phosphorylation in aqueous solution. *Science.* 161: 64-66.
- Lohrmann, R. 1977. Formation of nucleoside 5'-phosphoramidates under potentially prebiological conditions. *J. Mol. Evol.* 10: 137-154.
- Luo, R.H., Gilson, S.R., Potter, M.J., Gilson, M.K. 1998. The physical basis of nucleic acid base stacking. *Biophys. J.* 80: 140-148.
- Lutay, A.V., Chernolovskaya, E.L., Zenkova, M.A., Vlassov, V.V. 2006. The nonenzymatic template-directed ligation of oligonucleotides. *Biogeosci. Discuss.* 3: 1-21.
- Mansy, S.S., Schrum, J.P., Krishnamurthy, M., Tobè, S., Treco, D.A., Szostack, J.W. 2008. Template-directed synthesis of a genetic polymer in a model protocell. *Nature.* 454: 122-125.
- Maurette, M. 1998. Carbonaceous micrometeorites and the origin of life. *Orig. Life. Evol. Biosph.* 28: 385-412.

- Meli, M., Vergne, J., Decout, J.L., Maurel, M.C. 2002. Adenine-aptamer complexes: a bipartite RNA site that binds the adenine nucleic base. *J. Biol. Chem.* 277: 2104-2111.
- Meli, M., Vergne, Maurel, M.C. 2003. In vitro selection of adenine-dependent hairpin ribozymes. *J. Biol. Chem.* 278: 9835-9842.
- Miller, S. L. 1953. A production of amino acids under possible primitive Earth conditions. *Science.* 117: 528-529.
- Miller, S. L. 1998. A. Brack (ed.), *The molecular origin of life. Assembling pieces of the puzzle.* Cambridge University Press, Cambridge: pp 59-85.
- Morrow, J.R., Aures, K., Epstein, D. 1995. Metal-ion promoted attack of on alcohol on a phosphate diester-modeling the role of metal-ions in RNA self-splicing reactions. *J. Chem. Soc. Chem. Commun.* 23: 2431-2432.
- Muller, U.F. 2006. Re-creating an RNA world. *Cell. Mol. Life Sci.* 63: 1278-1293.
- Nakata, M., Zanchetta, G., Chapman, B.D., Jones, C.D., Cross, J.O., Pindak, R., Bellini, T., Clark, N.A. 2007. End-to-End Stacking and Liquid Crystal Condensation of 6- to 20-Base Pair DNA Duplexes. *Science.* 318: 1276-1279.
- Newcomb, L.F., Gellman, S.H. 1994. Aromatic stacking interactions in aqueous solution: evidence that neither classical hydrophobic effects nor dispersion forces are important. *J. Am. Chem. Soc.* 116, 4993-4994.
- Nielsen, P.E., Egholm, M., Berg, R.H., Buchardi, O. 1991. Sequence selective recognition of DNA by strand displacement with a thymine-substituted polyamine. *Science.* 254: 1497-1500.

Norberg, J., Nilsson, L. 1995 a. Stacking free energy profiles for all 16 natural ribonucleoside monophosphate in aqueous solution. *J. Am. Chem. Soc.* 117: 10832-10840.

Norberg, J., Nilsson, L. 1995 b. Temperature dependence of the stacking propensity of adenylyl-3',5'-adenosine. *J. Phys. Chem.* 99: 13056-13058.

Norberg, J., Nilsson, L. 1996 a. A conformational free energy landscape of ApApA from molecular dynamics simulation. *J. Phys. Chem.* 100: 2550-2554.

Norberg, J., Nilsson, L. 1996 b. Influence of adjacent bases on the stacking-unstacking process of single-stranded oligonucleotides. *Biopolymers.* 39: 765-768.

Norberg, J., Nilsson, L. 1998. Solvent influence on base stacking. *Biophys. J.* 74: 394-402.

Norberg, J., Nilsson, L. 2002. Molecular dynamics applied to nucleic acids. *Account Of Chemical Research.* 35: 465-472.

Oivanen, M., Kuusela, S., Lonnberg, H. 1998. Kinetics and mechanisms for the cleavage and isomerization of the phosphodiester bonds of RNA by Bronsted acids and bases. *Chem. Rev.* 98: 961-990.

Olah, G.A., Salem, G., Staral, J.S., Ho, T.L. 1978. Preparative carbocation chemistry. 13. Preparation of carbocation from hydrocarbons via hydrogen

abstraction with nitrosonium hexafluorophosphate and sodium nitrite trifluoromethanesulfonic acid. *J. Org. Chem.* 43: 173-175.

Olson, W.K. 1975. The spatial configuration of ordered polynucleotide chains. II. The poly(rA) helix. *Nucl. Acids Res.* 2: 2055-2068.

Oparin, A.I. 1938. "Origin of life". New York, McMillan

Oparin, A.I. 1961. Evolution of the genetic apparatus. *J. Mol. Biol.* 38: 3:381-393.

Orgel, L.E. 1968. Evolution of the genetic apparatus. *J. Mol. Biol.* 38-3: 381-393.

Orgel, L.E. 1992. Molecular replication. *Nature.* 358: 203-209.

Orgel, L.E. 1998. The origin of life--a review of facts and speculations. *Trends Biochem. Sci.* 23: 491-495.

Orgel, L.E. 2000. Self-organizing biochemical cycles. *Proc. Natl. Acad. Sci. USA.* 97: 12503-12507.

Orgel, L.E. 2004. Prebiotic chemistry and the origin of RNA world. *Crit. Rev. Biochem. Mol. Biol.* 39: 99-123.

Ostenberg, R., Orgel, L.E., Lohrmann, R. 1973. Further studies of urea-catalyzed phosphorylation reactions. *J. Mol. Evol.* 2, 2-3, 231-234.

Pace, N. R. 1997. A molecular view of microbial diversity and the biosphere. *Science.* 276: 734-74.

- Paecht-Horowitz, M., Berger, J., Katchalsky, A. 1970. Prebiotic synthesis of polypeptides by heterogeneous polycondensation of amino-acid adenylates. *Nature*. 228: 636-639.
- Pascal, R., Boiteau, L., Forterre, P., Gargaud, M., Lazcano, A., Lopez-Garcia, P., Moreira, D., Maurel, M.C., Pereto, J., Prieur, D., Reisse, J. 2006. Prebiotic Chemistry-Biochemistry- Emergence of Life. *Earth, Moon and Planets*. 98: 153-203.
- Petrovic, A. G., Polavarupu, P.L. 2005. Structural transitions in polyriboadenylic acid induced by the changes in pH and temperature: vibrational circular dichroism study in solution and film states. *J. Phys. Chem. B*. 109: 23698-23705.
- Pinder, J.C., Staynov, D.Z., Gratzer, W.B. 1974. Properties of RNA in formamide. *Biochemistry*. 13: 5367-5373.
- Pino, S., Ciciriello, F., Costanzo, G., Di Mauro, E. 2008. Nonenzymatic RNA ligation in water. *J. Biol. Chem*. 283: 36494-36503.
- Pitsch, S., Wendeborn, S., Jaun, B., Eschenmoser, A. 1993. Why pentose and not hexose nucleic acids? Pyranosyl-RNA (p-RNA). *Helv. Chim. Acta*. 76: 2161-2183.
- Pitsch, S. *et al.* 1995. Pyranosyl-RNA (p-RNA): base pairing selectivity and potential to replicate. *Helv. Chim. Acta*. 78: 1621-1635.
- Pohorille, A., Burt, S.K., MacElroy, R.D. 1994. Monte Carlo simulation of the influence of solvent on nucleic acid base associations. *J. Am. Chem. Soc*. 106: 402-409.
- Popper, K.R. 1963. *Conjectures and refutations: the growth of scientific knowledge*, Routledge & Kegan Paul, London.

Powner, M.W., Gerland, B., Sutherland, J.D. 2009. Synthesis of activated pyrimidine ribonucleotides in prebiotically plausible conditions. *Nature*. 459: 239.

Prabakar, K.J., Ferris, J.P. 1997. Adenine derivatives as phosphate-activating groups for the regioselective formation of 3',5'-linked oligoadenylates on montmorillonite: possible phosphate-activating groups for the prebiotic synthesis of RNA. *J. Am. Chem. Soc.* 119: 4330.

Pross, A. 2005. On the emergence of biological complexity: Life as a kinetic state of matter. *Origins Life Evol. Bios.* 35: 151-166.

Pross, A. 2005. Stability in chemistry and biology: Life as a kinetic state of matter. *Pure Appl. Chem.* 77: 1905-1921.

Rajamani, S., Vlassov, A., Benner, S., Coombs, A., Olasagasti, F., Deamer, D. 2008. Lipid-assisted Synthesis of RNA-like Polymers from Mononucleotides. *Origins Life Evol Biosphere*. 38: 57-74.

Reddy, P.M., Bruice, T.C. 2003. Solid-phase synthesis of positively charged deoxynucleic guanidine (DNG) oligonucleotide mixed sequences. *Bioorg. Med. Chem. Lett.* 13: 1281-1285.

Renz, M., Lohrmann, R., Orgel, L.E. 1971. Catalysts for the polymerization of adenosine cyclic 2',3'-phosphate on a poly (U) template. *Biochim. Biophys. Acta.* 240: 240463-240471.

Revzin, A., Neumann, E., Katchalsky, A. 1973. Metastable secondary structures in ribosomal RNA: a new method for analyzing the titration behaviour of rRNA. *Biopolymers*. 12: 2353-2383.

Ricardo, A., Carrigan, M.A., Olcott, A.N., Benner, S.A. 2004. Borate minerals stabilize ribose. *Science*. 303: 196.

Rohatgi, R., Bartel, D.P., Szostak, J.W. 1996. Kinetic and mechanistic analysis of nonenzymatic template-directed oligonucleotide ligation. *J. Am. Chem. Soc.* 118: 3332-3339.

Rollins, J. 2006. *Black Order*. New York: Harper Collins.

Russell, M.J., Hall, A.J. 1997. The emergence of life from iron monosulphide bubbles at a submarine hydrothermal redox and pH front. *J. Geol. Soc. (London)* 154: 377-402.

Russell, M., Martin, W. 2004. The rocky roots of the acetyl-CoA pathway. *Trends Biochem. Sci.* 29: 358-363.

Saladino, R., Ciambecchini, U., Crestini, C., Costanzo, G., Negri, R., Di Mauro, E. 2003. One-pot TiO₂-catalyzed synthesis of nucleic bases and acyclonucleosides from formamide: implications for the origin of life. *ChemBioChem*. 4: 514-521.

Saladino, R., Crestini, C., Costanzo, G., Di Mauro, E. 2004. Advances in the prebiotic synthesis of nucleic acid bases. Implications for the origin of life, *Curr. Org. Chem.* 8: 1425-1443.

Saladino, R., Crestini, C., Neri, V., Brucato, J.R., Colangeli, L., Ciciriello, F., Costanzo, G., Di Mauro, E. 2005. Synthesis and degradation of nucleic acids

components by formamide and Cosmic Dust Analogues. *ChemBioChem*. 6: 1368-1374.

Saladino, R., Crestini, C., Ciciriello, F., Di Mauro, E., Costanzo, G. 2006 (a) Origin of informational polymers: differential stability of phosphoester bonds in ribomonomers and oligomers. *J. Biol. Chem*. 281: 5790-5796.

Saladino, R., Crestini, C., Neri, V., Ciciriello, F., Costanzo, G., Di Mauro, E. 2006 (b) Origin of informational polymers: the concurrent roles of formamide and phosphates. *Chembiochem* 7: 1707-1714.

Saladino, R., Neri, V., Crestini, C., Costanzo, G., Graciotti, M., Di Mauro, E. 2008. Synthesis and degradation of nucleic acid components by formamide and iron sulfur minerals. *J. Am. Chem. Soc.* 130: 15512-15518.

Saladino, R., Crestini, C., Neri, V., Ciciriello, F., Pino, S., Costanzo, G., Di Mauro, E. 2009. From formamide to RNA: the roles of formamide and water in the evolution of chemical information. *Res. Mic.* 160: 441.

Sawai, H., Wada, M., Kouda, T., Ozaki, A.N. 2006. Nonenzymatic Ligation of Short-Chained 2'-5' - or 3'-5' -Linked Oligoribonucleotides on 2'-5' - or 3'-5' -Linked Complementary Templates. *ChemBioChem*. 7: 605-611.

Schmidt, J., Nielsen, P.E., Orgel, L.E. 1997. Information transfer from peptide nucleic acids to RNA by template- directed syntheses. *Nucleic Acids Res.* 25: 4797-4802.

Schneider-Bernloehr, H., Lohrmann, R., Sulston, J., Weimann, B.J., Orgel, L.E., Miles, H.T. 1968. Nonenzymatic synthesis of deoxyadenylate oligonucleotides on a polyuridylylate template. *J. Mol. Biol.* 14, 37,1: 151-155.

Schoning, K.U., Scholz P, Guntha S, Wu X, Krishnamurthy R, Eschenmoser A. 2000. Chemical etiology of nucleic acid structure : the α -threofuranosyl-(3'-2') oligonucleotide system. *Science*. 290:1347-1351.

Schwartz, A.W. 2006. Phosphorus in prebiotic chemistry. *Philos. Trans. R. Soc. London, Ser. B*. 361: 1743-1749.

Schwartzman, D. 1999. *Life, Temperature and the Earth. The self-organizing biosphere*. Columbia University Press. New York. 242 pgs.

Seckbach, J., Libby, W.F. 1970. Vegetative life on Venus. Investigations with algae which grow under pure CO₂ in hot acid media at elevated pressure. *Space Life Sci.* 2: 121-143.

Shoffstall, A.M. 1976. Prebiotic phosphorylation of nucleosides in formamide. *Origins Life Evol. Biosph.* 7: 399-412.

Shoffstall, A.M., Barto, R.J., Ramo, D.L. 1982. Nucleoside and deoxynucleoside phosphorylation in formamide solution. *Origins Life Evol. Biosph.* 12: 143-151.

Shoffstall, A.M., Liang, E.M. 1985. Phosphorylation mechanisms in chemical evolution. *Origins Life Evol. Biosph.* 15: 141-150.

Shoffstall, A.M., Mahone, S.M. 1988. Formate ester formation in amide solution. *Origins Life Evol. Biosph.* 18: 389-396.

Sinanoglou, O., Abdalnur, S. 1964. *Photochem Photobiol.* 3: 333.

Smith, K.C., Allen, F.W. 1953. The liberation of polynucleotides by the alkaline hydrolysis of ribonucleic acid from yeast. *J. Am. Chem. Soc.* 75: 2131-2133.

Smith, M., Moffat, J.G., Korana, H.G. 1958. Observations on the reactions of carbodiimides with acids and some new applications in the synthesis of phosphoric acid ester. *J. Am. Chem. Soc.* 80: 6204-6212.

Smith, M., Drummond, G.I., Korana, H.G. 1961. Cyclic Phosphates. IV. Ribonucleoside-3',5' Cyclic Phosphates. A General Method of Synthesis and Some Properties. *J. Amer. Chem. Soc.* 83: 698-706.

Soukup, G., Breaker, R. 1999. Relationship between internucleotide linkage geometry and the stability of RNA. *RNA*, 5: 1308-1325.

Spach, G. 1984. Chiral versus chemical evolutions and the appearance of life. *Origins Life Evol. Biosph.* 14: 433-437.

Steinbech, C., Richert, C. 1998. The role of ionic backbones in RNA structure: an unusually stable non-Watson-Crick duplex of a non-ionic analog in an apolar medium. *J. Am. Chem. Soc.* 120: 11576-11580.

Steitz, T., Moore, P.B. 2003. RNA, the first macromolecular catalyst: the ribosome is a ribozyme. *Trends Biochem. Sci.* 28: 411-418.

Stevens, T.O. 1997. *Microbiology of the Terrestrial subsurface*. Edited by Amy PS, Halderman DL. Boca Raton, FL. Chemical Rubber Company Press.

Sulston, J., Lohrmann, R., Orgel, L.E., Miles, H.T. 1968. Nonenzymatic synthesis of oligoadenylates on a polyuridylic acid template. *PNAS USA* 59: 726-733.

- Sutherland, J.D., Whitfield, J.N. 1997. Prebiotic chemistry: A bioorganic perspective. *Tetrahedron*. 53: 11493-11527.
- Tian, F., Toon, O.B., Pavlov, A.A., De Sterck, H. 2005. A Hydrogen-Rich Early Earth Atmosphere. *Science*. 308: 1014-1017.
- T'so, P.O.P., Helmkamp, G.K., Sander, C. 1962. Interaction of nucleosides and related compounds with nucleic acids as indicated by the change of helix-coil transition temperature. *Proc. Natl. Acad. Sci. U.S.A.* 48: 686.
- Usher, D.A., Mc Hale, A.H. 1976. Nonenzymatic joining of oligoadenylates on a polyuridylic acid template. *Science*. 192: 53-54.
- van Holde, K.E., Brahms, J., Michelson, A.M. 1965. Base interactions of nucleotide polymers in aqueous solution. *J. Mol. Biol.* 12: 726-739.
- van Holde, K.E. 1980. The Origin of Life: a thermodynamic critique in "The origin of life and evolution", H.O. Halvorson and K.E. van Holde EDs, Alan R. Liss, Inc. New York 31-46.
- Verlander, M.S., Lohrmann, R., Orgel, L.E. 1973. Catalysis for the self-polymerization of adenosine cyclic 2',3'-phosphate. *J. Mol. Evol.* 2: 303-316.
- Wächtershäuser, G. 1998. Before enzymes and template: theory of surface metabolism. *Microbiol. Rev.* 52: 452-484.
- Weimann, B.J., Lohrmann, R., Orgel, L.E., Schneider-Bernloehr, H., Sulston, J.E. 1968. Template-directed synthesis with adenosine-5'-phosphorimidazolide. *Science*. 26,161, 839: 387.

Wächtershäuser, G. 2006. From volcanic origins of chemoautotrophic life to Bacteria, Archea and Eukarya. *Philos. Trans. R. Soc. London, Ser. B.* 361: 1787-1806.

Wacker, W., Crothers, D.M., Sabol, S.L., Ratner, D.I., Muller, W. 1968. Studies concerning the behaviour of actinomycin in solution. *Biochemistry.*7: 1817-1823.

Westheimer, F.H. 1987. Why nature choose phosphate. *Science.* 235: 1173-1178.

White, H.B. 3rd. 1976. Coenzymes as fossils of an earlier metabolic state. *J. Mol. Evol.* 7: 101-104.

Woese, C. 1967. The evolution of the genetic code. *The genetic code*, pp 179-195, Harper & Row.

Woese, C., Kandler, O., Wheelis, M. L. 1990. Towards a natural system of organisms: proposal for the domains Archea, Bacteria and Eucarya. *Proc. Natl. Acad. Science, USA* 87: 4576-4579.

Yamagata, Y., Watanabe, H., Saitoh, M., Namba, T. 1991. Volcanic production of polyphosphate and its relevance to prebiotic evolution. *Nature (London)* 352: 516-519.

Yates, F. E. 1987. *Self-organizing system.* New York, NY: Plenum Press.

Zubay, G. 1998. Studies on the lead-catalyzed synthesis of aldopentoses. *Orig. Life Evol. Biosph.* 28: 13-26.

Zuker, M. 1989. On finding all suboptimal foldings of an RNA molecule. *Science*. 244: 48-52.