

Kent Academic Repository

Full text document (pdf)

Citation for published version

Adefila, Kehinde and Yan, Yong and Sun, Lijun and Wang, Tao (2016) Flow Measurement of CO₂ in a Binary Gaseous Mixture Using an Averaging Pitot Tube and Coriolis Mass Flowmeters. *Flow Measurement and Instrumentation* . ISSN 0955-5986.

DOI

<https://doi.org/10.1016/j.flowmeasinst.2016.12.007>

Link to record in KAR

<http://kar.kent.ac.uk/59688/>

Document Version

Author's Accepted Manuscript

Copyright & reuse

Content in the Kent Academic Repository is made available for research purposes. Unless otherwise stated all content is protected by copyright and in the absence of an open licence (eg Creative Commons), permissions for further reuse of content should be sought from the publisher, author or other copyright holder.

Versions of research

The version in the Kent Academic Repository may differ from the final published version.

Users are advised to check <http://kar.kent.ac.uk> for the status of the paper. **Users should always cite the published version of record.**

Enquiries

For any further enquiries regarding the licence status of this document, please contact:

researchsupport@kent.ac.uk

If you believe this document infringes copyright then please contact the KAR admin team with the take-down information provided at <http://kar.kent.ac.uk/contact.html>

Flow Measurement of CO₂ in a Binary Gaseous Mixture Using an Averaging Pitot Tube and Coriolis Mass Flowmeters

K. Adefila^a, Y. Yan^{a1}, L. Sun^b, T. Wang^c

^a School of Engineering and Digital Arts, University of Kent, Canterbury, CT2 7NT, UK

^b School of Engineering and Automation, Tianjin University, Tianjin, 300072, P. R. China

^c KROHNE LTD, Wellingborough, NN8 6AE, UK

ABSTRACT

To combat the growing emissions of CO₂ from industrial processes, Carbon Capture and Storage (CCS) and Carbon Capture and Utilization technologies (CCU) have been accepted worldwide to address these pressing concerns. So as to efficiently manage material and financial losses across the entire stream, accurate accounting and monitoring through fiscal metering of CO₂ in CCS transportation pipelines are core and required features for the CCS technologies. Moreover, these technical requirements are part of the legal compliance schemes and guidelines from various regulatory bodies. The CO₂ transportation pipelines will likely have multiple inputs from different capture plants, each with varying composition of CO₂ and thus introducing impurities into the CO₂ stream. The presence of other ordinary or hydrocarbon gases in the CO₂ gas stream could affect the functionality of metering instruments by introducing additional errors, particularly in the case of volumetric flowmeters. In this study, volumetric and direct mass measurement methods for the flow measurement of CO₂ mixtures using two totally different metering principles are experimentally evaluated. An Averaging Pitot Tube with Flow Conditioning Wing (APT-FCW) and Coriolis mass flowmeters (CMF) are used to assess the flow metering of CO₂ in a binary gaseous mixture. Different gases (nitrogen, air, oxygen, argon and propane) are diluted as contaminants into the pure CO₂ gas flow for various mass fractions to produce an

¹ Corresponding author: Tel: (0044)1227823015; E-mail: y.yan@kent.ac.uk

adulterated mixture of the CO₂ gas. Comparative analysis of the measurement results under these flow conditions relative to that of pure CO₂ gas show that the measurement error of the APT-FCW sensor increases with the mass fraction of the diluent component, and gases with density closer to that of CO₂ have a much lesser effect on the performance of the APT-FCW flow sensor for smaller mass fractions. The CMF proved to be very reliable in the gas combination processes and as a reference meter for the APT-FCW sensor. Further analytical observations are discussed in detail.

Keywords – Carbon capture and storage; Carbon capture and utilization; CO₂ gas; CO₂ mixtures; Averaging Pitot tube; Flow conditioning wing; Binary gaseous mixture; Coriolis mass flowmeters.

1. INTRODUCTION

Carbon Capture and Storage (CCS) and Carbon Capture and Utilisation (CCU) technologies have been accepted worldwide to play a pivotal role in the mitigation of anthropogenic CO₂ gas in power stations and industrial plants. This generally involves the transportation of CO₂ gas from the capture sites to storage locations such as saline formations and depleted oil and gas reservoirs [1]. CCU differs from CCS in the final destination of the captured CO₂ in which it is instead converted into commercial products rather than transferred to a suitable site for long-term storage [2]. Effective and accurate accounting during custody transfer as well as across the entire CCS chain is necessary to boost confidence in the technology as significant measurement errors could lead to considerable financial exposures. In CCS and CCU facilities, one of the early stages of the flue gas processing in the extraction of the CO₂ gas using ‘CO₂ strippers’ before being passed on to the compression systems for transportation. At the beginning of the CCS process in the capture plants for the launch of flow into the CO₂ transportation pipelines, the compression pressure conditions are essentially insufficient to produce liquid or other dense phases of the fluid [3]. The measurement uncertainty of existing metering instruments in the area of CO₂ flow measurement may be very high since most manufacturers do not normally calibrate their meters with CO₂ flows. If metering uncertainty is to be kept low – the arbitrary 1.5% by mass, as recommended by

the EU-Emissions Trading Scheme (ETS) [4], the need to recognize the presence of undesirable impurity contents in various stages along the pipeline leading to and at the storage platform is a fundamental requirement of the CCS technology. The presence of impurities in CO₂ transportation lines could affect the functionality of the flowmeters and resultantly increasing overall measurement uncertainty. Aside from this problem, the performance of currently available flowmeters for CO₂ mixture applications remains largely unknown. Although common standards for CO₂ purity are yet to be established within the CCS scheme, information concerning this has been deemed important to influence CCS related regulations and consultation re-routing in the near future [5]. Since most volumetric flowmeters employed in CCS facilities would require their flow data to be presented in terms of mass, the indispensable importance of density calculation of CO₂ mixtures is not only essential to the uncertainty of measurement results, but also for controlling CCS processes and planning as well as to ensure optimum design and operation of systems across the CCS streams. In addition, there is currently insufficient knowledge of the physical and thermodynamic properties and phase envelopes of CO₂ mixtures in the CCS chain [6]. With respect to the large scale metering processes of CCS, a slight uncertainty in the measured volumetric flow rate and hence the total mass of CO₂ can also introduce significant financial exposures.

In this paper, an Averaging Pitot Tube with Flow Conditioning Wing (APT-FCW) is used as a cost-effective technological option to measure a binary gaseous mixture with CO₂ as a base gas and other gases as minor components. Its measurement results are compared against those obtained from a set of multiple Coriolis mass flowmeters (CMFs). In addition to its strong promising potential of meeting the EU-ETS uncertainty requirement under the CCS scheme draft guideline, the CMF was selected for its industry-wide versatility for various flow conditions and very high reliability [7]. Previous studies [8] have also shown that the CMF offers stable and consistent performance and therefore capable of serving as a reference meter for the APT-FCW. The APT-FCW flow sensor has been demonstrated to meter pure gaseous CO₂ under laboratory conditions within an error of $\pm 1\%$ [8]. This present research examines the

level of metrological impact that the presence of gaseous impurities could have on the APT-FCW in CO₂ gas metering processes. Diluent gases – nitrogen (N₂), air, oxygen (O₂), argon (Ar) and Propane (C₃H₈) are used as contaminants and combined with the CO₂ gas at 10%, 15% and 20% fractions by mass to create a homogeneous binary gas mixture. The performance of the APT-FCW flow sensor, CMFs and other related measurements are also discussed.

2. MEASUREMENT PRINCIPLE

The Averaging Pitot Tube with the Flow Conditioning Wing geometry (APT-FCW) is a pressure-based flow sensor that measures the differential pressure (DP) at a point in the pipeline by averaging the differential signal produced by each of the laterally arranged sensing ports on its probe [9]. Along with its unique cross-sectional shape, the APT-FCW prototype offers a high level of flow measurement accuracy and repeatability in particular for large pipelines. The APT-FCW has the potential to become a useful and cost-effective technique to achieve satisfactory measurement uncertainty. A photographic representation along with the cross sectional shape of the APT-FCW [8] that was used in this study is shown in Fig. 1, while its metering principle is illustrated in Fig. 2. The high DP produced by the sensor is actually one of its most advantageous characteristics, particularly in comparison with other available models. Recent developments in averaging Pitot tube [8–12] have proven the sensor a reliable technology for single-phase gas and liquid flow applications. The measured pressure difference at the point of installation in the flow stream is a direct function of the average flow of the binary gas mixture which is calculated as: –

$$\bar{V} = K \sqrt{\frac{2\Delta P}{\rho_m}} \quad (1)$$

where \bar{V} is the average flow velocity in m/s, K is the average meter factor of the sensor (=0.50909), ΔP is the theoretical differential pressure across the sensor (the difference between the impact pressure and the blockage pressure) in Pa and ρ_m is the density of the gas mixture in kg/m³.

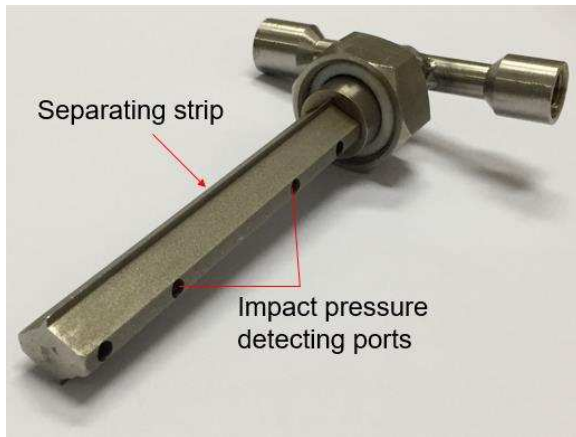

(a) APT-FCW.

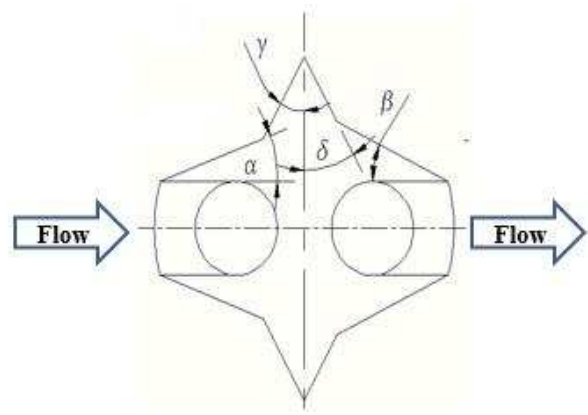

(b) Cross sectional shape [8].

Fig. 1. Picture and cross section of the APT-FCW where $\alpha=30^\circ$, $\beta=15^\circ$, $\delta=30^\circ$ and $\gamma=35^\circ$

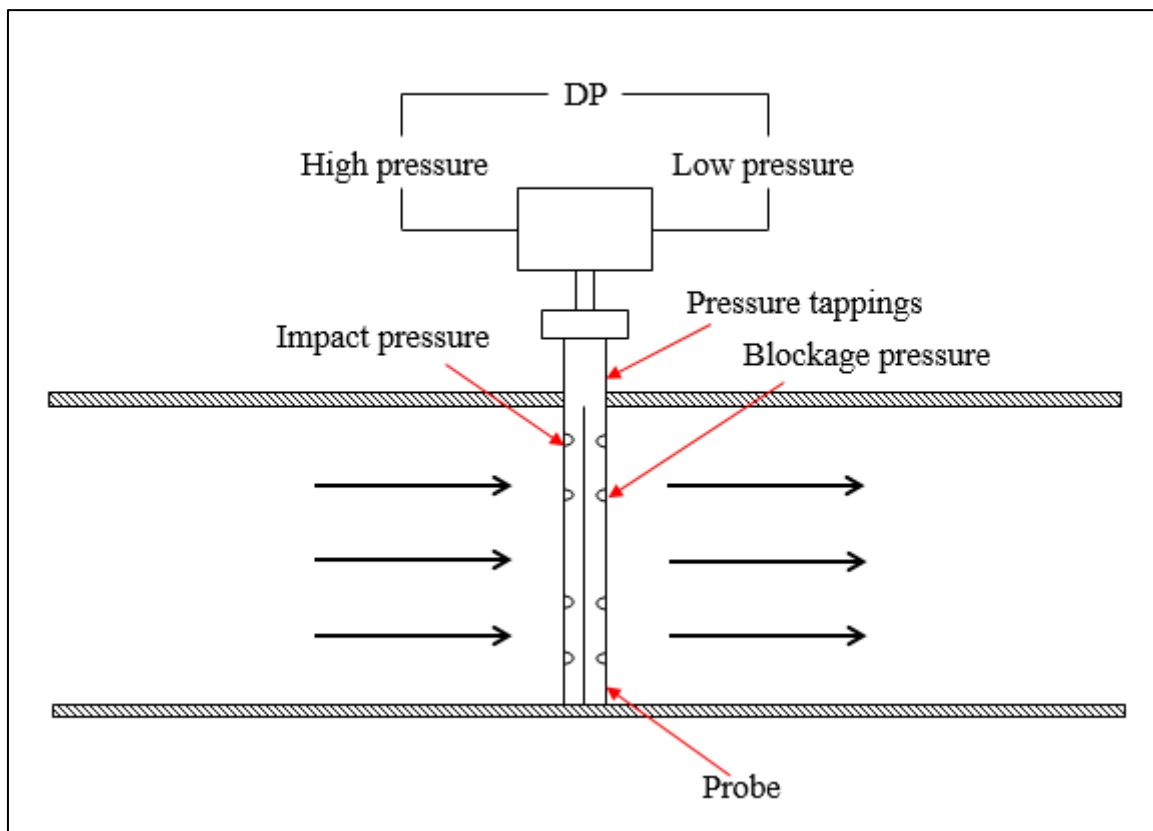

Fig. 2. Metering principle of the APT-FCW.

In earlier work [8, 9], K was predicted through Computational Fluid Dynamics (CFD) simulation. The APT-FCW was designed to measure the flow rate by averaging the velocities across the pipe section. When predicting the value of K , it is important that the point of average velocity within the cross section

of the pipe be accurately detected in order to achieve reliable flow rate measurement. A cross section perpendicular to the APT-FCW's detecting tube and which passes through the average point of the pipe velocity profile was taken as a 2-D simulation model. In practice, the average velocity point is not fixed. This is because as the flow velocity within the pipeline increases, the velocity profile becomes more irregular. Moreover, the velocity profile is associated with the radius of the pipeline and the exponent n of a fully developed velocity profile function, where n is influenced by Reynolds number. When the Reynolds number changes in the range of $4 \times 10^4 \sim 2.5 \times 10^5$ for the prediction of K , the distance between the average velocity point and the center of the pipeline ranges from $0.7546R$ and $0.7633R$, where R is the internal radius of the pipe. To simplify calculations, the average velocity point is taken at the average (i.e. $0.7589R$) [9]. The flow coefficient value is later experimentally finalized based on a 1-inch pipe and compensates for thermal expansion, discharge coefficient, velocity of approach and gas expansion factors relating to this piping conditions. In essence, the sensor's port diameters, locations and spacing will be different for a different pipe diameter.

A common and obvious challenge for volumetric flowmeters in the CCS scenario is the accurate determination of the mixture's density. The density of a gas mixture is normally adopted from the ideal gas law under the assumption that a real gas behaves as ideal under ordinary temperature and low pressure conditions. Hence compressibility effect is neglected. Moreover, since most of the equations of state (EOS) models are explicit in pressure and temperature and while also considering the maximum operating pressure (10 bar) of the flow test rig used in this study, the mathematically calculated 'reduced pressure' [13] under this condition becomes very small (0.03~0.05). This effectively approximates the mixture's compressibility value to 1. From previous uncertainty estimations [8], the combined uncertainty of the pressure and temperature measurements under the test conditions of the flow rig system is approximately $\pm 0.2\%$. Various existing accurate EOS models [14–17] with different range of validity, structure and general characteristics of the mixture components have been recently adopted for CO_2

mixtures. In the present study, the ideal gas approach is deemed acceptable for the density calculation of the CO₂ mixtures due to its very low uncertainty under the experimental test and laboratory conditions. To calculate the mixture density, first the molecular weight of the binary gas mixture is obtained as:–

$$M_m = \sum C_i M_i \quad (2)$$

where C and M are respectively the mass fraction (%) and molecular weight (g) of a component gas.

Equation (2) is then used to compute the specific gas constant in J/kg K as:–

$$R_M = 1 / \left(\frac{M_m}{8.314} \right) \quad (3)$$

The density of the mixture is finally calculated as:–

$$\rho_m = \frac{P}{R_m T} \quad (4)$$

where P is the absolute mixture pressure in Pa and T is the flow temperature in K.

The volumetric and mass flow rates can be computed using the following equations:–

$$q_v = \bar{V} \left(\pi \frac{D^2}{4} \right) \quad (5)$$

$$q_m = \rho_m \bar{V} \left(\pi \frac{D^2}{4} \right) \quad (6)$$

where D is the internal diameter of the pipe in m, q_v is the volumetric flow rate of the mixture in m³/s, q_m is the mass flow rate of the mixture in g/s and t is the flow run time in seconds.

The final step of calculation is to obtain the totalized or batch mass (Q_m) in grams, measured by the flow sensor which is deduced by noting the run time (t) during each flow test:

$$Q_m = q_m t \quad (7)$$

3. EXPERIMENTS

3.1 Flow System Setup

As pointed out in Section 1, the APT-FCW was extensively calibrated for pure CO₂ flows in earlier work [8, 18] and as such no further calibrations were carried out for the flow sensor during these experiments. This approach allows the reliability of the APT-FCW's default CO₂ calibrations to be investigated in the presence of foreign fluid components in the CO₂ flow stream. Taking into consideration that the custody transfer of CO₂ in CCS facilities is primarily in mass units, mixing of the gases was carried out by gravimetric method (i.e. mass fraction mixing) where the accuracy of this approach is principally dependent on the accuracy and general performance of the metering instruments measuring the flow rate of each component gas. Two Coriolis mass flowmeters (CMFs) were connected on each fluid component line to measure and monitor their respective flow rates. Fig. 3 depicts an overview representation of the flow test rig as well as other relevant flow operation accessories. The fluid component supply lines were both of 12 mm flexible hose while the main flow test pipeline was 22mm in internal diameter. Since CO₂ is the primary constituent gas in this flow test, a high-flow (0-167 g/s) CMF with metering error better than $\pm 0.35\%$ was fitted on the pure CO₂ gas line. To maintain high metering accuracy, a low-flow CMF model with a much lower range of 10 g/s and metering error better than $\pm 0.2\%$ was fitted on the diluent gas supply line. A separate unit which is the same model as the high-flow CMF on the pure CO₂ line was located downstream on the main process line to measure the flow rate of the CO₂ mixture and also serve as a reference to the tandem-installed APT-FCW module. All component gases were dry and their purity grade as supplied by the British Oxygen Company (BOC), UK were 99.95% and above. Pure CO₂ was delivered from a skid-assembly liquid vessel which was gasified with an electric vaporizer to around ambient temperature while the diluent gases were from pressurized cylinders, each gas with its own pressure rating.

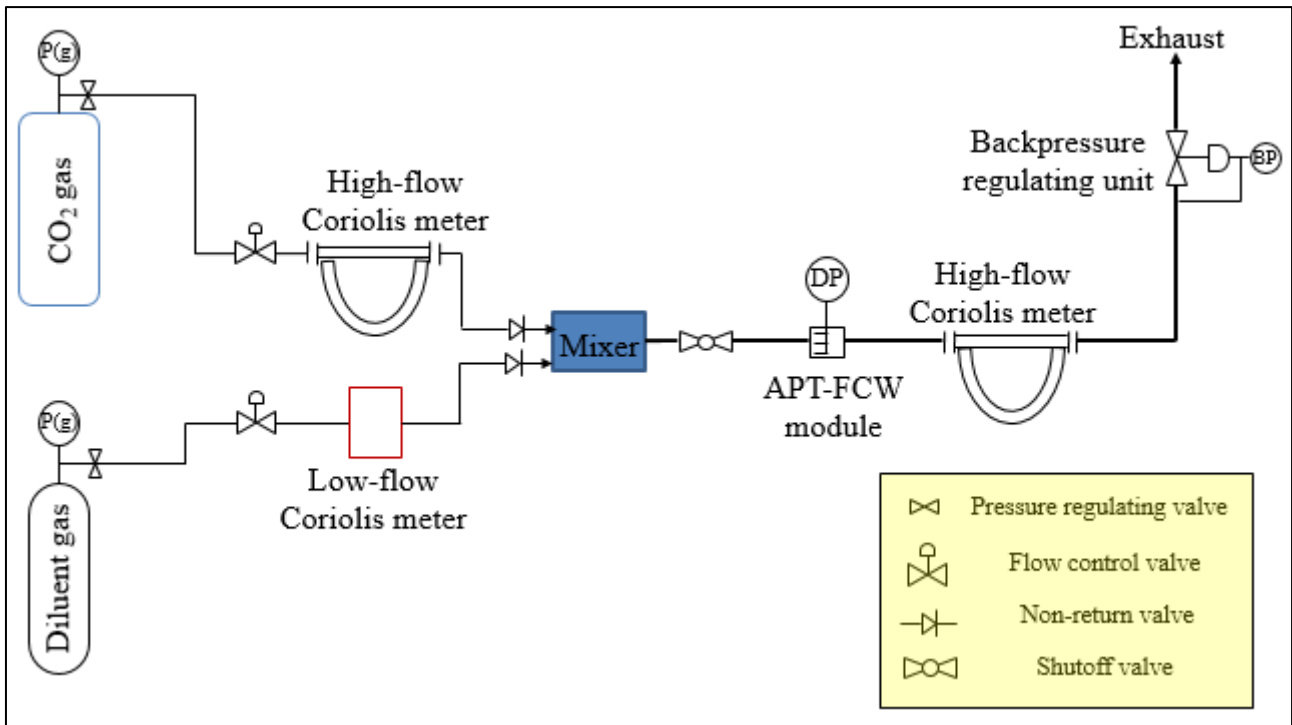

Fig. 3. Layout of flow operation and gas mixing process.

While certain key gases like hydrogen and methane including much heavier gases like butane which would likely represent more realistic foreign gas contents in CCS streams could not be used in the experimental test programme due to strict safety regulations in place for our laboratory environment [18], the test matrix was designed around safer gases of different molecular weights. A total of five diluent gases (N_2 , air, O_2 , Ar and C_3H_8) with molecular weights 28, 29, 32, 40 and 44 g, respectively, were used as contaminants for combination with the pure CO_2 gas. The mix fractions were 10%, 15% and 20%. It was technically challenging to test smaller mix fractions (e.g. 2, 4, 5%) of the impurities because owing to the chosen gravimetric method of gas mixing, the measurement uncertainty of the low-flow CMF would be too high for very low flow rates of 0.1, 0.2, and 0.3 g/s. Nominal discharge temperature of all the gases was around $20^\circ C$. Mass flow of the individual gas components were continuously supplied and regulated with high-precision control valves and their respective flow rates monitored with the CMFs. Aside from the control valves, the flow could be completely stopped at any time with a shut-off valve situated on the main pipeline. The component gases are passed through a mixer to ensure a homogeneous

mixture before being fed into the main test section. Non-return valves were installed on each supply line just before the mixer to prevent backflow and the component gases from cross-contaminating each other in their respective feed lines. Shift in the thermodynamic equilibrium in the mixture is assumed to be minimal and of little effect on the performance of the metering devices. Frictional drag on the pipe walls and heat transfer are considered to be negligible on the gas mixture. A DP transmitter with a range of 10 kPa and uncertainty of $\pm 0.075\%$ of the set span/range was located adjacent to the metering test section. The test section (APT-FCW and downstream CMF) is 1.2m upstream and 1.8m downstream of the flow rig. The blockage factor/beta ratio (the ratio of the diameter of the APT-FCW probe to that of the internal diameter of the flow pipe) is 0.36. A backpressure regulator fitted at the vent of the flow rig helped in providing pressurization and depressurization for zero offset calibration and generally flow pressure stabilization. The flow pressure, temperature and DP stabilities are ± 200 Pa(g), $\pm 1^\circ\text{C}$ and ± 1 Pa, respectively. Data logging units were used to handle the output readings from the DP transmitter and other auxiliary flow devices like the pressure transducer and temperature transmitter which collectively provided additional information to calculate the mass flows of the gas components as well as that of the mixture. Real-time data from the CMFs was obtained through a bespoke PC. Flow tests were conducted for a range of 5 to 10 g/s with an increment of 1 g/s. Each test point was repeated at least three times for a batch size of around 700g.

3.2 Meter Calibration and Verification

Resulting from the chosen gravimetric mixing technique, it is important that the laboratory operation of the CMFs be checked in order to establish an accurate, valid and reliable reference for the APT-FCW. The different specifications of the CMFs such as accuracy, range and zero stability was an added reason that necessitated this preliminary test procedure. The upstream high-flow (UHF) and downstream high-flow (DHF) CMFs had previously been calibrated in the laboratory with a mass batch size of around 700g to an operating accuracy of $\pm 0.35\%$ for single-phase gas flow traceable to a mass balancing system.

Specifications of the upstream low-flow (ULF) CMF are based solely on the information provided by the manufacturer.

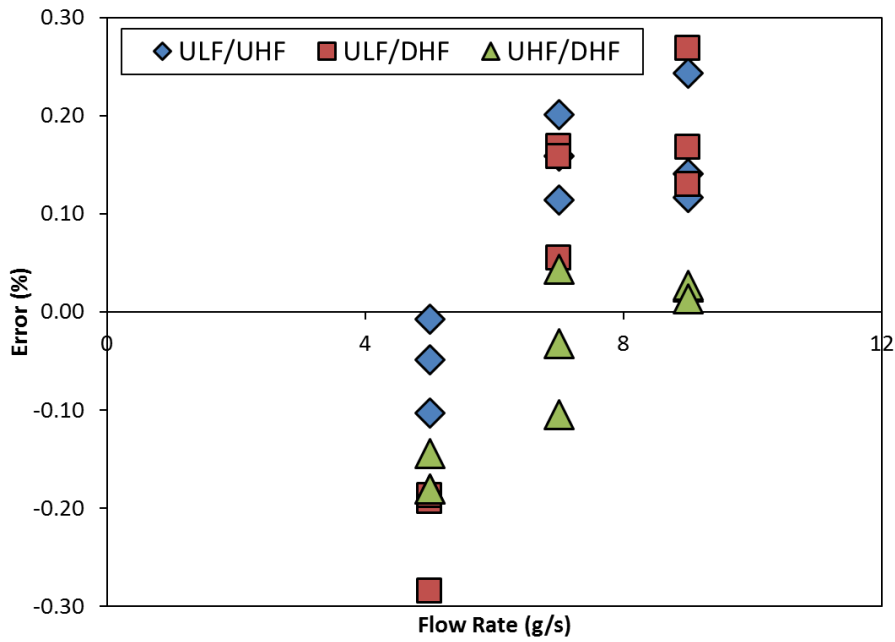

(a) Calibration data.

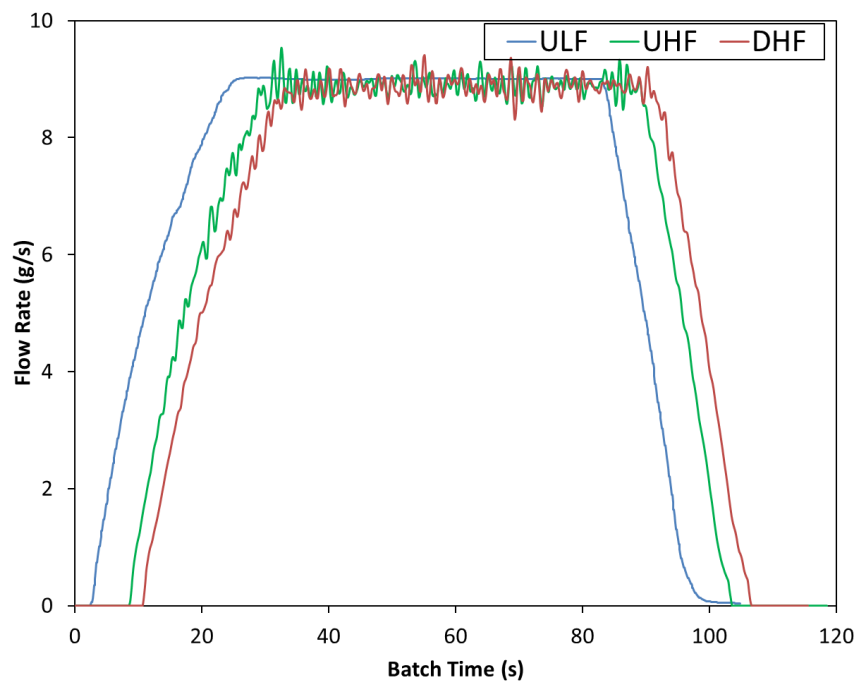

(b) Flow profile of CMFs at 9 g/s.

Fig. 4. Verification and comparison of CMFs.

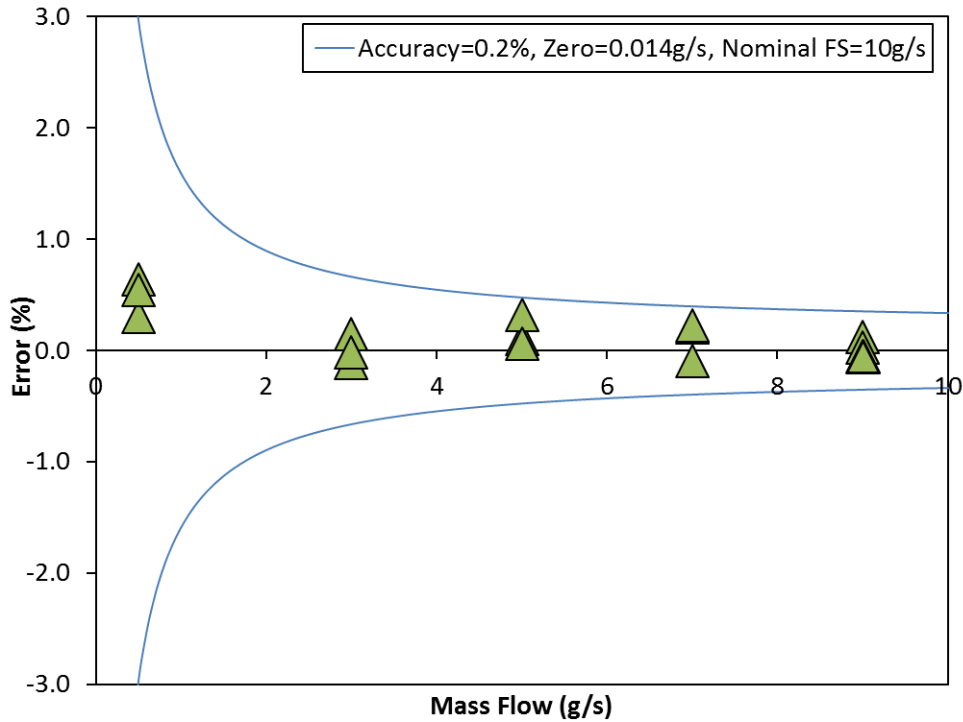

Fig. 5. Calibration and error envelope of the ULF CMF.

A serial flow connection was setup amongst all three CMFs for pure CO₂ gas in the order of; ULF, UHF and DHF. Different flow rates were tested for a batch size around 700g. The results in Fig. 4a show very good agreement among the meters and that the measurements taken fall substantially within the $\pm 0.5\%$ error bracket expectation by a reasonably good margin. Similarly, the graphs in Fig. 4b confirm these results at a selected 9-g/s test point. Notwithstanding the time delay in initiating each meter to the launch of flow which is clearly observable in Fig. 4b, this delay by a few seconds in data logging does not appear to severely influence the performance or final readings of the CMFs due to the standing-start-and-finish approach. Alternate arrangements of the meters produced similar results. Finally, since the ULF CMF would be handling very low flow rates (~ 0.5 g/s), it was necessary to verify its consistence at this region in accordance with those at the high end of its flow range. As a result, the meter was subjected to further tests against a weighing scale apparatus. Based on the single-phase calibration characteristics, it is evident from Fig. 5 that the meter yields an error within $\pm 1\%$ across the tested range despite its somewhat slightly high zero stability of 50 g/h where the maximum recorded

error was about 0.65% at the 0.5-g/s test point. The error of other test points fell well within our desired specification of $\pm 0.5\%$.

4. RESULTS AND DISCUSSION

Measurement results summarizing the measurement errors of the CMFs in mixing the component gases for different mass fractions to achieve a desired flow rate during the experimental tests are presented in Table I. The data were collected randomly across the entire test matrix for the evaluation of the CMFs under the stipulated experimental conditions. Looking at the data items, the performance of the CMFs is undoubtedly consistent for all diluent gases, mix fractions and across the mass flow test range. This process allowed sources of errors that might have been generated from the reference meters and possibly influenced the error of the final results from the APT-FCW to be quickly identified. Apparently in this case, the CMFs matched our performance requirement.

Table I. Experimental data on the performance of the Coriolis meters

Diluent gas	Mix fraction (%)	Flow rate (g/s)	ULF CMF (g)	UHF CMF (g)	Upstream meters total (g)	DHF CMF (g)	Error (%)
Nitrogen	10	6	79.85	617.65	697.50	699.51	-0.2882
		8	74.88	625.94	700.82	701.67	-0.1213
		10	71.21	634.02	705.23	704.10	0.1602
Air	15	6	107.89	590.67	698.56	699.87	-0.1875
		8	113.60	586.86	700.46	701.62	-0.1656
		10	100.09	601.52	701.61	700.80	0.1154
Oxygen	10	6	79.35	620.81	700.16	701.44	-0.1828
		8	72.38	631.77	704.15	703.48	0.0951
		10	71.70	633.15	704.85	704.25	0.0851
Argon	20	6	146.10	553.17	699.27	698.89	0.0543
		8	140.73	560.49	701.22	701.42	-0.0285
		10	125.36	579.46	704.82	703.21	0.2284
Propane	10	6	74.55	628.10	702.65	702.40	0.0356
		8	63.53	638.82	702.35	701.54	0.1153
		10	55.27	648.57	703.84	703.90	-0.0085

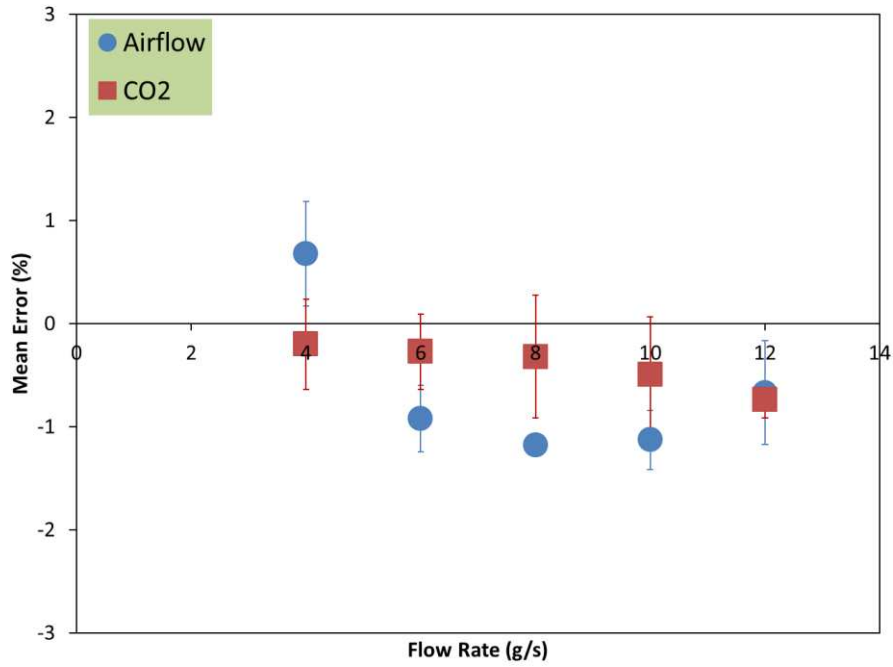

(a) Mean error of CO₂ and airflow.

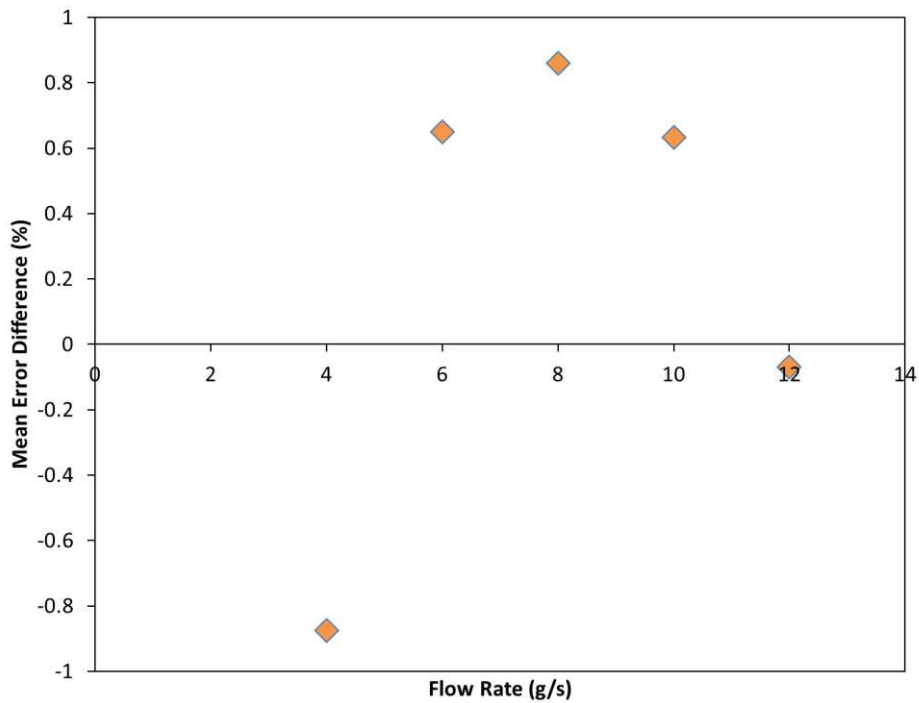

(b) Mean error difference between both gases.

Fig. 6. Comparative analysis of the APT-FCW's single-phase CO₂ calibration for a different gas.

It is noteworthy that with respect to a standard weighing calibration procedure in the laboratory, the total uncertainty of the CMFs and the APT-FCW are within $\pm 1\%$ and $\pm 1.5\%$, respectively. For the purpose of technical insight and reference, the plots in Fig. 6 show the measurement implication of applying the single-phase calibrations of the APT-FCW for pure CO₂ for a different gas like air. Since the K-factor of the APT-FCW sensor is predicted as a function of Reynolds number by combining the effect of the fluid density, viscosity and pipe diameter and velocity, the K-factor obtained for airflow at a specified Reynolds number will be the same for CO₂ or other fluids at that same Reynolds number. This will be further discussed in detail later in this section relative to the results of those of the diluent gases. Meanwhile, the results indicate that using the calibration settings of the CO₂ gas for a considerably less dense fluid like air may introduce additional measurement error anywhere within $\pm 1\%$. In the case of other gases and depending on the density of the test gas, it is logical to assume that this error could be different from this value.

Next, the data plot of the APT-FCW's measurement results of the two-component CO₂ mixtures with gaseous impurities are presented in Fig. 7 for all mix fractions. The data are used again to show the APT-FCW's measured total mass against that of the reference meter in Fig. 8. This provides a more concise representation of the sensor's results. The mass errors of the nitrogen and air mixtures in Figs. 7 (a) and 7 (b) are fairly identical and both show a similar error boundary of the plotted data since their molecular weights are relatively very close. At the low 10% mix fraction, CO₂ mixture with other heavy gases like argon and propane as seen in Figs. 7 (d) and 7 (e), operate mostly within the characteristic $\pm 1\%$ error limit of pure CO₂. The drift from this error boundary begins to appear more apparent as their mass fraction into the flow stream was increased. Across all the graphical plots of Fig. 7, overlapping of the mass errors amongst the three tested mix fractions can be observed. This could likely result from the general thermodynamic instability of CO₂ or perhaps its characteristic reaction with the individual diluent gases.

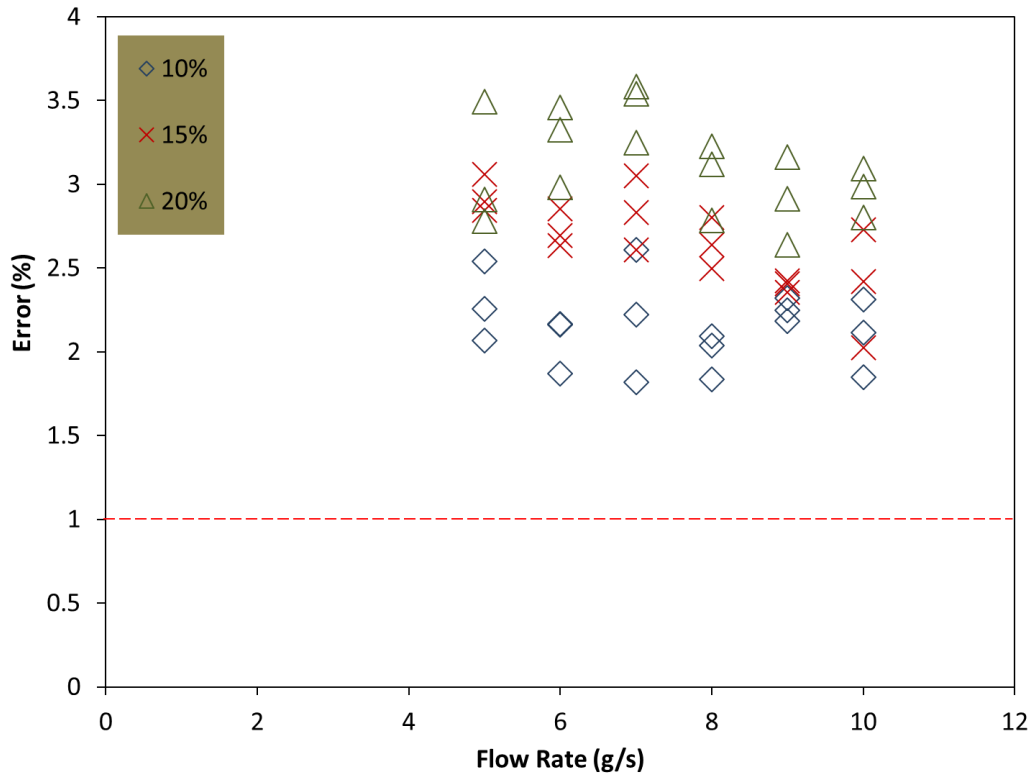

(a) Nitrogen.

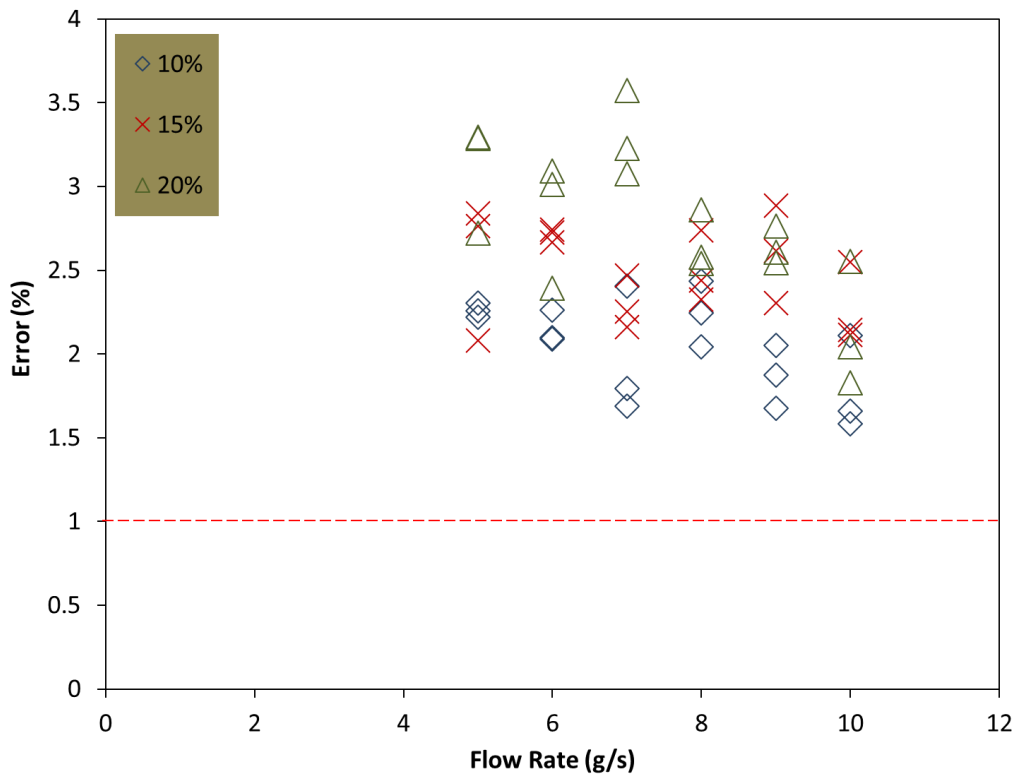

(b) Air.

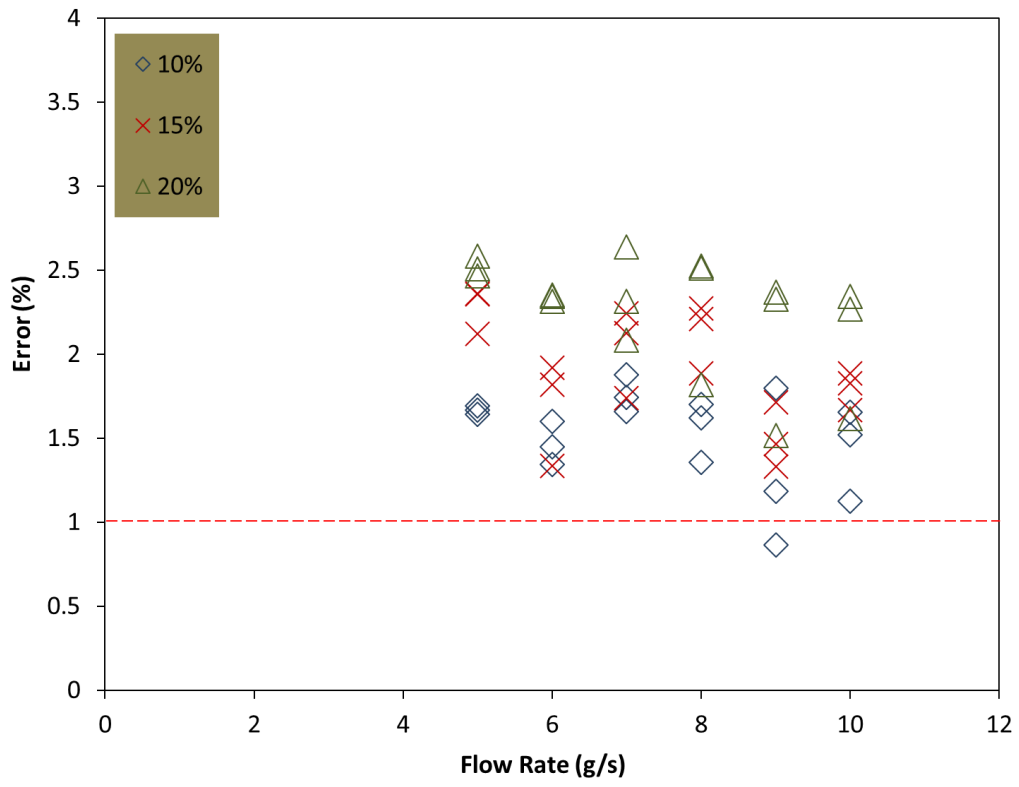

(c) Oxygen.

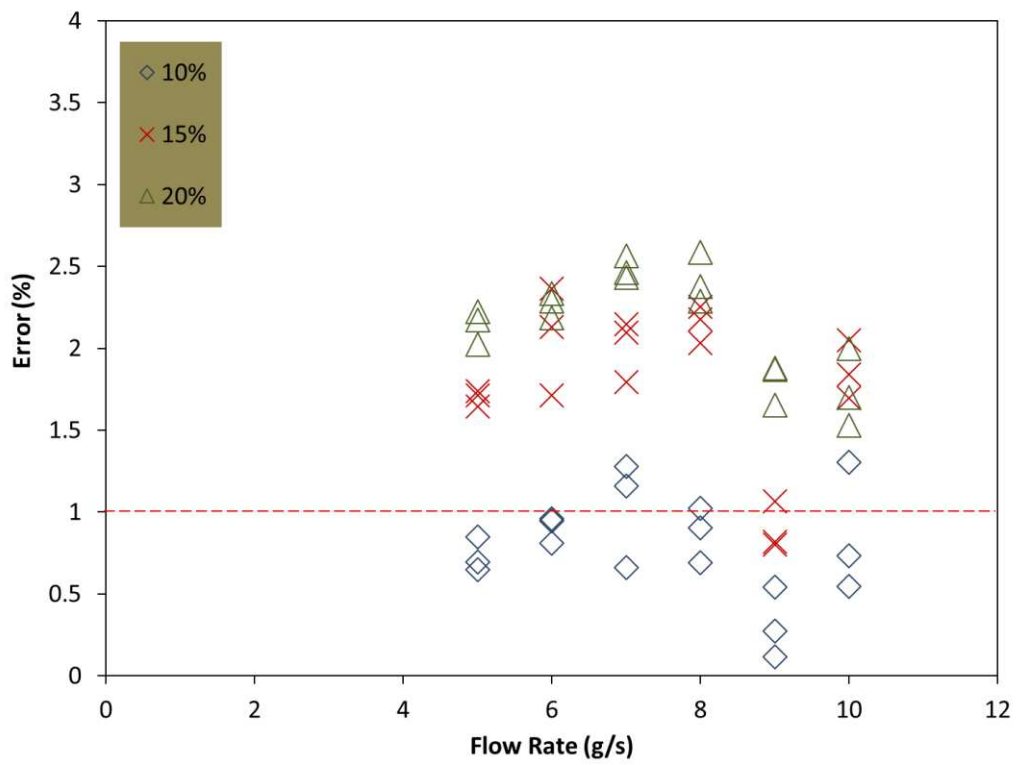

(d) Argon.

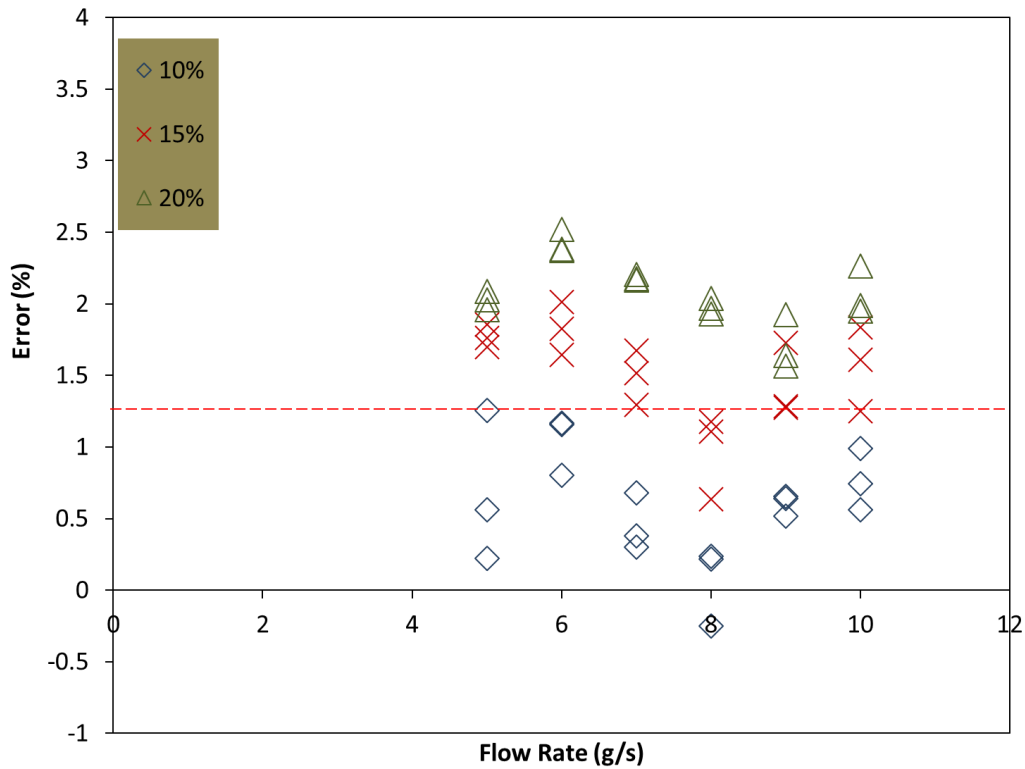

(e) Propane.

Fig. 7. Total mass errors of the APT-FCW.

From these plots, two quick, main and clear observations can be made. The APT-FCW's error increases with; 1) the mass fraction of the gaseous impurities and 2) as the molecular weight of the diluent gas gradually deviated from that of pure CO₂ (i.e. from propane to nitrogen). This interesting behaviour displayed by the sensor proposed an immediate and coherent question; if this error trend would continue proportionally as the mass fraction of the test diluent gas increased. The only way to confirm this suspicion was through actual experiments.

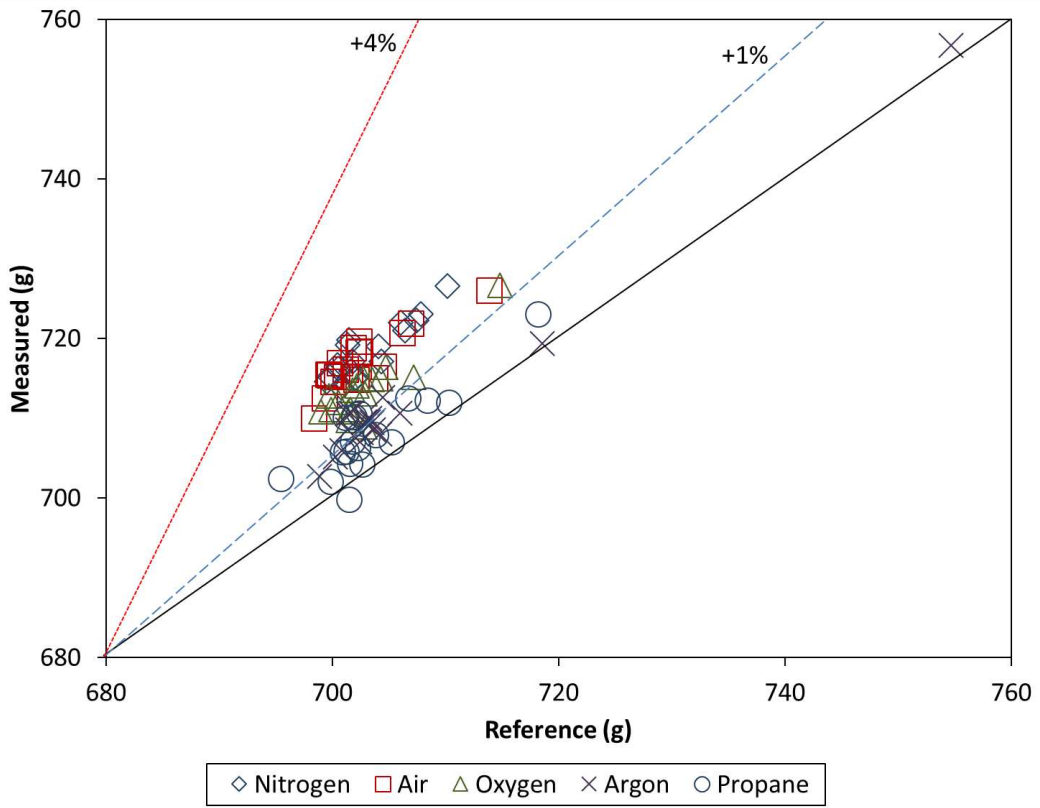

(a) 10%.

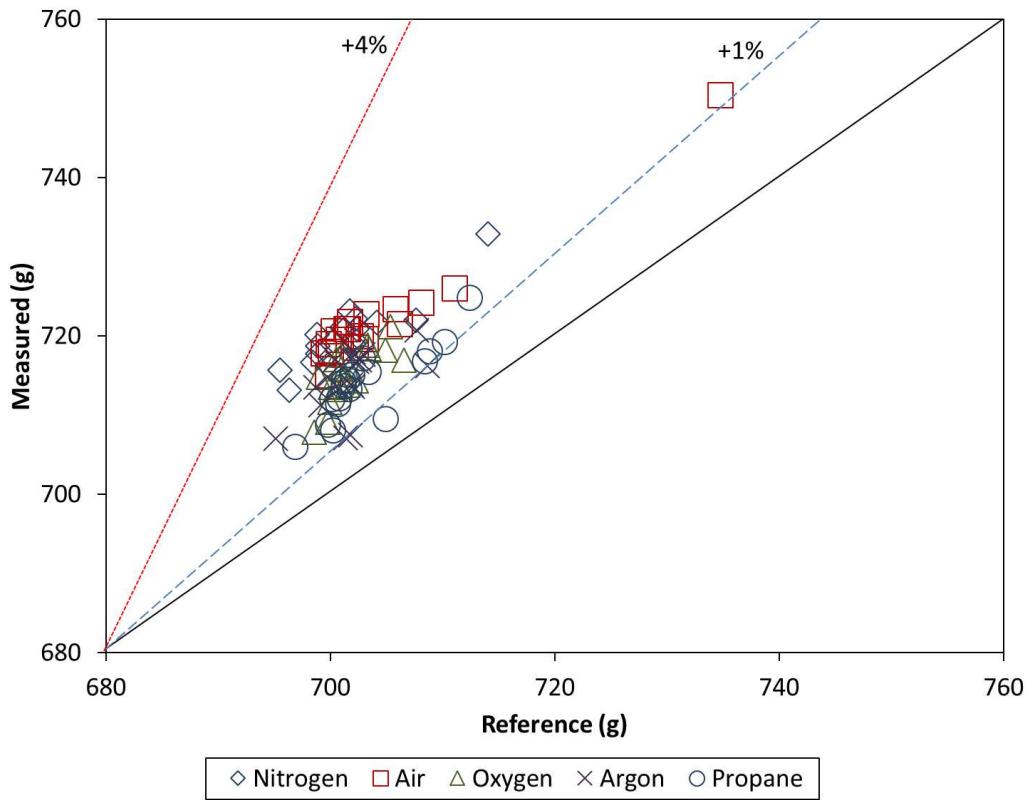

(b) 15%.

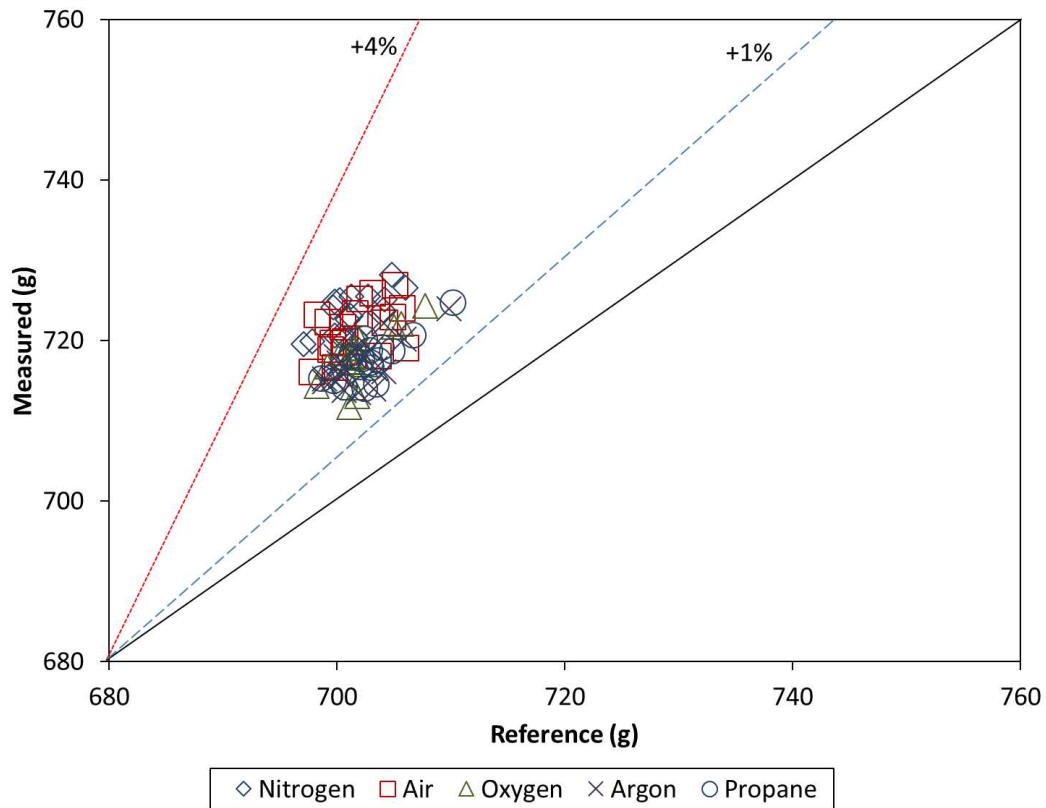

(c) 20%.

Fig. 8. Measured mass vs. reference meter at different mix fractions for the APT-FCW.

Table II presents data from other extra tests on different pure and adulterated fluids outside that of the original test matrix. With the broad pattern behaviour being similar for all plots in Fig. 7, surprisingly, examining the data contents of Table II, it is understood that the constant rising ‘additional’ measurement error tends to peak at around 1%. This occurs somewhere between a mix fraction of 20% and 50% of the diluent gas, for a total measurement error of just under 2%. This additional incurred error from the combination with a minor component gas appear to be rather retained and can be prevalent by different magnitudes (of course, depending on flow conditions) in subsequent mass fractions beyond the 50% point even by the time the flow stream became completely composed of only the diluent gas. This can be directly related to the test data previously shown in Fig. 6 with airflow, which to some extent confirms this behavioural pattern. It is also important to acknowledge the chosen ideal gas density model for influencing the observed error trend since the specific gas constant of the mixture obviously drifts

towards that of the diluent gas as it progressively became the primary content in the flow stream. To better understand these error trends and also to check if the gravimetric mixing method might have been an incompatible technique for the APT-FCW's pressure-based metering principle, more tests with CO₂ acting as its own diluent were conducted. Pure CO₂ from a pressurized cylinder on the minor component line was mixed with that from the main vessel on the high-flow line at different proportions. Table III validates the original $\pm 1\%$ error boundary of the APT-FCW from single-phase CO₂ calibration and thus rules out the suggested likelihood of a technical problem from the gravimetric mixing process. In practical terms, gases of lower density compared to CO₂ would normally require higher flow pressure to attain the same set mass flow rate for the CO₂ gas and vice versa. For this reason, the presence of less dense minor component gases would therefore virtually cause the mixture pressure for a particular mass test point to increase (depending on the mix fraction) and in turn, the DP output signal. For example, in this test, by up to 2.7 kPa at 10% mix, 6 kPa bar at 30% in the case of argon and up to 10.7 kPa at 10% mix, 19 kPa at 30% mix in the case of nitrogen.

Table II. Mass flow errors for the APT-FCW from supplementary tests on different fluids at 5 g/s

Fluid description	Average mass error (%)
Pure CO ₂	0.7194
CO ₂ + 10% argon	0.5242
CO ₂ + 15% argon	1.2415
CO ₂ + 20% argon	1.9275
CO ₂ + 40% argon	1.4104
CO ₂ + 60% argon	1.3871
CO ₂ + 80% argon	1.5031
Pure argon	1.6682
Pure air	-0.5408

Table III. Mass flow errors for the APT-FCW for CO₂-CO₂ mixtures at 5 g/s

Fluid description	Average mass error (%)
CO ₂ + 10% CO ₂	-0.6971
CO ₂ + 15% CO ₂	0.2287
CO ₂ + 20% CO ₂	-0.4777
CO ₂ + 40% CO ₂	0.1904
CO ₂ + 60% CO ₂	-0.1487
CO ₂ + 80% CO ₂	-0.2327

Conversely, the CO₂-CO₂ mixture does not seem to be strongly affected by these subtle pressure variations. Alternatively, it is of logical opinion that even if the component gases (CO₂ + other impurity gases) were to be precisely mixed into a pressurized cylinder and assuming an identical discharge temperature of around 20°C to that observed during the flow tests, the change in the mixture's pressure from that of pure CO₂ is still very likely and bound to influence the readings of the DP transmitter. Although actual experiments would be needed to fully validate this claim. This further explains the reason why available and well-established EOS models are explicit in the vapour pressure and temperature of the mixture. It is believed that the observed error for the APT-FCW originates mostly from the DP transmitter. For example, for a known and single type of contaminant, it is possible to recalibrate the DP transmitter to account for this foreign fluid component and hence reduce the overall flow measurement error. Additional in-depth analysis of the obtained measurement data revealed that a variation in temperature by about $\pm 5^\circ\text{C}$ translated to around 1% increase in metering error. This information confirms the critical essence of temperature stability of the mixture and its vital purpose in multi-component fluid density modelling. The general recurring error trend in the CO₂-impurity mixture which is absent in the CO₂-CO₂ combination, points that the behaviour of the APT-FCW for CO₂ mixtures requires more understanding and thus remains a welcoming challenge for future works. Perhaps

this apparent error trend lies somewhere else in more or certain thermodynamic properties which ultimately could be of more technical relevance than initially anticipated under the test conditions. Also, the characteristic interaction between CO₂ and the individual impurity gases which is a suspected source of the APT-FCW's metering error cannot be overlooked.

5. CONCLUSIONS

The influence of impurities in a two-component/binary CO₂ gaseous mixture using the APT-FCW sensor with respect to single-phase calibration characteristics has been investigated in this paper. A wide range of experiments were carried out on a CO₂ gas instrumentation system to understand the behaviour of CO₂ mixtures and how volumetric and direct mass measurement methods respond to this interesting behaviour. The ideal gas approach was used to serve as EOS for the density computation of the CO₂ mixtures. Experimental results have shown that the error of the APT-FCW in binary CO₂ mixtures increases with the mass fraction and molecular weight/density of the gas contaminant. Additional error of up to $\pm 3\%$ can be incurred depending on the type and mass fraction of the diluent gas. In the CO₂ mixtures, gases with molecular weight closer to that of CO₂ produced lesser additional errors; $\pm 0.3\%$ at 10% mix, $\pm 1\%$ at 15% mix and $\pm 1.5\%$ at 20% mix, in the case of propane. Further tests revealed that the behavioural pattern of the APT-FCW in CO₂-impurity mixtures does not appear to be prevalent in CO₂-CO₂ mixtures nor is its performance affected by the chosen gravimetric mixing method. The obtained measurement results and overall experimental assessment further demonstrates the APT-FCW as a potential cost-effective technology for CCS metering systems albeit a higher degree of uncertainty for CO₂ mixtures which consequently requires more understanding. With further investigations, the APT-FCW could be established to meet the EU-ETS $\pm 1.5\%$ uncertainty demand even when impurities are present in the CO₂ flow stream.

On the other hand, the CMFs were tested in a series connected configuration to verify their consistency for the actual CO₂ mixture test matrix, and to establish them as an accurate and reliable reference for the

APT-FCW. The results from this calibration test have shown that their performance met expectations. Data collected at random during the actual test programme have proven that the CMFs performed well over a wide mass flow range and are an effective technique for testing mass mixing of fluid components. The CMF should therefore have little difficulty coping with impurities in CCS pipelines.

An extension to this project would be to look into high dense flows of the mixture where the compressibility begins to diminish from 1. This is a more practical and realized scenario in actual CCS transmission pipelines where pressure and temperature changes can indeed be more significant and as such, more sophisticated EOSs would be required for density calculation of the mixture. To meet the rather high measurement uncertainty demands of the CCS framework, more thermodynamic properties are needed to perform these calculations accurately. Dense multiphase CO₂ mixtures with two or more minor components and the effects of phase shifts on meter performance as well as the formation of new phase envelopes remain to be fully investigated. These are some of the technical barriers that need to be overcome in the near future while implementing operating systems across the CCS streams.

ACKNOWLEDGEMENT

The authors would like to acknowledge the financial support of the UK CCS Research Centre (www.ukccsrc.ac.uk) in carrying out this work. The UKCCSRC is funded by the EPSRC as part of the RCUK energy programme. The authors would also like to thank KROHNE Limited for their support to provide some of the test equipment.

REFERENCES

- [1] C. Hardie, “Developing Measurement Facilities for Carbon Capture and Storage”. *Journal of Measurement and Control*, vol. 46, no. 2, pp. 44-49, 2013.

- [2] R.M. Cuellar-Franca and A. Azapagic, “Carbon Capture, Storage and Utilization Technologies: A Critical Analysis and Comparison of their Life Cycle Environmental Impacts” *Journal of CO₂ Utilization*, vol. 9, pp. 82-102, 2015.
- [3] SaskPower CCS, “Saskpower Carbon Capture Test Facility”, www.saskpowerccs.com/ccs-projects/shand-carbon-capture-test-facility/, 2014. (accessed 12.09.16).
- [4] European Commission (EU): “The European Commission Climate and Emissions Trading System Policies, Regulations and Guidelines”. ec.europa.eu/clima/policies/ets/index_en.htm, 2009. (accessed 12.09.16).
- [5] “A Technology Strategy for Fossil Fuel Carbon Abatement Technologies”, The Advanced Power Generation Technology Forum, U.K. Jan. 2014.
- [6] N.F. Glen, “CO₂ Fluid Properties and Flow Calculations for Operational and Measurement Purposes”, TUV NEL Ltd, Glasgow, U.K. Tech. Rep. 2012/402, Sept. 2012.
- [7] T. Wang and R. Baker, “Coriolis Flowmeters: A Review of Developments over the Past 20 Years, and an Assessment of the State of the Art and Likely Future Directions”, *Flow Measurement and Instrumentation*, vol. 40, pp. 99-123, 2014.
- [8] K. Adefila, Y. Yan, L. Sun and T. Wang, “Calibration of an Averaging Pitot Tube for Gaseous CO₂ Flowmetering”. *IEEE Transactions on Instrumentation and Measurement*, vol. 64, no. 5, pp. 1240-1249, 2015.
- [9] L. Zhang, L. Sun and L. Qi, “Experimental Research of Averaging Pitot Tube Flow Sensors with Flow Conditioning Wing”. *Proceedings of the IEEE International Conference on Electric Information and Control Engineering (ICEICE)*, pp. 382-385, Wuhan, China, 15-17 April 2011.
- [10] B. Dobrowolski, M. Kabacinski and J. Pospolita, “A Mathematical Model of the Self-Averaging Pitot Tube: A Mathematical Model of a Flow Sensor”. *Flow Measurement and Instrumentation*, vol. 16, no. 4, pp. 251-265, 2005.

- [11] M. Kabacinski and J. Pospolita, "Experimental Research into a New Design of Flow-Averaging Tube". *Flow Measurement and Instrumentation*, vol. 22, no. 5, pp. 421-427, 2011.
- [12] V. Vinod, T. Chandran, G. Padmakumar and K.K. Rajan, "Calibration of an Averaging Pitot Tube by Numerical Simulations". *Flow Measurement and Instrumentation*, vol. 24, no. 4, pp. 26-28, 2012.
- [13] R.W. Miller, "Flow Measurement Engineering Handbook", 3rd ed., McGraw-Hill Int., 1997. ISBN-13: 978-0-07-042366-4.
- [14] O. Kunz and W. Wagner, "The GERG-2008 Wide-Range Equation of State for Natural Gases and Other Mixtures: An Expansion of GERG-2004". *Journal of Chemical Engineering*, vol. 57, no. 11, pp. 3032-3091, 2012.
- [15] J.O. Valderrama, "A Generalized Patel-Teja Equation of State for Polar and Non-polar Fluids and their Mixtures. *Journal of Chemical Engineering of Japan*, vol. 23, no. 1, pp. 87-91, 1990.
- [16] G. Soave, "Equilibrium Constants for Modified Redlich-Kwong Equation of State". *Journal of Chemical Engineering Science*, vol. 27, no. 6, pp. 1197-1203, 1972.
- [17] Y. Peng and D.B. Robinson, "A New Two-Constant Equation of State", *Industrial and Engineering Chemistry Fundamentals*, vol. 15, no. 1, pp. 59-64, 1976.
- [18] K. Adefila, "Flow Measurement and Leakage Detection of Gaseous CO₂", Ph.D. Thesis, School of Engineering and Digital Arts, University of Kent, Canterbury, U.K., 2015.