



The mental representation and processing of syntactic structure: Evidence from Chinese

[Link to publication record in Manchester Research Explorer](#)

Citation for published version (APA):

Cai, Z. G. (2010). *The mental representation and processing of syntactic structure: Evidence from Chinese*. University of Edinburgh.

Citing this paper

Please note that where the full-text provided on Manchester Research Explorer is the Author Accepted Manuscript or Proof version this may differ from the final Published version. If citing, it is advised that you check and use the publisher's definitive version.

General rights

Copyright and moral rights for the publications made accessible in the Research Explorer are retained by the authors and/or other copyright owners and it is a condition of accessing publications that users recognise and abide by the legal requirements associated with these rights.

Takedown policy

If you believe that this document breaches copyright please refer to the University of Manchester's Takedown Procedures [<http://man.ac.uk/04Y6Bo>] or contact uml.scholarlycommunications@manchester.ac.uk providing relevant details, so we can investigate your claim.



The mental representation and processing
of syntactic structure:
Evidence from Chinese

Zhenguang Cai



PhD
University of Edinburgh
2010

Declaration

I hereby declare that this thesis is of my own composition, and that it contains no material previously submitted for the award of any other degree. The work reported in this thesis has been executed by myself, except where due acknowledgement is made in the text.

Zhenguang Cai
Edinburgh, November 18, 2010

Abstract

From the perspective of cognitive psychology, our knowledge of language can be viewed as mental representations and our use of language can be understood as the computation or processing of mental representations. This thesis explores the mental representation and processing of syntactic structure. The method used in this thesis is structural priming, a phenomenon in which people tend to repeat the linguistic structure that they have recently processed. The language under investigation is Chinese. The main research theme is divided up into four different questions.

The first question is how syntactic structure is mentally represented. For a long time this has been a question for syntacticians whose main evidence is their intuition. There are, however, recent calls for experimental methods in the investigation of syntactic representation. I propose that structural priming can be used as an experimental approach to the investigation of syntactic representation. More specifically, structural priming can illuminate the constituent structure of a syntactic construction and help us determine which syntactic analysis corresponds to the representation of the construction. Three structural priming experiments on some controversial constructions in Mandarin were reported to show that structural priming can be used to distinguish alternative analyses of a syntactic construction.

The second question concerns the use of thematic and lexical information in grammatical encoding in sentence production. Models of grammatical encoding differ in the locus of conceptual effects on grammatical encoding and the extent to which grammatical encoding is lexically guided. Five experiments were reported on these two issues. First, the results indicate that thematic information affects grammatical encoding by prompting the processor map thematic roles onto the same linear order as they were previously mapped. Though conceptual information was previously believed to only affect the assignment of grammatical functions (e.g., subject and object) to nouns (i.e., functional processing), this finding suggests that it

can influence the linear order of sentence constituents (i.e., positional processing) as well. The results also show that the processor persists in using the same argument structure of the verb, implying that grammatical encoding is lexically guided to some extent.

The third question concerns the processing of verb-phrase (VP) ellipsis in comprehension. Previous research on this topic disagrees on whether the interpretation of VP ellipsis is based over the syntactic or semantic representation of the antecedent and whether the antecedent representation is copied or reconstructed at the ellipsis site. An experiment was presented and the results show no structural priming effect from the ellipsis site. This suggests that no syntactic structure is reconstructed at the ellipsis and possibly no copying of the antecedent structure either. The results then favour a semantic account of VP ellipsis processing.

The last question concerns the lexico-syntactic representation of cognates in Cantonese-Mandarin bilinguals. Previous research has paid little attention as to whether cognates have shared or distinct lemmas in bilinguals. Two experiments show that the structural priming effect from the cognate of a verb was smaller than from the verb itself, suggesting that Cantonese/Mandarin cognates have distinct rather than shared lemmas, though the syntactic information associated with cognates is collectively represented across the two languages.

At the end of the thesis, I discussed the implications of these empirical studies and directions of further research.

Acknowledgements

My gratitude first of all goes to my supervisors Martin Pickering, Patrick Sturt and Holly Branigan, whose expertise and collaboration have helped shape the thesis into the current form. Martin is a model to me in academic rigor and originality and has provided constant support (in terms of both research and funding); a lot of his ideas have been incorporated in the thesis (I really appreciate the many *knock-and-talk* discussions with him and have enjoyed our occasional exchanges in politics). Patrick has shepherded me especially in research design and statistics (whose humour has often made discussions more fun). Holly has been a source of academic inspiration as well as warm encouragement (her knowledge in Chinese rightly guided me to work on Chinese). To them, I would like to say *xiexie*.

I would also like to thank my examiners Rob Hartsuiker and Martin Corley for the comments on the thesis; Martin has also been very kind and helpful in teaching me in statistics (especially LME). Janet McLean has kindly guided me in experimental software and statistics. Michael Jin has been a great friend and colleague, making my research more enjoyable and my life in Edinburgh much more fun with basketball, foosball and squash. Paul Brocklehurst has been like a big brother in life and research. Without the assistance from Yan Hao, Zhao Qian and Feng Cong, I could not have finished the experiments reported here (and many others). My thank-you list also includes Billy Lee, Masaya Yoshida, Wanyu Hung, Zeynep Ilkin, Iva Ivanova, Mateo Obregón, Mikel Santesteban Insausti, Helene Kreysa, Dina van der Hulst, Ollie Stewart, Gary Lewis, Lydia Hu, Penny Chang, Dai Qian, Wu Shuman, and Liao Hanqing.

Finally, I owe thanks to my parents, brothers and sisters, who have endured my long absence from home, and in particular Meixuan as an understanding sister. I am always indebted to my late grandfather for his education in my childhood (if only he could live to see my accomplishment with this thesis). Unfailing support and encouragement also come from Nan. Support also comes from “the Unoists” Hua,

Duo, Cheng, Xian, Guanyin, Laohu, and Panjie. I thank Dong Yanping Laoshi and Wang Suiping Laoshi for all their support.

My PhD research was generously funded by the University of Edinburgh through a Humanities and Social Sciences studentship and an Overseas Research Student award.

Contents

DECLARATION	I
ABSTRACT	III
CONTENTS	VII
CHAPTER 1 INTRODUCTION	1
1.1 Focus of the thesis	1
1.2 Organization of the thesis	4
1.3 Collaborations and presentations	5
CHAPTER 2 LITERATURE REVIEW	7
2.1 Introduction	7
2.2 Language as a cognitive computational system	8
2.3 Experimental syntax: Towards the mental representation of syntactic structure	10
2.3.1 Approaches to data collection in syntactic research	11
2.3.2 The informal introspection approach	12
2.3.3 Criticisms of the informal introspection approach.....	13
2.3.4 The experimental introspection approach	17
2.3.5 The experimental inference approach	19
2.3.6 Summary	21

2.4 The processing of syntactic structure in language production	21
2.4.1 The architecture of sentence production	22
2.4.2 Syntactic effects on grammatical encoding.....	31
2.4.3 Conceptual accessibility effects on grammatical encoding	33
2.4.4 Thematic effects on grammatical encoding	38
2.4.5 Summary	39
2.5 The processing of syntactic structure in language comprehension	39
2.5.1 Syntactic information and modular models	40
2.5.2 Non-syntactic information and interactive models	43
2.5.3 Structural complexity and cognitive factors	47
2.5.4 Use of syntactic and non-syntactic information in syntactic parsing.....	48
2.5.5 Use of syntactic and non-syntactic information in sentence interpretation ..	50
2.5.6 Summary	53
2.6 Bilingual syntactic representation and processing.....	54
2.6.1 Bilingual semantic representation and processing	54
2.6.2 Semantic representations and the bilingual lexicon.....	56
2.6.3 Bilingual lexical representation and processing.....	58
2.6.4 Bilingual syntactic representation and processing	62
2.6.5 Summary	65
2.7 Structural priming	65
2.7.1 The phenomenon of structural priming.....	65
2.7.2 Mechanism of structural priming	67
2.7.3 Structural priming as an experimental paradigm	70
2.8 An overview of Chinese	73
2.9 Summary and research questions.....	77
 CHAPTER 3 STRUCTURAL PRIMING AS AN APPROACH TO INVESTIGATING THE MENTAL REPRESENTATION OF SYNTACTIC STRUCTURE.....	 79

3.1 Overview of the chapter	79
3.2 Introduction	79
3.3 Language as a mental object	80
3.4 Constituency and the mental representation of syntax	81
3.5 Structural priming as an approach to mental representation of syntax.....	83
3.5.1 What aspects of the sentence persist in structural priming?	84
3.5.2 What is being primed in the persistence of constituent structure?.....	85
3.6 Structural priming studies on syntactic representation	87
3.7 The mental representation of the <i>ba</i>-construction	90
3.7.1 Alternative analyses of the <i>ba</i> -construction	90
3.7.2 Experiment 3.1	93
3.7.3 Discussion	98
3.8 The mental representation of the <i>bei</i>-construction	99
3.8.1 Alternative analyses of the <i>bei</i> -construction	99
3.8.2 Experiment 3.2	102
3.7.3 Discussion	105
3.9 The mental representation of the <i>steal</i>-construction.....	106
3.9.1 Alternative analyses of the <i>steal</i> -construction.....	106
3.9.2 Experiment 3.3	109
3.9.3 Discussion	111
3.10 General discussion.....	112
 CHAPTER 4 THE USE OF SYNTACTIC AND THEMATIC INFORMATION IN LANGUAGE PRODUCTION: EVIDENCE FROM STRUCTURAL PRIMING IN MANDARIN CHINESE.....	 115
4.1 Overview of the chapter	115

4.2 Introduction	115
4.3 Syntactic information in sentence production.....	117
4.4 Thematic information in sentence production	120
4.5 Interaction of syntactic and thematic information in sentence production	123
4.6 Dative, topic and <i>ba</i>- constructions in Mandarin Chinese	124
4.7 Experiment 4.1	126
4.8 Experiment 4.2	128
4.9 Experiment 4.3	133
4.10 Experiment 4.4	138
4.11 Experiment 4.5	142
4.12 General discussion.....	145
CHAPTER 5 PROCESSING VERB-PHRASE ELLIPSIS IN MANDARIN CHINESE: EVIDENCE AGAINST SYNTACTIC RECONSTRUCTION	151
5.1 Overview of the chapter	151
5.2 Introduction	151
5.3 The processing of VP ellipsis.....	152
5.3.1 Representation that mediates VP ellipsis processing.....	152
5.3.2 Mechanism of retrieval of antecedent representation	154
5.4 Psycholinguistic studies of VP ellipsis processing	156
5.4.1 Voice matching	157
5.4.2 Antecedent length/complexity	158
5.4.3 Distance between the antecedent and the ellipsis	159
5.4.4 Summary	160

5.5 Using structural priming to investigate sentence comprehension	161
5.6 Experiment 5.1	162
5.7 Discussion.....	169
 CHAPTER 6 LEXICAL AND SYNTACTIC REPRESENTATIONS BETWEEN CLOSELY RELATED LANGUAGES: EVIDENCE FROM CANTONESE- MANDARIN BILINGUALS.....	 171
6.1 Overview of the chapter	171
6.2 Introduction	172
6.3 Lexical and syntactic representations in bilinguals	173
6.4 Representation of Mandarin-Cantonese cognates	177
6.5 Structural priming and lexico-syntactic representations	180
6.6 Experiment 6.1	184
6.7 Experiment 6.2	189
6.8 Combined analysis for Experiments 6.1 and 6.2.....	191
6.9 Phonological similarity rating study	193
6.10 General discussion.....	198
 CHAPTER 7 CONCLUSIONS	 205
7.1 Aim of the thesis	205
7.2 Summary of empirical studies	205
7.3 Implications and directions of future research	209
7.3.1 Syntactic representations in language processing.....	209
7.3.2 The grammatical encoding of non-canonical syntactic constructions	212

7.3.3 Within- and cross-clause coreference processing	214
7.3.4 Language-specific lexical co-activation in bilingual language processing.	215
7.3.5 L2/L1 discrepancies in grammatical encoding in bilinguals.....	216
7.3.6 Structural priming as an experimental paradigm for language-related issues	218
7.4 Concluding remarks	219
REFERENCES	221
APPENDICES.....	251
A. Appendices for Chapter 3.....	251
A.1. Experimental materials for Experiments 3.1 & 3.2.....	251
A.2. Experimental materials for Experiment 3.3	259
B. Appendices for Chapter 4.....	267
B.1. Experimental materials for Experiment 4.1.....	267
B.2. Experimental materials for Experiment 4.2.....	271
B.3. Experimental materials for Experiments 4.3 & 4.4.....	275
B.4. Experimental materials for Experiment 4.5.....	281
C. Appendices for Chapter 5.....	285
C.1. Experimental materials for Experiment 5.1.....	285
D. Appendices for Chapter 6.....	293
D.1. Experimental materials for Experiments 6.1 and 6.2.....	293
D.2. Version 1A of the phonological similarity questionnaire in Chapter 6.....	297
D.3. Results of the phonological similarity ratings in Chapter 6.....	302

Chapter 1 Introduction

1.1 Focus of the thesis

A language can be viewed as a system of meaning-form pairs. For instance, a sentence can be seen as a stream of sounds or a string of letters that carries a message. At the sentence level, the pairing between meaning and form is largely governed by rules of syntax. Syntax has been the focus of much modern day linguistic inquiry (e.g., Chomsky, 1957) and also plays an important role in cognitive science (e.g., Chomsky, 1997; Jackendoff, 2003). This thesis is devoted to the investigation of syntactic representation and processing.

Though there are some other voices (e.g., Katz & Postal, 1991), the mainstream view of syntax is that it is internalized knowledge that every competent speaker of a language has (e.g., Chomsky, 1986a). Such a mentalistic view of syntax has underlain research on syntactic representation and processing in the past decades. In terms of syntactic representation or syntactic knowledge, great efforts have been invested in understanding the syntactic rules that underlie the vast number of possible sentences (e.g., Bresnan & Kaplan, 1982; Chomsky, 1981, 1993; Goldberg, 1995). To date, the investigation of syntactic knowledge has predominantly relied on syntactic introspection in grammaticality judgement, i.e., one's own intuition concerning whether a sentence is grammatical or not. Such an approach has been criticized for its lack of reliability (e.g., grammatical intuition may differ from person to person) and its lack of validity (e.g., grammaticality judgement is influenced by both grammatical and non-grammatical factors such as plausibility and processibility) (e.g., Schütze, 1996). The introspective approach also fails to deliver a good measurement of the gradient nature of grammaticality (e.g., some sentences may be more ungrammatical than others, Sorace & Keller, 2005). More relevant to this thesis, introspective evidence may be inconclusive concerning (or fail to illuminate) the mental representation (i.e., syntactic analysis) of some controversial

constructions such as the small-clause construction in English (e.g., Dubinsky, Egan, Schmauder, & Traxler, 2000). In Chapter 3 of this thesis, I propose that structural priming can serve as an experimental approach to the investigation of mental representation of syntactic structure (cf. Branigan, Pickering, Liversedge, Stewart, & Urbach, 1995; Pickering & Branigan, 1999).

Syntax has also played an important role in language processing research. In language production, the formulation of syntactic structure has also been a priority in the research agenda (e.g., Bock, 1982). Bock and Levelt (1994) posited two levels of grammatical encoding: a functional processing level where lemmas are selected and assigned grammatical functions (e.g., subject and object), and a positional processing level where lexemes (word-forms) are retrieved and the linear order of the sentence is determined. Psycholinguistic research so far has debated several aspects of grammatical encoding. First, it remains a controversy whether there are two levels of processing or there is just a single level (e.g., F. Ferreira, 2000). Second, researchers disagree over the extent to which lexical information (e.g., the argument structure of the verb) guides grammatical encoding (see V. S. Ferreira & Slevc, 2007, for a brief review). Third, there is debate whether conceptual information influences positional processing as well as functional processing (e.g., Branigan, Pickering, & Tanaka, 2008). In Chapter 4 of this thesis, I will focus on the latter two questions.

In language comprehension, debate has mainly centred on the way in which syntactic knowledge is used. Early research has focused on the timing and the extent to which syntactic and non-syntactic information is employed in syntactic parsing (e.g., F. Ferreira & Clifton, 1986; Trueswell et al., 1994). More recent studies have begun to ask the extent to which sentence parsing and interpretation are mediated by syntax. In terms of syntactic parsing, there has been observation that non-syntactic information also guides syntactic parsing (e.g., F. Ferreira, 2003). Research on the interpretation of pronominal expressions has suggested some privileged role for syntactic information relative to non-syntactic information (e.g., Sturt, 2003). Research on the processing of ellipsis, however, has been largely inconclusive whether syntax is a requisite (e.g., Frazier & Clifton, 2001; Martin & McElree, 2008). Chapter 5 in this thesis will follow up this issue.

How a bilingual (whether early or late and whether balanced or unbalanced) represents aspects of linguistic information of his two languages has long been an issue of bilingual research (see Kroll & Tokowicz, 2005, for a review). I will mainly focus on the lexical and syntactic aspects. Recent structural priming studies have confirmed that syntactic information can be integrated between languages in bilinguals (see Hartsuiker & Pickering, 2008, for a review). A less explored issue is the extent to which lexical information is also integrated across languages. For instance, it is under-specified whether cognates (translation equivalents that are similar in form) are represented as the same lemma or different lemmas (Sanchez-Casas & Garcia-Albea, 2005). It is possible that cognates in closely related languages have shared lexico-syntactic representations. I will explore this issue in Chapter 6 of the thesis.

I use structural priming in the investigation of the research questions. Structural priming is the phenomenon whereby people tend to persist in the use of linguistic structure (e.g., Bock, 1986b). For instance, after using a passive construction in the description of a transitive event (e.g., *the clown was kicked by the waitress*), there is a tendency for people to re-use the passive structure in the description of similar transitive events. Structural priming has been shown to mainly reflect the persistence of constituent structure (e.g., Bock & Loebell, 1990) and some aspects of conceptual (e.g., thematic) information (e.g., Chang, Bock, & Goldberg, 2003). Thus, structural priming as a paradigm can illuminate research on syntactic representation and processes and also the interaction of conceptual and syntactic information.

Most research on syntactic representation and processing has been done on English and related languages such as German and Dutch. Though much insight has been gained, it remains unknown how applicable conclusions from these findings are to non-European languages. In fact, there have been calls to investigate syntactic representation and processing from a cross-linguistic perspective (e.g., De Vincenzi & Lombardo, 2000; Jaeger & Norcliffe, 2009). Thus, I focus on Mandarin Chinese (and also Cantonese) in this thesis. Besides bringing cross-linguistic evidence, Chinese also provides ways that are impossible in English and related languages to investigate issues in syntactic representation and processing. For instance, thanks to

its relatively free word order, it is possible for researchers to disentangle syntactic and thematic information in Chinese (see Chapter 4).

1.2 Organization of the thesis

The thesis is concerned with the question: How is syntactic structure mentally represented and processed online? The question will be broken down into four research questions addressed in different chapters of the thesis.

Chapter 2 reviews the literature. This thesis mainly treats syntax as a system of mental representations and syntactic processing as cognitive computation of syntactic representations using syntactic rules and cognitive processes. I then review four subfields: experimental syntax, grammatical encoding in sentence production, syntactic processing in sentence comprehension and lexico-syntactic representation and processing in bilinguals. These subfields serve as backgrounds to the issues I examine in Chapters 3, 4, 5, and 6. I end the chapter by a review of structural priming and relevant properties of Chinese.

In Chapter 3, I propose structural priming as an experimental approach to the investigation of syntactic representations. I present three experiments that used structural priming to distinguish between different accounts for syntactic constructions whose syntactic analysis is currently under debate.

Chapter 4 reports five experiments to investigate the use of thematic and lexical information in grammatical encoding. I show that the processor persists in mapping analogous thematic roles onto the same linear order, which implies that thematic information is used in positional processing. Also, I present evidence that the processor also persists in the use of argument structure, which implies that grammatical encoding is lexically guided to some extent.

Chapter 5 examines the processing and interpretation of verb-phrase (VP) ellipsis. Previous syntactic and psycholinguistic research has debated whether VP ellipsis processing is mediated by the syntactic structure of the antecedent. I report an experiment that showed no evidence of the use of the antecedent structure.

Chapter 6 explores the lexico-syntactic representation of cognates in bilinguals of closely related languages (Cantonese and Mandarin). Previous research mainly investigated the form representation of cognates, without asking whether two

cognates share the same lemma. I report two experiments and a questionnaire study. The findings indicate that Mandarin-Cantonese cognates are represented as different lemmas though their syntactic information is commonly represented across the languages.

In Chapter 7, I summarize the empirical studies and discuss their implications and possible directions of future studies.

As Chapters 3, 4, 5 and 6 are based on relatively self-contained manuscripts (see the following section), some introductory text in these chapters may be repetitive from Chapter 2.

1.3 Collaborations and presentations

Most of the empirical studies reported in this thesis are based on collaborative work and have been presented in workshops and conferences.

Chapter 3 is based on a project with Martin J. Pickering, Qian Zhao, and Holly P. Branigan. Part of the project has been presented in the International Workshop on Language Production 2010 (Edinburgh, UK).

Chapter 4 is based on a manuscript by Zhenguang Cai, Martin J. Pickering, and Holly P. Branigan. The study (or part of it) has been presented in CUNY 2009 (Davis, California) and AMLaP 2009 (Barcelona, Spain).

Chapter 5 is an expanded version of a manuscript (submitted) co-authored by Zhenguang Cai, Martin J. Pickering, and Patrick Sturt. The study has been presented in AMLaP 2010 (York, UK).

Chapter 6 is based on a manuscript by Zhenguang Cai, Martin J. Pickering, Hao Yan, and Holly P. Branigan. The study (or part of it) has been presented in Psycholinguistics in Flanders Conference 2009 (Antwerp, Belgium) and AMLaP 2009 (Barcelona, Spain).

Chapter 2 Literature review

2.1 Introduction

One can explore language from different perspectives. From a physiological perspective, one can talk about how our articulatory system gives rise to a complex system of phones that constitute the phonetic repertoire of a language. From a neurological perspective, one can explore how neurons pattern in the generation or perception of a sentence. From a social perspective, language fulfils a lot of communicative and inter-personal functions. In this thesis, I am interested in the cognitive aspects of structure-building in language. I take structure-building in language as computation of cognitive symbols or mental representations (e.g., Chomsky, 1986a; Fodor, 1983; cf. Elman, 1990). To be more specific, I am investigating the mental representation of syntactic structure and the cognitive processes that underlie the formulation of syntactic structure in production and comprehension.

This literature review is organized as follows. In Section 2.2, I consider language as a cognitive-computational system consisting of representations and rules and, in addition, of cognitive processes that guide language production and comprehension. Next in Section 2.3, I review the experimental syntax programme which calls for experimental methods in the investigation of syntax. Section 2.4 deals with the formulation of syntactic structure in language production. I first discuss stages in speaking and then focus on the mapping from meaning to syntactic structure. In Section 2.5, I switch to sentence comprehension and review cognitive processes that have been shown to influence syntactic parsing. I then go on to discuss the extent to which sentence comprehension is mediated by syntax. Section 2.6 reviews research on bilingualism, especially bilingual lexico-syntactic representations. In Section 2.7, I briefly discuss the phenomenon and mechanism of structural priming, the experimental paradigm that I adopted in the investigation of

the research questions. Next in Section 2.8, I give an overview of Chinese, the language under investigation in this thesis. Section 2.9 is a summary of the review and research questions that I pursue in the thesis.

2.2 Language as a cognitive computational system

Perhaps the most revolutionary view in the modern study of language is the one articulated by Chomsky (1959) in the refutation of a behaviourist view of language:

“It appears that we recognize a new item as a sentence not because it matches some familiar item in any simple way, but because it is generated by the grammar that each individual has somehow and in some form internalized. And we understand a new sentence, in part, because we are somehow capable of determining the process by which this sentence is derived in this grammar.” (Chomsky, 1959, p.59)

This conception of language was born in a context when computer programmes were developed to resemble human cognition (Newell & Simon, 1961; Simon, 1957). The development of artificial intelligence and Chomsky’s generative linguistics together stimulated the view that language processing is a computing process that manipulates linguistic symbols (e.g., Miller, 1962). But what does it mean to say that language processing is the computation of linguistic symbols?

Marr (1982) provides an answer as to how the above question can be analysed and answered. He proposed that there are three levels of analysis of cognition: the computational level, the algorithmic level and the implementational level. The computational level is concerned with what the computing system does and why. At this level, language can be viewed as the use of linguistic devices to express meaning and social functions; language processing can be viewed as the translation between meaning (thoughts/propositions) and linguistic form (phonetic/written strings). The algorithmic level specifies a set of algorithms and the representations that these algorithms are applied to. At this level, the language system can be viewed as a system of linguistic symbols/representations and a set of rules that apply to the representations. Language processing can be viewed as the use of cognitive processes (e.g., parsing preferences and production processes) with linguistic knowledge under the constraints of other cognitive system (e.g., attention

and memory). The implementational level of computation represents the actual physical realizations of the computing system. Thus, at this level, language and language processing can be viewed as actual firing of systems of neurons that underlies our linguistic knowledge and the use of our articulatory and auditory systems in the actual production and comprehension of language.

As the thesis is mainly concerned with the cognitive rather than the social, physiological or neural aspects of language, I mainly focus on the algorithmic level of computation when I refer to syntax and syntactic processing. More specifically, I define syntax and syntactic processing as cognitive-computational systems as follows:

(i). Syntax is a computational system consisting of a set of primitive syntactic representations (such as lexical categories and argument structures) and syntactic rules that apply to these syntactic primitives to generate larger syntactic representations¹.

(ii) Syntactic processing (grammatical encoding in production and syntactic parsing in comprehension) is the online formulation of syntactic representations (from more primitive representations and according to syntactic rules), making use of cognitive processes inherent in the processor.

The definition of syntax above is actually in concord with the widely held conceptualization in generative syntax. Chomsky (1997, p.17), for instance, wrote: “In the language case, a particular state of the language faculty can be taken to be a computational system of rules and representations that generate a certain class of structured expressions, each with the properties of sound and meaning specified by the language in question.” The definition of syntactic processing also reflects the state of the art in the fields of both sentence comprehension and production. Psycholinguists generally acknowledge the existence of syntactic knowledge, though they disagree over whether syntax enjoys a privileged role in sentence comprehension and whether syntax is lexically dependent (e.g., MacDonald et al.,

¹ It is a controversial issue as to what syntactic representations are primitive or pre-stored and what syntactic representations are constructed online using syntactic rules. I will return to this issue in Chapter 7.

1994; Levelt, 1989) or independent (e.g., Frazier, 1987; Garrett, 1980). Certain cognitive processes are also argued to be present in syntactic parsing in comprehension (e.g., Frazier, 1987; Kimball, 1973), though again opinions are divided as to whether these processes are guided exclusively by syntactic information or are interactive results of various sources of information (See Section 2.5). Similarly, sentence production has been found to be constrained by semantic processes as well as syntactic rules (e.g., Bock & Warren, 1985; see also Section 2.4.2).

Before I take these definitions for granted, an elaboration is needed concerning syntactic representations and cognitive processes. Gallistel (2001) stated that mental representations are symbols of an information processing system which refer to things outside the system and they enter into symbol processing operations. Thus, a syntactic representation can be broadly defined as a mental symbol which refers to a certain syntactic generalization in a language. The mental representation of a syntactic structure can be roughly taken to be the *syntactic analysis* that is assigned to it. Cognitive processes, on the other hand, can be seen as the processing operations in comprehension or production that work on syntactic representations.

2.3 Experimental syntax: Towards the mental representation of syntactic structure

As pointed out by F. Ferreira (2005), linguists and other cognitive scientists have come to a state of ignoring each other's research on language: Linguists have worked their own way in their linguistic enterprise without consulting findings in psycholinguistics, language acquisition, neurolinguistics and computational linguistics, while other cognitive scientists have tended to ignore linguistic evidence because of its lack of empirical precision. Such tensions have resulted in some recent debates over theoretical assumptions in syntax between Lasnik (2002) and Phillips and Lasnik (2003) on one side and Edelman and Christiansen (2003) on the other, and over the reliability of syntactic data collection between Phillips (2009) and Culicover and Jackendoff (2010) on the one side, and Gibson and Fedorenko (2010, in press) on the other. Over the years, there have been calls for the use of experimental methods and quantitative analyses in syntactic data collection (Bard et

al., 1996; Cowart, 1997; Featherston, 2007; Gibson & Fedorenko, 2010; Schütze, 1996).

In this section, I review an emerging programme called experimental syntax. I discuss possible ways to collect data in syntactic research. Then I discuss criticisms of the current approach to syntactic data collection and present two alternative experimental approaches.

2.3.1 Approaches to data collection in syntactic research

In theory, there are two possible sources of syntactic data and two possible methods of data collection. In terms of the source, we can ask directly about the grammaticality of a sentence using introspection on our own syntactic knowledge (e.g., Chomsky, 1965; Katz, 1981). Introspection is the primary source of data in current syntactic research. Alternatively, we can use non-introspective behaviours to make inferences about the grammaticality of a sentence (e.g., Levelt, 1974). For instance, ungrammatical sentences, relative to grammatical controls, can cause reading disruption in self-paced reading and eyetracking and result in specific ERP signatures or activation in certain brain areas in neural imaging studies. Let's call the former source *introspection* and the latter *inference*. In terms of methods, we can use an *informal* method by consulting one or two informants (as commonly practiced in syntax) or an *experimental* method whereby we collect data from a group of participants under experimental settings (as practiced in cognitive psychology). Combining methodology and source of data, we can have four possible approaches to syntactic data collection. In the *informal introspection* approach, researchers collect introspective data from one or two informants and this has long been practiced in syntactic research. In the *experimental introspection* approach, researchers use experimental methods and quantitative analyses in collecting data from a large group of informants, as experimental syntax is advocating. In the *informal inference* approach, one can examine non-introspective behaviours triggered by syntax. Such an approach is rare in syntactic research (it is often practiced in neurolinguistics, though), so I will not review it. In the *experimental inference* approach, non-introspective behaviours indicative of syntactic representations are examined over a large group of participants.

2.3.2 The informal introspection approach

Informal introspection has dominated syntactic research and was not seriously challenged until about a decade ago (Cowart, 1997; Schütze, 1996). With the informal introspection approach, a researcher uses her own (and sometimes others') judgement concerning the grammaticality of a sentence in syntactic theorizing. F. Ferreira (2005) provides an illustration of informal introspection:

“Judgments are typically gathered as follows. An example sentence that is predicted to be ungrammatical is contrasted with some other sentence that is supposed to be similar in all relevant ways; these two sentences constitute a “minimal pair”. The author of the article provides the judgment that the sentence hypothesized to be bad is in fact ungrammatical, as indicated by the star annotating the example. ... Occasionally theorists seem to be aware enough of this problem that they decide to check judgments with a colleague down the hall (sometimes called the “Hey Sally” method).” (F. Ferreira, 2005, p.372)

The use of informal introspection is justified by the assumption that the grammar of a language is internalized in any native speaker of that language and is thus accessible to intuition (i.e., people can introspect on the grammar of their language). For instance, Katz (1981, p.214) likened informal introspection to a mathematician's use of intuition: “a process of exercising grammatical intuition with respect to a particular sentence and thereby [constructing] a sufficiently revealing concept of its grammatical structure for the informant to judge whether the sentence has a certain grammatical property or relation.” The use of informal introspection was further justified by the fact decades ago that “[t]here are, in other words, very few reliable experimental or data-processing procedures for obtaining significant information concerning the linguistic intuition of the native speaker” (Chomsky, 1965, p.19). Such a defence was well argued for in the context of the 1960s, when technology did not allow for analysis of large corpora, an observation of cognitive behaviour to the millisecond or measurement of brain activities. Furthermore, it is argued that informal introspection is actually a miniature experiment by using minimal pairs and the “Hey Sally” method (e.g., Phillips, 2009).

Others ways of investigating the linguistic knowledge, however, have been proposed. As noted by Chomsky himself, “[E]vidence could come from many

different sources apart from judgements concerning the form and meaning of expressions: perceptual experiments, the study of acquisition and deficit or of partially invented languages such as creoles” (Chomsky, 1986a, p. 37). The past two decades has witnessed increasing calls for more objective methods in syntactic data collection and criticisms of the informal introspection approach (e.g., Gibson & Fedorenko, 2010; Schütze, 1996) as well as current theoretical constructs (Edelman & Christiansen, 2003; F. Ferreira, 2005). I review some of these criticisms in the following section.

2.3.3 Criticisms of the informal introspection approach

Reliability of informal introspection

One of the most frequently quoted criticisms of current data collection in syntax is that syntactic evidence is often based on intuitions for one or two sentences from one or two informants (most often the researcher herself). Experimentally-oriented researchers have constantly questioned its reliability (e.g., Gibson & Fedorenko, in press; Schütze, 1996). Several factors may lead to the unreliability of data collected in the informal introspection approach.

The first concern is dialectal and/or idiolectal variation in grammaticality judgement when only one or two informants are consulted: A construction may be more grammatical in a certain dialect than in another or to a particular person than to another person. Also, item-specific effects may be exaggerated due to plausibility and processibility factors (an issue I will return to later) when only one or two items are considered. All these confounds may lead to a lack of generalizability.

Second, as the researcher has a stake in the judgement and a certain theoretical commitment, she may be biased when she herself was the source of data (e.g., she may be highly selective in finding a grammatical or ungrammatical sentence in support of a particular theory) (e.g., Spencer, 1972). Even if she consults other informants, the reliability of informal introspection may still be compromised as it probably involves the experimenter-expectancy effect.

Third, an informant repeatedly exposed to sentences of a similar type may fall into the danger of adopting a more stringent criterion in grammaticality judgement (e.g., Nagata, 1988, 1989; Snyder, 2000; cf. Sprouse, 2009) or a less strict one due to

structural priming (e.g., Luka & Barsalou, 2005). Thus, informal introspection is very susceptible to these biases (similar biases may be present with experimental introspection).

Gradience in grammaticality

Syntactic researchers have long acknowledged the “marginally grammatical” status of some sentences, that is, some sentences are not totally grammatical but are grammatically more acceptable than others. Experimental work has revealed evidence for fine degrees of grammaticality (Cowart, 1997; Keller, 2000; Sorace & Keller, 2005). Such judgements have led researchers to speculate that language is more gradient in grammaticality than just simply being grammatical, marginally grammatical and ungrammatical. However, without experimentation and quantitative analyses, it would be hard for syntactic researchers to have a good understanding of the gradient nature of grammaticality (and hence the nature of syntactic knowledge). In fact, Sorace and Keller (2005) used grammatical gradience to argue for the existence of different types of syntactic constraints (i.e., principles). Such a conclusion is consistent with grammatical theories within the framework of Optimality Theory (Prince & Smolensky, 1993).

Grammaticality and acceptability

In syntactic research, the acceptability of a sentence is often taken to reflect the grammaticality of the sentence. However, researchers have long warned against equalling acceptability with grammaticality (e.g., Chomsky, 1965; see Schütze, 1996 for a detailed review). The distinction between acceptability and grammaticality is also endorsed in Bever (1974), who argued that a sentence can be unacceptable due to non-grammatical as well as grammatical factors. One of the non-grammatical factors is processibility: We may find a sentence difficult to process (thus low in acceptability) not because it violates the grammar, but because its syntactic analysis is not the one that the processor opts for or the syntactic analysis is too complex (as in the case of centre-embedding sentences, e.g., Gibson, 1998). For instance, garden path sentences such as *the horse raced past the barn fell* are often assumed to be unacceptable/ungrammatical by naïve speakers not because they are ungrammatical

but because their analysis is not compatible with the one the processor opts for (e.g., Bever, 1970; Frazier & Fodor, 1978). Another factor is plausibility. For instance, garden path sentences can be ameliorated by plausibility (MacDonald et al., 1994; Trueswell et al., 1994). Thus, the non-distinction between acceptability and grammaticality is often cited by experimentalists as one of the weaknesses of informal introspection (Bard et al., 1996; Schütze, 1996).

Psychological reality of theoretical constructs

Grammatical frameworks often assume certain theoretical constructs. For instance, theories within the Principle and Parameter framework (Chomsky, 1981, 1995) assume syntactic representations such as functional phrases (e.g., Tense Phrase and Agreement Phrase) and also operations such as movement, merge and feature checking. Other generative frameworks such as Lexical Functional Grammar (e.g., Bresnan, 2001) and Simpler Syntax (Culicover & Jackendoff, 2005) assume representations such as syntactic functions (subject, object, etc) and a mapping from syntactic functions to syntactic constituents. These theoretical constructs tend to be theory-internal and different theories assume different theoretical constructs. For instance, although syntactic functions such as subject and object are core syntactic primitives in Lexical Functional Grammar and Simpler Syntax, they are considered only derived notions in the Principle and Parameter framework.

It has worried some empirically-oriented cognitive scientists that a theory of grammar is based on theoretical constructs which themselves want empirical justification (Edelman & Christiansen, 2003; F. Ferreira, 2005). Psycholinguists have tested the psychological reality of these constructs. A famous example is the studies on the derivational theory of complexity. The studies intended to provide (or, in some cases, to disconfirm) the psychological justification for the generative constructs such as deep structure and transformations (see Fodor, Garrett, & Bever, 1974, for a review). Later studies also explored the psychological reality of traces of movement that are assumed in Government-Binding Theory (GB henceforth), with some studies claiming traces (or gaps) to be psychologically real (e.g., Gibson & Warren, 2004; Stowe, 1986) and others disconfirming their reality (e.g., Traxler &

Pickering, 1996). In all, the call to test theoretical constructs of grammatical frameworks is still going on (e.g., Edelman & Christiansen, 2003; F. Ferreira, 2005).

Mental representation of syntactic structure

The current situation in syntactic research is that different grammatical frameworks, on the basis of theoretical constructs they assume, assign different syntactic representations (i.e., syntactic analyses) to many types of sentences. For the purpose of illustration, I briefly compare the syntactic representations for the passive construction in English (e.g., *the clown is kicked by the waitress*) under grammatical frameworks such as GB (Chomsky, 1981), Minimalism (Chomsky, 1995), Lexical Functional Grammar (LFG, Kaplan & Bresnan, 1982) and Simpler Syntax (Culicover & Jackendoff, 2005) to show how different these representations are.

Theories such as GB and Minimalism assume a derivational structure for the passive; that is, the syntactic representation of the passive reflects the history of the derivation of the passive from a deep structure (according to GB) or lexical assembly (according to Minimalism). LFG and Simpler Syntax assume simpler structural geometry for the passive. These theories, unlike GB and Minimalism, assume a separate representation for grammatical functions. Figure 2.1 presents the tree structures assumed under GB, FLG and Simpler Syntax. As shown in the figure, the tree structure for the passive construction is more complex in GB (and presumably in Minimalism too) than in LFG and Simpler Syntax. This is largely because LFG and Simpler Syntax stipulate a level of functional representation and thus reduce the need for complex tree structure, while GB (and Minimalism too) has to use the theoretical construct of movement to account for the position of the Patient. As different frameworks make different assumptions, it is difficult to compare these syntactic representations on the basis of grammaticality. Thus, it is necessary to introduce non-introspective methods to distinguish different accounts of syntactic representations.

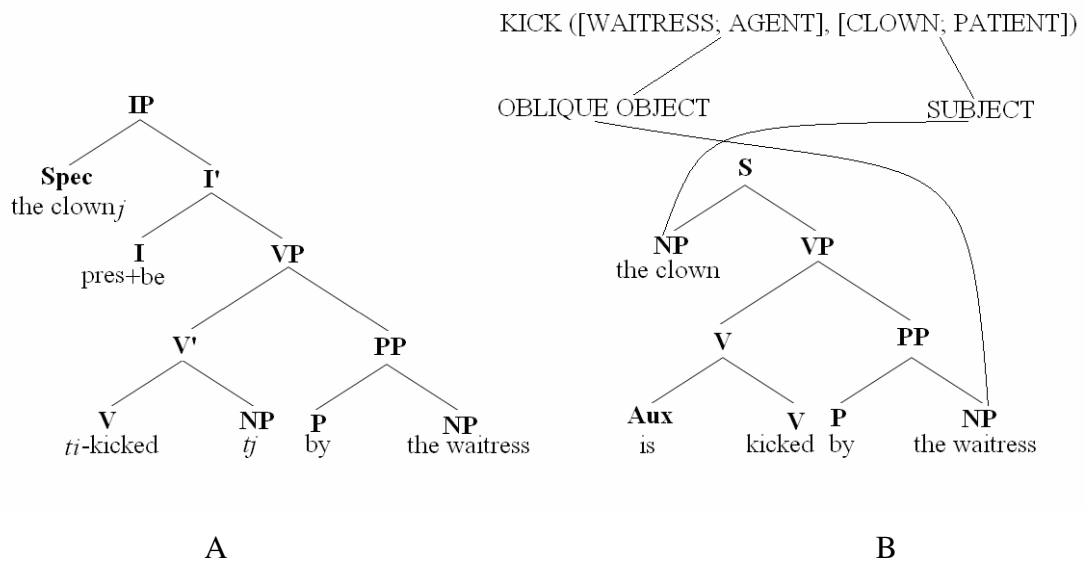

Figure 2.1: Syntactic representation of the sentence *the clown is kicked by the waitress* according to the GB theory (A) and LFG and Simpler Syntax (B).

2.3.4 The experimental introspection approach

As a response to the aforementioned shortcomings of the informal introspection approach, many researchers have advocated the use of experimental methods in the collection of introspective judgements (e.g., Bard et al., 1996; Cowart, 1997; Gibson & Fedorenko, in press). Three methods are often used in the experimental introspection approach: the categorical method, the ranking method and the ratio method (mainly magnitude estimation).

In the categorical method, participants are asked to assign a categorical grammaticality/acceptability judgement to a sentence (e.g., grammatical/acceptable or ungrammatical/unacceptable). A recent study using this method is Clifton, Fanselow, and Frazier (2006), who, by asking multiple informants to determine whether a sentence is acceptable, provided experimental results that disconfirmed previous conclusions that the violation of the Superiority Condition (e.g., *what can who do about it?*) can be ameliorated if there is a third *wh*-element (e.g., *what can who do about it when?*) (e.g., Hornstein, 1995).

The ranking method requires participants to assign grammaticality to a sentence in a (e.g., 5- or 7-point) scale. A recent study using the ranking method is Gibson and Fedorenko (in press). They were interested in testing the conclusion by

Chomsky (1986b) that the vacuous movement (e.g., *the manager tried to figure out what the waiter wondered who had ordered*) results in less ungrammaticality than Superiority condition violation (e.g., *the manager tried to figure out if the waiter wondered what who had ordered*). They asked participants to judge the naturalness of a sentence in a 5-point scale and found that, contrary to the informal introspection in Chomsky (1986b), the Superiority Condition violation sentence was judged as more acceptable than the vacuous movement sentence.

Magnitude estimation was originally used in psychophysics (Stevens, 1975) and was later introduced into grammaticality judgement tasks (Bard et al., 1996). It requires participants to assign a value representing the grammaticality of a sentence (e.g., *who do you think that the teacher likes?*), in reference to the value assigned to a modulus sentence (often a grammatical sentence that forms a minimal pair with the target sentence, e.g., *who do you think the teacher likes?*). Grammaticality values are then transformed into z-scores. The outcome of magnitude estimation is therefore ratio and is arguably more amendable in quantitative analyses (Bard et al., 1996). Using magnitude estimation, Featherston (2005) investigated the *that*-trace effect in German and found that although subject- and object-extractions do not differ in verb-second constructions, subject-extraction is much worse than object-extraction in verb-final constructions when *that* is present, contrary to previous conclusions based on informal introspection.

Apparently, experimental introspection can resolve some of the criticisms levelled against the informal introspection approach. First, by collecting data over multiple informants and multiple stimuli, it greatly improves the reliability of the data. Second, with the use of quantitative methods, it provides insight into the gradience of grammar (e.g., Sorace & Keller, 2005). However, it should be noted that experimental introspection also suffers from its failure to separate grammaticality from non-grammatical factors. If an individual is susceptible to plausibility and processibility factors in sentence judgment (see Schütze, 1996, for such an argument), so are a group of participants in an experimental setting (It should be noted that plausibility confounds can be minimized in magnitude estimation via the use of the modulus sentence). Furthermore, experimental introspection also has little to say about the psychological reality of syntactic theoretical constructs and the mental

representation of syntactic structure. These issues, I will argue, can be better resolved with the experimental inference approach.

2.3.5 The experimental inference approach

Instead of asking participants to intentionally resort to their syntactic knowledge, the experimental inference approach infers grammaticality and syntactic representations indirectly from non-introspective cognitive behaviours. There has been a long tradition for psychologists to use cognitive psychological methods in investigating syntactic issues. In these studies, researchers often first set up a link between a syntactic phenomenon and a cognitive behaviour that the syntactic phenomenon underlies. Such a cognitive behaviour can be reading times (as in self-paced reading and eyetracking studies), linguistic responses (as in picture description and structural priming studies) or even electrophysiological signals and brain images (as in ERP and fMRI studies). Some well-known early studies using experimental inference in the investigation of syntactic issues were studies on the derivational theory of complexity. These studies aimed to test the psychological reality of syntactic transformations and deep structures that were proposed in the 1960s (Chomsky, 1957, 1965). At that time, it was proposed that sentences were generated by applying transformations, when necessary, to kernel sentences. A passive sentence such as *the clown is kicked by the waitress* was generated by applying a passive transformation rule (i.e., demoting the subject² as the adjunct and promoting the object as the subject) to a kernel (or deep structure) sentence *the waitress kicks the clown*. Psychologists reasoned that if such a transformation was in fact psychologically real, then producing or comprehending a passive sentence would entail some extra cognitive process (corresponding to the application of the passive transformation) which would, for example, result in elevated reaction times in reading or production tasks. However, studies to prove the derivational theory of complexity yielded no convincing results (see Fodor et al., 1974, and Garnham, 1983, for reviews; cf. Berwick & Weinberg, 1983; Phillips, 1996).

² I am using the terms like subject and object for convenience's sake. Note that grammatical functions are not primitive representations in GB and Minimalisms.

One recent study that utilized reaction times in reading to investigate syntactic representations is Dubinsky, Egan, Schmauder, and Traxler (2000). They contrasted two accounts of the syntactic representation of the small-clause construction in English (e.g., *I want them on the bus now*). According to the *small-clause account*, the NP *them* and the PP *on the bus* forms a constituent (an agreement phrase, or AgrP) which itself serves as a complement of the verb *want* (Bowers, 1993; Starke, 1995). According to the *predication account*, both the NP *them* and the PP *on the bus* are arguments to the verb *want* and the PP predicates the NP (Carrier & Randall, 1992; Williams, 1983). As the small-clause account (but not the predication account) stipulates that the NP and the PP form an agreement phrase, the small-clause account (but not the predication account) predicts that the processor needs to check the agreement between *cake* and *not sitting on the cutting board on the table* (thus leading to longer reading times) in the SC-complement condition (i.e., 2.1a) but not in the NP-complement condition (i.e., 2.1b). Experimental findings confirmed this prediction and therefore supported the small-clause account of the small clause constructions in English. Thus, the experimental inference approach has the potential to investigate the mental representation of syntactic structure.

2.1a. SC-complement condition

Mary wanted the cake in the window, not sitting on the cutting board on the table.

2.1b. NP-complement condition

Mary wanted the cake in the window, not the one sitting on the cutting board on the table.

However, Dubinsky et al.'s study suffers from several problems. First, their conclusion was built on the unsupported assumption that computing agreement is costly. Second, the construction instantiated in the latter part of the sentence may be more frequent in (2.1b) than in (2.1a), which then led to the faster reading times in (2.1b). Third, the longer reading times in (2.1a) could also be a garden path effect; that is, participants preferred *cake in the window* as complex NP rather than as a small clause and would thus have to reanalyse when *not sitting on the cutting*

board... was processed. And finally, the observed difference could have risen during the computation of meaning rather than syntactic structure, as the two sentences in (2.1) differed in both syntax and semantics. Some of these problems may be inherent in reading time paradigms (e.g., self-paced reading or eyetracking) in the investigation of the mental representation of syntactic structure. For instance, when different sentences are compared in terms of reading times, there are always plausibility and processibility issues such as whether the sentences differ in terms of frequency and semantics and whether the reading time difference is due to processing preferences or rather a difference between syntactic representations.

2.3.6 Summary

In this section, I reviewed the weaknesses of the traditional methodology in syntactic data collection and the need to use experimental approaches. Experimental approaches can avoid problems such as reliability by surveying a number of informants and by observing data from multiple test items. Also, the quantitative analyses allow researchers to obtain finer measures of grammaticality. However, like informal introspection, these experimental approaches are also susceptible to performance factors such as plausibility and processibility. In Chapter 3, I propose that structural priming is less susceptible to plausibility and processibility effects and thus offers promising prospects in the investigation of the mental representation of syntactic structure. In the following section, I switch to the processing of syntactic structure in language production.

2.4 The processing of syntactic structure in language production

Speaking involves a series of cognitive processes. When describing, for instance, the event in Figure 2.2, a speaker needs first to apprehend the event as a kicking event which involves a waitress (the Agent) and a clown (the Patient). After forming this conceptual message, the speaker needs to access the words to convey the message. For example, she may choose the word *actress* for the Agent, *clown* for the Patient and *kick* for the action. The speaker also needs to organize these words into a well-formed sentence, for instance, *the waitress kicks the clown* or *the clown is kicked by*

the waitress. With the structure and lexical items in mind, she needs to phonologically encode the lexical items and articulate the utterance.



Figure 2.2: An example event for sentence production

In this section, I first give a sketch of the architecture of language production. Then I review components of the architecture that are relevant to the formulation of syntactic structure. I review how a speaker conceptualizes a message (conceptualization), and how she selects lexical items (lexical processing), and how these lexical items are organized into a syntactically well-formed structure (grammatical encoding). Then I review factors that influence grammatical encoding.

2.4.1 The architecture of sentence production

A theory of sentence production needs to specify the architecture (i.e., the organization of the cognitive components involved) and the information flow in the architecture (how different cognitive components interact). Though differing in details of the architecture and information flow, researchers generally agree that sentence production mainly involves three distinct but related stages or components. Levelt (1989) refers to these three stages as *conceptualization*, *formulation* and *articulation*. Conceptualization produces a conceptual structure. Formulation deals with lexical access, structural building and phonological encoding. Articulation is the use of motor programmes in the actual articulation of the sentence. As this thesis is concerned with the representation and processing of syntactic structure and as

phonological encoding and articulation have very limited roles in grammatical encoding (Cleland & Pickering, 2003; Bock, 1986a; cf. Santesteban, Pickering, & McLean, 2010), I will not review phonological encoding or articulation. Also, as formulation is a complex component, I will review it in two parts: lexical processing and grammatical encoding.

Conceptualization

Levelt (1989, p. 9) defines conceptualization as “...conceiving of an intention, selecting the relevant information to be expressed for the realization of this purpose, ordering this information for expression, keeping track of what was said before, and so on”. The definition implicates several related sub-tasks. First, the speaker generates the communicative intention, i.e., the purpose of producing a sentence. It can be to make a request, to convey information, or simply to socialize. After the generation of the communicative intention, the speaker selects information that she wants to convey, e.g., the waitress kicking the clown. The final sub-task in conceptualization is to organize the bits of information into a conceptual structure (Jackendoff, 1983; Levelt, 1989) as input to linguistic formulation.

Following Jackendoff (1983, 2002), I use a function-argument schema to illustrate the conceptual structure, which contains several components. Figure 2.3 represents a possible conceptual structure for the event in Figure 2.2. First, there are semantic representations of entities and action/state which are factored out of the event. KICK describes the action that the speaker perceives and two human beings in the event are identified as WAITRESS and CLOWN. Secondly, the conceptual structure contains propositional categories (square-bracketed in Figure 2.3) such as situation, event, and person. In Figure 2.3, the speaker wishes to express a situation of a kicking event that occurs in the present and involves two persons (WAITRESS and CLOWN). The organization of these categories corresponds to an event structure (Levelt, 1989, p. 79). Thirdly, the conceptual message contains relational meaning: WAITRESS is the Agent of the kicking event and CLOWN is the Patient. Finally, the conceptual structure also contains pragmatic and discourse information (i.e., perspective meaning). For instance, in Figure 2.3, the speaker assumes the hearer has some knowledge about the particular waitress and clown she is going to talk about;

hence both WAITRESS and CLOWN are labelled <Definite>. The conceptual message may also contain information such as givenness and emphasis.



Figure 2.3: An illustration of the conceptual structure of an event of a certain waitress kicking a certain clown.

Lexical processing

Once the speaker generates the conceptual structure, she needs to find appropriate words to express the semantic entities in the conceptual structure. A word encompasses different types of information. First, a word has meaning (i.e., corresponding to a lexical concept). Secondly, a word contains lexico-syntactic information such as lexical category (noun, verb, preposition etc), grammatical gender (masculine, feminine or neutral), grammatical number (mass or count noun) and so on. Third, a word has its form, either in terms of phonology or orthography. The theory of lexical access is about how a speaker accesses the different types of information in a word. The most influential model of lexical access is the staged and feed-forward model proposed by Levelt and colleagues (e.g., Levelt, 1989; Levelt, Roelofs, & Meyer, 1999). The model has three strata: the conceptual stratum which represents lexical meaning, the lemma stratum which specifies lexico-syntactic information, and the lexeme stratum which encodes phonological or orthographic information. For instance, according to the model, the verb *escort* is represented as something like ACCOMPANY (X,Y) at the conceptual stratum to stand for its meaning. Next at the lemma stratum, the verb has lexico-syntactic representation such as V(x, y) to stand for its lexical category (a verb) and subcategorization (a transitive verb with two arguments). Represented along is its tense and aspect information. Lemmas are linked to wordforms at the lexeme level, which is further linked to syllables and phonemes (see Levelt et al., 1999, p. 4, for such a model). This model of lexical access is widely assumed in sentence production research (e.g., Bock & Levelt, 1994; Pickering & Branigan, 1998), though there are also challenges

to the distinction between the lemma and the lexeme (e.g., Caramazza, 1997; Caramazza & Miozzo, 1997).

Research on the stages of lexical access has mainly considered single words. A question raised is whether the same stages of access hold when a word is produced in a sentence. According to Bock and Levelt's model, the stages do still hold: Lemmas are accessed during functional processing and lexemes are selected during positional processing. One recent study that looked at lexical access at a sentence level is Sahin et al. (2009). They asked brain-damaged patients to use a given word in a sentence context (e.g., use *walk* in *Yesterday they ____*) and recorded local field potentials from unaffected brain tissues. They found neural imaging evidence that the brain first identifies the word, then syntactically/morphologically inflects it according to tense, and finally phonologically encodes the inflection. These observations are argued to reflect stages in language production: lemma selection, grammatical encoding and phonological processing, and thus provide strong evidence for the staged model of lexical access and language production (Bock & Levelt, 1994; Levelt, Roelofs, & Meyer, 1999).

Grammatical encoding: Bock and Levelt (1994)

Grammatical encoding in language production is concerned with the organization and ordering of constituents (NP, V, PP etc.). The most influential model of grammatical encoding is the one proposed by Bock and Levelt (1994), who followed a previous framework developed in Garrett (1975, 1980). The model assumes that grammatical encoding consists of two temporally distinct levels of processing: functional processing and positional processing. Figure 2.4 illustrates how the syntactic structure of the sentence *the clown is kicked by the waitress* is formulated according to this model.

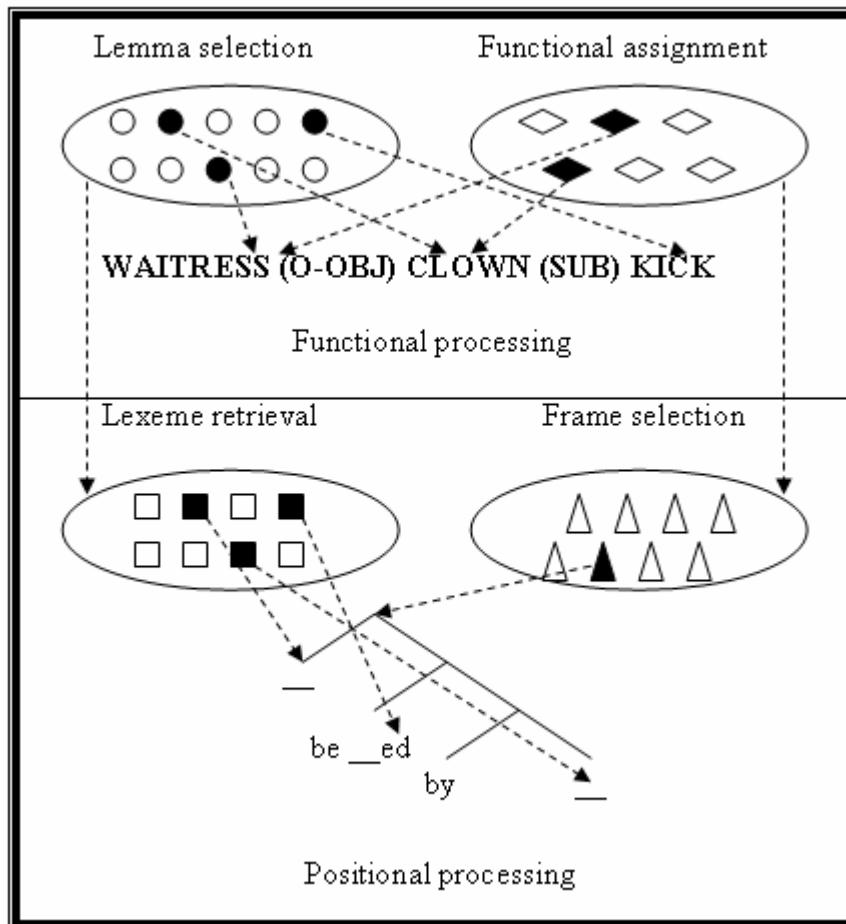

Figure 2.4: A schematic illustration of grammatical encoding of the sentence *the clown is kicked by the waitress*.

Bock and Levelt (1994) assumed that the conceptual structure contains distinct semantic entities that are directly translatable into lexical concepts, which trigger lemma selection during functional processing. The processor determines the lexical categories of the selected lemmas. For instance, in the example in Figure 2.4, both *WAITRESS* and *CLOWN* are encoded as nouns and *KICK* as a verb. Once the verb is selected, grammatical functions associated with the verb are also activated. For instance, the verb *kick* can include the subject function and the object function (in case of the active) or the oblique object function (in case of the passive). Functions are then assigned to NP constituents according to certain processes. By default, the subject function is assigned to constituents carrying a thematic role such Agent or Experiencer, or to constituents that are more animate, more concrete, more definite etc (see Bock & Warren, 1985, for more discussion).

In the model, functional assignment determines the final structure of the linguistic expression: If WAITRESS is assigned the subject function (and CLOWN the object function), the final outcome will be an active sentence; if CLOWN is assigned the subject function (and WAITRESS the oblique object function), the outcome will be a passive sentence. Lemma selection and functional assignment in the model are said to be at the same level (the functional processing) because they both target abstract lexical representations of content words (verbs, nouns, adjectives and adverbs). Function words and lexeme information are processed at positional processing in the model.

Suppose that, as illustrated in Figure 2.4, CLOWN is assigned the subject function and WAITRESS the oblique object function. The processor then continues with positional processing. At this level, lexemes are retrieved so that *clown* is retrieved for CLOWN, *waitress* for WAITRESS and *kick* for KICK. Meanwhile, a syntactic frame is selected on the basis of grammatical functions that have been assigned (in our case, the subject and the oblique object). Syntactic frames carry slots into which retrieved lexemes are inserted. Following earlier work by Garrett (1975, 1980), Bock and Levelt (1994) assumed that syntactic frames carry inflectional affixes such as past-participle *-ed* and progressive participle *-ing* and possibly prepositions such as *by* (but see Bock & Loebell, 1990). The syntactic frame determines the linear order of syntactic constituents. For example, in English, a subject-tagged noun is placed in a position before the verb and an object-tagged noun after the verb. Another task of positional processing is inflection: Lexemes are inflected according to grammatical number and subject-verb agreement. At the end of positional processing, the processor comes up with a fully structured string with lexemes that are ready for phonological encoding and articulation.

Bock and Levelt's model has several distinguishing features. Architecturally, it is a two-level model: Lemma selection and function assignment are done at the functional processing level, while lexeme retrieval, inflection and linearization of constituents are achieved at the positional processing level. Information flow among conceptualization, functional processing, positional processing and the later phonological processing is strictly feed-forward; that is, conceptualization feeds only to functional processing, whose output is then processed at the positional processing

level. Positional processing then feeds to phonological processing. Later levels cannot feed to preceding levels. Second, the model assumes that syntactic structure is independently stored as frames, contrary to the lexicalist claim that syntactic structure is projected from lexical items (e.g., F. Ferreira, 2000).

These features of the model are motivated both theoretically and empirically. On the theoretical side, Garrett (1975, 1980) and Bock and Levelt (1994) explicitly adopted the Lexical Functional Grammar (LFG, Kaplan & Bresnan, 1982) as their grammatical framework. As I have reviewed above, LFG assumes a functional structure where thematic roles are assigned functions and a constituent structure where linear order of constituents is determined; the grammatical functions drive the assembly of constituent structure. Such a function-structure mapping mechanism was adopted by Bock and Levelt (1994).

On empirical grounds, the two-level organization of the model was (partly) motivated on the basis of speech errors such as word exchanges (saying *I left my briefcase in my cigar*, when *I left my cigar in my brief case* is intended, Garrett, 1980, p. 188) and stranding exchanges (the separation of an inflectional affix from the target stem, e.g., saying *I thought the park was trucked* when *I thought that truck was parked* was intended, Garrett, 1980, p. 188). Garrett (1975, 1980) observed that word exchanges respect category information, i.e., mainly words of the same grammatical class are exchanged, while stranding exchanges are much less constrained by grammatical information of the words involved. These suggest that word exchanges occur at a level (i.e., functional processing) where lexical category information is processed and stranding exchange occurs at a level (i.e., positional processing³) where word-form information is processed. It was also proposed that during positional processing, a syntactic frame with inflections and function words is retrieved. This claim was based on stranding errors such as *he facilitated what he was doing to remove the barricade* (when the intended sentence was *he removed the barricade to facilitate what he was doing*, Garrett, 1980. p.198) and *even the best team losts* (with *-s* pronounced as /s/, when *even the best teams lost*, with *-s* pronounced as /z/ was intended). Note that in the first example the function word *to*

³ It should be noted that positional processing in Garrett (1975, 1980) mainly deals with word-form processing, while in this thesis, I mainly take positional processing to mainly deal with the construction of constituent structure and word order (see also Pickering et al., 2002).

stays in situ and attaches to the misplaced verb *facilitate*. In the second example, the plural inflection *-s* did not move with *team* and was phonologically contextualized by *lost* rather than *team*.

However, it should be noted that both the theoretical assumptions and empirical observations themselves are under debate. Grammatical functions are theory-internal constructs; they are not assumed as primitive syntactic constructs under some grammatical frameworks such as GB. Also, speech error evidence concerning different levels of processing is not conclusive. Word substitution occurs when a wrong word is used instead of the intended word (e.g., *I would like to see it now that I've written the book, uh, read the book.*). Garrett (1975, 1980) argued that these substitutions occur at the functional level where a semantically related lemma is selected by mistake. However, Dell and Reich (1981) found incorrectly substituted words tend to be related (i.e., more than chance) to intended words both in terms of semantics and phonology, the latter of which is not predicted by Garrett's model.

Alternative conceptualizations of grammatical encoding

Alternative models concerning grammatical encoding have been proposed. Kempen and Hoenkamp (1987) proposed a model whereby grammatical encoding involves function assignment and linearization (as in Bock & Levelt, 1994), but the two types of operations are not temporally distinguished. Also, the model is lexicalist in that it assumes the centrality of the lemma in structure building: A lemma brings its own syntactic category and projects into a major constituent category such as NP and VP. The verb also determines what syntactic functions are available to the processor. Such a model was adopted in Levelt (1989).

A more radically different model was proposed by F. Ferreira (2000). The model is lexicalist and has only one level, and is based on a formal grammatical system called Tree Adjoining Grammar (TAG; Joshi, Levi, & Takahashi, 1975). TAG assumes that lexical items are associated with primitive syntactic trees. Grammatical encoding can be seen as the adjoining and substitution of syntactic trees. Thus, for the event of a certain waitress kicking a certain clown, if the lemma CLOWN is selected first, the lemma brings a DP structure (a maximal projection of D[eterminer]). Tree structures are also brought by the lexical heads of the passive

form of KICK and the noun WAITRESS (see Figure 2.5). These structures are then combined (through substitution) to form a complete surface constituent structure, which is then sent to phonological encoding. One distinctive feature of F. Ferreira's model is that there is no distinction between a stage of unordered constituent structure and a stage of constituent linearization. In this sense, her model consists of strictly one level of grammatical encoding.

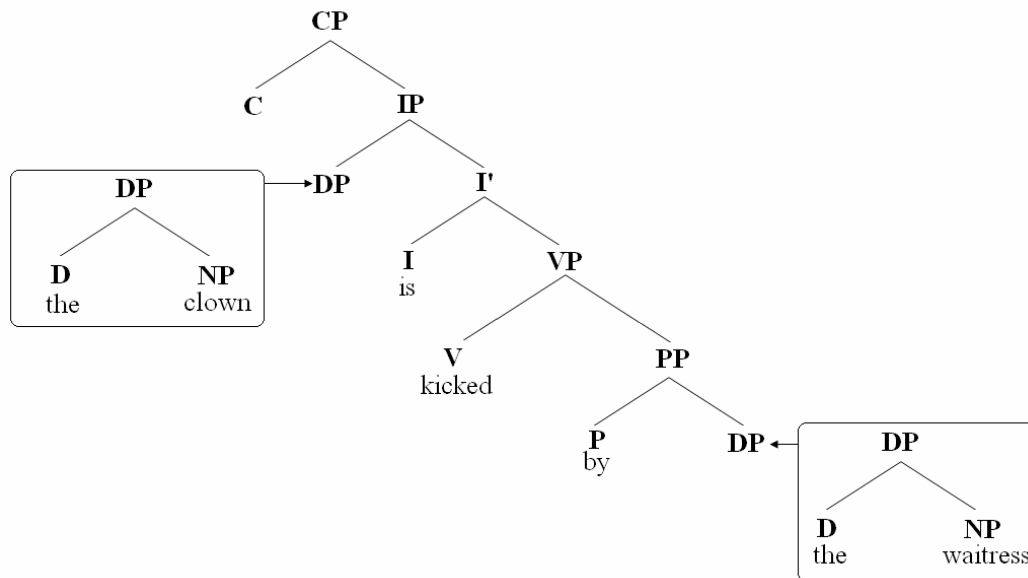

Figure 2.5: Grammatical encoding for the sentence *the clown is kicked by the waitress* in the model proposed by F. Ferreira (2000).

Summary

In this section, I broke down the architecture of sentence production into conceptualization, lexical processing and grammatical encoding. In conceptualization, the processor forms a conceptual structure as input to grammatical encoding. On the basis of the conceptual structure, the processor retrieves lemmas, which are used in grammatical encoding, and later selects lexical forms. Grammatical encoding, according to Bock and Levelt (1994), proceeds in two levels and structure-building is frame-based. However, there are alternative claims that grammatical encoding occurs in a single stage and that structure-building is lexically guided. In the following sections, I review empirical studies that explore the workings of grammatical

encoding. These studies have implications for the debates concerning the levels of processing and the nature of structure-building.

2.4.2 Syntactic effects on grammatical encoding

What sources of information can affect the inner workings of grammatical encoding? This is a question I review in this and the following sections. The most straightforward answer is that information from within grammatical encoding can affect the formulation of a syntactic structure. Studies often observe how residual information of previous syntactic processing affects the choice of grammatical structure, using the structural priming paradigm (which I will review in Section 2.7 below). There is good evidence that people tend to repeat syntactic structure from previous utterances produced by themselves or by others. Levelt and Kelter (1982) found that shop keepers, when answering a question over the telephone, tended to follow the way a question was put. For instance, they tended to say *at five o'clock* when asked *at what time does your shop close?*, and say *five o'clock* when asked *what time does your shop close?*. Bock (1986b) experimentally demonstrated that after repeating a double-object dative (henceforth DO) sentence as in (2.2a) or a prepositional-object dative (henceforth PO) sentence as in (2.2b), participants tended to use the same structure in their subsequent description of a dative event such as a girl passing a man a paintbrush. Similar priming occurred with actives and passives.

2.2a. A rock climber sold some cocaine to an undercover agent.

2.2b. A rock climber sold an undercover agent some cocaine.

Repetition of constituent structure

So what does structural priming imply about grammatical encoding? Bock (1986b) suggested that structural priming actually reflects the re-use of syntactic operations that are associated with the formulation of the prime sentence, though she did not speculate on what these syntactic operations were. One possibility is, according to a two-level model, that it is the functional structure that is primed. A DO sentence has a subject, a verb, a direct object and an indirect object while a PO sentence has a subject, a verb, an object and an oblique object. Once a functional structure is

computed, the processor tends to re-use the procedures that lead to the construction of the same functional structure.

But later studies suggest that functional processing may not be the locus of structural priming. Pickering et al. (2002), for instance, found no priming of (unshifted) PO responses following a shifted PO prime (e.g., *the racing driver showed to the helpful mechanic the torn overall*) (see also Salamoura & Williams, 2007, for a similar finding), though the two constructions have the same functional structure. In fact, it has been shown that it is the (surface) constituent structure that is primed. Hartsuiker, Kolk, and Huiskamp (1999) asked participants to first repeat a Dutch prime sentence that was in a NP-V-PP order (2.3a) or the reverse order (2.3b) and then to describe a picture such as a ball sitting under a table. They found that the order of words can be primed.

2.3a. Een boek ligt op de plank. (A book lies on the shelf)

2.3b. Op de plank ligt een boek. (On the shelf lies a book)

A similar finding was also observed in Hartsuiker and Westenberg (2000), who found priming of auxiliary-verb orders in Dutch. Similarly, Konopka and Bock (2009) found priming of the order of noun phrase and particle (*pull off a sweatshirt* vs. *pull a sweatshirt off*). Note that in these studies grammatical functions are held constant. For instance, in both (2.3a) and (2.3b), *een boek* is the subject and *de plank* is the oblique object. Bernolet, Hartsuiker and Pickering (2007) demonstrated that identical word order facilitated cross-language priming. So these studies indicate that structural priming may have a locus at the surface constituent structure, which, in terms of the model of Bock and Levelt (1994), is at the level of positional processing.

Lexical guidance in grammatical encoding

Structural priming studies also revealed the role of lexical information in the formulation of syntactic structure. Pickering and Branigan (1998) found that though structural priming occurs independently of lexical overlap, as found in Bock (1989), there was a boost of the priming effect when the same verb was used. A similar lexical boost was also observed in Cleland and Pickering (2003) for NP expressions.

They found there was a general tendency to use (2.5a) following (2.4a) and to use (2.5b) following (2.4b) when the nouns differed between the prime and the target (e.g., *knife-sheep*). The tendency was enhanced when the two nouns were the same (e.g., *sheep-sheep*) or semantically related (e.g., *goat-sheep*). These results suggest a lexical effect on grammatical encoding.

2.4a. The red sheep/goat/knife.

2.4b. The sheep/goat/knife that's red.

2.5a. The red sheep.

2.5b. The sheep that was red.

A more radical demonstration of the lexical effect was Melinger and Dobel (2005), who found that a German verb that is restricted to only DO use or PO use primed participants to use the corresponding DO or PO structure in their later sentence production. Thus, Melinger and Dobel (2005) suggested that grammatical encoding is lexically-driven rather than frame-based (cf. Wardlow Lane & Ferreira, 2010, for evidence for frame-based grammatical encoding). Furthermore, the study seems to suggest the use of verb argument structure in structural priming. This issue is addressed in Chapter 4.

2.4.3 Conceptual accessibility effects on grammatical encoding

As I reviewed in Section 2.4.1.1, the conceptual structure contains a variety of conceptual information, including definiteness, animacy, information structure and thematic roles. There has been good evidence that grammatical encoding can be influenced by information from conceptualization, though there is debate as to at which level of grammatical encoding these conceptual effects are realized (e.g., Branigan, Pickering, & Tanaka, 2008).

Most studies on conceptual effects focus on whether the accessibility of a concept affects its grammatical function or linear position in a sentence. According to Bock and Warren (1985, p.50), “[c]onceptual accessibility is the ease with which the mental representation of some potential referent can be activated in or retrieved

from memory”. A concept can be more accessible than another either because it has inherent conceptual features that attribute to its high accessibility or because it is rendered by discourse means to be more accessible. Prat-Sala and Branigan (2000, p.169) referred to the first type of conceptual accessibility as *inherent conceptual accessibility*, which is attributable to “intrinsic semantic characteristics, for example animacy, concreteness, and prototypicality”, and to the latter type of conceptual accessibility as *derived conceptual accessibility*, which according to them, is “a temporary property of an entity with respect to a particular nonlinguistic or linguistic context”.

Inherent conceptual accessibility

One of the first demonstrations of inherent conceptual accessibility effects was Bock and Warren (1985), who found that when people mis-recalled the form of a sentence, they tended to misplace the more imageable noun (e.g., *doctor* in 2.6a,b) in a higher grammatical function (e.g., subject) rather than in a lower function (e.g., object). For instance, (2.6b) tended to be more often recalled as (2.6a) rather than the other way round, even when syntactic structure was controlled for. But such an effect was not observed in conjunctions, that is, (2.7b) was not recalled as (2.7a) more often than the other way round. Since the two nouns in a transitive sentence involve different grammatical functions while the two nouns in a phrasal conjunct do not (they differ only in linear order), this is taken as evidence that imageability affects functional processing but not positional processing. It should be noted that the study did not control for animacy effect (e.g., *doctor* and *shock* in 2.6 contrast in animacy but not *winter* and *time* in 2.7).

2.6a. The doctor ministered the shock.

2.6b. The shock was ministered by the doctor.

2.7a. The hiker fought both winter and time.

2.7b. The hiker fought both time and winter.

McDonald, Bock, and Kelly (1993) investigated the animacy effect on grammatical encoding. They found animacy affected the assignment of grammatical functions such that more animate nouns tended to be recalled in a higher rather than lower grammatical function (e.g., *the students were frightened by the sounds* rather than *the sounds frightened the students*). Animacy, however, did not affect the order of elements in a phrasal conjunct (e.g., *the crew and the camera suffered minor injuries*). The study supported previous experimental findings that animacy affects functional processing (e.g., Byrne & Davidson, 1985) and that people tend to bind animacy to grammatical functions across utterances (Bock et al., 1992). Corpus studies also suggest that animacy affects the assignment of grammatical functions in the expression of possession in English (e.g., *the boy's eyes* is preferred over *the eyes of the boy*; e.g., Rosenbach, 2005).

But does animacy also affect word order? Word order and grammatical functions are hard to tease apart in English, as a higher grammatical function (e.g., subject) also tends to appear earlier in the sentence. But they can be teased apart in languages such as Spanish. Prat-Sala and Branigan (2000) found that when Spanish participants used the passive, the subject was more often an animate entity than an inanimate one (e.g., *la mujer fué atropellada por el tren*, literally “the woman was run over by the train”). However, when they produced left-dislocated object sentences (e.g., *a la mujer la atropelló el tren*, literally “the woman, the train ran her over”), the direct object (fronted to the beginning of the sentence) was more often an animate rather than inanimate entity. This strongly indicated that the animacy affects word order.

Branigan and Feleki (1999) tested whether animacy affects word order when grammatical functions were kept constant. For instance, Greek allows both SVO (e.g., 2.8a) and OVS actives (e.g., 2.8b). They found that people were more likely to misrecall a (SVO or OVS) sentence when the effect was to put an animate before an inanimate concept, directly suggesting an animacy effect on word order.

- 2.8a. Sta dimokratika politevmata, o politis sevete to sindagma.
 in democratic regimes the citizen-NOM respects the law-ACC
 In democratic regimes, the citizen respects the law
- 2.8b. Sta dimokratika politevmata, to sindagma sevete o politis.
 in democratic regimes the law-ACC respects the citizen-NOM
 In democratic regimes, the citizen respects the law

Similarly, Tananka, Branigan, and Pickering (submitted) found that Japanese speakers tended to recall an OSV sentence as an SOV sentence when the effect was to place an animate concept before an inanimate concept, independently of grammatical functions. However, the probability of recalling an OSV sentence as an SOV was the greatest when the effect was to place an animate concept at both an early position and the subject position of the sentence, which suggests that animacy has an effect on both word order and function assignment. A recent study found that prototypicality, another factor that contributes to conceptual accessibility, also affects both function assignment and word order (Onishi, Murphy, & Bock, 2008), such that a more prototypical concept of a category (e.g., apple in the category of fruit) tends to be placed both in the subject position and at a earlier position in the sentence than a less prototypical one (e.g., guava). There is also corpus evidence that animacy affects word order independently of grammatical functions in German subordinate clauses (Kempen & Harbusch, 2004). These studies imply that inherent conceptual accessibility seems to affect both functional processing and positional processing.

Derived conceptual accessibility

One way to temporarily manipulate conceptual accessibility is via semantic priming. Bock (1986a) showed that a word that was semantically primed tended to be chosen as the subject rather than the object of a sentence. She had participants describe an event such as a lightning striking a church, which can be described either as (2.9a) or (2.9b). She found participants tended to use (2.9a) following a semantic prime like *thunder* and to use (2.9b) following a semantic prime like *worship*. The results suggest that semantically primed (thus more available) lemmas tend to take a higher grammatical function or an early sentential position.

2.9a. The lightning struck the church.

2.9b. The church was struck by the lightning.

A second way to realize derived conceptual accessibility is by rendering a concept as given information. One such study is Bock and Irwin (1980), who asked participants to recall a sentence they had heard as an answer to a question. They found that people tended to place in an early position a concept which itself (e.g., *cowboy* or *horse* in 2.10a,b) or whose synonym (*Roy Rogers* or *stallion* in 2.10a,b) was mentioned in the question. For instance, there was a tendency to give (2.11a) as an answer to (2.10a) and (2.11b) as an answer to (2.10b). A similar givenness effect was also observed in Prat-Sala and Branigan (2000) and in a corpus study by Bresnan et al. (2007) on the English dative construction.

2.10a. A rancher received an inquiry from a cowboy/Roy Rogers about something he needed for his act. What did the rancher do?

2.10b. A ranger had a horse/stallion who kept running away. What did the ranger do?

2.11a. The ranger sold the cowboy the horse.

2.11b. The ranger sold the horse to the cowboy.

A third way to artificially manipulate conceptual accessibility is by directing the speaker's attention, as in the "fish" studies by Tomlin (1995, 1997). Tomlin showed participants a film of two fish moving toward each other and participants' attention was directed onto one of the fish. When the two fish met, one ate the other. Participants were instructed to describe the event. It was found that the attended fish in most cases was the subject of the sentence. The result was taken as evidence that perceptual attention affects grammatical function assignment.

Again, as these studies focused on English, it was impossible to tell whether the effect was on grammatical functions or word order. Myachykov and Tomlin (2008) used the "fish" study method with Russian speakers. In Russian, word order

can be scrambled in both actives (SVO and OVS) and passives (SOV and OSV) to allow the object to precede the subject when necessary. So in the “fish” study, if focal attention affects word order independently of grammatical functions, then people should scramble word order to put the attended fish before the unattended fish. This is what they found. For instance, when the attended fish was eaten, people tended to use the scrambled OVS sentence; passive sentences were rarely produced. This study suggests that at least in the case of attention, derived conceptual accessibility affects word order.

Summary

To sum up, accessibility factors, both inherent and derived, influence the formulation of syntactic structure. Recent studies on languages other than English have suggested that accessibility factors influence both grammatical functions and word order. For a model of grammatical encoding, these findings imply that if there is a distinction between functional processing and positional processing, the constraints on information flow assumed in Bock and Levelt’s (1994) model should be loosened (e.g., Vigliocco & Hartsuiker, 2002). For instance, it should allow for information from the conceptual structure to directly influence positional processing, as suggested in Branigan et al. (2008). This issue is related to the locus of thematic effects on grammatical encoding, which I will briefly discuss in the following section.

2.4.4 Thematic effects on grammatical encoding

As reviewed above, conceptual information such as animacy and prototypicality affects functional processing and positional processing. But what about other aspects of conceptual information such as thematic information? Though initial evidence suggested a lack of thematic effects on grammatical encoding (e.g., Bock & Loebell, 1990), more recent studies have suggested the opposite. For instance, it has been suggested that there is a hierarchy of thematic roles (e.g., Agent > Experiencer > Theme/Patient, Grimshaw, 1990; cf. Jackendoff, 1972). F. Ferreira (1994) found that in production, people tended to place higher thematic roles such as Agent and Experiencer as the subject more often relative to lower thematic roles such as Patient and Stimulus. Therefore, she found more passive sentences for verbs like *frighten*

(e.g., *the clown was frightened by the waitress*) than for verbs like *kick* and *fear* (e.g., *the clown was kicked/feared by the waitress*), presumably because passives with verbs like *frighten* but not passives with verbs like *kick/fear* assign a higher thematic role to the subject. This study demonstrates that thematic roles can influence the choice of syntactic structure.

The influence of thematic information has also been observed in structural priming (see Chapter 4 for further discussion). For instance, Hare and Goldberg (1999) suggested that the processor chooses a syntactic structure in order to maintain the same thematic ordering between prime and target. Chang, Bock, and Goldberg (2003) argued that the mapping between thematic roles and grammatical functions persists across utterances. Also, it was suggested that the processor perseveres in assigning emphasis to the same thematic roles (Benolet, Hartsuiker, & Pickering, 2009). Thus, though these studies suggest a role of thematic information in grammatical encoding, they disagree over the locus of the effects. The locus of thematic effects in structural priming is investigated in Chapter 4.

2.4.5 Summary

In this section, I first outlined the architecture of sentence production and then focused on grammatical processing. Models differ as to whether syntactic structure is formulated in one or two stages, whether grammatical encoding is lexically guided, and whether there is communication between conceptualization and positional processing. I then reviewed syntactic, conceptual accessibility and thematic effects on grammatical encoding. These studies tend to suggest some evidence of lexical guidance in grammatical encoding and conceptual effects on positional processing. In Chapter 4, I further explore these two issues by examining the role of argument structure in structural priming and the locus of structural priming from thematic information. In the following section, I will consider language comprehension.

2.5 The processing of syntactic structure in language comprehension

Comprehending a sentence involves a series of sub-processes. The processor needs to identify the words in a sentence, put them together into a syntactic structure and

interpret the meaning of the sentence (Of course, these processes may be executed sequentially or simultaneously). In this section, I focus on syntactic parsing, i.e., how the processor assigns a syntactic analysis to a sentence. I follow the assumption laid out in Section 2.2 that syntactic parsing is the construction of a syntactic structure by a processor (which consists of cognitive processes or parsing routines) that utilizes syntactic and possibly non-syntactic information. I first review different models of parsing. Then I consider the use of syntactic and non-syntactic information in syntactic parsing and sentence interpretation.

2.5.1 Syntactic information and modular models

Basically all models of syntactic parsing admit the role of syntax in the guidance of the processor; they differ, however, in the dominance of syntactic information. Modular models assume, in the spirit of modularity of mind (Fodor, 1983), that there is a stage (e.g., the initial analysis of the string) at which syntactic information alone is used. Non-syntactic (e.g., lexical frequency, semantic and contextual) information is used at a later stage to evaluate the appropriateness of the analysis proposed by syntactic information. Though there are many modular models in the literature (e.g., Gorrell, 1997; Pritchett, 1992), the Garden Path theory (e.g., Frazier, 1987) is by far the most influential. In what follows, I only review the Garden Path theory due to space limitations.

The Garden Path theory (e.g., F. Ferreira & Clifton, 1986; Frazier, 1987; Frazier & Fodor, 1978; Rayner et al., 1983) assumes that the processor constructs a syntactic analysis on the basis of lexical category information (N, V, P etc). In case of alternative syntactic analyses, the model stipulates that the processor chooses only one of them according to some syntax-based processing preferences. One of the preferences is Minimal Attachment. It reflects economy in processing and states that the processor, in case of a syntactically ambiguous string, adopts the analysis with the fewest structural nodes. For instance, in (2.12), the verb *examined* can be temporarily analysed as a past-tense main verb (e.g., [_S [_{NP} *the defendant*] [_{VP} *examined*...]]) or a past-participle in a reduced relative clause (e.g., [_{NP} [_{NP} *the defendant*] [_S [_{VP} *examined*...]]]). Minimal Attachment predicts that the processor

prefers the main-verb analysis because it involves fewer nodes than the reduced relative clause analysis.

2.12. The defendant examined by the lawyer turned out to be unreliable.

F. Ferreira and Clifton (1986) provided initial experimental evidence that when reading sentences like those in (2.13), people experienced more difficulty when they came to *by the lawyer* in (2.13a) than in (2.13b), regardless of whether the subject was a plausible (e.g., *defendant*) or implausible (e.g., *evidence*) Agent of the critical verb. These results support the use of Minimal Attachment and suggest that people rely on syntactic information rather than plausibility information. These findings, however, were later challenged by Trueswell et al. (1994). With stronger manipulation of the plausibility between the subject as the Agent and the critical verb, they found that plausibility modulated syntactic parsing: Though people experienced difficulty when the subject was a plausible Agent of the critical verb, such difficulty was eliminated when it was an implausible Agent. A more recent study by Clifton et al. (2003) found that the implausible subject reduced but did not eliminate the difficulty in the reduced relative clause reading.

2.13a. The defendant/evidence examined by the lawyer turned out to be unreliable.

2.13b. The defendant/evidence that was examined by the lawyer turned out to be unreliable.

Minimal Attachment also explains the processing of the ambiguity in (2.14). At the point of the NP *Pam*, the processor can either adopt a object analysis of the NP (the NP as the object of *forgot*, i.e., ..._S *He* [_{VP} *forgot Pam...*]) or adopt a subject analysis by creating an extra S node (i.e., *Pam* as the subject of a forthcoming complement clause, i.e., ..._S *He* [_{VP} *forgot* [_S *Pam...*]). The Garden Path theory predicts that the object analysis will be adopted due to its syntactic simplicity. Some studies confirmed this preference, even with verbs which prefer taking a complement clause rather than a direct object (e.g., *discover*) (e.g., F. Ferreira & Henderson, 1990;

Pickering, Traxler, & Crocker, 2000), while other studies fail to observe the Minimal Attachment effect with such verbs (e.g., Garnsey et al., 1997; Trueswell et al., 1993).

2.14. He forgot Pam needed a ride with him.

Another well-studied parsing preference is Late Closure, which states that when possible, an incoming constituent is attached to an existing constituent. For instance, according to Late Closure, in (2.15), *the socks* is temporarily analysed as the object of *knitting*, not as the subject of the forthcoming main clause. Such a principle guarantees incrementality in sentence processing, i.e., words are incorporated into the sentence as soon as possible (Marslen-Wilson, 1973).

2.15. When Mary was knitting the socks fell onto the floor.

Experimental studies on sentences like (2.15) have indicated that people at first analyse *the socks* as the object of *knitting* and thus experience difficulty when *fell* is processed (Clifton, 1993; F. Ferreira & Henderson, 1991; Frazier & Rayner, 1982; Warner & Glass, 1987). Pickering and Traxler (1998) further investigated whether plausibility affects Late Closure by manipulating the plausibility of the NP in question as the object of the preceding verb (e.g., *as the woman edited/sailed the magazine about fishing amused all the reporters*). They found a Late Closure effect even when the NP was not a plausible object of the verb (e.g., *sailed*), though it was easier for people to reanalyse in the implausible case.

A third preference is the Active Filler Strategy (AFS), which deals with the processing of long-distance dependencies. In (2.16), for instance, *who* is a moved constituent (a filler), whose canonical position (a gap) was supposed to be after the preposition *to*. AFS stipulates that the processor tries to identify a gap for the filler as soon as possible (e.g., Fodor, 1978; Stowe, 1986; cf. Pickering & Barry, 1991), in order to reduce the work load for the processor or in order to achieve incrementality.

2.16. My brother wanted to know who Ruth will bring us home to _ at Christmas.

In summary, the Garden Path theory is a modular model of syntactic parsing: It assumes that the processor builds a syntactic analysis on syntactic category information. Syntactic parsing is guided by a set of parsing preferences. Thus, in case of alternative structural analyses, these preferences help the processor to choose only one of them. The Garden Path theory thus only allows non-syntactic information to affect syntactic processing at a later stage (e.g., Rayner et al., 1983).

2.5.2 Non-syntactic information and interactive models

Interactive models of syntactic parsing take the position that the processor draws upon all possible sources of information simultaneously to evaluate alternative analyses for an ambiguous sentence (MacDonald et al., 1994; Trueswell & Tanenhaus, 1994). Interactive models tend to be lexicalist in that they often assume that syntactic information is projected from lexical items. Thus, they often oppose to the use of syntactic principles. They also assume parallel activations of alternative analyses. These analyses are then evaluated in face of all sources of information. The most supported analysis is then selected. In the following sub-sections, I review empirical studies concerning the use of non-syntactic information.

Lexical and semantic information

A frequently studied lexical issue is verb subcategorization (e.g., transitive vs. intransitive) and the relative frequencies of alternative subcategorizations. Trueswell et al. (1993) (see also Garnsey et al., 1997) used self-paced reading to examine the effect of the relative frequency of alternative subcategorizations of verbs. Note that verbs like *forget* tend to take an NP object while verbs like *hope* tend to take a sentence complement. Trueswell et al. observed that, in (2.17), though the processing of *the solution* was more difficult for both types of verbs when there was no *that*, the difficulty was greater for S-biased verbs. These results suggest that it was more difficult to integrate the NP as the object when the verb preferred a sentence complement. This is confirmed during the reading of *in*: Though the NP-biased condition was much harder to read when there was no *that* than when there was *that* (a typical Late Closure effect), such an effect was absent in the S-bias condition. This

suggests that in the S-bias condition, the NP *the solution* was not integrated as the object of the preceding verb (or the NP was costlessly reanalysed).

2.17a. The student forgot (that) the solution was in the back of the book. (NP-bias)

2.17b. The student hoped (that) the solution was in the back of the book. (S-bias)

Semantic information such as plausibility has also been observed to modulate syntactic ambiguity resolution. For instance, Garnsey et al. (1997) manipulated the plausibility between the critical verb and the post-verb NP (e.g., *regret the decision/reporter*). The Late Closure effect was smaller when the post-verb NP was an implausible object (*regret the reporter*) than when it was a plausible one (*regret the decision*), suggesting that the processor integrates the post-verb NP as an object to a lesser degree when it is implausible. Use of plausibility information was also found in many other studies (e.g., Pickering & Traxler, 1998; Traxler & Pickering, 1996; Trueswell et al., 1994).

Argument structure of the verb has also been found to be used during parsing. Boland et al. (1995) found that participants thought the sentence stopped making sense right at the verb (*visit/remind*) more often in (2.18a) than in (2.18b). This implies that for transitive verbs (e.g., *visit*), people had to attach the implausible *wh*-word as the direct object and thus found the sentence to stop making sense. While for control verbs such as *remind*, people could predict an object position for the *wh*-word at the infinitive clause. These results and others in the study suggest that people make immediate use of argument structure during syntactic parsing.

2.18a. Which prize did the salesman visit while in the city?

2.18b. Which movie did your brother remind to watch the show?

These studies have shown the use of non-syntactic information in parsing. Though it is possible that these findings can be accommodated by the Garden Path theory by arguing that non-syntactic information is employed at a later stage, there

has been evidence that non-syntactic contextual information is employed very early in sentence parsing, an issue I turn to in the following section.

Contextual information

Altmann and Steedman (1988), following Crain and Steedman (1985), proposed that the processor considers alternative analyses and selects one that is contextually supported. They showed evidence that the interpretation of the syntactically ambiguous phrase such like *blow open the safe with dynamite* depends on the context: When there is more than one safe, people tend to interpret the PP *with the dynamite* as modifying *the safe* (so that it is clear which safe is blown open), but when there is only one safe, the PP tends to be interpreted as modifying the VP. More recently, studies on contextual effect use the visual world paradigm, where participants listen to a sentence while their looks at a scene are recorded. Studies have suggested that people immediately use visual information to disambiguate sentences (e.g., Chambers et al., 2004; Spivey et al., 2002; Tanenhaus et al., 1995). Tanenhaus et al. (1995) had participants listen to instructions such as *put the apple on the towel in the box*, where *the towel* is temporarily ambiguous between a Goal interpretation (i.e., the goal of the putting action) and a Location interpretation (i.e., the place where the apple is). When the scene contained an apple on a towel, an empty towel, a box and a pen, participants tended to look at the empty towel, suggesting people mis-interpreted the PP *on the towel* as a Goal. However, when the pen was replaced with an apple on a napkin (thus there were two apples), people tended *not* to look at the empty towel after the instruction *put the apple on the towel in the box*, suggesting people had the Location interpretation for the PP. The rapid use of visual world information was also observed in Altmann and Kamide (1999), who found that when a participant heard a sentence fragment such as *the boy will eat...*, his eyes were immediately directed to edible objects in the visual scene (e.g., a cake).

These studies suggest that contextual information not only affects syntactic parsing, but it also exerts its effect at a very early stage. If this is correct, it falsifies the position that the initial stage of syntactic parsing uses only syntactic information. However, it should be noted that putting participants in a visual context may

artificially exaggerate the effect of context and participants may strategically use visual information to guide the parsing/interpretation of a sentence.

Frequency information

In this section, I focus instead on the effect of syntactic construction frequency on parsing. Many studies examine the parsing of relative clause attachment as in (2.19). The relative clause at the end of the sentence can be interpreted as modifying the high NP (*the daughter*) (i.e., high attachment) or the low NP (*the colonel*) (i.e., low attachment). Late Closure predicts that low attachment is the preferred analysis. Cuetos and Mitchell (1988) found that though low attachment is preferred in English, high attachment is preferred in Spanish. Follow-up studies have indicated cross-linguistic differences in relative clause attachment (see Papadopoulou, 2006, for a review).

2.19. The journalist interviewed the daughter of the colonel who had the accident.

Mitchell and colleagues (Mitchell & Cuetos, 1991; Mitchell et al., 1992, 1995) proposed that these cross-linguistic processing preferences reflect comprehenders' past experience with relative clause attachment in a language. On this account, when a relative clause can be attached in more ways, people resolve the ambiguity on the basis of such frequency information. For instance, English speakers prefer high attachment because high attachment is more common in the language. However, frequency accounts have been criticized for their frequency counts (e.g., Desmet, Brysbaert, & De Baecke, 2002). Also, it is unknown as to what causes the frequency distribution in the first place – it is possible that one attachment is more frequent simply because it conforms to some production or comprehension preference of the language processing mechanism.

2.5.3 Structural complexity and cognitive factors

Another line of parsing research asks the question why some grammatical and unambiguous sentences are very hard to understand (e.g., Chomsky & Miller, 1963; Yngve, 1960). One example is in (2.20).

2.20. The administrator who the intern who the nurse supervised had bothered lost the medical reports.

Gibson (1998) proposed the Syntactic Prediction Locality Theory (SPLT). According to SPLT, parsing difficulty involves both storage cost (the need to keep track of incomplete syntactic dependencies) and integration cost (which is in proportion to the discourse entities that intervene between the two elements to be attached). In (2.20), both costs are high: For instance, at *the nurse*, there are 3 incomplete dependencies (which are related to storage cost); at *bothered*, the processor needs to integrate the verb with the far-away subject *the intern* and the far-away object *the administrator* (these are related to integration cost).

An alternative account for the difficulty for (2.20) is the interference-based account proposed by Gordon and colleagues (Gordon, Hendrick, & Johnson, 2001, 2004; Gordon, Hendrick, & Levine, 2002). According to this account, the difficulty in (2.20) arises from the difficulty/failure to retrieve the relevant NPs due to interference when a verb is processed. For instance, the processor will probably fail to retrieve the subject and object for the verb *bothered* due to both the similarity of the NPs (all descriptions) and the distance between the verb and its dependents.

The two accounts seem to have their own support. On the one hand, there is evidence that the accessibility properties of discourse entities in the attachment path affect sentence complexity such that sentences were rated less complex when the intervening discourse entity was more accessible (e.g., *the reporter*) than when it was less accessible (e.g., *a reporter*) (Warren & Gibson, 2002). On the other hand, some studies have suggested the role of similarity interference in the processing of embedded sentences (Gordon et al., 2001; Warren & Gibson, 2005).

2.5.4 Use of syntactic and non-syntactic information in syntactic parsing

To what extent is syntactic parsing guided by syntactic information? According to the Garden Path theory (Frazier, 1987) and some interactive models (e.g., Altmann & Steedman, 1988), syntax provides possible analyses for the processor to choose from. On these accounts, a sentence is parsed entirely on the basis of syntactic information. Other interactive models, however, assume that both syntax and non-syntactic information can propose syntactic analyses and the choice or choices are made on the basis of competition (e.g., MacDonald et al., 1994; Trueswell & Tanenhaus, 1994). On these models, when non-syntactic information takes over the processor, the processor may construct an analysis inconsistent with the syntax in a sentence.

There is evidence that the processor actively uses syntactic information provided by the grammar. In (2.21a), for instance, *the school* cannot be moved out from the object position of *expand* (e.g., Chomsky, 1973), unless there is another gap for *the school* (e.g., Culicover & Postal, 2001). Thus, syntax in English dictates that a gap can be created inside the island as long as an additional gap is predicted. English syntax, however, prohibits the creation of a gap after *expanded* for *which schools* when the embedded clause is finite (e.g., 2.21b).

2.21a. The school superintendent learned which schools the proposal to expand _ drastically and innovatively upon the current curriculum would overburden _ during the following semester.

2.21b. The school superintendent learned which schools the proposal that expanded _ drastically and innovatively upon the current curriculum would overburden _ during the following semester.

Phillips (2006) investigated whether the processor can employ these fine grammatical representations during parsing. He observed a plausibility effect in (2.21a) but not in (2.21b) when *which schools* in (2.21a,b) was replaced with *which school students* (thus there was a semantic anomaly between *to expand/expanded* and *which school students*), suggesting that the processor can follow every nuance of grammatical information and posit a gap within an island but not in a finite clause, as dictated by syntax (see also Traxler & Pickering, 1996, for a similar conclusion).

There are, however, more studies attesting that the processor constructs analyses that are incompatible with the syntactic information in the sentence. Gibson and Thomas (1999) found that the doubly embedded sentence in (2.22) was more acceptable when one of the three (incomplete) VPs at the end of the sentence was deleted than when all of them were available. Such a result, however, may only suggest that the processor fails to construct a representation for the doubly embedded sentence due to high memory load (Gibson, 1998) or interference (Gordon et al., 2001).

2.22. The ancient manuscript that the graduate student who the new card catalog had confused a great deal was studying in the library was missing a page.

Tabor et al. (2004), however, showed that the processor constructs a globally inconsistent analysis even when there is no high memory load. They presented sentences like (2.23) to participants. Note that in (2.23a), it is possible to locally interpret *the player* as the subject for *tossed* but not for *thrown*. No such locally coherent analysis is possible in (2.23b). Tabor et al. found that people experienced more difficulty at *tossed/thrown a frisbee* in the reduced relative clause than in the full relative clause, reflecting a typical garden path effect. More interestingly, Tabor et al. found the difficulty associated with *tossed* was greater than that associated with *thrown*, suggesting that people constructed a locally coherent but globally inconsistent subject-verb-object analysis for *the player tossed a frisbee* (see Gibson, 2006, for an alternative account).

2.23a. The coach smiled at the player tossed/thrown a frisbee by the opposing team.

2.23b. The coach smiled at the player who was tossed/thrown a frisbee by the opposing team.

F. Ferreira (2003) also found that when participants were asked to identify the Agent or Patient of a sentence, they sometimes misinterpreted even very simple

sentences, especially when they were implausible passives such as *the dog was bitten by the man*. This and other findings in the study suggest that participants might be using parsing heuristics to treat N-V-N string as an Agent-Action-Patient semantic relation. The study suggests that the processor does not always follow syntactic proposals. Similar results using a paraphrasing task were also observed in Patson, Darowski, Moon, and Ferreira (2009).

These studies seem to suggest that the processor may not always select an analysis among those proposed by the syntax in the sentence. Instead, the processor may turn to certain sources of information and ignore others in its parsing, as demonstrated in Tabor et al. (2004) and the processor may have its own semantics-syntax mapping preferences, as shown by F. Ferreira (2003). Some ERP studies also suggest that people may construct syntactic analyses according to semantic information rather than syntactic information in a sentence (Kim & Osterhout, 2005; Van Herten, Kolk, & Chwilla, 2005). These results are consistent with some interactive models that assume the use of non-syntactic information in parsing.

2.5.5 Use of syntactic and non-syntactic information in sentence interpretation

To what extent is sentence interpretation mediated by syntax? Researchers have explored coreference processing (i.e., the interpretation of anaphoric expressions such as pronouns and ellipsis) to determine the extent to which syntax dictates the interpretations of these referential expressions. Take for instance the interpretation of pronominal expressions. If interpretation is based on syntactic analysis, then the search for the antecedent of a pronominal expression should follow the prescription of syntax, for instance, the binding theory as proposed in the GB framework (e.g., Chomsky, 1981).

Nicol and Swinney (1989) used a cross-modal priming paradigm to tap into the activation of NPs at the reflexive and pronoun sites (see 2.24). They found priming from DOCTOR at the PROBE position in (2.24a) but not from either BOXER or SKIER, just as the binding theory predicts. In (2.24b), Nicol and Swinney found priming from both BOXER and SKIER, but not DOCTOR, again as the binding theory predicts. This study suggests that the processor only activates structurally legitimate antecedents for reflexives and pronouns.

2.24a. The boxer told the skier that the doctor for the team would blame himself (PROBE) for the recent injury.

2.24b. The boxer told the skier that the doctor for the team would blame him (PROBE) for the recent injury.

Using self-paced reading, Clifton, Kennison, and Albrecht (1997) examined the processing of the sentences in (2.25). In (2.25a), the subject (*the supervisor[s]*), according to the binding theory, cannot be the antecedent of *him*, but in (2.25b), the subject is permitted by the binding theory to be the antecedent of *his*; however, due to number mismatch, only *the supervisor* can be the antecedent. Clifton et al. reasoned that if the processor only searches space specified by the binding theory, then *supervisor(s)* should be considered as a possible antecedent in (2.25b) but not in (2.25a). Thus, when the subject is plural, there should be a mismatch effect (i.e., longer reading times for the pronoun when the subject was plural) in (2.25b) only. The results confirmed their predictions.

2.25a. The supervisor(s) paid him yesterday to finish typing the manuscript.

2.25b. The supervisor(s) paid his assistant yesterday to finish typing the manuscript.

Other studies, however, found evidence that the processor also considers antecedent candidates that are syntactically disallowed. Bedecker and Straub (2002) used self-paced reading to investigate the effect of an inaccessible NP (*Bill/Beth* in 2.26) on the processing of pronouns. In (2.26a), the grammatically allowed (i.e., accessible) antecedent NP *John* matches in gender with the pronoun, while in (2.26b), it (*Jane*) does not. Bedecker and Straub found that in (2.26a), people slowed down when the inaccessible NP was *Bill*, suggesting people hesitated whether to identify *him* with *John* or *Bill*. This further suggests that the processor also considered candidates that were grammatically disallowed. Similar results were observed with reciprocals (e.g., *each other*). Bedecker and Straub (2002) proposed that the

processor employs all sources of information in the identification of the antecedent of an anaphoric expression.

2.26a. John thought that Bill/Beth owed him another chance to solve the problem.

2.26b. Jane thought that Bill/Beth owed him another chance to solve the problem.

The use of non-syntactic information in pronominal interpretation was also observed by Runner, Sussman, and Tanenhaus (2003). They asked participants to listen to a simple instruction such as *Look at Ken. Have Ken touch Harry's picture of him/himself* and then act out the instruction with toys. According to the binding theory, *him* can only refer to *Ken*, while *himself* can only refer to *Harry*. Runner et al. found that although people on most cases chose *Ken* as the antecedent of *him*, they did not consistently choose *Harry* as the antecedent of *himself*.

Sturt (2003) reasoned that the results in Bedecker and Straub (2002) may be a product of the use of both binding theory and other factors. More specifically, Sturt argued that the processor only consults the binding theory at the initial stage of processing and may later be influenced by other factors. He used eyetracking to investigate the parsing of sentences in (2.27). Grammatically, *the surgeon* is an accessible NP for the reflexive *himself/herself*, while *Jonathan/Jennifer* (and the corresponding *he/she*) are inaccessible NPs. If the binding theory is used and used early during parsing, there should a main effect of match of the accessible NP (i.e., difficulty for sentences with mismatched accessible NP) and such an effect should be captured in measures that reflect early processing (e.g., first pass times). If the processor goes beyond syntax at a later stage, there should be a main effect of match of the inaccessible NP captured in measures that reflect later processing (e.g., second pass times). These predictions were confirmed.

2.27a. Jonathan/Jennifer was pretty worried at the City Hospital. He/she remembered that the surgeon had pricked himself with a used syringe needle. There should be an investigation soon.

2.27b. Jonathan/Jennifer was pretty worried at the City Hospital. He/she remembered that the surgeon had pricked herself with a used syringe needle. There should be an investigation soon.

The study by Sturt (2003) shows that the processor searches for an antecedent in space specified by grammar at least at the initial stage of processing, though non-syntactic information fills in soon afterwards. However, it is yet to be explored whether such a conclusion applies only to reflexives or also to other anaphoric expressions such as VP ellipsis. In fact, research on other types of anaphoric expressions such as verb-phrase (VP) ellipsis has yielded conflicting results concerning the use of syntactic information in sentence interpretation. I will return to this issue in Chapter 5.

2.5.6 Summary

In this section, I reviewed different models of syntactic processing and related empirical studies. Overall, there have been myriad studies that attested the use of non-syntactic information such as lexical frequency, plausibility and contextual information, though the time course of the application of these sources of information is still debated. I then reviewed studies on the extent the syntactic analysis is guided by syntactic information. Many studies have suggested that the processor may use non-syntactic information in the construction of an analysis. In sentence interpretation, syntax seems to guide the search for an antecedent for a pronominal expression at an early stage but non-syntactic information comes into play subsequently. In order to further investigate the extent syntax mediates parsing and interpretation, I investigate the processing and interpretation of VP ellipsis in Chapter 5.

2.6 Bilingual syntactic representation and processing

Do bilinguals represent and process linguistic information differently from monolinguals? One straightforward answer would be no: Except for the fact that they use two languages, bilinguals speak and comprehend each language in the same way monolinguals do. Such an answer would be a bit simplistic on at least two grounds. First, it would be quite cognitively expensive to assume that bilinguals store all their semantic, syntactic, lexical and phonological representations separately for the two languages. Second, there may be interactions (i.e., information flow) at every linguistic level between the two linguistic systems even if they were separately represented. Thus, the representational relationship between a bilingual's two linguistic systems has been a central topic for psycholinguistic investigations of bilingualism (Kroll & Tokowicz, 2005) and can help account for discrepancies between bilinguals and monolinguals in language production and comprehension.

In this section, I first review bilingual semantic representations in bilinguals, the organization of the bilingual lexicon and finally syntactic representation and processing in bilinguals. I take a broad definition of bilingualism, including both balanced bilinguals (i.e., people equally highly proficient in both languages) and unbalanced ones (i.e., people more proficient in one language than in the other), and both early bilinguals (i.e., people who have learnt both languages as first languages or L1s) and late bilinguals (i.e., people who learnt one of the languages as a second language or L2).

2.6.1 Bilingual semantic representation and processing

Semantic or conceptual representations (or memories) refer to linguistic meanings (meanings and concepts that are verbally labelled). Most current models of bilingualism assume a single system of semantic representation (e.g., Costa, Miozzo, & Caramazza, 1999; Kroll & Shoh, 1992; Potter et al., 1984). Empirical studies have also pointed to a single system of semantic representations (see Francis, 1999; 2005, for reviews). Several lines of studies are relevant here. First, lexical decisions can be facilitated with a semantic prime of the same language, because the meaning of the prime activated the meaning of the target (Collins & Loftus, 1975), thus facilitating

lexical naming/decision. It has been found that when the semantic prime is in a different language, a similar priming effect is also observed (e.g., De Groot & Nas, 1991; Kirsner, Smith, Lockhart, King, & Jain, 1984), suggesting a common store of semantic representations in both languages.

A second line of evidence comes from studies on lexical interference such as Stroop effects (e.g., the naming of the colour of the word *red* in green is slowed) and picture-word interference (for instance, the interference caused by an accompanying word *sheep* when naming of picture of a goat). In both cases, the interference is presumed to arise from semantic representations. Cross-language Stroop tasks (i.e., using Language A to name the colour of a word of Language B) and cross-language picture-word interference tasks (i.e., using Language A to name a picture accompanied by a word of Language B) show reduced but reliable effects (e.g., Preston & Lambert, 1969; Smith & Kirsner, 1982), suggesting again a common semantic system for the two languages.

A third line of evidence for common semantic representations comes from findings that lexical access is facilitated if the target is presented immediately after its translation equivalent (e.g., Chen & Ng, 1989; Gollan, Forster, & Frost, 1997). Also, it has been shown that translation equivalents also result in an effect similar to the within-language repetition blindness effect (i.e., the failure for people to encode or retrieve the second occurrence of a repeated word in a sentence or list; e.g., Kanwisher, 1987) (e.g., MacKay & Miller, 1994; Sanchez-Casa, Davis, & Garcia-Albea, 1992).

There are, however, also studies that suggest language-specific semantic representations. Using a semantic rating task, Tokowicz, Kroll, De Groot, and Van Hell (2002) found that Dutch-English bilinguals rated translation equivalents of concrete concepts more semantically similar than those of abstract concepts. These findings are consistent with the proposal in Van Hell and De Groot (1998; see also De Groot, 1992) that semantic representations for concrete words are shared across languages while those for abstract words may only be partly shared. These findings, however, do not suggest that there are two language-specific semantic stores; they rather imply that concepts are better characterized as bunches of features which are shared to a better extent for concrete words than for abstract words between

languages. Thus, in this thesis, I assume a common store of semantic representations for bilinguals.

2.6.2 Semantic representations and the bilingual lexicon

Following common assumptions in both monolingual (e.g., Levelt et al., 1999) and bilingual (e.g., Kroll & Stewart, 1994) models of the lexicon, I assume distinct semantic and lexical representations. In face of a common semantic representation system and different lexical systems in a bilingual, the question is how the two lexical systems are linked to the common semantic system. For (early) balanced bilinguals, it can be imagined that both lexical systems are directly linked to the semantic system. Supporting such a model, Potter et al. (1984) found that proficient Chinese-English bilinguals took similar times to translate Chinese words into English and to describe pictures in English; thus they concluded that English words are not associated to Chinese words but directly connected to semantic representations (see Kroll & Curley, 1988, for similar results).

But what about unbalanced bilinguals? Kroll and Stewart (1994) proposed a developmental model called the Revised Hierarchical Model (see Figure 2.6) for unbalanced bilinguals. In the model, both lexical systems are linked to the semantic system. The link between L1 and semantics is, however, stronger than that between L2 and semantics. There are also lexical links between translation equivalents, with stronger links from L2 to L1.

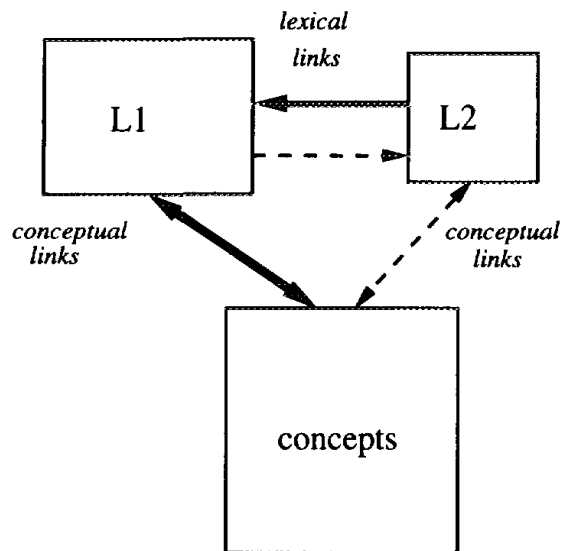

Figure 2.6: The Revised Hierarchical Model, taken from Kroll and Stewart (1994, p.158)

Many findings have supported predictions of the model. One prediction is that L1-L2 translation is more likely to be done via semantic representations while L2-L1 translation is more likely to occur via word association. Kroll and Stewart (1994) found that when source words (words to be translated) were clustered in semantic categories (e.g., names of fruit), relatively proficient Dutch-English bilinguals were affected (i.e., slower) in L1-L2 translation but not in L2-L1 translation, suggesting that L1-L2 but not L2-L1 translation is mediated by semantic representations. Kroll, Michael, Tokowicz, and Dufour (2002) found that though translation direction did not matter for high-proficiency bilinguals, low-proficiency bilinguals showed slower translation from L1 to L2 than from L2 to L1.

Another prediction of the model is that, in processing L2 words, less proficient bilinguals rely on lexical association with L1 equivalents while more proficient bilinguals rely on semantic representations. This is confirmed in Talamas, Kroll, and Dufour (1999), who asked English learners of Spanish and Spanish learners of English to determine whether English-Spanish word pairs were translation equivalents. They found that, relative to a control condition, proficient bilinguals were slower to reject lexical pairs as translation equivalents when the English word was paired with a Spanish word that was semantically related to the English word's Spanish equivalent. This suggests that translation was mediated by

semantic representations. Less proficient bilinguals, on the contrary, were slower to reject pairs where the English word was paired with a Spanish word that was orthographically related to the English word's Spanish equivalent, a manifestation of word-association translation. Similar orthography-related slowdown was observed in Spanish-English low-proficiency bilinguals (Sunderman, 2002).

There is, however, also evidence against the Revised Hierarchical Model. De Groot and Poot (1997) manipulated the concreteness of the target word in translation (e.g., *table* vs. *beauty*). Such a manipulation was supposed to be a semantic one and would therefore, according to the Revised Hierarchical Model, only affect low-proficiency bilinguals and L1-L2 translations. Contrary to the prediction, De Groot and Poot observed concreteness effects at all three proficiency levels and in both translation directions. Moreover, Altarriba and Mathis (1997) found a Stroop effect in beginning learners of Spanish who had only mastered some colour words. The result suggests that these learners had direct access to the meaning of these L2 words despite their low proficiency in L2. Some studies also yielded conflicting results. Sholl, Sankaranarayanan, and Kroll (1995) found that a concept that had been previously activated (by picture naming) facilitated L1-L2 translation (involving words of the previously activated concept) but not L2-L1 translation, as predicted by the Revised Hierarchical Model. However, a subsequent study by La Heij, Kerling, and Van der Velden (1996) found that the activated concept facilitated both directions of translation.

Whether and to what extent the L2 lexicon is associated with the L1 lexicon is still being researched. As acknowledged by Kroll and Tokowicz (2005), we may have to consider both overall proficiency and the familiarity with individual words in the understanding of the relationship among semantic representations and the two lexicons. One scenario is that the Revised Hierarchical Model holds generally, but very familiar L2 words are directly linked to semantic representations rather via L1 words, regardless of proficiency.

2.6.3 Bilingual lexical representation and processing

Following Levelt et al. (1999), research on bilingual lexical representation acknowledges a distinction between a lemma stratum that represents lexico-syntactic

information and a lexeme stratum that represents word-form information (e.g., Kroll & Tokowicz, 2005). Several key questions need to be resolved in order to understand how bilingual lexical information is represented. I first briefly review empirical studies on these questions and then consider their implications for a model of bilingual lexical representation and processing.

First, is lexical access language-selective or language-nonselective? In other words, does the activation of a word in language A activate related words in language B? Studies on *interlingual homographs* (words that are similar in form but different in meaning in two languages, such as *room* in English and Dutch) and *cognates* (words that are both similar in form and meaning, such as *water* in English and Dutch) have largely come up with evidence for the language-nonselective view (e.g., Brysbaert et al., 1999; De Moor, 1998; Sanchez-Casas et al., 1992; cf. Gerard & Scarborough, 1989). For instance, De Moor (1998) found that, in Dutch-English bilinguals, the English word *brand* facilitated the English word *fire*, whose Dutch equivalent is *brand*, suggesting some activation of the Dutch word *brand* when the English *brand* was processed. A recent study by Thierry and Wu (2007) found fMRI evidence that even in a completely English context, Chinese-English speakers activated orthographic information of Chinese translations of English target words. The language-nonselective view was also supported in bilingual lexical production. Hermans et al. (1998) observed interference from the English word *bench* when Dutch-English bilinguals were naming a picture of a mountain in English. As *bench* was phonologically similar to the Dutch word *berg* (“mountain”), the finding suggests that *berg* was activated during lemma selection (as the interference was only observed at SOA 0 ms, see Schriefers et al., 1990). These findings for language-nonselective access have at least two implications for bilingual lexical representation and processing. First, it suggests that lexical items in the non-response language are not totally inhibited. Second, priming of interlingual homographs and lexical neighbours suggests that lexical features may be shared, at least between languages that are phonologically/orthographically similar.

The second question concerns whether translation equivalents, especially cognates, are represented as the same or different lemmas. For instance, assuming that the English *water* and the Dutch *water* are represented by a single semantic

representation, it is possible to have two separate lemmas for the two words, in which case cognates are distinguished at the lemma level. Alternatively, the two words can share the same lemma representation and have different lexemes, in which case they are distinguished at the lexeme level. Current models of bilingual lexical representation are quite underspecified in terms of the lemma representation for cognates. For instance, Sanchez-Casas and Garcia-Albea (2005) argued that the distributed lexical/conceptual feature model of Kroll and De Groot (1997, see Figure 2.7) is compatible with both a same-lemma representation account of cognates and a separate-lemma representation account. The bilingual interactive model of Dijkstra and Van Heuven (1998) does not specify a lemma stratum, but it seems to favour a same-lemma representation for cognates (see Sanchez-Casas and Garcia-Albea, 2005). The question is also empirically under-explored. One relevant study is by Schoonbaert et al. (2007) who investigated the representation of translation equivalents in general and found that Dutch-English bilinguals may represent translation equivalents as distinct rather than the same lemmas; however, it remains to be investigated whether this can apply to cognates. I take up this issue in Chapter 6.

The third question relates to the representation of lexico-syntactic information such as lexical category, argument structure, grammatical gender and grammatical number. For instance, do bilinguals of languages that have similar gender systems (e.g., Italian and French) represent gender information of the two languages jointly or separately? Costa et al. (2003) did not find any evidence for shared representations of gender information. For instance, they asked highly proficient Croatian-Italian bilinguals and Italian monolinguals to name pictures in Italian. The Italian names for the pictures were either congruent or incongruent with the Croatian names in gender. They reasoned that if gender information was shared, there should be facilitation when picture names of the two languages were congruent in gender. They found that relative to monolinguals, the bilinguals did not gain from gender congruence in terms of either naming latency or error rates. Similar results were obtained in Catalan-Spanish bilinguals, Spanish-Catalan bilinguals and Italian-French bilinguals. However, using a similar design, Bordag (2004, 2006) found a facilitation effect when the picture names were congruent in gender between the two languages (reported in Bordag & Pechmann, 2007). Further evidence for shared representations

of gender information was found in Bordag and Pechmann (2007), who investigated bilinguals of Czech and German (in both language adjectives agree with nouns in gender) and found that in both bare noun productions and adjective + noun productions, pictures whose names had different genders across the two languages took longer to name. Perhaps the most compelling evidence for the shared representation of lexico-syntactic information between languages comes from between language structural priming studies (Hartsuiker et al., 2004; Loebell & Bock, 2001; Schoonbaert et al., 2007), an issue which I will return to in Chapter 6.

Findings concerning the three questions reviewed above can help us discriminate models of bilingual lexical representation. I will use the distributed lexical/conceptual feature model (Kroll & De Groot, 1997, see Figure 2.7) as an example. First, in terms of lexeme representation, the model assumes that translation equivalents share lexical features to an extent proportional to their lexeme similarity. These shared lexeme features account for the language-nonselctivity in lexical access. Second, in terms of lemma representation, the model assumes separate lemma representations for translation equivalents, though the lemma representation of cognates is not specified in the model (see Sanchez-Casas & Garcia-Albea, 2005, for some discussion; see also Chapter 6 for more discussion). Third, the distributed lexical/conceptual feature model assumes language-specific lexico-syntactic representations, which is quite inconsistent with the findings that lexico-syntactic information is collectively represented across languages. An empirically more compatible alternative is proposed in a bilingual model in Hartsuiker et al. (2004), which mainly differs from the distributed lexical/conceptual feature model in assuming shared representations of lexico-syntactic information such as lexical category, subcategorization, grammatical gender and grammatical number.

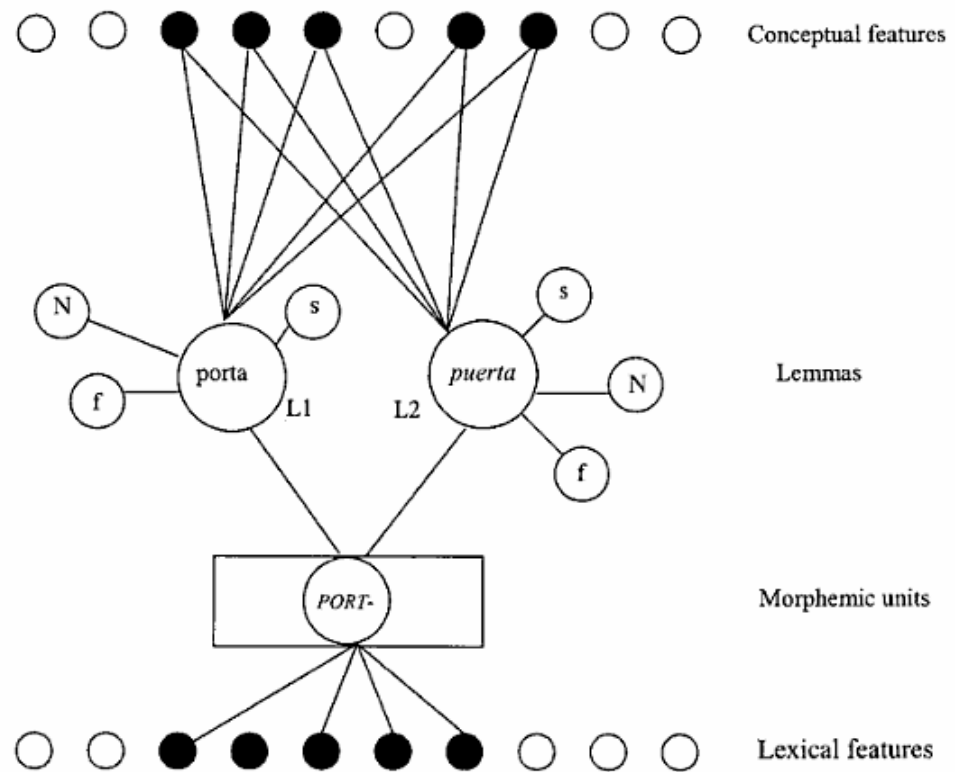

Figure 2.7: An illustration of bilingual lexical representation in the distributed lexical/conceptual feature model, with the assumption that cognates have different lemma representations (adapted from Sanchez-Casas and Garcia-Albea, 2005). The words *porta* and *puerta* are Catalan and Spanish cognates for “door”. L1 = first language, L2 = second language, N = noun, s = singular, f = feminine.

2.6.4 Bilingual syntactic representation and processing

Research on bilingual syntactic representation and processing often asks whether bilinguals compute syntactic representations as monolinguals do. Clahsen and Felser (2006) presented studies that indicate that late bilinguals do not compute native-like syntactic representations in their L2 sentence comprehension. Papadopoulou and Clahsen (2003) examined the processing of relative clause attachment in L2 Greek by Spanish-Greek, German-Greek and Russian-Greek bilinguals. Monolinguals of Greek, Spanish, German and Russian had been found to prefer high attachment, but Papadopoulou and Clahsen failed to find an attachment preference in L2 Greek for these bilinguals. They argued that the absence of native-like parsing preferences was

not a product of cross-linguistic influences, as all the learners' L1s have the same high attachment preference as Greek does. Late bilinguals are also found to process unbounded dependencies in their L2 differently from native speakers. Gibson and Warren (2004) found that it was easier for native speakers of English to retrieve the filler at the gap when there was an intermediate landing site for a filler (as in 2.28a, i.e., e_i after *claimed*) than when there was not (as in 2.28b). Marinis et al. (2005) asked whether the intermediate gap was also used by learners of English. They tested Chinese, Japanese, German and Greek learners of English and native speakers of English. As found in Gibson and Warren (2004), the intermediate gap in (2.28a) made it easier to retrieve the filler at the gap position for native speakers, but not for the learners, regardless of their L1s, suggesting that these learners did not employ syntactic representations to the extent native speakers did. These and other studies led Clahsen and Felser (2006) to argue that L2 syntactic representations are shallow.

2.28a. The manager who_i the consultant claimed e_i that the new proposal had pleased e_i will hire five workers tomorrow.

2.28b. The manager who_i the consultant's claim about the new proposal had pleased e_i will hire five workers tomorrow.

Non-native speakers, however, have been shown to be able to use less complicated syntactic representations such as argument structure. For instance, there is evidence that non-native speakers experience garden path sentences such as reduced relative clauses as native speakers do (e.g. Juffs, 1998), indicating that they are able to employ processing preferences such as Minimal Attachment (e.g., F. Ferreira & Clifton, 1986) or they are sensitive to frequency of active/passive use of the verb (e.g., MacDonald et al., 1994). Juffs and Harrington (1996) investigated the processing of sentences like *after Bill drank the water proved to be poison*, and found a Late Closure effect in non-native speakers similar to that observed with native speakers. These results all together suggest that non-native speakers compute some syntactic representations such as argument structure in a similar way as native speakers do, but not syntactically complex ones (e.g., intermediate gaps in Marinis et al., 2005).

More direct evidence of non-nativeness of late bilinguals comes from L2/L1 discrepancies in language production. That is, L2 speakers tend to fail to correctly produce certain morphological markings, such as the finiteness of verbs in French for German learners (e.g., Prévost & White, 2000) and tense and subject-verb agreement markings in English for Chinese learners (e.g., Lardiere, 1998a, 1998b). For instance, it is common for Chinese learners to produce sentences such as *Bill eat a cake yesterday* and *Bill like cakes*. Jiang (2004) found that Chinese learners were not sensitive to broken agreement in comprehension (e.g., *the key to the cabinets was rusty from many years of disuse*), though native speakers were. These findings have led to debates whether these L2 learners have deficits in the syntactic representation and processing or morphological processing (see Franceschina, 2001, for a review).

So what implications do these findings concerning the non-native syntactic representations in late bilinguals' L2 have for a model of bilingual syntactic representation and processing? De Bot (1992), on the basis of the production model in Levelt (1989), proposed a bilingual production model where a bilingual's two languages share the same lexicon (including lexico-syntactic representations) in proportion to the degree of similarity between the two languages, but they have separate processors. According to this model, non-native syntactic representation can be due to incompleteness in L2 lexico-syntactic representations or due to the malfunctioning of the L2 processor.

Ullman (2001) proposed that first language acquisition involves the encoding of lexical information in declarative memory and grammar in procedural memory. He argued that, as procedural learning fades with age, late bilinguals tend to encode grammatical knowledge in declarative memory. Thus, according to Ullman, non-nativeness in L2 processing is a result of the fact that L2 syntactic representations and some cognitive processes in the L2 processor (such as subject-verb agreement) are encoded in declarative (but not procedural) memory. A similar argument was endorsed in Clahsen and Felser (2006), who argued that (late) bilinguals compute shallower syntactic representations than monolinguals.

Different from the above accounts, Hartsuiker and Pickering (2008) attempted instead to account for the findings that syntactic processing in one language affects that in the other language. They proposed that cross-language

structural priming occurs because syntactic representations are shared for constructions that are similar across the languages. For instance, Dutch and English share representation for the double-object dative construction. But again, it is unknown whether non-native syntactic computation such as subject-verb agreement errors is a result of non-native lexico-syntactic representation (e.g., under-specification of grammatical number in L2 English) or failure on the part of the processor.

2.6.5 Summary

In summary, I reviewed bilingual semantic representations, the bilingual lexicon and bilingual syntactic representation and processing. I also identified two questions that I will further investigate in Chapter 6, that is, whether cognates have the same or different lemma representations and how syntactic information is represented in bilinguals. These may help answer the question concerning the non-native syntactic representation and processing in late bilinguals' L2.

2.7 Structural priming

2.7.1 The phenomenon of structural priming

Structural priming refers to the tendency for people to re-use syntactic structures that they have recently processed. For instance, if people have previously used an active transitive (rather than a passive transitive) or a DO dative (rather than a PO dative), they tend to use the same structure in subsequent utterances (Bock, 1986b). Such a tendency has been repeatedly observed in later studies (see Pickering & Ferreira, 2008, for a review).

There is good evidence that structural priming mainly reflects the persistence of constituent structure rather than lexical or thematic information or prosodic contour. Bock (1989) showed that structural priming does not depend on the repetition of closed-class words such as prepositions. A PO sentence with the preposition *for* (2.29a) primed PO responses as effectively as a PO sentence with the preposition *to* (2.29b).

2.29a. The secretary was baking a cake for her boss.

2.29b. The secretary was taking a cake to her boss.

Pickering and Branigan (1998) found that verb inflections did not affect the magnitude of structural priming; that is, a dative sentence (DO or PO) primed similarly no matter whether the verb form (e.g., *shows, show, showed, is showing*) was the same or different between the prime and the target. Furthermore, Bock and Loebell (1990) found that structural priming does not depend on the repetition of thematic roles. A sentence like (2.30a) where *the church* acts as a Goal and a PO dative like (2.30b) where *the church* acts as a Recipient priming PO responses to a similar extent. Furthermore, they found that a sentence (e.g., 2.31a) that has the same prosodic contour like that of a PO sentence (e.g., 2.31b) does not prime PO responses, which suggests that prosody is not likely to be the cause of structural priming.

2.30a. The wealthy widow drove an old Mercedes to the church.

2.30b. The wealthy widow gave an old Mercedes to the church.

2.31a. Susan brough a book to study.

2.31b. Susan brought a book to Stella.

Structural priming seems to be ubiquitous in language use. In production, there is demonstration of priming in transitives (actives vs. passives, e.g., Bock, 1986b, Bock & Loebell, 1990), in datives (DO vs. PO, e.g., Bock, 1986b, Pickering & Branigan, 1998; Potter & Lombardi, 1998), in complex noun constructions (e.g., *the red sheep vs. the sheep that is red*) (Cleland & Pickering, 2003), in complementizer production (e.g., *the mechanic mentioned (that) the car could use a tune-up*) (F. Ferreira, 2003), and verb-participle order (*pull off a sweatshirt vs. pull a sweatshirt off*) (Konopka & Bock, 2009) among many other constructions. In comprehension, people were found to anticipate the Recipient after the verb following a DO prime and the Theme following a PO prime (Arai, Van Gompel, & Scheepers, 2007), to read a reduced clause faster following another reduced relative

clause (Traxler, 2008a) and to process a coordinate phrase faster following a coordinate phrase of similar structure (Sturt, Keller, & Dubey, 2010). It has been observed in different languages and with different populations (see Pickering & Ferreira, 2008, for a review).

2.7.2 Mechanism of structural priming

The lexicalist activation account

Pickering and Branigan (1998) proposed that similar structure-building information of lexical heads such as verbs is collectively represented in a combinatorial node. Thus, the capacity for verbs to occur in a DO structure or in a PO structure is represented by a V-NP-NP combinatorial node or in a V-NP-PP combinatorial node. As the use of a DO or PO sentence activates the corresponding combinatorial node, residual activation of the combinatorial node facilitates the use of the same structure, giving rise to structural priming. I will call this account as *the lexicalist activation account*. This account is supported by the finding that the repetition of the verb between the prime and the target increases the priming effect (the lexical boost, e.g., Pickering & Branigan, 1998). For instance, Pickering and Branigan asked participants to read sentences in (2.32) and then complete a sentence fragment such as (2.33). They found a structural priming effect when the verb differed between the prime and the target and an increased effect when the verb was the same (e.g., 2.32b and 2.33).

2.32a. The pirate gave the sailor a book.

2.32b. The pirate sent the sailor a book.

2.33. The cowboy sent ...

A similar lexical boost was also found in Cleland and Pickering (2003) in the priming of complex NPs. Furthermore, they also found an increased priming effect when the lexical heads between the prime and the target are semantically related so that there is more priming of *the sheep that is red* from *the goat that is green* than from *the door that is green*. The lexicalist activation account was also supported by a

study by Melinger and Dobel (2005), who found the presentation of a DO-only verb or PO-only verb can lead people to use a DO or PO structure (see Section 2.4.2.2). The lexicalist activation account can be embedded in the interactive alignment account of dialogue (Pickering & Garrod, 2004), according to which structural priming occurs because interlocutors align with each other at all linguistic levels, including syntax. Syntactic alignment can help to achieve a successful dialogue.

The implicit learning account

Another important account of structural priming is the implicit learning account, which argues that structural priming occurs during the mapping of meaning and structure (Bock & Griffin, 2000). According to this account, the processor keeps track of the mapping frequency between events and linguistic structures. If a certain event type (e.g., a dative event) is mapped onto a certain structure (e.g., a DO structure), similar events tend to be mapped onto the same (e.g., DO) structure. An important contrast between this account and the lexicalist activation account is the prediction of the longevity of priming: According to the implicit learning account, structural priming should have a long-lasting effect while according to the lexicalist activation account, structural priming should be short-lived. Bock and Griffin (2000) presented evidence that structural priming can last over 10 filler sentences, suggesting that structural priming is long-lasting (see also Hartsuiker & Kolk, 1998; cf. Branigan et al., 1999, 2000). Later research suggests that although the lexical boost is short-lived (e.g., Hartsuiker, Bernolet, Schoonbaert, Speybroeck, & Vanderelst, 2008), structural priming tends to persist over intervening events (e.g., Bock & Griffin, 2000). The implicit learning account has also been computationally implemented to explain syntactic acquisition in children (Chang, Dell, & Bock, 2006).

Other accounts

There is evidence that structural priming can promote fluency in language production. For instance, Corley and Scheepers (2002) found that people were faster in initiating a primed than an unprimed response. A similar facilitation effect was also observed in Smith and Wheeldon (2001), who found that participants produced an utterance

faster if it followed the structure of the prime sentence. The priming effect on fluency occurs probably because priming makes it easier for the processor to plan syntactic structure. These findings, however, can be either incorporated into the lexicalist activation account (an already activated combinatorial node reduces the effort of syntactic planning or processing) or the implicit learning account (a recent mapping between an event type and a structure facilitates similar mappings).

What is being primed?

So why do people tend to repeat linguistic forms that they or others have used? One possible answer is that they explicitly remember the linguistic forms of previous utterances. There is evidence that explicit memory of syntactic structure may facilitate the persistence of syntactic structure in production. For instance, Bock et al., (1992) asked one group of people to focus on the form of the prime sentence (e.g., actives and passives) and another group to focus on the meaning of prime sentences in a priming study. They found that the form-focusing group showed stronger structural priming effects (e.g., more persistent in their use of syntactic structure) than the meaning-focusing group (who in fact were not susceptible to structural priming). However, what this shows is that structural priming may be enhanced by explicit memory; it does not show that explicit memory is the only cause of structural priming. Instead, there are studies which suggest that structural priming occurs without explicit memory. Bock (1986b) first observed that in a post-experiment interview, participants did not think that prime sentences were related to target pictures in any way. V. S. Ferreira et al. (2008) show that patients with anterograde amnesia were susceptible to structural priming to the same extent as normal controls were, though these patients had difficulty in recollecting previous experiences (e.g., Squire, 1992). Furthermore, it has been shown that even the presentation of a DO-biased or PO-biased verb could facilitate the production of DO or PO responses (Melinger & Dobel, 2005). As these verbs were presented in isolation (i.e., not in a sentence), the priming effect could not be attributed to explicit memory of syntactic forms. In sentence comprehension, there is also evidence that strategic cues do not enhance structural priming (Traxler & Trooley, 2008). Hence, all these studies tend to suggest that explicit memory plays only a limited role in structural priming, if it

matters at all. They instead suggest that structural priming is largely due to implicit or procedural memory/knowledge of linguistic forms (Bock, 1986b; Pickering & Ferreira, 2008).

But what is it that gives rise to structural priming? There is increasing evidence that both syntactic and thematic information can be primed (see Pickering & Ferreira, 2008). However, there is disagreement as to what syntactic and thematic information is primed. In terms of syntactic information, it is possible that it is syntactic representations (e.g., tree structures) that are primed. In this case, a syntactic representation previously used is more likely to be used again. Or alternatively, it is the procedures that compose the syntactic structure (e.g., phrase rules) that are primed. In this case, previously used procedures tend to be re-used again. This account is endorsed in Bock and Loebell (1990). Both syntactic representation priming and syntactic procedure priming can in fact be implemented in the lexical activation account and the implicit learning account. I will return to this issue in Chapter 3 and Chapter 7. There is also disagreement as to the locus of thematic effects in structural priming. I will investigate this question in Chapter 4.

2.7.3 Structural priming as an experimental paradigm

Though much research has looked at structural priming itself (i.e., the persistence of structure), structural priming has also been exploited as an experimental paradigm in the investigation of other issues. For instance, structural priming has been used to investigate syntactic reanalysis (Van Gompel, Pickering, Pearson, & Jacob, 2006) and syntactic parsing (Christianson, Luke, & Ferreira, 2010) in sentence comprehension (see Chapter 5 for more details). It has also been extensively used to study lexico-syntactic representations in bilinguals (e.g., Hartsuiker et al., 2004; see also Chapter 6). In this thesis, I will also use structural priming as an experimental paradigm to investigate syntactic representation (Chapter 3), syntactic parsing and interpretation (Chapter 5) and lexical representation (Chapter 6). Here, I give a brief review of structural priming paradigms in the investigation of language processing.

To induce structural priming, participants have to first process the prime in the priming phase and produce a target utterance in the target phase. In the literature, there have been quite a few structural priming paradigms. Bock and colleagues (e.g.,

Bock, 1986b, 1989; Bock & Loebell, 1990) used a memory test as a disguise. Before the experiment, they first asked participants to study some sentences and pictures. Later, in the real experiment, participants heard a sentence (from the experimenter), repeated it, and decided whether that sentence was in the study list. This constituted the priming phase, where participants processed the prime sentence. Immediately after the priming phase, participants saw a picture on a booklet page, described the event in the picture, and indicated whether they had seen the picture in the study list. This then serves as the target phase, where target responses were observed. Figure 2.8 gives an illustration of such a method.

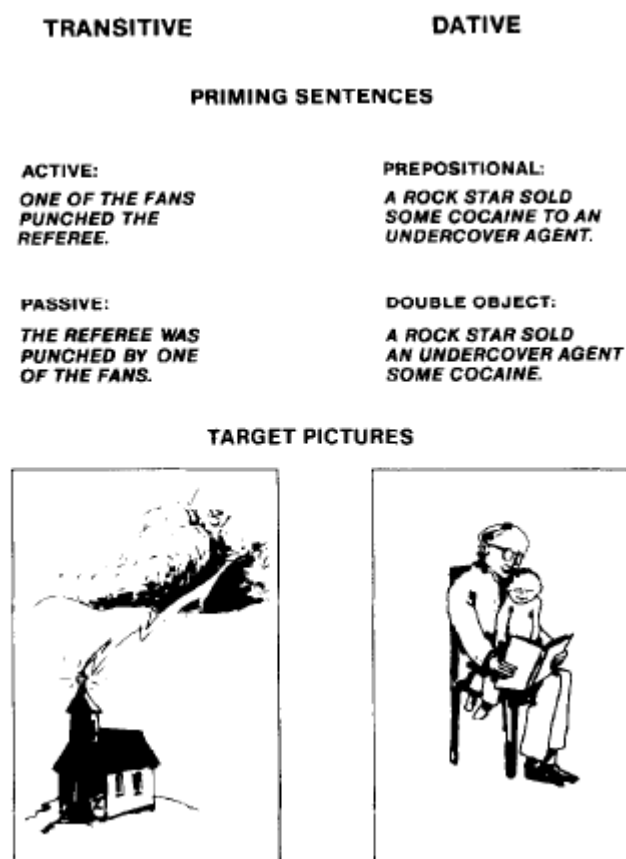

Figure 2.8: The structural priming procedure in Bock (1986b) (adapted from Bock, 1986b, p.361). Participants heard and repeated a sentence, which could involve an active or passive transitive target prime, a DO or PO dative target prime or an intransitive filler prime; then they described a target picture, which was a transitive or dative event in experimental trials and an intransitive event in filler trials.

Later studies also observed structural priming without any memory test disguise. Potter and Lombardi (1998) used a sentence-recall paradigm. They presented participants with pairs of sentence. On experimental trials, the first sentence of the pair was a target sentence and the second one was a prime sentence. Then participants were asked to recall the two sentences. They observed whether people's recall of the target sentence was influenced by the syntactic form of the prime sentence.

Pickering and Branigan (1998) asked participants to complete sentence preambles in both the priming and target phases. In the priming phase, participants were given in a booklet a sentence preamble such as *The racing driver showed the torn overall . . .* (which is typically completed in the PO form) or *The racing driver showed the helpful mechanic . . .* (which is typically completed in the DO form). In the target phase, participants were given preambles such as *The patient showed . . .* (which can be completed in either the DO or the PO form). Priming occurs if participants follow the syntactic form they use in the priming phase to complete the preamble in the target phase.

Later Branigan, Pickering, and Cleland (2000) introduced a dialogue paradigm to study structural priming. In this paradigm, a participant and a confederate take turns to describe pictures to each other. Unknown to the participant, the confederate actually reads a script (a prime sentence) while pretending to describe a picture. After that, the participant decides whether the picture she later sees matches the picture that the confederate "describes" and then describes a new picture (which is the target picture) to the confederate, who then pretends to decide whether he has the same picture as the participant has seen. Such a paradigm is much more natural than other previous paradigms, does not require a memory disguise, and has been shown to induce strong structural priming effects (Branigan et al., 2000); therefore it has been widely used and adapted in structural priming studies (e.g., Branigan et al., 2007; Hartuisker et al., 2009).

In this thesis, I employed structural priming in both a monologue setting and a dialogue setting. In a monologue setting, three paradigms similar to that used in Bock (1986b) were used. In *the sentence-repetition paradigm*, participants hear a pre-recorded prime sentence, repeat it, and then describe a target picture. This

paradigm was used in experiments in Chapter 3. In the picture-matching paradigm, participants hear a prime sentence, decides whether it matches a picture (i.e., the prime picture) they later see, and then describe a new picture (i.e., the target picture). This paradigm was used in experiments reported in Chapters 4 and 6. The third monologue paradigm is *the sentence-comprehension paradigm*, in which participants hear a pre-recorded prime sentence, answer a comprehension question about it (in some of the trials), and then describe the target picture. This paradigm was used in the experiment reported in Chapter 5. I also used the dialogue paradigm introduced in Branigan et al. (2000) in two experiments in Chapter 4.

2.8 An overview of Chinese

In this section, I give a brief introduction to Chinese, focusing on its linguistic varieties, its phonology/morphology system, its writing system and some of its syntactic properties.

Linguistic varieties of Chinese

Chinese is a branch of the Sino-Tibetan language family. Chinese itself contains a lot of linguistic varieties⁴, for instance Mandarin and Cantonese. In this sense, Chinese is a language family rather than a single language (see Chapter 6 for further discussion). Mandarin is the official language of China (mainland and Taiwan) and originated from dialects in northern China, especially Beijing area (Xing, 1991). Mandarin is spoken nationwide; most Chinese people can speak Mandarin as a first or second language. Cantonese is another linguistic variety that is mainly spoken in Guangdong Province, Hong Kong and Macao (see Matthews & Yip, 1994, for a review). Like most other Chinese varieties, Mandarin and Cantonese are unintelligible to each other (Tang & Van Heuven, 2009), though their phonologies are historically related. The two varieties share syntactic similarities as well as differences.

⁴ I use the neutral term *varieties* instead of *languages* or *dialects* because there has been no agreement as to whether different Chinese linguistic systems are languages or dialects. See Chapter 6 for some discussion on this issue.

Phonology, morphology and the writing system

Chinese is a tonal language. A Chinese syllable consists of an optional onset, a nucleus (a vowel and, in Mandarin, sometimes a nasal consonant coda) as well as a tone. There are 4 basic tones plus a weak tone in Mandarin, though the number of tones varies in different Chinese varieties. Tones are distinguishing phonological features such that the same a syllable with different tones are different morphemes, for instance, /ma1/ (“mother”), /ma2/ (“numb”), /ma3/ (“horse”), and /ma4/ (“scold”).

Most of the Chinese morphemes are monosyllabic. Most of these morphemes are themselves lexical items (or words). Each monosyllabic morpheme in Chinese has a corresponding character, the basic free standing writing unit, which itself consists of radicals. For instance, the character of *mei* (plum) is the character 梅, which itself consists of a semantic radical 木 (wood) and a phonological radical 每 (pronounced as /mei/). Currently, Chinese also adopts Roman script as its subsidiary writing system, which I use in this thesis.

Lexical categories and phrases

Major lexical categories in Chinese include nouns, verbs, adjectives, classifiers, adverbs, prepositions. I will give an overview of noun phrases and verb phrases. Chinese noun phrases consist of a head noun and many other optional modifying constituents. Modifying constituents precede the head noun, often in the order of (relative clause) - (demonstrative + CL.[assifier]) – (numeral + CL.) – (adjective) – head noun. An example is given in (2.34). As apparent in the example, Chinese nouns themselves do not carry morphological information to indicate gender or number. When adjectives and relative clauses modify head nouns, they are often marked with the marker *de*. When demonstratives or numerals modify head nouns, they are often used with a classifier. Different nouns are often associated with different classifiers. *Ge*, for instance, is often used with nouns referring to people (e.g., clown).

- 2.34. Ti-le xiaochou de na liang-ge nianqing de fuwuyuan
kick-LE clown DE that two-CL. young DE waitress
(The two young waitresses who hit the clown.)

Chinese verb phrases can have modifying constituents such as PPs and adverbs, which often precede the head verb, as shown in (2.35). Verbs in Chinese are often used with aspectual markers to express aspectual information. For instance, in (2.35), *-le* indicates that the action occurs in the past. Other aspectual markers include *-guo* (indicating the completion of an action) and *-zhe* (a marker of the progressive aspect). Like adjectives, adverbs are often used together with the marker *-de* (which is different in the written form from the marker for adjectives) when they modify the verb.

- 2.35. *zai canguan yongli-de ti-le xiaochou.*
in restaurant hard-DE kick-LE clown
(kick the clown hard in the restaurant)

The syntax of Chinese

The basic word order in Chinese is SVO, as shown in (2.36). Thus, in (2.36), the pre-verb noun is the subject and the post-verb noun is the object.

- 2.36. *Fuwuyuan ti-le xiaochou.*
waitress kick-LE clown
(The waitress kicked the clown.)

However, word order in Chinese can be scrambled, as in the various constructions in (2.37). (2.37a) is a *bei*-construction (the passive construction in Chinese) sentence, where the Patient (*xiaochou* [“clown”]) serves as the subject. (2.37b) is a *ba*-construction sentence, where the object/Patient occurs before the verb; it expresses some kind of affectedness of the object/Patient. (2.37c) is a topic construction sentence, where the object/Patient serves as the topic of the sentence. More discussion of these constructions will be provided in Chapter 3 and Chapter 4.

- 2.37a. *Xiaochou bei fuwuyuan ti-le.*
 clown BEI waitress kick-LE
 (The clown was kicked by the waitress.)
- 2.37b. *Fuwuyuan ba xiaochou ti-le.*
 waitress BA clown kick-LE
 (The waitress kicked the clown.)
- 2.37c. *Xiaochou fuwuyuan ti-le.*
 clown waitress kick-LE
 (The clown, the waitress kicked.)

Another syntactic property in Chinese is the elision of constituents that are contextually recoverable. A well-known phenomenon is argument drop: The subject or object can be omitted when it is contextually recoverable. Another common elision in Chinese is VP ellipsis, an example of which is shown in (2.38). The verb phrase in the second sentence in (2.38) is omitted because it can be recovered from the context. I examine VP ellipsis processing in Chapter 5.

- 2.38. *Fuwuyuan ti-le xiaochou. Shuishou ye ti-le.*
 waitress kick-LE clown. sailor also kick-LE.
 (The waitress kicked the clown. The sailor did too.)

Like English, Chinese has dative alternations. An example is given in (2.39). (2.39a) corresponds to the DO construction in English: The dative verb takes two NP constituents as arguments and the Recipient NP (*xiaochou* [“clown”]) precedes the Theme NP (*yiben shu* [“a book”]). (2.39b) corresponds to the PO construction in English: The dative verb takes an NP constituent (*yiben shu* [“a book”]) and a PP constituent (*gei xiaochou* [“to the clown”]). The two alternations express basically the same meaning.

- 2.39a. Fuwuyuan song-gei-le xiaochou yiben shu.
waitress give-to-LE clown a book
The waitress gave the clown a book.
- 2.39b. Fuwuyuan song-le yiben shu gei xiaochou.
waitress give-LE a book to clown
The waitress gave a book to the clown.

Exploiting syntactic properties in Chinese

Chinese is a language that is typologically different from Indo-European languages such as English and German. Syntactic processing in Chinese is worth investigating on several grounds. First, syntactic features and phenomena present in Chinese while absent in European languages may help us to understand mechanisms of language processing from a cross-linguistic perspective. Second, it is worth asking whether there are cognitive processes in the processor that are language-specific. For instance, does Chinese follow the same stages of grammatical encoding as English does? Or does the processor for Chinese have some processing stages for computing Chinese-specific syntactic phenomena such as classifier-noun agreement? Third, as shown above, the relatively free word order in Chinese allows researchers to independently manipulate semantic and syntactic information to some extent. Fourth, Chinese linguistic varieties are closely related and many Chinese people are bi- or multi-linguals. We can make use of these advantages in the investigation of bilingual syntax and lexicon. In this thesis, I especially exploit the latter two conveniences.

2.9 Summary and research questions

In the above reviews, I highlighted several questions concerning syntactic representation and processing. First, I reviewed the need to use experimental methods in the investigation of syntax. In Chapter 3 of the thesis, I propose that structural priming can be used as an experimental approach to the mental representation of syntax. I investigate some Chinese constructions whose syntactic analyses are under debate and demonstrate that structural priming can illuminate the syntactic representations of these constructions. Second, I reviewed various factors

that influence grammatical encoding in language production. I pointed out that research to date has been inconclusive as the locus of thematic effects in grammatical encoding and as to whether grammatical encoding is lexically guided. I address these questions by investigating structural priming from topic constructions in Chinese in Chapter 4. Third, the role of syntax in sentence processing and interpretation is still hotly debated. In Chapter 5, I ask whether the processing of ellipsis is mediated by syntax by looking at Chinese verb-phrase ellipsis. And finally, bilingual models of bilingual lexical representation and processing have been underspecified as to whether cognate translation equivalents have shared or distinct lemma representations. In Chapter 6, I look at the representation of cognate translation equivalents and their associated lexico-syntactic information in Cantonese-Mandarin bilinguals. In all, the thesis investigates syntactic representation and processing, making use of lexical and syntactic properties in Chinese. The main method is structural priming.

Chapter 3 Structural priming as an approach to investigating the mental representation of syntactic structure

3.1 Overview of the chapter

The mainstream view of syntax is that a syntactic construction has a corresponding mental representation (or syntactic analysis). The traditional approach to syntactic representation has relied on intuitive evidence, including intuition about the constituent structure of a construction. However, there are cases where our intuition about constituent structure is indeterminate. I argue that in such cases, structural priming can be used to determine the constituent structure and can hence help to distinguish among alternative syntactic analyses. I report three structural priming experiments on some Chinese syntactic constructions whose syntactic analysis is currently under debate. In two of the experiments, structural priming results provided evidence that can be used to discriminate between these alternative analyses. I therefore propose that structural priming can serve as an approach to the investigation of the mental representation of syntactic structure. Such a proposal echoes recent calls for experimental methods in syntactic research.

3.2 Introduction

For decades, syntactic research has relied on intuition on the part of the researcher (i.e., the informal introspection approach, see Section 2.3) in the exploration of human syntactic knowledge (e.g., Chomsky, 1957). Such an approach has been long criticized for its lack of reliability and validity. For instance, it has been pointed out that evidence based on individual intuition and on one or two items may be susceptible to confounds such as dialectal/idiolectal difference and item-specific

effects (e.g., Schütze, 1996). Grammaticality judgement itself has also been shown to reflect non-grammatical factors (e.g., plausibility and processibility) as well as grammatical factors (Bever, 1974; Chomsky, 1965). Furthermore, the categorical nature of grammaticality judgement may fail to capture gradience of grammar (e.g., Sorace & Keller, 2005). Researchers have proposed to address these issues by introducing experimental methods and quantitative analyses into syntactic research (Bard et al., 1996; Cowart, 1997; Featherston, 2005; Gibson & Fedorenko, in press; Keller, 2000; see also Section 2.3).

Instead of addressing grammaticality issues, this chapter focuses on the syntactic analysis or mental representation of syntactic constructions. For decades, constituent structure (i.e., the organization of linguistic materials) has been used as evidence for the mental representation (i.e., syntactic analysis) of a syntactic construction. However, constituency information may not be always accessible to intuition. I propose that structure priming can be used to determine the constituent structure of syntactic constructions whose constituency information seems indeterminate to our intuition, and can hence help to distinguish among alternative syntactic analyses of a controversial syntactic construction.

3.3 Language as a mental object

What is the object of linguistic inquiry? There has been disagreement among philosophers of language. According to the formalistic view, language is something separate from the minds of its speakers (Katz, 1981, 1996; Katz & Postal, 1991; Langendoen & Postal, 1984). That is, languages are platonic objects: They have an independent existence and are *discovered* by humans. The goal of linguistics, according to the formalistic view, is to provide systematic generalisations about the structural properties of sets of sentence-meaning pairs, with the ultimate aim of discovering what constitutes a possible natural language. Therefore, though formalistic linguists do not deny that humans mentally represent syntactic structure in some way; they simply believe that this is not part of their field of study (Katz, 1996). Another view of language is functionalism, which conceives language as an instrument of interpersonal communication (e.g., Dik, 1989; Halliday, 1994). According to the functionalistic view, the object of linguistic inquiry is the functions

(or use) of language rather than its structure, because the ultimate goal of language use is to exchange meaning and pragmatic functions rather than linguistic structure. The functionalistic view, however, also emphasizes the mental representation of language (though more of use rather than structure; e.g., Dik, 1996).

An alternative to the above two views is the mentalistic view of language and linguistic inquiry, which is best exemplified in the generative grammar frameworks proposed by Chomsky (1965, 1981, 1995). According to generative transformational grammar, we know which sentences are permissible and which are not because we are mentally equipped with the grammar of the language, which consists of linguistic (e.g., syntactic) rules. A newborn acquires a language by developing knowledge of these linguistic rules. Therefore, generative transformational grammar assumes linguistic rules are mentally represented in a competent speaker. The main object of linguistic inquiry, then, is to explore how linguistic rules are mentally represented (e.g., Lasnik, 2002). A similar goal is also pursued in other grammatical frameworks such as Lexical-Functional Grammar (e.g., Bresnan, 1978; Bresnan & Kaplan, 1982), Cognitive Grammar (e.g., Lakoff, 1987; Langacker, 1987) and Construction Grammar (e.g., Goldberg, 1995).

The mentalistic view has been long the most influential approach to linguistic inquiry (Jackendoff, 2003). Therefore, I follow the mentalistic view and assume that the mental representation of linguistic rules is one of the ultimate goals of linguistic inquiry. In fact, the main stream of cognitive science on language (language comprehension, production and acquisition in particular) depends largely on the assumption of linguistic mental representation (e.g., Frazier, 1987; Levelt, 1989; Lust et al., 1994). Thus, the study of mental representation is a crucial programme for mentalistic linguists and at least a valid research project from a general point of view.

3.4 Constituency and the mental representation of syntax

The investigation of syntactic knowledge has made use of, among other things, constituency information. Constituency refers to the organization of words into phrases and sentences. For instance, the sentence *John likes candies* has a constituent structure such as [*John [likes candies]*] such that *likes* and *candies* form a VP

constituent and the VP constituent [*likes candies*] forms a larger constituent with *John*. Constituency information provides evidence as to how a syntactic structure is mentally represented. For instance, both linguistic and psycholinguistic research has documented good evidence that people have different representations for the syntactically ambiguous phrase *the daughter of the colonel who had the accident*. Such an ambiguity arises because there are two possible constituent structures for the string: [[[*the daughter [of the colonel]] who...*]], in which case it is the daughter who had an accident, and [*the daughter [of [the colonel who...]]*], in which case it is the colonel who had an accident (e.g., Cuetos & Mitchell, 1988).

Constituency has been used to determine the mental representation of syntactic structures. For instance, there had been debate concerning the constituent structure of sentences containing of adverbials such as *on Tuesday* in (3.1). *On Tuesday* can be either analysed as a daughter constituent under S as in (3.2a) (e.g., Hornstein & Weinberg, 1981) or as a daughter constituent under VP as in (3.2b) (e.g., Emonds, 1976).

3.1 Andy had attacked Mal on Tuesday.

3.2a. ... [_{VP} had [_{V'} [_V attacked Mal] [_{PP} on Tuesday]]].

3.2b. ... [_{VP} [_{V'} had [_V attacked Mal] [_{PP} on Tuesday]]].

Andrews (1982) noticed that the sentence in (3.1) is ambiguous between a reading where the attacking happened on Tuesday and a reading where the attacking happened before Tuesday. He argued that such an ambiguity can be resolved if aspectual markers such as *had* are heads of VPs, taking other verb phrases as complements. In such an analysis, the PP *on Tuesday* can be either attached to the phrase *attacked Mal* (as in 3.2a, with the interpretation of attaching on Tuesday) or the phrase *had attacked Mal* (as in 3.2b, with the interpretation of attaching before Tuesday). The proposal that auxiliaries such as aspectual markers are heads was later used in the Phrase Structure Grammar (e.g., Gazdar, Pullum, & Sag, 1980).

Though the constituent structure of many syntactic constructions is unambiguously apparent to native speakers, the example above shows that, in some cases, constituency information is not readily accessible to introspection. Consider as

another example the small-clause construction in English, e.g., *Mary considered John a fool*. According to the small-clause account (e.g., Bowers, 1993; Starke 1995), the above sentence has the constituent structure ...*[_{VP} considered [_{SC} John a fool]]*, while according to the predication account (e.g., Carrier & Randall, 1992; Williams, 1983), the sentence has the constituent structure ... *[_{VP} considered John a fool]*. Thus, the two accounts differ in the constituency within the verb phrase. However, it is hard to determine the constituent structure of the small clause construction by means of introspection on (i.e., intuition about) constituency; therefore, it is desirable to bring in experimental methods (especially experimental inference methods) in the investigation of the constituent structure of constructions like the small-clause construction⁵. In what follows, I propose that structural priming can be used to detect constituency information.

3.5 Structural priming as an approach to mental representation of syntax

There seems to be a carefully observed doctrine in the study of language that syntacticians inquire into the representation of syntactic knowledge while psycholinguists explore the cognitive processes underlying language production and comprehension. The implication of this doctrine is that psycholinguistic evidence does not have much to say about the representation of syntactic knowledge. In this section, I argue that psycholinguistic evidence can illuminate issues of representation of syntactic knowledge and that structural priming can tap into the mental representation of syntactic structure and can be used an experimental paradigm in experimental syntax. The first part of the proposal is actually not new in psycholinguistics. For instance, Levelt, Roelofs, and Meyer (1999) have used psycholinguistic evidence to specify the representation as well as the processing of lexical entries (see also Kempen & Huijbers, 1983). I will not go into details of these theories (See Section 2.4.1.2 for a brief review of Levelt et al., 1999.); instead, I focus on structural priming.

⁵ Dubinsky et al. (2000) provided some evidence using experimental inference, but as I have reviewed, the conclusion was based on the assumption that computing agreement is costly, which itself needs justification. Furthermore, the results in the study might be susceptible to frequency, ambiguity and/or semantic confounds (see Section 2.3.5).

3.5.1 *What aspects of the sentence persist in structural priming?*

In recent years it has been found that structural priming may tap into different aspects of the sentence (see Pickering & Ferreira, 2008, for a review). First and foremost, structural priming has been found to reflect the persistence of constituent structure (e.g., Bock & Loebell, 1990; Hartsuiker & Westenberg, 2000; Konopka & Bock, 2009). Konopka and Bock (2009), for instance, examined the production of phrasal verbs as in *the toddler threw away one of his toys/ threw one of his toys away* where there are two alternative orders of the object NP (e.g., *one of his toys*) and the participle (e.g., *away*). They found the order of the NP and the participle can be primed. As the two orders differ only in constituent structure, such a finding suggests that priming reflects the persistence of constituent structure.

Second, there is evidence that thematic information also persists in structural priming (e.g., Bernolet et al., 2009; Chang et al., 2003; Hare & Goldberg, 1999). For instance, Chang et al. (2003) observed that though a *spray-with* sentence (e.g., *the man sprayed the car with wax*) and a *spray-on* sentence (e.g., *the man sprayed wax on the car*) do not differ in constituent structure, they differ in the mapping of thematic roles onto grammatical functions (the Goal is the direct object in the *spray-with* sentence and the indirect object in the *spray-on* sentence) (e.g., Levin, 1993). They found that when a participant had been exposed to one of the sentence types, they tended to re-use the same sentence type, suggesting that structural priming also reflects the persistence of thematic information. However, there is disagreement as to the locus of such persistence. Although Chang et al., argued that it is the mapping between thematic roles and grammatical functions that persists, their data can also be interpreted as the persistence of the mapping between thematic roles and linear order (e.g., Hare & Goldberg, 1999) (In fact, Chapter 4 of this thesis provides evidence against the mapping between thematic roles and grammatical functions and for the mapping between thematic roles and linear order). Another finding about the persistence of thematic information is that the processor tends to assign the same thematic role to a more emphatic position (e.g., the subject or an early position, Bernolet et al., 2009).

Finally, there is the finding that the processor is also sensitive to the binding between animacy information and grammatical functions. Bock et al. (1992) found

the processor tends to assign the subject function to nouns with the same animacy value (animate vs. inanimate), independent of the persistence of constituent structure (active vs. passive). For instance, participants produced more passives like *the boy was wakened by the alarm clock* after an animate-subject prime like *five people carried the boat* than after the inanimate subject prime like *the boat carried five people*, supposedly because the processor tends to assign the subject to an animate concept (e.g., boy) rather than an inanimate one (e.g., alarm clock) after the animate-subject prime, resulting the use of the passive structure. I assume that the animacy-function binding persists only if there is an animacy contrast between nouns. Furthermore, Bock et al. (1992) pointed out that animacy-function binding is probably a mediation between thematic roles and subjecthood (higher thematic roles such as Agent tend to be animate and also tend to serve as the subject). Therefore, I further assume that the processor persists in binding the same animacy to the subject function only.

3.5.2 What is being primed in the persistence of constituent structure?

As this chapter exploits the persistence of constituent structure in structural priming, it is necessary to first ask what is being primed in the persistence of constituent structure. There are two accounts in the literature. According to a procedure-based account, processing procedures associated with the formulation of the constituent structure of a sentence tend to be re-used, culminating in the persistence of constituent structure. For instance, during the production of a prime sentence, say, a passive sentence, the processor utilizes certain processing procedures to construct a passive constituent structure. These procedures tend to be re-used and therefore increase the likelihood of producing more passives, as observed in structural priming studies (e.g., Bock, 1986b). Such a procedure-based account was proposed in Bock and Loebell (1990). Since processing procedures are different in production and in comprehension (e.g., comprehending and producing a passive arguably involve different procedures), the procedure-based account would predict that structural priming occurs only within production or within comprehension; for example, structural priming can only be observed in production to production priming, but not in comprehension to production priming. However, there has been good evidence

that comprehending a prime can also lead to structural priming. For instance, Branigan et al. (2000) had a participant and a confederate describe pictures to each other and found strong priming effects, even though in the paradigm the participant was comprehending rather than producing the prime. Bock et al. (2007) found persistence of priming from auditorily presented primes across as many as ten filler trials, suggesting that comprehended primes are as effective as self-produced primes (e.g., Bock & Griffin, 2000). Therefore, it seems unlikely that structural priming is due to the re-use of modality-specific processing procedures.

A more plausible account is that structural priming occurs because of residual activation of linguistic representations used in both production and comprehension. Hence, the representation-based account predicts that there should be priming from comprehension to production, as shown in Branigan et al. (2000) and Bock et al. (2007). It also further predicts similar effects for production-production priming and for comprehension-production priming (though so far no studies have directly tested this prediction). The representation-based account can be implemented in the lexical activation account of structural priming in Pickering and Branigan (1998), if we assume that combinatorial nodes encode syntactic representations such as argument structure rather than production procedures. Though Pickering and Branigan (1998) did not commit to either the representation-based or the procedure-based account, the representation-based version of the model is more compatible with the model of lexical representation (e.g., Roelofs, 1992) that Pickering and Branigan's model is based upon. In fact, later developments of their model seem to be more representation-based rather than procedure-based (e.g., Branigan et al., 2000). The representation-based account may also be compatible with the implicit learning account of Bock and Griffin (2000) if we assume that the processor keeps track of the frequency of the mapping between an event and a structural representation rather than a production procedure.

There are studies that support the representation-based account. For instance, Melinger and Döbel (2005) found that the presence of a dative verb that only allows the DO structure (DO-only) or the PO structure (PO-only) led to the priming of DO or PO sentences. Such a finding strongly argues against the procedure-based account, as no processing procedures were associated with the prime (which was a

single verb). Instead, such a finding is consistent with the account in Pickering and Branigan (1998): A DO-only or PO-only verb activates the DO or PO combinatorial node, whose residual activation leads to priming. This representation-based account has also been extended to account for cross-language structural priming (e.g., Hartsuiker et al., 2004). Therefore, I assume that structural priming taps into linguistic representations rather than processing procedures. I propose that structural priming from syntactic information suggests some sort of representational categorization. That is, if Sentence A primes Sentence B, the processor must have assigned them to the same syntactic category. Particularly relevant to this chapter is constituent structure categorization. That is, if two sentences prime each other when thematic information is controlled, they must be assigned to the same constituent structure. In the next section, I review some structural priming studies that have explored the mental representation of syntactic structure.

3.6 Structural priming studies on syntactic representation

Bock, Loebell, and Morey (1992) observed that there is a tendency for people to map the same animacy to the same grammatical function. For instance, if the prime has animate-subject binding (e.g., 3.3b), people tend to have the same animate-subject binding in later productions. Such animacy-function binding is parallel to structural priming. They were interested in the priming of actives (e.g., *the alarm clock awakened the boy*) vs. passives (e.g., *the boy was awakened by the alarm clock*) following the two passive primes in (3.3). Note that according to the GB theory, the surface subject of a passive sentence has served the object function while the surface object has served the subject function in the deep structure. That means in (3.3b), the animate noun was bound to the object function (and inanimate noun to the subject function), just as in the active sentence *the alarm clock awakened the boy*, while the reverse is true in (3.3a). Thus, as animacy-function binding is found to be persistent, (3.3b) should induce more actives (e.g., *the alarm clock awakened the boy*) than (3.3a). In contrast to the GB account, other theories such as LFG assume that the surface subject and the surface object plays the subject function and the object function during functional processing. Thus, they predict that (3.3b) would induce more active sentences than (3.3a), a prediction which was confirmed in their study.

Their results therefore disconfirmed the GB account that the surface structure of a passive sentence is mapped from an underlying deep structure; they instead favoured the LFG account of the passives.

3.3a. A boat was carried by five people.

3.3b. Five people were carried by a boat.

In another study, Pickering, Branigan, and McLean (2002) were interested in the structural representation of the shifted PO in English (3.4d). According to GB (e.g., Chomsky, 1981), the shifted PO is derived from the canonical PO structure (e.g., deep structure in GB). Under this account, a shifted PO should behave quite similarly to a PO and differently from a DO, relative to a baseline sentence. Pickering et al. asked participants first to complete a prime-inducing sentence preamble (3.4a-d) and then to complete the target sentence preamble, which can be continued as either a DO or a PO. They found that although the DO prime induced more DO responses and the PO induced more PO responses relative to the baseline, the shifted PO primed behaved just like the baseline and differently from the PO prime and the DO prime. This finding suggests that the generation of a shifted PO sentence does not involve a canonical PO (however, see Chapter 4 for a different interpretation of the results).

3.4a. PO prime: The racing driver showed the torn overall . . .

3.4b. DO prime: The racing driver showed the helpful mechanic ...

3.4c. Baseline prime: The racing driver sneezed very . . .

3.4d. Shifted-PO prime: The racing driver showed to the helpful mechanic ...

Most relevant to the experiments in this chapter is a study in Bock and Loebell (1990). In one of the experiments, Bock and Loebell (1990) compared the priming of active sentences (e.g., *the alarm clock awakened the boy*) and passive sentences (e.g., *the boy was awakened by the alarm clock*) following a passive prime (3.5a), a locative prime (3.5b) or an active prime (3.5c). Bock and Loebell found that the locative prime led to as many passive responses as the passive prime did, both to

a greater extent than the active prime. In terms of thematic information, the passive and the locative sentence do not have much similarity as they presumably have different thematic roles. Therefore, the priming of passive sentences following the locative prime cannot be attributed to the persistence of thematic information. Furthermore, as all the three primes in (3.5) have animate subjects, it is unlikely the locative prime led to more passives than the active simply because of animacy to function (i.e., subject) binding. Thus, as argued by Bock and Loebell, the locative-passive priming must have its locus at the constituent structure level. In other words, priming suggests that the passive and the locative share the same constituent structure.

3.5a. The foreigner was confused by the blinking traffic light.

3.5b. The foreigner was loitering by the blinking traffic light.

3.5c. The foreigner misunderstood the blinking traffic light.

The finding in Bock and Loebell (1990) also has some crucial implications concerning the mental representation of the English passive construction. Note that Simpler Syntax and LFG assign very similar syntactic representations to the passive construction and the locative construction. GB and Minimalism assume that the subject originates in the direct object position and moves to the subject position in the passive construction but not in the locative construction. The two constructions are thus assigned very different analyses. Thus, the above finding seems to favour the Simpler Syntax and LFG accounts of the passive construction and argue against the GB and Minimalism accounts.

These studies suggest that structural priming can be used to determine how a syntactic structure is mentally represented. In what follows, I report three experiments investigating the mental representations (i.e., syntactic analyses) of some Chinese constructions. I follow the rationale in Bock and Loebell's (1990) study. That is, I observe whether a sentence that is unambiguous in terms of constituent analysis (like the locative sentence in Bock and Loebell's study) primes the target sentence (like the passive sentence in Bock and Loebell's study) when thematic information is controlled. If priming is observed, we can conclude that the

two sentences have the same or very similar constituent structure. I investigate the mental representation of the *ba*-construction in Experiment 3.1, of the *bei*-construction in Experiment 3.2, and of the *steal*-construction in Experiment 3.3.

3.7 The mental representation of the *ba*-construction

3.7.1 Alternative analyses of the *ba*-construction

The *ba*-construction (e.g., 3.6) is commonly used in Mandarin Chinese. It has been argued that the function of the *ba*-construction is to express affectedness (or disposal) (Chao, 1968; Wang, 1954): The post-*ba* NP is affected by the action in the event. In (3.6), *gongzhu* (“princess”) is the target of the criticizing act. In (3.7), the person denoted by the post-*ba* NP (i.e., the princess) is not affected at all by the event of someone seeing her, hence its ungrammaticality. Building on the notion of affectedness and disposal, later views argued that the *ba*-construction expresses transitivity of affectedness from the Agent NP to the Patient NP (Hopper & Thompson, 1980; Thompson, 1973).

3.6. Xiunv ba gongzhu piping-le.

Nun BA princess criticize-LE (The nun criticized the princess.)

3.7. *Xiunv ba gongzhu kanjian-le

Nun BA princess see-LE (The nun saw the princess.)

In syntax, there has been much debate concerning the categorical status of *ba* and the syntactic analysis of the *ba*-construction. Various proposals have been offered (see Huang, Li, & Li, 2009, for a review). Among these proposals, the most influential ones are *the preposition analysis* (Chao, 1968; Li, 1990) and *the light-verb analysis* (e.g., Huang et al., 2009). According to the preposition analysis, *ba* is a preposition like *by* in English passive constructions. The post-*ba* NP moves from the direct object position following the main verb (e.g., *piping-le* [“criticized”]) to the prepositional object position following *ba*, which is outside its original VP. According to such an analysis, the sentence in (3.6) has the syntactic analysis in Figure 3.1A. According to the light-verb analysis, *ba* is a light-verb like the English

verb *make* as in *John made Bill work hard*. In this analysis, the post-*ba* NP moves from the direct object position following the main verb to a position preceding the verb (but still within the same VP). Thus, the sentence in (3.6) has a syntactic analysis as in Figure 3.1B. As can be seen from the syntactic trees, a fundamental difference in terms of constituent structure between the two analyses is the constituency of the post-*ba* NP: In the preposition analysis, the post-*ba* NP forms a constituent with *ba*; while according to the light-verb analysis, the post-*ba* NP forms a constituent with the verb.

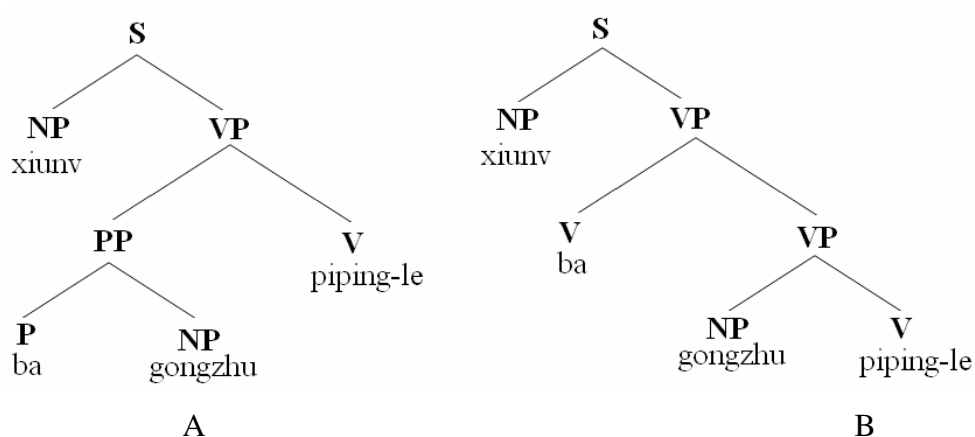

Figure 3.1: Constituent structures for the sentence in (3.6) according to the preposition analysis (A) and according to the light-verb analysis (B).

Current syntactic evidence is inconclusive as to the categorical status of *ba* and the syntactic analysis of the *ba*-construction. *Ba* (which was a verb in ancient Chinese) seems to have lost verbal properties. It does not take aspect markers such as *-le* and it does not occur in a *V-not-V* question as most verbs do (e.g., *ni chi-bu-chi*, literally, “you eat not eat” [do you want to eat?]). More importantly, it does not assign a thematic role to the post-*ba* NP. These observations have prompted some researchers to treat *ba* as a preposition (e.g., Chao, 1968), and hence the preposition analysis of the *ba*-construction. More evidence for the preposition analysis comes from the fact that *ba* and the post-*ba* NP must be adjacent: An adverb occurs after the post-*ba* NP rather than intervening between *ba* and the post-*ba* NP (e.g., 3.8), which suggests that the post-*ba* NP forms a constituent with *ba* rather than with the verb.

3.8. *Xiunv ba henhen-de gongzhu piping-le

Nun BA harshly princess criticize-LE

(Intended: The nun harshly criticized the princess)

However, the aforementioned observations concerning *ba* have also led some researchers to suggest that *ba* is a light verb (hence the light-verb analysis, e.g., Huang et al., 2009). For instance, the light verb *shi* (“make/cause”) similarly does not take aspect markers, does not occur in the V-not-V construction and does not assign thematic roles. Supporting the light-verb analysis, it was observed that in a coordinate construction (e.g., 3.9, adapted from Huang et al., 2009, p.166; coordinate constituents in square brackets), the second coordinate constituent can occur without *ba*, consistent with the proposal that the post-*ba* NP forms a constituent with the verb.

3.9. Ta ba [men xi-hao], [chuanhu ca-ganjing]-le

He BA door wash-finish window wipe-clean-LE

(He washed the door and wiped the window clean)

Structural priming provides a way to contrast the above two analyses of the *ba*-construction. More specifically, the two alternative analyses make different predictions concerning the priming of *ba*-construction responses following a *bi*-construction prime such as (3.10). The *bi*-construction expresses comparison between two things and is very similar in function to the *than*-construction in English (e.g., *John is taller than Mary*). Importantly, the *bi*-construction does not have similarity in terms of thematic roles with the *ba*-construction; therefore, there should be no priming of thematic information (i.e., no binding between thematic roles and functions, order, or emphasis) between them. Furthermore, we can control for any animacy-function binding priming by using only human NPs. Thus, neither of the two analyses predicts any priming in terms of thematic information or animacy-function binding between the *bi*-construction and the *ba*-construction. However, the two analyses make different predictions concerning priming from constituent structure. According to the preposition analysis but not the light-verb analysis, the *ba*-construction has a similar constituent structure to that of the *bi*-construction as in

(3.10), whose syntactic analysis is shown in Figure 3.2. Therefore, the preposition analysis but not the light-verb analysis predicts structural priming of *ba*-construction responses in terms of constituent structure from the *bi*-construction. Experiment 3.1 set out to test these predictions.

3.10. Xiunv bi gongzhu zhang de gao.

nun BI princess grow DE tall (The nun grew taller than the princess.)

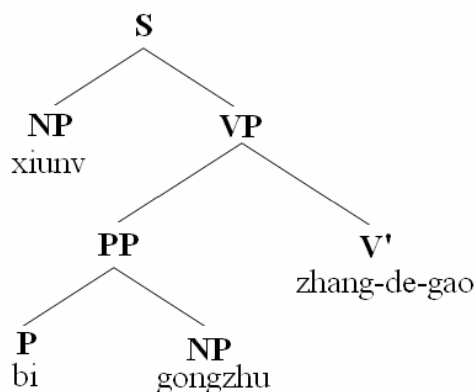

Figure 3.2: The constituent structure of the *bi*-construction sentence in (3.10).

3.7.2 Experiment 3.1

Experiment 3.1 observed the priming of canonical transitive responses (e.g., 3.11a) or *ba*-construction responses (e.g., 3.11b), following primes such as (3.12a-d).

3.11a. Fuwuyuan tishang-le xiaotou.

waitress kick-wound-LE burglar

3.11b. Fuwuyuan ba xiaotou tishang-le.

waitress BA burglar kick-wound-LE

(Both mean “The waitress kicked and wounded the burglar”.)

- 3.12a. Xiunv piping-le gongzhu. (Canonical transitive)
 nun criticize-LE princess (The nun criticized the princess.)
- 3.12b. Xiunv ba gongzhu piping-le. (*Ba*-construction)
 nun BA princess criticize-LE (The nun criticized the princess.)
- 3.12c. Xiunv bi gongzhu zhang de gao. (Bi-construction)
 nun than princess grow DE tall (The nun grew taller than the princess)
- 3.12d. Xiunv zhang de hen gao. (Intransitive baseline)
 nun grow DE very tall (The nun grew very tall)

All the experimental primes and targets contained two random people (e.g., a nun and a princess in 3.12). Thus, there is no issue of animacy-function binding priming. Furthermore, as neither the *bi*-construction nor the baseline has the same set of thematic roles with the target (canonical/*ba*-construction) responses, there should not be priming in terms of thematic information from the *bi*-construction and the baseline. There can be priming in terms of thematic order from the canonical transitive prime and the *ba*-construction prime. Thus, relative to the baseline prime, the canonical transitive prime (3.12a) and the *ba*-construction prime (3.12b) should respectively prime canonical responses and *ba*-construction responses in terms of both constituent structure and thematic information. Critically, according to the preposition analysis but not the light-verb analysis, the *bi*-construction prime (3.12c), relative to the baseline, should prime *ba*-construction responses in terms of constituent structure. Thus the two alternative analyses of the *ba*-construction make the following predictions concerning the priming of *ba*-construction responses (i.e., the tendency for *ba*-constructions to follow a prime).

3.13a. The preposition analysis:

ba-construction > *bi*-construction > baseline > canonical transitive

3.13b. The light verb analysis:

ba-construction > *bi*-construction = baseline > canonical transitive

Method

Participants. Thirty-two participants from the South China Normal University community were paid 10 RMB (roughly £1) to take part. They were native speakers of Mandarin Chinese.

Materials. There were 32 experimental items and 96 filler items. Each item consisted of a prime sentence and a target picture (see Figure 3.3). An experimental prime sentence had 4 versions as in (3.12). The filler prime sentences were either intransitive or dative sentences. The prime sentences were read by a female Mandarin speaker and were digitally recorded as WAV files. The target picture depicted an event that was not relevant to the event expressed in the prime sentence in terms of action or people and objects involved. A verb indicating the action in the event was printed below the picture (see Target picture in Figure 3.3). For the experimental target picture, the event always involved a person acting on another person (e.g., a waitress kicking a burglar). In this and the other experiments in this chapter, the verb always differed between the prime and the target.

Procedure. In this experiment (and also the following experiments in this chapter), I used *the sentence-repetition paradigm*. In the priming phase, participants heard a sentence (which was pre-recorded) and repeated it; then in the target phase, they described an unrelated picture. Figure 3.3 gives an illustration of the paradigm. The experiment was run on a computer using DMDX (Forster & Forster, 2003). Items and fillers were presented in individually pseudo-randomized orders so that there were 2-4 fillers separating every two experimental items. Participants were first shown figures (e.g., a pirate) and objects (e.g., a ball) that were to appear in the experiment, together with their names, in PowerPoint slides. After this, participants were presented with 3 practice items to get familiar with the experiment. During the experiment, participants first saw a line of dashes on the computer screen. After participants pressed the spacebar, the prime sentence was played. After the prime sentence, a cue appeared on the screen asking participants to repeat the prime sentence. After they repeated the prime sentence, participants pressed the spacebar and then the target picture appeared. Participants described the target picture in Mandarin Chinese using the verb printed below the picture. The experiment took about 40 minutes. See Figure 3.3 for an illustration of the experiment procedure.

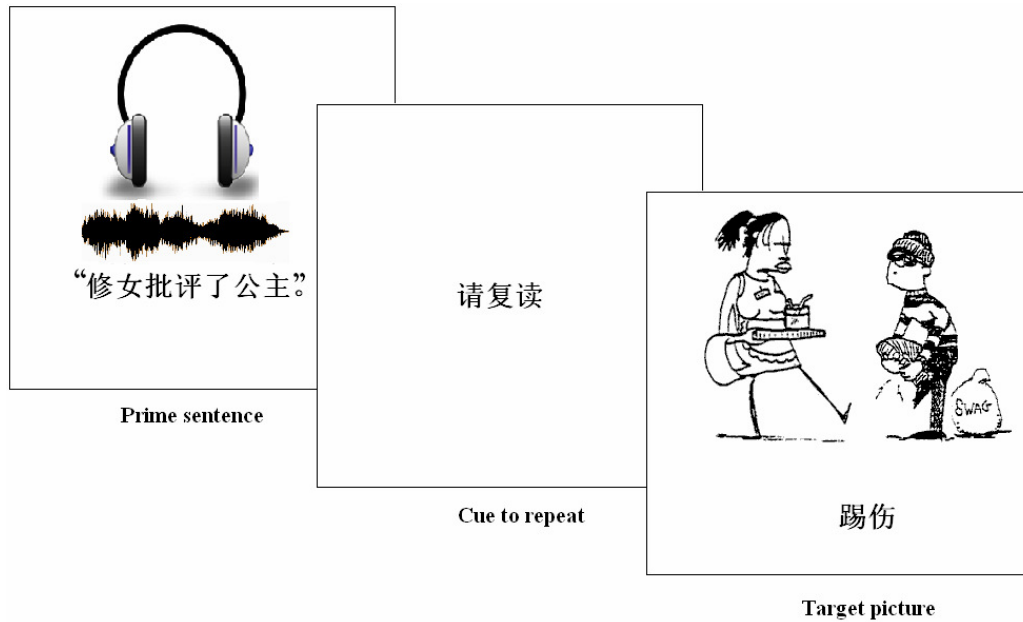

Figure 3.3: An illustration of the experiment paradigm and procedure. The auditory prime sentence means “The nun criticized the princess”; the cue to repeat means “Please repeat”. The target picture has a verb meaning “kick-wound” to indicate the action in the event.

Scoring. All responses were scored as canonical responses, *ba*-construction responses, or Others. A response was encoded as a canonical response when the sentence was in the NP1-V-NP2 form (where NP1 is the Agent, NP2 is the Patient and V was the verb printed in the picture); a response was encoded as a *ba*-construction response when the sentence was in the *ba*-construction (i.e., NP1-*ba*-NP2-V). All other responses were encoded as Other responses.

Data analysis. I used binomial logit mixed effects (LME) modelling to analyse data for this experiment (and also other experiments in this chapter). LME has been shown to be superior to ANOVA in handling categorical data like structural priming data (Jaeger, 2008). LME modelling takes both subjects and items as random intercepts. Models are built and their goodness of fit to the data is determined. I first built a null model with only subjects and items as random intercepts. Then I augmented the model by adding in one factor in a step-by-step fashion. For instance, in a 2 (A) * 2 (B) fully-crossed design, I built the null model (e.g., *fit.0*) with subjects and items as random intercepts. As the dependent variable

in the experiments in this thesis is binomial (i.e., it has two levels, e.g., active vs. passive responses), the null model can determine the relative frequencies of the levels of the dependent variable (e.g., whether there are more active responses than passive responses). Then I built an augmented model with the extra factor A (e.g., *fit.A*). By comparing *fit.A* with *fit.0*, I determined whether *fit.A* improves the fit over *fit.0*. If it does, that means factor A has a significant main effect. In the same vein, I determined whether Factor B has a significant main effect by comparing a model with Factor B with the null model. The main effect is measured using log-likelihood ratio χ^2 test. If a factor has a significant effect, the details of the effect can be determined by pairwise comparisons among its levels. For instance, for Factor A, the details of the main effect were further explored by comparing the level A2 with the level A1. In case of a factor with more than two levels, multiple comparisons were done. A pairwise comparison is reported in terms of the z-score and its p-value. To determine whether A and B significantly interact, I built a model with two main effects A and B (e.g., *fit.A+B*) and a model with the two main effects and their interaction (e.g., *fit.A×B*). By comparing *fit.A×B* with *fit.A+B*, I determined whether the interaction was significant.

Results

One participant was excluded from the analyses due to her failure to follow instructions in the description of target pictures. Table 3.1 presents the distribution of responses in different prime conditions and the proportion of *ba*-construction responses out of canonical and *ba*-construction responses.

Table 3.1: Response counts by prime condition and % of *ba*-construction responses in Experiment 3.1.

Responses	Canonical transitive	<i>Ba</i> - construction	<i>Bi</i> - construction	Intransitive
Canonical	191	173	168	159
<i>Ba</i> -construction	30	55	54	58
Others	27	31	26	20
% of <i>ba</i> -construction	14	24	24	27

LME analyses indicate that there were more canonical responses than *ba*-construction responses ($z = 5.306$, $p < .001$). Prime type had a main effect ($\chi^2(3) = 21.179$, $p < .001$). Pairwise comparisons show that the canonical transitive prime induced fewer *ba*-construction responses (more canonical responses) than the *ba*-construction prime ($z = -3.585$, $p < .001$), the *bi*-construction prime ($z = -3.635$, $p < .001$) and the baseline prime ($z = -4.128$, $p < .001$), while the latter three did not differ in the priming of *ba*-construction responses ($ps > .1$). The distribution of Other responses was unaffected by prime type ($\chi^2(3) = 2.7506$, $p > .1$).

3.7.3 Discussion

Experiment 3.1 observed a hierarchy of baseline = *ba*-construction = *bi*-construction > canonical transitive in the priming of *ba*-construction responses. The finding that the canonical transitive prime induced fewer *ba*-construction responses (more canonical responses) than any of the other primes could be due to priming of constituent structure, thematic information or both. There is no difference in priming between the *bi*-construction and the baseline, which seems to suggest some evidence against the preposition analysis (e.g., 3.13a) and for the light-verb analysis (e.g., 3.13b). However, the null difference should be taken with caution; it could be due to a lack of power in the experiment, as is evident in the fact that the *ba*-construction prime did not differ from the baseline either. It is also possible that neither the *ba*-construction nor the *bi*-construction was distinguished from the baseline simply because of the inverse frequency effect in structural priming (Hartsuiker & Kolk, 1998; Snider, 2008): Low-frequency prime types (such as the *ba*-construction prime) exerts a stronger effect than high-frequency prime types (such as the canonical transitive prime) so that the baseline prime was biased towards inducing *ba*-construction responses, resulting in the null differences between the baseline and the *ba*-construction and between the baseline and the *bi*-construction. Thus, although the null difference between the *bi*-construction and the baseline seems to favour the light-verb analysis, further experiments with more power are needed to determine whether such a null effect can be taken seriously.

Future experiments can also test whether a sentence that has a similar constituent structure as that in Figure 3.3B (i.e., the light-verb analysis of the *ba*-construction) behaves similarly as or differently from the *ba*-construction in priming *ba*-construction responses. One such example is the verb-complement construction as in (3.14a), whose syntactic analysis is in (3.14b). Note that in (3.14a), *gongzhu* (“princess”) forms a constituent with *zhang de gao* (“grow tall”). If the light-verb analysis of the *ba*-construction is correct, the verb-complement construction such as (3.14a) should behave similarly as the *ba*-construction in the priming of canonical vs. *ba*-construction responses.

3.14a. Xiunv shuo gongzhu zhang de gao.

Nun said princess grow DE tall
(the nun said the princess grew quite tall)

3.14b. [S Xiunv [VP shuo [S gongzhu zhang de gao]]]

3.8 The mental representation of the *bei*-construction

3.8.1 Alternative analyses of the *bei*-construction

Passivization in Mandarin Chinese is often expressed with the *bei*-construction. The *bei*-construction sentence in (3.15b), for instance, is a passive counterpart of the active transitive sentence in (3.15a). In the *bei*-construction, the Patient occurs at the subject position while the Agent occurs after the passive marker *bei*. The Agent NP can also be omitted in the *bei*-construction, as shown in (3.15c); in this case, the passive marker *bei* is kept.

- 3.15a. Xiunv piping-le gongzhu.
 nun criticize-LE princess
 (The nun criticized the princess.)
- 3.15b. Gongzhu bei xiunv piping-le
 princess BEI nun criticize-LE
 (The princess was criticized by the nun.)
- 3.15c. Gongzhu bei piping-le.
 princess BEI criticize-LE
 (The princess was criticized.)

Like the *ba*-construction, the *bei*-construction is controversial in terms of its syntactic analysis. Again, two major proposals have been offered in the literature (see Huang et al., 2009, for a review). According to *the preposition analysis* (Li, 1990; Wang, 1970), the *bei*-construction is pretty much like the English passive construction: The passive marker *bei* is a preposition which forms a PP with the post-*bei* NP. On a GB version of this account, the post-*bei* NP originates as the direct object of the verb and moves to be the object of the preposition. Figure 3.4A gives the constituent structure of the *bei*-construction sentence in (3.15b) according to the preposition analysis. Critically, in Figure 3.4A, the post-*bei* NP forms a constituent with *bei*. The alternative proposal is *the main-verb analysis* (Hashimoto, 1987; Huang et al., 2009), according to which *bei* is a main verb which takes a complement (e.g., *xiunv pingping-le* in 3.15b) as its argument. On a GB version of this account, in (3.15b), the direct object of *piping* (“criticize”) is a missing argument and *gongzhu* (“princess”) originates as the subject of the main clause rather than as the direct object of *piping* (“criticize”) via movement. Figure 3.4B gives an illustration of such an analysis to the sentence in (3.15b). Contrary to the preposition analysis, the main-verb analysis takes the post-*bei* NP and the verb to form a constituent.

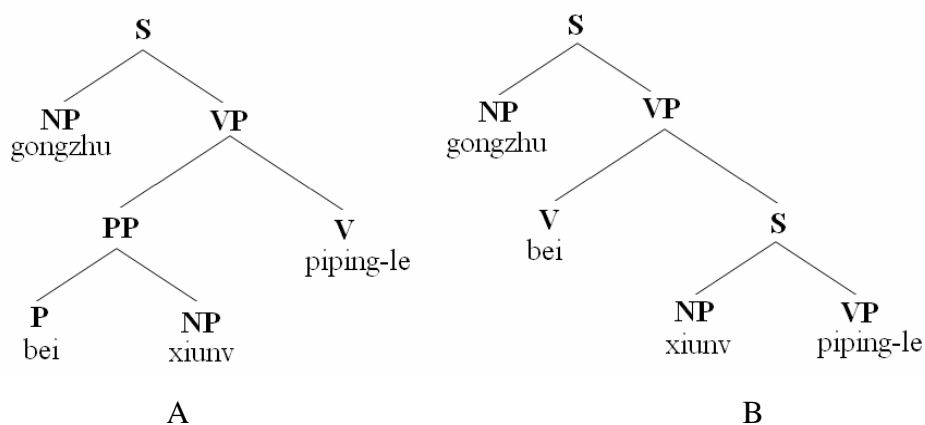

Figure 3.4: Constituent structures for the sentence in (3.15b) according to the preposition analysis (A) and according to the light-verb analysis (B).

Both proposals have pros and cons in the syntactic literature. It is most natural for speakers to package *bei* and the post-*bei* NP as one prosodic unit, suggesting that the two form a single constituent, as argued by the preposition analysis. However, there is also an argument that the post-*bei* NP forms a constituent with the following verb (e.g., Huang et al., 2009). Furthermore, the fact that *bei* can stand without the post-*bei* NP, as in the case of (3.15), seems to argue against the preposition analysis and favours the main-verb analysis. According to the main-verb analysis, the omission of the post-*bei* NP can be treated as a pro-drop phenomenon, which is quite common in Chinese. The main-verb analysis, however, also suffers from some problems. First, *bei* does not occur with aspect markers such as *-le* and *-guo*, as other Chinese main verbs do. Second, an adverb can occur either before *bei* or before the passivized verb (e.g., 3.16), without much change to the meaning. For verbs that take a complement as their argument, such change in adverb position would result in corresponding change in meaning, as in (3.17).

- 3.16. Gongzhu (yanli-de) bei xiunv (yanli-de) piping-le.
 princess (harshly) BEI nun (harshly) criticize-LE.
 (The princess was harshly criticized by the nun).

- 3.17. Gongzhu (hen-renzhe-de) shuo xiunv zai (hen-renzhen-de) xuexi.
 princess (very seriously) say nun be (very seriously) study
 (The princess said very seriously that the nun was studying/ The
 princess said that the nun was study very hard).

Though the two alternative analyses are hard to distinguish on the basis of syntactic introspective/intuitive data, they have different predictions in terms of structural priming. I again use the *bi*-construction as a comparator. According to the preposition analysis but not the main-verb analysis, the constituent structure of the *bei*-construction very much resembles that of the *bi*-construction (see Figure 3.2); thus, the preposition analysis predicts that, relative to a baseline prime, the *bi*-construction should behave more like the *bei*-construction in the priming of active vs. *bei*-construction responses. The main-verb analysis, on the other hand, predicts that the *bi*-construction should behave just like a baseline prime, priming neither active nor *bei*-construction responses. Experiment 3.2 was intended to test these predictions.

3.8.2 Experiment 3.2

Experiment 3.2 investigated the priming of active/*bei*-construction responses (e.g., 3.18) following an active (transitive) prime, a *bei*-construction prime, a *bi*-construction prime or an intransitive baseline prime (3.19a-d).

- 3.18a. Fuwuyuan tishang-le xiaotou.
 waitress kick-wound-LE burglar
 (The waitress kicked and wounded the burglar.)
- 3.18b. Xiaotou bei fuwuyuan tishang-le.
 burglar BEI waitress kick-wound-LE
 (The burglar was kicked and wounded by the waitress.)

- 3.19a. Xiunv piping-le gongzhu. (Active)
 nun criticize-LE princess
 (The nun criticized the princess.)
- 3.19b. Gongzhu bei xiunv piping-le. (*Bei*-construction)
 princess BEI nun criticize-LE
 (The princess was criticized by the nun.)
- 3.19c. Xiunv bi gongzhu zhang de gao. (*Bi*-construction)
 nun than princess grow DE tall
 (The nun grew taller than the princess.)
- 3.19d. Xiunv zhang de hen gao. (Intransitive baseline)
 nun grow DE very tall
 (The nun grew very tall.)

As in Experiment 3.1, all experimental primes and targets contained two random people. Thus, we can rule out priming of animacy-function binding. Also, as the *bi*-construction (3.19c) and the baseline (3.19d) differ in thematic roles from the target responses (e.g., 3.18), there should not be priming in terms of thematic information from the *bi*-construction prime or the baseline. Priming from thematic information is possible in the active prime (3.19a) and the *bei*-construction prime (3.19b). Thus, relative to the baseline, the active prime and the *bei*-construction prime should respectively prime active responses and *bei*-construction responses in terms of both constituent structure and thematic information. Critically, according to the preposition analysis but not the main-verb analysis, the *bi*-construction should prime *bei*-construction responses for constituent structure, relative to the baseline. Taken together, the two alternative analyses of the *bei*-construction have different predictions concerning the production of *bei*-construction responses following the different primes:

3.20a. The preposition analysis:

bei-construction > *bi*-construction > baseline > active

3.20b. The main-verb analysis:

bei-construction > *bi*-construction = baseline > active

Method

Participants. Fifty-two participants from the South China Normal University community were paid 10 RMB (roughly £1) to take part. They were native speakers of Mandarin Chinese. Four participants were excluded from data analyses due to either their failure to follow the instructions or technical failure in recording responses.

Materials. The same materials as in Experiment 3.1 were used except 1) I changed the *ba*-construction prime into the *bei*-construction prime (as in 3.19b), and 2) I replaced a third of the filler prime sentences with *bei*-construction sentences, in order to boost up the production of *bei*-construction sentences.

Procedure. The procedure was as in Experiment 3.1.

Scoring. Responses were encoded as active responses, *bei*-construction responses, or Others. A response was encoded as an active response if it was grammatically and semantically well-expressed and had the Subject-Verb-Object order. A response was encoded as a *bei*-construction response if it was a sentence in the *bei*-construction, with both the Patient and Agent expressed in the sentence. The rest of the responses were encoded as Others.

Results

The results of the experiment are presented in Table 3.2. LME analyses show that there were more active responses than *bei*-construction responses ($z = 8.086$, $p < .001$). There was a main effect of prime type ($\chi^2(3) = 19.05$, $p < .001$). Pairwise comparisons show that the *bei*-construction induced more *bei*-construction responses than the active prime ($z = -3.019$, $p < .01$), the *bi*-construction prime ($z = 3.845$, $p < .001$), and the intransitive baseline prime ($z = 2.15$, $p < .05$); the active prime did not differ from either the *bi*-construction prime or the baseline ($ps > .1$); the *bi*-construction induced fewer *bei*-construction responses than the baseline and the difference was approaching significance ($z = -1.829$, $p = .07$), suggesting that the *bi*-construction behaved more like the active prime rather than the *bei*-construction, relative to the baseline. Analyses of the Other responses showed a main effect of prime type ($\chi^2(3) = 13.471$, $p < .01$). The main effect was mainly driven by more

Other responses in the baseline prime and the *bi*-construction prime conditions (see the distribution of Others in Table 3.2).

Table 3.2: Response counts by prime condition and % of *bei*-construction responses in Experiment 3.2.

Responses	Active	<i>Bei</i> - construction	<i>Bi</i> - construction	Intransitive Baseline
Active	272	260	265	244
<i>Bei</i> -construction	24	46	20	28
Others	83	72	95	104
% of <i>bei</i> -construction	08	15	7	10

3.7.3 Discussion

There was a hierarchy of *bei*-construction > baseline > *bi*-construction = active (no difference between baseline and active, though) in the priming of *bei*-construction responses. The finding that the *bei*-construction prime led to more *bei*-construction responses than any other prime could be due to either constituent structure priming or thematic information priming, or a combination of both types of priming. More importantly, the results do not support the prediction of the preposition analysis that the *bi*-construction should prime *bei*-construction responses (see 3.20a); in fact, relative to the baseline, the *bi*-construction tended to prime active responses rather than *bei*-construction responses. These findings suggest that the *bei*-construction does not have a similar constituent structure to the *bi*-construction, thus disconfirming the preposition analysis.

However, it is unclear whether the *bei*-construction has the syntactic analysis that the main-verb analysis claims it to have (i.e., Figure 3.4B) (see above for both pros and cons for this analysis). Further experiments are needed to test the prediction of the main-verb analysis. One possible experiment is to investigate whether verb-complement sentences such as (3.21a) prime *bei*-construction responses. (3.21a) has a syntactic analysis as in (3.21b), which is similar in terms of constituent structure to

what the main-verb analysis claims the *bei*-construction to have. Thus, the main-verb analysis predicts sentences such as (3.21a) should prime *bei*-construction responses.

- 3.21a. Xiunv shuo gongzhu zhang de gao.
Nun say princess grow DE tall
(The nun said the princess grew quite tall)
- 3.21b. [S Xiunv [VP shuo [S gongzhu zhang de gao]]]

3.9 The mental representation of the *steal*-construction

3.9.1 Alternative analyses of the *steal*-construction

In this section, I examine a construction that I will refer to as the *steal*-construction, as shown in (3.22). In (3.22), *niuzai* (“cowboy”) acts as the person who stole *yiben shu* (“a book”) that belonged to *shuishou* (“sailor”). Superficially, the *steal*-construction is very similar to the double-object (DO) dative construction in Mandarin Chinese, e.g., (3.23). In both cases, there are two NPs following the verb. Thus, some researchers assume the *steal*-construction to have a similar constituent structure as the DO does; that is, it has a syntactic analysis as shown in Figure 3.5A. I will refer to this analysis as *the ditransitive analysis* (e.g., Zhang, 1998), as it stipulates that the verb takes two arguments. For convenience’s sake, I will refer to the first NP (e.g., *niuzai* [“cowboy”]) as NP1, the second NP (e.g., *shuishou* [“sailor”]) as NP2 and the third NP (e.g., *yiben shu* [“a book”]) as NP3.

- 3.22. Niuzai tou-le shuishou yiben shu.
cowboy steal-LE sailor one-CL book
(The cowboy stole a book from the sailor.)

- 3.23. Niuzai song-le shuishou yiben shu.
cowboy give-LE sailor one-CL book
(The cowboy gave the sailor a book.)

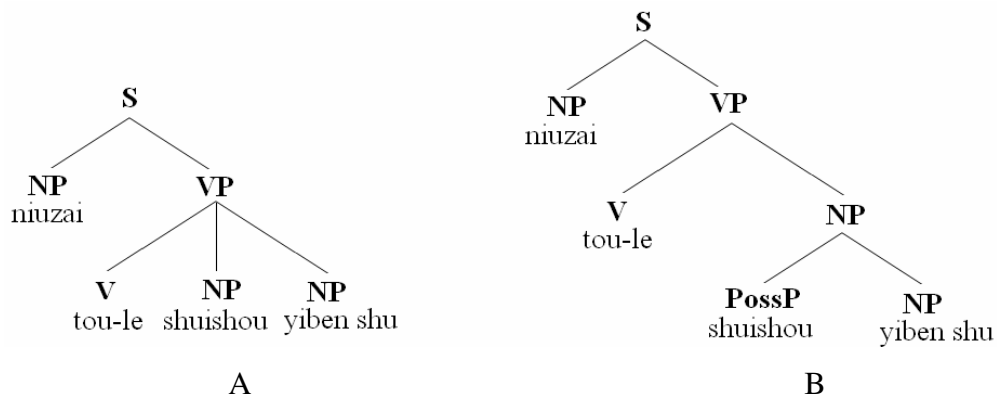

Figure 3.5: Constituent structures for the sentence in (3.22) according to the ditransitive analysis (A) and according to the monotransitive analysis (B).

There are counter arguments against treating the *steal*-construction as a ditransitive construction. First, NP2 differs in terms of thematic roles between the *steal*-construction (Source) and the DO construction (Recipient). Second, some researchers (e.g., Gu, 1999) caution against treating the *steal*-construction as a DO construction because while the DO construction allows NP2 to occur after NP3 (e.g., 3.24a), the *steal*-construction does not (e.g., 3.24b).

3.24a. Niuzai song-le yiben shu gei shuishou
 cowboy give-LE a-CL book to sailor
 (The cowboy gave a book to the sailor.)

3.24b. *Niuzai tou-le yiben shu cong shuishou.
 cowboy steal-LE a-CL book from sailor.
 (Intended: The cowboy stole a book from the sailor.)

Also, it has been observed that though it is possible in the DO construction to question NP2 when NP3 is topicalized (e.g., 3.25a), this is prohibited in the *steal*-construction (e.g., 3.25b) (Liu, 2006).

3.25a. Naben shu niuzai song-gei-le shui?
that book cowboy give-to-LE who?
(Who did the cowboy give the book to?)

2.25b. *Naben shu niuzai tou-le shui?
that book cowboy steal-LE who?
(Intended: Who did the cowboy steal that book from?)

Furthermore, the DO construction (e.g., 3.26a) but not the *steal*-construction (e.g., 3.26b) allows a contextually recoverable argument to be missing (Liu, 2006).

3.26a. Niuzai mai-le yiben shu. Houlai niuzai song-le shuishou \emptyset .
cowboy buy-LE a-CL book. Later cowboy give-LE sailor \emptyset
(The sailor bought a book. Later the cowboy give the sailor the book)

3.26b. *Shuishou mai-le yiben shu. Houlai niuzai tou-le shuishou \emptyset .
sailor buy-LE a-CL book. Later cowboy steal-LE sailor \emptyset
(Intended: The sailor bought a book. Later the cowboy stole it from the sailor.)

These discrepancies between the *steal*-construction and the DO construction have led some researchers to doubt the ditransitive analysis (e.g., Figure 3.5) and to propose the *monotransitive analysis* (e.g., Lin, 2007). The monotransitive analysis of the *steal*-construction sentence of (3.22) is provided in Figure 3.5B. Evidence for the monotransitive analysis comes from the observation that the *steal*-construction (e.g., 3.27a, repeated from 3.22) has a semantically equivalent monotransitive counterpart (e.g., 3.27b). According to such an analysis, the possessive marker *de* in (3.27b) can sometimes be deleted, resulting in a *steal*-construction (3.27a).

3.27a. Niuzai tou-le shuishou yiben shu.
cowboy steal-LE sailor one-CL book
(The cowboy stole a book from the sailor.)

3.27b. Niuzai tou-le shuishou de yiben shu.
cowboy steal-LE sailor DE one-CL book
(The cowboy stole a book from the sailor.)

The two analyses are hard to distinguish on the basis of syntactic introspective data, but they make different predictions concerning whether the *steal*-construction should prime DO responses. According to the ditransitive analysis, the *steal*-construction actually has the same constituent structure as the DO construction, thus it should prime DO responses, relative to a baseline. According to the monotransitive analysis, the *steal*-construction has a different constituent structure than the DO construction; thus the *steal*-construction should not prime DO responses. Experiment 3.3 was intended to test these predictions.

3.9.2 Experiment 3.3

In this experiment, I examined the priming of DO/PO responses following a DO prime (3.28a), a PO prime (3.28b), a *steal*-construction prime (3.28c) or an intransitive baseline prime (3.28d).

- 3.28a. Niuzai huan-gei shuishou yiben shu.
cowboy return sailor one-CL book
(The cowboy returned the sailor a book.)
- 3.28b. Niuzai huan-le yiben shu gei shuishou.
cowboy return-LE one-CL to sailor
(The cowboy returned a book to the sailor.)
- 3.28c. Niuzai tou-le shuishou yiben shu.
cowboy steal-LE sailor one-CL book
(The cowboy stole a book from the sailor.)
- 3.28d. Niuzai zai xiuxi.
cowboy be rest
(The cowboy was resting.)

As the subject in all the experimental prime sentences and the intended target responses (DO or PO) was human, animacy-function binding priming is not an issue here. Furthermore, neither the *steal*-construction nor the baseline have the same set of thematic roles as DO or PO sentences, they should not prime DO or PO sentences

in terms of thematic information. Relative to the baseline, the DO prime and the PO prime should respectively prime DO and PO responses in terms of constituent structure and thematic information. According to the ditransitive analysis but not the monotransitive analysis, the *steal*-construction, relative to the baseline, should prime DO responses in terms of constituent structure. Therefore, the two alternative analyses of the *steal*-construction have the following predictions concerning the production of DO responses following different primes.

3.29a. Ditransitive analysis:

DO > *steal*-construction > baseline > PO

3.29b. Monotransitive analysis:

DO > *steal*-construction = baseline > PO

Method

Participants. Thirty-two participants from the South China Normal University community were paid 10 RMB (roughly £1) to take part. They were native speakers of Mandarin Chinese.

Materials. The materials were similar to those in Experiments 3.1 and 3.2 except that the experimental prime sentences were like those in (3.28) and the target picture depicted a dative event rather than a transitive event. The *steal*-construction prime sentences were constructed using 14 verbs like *tou* “steal” (see Appendix A.2). The filler prime sentences were intransitives and transitives, and filler target pictures depicted either transitive or intransitive events.

Procedure. The experimental procedure was similar to that in Experiment 3.1.

Scoring. I adapted scoring criteria similar to those used in previous studies (e.g., Schoonbaert et al., 2007). All responses were scored as DOs, POs, or Others. A response was encoded as DO when the verb was followed by the Recipient and then the Theme (e.g., *huajua pao-gei xiaochou yige qiu*, [“the artist threw the clown a ball”]); a response was encoded as a PO when the verb was followed by the Theme and then the Recipient (e.g., *huajia pao-le yige qiu gei xiaochou*, [“the artist threw a ball to the sailor”]). The rest of the responses were encoded as Others.

Results

Table 3.3 presents the distribution of these responses in different prime conditions and the proportion of DOs out of DOs and POs.

Table 3.3: Response counts by prime condition and % of DO responses in Experiment 3.3.

Responses	DO	PO	<i>Steal-</i>	
			construction	Baseline
DO	121	75	115	108
PO	60	106	54	77
Others	75	75	87	71
% of DO	67	41	68	58

LME analyses indicate that there were comparable numbers of DO and PO responses ($z = -1.342$, $p > .1$). Prime condition had a main effect ($\chi^2(3) = 42.794$, $p < .001$). Pairwise comparisons show that the PO prime induced fewer DO responses (hence more PO responses) than the DO prime ($z = -5.915$, $p < .001$), the *steal*-construction prime ($z = -5.324$, $p < .001$), and the baseline prime ($z = -3.621$, $p < .001$). The DO prime induced more DO responses than the baseline prime ($z = 2.548$, $p < .05$), but comparable DO responses to the *steal*-construction ($z = .594$, $p > .1$). More importantly, the *steal*-construction induced more DO responses than the baseline prime ($z = 1.924$, $p = .05$). Analyses of the Other responses did not produce a significant main effect of prime type ($\chi^2(3) = 1.8557$, $p > .1$).

3.9.3 Discussion

Experiment 3.3 observed a hierarchy of $\text{DO} = \textit{steal}\text{-construction} > \text{baseline} > \text{PO}$ in the priming of DO responses. Such a finding is very similar to the prediction of the ditransitive analysis of the *steal*-construction (e.g., 3.28a), except that the DO prime did not induce more DO responses than the *steal*-construction prime. The null

difference between DO and the *steal*-construction could be due to a weak thematic effect that is hard to detect (Note that Bock and Loebell [1990] also failed to observe any thematic effect in passive to passive priming relative to locative to passive priming). More importantly, the *steal*-construction prime induced more DO responses than the baseline prime; in fact, the *steal*-construction prime induced as many DO responses as the DO prime did. All together, the results suggest that the *steal*-construction has the same constituent structure as the DO construction does, and hence support the ditransitive analysis.

3.10 General discussion

The three experiments reported above, especially Experiment 3.3, show that structural priming can be used to distinguish alternative syntactic analyses of a syntactic construction. Experiment 3.1 failed to distinguish the two alternative analyses of the *ba*-construction, probably due to a lack of power. Experiment 3.2 found that the *bi*-construction behaved differently from the *bei*-construction, which implies that the two constructions did not have similar constituent structure; such a finding disconfirms the preposition analysis of the *bei*-construction and favours the alternative analysis, that is, *bei* is a main verb taking a sentence complement, as argued for in Huang et al. (2009). Experiment 3.3 revealed that the *steal*-construction led to more DO responses than the baseline, suggesting that it has the same constituent structure as the DO construction, in line with the ditransitive analysis of the *steal*-construction (e.g., Zhang, 1998). These results have clearly demonstrated that structural priming can tap into the mental representation of a syntactic construction and provide evidence concerning controversial issues in syntactic analyses.

Therefore, structural priming can serve as an experimental approach to investigate the mental representation of syntax. Such an approach has several merits. Experimental in nature, structural priming is immune to reliability problems associated with the traditional approach (See Section 2.3.3.1 for some discussion). More importantly, compared with other approaches, it has the advantage of being free of confounds from processibility and plausibility factors. Processibility often affects people's judgement of the accessibility of a sentence; a sentence may be less

acceptable not because it is less grammatical but simply because it is harder to process (e.g., Bever, 1970). There is good evidence that structural priming occurs for difficult sentences that have been found to lead to garden path (LeDoux, Traxler, & Swaab, 2007; Tooley et al., 2009; Traxler, 2008b; Traxler & Tooley, 2008). For instance, Tooley et al. (2009) found that a reduced relative clause was easier to process when it was preceded by another reduced relative clause, a suggestion of structural priming. Thus, we can conclude that structural priming is not as sensitive to processibility as introspection and reading time methods are. In regard with plausibility, Christianson, Luke, and Ferreira (2010) found that although plausible passive primes (e.g., *the man was bitten by the dog*) led to more passive responses than plausible active primes (e.g., *the dog bit the man*), as repeatedly observed in the literature (e.g., Bock, 1986b; Bock & Loebell, 1990), implausible active primes (e.g., *the man bit the dog*) led to more passive responses than implausible passive primes (e.g., *the dog was bitten by the man*). Such an effect may be interpreted as a plausibility effect on structural priming. However, such a conclusion should be taken with caution, as the effect could have been a result of conscious reanalysis (for instance, deliberately interpreting *the dog was bitten by the man* as a more plausible sentence such as *the dog bit the man*). Such a scenario is quite likely considering the fact that many sentences in Christianson et al.'s study were implausible sentences that might have been deliberately re-interpreted.

Though structural priming can be used to detect the constituent structure of some controversial constructions, it should be noted that there may be some limitations. First, in case of structural priming in production (as in the experiments reported here), the scope of application may be limited due to its requirement of structural alternation. So far, researchers have explored structural alternations such as DO/PO, actives/passives, adjective vs. relative clause modification in NP construction, verb-participle alternation and so on (see Pickering & Ferreira, 2008). Of course, when appropriate structural alternatives are not available, one can turn to structural priming in comprehension or use appropriate structural alternatives in another language in cross-language priming (see Chapter 7 for more discussion on these issues). Another limitation is that although structural priming can sometimes rule out possibilities (i.e., shows that two constructions are not represented as related),

it cannot show how the construction in question is represented in these cases (i.e., when the construction in question is not represented in the same way as another alternative). Such is the case in Experiment 3.1, where the comparator, the *bi*-construction, did not prime either canonical transitive responses or *ba*-construction responses. Though these results suggest that the *ba*-construction is probably not represented similarly as the *bi*-construction is, there is no way we can infer from these results how the *ba*-construction is represented. A solution, then, is to seek an alternative comparator that may resemble the *ba*-construction in terms of constituent structure (e.g., the verb-complementizer construction, as suggested in Section 3.7.3).

Chapter 4 The use of syntactic and thematic information in language production: Evidence from structural priming in Mandarin Chinese

4.1 Overview of the chapter

Cross-linguistic evidence has questioned the mechanisms of grammatical encoding that have been proposed on the basis of evidence from English and related languages (e.g., Branigan et al., 2008). I used a structural priming paradigm to investigate grammatical encoding in Mandarin Chinese to examine 1) whether conceptual information affects positional processing as well as functional processing; and 2) whether grammatical encoding draws on verb argument structure. The results show that speakers of Mandarin Chinese tended to repeatedly map particular thematic roles to particular word order positions, irrespective of grammatical functions. Additionally, speakers tended to repeat argument structure across sentences, independently of constituent structure. These findings suggest that conceptual information can influence both functional processing and positional processing, and that grammatical encoding is lexically guided to some extent.

4.2 Introduction

Although speakers appear to produce most utterances effortlessly, they actually perform many complicated processes to get from an initial idea to sound. Three major stages have been identified, concerned with developing the idea or message (*conceptualization*), converting that idea into linguistic representations (*formulation*), and articulation (Levelt, 1989). In this chapter, I am concerned with two aspects of this general model, focusing on *grammatical encoding*, or the way in which speakers develop a grammatical representation of an utterance: First, I consider the nature of

the information flow between conceptualization and different stages of grammatical encoding; second, I consider the extent to which grammatical encoding is guided by the properties of particular words (V. S. Ferreira & Slevc, 2007).

The most influential model of production so far is that sketched in Bock and Levelt (1994), though other models which differ in some details have also been proposed (e.g., Garrett, 1980; Vigliocco & Hartsuiker, 2002). In Bock and Levelt's model, a pre-linguistic message or conceptual structure encoding information such as event participants, their roles in the event, and their animacy, definiteness and emphasis (see Levelt, 1989), is constructed out of the communicative intention. Subsequently, grammatical encoding takes place: Lemmas for the semantic elements in the conceptual message (e.g., nouns for event participant and verbs for events) are accessed and grammatical functions are assigned to these lemmas, a stage which is referred to as *functional processing*; then in the next stage (*positional processing*), the processor retrieves wordforms corresponding to the lemmas and assigns these to appropriate word order positions (e.g., the subject usually precedes the verb in English), resulting in a constituent structure of the sentence. Functional processing and positional processing are commonly viewed as two distinct stages of grammatical encoding.

Although there is broad agreement about the overall architecture of the processor, there is less consensus concerning the details of grammatical encoding. For example, previous studies of English have suggested that conceptual information influences functional processing but not positional processing (e.g., McDonald, Bock, & Kelly, 1993), but recent studies on other languages suggest that conceptual factors can affect constituent order (e.g., Branigan & Feleki, 1999; Branigan, Pickering, & Tanaka, 2008; Jaeger & Norcliffe, 2008; Kempen & Harbusch, 1994; Myachykov & Tomlin, 2008). Equally, Bock and Levelt (1994) assumed that grammatical encoding involves minimal lexical guidance, with the constituent structure being a stored syntactic frame that is retrieved on the basis of functional assignment, whereas other researchers take a different position, suggesting that the constituent structure is constructed dynamically on the basis of information associated with the verb (e.g., F. Ferreira, 2000).

To investigate these issues, I examined production in Mandarin Chinese, a language with relatively free word order, and which therefore allowed us to distinguish between effects associated with grammatical function assignment and effects associated with word order. To do this, I exploited the tendency for speakers to repeat the form of utterances that they have recently produced or comprehended (e.g., Bock, 1986b). In this chapter, I will use the term *structural priming* to refer to this tendency to repeat any abstract aspect of the form of utterances (note that the terms structural priming and syntactic priming have hitherto been used relatively interchangeably). Structural priming has been extensively exploited in the investigation of the mapping from conceptualization to grammatical encoding (Bock, Loebell, & Morey, 1992; Chang, Bock, & Goldberg, 2003), the mechanisms that underlie grammatical encoding (Bock, 1989; Bock & Loebell, 1990), and the linearization of constituents (Hartsuiker & Westenberg, 2000).

There is considerable evidence that structural priming is sensitive to different aspects of structure (Pickering & Ferreira, 2008), including the persistence of thematic information as well as syntax (e.g., Bernolet, Hartsuiker, & Pickering, 2009; Chang et al., 2003). Following these studies, I propose that structural priming has at least a syntactic component (which I will refer to as *syntactic priming*) and a thematic component (which I will refer to as *thematic priming*). Of course, this makes syntactic priming a theory-laden term, because linguistic theories make different assumptions about syntax (e.g., Chomsky, 1981; Goldberg, 1995; Pollard & Sag, 1994). Following practice in psycholinguistics (e.g., Carlson & Tanenhaus 1988, Stowe 1989), I assume here that representations associated with thematic roles (Agent, Theme, Recipient, etc.) are concerned with abstract aspects of meaning and are therefore not syntactic.

4.3 Syntactic information in sentence production

What constitutes syntactic information depends on the grammatical framework that is adopted. In this chapter, I will focus on the *constituent structure* of a sentence and the *argument structure* of the verb. Constituent structure encodes the actual hierarchical and linear organization of constituents such as NP, V, and PP. For instance, a double-object (DO) dative sentence such as *the cowboy gave the sailor a*

book has the constituent structure [S NP [VP V NP NP]], whereas a prepositional-object (PO) dative sentence such as *the cowboy gave a book to the sailor* has the constituent structure [S NP [VP V NP PP]], and a shifted-PO sentence such as *the cowboy gave to the sailor a book* has the constituent structure [S NP [VP V PP NP]].

Argument structure, on the other hand, is a lexical property associated with the verb's lexical entry (e.g., Grimshaw, 1990; Levin, 1993). A verb like *give* allows different structural alternatives onto which thematic roles associated with the event of giving can be mapped. For instance, the DO sentence and the PO sentence above use different argument structures of the verb *give*, while a shifted-PO sentence has the same argument structure as the PO sentence. Note that although argument structure tends to overlap with functional structure - for example, a PO sentence and a shifted-PO sentence share the same functional structure, with the functions subject, object and oblique object - the two notions are distinct: Argument structure is a lexical property while functional structure is a sentential property; and a verb can have two argument structures that can be syntactically realized in the same functional structure (e.g., *the man sprayed wax on the car* vs. *the man sprayed the car with wax*).

A number of studies have provided evidence that structural priming need not result from the repetition of lexical items (e.g., Bock, 1989), thematic roles, or prosody (e.g., Bock & Loebell, 1990), and hence that some structural priming is syntactic in nature. Importantly, Bock and Loebell (1990) demonstrated that an active locative sentence with a locative by-phrase (e.g., *the foreigner was loitering by the blinking traffic light*) primed the production of a passive sentence with an agentive by-phrase such as *the boy was stung by the bee* (and did so to the same extent as did a passive prime, such as *the foreigner was confused by the blinking traffic light*, though Potter and Lombardi, 1998, found reduced locative-to-passive priming compared to passive-to-passive priming). Note that the locative sentence has the same constituent structure as a passive sentence (i.e., NP-V-PP), suggesting that the locus of priming was the repetition of constituent structure.

In support of this, Hartsuiker and Westenberg (2000) found that Dutch speakers tended to repeat the order of verb and auxiliary, for instance producing the Dutch equivalent of "I couldn't pass through because the road blocked was" more

often after another sentence with verb-auxiliary order than after a (meaning- and thematically-equivalent) sentence with auxiliary-verb order. Similarly, Konopka and Bock (2009) found priming of order of noun phrase and particle (*pull off a sweatshirt* vs. *pull a sweatshirt off*). V. S. Ferreira (2003) demonstrated that whether speakers use the optional complementizer *that* is influenced by whether a prime sentence contains a syntactically similar *that* (e.g., *the company insured that the farm was covered for two million dollars*) but not by whether a prime contains a lexically similar pronominal *that* (e.g., *the company insured that farm for two million dollars*). Apart from ruling out a thematic account of all structural priming effects, these studies suggest that a syntactic component of structural priming reflects the surface constituent structure, which is based on the actual order of constituents rather than a putative underlying structure (see Bock, Loebell, & Morey, 1992).

But it is also possible there is another syntactic component of structural priming, with a locus in argument structure. For instance, Melinger and Dobel (2005) found in both German and Dutch that the presentation of a DO-only verb or PO-only verb in isolation primed people to produce a sentence with a DO or PO structure (and Salamoura & Williams, 2006, found similar results in a cross-linguistic study). Note that no overt constituent structure or thematic information is available in the prime verb; thus, it is unlikely that the priming effect was due to constituent structure or thematic information. More importantly, as there is no functional structure in a single verb, the effect cannot be attributed to priming from functional structure. A straightforward account, then, is that the priming is due to the activation of the argument structure associated with the verb's lexical entry: DO-only and PO-only verbs respectively activated the DO or PO argument structure and led to the production of DO or PO sentences. Note that in a sentence context, the same argument structure can be projected into different constituent structures; therefore, one way to identify (syntactic) priming based on argument structure is to observe whether priming occurs between sentences that differ in constituent structure but share same argument structure.

Whether people repeatedly use the same argument structure of the verb can also help resolve the debate about whether grammatical encoding is frame-based or lexically based. A recent study by Wardlow Lane and Ferreira (2010) seemed to

provide evidence for the frame-based account. They found that in stem-exchange errors (for instance, producing *records the hate* when *hates the record* is intended), people changed the intended nominal form (e.g., *REcord*) into the produced verb form (e.g., *reCORD*) in a VP syntactic context but not in a coordinate NP phrase (e.g., *records and hates*). These results suggest that people don't simply access the wrongly produced verb form regardless of the syntactic context. Instead, reverting from the nominal form to the verb form is driven by syntactic context, supporting the frame-based model. Such a conclusion, however, is inconsistent with the observation that the choice of syntactic structure in language production is a function of verb type, implying an important role for lexical content in structure choice (e.g., F. Ferreira, 1994). Evidence of priming for argument structure would provide further support for a lexical account of grammatical encoding: Because argument structure is arguably a lexical property, the persistent use of argument structure would suggest that grammatical encoding is lexically guided to some extent.

4.4 Thematic information in sentence production

Thematic information refers to the roles that noun phrases (NPs) assume in the event described by a sentence. For instance, in a sentence such as *the cowboy hit the sailor*, the NP *the cowboy* is the entity that carries out the action of hitting while the NP *the sailor* is the entity that is being acted upon. Though there is wide disagreement over the characterization of thematic roles (e.g., Dowty, 1991; Jackendoff, 1983; Fillmore, 1968), in this chapter, I follow practice in psycholinguistics (e.g., Carlson & Tanenhaus, 1988, Stowe, 1989) and identify thematic roles as Agent, Patient, Recipient, Theme etc. Furthermore, I assume thematic roles are semantic (or conceptual) primitives in the pre-linguistic message or conceptual structure (Jackendoff, 1987; Levelt, 1989), rather than syntactic constructs (Chomsky, 1981), and that they are tagged in the conceptual structure for discourse information such as emphasis and definiteness (e.g., Levelt, 1989). I assume further that thematic roles are assigned to syntactic elements such as constituents or grammatical functions during syntactic processing (e.g., Bock & Levelt, 1994). Though it is generally assumed that thematic roles are unordered in the conceptual structure (Jackendoff, 1987), I assume that the processor makes associations between particular thematic

roles and particular elements of the linguistic structure. There are two possible ways such mappings might occur. First, the processor might associate particular thematic roles with particular grammatical functions. This account is consistent with the proposal that conceptual information influences only functional processing. Second, the processor might instead - or additionally – persist in expressing thematic roles in a particular surface order. The processor, for instance, may persist in mapping all the thematic roles onto the *absolute* order (e.g., Agent mapped to first NP, Recipient mapped to second NP and Theme mapped to third NP in a DO sentence such as *the cowboy gave the sailor a book*); alternatively, it may only maintain the relative order of some (relevant) thematic roles (e.g., the Recipient precedes the Theme in a DO sentence and the reverse in a PO sentence). At this point, I do not distinguish between these two possibilities. The mapping of thematic roles to a particular linear order is plausible given the evidence that conceptual information influences word order (e.g., Branigan et al., 2008). Given these alternative mappings, it may therefore be possible to prime the relationship between thematic roles and grammatical functions (the *function mapping account*), the order of thematic roles (i.e., the relationship between thematic roles and word order; the *linear mapping account*), or both.

Chang et al. (2003) argued for a function mapping account. They found that participants were more likely to produce a *spray-on* sentence in which the Theme is mapped onto the direct object and the Recipient onto the oblique object (e.g., *the workers scuffed dirt across the kitchen floor*) after another *spray-on* sentence (e.g., *the man sprayed wax on the car*) than after a *spray-with* sentence (e.g., *the man sprayed the car with wax*) in which the Recipient is mapped on the direct object and the Theme onto the oblique object. However, these data are equally compatible with the linear mapping account, with participants perseverating in Theme-Recipient or Recipient-Theme order. In fact, Hare and Goldberg (1999) argued for linear mapping on the basis of their finding that *provide-with* sentences (e.g., *the officers provided the soldiers with guns*) primed DO responses rather than PO responses, even though *provide-with* sentences share surface constituent structure [V NP PP] with PO sentences rather than DO sentences (Note, however, that they used a design in which participants were repeatedly exposed to one type of prime sentence

throughout the experiment). Also, the results are not compatible with the function mapping account as a *provided-with* sentence and a DO sentence do not share the same mapping between thematic roles and grammatical functions.

To complicate matters further, Bernolet et al. (2009) proposed another account of thematic priming, in which people tend to persist in the assignment of emphasis (i.e., focus) to particular thematic roles (the *thematic emphasis account*). They found that participants were more likely to produce English active sentences after Dutch PP-initial passives (e.g., *door de bliksem wordt de kerk getroffen*, literally “by lightning is the church struck”) than after other types of Dutch passives in which the PP *door de bliksem* (“by lightning”) does not occur sentence-initially. They argued that this occurred because actives and PP-initial passives emphasize the Agent, in contrast to other English or Dutch passives. Such priming would occur during conceptualization, because assignment of emphasis to thematic roles involves purely semantic processes.

It is therefore possible that the results of Chang et al. (2003) and Hare and Goldberg (1999) are at least partly due to priming of thematic emphasis. Assuming that a thematic role receives more emphasis when it is placed in a higher grammatical function (e.g., subject) or an earlier sentence position (e.g., the initial position), a *spray-with* sentence in Chang et al.’s (2003) study, then, places more emphasis on the Goal than on the Theme. In order to maintain the emphasis on the Goal, participants tended to produce *spray-with* sentences rather than *spray-on* sentences after a *spray-with* prime. Similarly, a *provide-with* sentence places more emphasis on the Recipient rather than on the Theme, hence priming a DO sentence (which places the Recipient in a higher grammatical function or earlier position) rather than a PO sentence. However, such a thematic emphasis explanation requires that the post-verbal arguments differ markedly in emphasis between the alternative sentences considered in those studies. It may in fact be that strong emphasis is typically limited to subjects or first-mentioned constituents (or probably constituents receiving stress or other clear prosodic marking) (e.g., Levelt, 1989). If so, priming effects for the dative alternation would not be due to thematic emphasis.

4.5 Interaction of syntactic and thematic information in sentence production

The studies reviewed above suggest that the observed tendency to repeat structure may often reflect a combination of syntactic and thematic priming. In some cases, as in those described above, the two sources of priming may facilitate the same structural choice, but in other cases they may favour different choices. For example, consider dative constructions in English, which have been shown to be strongly malleable to structural priming (e.g., Bock, 1986b; Pickering & Branigan, 1998; Potter & Lombardi, 1998). Pickering et al. (2002) showed that though both DO and PO led to more DO and PO responses than the baseline, shifted-PO (e.g., *the racing driver showed to the helpful mechanism the torn overall*) behaved like an intransitive baseline (i.e., priming neither DO nor PO responses). Pickering et al. interpreted these effects in terms of syntactic priming, suggesting that shifted PO sentences did not prime DO or PO responses because they did not share word order with either structure. But their findings could have reflected joint influences of syntactic and thematic priming: Because shifted-PO sentences have the same thematic ordering (i.e., Recipient-Theme) as DO sentences, they may thematically prime DO responses. If so, then shifted-PO sentences would simultaneously thematically prime DO sentences and syntactically prime the argument structure of PO sentences; the two effects would therefore cancel each other out, yielding the pattern of effects observed by Pickering et al.

By investigating patterns of priming following non-canonical dative constructions such as shifted-PO, it is therefore possible to explore the possible mechanisms of thematic effects on grammatical encoding. If thematic priming in datives reflects persistence of mapping thematic roles to grammatical functions, this would support the proposal that conceptual information mainly influences functional processing (e.g., Bock & Warren, 1985). If in contrast thematic priming reflects persistence of mapping analogous thematic roles in the same linear order, this would support a production mechanism where conceptual information influences positional processing as well as functional processing (Branigan et al., 2008). Patterns of priming can also shed light on the debate as to whether grammatical encoding is lexically guided (e.g., V. S. Ferreira & Slevc, 2007). Argument structure can be viewed as a lexical property of the verb (e.g., Levin, 1993; Grimshaw, 1990); thus if

the argument structure of the verb can be primed in production, it would support a lexicalist approach to grammatical encoding.

In order to investigate thematic priming and syntactic priming in datives, we need dative constructions where thematic information and syntactic information can be independently manipulated. I therefore turn to Mandarin Chinese, a language that allows flexible constituent order in datives.

4.6 Dative, topic and *ba*- constructions in Mandarin Chinese

Mandarin has dative alternations, so that a message of a cowboy giving a sailor a book can be expressed in many ways (4.1-4.3). For example, it allows a DO structure (4.1a) or a PO structure (4.1b). The message can also be expressed in a topic construction (4.2a,b), where a constituent is topicalized and appears in the topic (often sentence-initial) position (Li & Thompson, 1981). For instance, the direct object (the bearer of the Theme) in a DO can be topicalized, resulting in a Topic-DO (4.2a); similarly, the oblique object (the bearer of the Theme) in a PO can be topicalized to result in a Topic-PO (4.2b). A further possibility that is common in Mandarin Chinese is the *ba*-construction (4.3), where the indirect object of a DO (e.g., *naben shu* [“that book”]) occurs preceding the verb (e.g., *song-gei* [“give-to”]). It expresses affectedness (or disposal) of a forwarded object NP (Chao, 1968; Wang, 1954; here *the book* was being given to another person), and can apply to a DO but not a PO.

- 4.1a. Niuzai song-gei le shuishou naben shu. (DO)
cowboy give-to LE⁶ sailor that book
(The cowboy gave the sailor that book.)
- 4.1b. Niuzai song le naben shu gei shuishou. (PO)
cowboy give LE that book to sailor
(The cowboy gave that book to the sailor.)

⁶ The morpheme/character *le* is an aspectual marker in Mandarin Chinese to indicate the finished state of an action.

- 4.2a. Naben shu niuzai song-gei le shuishou. (Topic-DO)
 that book cowboy give-to LE sailor
 (That book the cowboy gave the sailor.)
- 4.2b. Naben shu niuzai song le gei shuishou. (Topic-PO)
 that book cowboy give LE to sailor
 (That book the cowboy gave to the sailor)
- 4.3. Niuzai ba naben shu song-gei le shuishou. (Ba-DO)
 cowboy BA that book give-to LE sailor
 (The cowboy had the book given the sailor).

These constructions allow us to disentangle syntactic and thematic priming, and different accounts of thematic priming, in ways not possible in English or related languages. First, Topic-DO and Ba-DO sentences can help us contrast the function mapping account and the linear mapping account. The function mapping account predicts that Topic-DO and Ba-DO sentences should prime DO responses, because all three structures share the same thematic role to grammatical function mappings, with the Recipient being mapped to the direct object and the Theme being mapped onto the indirect object. The linear mapping account, on the other hand, predicts that Topic-DO and Ba-DO sentences, should prime PO responses, because all three structures share the same Theme-Recipient (relative) linear order. Second, these constructions allow us to determine whether there is syntactic priming based on repetition of argument structure, because Topic-DO and DO share the same argument structure despite having different constituent structures; similarly, Topic-PO and PO share argument structure but not constituent structure. Hence if there is a locus of priming based on argument structure, Topic-DO sentences should prime DO sentences and Topic-PO sentences should prime PO sentences.

I begin by examining whether there are differences in thematic emphasis for the Recipient and the Theme across different dative constructions. I first report two studies (Experiments 4.1 and 4.2) that tested whether there are differences in thematic emphasis associated with different grammatical functions or linear positions for the Theme and the Recipient. In Experiments 4.3 and 4.4, I aim to contrast the

function mapping account and the linear mapping account. Then in Experiment 4.5, I report an experiment that investigated the possible role of argument structure in syntactic priming.

4.7 Experiment 4.1

Experiment 4.1 tested whether DO, PO and Ba-DO sentences (4.4a-c) differ in emphasis (i.e., focus) on the Theme and the Recipient. Following Bernolet et al. (2009), I asked participants to read the sentences in (4.4a-c) and choose which of the two underlined and numbered thematic roles (the Theme and the Recipient) was the more emphasized. Participants were given examples as to what emphasis meant in the experiment.

- 4.4a. Niuzai song-gei le shuishou naben shu. (DO)
 1 2
 cowboy give-to LE sailor that book
 (The cowboy gave the sailor that book.)
- 4.4b. Niuzai song le naben shu gei shuishou. (PO)
 1 2
 cowboy give LE that book to sailor
 (The cowboy gave that book to the sailor.)
- 4.4c. Niuzai ba naben shu song-gei le shuishou. (Ba-DO)
 1 2
 cowboy BA that book give-to LE sailor
 (That book the cowboy gave the sailor.)

Method

Participants. Twenty-eight native speakers of Mandarin Chinese from the University of Edinburgh community were paid 1 pound to take part.

Materials. There were 18 sets of triplets as in (4.4) and 48 transitive filler sentences. For dative target sentences, the Theme and the Recipient were underlined and numbered, as in (4.4). For transitive fillers, the Agent and the Theme were underlined and numbered.

Procedure. The experiment was conducted in E-prime. All the sentences were individually pseudo-randomized. Participants were first instructed how to do the experiment with transitive active and passive examples. There are 3 practice items before the experiment. In the experiment, participants first saw a sentence in one frame and then decided which underlined noun phrase is the more emphasized one by pressing a key (*F* for the noun phrase underlined with 1 and *J* for the noun phrase underlined with 2). The experiment lasted for about 10 minutes.

Results

As the dependent variable was binomial in this experiment and the following experiments, I used logit mixed effects (LME) modelling for statistical analyses (see Jaeger, 2008). I first built a null model with only subject and item as random intercepts. A factor or variable is assumed to have a significant main effect if its addition to a model significantly improves the goodness of fit to the data. The main effect is measured in terms of log-likelihood ratio χ^2 test. To work out the details of a significant main effect, I also report pairwise comparisons among the levels of the factor; pairwise comparisons are reported with z scores and associated p-values.

Table 4.1: Counts of emphasized elements and proportion of Theme emphasis in Experiment 4.1.

Sentence type	DO	PO	Ba-DO
Recipient	58	49	51
Theme	110	119	117
% of Theme	65	71	70

I scored whether participants chose the Theme or the Recipient as the more emphasized thematic role (see Table 4.1; for ease of comparison, I also report proportions). LME analyses show that the Theme was considered to be more emphasized on more trials than the recipient ($z = 3.585$, $p < .001$). Sentence type did not produce a significant main effect ($\chi^2(2) = 1.111$, $p > .1$), suggesting that the neither the Theme nor the Recipient received different emphasis across sentence

types. Pairwise comparisons indicate no difference between DO and PO ($z = 1.08$, $p > .1$), between DO and Ba-DO ($z < 1$) or between PO and Ba-DO ($z < 1$).

Discussion

Although participants treated the Theme as the more emphasized, perhaps because it was preceded by the definite demonstrative (e.g., *naben* [“that”]), emphasis did not depend on sentence type. Most likely this reflects the fact that none of the conditions involved manipulation of the subject or first-mentioned phrase. These results suggest that these constructions do not differ in thematic emphasis (and hence any differences in priming between these constructions would not be due to priming of thematic emphasis). However, Experiment 4.1 depended on overt judgments of emphasis; we would be more confident of the results if we found a similar pattern in an experiment that manipulated emphasis implicitly.

4.8 Experiment 4.2

Experiment 4.2 directly tested whether there is any thematic priming due to thematic emphasis in canonical datives. If the Theme or the Recipient is more emphasized in DO or PO than in the other construction, then we would be able to prime the Theme-emphasized construction using a prime that emphasizes the Theme and to prime the Recipient-emphasized construction using a Recipient-emphasized prime, given the thematic emphasis priming effects observed in Bernolet et al. (2009).

Thematic emphasis can be realized syntactically, for instance, by making a thematic role as the subject or the topic, but such syntactic manipulation would also introduce constituent structure change. Thus, I instead manipulated thematic emphasis by a discourse means. I assume that new information is often the emphasis of a sentence (e.g., Levelt, 1989). For example, if the sentence *The cowboy hit the sailor* is an answer to the question *Who hit the sailor?*, then *the cowboy* is the new information and is often emphasized (that is why people would often stress *the cowboy* in this case). However, if the sentence is an answer to the question *Who did the cowboy hit?*, then *the sailor* is the new information and the emphasis of the sentence. In this experiment, I created texts that resembled mini-dialogues where the answer conveys something (either the Recipient or the Theme) new and thus make it

the emphasis of the sentence (see 4.5a-d). For instance, the question in (4.5a) inquires about the Recipient and thus the Recipient in the answer becomes the emphasis in the sentence.

4.5a. DO, Recipient-emphasized

Q: Niuzai song-gei le shui yiben shu?
cowboy give-to LE who a book
(Who did the cowboy give a book?)

A: Niuzai song-gei le shuishou yiben shu.
cowboy give-to LE sailor a book
(The cowboy gave the sailor a book.)

4.5b. DO, Theme-emphasized

Q: Niuzai song-gei le shuishou shenme-dongxi?
cowboy give-to LE sailor what
(What did the cowboy give the sailor?)

A: Niuzai song-gei le shuishou yiben shu.
cowboy give-to LE sailor a book
(The cowboy gave the sailor a book.)

4.5c. PO, Recipient-emphasized

Q: Niuzai song le yiben shu gei shui?
cowboy give LE a book to who
(Who did the cowboy give a book to?)

A: Niuzai song le yiben shu gei shuishou.
cowboy give LE a book to sailor
(The cowboy gave a book to the sailor.)

4.5d. PO, Theme-emphasized

Q: Niuzai song le shenme-dongxi gei shuishou?
cowboy give LE what to sailor
(What did the cowboy give to the sailor?)

A: Niuzai song le yiben shu gei shuishou.
cowboy give LE a book to sailor
(The cowboy gave a book to the sailor.)

The experiment had a 2 (construction: DO vs. PO) * 2 (emphasis: Recipient-emphasized vs. Theme-emphasized) design, resulting in four conditions as in (4.5a-d). The same verb was used between the prime and the target to enhance priming effects (e.g., Pickering & Branigan, 1998) so that emphasis effect, if any, would be more detectable. The repetition of the verb across prime and target was also followed in Experiments 4.3-4.5 below (except when the prime was an intransitive baseline).

Method

Participants. Twenty-eight people were recruited from the student community in Guangdong University of Foreign Studies, China. They were paid 10 RMB (roughly £1) to take part in the experiment. One participant was dropped due to his/her failure to follow the instructions in describing the pictures.

Materials. There were 24 experimental items and 72 fillers. Each item consisted of a mini-dialogue (the prime dialogue), a prime picture and a target picture (see Figure 4.1). Experimental prime dialogues were like those in (5a-d). Filler dialogues were composed of transitive and intransitive sentences. The prime picture had a verb printed at the bottom of the picture and the verb was always the same across the prime dialogue and the corresponding prime picture (see Figure 4.1). Half of these pictures matched the answer in the prime dialogue and the other half did not. For prime pictures that did not match, there was either a difference in the Agent, the Theme or the Recipient between answer in the mini-dialogue and the prime picture. The target picture was unrelated to the prime dialogue or the prime picture. Experimental target pictures depicted dative events. The target picture had a sentence preamble (with the verb) which could be only continued as a DO or a PO sentence. Filler target pictures either depicted transitive or intransitive events and sentence preambles were also provided. In this experiment (and also in Experiments 4.3-4.6), the verb was repeated between prime and target for all experimental items and for a third of the filler items (except in the baseline condition, if applicable), so that overall, the verb was repeated in half of the trials.

Procedure. I used the picture-matching structural priming paradigm, except that primes sentences were presented visually instead auditorily. The experiment was run with DMDX on a computer. There was individual randomization of the materials

for each participant. The order of all materials was randomized in such a way that two target trials were separated by 2-4 filler trials. Participants were first familiarized with the figures (e.g., cowboy) and objects (e.g., book) that were to appear in the experiment. Then they were given instructions with examples as to how to do the experiment. The experiment began with 4 practice trials. In the experiment, a line of dashes first appeared on the computer screen. After participants pressed the spacebar, the question of the mini-dialogue appeared. After comprehending the question, participants pressed the spacebar to retrieve the answer to the question. When they had comprehended the answer, they pressed the spacebar to retrieve the prime picture. They then decided whether the picture matched the dialogue (especially the answer in the dialogue) by pressing the *F* key (for a match) or the *J* key (for a mismatch). Once the choice was made, the target picture appeared and participants described the picture by first repeating the sentence preamble, using Mandarin Chinese. See Figure 4.1 for an illustration of the procedure. The experiment took about 30 minutes.

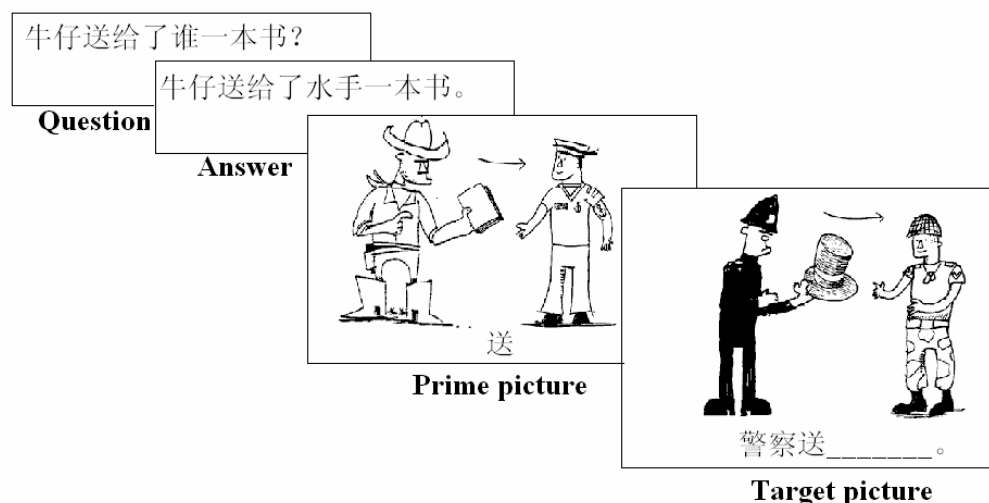

Figure 4.1: Experiment procedure in Experiment 4.2. The question is translated literally as “the cowboy gave whom a book?”; the answer is translated literally as “the cowboy gave the sailor a book.”; the prime picture has the verb *song* [“give”] printed at the bottom; the target picture has the sentence preamble *jingcha song* [“the policeman give”] _____ .

Data encoding. As standard practice in structural priming studies (e.g., Pickering & Branigan, 1998), all the productions were encoded as DOs, POs or

Others. A response was encoded as a DO when the verb was first followed by the Recipient and then the Theme (e.g., *jingcha song-gei shibing yiding maozi*, [“the policeman gave the soldier a hat”]), and encoded as a PO when the verb was first followed by the Theme and then the Recipient (e.g., *jingcha song-le yiding maozia gei shibing*, [“the policeman gave a hat to the soldier”]). The rest were encoded as Others, which mainly included the following cases: 1) when there was a change in the sentence preamble (e.g., when the verb was changed); 2) when the response was ungrammatical (e.g., *jingcha song-gei yiding maozi gei shibing*, [lit, “the policeman give-to a hat to the soldier”]); 3) when the Theme or the Recipient was missing (e.g., *jingcha song maozi*, [“the policeman gave a hat”]) and 4) when there was no response. This method of data encoding was adopted for this experiment and the following ones. This way of data encoding was followed in the following experiments.

Results

The results of the experiment are presented in Table 4.2. LME analyses show that there were more PO responses than DO responses (327 vs. 129, $z = 5.143$, $p < .001$). Construction had a significant main effect ($\chi^2(1) = 129.62$, $p < .001$): DO sentences led to more DO responses (thus less PO responses) than PO responses ($z = 9.221$, $p < .001$). Emphasis did not produce a significant main effect ($\chi^2(1) < 1$), suggesting that Theme-emphasized sentences did not lead to more PO responses (hence less DO responses) than Recipient emphasized sentences ($z = .369$, $p > .1$). There was no interaction between construction and emphasis ($\chi^2(1) < 1$). Analyses of the Other responses indicate that there were no main effects of construction and emphasis nor interaction between them in the distribution of Other responses.

Table 4.2: Response counts by prime condition and % of DO responses in Experiment 4.2.

Prime	DO, Recipient-emphasized	DO, Theme-emphasized	PO, Recipient-emphasized	PO, Theme-emphasized
DOs	60	57	12	11
POs	90	97	140	140
Others	12	8	10	11
% of DOs	40	37	8	7

Discussion

The results indicate that emphasis on either the Theme or the Recipient in datives does not persist in the subsequent production of DO and PO sentences. The lack of emphasis effect on structural priming at first seems to contradict with what Bernolet et al. (2009) found in transitive priming. The lack of emphasis priming, as I have argued, was a result of the fact that emphasis for the Theme and the Recipient did not differ between DO and PO. This stands in contrast with transitives: The Agent is emphasized in actives while the Patient is emphasized in passives. Overall, this experiment, together with Experiment 4.1, suggests that if there is any thematic priming in datives, it cannot be attributed to thematic emphasis priming.

4.9 Experiment 4.3

Experiments 4.1 and 4.2 established that any thematic priming in datives cannot be attributed to differences between DO and PO sentences in the emphasis placed on the relevant thematic roles. Hence any priming between dative sentences that is associated with thematic roles must be due to the way in which thematic roles are mapped onto grammatical functions or the way in which they are mapped on to linear positions (or both). In Experiment 4.3, I tested the function mapping account by comparing the priming of DO and PO responses following a Topic-DO prime, a PO prime, a DO prime, and an intransitive baseline (4.6a-d). I assumed that intransitive baselines have syntactic and thematic structures unrelated to either the PO or DO structure (e.g., Bock & Griffin, 2000; Pickering et al., 2002).

- 4.6a. Niuzai song-gei le shuishou naben shu. (DO)
 cowboy give-to LE sailor that book.
 (The cowboy gave the sailor that book.)
- 4.6b. Niuzai song le naben shu gei shuishou. (PO)
 cowboy give LE that book to sailor
 (The cowboy gave that book to the sailor.)
- 4.6c. Naben shu niuzai song-gei le shuishou. (Topic-DO)
 that book cowboy give-to LE sailor
 (That book the cowboy gave the sailor.)
- 4.6d. Niuzai zai shuijiao. (Baseline)
 cowboy be sleep.
 (The cowboy was sleeping)

I first consider predictions with respect to syntactic components of structural priming. Topic-DO differs in constituent structure from both DO and PO, so there could be no syntactic priming from surface constituent structure (e.g., Pickering et al., 2002). But repetition of argument structure can also give rise to priming; if so, Topic-DO sentences should prime DO sentences, as they have the same argument structure.

Now let's consider the thematic component of structural priming. According to the function mapping account, Topic-DO sentences should thematically prime DO responses because both constructions have the same thematic-role-to-grammatical-function mapping, in which the Recipient is mapped on the direct object and the Theme is mapped onto the indirect object (which is topicalized in Topic-DO). Thus, under the function mapping account, Topic-DO sentences should prime DO responses relative to the baseline, irrespective of whether there is syntactic priming from argument structure; however, they should prime DO responses less strongly than DO primes and more strongly than PO primes (because DO and PO primes share both thematic-role-to-grammatical-function mappings and constituent structure with DO and PO responses respectively, yielding two sources of priming). Table 4.3 summarizes the predicted priming following different primes under the function

mapping account. Combining both syntactic priming and thematic priming, the function mapping account predicts the following hierarchy in the strength of priming DO responses: DO > Topic-DO > Baseline > PO.

Table 4.3: Overall priming effect by Topic-DO (relative to baseline) according to different the function mapping account of thematic priming.

	DO	PO	Topic-DO	Baseline
Syntactic priming				
Constituent structure	DO	PO	Null	Null
Argument structure	DO/Null	PO/Null	DO/Null	Null
Thematic priming				
	DO	PO	DO	Null

I used the dialogue paradigm (Branigan, Pickering, & Cleland, 2000), in which a confederate, pretending to be a naïve participant, worked in turn with the participant by describing pictures to each other. In this paradigm, when the confederate was “describing” a picture to the participant, she was actually reading a script. In experimental trials, the script was one of the four sentences in (4.6a-d).

Method

Participants. Twenty-eight Mandarin Chinese speakers from the University of Edinburgh community were paid £4 to take part.

Materials. I created 24 experimental items and 72 filler items. Each item consisted of a prime sentence (with associated picture), a prime picture (to be matched with the prime sentence) and a target picture (to be described) (see Figure 4.2 for an example). The prime sentence for the participant was actually a sentence preamble which she had to complete according to the associated picture while the prime sentence for the confederate was a script printed below the picture. Experimental prime sentences were like those in (6a-d). Filler prime sentences were intransitives and transitives. I included 32 DO filler prime sentences (which were all sentence preambles to be completed as DO sentences by the participant) in order to

boost up the DO descriptions of the experimental target pictures⁷. The prime picture and the target picture were similar to those used in Experiment 4.2 (see Figure 4.2).

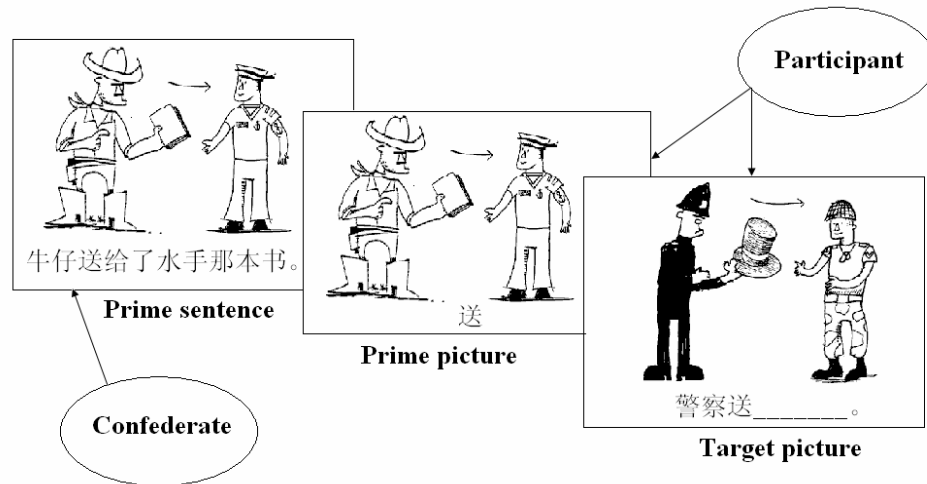

Figure 4.2: The experiment paradigm and procedure in Experiment 4.3. It illustrates a trial where the confederate “describes” a picture to the participant who then decides whether the prime picture she later sees matches the picture the confederate has “described” before she then described the target picture (by completing the sentence preamble) to the confederate. The prime sentence means “the cowboy gave the sailor that book”; the character provided in the prime picture means “give” and indicates the action in the picture. The target picture has a preamble literally meaning “the policeman give_____.”.

Procedure. Unlike in Experiment 4.2, the task in this experiment was a dialogue game where a participant and a confederate (a female speaker of Mandarin Chinese) took turns to describe pictures to each other (Branigan, Pickering, & Cleland, 2000). The participant and the confederate were both seated in front of a computer and could not see each other’s computer screen (though they could see each other’s face). At first, both the participant and the confederate were familiarized with the figures and objects that were to appear in the experiment, and then they were shown how to do the experiment with four example items. For the experimental trials, the confederate would first read out the prime sentence under the guise of

⁷ A pilot study without these DO fillers led to a dominance of PO responses, so I included more DO fillers to counteract this.

describing a picture to the participant, after which the participant would see a picture (i.e., the prime picture) and decide whether the picture matched the confederate's description, by pressing *F* (for match) or *J* (for mismatch). The participant then saw another picture which he/she described to the confederate by completing a sentence preamble (printed beneath the picture) in Mandarin Chinese. The confederate feigned matching a picture with the description she had heard. See Figure 4.2 for an illustration of the procedure. I had individual randomization of the materials for each participant. The order of all materials was randomized in such a way that two target trials were separated by 2-4 filler trials. The experiment took about 25 minutes.

Results

Table 4.4 presents the results of the experiment. LME analyses show that there were more PO responses than DO responses (444 vs. 213, $z = 3.34$, $p < .001$). Prime type had a significant main effect ($\chi^2(3) = 135.27$, $p < .0001$). Pairwise comparisons show that there was a hierarchy of DO > Baseline > Topic-DO > PO in the priming of DO responses (DO vs. Baseline: $z = 3.483$, $p < .001$; DO vs. Topic-DO: $z = 6.361$, $p < .001$; DO vs. PO: $z = 9.196$, $p < .001$; Baseline vs. Topic-DO: $z = 3.271$, $p < .01$; Baseline vs. PO: $z = 7.053$, $p < .001$; Topic-DO vs. PO: $z = 4.744$, $p < .001$). It should be noted that there seems to be a bigger priming effect for the PO prime (a 31% difference from the baseline) than for the DO prime (a 15% difference from the baseline), which seems to be at odds with inverse frequency effects in structural priming (Hartsuiker & Kolk, 1998; Snider, 2008). However, as this question is not relevant to main issues in this chapter, I will not attempt to address it. There were too few Other responses for statistical analysis.

Table 4.4: Response counts by prime condition and % of DO responses in Experiment 4.3.

Prime	DO	PO	Topic-DO	Baseline
DOs	90	15	42	66
POs	74	151	120	99
Others	2	0	5	3
% of DOs	55	9	26	40

Discussion

As expected, DO primes led to more DOs and fewer POs than baseline primes, and PO primes led to fewer DOs and more POs than baseline primes. This indicates that the PO and DO primes in Mandarin behaved similarly to PO and DO primes in English (e.g., Pickering et al., 2002). More interestingly, Topic-DO primes led to fewer DOs and more POs than baseline primes; in other words, Topic-DO sentences primed PO structures. This finding is incompatible with the predictions of the function mapping account, which predicts that Topic-DO sentences should prime DO structures, with which they share thematic role to grammatical function mappings. The linear mapping account, on the other hand, predicts that Topic-DO should thematically prime PO responses as they share the same Theme-Recipient linear order. Thus, the results can be accommodated by the linear mapping account, if we assume that the PO-favouring thematic priming overpowered the DO-favouring argument structure priming (or there is no argument structure priming at all), resulting in the overall priming of PO responses following Topic-DO, as observed in the experiment.

4.10 Experiment 4.4

In Experiment 4.4, I further tested the function mapping account by using Ba-DO primes, in which the Recipient is mapped onto the direct object and the Theme is mapped onto the (forwarded) indirect object, just as in DO sentences. As priming from argument structure in Ba-DO sentences (if any) would also favour DO responses, the function mapping account predicts that Ba-DO sentences should lead to more DO responses, relative to the baseline. Experiment 4.4 set out to test this prediction.

Experiment 4.3 has shown that the linear mapping account better explains thematic priming the function mapping account. Experiment 4.4 further examined whether thematic priming occurs because the processor persists in the absolute order of thematic roles (the Agent, the Recipient and the Theme) or just the relative order of the Recipient and the Theme, whose relative order varies crucially between a DO sentence (where the Recipient precedes the Theme) and a PO sentence (where the Theme precedes the Recipient). I compared priming of DO/PO sentences following a

Ba-DO prime and following a Topic-DO prime. Ba-DO and Topic-DO sentences share the relative order of Theme and Recipient (in both cases the Theme precedes the Recipient), but differ in their absolute order and hence their mapping to particular NP positions (i.e., Agent-NP1 – Theme-NP2 – Recipient-NP3 in a Ba-DO sentence and Theme-NP1 - Agent-NP2 – Recipient-NP3 in a Topic-DO sentence). Hence if priming reflects the relative order of the Theme and the Recipient only, Ba-DO and Topic-DO sentences should behave similarly, but if priming reflects the absolute order of thematic roles and their mapping to particular NP positions, a Ba-DO sentence should prime PO responses to a greater extent (due to the similarity in the absolute order of thematic roles and mapping to NP positions) than a Topic-DO sentence.

This experiment replicated the design of Experiment 4.3 except that the Topic-DO condition was replaced with a Ba-DO condition (see 4.7a-d). Again, I was interested in the difference in priming following Ba-DO and baseline primes.

- 4.7a. Niuzai song-gei le shuishou naben shu. (DO)
 cowboy give-to LE sailor that book.
 (The cowboy gave the sailor that book.)
- 4.7b. Niuzai song le naben shu gei shuishou. (PO)
 cowboy give LE that book to sailor
 (The cowboy gave that book to the sailor.)
- 4.7c. Niuzai ba naben shu song-gei le shuishou. (Ba-DO)
 cowboy BA that book give-to LE sailor
 (The cowboy gave the sailor the book.)
- 4.7d. Niuzai zai shuijiao. (Baseline)
 cowboy be sleep.
 (The cowboy was sleeping)

Method

Participants. Twenty-eight further Mandarin Chinese speakers from the University of Edinburgh community were paid £4 to take part.

Materials. The materials in Experiment 4.3 were used, except that I replaced the Topic-DO prime with the Ba-DO prime.

Procedure. The same procedure as in Experiment 4.3 was adopted.

Results

Table 4.5 gives the results from the experiment. LME analyses show that there were more PO responses than DO responses (463 vs. 206, $z = 3.472$, $p < .001$). Prime type had a significant main effect ($\chi^2(3) = 91.804$, $p < .0001$), suggesting different priming effects following different primes. Pairwise comparisons show a similar hierarchy as that in Experiment 4.3 in the priming of DO responses: DO > Baseline > Ba-DO > PO (DO vs. Baseline: $z = 3.909$, $p < .001$; DO vs. Ba-DO: $z = 6.64$, $p < .001$; DO vs. PO: $z = 8.04$, $p < .001$; Baseline vs. Ba-DO: $z = 3.213$, $p < .001$; Baseline vs. PO: $z = 5.175$, $p < .001$; Ba-DO vs. PO: $z = 2.333$, $p < .05$). There were too few Other responses for a statistical analysis.

Table 4.5: Response counts by prime condition and % of DO responses in Experiment 4.4.

Prime	DO	PO	Ba-DO	Baseline
DOs	85	24	38	59
POs	82	144	128	109
Others	1	0	2	0
% of DOs	51	14	23	35

Combined analysis of Experiments 4.3 and 4.4

I next compared Experiment 4.4 with Experiment 4.3, treating experiment and prime type (DO, PO, Topic-DO/Ba-DO, and Baseline) as variables. Figure 4.3 shows the proportion of DO responses following the primes in the two experiments. Across the two experiments, there were more PO responses than DO responses (907 vs. 419, $z = 4.493$, $p < .001$). Experiment as a factor did not produce a significant main effect ($\chi^2(1) < 1$), suggesting the overall frequencies of DO and PO responses did not differ between the experiments. Prime type produced a significant effect ($\chi^2(3) = 226.96$, $p < .0001$), with an hierarchy of DO > Baseline > Topic-DO/Ba-DO > PO in the

priming of DO responses. There was no significant interaction between experiment and prime type ($\chi^2(3) = 5.7413, p > .1$). Importantly, there was no difference in the priming of DO and PO responses between the Topic-DO prime in Experiment 4.3 and the Ba-DO prime in Experiment 4.4 ($z = .472, p > .1$).

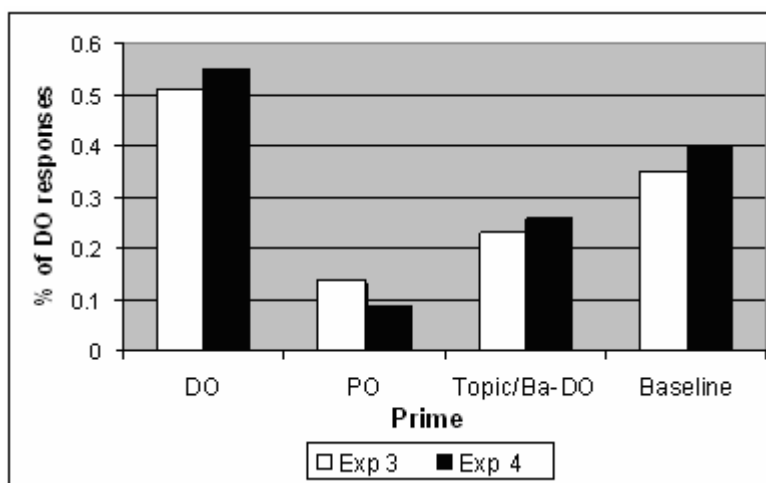

Figure 4.3: Proportion of DO responses following primes in Experiments 4.3 and 4.4.

Discussion

As in Experiment 4.3, DO primes led to more DOs and fewer POs than the baseline, and PO primes led to fewer DOs and more POs than the baseline, again indicating that the PO and DO primes in Mandarin behave similarly to PO and DO primes in English. More interestingly, Ba-DO primes led to fewer DOs and more POs than the baseline. In other words, Ba-DO sentences primed the PO structure. The finding that Ba-DO sentences led to more PO responses than the baseline suggests that, regardless of whether there is argument structure priming, Ba-DO thematically primes PO rather than DO responses. This further disconfirms the prediction of the function mapping account and supports the linear mapping account of thematic priming. Instead, the linear mapping account can better accommodate the results, as it predicts that Ba-DO should thematically prime PO responses as they share the same Theme-Recipient linear order.

The combined analysis confirmed that Ba-DO primes in Experiment 4.4 behaved similarly to Topic-DO primes in Experiment 4.3. Both constructions shared the order of Theme and Recipient roles and argument structure, but differed in the

position of the Agent role. Hence the similarity in priming following Ba-DO and Topic-DO sentences implies further that it is repetition of the relative order of the Theme and the Recipient, but not the order of all three thematic roles, that underlies thematic priming in datives.

4.11 Experiment 4.5

So far the experiments have shown that thematic priming in datives is driven by repetition of thematic ordering rather than thematic emphasis (see Experiments 4.1 and 4.2) or thematic role to function mapping (see Experiments 4.3 and 4.4). In particular, they provide support for the linear mapping account over the function mapping account. However, we have not demonstrated the existence of argument structure priming. To do this, we need to compare priming in conditions that exclude any possibility of thematic or constituent-structure priming. Experiment 4.5 thus included DO, PO, and Topic-DO primes, but also introduced a Topic-PO prime (e.g., 4.8a-d). As in Experiment 4.2, I repeated the verb across prime and target to magnify priming (Pickering & Branigan, 1998).

- 4.8a. Niuzai song-gei le shuishou naben shu. (DO)
 cowboy give-to LE sailor that book
 (The cowboy gave the sailor that book.)
- 4.8b. Niuzai song le naben shu gei shuishou. (PO)
 cowboy give LE that book to sailor
 (The cowboy gave that book to the sailor.)
- 4.8c. Naben shu niuzai song-gei le shuishou. (Topic-DO)
 that book cowboy give-to LE sailor
 (That book the cowboy gave the sailor.)
- 4.8d. Naben shu niuzai song le gei shuishou. (Topic-PO)
 that book cowboy give LE to sailor
 (That book the cowboy gave to the sailor.)

As in Experiments 4.3 and 4.4, I predict more DO responses following DO primes than following PO primes. In accord with Experiment 4.3, I predict that the

proportion of DO responses following a Topic-DO prime will be between the DO and PO prime conditions. But the critical condition is the Topic-PO prime condition. This condition has the same order of thematic roles as the Topic-DO condition; and the constituent structure of the Topic-PO condition differs from the constituent structure of both the DO and the PO conditions, just as the constituent structure of the Topic-DO condition does. However, in terms of the argument structure of the verb, Topic-PO, which has the same argument structure as PO, differs from Topic-DO, which has the same argument structure as DO. Hence if there is no argument structure priming, the Topic-PO and Topic-DO conditions should behave similarly. But if there is argument structure priming, then they should behave differently: The Topic-PO construction should lead to more PO responses than the Topic-DO construction. In this experiment, participants listened to a pre-recorded prime sentence (see Procedure below) rather than a confederate (as in Experiments 4.3 and 4.4). I made this change with the intention to see whether similar effects as those in Experiments 4.3 and 4.4 occur with a different paradigm.

Method

Participants. Twenty-four Mandarin Chinese speakers recruited from the student community in Guangdong University of Foreign Studies were paid 10 RMB (roughly £ 1) to take part in the experiment. Four participants were replaced with new participants because that they produced Other responses for more 1/3 of the experimental target pictures.

Materials. I created 32 experimental items and 96 filler items. Each item consisted of a prime sentence, a prime picture (to be matched with the prime sentence) and a target picture (to be described). The experimental prime sentences were dative sentences such as those in (4.8a-d) for experimental trials or transitive and intransitive for filler trials. All the prime sentences were read by a female Mandarin speaker and recorded as wav files. The prime picture and the target picture were similar to those in Experiments 4.3 and 4.4.

Procedure. The experimental procedure was similar to that in Experiments 4.3 and 4.4 (see Figure 4.2), except that in this experiment, participants did the experiment alone rather than with a confederate. Thus, the participant listened to pre-

recorded prime sentences (rather than to descriptions by a confederate) and decided whether a picture she later saw matched the sentence she had listened to, before she described a target picture by completing the sentence preamble. The experiment was run with DMDX on a computer. The experiment took about 40 minutes.

Results

Table 4.6 presents the results of Experiment 4.5. LME analyses show that there were fewer DO responses than PO responses (287 DOs vs. 462 POs, $z = 2.278$, $p < .05$). Prime type produced a significant effect ($\chi^2(3) = 226.8$, $p < .0001$), suggesting different priming patterns across the prime types. Pairwise comparisons revealed a hierarchy of prime types in the priming of DO responses: DO > Topic-DO > Topic-PO > PO (DO vs. Topic-DO: $z = 6.758$, $p < .001$; DO vs. Topic-PO: $z = 10.641$, $p < .001$; DO vs. PO: $z = 11.515$, $p < .001$; Topic-DO vs. Topic-PO: $z = 5.179$, $p < .001$; Topic-DO vs. PO: $z = 6.915$, $p < .001$; Topic-PO vs. PO: $z = 2.406$, $p < .05$). There were too few Other responses to conduct a statistical analysis.

Table 4.6: Response counts by prime condition and % of DO responses in Experiment 4.5.

Prime	DO	PO	Topic-DO	Topic-PO
DO	136	28	80	43
PO	50	162	105	145
Other	6	2	7	4
% DO	73	15	43	23

Discussion

Experiment 4.5 showed priming from PO and DO primes, as expected. In addition, Topic-DO primes induced levels of PO and DO responses that were intermediate between those following PO and DO primes. More importantly, Topic-PO primes led to more PO responses than Topic-DO primes, suggesting that there was a component to the overall priming effect that was associated with repetition of argument structure. Furthermore, a closer look at the priming effects revealed a bigger difference between DO and Topic-DO (30% difference in proportion of DOs)

than that between PO and Topic-PO (8%). To test whether the two differences were statistically different, I conducted a 2 (DO argument structure vs. PO argument structure) by 2 (canonical vs. topicalized) statistical analysis and found a significant main effect for both the first factor ($\chi^2(1) = 173.42, p < .0001$) and the second factor ($\chi^2(1) = 11.48, p < .0001$), suggesting that constructions with a DO argument structure led to more DO responses than constructions with a PO argument structure (58% vs. 19%) and that canonical constructions led to more DO responses than topicalized constructions (44% vs. 33%). More importantly, there is a significant interaction between the two factors ($\chi^2(1) = 38.262, p < .0001$), suggesting that the 30% difference between DO and Topic-DO was significantly larger than the 8% difference between PO and Topic-PO. This pattern is consistent with an account in which structural priming may reflect both thematic priming, driven by repetition of thematic ordering, and syntactic priming, with components associated with repetition of argument structure and repetition of surface constituent structure: PO primes differed from Topic-PO primes with respect to PO responses only in their extra priming from the repetition of surface constituent structure following PO primes, while DO primes differed from Topic-DO primes in both surface constituent priming and thematic priming.

4.12 General discussion

In five experiments, I examined dative structures in Mandarin Chinese. Experiments 4.1 and 4.2 showed that DO and PO sentences did not differ in emphasis for the Theme and the Recipient and hence that any differences in their priming behaviour could not be attributed to differences in their thematic emphasis. Experiments 4.3 and 4.4 showed that Topic-DO and Ba-DO thematically primed PO rather than DO responses relative to the baseline, suggesting that the processor persists in mapping analogous thematic roles to the same surface linear order rather than to the same grammatical functions. Furthermore, Topic-DO and Ba-DO behaved similarly despite their different thematic orders with respect to the position of the Agent, indicating that the processor tends to maintain the same relative linear order of relevant thematic roles (e.g., the Recipient and the Theme in datives). Experiment 4.5

compared priming following Topic-DO and Topic-PO primes, and found different patterns of priming for each prime. Because thematic priming was kept constant across the two constructions, such differences in their priming behaviour imply the existence of syntactic priming based on repetition of argument structure.

Taken together, these experiments suggest that structural priming can arise from persistence of different kinds of linguistic information; it consists at least of a thematic component, reflecting the persistence of thematic role to linear order mapping; and a syntactic component that reflects persistence of surface constituent structure and argument structure choice. Taking together the results from Experiments 4.3, 4.4 and 4.5, we can identify a hierarchy of prime types in the priming of DO responses. Such a hierarchy can be explained in terms of syntactic priming from surface constituent structure, syntactic priming from argument structure, and thematic priming. Table 4.7 gives a summary of these effects in the priming of DO responses. In Table 4.7, I take the full syntactic priming and thematic priming to be respectively 1. As syntactic priming has two subcomponents, I assume the strength of each subcomponent to be .5. Positive values indicate priming towards DO responses and negative values indicate priming towards PO responses. Combining both the syntactic and thematic priming effects yields a hierarchy in the priming of DO responses, DO > Baseline > Topic-DO/Ba-DO > Topic-PO > PO, as observed in the above experiments.

Table 4.7: Syntactic and thematic priming effects in the priming of DO responses.

	DO	Baseline	Topic/ Ba-DO	Topic- PO	PO
Syntactic priming					
Constituent structure	(.5)	(0)	(0)	(0)	(-.5)
Argument structure	(.5)	(0)	(.5)	(-.5)	(-.5)
Combined	1	0	.5	-.5	-1
Thematic priming	1	0	-1	-1	-1
Predicted structural priming	2	0	-.5	-1.5	-2

Syntactic and thematic information in language production

The interaction of syntactic and thematic information in structural priming can help us account for findings in previous studies. In Chang et al. (2003), *spray-with* sentences and *spray-on* sentences induced different patterns of priming, despite sharing the same surface constituent structure. However, they differ in thematic order and argument structure. Hence, each sentence type thematically and syntactically primes responses of the same structural type. Pickering et al.'s (2002) finding that shifted-PO primes do not prime PO sentences can be interpreted as a cancelling-out of priming from argument structure (i.e., shifted PO shares the same argument structure with PO) and priming from thematic order (shifted PO has the same thematic order as DO). Also, there is interaction between constituent structure information and thematic information, as in Hare and Goldberg (1999): A *provide-with* sentence shares the same thematic order with a DO sentence and the same constituent structure with a PO sentence. According to Table 4.7, it is predicted that there should be cancellation of the two priming effects to some extent, contrary to the observation in Hare and Goldberg (1999) that a *provided-with* prime behaved similarly to a DO prime. However, their finding should be taken with caution. First, prime type was a between subject condition. Second, they seemed not to take the intransitive baseline into statistical analysis, though they included it in the experiment; thus we do not know whether the *provide-with* prime actually behaved just like the baseline. A better controlled replication of the study (with prime type as a within-subject variable) is needed to verify the finding in Hare and Goldberg (1999).

The interaction of thematic and syntactic information also casts a different light on the findings of Bernolet et al. (2009), and specifically the priming behaviour of the PP-initial passive, a construction which has a passive argument structure but Agent-Patient ordering. The PP-initial passive was found to behave similarly to the baseline, priming neither actives nor passives in English. Though it is possible that this pattern reflected equal emphasis on the Agent and the Patient, another possibility is that the PP-initial passive thematically primed actives on the basis of thematic emphasis or thematic order, and syntactically primed passives on the basis of argument structure, with the two effects essentially cancelling each other out. If

correct, this would suggest that both syntactic information and thematic information perseverate in cross-language structural priming. Such an account could shed light on other cross-language structural priming findings. Hartsuiker et al. (2004) found that the priming effect of a Spanish dislocated active prime (e.g., *al camion lo persigue un taxi*, literally, “to the truck [patient/object] it chases a taxi [agent/subject]”) fell between that of an active prime and that of a passive prime in the priming of English actives and passives, presumably because of a thematic priming effect (favouring English passives) and an argument structure priming effect (favouring English actives) cancelling each other out. Salamoura and Williams (2007), following Hare and Goldberg (1999), showed that a Greek *provide-with* sentence primed an English DO instead of a PO, which can be interpreted as a stronger thematic priming effect and a weaker syntactic priming effect from constituent structure. Similarly, it is likely that thematic priming exerted a greater effect than syntactic priming in Heydel and Murray (2000), who observed that an active OVS sentence in German (e.g., *Den Manager berät ein PR-Mann*, literally, “the manager [patient/object] advises a PR-man [agent/subject]”) primed an English passive (with the same Patient-Agent order of thematic roles, i.e., reflecting thematic priming), rather than an active (with the same Agent-Subject/Patient-Object argument structure, i.e., reflecting syntactic priming).

Conceptual information in grammatical encoding

Earlier research on the effect of conceptual information on grammatical encoding looked at how factors affecting conceptual accessibility, such as animacy and concreteness of nouns, influenced the choice of syntactic structure in sentence recall. Bock and colleagues found that when people mis-recalled the form of a sentence, they tended to place the more accessible noun in a higher grammatical function (e.g., subject) rather than in a lower function (e.g., object) (e.g., recalling *the shock was ministered by the doctor* as *the doctor ministered the shock*). They argued that the processor utilizes conceptual information during functional processing only, by assigning higher grammatical functions to more accessible concepts (e.g., Bock & Warren, 1985; McDonald, Bock, & Kelly, 1993). However, as they mainly investigated English, a language in which grammatical functions and word order are

easily confusable, it is hard to distinguish whether the more accessible nouns are assigned to a higher function or an earlier position. Later research on other languages has suggested that more accessible nouns are placed in an earlier position as well as a high grammatical function (Branigan & Feleki, 1999; Tanaka et al., submitted; Myachykov & Tomlin, 2008). These studies have supported the proposal that conceptual information affects both functional processing and positional processing (e.g., Branigan et al., 2008). Such a proposal is supported by the finding in the current study that the processor tends to map analogous thematic roles onto the same linear order rather than the same grammatical functions, which suggests that thematic priming occurs during the mapping of conceptual information to positional processing rather to functional processing.

Given the linear mapping account, it is desirable to compare it with the thematic emphasis account proposed in Bernolet et al. (2009). They proposed that the processor tends to maintain emphasis on the same thematic role across utterances. Thus, the thematic emphasis account and the linear mapping account are not incompatible with each other: The former locates thematic priming at conceptualization while the latter locates it at the mapping from conceptualization to positional processing. In fact, it is possible that the binding of thematic emphasis across utterances is realized via function mapping or linear mapping. Note that the processor can either map an emphasized thematic role onto an emphasis-prominent grammatical function (e.g., the subject) during functional processing or place the emphasized thematic role in an emphasis-prominent linear position, say, the sentence-initial position, during positional processing. Both mechanisms are plausible as it has been argued that both the subject and sentence-initial position can crystallize emphasis (e.g., Levelt, 1989; Bernolet et al., 2009).

Use of argument structure in grammatical encoding

There is debate as to whether grammatical encoding is frame-based or lexically guided (e.g., V.S. Ferreira & Slevc, 2007). According to the frame-based model (e.g., Bock & Levelt, 1994), the construction of syntactic structure in language production is the retrieval of a syntactic frame on the basis of grammatical function assignment. For instance, if a subject function and an oblique object function are assigned in the

description of a transitive event, a syntactic frame corresponding to the constituent structure of the passive construction is retrieved and lexical items are inserted into the syntactic frame. In such a model, the use of argument structure associated with the lexical entry of a verb is underplayed. For instance, for a dative event such as a cowboy passing a sailor a book, the processor assigns grammatical functions to selected lemmas such as COWBOY, SAILOR and BOOK on the basis of the conceptual information of these lemmas. For instance, between the Theme and the Recipient, the direct object function is more likely to be assigned to the one that is given (e.g., Bock & Irwin, 1980; V.S. Ferreira & Yoshita, 2003), that is more concrete (e.g., Bock & Warren, 1985), that is more animate (e.g., McDonald et al., 1993) and so on. The finding that the participants tended to repeatedly use the same argument structure of the verb suggests that the processor also utilizes lexical information in the selection of the constituent structure. Such an implication suggests that grammatical encoding is lexically guided to some extent and is consistent with models of grammatical encoding that assumes the centrality of the verb in the formulation of a sentence (e.g., F. Ferreira, 2000; Kempen & Hoenkamp, 1987; Levelt, 1989).

Conclusion

I found that structural priming is sensitive to both thematic information such as thematic ordering and syntactic information such as constituent structure and argument structure. Thematic priming occurs because the processor perseverates in mapping analogous thematic roles onto the same linear order, which suggests that conceptual information is utilized in positional processing. Syntactic priming from argument structure also implies that grammatical encoding is guided by the lexical entry of the verb to a certain extent.

Chapter 5 Processing verb-phrase ellipsis in Mandarin Chinese: Evidence against syntactic reconstruction

5.1 Overview of the chapter

Theories differ as to how people recover the meaning of verb-phrase (VP) ellipsis. According to the syntactic reconstruction account, people re-construct the syntactic structure of the antecedent in a piece-by-piece manner. This account thus predicts that the ellipsis site contains full syntactic information. Using the structural priming paradigm, I found that, in Mandarin, an ellipsis prime (a double-object or prepositional-object dative antecedent plus a VP ellipsis) was less effective in priming than a full-form prime sentence (the same antecedent plus the full-form equivalent of the VP ellipsis) but behaved similarly to a baseline prime (the same antecedent plus a neutral sentence). The result thus indicates that syntactic structure is not re-constructed at the ellipsis site. Overall, the result is compatible with a semantic account whereby VP ellipsis is interpreted via semantic representation.

5.2 Introduction

To what extent is sentence comprehension mediated by syntax? Different theories of sentence comprehension have different answers to this question. There has been empirical evidence that the parser may not strictly follow syntactic information in syntactic analysis (F. Ferreira, 2003; Tabor et al, 2004). Studies on the processing of pronouns and reflexives also indicate that the interpretation of these anaphoric expressions is mediated by both syntactic and non-syntactic information (e.g., Bedecker & Straub, 2002; Runner et al., 2003), though there is evidence that syntactic information may enjoy some temporal privilege over non-syntactic information in the search of antecedents (e.g., Sturt, 2003). In this chapter, I will explore the processing and interpretation of another type of anaphoric expression,

verb-phrase (VP) ellipsis. There is psycholinguistic as well as syntactic debate as to whether the interpretation of VP ellipsis (and other types of ellipsis as well) is mediated by syntax.

5.3 The processing of VP ellipsis

In everyday language, the interpretation of a sentence (or clause) sometimes depends on a previous sentence. One type of such dependencies is verb-phrase (VP) ellipsis. For instance, in (5.1), the supposedly elided VP *give the teacher a drawing* following *did* has the same meaning as the verb phrase in the preceding sentence; hence, the second sentence means that the boy gave the teacher a drawing too. I refer to the first sentence in (5.1) as the antecedent sentence, and the missing VP following *did* in the second sentence as the ellipsis site. Such ellipsis is found in many languages, including English and Mandarin Chinese.

5.1. The girl gave the teacher a drawing. The boy did too.

In this chapter, I investigate how VP ellipsis in Mandarin is processed and interpreted. I propose that two orthogonal issues need to be considered in the research on VP ellipsis processing. The first issue concerns the representation that mediates the interpretation of the VP ellipsis. The second issue concerns the mechanism of retrieval. I explore these two issues in more detail in what follows.

5.3.1 Representation that mediates VP ellipsis processing

Several proposals have been put forward concerning what representation is required for VP ellipsis processing. They fall into two basic types: *the syntactic account* and *the semantic account*. According to the syntactic account, the syntactic structure of the antecedent VP is reproduced at the ellipsis site (e.g., Haik, 1987; Kitagawa, 1991; Lappin, 1993) and VP ellipsis is interpreted on the basis of the reproduced syntactic structure. Linguistic evidence for the syntactic account comes from sentences as in (5.2). In (5.2b), the non-elliptical counterpart of (5.2a), *he* cannot refer to *Bill* due to the constraint of Principle C of the binding theory (i.e., a description such as *Bill*

should not be bound). The binding theory is also argued to be working in (5.2a), as the pronoun *he* cannot refer to *Bill* either. As the binding theory is supposed to be a syntactic constraint, this finding suggests that the VP ellipsis in (5.2b) is interpreted via syntactic structure.

5.2a. She defended Bill, and he did too.

5.2b. She defended Bill, and he defended Bill too.

However, there has been evidence that the binding theory may actually not apply in ellipsis (e.g., Dalrymple, 1991). In (5.3), if the elliptical VP is present at the ellipsis site, the interpretation of *she* as *Sue* would result in a violation of Principle B of the binding theory (i.e., ...*before she_i did arrive at Sue_i's apartment*). However, it is acceptable to interpret *she* as referring to *Sue* in (5.3), contrary to the prediction of the syntactic account. To accommodate data like (5.3) with the syntactic account, Fiengo and May (1994) proposed that when the VP is reconstructed, there is “vehicle change”, that is, *Sue's* is changed to *her* at the ellipsis site (i.e., *before she did [arrive at her apartment]*).

5.3. Harry got to Sue's apartment before she did.

Further support for the syntactic account comes from island constraint violation for unbounded dependencies into ellipsis site (e.g., Haik, 1987). Consider (5.4). In (5.4a), the sentence is grammatical, as, according to the syntactic account, the reconstruction of the VP at the ellipsis site does not violate the island constraint. However, the reconstruction of the VP in (5.4b) violates the island constraint, which prohibits the movement of an NP element (e.g., *everything*) out of a syntactic island (e.g., *the claim that he did...*); hence the ungrammaticality in (5.4b).

5.4a. John read everything which Bill did.

5.4b. *John read everything which Bill believes the claim that he did.

Contrary to the syntactic account, the semantic account (e.g., Chao, 1978; Dalrymple et al., 1991; Hardt, 1993) argues that the processor resorts to the semantic representation of the antecedent in the processing of VP ellipsis. In support of this account, there is evidence that VP ellipsis does not require a syntactically suitable VP in the antecedent sentence. For example, in (5.5) (an example taken from Hardt, 1993, p.35), the string *he never does* refers to *he never drinks excessively*, but there is no such antecedent in the discourse.

5.5. People say that Harry is an excessive drinker at social gatherings. Which is strange, because he never does at my parties.

Hardt (1993) considered VP ellipsis as a proverb, on a par with a pronoun (which the term *proverb* was coined after). That is, VP ellipsis is similar to a pronoun except that it refers to an event (as denoted by a VP expression) rather than an entity (as denoted by an NP expression). According to his account, VP ellipsis does not have internal syntactic structure and to interpret the VP ellipsis is to identify some event in the discourse model that can serve as a semantically appropriate antecedent for VP ellipsis. Thus, the VP ellipsis in (5.5) refers to the discourse event denoted by *is an excessive drinker at social gatherings*.

5.3.2 Mechanism of retrieval of antecedent representation

Frazier and Clifton (2001) proposed two ways in which syntactic structure could be constructed. One of them is *structure building*, by which they mean a mechanism that “takes input items and attaches them into the syntactic tree, postulating only as many syntactic nodes as required given the grammar of the language, the input, and the evidence that the parser has received so far” (p.1). The other is *structure copying*, which they proposed “involves only the inference needed to identify the ellipsis site and its syntactic scope, and, therefore, copying more structure doesn’t necessarily cost more than copying less structure: the same number of inferences may be required independent of the amount of structure built (p.1).” Here I follow Frazier and Clifton (2001) and propose that there are two mechanisms whereby an antecedent representation (syntactic or semantic) can be retrieved in the

interpretation of VP ellipsis. The antecedent representation can be wholly copied to the ellipsis site (i.e., *the copying mechanism*). Alternatively, it can be reconstructed at the ellipsis site step by step using structure building (i.e., *the reconstruction mechanism*). Note that how a representation is retrieved is orthogonal to what nature that representation is. Thus, we can have a syntactic representation that is either copied or reconstructed and a semantic representation that is either copied or reconstructed.

The syntactic copying account is proposed by Frazier and Clifton (2001). According to this account, the syntactic structure of the antecedent is copied to the ellipsis site, and thus there is no cost associated with the copying. In other words, the copying of a more complex structure is not more costly than the copying of a less complex one. In contrast is *the syntactic reconstruction account*, which argues that the syntactic structure is built step by step at the ellipsis site. Consistent with such an account are many earlier syntactic proposals that assume full syntactic structure at the ellipsis site. For instance, according to Fiengo and May (1994), when the antecedent structure is built at the ellipsis site, there may be vehicle change. Thus, in (5.6), the ellipsis contains a covert (i.e., phonologically unrealized) syntactic structure of the antecedent (in square brackets) where *Sue's* has been changed to *her*. Implicit in Fiengo and May's account is that there is a reconstruction of the antecedent material at the ellipsis site. The syntactic reconstruction account has also been argued for in psycholinguistic research, for instance in Murphy (1985), a study which I will return to in more detail later.

5.6. Harry got to Sue's apartment before she did [get to her apartment].

A similar dichotomy can be applied to the semantic account. *The semantic copying account* is the proposal that the processor refers to certain semantic/discourse representations in the interpretation of ellipsis. Hardt's (1993) proverb account of VP ellipsis is such an example, as VP ellipsis is argued to be a proform (i.e., a pronoun-like anaphor) which refers to a discourse event in its interpretation. The semantic copying account is also argued for in psycholinguistic studies such as Martin and McElree (2008), who argued that the ellipsis is like a

pointer to the semantic representation of its antecedent. *The semantic reconstruction account*, on the other hand, argues that semantic representation is reconstructed step by step at the ellipsis site. Similar proposals can be found in studies on the strict/sloppy ambiguity in VP ellipsis as in (5.7), where the ellipsis can be interpreted as John saw Mary's mother (strict reading) or John saw his own mother (sloppy reading). Sag (1976) and Williams (1977) proposed that the interpretation of VP ellipsis involves lambda abstraction at the semantic representation. For instance, the interpretation of the VP ellipsis involves the construction of the semantic representation like $\lambda X [X \text{ SAW HER}/X'S \text{ MOTHER}]$ at the ellipsis site and the assignment of X to JOHN (i.e., the semantic representation of the subject of the ellipsis clause). The strict reading is obtained if *HER* is chosen in the interpretation and the sloppy reading is obtained if *X'S* is placed with *JOHN'S*. Thus, in this account, the semantic representation is in some sense re-constructed.

5.7 Mary saw her mother; John did too.

Rather than trying to distinguish among all these four accounts, I instead ask whether syntactic structure is available at the ellipsis site. More specifically, I focus on the syntactic reconstruction account and test whether syntactic structure of the antecedent is reconstructed at the ellipsis site.

5.4 Psycholinguistic studies of VP ellipsis processing

Psycholinguistic studies have attempted to explore the nature of the antecedent representation (i.e., syntactic or semantic representation) that mediates the processing/interpretation of VP ellipsis and the mechanism (i.e., copying or reconstruction) whereby the antecedent representation is retrieved. Three aspects of experimental work on the processing of ellipsis are relevant to these questions: voice matching between the antecedent and the ellipsis, the length/complexity of the antecedent, and the distance between the antecedent and the ellipsis site.

5.4.1 Voice matching

Sentences that differ in voice but refer to the same event presumably have more similarity in semantics than in syntax. Thus, the syntactic account predicts that voice mismatch between the ellipsis and the antecedent should reduce acceptability and cause processing difficulty, whereas the semantic account predicts less severe problems. Murphy (1985) was one of the first studies to look at the effect of voice matching on the interpretation of VP ellipsis. He asked participant to read sentences such as in (5.8). He manipulated both voice matching and distance between the antecedent and the ellipsis. He found that there was a voice matching effect when the antecedent and the ellipsis were adjacent: People were slower in comprehending the ellipsis clause when there is a voice mismatch. But there was no voice mismatching effect when the antecedent and the ellipsis were separated by other sentences.

5.8a. Leslie kicked the ball. (.....) But Fran wouldn't.

5.8b. The ball was kicked by Leslie (.....) But Fran wouldn't.

A similar study was also reported by Tanenhaus and Carlson (1990), who asked participants to read the sentences as in (5.9) and to judge whether they made sense. They found that when there was a voice mismatch (e.g., 5.9b), people judged the sentence to make sense less often than when there was no voice mismatch (5.9a). The effect of voice matching is also found in reading times: People were slower in comprehending VP ellipsis when there was voice mismatch.

5.9a. Someone has to take out the garbage. But Bill refused to.

5.9b. The garbage has to be taken out. But Bill refused to.

At the first glance, the above studies seem to suggest that voice matching is a requisite for VP ellipsis interpretation and thus support the syntactic account. However, Tanenhaus and Carlson (1990) also found their participants rated ellipsis with voice mismatch as acceptable 70% of the time, though the syntactic account predicts that it should be ungrammatical. More recently, Arregui, Clifton, Frazier and Moulton (2006) proposed that the processor syntactically restructures antecedent

material to create an antecedent for the ellipsis. Such an account seems to be able to accommodate the finding that 70% of the time voice-mismatch ellipsis sentences were judged acceptable. However, an alternative explanation could be that the restructuring takes places over semantic representations rather than syntactic representations (e.g., Dalrymple et al., 1991; Sag, 1976; Williams, 1977).

5.4.2 Antecedent length/complexity

Longer antecedents tend to have more complex structure than shorter antecedents, so a (semantic or syntactic) reconstruction account predicts that they should lead to more difficulty at the ellipsis site. In accord with this, Murphy (1985) found that people took longer to read a VP ellipsis following a long/complex antecedent (e.g., 5.10b) than a short/less complex antecedent (e.g., 5.10a); however, a similar length effect was also observed with a VP anaphor (e.g., *his uncle did it too*). As VP anaphors are commonly assumed to be resolved at a discourse level (Tanenhaus & Carlson, 1990; Hankamer & Sag, 1976), the antecedent length effect was more likely to be due to semantic or discourse processing rather than syntactic processing.

5.10a. Jimmy swept the tile floor. His uncle did too.

5.10b. Jimmy swept the tile floor behind the chairs free of hair and cigarettes.
His uncle did too.

Furthermore, more recent studies seemed to have failed to observe any antecedent length effect. Frazier and Clifton (2001) found that it took the same time to read a VP ellipsis (e.g., *Tina did too*) whether it followed a longer and more complex structure (e.g., *Sarah got up the courage to leave her boyfriend last May*) or a shorter and less complex one (e.g., *Sarah left her boyfriend last May*). The lack of length/complexity effect in Frazier and Clifton (2001) was taken as evidence for their syntactic copying account.

The lack of antecedent length effect was also observed by Martin and McElree (2008). Using both speed-accuracy trade-off and eyetracking, Martin and McElree found that the length/complexity of the antecedent (e.g., *The history professor understood Roman mythology* vs. *The history professor understood Rome's*

swift and brutal destruction of Carthage) did not affect the speed in the processing of the ellipsis (e.g., *but the over-worked students did not*). Martin and McElree (2008) suggested that the processing of the ellipsis involves a pointer to the memory representation of the antecedent VP. Such a conclusion is quite similar to the semantic copying account.

5.4.3 Distance between the antecedent and the ellipsis

Finally, effects of distance may help discriminate the accounts. Given the evidence for the short-lived nature of memory for syntactic structure (e.g., Sachs, 1967; cf. Bock & Griffin, 2000), the syntactic account predicts that it would be harder to reconstruct the syntactic structure of the VP antecedent when the ellipsis is distant from the antecedent than when it is close. Garnham (1987) found evidence for this prediction. He varied the distance of the antecedent from the ellipsis (1, 2 or 3 sentences back). He found that VP ellipsis was processed the fastest when the antecedent was only 1 sentence back, though there was no difference when the antecedent was either 2 or 3 sentences between.

A similar distance effect was observed by Garnham and Oakhill (1987). They asked people to read sentences as in (5.11). Note that people could be misled by plausibility information in the processing of *the nurse had too* (as nurses often examine people rather than being examined) but not in the processing of *the child had too*. They found that people were more susceptible to plausibility information when the ellipsis was farther away from the antecedent than when it was closer.

5.11. It had been a busy morning in the hospital.

The elderly patient had been examined by the doctor.

(during the ward round)

The child/nurse had too.

But it is controversial whether the effect of distance is due to syntactic decay or semantic decay. In fact, there is evidence that the distance effect is due to the decay of semantic representation over time. Martin and McElree (2008) monitored

participants' eye movement when they were reading sentences like (5.12), where the distance between the antecedent and the ellipsis was manipulated (with or without the materials in the brackets). They found no first pass effects of distance in the ellipsis site and the follow-up region, which was taken as evidence that participants had no difficulty identifying the antecedent. They did, however, find that subjects spent more time re-reading the antecedent region in the distant antecedent condition than in the close antecedent condition. They interpreted this finding as suggesting that the semantic representation decayed over time when the antecedent was distant.

5.12. The editor admired the author's writing, but (everyone at the publishing house was shocked to hear that) the critics did not, even though his first book won an award.

Another possibility is that syntactic representations change over time more quickly than semantic representations, so that the ellipsis makes reference to a syntactic representation for a close antecedent and a semantic representation for a more distant antecedent. This might be compatible with Murphy's (1985) findings of a length effect for close but not distant antecedents (assuming that length relates better to syntactic than semantic complexity) and of a voice mismatch effect for close but not distant antecedents. But overall the evidence does not discriminate among the accounts.

5.4.4 Summary

So far, all the three lines of research on VP ellipsis processing have yielded conflicting findings concerning the representation that mediates the interpretation of VP ellipsis and the mechanism whereby such representation is retrieved. One possible reason for these conflicting findings is that the paradigms used (e.g., self-paced reading and eye tracking) are sensitive to both syntactic and semantic information. For instance, it is hard to tell whether the distance effect is due to decay of syntactic or semantic representation. Also, if re-structuring is used when there is no appropriate antecedent VP, it is hard to tell whether such re-structuring is applied to a syntactic representation or a semantic representation. In what follows, I

introduce structural priming as a method in the investigation of VP ellipsis processing.

5.5 Using structural priming to investigate sentence comprehension

Structural priming has been used to investigate syntactic issues in sentence processing. For example, van Gompel, Pickering, Pearson, and Jacob (2006) used structural priming to explore whether people fully abandon the initial wrong parse after reanalysing a sentence. They first asked participants to comprehend sentences such as (5.13) and later complete sentence preamble where the verb could be used transitively or intransitively (e.g., *When the doctor was visiting...*).

5.13a. While the man was visiting the children who were surprisingly pleasant and funny played outside.

5.13b. While the man was visiting, the children who were surprisingly pleasant and funny played outside.

Note that (5.13a) is ambiguous. The NP *the child...* has been found to be initially attached as the object of the verb *visiting* and later reanalysed as the subject of the main clause (e.g., Pickering & Traxler, 1998). No such ambiguity is present in (5.13b). There is evidence that people may not fully abandon the initial syntactic analysis (e.g., interpreting *the child...* as the object of *visiting*) even after they have reanalysed the sentence (e.g., Christianson, Hollingworth, Halliwell, & Ferreira, 2001). Van Gompel et al. (2006) found that people used a verb (e.g., *visiting*) transitively more often following (5.13a) than following (5.13b), confirming previous finding that the initial syntactic analysis may still be available after the sentence is reanalysed.

Another study by Christianson et al. (2010) used structural priming to investigate whether semantic information (i.e., plausibility) can lead to syntactic analyses. They found that implausible passive primes such as *the dog was bitten by the man* actually led to more active responses though plausible passives such as *the man was bitten by the dog* led to more passive responses. They took this as evidence that people use both syntactic and semantic information to arrive at syntactic

analyses. For instance, in *the dog was bitten by the man*, semantic considerations would lead people to map *the dog* onto the Agent role and *the man* onto the Patient role of the biting event, arriving at an Agent-action-Patient analysis of the sentence.

5.6 Experiment 5.1

In this section, I report an experiment where I used structural priming to investigate the processing of VP ellipsis in Mandarin Chinese. If VP ellipsis is processed via the syntactic structure of antecedent, then participants should tend to use the syntactic structure of the antecedent in utterances following the comprehension of a VP ellipsis. VP ellipsis is common in Chinese. For instance, (5.14) involves a VP ellipsis (e.g., Xu, 2003): Supposedly, there is an elided VP *jie-gei shuishou naba qiang* [“lend the sailor that gun”] following *bu xiang* [“not want to”]. Similar to English VP ellipsis, the interpretation of Chinese VP ellipsis is dependent on an antecedent in the discourse.

- 5.14. Fuwuyuan xiang jie-gei shuishou naba qiang; chushi que bu xiang.
Waitress want lend-to sailor that gun; chef however not want
(The waitress wanted to lend the sailor that gun; however, the chef did not want to.)

I used the sentence-comprehension paradigm in the experiment. Participants heard one of the prime sentences in Table 5.1 below and then described a picture using the same verb in the texts (e.g., *jie*, [“lend”]) (see Figure 5.1 for the experiment paradigm and procedure). I investigated the extent to which they repeated the structure of the antecedent sentence in the prime sentence following each of the primes in Table 5.1.

Table 5.1: Examples of experimental sentences in Experiment 5.1.

Sentence type	DO antecedent sentences
	<i>Fuwuyuan xiang jie-gei shuishou naba qiang. yinwei haipa reshi,...</i> waitress want lend-to sailor that gun. because afraid trouble (The waitress wanted to lend the sailor that gun. Being afraid of running into trouble, ...)
ellipsis	<i>... chushi que bu xiang.</i> chef however not want (...the chef did not want to).
full-form	<i>... chushi que bu xiang jie-gei shuishou naba qiang.</i> chef however not want lend-to sailor that gun (... the chef did not want to lend the sailor that gun.)
baseline	<i>... chushi mei shuohua</i> chef not speak (... the chef did not speak.)
	PO antecedent sentences
	<i>Fuwuyuan xiang jie naba qiang gei shuishou. yinwei haipa reshi,...</i> waitress want lend that gun to sailor because afraid trouble (The waitress wanted to lend that gun to the sailor. Being afraid of getting into trouble, ...)
ellipsis	<i>... chushi que bu xiang.</i> chef however not want (...the chef did not want to.)
full-form	<i>... chushi que bu xiang jie naba qiang gei shuishou</i> chef however not want lend that gun to sailor (... the chef did not want to lend that gun to the sailor].
baseline	<i>... chushi mei shuohua.</i> chef not speak (... the chef did not speak.)

The DO/full-form and PO/full-form conditions used two prime sentences (both PO or both DO). Following previous studies, I predict strong priming for PO and DO responses respectively following these primes, because one of the primes immediately precedes the target picture and both use the same verb as the target (e.g., Pickering & Branigan, 1998). In contrast, DO/baseline and PO/baseline replace the second prime sentence by a “neutral” sentence that does not use a PO or DO construction. I predict weaker priming following these primes than the full-form primes: The intervening sentence should not prime either construction (e.g., Branigan et al., 1999; Pickering et al., 2002), because it uses one prime rather than two (e.g., Kaschak et al., 2004), and because the “lexical boost” due to verb repetition appears to be largely or entirely limited to cases where primes and targets are adjacent (e.g., Hartsuiker et al., 2008). The adjunct phrases (e.g., *yinwei haipa reshi*) increase the distance between prime and target. I therefore predict greater priming following the full-form primes than the baseline primes.

The critical conditions are the DO/ellipsis and PO/ellipsis conditions. In DO/ellipsis and PO/ellipsis, comprehenders have to interpret the elliptical construction *chushi que bu xiang* (“but the chef did not want to”). According to syntactic reconstruction, they should re-use the syntactic information (syntactic procedures or representations) associated with forming the DO analysis in processing DO/ellipsis primes and with forming the PO analysis in processing PO/ellipsis primes. These conditions should therefore have the same priming effect as DO/full-form and PO/full-form primes. Thus, people should tend to produce a DO construction after DO/ellipsis primes to the same extent as after DO/full-form primes, and to produce a PO construction after PO/ellipsis primes to the same extent as after PO/full-form primes. Syntactic copying may make the same predictions, if the locus of priming is the presence of the complete representation.

In contrast, semantic accounts (whether involving reconstruction or copying) predict that comprehenders should access semantic representations in the ellipsis primes, whether via reconstruction or copying. As these representations are largely the same for PO and DO constructions, the ellipsis should not in itself lead to priming. These conditions should therefore behave similarly to the baseline primes, and show less priming than the full-form primes.

In conclusion, all accounts predict more priming for the full-form primes than the baseline primes. If the ellipsis primes behave like the full-form primes, this would be incompatible with semantic accounts. But if they behave like the baseline primes, this would be incompatible with syntactic reconstruction.

Method

Participants. Sixty participants from universities in Guangzhou, China were paid 15 RMB (roughly £1.50) to take part. Three of the participants were excluded from data analysis because they produced Other responses on at least 1/3rd of experimental trials.

Stimuli. There were 36 experimental items and 108 filler items. Each item consisted of a prime sentence and a target picture. For the experimental items, the prime sentence was one of the versions in Table 5.1. Experimental target pictures depicted a dative event; there was a sentence preamble containing the same dative verb as the prime text. See Figure 5.1 for an example of the experimental items. For the filler items, the prime sentence used various syntactic constructions with transitive or intransitive verbs. Filler target pictures depicted transitive or intransitive events; there was also a sentence preamble, though it might not always had the same verb used in the prime text.

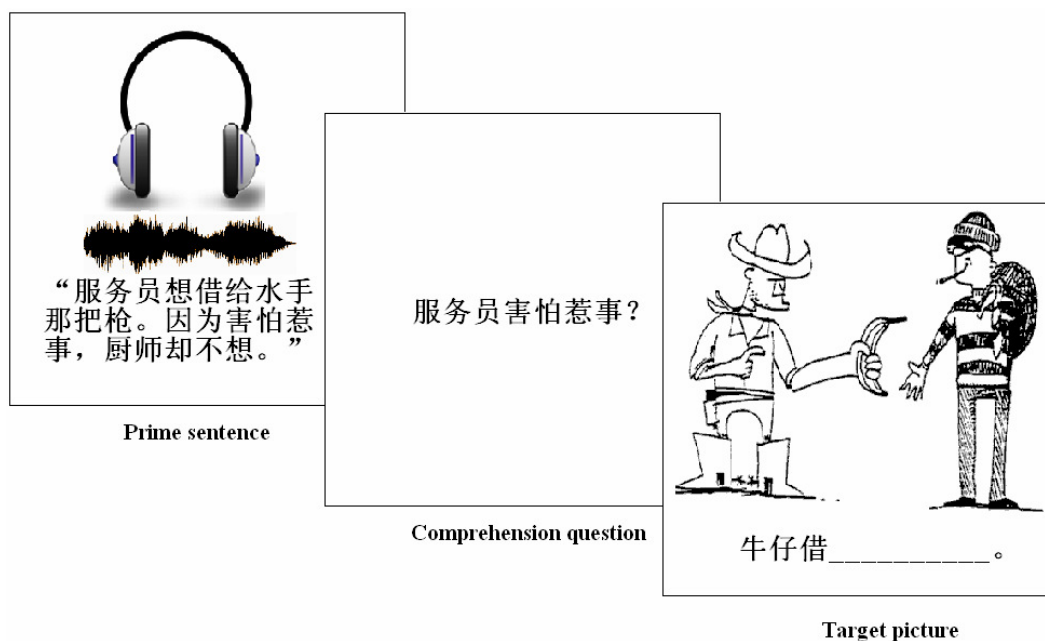

Figure 5.1: Experiment procedure. The prime sentence means “The waitress wanted to lend the sailor that gun, but being afraid of getting into trouble, the chef did not want to”; the comprehension question means “Was the waitress afraid of getting into trouble?”; the target picture has a preamble meaning “The cowboy lent _____.”.

Procedure. I created 6 stimulus lists. Each list was divided into two blocks so that each target dative verb (e.g., *song* “give”) was used only once in each block. The order of the blocks was counter-balanced across participants. The order of items within each block was individually randomized for each participant. Participants were told that they would be tested on their memories of the sentences they read. The experiment was carried out in DMDX (Forster & Forster, 2003). After being given the experiment instructions, participants were familiarized with the names of figures and objects that appeared in the experiment, and then underwent a practice session of four trials. In the experiment, participants saw a line of dashes, pressed the spacebar, and heard a prime sentence. For half of the trials, they then saw a comprehension question about the prime sentence. Half of the questions required a yes response as the correct answer and the other half required a no response. Participants responded by pressing *F* (yes) or *J* (no). Then they saw a target picture and described it using the sentence preamble. The experiment lasted about 45 minutes.

Scoring. Responses in which the verb was followed by a noun phrase denoting the Recipient and then a noun phrase denoting the Theme were scored as DOs; responses in which the verb was followed by a noun phrase denoting the Theme and then a prepositional phrase using *gei* were scored as POs. All other responses were scored as Others.

Results

Out of the 2052 responses, 120 were scored as Others (6%). There were 283 DO responses (14%) and 1649 PO responses (80%). As we were interested in the effect of sentence type on priming, we used priming (primed vs. unprimed responses) rather than response type (DO vs. PO response) as the dependent variable. A DO or PO response was counted as a *primed* response if it was the same form as the prime sentence and as an *unprimed* response otherwise. We used logistic mixed effects modelling to analyze the data (Jaeger, 2008). In the analysis, we first determined which effects were significant predictors in modelling the data and only used significant predictors in the final model. We used sentence type (full-form, ellipsis, and baseline), antecedent construction (DO and PO), and comprehension question (with or without a comprehension question) as fixed predictors in the modelling; both subject and item were treated as random intercepts. As shown in Table 5.2, only sentence type and antecedent produced significant effects in the modelling of the data. Hence, we included sentence type and antecedent construction as the predictors in the model. Table 5.3 presents the distribution of primed and unprimed responses by sentence type and antecedent construction.

Table 5.2: Results of LME analyses for Experiment 5.1.

Effects	
Sentence type	$\chi^2(2) = 6.3205, p < .05$
Antecedent construction	$\chi^2(1) = 11168.6, p < .001$
Comprehension question	$\chi^2(1) = 6.1365, p > .05$
Sentence type * Antecedent construction	$\chi^2(2) = .1914, p > .05$
Sentence type * Comprehension question	$\chi^2(2) = 5.2207, p > .05$
Antecedent construction * Comprehension question	$\chi^2(1) = 1.9928, p > .05$
Sentence type * Antecedent construction * Comprehension question	$\chi^2(2) = 1.7718, p > .05$

Table 5.3: Responses according to sentence type and antecedent construction and priming effect according to sentence type.

Sentence type	Ellipsis		Full-form		Baseline		
	Antecedent	DO	PO	DO	PO	DO	PO
DO		57	32	88	17	66	23
PO		269	287	238	299	255	301
Others		16	23	16	26	21	18
% of PO		0.83	0.90	0.73	0.95	0.79	0.93
Primed		344		387		367	
Unprimed		301		255		278	
Priming		.53		.60		.57	

There were reliably more primed responses than unprimed responses ($z = 4.798, p < .001$), a standard structural priming effect. For sentence type, full-form induced stronger priming effect than both ellipsis (Estimate = .65, SE = .17, $z = 3.72, p < .001$) and the baseline (Estimate = .36, SE = .17, $z = 2.09, p < .05$), while there was no difference in priming effect between ellipsis and baseline (Estimate = -.2901, SE = .17, $z = -.17, p > .05$). For antecedent construction, people used the same structure as the antecedent when the antecedent was a PO construction more often than when it was a DO construction (Estimate = 4.26, SE = .16, $z = 26.29, p < .001$); however, it should be noted that the effect could be due to the fact that the PO

construction is more frequent than the DO construction. The distribution of “Other” responses did not differ by condition ($ps > .1$).

5.7 Discussion

The experiment investigated the extent to which people are primed by a PO or DO sentence followed by a VP ellipsis in Mandarin. The magnitude of priming following an elliptical sentence was equivalent to that following a neutral sentence that did not repeat the PO or DO structure, and was less than that following a repeated PO or DO structure. Thus participants did not process the VP ellipsis in a way that primed the syntactic structure of its antecedent.

The findings are therefore incompatible with the syntactic reconstruction account, in which people comprehend a VP ellipsis using the same syntactic processes as they use comprehending its antecedent. The results are also incompatible with the syntactic copying account if structural priming is sensitive to “syntactic copies” as proposed by Frazier and Clifton (2001). Syntactic copying may involve a *transparent* syntactic representation. For instance, for the sentence *the girl gave the teacher a drawing, the boy did too*, the processor may copy the structure [_{VP} V NP NP] at the ellipsis site. Alternatively, the processor may just copy an *opaque* structure of the antecedent such as [VP] to the ellipsis site. If syntactic copying involves a transparent syntactic representation, which arguably leads to structural priming (e.g., Pickering & Branigan, 1998), the syntactic copying account, like the syntactic reconstruction account, also predicts structural priming from the ellipsis, contrary to the findings. If, however, what is copied is only an opaque structure, then the syntactic copying account predicts no priming from the ellipsis site, consistent with the results.

More compatible with the results is the semantic account. As the PO and the DO alternates (as used in the experiment) have largely the same meaning, the VP ellipsis should lead to reactivation of similar semantic representations in both cases. Thus, the results suggest that the processing and interpretation of VP ellipsis does not have to be mediated by syntax.

Such a conclusion disagrees with some studies on the processing of pronominal anaphora. For instance, Sturt (2003) found that at an early stage of processing, the search for the antecedent is guided by syntactic information (e.g., the

binding theory), though non-syntactic information comes into play subsequently. There are two possible reasons for the discrepancy. First, what Experiment 5.1 showed is that no residual syntactic information was used in a subsequent utterance after the processing of VP ellipsis. Thus, it is possible that syntactic information may play some limited role or/and at an initial stage in VP ellipsis processing but it is quickly overrun by non-syntactic information (e.g., Shapiro et al., 2003); hence, no structural priming is detected at VP ellipsis. Such an explanation implies that the null difference between ellipsis primes and baseline primes was due to a lack of power in our experiment. However, such a possibility is quite unlikely given the finding that ellipsis primes induced even numerically less priming than the baseline. A more plausible account for the discrepancy between the current study and Sturt (2003), then, is that ellipsis and pronominal expressions are two different types of anaphoric expressions and may be processed with different manners, though there is suggestion that they may be both proforms (e.g., Hardt, 1993). In fact, reflexives in Sturt (2003) have a within-clause antecedent while VP ellipsis and its antecedent often occurs in different clauses. As syntax is more concerned with within-clause rather than between-clause linguistic organization, it is possible that the processing of anaphoric expressions such as VP ellipsis is not mediated by syntax because these expressions have cross-clause antecedents. Of course, these possibilities are empirical questions for further research. I will return to this issue in Chapter 7.

Chapter 6 Lexical and syntactic representations between closely related languages: Evidence from Cantonese-Mandarin bilinguals

6.1 Overview of the chapter

To what extent do bilinguals share lexical and syntactic representations between their two languages? Recent evidence suggests that they have shared syntactic representations for similar constructions between languages but retain distinct representations for noncognate translation equivalents (e.g., Hartsuiker & Pickering, 2008). I inquire whether bilinguals have more integrated representations of cognates. Psycholinguistic findings that cognates tend to have a closer relationship than noncognates have led to two alternative accounts concerning the representation of cognates: the separate-lemma representations account (i.e., cognates have distinct lemmas) and the shared-lemma account (i.e., cognates share the same lemma). Using structural priming, I found that, in bilinguals of Cantonese and Mandarin, cognate verbs (between the prime and the target) led to a smaller boost than same verbs did. The reduced boost suggests that cognates have separate lemmas rather than a single lemma. Two other findings were also observed. First, cross-language structural priming occurred regardless of verb meaning, suggesting that syntactic information associated with cognates is shared between languages, though cognates are represented separately. Second, there was an advantage for within-language priming over between-language priming. I interpreted such an advantage as the result of a language node passing activation to all the lemmas linked to it. Implications for bilingual lexical and syntactic representation and processing were discussed.

6.2 Introduction

To what extent do speakers of more than one language share lexical and syntactic representations between their languages? Previous work has addressed languages that are not very closely related, and suggests that certain syntactic representations are shared between the languages though lexical representations are maintained separately. In this chapter, I ask whether speakers of two very closely related languages, Mandarin and Cantonese, make use of more fully integrated lexical and syntactic representations. To do this, I examine the occurrence of structural priming effects between Mandarin and Cantonese sentences that contain verbs that have the same meaning.

Most theories of bilingualism assume that bilinguals do not represent their languages entirely separately but rather have a representation that is at least partly integrated (see Hartsuiker & Pickering, 2008). However, they tend to assume that this integrated representation draws on language-specific lexical representations; that is, words in a bilingual's lexicon are "tagged" for their language. In general, this appears necessary to prevent bilinguals regularly mixing up their languages. But is such a separation always necessary? If two languages use words with similar forms and meanings, it would in principle be possible to represent those words once (with differences between the languages being indicated). Such words would therefore not belong to either lexicon, but would constitute an integrated lexicon. In linguistics, such words tend to be known as *cognates*, though the term can have rather different meanings to different researchers. Though there are also interesting aspects of cognates such as the historical (etymological) relationship between cognates and the degrees of cognateness, from the perspective of language processing, psycholinguists are more interested in whether cognates can be shared across languages and, if they can, at what level (Sanchez-Casas & Garcia-Albea, 2005).

The typical approach to the above question might be to consider two clearly different languages that contain a fairly small set of cognates (whether related by etymology, being loan words, or even by chance). In this chapter, I take a different approach of considering Mandarin and Cantonese, in which almost all words are related. Mandarin and Cantonese have many characteristics that are usually associated with distinct languages, with their spoken forms being mutually

unintelligible (Tang & van Heuven, 2009). But in many other respects they are closely related. Notably, they share a large part of the grammar and the same orthography (Mandarin and Cantonese generally use the same characters to express the same meanings). In fact, they are officially referred to by the Chinese Academy of Social Sciences as two dialects of the same language, Chinese (Xing, 1991).

Importantly, the majority of Mandarin-Cantonese translation equivalents are cognates in the sense that they are equivalent in meaning, related in etymology, similar in phonology and identical in orthography. For instance, the Mandarin verb *di* and its Cantonese equivalent *dai* (both meaning “pass”) differ only in the vowel, while the Mandarin *huan* and its Cantonese equivalent *wan* (both meaning “return”) differ in the consonant. As these phonological differences in cognates result from historical changes (e.g., Baxter, 1992), the variation is often systematic and predictable. For instance, there is a systematic correspondence between the Mandarin consonant /hu/ (pronounced as [xw] in IPA) and the Cantonese /w/ (pronounced as [w] in IPA), as in *huan* – *wan* (“return”), and *huai* – *wai* (“bad”). In some cases, including verbs such as *song-song* (“give”), they differ between Mandarin and Cantonese only in their tone. In addition, all these translation equivalents are orthographically identical, as the two languages employ the same writing system (e.g., the same character, 递, is used for both *di* and *dai*).

6.3 Lexical and syntactic representations in bilinguals

There is substantial evidence to suggest bilinguals represent their two vocabularies in a single interconnected lexicon (e.g., Kroll & Stewart, 1994). De Bot (1992) proposed that during production, bilinguals use separate production systems to draw on this single lexicon. However, these systems may interact with one another, to an extent that depends on how closely the two languages are related, with closely related languages having closely integrated systems. With respect to syntax, Hartsuiker et al. (2004) proposed that bilinguals share syntactic representations between languages in cases where the relevant structures are sufficiently similar in the two languages. Indeed, we might expect that the extent to which bilinguals share syntactic representations and properties between languages depends on the extent to which those languages have similar structural properties: The more similar their

languages, the more they will share syntactic representations and processes. For example, the (surface) representations of the double-object (DO) and prepositional-object (PO) dative constructions are similar in Dutch and English; but the two languages differ substantially in other respects, such as word order in subordinate clauses, where English is verb-medial and Dutch is verb-final. We might therefore expect bilingual speakers of these languages to have shared representations for a relatively restricted part of their grammars. In other words, they would have two production systems, but (limited) aspects of the systems would be shared.

One such model is proposed in Schoonbaert, Hartsuiker, and Pickering (2007) for Dutch-English bilinguals (see Figure 6.1 for an adapted version in which language proficiency, i.e., a distinction between the speaker's first language (L1) and second language (L2), is ignored). This was based on Pickering and Branigan's (1998) model of syntactic representation in monolingual speakers, which in turn drew on Levelt, Roelofs, and Meyer's (1999) model of lexical representation. The model focuses on the *lemma* stratum, with each lemma representing the base form of a lexical item and its associated morphosyntactic information such as structure-building properties (Levelt et al., 1999). In the model, lemmas of the two languages are connected to the same conceptual representations but are distinguished by respective language nodes (see also Hartsuiker et al., 2004; Hartsuiker & Pickering, 2008). Lemmas are also linked to *combinatorial nodes*, representing the syntactic constructions in which they can occur. These syntactic representations, if sufficiently similar, are shared between languages (as the DO and PO constructions are). In the model, translation-equivalent words have separate lemma representations although syntactic features shared by those words (e.g., tense, combinatorial potential) have shared representations.

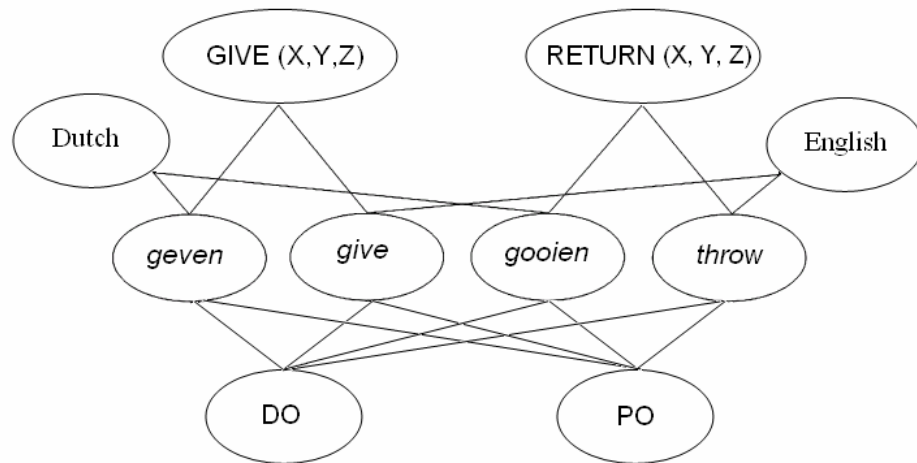

Figure 6.1: A model of lexico-syntactic representations proposed in Schoonbaert et al. (2007) for Dutch-English bilinguals.

Schoonbaert et al. (2007) based their model on translation equivalent verbs as a whole, and did not distinguish cognate translation equivalents from noncognate ones (*noncognates* henceforth). But there are reasons to believe that the nature of lexico-syntactic representations in bilinguals may be affected by the distinction between cognate and noncognate translation-equivalents. Cognates but not noncognates tend to have the same meaning and are phonologically and/or orthographically similar (and identical in some cases), and are usually etymologically related (Costa, Caramazza, & Sebastian-Galles, 2000). Though non-cognate translation equivalents have close relationships in bilingual language processing (e.g., Schoonbaert et al., 2009, in press), it has long been observed that cognates enjoy a closer relationship than noncognates in at least some aspects of bilingual language processing (see Sanchez-Casas & Garcia-Albea, 2005, for a review). In comprehension, lexical access is facilitated for cognate translation-equivalents but not (or to a lesser degree) with noncognate translation-equivalents (e.g., Garcia-Albea et al., 1996; Davis et al., 2010; cf. De Groot & Nas, 1991). For instance, Davis et al. (2010) found significant priming between English and Spanish cognates (e.g., *rich-rico*), but not between noncognates (e.g., *duck-pato*). Furthermore, they observed that the facilitation from cognates is not dependent on the degree of form overlap (i.e., phonological/orthographic similarity) between cognates. Moreover, Garcia-Albea et al. (1996) found that, in Spanish-Catalan bilinguals, the magnitude

of priming for a word (e.g., *coche*; Spanish “car”) was identical following its cognate (*cotxe*; Catalan “car”) as following the same word (i.e., identity prime).

In language production, Costa et al. (2000) compared the naming of pictures with cognate names in Spanish and Catalan (e.g., *gato-gat*; ‘cat’) and pictures with non-cognate names (e.g., *mesa-taula*; “table”). Though Spanish monolinguals showed no difference for the two types of pictures, Catalan-Spanish bilinguals showed faster naming times in Spanish for pictures with cognate names than for those with noncognate names. Catalan-Spanish bilinguals showed the same advantage for cognates when naming the picture in Catalan. Costa et al. interpreted the cognate advantage as a result of cascading activation from a non-selected word (e.g., GAT) to the phonological features (e.g., /g/, /a/ and /t/), which in turn adds activation to phonological features for the target word in the cognate case (e.g., /g/, /a/, /t/ and /o/), but not in the non-cognate case. However, this interpretation is undermined by the evidence that cognate effects are not dependent on form overlap (e.g., Davis et al., 2010; cf. Van Assche et al., 2009): If cognate facilitation were a result of extra activation at the phonological level, there should be larger facilitation for more similar cognates than for less similar ones, contrary to the finding by Davis et al.

An alternative interpretation that is compatible with such evidence is that cognates but not noncognates have shared morphological or lemma representations. Thus, in the case of pictures with cognate names in Costa et al. (2000), the facilitation effect observed with cognates would arise because of extra activation of the same morphological or lemma representation by the cognate counterpart in the non-response language. For instance, given that lexical access is language non-selective, the access of, say, a Spanish word also entails the activation the Catalan equivalent. If cognates but not noncognates have the same morphological or lemma representation, there will be extra activation of the morphological or lemma representation for cognates relative to noncognates, giving rise to the facilitation effect. Furthermore, as the shared morphological or lemma representation is independent of wordform, the cognate effect is then not dependent on the degree of form overlap (e.g., Davis et al., 2010). In keeping with this, Sanchez-Casas and Garcia-Albea (2005) speculated that cognates have a shared morphological

representation between the lemma stratum and the wordform stratum (e.g., Levelt et al., 1999). They also entertained the possibility that the shared representation between cognates is actually the lemma. On this account, cognates but not noncognates have the same lemma, which is linked to different wordforms (or phonological features). But because studies so far have mainly investigated the relationship between cognates with respect to wordform, existing evidence is insufficient to determine whether cognates have shared or separate lemma representations.

Schoonbaert et al. (2007)'s model (see Figure 6.1) suggests separate lemma representations for translation equivalents. However, the model was based on evidence from English and Dutch, two clearly distinguished languages that have a relatively limited number of cognates; in fact, of the 6 pairs of Dutch-English verbs that Schoonbaert et al. (2007) used, only one pair was cognate (i.e., *geeft* - *give*). Thus, though the model holds for noncognates, it remains a question whether it also holds for cognates.

6.4 Representation of Mandarin-Cantonese cognates

We can contrast two accounts of cognate representations in Cantonese-Mandarin bilinguals. The *separate lemma account* (Figure 6.2a) assumes that such bilinguals have different lemmas for cognates, just as for noncognates, as assumed in Schoonbaert et al. (2007). Alternatively, the *shared lemma account* (Figure 6.2b) assumes that such bilinguals (and bilinguals of other closely related pairs of languages) have shared lemmas for cognates. Note that in both accounts, lemmas are linked to the relevant conceptual representations, language nodes, and combinatorial nodes. The crucial difference is that cognates are represented as different lemmas in one account but as the same lemma in the other.

The two accounts therefore explain in different ways how speakers select wordforms from the appropriate language. In the separate-lemma account, a speaker selects either a Mandarin or a Cantonese lemma, and this leads to activation of the appropriate wordform. Language selection in this account therefore occurs at the lemma level. In the shared-lemma account, in contrast, the lemma is shared between Mandarin and Cantonese, but I assume that this shared lemma (e.g., *di/dai*) is linked

to two separate word-form nodes (*/di/* and */dai/*), which are also connected to their respective language nodes (i.e., */di/* to Mandarin and */dai/* to Cantonese). Thus a bilingual who chooses to use Mandarin activates the *di/dai* lemma and the Mandarin node, which in turn collectively activate the */di/* word-form node. Language selection in this account therefore occurs at the word-form level.

The two accounts also explain in different ways how speakers encode different structural preferences for each language, such that common syntactic constructions which are used with different frequencies in each language; for example, the DO construction is much rarer in Cantonese than in Mandarin (see Experiment 6.2 below)⁸. The separate-lemma account can explain such differences in terms of the strength of the links between each verb lemma and the combinatorial nodes. For instance, if the Mandarin verb *di* occurs more frequently in the DO construction than its Cantonese cognate *dai*, such a difference in frequency can be captured by assigning a stronger link from *di* to the DO node than from *dai* to the DO node. In the shared-lemma account as sketched in Figure 6.2b, there is only one lemma *di* and *dai* (i.e., *dildai* in Figure 6.2b), and hence only one link to the DO node. However, the shared-lemma model can account for frequency differences by assuming links between the language nodes and the combinatorial nodes. In this case, there would be a stronger link from the Mandarin node to the DO node than from the Cantonese node to the DO node. In this account, the choice of a construction would therefore result from activation from the lemma node and the relevant language node.

⁸ It has been suggested that the DO construction is grammatical only with a limited set of verbs such as *bei* in Hong Kong Cantonese (e.g., Tang, 1993). However, the DO construction seems to be acceptable with all the dative verbs used in this study in Guangzhou Cantonese, as can be seen in participants' production of DO constructions in Guangzhou Cantonese in Experiment 6.2.

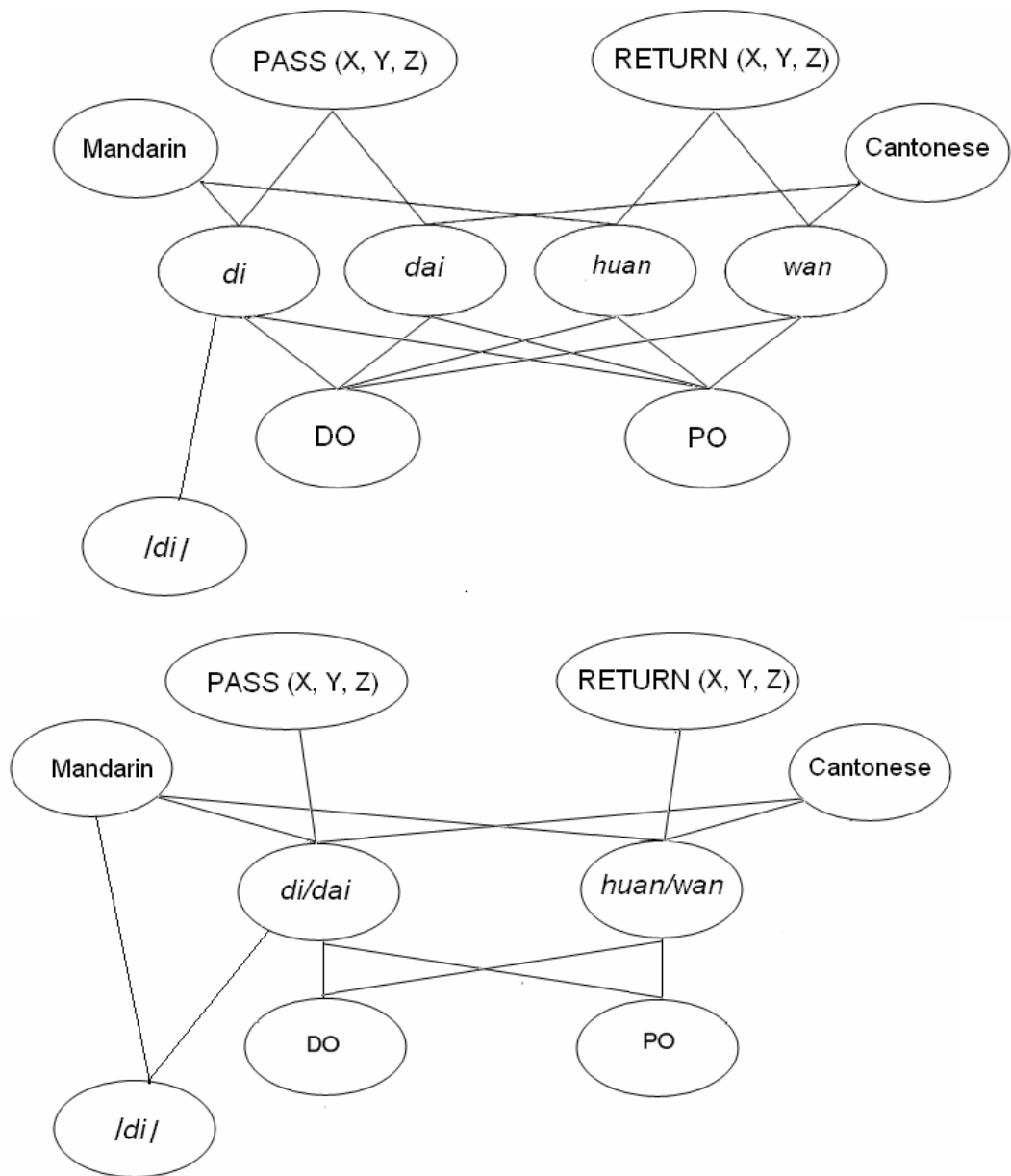

Figure 6.2: Two accounts of the lexico-syntactic representations in Cantonese-Mandarin bilinguals. Figure 6.2a (top): the separate-lemma account; Figure 6.2b (bottom): the shared-lemma account.

There are three reasons why shared-lemma account might appear to be more plausible. First, cognates in Mandarin and Cantonese have the same written form and closely related phonology. Second, many cognates in Mandarin and Cantonese have very similar morphosyntactic properties. Third, the shared-lemma account would appear to be more economical in terms of representation and would thus serve as a

more effective learning mechanism for a bilingual acquiring the two languages. Note that a child learning Cantonese and Mandarin simultaneously would usually find that a word in one language has an equivalent in the other language that could be used similarly and differs in phonology in only minor ways. In principle, such a situation could well result in him or her representing the two words as two variants of the same base form (i.e., lemma).

6.5 Structural priming and lexico-syntactic representations

Let's now consider how these two accounts can be contrasted using a structural priming paradigm. Over the past decade, researchers have extensively exploited structural priming to investigate lexical and syntactic representation and processing in language production (see Pickering & Ferreira, 2008, for a review). Structural priming refers to the tendency for people to repeat utterance forms to which they have been recently exposed. Bock (1986b) found that English-speaking participants are more likely to describe a picture using a PO form such as *the girl is handing a paintbrush to the boy* after hearing and repeating another otherwise unrelated PO sentence such as *the rock star sold some cocaine to the undercover agent* than a DO sentence with the same meaning (*the rock star sold the undercover agent some cocaine*). Such priming does not depend upon lexical repetition (Bock, 1986b, 1989), though it is greatly enhanced when the lexical heads (e.g., the main verb) of prime and target utterances are the same (the *lexical boost*; Pickering & Branigan, 1998) or semantically related (the *semantic boost*; Cleland & Pickering, 2003).

The enhancement of structural priming with identical or related lexical heads can be captured by the lexical representation model proposed by Pickering and Branigan (1998). On their account, producing an utterance with a particular structure activates the relevant lemma node and combinatorial node (corresponding to the relevant construction), as well as the link between them. In this account, structural priming is due to residual activation of the combinatorial node; the lexical boost to structural priming is due to residual activation of the lemma node (e.g., *give*), the combinatorial node (e.g., PO), and the link between them. The semantic boost occurs because each lemma node is linked to a conceptual node at the conceptual level, and nodes representing semantically related concepts are linked; activation during

production or comprehension of a particular concept (e.g., GIVE) leads to some activation of related concepts (e.g., HAND), causing co-activation of the HAND lemma and the relevant combinatorial node, and hence enhanced priming. Note however that there is no evidence for a phonological boost (e.g., from *the ship that is red* to *the sheep that is red* in noun phrase priming), suggesting a limit in feedback from form levels to the lemma level (see Cleland & Pickering, 2003).

Evidence from structural priming has provided the main evidence that bilingual speakers integrate the syntactic representation of their two languages to at least some degree. For example, Loebell and Bock (2003) found that German-English bilinguals tended to use a PO or DO form in German if they had just used the structurally equivalent form in English, and vice versa. Similarly, Hartsuiker et al. (2004) found that participants were more likely to use an English passive if they had just heard a Spanish passive than a Spanish active (see also Heydel & Murray, 2000; Meijer & Fox Tree, 2003). Hartsuiker et al. explained their findings within an extension of Pickering and Branigan's (1998) model of monolingual syntactic representation. They suggested that at the lemma stratum, Spanish and English verbs are represented distinctly but are linked to the same combinatorial nodes (e.g., active and passive nodes). For example, producing a passive in Spanish activates the passive node, which thus increases the likelihood of subsequently using a passive in English.

Schoonbaert et al. (2007) provided evidence for separate representations for translation equivalents and shared representation for combinatorial nodes. They found that within-language priming and the (within-language) lexical boost occurred to comparable extents in both Dutch (L1) and English (L2) in dative production for Dutch-English bilinguals. Between-language priming also occurred from Dutch to English and vice versa, providing further evidence that the two languages share some combinatorial nodes. Furthermore, between-language priming was stronger from Dutch (L1) to English (L2) for sentences involving translation-equivalent verbs (which were mainly noncognates; e.g., *gooien* and *throw*) than for sentences involving verbs that were unrelated in meaning (e.g., *gooien* ["throw"] and *give*). However, this between-language *translation-equivalent boost* was only one seventh the size of the within-language lexical boost. To account for these findings,

Schoonbaert et al. proposed that English and Dutch (noncognate) translation-equivalent verbs do not have a single lemma representation; hence translation equivalents did not lead to a lexical boost. Rather, they have lemma representations that are distinct but related (through links to the same concept). Thus, the translation-equivalent occurred due to the co-activation (via the shared concept) from the lemma of the verb in the prime sentence to the lemma of its translation-equivalent, similar to the mechanism for the semantic boost (e.g., between *goat* and *sheep*) observed by Cleland and Pickering (2003). It should be noted that Schoonbaert et al. only observed the translation-equivalent boost in priming from L1 (Dutch) to L2 (English) not the other way round; I return to this in General discussion.

The finding that verbs with distinct but related lemmas induce a boost that is smaller than the lexical boost can help us contrast the separate-lemma account (Figure 6.2a) and the shared-lemma account (Figure 6.2b) of cognate representations. I investigated bilinguals who speak closely related languages namely Mandarin and Cantonese. Consider the dative alternation in both Mandarin and Cantonese, as in (6.1a-d), which is similar to the English dative alternation, with the PO form involving the preposition *gei* (to) and the inverse order of arguments from the DO form^{9, 10}.

6.1 a. Niuzai di/huan-gei shuishou yitiao xiangjiao. (Mandarin DO)

cowboy pass/return sailor a banana

6.1 b. Niuzai di/huan-le yitiao xiangjiao gei shuishou. (Mandarin PO)

cowboy pass/return-ASP a banana to sailor

6.1c. Ngaozai dai/wan-bei suisau yattiu heungjiu. (Cantonese DO)

cowboy pass/return sailor a banana

6.1d. Ngaozai dai/wan-joh yattiu heungjiu bei suisau. (Cantonese PO)

cowboy pass/return-ASP a banana to sailor

⁹ The romanized transcripts for Mandarin follow the standard romanization system used in China. The romanized transcripts for Cantonese were obtained from a web-based spelling translator <http://www.kawa.net/works/ajax/romanize/chinese-e.html>.

¹⁰ Because both Mandarin and Cantonese words tend to have a bi-syllabic structure, it sounds more natural for the dative verb in the PO form in both languages to have an aspectual particle. In contrast, the verb in the DO form is already bi-syllabic and would sound less natural if it had an aspectual particle. The particles *-le* and *-joh* are telic (i.e., they refer to completed actions). Despite the presence of the aspectual particle in the PO form, both forms have essentially the same meaning.

How might such sentences prime participants' choice of syntax when describing an event such as a policeman passing a soldier a hat, which can equally well be described using a DO or PO form in both Mandarin and Cantonese? Both the separate- and shared-lemma accounts of course predict within-language priming (e.g., the likelihood of using a Mandarin DO in the description would be higher following [6.1a] than [6.1b]) and a lexical boost (priming would be greater when the prime and the target have the same verb than different verbs). Both accounts also predict between-language priming (e.g., the likelihood of using a Mandarin DO in the description would be higher following [6.1c] than following [6.1d]), because under both accounts combinatorial nodes are shared between languages. Moreover, both accounts predict a translation-equivalent boost to priming (i.e., greater between-language priming when the prime and target have same-meaning verbs than when they have different-meaning verbs), because on both accounts, translation-equivalent verbs share a conceptual node that passes activation to linked lemmas, so that a prime containing a particular verb in a particular structure will lead to co-activation of its translation-equivalent lemma and the relevant combinatorial node, yielding enhanced priming.

However, the two accounts make different predictions concerning the magnitude of the translation-equivalent boost. The separate-lemma account predicts that the translation-equivalent boost should be smaller than the lexical boost (as observed by Schoonbaert et al., 2007). For example, when the target description is in Mandarin using the verb *di*, the translation equivalent boost from the *dai*-sentence compared to the *wan*-sentence in (6.1c) should be smaller than the lexical boost from the *di*-sentence compared to the *huan*-sentence in (6.1a). This is because when the prime sentence involves *dai*, the *dai* lemma becomes most activated and the separate *di* lemma is activated to a smaller extent (through the shared concept node). In contrast, the shared-lemma account predicts that the translation-equivalent boost should be comparable to the lexical boost, because the same shared lemma is activated when a prime containing *dai* is processed as when a prime containing *di* is processed.

Thus, we can examine whether cognates between Mandarin and Cantonese have shared or distinct lemma representations by comparing the extent to which priming is increased by repeating the same verb between sentences (i.e., the lexical boost) versus the extent to which priming is increased by repeating a cognate verb with the same meaning between sentences (i.e., the translation-equivalent boost). In Experiment 6.1, participants produced target descriptions in Mandarin; in Experiment 6.2, they produced target descriptions in Cantonese. In each experiment, they comprehended descriptions in both languages. As well as manipulating prime structure and prime language, I manipulated whether prime and target verbs had the same meaning (*same verbs* in within-language priming and *cognate verbs* in between-language priming) or different meanings. I predicted within- and between-language structural priming, together with a lexical boost and a translation-equivalent boost. But as we have seen, comparison of the magnitude of the translation-equivalent boost (from cognate verbs) as compared to that of the lexical boost (from same verbs) should allow us to distinguish the separate- and shared-lemma accounts.

6.6 Experiment 6.1

Method

Participants. Seventy-two college students in Guangzhou were paid 15 RMB (roughly £1.5) to take part. They were native speakers of Cantonese living in a predominantly Cantonese-speaking region but had used Mandarin since early childhood, and used both languages daily.

Materials. I created 32 experimental items and 96 filler items. Each item comprised a prime sentence, a prime picture, and a target picture (see Figure 6.3). An experimental prime sentence had 8 versions: a Mandarin PO sentence, a Mandarin DO sentence, a Cantonese PO sentence, and a Cantonese PO sentence (see 6.1a-d); each of the sentences also had a same-meaning verb version (i.e., same-meaning verbs between prime and target) and a different-meaning verb version (i.e., different-meaning verbs between prime and target). The filler prime sentences included 48 active transitives and 48 intransitives. Half of the transitives and intransitives were in Mandarin and the other half were in Cantonese. The prime sentences were read by a

female speaker from the same population as the participants and were digitally recorded as WAV files in a recording studio.

The prime pictures depicted entities interacting in an action; a verb indicating the action was printed below the picture. Half of the depicted events matched the event described by the corresponding prime sentence; the other half did not. For the mismatching experimental prime pictures, the Agent, the Theme, or the Recipient in the event was incompatible with the sentence; for the mismatching transitive filler prime pictures, either the Agent or the Patient was incompatible; for the mismatching intransitive filler prime pictures, the Agent was incompatible.

The target picture depicted an event that was unrelated to the event expressed in the prime sentence or prime picture and did not involve any of the same entities. It included a sentence preamble and an underline below the depicted event. For experimental target pictures and filler target pictures that depicted a mono-transitive event, the preamble included the Agent and the verb. The use of the preamble in the experimental target pictures helped induce DO or PO utterances (by preventing the use of other alternative constructions such as the *ba*-construction). For filler target pictures that depicted an intransitive event, the preamble contained the subject only.

Procedure. I used the picture-matching paradigm of structural priming. Instructions were given in Mandarin. Participants were told to produce target completions in Mandarin. The experiment was run on a computer using DMDX (Forster & Forster, 2003). Items were presented in individually randomized orders so that 2-4 fillers separated experimental items. Participants were first shown the entities (e.g., a pirate, a ball) that were to appear in the experiment, together with their names, in PowerPoint slides. After this, participants were presented with 3 practice items. For each item (in both the practice and the real experiment), participants first saw a line of dashes on the computer screen. After participants pressed the spacebar, the prime sentence was played. The prime picture then appeared and participants decided whether it matched the prime sentence by pressing *F* (match) or *J* (mismatch). The target picture then appeared and participants described it using the preamble provided as the beginning of their description (see Figure 6.3). The experiment took about 45 minutes.

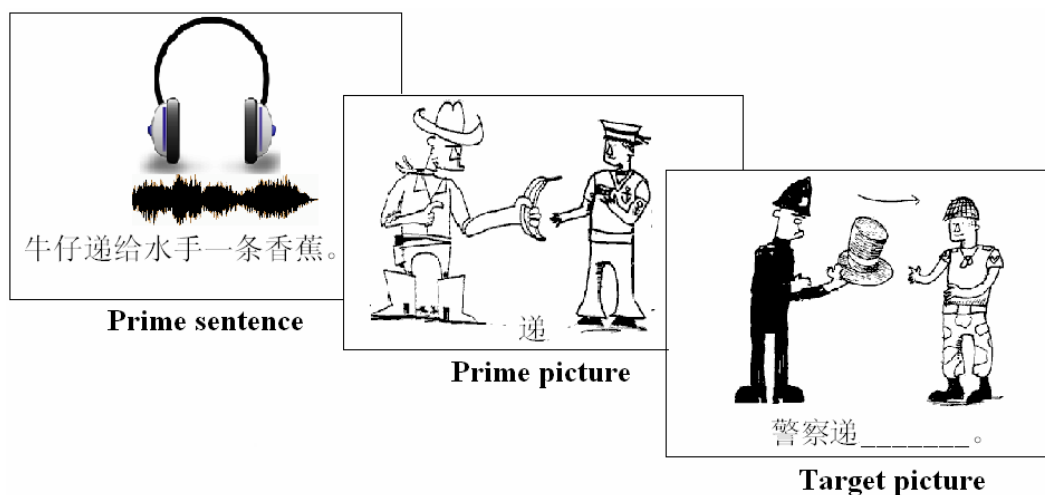

Figure 6.3: The experiment paradigm and procedure in Experiment 6.1. The prime sentence means “the cowboy passed the sailor a banana”; the character provided in the prime picture means “pass” and indicates the action in the picture. The target picture has a preamble literally meaning “the policeman pass_____.”.

Scoring. Following previous studies (e.g., Pickering & Branigan, 1998), all responses were scored as DOs, POs, or Others. A response was encoded as DO when the verb was followed by the Recipient and then the Theme (e.g., *jingcha di-gei shibing yiding maozi*, “the policeman passed the soldier a hat”), and as PO when the verb was followed by the Theme and then the Recipient (e.g., *jingcha di-le yiding maozi gei shibing*, “the policeman passed a hat to the soldier”). The rest of the responses were encoded as Others (which include cases where the preamble was changed, the response was ungrammatical, the Theme or the Recipient was omitted, or there was no response).

Data analysis

I carried out analyses that compared the number of *primed responses* (where the target had the same structure as the prime; i.e., a DO response following a DO prime or a PO response following a PO prime) and *unprimed responses* (where the target had the alternative structure to the prime; i.e., a DO response following a PO prime or a PO response following a DO prime). Thus, structural priming is measured by the relative frequencies of primed vs. unprimed responses, rather than as an interaction between prime construction and target construction (e.g., Pickering & Branigan,

1998), and, in keeping with this approach, the lexical boost was captured as whether priming was greater following same verb primes than following different verb primes, rather than as an interaction of prime construction (PO vs. DO) and verb (same vs. different). Analyzing the data in this way reduced the complexity of the analyses. For convenience, I also report the priming effect for each condition, calculated as the primed responses in each condition divided by the sum of primed and unprimed responses in that condition.

In the statistical analysis, I used logit mixed effects (LME) modelling (e.g., Baayen, 2008; Jaeger, 2008), and followed the analysis adopted in Sturt, Keller, and Dubey (2010). I first applied centering to the fixed predictors, assigning numeric values with a range of 1 and a mean of 0 to levels within a predictor. I then built a model with all centred fixed predictors (with both subjects and items as random intercepts).

Results and discussion

Table 6.1 reports DO, PO, and Other responses in each condition. Table 6.2 reports the statistic results of LME analyses. The intercept indicates that there were significantly more primed responses than unprimed responses, indicating that participants tended to use the same structure as the prime when describing the target picture: In other words, structural priming occurred. Verb meaning had a significant main effect, with same-meaning verbs inducing greater priming effects than different-meaning verbs (.78 vs. .61). Separate analyses indicated that the effect held for both within-language priming (Estimate = 1.04, SE = .14, $z = 7.17$, $p < .001$) and between-language priming (Estimate = .66, SE = .13, $z = 5.16$, $p < .001$), suggesting that there was a lexical boost when the same verbs were used between prime and target in within-language priming, and a translation-equivalent boost when cognates were used between prime and target. There was also a significant main effect of prime language, with greater within-language priming than between-language priming (.74 vs. .65). The effect was observed with both same-meaning verbs (Estimate = .68, SE = .15, $z = 4.48$, $p < .001$) and different-meaning verbs (Estimate = .27, SE = .12, $z = 2.16$, $p < .05$).

Table 6.1: Target responses and priming effect by prime condition in Experiment 6.1.

	Same-meaning verbs				Different-meaning verbs			
	Within		Between		Within language		Between language	
	language	language	language	language	language	language	language	language
	DO	PO	DO	PO	DO	PO	DO	PO
	prime	prime	prime	prime	prime	prime	prime	prime
DO	195	12	152	28	126	50	106	65
PO	84	271	128	255	150	230	168	212
Other	9	5	8	5	12	8	14	11
Primed	466		407		356		318	
Unprimed	96		156		200		233	
Priming	.83		.72		.64		.58	

Table 6.2: LME results for Experiment 6.1.

	<i>Estimate</i>	<i>SE</i>	<i>z</i>	<i>p</i>
Intercept	.89	.07	12.87	< .001
Verb meaning	.85	.10	8.81	< .001
Prime language	.46	.10	4.72	< .001
Verb meaning * Prime language	.36	.19	1.87	= .06

The finding of greater within-language priming than between-language priming for different-meaning verbs stands in contrast to Schoonbaert et al.'s (2007) finding of comparable within-language and between-language priming for sentences involving different-meaning verbs. In principle, the greater within-language priming for same- than different-meaning verbs could reflect simply a within-language priming advantage (as with different meaning verbs), or a combination of a within-language priming advantage and a boost to priming when the same verb is repeated in prime and target compared to when cognate verbs are used in prime and target. In fact, there was a marginally significant interaction between verb meaning and prime language, which suggests that the difference in priming between same verbs and cognate verbs cannot simply be a within-language advantage. In other words, there was a greater boost when the prime and target involved the same verb than when

they involved cognate verbs. This suggests that while same-verbs induced a lexical boost (e.g., Pickering & Branigan, 1998), cognate verbs induced a relatively smaller translation-equivalent boost (e.g., Schoonbaert et al., 2007). Finally, analyses of Other responses showed no main effects of verb meaning or prime language, nor any significant interaction.

These results are therefore incompatible with the shared-lemma account, which predicts comparable within- and between-language priming for both same-meaning verbs (i.e., cognate verbs should induce similar priming effects as same verbs do). Instead, they support the separate-lemma account. Furthermore, the results suggest a within-language priming advantage even for unrelated verbs, an issue I will return to in the General discussion. In Experiment 6.2, I replicated Experiment 6.1 but using Cantonese as the target language. This provided further tests of the two accounts and additionally allowed us to conduct a combined analysis to compare lexical preferences between Mandarin and Cantonese.

6.7 Experiment 6.2

Method

Participants. Seventy-two further participants from the same population as the participants in Experiment 6.1 were paid 15 RMB (roughly £1.5) to take part. Seven participants were replaced because they produced Other responses for more than 1/3 of targets or because of technical problems such as recording failures.

Materials, Procedure, and Scoring. These were the same as Experiment 6.1, except that participants were asked to describe the target picture in Cantonese. It should be noted that I continued using Mandarin as for experimental instructions partly to keep consistency between Experiments 6.1 and 6.2, and partly because Mandarin is more appropriate than Cantonese in academic situations.

Results and discussion

Table 6.3 presents the descriptive results of the experiment and Table 6.4 presents results of LME analyses.

Table 6.3: Target responses and priming effect by prime condition in Experiment 6.2.

	Same-meaning verbs				Different-meaning verbs			
	Within language		Between language		Within language		Between language	
	DO prime	PO prime	DO prime	PO prime	DO prime	PO prime	DO prime	PO prime
DO	110	3	69	5	41	10	42	13
PO	166	276	203	268	225	253	224	250
Other	12	9	16	15	22	25	22	25
Primed	386		337		294		292	
Unprimed	169		208		235		237	
Priming	.70		.62		.56		.55	

Table 6.4: LME results for Experiment 6.2

	<i>Estimate</i>	<i>SE</i>	<i>z</i>	<i>p</i>
Intercept	.45	.06	7.6	< .001
Verb meaning	.45	.09	4.99	< .001
Prime language	.19	.09	2.07	< .05
Verb meaning * Prime language	.34	.18	1.89	= .06

As shown in Table 6.4, the significant intercept indicates more primed than unprimed responses: Participants tended to use the same structure as the prime when describing the target picture. Same-meaning verbs induced greater priming effects than different-meaning verbs (.66 vs. .55), which is true for both within-language priming (Estimate = .61, SE = .13, $z = 4.78$, $p < .001$) and between-language priming (Estimate = .27, SE = .12, $z = 2.21$, $p < .05$). These findings suggest both a lexical boost from same verbs and a translation-equivalent boost from cognate verbs. Prime language also produced a significant main effect: There was greater within-language than between-language priming (.63 vs. .59). Separate analyses show that the effect of prime language held with same-meaning verbs (Estimate = .36, SE = .13, $z = 2.8$, $p < .01$), but not with different-meaning verbs (Estimate = .02, SE = .12, $z = .12$, $p > .1$). In other words, the main effect of prime language was driven by same-meaning

verbs only, which gave rise to the marginally significant interaction between verb meaning and prime language. Such an interaction suggests that the within-language advantage for same-meaning verbs reflected the difference between the (greater) lexical boost from same verbs and the (smaller) translation-equivalent boost from cognate verbs rather than a general within-language priming effect (which was actually absent in Experiment 6.2).

As in Experiment 6.1, Experiment 6.2 showed a general structural priming effect, this time when Cantonese was the target language. The finding that cognate verbs induced a smaller boost than same verbs did suggests that cognate verbs are represented as distinct lemmas, supporting the separate-lemma account. Unlike Experiment 6.1, Experiment 6.2 did not show greater within-language priming than between-language priming for different-meaning verbs. This null effect may reflect the fact that participants used the PO structure about 90% of the time for different-meaning verbs. Across both same- and different-meaning verbs, the strong tendency to produce PO responses may have underlain the relatively small priming effects (i.e., there was a ceiling effect).

6.8 Combined analysis for Experiments 6.1 and 6.2

Note that the interaction of verb meaning and prime language was only marginally significant in both experiments. I suspect that this may be a result of the relative lack of power in the experiments. I therefore carried out further analyses pooling data across the two experiments. The first purpose of the combined analysis was to see whether verb meaning and prime language significantly interacted when the power of the analysis was augmented. The fixed predictors included response language (Mandarin in Experiment 6.1 and Cantonese in Experiment 6.2), verb meaning (same-meaning vs. different-meaning verbs) and prime language (within-language vs. between language priming); see Table 6.5. The intercept was significant, with more primed than unprimed responses. Response language had a main effect: Mandarin was more susceptible to structural priming than Cantonese. Response language also interacted with verb meaning and prime language: Again the effect of verb meaning and prime language was greater in Mandarin than in Cantonese, most likely reflecting that the frequencies of DO and PO were more unbalanced in Cantonese

than in Mandarin (see below). Verb meaning had a significant main effect, with same-meaning verb inducing greater priming than different-meaning verbs. This held for within-language priming (Estimate = .82, SE = .10, $z = 8.54$, $p < .001$), indicating a lexical boost, and for between-language priming (Estimate = .47, SE = .09, $z = 5.22$, $p < .001$), indicating a translation-equivalent boost. Prime language had a significant main effect, with greater priming within languages than between languages. The effect was significant for same-meaning verbs (Estimate = .51, SE = .1, $z = 5.18$, $p < .001$) but only marginally significant for different-meaning verbs (Estimate = .14, SE = .09, $z = 1.63$, $p = .10$). Note that within-language priming was robust for different meaning verbs when Mandarin was the response language (Experiment 6.1) but not when Cantonese was the response language, probably because of the very strong PO-bias in Cantonese (see below). I therefore draw the interim conclusion that there was an advantage for within-language priming over between-language priming for different-meaning verbs. But it should be noted that, given that the previous studies that did not observe any within-language advantage in cross-language structural priming for different-meaning verbs (e.g., Hartsuiker et al., 2004; Schoonbaert et al., 2007), further studies need to test whether such an advantage is real and why it is present in Cantonese-Mandarin bilinguals (and only when Mandarin was the response language) but not in other bilinguals. I will return to this issue in Section 6.10 below.

There was a significant interaction between verb meaning and prime language: There was a much larger difference between the magnitude of within-language priming and between-language priming for same-meaning verbs than for different-meaning verbs. This suggests that besides the general within-language advantage in structural priming (as observed in Experiment 6.1), same verbs were additionally subject to greater priming than cognate verbs. Thus, as observed in both Experiment 6.1 and Experiment 6.2, the combined analysis confirms that cognate verbs led to a translation-equivalent boost that was smaller than the lexical boost experienced by same verbs. This in turn suggests that cognate verbs have distinct rather shared lemma representations (Schoonbaert et al., 2007). The three way interaction was not significant.

Table 6.5: LME results for Experiments 6.1 and 6.2 combined.

	<i>Estimate</i>	<i>SE</i>	<i>z</i>	<i>p</i>
Intercept	.67	.05	14.6	< .001
Response language	.44	.09	4.89	< .001
Verb meaning	.65	.07	9.88	< .001
Prime language	.32	.07	4.89	< .001
Response language * verb meaning	.41	.13	3.04	< .001
Response language * prime language	.27	.13	2.05	< .05
Verb meaning * Prime language	.35	.13	2.65	< .01
Response language * Verb meaning * Prime language	.02	.26	.09	> .1

The second purpose of the combined analysis was to see whether the frequencies of DO and PO responses differed between Mandarin and Cantonese. I therefore conducted a separate set of analyses using response (DO vs. PO) as the dependent variable. There were more PO responses (.77) than DO responses (.23) across the two experiments (i.e., for Mandarin and Cantonese responses collapsed together). Adding target language as a predictor produced a significant effect ($\chi^2(1) = 40.004, p < .001$), with more DOs in Mandarin (.33) than in Cantonese (.14), and more POs in Cantonese (.86) than in Mandarin (.67).

6.9 Phonological similarity rating study

Same-meaning verbs in the within-language conditions are the same verbs and therefore of course have the same phonological form. In contrast, same-meaning verbs in the between-language conditions often have different phonological forms (e.g., *di* and *dai*; 'pass'). Thus it is conceivable that phonological similarity may be a cause of stronger within- than between-language priming for same-meaning verbs, and by extension, the greater advantage of within- over between-language priming for same-meaning than for different-meaning verbs.

Such an explanation is unlikely given the lack of evidence of a phonological boost to structural priming. Pickering and Branigan (1998) found that repeating the

verb enhanced priming (the lexical boost) in sentence completion, but found that repeating the form of the verb (e.g., *gave-gave* vs. *was giving-gave*) did not enhance priming. This provides evidence that the lexical boost depends on lemma repetition rather than morphological or, importantly, phonological repetition. Second, I have already noted that Cleland and Pickering (2003) found no phonological boost to priming of noun-phrase structure (e.g., a *ship-sheep* prime-target pair did not enhance priming despite their phonological similarity). Finally, Bock and Loebell (1990) found no priming on the basis of metrical similarity alone (e.g., a sentence like *Susan brought a book to study* did not prime PO responses). However, recent work suggests that there is a homophone boost, with participants being more likely to describe a flying bat as *the bat that's red* after hearing *the bat that's red* (where *bat* referred to a cricket bat) than after hearing *the pool that's red* (Santesteban, Pickering, & McLean, 2010). Full phonological overlap therefore appears to enhance structural priming, but it is likely due to a shared word-form node (*bat*) rather than overlapping phonemes (as is the case in *di* vs. *dai*).

To test whether phonological similarity could have enhanced structural priming for same-meaning verbs, I obtained two measures of phonological similarity (quantitative rating and categorical rating) between verb pairs. In quantitative rating, I asked 32 further participants from the same population as Experiments 6.1 and 6.2 to rate the phonological similarity for the cognate verb pairs (e.g., *di* - *dai*) used in the experiments on a scale from 1 (*they sound very alike*) to 7 (*they sound very different*). I interleaved the 14 pairs of target cognate verbs with 14 filler pairs of Mandarin-Cantonese cognates, began the questionnaire with 8 practice items, and reversed the order of presentation for half the participants. To control for any ordering effects, I asked half the participants to compare the Mandarin pronunciation of the character against the Cantonese pronunciation and the other half to compare the Cantonese pronunciation of the character against the Mandarin pronunciation. As every verb is phonologically identical to itself, I did not ask participants to rate the phonological similarity of same verb pairs (e.g., *di* - *di*); instead, I automatically assign 1 to same-verb pairs. See Appendix D.3 for the results of the rating.

In the second measure, I assigned cognate pairs to 4 ranked categories of phonological similarity on the basis of phonological overlap. I first categorized same

verbs (e.g., *di – di*; ‘pass’) as *identical* (with a rank value of 1). I then categorized a pair as having *high similarity* (with a rank value of 2) when the two pronunciations did not differ in either onset or rhyme (but might differ in tone; e.g., *song* in Mandarin vs. *song* in Cantonese), as having *medium similarity* (with a rank value of 3) when the two pronunciations differed in either onset or rhyme (but not both; e.g., *di* in Mandarin and *dai* in Cantonese), and as having *low similarity* (with a rank value of 4) when they differed in both onset and rhyme (e.g., *na* in Mandarin and *lo* in Cantonese). Thus, the rank values corresponded to how different in phonology the two verbs in a cognate pair were. See Appendix D.3 for the results of the rating.

Note that verb status (same verb vs. cognate verb) and phonological similarity should have high collinearity, i.e., same-verb pairs should be phonologically more similar than cognate-verb pairs. In fact, the correlation coefficient between verb status and phonological similarity was .83 in the quantitative rating and .86 in terms of the categorical rating. Thus, any effect caused by one of the two factors could in theory also be attributed to the other factor. In other words, the greater structural priming effect observed with same verbs than with cognate verbs could be also be attributed to the greater phonological similarity in same verbs than in cognate verbs. To determine which factor genuinely gave rise to the effect, I modelled the data with both factors as predictors and determined whether one predictor could be subsumed by the other, for example whether phonological similarity would be subsumed by verb status, such that verb status made an extra contribution to the model fit of the data independently of phonological similarity.

I therefore modelled the data from same-meaning verbs (same verbs and cognate verbs) with verb status and phonological similarity as fixed predictors and priming (primed vs. unprimed response) as the dependent variable. Levels of a fixed predictor were first transformed into numeric and then centred around the value 0 (as in Experiments 6.1 and 6.2). I first built a null model with priming as the dependent variable and subjects and items as random intercepts. I then added one predictor (e.g., phonological similarity) to see whether it significantly improved the goodness of the model fit. I then added in the other predictor (e.g., verb status) to see whether the new predictor independently contributed to the fit of the model. If it did, I then concluded that the first predictor (e.g., phonological similarity) could be subsumed

by the second predictor (e.g., verb status). I also reversed the order of predictor addition (e.g., adding in verb status first and then phonological similarity). I conducted two separate analyses, one with each of the measures of phonological similarity; see Table 6.6. To further test whether phonological similarity had an effect in structural priming, I also modelled the priming data from cognate verbs only. If phonologically more similar cognate verbs (e.g., *song* – *song* [“give”]) induce more structural priming than phonologically less similar cognate pairs (e.g., *huan* – *wan* [“return”]), then we would expect phonological similarity for a cognate pair to significantly predict the priming patterns in cognate verbs.

Experiment 6.1. In both quantitative rating and categorical rating, both verb status alone and phonological similarity alone significantly predicted the priming data, but critically, model comparisons indicated that phonological similarity could be subsumed by verb status, but not vice versa. These results suggest that phonological similarity alone does not wholly account for the difference in magnitude of priming for same verbs and cognate verbs; in other words, even if phonological similarity does give rise to structural priming, at least part of the difference between same verbs and cognate verbs was caused by something other than phonology. In fact, when I modelled the priming data from cognate verbs only with phonological similarity as a predictor, phonological similarity did not significantly predict priming, either in terms of quantitative rating ($\chi^2(1) = .5189$, $p > .1$) or categorical rating ($\chi^2(1) = .0001$, $p > .1$).

Experiment 6.2. In quantitative rating, both phonological similarity and verb status significantly predicted priming; however, phonological similarity was subsumed (marginally significantly) by verb status, but not vice versa. In categorical rating, the two predictors both significantly predicted priming, but neither subsumed the other. These results suggest that something other than phonological similarity gave rise to the difference in priming between same verbs and cognate verbs. In fact, using phonological similarity to model priming data from cognate verbs showed that the priming patterns with cognate verbs were not predicted by phonological similarity, either in terms of quantitative rating ($\chi^2(1) = .1848$, $p > .1$) or categorical rating ($\chi^2(1) = .7291$, $p > .1$).

Table 6.6: Effects of verb status (VS) and phonological similarity (PS) in the prediction of structural priming for same-meaning verbs

Experiment 6.1		
	Quantitative rating	Categorical rating
PS vs. Null	$\chi^2(1) = 13.633, p < .001$	$\chi^2(1) = 16.641, p < .001$
VS vs. Null	$\chi^2(1) = 20.045, p < .001$	$\chi^2(1) = 20.045, p < .001$
VS+PS vs. PS	$\chi^2(1) = 6.4987, p < .05$	$\chi^2(1) = 3.555, p = .06$
PS+VS vs. VS	$\chi^2(1) = .0866, p > .1$	$\chi^2(1) = .1511, p > .1$

Experiment 6.2		
	Quantitative rating	Categorical rating
PS vs. Null	$\chi^2(1) = 4.1469, p < .05$	$\chi^2(1) = 7.6502, p < .01$
VS vs. Null	$\chi^2(1) = 7.6675, p < .01$	$\chi^2(1) = 7.6675, p < .01$
VS+PS vs. PS	$\chi^2(1) = 3.7419, p = .05$	$\chi^2(1) = .5826, p > .1$
PS+VS vs. VS	$\chi^2(1) = .2212, p > .1$	$\chi^2(1) = .5653, p > .1$

Experiments 6.1 and 6.2 combined		
	Quantitative rating	Categorical rating
PS vs. Null	$\chi^2(1) = 13.959, p < .001$	$\chi^2(1) = 21.605, p < .001$
VS vs. Null	$\chi^2(1) = 24.966, p < .001$	$\chi^2(1) = 24.966, p < .001$
VS+PS vs. PS	$\chi^2(1) = 11.633, p < .001$	$\chi^2(1) = 3.8822, p < .05$
PS+VS vs. VS	$\chi^2(1) = .6259, p > .1$	$\chi^2(1) = .5212, p > .1$

Experiments 6.1 and 6.2 combined. Verb status and phonological similarity (both the quantitative rating and the categorical rating) significantly predicted priming, but phonological similarity was subsumed by verb status. Furthermore, phonological similarity did not significantly predict priming patterns with cognate verbs, either in terms of quantitative rating ($\chi^2(1) = .713, p > .1$) or categorical rating ($\chi^2(1) = .4405, p > .1$).

These findings suggest that same verbs induced more structural priming than cognate verbs not simply because the former had more phonological similarity than

the latter. An explanation that is more compatible with these findings is that cognate verbs have distinct lemmas (unlike same verbs) and thus use of cognate verbs in successive sentences yields a boost that is smaller than the lexical boost when the same verb is used in successive sentences (e.g., Schoonbaert et al., 2007). Furthermore, the results indicate that phonological similarity of cognate verbs did not predict priming; in other words, it is not the case the cognate pairs that are phonologically more similar induced more structural priming.

6.10 General discussion

Two experiments demonstrated both within- and between-language priming for two closely related languages, Mandarin and Cantonese. They also showed a general within-language over between-language advantage in structural priming when verbs were unrelated (though only when Mandarin was the response language). More importantly, the results demonstrated the existence of stronger boost for same verbs (i.e., a lexical boost) than for cognate verbs (i.e., a translation-equivalent boost). The difference between same verbs and cognate verbs was not merely an effect of the general advantage of within-language priming, as the advantage of within- over between-language priming was greater for same- than different-meaning verbs. This suggests that the difference in priming was related to the relationship between the prime and target verbs (i.e., same verbs vs. cognate verbs). Further analyses demonstrated that the difference in priming could not be attributed to a phonological similarity effect. Hence I conclude that the relevant relationship relates to the lemma level, and specifically that repeated use of cognate verbs led to a weaker boost to priming than repeated use of same verbs because repeated use of cognate verbs involved activating distinct lemma representations whereas repeated use of same verbs involved activating the same lemma representation. The results thus support the separate-lemma model, in which Cantonese-Mandarin bilinguals have different lemmas for Mandarin and Cantonese translation-equivalents. This suggests that even for languages as close as Cantonese and Mandarin, speakers tend to distinguish them at the lexico-syntactic level.

The representation of translation equivalents in bilinguals

The results in the study suggest that Cantonese-Mandarin bilinguals have separate lemma representations for cognate translation-equivalents. Two implications can be drawn from this finding. First, it suggests that even though bilinguals tend to collectively represent common syntactic information between their two languages, they maintain separate lexical (e.g., lemma) representations for translation-equivalents. Though separate representations seem to be uneconomical, they have certain processing advantages. For instance, separate representations can better prevent bilinguals from producing unnecessary and unwanted code-switches (e.g., use of Mandarin words in a Cantonese sentence). The second implication is that the cognate facilitation effect observed in the literature is probably due to a common morphological rather than a common lemma representation for cognates. For instance, in lexical priming, the recognition of a word is better facilitated by a cognate prime than by a noncognate prime because in the former case but not in the latter case a common morphological representation has been activated by the prime. The conclusion that the facilitation effect for cognates arises at a morphological rather than phonological level is also supported by my finding that the structural priming effect was not affected by the degree of phonological overlap between a cognate pair. Such a finding is consistent with Davis et al.'s (2010) finding that cognate facilitation in lexical priming is not dependent on the degree of form overlap.

The representation of syntactic information in bilinguals

The experiments reported here provide support for the separate-lemma account, and are therefore broadly compatible with Hartsuiker and Pickering's (2008) model. However, the finding of stronger priming from Mandarin to Mandarin than from Cantonese to Mandarin for different-meaning verbs does not fit with their discussion, and instead suggests that language nodes receive and distribute activation like other nodes. (The lack of a comparable effect in Experiment 6.2 is likely because of Cantonese's strong preference for the PO construction.)

Bilinguals tend to have very strong control over which language(s) to use (e.g., Grosjean, 1997). This is compatible with lemmas being tagged for language (Green, 1998), with the speaker selecting a language and in doing so activating the

relevant “language task schema” (similar to the language node). This language selection then inhibits the activation of lexical information of the non-response language and ensures the use of lexical items of the desired language (see Dijkstra & Van Heuven, 1998, 2002 for a similar inhibition mechanism for bilingual visual word recognition). Language-selection presumably takes place “early,” when the speaker is formulating the message. This leads to much greater activation of lemmas that are linked to the language node (i.e., lemmas of that language) than lemmas that are not linked to the language node. Thus my proposals are compatible with Green, except that his model is couched in terms of inhibition of the non-selected language rather than facilitation of the lemmas of the selected language. It can also explain occasional mis-selection of lemmas from the inappropriate language, in that a node will occasionally accrue sufficient activation from other sources to override activation from the language node.

Note that Hartsuiker and Pickering (2008) assumed a language control mechanism, but did not assume that the language nodes act like other nodes (see also Hartsuiker et al., 1994; Schoonbaert et al., 2007). That is, they assumed that unlike other nodes such as conceptual nodes, activation from a lemma to a language node is not passed on to other lemmas that are linked to that language node. This is less compatible with Green (1998), and also fails to explain the greater within- than between-language priming for different-meaning verbs observed in Experiment 6.1.

The nature of between-language structural priming

Schoonbaert et al. (2007) in fact argued that the boost to activation for same-meaning verbs over different-meaning verbs occurs during the processing of the target response rather than during the processing of the prime response (e.g., Cleland & Pickering, 2003). They proposed this account to explain their finding of a translation-equivalent boost from their L1 (Dutch) to their L2 (English) but not vice versa. Because models of bilingual lexical processing (e.g., Kroll & Stewart, 1994) suggest weaker links from concepts to L2 lemmas than to L1 lemmas, the lack of a translation-equivalent boost from L2 to L1 could be due to the target L1 lemma activating the shared concept, but the shared concept failing to activate the L2 lemma (see Schoonbaert et al., 2007, pp. 165-166). However, the current study showed a

translation-equivalent boost from Cantonese to Mandarin and from Mandarin to Cantonese. (Recall that the participants in my experiments were native Cantonese speakers, though they had used Mandarin from early childhood.) It is therefore possible that Schoonbaert et al. (2007) simply failed to detect a real effect, and so it may be premature to assume a target-based account of the translation-equivalent boost, or indeed of the lexical boost within a language.

Another difference between Schoonbaert et al. (2007) and the study reported here relates to the numerical size of priming effects. As they interpreted their data primarily in terms of the lexical boost and the translation-equivalent boost, I do the same here. Experiment 6.1 showed a .38 lexical boost [i.e., $(.96 - .30) - (.82 - .54)$] and a .28 translation-equivalent boost (see Table 6.1), and Experiment 6.2 showed a .28 lexical boost and a .12 translation-equivalent boost (see Table 6.3). In contrast, they showed lexical boosts of .27 and .29 in Experiments 1 and 3, and translation-equivalent boosts of .09 and -.01 (which was non-significant) in Experiments 2 and 4. When considered as a whole, the lexical boost in my experiments is 1.65 times the translation-equivalent boost; but the lexical boost in Schoonbaert et al. is 7.00 times the translation-equivalent boost. If this difference is real, it may reflect the closeness of Mandarin and Cantonese in comparison to English and Dutch, with more activation flowing between translation-equivalent lemma via the concept node for more closely related languages. However, this could be simply due to the fact that I used cognate verbs while Schoonbaert et al. mainly used noncognates. For instance, it is also possible that apparent translation-equivalents in more distantly related languages tend to have some differences in meaning, and that these differences reduce the priming. Alternatively, the size of the translation-equivalent boost may be a consequence of the fact that the participants in this study were fairly balanced bilinguals who acquired both languages early, or because they tended to switch languages more regularly than Schoonbaert et al.'s participants.

Psycholinguistic evidence for Mandarin and Cantonese as two languages

Linguists (such as sociolinguists) have long been interested in whether language variants are languages or dialects of a single language (e.g., Haugen, 1966). In contrast, psycholinguists have shown little interest in the representation and

processing of languages versus dialects, and work on bilingualism has almost entirely focused on speakers of clearly different languages. However, the experiments reported here can be interpreted as testing whether Mandarin and Cantonese have some of the characteristics of languages or dialects.

Conclusions from the experiments suggest that Mandarin and Cantonese have some characteristics associated with different languages, in particular having separate lemmas associated with different language nodes. Their phonological differences, together with the fact that they are mutually unintelligible (Tang & van Heuven, 2009), suggest that they also do not have fully integrated phonological representations. It therefore appears that Mandarin and Cantonese are represented separately, just as languages such as English and Dutch are. In other words, they appear to have the psycholinguistic characteristics associated with separate languages.

Further support for Mandarin and Cantonese as two different languages also comes from my finding that they differ in the frequencies of DO and PO constructions. As shown in the combined analyses, the PO construction is more frequently used in Cantonese than in Mandarin, and the DO is more frequently used in Mandarin than in Cantonese. This difference again shows that Mandarin and Cantonese are represented distinctly at a syntactic level. Hence I suggest that Mandarin and Cantonese not only represent cognate verbs differently, but also differ in the relative strengths of the links that connect verbs to the DO and PO nodes. Such a verb-general preference can be captured by stipulating a stronger link to the DO node in Mandarin than in Cantonese, and conversely a stronger link to the PO node in Cantonese than in Mandarin.

Conclusion

Several key findings were observed in the experiments reported here. First, the experiments demonstrated that cognate verbs induced a smaller boost to priming than same verbs did. The disparity cannot be attributed to differences in phonological overlap between same verbs and cognate verbs. They instead suggest that cognate verbs have separate rather than a shared lemma representation. Second, structural priming was observed regardless whether the verbs between the prime and the target had the same meaning, indicating that syntactic information associated with dative

verbs in Mandarin and Cantonese is shared across the two languages, even though these verbs themselves are represented separately. Third, there was a within-language advantage in structural priming even when unrelated verbs were used, which suggests that using a lemma in one language spreads activation, via the language node, to lemmas of the same language. Taken together, the results support a model of bilingual lexico-syntactic representation in which speakers of closely related languages represent lexico-syntactic information in a similar way to speakers of clearly distinct languages. In particular, the fact that two languages have almost identical syntax (and indeed writing system) does not mean that they fully integrate their lemma strata. Instead, they retain separate lemmas that are linked to their relevant language nodes. More generally, the results help extend the study of bilingual language processing to languages that are very closely related.

Chapter 7 Conclusions

7.1 Aim of the thesis

In this thesis, I explored the linguistic system from a cognitive/computational perspective and investigated the representation and processing of syntactic structure. Assuming syntactic knowledge as mental representations and syntactic processing as the computation of these representations, I investigated four questions in the thesis. First, how can we investigate the mental representation of syntactic structure? Second, how is syntactic structure formulated in sentence production? Third, to what extent does syntactic structure mediate sentence comprehension? And last, to what extent do bilinguals share lexico-syntactic representations between their two languages? In the next section, I give a summary of the empirical investigations of these questions.

7.2 Summary of empirical studies

I used structural priming as the experimental paradigm and exploited some interesting properties of Chinese in the investigation of the above questions. Structural priming is argued to tap into, among other things, syntactic and thematic representations and has been extensively used to explore issues in syntactic processing (Pickering & Ferreira, 2008). I focused on the Chinese languages for two reasons. First, some properties present in Chinese but not in English and related languages can help to distinguish between theoretical accounts of certain representational and processing issues. Second, research on sentence processing (especially language production) has been predominantly based on European languages (Jaeger & Norcliffe, 2008). Chinese is typologically different from European languages and the investigation of it may come up with a more universal understanding of the mechanisms of language processing.

In Chapter 3, I proposed that structural priming can be used as an experimental approach to investigating the mental representation of syntactic structure. As I reviewed in Chapter 2, there is increasing dissatisfaction with the current dominant method in syntactic research (i.e., informal introspection) and there have been calls for experimental methods in syntactic data collection. Structural priming, as I have shown, can be used to determine the constituent structure of a controversial construction, as it can reflect the persistence of constituent structure (e.g., Bock & Loebell, 1990). As constituency information illuminates the syntactic analysis (mental representation) of a syntactic construction, we can then use structural priming to distinguish between alternative accounts of the syntactic analysis.

Following this rationale, I investigated three syntactic constructions in Mandarin Chinese whose syntactic analysis is under debate. Take for instance the *steal*-construction (e.g., *niuzai tou-le shuishou yiben shu*, lit., cowboy steal sailor a book [“the cowboy stole a book from the sailor”]). According to the ditransitive analysis the two post-verb NPs (e.g., *shuishou* [sailor] and *yiben shu* [a book]) are both arguments of the verb, while according to the monotransitive analysis, *shuishou yiben shu* (“sailor a book”) is actually an NP consisting of a possessor (i.e., *shuishou*) and a possessee (i.e., *yiben shu*), like *sailor’s book* in English. The two analyses make different predictions as to whether the *steal*-construction can prime a DO dative sentence. According to the ditransitive analysis but not the monotransitive analysis, the *steal*-construction and the DO construction have the same constituent structure and therefore there should be structural priming of DO responses following a *steal*-construction prime. Experiment 3.3 showed that the *steal*-construction primed DO responses as effectively as the DO construction and to a greater extent than an intransitive baseline. The results therefore support the ditransitive analysis of the *steal*-construction. Another experiment (Experiment 3.2) showed that the *bei*-construction in Mandarin behaved differently from the *bi*-construction, excluding the possibility that the *bei*-construction has a preposition analysis. Experiment 3.1, however, failed to come up with conclusive evidence concerning the representation of the *ba*-construction. These experiments together suggest that structural priming can be used to determine the syntactic analysis (mental representation) of a

controversial syntactic construction. Such an approach has the advantage of being less susceptible to processibility and plausibility confounds than other experimental approaches such as experimental introspection.

Next in Chapter 4, I investigated the use of thematic and lexical information in grammatical encoding in sentence production. Models of grammatical encoding to date disagree over both the flow of information between conceptualization and grammatical encoding (e.g., Branigan et al., 2008) and the extent to which lexical information is used in the construction of the syntactic structure (e.g., F. Ferreira & Engelhardt, 2006). I first proposed that structural priming has at least two subcomponents: syntactic priming, which reflects the persistence of some aspect of syntactic information (e.g., constituent structure), and thematic priming, which reflects the persistence of some aspect of thematic information (e.g., thematic emphasis persistence). In Experiments 4.1 and 4.2, I first ruled out the possibility that thematic priming in datives is due to thematic emphasis persistence (e.g., Bernolet et al., 2009). In Experiments 4.3 and 4.4, I provided evidence against the account that thematic priming occurs because the processor persists in mapping the same thematic roles onto the same grammatical functions (Chang et al., 2003). The results instead favour the account that thematic priming occurs because the processor tends to maintain the relative order of certain thematic roles (e.g., Hare & Goldberg, 1999). Such a finding supports the proposal that conceptual information influences positional processing as well as functional processing (e.g., Branigan et al., 2008). In Experiment 4.5, I showed that when both thematic information and constituent structure information were kept constant, there was persistent use of the same argument structure across utterances, suggesting that the processor utilizes lexical information such as argument structure in grammatical encoding, favouring a lexicalist account of grammatical encoding (e.g., F. Ferreira, 2000).

In Chapter 5, I switched to sentence comprehension and asked whether the processing of VP ellipsis is mediated by the syntactic structure of the antecedent. Both the syntactic account and the semantic account have their support in the linguistic literature. Furthermore, the antecedent representation (syntactic or semantic) might be retrieved in two different ways: It can be copied or reconstructed. Psycholinguistic evidence so far has been inconclusive in both issues. The lack of

consensus is probably due to the fact that the methods used so far (e.g., self-paced reading and eyetracking) are susceptible to processibility and plausibility confounds. Thus, I used structural priming to investigate how VP ellipsis is processed. I examined whether there was structural priming from the ellipsis site. Note that if the structure of the antecedent is reconstructed at the ellipsis site, we should observe structural priming there. Therefore, VP ellipsis should behave similarly to its non-elliptical counterpart and differently from a neutral baseline sentence. But if there is no syntactic structure reconstructed, VP ellipsis should behave similarly to the neutral baseline and prime to a lesser degree than the non-elliptical counterpart. Results in Experiment 5.1 support the latter scenario and suggest that no syntactic structure is reconstructed at the ellipsis site. This finding implies that the processing of VP ellipsis (and probably ellipsis in general) is not mediated by the syntactic structure of the antecedent but by some semantic representation.

In Chapter 6, I explored lexico-syntactic representation in bilinguals. Recent research has suggested that bilinguals share syntactic representations for constructions that are sufficiently similar enough between the two languages (Hartsuiker & Pickering, 2008). I asked whether bilinguals also share lemma representations for cognates. Bilingual lexical processing models to date are underspecified as to whether cognates have shared or distinct lemma representations in the bilingual lexicon (Sanchez-Casas & Garcia-Albea, 2005). Magnitude of structural priming boosts has been used to determine whether two lexical forms have the same lemma. For instance, it is found that structural priming between sentences containing lexical heads (e.g., verbs) that belong to the same lemma leads to a lexical boost (Pickering & Branigan, 1998), while structural priming between sentences containing lexical heads with distinct but related lemmas leads to a smaller boost (the semantic boost in within language priming [Cleland & Pickering, 2003], and the translation-equivalent boost in between language priming [Schoonbaert et al., 2007]). Thus, I investigated whether sentences with Mandarin-Cantonese cognate verbs lead to a similar boost as or a smaller boost than sentences with the same verb (Mandarin or Cantonese).

Experiments 6.1 and 6.2 found that cognates led to a translation-equivalent boost rather than a lexical boost. Such a finding held even when possible

phonological influences on structural priming were considered. The results suggest that cognates have distinct lemma representations. Two other findings were also observed. First, the existence of cross-language priming between Mandarin and Cantonese suggests that syntactic information associated with cognates is collectively represented across the two languages, despite the fact that cognates are represented separately. Second, it was found in Experiment 6.1 that when different-meaning verbs were used, within-language priming induced a stronger effect than between-language priming. Such a within-language advantage may be a result of co-activation of lexical items of the same language via the language node when a certain lexical item is used (see Section 7.3.4 below for more discussion).

7.3 Implications and directions of future research

In this section, I discuss some implications of the empirical studies for language representation and processing and some possible directions of future research.

7.3.1 Syntactic representations in language processing

As I briefly discussed in Section 2.2, a computational system such as language processing consists of a set of declarative data (representations) and algorithms (processes). Throughout the thesis, I have assumed that syntactic structure is formulated using syntactic representations without discussing the nature of these representations. A question is: Which syntactic representations are pre-stored and which are constructed online using syntactic operations? At one extreme, one can conceive that everything is built online from lexical category representations such as N, V and P. This view entails that all syntactic structures are built online and speakers don't have any pre-stored syntactic representations. The opposite extreme view is that speakers have pre-stored representations for all syntactic constructions available in a language; grammatical encoding, then, involves only the selection of a syntactic representation (or syntactic frame). The former view implicates huge computation load on the algorithms in the cognitive system while the latter view requires a huge storage of declarative data.

A more realistic proposal is that some syntactic representations are pre-stored while some are constructed online. Such a view is held in the lexicalist model by F. Ferreira (2000) (see also Section 2.4.1). In this model, a lexical item brings its own syntactic information or, more specifically, a maximal projection of tree structure. Thus, these tree structures are pre-stored syntactic representations. Consider the sentence *John drove a car along the lake*. The verb *drive* brings a tree structure that is specified for both the external and internal arguments (e.g., *John* and *a car*), but not for an adjunct (e.g., *along the lake*). The model, however, allows adjoining, that is, the addition of phrase structure markers to the tree structure using phrase structure rules. Therefore, the adjunct *along the lake* can be attached to *John drove a car*. Thus, in this model, head-argument relations are represented as pre-stored syntactic representations while other structural relations such as head-adjunct relations are computed online. Such a view is quite consistent with the argument/adjunct distinction in the sentence comprehension literature (e.g., Liversedge et al., 1998; Frazier & Clifton, 1996).

It has been demonstrated that structural priming occurs between two sentences that share the same constituent structure (e.g., between a passive sentence and a locative intransitive sentence, e.g., Bock & Loebell, 1990) and between two sentences that differ in constituent structure but share the same argument structure (e.g., between a Topic-DO sentence and a DO sentence; see Experiment 4.5). One implication of these findings is that priming from argument structure and priming from surface constituent structures (that are not related in terms of argument structure) may be represented differently. The distinction between head-argument and head-adjunct relations may capture the difference between constituent structure priming and argument structure priming. In F. Ferreira's (2000) model, argument structure priming occurs due to the use of the same tree structure. For instance, the verb in a DO sentence and that in a Topic-DO sentence both carry the same tree structure (i.e., with an external NP argument and two internal NP arguments), thus giving rise to argument structure priming. Constituent structure priming, on the other hand, occurs because the processing of the prime sentence results in a syntactic representation which tends to be re-used in subsequent productions. For instance, for a locative sentence such as *the foreigner was loitering by the blinking traffic light*,

the processor formulates the syntactic representation NP-V-PP (ignoring other specifics such as functional categories) by combining a pre-stored NP-V representation for *the foreigner was loitering* and the PP *by the blinking traffic light*. The online constructed representation NP-V-PP, then, facilitates the use of the passive argument structure of a verb, giving rise to the production of the passive construction, as observed in Bock and Loebell (1990). One problem with this model is that tree structures are supposed to be lexicalized, i.e., each lexical item has its own tree structure. Thus, the mechanism of structural priming within this model is still to be worked out.

A less lexicalist alternative is the model put forward by Pickering and Branigan (1998). In the model, similar syntactic information (e.g., DO structure for dative verbs) is collectively represented as combinatorial nodes in the lexicon. In this model, structural priming occurs because of residual activation of a combinatorial node. As I discussed in Chapter 3, later developments of the model tend to assume a representation-based rather than procedure-based account of the combinatorial node; therefore, I assume that combinatorial nodes are syntactic representations. As these combinatorial nodes are stored in the lexicon (i.e., not constructed online), they can be viewed as pre-stored syntactic representations. But these representations are not necessarily head-argument relations. For instance, it has been argued that a noun lemma is linked to, among other things, both a combinatorial node for the adjective - noun construction (e.g., *the red sheep*) and a combinatorial node for the noun - relative clause construction (e.g., *the sheep that is red*). Both these pre-stored combinatorial nodes represent head-adjunct relations. So what representations are pre-stored and what are constructed online according to this model? One possible answer is the argument/adjunct distinction plus a frequency mechanism for adjuncts. That is, for head-argument relations, they are always represented as combinatorial nodes or pre-stored representations. Thus, priming from argument structure is a result of the residual activation of a combinatorial node that represents a head-argument relation. For head-adjunct relations, whether they are pre-stored representations depends on their frequency. Only frequent head-adjunct relations are pre-stored as combinatorial nodes. As briefly mentioned in Chapter 4, one way for the model to account for syntactic construction frequency is by varying the strength of a link

between a lemma and a combinatorial node. For instance, Cantonese verbs occur much more often in the PO structure than in the DO structure. These frequencies can be captured by stipulating a strong link from a Cantonese verb to the PO combinatorial node and a weak link to the DO combinatorial node. Thus, whether a head-adjunct relation is pre-stored representation depends on how frequently that relation is used (and probably how widely applicable it is to lexical items); if it is frequent to a certain extent and/or applicable to a certain number of lexical items, a combinatorial node (i.e., a pre-stored syntactic representation) can be established and linked to relevant lexical items.

The above conceptualization of syntactic representations has two implications. First, the assumption that head-argument relations are necessarily represented as pre-stored syntactic representations captures the long-held view that arguments are lexical properties and (syntactic or semantically) obligatory, while adjuncts are not (e.g., Chomsky, 1981; Koenig et al., 2003). Second, the stipulation that frequency determines whether head-adjunct relations can be pre-stored syntactic representations partly corresponds to the proposal that there is a grey area for the argument-adjunct distinction and that frequency information contributes to the argument/adjunct distinction assumed in the literature (e.g., MacDonald et al., 1994; Manning, 2003). The above approach to syntactic representations may shed light on the debate on the argument-adjunct distinction (see Tutunjian & Boland, 2008, for a review).

7.3.2 The grammatical encoding of non-canonical syntactic constructions

Pickering et al. (2002) found that the shifted-PO construction in English behaved similarly to a baseline and primed neither DO nor PO responses; they thus reasoned that the grammatical encoding of shifted-PO does not involve a stage where a PO structure is constructed. I argued in Chapter 4 that the baseline-like behaviour of shifted-PO could be a result of a cancelling-out of structural priming from argument structure (which favours DO responses) and structural priming from thematic order (which favours PO responses). This possibility is supported in Chapter 4, where I showed that a Topic-DO sentence primed a DO response on the basis of its argument structure and primed a PO response on the basis of its thematic order. If correct, it seems that the grammatical encoding for shifted-PO in English and Topic-DO in Chinese does involve a stage when the argument structure is consulted. I will use the

Chinese Topic-DO as illustration of the grammatical encoding of non-canonical constructions.

There are two possible ways to capture the formulation of Topic-DO. For an illustrative purpose, I use the model in Pickering and Branigan (1998). One possible way is that Topic-DO can be directly represented as a combinatorial node (i.e., a pre-stored syntactic representation), together with the DO and PO combinatorial nodes, which all Chinese dative verbs are linked to. Hence, the grammatical encoding of Topic-DO is a one-stage process. Such a conceptualization, however, is disfavoured on at least two grounds. First, it entails that all dative verbs are linked to, besides DO and PO nodes, many other nodes representing syntactic constructions such as Topic-DO, Topic-PO and Ba-DO. Second and more importantly, there is no mechanism to account for the priming between Topic-DO and DO.

An alternative (and more sensible) conceptualization is that Topic-DO is constructed from a DO argument structure. In terms of the combinatorial node model, all dative verbs have only the DO and the PO combinatorial nodes. Thus, the grammatical encoding of DO-related constructions (DO, Topic-DO and Ba-DO) involves the use of the DO combinatorial nodes, and the grammatical encoding of PO-related constructions (PO and Topic-PO) involves the use of the PO combinatorial node. This accounts for the priming of argument structure. A question is: How non-canonical constructions are constructed. There are two possible mechanisms. One possibility is the use of syntactic operations such as topicalization on combinatorial nodes. Thus, the application of topicalization to the DO combinatorial node generates the Topic-DO construction. Such a mechanism accounts for the intuition that Topic-DO and other topic constructions are the same syntactic phenomenon; it is also consistent with the lexicalist model of grammatical encoding proposed by F. Ferreira (2000). For instance, a Mandarin dative verb brings a maximal tree structure (including a sentence-initial topic position). Topicalization, when applied, requires the emphasized NP to be inserted into the topic position. An alternative mechanism is to assume that word order is specified independently of hierarchical structure (e.g., Kempen & Hoenkamp, 1987). In this case, the formulation of a Topic-DO sentence for instance, involves a stage where a hierarchical structure is assembled (i.e., the selection of the DO combinatorial node)

and a stage where the emphasized NP is placed at a sentence-initial position. Note that in this case, there is no extra use of a topicalization operation in the formulation of the Topic-DO construction; the DO construction and the Topic-DO construction are only two alternative word orders of the same hierarchical structure.

7.3.3 Within- and cross-clause coreference processing

Although both syntactic information and non-syntactic information eventually affect the search of antecedents for reflexives and pronouns, there is evidence that syntactic information (i.e., the binding theory) enjoys a certain privilege in the initial search path (Sturt, 2003; see also Section 2.5.5). In Chapter 4, however, I observed no reference to syntactic information in the processing of another type of anaphoric expressions, VP ellipsis. I briefly mentioned that such a discrepancy could be due to the fact that the reflexives in Sturt (2003) had antecedents within the same clause while the VP ellipsis in Chapter 4 had antecedents in a different clause. I explore this possibility a bit further.

The hypothesis is that when a candidate that can act as an antecedent for an anaphoric expression (e.g., a pronoun, a reflexive or an ellipsis) is in the same clause as the anaphor, the processor accepts or discards the candidate as the antecedent mainly on the basis of syntactic information. Thus, in the sentence *the supervisors paid his assistant yesterday to finish typing the manuscript*, the processor initially treats *the supervisors* as the antecedent for the pronoun *his* regardless of number mismatch (Clifton et al., 1997) because the candidate and the anaphor are in the same clause and thus the processor resorts to the binding theory, according to which *supervisor(s)* is structurally possible as the antecedent. Furthermore, in a sentence like *the surgeon had pricked herself with a used syringe needle*, the processor initially treats *the surgeon* as the antecedent of the reflexive *herself* regardless of gender mismatch because the binding theory allows *the doctor* to be the antecedent (Sturt, 2003). However, when a possible antecedent is outside the clause where the anaphoric expression is, the processor resorts to non-syntactic as well as syntactic information. Take for instance the sentence *John amazed Bill time after time because he was so talented*. Note that both *John* and *Bill* can be the antecedent for the pronoun *he* but neither is in the same clause as *he* is. Though there is evidence that

people tend to identify the pronoun with the subject (thus on the basis of syntactic information), such a tendency can be overridden by semantic and lexical information. McDonald and MacWhinney (1995) found that such a subject-preference was reversed when the verb was one like *admire*, in which case people preferred to identify *he* with *Bill*. A related question is why there should be a within/beyond clause distinction for the use of syntactic information and non-syntactic information. One possible explanation is that syntactic information is short-lived (Sachs, 1967; cf. Bock & Griffin, 2000) such that semantic information tends to take over when there is a long distance between the anaphoric expression and the antecedent. Consistent with this explanation, there is evidence that the resolution of a pronoun is slowed when its antecedent is distant (e.g., Ehrlich & Rayner, 1983). Such an explanation also accounts for the finding that the processing of VP ellipsis is not mediated by syntax. In VP ellipsis, the antecedent is outside of the clause of the ellipsis site (in fact, the antecedent and the ellipsis site can be separated by other phrases/sentences). Thus, the hypothesis explains why VP ellipsis is mediated by non-syntactic information. In fact, there is evidence that the role of syntactic information is more limited when the antecedent and the ellipsis site are farther away (e.g., Murphy, 1985; Garnham, 1987), further confirming the hypothesis that the reliance on syntactic information decreases over distance.

7.3.4 Language-specific lexical co-activation in bilingual language processing

In Chapter 6, I reported some tentative evidence of an advantage for within-language priming over between-language priming even when the verbs are unrelated in meaning. Such a finding contradicts the previous claim for a lack of such a within-language advantage (Hartsuiker & Pickering, 2008). I briefly discussed the finding in terms of activation rather than inhibition in language control in bilingual lexical processing (see also La Heij, 2005, for a similar view); more specifically, I argued that the within-language advantage is a result of co-activation of lemmas of the same language. Such a view corresponds to a recent proposal that resonance plays an important role in bilingual language processing (e.g., MacWhinney, 2005), and has some implications for bilingual language acquisition and processing. For instance, consider the fact that bilinguals tend not to mix up words of different languages

(unless they intentionally do so, as in code-switching). How do they manage to do that? One obvious answer is (conscious) language choice (e.g., via a language node; Green, 1998). Another mechanism (and an automatic one) is co-activation within the lexical system of a language. Note that words are often learnt in a context (with already learnt words of the same language). Assuming that using words of a language produces a co-activated state of all the lexical items of the same language, a new word, when being learnt, is then associated with lexical items of the same language rather than of the other language. Therefore, the use of a lexical item is more likely to automatically co-activate lexical items of the same language than those of the other language. For example, a Cantonese-Mandarin bilingual child learns to associate the Mandarin verb *di* (“pass”) with other Mandarin words. When he intends to describe in Mandarin an event of a cowboy passing a sailor a banana, the use of the Mandarin word *niuzai* (“cowboy”), together with the selected language node, produces a co-activated state of the whole Mandarin lexicon, including the word *di*. Thus, it is very likely that *di* will be produced instead of its Cantonese counterpart *dai*. Hence, bilinguals can keep using words of the same language, probably both because of the (conscious) use of a language node and because of the co-activated state of the lexical system of the response language.

7.3.5 L2/L1 discrepancies in grammatical encoding in bilinguals

In Chapter 6, I showed that Cantonese-Mandarin bilinguals share syntactic information that is common between languages (e.g., DO and PO constructions). What is less explored is the representation and processing of syntactic information that is not commonly present in both languages. It has been observed that L2 learners sometimes have difficulty producing some syntactic features in the L2, especially when these syntactic features are not present in the L1. Such a phenomenon is referred to as L2/L1 discrepancies (see Francischina, 2001, for a review). For instance, Chinese does not have tense and agreement markings while both these syntactic properties are present in English. It has been observed that Chinese-English learners (late bilinguals) have difficulty in producing native-like tense and agreement markings (e.g., Lardiere, 1998a, 1998b). Second language acquisition researchers have been debating whether L2/L1 discrepancies are a result of representational

failure or processing failure. According to the former account, L2 marking errors occur because something goes wrong in the syntactic computation system in L2 production (e.g., Hawkins & Chan, 1997; Hawkins & Casillas, 2008). For instance, building on Minimalism, Hawkins and Casillas (2008) argued that L2 learners of English make tense and agreement marking errors because their L2 grammar of English lacks uninterpretable features such as agreement. On the processing failure account, L2 learners produce marking errors not because their grammar is impaired, but simply because tense and agreement markings involve morphological and phonological processes that are hard to execute. For instance, producing a past-tense verb involves the morphological process of adding an *-ed* suffix to the verb and the phonological and articulatory processes to realize the morpheme, which L2 learners may fail to do, resulting in tense marking errors. Both accounts seem to have support from individual case reports and corpus data but the debate so far has remained inconclusive (for recent debates on this issue, see Lardiere, 2009 and following commentaries).

Psycholinguists have been surprisingly silent on this issue. Apparently, L2/L1 discrepancies are production phenomena; whatever cause of the discrepancies is, the locus of the errors must be in the production system. Take agreement marking for instance. For two decades since Bock and Miller (1991), psycholinguists have worked on how agreement in production works. A lot of insight has been gained as to how native speakers of English, for example, produce subject-verb agreement (e.g., Eberhard, Cutting, & Bock 2005). For instance, Bock, Eberhard, and Cutting (2004) proposed that agreement production consists of a *marking phase* during functional processing where conceptual information concerning number is turned into linguistic information concerning number, and a *morphing phase* during positional processing where morphological information for number agreement is realized. These two phases in agreement production actually roughly correspond to the representational failure account and the processing failure account in L2 research. That is, L2 agreement marking errors can be a failure in marking phase (according to the representational failure account) or a failure in the morphing phase (according to the processing failure account). Thus, by transforming the syntax-based second language research accounts into testable psycholinguistic hypotheses, we can design

experiments to test these hypotheses rather than relying merely on case observations and corpus data.

7.3.6 Structural priming as an experimental paradigm for language-related issues

In Chapter 3, I showed that structural priming in production can be used as an experimental approach to investigating the mental representation of syntactic constructions. The paradigm requires that the target response has at least two structural alternatives (e.g., DO and PO datives) that express basically the meaning so that we can observe whether the prime activates one of the alternatives. So far researchers have exploited a lot of alternative constructions such as DO/PO datives, active/passive transitives, adjective-noun/noun-RC constructions, verb-object-participle/verb-participle-object phrases (e.g., *put on the shirt* vs. *put the shirt on*), complement clauses with or without *that*, and a variety of structural alternatives in non-English languages (see Pickering & Ferreira, 2008, for a review). However, it should be acknowledged that in some cases, it may be hard to find appropriate target constructions.

As I briefly discussed in Chapter 3, there are two alternative options. First, we can make use of cross-language priming. Thus, by making use of structural alternations in other languages, we can determine the mental representation of a syntactic construction (though of course, this requires the assumption that bilinguals have the same representations as monolinguals do for the syntactic constructions in question). In fact, some researchers have made use of cross-language priming, though in the investigation of *processing* rather than *representational* issues. For instance, Bernolet et al. (2009) explored the persistence of thematic emphasis and used Dutch active/passive constructions to prime English active/passive sentences. Shin and Christianson (2009) used Korean dative constructions to prime English dative constructions and argued that there is cross-language structural priming at the functional assignment level. Second, we can exploit structural priming in language comprehension. It has been observed that people's eye movement in the visual world paradigm is affected by a linguistic prime (e.g., Arai, Van Gompel, & Scheepers, 2007), that people read a construction faster if they have read the same construction before (e.g., Sturt, Keller, & Dubey, 2010; Traxler, 2008a), that the amplitude of

P600 in ERP is reduced for a syntactic construction that is primed (e.g., Tooley, Traxler, & Swaab, 2009), and that there is decrease in activity in the left inferior frontal, the left precentral and the left middle temporal regions if a construction is primed (e.g., Weber & Indefrey, 2009). The multitude of these structural priming methods will make the paradigm a promising approach in the investigation of the mental representation of syntactic knowledge, especially in cases where introspection-based approaches fail to provide conclusive evidence.

Structural priming can also be used to investigate various other issues in language research. For instance, it has been applied to the investigation of syntactic reanalysis in sentence comprehension (e.g., Van Gompel et al., 2006) and of the use of semantic strategies in syntactic parsing (e.g., Christianson et al., 2010). In this thesis, I have demonstrated that structural priming can be used to tap into the processing of anaphoric expressions such as VP ellipsis (see Experiment 5.1). The same rationale used in Experiment 5.1 can also be applied to the investigation of other ellipsis phenomena such as gapping (e.g., *John gave his money to Mary; Bill to Jane*) (e.g., Carlson, 2001) and sluicing (e.g., *John gave his money to someone. Guess who.*) (e.g., Yoshida et al., in press). In Experiments 6.1 and 6.2, I demonstrated that structural priming can be used to determine whether two linguistic varieties have shared representations. One implication of this demonstration is that we can use structural priming to determine whether people mentally represent two linguistic varieties as two languages or two dialects of the same language. Thus, structural priming is instrumental in the investigation of both language-related representational and processing issues.

7.4 Concluding remarks

This thesis set out to investigate the mental representation and processing of syntactic structure. I have demonstrated that structural priming can be used as experimental paradigm to determine the mental representation of syntactic constructions. I then showed that the processor persists in placing analogous thematic roles in the same linear order, a finding that suggests that conceptual information affects positional processing as well as functional processing. I also presented evidence that argument structure is utilized in grammatical encoding, which implies

that grammatical encoding in sentence production is lexically guided to some extent. Next I showed that the processing of VP ellipsis does not have to be mediated by syntax. Finally, I found that cognates of closely related languages such as Mandarin and Cantonese are represented as distinct lemmas, though syntactic information of associated with them is shared. Implications of these findings to syntax and language processing in general are discussed. As such this thesis also provides examples of how structural priming can be used to investigate a variety of language-related issues.

References

- Altarriba, J., & Mathis, K. M. (1997). Conceptual and lexical development in second language acquisition. *Journal of Memory and Language*, *36*, 550-568.
- Altmann, G. T. M., & Kamide, Y. (1999). Incremental interpretation at verbs: restricting the domain of subsequent reference. *Cognition*, *73*, 247-264.
- Altmann, G. T. M., & Steedman, M. (1988). Interaction with context during human sentence processing. *Cognition*, *30*, 191-238.
- Andrews, A., III. (1982). A note on the constituent structure of adverbials and auxiliaries. *Linguistic Inquiry*, *13*, 313-317.
- Arai, M., Van Gompel, R. P. G., & Scheepers, C. (2007). Priming ditransitive structures in comprehension. *Cognitive Psychology*, *54*, 218-250.
- Arregui, A., Clifton, C., Jr., Frazier, L., & Moulton, K. (2006). Processing elided verb phrases with flawed antecedents: The recycling hypothesis. *Journal of Memory and Language*, *55*, 232-246.
- Baayen, R. H. (2008). *Analyzing linguistic data: A practical introduction to statistics using R*. Cambridge: Cambridge University Press.
- Badecker, W., & Straub, K. (2002). The processing role of structural constraints on the interpretation of pronouns and anaphora. *Journal of Experimental Psychology: Learning Memory and Cognition*, *28*, 748-769.
- Bard, E. G., Robertson, D., & Sorace, A. (1996). Magnitude estimation of linguistic acceptability. *Language*, *72*, 32-68.
- Baxter, W. H. (1992). *A Handbook of Old Chinese Phonology*. New York: Mouton de Gruyter.
- Bernolet, S., Hartsuiker, R. J., & Pickering, M. J. (2007). Shared syntactic representations in bilinguals: Evidence for the role of word-order repetition.

- Journal of Experimental Psychology: Learning, Memory, and Cognition*, 33, 931-949.
- Bernolet, S., Hartsuiker, R. J., & Pickering, M. J. (2009). Persistence of emphasis in language production: A cross-linguistic approach. *Cognition*, 112, 300-317.
- Berwick, R., & Weinber, A. S. (1983). The role of grammars in models of language use. *Cognition*, 13, 1-16.
- Bever, T. G. (1970). The cognitive basis for linguistic structures. In J. R. Hayes (Ed.), *Cognition and the development of language*. New York: John Wiley.
- Bever, T. G. (1974). The ascent of the specious or there's a lot we don't know about mirrors. In D. Cohen (Ed.), *Explaining linguistic phenomena* (pp. 173-200). New York: Hemisphere Publishing Corporation.
- Bock, J. K. (1982). Toward a cognitive psychology of syntax: Information processing contributions to sentence formulation. *Psychological Review*, 89, 1-47.
- Bock, J. K. (1986a). Meaning, sound, and syntax: Lexical priming in sentence production. *Journal of Experimental Psychology: Learning, Memory, and Cognition*, 12, 575-586.
- Bock, J. K. (1986b). Syntactic persistence in language production. *Cognitive Psychology*, 18, 355-387.
- Bock, J. K. (1989). Closed-class immanence in sentence production. *Cognition*, 31, 163-186.
- Bock, J. K., Dell, G. S., Chang, F., & Onishi, K. H. (2007). Structural persistence from language comprehension to language production. *Cognition*, 104, 437-458.
- Bock, J. K., Eberhard, K. M., & Cutting, J. C. (2004). Producing number agreement: How pronouns equal verbs. *Journal Of Memory and Language*, 51, 251-278.
- Bock, J. K., & Griffin, Z. M. (2000). The persistence of structural priming: Transient activation or implicit learning? *Journal of Experimental Psychology: General*, 129, 177-192.
- Bock, J. K., & Irwin, D. E. (1980). Syntactic effects of information availability in sentence production. *Journal of Verbal Learning and Verbal Behavior*, 19, 467-484.

- Bock, J. K., & Levelt, W. J. M. (1994). Language production: Grammatical encoding. In M. A. Gernsbacher (Ed.), *Handbook of psycholinguistics* (pp. 945-984). San Diego: Academic Press.
- Bock, J. K., & Loebell, H. (1990). Framing sentences. *Cognition*, 35, 1-39.
- Bock, J. K., Loebell, H., & Morey, R. (1992). From conceptual roles to structural relations: Bridging the syntactic cleft. *Psychological Review*, 99, 150-171.
- Bock, J. K., & Miller, C. A. (1991). Broken agreement. *Cognitive Psychology*, 23, 45-93.
- Bock, J. K., & Warren, R. K. (1985). Conceptual accessibility and syntactic structure in sentence formulation. *Cognition*, 21, 47-67.
- Boland, J. E., Tanenhaus, M. K., Garnsey, S. M., & Carlson, G. N. (1995). Verb argument structure in parsing and interpretation: Evidence from wh-questions. *Journal of Memory and Language*, 34, 774-806.
- Bordag, D. (2004). Interaction of L1 and L2 systems at the level of grammatical encoding: Evidence from picture naming. In S. Foster-Cohen (Ed.), *EUROSLA Yearbook 4 (2004)* (pp. 203-230). Amsterdam: John Benjamins.
- Bordag, D. (2006). *Psycholinguistische Aspekte der Interferenzerscheinungen in der Flexionsmorphologie des Tschechischen als Fremdsprache*. Hildesheim: G. Olms Verlag.
- Bordag, D., & Pechmann, T. (2007). Factors influencing L2 gender processing. *Bilingualism: Language and Cognition*, 10, 299-314.
- Bowers, J. (1993). The syntax of predication. *Linguistic Inquiry*, 24, 591-656.
- Branigan, H. P., & Feleki, E. (1999). Conceptual accessibility and serial order in Greek language production. In *Proceedings of the 21st Conference of the Cognitive Science Society*. Vancouver.
- Branigan, H. P., Pickering, M. J., & Cleland, A. A. (1999). Syntactic priming in written production: Evidence for rapid decay. *Psychonomic Bulletin & Review*, 6, 635-640.
- Branigan, H. P., Pickering, M. J., & Cleland, A. A. (2000). Syntactic co-ordination in dialogue. *Cognition*, 75, B13-B25.

- Branigan, H. P., Pickering, M. J., Liversedge, S. P., Stewart, A. J., & Urbach, T. P. (1995). Syntactic priming: Investigating the mental representation of language. *Journal of Psycholinguistic Research*, 24, 489-506.
- Branigan, H. P., Pickering, M. J., McLean, J. F., & Cleland, A. A. (2007). Syntactic alignment and participant role in dialogue. *Cognition*, 104, 163-197.
- Branigan, H. P., Pickering, M. J., Stewart, A. J., & McLean, J. F. (2000). Syntactic priming in spoken production: Linguistic and temporal interference. *Memory & Cognition*, 28, 1297-1302.
- Branigan, H. P., Pickering, M. J., & Tanaka, M. (2008). Contributions of animacy to grammatical function assignment and word order during production. *Lingua*, 118, 172-189.
- Bresnan, J. (1978). A realistic transformational grammar. In M. Halle, J. Bresnan & G. A. Miller (Eds.), *Linguistic theory and psychological reality* (pp. 1-59). Cambridge, MA: MIT Press.
- Bresnan, J. (2001). *Lexical-Functional Syntax*. Oxford: Blackwell.
- Bresnan, J., Cueni, A., Nikitina, T., & Baayen, H. (2007). Predicting the Dative Alternation. In G. Boume, I. Kraemer & J. Zwarts (Eds.), *Cognitive Foundations of Interpretation* (pp. 69--94). Amsterdam: Royal Netherlands Academy of Science.
- Bresnan, J., & Kaplan, R. M. (1982). Introduction: Grammars as mental representations of language. In J. Bresnan (Ed.), *The mental representation of grammatical relations* (pp. xvii-lij). Cambridge, MA: MIT Press.
- Brysbaert, M., Van Dyck, G., & Van de Poel, M. (1999). Visual word recognition in bilinguals: Evidence from masked phonological priming. *Journal of Experimental Psychology: Human Perception and Performance*, 25, 137-148.
- Byrne, B., & Davidson, E. (1985). On putting the horse before the cart: Exploring conceptual bases of word order via acquisition of a miniature artificial language. 24, 377-389.
- Caramazza, A. (1997). How many levels of processing are there in lexical access? *Cognitive Neuropsychology*, 14, 177-208.

- Caramazza, A., & Miozzo, M. (1997). The relation between syntactic and phonological knowledge in lexical access: Evidence from the 'tip-of-the-tongue' phenomenon. *Cognition*, *64*, 309-343.
- Carlson, G. N., & Tanenhaus, M. K. (1988). Thematic roles and language comprehension. In W. Wilkins (Ed.), *Thematic relations* (Vol. 21, pp. 263-288). San Diego: Academic Press.
- Carlson, K. (2001). The effects of parallelism and prosody in the processing of gapping structures. *Language and Speech*, *44*, 1-26.
- Carrier, J., & Randall, J. (1992). The argument structure and syntactic structure of resultatives. *Linguistic Inquiry*, *23*, 173-234.
- Chambers, C. G., Tanenhaus, M. K., & Magnuson, J. S. (2004). Action-based affordances and syntactic ambiguity resolution. *Journal of Experimental Psychology: Learning, Memory, & Cognition*, *30*, 687-696.
- Chang, F., Bock, J. K., & Goldberg, A. (2003). Can thematic roles leave traces of their places? *Cognition*, *90*, 29-49.
- Chang, F., Dell, G. S., Bock, J. K., & Griffin, Z. M. (2000). Structural priming as implicit learning: A comparison of models of sentence production. *Journal of Psycholinguistic Research*, *29*, 217-229.
- Chang, F., Dell, G. S., & Bock, K. (2006). Becoming syntactic. *Psychological Review*, *113*, 234-272.
- Chao, W. (1987). *On ellipsis*. Unpublished PhD thesis, University of Massachusetts-Amherst, Amherst, M.A.
- Chao, Y.-R. (1968). *A grammar of spoken Chinese*. Berkeley: University of California Press.
- Chen, H.-C., & Ng, M.-L. (1989). Semantic facilitation and translation priming effects in Chinese-English bilinguals. *Memory & Cognition*, *17*, 454-462.
- Chomsky, N. (1957). *Syntactic Structures*. The Hague: Mouton.
- Chomsky, N. (1959). A Review of B. F. Skinner's Verbal Behavior. *Language*, *35*, 26-58.
- Chomsky, N. (1965). *Aspects of the theory of syntax*. Cambridge, MA: MIT Press.

- Chomsky, N. (1973). Conditions on transformations. In S. Anderson & P. Kiparsky (Eds.), *A festschrift for Morris Halle* (pp. 232-286). New York: Holt, Rinehart & Winston.
- Chomsky, N. (1981). *Lectures on government and binding*. Dordrecht: Foris.
- Chomsky, N. (1986a). *Barriers*. Cambridge, Mass: MIT Press.
- Chomsky, N. (1986b). *Knowledge of language: Its nature, origin, and use*. New York: Praeger.
- Chomsky, N. (1995). *The Minimalist Program*. Cambridge, MA: The MIT Press.
- Chomsky, N. (1997). Language and cognition. In D. M. Johnson & C. E. Erneling (Eds.), *The future of the cognitive revolution* (pp. 15-31). New York: Oxford University Press.
- Chomsky, N., & Miller, G. A. (1963). Introduction to the formal analysis of natural languages. In R. D. Luce, R. R. Bush & E. Galanter (Eds.), *Handbook of Mathematical Psychology, vol.2* (pp. 269-321). New York: Wiley.
- Christianson, K., Hollingworth, A., Halliwell, J., & Ferreira, F. (2001). Thematic roles assigned along the garden path linger. *Cognitive Psychology*, 42, 368-407.
- Christianson, K., Luke, S. G., & Ferreira, F. (2010). Effects of plausibility on structural priming. *Journal of Experimental Psychology: Learning Memory and Cognition*, 36, 538-544.
- Clahsen, H., & Felser, C. (2006). Grammatical processing in language learners. *Applied Psycholinguistics*, 27, 3-42.
- Cleland, A. A., & Pickering, M. J. (2003). The use of lexical and syntactic information in language production: Evidence from the priming of noun-phrase structure. *Journal of Memory and Language*, 49, 214-230.
- Clifton, C., Jr. (1993). Thematic roles in sentence parsing. *Canadian Journal of Experimental Psychology*, 47, 222-246.
- Clifton, C., Jr., Fanselow, G., & Frazier, L. (2006). Amnestying Superiority Violations: Processing Multiple Questions. *Linguistic Inquiry*, 37, 51-68.
- Clifton, C., Jr., Kennison, S. M., & Albrecht, J. E. (1997). Reading the words her, his, him: Implications for parsing principles based on frequency and structure. *Journal of Memory and Language*, 36, 276-292.

- Clifton, C., Jr., Traxler, M. J., Mohamed, M. T., Williams, R. S., Morris, R. K., & Rayner, K. (2003). The use of thematic role information in parsing: Syntactic processing autonomy revisited. *Journal of Memory and Language*, *49*, 317-334.
- Collins, A. M., & Loftus, E. F. (1975). A spreading-activation theory of semantic processing. *82*, 407-428.
- Corley, M., & Scheepers, C. (2002). Syntactic priming in English sentence production: Categorical and latency evidence from an Internet-based study. *Psychonomic Bulletin & Review*, *9*, 126-131.
- Costa, A., Caramazza, A., & Sebastián-Gallés, N. (2000). The cognate facilitation effect: Implications for models of lexical access. *Journal of Experimental Psychology: Learning, Memory and Cognition*, *26*, 1283-1296.
- Costa, A., Kovacic, D., Franck, J., & Caramazza, A. (2003). On the autonomy of the grammatical gender systems of the two languages of a bilingual. *Bilingualism: Language and Cognition*, *6*, 181-200.
- Costa, A., Miozzo, M., & Caramazza, A. (1999). Lexical selection in bilinguals: Do words in the bilingual's two lexicons compete for selection? *Journal of Memory and Language*, *41*, 365-397.
- Cowart, W. (1997). *Experimental syntax: Applying objective methods to sentence judgments*. Thousand Oaks, CA: Sage.
- Crain, S., & Steedman, M. (1985). On not being led up the garden path: The use of context by the psychological syntax processor. In D. R. Dowty, L. Karttunen & A. M. Zwicky (Eds.), *Natural language parsing: Psychological, computational, and theoretical perspectives* (pp. 320-358). Cambridge: Cambridge University Press.
- Cuetos, F., & Mitchell, D. C. (1988). Cross-linguistic differences in parsing: Restrictions on the use of the Late Closure strategy in Spanish. *30*, 73-105.
- Culicover, P., & Jackendoff, R. (2005). *Simpler Syntax*. Oxford: Oxford University Press.
- Culicover, P., & Jackendoff, R. (2010). Quantitative methods alone are not enough: Response to Gibson and Fedorenko. *Trends in Cognitive Sciences*, *14*, 234-235.

- Culicover, P., & Postal, P., M. (Eds.). (2001). *Parastic gaps*. Cambridge, MA: MIT Press.
- Dalrymple, M., Sheiber, S. M., & Pereira, F. C. N. (1991). Ellipsis and higher-order unification. *Linguistics and Philosophy*, *14*, 399-452.
- Davis, C., Sanchez-Casas, R., Garia-Albea, J. E., Guasch, M., Molero, M., & Ferre, P. (2010). Masked translation priming: Varying language experience and word type with Spanish–English bilinguals. *Bilingualism: Language and Cognition*, *13*, 137-155.
- De Bot, K. (1992). A bilingual production model: Levelt's 'speaking' model adapted. *Applied linguistics*, *13*, 1-24.
- De Groot, A. M. B. (1992). Bilingual lexical representation: A closer look at conceptual representations. In R. Frost & L. Katz (Eds.), *Orthography, Phonology, Morphology, and Meaning* (pp. 389-412). Amsterdam: North-Holland.
- De Groot, A. M. B., & Nas, G. L. J. (1991). Lexical representation of cognates and noncognates in compound bilinguals. *Journal of Memory and Language*, *30*, 90-132.
- De Groot, A. M. B., & Poot, R. (1997). Word translation at three levels of proficiency in a second language: The ubiquitous involvement of conceptual memory. *Language Learning*, *47*, 215-264.
- De Moor, W. (1998). *Visuele woordherkenning bij tweetalige personen* [Visual word recognition in bilinguals]. Unpublished PhD thesis, University of Ghent, Ghent, Belgium.
- De Vincenzi, M., & Lombardo, V. (Eds.). (2000). *Cross-linguistic Perspectives on Language Processing*. Dordrecht: Kluwer Academic Press.
- Dell, G. S., & Reich, P. A. (1981). Stages in sentence production: An analysis of speech error data. *Journal of Verbal Learning and Verbal Behavior*, *20*, 611-629.
- Desmet, T., Brysbaert, M., & De Baecke, C. (2002). The correspondence between sentence production and corpus frequencies in modifier attachment. *Quarterly Journal of Experimental Psychology*, *55A*, 879-896.

- Dijkstra, A., & Van Heuven, W. J. B. (1998). The BIA model and bilingual word recognition. In J. Grainger & A. Jacobs (Eds.), *Localist Connectionist Approaches to Human Cognition*. Hillsdale, NJ: Lawrence Erlbaum Associates.
- Dijkstra, A., & Van Heuven, W. J. B. (2002). The architecture of the bilingual word recognition system: From identification to decision. *Bilingualism: Language and Cognition*, 5, 175-197.
- Dik, S. C. (1989). *The theory of Functional Grammar, Part 1*. Dordrecht: Foris.
- Dik, S. C. (1996). Functional grammar. In E. K. Brown & J. E. Miller (Eds.), *Concise encyclopedia of syntactic theories* (pp. 84-92). Cambridge: Cambridge University Press.
- Dowty, D. (1991). Thematic proto-roles and argument selection. *Language*, 67, 547-619.
- Dubinsky, S., Egan, M., Schmauder, R., & Traxler, M. J. (2000). Functional projections of predicates: Experimental evidence from coordinate structure processing. *Syntax*, 3, 182 - 214.
- Eberhard, K. M., Cutting, J. C., & Bock, K. (2005). Making syntax of sense: Number agreement in sentence production. *Psychological Review*, 112, 531-559.
- Edelman, S., & Christiansen, M. H. (2003). How seriously should we take Minimalist syntax? *Trends in Cognitive Sciences*, 7, 60-61.
- Ehlich, K., & Rayner, K. (1983). Pronoun assignment and semantic integration during reading: Eye movements and immediacy of processing. *Journal of Memory and Language*, 22, 75-87.
- Elman, J. L. (1990). Finding structure in time. *Cognitive Science*, 14, 179-211.
- Emonds, J. (1976). *A Transformational Approach to English Syntax*. New York: Academic Press.
- Featherston, S. (2005). *That*-trace in German. *Lingua*, 115, 1277-1302.
- Featherston, S. (2007). Data in generative grammar: The stick and the carrot. *Theoretical Linguistics*, 33, 269-318.
- Ferreira, F. (1994). Choice of passive voice is affected by verb type and animacy. *Journal of Memory and Language*, 33, 715-736.

- Ferreira, F. (2000). Syntax in language production: An approach using tree-adjoining grammars. In L. Wheeldon (Ed.), *Aspects of language production*. (pp. 291-330). Philadelphia, PA, US: Psychology Press/Taylor & Francis.
- Ferreira, F. (2003). The misinterpretation of noncanonical sentences. *Cognitive Psychology*, *47*, 164 - 203.
- Ferreira, F. (2005). Psycholinguistics, formal grammars, and cognitive science. *The Linguistic Review*, *22*, 365-380.
- Ferreira, F., & Clifton, C. (1986). The independence of syntactic processing. *Journal of Memory and Language*, *25*, 348-368.
- Ferreira, F., & Engelhardt, P. (2006). Syntax and production. In M. J. Traxler & M. A. Gernsbacher (Eds.), *Handbook of Psycholinguistics* (2nd ed.). San Diego: Academic Press.
- Ferreira, F., & Henderson, J. M. (1990). Use of verb information in syntactic parsing: Evidence from eye movements and word-by-word self-paced reading. *Journal of Experimental Psychology: Learning, Memory, and Cognition*, *16*, 555-568.
- Ferreira, V. S. (2003). The persistence of optional complementizer production: Why saying "that" is not saying "that" at all. *Journal of Memory and Language*, *48*, 379-398.
- Ferreira, V. S., Bock, J. K., Wilson, M. P., & Cohen, N. J. (2008). Memory for syntax despite amnesia. *Psychological Science*, *19*, 940-946.
- Ferreira, V. S., & Slevc, L. R. (2007). Grammatical encoding. In G. Gaskell (Ed.), *Oxford Handbook of Psycholinguistics* (pp. 453 - 470). Oxford, UK: Oxford University Press.
- Ferreira, V. S., & Yoshita, H. (2003). Given-new ordering effects on the production of scrambled sentences in Japanese. *Journal of Psycholinguistic Research*, *32*, 669-692.
- Fiengo, R., & May, R. (1994). *Indices and identity*. Cambridge, MA: MIT Press.
- Fodor, J. A. (1983). *The modularity of mind*. Cambridge, MA: MIT Press.
- Fodor, J. A., Bever, T. G., & Garrett, M. F. (1974). *The psychology of language*. New York: McGraw-Hill.

- Fodor, J. D. (1978). Parsing strategics and constraints on transformations. *Linguistic Inquiry*, 9, 427-473.
- Forster, K. I., & Forster, J. C. (2003). DMDX: A window display program with millisecond accuracy. *Behavior Research Methods, Instruments & Computers*, 35, 116-124.
- Franceschina, F. (2001). Morphological or syntactic deficits in near-native speakers? An assessment of some current proposals. *Second Language Research*, 17, 213-247.
- Francis, W. S. (1999). Cognitive integration of language and memory in bilinguals: semantic representation. *Psychological Bulletin*, 125, 193-222.
- Francis, W. S. (2005). Bilingual semantic and conceptual representation. In J. F. Kroll & A. M. B. de Groot (Eds.), *Handbook of bilingualism: Psycholinguistic approaches* (pp. 51-267). New York, NY: Oxford University Press.
- Frazier, L. (1987). Sentence processing: A tutorial review. In M. Coltheart (Ed.), *Attention and performance XII: The psychology of reading* (pp. 559-586). Hillsdale, NJ: Erlbaum.
- Frazier, L., & Clifton, C., Jr. (1996). *Construal*. Cambridge, MA: MIT Press.
- Frazier, L., & Clifton, C., Jr. (2001). Parsing coordinates and ellipsis: Copy. *Syntax*, 4, 1-22.
- Frazier, L., & Fodor, J. D. (1978). The sausage machine: A new two-stage parsing model. *Cognition*, 6, 291-325.
- Frazier, L., & Rayner, K. (1982). Making and correcting errors during sentence comprehension: Eye movements in the analysis of structurally ambiguous sentences. *14*, 178-210.
- Gallistel, C. R. (2001). Mental representations, psychology of. In N. J. Smelser & P. B. Baltes (Eds.), *International Encyclopaedia of the Social and Behavioural Sciences* (pp. 9691 - 9695). New York: Elsevier.
- Garcia-Albea, J. E., Sanchez-Casas, R., & Valero, T. (1996). *Form and meaning contribution to word recognition in Catalan-Spanish bilinguals*. Paper presented at the meeting of the Ninth Conference of the European Society for Cognitive Psychology, University of Würzburg, Germany.

- Garnham, A. (1983). Why psycholinguists don't care about DTC: A reply to Ben&k and Weinberg. *Cognition*, 15, 263-269.
- Garnham, A. (1987). Effects of antecedent distance and intervening text structure in the interpretation of ellipses. *Language and Speech*, 30, 59-68.
- Garnham, A., & Oakhill, J. V. (1987). Interpreting elliptical verb phrases. *Quarterly Journal of Experimental Psychology*, 39A, 611-627.
- Garnsey, S. M., Pearlmutter, N. J., Myers, E., & Lotocky, M. A. (1997). The contributions of verb bias and plausibility to the comprehension of temporarily ambiguous sentences. *Journal of Memory and Language*, 37, 58-93.
- Garrett, M. F. (1975). The analysis of sentence production. In G. H. Bower (Ed.), *The psychology of learning and motivation* (Vol. 9, pp. 133-177). New York: Academic Press.
- Garrett, M. F. (1980). Levels of processing in sentence production. In B. Butterworth (Ed.), *Language production* (Vol. 1, pp. 177-220). London: Academic Press.
- Gazdar, G. J. M., Pullum, G. K., & Sag, I. (1981). A Phrase Structure Grammar for the English Auxiliary System. In I. Sag (Ed.), *Stanford Working Papers in Grammatical Theory* (Vol. I, pp. 1-124). Stanford, CA: Stanford Cognitive Science Group, Stanford University
- Gerard, L. D., & Scarborough, D. L. (1989). Language-specific lexical access of homographs by bilinguals. *Journal of Experimental Psychology: Learning, Memory, and Cognition*, 15, 305-315.
- Gibson, E. (1998). Linguistic complexity: locality of syntactic dependencies. *Cognition*, 68, 1-76.
- Gibson, E. (2006). The interaction of top-down and bottom-up statistics in the resolution of syntactic category ambiguity. *Journal of Memory and Language*, 54, 363-388.
- Gibson, E., & Fedorenko, E. (2010). Weak quantitative standards in linguistics research. *Trends in Cognitive Sciences*, 14, 233-234.
- Gibson, E., & Fedorenko, E. (in press). The need for quantitative methods in syntax. *Language and Cognitive Processes*.

- Gibson, E., & Thomas, J. (1999). Memory limitations and structural forgetting: The perception of complex ungrammatical sentences as grammatical. *Language and Cognitive Processes*, 14, 225-248.
- Gibson, E., & Warren, T. (2004). Reading time evidence for intermediate linguistic structure in long-distance dependencies. *Syntax*, 7, 55-78.
- Goldberg, A. E. (1995). *Constructions: A construction grammar approach to argument structure*. Chicago: University of Chicago Press.
- Gollan, T. H., Forster, K. I., & Frost, R. (1997). Translation priming with different scripts: Masked priming with cognates and noncognates in Hebrew-English bilinguals. *Journal of Experimental Psychology: Learning, Memory, and Cognition*, 23, 1122-1139.
- Gordon, P. C., Hendrick, R., & Johnson, M. (2001). Memory interference during language processing. *Journal of Experimental Psychology: Learning, Memory and Cognition*, 27, 1411-1423.
- Gordon, P. C., Hendrick, R., & Johnson, M. (2004). Effects of noun phrase type on sentence complexity. *Journal of Memory and Language*, 51, 715-726.
- Gordon, P. C., Hendrick, R., & Levine, W. H. (2002). Memory-load interference in syntactic processing. *Psychological Science*, 13, 425-430.
- Gorrell, P. (1995). *Syntax and parsing*. Cambridge: Cambridge University Press.
- Green, D. W. (1998). Mental control of the bilingual lexico-semantic system. *Bilingualism: Language and Cognition* 1, 67-81.
- Grimshaw, J. (1990). *Argument structure*. Cambridge, MA: MIT Press.
- Grosjean, F. (1997). Processing mixed language: Issues, findings, and models. In A. M. B. de Groot & J. F. Kroll (Eds.), *Tutorials in bilingualism: Psycholinguistic perspectives* (pp. 225 - 254). Mahwah, NJ: Lawrence, Erlbaum Associates.
- Gu, Y. (1999). Shuangbinyu jiegou [The ditransitive construction]. In L. Xu (Ed.), *Gongxing yu gexing: Hanyu yuyanxue zhong de zhengyi* [Language-generalization and language-specificity: Debates in Chinese linguistics] (pp. 60-90). Beijing: Beijing Language and Culture University Press.
- Haik, I. (1987). Bound VPs that need to be. *Linguistic Inquiry*, 10(03), 503-530.

- Halliday, M. A. K. (1994). *An introduction to Functional Grammar* (2nd ed.). London: Arnold.
- Hankamer, J., & Sag, I. (1976). Deep and surface anaphora. *Linguistic Inquiry* 7, 391-428.
- Hardt, D. (1993). *Verb phrase ellipsis: form, meaning, and processing*. Unpublished PhD thesis, University of Pennsylvania, Philadelphia, PA.
- Hare, M. L., & Goldberg, A. E. (1999). Structural priming: Purely syntactic? In M. Hahn & S. C. Stones (Eds.), *Proceedings of the 21st Annual Meeting of the Cognitive Science Society* (pp. 208–211). Mahwah, NJ: Erlbaum.
- Hartsuiker, R. J., Bernolet, S., Schoonbaert, S., Speybroeck, S., & Vanderelst, D. (2008). Syntactic priming persists while the lexical boost decays: Evidence from written and spoken dialogue. *Journal of Memory and Language*, 58, 214-238.
- Hartsuiker, R. J., & Kolk, H. H. (1998). Syntactic Persistence in Dutch. *Language and Speech*, 41, 143-184.
- Hartsuiker, R. J., Kolk, H. H. J., & Huiskamp, P. (1999). Priming word order in sentence production. *Quarterly Journal of Experimental Psychology: Human Experimental Psychology*, 52, 129-147.
- Hartsuiker, R. J., & Pickering, M. J. (2008). Language integration in bilingual sentence production. *Acta Psychologica*, 128, 479-489.
- Hartsuiker, R. J., Pickering, M. J., & Veltkamp, E. (2004). Is syntax separate or shared between languages? Cross-linguistic syntactic priming in Spanish-English bilinguals. *Psychological Science*, 15, 409-414.
- Hartsuiker, R. J., & Westenberg, C. (2000). Word order priming in written and spoken sentence production. *Cognition*, 75, B27-B39.
- Hashimoto, M. (1987). Hanyu beidongshi de lishi quyü fazhan [The historical and geographical development of Chinese passive constructions]. *Zhongguo Yuwen*, 196, 36-49.
- Haugen, E. (1966). Dialect, language, nation. *American Anthropologist*, 68, 922-935.
- Hawkins, R., & Casillas, G. (2008). Explaining frequency of verb morphology in early L2 speech. *Lingua*, 118, 595-612

- Hawkins, R., & Chan, C. Y.-H. (1997). The partial availability of Universal Grammar in second language acquisition: the 'Failed Functional Features Hypothesis'. *Second Language Research*, 13, 187–226.
- Hermans, D., Bongaerts, T., De Bot, K., & Schreuder, R. (1998). Producing words in a foreign language: Can speakers prevent interference from their first language? *Bilingualism: Language and Cognition*, 1, 213-229.
- Heydel, M., & Murray, W. S. (2000). In V. Lombardo (Ed.), *Cross-linguistic perspectives on language processing* (pp. 227–254). Dordrecht/London: Kluwer Academic.
- Hopper, P. J., & Thompson, S. A. (1980). Transitivity in grammar and discourse. *Language*, 56, 251-299.
- Hornstein, N. (1995). *Logical form*. Cambridge, Mass: Blackwell.
- Hornstein, N., & Weinber, A. (1981). Case theory and preposition stranding. *Linguistic Inquiry*, 12, 55-92.
- Huang, C.-T. J., Li, Y.-H. A., & Li, Y. (2009). *The syntax of Chinese*. Cambridge: Cambridge University Press.
- Jackendoff, R. (1972). *Semantic Interpretation in Generative Grammar*. Cambridge, Mass: The MIT Press.
- Jackendoff, R. (1983). *Semantics and cognition*. Cambridge, MA: MIT Press.
- Jackendoff, R. (1987). The status of thematic relations in linguistic theory. *Linguistic Inquiry*, 18, 369-411.
- Jackendoff, R. (2002). *Foundations of language: brain, meaning, grammar, evolution*. Oxford, UK: Oxford University Press.
- Jackendoff, R. (2003). Reintegrating generative grammar (precis of *Foundations of Language*). *Behavioral and Brain Sciences*, 26, 651-665.
- Jaeger, T. F. (2008). Categorical data analysis: Away from ANOVAs (transformation or not) and towards logit mixed models. *Journal of Memory and Language*, 59, 434-446.
- Jaeger, T. F., & Norcliffe, E. (2009). The cross-linguistic study of sentence production. *Language and Linguistics Compass*, 3, 866-887.
- Jiang, N. (2004). Morphological insensitivity in second language processing. *Applied Psycholinguistics*, 25, 603-634.

- Joshi, A. K., Levy, L., & Takahashi, M. (1975). Tree adjunct grammars. *Journal of the Computer and System Sciences*, 10, 136-163.
- Juffs, A. (1998). Main verb vs. reduced relative clause ambiguity resolution in second language sentence processing. *Language Learning*, 48, 107-147.
- Juffs, A., & Harrington, M. (1996). Garden path sentences and error data in second language sentence processing research. *Language Learning*, 46, 286-324.
- Kanwisher, N. G. (1987). Repetition blindness: Type recognition without token individuation. *Cognition*, 27, 117-143.
- Kaplan, R. M., & Bresnan, J. (1982). Lexical-functional grammar: A formal system for grammatical representation. In J. Bresnan (Ed.), *The mental representation of grammatical relations* (pp. 173-281). Cambridge, MA: MIT Press.
- Kaschak, M. P., Loney, R. A., & Borreggine, K. L. (2006). Recent experience affects the strength of structural priming. *Cognition*, 99, B73-B82.
- Katz, J. (1981). *Language and other abstract objects*. Totowa, New Jersey: Rowman and Littlefield.
- Katz, J. (1996). The unfinished Chomskyan revolution. *Mind & Language*, 11, 270-294.
- Katz, J., & Postal, P., M. (1991). Realism vs. conceptualism in linguistics. *Linguistics and Philosophy*, 5, 515 - 554.
- Keller, F. (2000). *Gradience in grammar: Experimental and computational aspects of degrees of grammaticality*. Unpublished PhD thesis, University of Edinburgh, Edinburgh.
- Kempen, G., & Harbusch, K. (2004). A corpus study into word order variation in German subordinate clauses: Animacy affects linearization independently of grammatical function assignment. In T. Pechmann & C. Habel (Eds.), *Multidisciplinary approaches to language production* (pp. 173-181). Berlin: Mouton de Gruyter.
- Kempen, G., & Hoenkamp, E. (1987). An incremental procedural grammar for sentence formulation. *Cognitive Science*, 11, 201-258.
- Kempen, G., & Huijbers, P. (1983). The lexicalization process in sentence production and naming: Indirect election of words. *Cognition*, 14, 185-209.

- Kim, A., & Osterhout, L. (2005). The independence of combinatoriy semantic processing: Evidence from event-related potentials. *Journal of Memory and Language*, 52, 205-225.
- Kimball, J. (1973). even principles of surface structure parsing in natural language. *Cognition*, 2, 15 - 47.
- Kirsner, K., Smith, M. C., Lockhart, R. S., King, M. L., & Jain, M. (1984). The bilingual lexicon: Language-specific units in an integrated network. *Journal of Verbal Learning and Verbal Behavior*, 23, 519-539.
- Kitagawa, Y. (1991). Copying identity. *Natural Language and Linguistic Theory*, 9, 497–536.
- Koenig, J.-P., Mauner, G., & Bienvenue, B. (2003). Arguments for adjuncts. *Cognition*, 89, 67–103.
- Konopka, A. E., & Bock, K. (2009). Lexical or syntactic control of sentence formulation? Structural generalizations from idiom production. *Cognitive Psychology*, 58, 68-101.
- Kroll, J. F., & Curley, J. (1988). Lexical memory in novice bilinguals: The role of concepts in retrieving second language words. In M. Gruneberg, P. Morris & R. Sykes (Eds.), *Practical aspects of memory* (pp. Vol. 2, 389-395).
- Kroll, J. F., & De Groot, A. M. B. (1997). Lexical and conceptual memory in the bilingual: Mapping form to meaning in two languages. In A. M. B. De Groot & J. F. Kroll (Eds.), *Tutorials in bilingualism* (pp. 169-199). Mahwah, NJ: Lawrence Erlbaum.
- Kroll, J. F., Michael, E., Tokowicz, N., & Dufour, R. (2002). The development of lexical fluency in a second language. *Second Language Research*, 18, 137-171.
- Kroll, J. F., & Sholl, A. (1992). Lexical and conceptual memory in fluent and nonfluent bilinguals. In R. Harris (Ed.), *Cognitive processsing in bilinguals* (pp. 191-204). Amsterdam: Elsevier.
- Kroll, J. F., & Stewart, F. (1994). Category interference in translation and picture naming: Evidence for asymmetric connections between bilingual memory representations. *Journal of Memory and Language*, 33, 149-174.

- Kroll, J. F., & Tokowicz, N. (2005). Models of bilingual representation and processing: Looking back and to the future. In J. Kroll & A. M. B. De Groot (Eds.), *Handbook of Bilingualism* (pp. 531 - 553). Oxford, UK: Oxford University Press.
- La Heij, W., Hooglander, A., Kerling, R., & Van der Velden, E. (1996). Nonverbal context effects in forward and backward word translation: Evidence for concept mediation. *Journal of Memory and Language*, 35, 648-665.
- La Heij, L. (2005). Selection processes in monolingual and bilingual lexical access. In J. F. Kroll & A. M. B. De Groot (Eds.), *Handbook of bilingualism: psycholinguistic approaches* (pp. 289-307). Oxford: Oxford University Press.
- Lakoff, G. (1987). *Women, fire, and dangerous things: What categories reveal about the mind*. Chicago: Chicago University Press.
- Langacker, R. W. (1987). *Foundations of Cognitive Grammar* (Vol. 1). Stanford: Stanford University Press.
- Langendoen, D. T., & Postal, P. (1984). *The vastness of natural languages*. Oxford: Basil Blackwell.
- Lappin, S. (1993). Ellipsis resolution at s-structure. In A. Schafer (Ed.), *Proceedings of NELS 23* (pp. 255-269). Amherst, MA: University of Massachusetts Press.
- Lardiere, D. (1998a). Case and tense in the 'fossilized' steady state. *Second Language Research*, 14, 1-26.
- Lardiere, D. (1998b). Dissociating syntax from morphology in a divergent end-state grammar. *Second Language Research*, 14, 359-375.
- Lardiere, D. (2009). Some thoughts on the contrastive analysis of features in second language acquisition. *Second Language Research*, 25, 173-227.
- Lasnik, H. (2002). The minimalist program in syntax. *Trends in Cognitive Sciences*, 6, 432-437.
- LeDoux, K., Traxler, M. J., & Swaab, T. Y. (2007). Syntactic priming in comprehension: Evidence from event-related potentials. *Psychological Science*, 18, 135-143.
- Levelt, W. J. M. (1974). *Formal grammars in linguistics and psycholinguistics* (Vol. Vol. III, Psycholinguistic applications). The Hague: Mouton.

- Levelt, W. J. M. (1989). *Speaking: From intention to articulation*. Cambridge, MA: MIT Press.
- Levelt, W. J. M., & Kelter, S. (1982). Surface form and memory in question answering. *Cognitive Psychology*, 14, 78-106.
- Levelt, W. J. M., Roelofs, A., & Meyer, A. S. (1999). A theory of lexical access in speech production. *Behavioral & Brain Sciences*, 22, 1-75.
- Levin, B. (1993). *English verb classes and alternations: A preliminary investigation*. Chicago: University of Chicago Press.
- Li, C. N., & Thompson, S. A. (1981). *Mandarin Chinese: a functional reference grammar*. Berkeley: University of California Press.
- Li, F.-K. (1973). Languages and Dialects of China. *Journal of Chinese Linguistics* 1, 1-13.
- Li, Y.-H. A. (1990). *Order and constituency in Mandarin Chinese*. Dordrecht: Kluwer.
- Lin, J. (2007). *The 'ditransitive construction' with indirect object as provider in Mandarin Chinese*. Paper presented at the Construction of Meaning Workshop, Stanford University, Stanford, California.
- Liu, F.-H. (2006). Dative constructions in Chinese. *Language and Linguistics*, 7, 863-904.
- Liversedge, S. P., Pickering, M. J., Branigan, H. P., & Van Gompel, R. P. G. (1998). Processing arguments and adjuncts in isolation and context: The case of by-phrase ambiguities in passives. *Journal of Experimental Psychology: Learning, Memory, and Cognition*, 24, 461-475.
- Loebell, H., & Bock, K. (2003). Structural priming across languages. *Linguistics*, 41, 791-824.
- Luka, B. J., & Barsalou, L. W. (2005). Structural facilitation: Mere exposure effects for grammatical acceptability as evidence for syntactic priming in comprehension. *Journal of Memory and Language*, 52, 436-459.
- Lust, B., Hermon, G., & Kornfilt, J. (Eds.). (1994). *Syntactic theory and first language acquisition: cross-linguistic perspectives* (Vol. 2, Binding, dependencies, and learnability). Hillsdale, NJ: Erlbaum Associates.

- MacDonald, M. C., Pearlmutter, N. J., & Seidenberg, M. S. (1994). The lexical nature of syntactic ambiguity resolution. *Psychological Review*, *101*, 676-703.
- MacKay, D. G., & Miller, M. D. (1994). Semantic blindness: Repeated concepts are difficult to encode and recall under time pressure. *Psychological Science*, *5*, 52-55.
- MacWhinney, B. (2005). A unified model of language acquisition. In J. F. Kroll & A. M. B. De Groot (Eds.), *Handbook of bilingualism: psycholinguistic approaches* (pp. 49-67). Oxford: Oxford University Press.
- Manning, C. (2003). Probabilistic syntax. In R. Bod, J. Hay & S. Jannedy (Eds.), *Probabilistic linguistics*. Cambridge, MA: MIT Press.
- Marinis, T., Roberts, L., Felser, C., & Clahsen, H. (2005). Gaps in second language sentence processing. *Studies in Second Language Acquisition* *27*, 53-78.
- Marr, D. (1982). *Vision*. New York: Freeman.
- Marslen-Wilson, W. (1973). Linguistic structure and speech shadowing at very short latencies. *Nature*, *244*, 522-523.
- Martin, A. E., & McElree, B. (2008). A content-addressable pointer mechanism underlies comprehension of verb-phrase ellipsis. *Journal of Memory and Language*, *58*, 879-906.
- Matthews, S., & Yip, V. (1994). *Cantonese: A Comprehensive Grammar*. London: Routledge.
- Maurer, G., Tannenhaus, M. K., & Carlson, G. N. (1995). A note on parallelism effects in processing deep and surface verb-phrase anaphora. *Language and Cognitive Processes*, *10*, 1-12.
- McDonald, J. L., Bock, K., & Kelly, M. H. (1993). Word and world order: Semantic, phonological, and metrical determinants of serial position. *Cognitive Psychology*, *25*, 188-230.
- McDonald, J. L., & MacWhinney, B. (1995). The time course of anaphor resolution: Effects of implicit verb causality and gender. *Journal of Memory and Language*, *34*, 543-566.
- Meijer, P. J. A., & Fox Tree, J. E. (2003). Building syntactic structures in speaking: A bilingual exploration. *Experimental Psychology*, *50*, 184-195.

- Melinger, A., & Dobel, C. (2005). Lexically-driven syntactic priming. *Cognition*, 98, B11-B20.
- Miller, G. A. (1962). Some psychological studies of grammar. *American Psychologist*, 17, 748-762.
- Mitchell, D. C., Corley, M. M. B., & Garnham, A. (1992). Effects of context in human sentence parsing: Evidence against a discourse-based proposal mechanism. *Journal of Experimental Psychology: Learning, Memory, and Cognition*, 18, 69-88.
- Mitchell, D. C., & Cuetos, F. (1991). The origins of parsing strategies. In C. Smith (Ed.), *Current Issues in Natural Language Processing*. Austin, TX: Center for Cognitive Science, University of Texas.
- Mitchell, D. C., Cuetos, F., Corley, M. M. B., & Brysbaert, M. (1995). Exposure-based models of human parsing: Evidence for the use of coarse-grained (nonlexical) statistical records. *Journal of Psycholinguistic Research*, 24, 469-488.
- Murphy, G. L. (1985). Processes of understanding anaphora. *Journal of Memory and Language*, 24, 290-303.
- Myachykov, A., & Tomlin, R. (2008). Perceptual priming and structural choice in Russian sentence production. *Journal of Cognitive Science*, 6, 31-48.
- Nagata, H. (1988). The relativity of linguistic intuition: The effect of repetition on grammaticality judgments. *Journal of Psycholinguistic Research*, 17, 1-17.
- Nagata, H. (1989). Effect of repetition on grammaticality judgments under objective and subjective self-awareness conditions. *Journal of Psycholinguistic Research*, 18, 255-269.
- Newell, A., & Simon, H. A. (1961). Simulation of human thought. In D. Wayne (Ed.), *Current Trends in Psychology Theory* (pp. 152 - 179). Pittsburgh, PA: University of Pittsburgh Press.
- Nicol, J., & Swinney, D. (1989). The role of structure in coreference assignment during sentence comprehension. *Journal of Psycholinguistic Research*, 18, 5-19.
- Onishi, K. H., Murphy, G. L., & Bock, K. (2008). Prototypicality in sentence production. *Cognitive Psychology*, 56, 103-141.

- Papadopoulou, D. (2006). *Cross-linguistic variation in sentence processing*. Amsterdam: Springer.
- Papadopoulou, D., & Clahsen, H. (2003). Parsing strategies in L1 and L2 sentence processing: A study of relative clause attachment in Greek. *Studies in Second Language Acquisition*, 25, 501-528.
- Patson, N. D., Darowski, E. S., Moon, N., & Ferreira, F. (2009). Lingerin misinterpretations in garden-path sentences: Evidence from a paraphrasing task. *Journal of Experimental Psychology: Learning, Memory, and Cognition*, 35, 280-285.
- Phillips, C. (2006). The real-time status of island phenomena. *Language*, 82, 795-823.
- Phillips, C. (1996). *Order and structure*. MIT, Cambridge, MA.
- Phillips, C. (2009). Should we impeach armchair linguists? In S. S. Iwasaki, H. Hoji, P. Clancy & S.-O. Sohn (Eds.), *Japanese-Korean Linguistics 17: CSLI Publications*.
- Phillips, C., & Lasnik, H. (2003). Linguistics and empirical evidence. *Trends in Cognitive Sciences*, 7, 61-62.
- Pickering, M., & Barry, G. (1991). Sentence processing without empty categories. *Language and Cognitive Processes*, 6, 229-259.
- Pickering, M. J., & Branigan, H. P. (1998). The representation of verbs: Evidence from syntactic priming in language production. *Journal of Memory and Language*, 39, 633-651.
- Pickering, M. J., & Branigan, H. P. (1999). Syntactic priming in language production. *Trends in Cognitive Sciences*, 3, 136-141.
- Pickering, M. J., Branigan, H. P., & McLean, J. F. (2002). Constituent structure is formulated in one stage. *Journal of Memory and Language*, 46, 586-605.
- Pickering, M. J., & Ferreira, V. S. (2008). Structural priming: A critical review. *Psychological Bulletin*, 134, 427-459.
- Pickering, M. J., & Garrod, S. (2004). Toward a mechanistic psychology of dialogue. *Behavioral and Brain Sciences*, 27, 169-226.
- Pickering, M. J., & Traxler, M. J. (1998). Plausibility and recovery from garden paths: An eye-tracking study. *Journal of Experimental Psychology: Learning, Memory, & Cognition*, 24, 940-961.

- Pickering, M. J., Traxler, M. J., & Crocker, M. W. (2000). Ambiguity resolution in sentence processing: Evidence against likelihood. *Journal of Memory and Language*, 43, 447-475.
- Pollard, C., & Sag, I. A. (1994). *Head-driven phrase structure grammar*. Chicago: University of Chicago Press.
- Potter, M. C., & Lombardi, L. (1998). Syntactic priming in immediate recall of sentences. *Journal of Memory and Language*, 38, 265-282.
- Potter, M. C., So, K.-F., Von Eckhardt, B., & Feldman, L. B. (1984). Lexical and conceptual representation in beginning and proficient bilinguals. *Journal of Verbal Learning and Verbal Behavior*, 23, 23-38.
- Prat-Sala, M., & Branigan, H. P. (2000). Discourse constraints on syntactic processing in language production: A cross-linguistic study in English and Spanish. *Journal of Memory and Language*, 42, 168-182.
- Preston, M. S., & Lambert, W. E. (1969). Interlingual interference in a bilingual version of the stroop color-word task. *Journal of Verbal Learning and Verbal Behavior*, 8, 295-301.
- Prévost, P., & White, L. (2000). Missing surface inflection or impairment in second language acquisition? Evidence from tense and agreement. *Second Language Research*, 16, 103-133.
- Prince, A., & Smolensky, P. (1993). *Optimality theory : Constraint interaction in generative grammar*. New Brunswick, NJ: Rutgers Center for Cognitive Science Rutgers the State University of New Jersey.
- Pritchett, B. (1992). *Grammatical competence and parsing performance*. Chicago, IL: University of Chicago Press.
- Rayner, K., Carlson, M., & Frazier, L. (1983). The interaction of syntax and semantics during sentence processing: Eye movements in the analysis of semantically biased sentences. *Journal of Verbal Learning and Verbal Behavior*, 22, 358-374.
- Roelofs, A. (1992). A spreading-activation theory of lemma retrieval in speaking. *Cognition*, 42, 107-142.
- Rosenbach, A. (2005). Animacy versus weight as determinants of grammatical variation in English. *Language*, 81, 613-644.

- Ross, J. R. (1967). *Constraints on variables in syntax*. Unpublished doctoral dissertation, Massachusetts Institute of Technology.
- Runner, J. T., Sussman, R. S., & Tanenhaus, M. K. (2003). Assignment of reference to reflexives and pronouns in picture noun phrases: Evidence from eye movements. *Cognition*, *81*, B1-13.
- Sachs, J. S. (1967). Recognition memory for syntactic and semantic aspects of connected discourse. *Perception & Psychophysics*, *2*, 437-442.
- Sag, I. (1976). *Deletion and logical form*. Unpublished PhD thesis, MIT, Cambridge, MA.
- Sahin, N. T., Pinker, S., Cash, S. S., Schomer, D., & Halgren, E. (2009). Sequential processing of lexical, grammatical, and phonological information within Broca's area. *Science*, *326*, 445 - 449.
- Salamoura, A., & Williams, J. N. (2007). Processing verb argument structure across languages: Evidence for shared representations in the bilingual lexicon. *Applied Psycholinguistics*, *28*, 627-660.
- Sanchez-Casas, R., & Carcia-Albea, J. E. (2005). The representation of cognate and noncognate words in bilingual memory. In J. Kroll & A. M. B. De Groot (Eds.), *Handbook of Bilingualism* (pp. 226 - 250). Oxford, UK: Oxford University Press.
- Sanchez-Casas, R., Davis, C. W., & Garcia-Albea, J. E. (1992). Bilingual lexical processing: Exploring the cognate/noncognate distinction. *European Journal of Cognitive Psychology*, *4*, 293-310.
- Santesteban, M., Pickering, M. J., & McLean, J. F. (2010). Lexical and phonological effects on syntactic processing: Evidence from syntactic priming. *Journal of Memory and Language*, *63*, 347-366.
- Schoonbaert, S., Duyck, W., Brysbaert, M., & Hartsuiker, R. (2009). Semantic and translation priming from a first language to a second and back: Making sense of the findings. *Memory and Cognition*, *37*, 569-586
- Schoonbaert, S., Hartsuiker, R. J., & Pickering, M. J. (2007). The representation of lexical and syntactic information in bilinguals: Evidence from syntactic priming. *Journal of Memory and Language*, *34*, 807-820.

- Schoonbaert, S., Holcomb, P. J., Grainger, J., & Hartsuiker, R. J. (in press). Testing asymmetries in non-cognate translation priming: Evidence from RTs and ERPs. *Psychophysiology*.
- Schriefers, H., Meyer, A. S., & Levelt, W. J. M. (1990). Exploring the time-course of lexical access in language production: Picture-word interference studies. *Journal of Memory and Language*, 29, 86–102.
- Schütze, C. T. (1996). *The empirical base of linguistics: Grammaticality judgments and linguistic methodology*. Chicago: University of Chicago Press.
- Shapiro, L. P., Hestivik, A., Lesan, L., & Garcia, A. R. (2003). Charting the time-course of VP-ellipsis sentence comprehension: Evidence for an initial and independent structural analysis. *Journal of Memory and Language*, 49, 1-19.
- Shin, J. A., & Christianson, K. (2009). Syntactic processing in Korean-English bilingual production: Evidence from cross-linguistic structural priming. *Cognition*, 112, 175-180.
- Sholl, A., Sankaranarayanan, A., & Kroll, J. F. (1995). Transfer between picture naming and translation: A test of asymmetries in bilingual memory. *Psychological Science*, 6, 45-49.
- Simon, H. A. (1957). *Models of Man*. New York, NY: Wiley.
- Smith, M., & Wheeldon, L. (2001). Syntactic priming in spoken sentence production: An online study. *Cognition*, 78, 123-164.
- Smith, M. C., & Kirsner, K. (1982). Language and orthography as irrelevant features in colour-word and picture-word stroop interference *The Quarterly Journal of Experimental Psychology Section A*, 34, 153-170.
- Snider, N. (2008). *An exemplar model of syntactic priming*. PhD thesis. Stanford University.
- Snyder, W. (2000). An experimental investigation of syntactic satiation effects. *Linguistic Inquiry*, 31, 575-582.
- Sorace, A., & Keller, F. (2005). Gradience in linguistic data. *Lingua*, 115, 1497-1524.
- Spencer, N. J. (1972). Differences between linguists and nonlinguists in intuitions of grammaticality-acceptability. *Journal of Psycholinguistic Research*, 2, 83-98.

- Spivey, M. J., Tanenhaus, M. K., Eberhard, J. M., & Sedivy, J. C. (2002). Eye movements and spoken language comprehension: Effects of visual context on syntactic ambiguity resolution. *Cognitive Psychology*, *45*, 447-481.
- Sprouse, J. (2009). Revisiting satiation. *Linguistic Inquiry*, *40*, 329-341.
- Squire, L. R. (1992). Memory and the hippocampus: A synthesis from findings with rats, monkeys, and humans. *Psychological Review*, *99*, 195-231.
- Starke, M. (1995). On the format for small clauses. In A. Cardinaletti & M. T. Guasti (Eds.), *Small clauses*. New York: Academic Press.
- Stevens, S. S. (1975). *Psychophysics: Introduction to its perceptual, neural and social prospects*. New York: John Wiley.
- Stowe, L. A. (1986). Evidence for on-line gap location. *Language and Cognitive Processes*, *1*, 227-245.
- Stowe, L. A. (1989). Thematic structures and sentence comprehension. In G. N. Carlson & M. K. Tanenhaus (Eds.), *Linguistic structure in language processing* (pp. 319-357): Kluwer Academic Press.
- Sturt, P. (2003). The time-course of the application of binding constraints in reference resolution. *Journal of Memory and Language*, *48*, 542 - 562.
- Sturt, P., Keller, F., & Dubey, A. (2010). Syntactic priming in comprehension: Parallelism effects with and without coordination. *Journal of Memory and Language*, *62*, 333–351.
- Sunderman, G. (2002). *Lexical development in a second language: Can the first language be suppressed?* Unpublished PhD thesis, The Pennsylvania State University, University Park, PA.
- Tabor, W., Galantucci, B., & Richardson, D. (2004). Effects of merely local syntactic coherence on sentence processing. *Journal of Memory and Language*, *50*, 355–370.
- Talamas, A., Kroll, J. F., & Dufour, R. (1999). From form to meaning: Stages in the acquisition of second-language vocabulary. *Bilingualism: Language and Cognition*, *2*, 45-58.
- Tanaka, M., Branigan, H. P., & Pickering, M. J. (submitted). *Conceptual influences on word order and voice in Japanese sentence production*. Unpublished manuscript.

- Tanenhaus, M. K., & Carlson, G. N. (1990). Comprehension of deep and surface verbphrase anaphors. *Language and Cognitive Processes*, 5, 257-280.
- Tanenhaus, M. K., Spivey-Knowlton, M. J., Eberhard, K. M., & Sedivy, J. C. (1995). Integration of visual and linguistic information in spoken language comprehension. *Science*, 268, 1632-1634.
- Tang, C., & van Heuven, V. J. (2009). Mutual intelligibility of Chinese dialects experimentally tested. *Lingua*, 119, 709-732.
- Tang, S.-W. (1993). *Dative constructions in Cantonese*. The Chinese University of Hong Kong, Hong Kong.
- Thierry, G., & Wu, Y. J. (2007). Brain potentials reveal unconscious translation during foreign-language comprehension. *PNAS*, 104, 12530-12535.
- Thompson, S. A. (1973). Transitivity and the *ba* construction in Mandarin Chinese. *Journal of Chinese Linguistics*, 1, 208-221.
- Tokowicz, N., Kroll, J. F., De Groot, A. M. B., & Van Hell, J. G. (2002). Number of translation norms for Dutch-English translation pairs: A new tool for examining language production. *Behavior Research Methods, Instruments, and Computers*, 34, 435-451.
- Tomlin, R. S. (1995). Focal attention, voice, and word order. In P. Downing & M. Noonan (Eds.), *Word order in discourse* (pp. 517-552). Amsterdam: John Benjamins.
- Tomlin, R. S. (1997). Mapping conceptual representations into linguistic representations: The role of attention in grammar. In J. Nuyts & E. Pederson (Eds.), *Language and conceptualization* (pp. 162-189). Cambridge: Cambridge University Press.
- Tooley, K. M., Traxler, M. J., & Swaab, T. Y. (2009). Electrophysiological and Behavioral Evidence of Syntactic Priming in Sentence Comprehension. *Journal of Experimental Psychology-Learning Memory and Cognition*, 35, 19-45.
- Traxler, M. J. (2008a). Lexically independent priming in online sentence comprehension. *Psychonomic Bulletin & Review*, 15, 149-155.
- Traxler, M. J. (2008b). Structural priming among prepositional phrases: Evidence from eye movements. *Memory & Cognition*, 36, 659-674.

- Traxler, M. J., & Pickering, M. J. (1996). Plausibility and the processing of unbounded dependencies: An eye-tracking study. *Journal of Memory and Language*, 35, 454-475.
- Traxler, M. J., & Tooley, K. M. (2008). Priming in sentence comprehension: Strategic or syntactic? *Language and Cognitive Processes*, 23, 609-645.
- Trueswell, J. C., & Tanenhaus, M. K. (1994). Toward a lexicalist framework for constraint-based syntactic ambiguity resolution. In C. J. Clifton, L. Frazier & R. K. Rayner (Eds.), *Perspectives in Language Processing* (pp. 155-179). Hillsdale, NJ: Erlbaum.
- Trueswell, J. C., Tanenhaus, M. K., & Garnsey, S. M. (1994). Semantic influences on parsing: Use of thematic role information in syntactic ambiguity resolution. *Journal of Memory and Language*, 33, 285-318.
- Trueswell, J. C., Tanenhaus, M. K., & Kello, C. (1993). Verb-specific constraints in sentence processing: Separating effects of lexical preference from garden-paths. *Journal of Experimental Psychology: Learning, Memory, and Cognition*, 19, 528-553.
- Tutunjian, D., & Boland, J. E. (2008). Do we need a distinction between arguments and adjuncts? Evidence from psycholinguistic studies of comprehension. *Language and Linguistics Compass*, 2, 631-646.
- Ullman, M. T. (2001). The neural basis of lexicon and grammar in first and second language: The declarative/procedural model. *Bilingualism: Language and Cognition*, 4, 105-122.
- Van Assche, E., Duyck, W., Hartsuiker, R. J., & Diependaele, K. (2009). Does bilingualism change native-language reading? Cognate effects in a sentence context. *Psychological Science*, 20, 923 – 927.
- Van Gompel, R. P. G., Pickering, M. J., Pearson, J., & Jacob, G. (2006). The activation of inappropriate analyses in garden-path sentences: Evidence from structural priming. *Journal of Memory and Language*, 55, 335-362.
- Van Hell, J. G., & De Groot, A. M. B. (1998). Disentangling context availability and concreteness in lexical decision and word translation. *The Quarterly Journal of Experimental Psychology*, 51A, 41-63.

- Van Herten, M., Kolk, H. H., & Chwilla, D. J. (2005). An ERP study of P600 effects elicited by semantic anomalies. *Cognitive Brain Research*, 22, 241-255.
- Vigliocco, G., & Hartsuiker, R. J. (2002). The interplay of meaning, sound, and syntax in sentence production. *Psychological Bulletin*, 128, 442-472.
- Wang, L. (1954). *Zhongguo yufa lilun* [Theory of Chinese grammar]. Beijing: Zhonghua shuju.
- Wang, P. C. T. (1970). *A transformational approach to Chinese ba and bei*. Unpublished PhD thesis, University of Texas, Austin, TX.
- Wardlow Lane, L., & Ferreira, V. S. (2010). Abstract syntax in sentence production: Evidence from stem-exchange errors. *Journal of Memory and Language*, 62, 151-165.
- Warner, J., & Glass, A. L. (1987). Context and distance-to-disambiguation effects in ambiguity resolution: Evidence from grammaticality judgments of garden path sentences. *Journal of Memory and Language*, 26, 714-738.
- Warren, T., & Gibson, E. (2002). The influence of referential processing on sentence complexity. *Cognition*, 85, 79-112.
- Warren, T., & Gibson, E. (2005). Effects of NP type in reading cleft sentences in English. *Language and Cognitive Processes*, 20, 751-767.
- Weber, K., & Indefrey, P. (2009). Syntactic priming in German-English bilinguals during sentence comprehension. *NeuroImage*, 46, 1164-1172.
- Williams, E. (1977). Discourse and logical form. *Linguistic Inquiry*, 8, 101-139.
- Williams, E. (1983). Against small clauses. *Linguistic Inquiry*, 14, 287-208.
- Xing, F. (1991). *Xiandai Hanyu* [Modern Chinese]. Beijing: Chinese Higher Education Press.
- Yngve, V. H. (1960). A model and an hypothesis for language structure. *Proceedings of the American Philosophical Society*, 104, 444-466.
- Yoshida, M., Walsh-Dickey, M., & Patrick Sturt, P. (in press). Predictive processing of syntactic structure: Sluicing and ellipsis in real-time sentence processing. *Language and Cognitive Processes*.
- Zhang, N. (1998). Argument interpretations of the ditransitive construction. *Nordic Journal of Linguistics*, 21, 179-209.

Appendices

A. Appendices for Chapter 3

A.1. Experimental materials for Experiments 3.1 & 3.2

In each set of the sentences below, the first four sentences were prime sentences in Experiment 3.1 and the last (6th) sentence is an active description of the target picture. In Experiment 3.2, everything was the same except that the ba-construction prime sentence (the 2nd sentence) was replaced with the bei-construction prime sentence (the 5th sentence). For this appendix and all the others, the sentences are given in Chinese characters rather than in pinyin and English translations of the sentences are provided in the parentheses. Due to language differences, English translations sometimes do not correspond in syntactic construction with the Chinese sentences.

1

修女批评了公主。(The nun criticized the princess.) (Canonical transitive)

修女把公主批评了。(The nun BA the princess criticized) (Ba-construction)

修女比公主长得高。(The nun grew taller than the princess.) (Bi-construction)

修女长得很高。(The nun grew very tall.) (Intransitive baseline)

公主被修女批评了。(The princess was criticized by the nun.) (Bei-construction)

服务员踢伤了小偷。(The waitress kicked the burglar.) (Target)

2

武士击倒了牧师。(The knight knocked the priest over.)

武士把修牧师击倒了。(The knight BA the priest knocked over.)

武士比牧师长得胖。(The priest grew fatter than the knight.)

武士长得很胖。(The knight grew very fat.)

修牧师被武士击倒了。(The priest was knocked over by the knight.)

教授批评了拳击手。(The professor criticized the boxer.)

3

海盗打伤了水手。(The pirate wounded the sailor.)

海盗把水手打伤了。(The pirate BA the sailor wounded.)

海盗比水手长得矮。(The pirate grew shorter than the sailor.)

海盗长得很矮。(The pirate grew very short.)

水手被海盗打伤了。(The sailor was wounded by the pirate.)

牛仔击倒了医生。(The cowboy knocked the doctor over.)

4

医生枪杀了消防队员。(The doctor shot the fireman.)

医生把消防队员枪杀了。(The doctor BA the fireman shot.)

医生比消防队员长得瘦。(The doctor grew thinner than the fireman.)

医生长得很瘦。(The doctor grew very thin.)

消防队员被医生枪杀了。(The fireman was shot by the doctor.)

教授打伤了牧师。(The professor wounded the priest.)

5

印第安人刺痛了游泳选手。(The Indian stabbed the swimmer.)

印第安人把游泳选手刺痛了。(The Indian BA the swimmer stabbed.)

印第安人比游泳选手跳得高。(The swimmer jumped higher than the swimmer.)

印第安人跳得很高。(The Indian jumped high.)

游泳选手被印第安人刺痛了。(The swimmer was stabbed by the Indian.)

厨师枪杀了小偷。(The chef shot the burglar.)

6

厨师挠痒了囚犯。(The chef tickled the prisoner.)

厨师把囚犯挠痒了。(The chef BA the prisoner tickled.)

厨师比囚犯跳得远。(The chef jumped longer than the prisoner.)

厨师跳得很远。(The chef jumped long.)

囚犯被厨师挠痒了。(The prisoner was tickled by the chef.)

教授刺痛了小偷。(The professor stabbed the burglar.)

7

滑雪运动员拉走了潜水运动员。(The skier dragged the diver.)

滑雪运动员把潜水运动员拉走了。(The skier BA the diver dragged.)

滑雪运动员比潜水运动员跑得快。(The skier ran faster than the diver.)

滑雪运动员跑得很快。(The skier ran very fast.)

潜水运动员被滑雪运动员拉走了。(The diver was dragged by the skier.)

画家挠痒了舞蹈员。(The artist tickled the dancer.)

8

小丑戳痛了小偷。(The clown was poked by the burglar.)

小丑把小偷戳痛了。(The clown BA the burglar poked.)

小丑比小偷跑得慢。(The clown ran more slowly than the burglar.)

小丑跑得很慢。(The clown ran very slowly.)

小偷被小丑戳痛了。(The burglar was poked by the clown.)

牛仔拉走了士兵。(The cowboy dragged the soldier.)

9

士兵推倒了牛仔。(The soldier pushed the cowboy over.)

士兵把牛仔推倒了。(The soldier BA the cowboy pushed over.)

士兵比牛仔吃得多。(The soldier ate more than the cowboy.)

士兵吃得很多。(The soldier ate a lot.)

牛仔被士兵推倒了。(The soldier was pushed over by the cowboy.)

教授戳痛了拳击手。(The professor poked the boxer.)

10

巫婆打败了画家。(The witch beat the artist.)

巫婆把画家打败了。(The witch BA the artist beat.)

巫婆比画家吃得少。(The witch ate less than the artist.)

巫婆吃得很少。(The witch ate very little.)

画家被巫婆打败了。(The artist was beaten by the witch.)

修女推倒了舞蹈员。(The nun pushed the dancer over.)

11

教授踢伤了舞蹈员。(The professor kicked the dancer.)

教授把舞蹈员踢伤了。(The professor BA the dancer kicked.)

教授比舞蹈员赚得多。(The professor earned more than the dancer.)

教授赚了很多。(The professor earned a lot.)

舞蹈员被教授踢伤了。(The dancer was kicked by the professor.)

牛仔打败了拳击手。(The cowboy beat the boxer.)

12

服务员批评了教授。(The waitress criticized the professor.)

服务员把教授批评了。(The waitress BA the professor criticized.)

服务员比教授穿得更正式。(The waitress wore more formally than the professor.)

服务员穿得很正式。(The waitress wore very formally.)

教授被服务员批评了。(The professor was criticized by the waitress.)

警察踢伤了拳击手。(The policeman kicked the boxer.)

13

士兵击倒了拳击手。(The soldiers knocked over the boxer.)

士兵把拳击手击倒了。(The soldier BA the boxer knocked over.)

士兵比拳击手穿得更随便。(The soldier wore more casually than the soldier.)

士兵穿得很随便。(The soldier wore very casually.)

拳击手被士兵击倒了。(The boxer was knocked over by the soldier.)

警察批评了舞蹈员。(The policeman criticized the dancer.)

14

警察打伤了牧师。(The policeman wounded the priest.)

警察把牧师打伤了。(The policeman BA the priest wounded.)

警察比牧师骂得更凶。(The policeman cursed more strongly than the priest.)

警察骂得很凶。(The policeman cursed strongly.)

牧师被警察打伤了。(The priest was wounded by the policeman.)

拳击手击倒了牛仔。(The boxer knocked the cowboy over.)

15

小偷枪杀了巫婆。(The burglar shot the witch.)

小偷把巫婆枪杀了。(The burglar BA the witch shot)

小偷比巫婆笑得更大声。(The burglar laughed more loudly than the witch.)

小偷笑得很大声。(The burglar laughed loudly.)

巫婆被小偷枪杀了。(The witch was shot by the burglar.)

牛仔打伤了游泳选手。(The cowboy wounded the swimmer.)

16

牛仔踢伤了潜水运动员。(The cowboy kicked the diver.)

牛仔把潜水运动员踢伤了。(The cowboy BA the diver kicked.)

牛仔比潜水运动员走得快。(The cowboy walked faster than the diver.)

牛仔走得很快。(The cowboy walked very fast.)

潜水运动员被牛仔踢伤了。(The diver was kicked by the cowboy.)

画家枪杀了游泳选手。(The artist shot the swimmer.)

17

武士批评了水手。(The knight criticized the sailor.)

武士把水手批评了。(The knight BA the sailor criticized.)

武士比水手走得快。(The knight walked faster than the sailor.)

武士长得很快。(The knight walked very fast.)

水手被武士批评了。(The sailor was criticized by the knight.)

画家打败了小丑。(The artist beat the clown.)

18

牧师击倒了修女。(The priest knocked the nun over.)

牧师把修女击倒了。(The priest BA the nun knocked over.)

牧师比修女笑得更大声。(The priest laughed more loudly than the nun.)

牧师笑得很大声。(The priest laughed very loudly.)

修女被牧师击倒了。(The nun was knocked over by the priest.)

服务员踢伤了小丑。(The waitress kicked the clown.)

19

海盗打伤了公主。(The pirate wounded the princess.)

海盗把公主打伤了。(The pirate BA the princess wounded.)

海盗比公主骂得更凶。(The pirate cursed more strongly than the princess.)

海盗骂得很凶。(The pirate cursed very strongly.)

公主被海盗打伤了。(The princess was wounded by the pirate)

修女批评了教授。(The nun criticized the professor.)

20

厨师枪杀了游泳选手。(The chef shot the swimmer.)

厨师把游泳选手枪杀了。(The chef BA the swimmer shot.)

厨师比游泳选手穿得更随便。(The chef wore more casually than the swimmer.)

厨师穿得很随便。(The chef wore very casually.)

游泳选手被厨师枪杀了。(The swimmer was shot by the chef.)

画家击倒了牧师。(The artist knocked the priest over.)

21

囚犯刺痛了医生。(The prisoner stabbed the doctor.)

囚犯把医生刺痛了。(The prisoner BA the doctor stabbed.)

囚犯比医生穿得更正式。(The prisoner wore more formally than the doctor.)

囚犯穿得很正式。(The prisoner wore very formally.)

医生被囚犯刺痛了。(The doctor was stabbed by the prisoner.)

画家打伤了战士。(The artist wounded the soldier.)

22

消防队员挠痒了滑雪运动员。(The fireman tickled the skier.)

消防队员把滑雪运动员挠痒了。(The fireman BA the skier tickled.)

消防队员比滑雪运动员赚得多。(The fireman earned more than the skier.)

消防队员赚得很多。(The fireman earned a lot.)

滑雪运动员被消防队员挠痒了。(The skier was tickled by the fireman.)

拳击手枪杀了画家。(The boxer shot the artist.)

23

潜水运动员拉走了印第安人。(The diver dragged the Indian.)

潜水运动员把印第安人拉走了。(The diver BA the Indian dragged.)

潜水运动员比印第安人吃得少。(The diver ate less than the Indian.)

潜水运动员吃得很少。(The diver ate very little.)

印第安人被潜水运动员拉走了。(The Indian was dragged by the diver.)

警察刺痛了牧师。(The policeman stabbed the priest.)

24

牛仔戳痛了小丑。(The cowboy poked the clown.)

牛仔把小丑戳痛了。(The cowboy BA the clown poked.)

牛仔比小丑吃得多。(The cowboy ate more than the clown.)

牛仔吃得很多。(The cowboy ate a lot.)

小丑被牛仔戳痛了。(The clown was poked by the cowboy.)

服务员挠痒了医生。(The waitress tickled the doctor.)

25

小偷推倒了士兵。(The burglar pushed the soldier over.)

小偷把士兵推倒了。(The burglar BA the soldier pushed over.)

小偷比士兵跑得慢。(The burglar ran slower than the soldier.)

小偷跑得很慢。(The burglar ran very slowly.)

士兵被小偷推倒了。(The soldier was pushed over by the burglar.)

牛仔拉走了小丑。(The cowboy dragged the clown.)

26

舞蹈员打败了巫婆。(The dancer beat the witch.)

舞蹈员把巫婆打败了。(The dancer BA the witch beat.)

舞蹈员比巫婆跑得快。(The dancer ran faster than the witch.)

舞蹈员跑得很快。(The dancer ran very fast.)

巫婆被舞蹈员打败了。(The witch was beaten by the dancer.)

警察戳痛了士兵。(The policeman poked the soldier.)

27

画家刺痛了教授。(The artist stabbed the professor.)

画家把教授刺痛了。(The artist BA the professor stabbed.)

画家比教授跳得远。(The artist jumped longer than the professor.)

画家跳得很远。(The artist jumped very long.)

教授被画家刺痛了。(The professor was stabbed by the artist.)

小丑推倒了修女。(The clown pushed the nun over.)

28

修女挠痒了武士。(The nun tickled the knight.)

修女把武士挠痒了。(The nun BA the knight tickled.)

修女比武士跳得高。(The nun jumped higher than the knight.)

修女跳得很高。(The nun jumped very high.)

武士被修女挠痒了。(The knight was tickled by the nun.)

战士打败了画家。(The soldier beat the artist.)

29

水手拉走了牧师。(The sailor dragged the priest.)

水手把牧师拉走了。(The sailor BA the priest dragged.)

水手比牧师长得瘦。(The sailor grew thinner than the priest.)

水手长得很瘦。(The sailor grew very thin.)

牧师被水手拉走了。(The priest was dragged by the sailor.)

画家刺痛了小丑。(The artist stabbed the clown.)

30

医生推倒了海盗。(The doctor pushed the pirate over.)

医生把海盗推倒了。(The doctor BA the pirate pushed over.)

医生比海盗长得矮。(The doctor grew shorter than the pirate.)

医生长得很矮。(The doctor grew very short.)

海盗被医生推倒了。(The pirate was pushed over by the doctor.)

牧师挠痒了画家。(The priest tickled the artist.)

31

公主打败了厨师。(The princess beat the chef.)

公主把厨师打败了。(The princess BA the chef beat.)

公主比厨师长得胖。(The princess grew fatter than the chef.)

公主长得很胖。(The princess grew very fat.)

厨师被公主打败了。(The chef was beaten by the princess.)

海盗拉走了士兵。(The pirate dragged the soldier.)

32

滑雪运动员踢伤了囚犯。(The skier kicked the prisoner.)

滑雪运动员把囚犯踢伤了。(The skier BA the prisoner kicked.)

滑雪运动员比囚犯长得高。(The skier grew taller than the prisoner.)

滑雪运动员长得很高。(The skier grew very tall.)

囚犯被滑雪运动员踢伤了。(The prisoner was kicked by the skier.)

厨师推倒了游泳选手。(The chef pushed the swimmer over.)

A.2. Experimental materials for Experiment 3.3

The first four sentences in each set were prime sentences and the last sentence is a DO description of the target picture.

1

牛仔还给水手一本书。(The cowboy returned the sailor a book.) (DO)

牛仔还了一本书给水手。(The cowboy returned a book to the sailor.) (PO)

牛仔偷了水手一本书。(The cowboy stole a book from the sailor.) (Steal-construction)

牛仔在休息。(The cowboy was resting.) (Baseline)

警察送给了士兵一顶帽子。(The policeman gave the soldier a book.) (Target)

2

厨师带给牧师一个面包。(The chef brought the priest a bun.)

厨师带了一个面包给牧师。(The chef brought a bun to the priest.)

厨师吃了牧师一个面包。(The chef ate a bun of the priest' s.)

厨师在休息。(The chef was resting.)

教授还给了游泳选手香蕉。(The professor returned the swimmer a banana.)

3

海盗卖给水手一个蛋糕。(The pirate sold the sailor a cake.)

海盗卖了一个蛋糕给水手。(The pirate sold a cake to the sailor.)

海盗骗了水手一个蛋糕。(The pirate deceived the sailor of a cake.)

海盗在休息。(The pirate was resting.)

厨师带给了拳击手一个排球。(The chef brought the boxer a volleyball.)

4

海盗奖给水手一个排球。(The pirate awarded the sailor a volleyball.)

海盗奖了一个排球给水手。(The pirate awarded a volleyball to the sailor.)

海盗拿了水手一个排球。(The pirate took a volleyball from the sailor.)

海盗在休息。(The pirate was reading.)

警察卖给了拳击手一把手枪。(The policeman sold the boxer a gun.)

5

修女带给医生一个香蕉。(The nun brought the doctor a banana.)

修女带了一个香蕉给医生。(The nun brought a banana to the doctor.)

修女抢了医生一个香蕉。(The doctor robbed the doctor of a banana.)

修女在睡觉。(The nun was sleeping.)

画家奖给了小丑一个苹果。(The artist awarded the clown an apple.)

6

教授赏给游泳选手一个水壶。(The professor rewarded the swimmer a jug.)

教授赏了一个水壶给游泳选手。(The professor rewarded a jug to the swimmer.)

教授砸了游泳选手一个水壶。(The professor smashed a jug of the swimmer's.)

教授在睡觉。(The professor was sleeping.)

修女带给了士兵一本书。(The nun brought the soldier a book.)

7

服务员递给水手一把枪。(The waitress passed the sailor a gun.)

服务员递了一把枪给水手。(The waitress passed a gun to the sailor.)

服务员没收了水手一把枪。(The waitress confiscated a gun of the sailor's.)

服务员在睡觉。(The waitress was sleeping.)

牛仔赏给了小偷一条香蕉。(The cowboy rewarded the thief a banana.)

8

厨师捎给医生一把伞。(The chef brought the doctor an umbrella.)

厨师捎了一把伞给医生。(The chef brought an umbrella to the doctor.)

厨师弄丢了医生一把伞。(The chef lost an umbrella of the doctor's.)

厨师在跑步。(The chef was running.)

教授递给了士兵一个杯子。(The professor passed the soldier a cup.)

9

牛仔抛给水手一只手表。(The cowboy threw the sailor a watch.)

牛仔抛了一只手表给水手。(The cowboy threw a watch to the sailor.)

牛仔用坏了水手一只手表。(The cowboy outwore a watch of the sailor's.)

牛仔在跑步。(The cowboy was running.)

警察租捎了游泳选手一顶帽子。(The policeman brought the swimmer a hat.)

10

教授拿给牧师一颗钻石。(The professor handed the priest a diamond.)

教授拿了一颗钻石给牧师。(The professor handed a diamond to the priest.)

教授霸占了牧师一颗钻石。(The professor usurped a diamond of the priest's.)

教授在跑步。(The professor was running.)

画家抛给了小丑一个排球。(The artist threw the clown a volleyball.)

11

警察交给拳击手三百块钱。(The policeman submitted the boxer 300 yuan)

警察交了三百块钱给拳击手。(The policeman submitted 300 yuan to the boxer.)

警察罚了拳击手三百块钱。(The policeman fined the boxer 300 yuan.)

警察在跑步。(The policeman was running.)

牛仔拿给了小丑一条香蕉。(The cowboy handed the clown a banana.)

12

教授赠给拳击手一只手表。(The professor bestowed-upon the boxer a watch.)

教授赠了一只手表给拳击手。(The professor bestowed-upon a watch to the boxer.)

教授赢了拳击手一只手表。(The professor won a watch from the boxer.)

教授在跑步。(The professor was running.)

画家交给了医生一把手枪。(The artist submitted the doctor a gun.)

13

牛仔捐给小丑很多钱。(The cowboy donated the cowboy a lot of money.)

牛仔捐了很多钱给小丑。(The cowboy donated a lot of money to the cowboy.)

牛仔花了小丑很多钱。(The cowboy spent a lot of money of the clown's.)

牛仔在工作。(The cowboy was working.)

教授赠给了游泳选手一顶帽子。(The professor bestowed-upon the swimmer a hat.)

14

海盗送给水手一件古董。(The pirate gave the sailor an antique.)

海盗送了一件古董给水手。(The pirate gave an antique to the sailor.)

海盗打破了水手一件古董。(The pirate broke an antique of the sailor's.)

海盗在工作。(The pirate was working.)

服务员捐给小丑一个杯子。(The waitress donated the clown a cup.)

15

画家卖给士兵一幅油画。(The artist sold the soldier a painting.)

画家卖了一幅油画给士兵。(The artist sold a painting to the soldier.)

画家偷了士兵一幅油画。(The artist stole a painting from the soldier.)

画家在工作。(The artist was working.)

海盗送给小丑一本书。(The pirate gave the clown a book.)

16

画家送给水手一个蛋糕。(The artist gave the sailor a cake.)

画家送了一个蛋糕给水手。(The artist gave a cake to the sailor.)

画家吃了水手一个蛋糕。(The artist ate a cake of the sailor's.)

画家在工作。(The sailor was working.)

牛仔卖给牧师一个苹果。(The cowboy sold the priest an apple.)

17

警察还给士兵一块金币。(The policeman returned the soldier a gold coin.)

警察还了一块金币给士兵。(The policeman returned a gold coin to the soldier.)

警察偷了士兵一块金币。(The policeman stole a gold coin from the soldier.)

警察在休息。(The policeman was resting.)

服务员交给舞蹈员一个蛋糕。(The waitress submitted the dancer a cake.)

18

厨师带给游泳选手一块蛋糕。(The chef brought the swimmer a cake.)

厨师带了一块蛋糕给游泳选手。(The chef brought a cake to the swimmer.)

厨师吃了游泳选手一块蛋糕。(The chef ate a cake of the swimmer's.)

厨师在休息。(The chef was resting.)

厨师送给小偷一个水壶。(The chef gave the burglar a jug.)

19

厨师卖给游泳选手一件古董。(The chef sold the swimmer an antique.)

厨师卖了一件古董给游泳选手。(The chef sold an antique to the swimmer.)

厨师骗了游泳选手一件古董。(The chef deceived the swimmer of an antique.)

厨师在休息。(The chef was resting.)

警察还给小丑一把枪。(The policeman returned the clown a gun.)

20

修女奖给小偷一个杯子。(The nun awarded the burglar a cup.)

修女奖了一个杯子给小偷。(The nun awarded a cup to the burglar.)

修女拿了小偷一个杯子。(The nun took a cup from the burglar.)

修女在休息。(The nun was resting.)

海盗带给小丑一本书。(The pirate brought the clown a book.)

21

厨师递给舞蹈员一个排球。(The chef passed the dancer a volleyball.)

厨师递了一个排球给舞蹈员。(The chef passed a volleyball to the dancer.)

厨师抢了舞蹈员一个排球。(The chef seized a volleyball from the dancer.)

厨师在跑步。(The chef was running.)

教授卖给医生一个蛋糕。(The professor sold the doctor a cake.)

22

巫婆赏给囚犯一个杯子。(The witch rewarded the prisoner a cup.)

巫婆赏了一个杯子给囚犯。(The witch rewarded a cup to the prisoner)

巫婆砸了囚犯一个杯子。(The witch broke a cup of the prisoner's.)

巫婆在跑步。

教授奖给士兵一把枪。(The professor awarded the soldier a gun.)

23

警察递给印第安人一个排球。(The policeman passed the Indian a volleyball.)

警察递了一个排球给印第安人。(The policeman passed a volleyball to the Indian.)

警察没收了印第安人一个排球。(The policeman confiscated a volleyball of the Indian's.)

警察在跑步。(The policeman was running.)

教授递给医生一个苹果。(The professor passed the doctor an apple.)

24

拳击手捎给服务员一顶帽子。(The boxer brought the waitress a hat.)

拳击手捎了一顶帽子给服务员。(The boxer brought a hat to the waitress.)

拳击手弄丢了服务员一顶帽子。(The boxer lost a hat of the waitress's.)

拳击手在跑步。(The boxer was running.)

画家赏给拳击手一本书。(The artist rewarded the boxer a book.)

25

滑雪运动员抛给水手一部手机。(The skier threw the sailor a mobile phone.)

滑雪运动员抛了一部手机给水手。(The skier threw a mobile phone to the sailor.)

滑雪运动员弄坏了水手一部手机。(The skier broke a mobile phone of the skier's.)

滑雪运动员在工作。(The skier was working.)

修女递给游泳选手一顶帽子。(The nun passed the swimmer a hat.)

26

公主拿给士兵一把剑。(The princess handed the soldier a sword.)

公主拿了一把剑给士兵。(The princess handed a sword to the soldier.)

公主霸占了士兵一把剑。(The princess usurped a sword of the soldier's.)

公主在工作。(The princess was working.)

牛仔捎给牧师一个苹果。(The cowboy brought the priest an apple.)

27

牛仔交给海盗三百块钱。(The cowboy submitted the pirate 300 yuan.)

牛仔交了三百块钱给海盗。(The cowboy submitted 300 yuan to the pirate.)

牛仔罚了海盗三百块钱。(The cowboy fined the pirate 300 yuan.)

牛仔在工作。(The cowboy was working.)

警察抛给牧师一本书。(The policeman threw the priest a book.)

28

消防队员赠给囚犯一条项链。(The fireman bestowed-upon the prisoner a necklace.)

消防队员赠了一条项链给囚犯。(The fireman bestowed a necklace upon the prisoner.)

消防队员赢了囚犯一条项链。(The fireman won a necklace from the prisoner.)

消防队员在工作。(The fireman was working.)

教授拿给游泳选手一本书。(The professor handed the swimmer a book.)

29

公主武士捐给武士一个月的工资。(The princess donated the knight a month's salary.)

公主捐了一个月的工资给武士。(The princess donated a month's salary to the knight.)

公主花了武士一个月的工资。(The princess spent a month's salary of the knight's.)

公主在睡觉。(The princess was sleeping.)

教授交给厨师一顶帽子。(The professor submitted the chef a hat.)

30

小偷送给警察一个杯子。(The burglar gave the policeman a cup.)

小偷送了一个杯子给警察。(The burglar gave a cup to the policeman.)

小偷打坏了警察一个杯子。(The burglar broke a cup of the policeman's.)

小偷在睡觉。(The burglar was sleeping.)

牧师赠给士兵一顶帽子。(The priest bestowed-upon the soldier a hat.)

31

小偷卖给游泳运动员一条项链。(The burglar sold the swimmer a necklace.)

小偷卖了一条项链给游泳运动员。(The burglar sold a necklace to the swimmer.)

小偷抢了游泳运动员一条项链。(The burglar robbed the swimmer of a necklace.)

小偷在睡觉。(The burglar was sleeping.)

警察捐给画家一本书。(The policeman donated the artist a book.)

32

士兵送给画家一件文物。(The soldier gave the artist an antique.)

士兵送了一件文物给画家。(The soldier gave an antique to the artist.)

士兵没收了画家一件文物。(The soldier confiscated an antique of the artist's.)

士兵在睡觉。(The soldier was sleeping.)

警察拿给小丑一把枪。(The policeman gave the clown a gun.)

B. Appendices for Chapter 4

B.1. Experimental materials for Experiment 4.1

1

牛仔送给了水手那本书。(The cowboy gave the sailor that book.)

牛仔送了那本书给水手。(The cowboy gave that book to the sailor.)

牛仔把那本书送给了水手。(The cowboy BA that book gave the sailor.)

2

厨师还给了修道士那个球。(The chef returned the priest that ball.)

厨师还了那个球给修道士。(The chef returned that ball to the priest.)

厨师把那个球还给了修道士。(That ball the chef returned the priest.)

3

厨师扔给了水手那顶帽子。(The chef threw the sailor that hat.)

厨师扔了那顶帽子给水手。(The chef threw that hat to the sailor.)

厨师把那顶帽子扔给了水手。(The chef BA that hat threw the sailor.)

4

海盗卖给了水手那个球。(The pirate sold the sailor that ball.)

海盗卖了那个球给水手。(The pirate sold that ball to the sailor.)

海盗把那个球卖给了水手。(The pirate BA that ball sold the sailor.)

5

修女赏给了医生那个水壶。(The nun rewarded the doctor the jug.)

修女赏了那个水壶给医生。(The nun rewarded the jug to the doctor.)

修女把那个水壶赏给了医生。(The nun BA that jug rewarded the doctor.)

6

修女丢给了拳击手那个水壶。(The nun tossed the boxer that jug.)

修女丢了那个水壶给拳击手。(The nun tossed that jug to the boxer.)

修女把那个水壶丢给了拳击手。(The nun BA that jug tossed the boxer.)

7

教授借给了水手那把枪。(The professor lent the sailor that gun.)

教授借了那把枪给水手。(The professor lent that gun to the sailor.)

教授把那把枪借给了水手。(The professor BA that gun lent the sailor.)

8

厨师递给了医生那个苹果。(The chef passed the doctor that apple.)

厨师递了那个苹果给医生。(The chef passed that apple to the doctor.)

厨师把那个苹果递给了医生。(The chef BA that apple passed the doctor.)

9

牛仔租给了服务员那条香蕉。(The cowboy rented the waitress that banana.)

牛仔租了那条香蕉给服务员。(The cowboy rented that banana to the waitress.)

牛仔把那条香蕉租给了服务员。(The cowboy BA that banana rented the waitress.)

10

水手抛给了修道士那个苹果。(The sailor chucked the priest that apple.)

水手抛了那个苹果给修道士。(The sailor chucked that apple to the priest.)

水手把那个苹果抛给了修道士。(The sailor BA that apple chucked the priest.)

11

警察拿给了拳击手那个水壶。(The policeman handed the boxer that jug.)

警察拿了那个水壶给拳击手。(The policeman handed that jug to the boxer.)

警察把那个水壶拿给了拳击手。(The policeman BA that jug handed the boxer.)

12

教授交给了水手那个球。(The professor submitted the sailor that ball.)

教授交了那个球给水手。(The professor submitted that ball to the sailor.)

教授把那个球交给了水手。(The professor BA that ball submitted the sailor.)

13

武士交给了舞蹈员那个蛋糕。(The knight submitted the dancer that cake.)

武士交了那个蛋糕给舞蹈员。(The knight submitted that cake to the dancer.)

武士把那个蛋糕交给了舞蹈员。(The knight BA that cake submitted the dancer.)

14

海盗送给了水手那个杯子。(The pirate gave the sailor that cup.)

海盗送了那个杯子给水手。(The pirate gave that cup to the sailor.)

海盗把那个杯子送给了水手。(The pirate BA that cup gave the sailor.)

15

画家还给了拳击手那条香蕉。(The artist returned the boxer that banana.)

画家还了那条香蕉给拳击手。(The artist returned that banana to the boxer.)

画家把那条香蕉还给了拳击手。(The artist BA that banana returned the boxer.)

16

公主扔给了小丑那个球。(The princess threw the clown that ball.)

公主扔了那个球给小丑。(The princess threw that ball to the clown.)

公主把那个球扔给了小丑。(The princess BA that ball threw the clown.)

17

警察卖给了战士那本书。(The policeman sold the soldier that book.)

警察卖了那本书给战士。(The policeman sold that book to the soldier.)

警察把那本书卖给了战士。(The policeman BA that book sold the soldier.)

18

厨师赏给了画家那顶帽子。(The chef awarded the artist that hat.)

厨师赏了那顶帽子给画家。(The chef awarded that hat to the artist.)

厨师把那顶帽子赏给了画家。(The chef BA that hat awarded the artist)

19

海盗丢给了小丑那个球。(The pirate tossed the clown that ball.)

海盗丢了那个球给小丑。(The pirate tossed that ball to the clown.)

海盗把那个球丢给了小丑。(The pirate BA that ball tossed the clown.)

20

修女借给了小丑那把枪。(The nun lent the clown that gun.)

修女借了那把枪给小丑。(The nun lent that gun to the clown.)

修女把那把枪借给了小丑。(The nun BA that gun lent the clown.)

21

厨师递给了舞蹈员那个球。(The chef passed the dancer that ball.)

厨师递了那个球给舞蹈员。(The chef passed that ball to the dancer.)

厨师把那个球递给了舞蹈员。(The chef BA that ball passed the dancer.)

22

牛仔租给了小丑那顶帽子。(The cowboy rented the clown that hat.)

牛仔租了那顶帽子给小丑。(The cowboy rented that hat to the clown.)

牛仔把那顶帽子租给了小丑。(The cowboy BA that hat rented the clown.)

23

厨师抛给了修女那个杯子。(The chef chucked the nun that cup.)

厨师抛了那个杯子给修女。(The chef chucked that cup to the nun.)

厨师把那个杯子抛给了修女。(The chef BA that cup chucked the nun.)

24

牛仔拿给了修道士那个苹果。(The cowboy handed the priest that apple.)

牛仔拿了那个苹果给修道士。(The cowboy handed that apple to the priest.)

牛仔把那个苹果拿给了修道士。(The cowboy BA that apple handed the priest.)

B.2. Experimental materials for Experiment 4.2

Each set of the following consisted of 4 question-answer pairs corresponding to the prime condition in the experiment. The last sentence is a DO description of the target picture. From Set 2 onward, I only provided the DO, Recipient-emphasized question-answer pair as an example.

1

DO, Recipient-emphasized

Q: 牛仔送给谁一本书? (The cowboy gave whom a book?)

A: 牛仔送给了水手一本书。(The cowboy gave the sailor a book.)

DO, Theme-emphasized

Q: 牛仔送给了水手什么东西? (The cowboy gave the sailor what?)

A: 牛仔送给了水手一本书。(The cowboy gave the sailor a book.)

PO, Recipient-emphasized

Q: 牛仔送了一本书给谁? (The cowboy gave a book to whom?)

A: 牛仔送了一本书给水手。(The cowboy gave a book to the sailor.)

PO, Theme-emphasized

Q: 牛仔送了什么东西给水手? (The cowboy gave what to the sailor?)

A: 牛仔送了一本书给水手。(The cowboy gave a book to the sailor.)

Target

警察送给战士一顶帽子。(The policeman gave the soldier a hat.)

2

Q: 厨师还给了谁一个球? (The chef returned whom a ball?)

A: 厨师还给了修道士一个球。(The chef returned the priest a ball.)

教授还给游泳选手一条香蕉。(The professor returned the swimmer a banana.)

3

Q: 厨师扔给了谁一顶帽子? (The chef threw whom a hat?)

A: 厨师扔给了水手一顶帽子。(The chef threw the sailor a hat.)

画家扔给战士一条香蕉。(The artist threw the soldier a banana.)

4

Q: 海盗卖给了谁一个球? (The pirate sold whom a ball?)

A: 海盗卖给了水手一个球。(The pirate sold the sailor a ball.)

警察卖给拳击手一把枪。(The policeman sold the boxer a gun.)

5

Q: 修女赏给了谁一个水壶? (The nun rewarded whom a jug?)

A: 修女赏给了医生一个水壶。(The nun sold the doctor a jug.)

画家赏给小丑一个苹果。(The artist rewarded the clown an apple.)

6

Q: 修女丢给了谁一个水壶? (The nun tossed whom a jug?)

A: 修女丢给了拳击手一个水壶。(The nun tossed the boxer a jug.)

海盗丢给小偷一顶帽子。(The pirate tossed the burglar a hat.)

7

Q: 服务员借给了谁一把枪? (The waitress lent whom a gun?)

A: 服务员借给了教授一把枪。(The waitress lent the professor a gun.)

牛仔借小偷香蕉。(The cowboy lent the burglar a banana.)

8

Q: 厨师递给了谁一个水壶? (The chef passed whom a jug?)

A: 厨师递给了服务员一个水壶。(The chef passed the waitress a jug.)

教授递给战士一个杯子。(The professor passed the soldier a cup.)

9

Q: 牛仔租给了谁一条香蕉? (The cowboy rented whom a banana?)

A: 牛仔租给了滑雪运动员一条香蕉。(The cowboy rented the skier a banana.)

警察租给游泳选手一顶帽子。(The policeman rented the swimmer a hat.)

10

Q: 教授抛给了谁一个苹果? (The professor chucked whom an apple?)

A: 教授抛给了工人一个苹果。(The professor chucked the worker an apple.)

画家抛给小丑一个球。(The artist chucked the clown a ball.)

11

Q: 警察拿给了谁一个蛋糕? (The policeman handed whom a cake?)

A: 警察拿给了印第安人一个蛋糕。(The policeman handed the Indian a cake.)

牛仔拿给小丑一条香蕉。(The cowboy handed the clown a banana.)

12

Q: 教授交给了谁一个球? (The professor submitted whom a ball?)

A: 教授交给了记者一个球。(The professor submitted the reporter a ball.)

画家交给医生一把枪。(The artist submitted the doctor a gun.)

13

Q: 服务员交给了谁一个蛋糕? (The waitress submitted whom a cake?)

A: 服务员交给了画家一个蛋糕。(The waitress submitted the artist a cake.)

教授交给厨师一顶帽子。(The professor submitted the chef a hat.)

14

Q: 海盗送给了谁一个蛋糕? (The pirate gave whom a cake?)

A: 海盗送给了消防员一个蛋糕。(The pirate gave the fireman a cake.)

厨师送给小偷一个水壶。(The chef gave the burglar a jug.)

15

Q: 画家还给了谁一条香蕉? (The artist returned whom a banana?)

A: 画家还给了游泳选手一条香蕉。(The artist returned the swimmer a banana.)

警察还给小丑一把枪。(The policeman returned the clown a gun.)

16

Q: 厨师扔给了谁一个球? (The chef threw whom a ball?)

A: 厨师扔给了魔术师一个球。(The chef threw the magician a ball.)

教授扔给医生一个苹果。(The professor threw the doctor an apple.)

17

Q: 警察卖给了谁一个水壶? (The policeman sold whom a jug?)

A: 警察卖给了农民一个水壶。(The policeman sold the farmer a jug.)

教授卖给医生一个蛋糕。(The professor sold the doctor a cake.)

18

Q: 厨师赏给了谁一顶帽子? (The chef awarded whom a hat?)

A: 厨师赏给了巫婆一顶帽子。(The chef awarded the witch a hat.)

教授赏给战士一把枪。(The professor awarded the soldier a gun.)

19

Q: 海盗丢给了谁一个球? (The pirate tossed whom a ball?)

A: 海盗丢给了小丑一个球。(The pirate tossed the clown a ball.)

服务员丢给战士一本书。(The waitress tossed the soldier a book)

20

Q: 修女借给了谁一把枪? (The nun lent whom a gun?)

A: 修女借给了小偷一把枪。(The nun lent the burglar a gun.)

画家借给拳击手一本书。(The artist lent the boxer a book.)

21

Q: 厨师递给了谁一个球? (The chef passed whom a ball?)

A: 厨师递给了舞蹈员一个球。(The chef passed the dancer a ball.)

修女递给游泳选手一顶帽子。(The nun passed the swimmer a hat.)

22

Q: 牛仔租给了谁一顶帽子? (The cowboy rented whom a hat?)

A: 牛仔租给了小丑一顶帽子。(The cowboy rented the clown a hat.)

牛仔租给修道士一个苹果。(The cowboy rented the priest an apple.)

23

Q: 厨师抛给了谁一个杯子? (The chef chucked whom a cup?)

A: 厨师抛给了修女一个杯子。(The chef chucked the nun a cup.)

警察抛给修道士一本书。(The policeman chucked the priest a book.)

24

Q: 牛仔拿给了谁一个苹果? (The cowboy handed whom an apple?)

A: 牛仔拿给了修道士一个苹果。(The cowboy handed the priest an apple.)

教授拿给游泳选手一本书。(The professor handed the swimmer a book.)

B.3. Experimental materials for Experiments 4.3 & 4.4

In each set of the sentences, the first four sentences are prime sentences in Experiment 4.3. The last sentence is a DO description of the target picture. In Experiment 4.4, the Topic-DO sentence (the 3rd sentence) was replaced with the Ba-DO sentence (the 5th sentence). The same baseline sentence was used in every 4 sets, but the materials were randomized in such a way that a participant only saw one occurrence of the repeated baseline sentences.

1

牛仔送给了水手那本书。(The cowboy gave the sailor that book.) (DO)

牛仔送了那本书给水手。(The cowboy gave that book to the sailor.) (PO)

那本书牛仔送给了水手。(That book the cowboy gave the sailor.) (Topic-DO)

巫婆哭了。(The witch cried.) (Baseline)

牛仔把那本书送给了水手。(The cowboy BA that book gave the sailor.) (Ba-DO)

警察送给战士一顶帽子。(The policeman gave the soldier a hat.) (Target)

2

厨师还给了修道士那个球。(The chef returned the priest that ball.)

厨师还了那个球给修道士。(The chef returned that ball to the priest.)

那个球厨师还给了修道士。(The chef BA that ball returned the priest.)

巫婆哭了。(The witch cried.)

厨师把那个球还给了修道士。(That ball the chef returned the priest.)

教授还给游泳选手一条香蕉。(The professor returned the swimmer a banana.)

3

厨师扔给了水手那顶帽子。(The chef threw the sailor that hat.)

厨师扔了那顶帽子给水手。(The chef threw that hat to the sailor.)

那顶帽子厨师扔给了水手。(That hat the chef threw the sailor.)

巫婆哭了。(The witch cried.)

厨师把那顶帽子扔给了水手。(The chef BA that hat threw the sailor.)

画家扔给战士一条香蕉。(The artist threw the soldier a banana.)

4

海盗卖给了水手那个球。(The pirate sold the sailor that ball.)

海盗卖了那个球给水手。(The pirate sold that ball to the sailor.)

那个球海盗卖给了水手。(That ball the pirate sold the sailor.)

巫婆哭了。(The witch cried.)

海盗把那个球卖给了水手。(The pirate BA that ball sold the sailor.)

警察卖给拳击一把手枪。(The policeman sold the boxer a gun.)

5

修女赏给了医生那个水壶。(The nun rewarded the doctor the jug.)

修女赏了那个水壶给医生。(The nun rewarded the jug to the doctor.)

那个水壶修女赏给了医生。(That jug the nun rewarded the doctor.)

滑雪运动员在点头。(The skier was nodding.)

修女把那个水壶赏给了医生。(The nun BA that jug rewarded the doctor.)

画家赏给小丑一个苹果。(The artist rewarded the clown an apple.)

6

修女丢给了拳击手那个水壶。(The nun tossed the boxer that jug.)

修女丢了那个水壶给拳击手。(The nun tossed that jug to the boxer.)

那个水壶修女丢给了拳击手。(That jug the nun tossed the boxer.)

滑雪运动员在点头。(The skier was nodding.)

修女把那个水壶丢给了拳击手。(The nun BA that jug tossed the boxer.)

海盗丢给小偷一顶帽子。(The pirate tossed the burglar a hat.)

7

教授借给了水手那把枪。(The professor lent the sailor that gun.)

教授借了那把枪给水手。(The professor lent that gun to the sailor.)

那把枪教授借给了水手。(That gun the professor lent the sailor.)

滑雪运动员在点头。(The skier was nodding.)

教授把那把枪借给了水手。(The professor BA that gun lent the sailor.)

牛仔借给小偷一条香蕉。(The cowboy lent the burglar a banana.)

8

厨师递给了医生那个苹果。(The chef passed the doctor that apple.)

厨师递了那个苹果给医生。(The chef passed that apple to the doctor.)

那个苹果厨师递给了医生。(That apple the chef passed the doctor.)

滑雪运动员在点头。(The skier was nodding.)

厨师把那个苹果递给了医生。(The chef BA that apple passed the doctor.)

教授递给战士一个杯子。(The professor passed the soldier a cup.)

9

牛仔租给了服务员那条香蕉。(The cowboy rented the waitress that banana.)

牛仔租了那条香蕉给服务员。(The cowboy rented that banana to the waitress.)

那条香蕉牛仔租给了服务员。(That banana the cowboy rented the waitress.)

滑雪运动员在笑。(The skier was laughing.)

牛仔把那条香蕉租给了服务员。(The cowboy BA that banana rented the waitress.)

警察租给游泳选手一顶帽子。(The policeman rented the swimmer a hat.)

10

水手抛给了修道士那个苹果。(The sailor chucked the priest that apple.)

水手抛了那个苹果给修道士。(The sailor chucked that apple to the priest.)

那个苹果水手抛给了修道士。(That apple the sailor chucked the priest.)

滑雪运动员在笑。(The skier was laughing.)

水手把那个苹果抛给了修道士。(The sailor BA that apple chucked the priest.)

画家抛给小丑一个球。(The artist chucked the clown a ball.)

11

警察拿给了拳击手那个水壶。(The policeman handed the boxer that jug.)

警察拿了那个水壶给拳击手。(The policeman handed that jug to the boxer.)

那个水壶警察拿给了拳击手。(That jug the policeman handed the boxer.)

滑雪运动员在笑。(The skier was laughing.)

警察把那个水壶拿给了拳击手。(The policeman BA that jug handed the boxer.)

牛仔拿给小丑一条香蕉。(The cowboy handed the clown a banana.)

12

教授交给了水手那个球。(The professor submitted the sailor that ball.)

教授交了那个球给水手。(The professor submitted that ball to the sailor.)

那个球教授交给了水手。(That ball the professor submitted the sailor.)

滑雪运动员在笑。(The skier was laughing.)

教授把那个球交给了水手。(The professor BA that ball submitted the sailor.)

画家交给医生一把枪。(The artist submitted the doctor a gun.)

13

武士交给了舞蹈员那个蛋糕。(The knight submitted the dancer that cake.)

武士交了那个蛋糕给舞蹈员。(The knight submitted that cake to the dancer.)

那个蛋糕武士交给了舞蹈员。(That cake the knight submitted the dancer.)

巫婆在睡觉。(The witch was sleeping.)

武士把那个蛋糕交给了舞蹈员。(The knight BA that cake submitted the dancer.)

教授交给厨师一顶帽子。(The professor submitted the chef a hat.)

14

海盗送给了水手那个杯子。(The pirate gave the sailor that cup.)

海盗送了那个杯子给水手。(The pirate gave that cup to the sailor.)

那个杯子海盗送给了水手。(That cup the pirate gave the sailor.)

巫婆在睡觉。(The witch was sleeping.)

海盗把那个杯子送给了水手。(The pirate BA that cup gave the sailor.)

厨师送给小偷一个水壶。(The chef gave the burglar a jug.)

15

画家还给了拳击手那条香蕉。(The artist returned the boxer that banana.)

画家还了那条香蕉给拳击手。(The artist returned that banana to the boxer.)

那条香蕉画家还给了拳击手。(That banana the artist returned the boxer.)

巫婆在睡觉。(The witch was sleeping.)

画家把那条香蕉还给了拳击手。(The artist BA that banana returned the boxer.)

警察还给小丑一把枪。(The policeman returned the clown a gun.)

16

公主扔给了小丑那个球。(The princess threw the clown that ball.)

公主扔了那个球给小丑。(The princess threw that ball to the clown.)

那个球公主扔给了小丑。(That ball the princess threw the clown.)

巫婆在睡觉。(The witch was sleeping.)

公主把那个球扔给了小丑。(The princess BA that ball threw the clown.)

教授扔给医生一个苹果。(The professor threw the doctor an apple.)

17

警察卖给了战士那本书。(The policeman sold the soldier that book.)

警察卖了那本书给战士。(The policeman sold that book to the soldier.)

那本书警察卖给了战士。(That book the policeman sold the soldier.)

消防队员在跑步。(The fireman was running.)

警察把那本书卖给了战士。(The policeman BA that book sold the soldier.)

教授卖给医生一个蛋糕。(The professor sold the doctor a cake.)

18

厨师赏给了画家那顶帽子。(The chef awarded the artist that hat.)

厨师赏了那顶帽子给画家。(The chef awarded that hat to the artist.)

那顶帽子厨师赏给了画家。(That hat the chef awarded the artist)

消防队员在跑步。(The fireman was running.)

厨师把那顶帽子赏给了画家。(The chef BA that hat awarded the artist)

教授赏给战士一把枪。(The professor awarded the soldier a gun.)

19

海盗丢给了小丑那个球。(The pirate tossed the clown that ball.)

海盗丢了那个球给小丑。(The pirate tossed that ball to the clown.)

那个球海盗丢给了小丑。(That ball the pirate tossed the clown.)

消防队员在跑步。(The fireman was running.)

海盗把那个球丢给了小丑。(The pirate BA that ball tossed the clown.)

服务员丢给战士一本书。(The waitress tossed the soldier a book.)

20

修女借给了小丑那把枪。(The nun lent the clown that gun.)

修女借了那把枪给小丑。(The nun lent that gun to the clown.)

那把枪修女借给了小丑。(That gun the nun lent the clown.)

消防队员在跑步。(The fireman was running.)

修女把那把枪借给了小丑。(The nun BA that gun lent the clown.)

画家借给拳击手一本书。(The artist lent the boxer a book.)

21

厨师递给了舞蹈员那个球。(The chef passed the dancer that ball.)

厨师递了那个球给舞蹈员。(The chef passed that ball to the dancer.)

那个球厨师递给了舞蹈员。(That ball the chef passed the dancer.)

拳击手在跑步。(The boxer was running.)

厨师把那个球递给了舞蹈员。(The chef BA that ball passed the dancer.)

修女递给游泳选手一顶帽子。(The nun passed the swimmer a hat.)

22

牛仔租给了小丑那顶帽子。(The cowboy rented the clown that hat.)

牛仔租了那顶帽子给小丑。(The cowboy rented that hat to the clown.)

那顶帽子牛仔租给了小丑。(That hat the cowboy rented the clown.)

拳击手在跑步。(The boxer was running.)

牛仔把那顶帽子租给了小丑。(The cowboy BA that hat rented the clown.)

牛仔租给修道士一个苹果。(The cowboy rented the priest an apple.)

23

厨师抛给了修女那个杯子。(The chef chucked the nun that cup.)

厨师抛了那个杯子给修女。(The chef chucked that cup to the nun.)

那个杯子厨师抛给了修女。(That cup the chef chucked the nun.)

拳击手在跑步。(The boxer was running.)

厨师把那个杯子抛给了修女。(The chef BA that cup chucked the nun.)

警察抛给修道士一本书。(The policeman chucked the priest a book.)

24

牛仔拿给了修道士那个苹果。(The cowboy handed the priest that apple.)

牛仔拿了那个苹果给修道士。(The cowboy handed that apple to the priest.)

那个苹果牛仔拿给了修道士。(That apple the cowboy handed the priest.)

拳击手在跑步。(The boxer was running.)

牛仔把那个苹果拿给了修道士。(The cowboy BA that apple handed the priest.)

教授拿给游泳选手一本书。(The professor handed the swimmer a book.)

B.4. Experimental materials for Experiment 4.5

In Set 1, the first four sentences correspond to the 4 prime sentences used in the experiment and the last sentence is a DO description of the target picture. For Set 2 onward, only the DO prime sentence and the description of the target picture are given as examples.

1

牛仔送给了水手那本书。(The cowboy gave the sailor that book.) (DO)

牛仔送了那本书给水手。(The cowboy gave that book to the sailor.) (PO)

那本书牛仔送给了水手。(That book the cowboy gave the sailor.) (Topic-DO)

那本书牛仔送了给水手。(That book the cowboy gave to the sailor.) (Topic-PO)

警察送给了士兵一顶帽子。(The policeman gave the soldier a book.) (Target)

2

公主还给了牧师那个排球。(The princess returned the priest that volleyball.)

教授还给了游泳选手香蕉。(The professor returned the swimmer a banana.)

3

海盗让给了水手那个蛋糕。(The pirate let-have the sailor that cake.)

厨师让给了拳击手一个排球。(The chef let-have the boxer a volleyball.)

4

海盗卖给了水手那个杯子。(The pirate sold the sailor that cup.)

警察卖给了拳击手一把手枪。(The policeman sold the boxer a gun.)

5

修女奖给了医生那个水壶。(The nun awarded the doctor that jug.)

画家奖给了小丑一个苹果。(The artist awarded the clown an apple.)

6

教授买给了消防员那条香蕉。(The professor bought the fireman that banana.)

修女买给了士兵一本书。(The nun bought the soldier a book.)

7

服务员借给了水手那把枪。(The waitress lent the sailor that gun.)

牛仔借给了小偷一条香蕉。(The cowboy lent the thief a banana.)

8

印第安人递给了医生那个水壶。(The Indian passed the doctor that jug.)

教授递给了士兵一个杯子。(The professor passed the soldier a cup.)

9

牛仔租给了水手那条香蕉。(The cowboy rented the sailor that banana.)

警察租给了游泳选手一顶帽子。(The policeman rented the swimmer a hat.)

10

教授抛给了牧师那个排球。(The professor threw the priest that volleyball.)

画家抛给了小丑一把手枪。(The artist threw the clown a gun.)

11

警察拿给了拳击手那个蛋糕。(The policeman handed the boxer that cake.)

牛仔拿给了小丑香蕉。(The cowboy handed the clown a banana.)

12

教授交给了游泳选手那个排球。(The professor submitted the swimmer that volleyball.)

画家交给了医生一把手枪。(The artist submitted the doctor a gun.)

13

牛仔交给了小丑那条香蕉。(The cowboy submitted the clown that banana.)

教授交给了厨师一顶帽子。(The professor submitted the chef a hat.)

14

厨师送给了水手那个蛋糕。(The chef gave the sailor that cake.)

牧师送给了小偷一个水壶。(The priest gave the thief a jug.)

15

画家还给了士兵那条香蕉。(The artist returned the soldier that banana.)

警察还给了小丑一把手枪。(The policeman returned the clown a gun.)

16

画家让给了水手那个苹果。(The artist let-have the sailor that apple.)

海盗让给了士兵一本书。(The pirate let-have the sailor a book.)

17

警察卖给了士兵那个水壶。(The policeman sold the soldier that jug.)

教授卖给了医生一个蛋糕。(The professor sold the doctor a cake.)

18

厨师奖给了拳击手那顶帽子。(The chef awarded the boxer that hat.)

教授奖给了士兵一把手枪。(The professor awarded the soldier a gun.)

19

厨师买给了游泳选手那个水壶。(The chef bought the swimmer that jug.)

教授买给了医生一个苹果。(The professor sold the doctor an apple.)

20

海盗借给了小偷那把枪。(The pirate lent the thief that gun.)

画家借给了拳击手一本书。(The artist awarded the boxer a book.)

21

厨师递给了舞蹈员那个排球。(The chef passed the dancer that volleyball.)

修女递给了游泳选手一顶帽子。(The nun passed the swimmer a hat.)

22

画家租给了医生那顶帽子。(The artist rented the doctor that hat.)

牛仔租给了牧师一个苹果。(The cowboy rented the priest an apple.)

23

厨师抛给了修女那个杯子。(The chef threw the nun that cup.)

警察抛给了牧师一本书。(The policeman threw the priest a book.)

24

牛仔拿给了游泳选手那个苹果。(The cowboy handed the swimmer that book.)

教授拿给了舞蹈员一本书。(The professor handed the dancer a book.)

25

牛仔送给了游泳选手那个蛋糕。(The cowboy gave the swimmer that cake.)

海盗送小丑一本书。(The pirate gave the clown a book.)

26

教授卖给了士兵那把枪。(The professor sold the soldier that gun.)

牛仔卖给了牧师一个苹果。(The cowboy sold the priest an apple.)

27

修女赠给了士兵那本书。(The nun bestowed-upon the soldier that book.)

画家赠给了游泳选手一顶帽子。(The artist bestowed-upon the swimmer a hat.)

28

修女捐给了小偷那条香蕉。(The nun donated the thief that banana.)

服务员捐给了小丑一个杯子。(The waitress donated the thief a cup.)

29

海盗赠给了拳击手那个水壶。(The pirate bestowed-upon the boxer that jug.)

牧师赠给了士兵一顶帽子。(The priest bestowed-upon the soldier a hat.)

30

教授捐给了牧师那顶帽子。(The professor donated the priest that hat.)

画家捐给了警察书。(The artist donated the policeman a book.)

31

画家拿给了士兵一条香蕉。(The artist handed the soldier that banana.)

警察拿给了小丑那把手枪。(The policeman handed the clown a gun.)

32

公主交给了士兵一本书。(The princess submitted the soldier that book.)

服务员交给了舞蹈员那个蛋糕。(The waitress submitted the dancer a cake.)

C. Appendices for Chapter 5

C.1. Experimental materials for Experiment 5.1

In each set of the experimental sentences, there are 6 prime sentences (respectively DO-ellipsis, DO-full-form, DO-baseline, PO-ellipsis, PO-full-form, and PO-baseline, as in Set 1). In all the following except Set 1, Only the DO primes (DO-ellipsis/full-form/baseline) are given as an example. In half of the sets (the odd-number sets), there is a yes/no comprehension question. The last sentence is a DO description of the target picture.

1

(DO-ellipsis)

牛仔想送给水手那本书。不知道为什么，海盗却不想。

(DO-full-form)

牛仔想送给水手那本书。不知道为什么，海盗却不想送给水手那本书。

(DO-baseline)

牛仔想送给水手那本书。不知道为什么，海盗很生气。

(PO-ellipsis)

牛仔想送那本书给水手。不知道为什么，海盗却不想。

(PO-full-form)

牛仔想送那本书给水手。不知道为什么，海盗却不想送那本书给水手。

(PO-baseline)

牛仔想送那本书给水手。不知道为什么，海盗很生气。

(The cowboy wanted to give the sailor the book. Due to some reason, the pirate did not want to/ the pirate did not want to give the sailor the book/ the sailor was angry.)

(Question [for odd-numbered trials only])

海盗不愿意送那本书给水手？(Was the pirate unwilling to give the book to the sailor?)

(Target)

警察送给士兵一顶帽子 (The policeman gave the soldier a hat.)

2

士兵想还给牧师那个排球。由于心里不高兴，士兵的朋友却不想/士兵的朋友却不想还给牧师那个排球/士兵的朋友走开了。(The soldier wanted to return the priest the volleyball. Being unhappy, the soldier's friend did not want to / the soldier's friend did not want to return the priest the volleyball/ the soldier's friend went away.)

教授还给游泳选手一条香蕉 (professor returned the swimmer a banana)

3

海盗想让给水手那个蛋糕。因为自己肚子饿，教授却不想/教授却不想让给水手那个蛋糕/教授很郁闷。(The pirate wanted to let the sailor have the cake. Feeling hungry, the professor did not want to/ the professor did not want to let the sailor have the cake/ the professor was gloomy.)

教授肚子不饿? (Was the professor not hungry?)

厨师让给拳击手一个排球 (The chef let the boxer have a volleyball.)

4

海盗想卖给水手那件古董。由于嫌价钱低，海盗的同伙却不想/海盗的同伙却不想卖给水手那件古董/海盗的同伙发了火。(The pirate want sell the sailor the antique.

Thinking that the price was low, the pirate's colleague did not want to/ the pirate's colleague did not want to sell the sailor the antique/ the pirate's colleague lost his temper.)

警察卖给拳击一把手枪 (The policeman sold the boxer a gun)

5

牧师想奖给医生那部车。由于另有打算，修女却不想/修女却不想奖给医生那部车/没表态。(The priest wanted to award the doctor the car. Having got another plan, the nun did not want to/ the nun did not want to award the doctor the car/ the nun did not say anything.)

修女对那部车另有打算? (Had the nun got another plan for the car?)

画家奖给小丑一个桔子 (The artist awarded the clown orange)

6

教授想买给舞蹈员那条项链。因为不愿多花钱，教授的爱人却不想/教授的爱人却不想买给舞蹈员那条项链/教授的爱人在犹豫。(The professor wanted to buy the dancer the necklace. In order not to spend too much money, the professor's wife did not want to/ did not want to buy the dancer the necklace/ the professor's wife was hesitating.)

修女买给士兵一本书 (The nun bought the soldier a book)

7

服务员想借给水手那把枪。因为害怕惹事，厨师却不想/厨师却不想借给水手那把枪/厨师没说话。(The waitress wanted to lend the sailor the gun. Being afraid of getting into trouble, the chef did not want to/ the chef did not want to lend the sailor the gun/ the chef did not say anything.)

服务员怕惹事? (Was the waitress afraid of getting into trouble?)

牛仔借给小偷一条香蕉 (The cowboy lent the thief a banana)

8

印第安人想递给医生那封信。因为保密的缘故，巫婆却不想/ 巫婆却不想递给医生那封信/ 巫婆很谨慎。(The Indian wanted to pass the doctor the letter. Wishing to keep it secret, the witch did not want to/ did not want to pass the doctor the letter/ the witch was very cautious.)

教授递给士兵一个杯子 (The professor passed the soldier a cup)

9

牛仔想租给水手那部车。出于某些原因，医生却不想/ 医生却不想租给水手那部车/ 医生很生气。(The cowboy wanted to rent the sailor the car. Due to some reason, the doctor did not want to/ the doctor did not want to rent the sailor the car/ the doctor was angry.)

医生不愿意送给水手那部车？ (Was the doctor willing to rent the sailor the car?)

警察租给游泳选手一顶帽子 (The policeman rented the swimmer a hat)

10

教授想抛给牧师那个排球。由于素描尚未完成，画家却不想/ 画家却不想抛给牧师那个排球/ 画家想回家。(The professor wanted to throw the priest the volleyball. Because the portrait was not yet finished, the artist did not want to/ did not want to throw the priest the volleyball/ the artist wanted to go home.)

士兵抛给小丑一条香蕉 (The soldier threw the clown a banana)

11

警察想拿给拳击手那个蛋糕。很奇怪的是，滑雪运动员却不想/ 滑雪运动员却不想拿给拳击手那个蛋糕/ 滑雪运动员很生气。(The policeman wanted to hand the boxer the cake. Strangely, the skier did not want to/ the skier did not want to hand the boxer the cake/ the skier was very angry.)

警察的行为很让人觉得奇怪？ (Was the policeman acting strangely?)

牛仔拿给小丑一条香蕉 (The cowboy handed the clown a banana)

12

教授想交给警察那件古董。令人不解的是，巫婆却不想/ 巫婆却不想交给警察那件古董/ 巫婆很谨慎。(The professor wanted to pass the policeman the antique. To our puzzlement, the witch did not want to/ the witch did not want to pass the policeman the antique/ the witch was very cautious.)

画家交给医生一把枪 (The artist passed the doctor a gun)

13

海盗想赠给拳击手那个手表。出乎大家意料，厨师却不想/ 厨师却不想赠给拳击手那个手表/ 厨师很爽快。(The pirate wanted to give the boxer the watch as a present. Out of everyone's expectation, the chef did not want to/ did not want to give the boxer the watch as a present/ the chef was very generous.)

厨师的行为出乎大家的意料? (Was what the chef did surprising?)

牧师赠给士兵一顶帽子 (The priest gave the soldier a hat as a gift.)

14

教授想捐给牧师那笔钱。没想到的是，医生却不想/ 医生却不想捐给牧师那笔钱/ 医生不签字。(The professor wanted to donate the money to the priest. Unexpectedly, the doctor did not want to/ did not want to donate the money to the priest/ the doctor refused to sign his name.)

警察捐给画家一本书 (The policeman donated a book to the artist.)

15

巫婆想丢给游泳选手那个面包。因为自己也饿，牧师却不想/ 牧师却不想丢给游泳选手那个面包/ 牧师很为难。(The witch wanted to toss the swimmer the donut. Because he was also hungry, the priest did not want to/ the priest did not want to toss the swimmer the donut/ the priest did not know what to do.)

牧师觉得很饱? (Did the priest feel full?)

画家丢给士兵一个苹果 (The artist tossed the soldier an apple)

16

滑雪运动员想扔给乞丐那个硬币。令人气愤的是，画家却不想/ 画家却不想扔给乞丐那个硬币/ 画家发怒了。(The skier wanted to throw the beggar the coin. In everyone's fury, the artist did not want to/ the artist did not want to throw the beggar the coin/ the artist became mad.)

牛仔扔给士兵一本书 (The cowboy threw the soldier a book)

17

消防队员想赏给印第安人那块手表。令人不解的是，士兵却不想/ 士兵却不想赏给印第安人那块手表/ 士兵很自私。(The fireman wanted to award the Indian the watch. To everyone's puzzlement, the soldier did not want to/ the soldier did not want to award the Indian the watch/ the soldier was very selfish.)

大家不能理解士兵的行为? (Was the soldier's behaviour out of everyone's expectation?)

警察赏给画家一顶帽子 (The policeman rewarded the artist a hat)

18

公主想带给囚犯那封家书。令人疑惑的是，武士却不想/武士却不想带给囚犯那封家书/武士没表态。(The princess wanted to bring the prisoner the letter from home. Very puzzlingly, the knight did not want to/ the knight did not want to bring the prisoner the letter from home/ the knight did not give his opinion.)

警察带给小丑一把枪 (The policeman brought the clown a gun)

19

教授想带给舞蹈员那个蛋糕。由于心存嫉妒，教授的爱人却不想/教授的爱人却不想带给舞蹈员那个蛋糕/教授的爱人在哭泣。(The professor wanted to bring the dancer the cake. Out of jealousy, the professor's wife did not want to/ the professor's wife did not want to bring the dancer the cake/ the professor's wife was sobbing.)

教授心存嫉妒? (Was the professor jealous?)

厨师带给牧师一个排球 (The chef brought the priest a volleyball)

20

警察想送给水手那块手表。因为货源紧张，商人却不想/商人却不想送给水手那块手表/商人没说话。(The policeman wanted to give the sailor the watch. Because there was a short of supplies of the watches, the businessman did not want to/ the businessman did not want to give the sailor the watch/ the business did not say a word.)

厨师送给小偷一个水壶 (The chef gave the thief a jug)

21

画家想还给士兵那笔钱。由于贪心的缘故，画家的弟弟却不想/画家的弟弟却不想还给士兵那笔钱/画家的弟弟想赖账。(The artist wanted to return the soldier the money. Because of greed, the artist's brother did not want to/ the artist's brother did not want to return the soldier the money/ the artist's brother wanted to deny the debt.)

画家的弟弟想贪那笔钱? (Was the artist's brother greedy for the money?)

警察还给小丑一把枪 (The policeman returned the clown a gun)

22

画家想让给水手那份礼物。由于比较小气，画家的妻子却不想/画家的妻子却不想让给水手那份礼物/画家的妻子不高兴。(The artist wanted to let the sailor have the gift. Due to her ungenerosity, the artist's wife did not want to/ the artist's wife did not want to let the sailor have the gift/ the artist's wife was unhappy.)

海盗让给小丑一本书 (The pirate let the clown have the book.)

23

服务员想卖给士兵那套西装。由于觉得价钱低，服务员的丈夫却不想/ 服务员的丈夫却不想卖给士兵那套西装/ 服务员的丈夫很失望。(The waitress wanted to sell the soldier the suit. Thinking the price was low, the waitress' husband did not want to/ the waitress' husband did not want to sell the soldier the suit/ the waitress' husband was disappointed.)
服务员觉得士兵出的价钱比较低? (Was it the waitress who thought the price was low?)
教授卖给医生一个蛋糕 (The professor sold the doctor a cake.)

24

厨师想奖给拳击手那条领带。因为另有想法，服务员却不想/ 服务员却不想奖给拳击手那条领/ 服务员没表态。(The chef wanted to award the boxer the tie. Having got her own plan, the waitress did not want to/ the waitress did not want to award the boxer the tie/ the waitress did not give her opinion.)

教授奖给士兵一把枪 (The professor awarded the soldier a gun)

25

厨师想买给游泳选手那部手机。由于不想乱花钱，厨师的妻子却不想/ 厨师的妻子却不想买给游泳选手那部手机/ 厨师的妻子有意见。(The chef wanted to buy the swimmer the mobile phone. Not wishing to spend too much money, the chef's wife did not want to/ the chef's wife did not want to buy the swimmer the mobile phone/ the chef's wife was complaining.)

厨师的妻子比较节俭? (Was the chef's wife thrifty?)

教授买给医生一个苹果 (The professor bought the doctor an apple.)

26

海盗想借给小偷那把枪。由于害怕会出事，牛仔却不想/ 牛仔却不想借给小偷那把枪/ 牛仔退缩了。(The pirate wanted to lend the thief the gun. Being afraid of any possible consequence, the cowboy did not want to/ the cowboy did not want to lend the thief the gun/ the cowboy backed out.)

画家借给拳击手一本书 (The artist lent the boxer a book)

27

厨师想递给舞蹈员那个排球。由于舍不得，厨师的儿子却不想/ 厨师的儿子却不想递给舞蹈员那个排球/ 厨师的儿子生气了。(The chef wanted to pass the dancer the volleyball. Still wishing to keep it, the chef's son did not want to/ the chef's son did not want to pass the dancer the volleyball/ the chef's son was angry.)

厨师舍不得那个排球? (Did the chef want to keep the volleyball?)

修女递给游泳选手一顶帽子 (nun passing swimmer hat)

28

画家想租给医生那套房子。出于个人考虑，画家的儿子却不想/ 画家的儿子却不想租给医生那套房子/ 画家的儿子在犹豫。(The artist wanted to rent the doctor the house. Out of his personal considerations, the artist's son did not want to/ the artist's son did not want to rent the doctor the house/ the artist's son was hesitating.)

牛仔租给修道士一个苹果 (The cowboy rented the priest an apple)

29

厨师想抛给修女那个奖牌。不知道为什么，服务员却不想/ 服务员却不想抛给修女那个奖牌/ 服务员不说话。(The chef wanted to throw the nun the medal. Due to some reason, the waitress did not want to/ the waitress did not want to throw the nun the medal/ the waitress did not say a word.)

服务员不愿意抛给修女那个奖牌？(Was the waitress unwilling to throw the nun the medal?)

警察抛给修道士一本书 (The policeman threw the priest a book)

30

牛仔想拿给游泳选手那块手表。令人不解的是，滑雪运动员却不想/ 滑雪运动员却不想拿给游泳选手那块手表/ 滑雪运动员生气了。(The cowboy wanted to hand the swimmer the watch. Strangely, the skier did not want to/ the skier did not want to hand the swimmer the watch/ the skier was angry.)

教授拿给牛仔一本书 (The professor handed the cowboy a book)

31

牛仔想交给小丑那份礼物。没想到的是，拳击手却不想/ 拳击手却不想交给小丑那份礼物/ 拳击手有意见。(The cowboy wanted to pass the clown the gift. Unexpectedly, the boxer did not want to/ the boxer did not want to pass the clown the gift/ the boxer was had a complaint.)

牛仔不想交那份礼物给小丑？(Was the cowboy unwilling to pass the gift to the clown?)

教授交给厨师一顶帽子 (The professor passed the chef a hat)

32

修女想赠给士兵那本书。令人吃惊的是，牧师却不想/ 牧师却不想赠给士兵那本书/ 牧师直摇头。(The nun wanted to give the soldier the book as a present. Surprisingly, the priest did not want to/ the priest did not want to give the soldier the book as a present/ the priest shook his head.)

画家赠给游泳选手一顶帽子 (artist gave the swimmer a hat as a gift.)

33

士兵想捐给乞丐那些衣服。令人气愤的是，警察却不想/ 警察却不想捐给乞丐那些衣服/ 警察否决了。(The soldier wanted to donate the clothes to the beggar. To everyone's shock, the policeman did not want to/ the policeman did not want to donate the clothes to the beggar/ the policeman objected)

警察令人气愤? (Was the policeman's act shocking?)

服务员捐给小丑一个杯子 (The waitress donated a cup to the clown.)

34

画家想丢给巫婆那条香蕉。很奇怪的是，教授却不想/ 教授却不想丢给巫婆那条香蕉/ 教授流泪了。(The artist wanted to toss the witch the banana. Strangely, the professor did not want to/ the professor did not want to toss the witch the banana/ the professor was crying.)

厨师丢给舞蹈员一个杯子 (The chef tossed the dancer a cup)

35

教授想扔给囚犯那顶帽子。由于心存偏见，消防队员却不想/ 消防队员却不想扔给囚犯那顶帽/ 消防队员走开了。(The professor wanted to throw the prisoner the hat. Out of prejudice, the fireman did not want to/ the fireman did not want to throw the prisoner the hat/ the fireman walked away.)

教授心存偏见? (Was the fireman prejudiced?)

警察扔给士兵一个苹果 (The policeman threw the soldier an apple.)

36

武士想赏给巫婆那块金币。令人不满的是，公主却不想/ 公主却不想赏给巫婆那块金币/ 公主很吝啬。(The knight wanted to award the witch the gold coin. To everyone's disappointment, the princess did not want to/ the princess did not want to award the witch the gold coin/ the princess was stingy.)

牛仔赏给游泳选手一个蛋糕 (The cowboy rewarded the swimmer a cake.)

D. Appendices for Chapter 6

D.1. Experimental materials for Experiments 6.1 and 6.2

In Set 1, the first sentence corresponds to the DO (same-verb/different-verb) prime and the second sentence to the PO (same-verb/different-verb) prime. The last sentence is a DO description of the target picture. From Set 2 onward, I only provide the DO (same-verb/different-verb) prime sentence and the target picture description. The same materials were used in Experiments 6.1 & 6.2. All the prime sentences had a Mandarin version and a Cantonese version.

1

牛仔送/捐给水手一本书。(The cowboy gave/donated the sailor a book.) (DO, same-verb/different-verb)

牛仔送/捐一本书给水手。(The cowboy gave/donated a book to the sailor.) (PO, same-verb/different-verb)

警察送给士兵一顶帽子。(The policeman gave the soldier a book.) (Target)

2

公主还/送给牧师一个排球。(The princess returned/gave the priest a volleyball.)

教授还给游泳选手香蕉。(The professor returned the swimmer a banana.)

3

海盗让/还给水手一个蛋糕。(The pirate let-have/returned the sailor a cake.)

厨师让给拳击手一个排球。(The chef let-have the boxer a volleyball.)

4

海盗卖/让给水手一个杯子。(The pirate sold/let-have the sailor a cup.)

警察卖给拳击手一把手枪。(The policeman sold the boxer a gun.)

5

修女奖/卖给医生一个水壶。(The nun awarded/sold the doctor a jug.)

画家奖给小丑一个苹果。(The artist awarded the clown an apple.)

6

教授买/奖给消防员一条香蕉。(The professor bought/awarded the fireman a banana.)

修女买给士兵一本书。(The nun bought the soldier a book.)

7

服务员借/买给水手一把手枪。(The waitress lent/bought the sailor a gun.)

牛仔借给小偷一条香蕉。(The cowboy lent the thief a banana.)

8

印第安人递/借给医生一个水壶。(The Indian passed/lent the doctor a jug.)

教授递给士兵一个杯子。(The professor passed the soldier a cup.)

9

牛仔租/递给水手一条香蕉。(The cowboy rented/passed the sailor a banana.)

警察租给游泳选手一顶帽子。(The policeman rented the swimmer a hat.)

10

教授抛/租给牧师一个排球。(The professor threw/rented the priest a volleyball.)

画家抛给小丑一把手枪。(The artist threw the clown a gun.)

11

警察拿/抛给拳击手一个蛋糕。(The policeman handed/throw the boxer a cake.)

牛仔拿给小丑香蕉。(The cowboy handed the clown a banana.)

12

教授交/拿给游泳选手一个排球。(The professor submitted/handed the swimmer a volleyball.)

画家交给医生一把手枪。(The artist submitted the doctor a gun.)

13

牛仔交/拿给小丑一条香蕉。(The cowboy submitted/handed the clown a banana.)

教授交给厨师一顶帽子。(The professor submitted the chef a hat.)

14

厨师送/交给水手一个蛋糕。(The chef gave/submitted the sailor a cake.)

牧师送给小偷一个水壶。(The priest gave the thief a jug.)

15

画家还/交给士兵一条香蕉。(The artist returned/submitted the soldier a banana.)

警察还给小丑一把手枪。(The policeman returned the clown a gun.)

16

画家让/送给水手一个苹果。(The artist let-have/gave the sailor an apple.)

海盗让给士兵一本书。(The pirate let-have the sailor a book.)

17

警察卖/还给士兵一个水壶。(The policeman sold/returned the soldier a jug.)

教授卖给医生一个蛋糕。(The professor sold the doctor a cake.)

18

厨师奖/让给拳击手一顶帽子。(The chef awarded/let-have the boxer a hat.)

教授奖给士兵一把手枪。(The professor awarded the soldier a gun.)

19

厨师买/卖给游泳选手一个水壶。(The chef bought/sold the swimmer a jug.)

教授买给医生一个苹果。(The professor sold the doctor an apple.)

20

海盗借/奖给小偷一把手枪。(The pirate lent/awarded the thief a gun.)

画家借给拳击手一本书。(The artist awarded the boxer a book.)

21

厨师递/买给舞蹈员一个排球。(The chef passed/bought the dancer a volleyball.)

修女递给游泳选手一顶帽子。(The nun passed the swimmer a hat.)

22

画家租/借给医生一顶帽子。(The artist rented/lent the doctor a hat.)

牛仔租给牧师一个苹果。(The cowboy rented the priest an apple.)

23

厨师抛/递给修女一个杯子。(The chef threw/passed the nun a cup.)

警察抛给牧师一本书。(The policeman threw the priest a book.)

24

牛仔拿/租给游泳选手一个苹果。(The cowboy handed/rented the swimmer a book.)

教授拿给舞蹈员一本书。(The professor handed the dancer a book.)

25

牛仔送/交给游泳选手一个蛋糕。(The cowboy gave/submitted the swimmer a cake.)

海盗送小丑一本书。(The pirate gave the clown a book.)

26

教授卖/送给士兵一把手枪。(The professor sold/gave the soldier a gun.)

牛仔卖给牧师一个苹果。(The cowboy sold the priest an apple.)

27

修女赠/卖给士兵一本书。(The nun bestowed-upon/sold the soldier a book.)

画家赠给游泳选手一顶帽子。(The artist bestowed-upon the swimmer a hat.)

28

修女捐/赠给小偷一条香蕉。(The nun donated/bestowed-upon the thief a banana.)

服务员捐给小丑一个杯子。(The waitress donated the thief a cup.)

29

海盗赠/抛给拳击手一个水壶。(The pirate bestowed-upon/threw the boxer a jug.)

牧师赠给士兵一顶帽子。(The priest bestowed-upon the soldier a hat.)

30

教授捐/拿给牧师一顶帽子。(The professor donated/handed the priest a hat.)

画家捐给警察书。(The artist donated the policeman a book.)

31

画家拿/赠给士兵一条香蕉。(The artist handed/bestowed-upon the soldier a banana.)

警察拿给小丑一把手枪。(The policeman handed the clown a gun.)

32

公主交/捐给士兵一本书。(The princess submitted/donated the soldier a book.)

服务员交给舞蹈员一个蛋糕。(The waitress submitted the dancer a cake.)

D.2. Version 1A of the phonological similarity questionnaire in Chapter 6

Participants in Version 1 were asked to compare the Mandarin pronunciation against the Cantonese pronunciation while those in Version 2 were asked to compare Cantonese against Mandarin. Within each version, there were two orders: Order A is the one listed below while order B reversed the order of all the items (except for the practice items [the first 8 characters in the following list]).

问卷调查

在这个问卷里，你将判断一个字的普通话读音和广州话读音的差别有多大。1 表示非常相似，7 表示非常不同。例如，“界”这个字的普通话读音和广州话读音非常不同，而“拖”的普通话读音和广州话读音非常相似。请圈 (○) 一个数字 (量表中的任何一个) 来表示区别的程度。整个问卷只需 10 分钟左右。谢谢你的帮助。

香

(非常相似) 1-----2-----3-----4-----5-----6-----7 (非常不同)

踢

(非常相似) 1-----2-----3-----4-----5-----6-----7 (非常不同)

车

(非常相似) 1-----2-----3-----4-----5-----6-----7 (非常不同)

接

(非常相似) 1-----2-----3-----4-----5-----6-----7 (非常不同)

举

(非常相似) 1-----2-----3-----4-----5-----6-----7 (非常不同)

见

(非常相似) 1-----2-----3-----4-----5-----6-----7 (非常不同)

洁

(非常相似) 1-----2-----3-----4-----5-----6-----7 (非常不同)

推

(非常相似) 1-----2-----3-----4-----5-----6-----7 (非常不同)

送

(非常相似) 1-----2-----3-----4-----5-----6-----7 (非常不同)

云

(非常相似) 1-----2-----3-----4-----5-----6-----7 (非常不同)

还

(非常相似) 1-----2-----3-----4-----5-----6-----7 (非常不同)

让

(非常相似) 1-----2-----3-----4-----5-----6-----7 (非常不同)

追

(非常相似) 1-----2-----3-----4-----5-----6-----7 (非常不同)

卖

(非常相似) 1-----2-----3-----4-----5-----6-----7 (非常不同)

打

(非常相似) 1-----2-----3-----4-----5-----6-----7 (非常不同)

记

(非常相似) 1-----2-----3-----4-----5-----6-----7 (非常不同)

奖

(非常相似) 1-----2-----3-----4-----5-----6-----7 (非常不同)

杀

(非常相似) 1-----2-----3-----4-----5-----6-----7 (非常不同)

买

(非常相似) 1-----2-----3-----4-----5-----6-----7 (非常不同)

笑

(非常相似) 1-----2-----3-----4-----5-----6-----7 (非常不同)

借

(非常相似) 1-----2-----3-----4-----5-----6-----7 (非常不同)

递

(非常相似) 1-----2-----3-----4-----5-----6-----7 (非常不同)

颜

(非常相似) 1-----2-----3-----4-----5-----6-----7 (非常不同)

跳

(非常相似) 1-----2-----3-----4-----5-----6-----7 (非常不同)

租

(非常相似) 1-----2-----3-----4-----5-----6-----7 (非常不同)

抢

(非常相似) 1-----2-----3-----4-----5-----6-----7 (非常不同)

抛

(非常相似) 1-----2-----3-----4-----5-----6-----7 (非常不同)

做

(非常相似) 1-----2-----3-----4-----5-----6-----7 (非常不同)

拿

(非常相似) 1-----2-----3-----4-----5-----6-----7 (非常不同)

坐

(非常相似) 1-----2-----3-----4-----5-----6-----7 (非常不同)

咬

(非常相似) 1-----2-----3-----4-----5-----6-----7 (非常不同)

交

(非常相似) 1-----2-----3-----4-----5-----6-----7 (非常不同)

赠

(非常相似) 1-----2-----3-----4-----5-----6-----7 (非常不同)

寄

(非常相似) 1-----2-----3-----4-----5-----6-----7 (非常不同)

烧

(非常相似) 1-----2-----3-----4-----5-----6-----7 (非常不同)

捐

(非常相似) 1-----2-----3-----4-----5-----6-----7 (非常不同)

D.3. Results of the phonological similarity ratings in Chapter 6

Verbs	Quantitative rating mean (SD)	Categorical rating mean
送	1.88 (1.22)	2
还	4.1 (1.86)	3
让	4.7 (1.85)	4
卖	2.2 (1.31)	2
奖	3.88 (1.65)	3
买	2.07 (1.42)	2
借	2.36 (1.2)	3
递	3.94 (1.46)	3
租	4 (1.75)	3
抛	1.85 (1.86)	2
拿	2.97 (2.26)	4
交	4 (1.78)	4
赠	2.88 (1.81)	2
捐	4.85 (1.57)	4