



Application of value-driven design to commercial aero-engine systems

DOI:
[10.2514/6.2010-9058](https://doi.org/10.2514/6.2010-9058)

[Link to publication record in Manchester Research Explorer](#)

Citation for published version (APA):

Cheung, J., Scanlan, J., Wong, J., Forrester, J., Eres, H., Collopy, P., Hollingsworth, P., Wiseall, S., & Briceno, S. (2010). Application of value-driven design to commercial aero-engine systems. In *10th AIAA Aviation Technology, Integration and Operations Conference 2010, ATIO 2010|10th AIAA Avia. Tech., Int. and Oper. Conf. 2010, ATIO 2010* (Vol. 1). American Institute of Aeronautics and Astronautics . <https://doi.org/10.2514/6.2010-9058>

Published in:

10th AIAA Aviation Technology, Integration and Operations Conference 2010, ATIO 2010|10th AIAA Avia. Tech., Int. and Oper. Conf. 2010, ATIO 2010

Citing this paper

Please note that where the full-text provided on Manchester Research Explorer is the Author Accepted Manuscript or Proof version this may differ from the final Published version. If citing, it is advised that you check and use the publisher's definitive version.

General rights

Copyright and moral rights for the publications made accessible in the Research Explorer are retained by the authors and/or other copyright owners and it is a condition of accessing publications that users recognise and abide by the legal requirements associated with these rights.

Takedown policy

If you believe that this document breaches copyright please refer to the University of Manchester's Takedown Procedures [<http://man.ac.uk/04Y6Bo>] or contact uml.scholarlycommunications@manchester.ac.uk providing relevant details, so we can investigate your claim.



Application of Value-Driven Design to Commercial Aero-Engine Systems

Julie Cheung¹, James Scanlan², James Wong³, Jennifer Forrester⁴ and Hakki Eres⁵
University of Southampton, Southampton, SO17 1BJ, United Kingdom

Paul Collopy⁶
Value-Driven Design Institute, Urbana, Illinois, 61803, USA

Peter Hollingsworth⁷
University of Manchester, Manchester, M60 1QD, United Kingdom

Steve Wiseall⁸
Rolls-Royce plc, Derby, DE24 8BJ, United Kingdom

and

Simon Briceno⁹
Georgia Institute of Technology, Atlanta, GA, 30332-0150, USA

Value-Driven Design provides a framework to enhance the systems engineering processes for the design of large systems. By employing economics in decision making, Value-Driven Design enables rational decision making in terms of the optimum business and technical solution at every level of engineering design. This paper explains the application of Value-Driven Design to the aero-engine system through two case studies, which were conducted through workshops under the Rolls-Royce plc Advanced Cost Modeling Methodologies project. The Surplus Value Theory was utilized to provide a metric that can trade-off component designs with changes in continuous and discrete design variables. Illustrative results are presented to demonstrate how the methodology and modeling approach can be used to evaluate designs and select the value-enhancing solution.

I. Introduction

Design of aerospace systems is inherently complex, particularly with the emergent environmental and economical concerns. By 2020, the Advisory Council for Aeronautics Research in Europe (ACARE) [1] sets out targets to the aerospace industry to reduce Nitrogen Oxides by 80%, Carbon Dioxide emissions by 50%, reduce current average perceived noise levels by half, increase safety by 5-fold and improve cost effectiveness significantly. These targets impose great pressures on the entire aerospace industry, from manufacturers and supply chains to the aircraft operators. Not only does the aerospace industry aim to develop products and services to meet these targets, but they also have to remain competitive. That is, committing to producing products which meet or exceed the demands of the customers over their competitors.

¹ EngD Research Engineer, Computational Engineering and Design, School of Engineering Sciences.

² Professor of Design, Computational Engineering and Design, School of Engineering Sciences. AIAA Member.

³ PhD Student, Computational Engineering and Design, School of Engineering Sciences.

⁴ Senior Consulting Engineer, Research Institute for Industry, School of Engineering Sciences.

⁵ Senior Research Fellow, Computational Engineering and Design, School of Engineering Sciences. AIAA Member.

⁶ Executive Director, PO Box 247, Urbana IL 61803. AIAA Associate Fellow.

⁷ Lecturer, School of MACE, PO Box 88, Manchester, M13 9PL, United Kingdom, AIAA Member.

⁸ Team Leader, E&T Cost Methods, PO Box 31, Derby, DE24 8BJ, United Kingdom.

⁹ Research Engineer II, Aerospace Systems Design Laboratory, School of Aerospace Engineering. AIAA Member.

Bringing ‘value’ to the customers is an important aspect of engineering design. Decisions made during design should always add value to the solution space; however it is a great challenge to effectively understand, the impact of changing design variables at the micro-level on the overall system ‘value.’ This is also supported by Browning [2] who presents the idea that process improvement in product development cannot just focus on waste, time or cost reduction but the purpose should be to maximize the product value.

A. The Problem

Design teams would like to deliver the best possible design, but is this possible when projects have no formal way to talk about what “best” means? To reduce this conundrum to even simpler terms, if an engineer enters a review with two alternative designs; can reviewers say which is better? Can they identify the better design in a way that is objective, repeatable, and transparent?

Perhaps one design meets requirements, (component target) and one does not, in which case the former is clearly better. But is it? To illustrate the point, consider two designs for a fan stator vane. Design A will weigh 3kg for a vane set and has a projected life of 20,000 hours. Design B will weigh 1kg with a life of 19,990 hours, and in every other way is identical to A. The life requirement is 20,000 hours and the weight requirement is less than 3 kg. Is Design A, which meets requirements, (or component target) clearly better than Design B (Figure 1)?

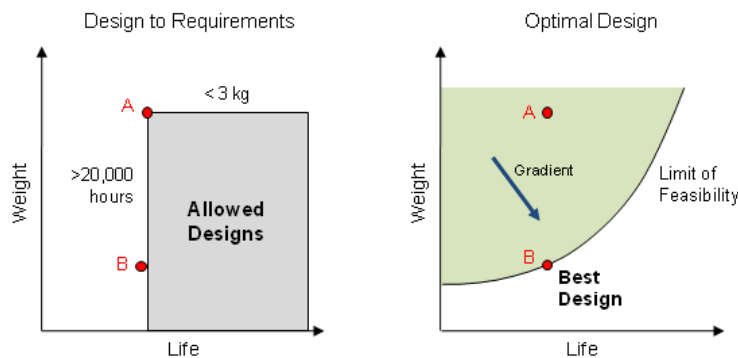

Figure 1: Limitation of requirement specification

If the case were not so simple, for example if the two components in combination (in one design option) were, worse in weight but better in life; how can one establish whether the option is an improvement or a detriment? In general, there is currently no way to talk about better or worse with respect to an ad hoc aggregate of components. Sometimes there are systems engineering trade factors to point the way, but a trade factor between weight and life would be unusual. Besides, from where do trade factors come?

What is required is a process or rule for comparing designs to highlight which is better. For a successful engine or aircraft, then the rule should trace back through a chain of reasoning that begins with how the system design impacts product profitability. For example, the Bombardier CSeries CS300 (an all-new airplane) could potentially generate greater profits (Figure 2) due to its lower fuel burn compared to the current Airbus A319 or re-engined A319 [3]. This presents choices to airlines as to whether to continue operating current technology or invest in new technology. A broad view of what makes an aircraft and engine profitable should address all the significant ways in which attributes of the product impact customers and influence their purchase decisions.

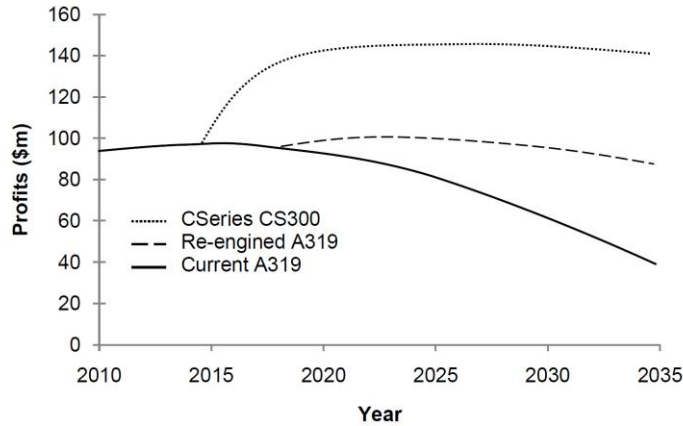

Figure 2: Comparing profits between Bombardier CSeries with re-engined Airbus A319 (adapted from [3])

In summary, there is a need for better guidance for design choices, a guidance that translates the desires of customers and business developers into terms that are immediately meaningful to design engineers. The guidance should be consistent among aircraft conceptual designers, engine preliminary designers, or any engineer making decisions throughout the supply chain.

Before, it was mentioned that the method should be objective, repeatable, and transparent. To expand on these criteria:

- Objective means that decisions should not be opinionated. Instead, every design decision should be based entirely on facts, test results, and analyses.
- Repeatable means that, given the same facts, test results, and analyses, the same decision will always result, even if the decision is made by a different designer or a different design team.
- Transparent means that the design process should easily yield the reasons for the decision. That is, the process should not be a black box into which data is entered, and then a result is generated. Instead, a clear understandable method is required where the engineer and everyone else can observe and critique the process.

The process that addresses these problems and meets these criteria is Value-Driven Design (VDD) [4]. Thus, the overall aim of this research initiative is to improve the understanding of VDD by developing and demonstrating relevant case studies and associated value models. This work was conducted through workshops and working with experts within the field of VDD.

This paper discusses the concept of VDD and explains the modeling approach taken to incorporate aero-engine component design into the air transportation system models. Finally, illustrative results are shown to demonstrate how VDD could be used for design decision making.

II. What is Value-Driven Design?

A. Value-Driven Design Defined

A profitable engine program depends on customer demand, translated into price and market share. Demand, price, and cost are economic concepts, and the discipline of economics can integrate all these factors into a meaningful and useful whole.

The notion of choosing one design alternative over another, and using this as a step in searching for the best design, is central to the discipline of optimization (Figure 3). Optimization provides a great deal of relevant theory, whether a computerized search tool is used to do the searching, or an engineering team manually looks for the best design. For example, the rule for determining whether an alternative design is better is called an objective function in optimization theory. In systems engineering, objective functions can be flowed down to sub-systems and components in order to maintain balances in the system.

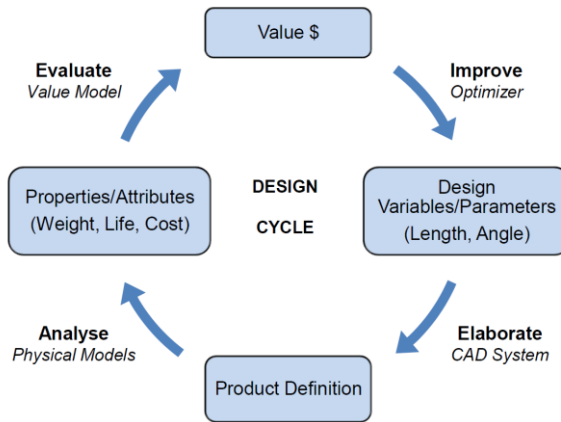

Figure 3: Design cycle for optimization (adapted from [4])

Thus, VDD combines three disciplines (economics, optimization, and systems engineering) and can be defined as: “an improvement to the systems engineering process that employs economics to enable optimization thinking at every level of engineering design”.

It is especially applicable to the development of large systems and provides a designer with a numerical measure of ‘design goodness’ that can be used for optimization purposes. Figure 4 shows how this improvement can be implemented in an optimization process through the development of suitable models. Here it is illustrated that product value (profitability) can be used as an overall system design objective function. If each component is optimized to maximize this value, then the overall system will be optimized too. This will ensure that by designing the “best” components, one will be realizing the “best” system.

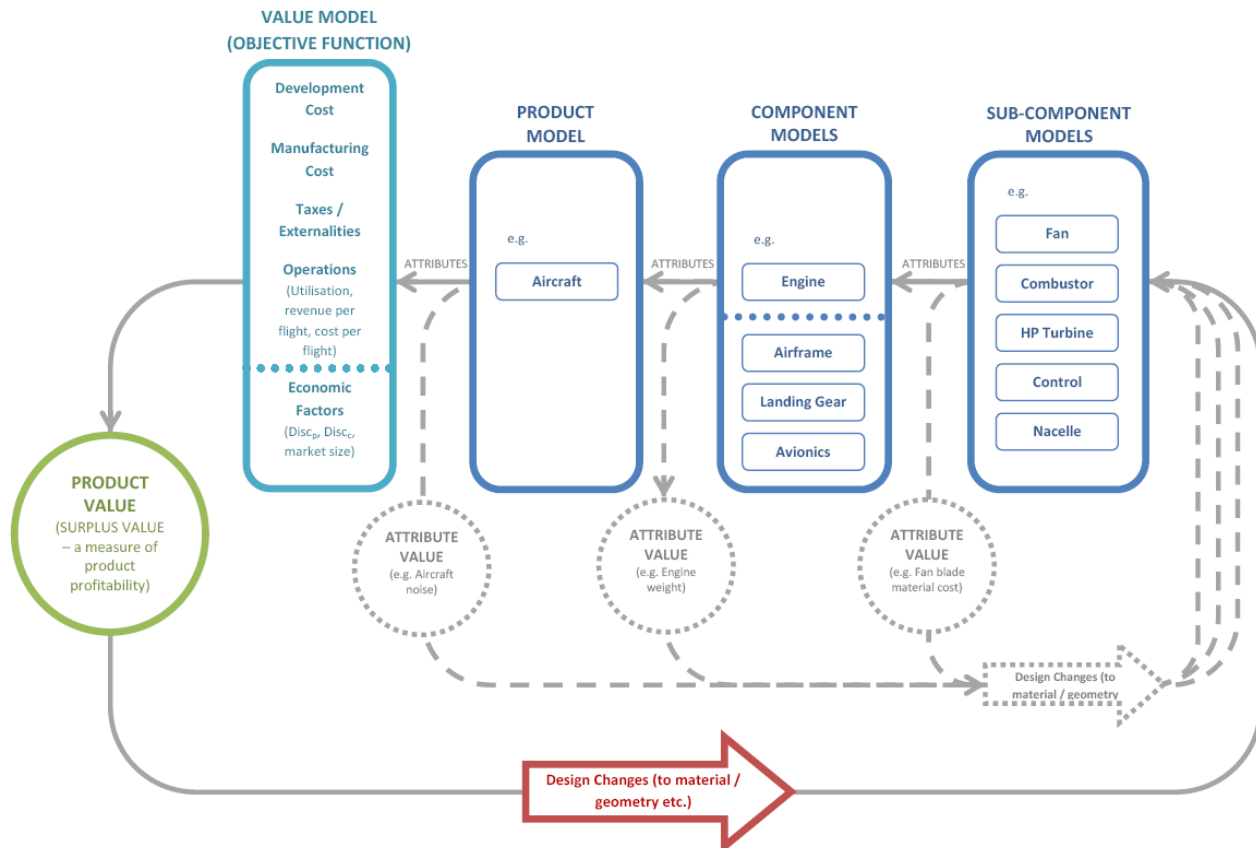

Figure 4: The VDD process (a global optimization of product profitability)

B. The History of Value-Driven Design

VDD began with a lecture by Herbert Simon in 1968 [5]. Simon was a polymath, nominally a psychologist, who won the Turing Medal for pioneering work in artificial intelligence, but also won the Nobel Prize in economics. Simon claimed that the essential problem of engineering design existed at the boundary between the internal structure of a product designed by engineers and the external aspect of the product, which is how it is seen by users and which determines how it relates to its environment. VDD elucidates the boundary between internal and external in a way that is true to Simon's vision. Simon also thought deeply about the hierarchical organization of complex engineered systems like aircraft and engines, and how optimization could be achieved within a hierarchy.

Simon and his predecessors in decision theory understood that values or preferences are critical to rational choice, but it was Ralph Keeney who developed the idea that values could be formally expressed in a model [6]. However, Keeney treated the structure of values as unknowable, and constructed his models as multiple linear regressions to subjective preferences of stakeholders. This would be like developing an aircraft performance model purely by regression to aircraft test data, with no notion of flight dynamics or aerodynamics. Such a model requires a great deal of data to yield any precision, and extrapolation becomes an unwise exercise in naked hope.

In this context, it is fair to note that Thomas Saaty developed the idea that values have a hierarchical structure [7], but his analytical hierarchy process is designed only to make choices between pre-established alternatives, and in spite of later adaptations, cannot produce a consistent, logical value model or objective function.

VDD adds the idea that value models have an internal structure of microeconomic logic, in the same way that aircraft engine performance models use thermodynamics and aerodynamics to form their internal equations. Because of this internal structure, VDD value models only require one to two dozen parameters to be fitted to external data, and limited extrapolations can be made with confidence.

VDD has also formalized the solution to distributed optimal design, although this solution is fairly obvious once the design problem is viewed as formulating consistent objective functions for each component.

In 2005, the American Institute of Aeronautics and Astronautics formed the Value-Driven Design Program Committee to advance the development and application of VDD concepts and methods. In 2008, the US DARPA (Defence Advanced Research Projects Agency) F6 military satellite program mandated the use of Value-Centric Design (a version of VDD developed by Joseph Saleh at the Georgia Institute of Technology) and system value models by four satellite manufacturers in designing new satellite architecture [8]. There is currently continuing research under the DARPA System F6 Program.

C. Value-Driven Design Research Initiatives

VDD is the subject of interest within industry and academia. A number of recent, current and imminent programs that incorporate VDD themes are shown in Table 1.

Table 1: Research initiatives with VDD themes

Program	VDD Element	Key Industry Partners	Period
FLAVIIR (Flapless Air Vehicle Integration Research)	The development of an operations simulation of a fleet of Unmanned Air Vehicles (UAV) to evaluate technology options	BAE Systems	2005-2010
VDD (Value-Driven Design) Workshops	Development of example gas turbine based VDD examples and framework	Rolls-Royce	2009-2010
CRESCENDO (Collaborative and Robust Engineering using Simulation Capability Enabling Next Design Optimization)	Use of VDD to demonstrate design decisions associated with more electric technologies and "bleedless" engines.	Airbus, Rolls-Royce, EADS, Volvo	2008-2011
SILOET (Strategic Investment in Low-carbon Engine Technology)	Development of sophisticated LCC and unit cost tools consistent with a VDD vision	Rolls-Royce, BAE Systems, GKN	2009-2012
SAMULET (Strategic Affordable Manufacturing in the UK with Leading Environmental Technology)	Development of detailed component and material supply chain optimization	Rolls-Royce	2010-2012

D. How Value-Driven Design Works

Value Driven Design requires the development of a System Value Model, in the case study this will be a commercial aircraft. The model links an economic model of the operation of an aircraft fleet with the aircraft product model, linked in turn to the engine and other component models (Figure 4).

The Systems Value Model is an economics-based long term profitability model, for instance an aircraft fleet in operation. It includes conventional measures of profitability together with societal impact in the form of noise and emissions taxes. The revenue that an aircraft can earn depends on the airline operations. Thus, the aircraft product model provides the extensive attributes (these are properties which impact the properties of the system [9]) needed for the Systems Value Model to run – for example aircraft payload, fuel burn, weight, reliability, engine number, development cost, unit cost, maintenance cost etc. Many of the aircraft product model attributes are dependent on each other and link the terms with which engineers are familiar to those of economics. The engine product model provides the engine attributes needed by the aircraft product model. Figure 5 shows a schematic diagram of the interconnection between the models.

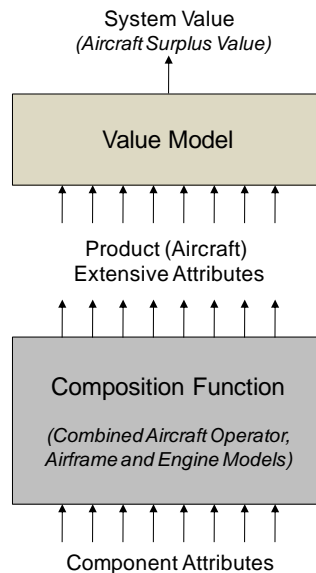

Figure 5: Schematic of value model structure

The development of the composition function is not a straight forward process and needs an understanding of the relationships between the aircraft operator, airframer, engine and component. To enable this activity, a generalized methodology was developed. Castagne *et al.* [10] also implemented a VDD methodology for the optimization of an aircraft fuselage panel, which showed panel geometries when optimized for different objective functions. In this paper, a larger study is developed to encompass the aero-engine system and engine component design, with a focus on the methodology.

III. Value-Driven Design Modeling Approach

VDD process steps 1 to 8 were devised to support model development, to communicate its understanding and to enable VDD to be demonstrated on a simplified test case pilot study. The modeling approach followed the steps illustrated in Figure 6:

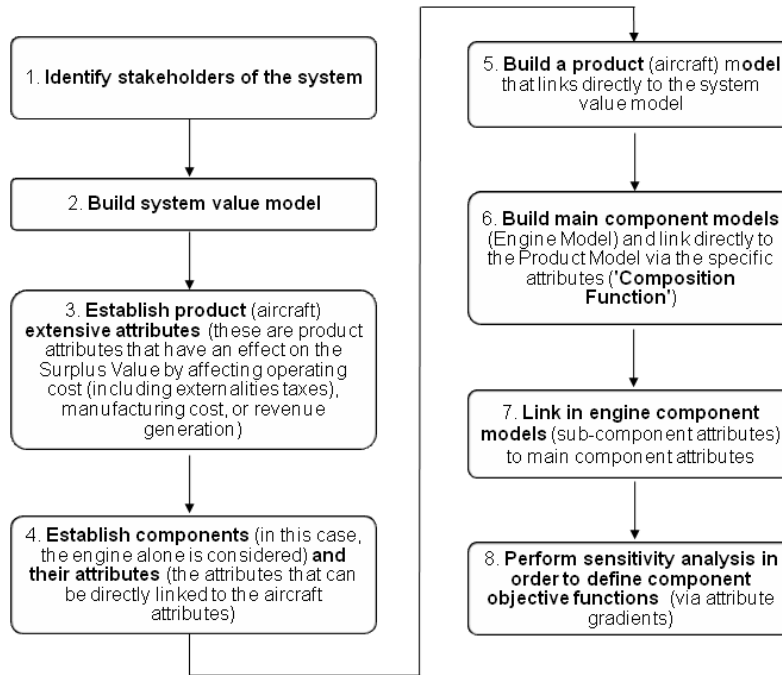

Figure 6: Generalized VDD modeling process steps

The pilot case study was initially based on a starting point of a 110-190 passenger aircraft with V2500-like engines operating in a route structure similar to Alaska Airlines' 737NGs. Open data sources were used and consisted of a combination of the experiences of the authors and published sources such as the Bureau of Transportations Statistics [11], the Airline Data Project conducted by the Massachusetts Institute of Technology (MIT) [12] and Jane's All the World's Aircraft [13]. Where data was not available, estimates were used in order to continue with demonstrating the approach.

The first task was to qualitatively identify the key stakeholders of the system; those that impact the profitability – for example airline directors, leasing company, aircraft and engine manufacturers, airport operators etc. This starts the process of establishing whose value is being maximized and how to incorporate them in the models. For instance, Steps 3 and 4 consider the stakeholders to help determine attributes.

The following subsections provide further detail of the process steps in Figure 6.

A. The System Value Model

For a commercial aircraft engine design, the value model is a model of the airliner in service. The value model is concerned with how the airliner creates profit for its owner from the overall revenue, which is translated into purchase price, and feeds into the program cash-flow stream of the manufacturer. The amount of competition will determine how the profit is split, but the bigger the pie, the bigger the pieces. Because the value model only concerns the way the user (airline) employs the product (aircraft), the model should contain no internal details of the aircraft design. That is, an economist should be able to build the entire value model without knowing anything about how the aircraft or the jet engine works.

The two most important parts of a value model are representations of:

1. How the customer makes revenue from the product, and
2. How the product causes the customer to incur costs.

The value model must also translate customer profit into product price and balance product price with manufacturing cost in a discounted cash-flow analysis, an exercise that has much in common with developing a business plan for a new product.

The aviation industry structure is complex, with competing airlines, competing aircraft manufacturers, and competing engine manufacturers. In this case study, the Surplus Value imagines a much simpler structure, in which one firm includes the airline, the manufacturer of aircraft for the airline, and the manufacturer of engines for the aircraft. Surplus Value Theory [14] shows that the best engine design for this simple firm is the same as the best engine design for the actual engine manufacturer in the actual complex industry. However the profit model for the simple company (ticket revenues minus aircraft operating cost minus equipment manufacturing cost) is much simpler and does not require competitive analyses. In the study's value model, which is based on the Surplus Value Theory, the calculated profit is the combined profit of the airline, aircraft manufacturer, and engine manufacturer (Figure 7). While this is only a surrogate for what is actually intended to maximize (engine manufacturer profit), it is equivalent for making design choices.

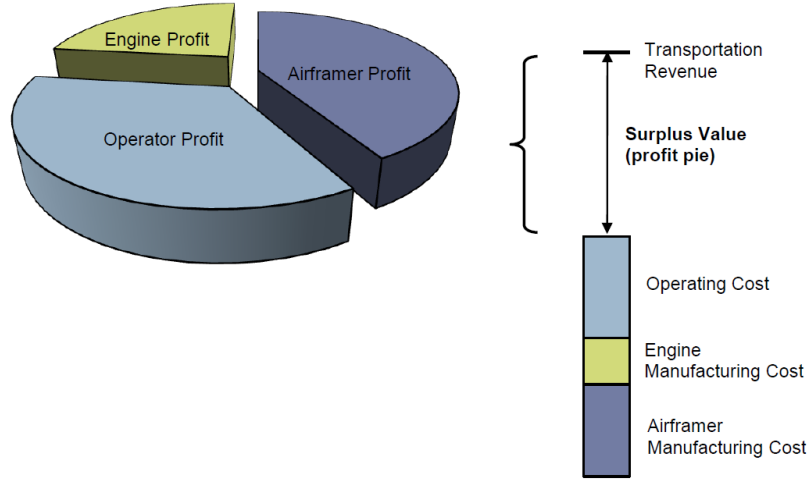

Figure 7: Revenue and profit for simplified aircraft system

The Surplus Value Theory provides a simplified equation that is a subset of Net Present Value (NPV) [14], based on several assumptions. NPV is used by economists to describe profit as it varies over a number of years for a program life and is a basis for businesses' investment decisions. Equation (1) gives the Surplus Value calculation for the commercial aviation industry case study:

$$\begin{aligned}
 \text{Surplus Value} &= \text{Disc}_p \times \text{Market size} \times \\
 &\left(\begin{aligned}
 &\text{Disc}_c \times \text{Utilization} \times \\
 &\text{Revenue per flight} - \text{Cost per flight} - \text{Delay and cancellation costs} - \text{Externalities tax per flight} \\
 &- \text{Manufacturing costs} \\
 &- \text{Development costs}
 \end{aligned} \right) \quad (1)
 \end{aligned}$$

Where:

- Disc_p and Disc_c are multipliers on a single year's revenue and costs based on the discount rate and program life for the producers/manufacturers and customer (operator) respectively.
- Market size is the number of aircraft.
- Utilization (Flights per year) defined by aircraft operations.
- $\text{Revenue per flight}$ generated from passengers and cargo.
- Cost per flight reflects operating costs.
- $\text{Externalities tax per flight}$ encourages representation of societal good (noise and emission tax).
- $\text{Delay and cancellation costs}$ include a probability of delay/cancellation and an associated cost.
- $\text{Manufacturing costs}$ for airframe and engine.
- Development costs for airframe and engine.

In accordance with the Surplus Value Theory, the model optimizes the combined profit of the engine manufacturer, the airframer that incorporates the engine, and the airline that employs the aircraft. The theory shows that optimizing the combined profit (or optimizing the profit of an imaginary corporation that performs all three roles) will yield the same engine design as maximizing the profit of the engine manufacturer, which is the ultimate goal. The combined Surplus Value is simpler to compute because it is not affected by the actions of competing engine manufacturers and competing airframers.

B. The Product and Component Attributes

Steps 3 and 4 begin by determining the inputs or more generally the connections to the value model (the engineering attributes of the product) such as the aircraft attributes that affect the revenue, the operating and manufacturing costs. For a commercial airline, typical attributes are payload, range, fuel burn, maintenance cost, and manufacturing cost. It is important that these inputs are expressed in terms that are meaningful to design engineers.

As an exercise to aid in ensuring that all attributes that have a direct impact on the revenue and profit are considered, it is pertinent to consider the stakeholders in the airline business. Some may have very little impact on profit. For example, the top of climb thrust can be an aircraft attribute because it is important to the flight crew. If the flight crew influences the choice of aircraft and therefore affects the aircraft value via demand then this is indeed an important attribute to include. Of course, when stakeholders are considered the competition aspect should be included. Competitive uncertainties can be incorporated into a model using Game Theory, which Briceno [15] investigated to assist the selection process of engine architectures. However, for the simplicity of demonstrating the VDD approach, this paper does not consider competition.

Similarly, the attributes for the components should be formally determined in order to ensure that none are missed. These are the engineering attributes of the components that have a quantifiable effect on the formerly determined product attributes and, therefore, product overall value. An example of the stakeholders, aircraft and engine attributes, determined using simplified Quality Function Deployment (QFD) matrices, are illustrated in Figure 8. The QFD matrix acted as a checklist to support model development.

Stakeholders		Aircraft Attributes																				
		Engine Attributes																				
1 Flight Crew		Aircraft Attributes	1 Manufacturing Cost	2 Weight	3 SFC	4 Nacelle Drag	5 Engine Caused Delays and Cancellations	6 Maintenance Cost	7 TET etc.	8 LTO NOx SOx PM Emissions Indices	9 CO2 Emissions Index	10 Engine Noise	11 Takeoff Mean Thrust	12 Top of Climb Thrust	13 Engine Vibration Levels	14 Power Takeoff	15 Spoolup Speed	16 Reverse Thrust	17 Engine Architecture	18 Flyability	19 Flyability	
2 Airline Directors			1 Yield (Revenue per RPM)																			
3 Passangers			2 Flight Time																			
4 Leasing Company			3 Aircraft Delays and Cancellations																			
5 Air Traffic Control System			4 Comfort																			
6 Airport Operators			5 Hull Loss Rate																			
7 Regulatory Agencies			6 Payload	6.1 Aircraft Cargo Capacity																		
8 Airport Neighbors			7 Range	6.2 Thrust Limit Factor																		
9 Governments			8 Block Fuel																			
10 Maintenance Crew			9 Empty Weight																			
11 Aircraft Manufacturers			10 Taxi Time																			
12 Engine Manufacturers			11 Maintenance Cost per Hour																			
		12 Time Value of Money (Disc_c & Disc_r)																				
		13 Turn Time																				
		14 Maintenance Infrastructure																				
		15 Manufacturing Cost																				
		16 LTO Emissions																				
		17 Noise																				

Engine A Attributes		Example Engine Component									
		Engine Component Attributes									
		1 Surface Area	2 Stage diameter	5 Max. Thickness	6 Part volume	7 No. Parts per Engine	8 Hub-Tip Ratio	9 Mass (Material)	10 Life - MTBF		
1	Manuf. Cost		X			X	X	X			
2	Engine Set Weight		X		X	X		X			
3	SFC	X	X	X		X		X			
4	Nacelle Drag		X								
5	Main. Cost		X			X				X	
6	Engine Noise		X			X					

Figure 8: Identifying attributes and their links

1. The Product and Component Models

For steps 5-7, by determining where the quantifiable links lie (Figure 9), it is then possible to begin populating the combined model (composition function) with equations calculating aircraft attributes from given inputs. These equations are based on experience and information from open sources. The models were constructed using a hierarchical modeling tool known as Vanguard Studio, which has also been used to model Surplus Value. Vanguard Studio is a visual planning and analysis tool that is now being used for unit cost modeling for Rolls-Royce. VDD does not require any specific toolset, however it is important to create a model that is easily edited and displayed; and can be linked to more complex component and cost models. Discussions on the models are given in the case studies in section IV.

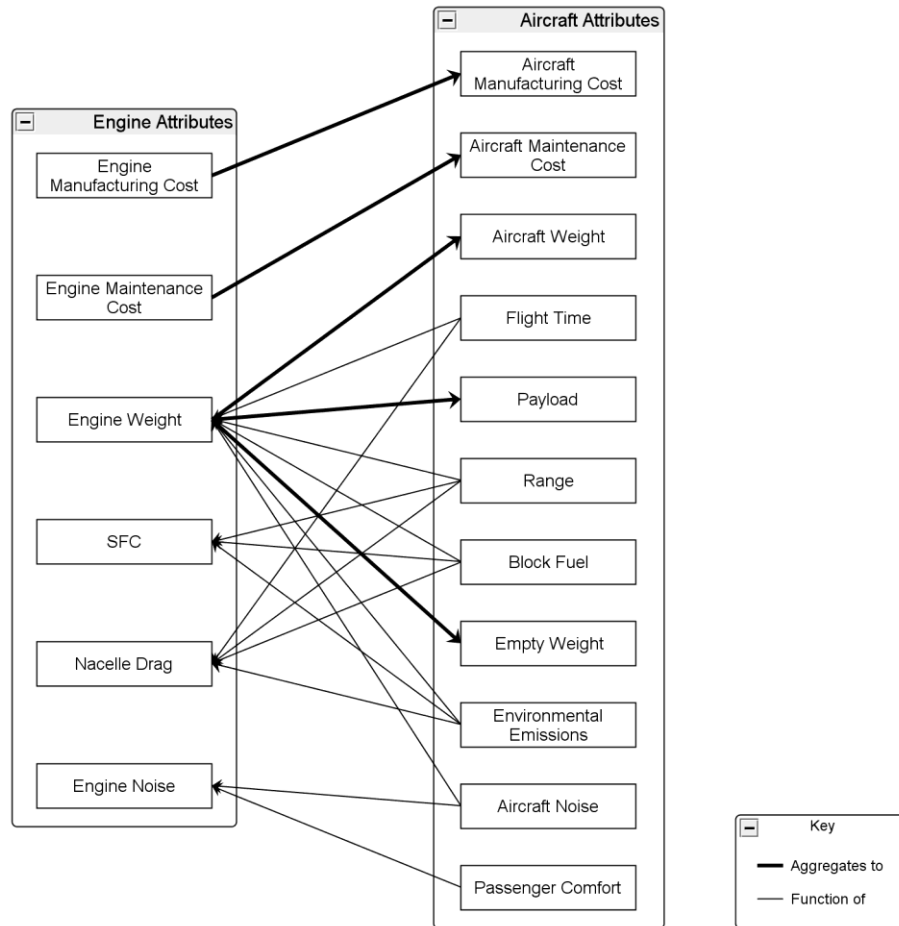

Figure 9: Composition function - links between aircraft and engine attributes

C. Design Objective Functions

The next step is to derive local objective functions for each component from the system value model (Surplus Value). For a commercial airliner, the engine is one of the most important components. The key to deriving the engine objective function is to note that the system attributes that go into the system value model are functions of component attributes. For instance, the aircraft weight is the sum of the weights of all the components, and the aircraft range is a performance function of various component attributes including engine weight and specific fuel consumption. Therefore, sensitivity analysis can be used to determine how much system value (the value model output) changes for a small change in each attribute of the engine. For example, in the illustrative figure (Figure 10), for each unit increase in component weight, the system value will decrease by \$130. These changes form partial derivatives of system value versus each engine attribute. The engine objective function is the sum of all the engine attributes times their corresponding partial derivatives.

Figure 10 is an example of how a component objective function can be displayed to a component design team. The first column captures the current values (supplied by the designers) of the attributes that characterize the success of the component design. The objective function is the inner product of the vectors in the first two columns. That is, it is a linear function in which each coefficient in the second column is multiplied by the attribute in the first column, then all the products (shown in the rightmost column) are summed. The sum is \$43,668, and this is the output of the objective function. It would be possible, with a composition function, to compare the objective function gradient for the weight to each component such that it is clear where investment would have the greatest effect on overall value. This approach would also avoid investing in a reduction of attributes with very small gradients.

Deriving the objective function comes down to quantifying the gradient using a sensitivity analysis on the attribute of interest. Each number in the gradient is the partial derivative of system value versus the component attribute for the row. Thus, the Design Value at the bottom of the table increases \$ for \$ with system value, which is expressed in this example as unit profit. This illustrates how a sensitivity analysis might be performed in order to give greater understanding to the engineers of the impact of a small change in one attribute.

	Status	Gradient	Value
Efficiency	90%	150,000	135,000
Weight	700	-130	-91,000
Reliability	1500	2	3,450
Maintainability	7.8	-340	-2,652
Maintenance Cost	500	-1	-250
Support Equipment	12	-15	-180
Manufacturing Cost	700	-1	-700
Design Value			\$ 43,668

Figure 10: Effect of component attribute on system value (Adapted from [3])

The overall objective is to maximize the system value.

In a similar way, an objective function for design of the high pressure turbine can be derived from the objective function for the engine, and an objective function for a turbine blade can be derived from the objective function for the turbine. Like requirements flow-down, the VDD process is completely scalable.

For example, say that the aircraft has n attributes, $x_1 \dots x_n$. Let π represent the Surplus Value of the aircraft. Then the aircraft objective function is:

$$\pi = f_{aircraft}(x_1, x_2, \dots, x_n) \quad (2)$$

Let the attributes of the engine be $y_1 \dots y_m$. Assume there are constructed functions that determine the x 's from the y 's. Then the objective function for the engine is:

$$v_e = \sum_{j=1}^m \left(\sum_{i=1}^n \frac{\partial \pi}{\partial x_i} \cdot \frac{\partial x_i}{\partial y_j} y_j \right) \quad (3)$$

Similarly, if the attributes of the turbine are $z_1 \dots z_p$, the objective function for the turbine is Eq. 4 with all derivatives taken at the point of the preliminary design. And so on. The coefficients of the objective functions are the numbers shown in the gradient column in Figure 10.

$$v_t = \sum_{k=1}^p \left(\sum_{j=1}^m \frac{\partial v_e}{\partial y_j} \cdot \frac{\partial y_j}{\partial z_k} z_k \right) \quad (4)$$

The obvious use for a component objective function, or in particular an engine objective function, is to insert it into iSight or a similar tool and perform design optimization. However, it can also be used for systems engineering trade studies – the attributes for each trade option are defined, and the one with the higher objective function value is preferred (plug the attributes for each option into a table like the one in Figure 10 and see which option yield the higher Design Value). The objective function can also be used for technology evaluation – the values of the engine with and without the technology are compared, and the difference is the value of the technology [16]. Response surface analysis can be performed by using the objective function to evaluate a parametric set of engine designs. A key benefit in all these applications is that the number produced by the objective function corresponds directly to program profitability. Therefore, studies executed for engineering design are also meaningful to business developers and senior executives.

VDD opens the way to a much more effective method for managing risk during product development programs [17]. When designs can be monetized, and technologies can be monetized, the technical risk of employing a new technology or attempting a novel design can be treated as a financial risk, and all the tools and strategies developed by sophisticated corporations for managing financial risk are available for managing technical risk. Design programs can advance from simple rules for eliminating or mitigating risk to more profitable decision processes that see the opportunity in new designs and manage the opportunity with appropriate conservatism.

In the end, though, the most important use for VDD is to help design engineers find the best designs, so that their collective effort produces the best engine and ultimately the best aircraft for the airline and airframer.

IV. Aero-Engine Subsystem Studies

Following the details of the approach, the case studies demonstrate how to integrate aero-engine subsystem (the components) level design into a VDD process. For each system level (SL) interface in Figure 11, the attributes determined provide the quantifiable links. In one direction, attributes are determined by sequentially working down each level from the system value (Surplus Value). In a complex system there can be many subⁿ-systems, where *n* is the number of levels. After the attributes of the last SL have been determined, attribute models are then built and integrated to the adjacent levels relevant attribute model. Finally, the Surplus Value can then be calculated.

The studies illustrate the use of VDD for trade studies and technology evaluation by incorporating two exemplar engine component models enabling:

1. An investigation into the effect of engine cycle, in this case the turbine entry temperature (TET), due to material selection upon overall value, and
2. A comparison study between a composite and a conventional titanium alloy fan blade.

In order to study the effects of changing design parameters or to make a comparative study between two design options, models must be created for the components that produce performance attribute values, operations and emissions data, maintenance data, and costs. The results shown in this paper are currently at the preliminary stage and are used for illustrative purposes to show how VDD can be used for decision making.

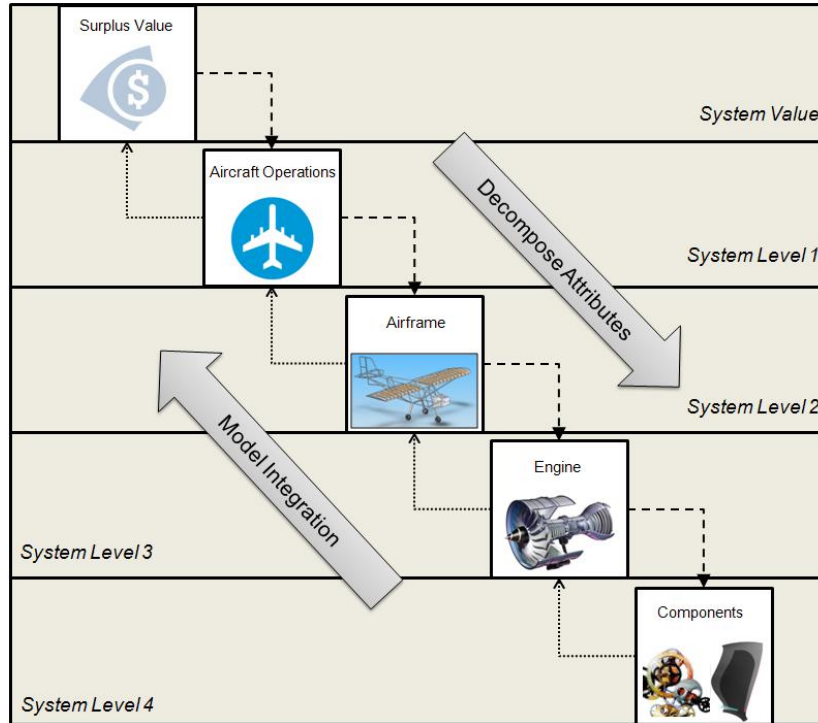

Figure 11: Aircraft System Hierarchy

A. Aircraft Attribute Models

For SL1 and SL2, the development of a revenue estimation capability requires both an understanding of the airline operating environment and the capability of the airframe-engine combination. From the airline's perspective this environment includes the airlines network, their competitors, and the innate demand from the consumer. For the case studies a simplified network is modeled, and competitive effects are assumed to be static, where the airline's or its competitors' actions will not have an effect on the default yield or underlying demand for travel. This means that the snapshot of the industry is essentially frozen. Therefore, yield becomes a function of aircraft cruise Mach number, cruise altitude and stage length. Other attributes include:

- Payload – to determine the amount of payload that can be carried over a given stage length it is necessary to determine both the maximum allowable takeoff weight, based upon airport, aircraft, and engine properties, and the payload range curve for that takeoff weight.
- Cruise fuel burn – this is a function of mission range.
- Revenue – this is a function of passenger, cargo, demand and route.
- Operating costs – the cost of the operating and aircraft in service is determined by two primary components, the operating costs that are directly related to the aircraft and the externalities taxes associated with the negative effects of operating the aircraft on surrounding communities.

Modeling the aircraft operations and the dependencies on the performance of the aircraft generates a complex model. The inputs to these models are determined from the engine attributes (SL3) and subsequently the engine component attributes (SL4). Therefore, the two case studies presented in this paper develop the models required for SL3 and SL4.

B. Case Study 1: Continuous Design Variable – Turbine Entry Temperature

1. Introduction

The ability of gas turbines to operate at higher temperatures is critical to improving their performance. This has driven gas turbine manufacturers to continually pursue higher Turbine Entry Temperatures (TET). Figure 12 shows how TET in Rolls-Royce engines has risen over a 60 year period [18]. TET impacts a variety of engine attributes which include thermal efficiency, overall pressure ratio, cooling requirement, engine deterioration and engine core weight. This presents a challenge in assessing which TET value would generate an optimum engine design. A higher TET would be able to improve thermal efficiency; however this would also result in the acceleration of engine deterioration. To address this, improved cooling designs and better materials could be used, but this could come at the expense of higher development and material costs, and increased engine weight. This scenario provides a useful setting to demonstrate how VDD can provide a singular value to rank designs when faced with various competing factors.

For this case study, the main objective will be to analyze how improvements to TET affect Surplus Value. This TET change will be assumed to be motivated by the availability of improved materials. To keep the scope of the study manageable, only the effects of the change to the High Pressure Turbine (HPT) stages will be modeled.

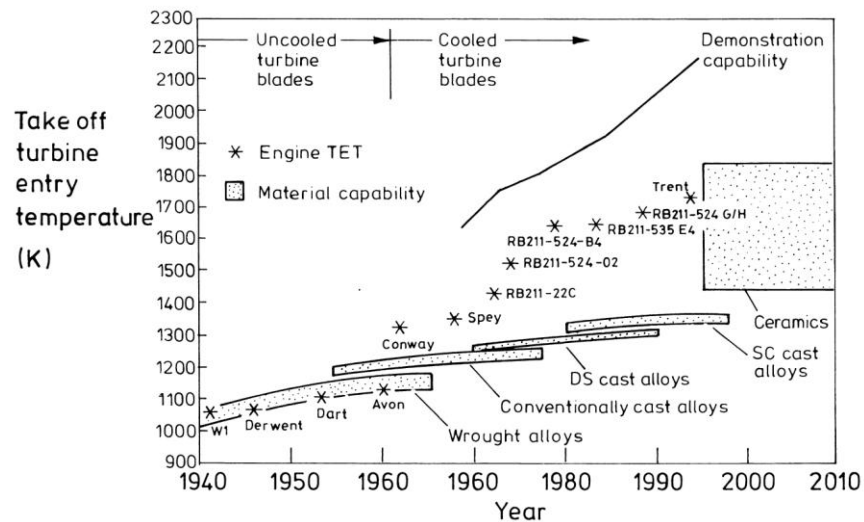

Figure 12: Turbine entry temperature for Rolls-Royce engines since 1940

A number of key engine attributes were identified to have connections with the turbine blade component attributes. These were:

1. Engine weight
2. Maintenance cost
3. Manufacturing cost
4. Nitrogen oxide (NO_x) and carbon dioxide (CO_2) emissions
5. Specific fuel consumption (SFC)
6. Turbine entry temperature

2. Model Architecture

Figure 13 shows an IDEF0 (Integration Definition for Function Modeling 0) diagram constructed for this case study. As the IDEF0 diagram class is generally used to show data flow, system control, and functional flow, it is able to illustrate the various processes and data flows required to relate TET to the engine attributes of interest. An integrated model was constructed according to the IDEF0 model using a commercial software integration package, iSight-FD. Software integration packages provide the capability to link analysis models and define the analysis sequence and process.

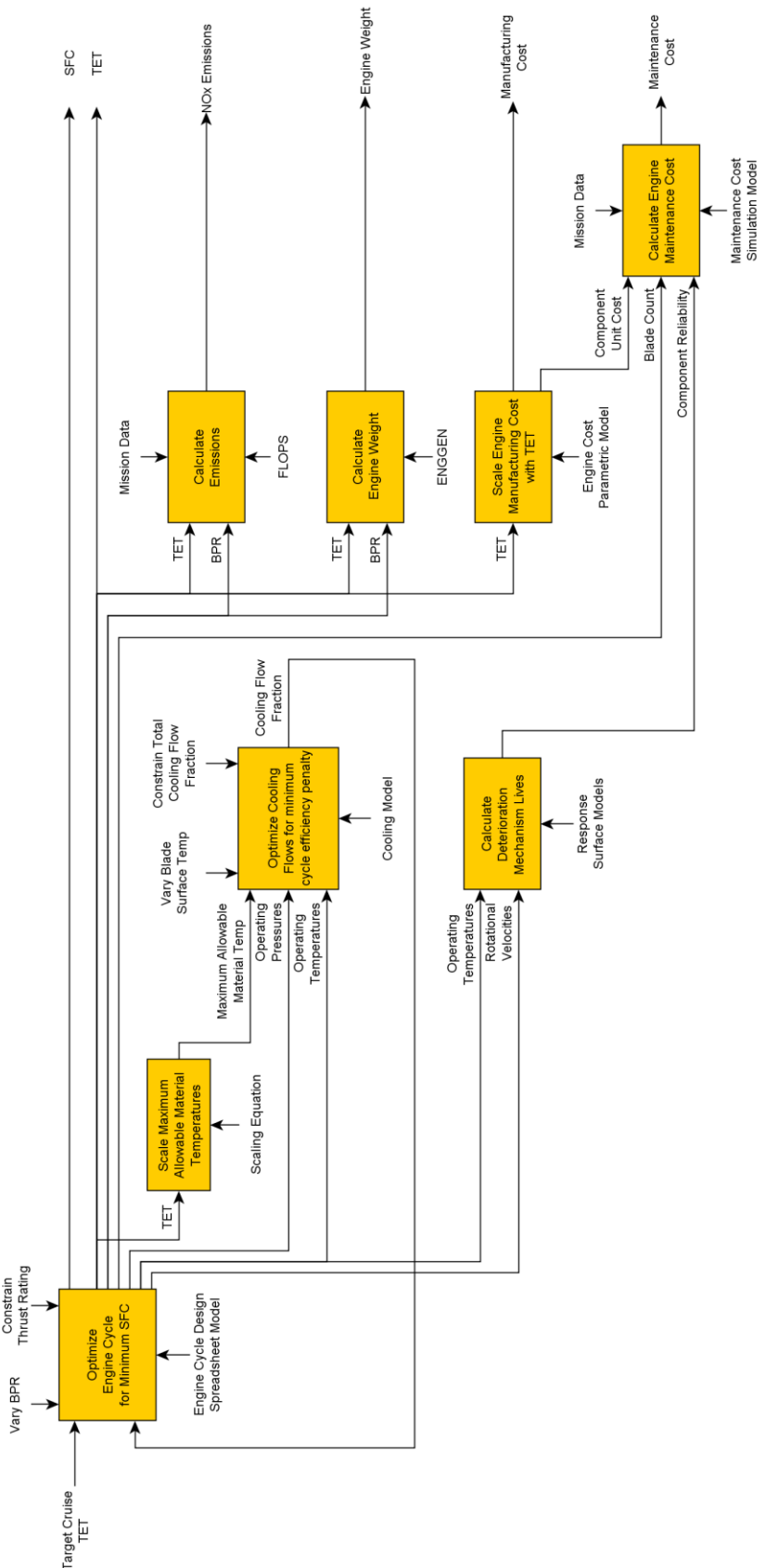

Figure 13: IDEF0 diagram for TET study

The following describes the connections of the engine attributes with the component attributes and how they were modeled:

1. **Engine Weight:** The TET of an engine design directly influences the size of the engine core; and by extension engine weight. The ENGGEN program was used to predict how engine weight would change with TET. ENGGEN is a stand-alone version of the Flight Optimization System (FLOPS) [19] engine cycle analysis module developed by NASA. FLOPS is a multidisciplinary system of computer programs for conceptual and preliminary design and evaluation of advanced aircraft concepts. It consists of nine primary modules: weights, aerodynamics, engine cycle analysis, propulsion data scaling and interpolation, mission performance, takeoff and landing, noise footprint, cost analysis, and program control.
2. **Maintenance Cost:** In general, total maintenance cost is the aggregation of cost elements such as repairs, component replacement, tooling, inventory and labor. It is a function of engine reliability and the selected maintenance strategy. The cost of maintenance is typically non-linear and accumulates at different rates over the life of the engine. Maintenance cost will hence be predicted using a discrete event simulation (DES) model developed in the IPAS project [20]. Simulation is suitable for this kind of problem as it is able to handle the required statistical and logical demands. The costs considered in the model include fixed shop visit costs, labor costs, repair costs, and component replacement costs.
3. **Manufacturing Cost:** It is expected that raised operating temperatures will increase the cost of manufacturing due to different materials and manufacturing methods used. Manufacturing cost of the engine was calculated using cost models developed from the Design Analysis Tool for Unit-cost Modeling (DATUM) project [21]. The main aim of DATUM was to establish a costing capability to support design decision making for all phases of the product development process. These models generate component costs from inputs such as component geometries and materials.
4. **NO_x and CO₂ emissions:** Gas turbine emissions are linked to the TET of the engine as it controls thermal efficiency and SFC. The calculation of total emissions produced is also dependent on the specific flight profile. The relationship of emissions with TET was modeled using the FLOPS tool.
5. **SFC:** A spreadsheet model of the open-gas turbine cycle was used to predict the changes in engine design with changes in TET. The model is able to generate the diameters, angular velocities, temperatures and pressures for the various stages in the designed turbine. In gas turbine design, a change in TET influences many aspects of the aero-engine such as core size, thermal efficiency, overall pressure ratio, thrust and SFC. To produce an improvement in SFC, the thrust requirement must be held constant for the varying levels of TET.

3. Results

Figure 14 shows how Surplus Value varies with TET and overall pressure ratio (OPR); TET and OPR need to be adjusted concurrently to maximize thermal efficiency [18]. The highest Surplus Values are concentrated around the highest TET values and this indicates that engine fuel burn is dominant. At the lower scale of TET for all OPR values, there is a steep step change in Surplus Value. This was due to a change in stage length which increased utilization of the aircraft; thereby significantly raising revenue. As mentioned earlier, the main aim of the case study was to illustrate the VDD process in the context of aero-engine design and guess estimates were used where real data was not available.

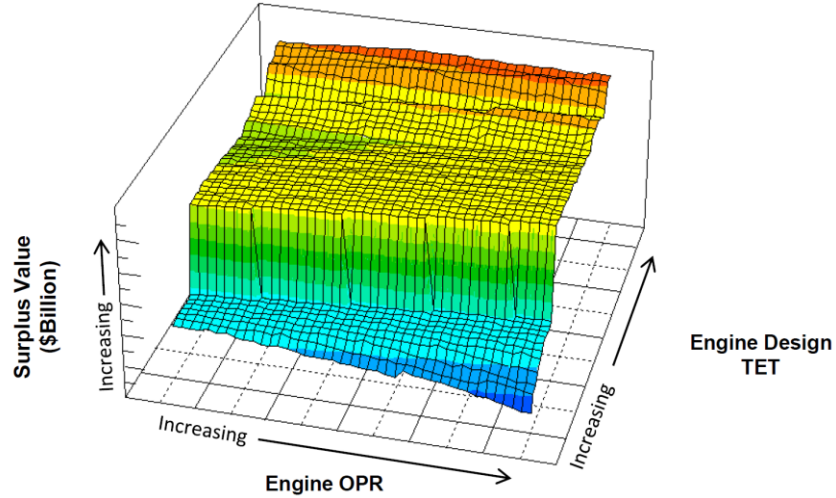

Figure 14: Sample results - Surplus Value vs. engine OPR and engine design TET

C. Case Study 2: Discrete Design Variable – Low Pressure Fan Blade Material

1. Introduction

Consider a chief design engineer at a design review meeting with their team reviewing the choices of titanium fan blades and new carbon composite fan blades (Figure 15), they will face highly complex decisions in the trade-off. Considerations such as performance (component efficiency), weight, all forms of cost, life (reliability), maintainability and noise will all need to be taken into account. Each of these attributes would be addressed by a team of specialists, known as an Integrated Project Team (IPT), to perform detailed analysis on the design of a fan blade. Although there may be local level trade-offs for instance between life and unit cost, or performance and weight, the consideration of the entire system is not formally practiced. This is where VDD would be beneficial – to support design decision-making and to use the value measure to rank designs, where the design with a greater value would be more favorable.

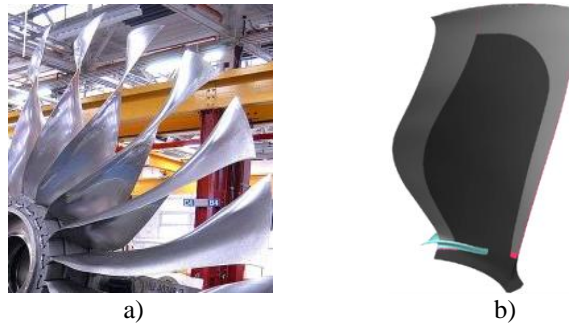

Figure 15: Low pressure fan blades (a) Conventional Titanium blades, (b) Carbon composite blade

Component attributes are the features of the blade. As models are required for each engine attribute, only a manageable selection were chosen and linked to fan blade attributes. Design features of the fan blade were chosen based on three high-level parameters, which were blade weight, number of blades and fan stage diameter. However, there are more intricate design features of a fan blade design which has not been considered here.

2. Model Architecture

The engine attributes that had connections with the fan blade attributes were: Nacelle Drag, Manufacturing Cost, Maintenance Cost, SFC, Noise and Weight. The mapping of the attributes is shown in Figure 16. Due to limited information for certain attributes, simple scaling rules were developed using information that was available. Currently, the models assume that the fan blade attributes are independent of other engine component changes.

For each engine attribute, a data point exists each for the titanium blade and the composite blade such as two different manufacturing costs or noise output. The following explains the dependencies between the engine and component attribute:

1. Manufacturing cost: This depends on material type, the amount of material used and the manufacturing process. A combination of manufacturing process cost models and parametric cost models were developed, and scaled to the relevant stage diameter.
2. Weight: Material properties, stage diameter and number of blades are all factors that impact the weight. The weight is a rough estimate and a factor was applied, since detailed fan blade geometries are proprietary information.
3. SFC: The calculation for determining SFC was based on a turbofan engine cycle calculator. The component efficiency represented the performance of the fan blade. In future, a relationship between the efficiency and fan blade geometry could be used to evaluate the impact on SFC.
4. Nacelle drag: It is assumed that the nacelle drag is directly proportional to the fan stage diameter. An empirical formula was used based on engine cycle parameters and the stage diameter [22].
5. Maintenance cost: This is determined by the life of the fan blade and how many there are in an engine set. The Mean-Time-Between-Failure / fatigue life should be taken into consideration to identify how often the blades will need to be replaced. Due to limited information, the maintenance cost was factored to provide a rough estimate.
6. Engine noise: The NASA FLOPS tool was used to predict the perceived noise with respect to the fan stage diameter and number of blades.

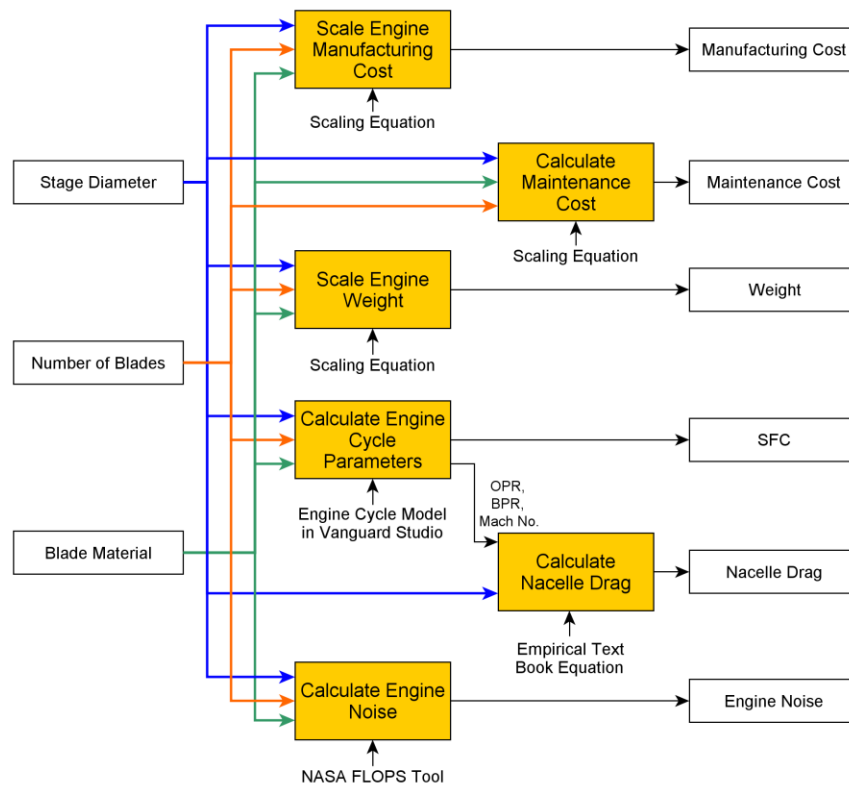

Figure 16: Engine and component attributes map for fan blade material study

3. Results

The Surplus Value model results were generated and shown in Figure 17. The results provide an insight to how the Surplus Value could be used for reviewing design decisions, for instance how design or operating parameters affect the overall system value. The design option with the highest Surplus Value would be the best solution. In this case the results suggest that the composite fan blade would generate more Surplus Value, thus it would be more profitable for the whole system. These are currently preliminary results for illustration, as multifidelity models were utilized. The complex behavior between the design parameters and Surplus Value is undergoing further investigation with improvements to model fidelity.

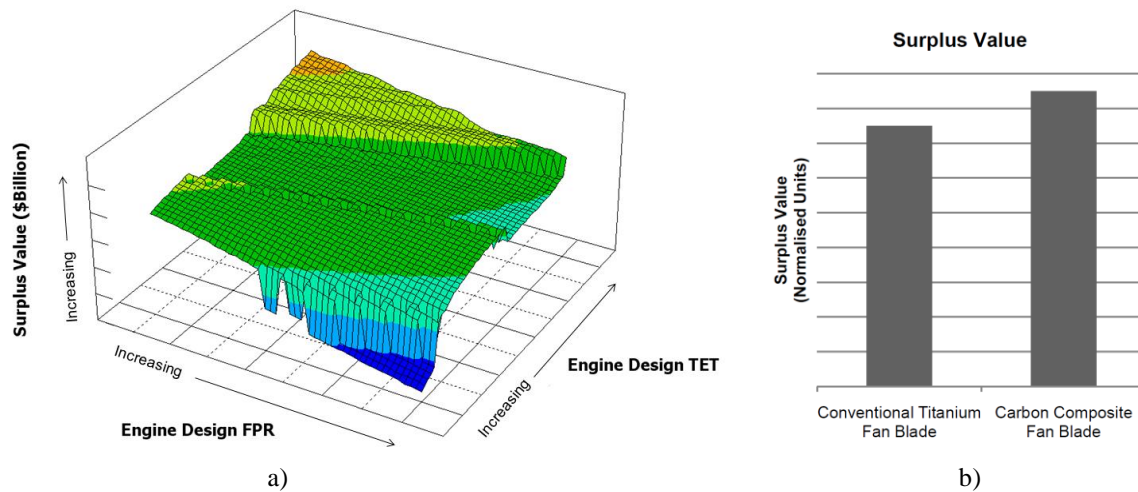

Figure 17: Sample results, a) surface plot of Surplus Value against FPR and TET, b) Surplus Value difference between Titanium and Composite fan blades

D. Model Validation

The models created so far have been validated via an expert panel only. The range of experience of the panel and validation against industry data from trusted sources has allowed an approximate model to be produced that produces a realistic value for overall Surplus Value. However, it is good practice to investigate alternative methods for calculating the Surplus Value terms and if this demonstration model proves popular, such refinements may be made during future collaborations. The validity of the detailed models will be thoroughly tested as part of the research programs through which they were initially constructed.

Of course, numerous sensitivity studies will be carried out on the model as new terms are added and refinements will be made as necessary. This relies upon the experience of the experts constructing the model, but where knowledge is lacking advice will be sought from industry to refine the model.

The models are for demonstration purposes and, as such, it is required to behave as one expects in terms of magnitudes and trends but detailed refinements will need to be made if the models are to be considered in industry. Design of Experiment (DoE) methods might also be suitable to identify the effects of each attribute.

V. Conclusion

The main objective of this research was to improve the understanding of VDD by applying and demonstrating the framework to an air transportation system, with particular focus on the aero-engine. A methodology was developed for the integration of computational models required for the Surplus Value Theory, which enabled VDD to be performed. Identifying attributes for the entire system was an important task to ensure that each system level was connected such that the Surplus Value can be calculated.

Two case studies were presented to investigate the effects of changing TET and fan blade material on the Surplus Value. The outcome of these studies showed how detailed design can be included in VDD. Illustrative results were shown to highlight how VDD could evaluate which design solution would yield the greatest value.

Once a System Value model has been constructed, VDD can be applied with the potential to enhance a business by providing an aid to design decision making and ultimately increase profit through its use in the following applications:

- System trade studies – the impact on system value of selecting different propulsion system options, such as open rotor versus conventional 2/3 shaft.
- Technology evaluation – the impact of new technology insertion can be assessed in value terms: Composite fan versus conventional fan for example.
- Parametric studies – robust assessment of cycle parameters such as pressure ratios and cycle temperatures to optimize value.
- Distributed optimal design – the value metric can act as a single measure of system ‘goodness’. This can be used in multidisciplinary optimization studies.
- Linking market and economic models with propulsion systems design ensures the impact of changes in one area can be quickly seen in another. This helps to improve Systems Engineering decision making capability.

Finally, for future work, the models can ultimately be developed to a level of confidence such that the results of the Surplus Value model can be analyzed in detail, in particular to establish the design objective functions for components. This can then provide a platform for optimization and automation to generate the best design in the case studies.

Acknowledgments

This work has been conducted through the Southampton University Technology Centre. The authors would like to thank Rolls-Royce plc and the UK-HMG Technology Strategy Board – SILOET Program for the funding and support of this project.

References

- ¹ ACARE. "European Aeronautics: A Vision for 2020," *Advisory Council for Aeronautics Research in Europe (ACARE)*, [online document], <http://www.acare4europe.com/docs/Vision%202020.pdf> [cited 29 September 2009].
- ² Browning, T. R. "On Customer Value and Improvement in Product Development Process," *Systems Engineering* Vol. 6, No. 1, 2003, pp. 49-61.
- ³ Kingsley-Jones, M. "C-Series Will See Off Re-Engined Rivals," *Flight International*. Vol. 177, 5224 (26 January - 01 February 2010), Reed Business Information Ltd, Sutton UK, 2010.
- ⁴ Collopy, P., and Hollingsworth, P. "Value-Driven Design," *9th AIAA Aviation Technology, Integration and Operations (ATIO) Conference*. Hilton Head, South Carolina, USA, 2009.
- ⁵ Simon, H. A. "The Sciences of the Artificial," *Chapter 3: The Science of Design*. The MIT Press, Cambridge MA, 1969.
- ⁶ Keeney, R. L., and Raiffa, H. *Decisions with Multiple Objectives: Preferences and Value Tradeoffs*, New York, USA: Wiley, 1976.
- ⁷ Saaty, T. L. *The Analytic Hierarchy Process*, New York, USA: McGraw-Hill, 1980.
- ⁸ Brown, O., Eremenko, P., and Collopy, P. "Value-Centric Design Methodologies for Fractionated Spacecraft: Progress Summary from Phase 1 of the Darpa System F6 Program," *AIAA Space Conference and Exposition*. Pasadena, CA, USA, 2009.
- ⁹ Collopy, P. "Economic-Based Distributed Optimal Design." AIAA Paper 2001-4675, American Institute of Aeronautics and Astronautics, Reston, VA, 2001.
- ¹⁰ Castagne, S., Curran, R., and Collopy, P. "Implementation of Value-Driven Optimisation for the Design of Aircraft Fuselage Panels," *International Journal of Production Economics* Vol. 117, 2009, pp. 381-388.
- ¹¹ BTS. "Bureau of Transportation Statistics," [online], www.bts.gov [cited 23 February 2009].
- ¹² Swelbar, W. S., and Belobaba, P. P. "Airline Data Project," *Massachusetts Institute of Technology*, [online], <http://web.mit.edu/airlinedata/www/default.html> [cited 23 February 2009].
- ¹³ Jackson, P. "Airbus A320," *Jane's All the World's Aircraft 2006-2007*. Jane's Information Group, London, 2006, pp. 262-265.
- ¹⁴ Collopy, P. "Surplus Value in Propulsion System Design Optimization." AIAA Paper 97-3159, American Institute of Aeronautics and Astronautics, Reston, VA, USA, 1997.
- ¹⁵ Briceno, S. I., and Mavris, D. N. "Strategic Decision-Making: Applications of Game Theory in a Systems Approach to Commercial Engine Selection," *AIAA 5th Aviation, Technology, Integration, and Operations Conference*. Arlington, Virginia, USA, 2005, pp. 1-10.
- ¹⁶ Collopy, P., and Horton, R. "Value Modelling for Technology Evaluation." AIAA Paper 2002-3622, American Institute of Aeronautics and Astronautics, Reston, VA, USA, 2002.

¹⁷ Collopy, P. "Balancing Risk and Value in System Development." AIAA Paper 2003-6376, American Institute of Aeronautics and Astronautics, Reston, VA, USA, 2003.

¹⁸ Cumpsty, N. *Jet Propulsion: A Simple Guide to the Aerodynamics and Thermodynamics Design and Performance of Jet Engines*, 2nd ed., Cambridge UK: Cambridge University Press, 2003.

¹⁹ McCullers, L. A. "Flight Optimization System (F.L.O.P.S)." Release 6.11 ed., NASA Langley Research Center, Hampton, VA 23681, USA, 2004.

²⁰ IPAS. "Integrated Products and Services (I.P.A.S) Project Website," [online], <http://www.3worlds.org> [cited 31 January 2010].

²¹ Scanlan, J., Rao, A., Bru, C., Hale, P., and Marsh, R. "The Datum Project: A Cost Estimating Environment for the Support of Aerospace Design Decision Making," *Journal of Aircraft* Vol. 43, No. 4, 2005, pp. 1022-1028.

²² Jenkinson, L. R., Simpkin, P., and Rhodes, D. *Civil Jet Aircraft Design*, London: Arnold, 1999.