



# Open Research Online

---

The Open University's repository of research publications and other research outputs

## Comparing perspectives on the role of ICT in education

### Conference or Workshop Item

How to cite:

Fox, B. and Twining, P. (2006). Comparing perspectives on the role of ICT in education. In: SITE International Conference Annual 2006 (Crawford, C. and et., al. eds.), Association for the Advancement of Computing in Education, Charlottesville (Va), USA, pp. 1551–1558.

For guidance on citations see [FAQs](#).

© [\[not recorded\]](#)

Version: [\[not recorded\]](#)

Link(s) to article on publisher's website:

[http://www.editlib.org/index.cfm?fuseaction=Reader.ViewAbstract&paper\\_id=22281](http://www.editlib.org/index.cfm?fuseaction=Reader.ViewAbstract&paper_id=22281)

---

Copyright and Moral Rights for the articles on this site are retained by the individual authors and/or other copyright owners. For more information on Open Research Online's data [policy](#) on reuse of materials please consult the policies page.

---

[oro.open.ac.uk](http://oro.open.ac.uk)

# Comparing Perspectives on the Role of ICT in Education

Bob Fox  
University of Worcester  
UK  
[b.fox@worc.ac.uk](mailto:b.fox@worc.ac.uk)

Peter Twining  
The Open University  
UK  
[P.Twining@open.ac.uk](mailto:P.Twining@open.ac.uk)

**Abstract:** This paper explores the rationales that people with specific educational roles thought should underpin educational ICT use. It provides a brief overview of the dICTatEd project followed by a summary of the analysis of over 2,000 responses to the project's web-based questionnaire. Respondents were asked to rate and rank the relative importance they ascribed to each of 19 rationales. Analysis indicates general agreement that some rationales represent poor reasons for using ICT in education while others should be important in driving educational ICT use. However, there was substantial variation between the views of the eight groups within the sample about the relative importance of each rationale. This analysis thus supports an underpinning premise upon which the dICTatEd project is founded: that a key reason for the lack of impact of the substantial investments in ICT in education that have taken place is a lack of shared understandings about the rationales for using ICT in education.

## The dICTatEd Project

dICTatEd (Discussing ICT, Aspirations & Targets for Education) is a project that aims to stimulate and inform the 'educational' ICT debate, in order to enhance the educational impact of expenditure on ICT in education. In the context of this research ICT is taken to mean computer related technologies, but, unusually for the UK, the definition used here excludes OHPs, televisions, tape recorders and so forth.

dICTatEd is predicated on the existence of a 'reality rhetoric gap' (Trend, Davis and Loveless 1999) - despite huge levels of investment in ICT in education (e.g. Twining 2002a) ICT does not appear to have a proportionately large impact on learning outcomes (e.g. Cuban 2001; Twining 2002b). One of the key reasons that has been identified for this lack of impact of ICT in education is the lack of shared understandings (visions) about the rationales for using ICT in education (Twining 2002b).

The 'educational' ICT literature makes frequent reference, both directly and indirectly, to rationales for the use of ICT in education. A literature review was carried out in 2003 which resulted in 19 distinct rationales for the use of ICT in education being identified (Tab. 1).

A web-based questionnaire was developed in order to stimulate debate and explore respondents' views on which of these rationales *should* underpin the use of ICT in education (the questionnaire can be accessed at <http://www.meD8.info/qqa/>). The questionnaire asks respondents to:

- Say whether or not they think that ICT *should be* an essential component of education (for a particular age range of learners)
- Rate the 19 rationales on a seven point scale (Fig. 1)
- Rank the rationales (showing which three they think *should be* the most important, in order of preference).

<b>Rationale</b>	<b>Source</b>
1. In order to learn IT skills	Harris (1999); Twining (2001a; 2002b; 2002c)
2. As a tool to achieve traditional teaching and learning goals across the curriculum	Harris (1999); Pelgrum and Plomp (1991); Twining (2001a; 2002b; 2002c)
3. In order to extend and enrich learning across the curriculum	Cuban (1993); Harris (1999); Hexel, De Marcellus and Bernoulli (1998); Twining (2001a; 2002b; 2002c)
4. In order to motivate learners	Hexel et al. (1998); Twining (2001a; 2002b; 2002c)
5. As a catalyst for educational change	Moseley, et al (1999); Pelgrum and Plomp (1991); Twining (2001a; 2002b; 2002c)
6. Because of the impact of ICT on the nature of knowledge	Cloke (2000); Twining (2001b)
7. In order to fundamentally change teaching and learning	Dwyer, Ringstaff and Sandholtz (1990); Cuban (2001); Twining (2001a; 2002b; 2002c)
8. As a tool to support learners in thinking about their own learning	Twining (2001a; 2002b; 2002c)
9. In order to provide access to the curriculum for those who might otherwise be excluded from it	Twining (2001a; 2002b; 2002c)
10. In order to increase productivity in education	Cuban (1993)
11. In order to reduce the cost of education	Pelgrum and Plomp (1991)
12. In order to make education more efficient	Moseley et al. (1999); Cuban (2001); Twining (2002b; 2002c)
13. As a substitute for teachers	Harris (1999)
14. In order to reward learners	Harris (1999); Twining (2002b; 2002c)
15. As preparation for living in a society that is permeated with technology	Pelgrum and Plomp (1991); Cuban (1993)
16. As preparation for work (employment)	Pelgrum and Plomp (1991); Cuban (2001)
17. In order to support and stimulate the country's economic development	Pelgrum and Plomp (1991)
18. In order to impress stakeholders (e.g. inspectors, funders, prospective parents/students)	Pelgrum and Plomp (1991); Twining (2002b; 2002c)
19. In order to reduce inequalities between students/pupils with differential access to ICT outside formal education	Twining (2002b; 2002c)

**Table 1:** The 19 rationales for 'educational' ICT synthesized from the literature

By the end of June 2005 over 5,880 respondents had submitted validated responses to the questionnaire. This paper examines a subset of 2,136 of these responses, from respondents who identified themselves as fitting into specific educational roles (see Table 2 for details of these roles and the numbers of respondents in each).

## Methodology

The questionnaire was publicized in three main ways: emails were sent to 15,000 Open University students in the summer of 2003; emails were sent to a number of maillists within the UK and internationally; colleagues in other educational organizations publicized the questionnaire with their students/colleagues (see <http://www.meD8.info/dictated/collaborators.htm> for a list of the people involved in using the questionnaire within their own organizations).

The questionnaire asks respondents to answer questions in relation to specific age ranges of learners. At the end of the questionnaire respondents have the opportunity to either respond to the key questions again in relation to other age ranges and/or to apply their responses to other age ranges. Thus one respondent may submit more than one set of responses to the questionnaire.

## Data analysis

Numbers in the following tables do not necessarily tally, as some respondents identified themselves in more than one category, and there were also some nil returns in some sections.

### The respondents

Eight roles were identified, as shown in Table 2. Some caution needs to be exercised over these role designations: ‘Consultants’, for example, did not *necessarily* work in the field of ICT; ‘Parents’ were not a cross-section of the whole population – they were usually Open University students who identified ‘parent’ as their primary role.

Role	N =
Teacher Educators	151
Advisers (Advisers 44, Advisory Teachers 39, Inspectors 7, Consultants 102)	192
Parents	237
Primary Teachers (5 to 11 year olds), Teachers 178, Deputy Heads (Vice Principals) 9, Heads (Principals) 23	210
Secondary Teachers (12 to 18 year olds), Teachers 399, Deputy Heads (Vice Principals) 25, Heads (Principals) 18	442
Teaching Assistants (Teachers’ aids)	64
Primary Student/Trainee Teachers	485
Secondary Student/Trainee Teachers	385

**Table 2:** The numbers of respondents who identified themselves as fitting into each role (N=2136)

Of the 2083 respondents who identified their gender, 1373 were female and 710 were male. 1619 were located in the United Kingdom, and 517 elsewhere, including for example: Africa, Australia, Canada, China, Finland, France, Germany, Greece, Hong Kong, Japan, Malaysia, New Zealand, Portugal, Russian Federation, South America, Spain, Sweden, Turkey, and the USA. The questionnaire is available in Turkish and Greek as well as English. Table 3 displays these figures, by role.

Role	Gender		Location	
	Male	Female	In UK	Not in UK
Teacher Educators	76	70	85	66
Advisers	94	94	119	73
Parents	176	55	205	32
Primary Teachers	148	58	126	84
Secondary Teachers	237	194	237	205
Teaching Assistants	54	7	62	2
Primary Trainees	400	75	457	28
Secondary Trainees	188	157	328	27

**Table 3:** Gender and location of respondents by role

The imbalance between sexes among Primary Teachers and Primary Trainees reflects recruitment patterns to the profession; as one might predict, the balance is more even for Secondary Teachers and Secondary Trainees. The vast majority of Teaching Assistants in the UK are female, which is reflected in the sample. There are marked differences in the balance between locations for Trainees and for Teachers and most other roles. This is because the Trainees’ responses were mainly solicited from a range of UK universities and other training establishments, whereas most Teachers’ responses came through their connection with the Open University or through emails sent to ‘educational ICT’ related maillists (such as IFETS).

Respondents were asked, “Should ICT be an essential component of education [for the age group that you have chosen]?” (The text in square brackets was replaced by the age range that the respondent had chosen to respond in relation to). They were also asked to provide a reason for their answer. A clear majority in each category gave a positive response (Tab. 4), and even some of the ‘No’ responses could have been ‘Yes’ (e.g. ‘No, because ICT is more than just computers’). There was also a tendency for some Open University students to interpret the question

as meaning ‘Should it be compulsory for Open University students to have computers?’ It is intended that a close analysis of these responses will form the substance of a subsequent paper.

Role	Yes	No
Teacher Educators	138 (91.4%)	13 (8.6%)
Advisers	177 (92.2%)	15 (7.8%)
Parents	201 (84.8%)	36 (15.2%)
Primary Teachers	184 (87.6%)	26 (12.4%)
Secondary Teachers	395 (89.4%)	47 (10.6%)
Teaching Assistants	57 (89.1%)	7 (10.9%)
Primary Trainees	452 (93.2%)	33 (6.8%)
Secondary Trainees	332 (93.5%)	23 (6.5%)

**Table 4:** Should ICT be an essential component of education?

### Ratings of the rationales

Respondents rated each of the 19 rationales on a seven-point scale, ranging from ‘Extremely important’ to ‘A very poor reason’. This range is represented in the following figures as between +3 and –3. Mean ratings were calculated for each rationale, for the whole sample and for each of the eight role categories. Of the 19 rationales, 15 received generally positive ratings, and 4 generally negative ratings (Fig. 1).

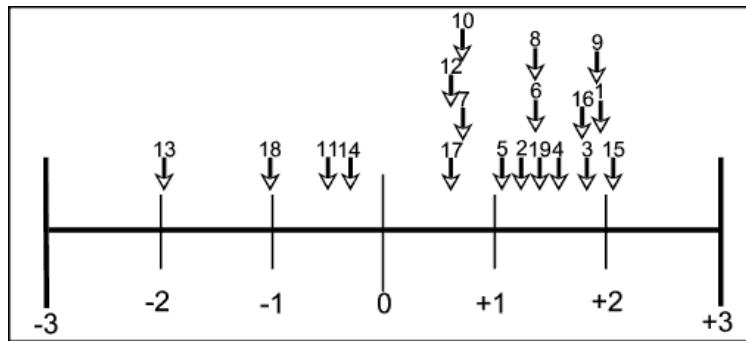
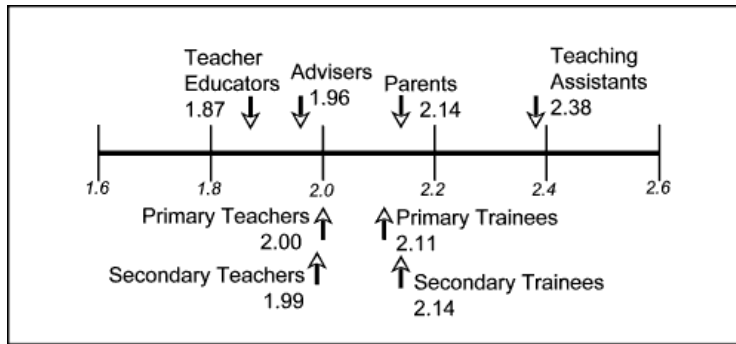

**Figure 1:** Distribution of mean ratings for each of the nineteen rationales

As one might expect, given the nature of the sample, there was considerable overall agreement between the different role categories, and there were no instances of some groups giving a positive rating while others were negative. For some of the rationales the means for the eight role categories varied relatively little from the overall mean for that rationale; in the cases of rationales 8 and 17, for example, the whole range of means spanned less than half a point. For others, there was a wider variation, in some cases in excess of one point on the seven-point scale. The statistical significance of the variations was tested using single factor ANOVA. This paper looks at five sets of responses, attempting to note patterns and suggest some possible explanations.

#### ***Rationale 15: As preparation for living in a society that is permeated with technology***

This was rated the most popular rationale overall (the only one whose overall mean exceeded 2), and Figure 2 appears to indicate no particular pattern across the eight role categories. As is often the case within this analysis, the ratings of the Advisers and the Teacher Educators appear to be quite close to each other. The Teacher Educators and Teaching Assistants were the only groups whose variation from the overall mean was statistically significant ( $p < 0.05$ ).



**Figure 2:** Distribution of mean ratings for Rationale 15 (overall mean = 2.06, range of means = 0.52)

***Rationale 1: In order to learn IT skills***

Overall this was rated the second most popular rationale. The range of means is wider than for Rationale 15, with the variance of five groups achieving statistical significance (Teacher Educators and Teaching Assistants at  $p < 0.05$ , Primary Teachers at  $p < 0.01$ , and Advisers and Secondary Trainees at  $p < 0.001$ ) On the other hand, the order is strikingly similar to Rationale 15, perhaps because these two rationales place similar emphasis on the development of ICT skills rather than, say, the use of ICT to support learning in a more general sense.

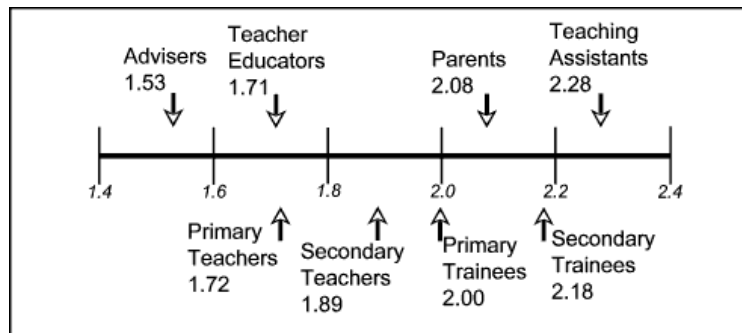

**Figure 3:** Distribution of mean ratings for Rationale 1 (overall mean = 1.93, range of means = 0.75)

***Rationale 9: In order to provide access to the curriculum for those who might otherwise be excluded***

This was rated the third most popular rationale. The means for seven of the eight role categories are relatively tightly clustered (with a range of 0.27), with Teaching Assistants as an outlier, the only group whose variation from the overall mean achieved statistical significance ( $p < 0.001$ ). This probably reflects the nature of Teaching Assistants' work, which often entails working in direct support of individual children with specific learning needs – increasingly these needs are being addressed through the use of ICT.

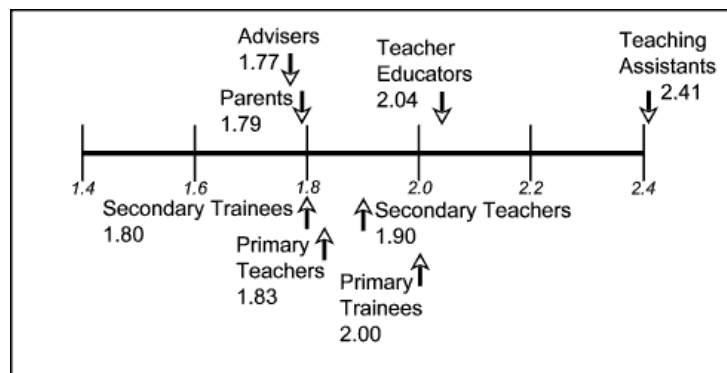

**Figure 4:** Distribution of mean ratings for Rationale 9 (overall mean = 1.91, range of means = 0.63)

**Rationale 13: As a substitute for teachers**

Perhaps unsurprisingly for this sample, this was the least popular rationale, rated as -3 by a high proportion of respondents. Teaching Assistants were the most strongly opposed group, perhaps from dread of the image of a teacherless class of children working away at computer-based programmed instruction, with only Teaching Assistants available to manage the systems. On the other hand, the range of means is relatively wide. The variance of four groups achieved statistical significance: Parents ( $p < 0.05$ ), Teaching Assistants, Secondary Teachers and Teacher Educators (all  $p < 0.01$ ). Why were the Teacher Educators so relatively lukewarm in their rejection? Possibly because the rationale could be interpreted in a different way: the ubiquity of networked computing, and the increasing opportunities for distributed learning may render obsolete the role of the teacher in its traditional sense.

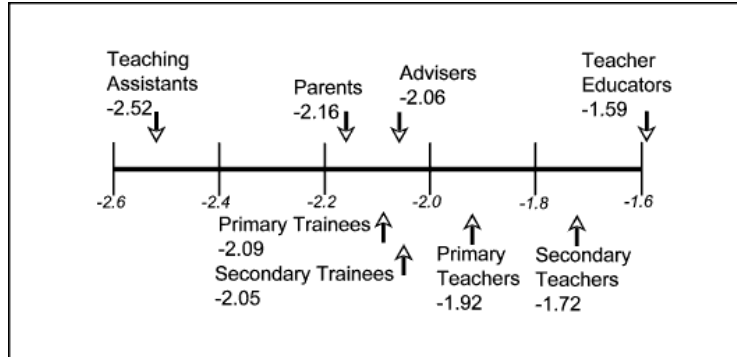

**Figure 5:** Distribution of mean ratings for Rationale 13 (overall mean = -1.97, range of means = 0.93)

**Rationale 7: In order to fundamentally change teaching and learning.**

In considering the responses to this rationale (Fig. 6), which addresses the potential of ICT to bring about fundamental change in teaching and learning, it will probably come as little surprise to discover that the Parents are the most conservative group – perhaps with more commitment to traditional ideas of school and curriculum (but why should their perspectives be mirrored by Secondary Trainees?). Given the generally positive response to the majority of the rationales, this is very lukewarm. At the other end of the scale the Teacher Educators and Advisers are far more positive about the possibilities of bringing about fundamental change. Four groups varied significantly from the overall mean: Teacher Educators, Advisers, Parents and Secondary Trainees (all  $p < 0.001$ ).

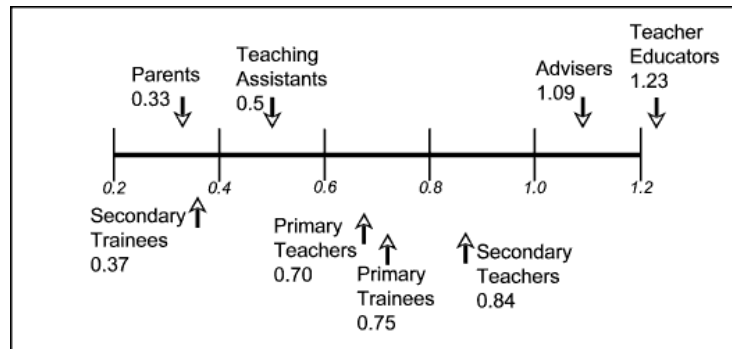

**Figure 6:** Distribution of mean ratings for Rationale 7 (overall mean = 0.71, range of means = 0.90)

Figure 7 shows the actual distribution of ratings for this rationale by Parents and by Teacher Educators. Just over half of Parents (51%) gave a positive rating, by comparison with 75% of Teacher Educators. Might this be due to the Parents, who we have already identified as predominantly being OU students, being less comfortable with the notion of change than the Teacher Educators, many of whom were ICT specialists and thus potentially more familiar with the potential that ICT offers for change? Further work is required in order to unpack the potential explanations of these differences as the current data is only sufficient to highlight that they exist, not their underlying causes.

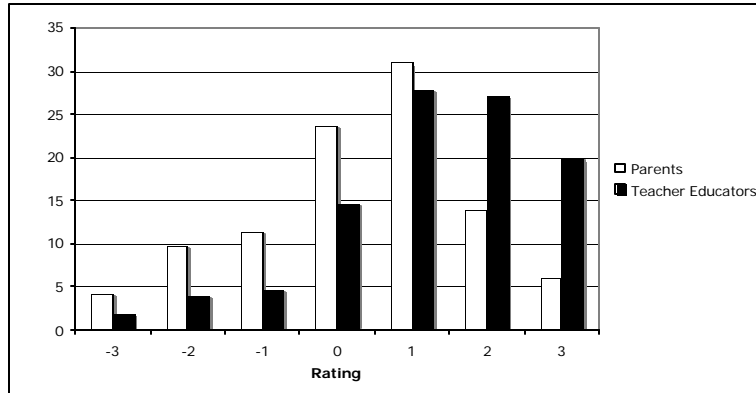

**Figure 7:** Distribution of ratings for Rationale 7 by Parents (n=236) and Teacher Educators (n=151)

### Ranking the rationales

Respondents were asked to rank the rationales by identifying: the one that they thought was the most important; the one that they thought was second most important; and the one that they thought was the third most important. In analyzing this data a ranking of ‘most important’ was scored as 3 points, second most important as 2 points and third most important as 1 point. Using this approach there was a close correlation (approximately 0.7) between the ratings and rankings of the rationales overall. Table 5 summarizes the mean ranking by role of respondent for the five most ‘popular’ rationales.

Role	Rationale				
	15	3	1	6	9
Parents	1 <sup>st</sup>	4 <sup>th</sup>	2 <sup>nd</sup>	3 <sup>rd</sup>	5 <sup>th</sup>
Teaching Assistants	1 <sup>st</sup>	5 <sup>th</sup>	3 <sup>rd</sup>	6 <sup>th</sup>	2 <sup>nd</sup>
Secondary Teachers	1 <sup>st</sup>	2 <sup>nd</sup>	4 <sup>th</sup>	3 <sup>rd</sup>	5 <sup>th</sup>
Secondary Trainees	1 <sup>st</sup>	3 <sup>rd</sup>	2 <sup>nd</sup>	6 <sup>th</sup>	5 <sup>th</sup>
Primary Teachers	2 <sup>nd</sup>	1 <sup>st</sup>	3 <sup>rd</sup>	8 <sup>th</sup>	4 <sup>th</sup>
Primary Trainees	2 <sup>nd</sup>	1 <sup>st</sup>	3 <sup>rd</sup>	6 <sup>th</sup>	4 <sup>th</sup>
Teacher Educators	2 <sup>nd</sup>	1 <sup>st</sup>	6 <sup>th</sup>	3 <sup>rd</sup>	4 <sup>th</sup>
Advisers	3 <sup>rd</sup>	1 <sup>st</sup>	7 <sup>th</sup>	2 <sup>nd</sup>	4 <sup>th</sup>

**Table 5:** Summary of the rankings of the five most popular rationales by role or respondent

Rationale 15 (As preparation for living in a society that is permeated with technology) was ranked the most highly by Parents, Teaching Assistants, Secondary Teachers and Secondary Trainees. This was also the rationale that achieved the highest average rating overall (Fig. 1). It was ranked second by all the other role categories other than Advisers who ranked it third most important overall. One might question whether Rationale 15 is an educational rationale at all; it certainly doesn’t provide much assistance in identifying how ICT should be being used to enhance education. This being the case the general agreement about its relative importance should perhaps be a cause for concern. Rationale 3 (In order to extend and enrich learning across the curriculum), on the other hand, does clearly have an educational focus, and was ranked the most highly by Advisers, Teacher Educators, Primary Teachers and Primary Trainees. Rationale 3 was rated fourth overall (Fig. 1). Rationales 15 and 3 between them accounted for the first place ranking by all eight role categories of respondents.

Primary Teachers’ and Primary Trainees’ overall rankings of the rationales were very similar, in that they shared the same rationales in 1<sup>st</sup>, 2<sup>nd</sup>, 3<sup>rd</sup> and 4<sup>th</sup> place. Primary Trainees’ and Teacher Educators’ overall rankings of the rationales were also very similar, in that they included the same first six rationales, with the rankings of rationales 1 and 6 being reversed (Tab.5). There were fewer apparent similarities between the other categories of respondents.



## Conclusions

The data analysis indicates that there are some similarities between the views of the different categories of respondent. For example, there was general agreement that rationales 13 (As a substitute for teachers), 18 (In order to impress stakeholders), 11 (In order to reduce the cost of education) and 14 (In order to reward teachers) were poor reasons for using ICT in education, and that rationales 15 (As preparation for living in a society that is permeated with technology), 9 (In order to provide access to the curriculum for those who might otherwise be excluded), 1 (In order to learn IT skills), 3 (In order to extend and enrich the curriculum) and 16 (As preparation for work (employment)) were the best reasons. However, there is an evident lack of agreement across the different role categories about the relative importance of the different rationales. This lends weight to the main assumption underpinning the dICTatEd research, namely that one of the key reasons that has been identified for the lack of impact of ICT in education is the lack of shared understandings (visions) about the rationales for using ICT in education (Twining 2002c). It remains to be seen whether the dICTatEd project will achieve its primary aim of helping to develop such shared understandings by raising the issue and stimulating debate about it. However, the continued existence of the web-based questionnaire (which can be accessed from the dICTatEd website at <http://www.meD8.info/dictated/>) will enable changes in views to be monitored over time.

Clearly further work is needed to unpack the findings presented here, particularly in order to develop deeper understandings of the reasons for these differences in perspective. One of the limitations of the analysis within this paper is its focus on the quantitative data from the questionnaires. Analysis of some of the 'free text' entries will help to expand our understanding, but this will need to be supplemented with further qualitative work that probes people's understandings and motivations in a way that the dICTatEd study has not yet attempted.

## References

- Cloke, C. (2000) *Planning to use ICT, factors which influence teachers*. ESRC ICT & Pedagogy.
- Cuban, L. (1993). Computers meet classroom: Classroom wins. *Teachers College Record* 95(2): p.185 (26p).
- Cuban, L. (2001). *Oversold and Underused: Computers in the Classroom*. London: Harvard University Press.
- Dwyer, D.C., Ringstaff, C. and Sandholtz, J.H. (1990). *Teacher Beliefs and Practices Part I: Patterns of Change. The Evolution of Teachers' Instructional Beliefs and Practices in High-Access-to-Technology Classrooms. First to fourth year findings*. Cupertino: Apple Computer Inc.
- Harris, S. (1999). *INSET for IT: a review of the literature relating to preparation for and use of IT in schools*. Slough: National Foundation for Educational Research.
- Hexel, D., De Marcellus, O. and Bernoulli, M. (1998). Potentials and constraints of ICT in schools. *Educational Media International* 35(3): pp.149-156.
- Moseley, D., Higgins, S., Bramald, R., Hardman, F., Miller, J., Mroz, M., Tse, H., Newton, D., Thompson, I., Williamson, J., Halligan, J., Bramald, S., Newton, L., Tymms, P., Henderson, B. and Stout, J. (1999). *Ways forward with ICT: Effective pedagogy using Information and Communications Technology for Literacy and Numeracy in Primary Schools*. Newcastle: University of Newcastle.
- Pelgrum, W. and Plomp, T. (1991). *The Use of Computers in Education Worldwide*. Oxford: Pergamon Press.
- Trend, R; Davis, N. and Loveless, A. (1999). *Information and Communications Technology*. London: Letts Educational.
- Twining, P. (2001a). Planning to use ICT in schools?, *Education 3-13* 29(1): pp.9-17.
- Twining, P. (2001b). *E211 Learning Matters: Challenges of the Information Age - Software Guide*, Milton Keynes: The Open University.
- Twining, P. (2002a) *ICT in Schools: Estimating the level of investment*. Milton Keynes: meD8. meD8, <http://www.meD8.info/docs> (visited 31.1.03).
- Twining, P. (2002b) *Enhancing the Impact of Investments in Educational ICT*. PhD Thesis, Milton Keynes: Open University. <http://kn.open.ac.uk/public/document.cfm?documentid=2515> (visited 31.1.03).
- Twining, P. (2002c). Conceptualising Computer Use in Education: introducing the Computer Practice Framework (CPF), *British Educational Research Journal* 28(1): pp.95-110.