

University of Windsor Scholarship at UWindsor

Electronic Theses and Dissertations

2014

A Heuristic Approach for Impairment-Aware Static RWA in WDM Translucent Networks

Ganeshsantosh Akula
University of Windsor

Follow this and additional works at: <http://scholar.uwindsor.ca/etd>

Recommended Citation

Akula, Ganeshsantosh, "A Heuristic Approach for Impairment-Aware Static RWA in WDM Translucent Networks" (2014). *Electronic Theses and Dissertations*. Paper 5227.

This online database contains the full-text of PhD dissertations and Masters' theses of University of Windsor students from 1954 forward. These documents are made available for personal study and research purposes only, in accordance with the Canadian Copyright Act and the Creative Commons license—CC BY-NC-ND (Attribution, Non-Commercial, No Derivative Works). Under this license, works must always be attributed to the copyright holder (original author), cannot be used for any commercial purposes, and may not be altered. Any other use would require the permission of the copyright holder. Students may inquire about withdrawing their dissertation and/or thesis from this database. For additional inquiries, please contact the repository administrator via email (scholarship@uwindsor.ca) or by telephone at 519-253-3000ext. 3208.

A Heuristic Approach for Impairment-Aware Static RWA in WDM
Translucent Networks.

by

Ganesh Santosh Akula

A Thesis

Submitted to the Faculty of Graduate Studies
through the School of Computer Science
in Partial Fulfillment of the Requirements for
the Degree of Master of Science at the
University of Windsor

Windsor, Ontario, Canada

2014

© 2014, Ganesh Santosh Akula

A Heuristic Approach for Impairment-Aware Static RWA in WDM
Translucent Networks.

by

Ganesh Santosh Akula

APPROVED BY:

S. Panday

Department of Chemistry and Biochemistry

X. Yuan

School of Computer Science

S. Bandyopadhyay, Advisor

School of Computer Science

A. Jaekal, Advisor

School of Computer Science

September 16, 2014

DECLARATION OF ORIGINALITY

I hereby certify that I am the sole author of this thesis and that no part of this thesis has been published or submitted for publication.

I certify that, to the best of my knowledge, my thesis does not infringe upon anyone's copyright nor violate any proprietary rights and that any ideas, techniques, quotations, or any other material from the work of other people included in my thesis, published or otherwise, are fully acknowledged in accordance with the standard referencing practices. Furthermore, to the extent that I have included copyrighted material that surpasses the bounds of fair dealing within the meaning of the Canada Copyright Act, I certify that I have obtained a written permission from the copyright owner(s) to include such material(s) in my thesis and have included copies of such copyright clearances to my appendix.

I declare that this is a true copy of my thesis, including any final revisions, as approved by my thesis committee and the Graduate Studies office, and that this thesis has not been submitted for a higher degree to any other University or Institution.

ABSTRACT

In a Wavelength Division Multiplexed (WDM) optical network, data is communicated using modulated optical signals. In a WDM network, corresponding to each connection request, a lightpath is to route the optical signals through the network. During its propagation through the optical network the quality of an optical signal degrades due to various physical phenomena. Regenerators are devices to restore the quality of optical signals in WDM networks. Our objective is to propose a new heuristic to carry out Routing and Wavelength Assignment (RWA), taking into consideration the physical layer impairments. For a given set of source-destination pairs and the topology of a network, this heuristic will carry out RWA using a minimum number of regenerators, while maintaining a desired level of quality of transmission.

DEDICATION

To my loving parents:

Father: Sivanna Akula

Mother: Rajeswari Akula

ACKNOWLEDGEMENTS

I would like to take this opportunity to convey my sincere thanks to my supervisors, Dr. Subir Bandyopadhyay and Dr. Arunita Jaekel, for their guidance and support all throughout my graduate studies. This work could not have been achieved without their advice, suggestions and cooperation.

I would like to thank members of my M.Sc. thesis committee, Dr. Siyaram Pandey, Dr. Xiaobu Yuan and Dr. Luis Rueda for their valuable time, suggestions and constructive comments.

I would also like to thank Dr. Quazi R. Rahman, Sri Harsha Varanasi [1], Arijit Paul [2], Ramlal for their cordial support and help, as well as everybody else who has offered any help, during my graduate study at the University of Windsor.

Ganesh Santosh Akula

TABLE OF CONTENTS

DECLARATION OF ORIGINALITY	iii
ABSTRACT	iv
DEDICATION	v
ACKNOWLEDGEMENTS	vi
LIST OF TABLES	xi
LIST OF FIGURES	xiii
LIST OF ACRONYMS	xiv
1 Introduction	1
1.1 Overview of Optical Networks	1
1.2 Motivation	3
1.3 Problem Statement	4
1.4 Thesis Organization	5
2 Review	6
2.1 Introduction to optical fiber communication	6
2.2 Components of Optical Network	8
2.2.1 Transmitter (TX) and Receiver (RX)	9
2.2.2 De-multiplexer and Multiplexer	10
2.2.3 Optical Cross Connect	10
2.2.4 Optical Amplifier	11

2.2.5	Regenerator	11
2.3	Different types of optical networks	13
2.3.1	Transparent Network	13
2.3.2	Opaque network	13
2.3.3	Translucent network	14
2.4	Introduction to physical layer impairments	14
2.4.1	Linear Impairments	14
2.4.2	Non-Linear Impairments	16
2.5	Routing and Wavelength Assignment (RWA)	18
2.5.1	RWA in translucent networks	20
2.6	K -Shortest Paths Algorithm	22
3	A Heuristic Approach for Impairment-Aware Static RWA in WDM	
	Translucent Networks	24
3.1	A Heuristic Approach for Solving RWA Problem	25
3.1.1	Notations	26
3.2	Maximal Clique	31
3.3	Integer Linear Programming (ILP) Formulation to reduce the congestion	33
3.3.1	Notation of Variables	34
3.3.2	Description of the ILP	35
3.4	Example	37
3.4.1	Computing Shortest Paths	38
3.4.2	Regenerator Locations	39
3.4.3	Maximal Clique	40
3.4.4	Selection of Optimal Paths	40
3.4.5	Channel Assignment	41

4	Experimental Results	42
4.1	Simulation Overview	42
4.1.1	Network Generator	45
4.1.2	Commodity Generator	46
4.1.3	k -Shortest Paths Generator	46
4.1.4	Module2	47
4.2	Results	49
4.2.1	Execution Time	49
4.2.2	Regenerator Count	51
4.2.3	Commodities Handled	53
4.2.4	Effect of Number of Channels per Fiber	54
4.3	Repare vs Heuristic Approach	55
4.3.1	Comparison of Execution Time	56
5	Conclusion and Future Work	60
5.1	Conclusion	60
5.2	Future Work	61
	Bibliography	62
	VITA AUCTORIS	66

LIST OF TABLES

3.2.1 4 paths through a network	32
3.4.1 Length of edges for the network shown in Fig. 3.4.1.	37
3.4.2 Summary of Maximal Clique for the three requests.	40
3.4.3 Summary of optimal routes selected by the ILP.	41
3.4.4 Summary of Lightpath allocation to all the requests	41
4.1.1 Description of different modules in a simulator	44
4.1.2 Weight of Bi-directional Edges for a particular instance of network topology shown in Fig. 4.1.2.	46
4.1.3 Summary of Module 2 components described above.	48
4.2.1 Execution time for 20-Node networks for Different commodity size . .	50
4.2.2 Execution time for 40-Node networks for Different commodity size . .	50
4.2.3 Execution time for 60-Node networks for Different commodity size . .	50
4.2.4 Regenerators Count for 20 Node size network	52
4.2.5 Regenerators Count for 40 Node size network	52
4.2.6 Regenerators Count for 60 Node size network	52
4.2.7 Successfully Handled Commodities for 20 Node size network	54
4.2.8 Successfully Handled Commodities for 40 Node size network	54
4.2.9 Successfully Handled Commodities for 60 Node size network	54
4.3.1 Node and Commodity size considered for comparison purpose	56
4.3.2 Execution Time Comparision for 8 node network	57

4.3.3 Execution Time Comparison for 10 node network	57
4.3.4 Execution Time Comparison for 12 node network	58

LIST OF FIGURES

2.1.1 Optical Fiber Cross-Section [3].	7
2.1.2 Figure Showing Total Internal Reflection of Optical Signal [4].	8
2.2.1 Diagram showing different optical components [5].	9
2.2.2 Figure showing optical cross connect [6].	10
2.2.3 Figure showing a sample regenerator [7].	12
2.2.4 Figure showing 3R regenerator [8].	13
2.4.1 Figure showing a. Adjacent Channel Interference b. cross talk on lightpath by other lightpath [9].	18
3.1.1 Optical Reach and Regenerator Placement	29
3.2.1 Path Intersection Graph for $m = 2$	33
3.4.1 6-Node Network Topology	37
4.1.1 Simulator Block Diagram.	43
4.1.2 A 5-node network	45
4.2.1 Shows Time taken for different commodity size for every node size network	51
4.2.2 Graph Showing Total Number of Regenerators used.	53
4.2.3 Percentage of Failures in a 60-Node network for Different Channel Size	55
4.3.1 Time taken for different commodity size in a 8 node network	57
4.3.2 Time taken for different commodity size in a 10 node network	58

4.3.3 Time taken for different commodity size in a 12 node network	59
--	----

LIST OF ACRONYMS

ILP - Integer Linear Program

OXC - Optical Cross Connect

RWA - Routing and Wavelength Assignment

WDM - Wavelength Division Multiplexing

TX - Transmitter

RX - Receiver

E-O-E - Electrical-Optical-Electrical

ASE - Amplified Spontaneous Emission

CD - Chromatic Dispersion

PMD - Polarization-Mode Dispersion

XPM - Cross Phase Modulation

FWM - Four Wave Mixing

XT - Optical Switch Cross Talk

Chapter 1

Introduction

1.1 Overview of Optical Networks

Currently nearly half of the whole world population uses internet [10]. This involves a huge amount of data transfer, potentially over long distances. The need for reliable high speed communication is growing rapidly, due to a wide range of applications including e-commerce applications, multimedia gaming etc. Various actions can be performed through network communications like data transfer, sending emails to communicate from one part of the world to another part of the world, or connect to a high speed server to perform remote computations.

Initially electronic communication started with copper as the medium to transfer data to be communicated between any two computers [6]. Typically such communication is suitable for short to medium distances, ranging from 1km - 4.5 km [11]. Relatively high levels of signal attenuation and noise make this unsuitable for high speed communication over long distances.

Some of the disadvantages of copper wire communication are [12]:

- Cannot handle higher bandwidth data communication.
- High signal to noise may occur.

- High bit error rate may occur.
- suitable for carrying data over relatively short distance only.

Fiber optic communication can be used to mitigate many of the disadvantages mentioned above. Unlike copper wire, optical fibers can carry huge amounts of data at a very high speed over long distances. Because the optical fiber is very thin and flexible it is also easier to install [12]. Some of the important advantages of fiber optic communication are [12]:

- High bandwidth (up to terabits per sec).
- Low signal attenuation.
- Low signal distortion.
- Low cost.
- Low material usage.
- Low power requirement.
- Low space requirement.

An important factor contributing success of optical fiber communication is the concept of wavelength division multiplexing (WDM) [6]. WDM divides the vast transmission bandwidth available on a fiber into several non-overlapping smaller capacity channels. Each of these channels can be operated at moderate bit rate (2.5-40 Gb/s) [6], and corresponds to a different wavelength. The available bandwidth is envisioned as a set of channels, which are separated by a minimum distance called channel spacing to avoid any kind of interference.

1.2 Motivation

All-optical networks [13], using wavelength division multiplexing (WDM), are attractive candidates for building wide area networks (WANs). A *lightpath* in a WDM network is an end-to-end optical communication channel between two nodes, traversing one or more links in the physical topology [6], and the set of lightpaths define the *logical* topology of the network. For each lightpath (logical edge in the logical topology), it is necessary to determine the physical route and the associated wavelength (or channel); this is the well-known *routing and wavelength assignment* (RWA) problem [6].

Although optical fibers can transmit signals over relatively long distances, due to transmission impairments due to physical phenomena, signal regeneration is required if the length of a lightpath exceeds a specified limit. A lightpath which requires such signal regeneration is called a *translucent* lightpath [15]; and an optical network with one or more translucent lightpaths is called a *translucent* optical network. In the past decades, much work has been done in the area of RWA for *transparent* optical networks, i.e. networks consisting solely of lightpaths that do not require signal regeneration. However, traditional RWA approaches for transparent networks are not directly useful for translucent networks.

The signal regeneration required in translucent lightpaths are carried out by specialized equipment called *regenerators* [16]. Such regenerators can be costly and specialized RWA strategies for translucent networks, also called impairment-aware RWA (IA-RWA), must take this into consideration. This increases the complexity of IA-RWA compared to traditional RWA, which has been shown to be NP-complete [14]. Therefore, it is important to develop efficient heuristic techniques for IA-RWA, which can consider additional parameters such as regenerator cost and availability, effect of impairments and the length of lightpaths, and still generate good solutions within a reasonable time.

1.3 Problem Statement

One of the major challenges for wavelength division multiplexed optical networks is routing and wavelength assignment (RWA) of optical signals, taking into consideration the impairments caused by the physical layer. Classic algorithms for RWA which do not consider impairments are traditionally used to solve the RWA problem in transparent networks [9]. In a long haul translucent WDM network, optical signals are regenerated at selected nodes to recover the quality and the level of the signals. In such networks the use of classic RWA may give an invalid solution, since the algorithm does not take into account the degradation of signals due to physical impairments.

In this thesis, we investigate the problem of static RWA in translucent networks, taking into account the physical impairments. Given a physical fiber network, with a specified amount of resources, we propose a new heuristic approach for performing RWA that establishes as many translucent lightpaths as possible and makes the best utilization of optical-electrical-optical (O-E-O) regenerators and other optical network resources. Our approach is efficient and can handle large networks, with many demands.

In order to evaluate our proposed approach, we have generated random networks or physical topologies of different sizes. For each network, we have generated a number of different demand sets, consisting of the set of lightpaths to be established over the network. The generated random topologies, demand sets and network parameters, including the number of available channels per fiber and regenerator locations are provided as input to our algorithm.

We have compared our proposed approach with a well known existing approach [17], which also solves the RWA problem for translucent networks. We compare our solution to the existing one in terms of the following important parameters:

- the number of regenerators needed to satisfy the commodities,

- the number of channels utilized and
- the total execution time.

1.4 Thesis Organization

The thesis is organized as follows, Chapter 2 covers the relevant background material, including fundamentals of optical networks. It also describes recent work in RWA for WDM network, in particular for translucent networks. Chapter 3 presents our proposed heuristic approach, along with some illustrative examples. Chapter 4 presents and discusses our simulation results and provides comparisons with existing techniques. Finally in Chapter 5 presents our conclusions and some directions for future work.

Chapter 2

Review

This chapter introduces some fundamental concepts of optical networks that are required for the remainder of the thesis. This includes a review of common networking components, as well as an overview of existing approaches for RWA in both transparent and translucent optical networks. We also review a well-known algorithm [18] for finding k-shortest paths for a given topology, which we use in our heuristic and a translucent RWA algorithm [17], which we use for comparisons in Chapter 4.

2.1 Introduction to optical fiber communication

Optical signals are electromagnetic signals which are modulated to carry information over long distances [19]. In order to transmit these modulated signals a specially designed medium are called *optical fiber* is used.

An optical fiber is thin, flexible glass cylinder core made of pure silica with certain refractive index, which is surrounded by another cylindrical layer called cladding made of doped silica with a lower refractive index than core [6]. The third layer called buffer covers the core and cladding and provides a protective layer to the fiber and protects from any kind of damage such as variation in environments or climatic conditions. Fig 2.1 shows the cross section of an optical fiber consisting of the three different

layers mentioned above.

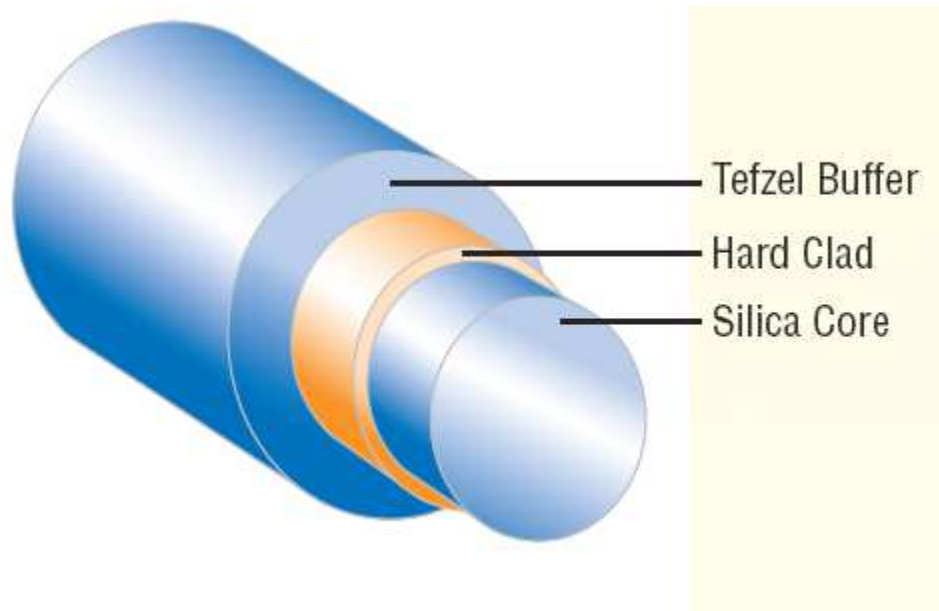

Fig. 2.1.1: Optical Fiber Cross-Section [3].

In optical fiber communication many individual optical fibers are collected together to form an optical cable. These optical cables can then be deployed under the water surface or under the ground to connect geographically distant nodes. The optical signal carries the data or information which is to be transmitted along the optical fiber. The signal is transmitted using the concept of *total internal reflection* [20]. Each light pulse, which is to be propagated, is incident on the core-cladding interface at an angle greater than critical angle. Since the refractive index of the cladding is less than that of the core, the optical signal traverses along the medium because of total internal reflection. Fig 2.1.2 illustrates how a signal travels along a fiber using total internal reflection.

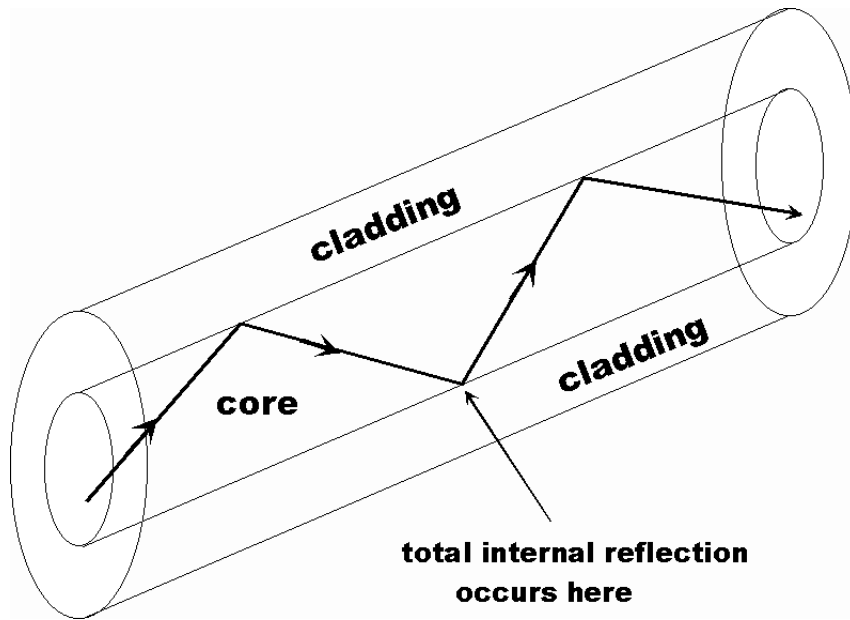

Fig. 2.1.2: Figure Showing Total Internal Reflection of Optical Signal [4].

2.2 Components of Optical Network

Each node in an optical network performs a variety of functions and makes use of a number of different devices and components to carry out its tasks. In this section, we briefly describe the following essential components of an optical network.

- Transmitter and Receiver.
- Multiplexer and De-multiplexer.
- Optical cross connects.
- Optical Amplifier.
- Regenerators.

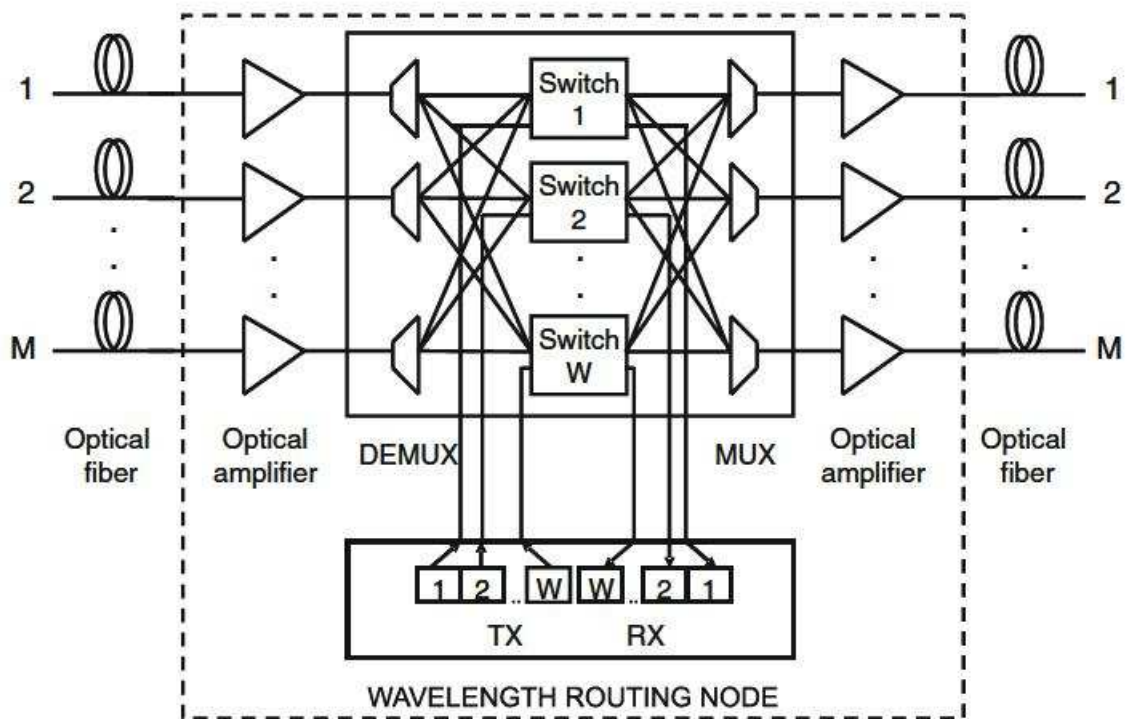

Fig. 2.2.1: Diagram showing different optical components [5].

2.2.1 Transmitter (TX) and Receiver (RX)

Optical signals are generated by a laser [21, 22] which stands for *light amplification by stimulated emission of radiation*. An electronic device called transmitter (TX) is used to generate an optical signal of a particular wavelength. Mostly fixed wavelength transmitters are used in current networks. The data which is in present in electronic form is converted to an encoded optical signal using various modulation schemes [6]. At the destination node, these encoded signals are converted back to electronic domain using an electronic device called a receiver (RX).

2.2.2 De-multiplexer and Multiplexer

A multiplexer (MUX) has a number of inputs, each carrying signals using a distinct channel. It combines all these signals to generate a single output signal that is transmitted on the output fiber. At an intermediate node or at the destination node, this combined optical signal needs to be separated into its constituent channels. This operation is performed by a de-multiplexer (DEMUX).

2.2.3 Optical Cross Connect

An optical cross-connect (OXC) is a device used to switch high-speed optical signals from an input port to an output port of a node in a fiber optic network. The connections between the outputs of the de-multiplexer and the inputs of the multiplexers determine how the signals on the input fibers will be routed to the output fibers.

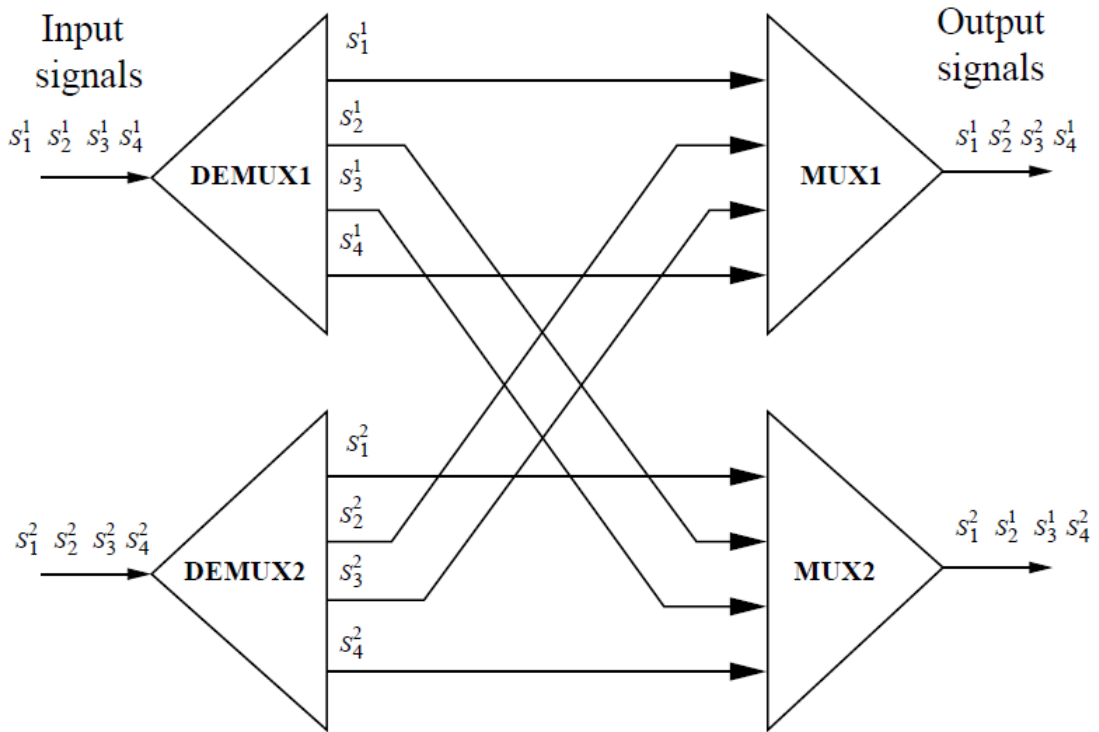

Fig. 2.2.2: Figure showing optical cross connect [6].

There are two types of optical cross connects a) static or b) dynamic [6], depending on whether the connections from the outputs of the de-multiplexers to the inputs of the multiplexers are fixed or can be set in a dynamic fashion. Fig 2.4 shows a diagram of a static cross connect.

2.2.4 Optical Amplifier

As the optical signal travels along a fiber, the signal strength decreases due to attenuation. If the signal level is allowed to decrease too much, it will not be possible to detect it properly at the destination. Therefore it is essential to amplify the signal after specified intervals, and it is desirable to do this without converting the signal to the electronic domain. This function is performed by an component called an *optical amplifier* [6], which are placed at regular intervals along the fiber.

2.2.5 Regenerator

Optical amplifiers can boost the signal strength, but the signal is also subject to distortion due to physical impairments in the fiber. Such distortions cannot be compensated for by simple amplification. A regenerator is used to overcome such problems by restoring the signal to its original form. This involves a conversion of the optical signal into electrical form, then reconvertng it back to the optical domain. The amount of distortion increases with distance and in current wide-area networks (WAN), a signal may need to undergo regeneration multiple times as it travels from its source node to its destination.

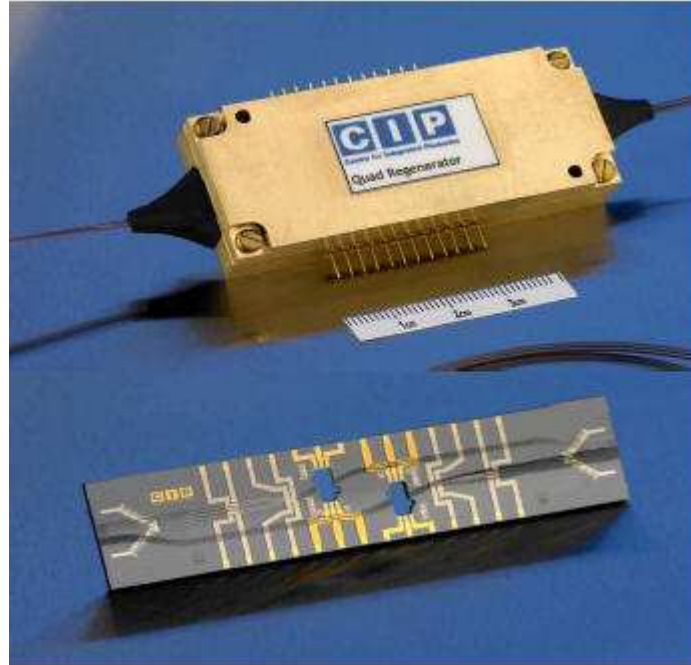

Fig. 2.2.3: Figure showing a sample regenerator [7].

The regeneration process is often referred to as *3R regeneration*, since it involves three main operations: i) re-amplifying ii) re-shaping and iii) re-timing [16] of the signal, all of which is carried out in the electronic domain. After 3R regeneration the signal is essentially restored its original state and can continue propagating along the fiber. Fig. 2.2.4 shows a block diagram of the operations performed in a regenerator. The regenerator along with signal regeneration also has the capability of performing wavelength conversion at no additional cost. This is possible because, when converting the signal from the electronic to optical domain any available wavelength can be selected. The maximum distance travelled by the optical signal before a regenerator is required is called *optical reach* [8], it is considered as a metrix for placing regenerators along the optical signal.

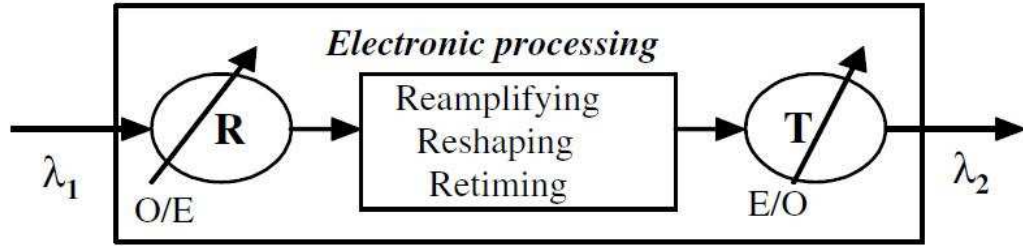

Fig. 2.2.4: Figure showing 3R regenerator [8].

2.3 Different types of optical networks

Optical networks can be classified into 3 types [15], as follows:

- Transparent Network
- Opaque Network
- Translucent Network

2.3.1 Transparent Network

A network is said to be *transparent* if there are no regenerators used on any lightpath established over the network [15]. In this type of network all source-destination are within the *optical reach* [8], which is the maximum distance the signal may travel without needing regeneration. This means that transparent networks are relatively small and can only cover limited geographical distances.

2.3.2 Opaque network

In *opaque* optical networks [15], regenerators are available at each node. As the optical signal travels from its source to its destination, it undergoes signal regeneration at each intermediate node. This means the signal quality remains relatively high along

the entire path. However, the requirement of having regenerators at each node, means the cost of the network will be very high.

2.3.3 Translucent network

This third type of network, a *translucent* optical network [15], attempts to overcome the limitations of both transparent and opaque networks. A Translucent lightpath is a combination of two or more transparent lightpaths with each transparent component called a *segment* of the translucent lightpath. In this type of network there is no need to place regenerators at every node, rather regenerators are placed sparsely throughout the network at specified nodes. Instead of undergoing regeneration at each intermediate node, the optical signals are only regenerated when required. This allows lightpaths to cover long distances, by undergoing signal regeneration; but the cost of translucent networks is much less compared to opaque networks.

2.4 Introduction to physical layer impairments

During the propagation of an optical signal along the fiber there will be distortion of optical signal due to various *physical layer impairments* [15] and interference from co-propagating signals. These impairments can be classified as: a) Linear Impairments and b) Non-Linear Impairments.

2.4.1 Linear Impairments

When an optical signal propagates along a fiber, the intensity of the signal gradually decreases and the shape of the signal also gets distorted. Signal distortion will occur even if there are no other signals propagating along the same fiber and interfering with the original signal. Such distortion, which is independent of other signals, is caused by physical *layer impairments* that arise due to the physical characteristics

of the fiber itself and are referred to as linear impairments [15]. Some common linear impairments in optical fibers are listed below and briefly described in this section.

- Amplified Spontaneous Emission (ASE)
- Attenuation
- Chromatic Dispersion (CD)
- Polarization-Mode Dispersion (PMD)

Amplified Spontaneous Emission (ASE)

Spontaneous emission is the process by which atoms or molecules in an excited state undergo a transition to a lower energy state or ground state and emit energy [23]. ASE (*amplified spontaneous emission*) is generated when the emitted energy due to spontaneous emission, which is considered as a new optical signal, is amplified along with other existing optical signals by the optical amplifier. This new signal propagates with other optical signals along the fiber, and is detected as noise at the receiver end [24]. Since it is generated during propagation, it decreases the intensity of the actual signal and is one of the main sources of low signal strength at the receiver.

Attenuation

Attenuation is one of the linear impairments that occurs when an optical signal propagates along the fiber, where it gets scattered; or absorption of the optical signal along the edges occurs [25]. Apart from this other factors such as the environment in which the fiber is placed, the way it is bent and other manufacturing defects can also lead to attenuation. Attenuation causes decrease in the intensity of the optical signal resulting in a lower signal to noise ratio (SNR) at the receiver.

Chromatic Dispersion (CD)

Chromatic Dispersion in an optical fiber occurs when the different frequencies of the optical signal travel with different velocities, and arrive at the destination at different times [24]. A special type of fiber, called dispersion compensating fiber [24], can be used to negate the adverse effects of chromatic dispersion.

Polarization Mode Dispersion

Polarization is a property of a wave that can oscillate with more than one orientation [26]. Polarization Mode Dispersion is a phenomenon in optical fiber communication, which occurs when different polarizations of optical signals (caused due to non-circular nature of the optical fiber) travel with different velocities and arrive at the destination node at different times [24].

2.4.2 Non-Linear Impairments

The linear impairments discussed above affect the optical signal and are independent of existence of other lightpaths along its path. On the other hand, *nonlinear impairments* [15] occur when different optical signals traversing a common node or link interfere with each other. So, the effects of nonlinear impairments are dependent on the number of lightpaths (along with their assigned paths and channels) that are established over the network at any given time. In this section, we briefly discuss the following 3 types of non-linear impairments.

- Cross Phase Modulation (XPM)
- Four Wave Mixing (FWM)
- Optical Switch Cross Talk (XT)

Cross Phase Modulation (XPM) [9]

This type of impairment is caused due to existence of light path on adjacent, second adjacent channels in the same optical fiber. As shown in Fig: 2.4.1 light path p experience adjacent channel interference on edges (n_1, n_2) (n_2, n_3) (n_3, n_4) due to existence of adjacent channels $w+1$, $w-1$ and it effects the light path on channel w .

Four Wave Mixing (FWM) [9]

FWM is a non-linear phenomenon in which three channels combine together to form a fourth which happens to match with one of the channel among the three mixed. The effects of FWM is more when they are more active adjacent channels. In Fig: 2.4.1 w , $w+1$, $w-1$ represents adjacent channels.

Optical Switch Cross Talk (XT) [9]

It is power leakage between lightpaths crossing same switch and using the same wavelength as shown in figure 2.4.1, there are two interfering sources on node n_2 as shown in figure 2.4.1 below and one on node n_1 .

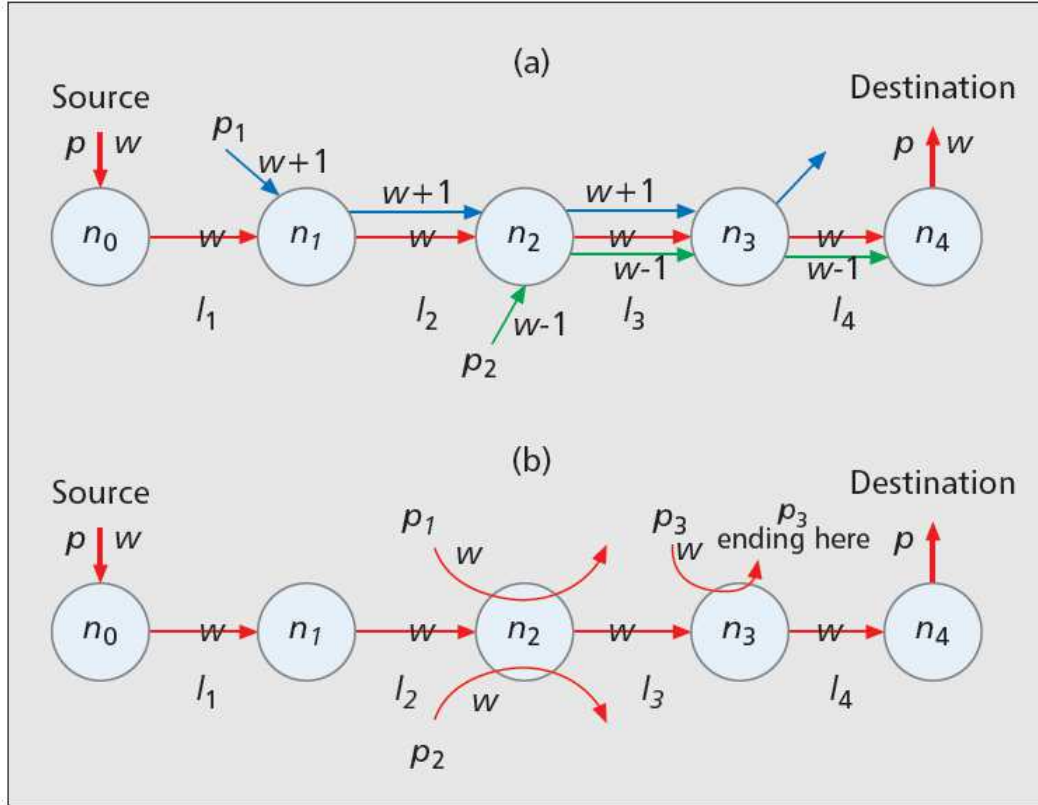

Fig. 2.4.1: Figure showing a. Adjacent Channel Interference b. cross talk on lightpath by other lightpath [9].

2.5 Routing and Wavelength Assignment (RWA)

A lightpath [6], in an optical network, is defined as a point-to-point communication path that optically connects an optical transmitter at a source end-node to an optical receiver at a destination end-node. The Route and Wavelength Assignment (RWA) problem [6] assigns a route over the physical topology and an available channel on each edge of that route for each lightpath established over the network. In [17], the authors provide an excellent review of the routing and wavelength assignment (RWA) problem for WDM networks. In order to solve the RWA problem two important constraints have to be considered:

- Wavelength Clash Constraint
- Wavelength Continuity Constraint

Wavelength Clash Constraint

The *wavelength clash constraint* states that if two or more lightpaths share a common physical link, then each lightpath must be assigned a unique channel (or wavelength) on that link. In other words, no two lightpaths traversing a common link at a given time may be assigned the same channel.

Wavelength Continuity Constraint

The *wavelength continuity* constraint states that in the absence of wavelength converters, the same channel must be maintained along the entire route of a lightpath. In other words, if a lightpath traverses multiple physical links then it must be assigned the same channel on each link in its path.

Two possible scenarios are typically considered for the RWA problem. In *static* allocation all lightpaths are planned in advance so that either a specific lightpath is pre-assigned for each possible source destination pair or the entire set of lightpath requests is known beforehand and channel assignments are made for the request as a whole [6]. In *dynamic* allocation, lightpaths are created on demand and are taken down when the communication is over, and the WDM channels used for this communication are reclaimed for future use in some other communication [6]. In a dynamic scheme a connection request may fail, if adequate resources are not available in the network.

Different approaches to solving the RWA problem, typically try to optimize some specified design objectives, while finding a feasible route and wavelength for each lightpath. For example, the objective may be to minimize the amount of resources used, or maximize the number of lightpaths established given certain resource con-

straints. Both integer linear program (ILP) based optimal solutions and heuristic approaches [17], [27], [28], have been proposed in the literature to solve the RWA problem.

2.5.1 RWA in translucent networks

When considering RWA in translucent networks, a number of additional factors need to be considered such as the distance between the source and destination nodes of the lightpath, the amount of distortion caused by physical layer impairments, and the availability of regenerators along the selected path. In recent years, a number of researchers have considered the problem of RWA in translucent networks [17], [27]. In this section we briefly review some of the important work in this area that is relevant to this thesis.

In [17] the authors state that during transmission of an optical signal, impairments are caused by the optical fiber or components used in the optical network. These impairments are the main cause for bit errors during transmission of optical signals. To overcome this, authors introduce a novel ILP based technique for small networks and a heuristic approach for large networks. The main objective of both the ILP and heuristic approach is to place or utilize as few regenerators as possible.

In [27] the authors propose a new ILP technique and a greedy heuristic algorithm to solve impairment aware-routing and wavelength assignment (IA-RWA) problem, along with placement of regenerators at selected sites. The placement and assigning of regenerators is considered as a virtual topology design problem, which uses the ILP and greedy heuristic technique to solve the problem. This approach determines the sequence of regenerators (if any) to be utilized by each connection request (s, d). Each request is then transformed into a sequence of transparent lightpaths by terminating and regenerating the signal at the specified intermediate nodes, and RWA is performed with the goal of minimizing the number of blocked connections. The

authors state that the use of the quality factor estimator called Q_{factor} , reduces the complexity of the virtual topology design problem makes the approach efficient for small and large scale heterogeneous mesh networks.

In [28], the authors propose a novel ILP model, which considers physical layer impairments for small or medium size networks. The authors also propose a heuristic approach for wide-area or large networks, which considers linear and non-linear physical impairments individually. The main objective of the heuristic and ILP approaches is to reduce number of regenerators to be placed and accommodate the maximum number of requests.

For each lightpath demand a set of valid semi-lightpaths, which are transparent lightpath segments traversing a sequence of fibers without undergoing any signal regeneration, is calculated. These semi-lightpaths form a reachability graph [29], which describes the ability of the semi-lightpaths to reach from one node to another. The goal is to improve the strength of the signal and minimize the number of lightpaths which are blocked, by placing a minimum numbers of regenerators. In this approach, each lightpath is divided or segmented into a number of semi-lightpaths if the quality of the signal measured by QoT estimator is less than the threshold. This is accomplished by placing regenerators at required nodes. The ILP technique works fine for small size networks, but not for larger networks. A heuristic approach called 3-step heuristic is proposed for large networks, which considers linear physical impairments.

In [30], the authors state that the techniques used to strengthen the signal quality and to determine how many lightpaths should be deployed in a network should be of low cost without compromising the quality of the optical signal. The authors propose a novel ILP technique and use CPLEX to solve the ILP formulation [31]. The main aim of the ILP formulation is to minimize the total cost of the dimensioned network (the optimization of the capacity put on deployed network).

The authors claim that this approach, dimensioning of WDM network and placing

regenerators for long haul optical WDM network considering impairments, reduced the number of regenerators to be deployed. This results in a lower cost network design, when compared with length-based regeneration approach.

2.6 *K*-Shortest Paths Algorithm

In order to solve the translucent RWA problem, one important task that must be performed is to determine a set of possible routes between each source-destination node pair. There are a number of existing techniques that can be used to accomplish this task, and we have selected and implemented one well-known technique called Yen's algorithm [18] for our research. Since this algorithm is an important part of our heuristic, we are giving a brief overview of the algorithm in this section.

Given a graph $G (V, E)$ consisting of $|V|$ vertices and $|E|$ edges and distances between the vertices, Yen's algorithm can be used to find the k shortest loopless paths between any two vertices. A path is said to be loopless if a node already covered during the path formation is not encountered or traversed again. The reason for choosing k -shortest loopless paths is that sometimes the shortest path route for a given commodity cannot be used to satisfy the request due to insufficient channels. In this case alternative routes should be tried, in order to reduce the blocking probability.

Yen's algorithm is basically divided into stages as described below:

- First find the shortest path using any of the available shortest path algorithms and then explore for next shortest path by finding $k-1$ deviations of the best path. Each path found will be a potential candidate for next shortest path and stored in a separate list.
- In the next stage iteratively pick up the shortest path among available paths in the candidate list and further explore and update the paths in candidate list, until all the k shortest paths are determined.

This algorithm was implemented as a part of our proposed heuristic to find k shortest paths between each node pair. These paths were then given as input to other functions in the heuristic for further processing, as discussed in Chapter 3.

Chapter 3

A Heuristic Approach for Impairment-Aware Static RWA in WDM Translucent Networks

In this chapter we will discuss how we carried out routing and wavelength assignment (RWA). It is always important to utilize the full capabilities of the optical fibers in the network to make best use of the network resources. Our objective is to maximize the number of requests for communication that can be handled by the network, taking into consideration all the physical layer impairments. Even without taking into account the physical layer impairments, the classic RWA is known to be NP-complete [14]. In order to handle networks of practical size, it is necessary to use a heuristic that gives “reasonably good” solutions. Our heuristic algorithm uses *integerlinearprogramming* (*ILP*) technique to determine promising paths for each (*source,destination*) pair and uses CPLEX to solve the problem.

In our heuristic we have used Yen’s algorithm [18] described in Chapter 2 to find k shortest paths between the source and destination of each request for communication and have used the concept of maximal clique to eliminate paths which are not likely

to give good results. The heuristic works for both small (~ 20 nodes) and large (~ 60 node) sized networks.

3.1 A Heuristic Approach for Solving RWA Problem

The input to the heuristic includes details about the network, the optical reach and the requests for data communication. The network is represented by a weighted graph $G = (N, E)$, where N denotes a set of nodes, with each node corresponding to a computer in the network and E denotes a set of edges, where each edge $(i, j) \in E$ denotes a fiber from node i to node j . Each edge (i, j) has a weight denoting the length of the fiber from i to j . We view the requests for data communication as a set of commodities to be shipped, using the network represented by graph G . Each commodity is characterized by the pair (s, d) where the nodes s and d denote the source and the destination for the request for data communication respectively. If the heuristic can ship a commodity, say from s to d , it means that a translucent lightpath may be set up from s to d , without violating either the network layer constraints or the physical layer constraints. In our approach we have estimated the physical layer impairments using the notion of optical reach discussed in Chapter 2.2.5. This means that the length of each segment of the translucent lightpath from s to d must not exceed the optical reach θ . The objective of our approach is to satisfy as many requests for communication as possible, taking into consideration the physical layer impairments and the network layer constraints. If a request (s, d) is successful, then the heuristic assigns a route for shipping the commodity corresponding to (s, d) , from s to d , using the route determined by the heuristic. At the same time, the heuristic ensures that a channel number can be assigned to each segment to this translucent lightpath corresponding to the commodity (s, d) . The algorithm uses an iterative

approach and is described below.

3.1.1 Notations

(s, d) : the (source, destination) pair corresponding to the request for communication.

R : a list of user requests for communication, where each request is a pair consisting of a source node s and destination node d .

E : the set of edges in the network, where an edge in the graph is represented by a pair (i, j) , which corresponds to a fiber connecting node i to node j .

N : the set of nodes in the network.

$G = (N, E)$: the network graph having set of nodes N and set of edges E .

C_e : the set of channels on edge $e \in E$ in graph G which are available for setting up new lightpaths.

C : a list of sets C_e , for all edges $e \in E$. We assume that, by specifying edge e , the set C_e may be retrieved from list C .

θ : a constant representing the optical reach of the network G .

$W(e)$: gives the length of the fiber corresponding to edge $e \in E$.

P_d^s : represents the list of shortest paths from s to d that is currently under consideration.

P_d^{sr} : represents the r^{th} shortest path from s to d in the list P_d^s .

P : represents the list of all lists P_d^s , $(s, d) \in R$. We assume that, by specifying s and d , the element P_d^s may be retrieved from list P .

γ_d^{sr} : represents the regenerator location (s) for path P_d^{sr} .

γ_d^s : represents the list of regenerator locations for the paths in γ_d^{sr} .

m : a small integer denoting the maximum number of edges two paths for the same source destination pair are allowed to share.

M_d^s : a maximal clique of paths for the pair (s, d) .

M : represents the set of all sets M_d^s , $(s, d) \in R$. We assume that, by specifying s and d , the element M_d^s may be retrieved from list M .

ψ_d^s : the index number associated with the candidate path, from source s to destination d , that is currently under consideration.

ψ : list of all ψ_d^s , $(s, d) \in R$. We assume that, by specifying s and d , the element ψ_d^s may be retrieved from list ψ .

$yen(G, s, d, k)$: This function returns a list of k shortest paths from source s to destination d , in graph G , using Yen's algorithm [18]. If k paths cannot be found, the function returns a list containing as many paths from s to d as possible.

$regloc(G, P_d^s, \theta)$: This function returns a list of regenerator locations. Each element in the list corresponds to a path in P_d^s .

$maxclique(G, P_d^s, m)$: This function determines a maximal clique of paths which have m or fewer common edges.

$selectpathilp(G, R, M, P)$: This function selects, for each source, destination pair (s, d) in list R , the path from s to d that reduce the congestion of the network as much as possible. The path selected by the ILP is identified by its location (or index) in the list P_d^s . The function returns a list of the indices of all the paths corresponding to the commodities in R .

$assign_channel(G, p, r, C)$: This function takes as arguments the graph G , a path p for a commodity (say from s to d), a regenerator placement scheme r for the supplied path from s to d and the list of the set of channels available on each fiber in the network. The function returns true if it is possible to set up a translucent lightpath from s to d using the supplied path. Otherwise, the function returns false.

$channel_fill(G, p, r, C)$: This function is similar to $assign_channel(G, p, r, C)$. The only difference is that this function is called after $assign_channel(G, p, r, C)$ has verified that a lightpath can be set up using the path p and this function actually allots a channel to each segment and updates the values of C_e for all $e \in E$.

delete_element(\mathbf{R}, s, d): This function deletes commodity (s, d) from the list \mathbf{R} of all commodities.

delete_path(p, P_d^s): This function deletes an infeasible path p from P_d^s , the list of paths from s to d .

Algorithm 1 Heuristic

Input : Network Graph \mathbf{G} , the set of requests for communication \mathbf{R} , the values of m and θ

Output: Route and Wavelength assignment for the maximum possible number of requests for communication.

```

1: for each  $(s, d)$  in list  $\mathbf{R}$  do
2:    $P_d^s \leftarrow \text{yen}(G, s, d, k)$ 
3:    $\gamma_d^s \leftarrow \text{regloc}(G, P_d^s, \theta)$ 
4: end for
5: while (more requests may be handled) do
6:   for each  $(s, d)$  in list  $\mathbf{R}$  do
7:      $M_d^s \leftarrow \text{maxclique}(G, P_d^s, m)$ 
8:   end for
9:    $\psi \leftarrow \text{selectpathilp}(G, \mathbf{R}, M, P)$ 
10:  for each  $(s, d)$  in list  $\mathbf{R}$  do
11:    if ( $\text{assign\_channel}(G, P_d^{s\psi_d^s}, \gamma_d^{s\psi_d^s}, C)$ ) then
12:       $C \leftarrow \text{channel\_fill}(G, P_d^{s\psi_d^s}, \gamma_d^{s\psi_d^s}, C)$ 
13:       $\mathbf{R} \leftarrow \text{delete\_element}(\mathbf{R}, s, d)$ 
14:    else
15:       $P_d^s \leftarrow \text{delete\_path}(P_d^{s\psi_d^s}, P_d^s)$ 
16:    end if
17:  end for
18: end while

```

The algorithm described above may be viewed as a three stage process as follows:

Stage 1: Identify potential paths for each commodity (lines 1 – 4).

Stage 2: Find out which sets of paths are pairwise edge-disjoint to the maximum extent that we allow (lines 6 – 8).

Stage 3: Select a promising path for each commodity and check if the path may be used to set up a translucent lightpath (lines 9 – 17).

We repeated Stages 2 and 3 until we find that no new request can be handled.

In Stage 1, we used Yen’s algorithm¹ to find k -shortest paths from s to d in graph G for the commodity (s, d) (Step 2 of Algorithm 1). These paths are saved in set P_d^s . In Step 3 we call function *regloc* with arguments G, P_d^s and θ representing the network graph, the set of paths for the commodity (s, d) found in Step 2 and the optical reach respectively. This function finds the locations of the regenerator nodes for each path in P_d^s . For instance, if a path from s to d is as shown in 3.1.1, and the value of $\theta = 1000$, it is easy to see that one feasible placement is to put regenerators at b and e as shown in Figure 3.1.1 .

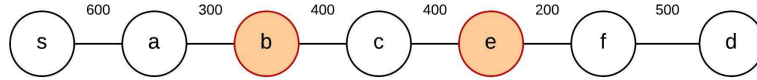

Fig. 3.1.1: Optical Reach and Regenerator Placement

The RWA problem we considered becomes intractable if we consider all possible paths for each commodity. To address this we have restricted our search space by limiting the number of paths for each commodity in successive stages. In Stage 1, we generated only k possible paths for each commodity, for some small value of k . In Stage 2, our task is to further reduce the set of paths for each commodity by selecting the most promising path for each commodity. Our rationale was that, if two paths p_1 and p_2 share many edges, it is likely that, when path p_1 is not usable due to network layer constraints, path p_2 is also not usable for the same reason. Our approach was to select a subset of paths from P_d^s , such that the number of shared edges between any two paths in our selected subset does not exceed some small number m . In Step 7, we have accomplished this using the function *maxclique* described in Section 3.2. After the heuristic completes Step 8, for each commodity (s, d) , we have a set M_d^s

¹described in Section 2.6

representing the promising paths for the commodity. List M is a list of all these sets M_d^s .

The objective of Step 9 is to select exactly one path for each commodity, such that the congestion of the network is minimized. Clearly the congestion cannot exceed the number of channels on a fiber. Further, if the commodities use paths that reduces the congestion, the likelihood that a channel assignment will succeed is improved. Function *selectpathilp* takes, as arguments, the graph G , the set of commodities R , the list of all cliques M and the list of all paths P . The function invokes a mathematical programming formulation, based on Integer Linear Programming (ILP), to select a path for each commodity. In Section 3.3 we have explained the ILP we used to carry out this selection. Function *selectpathilp* determines an index r which identifies path P_d^{sr} as the selected path for commodity (s, d) , for all $(s, d) \in R$. This index is saved in ψ_d^s , an element of list ψ .

The objective of the for-loop (lines 10 – 17) is to handle as many requests for communication as possible by allotting available network resources. In other words, we wish to allocate channels to set up as many lightpaths as possible in response to the requests in R . For some commodities the process may fail, since channels may not be available on the selected paths of such commodities, due to network layer constraints.

In Step 11, function *assign_channel* takes as arguments a graph G , a path p for each commodity, the corresponding regenerator placement a and the available channels C on each fiber in the network. We identify the path selected in Step 9, for commodity (s, d) , by its index ψ_d^s . Therefore $P_d^{s\psi_d^s}(\gamma_d^{s\psi_d^s})$ gives the path (regenerator placement) for the commodity (s, d) . If it returns true it means that channels are available to set up a lightpath from s to d using path $P_d^{s\psi_d^s}$. In other words, we know how we can set up a lightpath from s to d without violating either the network layer constraints or the physical layer constraints. Function *assign_channel* uses

the regenerator locations specified in $\gamma_d^{s\psi_d^s}$ to identify the segments. By taking into account the available channels on all fibers in a segment, it is simple to check whether at least one channel is available for each segment. If so, the function returns true. Otherwise, it returns false.

If function *assign_channel* returns true, in Step 12, function *channel_fill*) takes the same arguments as function *assign_channel* and actually allocates channels to the current commodity. The function returns the new list of available channels on each edge of the network. This is saved in C . Function *assign_channel* works in a way similar to function *assign_channel*, except for two differences. When it is invoked, we know that each segment has an available channel that may be used for this commodity. Function *assign_channel* simply allots one of these available channels to each segment and updates the list C . Since we have handled the commodity (s, d) in Step 12, in Step 13, we delete the commodity (s, d) from the list of commodities R , using function *delete_element*. Function *delete_element* is trivial and we have not described it.

If function *assign_channel* returns false, it means that the selected path $P_d^{s\psi_d^s}$ for commodity (s, d) cannot be used to set up a lightpath. In that case in Step 15, we delete the selected path $P_d^{s\psi_d^s}$ from the list of all path P_d^s , using function *delete_path* - another trivial function.

3.2 Maximal Clique

As explained in Section 3.1, we wish to consider a relatively small set of paths for each commodity and it is important to consider paths which which are “as disjoint as possible” compared to the remaining paths. To do this we use variable m to denote the maximum number of edges that two paths in our selected set are allowed to share. We use the concept of cliques and maximal cliques [32] in order to select, from k shortest paths obtained in Step 2 of the heuristic, the set of paths M_d^s . We now

construct a *Path Intersection Graph (PIG)* for a list of paths P_d^s as follows. Each node in the PIG is a path in the list of paths P_d^s , so that a node p^r in PIG corresponds to some path $P_d^{sr} = s \rightarrow a_1 \rightarrow a_2 \rightarrow a_3 \rightarrow \dots \rightarrow d$. There will be an edge between two nodes p^a and p^b of a PIG if the corresponding paths share m or fewer edges.

Example

Let 4 paths P_1, P_2, P_3, P_4 be as shown in Table 3.2.1.

Table 3.2.1: 4 paths through a network

Node	Path it Represents
P_1	$s_1 \rightarrow a \rightarrow b \rightarrow c \rightarrow d \rightarrow d_1$
P_2	$s_2 \rightarrow f \rightarrow g \rightarrow h \rightarrow i \rightarrow d_2$
P_3	$s_3 \rightarrow f \rightarrow g \rightarrow h \rightarrow i \rightarrow j \rightarrow d_3$
P_4	$s_4 \rightarrow a \rightarrow b \rightarrow c \rightarrow d \rightarrow e \rightarrow d_4$

In the corresponding PIG there will be 4 nodes labelled P_1, P_2, P_3 and P_4 . We see that path P_1 in table above does not share any edge with paths P_2 and P_3 and shares 3 edges with path P_4 . Assuming $m = 2$, we see that, in the PIG, nodes

- P_1 and P_2 will be connected by an edge.
- P_1 and P_3 will be connected by an edge.
- P_1 and P_4 will *not* be connected by an edge.

Proceeding in this way we obtain the PIG shown in Figure 3.2.1.

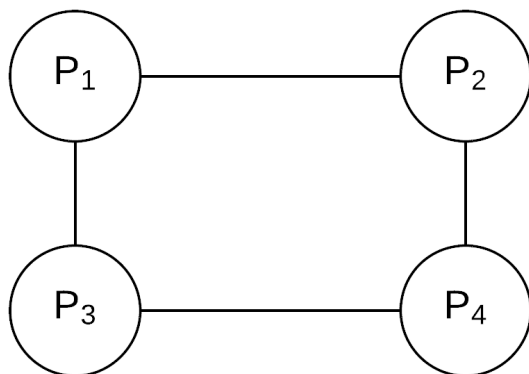

Fig. 3.2.1: Path Intersection Graph for $m = 2$

Many techniques for finding the maximal clique of a graph are known [32]. We have used the algorithm in [33]

3.3 Integer Linear Programming (ILP) Formulation to reduce the congestion

The function *selectpathilp()* in the heuristic described above has the following arguments - i) the network graph G , ii) the set of requests R , iii) the set of paths M_d^s that form a maximal clique and iv) the list of paths P_d^s . The function identifies the maximum number of commodities which may be considered in this iteration to reduce the congestion without exceeding the maximum number of paths that may use any edge in the network. The most important component of the function is an ILP. We now discuss the ILP formulation² and the notation used to describe the ILP.

²A similar ILP formulation for designing transparent lightpaths appear in [34]. The objective function used here is different. We have included the explanations for the constraints here to make the thesis self-contained.

3.3.1 Notation of Variables

- τ_{max} : variable denoting the congestion. In other words, it gives the maximum number of (s,d) pairs that navigate through any edge.
- η_{ch} : denotes the number of channels per fiber.
- ρ_d^s : a constant representing the total number of paths in M_d^s for the commodity (s, d) .
- R : the set of requests for communication not handled yet.
- E : the set of all edges which represents an optical fiber in the network.
- h_e : a constant denoting how many lightpaths which were handled previously uses the edge $e \in E$.
- N_d^{sr} : a constant denoting the total number of regenerators for path r of request (s, d) .
- M : a large constant.
- f_d^s : binary value defined as follows:

$$f_d^s = \begin{cases} 1 & \text{if the lightpath for request } (s, d) \text{ can be handled without} \\ & \text{the congestion exceeding } \eta_{ch}, \\ 0 & \text{otherwise.} \end{cases}$$
- b_{de}^{sr} : a constant defined as follows:

$$b_{de}^{sr} = \begin{cases} 1 & \text{if path } r \text{ of commodity } (s, d) \text{ uses edge } e, \\ 0 & \text{otherwise.} \end{cases}$$
- z_d^{sr} : binary variable defined as follows:

$$z_d^{sr} = \begin{cases} 1 & \text{if path } r \text{ is chosen for request } (s, d) \text{ without} \\ & \text{the congestion exceeding } \eta_{ch}, \\ 0 & \text{otherwise.} \end{cases}$$

3.3.2 Description of the ILP

The main objective of the Integer Linear Programming formulation is as follows:

- maximize the total number of requests to be handled and minimize blocking of lightpaths.
- minimize the number of channels utilized.
- minimize the total number of regenerators utilized.

Objective

$$\text{Maximize } M \cdot \sum_{(s,d) \in R} f_d^s - \tau_{max} - \sum_{(s,d) \in R} \sum_{r=1}^{\rho_d^s} N_d^{sr} \cdot z_d^{sr} \quad (3.1)$$

Subject to:

1) If request $(s, d) \in R$ is handled in this iteration, choose exactly one path from available ρ_d^s paths to handle this request.

$$\sum_{r=1}^{\rho_d^s} z_d^{sr} = f_d^s, \quad \forall (s, d) \in R \quad (3.2)$$

2) The value of the congestion of the network is τ_{max} lightpaths, taking into account the fact that h_e lightpaths are already using edge e .

$$\sum_{(s,d) \in R} \sum_{r=1}^{\rho_d^s} z_d^{sr} \cdot b_{de}^{sr} + h_e \leq \tau_{max}, \quad \forall e \in E \quad (3.3)$$

3) The total number of channels utilized on any given fiber must be less than the maximum allowed channels per fiber.

$$\tau_{max} \leq \eta_{ch} \quad (3.4)$$

Explanations

The objective function (Equation (3.1)) is a composite function that takes into account the following requirements:

- Maximize the total number of requests that may be handled in this iteration. If request $(s, d) \in R$ can be handled, $f_d^s = 1$.
- Minimize the congestion, τ_{max} .
- Minimize the number of regenerators used. The number of regenerators to handle the request $(s, d) \in R$ using path r is N_d^{sr} and this number has to be taken into account, only if path r is used to handle this request (i.e., $z_d^{sr} = 1$).

Constraint (3.2) enforces that, if request $(s, d) \in R$ is handled in this iteration (i.e., $f_d^s = 1$), exactly one of ρ_d^s paths for the request will be selected. Further, if the request is not handled in this iteration (i.e., $f_d^s = 0$), no path will be selected for this request.

In the left hand side of constraint (3.3), $z_d^{sr} = 1$, only if r^{th} path is used to handle request (s, d) is handled. If this path uses edge e , $b_{de}^{sr} = 1$. Thus $z_d^{sr} \cdot b_{de}^{sr} = 1$ only if request (s, d) is handled and path r is used for the request. Therefore $\sum_{(s,d) \in R} \sum_{r=1}^{\rho_d^s} z_d^{sr} \cdot b_{de}^{sr}$ gives the total number of requests handled in this iteration that uses edge e . This edge is already carrying h_e lightpaths. Therefore the total number of lightpaths on edge e is $\sum_{(s,d) \in R} \sum_{r=1}^{\rho_d^s} z_d^{sr} \cdot b_{de}^{sr} + h_e$. Constraint (3.3), considering all edges in the network therefore ensures that τ_{max} is at least the value of the congestion. Since the objective function minimizes τ_{max} , τ_{max} must be the congestion.

Constraint (3.4) simply ensures that the value of congestion never exceeds the number of channels on each fiber.

3.4 Example

The example given below illustrates our heuristic algorithm using the 6-node network shown in Figure 3.4.1 below.

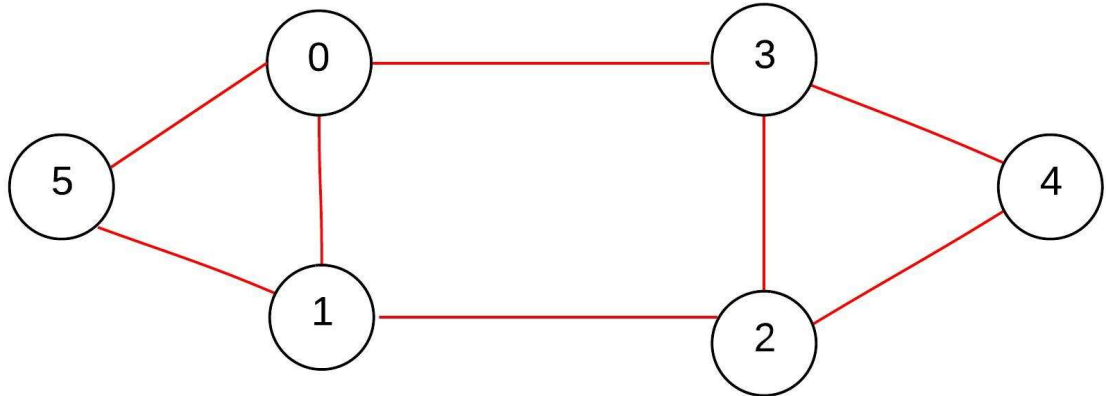

Fig. 3.4.1: 6-Node Network Topology

The distances between adjacent nodes in the network are provided in the Table 3.4.1 below.

Table 3.4.1: Length of edges for the network shown in Fig. 3.4.1.

0	600	0	600	0	800
600	0	900	0	0	300
0	900	0	700	800	0
600	0	700	0	500	0
0	0	800	500	0	0
800	300	0	0	0	0

We have selected three (s, d) pairs as follows:

- $(0,1)$

- (0,2)
- (4,5)

3.4.1 Computing Shortest Paths

In Step 2 of the heuristic, we find k -shortest paths for each request, assuming $k = 4$. The following are the shortest paths for each request. We have given the distance of each path within parenthesis.

- User Request (0,1)

$$p_1 \Rightarrow 0 \rightarrow 1(600)$$

$$p_2 \Rightarrow 0 \rightarrow 5 \rightarrow 1(1100)$$

$$p_3 \Rightarrow 0 \rightarrow 3 \rightarrow 2 \rightarrow 1(2200)$$

$$p_4 \Rightarrow 0 \rightarrow 3 \rightarrow 4 \rightarrow 2 \rightarrow 1(2800)$$

- User Request (0,2)

$$p_1 \Rightarrow 0 \rightarrow 3 \rightarrow 2(1300)$$

$$p_2 \Rightarrow 0 \rightarrow 1 \rightarrow 2(1500)$$

$$p_3 \Rightarrow 0 \rightarrow 3 \rightarrow 4 \rightarrow 2(1900)$$

$$p_4 \Rightarrow 0 \rightarrow 5 \rightarrow 1 \rightarrow 2(2000)$$

- User Request (4,5)

$$p_1 \Rightarrow 4 \rightarrow 3 \rightarrow 0 \rightarrow 5(1900)$$

$$p_2 \Rightarrow 4 \rightarrow 2 \rightarrow 1 \rightarrow 5(2000)$$

$$p_3 \Rightarrow 4 \rightarrow 3 \rightarrow 0 \rightarrow 1 \rightarrow 5(2000)$$

$$p_4 \Rightarrow 4 \rightarrow 3 \rightarrow 2 \rightarrow 1 \rightarrow 5(2400)$$

3.4.2 Regenerator Locations

We have assumed in this example that the optical reach is equal to 1000. If the distance to be travelled from the source node (or the last preceding regenerator node) to any node in a path is greater than the optical reach, we have placed a regenerator at that node to strengthen the signal and enable it to propagate to the next node. The regenerator placements are shown below.

- User Request (0,1)

$p_1 \Rightarrow 0 \rightarrow 1$ (no regenerator needed)

$p_2 \Rightarrow 0 \rightarrow 5 \rightarrow 1$ (regenerator needed at node 5)

$p_3 \Rightarrow 0 \rightarrow 3 \rightarrow 2 \rightarrow 1$ (regenerators needed at nodes 3 and 2)

$p_4 \Rightarrow 0 \rightarrow 3 \rightarrow 4 \rightarrow 2 \rightarrow 1$ (regenerators needed at nodes 3, 4 and 2)

- User Request (0,2)

$p_1 \Rightarrow 0 \rightarrow 3 \rightarrow 2$ (regenerator needed at node 3)

$p_2 \Rightarrow 0 \rightarrow 1 \rightarrow 2$ (regenerator needed at node 1)

$p_3 \Rightarrow 0 \rightarrow 3 \rightarrow 4 \rightarrow 2$ (regenerators needed at nodes 3 and 4)

$p_4 \Rightarrow 0 \rightarrow 5 \rightarrow 1 \rightarrow 2$ (regenerators needed at nodes 5 and 1)

- User Request (4,5)

$p_1 \Rightarrow 4 \rightarrow 3 \rightarrow 0 \rightarrow 5$ (regenerators needed at nodes 3 and 0)

$p_2 \Rightarrow 4 \rightarrow 2 \rightarrow 1 \rightarrow 5$ (regenerators needed at nodes 2 and 1)

$p_3 \Rightarrow 4 \rightarrow 3 \rightarrow 0 \rightarrow 1 \rightarrow 5$ (regenerators needed at nodes 3, 0 and 1)

$p_4 \Rightarrow 4 \rightarrow 3 \rightarrow 2 \rightarrow 1 \rightarrow 5$ (regenerators needed at nodes 3, 2 and 1)

3.4.3 Maximal Clique

In Step 7 of the heuristic, we form the maximum clique for each set of paths. Here we used $m = 2$. In this example let us consider the requests present in set of requests.

- For the request $(0, 1)$ we consider paths p_1, p_2, p_3 and p_4 given above and form the maximal clique $\{p_1, p_2, p_3, p_4\}$. It may be readily verified that no two paths share more than $m = 2$ edges.
- For the request $(0, 2)$ we consider paths p_1, p_2, p_3 and p_4 given above and form the maximal clique $\{p_1, p_2, p_3, p_4\}$.
- For the request $(4, 5)$ we consider paths p_1, p_2, p_3 and p_4 given above and form the maximal clique $\{p_1, p_2, p_3, p_4\}$.

Table 3.4.2: Summary of Maximal Clique for the three requests.

Request	Maximal Clique
$(0,1)$	$\{1,2,3,4\}$
$(0,2)$	$\{1,2,3,4\}$
$(4,5)$	$\{1,2,3,4\}$

3.4.4 Selection of Optimal Paths

In Step 9 of the heuristic, we use the ILP discussed in Section 3.3 to select exactly one path for each request. The function *selectilp* selects the optimal paths for each request pair (s, d) . Problem formulation is done through ILP technique and uses CPLEX to solve the problem. For the requests considered in this example the paths selected are as follows.

Table 3.4.3: Summary of optimal routes selected by the ILP.

Request	Path	Path Number	Regenerators Count
(0,1)	$0 \rightarrow 1$	p_1	0
(0,2)	$0 \rightarrow 3 \rightarrow 2$	p_1	1
(4,5)	$4 \rightarrow 3 \rightarrow 0 \rightarrow 5$	p_1	2

These solutions are returned by CPLEX after solving the ILP formulation.

3.4.5 Channel Assignment

After selecting optimal paths for each request pair (s, d) we then check, in Step 11, if a channel can be assigned to each segment of all three routes.

It turns out that all three paths are edge-disjoint and therefore we are free to use these paths and assign channel 0 to each segment of all three paths. The summary of the allocation of routes and channels to each request is shown in to all the requests is given below.

Table 3.4.4: Summary of Lightpath allocation to all the requests

Requests	Optimal Path	Regenerator Location	Channel assigned To all Segments
(0,1)	$0 \rightarrow 1$	No Regenerators	C_0
(0,2)	$0 \rightarrow 3 \rightarrow 2$	3	C_0
(4,5)	$4 \rightarrow 3 \rightarrow 0 \rightarrow 5$	3,0 (2)	C_0

Chapter 4

Experimental Results

4.1 Simulation Overview

In this chapter, we present the simulation results of our proposed heuristic approach for impairment aware RWA in translucent optical networks. We evaluate the performance of the heuristic in terms of three important parameters of interest:

- Number of regenerators required,
- Blocking Probability,
- Execution time.

We have tested our approach on numerous network topologies of various sizes, with a range of different traffic loads for each network. All the modules were implemented in the C language and the ILP formulations were solved using IBM CPLEX [31] .

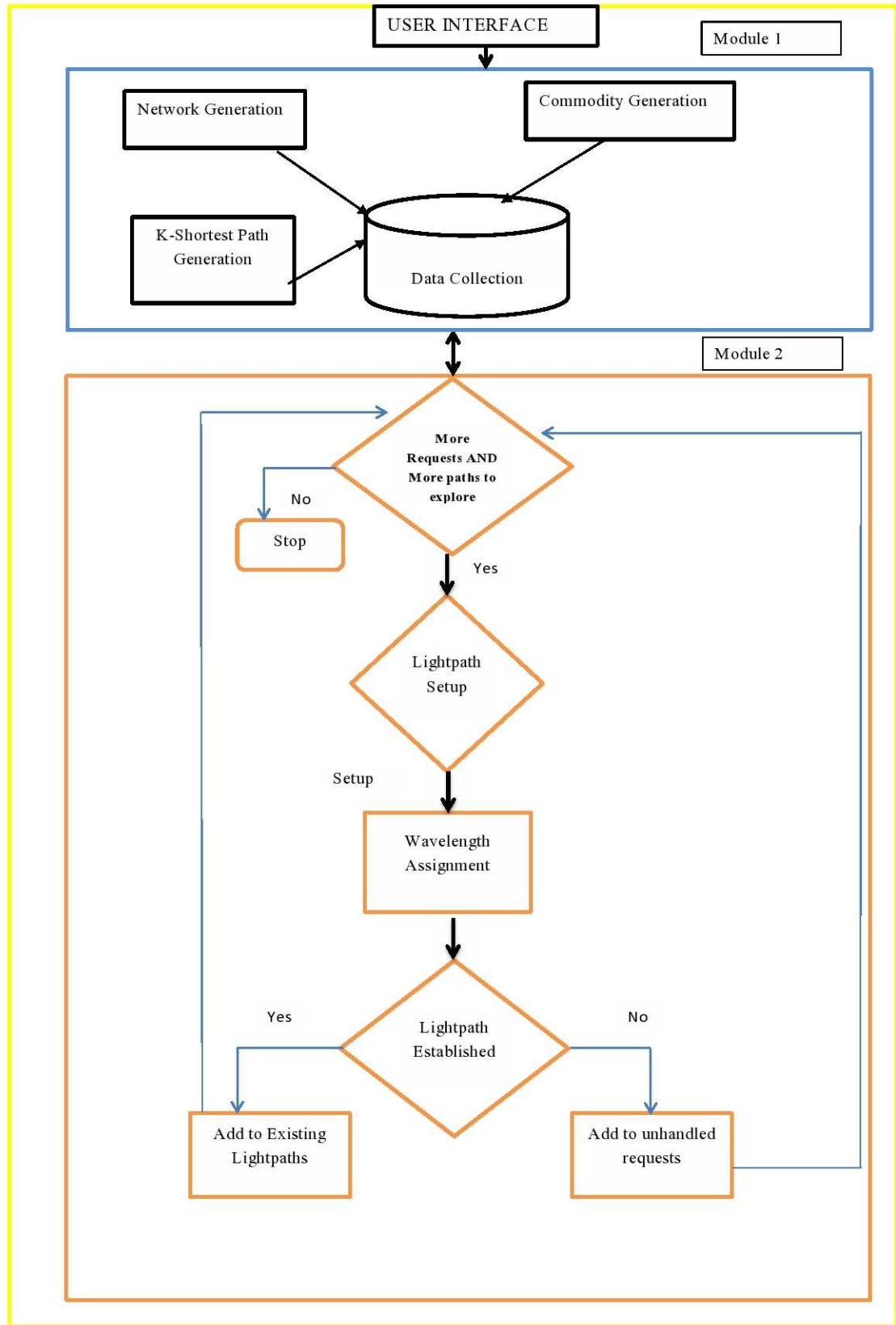

Fig. 4.1.1: Simulator Block Diagram.

Fig. 4.1.1 shows a block diagram of the simulation setup for testing our RWA approach. Table 4.1.1 gives us the summary of functionality of different modules in a simulator.

Table 4.1.1: Description of different modules in a simulator

Component	Functionality
Network Generator	generates network topology with given node size
Commodity Generator	generates Different request pairs (s, d) for communication
k -Shortest Path generator	generates k -shortest paths between every pair of commodity in the set.
Module 2	Implement approach in Algorithm 1 to establish connections for the requests.

In Figure Fig. 4.1.1 Module1 and Module2 together form the whole simulation setup. Module1 is responsible for initializing the environment for each test case and consists of the following components: i) a network generator, ii) k -shortest path generator, and iii) connection request generator, which will be discussed in detail. Module2 is responsible for actually carrying out the impairment aware RWA and has been discussed in Chapter 3.

Before running the simulation the following input parameters are to be provided by the user.

- Number of nodes in a network.
- Degree of each node.
- Number of user requests pair (s, d) .
- Optical reach value.

All the data provided by the user, as well as the outputs of the individual modules are collected in a data repository, where the data can be further processed if needed and used accordingly.

4.1.1 Network Generator

This is the first module in the whole simulation setup and it generates a random network topology, based on the required network size (i.e., the number of nodes in the network) as provided by the user. Each node of the graph is considered to have a maximum degree of four. The generator randomly assigns bi-directional edges between node pairs, while ensuring that nodal degree constraints are not violated. It also assigns distances to these edges. The resultant network topology, along with its edge distances is represented as a two dimensional matrix and stored in the data repository. A sample five node network, with its corresponding representation is shown below.

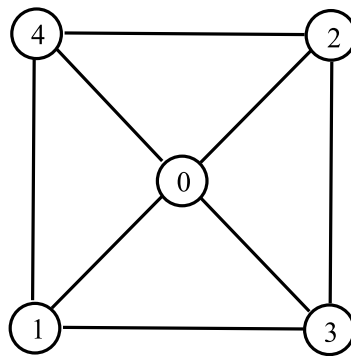

Fig. 4.1.2: A 5-node network

Table 4.1.2: Weight of Bi-directional Edges for a particular instance of network topology shown in Fig. 4.1.2.

0	800	600	700	600
800	0	0	800	700
600	0	0	600	900
700	800	600	0	0
600	700	900	0	0

4.1.2 Commodity Generator

After the network topology is generated we now generate different user request pairs (s, d) for communication, where s represents the source and d represents the destination for a given connection request. Each connection request is regarded as a *commodity*, and is represented by a (source, destination) node pair (s, d) . In the remainder of this thesis, we use the terms “commodity” and “request” interchangeably. The user has to specify the number of commodities that are to be in the network. For each commodity, the source and destination nodes are generated randomly and stored in the data repository for further processing. Some commodity examples for the 5-node network topology in Fig. 4.1.2 are:

- (1,2)
- (4,3)
- (3,2)

4.1.3 k -Shortest Paths Generator

The next component in the simulation is responsible for generating k - shortest paths for each request or commodity (s, d) . We have implemented Yen’s algorithm [18], to

generate the required number of paths between each node pair, which are then stored in the data repository. Let us consider the network topology shown in Fig. 4.1.2, and the distance of each edge as shown in table 4.1.2. For a particular request pair say (4,3), the k - shortest path generator module (for $k = 4$) returns the following paths .

- $4 \rightarrow 0 \rightarrow 3$
- $4 \rightarrow 1 \rightarrow 3$
- $4 \rightarrow 2 \rightarrow 3$
- $4 \rightarrow 0 \rightarrow 2 \rightarrow 3$

4.1.4 Module2

Module 2, which is described in detail in Chapter 3, is responsible for implementing our proposed heuristic. All the required inputs (generated in Module 1) are collected from the data repository. Module 2 has the following individual components which are described below

- Lightpath Setup
- Wavelength Assignment
- Lightpath Establishment

The first component in Module 2 is *lightpath setup*, which specifies a route for each commodity. The next component *wavelength assignment* performs two main operations:

- Check if channel assignment is possible on the selected route.
- If so, assign a feasible channel to the route; otherwise delete the route from the set of routes to be considered for the given commodity.

In the last component *Lightpath establishment*, information for all successfully handled paths, including routes and channel assignments, are added to the data repository; then all remaining lightpath requests which are sent for further processing to the next iteration. The following table shows the relationship between the components in Module 2 and the specific steps and functions described in *Algorithm 1* in Chapter 3.

Table 4.1.3: Summary of Module 2 components described above.

Component	Operation Performed
Lightpath setup	$maxclique(G, P_d^s, m), selectpathlp(G, R, M)$
Wavelength Assignment	$assign_channel(G, \psi_d^s, C), channel_fill(G, \psi_d^s), delete_path(G, \psi_d^s, P_d^s)$
Lightpath Establishment	adds to existing lighpaths if handled else request send to next iteration

Finally, the detailed simulation results for each run are recorded in Module2 and saved in the data repository. The following information for each run is saved by Module 2:

- Route and wavelength information for all the successfully handled commodities.
- List of blocked requests.
- Number of successfully handled and blocked requests.
- Total number of regenerators used.
- Regenerator locations for each successful lightpath.
- Total execution time.

4.2 Results

We have tested our algorithm on different network topologies, where we varied the sizes of the networks from 20-nodes to 60-nodes. Each bidirectional edge in the topology is assumed to consist of 2 unidirectional physical fiber links, where each link can accommodate 12 WDM channels. For each network topology, we ran simulations with 40, 60 and 100 connection requests.

We have generated five different network topologies for each network size that were considered. For each topology we have considered five sets of commodities of each size, (i.e. five sets of 40 commodities, five sets of 60 commodities, and five sets of 100 commodities) to exhaustively check different scenarios. The results presented in this section are based on the average of at least 25 runs. Since the route calculation step involves an ILP, it is possible that the ILP may not converge and give an optimal solution in a reasonable time. If the ILP was unable to generate an optimal solution within 3600 seconds, for a particular demand set, the corresponding run was discarded.

4.2.1 Execution Time

The execution time is the total time required to find the routes and the wavelengths for all successfully handled commodities. It is computed from the start of the ILP until all the lightpath requests are handled or no more paths remain to be explored for any unhandled requests.

Table 4.2.1: Execution time for 20-Node networks for Different commodity size

Commodity Size	Ave Execution Time(sec)
40	0.0116
60	0.0152
100	0.0264

Table 4.2.1 - Table 4.2.3 show the average execution times for a 20-node, 40-node and 60-node network respectively, with 3 sets of different sized sets of commodities. As mentioned earlier, the values reported in these tables are based on an average from 25 runs of each set.

Table 4.2.2: Execution time for 40-Node networks for Different commodity size

Commodity Size	Ave Execution Time(sec)
40	0.0124
60	0.0224
100	0.0364

Table 4.2.3: Execution time for 60-Node networks for Different commodity size

Commodity Size	Ave Execution Time(sec)
40	0.0204
60	0.03
100	0.0364

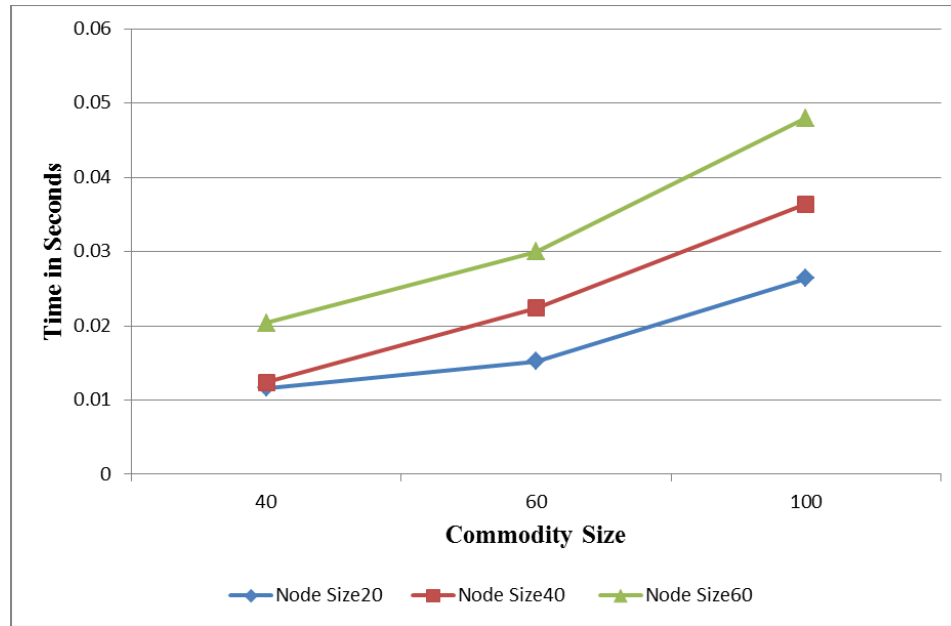

Fig. 4.2.1: Shows Time taken for different commodity size for every node size network

Fig. 4.2.1 compares the execution times for different network sizes. As expected, we see that the execution time increases both with network size and with the size of the set of commodities.

4.2.2 Regenerator Count

When performing IA-RWA, one of the most important parameters to consider is the number of regenerators required to establish the set of lightpaths. A regenerator needs to be placed at a particular node, if it is determined that the signal quality of a lightpath traveling through that node will fall below a specified threshold (for e.g. by exceeding the optical reach) before reaching the next node. In our simulations, we have considered an optical reach of 1000 km. It is essential to try to minimize number of regenerators, since 3R regeneration requires expensive equipment and increases the overall cost of the network.

Table 4.2.4 - Table 4.2.5 show the average number of regenerators needed for different network sizes and commodity set sizes. The fractional values are the result

of averaging over 25 different runs.

Table 4.2.4: Regenerators Count for 20 Node size network

Commodity Size	Total Number of Regenerators
40	69.12
60	106.08
100	175.32

Table 4.2.5: Regenerators Count for 40 Node size network

Commodity Size	Total Number of Regenerators
40	89.2
60	134.04
100	224

Table 4.2.6: Regenerators Count for 60 Node size network

Commodity Size	Total Number of Regenerators
40	104.48
60	161.52
100	271.8

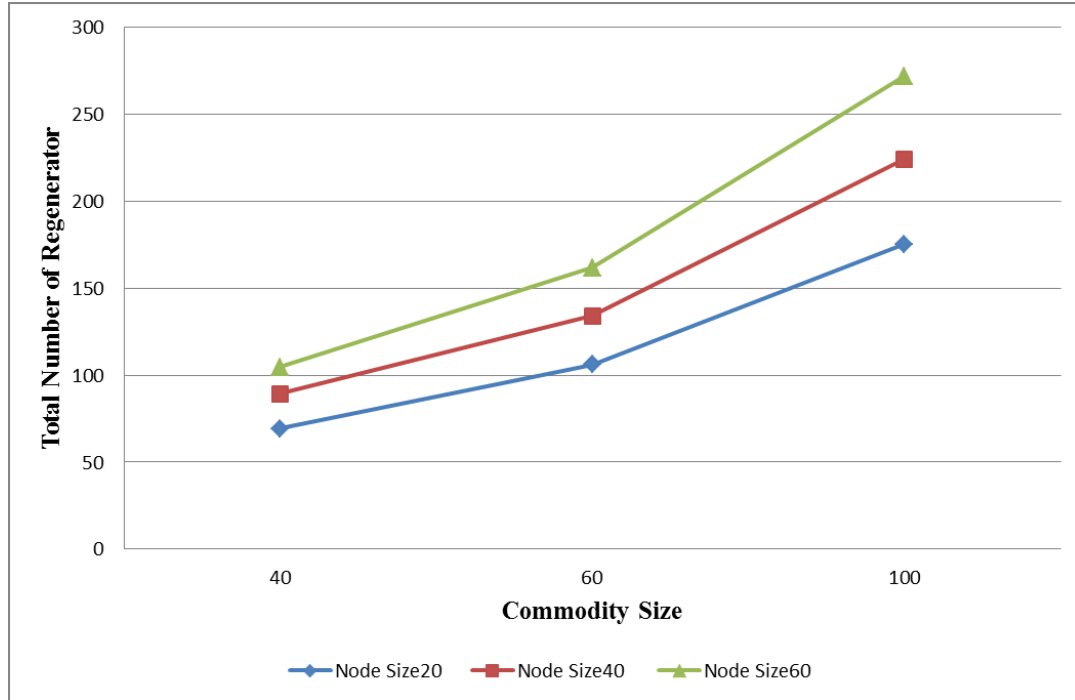

Fig. 4.2.2: Graph Showing Total Number of Regenerators used.

Fig. 4.2.2 illustrates that the number of regenerators required increases as the size of commodities increases, and with increase in the size of the network. This is because for larger networks, there are more node-pairs that are separated by a distance larger than the optical reach, and if more commodities are considered it is likely that more such node-pairs will be selected.

4.2.3 Commodities Handled

A request (s, d) for communication from source s to destination d is said to be handled if we can assign a route and a channel (wavelength) along that route, to carry the signal; otherwise the request is said to be blocked. Table 4.2.8 - Table 4.2.9 show the average number of successfully handled requests for different test scenarios. We note that for the 20-node and 40-node networks, all requests could be handled for all commodity sizes. Even for the 60 node networks, on average over 99% of the

requests could be handled successfully. This is likely because, each fiber link can accommodate 12 channels, which is sufficient for the number of commodities presented to the networks.

Table 4.2.7: Successfully Handled Commodities for 20 Node size network

Commodity Size	Number of Request Pairs Handled
40	40
60	60
100	100

Table 4.2.8: Successfully Handled Commodities for 40 Node size network

Commodity Size	Number of Request Pairs Handled
40	40
60	60
100	100

Table 4.2.9: Successfully Handled Commodities for 60 Node size network

Commodity Size	Number of Request Pairs Handled
40	39.96
60	59.96
100	99.96

4.2.4 Effect of Number of Channels per Fiber

In the previous section we noted that with 12 channels per fiber, almost all the requests could be handled. In this section, we investigate how changing the number of available channels per fiber affects the blocking probability. Fig. 4.2.3 compares the

percent of blocked connections in a 60-node network, for different commodity sizes, with 8 and 12 available channels per fiber respectively. As expected, the blocking rate increases as the capacity of the fibers is decreased. However, unlike some previous approaches, if all requests cannot be accommodated, our approach still returns a solution which handles the maximum number of requests, rather than simply returning an infeasible solution.

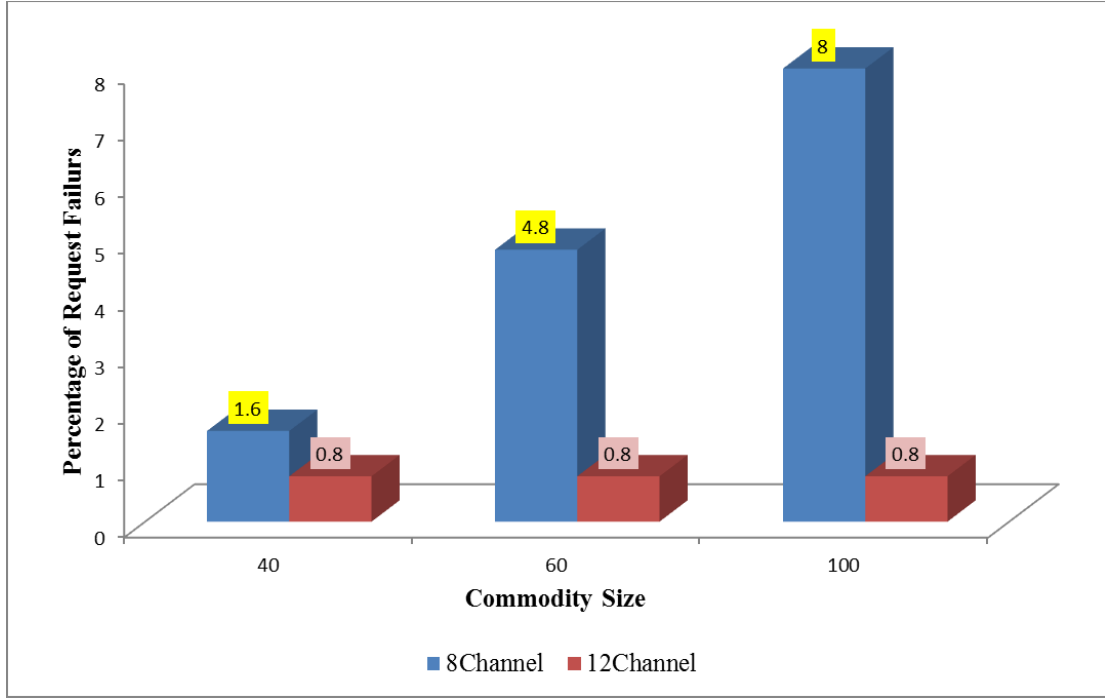

Fig. 4.2.3: Percentage of Failures in a 60-Node network for Different Channel Size

4.3 Repair vs Heuristic Approach

In this section we compare our approach with an existing technique [17] available in the literature, which also considers the problem of IA-RWA in translucent WDM networks. [17] uses an ILP based technique, to provide solutions for small size networks. Since REPAIR cannot handle large networks, we have selected 8-node, 10-node, and 12-node network topologies for our comparisons. The commodity set sizes considered for the different network topologies are shown in Table 4.3.1. For each network

size, five different topologies were considered and for each commodity size, five different sets of requests were considered. So, the results reported in this section are the average values over 25 runs.

Table 4.3.1: Node and Commodity size considered for comparison purpose

Network Size	Commodity Set Size
8	15, 20, 25
10	20, 25, 35
12	20, 35, 45

CPLEX is used to solve the ILP in both REPARE and our proposed approach. All the experiments are performed on Intel Core i5-2430 @2.40 GHz, RAM 4.00 GB. We compare the two approaches in terms of the following parameters to determine the performance of the algorithms.

- Execution time taken to successfully handle all requests $(s, d) \in R$.
- Total number of regenerators used in the whole network scenario for a set of commodities.

We do not make any comparisons in terms of the number of blocked connections, since REPARE only returns a feasible solution if all requests can be handled. Otherwise it simply states that the problem is infeasible. It does not attempt to route the maximum possible requests, as our approach does.

4.3.1 Comparison of Execution Time

The tables and graphs in this section clearly indicate that even though both approaches involve solving an ILP, our proposed algorithm can generate solutions much quicker than REPARE. Furthermore, we note that the solution time for REPARE

increases very rapidly with the size of the network and the number of commodities being considered. On the other hand, the solution times for our approach appear to be fairly independent of network size (at least for the small networks considered here) and increase slowly with the number of commodities.

Table 4.3.2: Execution Time Comparison for 8 node network

Commodity Size	REPARE	HEURISTIC
15	7.9352	0.0108
20	15.2048	0.0112
25	22.1892	0.0116

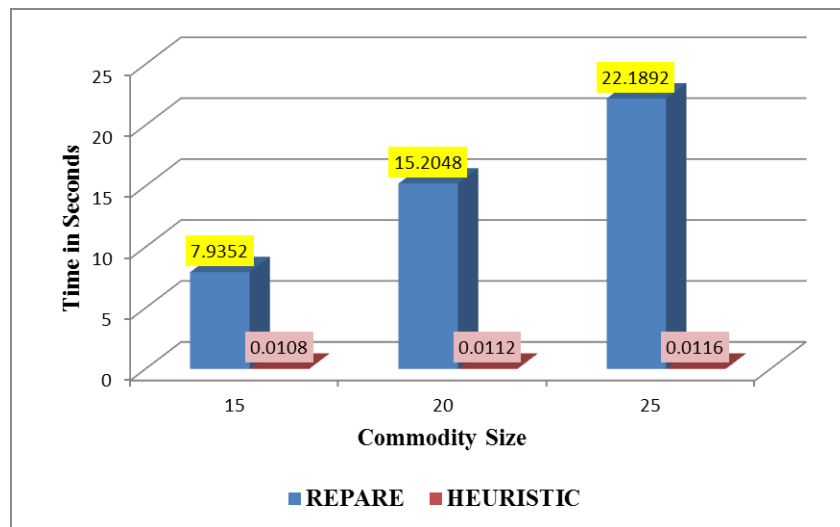

Fig. 4.3.1: Time taken for different commodity size in a 8 node network

Table 4.3.3: Execution Time Comparison for 10 node network

Commodity Size	REPARE	HEURISTIC
20	65.7716	0.01
25	42.348	0.0104
35	76.53	0.0124

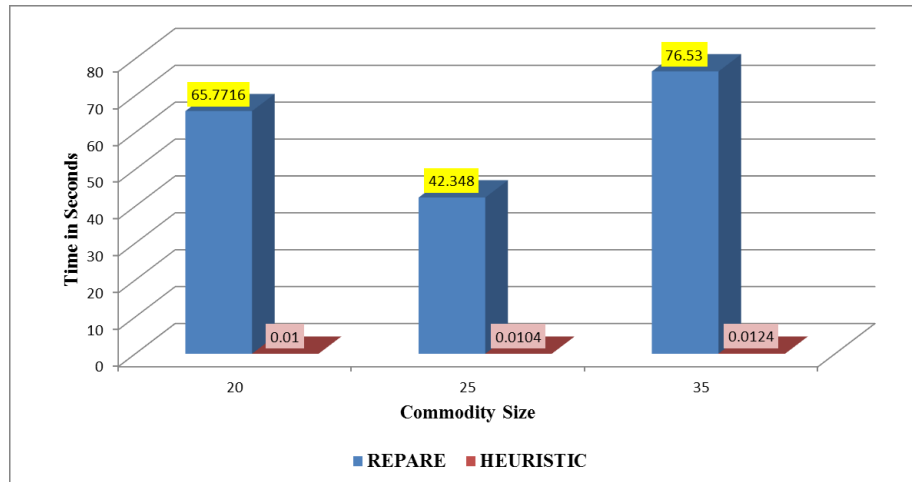

Fig. 4.3.2: Time taken for different commodity size in a 10 node network

Table 4.3.4: Execution Time Comparison for 12 node network

Commodity Size	REPAIR	HEURISTIC
20	32.2872	0.0096
35	194.5908	0.0108
45	349.4528	0.0132

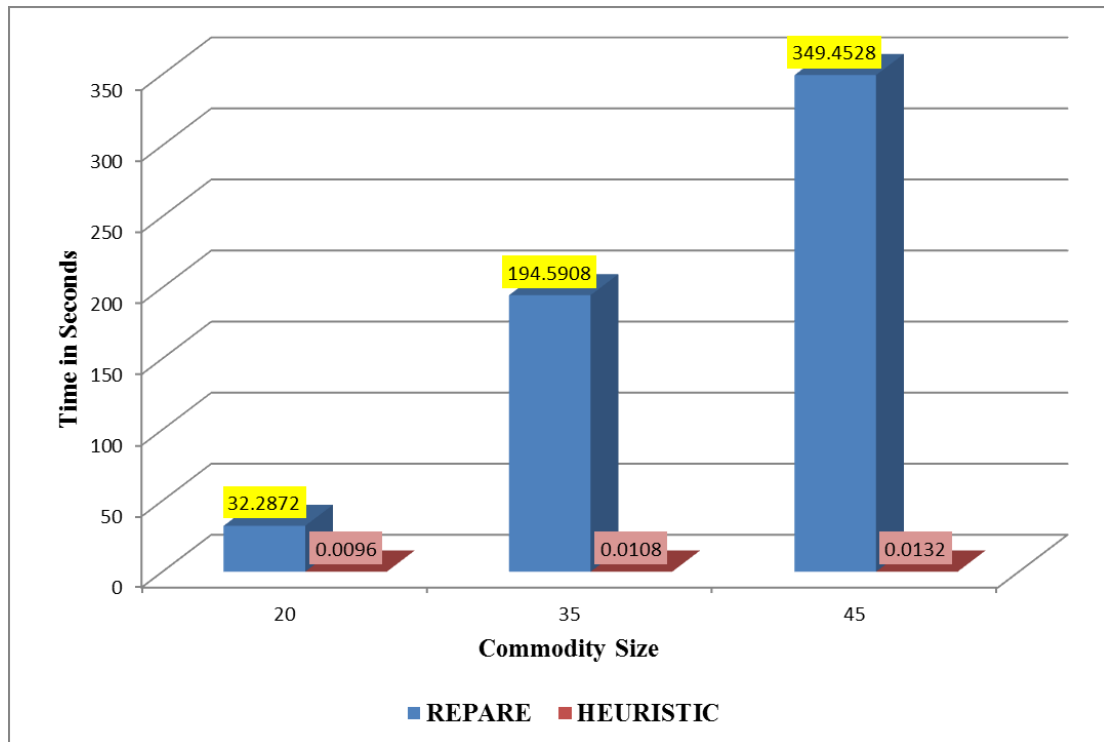

Fig. 4.3.3: Time taken for different commodity size in a 12 node network

Chapter 5

Conclusion and Future Work

5.1 Conclusion

In this thesis, we proposed a new heuristic approach for solving static impairment aware RWA problem in translucent networks. We used an iterative approach for solving the problem; in each iteration our heuristic attempts to establish additional lightpaths over the network to route user requests that have not been accommodated yet. The goal is to handle as many requests as possible, while at the same time minimizing the total number of regenerators used in the network as well as channel utilization.

The proposed heuristic works well for practical size networks. We have tested our approach with different network topologies and with numerous sets of user requests and evaluated its performance with respect to the execution time, the blocking rate and the number of regenerators. In order to compare the performance of the heuristic we have also implemented an existing technique available in the literature for solving the static IA-RWA problem [17].

Based on our simulations, we observed that our proposed heuristic performs significantly better in terms of the total number of regenerators required to successfully

establish lightpaths for all user requests, with average improvements of 17% - 45%. This is important because 3R regenerators are expensive and reducing the number of regenerators can have a considerable impact on the overall cost of the network. We also compared the number of channels required to handle the same number of demands, and in each case the proposed heuristic required fewer channels. Finally, we observed that our approach was able to generate feasible solution in much less time compared to REPARE, and the rate of increase of execution time with the problem size was also much lower.

5.2 Future Work

In this thesis, we have estimated the amount of impairment in terms of the *optical reach*. However, the distortion of a signal depends not only on the distance traveled, but is also affected by other lightpaths traversing common links and nodes. Therefore, the distance an optical signal can travel before needing regeneration will depend on the network traffic pattern. Our work can be extended to consider the effects of the current network state and traffic load, rather than just considering a uniform optical reach for all connection requests.

In this work, we have assumed that the network is fault-free and have not considered the effect of link or node failures. For example, if a regenerator site node fails, then 3R regeneration will no longer be available at that node. Therefore, all lightpaths through that node must be rerouted, and we may need to place additional regenerators at other nodes. A promising direction for future work would be to perform IA-RWA, while considering single or multiple link/node failures.

Bibliography

- [1] Varanasi, S.H.: Impairment-aware dynamic routing and wavelength assignment in translucent optical wdm networks
- [2] Paul, A.: An optimal and a heuristic approach to solve the route and spectrum allocation problem in ofdm networks
- [3] Fiberguide Optic Company: Hard clad fiber anhydroguide superguide silica core hard polymer coated fiber
- [4] Davis, C.C.: Fiber optic technology and its role in the information revolution. (1692)
- [5] Pereira, H., Chaves, D., Bastos-Filho, C., Martins-Filho, J.: Osnr model to consider physical layer impairments in transparent optical networks. *Photonic Network Communications* **18**(2) (2009) 137–149
- [6] Bandyopadhyay, S.: *Dissemination of Information in Optical Networks: From Technology to Algorithms*. Springer (2008)
- [7] comstar: Cip technologies
- [8] Sen, A., Murthy, S., Bandyopadhyay, S.: On sparse placement of regenerator nodes in translucent optical network. In: *Global Telecommunications Conference, 2008. IEEE GLOBECOM 2008*. IEEE, IEEE (2008) 1–6

- [9] Christodoulopoulos, K., Manousakis, K., Varvarigos, E.: Offline routing and wavelength assignment in transparent wdm networks. *Networking, IEEE/ACM Transactions on* **18**(5) (2010) 1557–1570
- [10] Miniwatts Marketing Group: World internet users and population stats
- [11] Fiber Optics Association : Fiber optics and premises cabling
- [12] Creative Commons Attribution Share-Alike: Wire advantages and disadvantages
- [13] Ramamurthy, B., Ramakrishnan, A.: Virtual topology reconfiguration of wavelength-routed optical wdm networks. In: *Global Telecommunications Conference, 2000. GLOBECOM'00. IEEE. Volume 2., IEEE* (2000) 1269–1275
- [14] Chlamtac, I., Ganz, A., Karmi, G.: Lightpath communications: An approach to high bandwidth optical wan's. *Communications, IEEE Transactions on* **40**(7) (1992) 1171–1182
- [15] Azodolmolky, S., Klinkowski, M., Marin, E., Careglio, D., Pareta, J.S., Tomkos, I.: A survey on physical layer impairments aware routing and wavelength assignment algorithms in optical networks. *Computer Networks* **53**(7) (2009) 926–944
- [16] Yang, X., Ramamurthy, B.: Sparse regeneration in translucent wavelength-routed optical networks: Architecture, network design and wavelength routing. *Photonic network communications* **10**(1) (2005) 39–53
- [17] Zhang, W., Tang, J., Nygard, K., Wang, C.: Repare: Regenerator placement and routing establishment in translucent networks. In: *Global Telecommunications Conference, 2009. GLOBECOM 2009. IEEE, IEEE* (2009) 1–7
- [18] Yen, J.Y.: Finding the k shortest loopless paths in a network. *management Science* **17**(11) (1971) 712–716

- [19] International Telecommunications Union: The world in 2013: Ict facts and figures
- [20] Wikipedia: Total internal reflection
- [21] Duarte, F.J.: Tunable laser optics. Academic Press (2003)
- [22] Silfvast, W.T.: Laser fundamentals. Volume 459. Cambridge University Press New York (1996)
- [23] Wikipedia: Spontaneous emission
- [24] Ramaswami, R., Sivarajan, K., Sasaki, G.: Optical Networks: A Practical Perspective. 3rd edn. Morgan Kaufmann Publishers Inc., San Francisco, CA, USA (2009)
- [25] Wikipedia: Optical fiber
- [26] Wikipedia: Polarization
- [27] Manousakis, K., Christodoulopoulos, K., Kamitsas, E., Tomkos, I., Varvarigos, E.A.: Offline impairment-aware routing and wavelength assignment algorithms in translucent wdm optical networks. *Journal of Lightwave Technology* **27**(12) (2009) 1866–1877
- [28] Garcia-Manrubia, B., Pavon-Marino, P., Aparicio-Pardo, R., Klinkowski, M., Careglio, D.: Offline impairment-aware rwa and regenerator placement in translucent optical networks. *Lightwave Technology, Journal of* **29**(3) (2011) 265–277
- [29] Wikipedia: Reachability

- [30] Katrinis, K.M., Tzanakaki, A.: On the dimensioning of wdm optical networks with impairment-aware regeneration. *Networking, IEEE/ACM transactions on* **19**(3) (2011) 735–746
- [31] IBM: Ilog cplex: High-performance software for mathematical programming and optimization. <http://www-01.ibm.com/software/commerce/optimization/cplex-optimizer/>.
- [32] Wikipedia: Clique problem
- [33] Wikipedia: Bronkerbosch algorithm
- [34] Zawada, S., Ghosh, S., Luo, F., Varanasi, S., Jaekel, A., Bandyopadhyay, S.: Poster: A new approach to impairment-aware static rwa in optical wdm networks. In: *Distributed Computing and Networking*. Springer (2013) 456–457

VITA AUCTORIS

NAME: Ganesh Santosh Akula

PLACE OF BIRTH: Hyderabad, India

YEAR OF BIRTH: 1988

EDUCATION: Jawaharlal Nehru Technological University, Hyderabad,
India
Bachelor of Technology, Computer Science 2011

University of Windsor, Windsor ON, Canada
Master of Science, Computer Science 2014