



1997

Fire-cracked Rock Use and Reuse in the Hueco Bolson, Fort Bliss, Texas

Cynthia L. Tennis

Center for Archaeological Research

Johanna M. Hunziker

Center for Archaeological Research

Jeff D. Leach

Center for Archaeological Research

Follow this and additional works at: <http://scholarworks.sfasu.edu/ita>

 Part of the [American Material Culture Commons](#), [Archaeological Anthropology Commons](#), [Cultural Resource Management and Policy Analysis Commons](#), [Historic Preservation and Conservation Commons](#), [History Commons](#), [Human Geography Commons](#), [Other Anthropology Commons](#), [Other Arts and Humanities Commons](#), [Other History of Art, Architecture, and Archaeology Commons](#), [Other Social and Behavioral Sciences Commons](#), and the [Technical and Professional Writing Commons](#)

Tell us how this article helped you.

Recommended Citation

Tennis, Cynthia L.; Hunziker, Johanna M.; and Leach, Jeff D. (1997) "Fire-cracked Rock Use and Reuse in the Hueco Bolson, Fort Bliss, Texas," *Index of Texas Archaeology: Open Access Gray Literature from the Lone Star State*: Vol. 1997 , Article 8. <https://doi.org/10.21112/ita.1997.1.8>

ISSN: 2475-9333

Available at: <http://scholarworks.sfasu.edu/ita/vol1997/iss1/8>

Fire-cracked Rock Use and Reuse in the Hueco Bolson, Fort Bliss, Texas

Creative Commons License



This work is licensed under a [Creative Commons Attribution-Noncommercial 4.0 License](https://creativecommons.org/licenses/by-nc/4.0/)

Fire-cracked Rock Use and Reuse in the Hueco Bolson, Fort Bliss, Texas

Cynthia L. Tennis, Johanna M. Hunziker, and Jeff D. Leach

with a contribution by Wulf Gose

*Archaeological Survey Report, No. 257
Center for Archaeological Research
The University of Texas at San Antonio*

*Archaeological Technical Reports, No. 12
Anthropology Research Center
The University of Texas at El Paso*

1997

Fire-cracked Rock Use and Reuse in the Hueco Bolson, Fort Bliss, Texas

Cynthia L. Tennis, Johanna M. Hunziker, and Jeff D. Leach
with a contribution by Wulf Gose

Robert J. Hard and C. Britt Bousman
Principal Investigators

prepared for the
Department of the Army
Directorate of the Environment
Cultural Resource Branch
Fort Bliss, Texas

contract number DABT51-95-D-0029

Archaeological Survey Report, No. 257
Center for Archaeological Research
The University of Texas at San Antonio

Archaeological Technical Reports, No. 12
Anthropology Research Center
The University of Texas at El Paso

The following information is provided in accordance with the General Rules of Practice and Procedure, Chapter 41.11 (Investigative Reports), Texas Antiquities Committee:

1. Type of investigation: Artifact analysis
2. Project name: Fort Bliss Fire-cracked Rock
3. County: El Paso
4. Principal investigators: Robert J. Hard and C. Britt Bousman
5. Name and location of sponsoring agency: U.S. Army, Fort Bliss, Texas
6. Texas Antiquities Committee Permit No.: n/a
7. Published by the Center for Archaeological Research, The University of Texas at San Antonio, 6900 N. Loop 1604 W., San Antonio, Texas 78249-0658, 1997

A list of publications offered by the Center for Archaeological Research is available. Call (210) 458-4378; write to the Center for Archaeological Research, The University of Texas at San Antonio, 6900 N. Loop 1604 W., San Antonio, Texas 78249-0658; e-mail to car@lonestar.utsa.edu; or visit CAR's Web site at <http://www.csbs.utsa.edu/research/car/index.htm>.

REPORT DOCUMENTATION PAGE

Form Approved
OMB No. 0704-0188

Public reporting burden for this collection of information is estimated to average 1 hour per response, including the time for reviewing instructions, searching existing data sources, gathering and maintaining the data needed, and completing and reviewing the collection of information. Send comments regarding this burden estimate or any other aspect of this collection of information, including suggestions for reducing this burden, to Washington Headquarters Services, Directorate for Information Operations and Reports, 1215 Jefferson Davis Highway, Suite 1204, Arlington, VA 22202-4302, and to the Office of Management and Budget, Paperwork Reduction Project (0704-0188), Washington, DC 20503.

1. AGENCY USE ONLY (Leave blank)	2. REPORT DATE 1997	3. REPORT TYPE AND DATES COVERED Burned rock analysis, 1996-1997
---	-------------------------------	--

4. TITLE AND SUBTITLE <i>Fire-cracked Rock Use and Reuse in the Hueco Bolson, Fort Bliss, Texas</i>	5. FUNDING NUMBERS DABT51-95-D-0029
---	---

6. AUTHOR(S) Cynthia L. Tennis, Johanna M. Hunziker, and Jeff D. Leach	
--	--

7. PERFORMING ORGANIZATION NAME(S) AND ADDRESS(ES) Center for Archaeological Research, UTSA 6900 N. Loop 1604 W. San Antonio, Texas 78249	8. PERFORMING ORGANIZATION REPORT NUMBER Archaeological Survey Report, No. 257
---	--

9. SPONSORING / MONITORING AGENCY NAME(S) AND ADDRESS(ES) Department of the Army Directorate of the Environment Cultural Resource Branch Fort Bliss, Texas	10. SPONSORING / MONITORING AGENCY REPORT NUMBER
---	---

11. SUPPLEMENTARY NOTES Published jointly with The University of Texas at El Paso, Anthropology Research Center Archaeological Technical Reports, No. 12

12a. DISTRIBUTION / AVAILABILITY STATEMENT	12b. DISTRIBUTION CODE
---	-------------------------------

13. ABSTRACT (Maximum 200 words) The Center for Archaeological Research of The University of Texas at San Antonio conducted an analysis of 29,058 pieces of fire-cracked rock and burned caliche selected from a sample of hundreds of features tested as part of the Hueco Mountain Archaeological Project at Fort Bliss, Texas. Feature and non-feature material included in this analysis were collected from site FB 13237 located on the proximal fan, FB 12719 within the basin area, and FB 12412 situated in the transitional zone between the two. The goal of the analysis was to identify patterns of attribute variability in burned rock that could be used to infer function of the various features and sites in the sample. Specific burned rock attributes used in the study were material type, size, weight, and the presence or absence of fracturing, cortex, and discoloration. These attributes were recorded and compared in various combinations at course- and fine-grained levels of intensity to address issues of reuse, recycling, feature function, thermally induced morphological variability, and how these variables might relate to specific land forms through time. Through these comparisons, patterns relating to expedient material selection, feature type, reuse and feature function were identified.

14. SUBJECT TERMS	15. NUMBER OF PAGES 156
	16. PRICE CODE

17. SECURITY CLASSIFICATION OF REPORT Unclassified	18. SECURITY CLASSIFICATION OF THIS PAGE Unclassified	19. SECURITY CLASSIFICATION OF ABSTRACT Unclassified	20. LIMITATION OF ABSTRACT UL
--	---	--	---

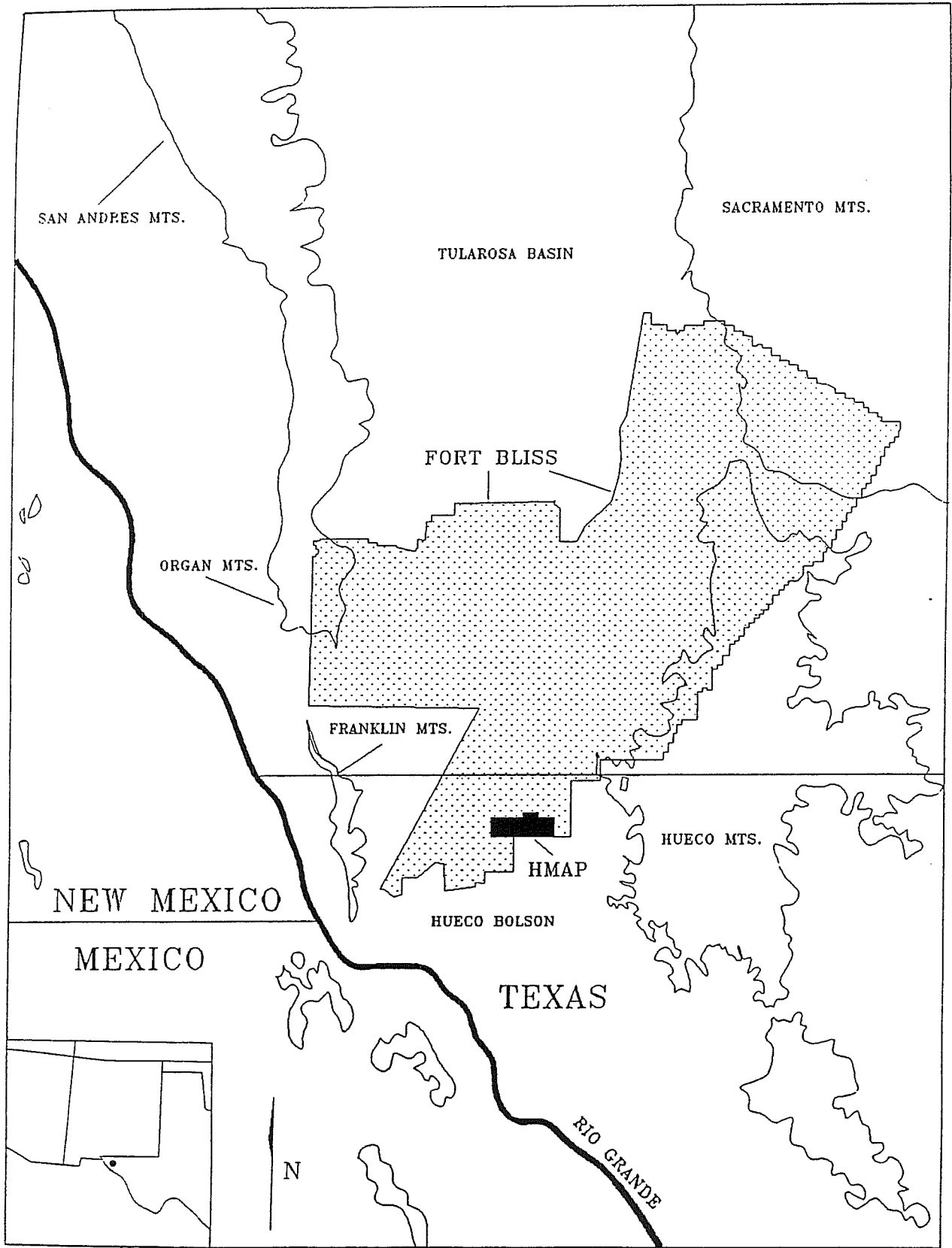

Hueco Mountain Archaeological Project Study Area

Abstract

The Center for Archaeological Research of The University of Texas at San Antonio conducted an analysis of 29,058 pieces of fire-cracked rock and burned caliche selected from a sample of hundreds of features tested as part of the Hueco Mountain Archaeological Project at Fort Bliss, Texas. Feature and non-feature material included in this analysis were collected from site FB 13237 located on the proximal fan, FB 12719 within the basin area, and FB 12412 situated in the transitional zone between the two.

The goal of the analysis was to identify patterns of attribute variability in burned rock that could be used to infer function of the various features and sites in the sample. Specific burned rock attributes used in the study were material type, size, weight, and the presence or absence of fracturing, cortex, and discoloration. These attributes were recorded and compared in various combinations at course- and fine-grained levels of intensity to address issues of reuse, recycling, feature function, thermally induced morphological variability, and how these variables might relate to specific land forms through time.

Through these comparisons, patterns relating to expedient material selection, feature type, reuse and feature function were identified.

Contents

Abstract	i
List of Figures	iii
List of Tables	iv
Acknowledgments	v
Chapter 1: Introduction	1
Chapter 2: Literature Review	2
Ethnographic Analogies	2
Regional Studies	3
Formation Process Analyses	4
Macro- and Micro-Botanical Analyses	7
Soil Analyses	7
Effects of Natural Fire	7
Cooking Temperatures	8
Summary	8
Chapter 3: Site and Feature Descriptions	9
Site FB 12719 (41EP628)	9
Site FB 12412 (41EP3155)	11
Site FB 13237 (41EP3546)	11
Chapter 4: Methodology	14
Material Type	14
Count, Size, and Weight	14
Discoloration	15
Fracturing	15
Cortex	15
Data Entry	15
Archaeomagnetic Analysis	15
Chapter 5: Analysis	16
Intersite Analysis	16
Intrasite Analysis	21
Block-level Analysis	26
Chapter 6: Summary and Conclusions	51
References Cited and Project Bibliography	55
Appendix A: Burned Rock Data by Site	63
Appendix B: Archaeomagnetic Analysis of Burned Rocks from Fort Bliss, Wulf Gose	123

Figures

Frontispiece: Hueco Mountain Archaeological Project Study Area

1. Material weights	17
2. Material quantities	18
3. Total site quantity distributions	20
4. Total site weight distributions	20
5. Feature quantity distribution	21
6. Non-feature vs. feature comparison, FB 12719	21
7. Limestone frequency distribution, FB 12719	22
8. Average weight comparison, FB 12719	22
9. Non-feature vs. feature comparison, FB 12412	24
10. Limestone frequency by size class, FB 12412	24
11. Average weight comparison, FB 12412	25
12. Non-feature and feature comparison, FB 13237	26
13. Limestone frequency by size class, FB 13237	27
14. Average weight comparison, FB 13237.	28
15. Density plot by weight, Block C1, FB 13237	29
16. Frequencies by size class Block C1, FB 13237	30
17. Density plot by weight, Block B1, FB 13237	31
18. Frequencies by size class Block B1, FB 13237	33
19. Density plot by weight, Block A1, FB 13237	34
20. Frequencies by size class Block A1, FB 13237	35
21. Density plot by weight, Block A2, FB 12412	37
22. Frequencies by size class Block A2, FB 12412	38
23. Density plot by weight, Block A1, FB 12412	39
24. Density plot by weight, Block B1, FB 12412	40
25. Frequencies by size class Block B1, FB 12412	41
26. Density plot by weight, Block B1, FB 12719	42
27. Frequencies by size class Block B1, FB 12719	43
28. Density plot by weight, Block A1, FB 12719	46
29. Density plot by count, Block A1, FB 12719	48
30. Three-dimensional surface contour map, Block A1, FB 12719	49
B1. Vector component diagram for rock M.	125
B2. Vector component diagram for rock K.	125
B3. Vector component diagram for rock A.	126
B4. Vector component diagram for rock T.	126
B5. Histogram of magnetically estimated temperatures of heating of burned rocks from Fort Bliss . . .	127

Tables

1. Archaeobotanical Remains Recovered from Flotation Samples	10
2. Faunal Remains Recovered from Sites FB 12412 and FB 12719	10
3. Size Class Categories	14
4. Material Composition	17
5. Feature Descriptions	19
6. FB 12719, Fire-cracked Rock and Burned Caliche Details	23
7. FB 12412, Fire-cracked Rock and Burned Caliche Details	25
8. FB 13237, Fire-cracked Rock Details	26
9. FB 13237, Fracture and Cortex Percentages	36
10. FB 12412, Fracture and Cortex Percentages (Limestone Only)	41
11. Weight and Quantity of Non-feature Burned Rock in Block B1 by Material Type	44
12. Percent of Burned Rock in Each Size Range	44
13. Burned Rock Weight by Material from Select Feature Proveniences in Block B1	45
14. FB 12719, Fracture and Cortex Percentages (Limestone Only)	45
15. Total Weight and Quantity of Burned Rock from Block A1	47
16. FB 12719, Fracture and Cortex Percentages	50
B1. Fire-cracked Rock from Fort Bliss	124

Acknowledgments

The staff at the Center for Archaeological Research wishes to acknowledge Jim Bowman, Galen Burgett, and Kelly Poche from the Directorate of Environment, Conservation Division at Fort Bliss, and Dr. John Peterson from The University of Texas at El Paso for their assistance in coordinating this joint research effort. We would also like to thank Dr. Ray Mauldin and the rest of the staff at the Anthropology Research Center at The University of Texas at El Paso for sharing their knowledge of the region. The authors would like to personally thank Robert J. Hard, CAR director, for his leadership in this analysis and Marcie Renner, CAR editor, for her patience and expertise in preparing the manuscript.

Chapter 1. Introduction

This report is an outgrowth of the Heuco Mountain Archaeological Project (HMAP), part of a long-term management strategy designed to manage and, when necessary, to mitigate the impact or potential impact of military maneuvering to cultural resources on Fort Bliss, Texas. The HMAP study area is located on the eastern edge of the Heuco Bolson, part of the Tularosa Valley which extends from south-central New Mexico, through extreme west Texas, and into northern Chihuahua, Mexico. The Hueco Bolson is situated between the Franklin-Organ mountains to the west and the Hueco-Sacramento Mountains to the east.

Fieldwork for the HMAP consisted of an initial (Phase I) survey of a 26-km² strip at the western edge of the Hueco Mountains. Subsequently, the southern 14 km² of the study area were subjected to a 100-percent, point provenienced surface collection (Phase IIA), subsurface testing (Phase IIB), and data collection (Phase III). These last three phases of investigation resulted in the identification and recording of 533 sites, 172 of which received subsurface testing and data collection.

Three of the 172 tested sites—FB 12412, FB 12419, and FB 13237—were selected for burned rock analysis. Site selections were made in consultation with Fort Bliss archaeologists based on the completeness of the sites' burned-rock collections and their topographic locations. The analysis of 100 percent of the burned rock from the three sites was undertaken to address issues of function, recycling, and reuse of fire-cracked features.

Chapter 2. Literature Review

In preparation for the Fort Bliss fire-cracked and burned caliche analysis, a bibliography was compiled of recent research dealing with experimentation, analytical methodologies, and formational and functional interpretations of thermally altered caliche and burned rock from around the world. This bibliography is included with the cited references. The following review is a synthesis of regionally applicable data.

Rocks were used prehistorically in association with fire because of their ability to contain, absorb, retain, and transfer heat for bathing, warmth, and cooking. Remnants of these activities appear on the global scale in the archaeological record in a wide range of forms, from small hearths with lightly burned stones and slabs to large accumulations or mounds of fire-cracked rocks. In the last 10 years, new interest in the behavioral implications of the variations in form and function of these accumulations has led to a renewed interest in their analysis. New methods of investigating and interpreting the functions of these abundant remnants of past lifeways are being developed. This paper reviews the analytical methods used in these developing approaches.

Ethnographic Analogies

Although not a new approach, ethnographic accounts of the use of heated stones in food preparation are at the base of most of the recent archaeological work (e.g. Binford 1983; Goode 1991; Hester 1991; House and Smith 1975; Thoms 1989). These accounts offer insight into prehistoric behavioral practices that may account for some of

the burned-rock features analyzed by archaeologists today.

In their ethnographic synthesis of North American Indians, Driver and Massey (1957) document various techniques involving the use of stones in cooking. Stone boiling was the dominant method of food preparation in the Sub-Arctic, the Northwest Coast, the West Coast, the Plains, and the Great Basin geographical areas where pottery was absent and mobility high. Rocks were heated directly in the fire, then removed with sticks or wooden tongs and placed in animal skin, bark, or woven containers of liquid. Cabeza de Vaca recorded the use of barrel cactus as containers in his description of stone boiling techniques by "unidentified" tribes on the Texas Coast (Driver and Massey 1957). Heated rocks were renewed frequently to maintain the desired amount of boiling, and a sufficient supply of stones made the process faster. Wet stones were apparently not immediately reused, as the moisture content slowed the reheating time. Stone boiling was used in the preparation of most foods, as well as in acorn-processing and grease-rendering activities.

The use of rock in earth ovens, "a kind of Indian fireless cooker," is also documented along the western coast of North America, in the desert Southwest, and across all of Mesoamerica (Driver and Massey 1957). Earth ovens are described as holes in the ground into which hot stones and food were placed. Meat and plant foods, frequently premoistened and wrapped in leaves or bark, were placed in the pits, then covered with dirt and allowed to cook overnight. Fires were sometimes built on top of the pits to add additional heat, and water was occasionally added to increase the amount of steam.

Pits filled with fire and heated rocks were also used in desert regions to cook agave buds. "Often a number of families or a whole community cooked their agave in a single huge pit, which might be used year after year" (Driver and Massey 1957).

In areas where stone boiling was common, meat was most frequently broiled on stakes or horizontal frames suspended over the fire or roasted directly on heated stones beside the fire. Hot stones were also used as direct sources of heat for baking acorn bread in California (Driver and Massey 1957).

Direct ethnographic analogies for behaviors associated with the uses of heated stones have also been drawn from studies of extant groups of hunter-gatherers. Studies of the Alyawara (Binford 1986; O'Connell 1987), the Efe (Fisher and Strickland 1989), the Dobe Bushmen (Yellen 1977), and the !Kung Bushmen in Africa (Binford 1983), and the Nunamuit of Alaska (Binford 1983) supplied models of intra-site distribution of fire-cracked features that are applicable for archaeological interpretations of group size, site structure, and site function. These studies documented the variety of tasks that take place around nuclear family hearths (Yellen 1977) and the distributional patterning of artifacts that result from activities around these hearths (Binford 1983, 1986). Fisher and Strickland (1989) documented the distributional relationship between exterior hearths and structure opening in Efe villages as well as the varying distances between hearths. These site-structure studies (Binford 1983; O'Connell 1987; Yellen 1977) also show that large, communal cooking activities involving earth ovens and roasting pits take place away from the main camp, information that provides behavioral implications regarding the occupational history of site formation in archaeological interpretations.

Results of regional surveys in Sweden illustrate spatial relationship similar to ethnographically observed patterns between the prehistoric *Skärvtenshögar* (burnt mounds) and settlements recorded there. Swedish mounds characteristically contain a mix of stone, ash, pottery, daub, grinding stones, and hammer stones and are defined as refuse

dumps. They are consistently located 10–30 m away from settlements (Larsson 1990).

Descriptions of active and abandoned sotol distilleries in Mexico provide comparative information for archaeological burned rock features (Tunnell and Madrid 1990). The authors report that the sotol ovens in Chihuahua used for sotol distillation are approximately 3 m across and 2.5 m deep. These measurements are similar to those from ovens at Casas Grandes. The ovens are completely lined with rock and have a domed firing box filling the lower half of the oven, also made of rock. Between 300–400 sotol heads are placed on top of the firing box and the whole oven is covered by a 30-cm-thick layer of soil and baked for 24–28 hours. Water is added to the oven from a hole in the top to produce steam, which keeps the sotol moist and prevents scorching. The rocks that make up the firing box are replaced after 10–14 firings as they become too broken, and are discarded down slope from the ovens forming mounded accumulations of burned rock (Tunnell and Madrid 1990).

Regional Studies

Region-wide investigations of small fire-cracked features have also been conducted recently. The results of a distributional comparison of radiocarbon and obsidian hydration dates from hearth features and artifacts in the central basin area near El Paso have been used to suggest a significant change in land-use patterns in that area (Mauldin 1994). Mauldin argues that the distribution of 114 radiocarbon dates from fire-cracked hearth features, hearth stains, and a few pit features established a pattern suggesting that small sites with features were utilized during a limited time span in the basin. The small hearth sites in the basin are earlier than the larger sites concentrated along the alluvial fans and rivers near the mountains. Further comparisons between the dates from hearths and obsidian hydration dates and diagnostic artifacts from sites not associated with hearths in the basin indicate that while use of the basin area continued through the prehistoric, later use of the basin did not involve the use of hearths (Mauldin 1994).

The large quantities of burned rock characteristic of *fulacht fiadh* (burnt mounds) in Scotland have been attributed to frequent use or repeated use over long periods of time (Barfield and Hodder 1987, as cited by Barber 1990). To examine this interpretation, Barber (1990) applied three analytical methods to interpret the use of burnt mounds across Scotland. Citing previously conducted experiments which produced 0.5 m³ of broken stone per boiling, he argues that the volume of stone typically found on *fulacht fiadh* in Scotland represents from 40 to 400 “boilings” (Barber 1990). At the rate of 10 cookings per year, the largest site’s deposit would accumulate in as little as 40 years. The absence of turf regeneration horizons in excavations indicates that no long periods of abandonment occurred, and a review of multiple radiocarbon samples revealed closely grouped dates. The correlation of these three indications of short-term use is suggestive of relatively rapid mound accumulation (Barber 1990).

Formation Process Analyses

Investigations into the actual formation processes involved in burned-rock feature accumulation are undertaken to provide a better understanding of the functional differences these features represent. Methods of identifying these processes focus on the direct thermodynamic effects of cultural activities reflected by morphological changes in fire-cracked rocks and results of experiments designed to replicate these activities.

Volumetric Comparisons

In a study of camas-roasting pits in the Calispell Valley in northeastern Washington State, simple artifact and feature frequency and density data were used to identify the archaeological signature of camas-processing sites and to argue that they were temporally and functionally related to nearby residential sites (Thoms 1989). Relative oven size was used as a measure of camas intensification, and the increase of oven frequency was used to infer increased intensification through time. Ethnographic accounts from that area indicate that rocks

10–15 cm in diameter were consistently selected for use in earth ovens. Because heat loss is directly related to the amount of surface area relative to rock volume, Thoms (1989) also suggests that the average rock size in archaeological features should be a relative indicator of feature use.

Estimates of the total density of burned rock occurring in mounds and middens are obtained by Larsson (1990) through calculations of cubic area and extrapolation based on sample counts and weights (Hines 1995). Both authors suggest that analysis of volumetric variables may provide comparative data for inferring socio-economic and population density differences between features.

At the Head-Smashed-In Buffalo Jump site in Alberta, Canada, all fire-cracked rocks larger than five centimeters in diameter were counted, measured, weighed, and mapped (Brink and Dawe 1989). Although sandstone is the local rock type, over 80 percent of the burned rock at the site was quartzite and other stones imported from deposits 2–4 km away. The selection of non-sandstone material is seen as an indication of stone-boiling activities, as sandstone had proved unsatisfactory in stone boiling during previous experiments (Brink et al. 1986, cited by Brink and Dawe 1989). The authors argue that the masses of burned rock at the site did *not* result from grease-extracting activities, based on the observation that the total weight of burned rock recovered from the largest pit at the site (153.6 kg), is substantially smaller than the 700 kg of burned stone from a single degreasing feature reported by Binford (1978, as cited by Brink and Dawe 1989). They propose that the rock accumulation is the result of meat boiling to feed the large group during butchering activities (Brink and Dawe 1989).

Statistical analysis of the variation in rock shape and density was conducted on fire-cracked rock from four known feature types in the Calispell Valley (Sanders et al. 1991). Their analytical process defined material type and fracture shape, and compared these characteristics between and within data subsets from residential, camas-processing, and special-purpose sites to identify the relationship

between fire-cracked rock morphology and functionally distinct features. They found that blocky and curvilinear fracturing occurred in the same densities in oven features, possibly as the result of moisture intentionally added for steaming, while a low frequency (6.4 percent) of blocky fracturing was present in boiling pits. The authors conclude that the proportion of blocky to linear densities is not indicative of functional differences. There is too much variation within the single-function classes they examine to allow for functional classifications to be developed based only on fire-cracked rock.

Mauldin et al. (1994) explored the topic of reuse of features by comparing the sizes of burned caliche nodules recovered from 165 features in the central Heuco Bolson with experimentally fired caliche. The experimental firing showed that the largest nodule size class decreased with subsequent firings. The experimental size distribution, however, was different from the archaeologically observed size distribution, which was dominated by small items. They propose that the disproportionately large percentage of small sizes could be a function of exposure and modern disturbance (Mauldin et al. 1994). The authors also found a correlation between increased frequency of artifacts and decrease in burned rock size, supporting the use of size frequency as a measure of feature reuse.

Archeomagnetic Analysis

Archeomagnetic analysis applies the principles of paleomagnetism to archaeological phenomena (Collins et al. 1990). Magnetic minerals in rocks produce a record of thermoremanent magnetization, moving from their original position during heating and realigning to north as they cool. These remanent directions were originally correlated with known pole positions to address chronological questions, but recently, vector patterns have been used to infer prehistoric cultural behaviors and post-depositional processes reflected in burned rock in the archaeological record (Takac 1995). Comparison of magnetic alignments from multiple in situ samples from burned features have been used to infer function based on whether rocks were moved after

they cooled and represent rake-out or dump activities or were allowed to cool in place in an undisturbed hearth (Collins et al. 1990).

Controlled experiments measuring the degree of realignment and declination that occurs at different temperatures have produced results that can be used to estimate the amount of heat produced by archaeological features and to infer the length of the heating episode (Collins et al. 1990). Additional on-going experimentation is attempting to identify magnetic signatures resulting from stone boiling (Takac 1995).

Thin-Section Analysis

Thin sections of reddened gritstone from burnt mounds in the south Cumbrian area in England contain fractured grains of quartz, indicating the rock has been subjected to thermal shock. These internal fractures and rough-sided, re-entrant exterior angles are classified as characteristic of the effect of sudden cooling rather than direct heat which produces smoother, plain or curved fractures (Nixon 1990).

Experimental Replication

Experimental boiling studies have been conducted in southwest Wales where burnt mound formation processes are visible in excavation (Williams 1990). Here, Iron Age mounds are associated with a succession of pits dug into the underlying clay. Mounds accumulate as cracked boiling stones are removed from the pits. In some cases, separate dump sequences have been identified. A number of experiments were carried out based on the results of excavations at one site. Local surface boulders were used to boil water, producing cracked-rock debris of the type seen in the mounds. A pit was then dug based on excavated pit dimensions (not given in report). The pit was filled with water and a leg of lamb was successfully cooked using heated stones. Based on the 70 kg of cracked rock produced during this cooking experiment, it was estimated that one of the mounds at this site represented between 20 and 60 pit uses (Williams 1990).

A controlled stone-boiling experiment was conducted to compare the effect of repeated heating/dowsing episodes on seven naturally occurring rock types in Ireland (Buckley 1990). For this experiment a wooden trough was constructed based on the average dimensions of troughs excavated in association with *fulacht fiadh* in that country (l=1.9 m, w=0.9 m, d=0.9 m). An average beginning rock size of 15 cm was selected based on ease of transport and rapid heating time. Stones were heated for 15 minutes in an open hearth next to the trough and placed in water preheated to a temperature of 28°C. The number of heating/dowsing episodes necessary to reduce the different rocks to less than five centimeters produced the following results: micaceous sandstones (5), limestone (6), agglomerate (10), akrose (12), basalt (20), and vesiculated basalt and gabbro (>25). The author uses these results to suggest that perceived distributional differences of burnt mounds in Ireland might actually be the result of differential properties of naturally available rocks (Buckley 1990).

Numerous controlled experiments have been conducted to identify specific morphological responses resulting from thermodynamic differences created by slow cooling in hearths and earth ovens versus rapid cooling from submersion during stone boiling (Draper and Stanfield 1987; Duncan and Doleman 1991; House and Smith 1975; Jackson 1995; Mauldin et al. 1994; Sanders et al. 1991; Thoms 1989; Whitkind 1977). These attempts to experimentally replicate the various fracture patterns found archaeologically in fire-cracked rock and burned caliche have thus far produced ambiguous results.

Schalk and Maette (1988) identified two basic morphological responses to heat stress in rock: curvilinear fractures where the angle at the spall edge and the rock surface is less than 45°, and blocky/angular fractures where angles are almost 90°. They hypothesize that curvilinear fractures result from uneven temperature gradients within the rock during heating, while blocky fractures result from rapid cooling of heated rock. While Thoms (1986), Draper and Stanfield (1987), and Duncan and Doleman (1991) have recreated blocky fractures

from stone-boiling experiments, similar experiments by House and Smith (1975), Jackson (1996), and Witkind (1977) have proven unsuccessful. Stones left in the ashes to cool to simulate hearth stones showed evidence of discoloration but did not develop fractures (Duncan and Doleman 1991; Mauldin et al. 1994). Statistical analysis of the frequency of blocky vs. curvilinear fracturing in oven features and boiling pits in archaeological sites in the Calispell Valley did not support the relationship of blocky fractures and boiling activities (Sanders et al. 1991). They propose that material type, size of rock, and the rate, duration, and intensity of the firing episode rather than the cooling method produce the variations recorded in archaeologically fire-cracked rock (House and Smith 1975; Sanders et al. 1991; Witkind 1977).

Similar ambiguity has resulted from experiments on thermal conductivity of caliche. Experiments conducted by Lintz (1989) and Duncan and Doleman (1991) found that caliche discolors at temperatures of 300–700°C, temperatures hotter than natural grass fires. The experiments conducted by Lintz (1989) indicate that caliche holds together well and is effective in transferring heat for stone boiling, while similar experiments by Duncan and Doleman (1991) found that after two boilings, caliche samples were reduced to fine sediment and no longer held or transferred heat. Experiments by Mauldin et. al (1994) indicate that features containing rock (caliche) maintained temperatures over 300°C for up to nine hours, while wood fire temperatures dropped to below 150°C in this same time period, indicating that the addition of rock to features substantially extends the heating period. Lintz (1989) also found that metaquartzite and chert had better heat conductivity than sandstone, while House and Smith (1975) report that sandstone fragmented less readily than chert or quartzite and seemed to maintain the boil longer. It appears these differences may also depend upon regional variability in raw materials and differences in heating temperatures.

Macro- and Microbotanical Analyses

Pollen Analysis

In the synthesis of 225 central Texas middens, Howard (1991) examined the amount of botanical information obtained from these excavations. While a functional hypothesis of vegetal preparation is supported by the presence of milling stones in association with 83 percent of the middens, the botanical samples from 19 of these middens failed to provide a recognizable pattern of plant use (Howard 1991). Out of 13 samples analyzed for macrobotanical remains, only oak, hackberry, and walnut were found in more than one midden (oak=5, hackberry=5, walnut=2). Six attempts have been made to collect microbotanical samples, two of which yielded interpretable quantities of pollen. These pollen, however, represent taxa still present in the modern environment and are therefore not clearly indicative of prehistoric economic use (Howard 1991).

Organic Residue Analysis

Organic residue analysis involves testing for different identifiable lipids that have adhered to or been absorbed into artifacts—burned rocks as well as chipped-stone tools (Collins et al. 1990). Fatty acid lipids provide a chemically based, general taxonomic classification of plant residues. Sterols are another type of lipid that can be used to identify plant vs. animal organic residue remains. Sterol analysis provides a more precise differentiation between plant and animal residue as there are very few sterols that are present in both. In the study of the Camp Pearl Wheat site, samples of stone tools, burned hearth stones, and unmodified limestone rocks were tested. The burned rock analysis revealed a predominance of faunal residue reflective of either a higher frequency of meat in the diet or a cooking technology where more meat was in direct contact with the heated stones (Collin et al. 1990). Residue analysis of burned rocks from Mustang Branch and the Barton site in central Texas produced evidence of cooking and drying meat (Ricklis and Collins 1994). Analysis of multiple

sides of the rocks were conducted to differentiate between boiling stones where residue would be expected on all sides, and hearth stones where residue should appear predominately on only one side. In this analysis, sufficient variation on the sides was present to allow the author to rule out boiling (Ricklis and Collins 1994).

Soil Analyses

Routine soil analyses of matrix in burnt mounds in Scotland reveals that phosphate levels in burnt mound deposits are higher than those found in the local top soils and subsoils. Also, higher-than-normal quantities of organic material in burnt mounds are revealed through 'Loss On Ignition' (LOI) tests (Russell-White 1990a). High phosphate levels normally indicate decayed bone, but may also be due to the presence of burned ash in the mounds. High LOI values generally mean that organic material has been added to the soil, but could also be the result of decayed, unburned fuel. These ambiguities render soil analyses inconclusive methods of identifying burnt mound function (Russell-White 1990a). Phosphate analyses from hearth features in central Texas have also produced inconclusive results (Collins et al. 1990).

Effects of Natural Fire

Bellomo (1993) and Connor et al. (1989) conducted investigations into the characteristics and effects of naturally occurring fire. Their research has applications for the study of burned rock. Bellomo (1993) employed a methodological approach to identifying humanly controlled fire. His method involves microscopic and magnetometer examinations of soil in the field and archeomagnetic examinations in the lab. He compared information from controlled grass fires, controlled tree-stump burns, and experimental campfires. He found that campfires generate mean temperatures of 600°C and maintain mean temperatures of 400°C for 1.5–3 hours. Grass fires generate a mean temperature of 225°C and maintain a temperature in excess of 100°C for only two minutes. The author also found

that multiburn campfires (three to four experimental uses) produced basin-shaped features which extend approximately 15 cm below the surface and exhibit a high degree of oxidation and changes in magnetic characteristics (Bellomo 1993).

In their investigations, Connor et al. (1989) evaluated the effects of forest fires on archaeological contents. They identified four important effects that may be noted on archaeological sites: 1) mosaic burn patterns with sharply defined boundaries; 2) morphological changes to stone and bone is limited to the level of the burn or within several centimeters below the burn surface; 3) specific oxidized soil features are present; and 4) layers of fluffy, white ash are present. Thermal damage to surface rock, found in basins of treefalls, varies with rock material: sandstone reddened but did not crack; quartzite occasionally exhibits a blackened surface; and obsidian showed signs of feathering, shattering, and surficial weathering (Connor et al. 1989).

Cooking Temperatures

In a study of hunter-gatherer pottery, Reid (1989) presents information on cooking temperatures from Lundberg and Kotschevar (1965). The temperatures have a direct bearing on functional interpretations of burned caliche and fire-cracked rock cooking features. The nutritional value and caloric accessibility of protein, fat, and carbohydrates from plant and animal food sources is increased by the use of controlled heating to specific temperatures required to produce palatable effects. The author identified two basic methods of cooking: dry and moist. Dry cooking includes broiling, roasting, baking, and parching. These techniques require temperatures in the coals and embers ranging from 150°C (where meat begins to broil) to 550–625°C. Moist cooking includes simmering, boiling, and steaming, which require lower temperatures, from 85°C (where simmering begins) to 100°C+ needed for steaming.

Pressure cooking with steam in capped cooking pits with alternating layers of hot rocks and moist vegetation gelatinizes the plant carbohydrates so the

finished product can be pressed in compact form for easier transport or storage (Reid 1989). The author reports that simmering at 85–88°C, where bubbles form below but do not break the surface, is most suitable for stewing meats and for oil and grease rendering from seeds and fractured bones. Higher temperatures that produce a rolling boil are not suitable for these purposes, as boiling makes meat tough and prevents skimming of released oils and fats. Boiling only becomes adaptive for cooking starchy cereal grains and roots which do not completely gelatinize below a temperature of 93°C. He suggests that a covariant relationship should exist between the exploitation of carbohydrate seeds and boiling (Reid 1989).

Summary

This review of analytical methodologies available for investigating and interpreting burned-rock features presents archaeologists with a new set of research design decisions. As early as 1980, archaeologists began to call for consistent recording of variables within burned-rock clusters as they realized that these variations could be used to explain differences in function, differences in site types, and differential availability or preferential collection of resources (White 1980). Since not all sites offer equal amounts of information and not all projects afford equal opportunities for data retrieval, choices must be carefully examined as some methods have proved more productive than others. Well-designed field and analytical programs, along with experimental results and inferences from interdisciplinary studies, provide avenues to increase our understanding of the function of burned-rock features. Such an understanding is a prerequisite for a broad range of behavioral interpretation including subsistence, seasonality, population fluctuations, and social organization.

Chapter 3. Site and Feature Descriptions

Of the 172 sites tested during the HMAP, the following were chosen for the burned rock study: FB 12719 (41EP628), FB 12412 (41EP3155), and FB 13237 (41EP3546). Each of the three sites is located in a different environmental zone. Site FB 12719 is located in the central basin (elevation 1,230 to 1,240 m above mean sea level [amsl]), FB 12412 is located in the transitional zone (elevation 1,240 to 1,250 m amsl), and FB 13237 is on the proximal fan of the Hueco Mountains (elevation 1270 m amsl). The following descriptions were obtained from field summaries provided by Fort Bliss archaeologists.

Site FB 12719 (41EP628)

Site FB 12719 covers an area of 5,364 m². The local environment is characterized by mesquite-stabilized dunes, interdunal deflationary depressions, recurrent sheet sands, and isolated patches of local forbs and grasses. The site was identified during the Phase I collection as a surface scatter of burned rock and artifacts. Six features were recorded on the surface: 30, 31, 32, 33, 34, and 37. A total of 448 m² was excavated within two excavation blocks: A1 and B1.

Block A1

A large excavation block was established over Features 32, 33, and 34. Feature 32 is described as a light-bulb-shaped pit structure measuring 3.95 x 2.80 x 0.25 m. Artifacts recovered from the feature fill include chipped stone, ground stone, unspecified brownware ceramics, burned rock, and burned bone. The following three radiocarbon dates were

obtained from Feature 32: 1060±50 B.P., 1140±70 B.P., and 1240±60 B.P. (all dates adjusted).

Within Feature 32, Features 78 and 85 were recorded on the structure floor. Feature 78 was a basin-shaped hearth measuring 0.37 x 0.47 x 0.10 m. Feature 85 was a possible posthole measuring 0.25 m in diameter and 0.05 m in depth.

Feature 33, also a pit structure, is described as being semi-circular in shape and measuring 2.65 x 3.60 x 0.20 m. Artifacts recovered from the feature fill include chipped stone, unspecified brownware ceramics, ground stone, and burned rock. Two radiocarbon dates, 1040±80 B.P. and 1500±110 B.P., were obtained from Feature 33. A flotation sample from Feature 33 contained pieces of Fabaceae and *Atriplex/Sarcobatus* charcoal in addition to *Chenopodium* seed and charred bone (Table 1).

Feature 34 is described as a large, roughly circular pit structure measuring 4.15 x 2.95 x 0.15 m. Artifacts recovered from the feature fill include unspecified brownware ceramics, El Paso brownware ceramics, chipped stone, ground stone, a ceramic spindle whorl, burned bone, and burned rock. Two circular, basin-shaped hearths with carbonaceous ash fill, Features 80 and 89, were identified on the structure floor. Feature 80 measured 0.35 m in diameter and 0.10 m in depth. Feature 89 measured 0.62 x 0.80 x 0.18 m. Radiocarbon dates of 1360±70 B.P. and 1200±110 B.P. were obtained for Feature 34 and Feature 80 respectively.

Table 1. Archaeobotanical Remains Recovered From Flotation Samples

Taxon	Common	Site FB 13237		Site FB 12719		Site FB 12412	
		Ftr. 40	Ftr. 46	Ftr. 33	Ftr. 32	Ftr. 12	Ftr. 16
<i>Bahia absinthifolia</i>	hairy seed bahia		2				
Caryophyllaceae	pink family	3					
<i>Euphorbia cf. serrula</i>	spurge	25	1				
<i>Solanum eleagnifolium</i>	purple nightshade	1					
<i>Chenopodium</i>	seed			x			
<i>Prosopis</i>	charcoal	x (cf.)				x (cf.)	x
Fabaceae	charcoal	x		x	x		
<i>Atriplex/Sarcobatus</i>	charcoal			x			

x = presence

cf. = compares favorably

Block B1

A second excavation block was established over Feature 30. Feature 30 is described as a small, dish-shaped hearth with an ash stain and burned rock, measuring 0.50 x 0.40 x 0.04 m. Excavation of the block exposed Feature 77, a semi-circular dish-shaped hearth with carbonaceous ash measuring 0.60 x 0.50 x 0.10 m. A single flake and burned caliche were recovered from feature fill. Artifacts recovered from non-feature contexts include chipped stone, ground stone, unspecified brownware ceramics, and burned rock.

A large amount of animal bone was recovered from site FB 12719, mostly from the pit structures (Table 2). Feature 32 contained 601 pieces of bone consisting of mainly black-tailed jackrabbit (*Lepus californicus*), unidentified Lagomorph, and unidentified small and medium mammal. Feature 33 contained 343 pieces of bone consisting of black-tailed jackrabbit, cottontail (*Sylvilagus* sp.), unidentified Lagomorph, squirrel (Sciuridae), unidentified Artiodactyla, and unidentified small and medium mammal. Pieces of unidentified small/medium mammal were recovered from Features 78 and 85.

Table 2. Faunal Remains Recovered From Sites FB 12412 and FB 12719

Site	Feature Number	Total Bone Count	MNI <i>Lepus</i>	MN <i>Sylvilagus</i>
FB 12412	—	1 (modern)	—	—
FB 12719	—	7 (modern)	—	1
	—	252	2	1
	32	601	6	—
	33	343	4	1
	34	32	1	—
	78	7	—	—

Site FB 12719 was determined to be a residential site associated with the Late to Middle Formative period. It is not clear whether the structures represent two or more contemporaneous occupations or a series of single occupations.

Site FB 12412 (41EP3155)

Site FB 12412 is 44,463.36 m² in size and is located within the transitional zone between the rocky fan of the Hueco Mountains and the basin. The local environment is dominated by creosote bush (*Larrea tridentata*) and tarbush (*Flourensia cernua*). Mesquite (*Prosopis glandulosa*), and broom snakeweed (*Xanthocephalam sarothrae*), along with various succulents, forbs, and grasses, are also present.

Twenty features were identified on the surface. Features 1–19 and 24 are described as discrete concentrations of burned rock ranging from 1–8 m in diameter. Only Features 3, 9, 12, and 16 were tested. Features 3 and 9 are described as discrete concentrations of burned caliche measuring 8 x 4 m and 3 x 2 m respectively. Feature 12 is described as a discrete concentration of burned caliche with carbonaceous stain measuring two meters in diameter. Feature 16 is described as a discrete concentration of burned rock measuring three meters in diameter. A total of 199 m² was excavated within three excavation blocks: A1, A2, and B1.

Block A1

A 10-x-10-m block was established to encompass Feature 12. Testing revealed that Feature 12 was a circular, basin-shaped hearth with charcoal and ash fill measuring 0.77 x 0.64 x 0.15 m. A single piece of burned unspecified brownware ceramic was recovered from the feature fill. Artifacts recovered from non-feature areas within the block include unspecified brownware ceramics, chipped stone, burned rock, and a single projectile point. A radiocarbon date of 1070±60 B.P. was obtained from Feature 12.

Block A2

A second 10-x-10-m block was established to encompass Features 3 and 9. Testing revealed that for both features the concentrations of burned caliche were confined to the surface. No staining or subsurface concentrations of burned rock or caliche were encountered. Two discrete concentrations of chipped stone artifacts were identified subsurface, one in the area of Feature 3, the other just west of Feature 9.

Block B1

An 8-x-8-m excavation block was established to encompass Feature 16. After subsurface testing, Feature 16 was described as a circular, rock-lined hearth with charcoal, carbonaceous ash, and burned rock fill, measuring 2.0 m in diameter and 0.14 m in depth. Artifacts recovered from the feature fill include chipped stone, flake tools, and burned caliche. Flotation samples contained charred bone and *Prosopis* charcoal. A single specimen of small/medium mammal bone was recovered from non-feature context. This specimen was described as being of probable modern origin. The following three radiocarbon dates were obtained from Feature 16: 1060±70 B.P., 870±50 B.P., and 790±60 B.P.

Site FB 12412 is a multicomponent site with at least two separate occupational episodes indicated from the radiocarbon dates. Site function is not known, but the discrete concentrations of lithic artifacts indicate special activity areas within the site.

Site FB 13237 (41EP3546)

Site FB 13237 is located on the alluvial fan on the western base of the Hueco Mountains and is 5,524.60 m² in size. The local environment is dominated by creosote bush, tarbush, mesquite, and broom snakeweed on the distal portion of the fan. The proximal portion is dominated by creosote bush and tarbush with some mesquite, prickly pear (*Opuntia phaeacantha*), lechuguilla (*Agave*

lechuguilla), and various other succulents. Various forbs and grasses are sparsely distributed over both the proximal and distal portions of the fan.

Fourteen features—Features 39–51 and 77—were identified on the surface. All surface features other than Features 51 and 77 were described as concentrations of burned limestone. Feature 51 was a concentration of burned limestone with a carbonaceous stain, and Feature 77 was a discrete cluster of ceramic sherds. Three excavation blocks—Blocks A1, B1, and C1—were established and a total of 48 m² was excavated.

Block A1

A 4-x-4-m excavation block was established over Feature 48. Feature 48 is described as a surficial concentration of burned limestone, measuring 13 x 9 m. Subsurface testing revealed an increase in burned rock density and number of large rocks, but no stains were noted. Artifacts recovered from Feature 48 (which encompasses all of Block A1) include unspecified brownware ceramics, chipped stone, flake tools, burned rock, and one bone bead.

Block B1

A second 4-x-4-m block was established over a concentration of burned rock. The latter, measuring 6 x 4 m, was designated Feature 46 on the surface. Subsurface testing revealed that Feature 46 was a rock-lined, basin-shaped hearth pit with carbonaceous ash, charcoal, and burned rock fill. The hearth pit measured an estimated 1.15 m in diameter and 0.25 m deep. Feature 46 extended beyond the limits of the test area for an unknown distance. A single radiocarbon date of 4120±80 B.P. was obtained from Feature 46. Flotation samples yielded bahia (*Bahia absinthifolia*), spurge (*Euphorbia* cf. *serrula*), and unidentified charcoal fragments.

Testing within the block also exposed a small, oval-shaped carbonaceous stain designated Feature 98. Further testing revealed that Feature 98 was a

shallow, irregular, basin-shaped pit measuring 0.70 x 0.95 x 0.09 m, with a light carbonaceous ash fill. Artifacts recovered from the feature fill include chipped stone and burned limestone. A large number of burned limestone pieces was recovered from throughout the block.

Block C1

A third 4-x-4-m test block was established over Feature 40, which was defined by a 7-x-5-m concentration of burned rock on the surface. Subsurface testing revealed that Feature 40 was a conical-shaped, cobble-lined hearth pit with carbonaceous ash and charcoal fill. The pit hearth measured 0.80 x 0.70 x 0.18 m. Artifacts recovered from the feature fill include chipped stone, unspecified brownware ceramics, and burned limestone. A single radiocarbon date of 670±60 B.P. was obtained from Feature 40. Flotation samples yielded Caryophyllaceae, spurge, purple nightshade (*Solanum eleagnifolium*), and Fabaceae and *Prosopis* charcoal.

Subsurface testing also revealed two additional features, 102 and 103, not evident on the surface. Feature 102 was a semicircular, basin-shaped, rock-ringed hearth with carbonaceous ash and rock fill. This hearth measured 0.83 x 0.56 x 0.24 m. Artifacts recovered from Feature 102 fill include chipped stone, unspecified brownware ceramics, and burned limestone. A single radiocarbon date of 1660±70 B.P. was obtained from Feature 102. Flotation samples yielded only unidentified charcoal fragments.

Feature 103 was also a semicircular, basin-shaped, rock-ringed hearth with carbonaceous ash fill. Only half of Feature 103 was investigated because it extended beyond the test block. The extrapolated measurements for this feature are 0.80 x 0.56 x 0.15 m. No artifacts were recovered from the feature fill.

Non-feature artifacts recovered from the site, surface and subsurface, include El Paso Brownware,

El Paso Bichrome, El Paso Polychrome, and unspecified brownware ceramics, chipped stone, retouched flakes, a single core, and burned limestone.

Site FB 13237 is a multicomponent site with at least three temporally discrete episodes of occupation as indicated by the radiocarbon dates. Periods of occupation range from the Late Archaic to the Early and Late Formative.

Chapter 4. Methodology

The analysis of 100 percent of the burned rock from three of the 172 sites excavated during the HMAP was undertaken to address issues of function, recycling, and reuse of fire-cracked features. Sites, FB 12412, FB 12419, and FB 13237 were selected in consultation with Fort Bliss archaeologists based on their topographic location and the completeness of their burned-rock collection. Attributes chosen with these specific research questions in mind include material type, size, weight, and presence or absence of fracturing, cortex, and discoloration. These attributes were recorded for all feature and non-feature burned rocks collected.

Material Type

The rocks from each provenience were first sorted by material. Material types were coded as 1 through 15: 1=chert, 2=Rancheria chert, 3=quartzite, 4=limestone, 5=rhyolite, 6=sandstone, 7=granitic, 8=basalt, 9=vesicular basalt, 14=caliche, 15=other. (These codes had already been established for earlier projects; code numbers 10 through 13 were not encountered during this

analysis.) Material selection has been viewed in other studies as both a reflection of material availability (Mauldin et al. 1994; O’Laughlin 1980) and as an indication of feature function (Duncan and Doleman 1991; Oakes 1981). The geographical distribution of the sites in this study may supply additional information to this discussion.

Count, Size, and Weight

Each material type was sorted by size (maximum diameter). Size categories were coded as 1 through 12: size 1 being less than 1.5 cm, categories 2 through 4 increased sequentially by 1.5-cm increments, and categories 5 and above increased sequentially by 2.5-cm increments (Table 3). The number of rocks in each size category was recorded and weighed on an electronic balance. We hoped that by comparing size to average weight in each category, differences in fracturing patterns would be seen between features with different functions. Experimental work (Burkley 1990; Duncan and Doleman 1991; Schalk and Maette 1988; etc.) indicates that stones used for boiling fracture in a

Table 3. Size/Class Categories

Size Class	Range in cm	Midpoint
1	<1.5	.75
2	1.5-2.5	2
3	2.5-4	3.25
4	4-5.5	4.75
5	5.5-8	6.75
6	8-10.5	9.25

Size Class	Range in cm	Midpoint
7	10.5-13	11.75
8	13-15.5	14.25
9	15.5-18	16.75
10	18-20.5	19.25
11	20.5-23	21.75
12	23-25.5	24.25

blocky pattern due to thermal shock. Stones used in pit features for baking, parching, etc. are heated and cooled more slowly and therefore fracture in a curvilinear pattern. These different fracturing patterns should be reflected in a size-to-weight ratio comparison.

Discoloration

Interior alterations in material color were to identify burned stone and caliche. For each size category within each material type, the number of burned rocks exhibiting thermal discoloration was recorded. To make this assessment, small pieces were broken off from each rock specimen. When discoloration was found to exist only on the surface, this change, in the case of limestone, was attributed to weathering and the specimen was removed from the collection. Caliche specimens with only surface discoloration were also removed from the sample.

Fracturing

The burned rocks within each size category and material type other than caliche were observed for fracturing. Fracturing was recorded as present or absent. Any breaks that appeared to be a result of post-excavation damage were not recorded. If rocks with fresh breaks could be refit with another piece, they were recorded as a single specimen. With caliche, distinguishing between fragmentation caused by thermal alteration and that resulting from natural causes is difficult; therefore, fragmentation was not recorded for caliche.

The degree of fracturing can be a result of amount and type of use. As rocks are exposed to repeated episodes of heating and cooling, they fracture into smaller and smaller pieces. The degree of fracturing can be used to address questions of reuse and recycling of rock. Repeated use of a feature should result in a greater amount of fractured versus non-fractured rock. A greater degree of fracturing may also be a result of feature function in that certain activities—such as stone boiling—tend to fracture rock at a faster rate.

Cortex

The presence of cortex on material other than caliche was noted, although amount of cortex remaining was not determined due to the large sample size and time constraints. The presence of cortex on fractured material may help in identifying patterns of reuse. With the continued fracturing and reduction in size of stone, the number of specimens with cortex present should decrease. The amount of stone with no cortex present should reflect a higher degree of fracturing.

Data Entry

All attribute data were entered into a spreadsheet program (QuattroPro[®]) containing provenience information. Complete data tables are given in Appendix A. Collection numbers on each bag were used to tie the attribute information with provenience information. Density distributions of rock at the level of excavation block, 1-x-1-m unit, feature, and level were constructed using a mapping program (Surfer[®]).

Archaeomagnetic Analysis

In addition to the recording of attributes, several samples of limestone from eight features were selected for archeomagnetic analysis by Wulf Gose of The University of Texas at Austin (Appendix B). It was hoped that the archaeomagnetic analysis would identify subsequent firing episodes in a single feature and the temperature at which the rock was fired.

Chapter 5. Analysis

Analysis of the thermally altered caliche and burned rock was undertaken to investigate patterns that might address the following research issues: 1) evidence of reuse/recycling, 2) feature function, 3) chronological relationships, 4) evidence of post-depositional site formation processes, and 5) morphological variability in the rock due to temperature variation. Investigation of the data from the three sites was approached on three levels. Coarse-grained comparisons of burned rock raw material and feature types on an intersite basis were conducted to identify variations in temporal, functional, and topographic land use in the study area. Intrasite variation between non-feature and feature burned rock by weight, quantity, and rock sizes was examined for patterns that could be attributed to different feature function(s) and use. Fine-grained variations in burned rock size, weight, and percent of fracture of non-feature and feature burned rocks within selected provenances were analyzed to identify patterns of reuse and discard. Rock core samples from selected features were submitted for archeomagnetic testing for evidence of function and reuse through variations in firing temperatures and heating episodes.

Intersite Analysis

The assemblage used for this analysis consisted of 29,058 pieces of fire-cracked rock and burned caliche weighing 554,511.2 g (1,223 lbs). As shown in Table 4, limestone accounted for 96 percent of the total weight and 68 percent of the total quantity, while burned caliche comprised four percent of the weight and 31 percent of the quantity. Other material types, which contributed less than one percent to the total weight and one percent to the total quantity, include chert, Rancheria chert,

rhyolite, sandstone, granitic, basalt, vesicular basalt, and unknown other.

Eighty-eight percent (n=489,487.63 g) of the total sample weight and 52 percent of the quantity (n=15,248) was recovered from site FB 13237, located on the proximal fan of the Hueco Mountains. Four percent of the sample weight (n=20,268.69 g) and 18 percent of the quantity (n=5,272) was collected from site FB 12412 in the transitional zone. Burned rock and caliche from the basin site, FB 12719, accounts for eight percent (n=44,754.88 g) of the sample weight and 29 percent (n=8,538) of the total burned rock.

Material Types

As illustrated in Figures 1 and 2, material composition varies between sites. The contribution of total caliche weight and count increases from <1 percent on the proximal fan (FB 13237) to 61 and 75 percent respectively at the basin site (FB 12719). A similar pattern of increasing frequencies of burned caliche is seen in feature composition from these sites. While no burned caliche was recovered from the features on the proximal fan site (FB 13237), burned caliche makes up 37 percent of feature material and 44 percent of feature weight from the site in the transitional zone (FB 12412) and 77 percent of the feature material and 40 percent of the feature weight in the basin site (FB 12719). These findings follow the general pattern established in the El Paso area of caliche utilization in basin and lowland areas and use of non-caliche rock in the Piedmont areas. This pattern is traditionally viewed as a reflection of the availability of materials (Mauldin et al. 1994; O'Laughlin 1980). In his survey of prehistoric sites on the alluvial fans of the

Table 4. Material Composition

Site	Material	Total Weight		Total Quantity		Non-feature Weight		Non-feature Quantity		Feature Weight		Feature Quantity	
		g	%	#	%	g	%	#	%	g	%	#	%
12719	caliche	16276.28	36	6418	75	10717.45	35	5004	75	5558.83	40	1414	77
	limestone	27216.12	61	1935	23	19113.92	62	1553	23	8102.2	59	385	21
	other	1262.48	3	185	2	1109.14	4	144	2	153.34	1	41	2
Site Total		44754.88		8538		30940.51		6698		13814.37		1840	
12412	caliche	5796.88	29	2690	51	4024.4	25	2082	52	1772.5	44	473	37
	limestone	14381.64	71	2556	48	12169.92	75	1892	47	2211.72	55	798	63
	other	90.17	0	26	1	34.23	0	22	1	55.94	1	5	0
Site Total		20268.69		5272		16228.55		3996		4040.16		1276	
13237	caliche	203.64	0	6	0	203.64	0	6	0	0	0	0	0
	limestone	488567.65	100	15219	100	254433.7	1	10927	1	234143.7	1	4292	100
	other	716.34	0	23	0	695.97	0	20	0	10.67	0	3	0
Site Total		489487.63		15248		255333.3		10953		234154.4		4295	
All sites	caliche	22276.8	4	9114	31								
	limestone	530165.41	96	19710	68								
	other	2068.99	0	234	1								
Total		554511.2		29058									

Franklin Mountains northwest of El Paso, O’Laughlin (1980) found no fire-cracked rock features containing burned caliche, while Mauldin’s study of 790 features within the Hueco Bolson found that over 80 percent of the features contained caliche (Mauldin et al. 1994).

Studies from the Tularosa Basin north of El Paso, however, produced a different pattern of material selection. Oakes (1981) found the fire-cracked rock assemblage on the western side of the basin is dominated by limestone even though the nearest source of this material is 6.5 km away. Duncan and Doleman (1991) report that although the nearest source of non-caliche rock is 3–5 km away from their portion of the study area and caliche is readily available, burned caliche accounted for only 13 percent of the total fire-cracked rock quantity and 2.5 percent of the total assemblage weight. Duncan and Doleman (1991) suggests the predominance of

imported rock from substantial distances indicates this material was selected for functional reasons, most probably stone boiling, while burned caliche may represent impromptu or incidental fires.

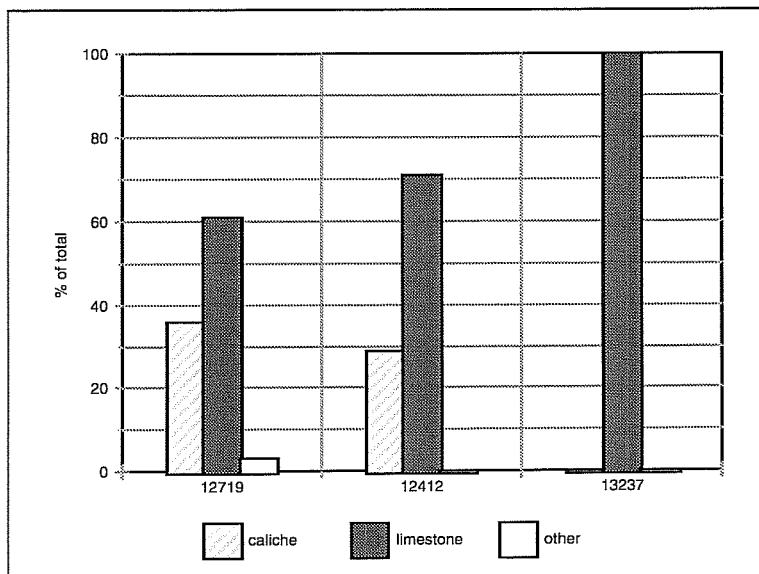

Figure 1. Material weights.

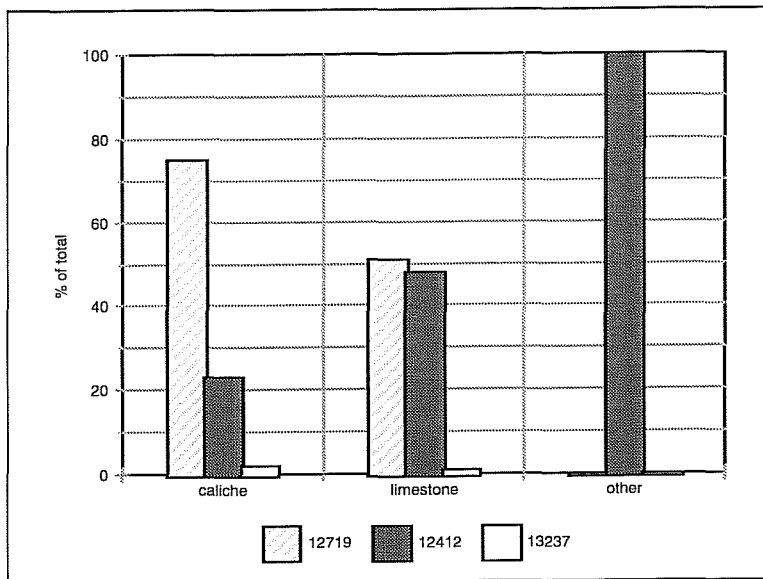

Figure 2. *Material quantities.*

Availability rather than function appears to have been a factor in material selection in our study area. Although the three sites are located in different environmental zones, no more than 1.5 km separates the basin site, FB 12719, from the nearest source of limestone. Therefore, if limestone was of functional importance, it would have been reasonably accessible, especially to site FB 12412 located in the transitional zone at the base of the alluvial fan. The increasing frequency of burned caliche as one moves into the basin suggests expedient use of available materials for general-purpose activities not requiring large quantities of limestone, as proposed by Carmichael (1985), Hard (1983), and Whalen (1977).

Feature Type

Feature type classifications are assigned in this report based on the morphological categories of fire-cracked rock features defined at the Goberadora site by Miller (1989, 1990). The four categories are:

- 1) Rock-lined pits: shallow basin pits averaging one meter in diameter with walls and base lined completely with unbroken cobbles averaging 20–30 cm in diameter. Spaces

between the cobbles are often filled with smaller, sometimes fractured, rocks.

- 2) Fire-cracked rock discard scatters: dispersals of highly fractured rock with no evidence of underlying basins or pits. Discard scatters are generally found in direct association with rock-lined pits.
- 3) Fire-cracked rock middens: dense accumulations of fire-cracked rock not directly associated with rock-lined pits
- 4) Hearths: small, shallow basins or pits with fill composed of darkly stained soil and a small number of burned rocks.

This analysis includes burned rock from 18 features identified during excavation (Table 5). Features from site FB 13237, located on the distal fan, include two rock-lined pits, three hearth features, and one burned-rock discard scatter. Features excavated at site FB 12412, located in the transitional zone, include one rock-lined pit, one hearth, and two burned rock scatters. Aside from the burned caliche and fire-cracked rock associated with the fill of the three pit structures on site FB 12719 in the basin, all excavated features from this site are identified as hearths.

The three rock-lined pits have diameters ranging in size from 0.8–2 m, and are between .18–.14 m deep. Feature 16 from site FB 12412 and Feature 46 from site FB 13237 are similar in size, but Feature 46, while not fully excavated, contained almost twice as many burned rocks. Eight basin-shaped hearth features were identified. These hearths have an average area of .39 m (std .15 m) and range in area from .17–.67 m.

Radiocarbon Dates

Radiocarbon dates were recovered from 10 of the excavated features (Table 5). With the exception of the date from Feature 85, features at site FB 12719 and FB 12412 fall within the range established for the Mesilla phase (A.D. 300–1100) in the El Paso

Table 5. Feature Descriptions

Site	Blk.	Ftr.	Description	Dimensions (meters)	Burned Rock		¹⁴ C Date
					Quantity	Wgt. (g)	
12719 Central Basin UTM 8728	B1	30	dish-shaped hearth	.50 x .40 x .04	325	2000.86	
	A1	32	bulb-shaped pit structure	3.95 x 2.80	328	5501.16	1060±50 1140 ±60 1240 ±60
		78	hearth inside Ft 32	37 x .47 x .10	10	12.19	
		33	pit structure	2.65 x 3.60	718	3667.75	1040±80 1500±110
		34	pit structure	4.15 x 2.95	361	2390.37	1360±70
		80	hearth feature inside Ft 34	.35 diam x .10	2	.51	1200±110
		89	basin-shaped hearth inside Ft. 34	.35 x .10 circular	33	68.89	
		85	possible post hole inside Ft. 32	.25 x .05	20	18.65	1710±150
12412 Transitional UTM 8928	A1	12	basin-shaped hearth pit; brownware, flakes	.77 x .64 x .15 circular	119	163.33	1070±60
	B2	16	deep rock-lined hearth	2.0 diam. x 1.4	270	894.70	870±50 790±60 1060±70
	A2	3	concentration of burned caliche and rock	8 x 4	673	1792.58	
		9	concentration of burned caliche and rock	3 x 2	209	1138.65	
13237 Proximal Fan UTM 9029	C1	40	cobble-lined hearth	.80 x .70 x .18	346	88170.09	670±60
		102	basin-shaped, FCR-ringed hearth	.83 x .56 x .24 semi-circular	165	49206.50	1660±70
		103	FCR-ringed, semi-circular, basin- shaped hearth; ½ excavated	.80 x .56 x .15	55	12690.00	
	B1	46	deep rock-lined, steep-sided, basin- shaped hearth; not fully excavated	1.5 diam x .25	508	44352.72	4120±80
		98	basin-shaped stain	.70 x .95 x .09			
	A1	48	FCR concentration w/o pit outline		3209	39859.25	

area. This phase is characterized by a substantial amount of residential mobility, the use of huts and pithouses, and a subsistence economy based primarily on hunting and gathering (Hard 1983; Hard et al. 1994; Whalen 1981). Dates from

features on site FB 13237 range from the Archaic period to the El Paso phase when residential sites appear to cluster at the toes of the alluvial fans (Hard et al. 1994; Mauldin 1994).

Rock Size-Class Comparison

Frequency of total weight and quantity of non-feature and feature burned caliche and fire-cracked rock from the three sites were compared by size class to search for patterns associated with function (Figures 3 and 4). The small size-classes dominate all contexts, creating the skewed distributions in Figure 3. Burned rocks smaller than 2.5 cm in diameter make up over 60 percent of the rock recovered from each of the three sites: FB 12719 (90 percent, n=7,655), FB 12412 (90 percent, n=4765), and FB 13237 (63 percent, n=9744). The percent of total site weight contributed by rocks in the different size classes presents a different pattern (Figure 4). A normal distribution pattern is present at site FB 13237. Weights at site FB 12719 show a bimodal distribution with rocks in size-class 3 (2.4–4 cm) and size-class 5 (5.5–8 cm) contributing a slightly disproportionate amount to the total. At site FB 12412, a slightly skewed unimodal distribution is seen. The skewed and bimodal rock weight patterns at FB 12719 and FB 12412 are most probably the result of the mix of caliche and limestone at these sites. Figure 5 illustrates that features from the three sites are also dominated by burned rocks four centimeters or less in diameter.

Archaeomagnetic Comparisons

Archeomagnetic analyses to identify firing temperatures and multiple-firing episodes were conducted on a small sample of burned limestone from each of the three sites. Results from these tests, presented in detail in Appendix B, produced patterned differences between firing temperatures at these sites. With the exception of one sample, rocks from FB12412 and FB12719 displayed evidence of maximum heating temperatures between 300°–375°C while heating temperatures from FB13237 ranged from 350°–500°C. Gose (Appendix B) suggests these differences may reflect a difference in food being processed at these sites, with the hotter rocks at FB13237 used for processing meat and the cooler rocks at FB12412 and FB12719 used in plant processing. Cooking information from Reid (1989) and Lundberg and Kotschevar (1965) indicate that temperatures within both these ranges are required for dry cooking techniques such as roasting, broiling, baking, and parching.

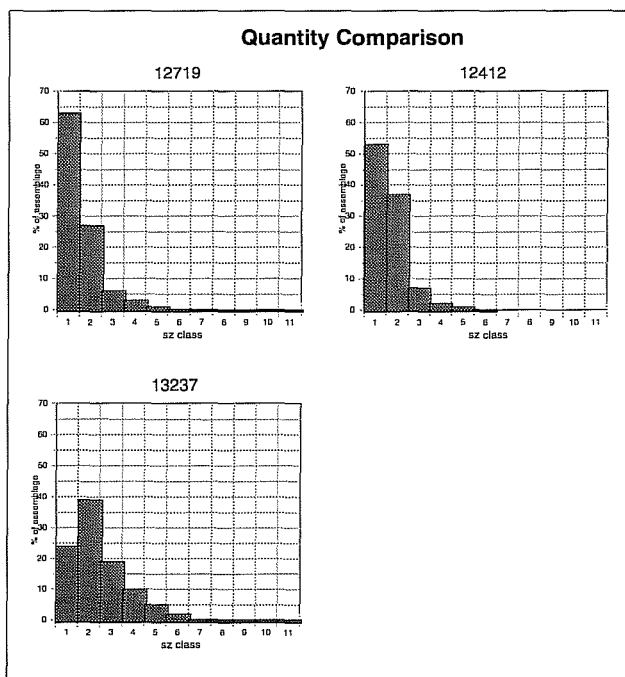

Figure 3. Total site quantity distributions.

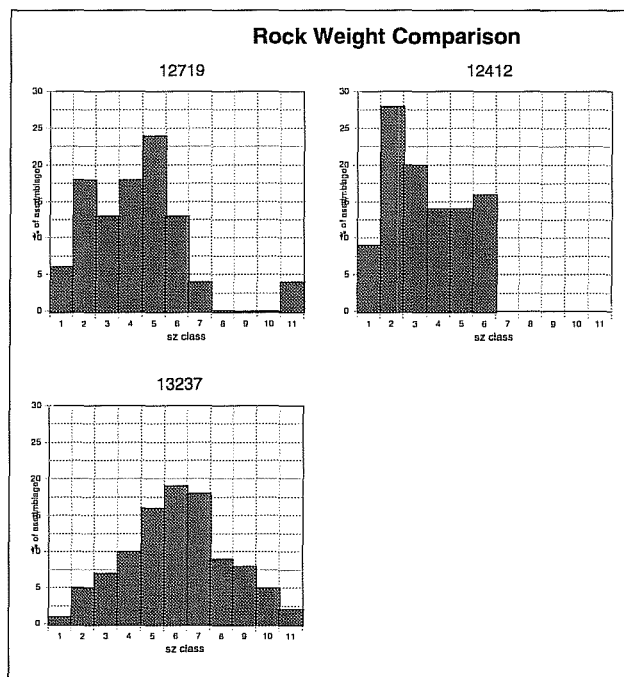

Figure 4. Total site weight distributions.

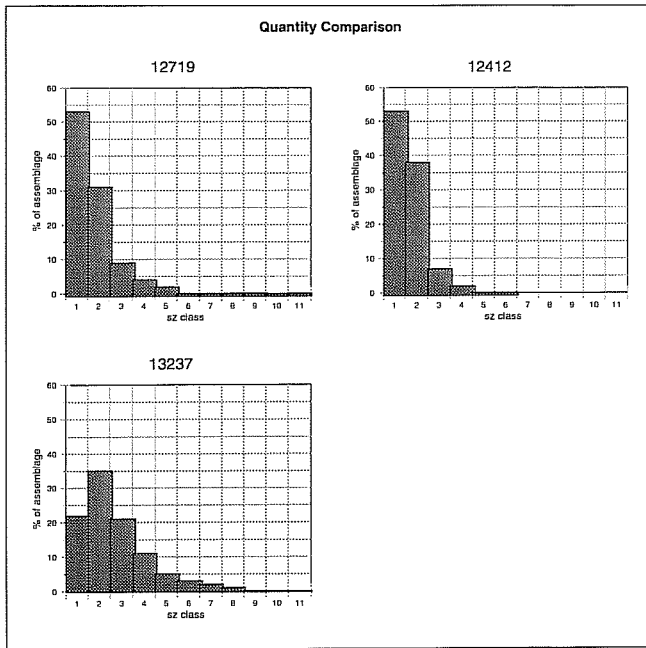

Figure 5. Feature quantity distribution.

Intrasite Analysis

Intrasite analysis was conducted to search for patterns of discard and reuse. Attributes included in this fine-grain analysis include comparisons of non-feature vs. feature weight and quantity, and mean, standard deviation, and frequency of size class for non-feature and feature rock.

Site FB 12719

Feature and non-feature weight and quantity of rocks from FB12719 were compared by frequency in size class. If the non-feature rocks represent discarded stone that had become too fractured to effectively hold/transfer

heat, these rocks should be consistently smaller than the rocks identified as part of the feature. Figure 6 illustrates that non-feature burned rocks (all material types) are smaller than feature burned rocks with the frequency of size-class 1 (<1.5 cm) in the non-feature assemblage accounting for 64 percent (n=4,296), as opposed to the feature assemblage of 57 percent (n=1,055). The histogram of weight by size class in the non-feature assemblage shows a distribution skewed toward the larger sizes, unlike the normal distribution displayed by the feature rock weights. While all the burned rock and caliche on this site is small, both of these patterns suggest the overall non-feature rocks do represent discards.

Quantity distributions by size class for rocks from individual features and non-feature rock was investigated to consider differences or similarities that may relate to function. However, because of the friable nature of caliche, only size classes of burned limestone are included. These findings are illustrated in Figure 7. A pattern of dominance of smaller burned rocks is again present. It is, however, interesting that the

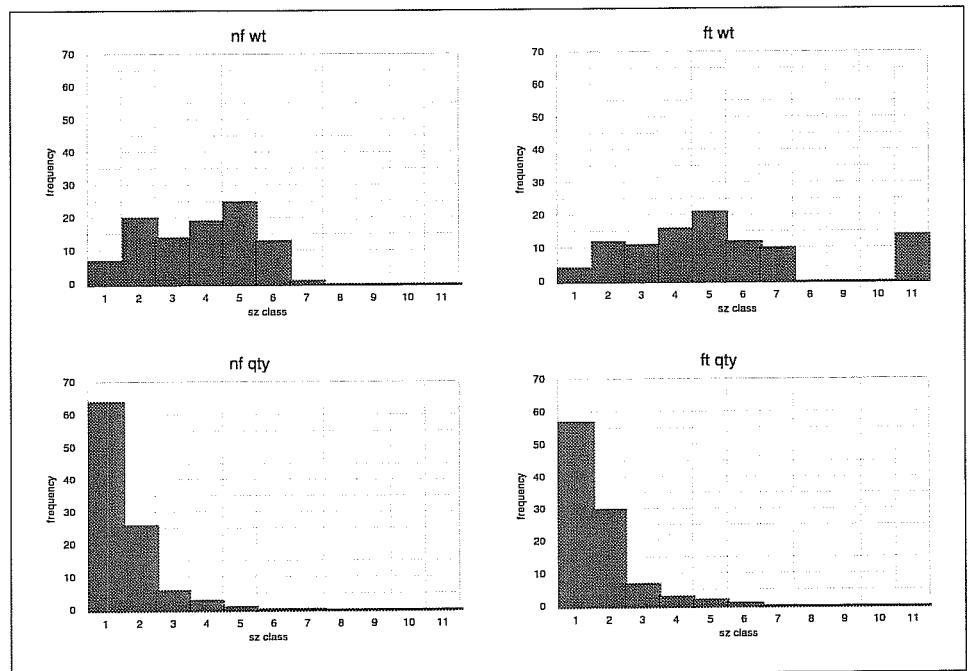

Figure 6. Non-feature vs. feature comparison, FB 12719.

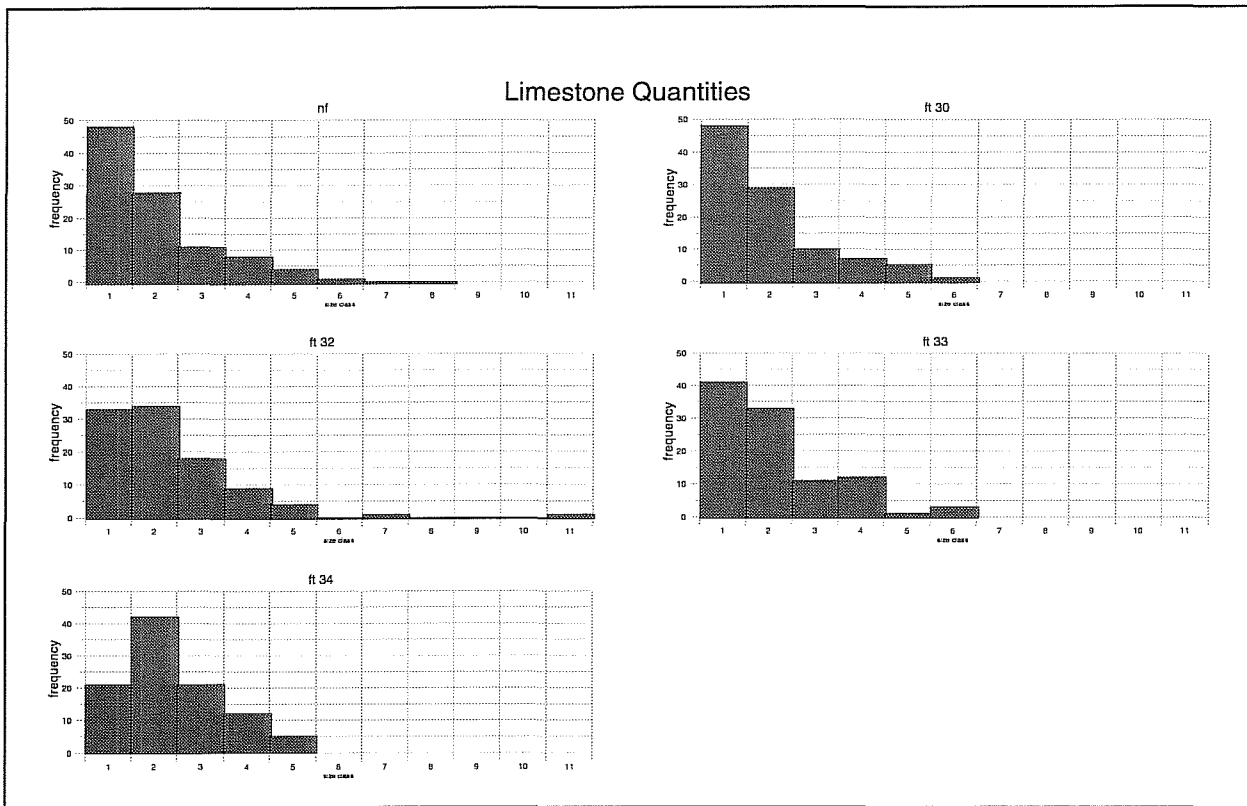

Figure 7. Limestone frequency distribution, FB12719.

size frequencies of the non-feature limestone most closely resembles those of Feature 30, the one dish-shaped hearth not associated with a pit structure on this site, suggesting that the non-feature limestone could represent disarticulated hearth features.

heavier average weight of size 5 and 6 rocks in Feature 32 suggests these rocks are less fractured and possibly blockier than the same sized rock from other portions of the site. The inverse is seen in the

Mean size of burned limestone recovered from the entire site ranges from 2.02–2.61 cm, while the burned caliche ranges from 1.09–1.46 in mean size (Table 6). Duncan and Doleman (1991) suggest that differences between blocky fracture patterns associated with stone-boiling activities and curvilinear fracturing associated with dry-cooking activities should be evident in comparisons of rock size and average weight. The variations in the average weights by size class for the burned limestone at site FB 12719 is illustrated in Figure 8. Aside from the expected observation that as rocks get bigger they get heavier, the

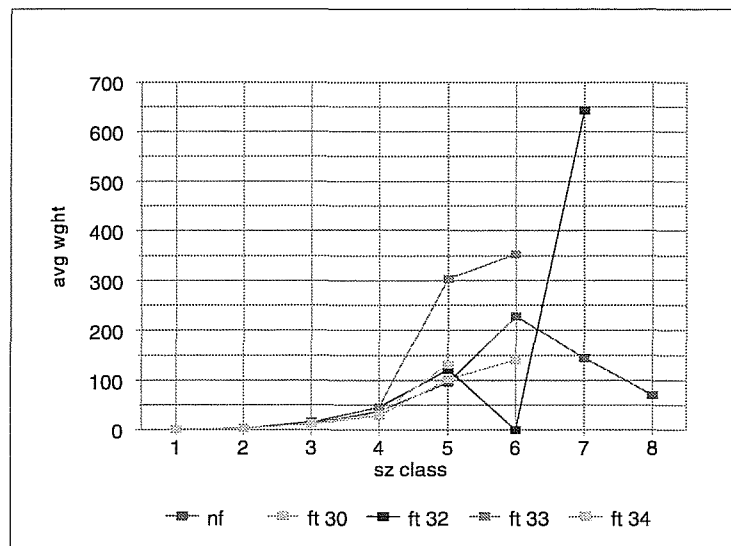

Figure 8. Average weight comparison, FB12719.

Table 6. FB 12719, Fire-cracked Rock and Burned Caliche Details

Site	Feature	Material	Qty	Weight (g)	Rock Size Range (cm)	Mean Size (cm) (std)	¹⁴ C Date (B.P.)
12719	30	limestone	114	1285.6	<1.5-10.5	2.02 (1.76)	
		caliche	211	715.26	<1.5-8	1.09 (.99)	
	32	limestone	79	3603.27	<1.5-23	2.61 (2.86)	1060±50 1140±60 1240±60
		caliche	736	3622.32	<1.5-15.5	1.49 (1.16)	
	78	limestone	0				
		caliche	10	11.79	<1.5-2.5	2 (1)	
	33	limestone	76	1671.29	<1.5-10.5	2.2 (1.84)	1040±80 1500±110
		caliche	1319	8116.92	<1.5-10.5	1.63 (1.42)	
	34	limestone	110	1540.63	<1.5-8	2.54 (1.52)	1360±70
		caliche	1520	14399.54	<1.5-18	1.83 (1.6)	
	80	limestone	2	.51	1.5 only		1200±110
		caliche	0				
	89	limestone	0				
		caliche	33	68.89	<1.5-5.5		
	85	limestone	0				1710±150
		caliche	18	18.44	<1.5-2.5		

larger non-feature rocks where the decreased average weight in size 7 and 8 rocks suggests the fractures in these rocks are less blocky, more curvilinear. While much of the burned rock from this site was recovered from fill within structures (Features 32, 33, and 34), these two fracture patterns suggest burned limestone served multiple functions at FB 12719.

Site FB 12412

Feature and non-feature weight and quantity comparisons by size class of rocks from FB 12412 are shown in Figure 9. No difference is seen between feature and non-feature size class frequency distribution; both assemblages are heavily skewed to the right, reflecting the dominance of rock sizes smaller than 2.5 cm in diameter. The weight distribution diagrams illustrate that although over 50 percent of both feature and non-feature weight comes from rocks smaller than four centimeters in diameter, 56

percent of the weight (n=2258.97 g) in the features is concentrated in size classes 2 and 3.

As at site FB 12719, over 75 percent of the burned limestone assemblage at FB 12412 is dominated by smaller rocks (Figure 10). A similar distribution pattern is seen between the of rock from Features 3 and 9, the two burned rock scatters. Size class 2 (1.5-2.5 cm) is the most frequent and no rocks larger than size 5 (5.5-8 cm) are present. The size distribution of burned rocks in Feature 16 (a rock-lined pit) most closely resembles the distribution of the non-feature rocks with rocks <1.5 cm being the most frequent. No clear pattern between discarded non-feature burned rock and feature burned rock could be identified in these two analyses.

Mean size of burned limestone from FB 12412 ranges from 1.37-2.06 cm, while burned caliche mean sizes are between 1.12-1.57 cm (Table 7). These mean limestone sizes are smaller than those from FB 12719 (Table 6), although FB 12412 is

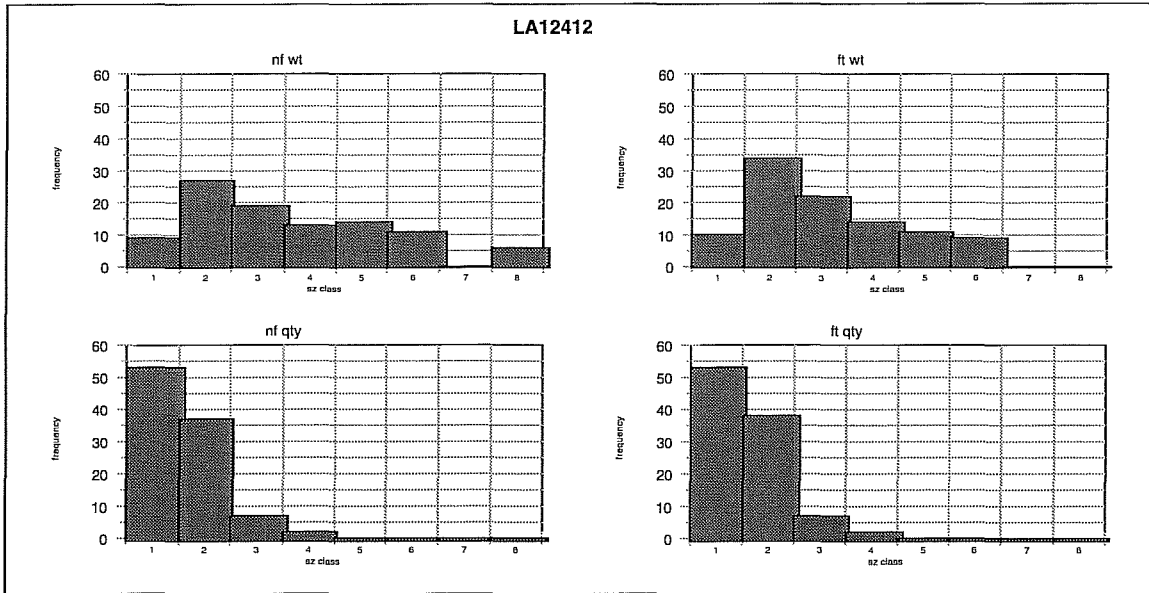

Figure 9. Non-feature vs. feature comparison, FB 12412.

located closer to a limestone source. These smaller sizes may result from functional differences at FB 12412 or from more intense use of the features.

Comparison of average weights in size classes for the limestone recovered from FB 12412 is illustrated in Figure 11. Size 2 rocks (1.5–2.5 cm) in the non-feature assemblage have a greater average weight than size 2 rocks from the features. This is also true for size 5 rocks (5.5–8 cm) from Feature 9. The heavier average weights suggest these rocks are more angular/blocky in shape, but no clear functionally related pattern of fracturing is evident.

Site FB 13237

Feature and non-feature weight and quantity comparisons by size class for rocks from FB 13237 are shown in Figure 12. Both the non-feature and feature weight frequencies approach a normal distribution. Non-feature weights are skewed slightly toward the larger sizes while feature weights are skewed slightly toward the smaller

sizes, reflecting the influence of the large rocks in the rock-lined pit features. The quantity histograms, however, are sharply skewed to the right, graphically illustrating that 84 percent of non-feature rock (n=9,285) and 78 percent of the feature rock (n=3,355) are smaller than four centimeters in diameter.

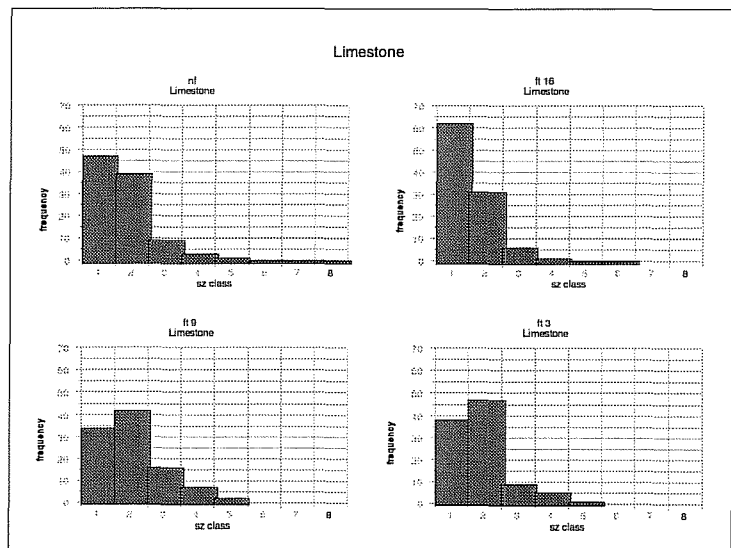

Figure 10. Limestone frequency by size class, FB12412.

Table 7. FB 12412, Fire-cracked Rock and Burned Caliche Details

Feature	Material	Quantity	Weight (g)	Rock Size Range (cm)	Mean size (cm) (std)	¹⁴ C Date B.P.
non-feature	limestone	2083	12169.92	<1.5-15.5	1.7 (1.25)	
	caliche	1892	4024.38	<1.5-10.5	1.34 (.82)	
12	limestone	6	34.04	<1.5-4	2 (1.02)	1070±60
	caliche	113	129.32	<1.5-2.5	1.12 (.57)	
16	limestone	250	872.81	<1.5-10.5	1.37 (1.01)	870±50 790±60 1060±70
	caliche	20	21.89	<1.5-2.5	1.13 (.59)	
3	limestone	116	593.61	<1.5-8	1.83 (1.14)	
	caliche	557	1196.56	<1.5-5.5	1.44 (.83)	
9	limestone	101	711.29	<1.5-8	2.06 (1.33)	
	caliche	20	108	<1.5-10.5	1.57 (1.17)	

Size distribution patterns of non-feature rocks and rocks in individual features, illustrated in Figure 13, show considerable variability which is also reflected in differences in mean size and standard deviations given in Table 8. Similarities are present between Feature 48, the burned-rock concentration, and the non-feature rocks from other parts of the sites.

Eighty-six percent of the Feature 48 assemblages (n=2,489) and 84 percent of the non-feature assemblage (n=9,249) are ≤4 cm in diameter with mean sizes of 2.41 cm (std=1.54) and 2.54 cm (std=1.94) respectively. The higher frequency of smaller rocks and the overall smaller rock size make these accumulations distinguishable as discard assemblages when compared to the other designated features.

Mean sizes of fire-cracked rock from the hearth and rock-lined pit features at FB 13237 range from 3.66-7.15 cm (Table 8). The largest means, 7.15 cm and 6.23 cm, are from Features 102 and 103

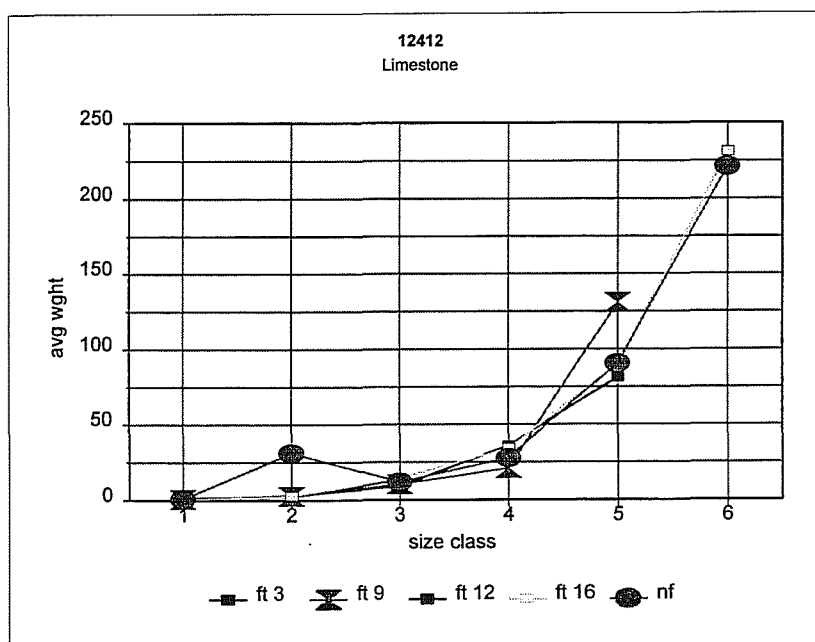

Figure 11. Average weight comparison, FB 12412.

respectively, the two features described as basin-shaped, ringed hearths. Variations between these two may be a result of partial excavation of Feature 103. While Features 40 and 46, the two rock-lined pits, contain rocks of up to 20.5 cm and 13 cm respectively, the lower means may result from smaller rock used as fill between larger cobbles in

Block-Level Analysis

A fine-grained analysis was conducted to compare attributes of burned rocks from features with those from the surrounding non-feature excavation block. Pattern recognition analyses were performed by generating grid-based density contour maps in Surfer[®]. The total weight and counts of burned rock from selected areas were summed by excavation units (1 x 1 m) and plotted by levels for a given block. The density patterns created by the contour program are enhanced by adding grid lines for individual units and boundary information for features within

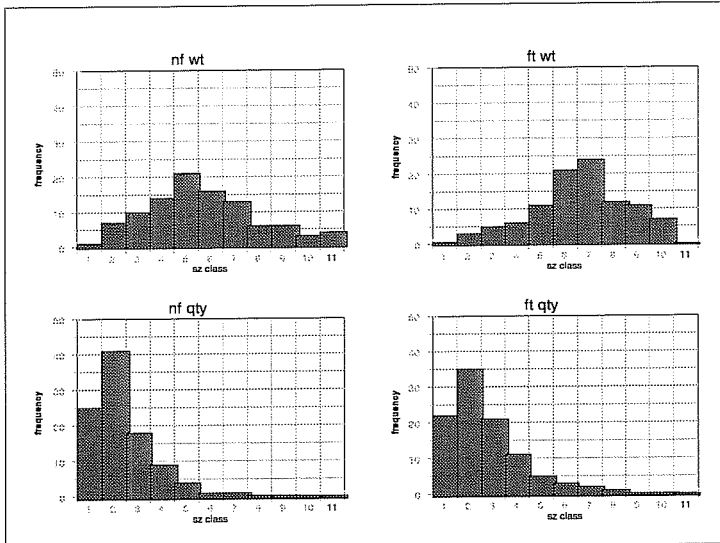

Figure 12. Non-feature and feature comparison, FB 13237.

the lining as described by Miller (1989, 1990). The smaller rocks could also represent discarded rocks that accumulated in the fill and were not identified separately during excavated. Comparison of average rock weights (Figure 14) revealed no patterns suggestive of functionally differentiated fracturing at FB 13237.

each of the excavation blocks. Using the density patterns generated by this application, we were able to isolate areas of relatively dense burned rock that were not identified during excavation and were not apparent in the site level comparisons.

Table 8. FB 13237 Fire-cracked Rock Details

Feature	Material	Quantity	Weight (g)	Rock Size Range (cm)	Mean Size (cm) (std)	¹⁴ C Date B.P.
non-feature	limestone	10953	255,333.3	<1.5-23	2.54 (1.94)	
40	limestone	346	88170.09	<1.5-20.5	5.66 (4.4)	670±60
102	limestone	165	49206.50	<1.5-20.5	7.15 (4.25)	1660±70
103	limestone	55	12690.00	<1.5-13	6.23 (3.5)	
46	limestone	508	44352.72	<1.5-13	3.9 (2.97)	4120±80
48	limestone	3209	39859.25	<1.5-18	2.41 (1.54)	
98	limestone	11	138.09	<1.5-8	3.66 (1.6)	

LA13237

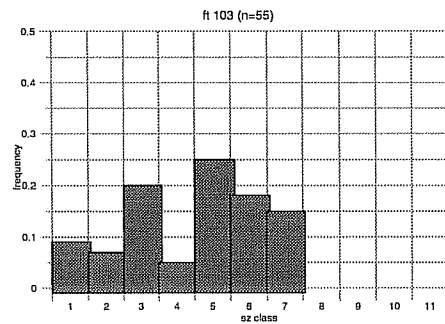
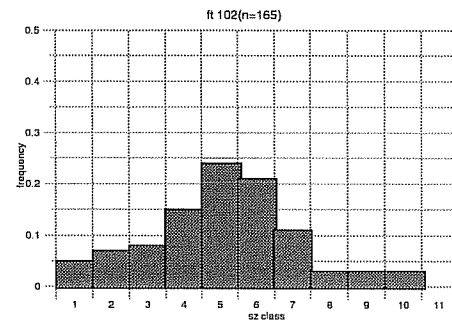
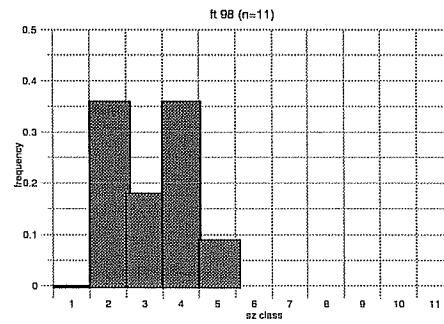
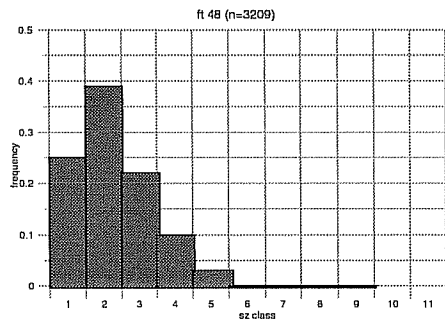
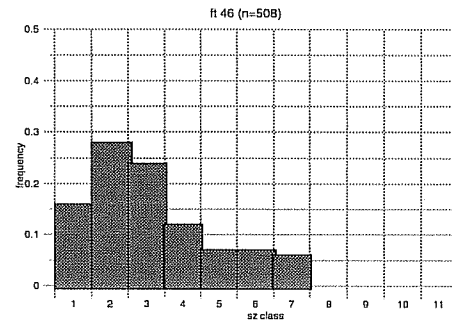
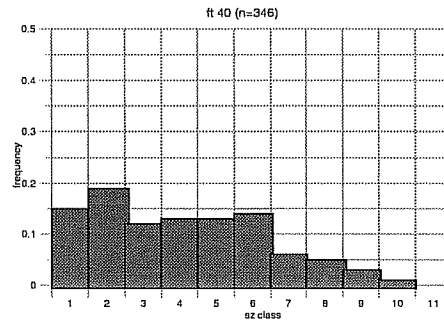
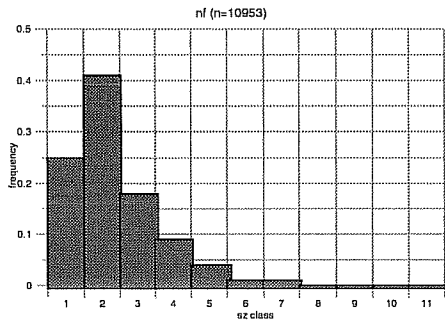

Figure 13. Limestone frequency by size class.

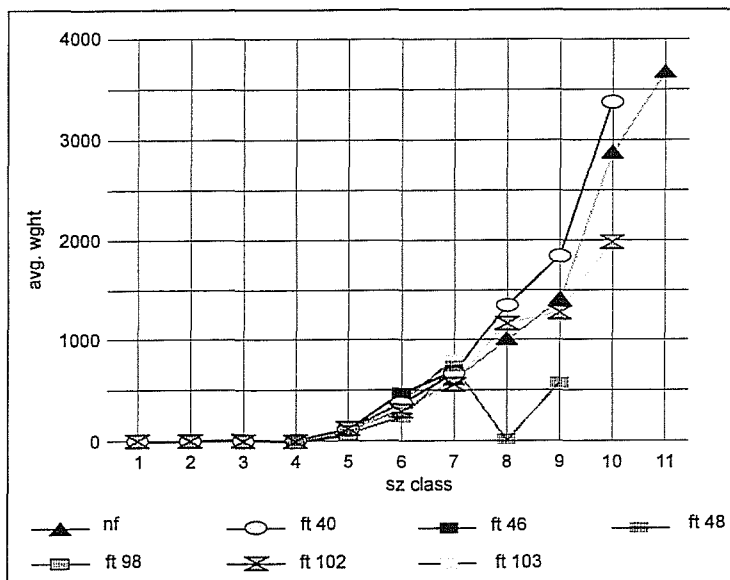

Figure 14. Average weight comparison, FB 13237.

FB 13237

Block C1

Block C1 was established in the field to investigate a large concentration of burned rock visible on the surface, originally designated Feature 40. The density plot for Level 3 (the first level excavated in this block) indicates a cluster of burned rock in Units E166/N189 and E167/N189, with lesser amounts of burned rock in the surrounding units in the eastern half of the block (Figure 15). Units E164/N187-190, E165/N187-190, and E166/N187 were not excavated as part of Level 3, as they are stratigraphically lower than the units on the eastern side of the block and were not excavated until Level 4. However, those units excavated as part of Level 3 clearly reveal patterning in burned rock density.

The boundaries for Features 102 and 103 are clearly defined on the contour plot of Level 4 (Figure 15). At this depth, Feature 40 was reclassified in the field from a surface scatter of burned rock to a subsurface, rock-lined pit. The density plot for Level 4 reveals some high-density areas in addition to the features. Interestingly, the cluster of burned rock noted in Level 3 is no longer visible.

In Level 4, Features 102 and 103 become defined based on the density of rock in their respective units, whereas, Feature 40 is not completely defined. None of the feature locations identified in this block was directly discernable from surface densities (Level 3) of burned rock. Also of interest in Level 4 is the relatively high density of burned rock in the extreme northeast corner (Unit E167/190) of the block. This area of the block within Level 4 has the highest density of burned rock. The excavators did not note this area on any of the excavation forms and it was not assigned a feature number in the field.

Density contour plots of the burned rock in Level 5 (Figure 15) demonstrate a decreasing distribution of burned rock when compared to the overlying Level 4. Burned rocks associated with Features 102 and 103 remain evident, suggesting that both features continue into this level. Feature 102 appears to have more burned rock in this level than does Feature 103. The upper portion of Feature 40 is identified by the high-density of burned rock in Unit E166/N189. The high-density of burned rock noted in the extreme northeast corner of the block in Level 3, however, has all but disappeared. The density of non-feature burned rock is beginning to decline at this level as well.

Examination of Level 6, which includes only Unit E166/N189, reveals a large quantity of burned rock within the Feature 40 limits (see Figure 15). This level defines the bottom of that feature and the vertical extent of burned rock in this excavation block. Level 6 was not excavated in units containing Features 102 and 103 as the bottom of each features was reached in Level 5.

To compare patterns in burned rock size between features and non-feature areas in this block, the percentage of rock in each size category was plotted for a number of proveniences (Figure 16). In Level 3, which is composed of non-feature burned rock, 50 percent of the rock was in the 1-2 size range, 38 percent was in the 3-4 size range, 11 percent in the 5-6 size range, and 1 percent was in the 7-8 size

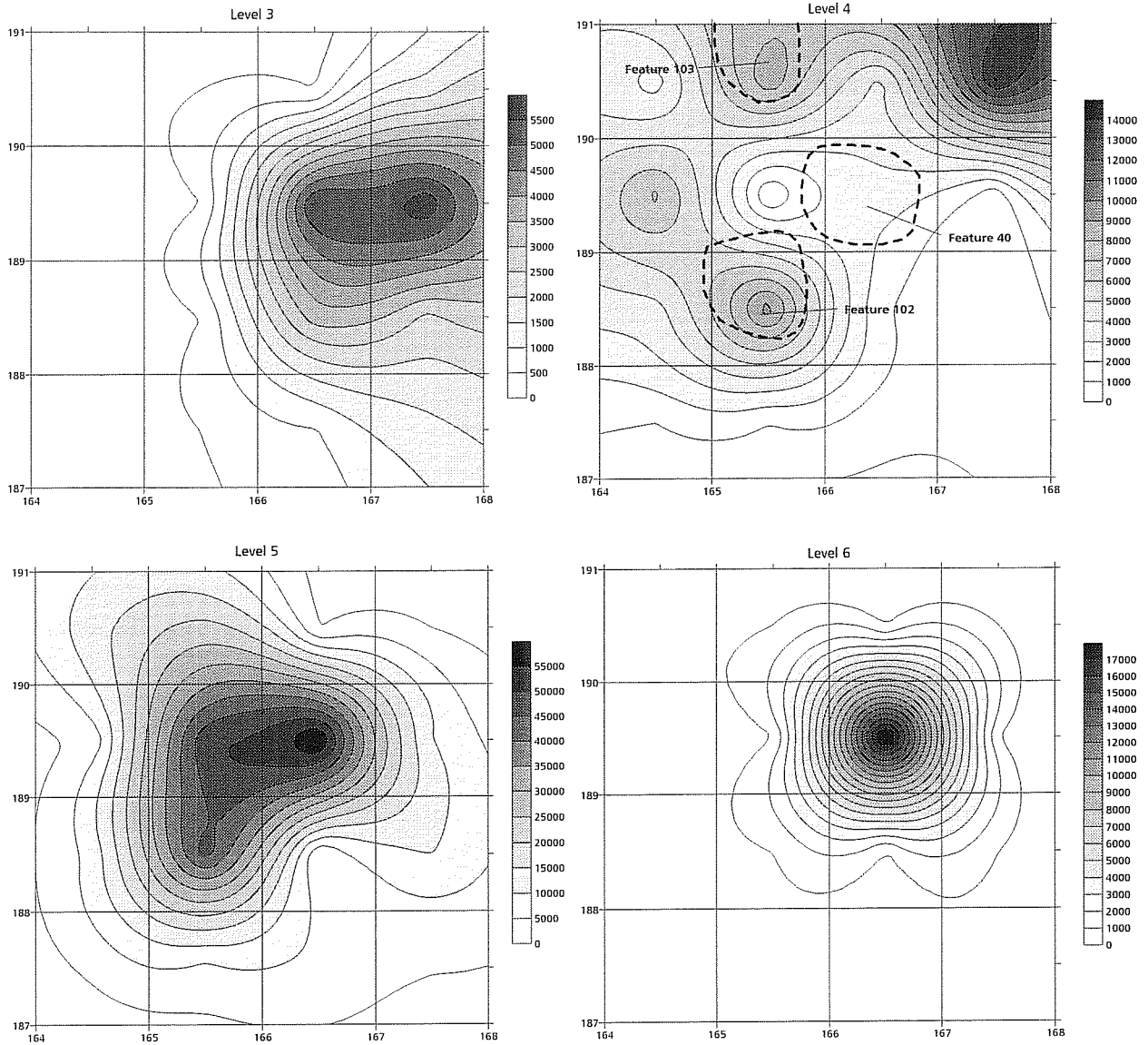

Figure 15. Density plot by weight, Block CI, FB 13237.

range. The small size of these non-feature rocks is graphically illustrated in the skewed histogram in Figure 16.

In Level 4 the high density area of non-feature rocks identified in Unit E167/N190 in the northeast corner of the block was plotted separately (Figure 16). Again over 85 percent of the burned rock falls within the 1-4 size category.

To compare feature rock to the non-feature rock discussed above, the bottoms of the features were identified to isolated the burned rock that constitutes the heating elements. The goal is to determine if “intact” heating elements are present within these features, as the excavations notes indicate. If present, we would expect the heating elements to contain a higher frequency of larger rocks than non-feature burned rock.

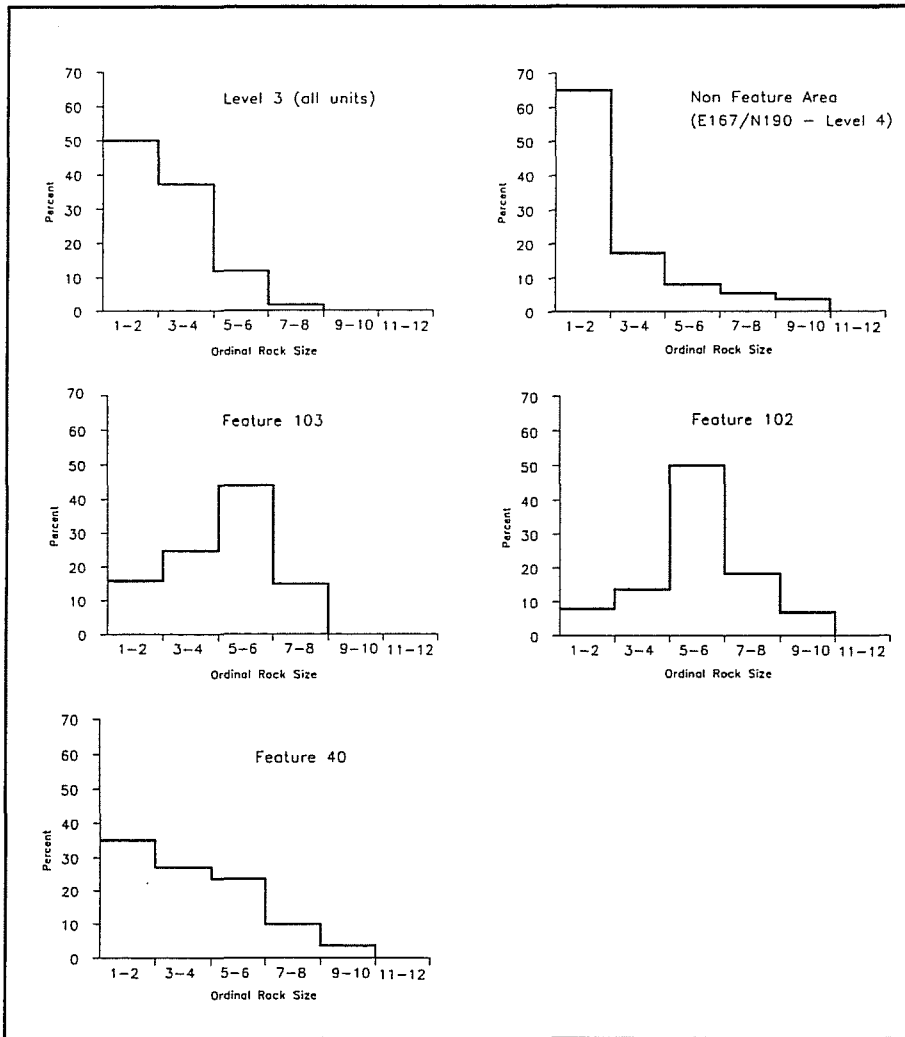

Figure 16. *Frequencies by size class, Block C1, FB 13237.*

Feature 103, which is best defined by a high-density of burned rock in Level 4, has 16 percent of its burned rock in the 1-2 size range, 25 percent in the 3-4 size range, 44 percent in the 5-6 size range, and 15 percent in the 7-8 size range (Figure 16).

For Feature 102 only the burned rock recovered from Level 5 of Unit E165/N188, the area identified as the feature bottom during excavation, is included in this analysis (Figure 16). Here, 77 percent of the burned rock is size 5 or larger.

For Feature 40, the burned rock recovered from Unit E166/N189 Levels 5 and 6, the bottom (heating element) is considered. Of that rock 36 percent is in the 1-2 size range, 27 percent in the

3-4 size range, 24 percent in the 5-6 size range, 10 percent in the 7-8 size range, and 3 percent is in the 9-10 size range (Figure 16).

When we compare the differences in the size of burned rock recovered from feature and non-feature areas in Block C1, we see a distinctive pattern. The majority of the burned rock recovered from non-feature areas is small, burned rock from Features 102 and 103 is dominated by the larger size classes. Feature 40, however, is not dominated by the larger burned rock classes, but, as illustrated in Figure 16, has an almost unimodal distribution only slightly skewed to the right. The differences between size frequencies in Feature 40 and Features 102 and 103 may indicate a different function or use history. Feature 40 is described as an intact cobble-lined pit without a specific heating element, while Features 102 and 103 are

identified as rock-ringed stains with burned rock in the feature fill which probably represent heating elements. This difference may also be a function of excavation techniques or of our arbitrary assignment of heating elements.

The differences in size-frequency distributions between feature and non-feature burned rock is evident. The smaller size of the non-feature burned rocks recovered from above the features and from the extreme northeastern corner of Level 4 (E167/N190) suggests this rock has been discarded after repeated use has reduced them to a size no longer efficient for retaining or transferring heat. Since there is no indication in the excavation notes that other features lie just outside of the area

investigated, we suggest that the discarded rocks in Level 3 and in the northeastern corner of the excavation block are associated with the identified features in this block.

Estimates of maximum firing temperatures for sample rocks in Block C1 indicate the non-feature rocks were subjected to uniformly higher degrees of heat than those remaining within the feature boundaries. It is possible that these non-feature rocks represent discarded remnants of heating

elements from Features 40, 102, or 103. At the same time however, the lack of multiple magnetic vectors for the majority of these samples seems to point away from reuse (see Appendix B).

Block B1

The density contour maps for Block B1 were plotted using total weight of rock recovered from each of the 16 1-x-1-m excavation unit levels (Figure 17). Burned rock was recovered from all three excavation levels (Levels 2, 3, and 4). This

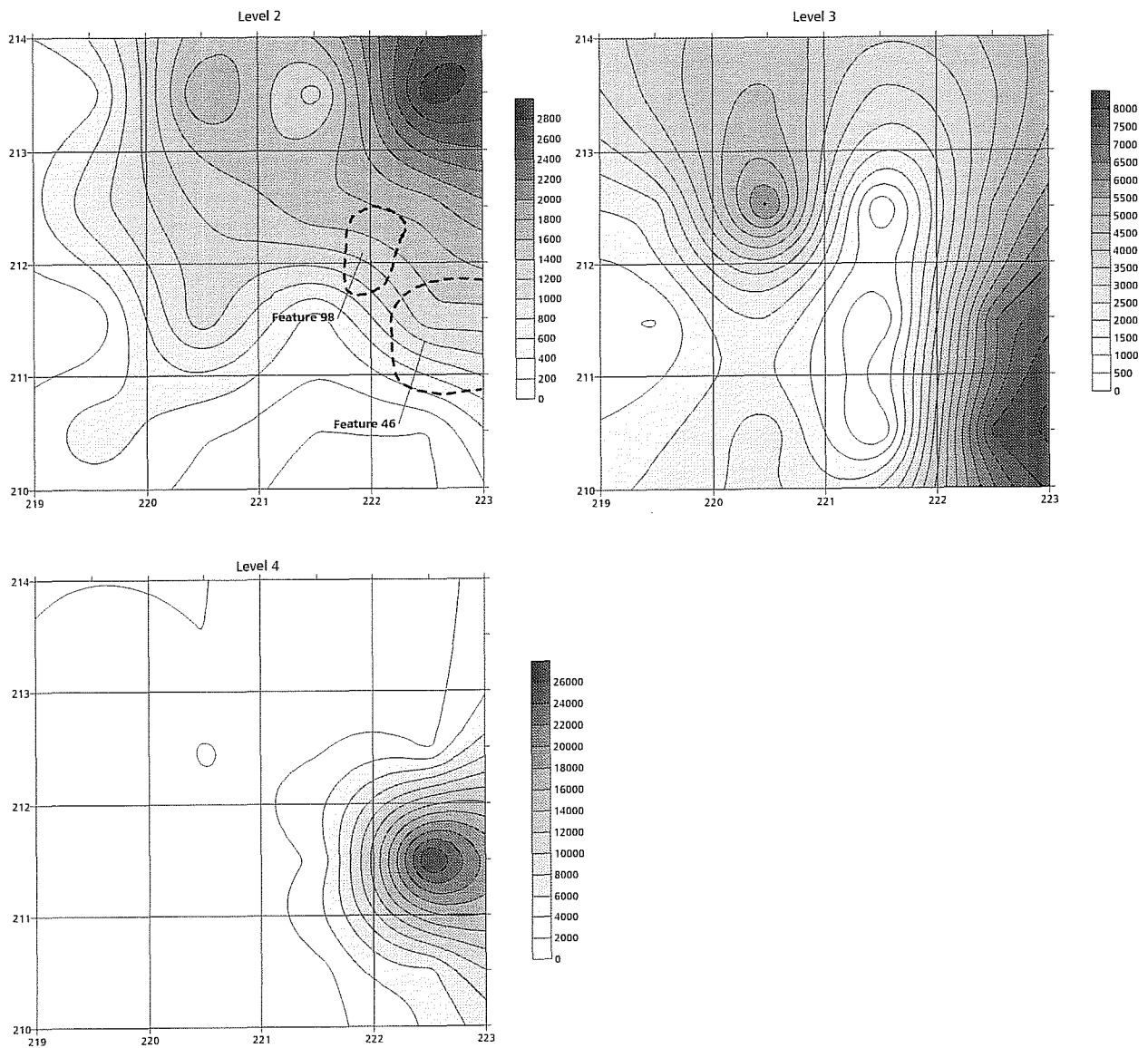

Figure 17. Density plot by weight, Block B1, FB 13237.

block was established to investigate a concentration of burned rock on the surface originally designated Feature 46.

Within Level 2, burned rock is scattered throughout the block with a distinct concentration in the extreme northeastern corner (Unit E222/N213) (Figure 17). The horizontal limits of Features 46 and 98 are depicted in this level for comparison with the lower levels, although Feature 46 extends into Level 4, and Feature 98 continues into Level 3.

The pattern revealed in Level 3 shows burned rock scattered throughout the block with areas of higher burned rock density evident in Unit E220/N212 and in the southeastern corner of the block (Figure 17). Interestingly, the area outlined in Level 2 as containing Feature 98 shows a low-density of burned rock in Level 3. This is as expected as Feature 98 was described a shallow pit with ash fill. This plot illustrates that any burned rock associated with Feature 98 is confined to Level 2 although the stain from this feature extends into Level 3.

The density plot for Level 4 clearly defines the bottom, or heating element, of the rock-lined hearth designated Feature 46, in Units E222/N210 and E222/N211. The higher density of burned rock in this area was evident in the Level 3 plot, but does not become defined until Level 4.

To compare patterns in the feature and non-feature burned rock areas within the block were isolated. To look more closely size distribution of burned rock from the high-density area revealed in Level 2 in Unit E222/N213 the rock from this unit was plotted separately. The frequencies by size class for this provenience are as follows: 51 percent of the burned rock is in the 1–2 size range, 41 percent is in the 3–4 size range, 7 percent is in the 5–6 size range, and 1 percent is in the 7–8 size range (Figure 18). When we look at the node identified in Level 3 in Unit E220/N212 we see a similar pattern. In this area, 81 percent of the burned rock is in the 1–2 size range, 18 percent is in the 3–4 size range, and 1 percent is in the 5–6 size range (Figure 18). Clearly, both of these non-feature concentrations are characterized by a high frequency of small burned rock.

To construct the burned rock size distributions for features in this block, the heating elements, or bottoms of the features, were isolated. Feature 98 was not considered in this comparison since it was an ash stain with very little associated burned rock, and the density contour plots reveal no distinct clustering of burned rock in the units containing this feature. Feature 46, however, was a rock-lined pit that is well-defined in the density contour plots (Figure 17). As mentioned above, Feature 46 is present in Levels 2 and 3, but is most clearly defined in Unit E222/N211 in Level 4. A plot of the size distribution within Unit E222/N211 in Level 4 reveals that 25 percent of the burned rock is in the 1–2 size range, 32 percent is in the 3–4 size range, 30 percent is in the 5–6 size range, and 14 percent is in the 7–8 size range (Figure 18). This plot shows that the burned rock recovered from the bottom of Feature 46, which represents the heating element, has a greater frequency of larger burned rocks than the burned rock recovered from the non-feature areas.

The density contour plots and burned rock size frequency histograms reveal interesting patterns. The area with a high-density of non-feature burned rock identified in Level 2 (Unit E222/N213) has a burned-rock size distribution similar to that identified for the discard areas in Block C1 (see discussion above). In addition, the high-density area identified in Level 3 in Unit E220/N212 also appears to be representative of a discard area. Interestingly, the high density area in Level 3 was not distinguishable in the overlying level and is therefore stratigraphically lower than the discard area in Level 2. This suggests that the two discard events are stratigraphically and chronologically separate. However, this vertical difference seen on the density plots may be a function of assigning arbitrary collection levels in the field rather than a real difference in vertical position. Nevertheless, we can not rule out that the vertical separation between the two is real, and thus represents reuse with some unknown time passing between the two events. The horizontal association of these discard scatters to the rock-lined pit Feature 46 suggests these clusters are related to Feature 46 which produced a single radiocarbon date of 4120–80 B.P., the oldest date from site FB 13237.

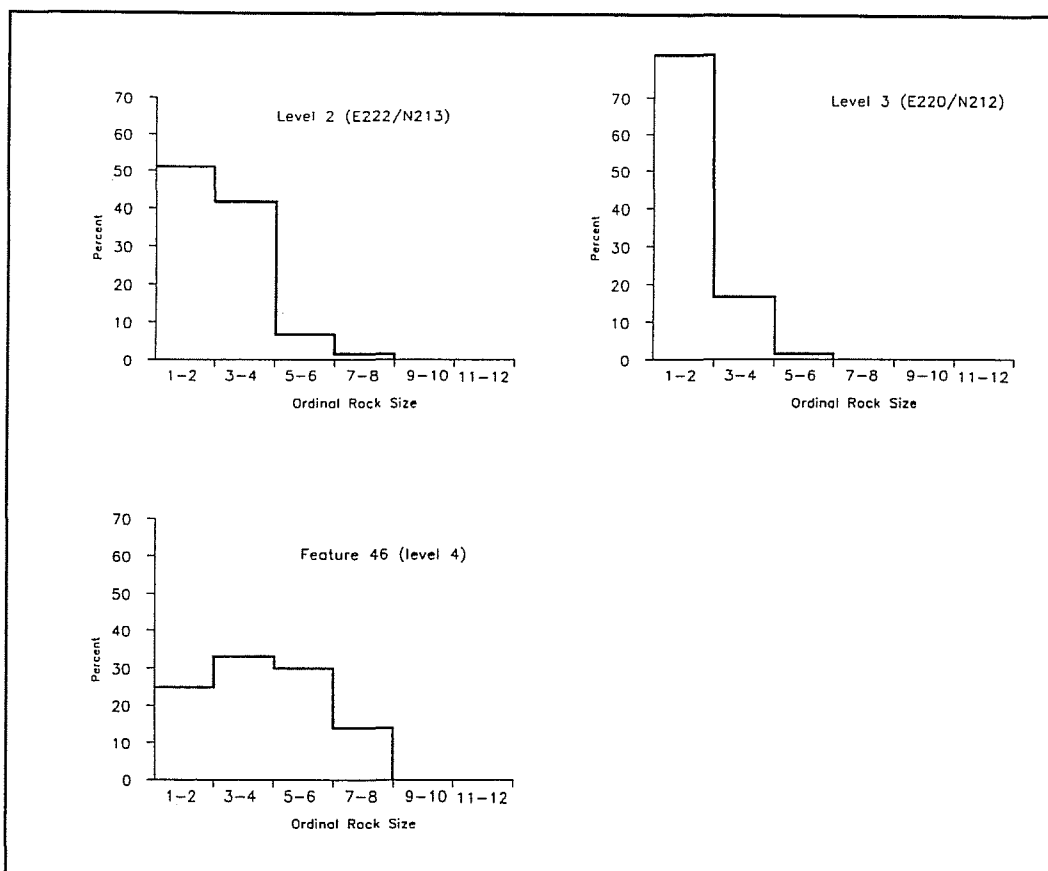

Figure 18. *Frequencies by size class, Block B1, FB 13237.*

Additional evidence of reuse of Feature 46 is present in the multiple magnetic vectors identified in the archaeomagnetic analysis (Appendix B).

Block A1

The entire 16 m² of Block A1 was designated Feature 48, so when constructing the density plots the limits of the excavation area served as the limits of the feature. Like the other blocks on the site, the total weight of burned rock by unit was summed and plotted in a series of density contour plots by excavation level (Levels 1 and 2) (Figure 19).

The density plot of Level 1 reveals a scatter of burned rock over the southern and eastern portion of the block, with a high density area in Unit E254/N188 (Figure 19). However, several units in the northern and western portion of the block were not excavated as part of Level 1 because these units

lie stratigraphically lower on the surface and were excavated as part of Level 2. In Level 2, a high-density of burned rock is evident in Unit E253/N188, and a high-density area is visible along the western edge of the block.

According to the excavation notes, there was no evidence of pits or charcoal staining in either level of the block, so a comparison between feature and non-feature rock is not possible. Therefore, we compared the distribution of burned rock from the high density areas to that of the entire level.

The size distribution plot of high-density area in Level 1 (Unit E254/N188) revealed that 69 percent of the burned rock is in the 1-2 size range, 27 percent is in the 3-4 size range, and 3 percent is in the 5-6 size range (Figure 20). When we plot all the Level 1 rock, 60 percent is in the 1-2 size range, 37 percent is in the 3-4 size range, 6 percent is in the

5-6 size range, and 1 percent is in the 7-8 size range (Figure 20).

The second high-density area, Unit E253/N188 in Level 2, has the following distribution: 68 percent of the burned rock is in the 1-2 size range, 27 percent is in the 3-4 size range, 3 percent is in the 5-6 size range, and 1 percent is in the 7-8 size range (Figure 20). The distribution for all of the burned rock in Level 2 is, 70 percent in the 1-2 size range, 29 percent is in the 3-4 size range, and 2 percent is in the 5-6 size range (Figure 20). At a block level, all of Levels 1 and 2, 68 percent of the burned rock is in the 1-2 size range, 30 percent is in the 3-4 size range, 2 percent is in the 5-6 size range, and 1 percent is in the 7-8 size range (Figure 20).

From the size range comparisons discussed above, it is clear that the burned rock in Block A1 is predominately small pieces. While several areas of higher densities of burned rock are identified in the density plots, these areas have similar distribution patterns on the accompanying histograms. The size distributions for the high density areas and the entire block are similar to the ones noted for the discard areas in Blocks C1 and B1. More importantly, no distributions that look like the feature elements identified in Blocks C1 and B1 are evident for Feature 48 (Block A1). This suggests that this block either 1) represents heavily used feature(s) that have since deflated, which would explain the absence of discernable pits and ash/charcoal staining; or 2) it represents the remains of a discard area from pit features that were missed by the placement of the excavation block. Either of these explanations is plausible, but we

suggest the latter is more plausible due to the low frequency of large rocks. In order for the size distribution seen in Block A1 to be a result of deflated, heavily used feature, the use must have been extensive. Given the availability of limestone

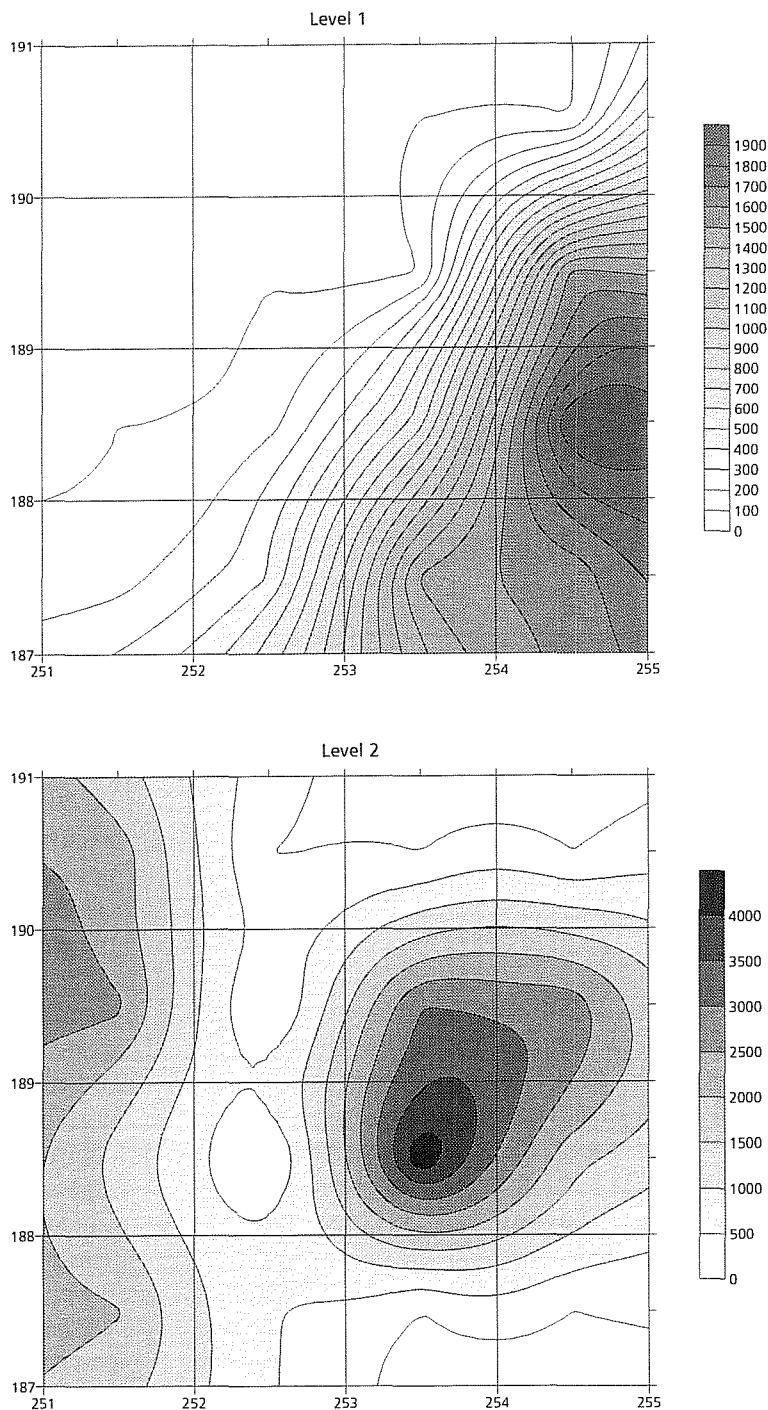

Figure 19. Density plot by weight, Block A1, FB 13237.

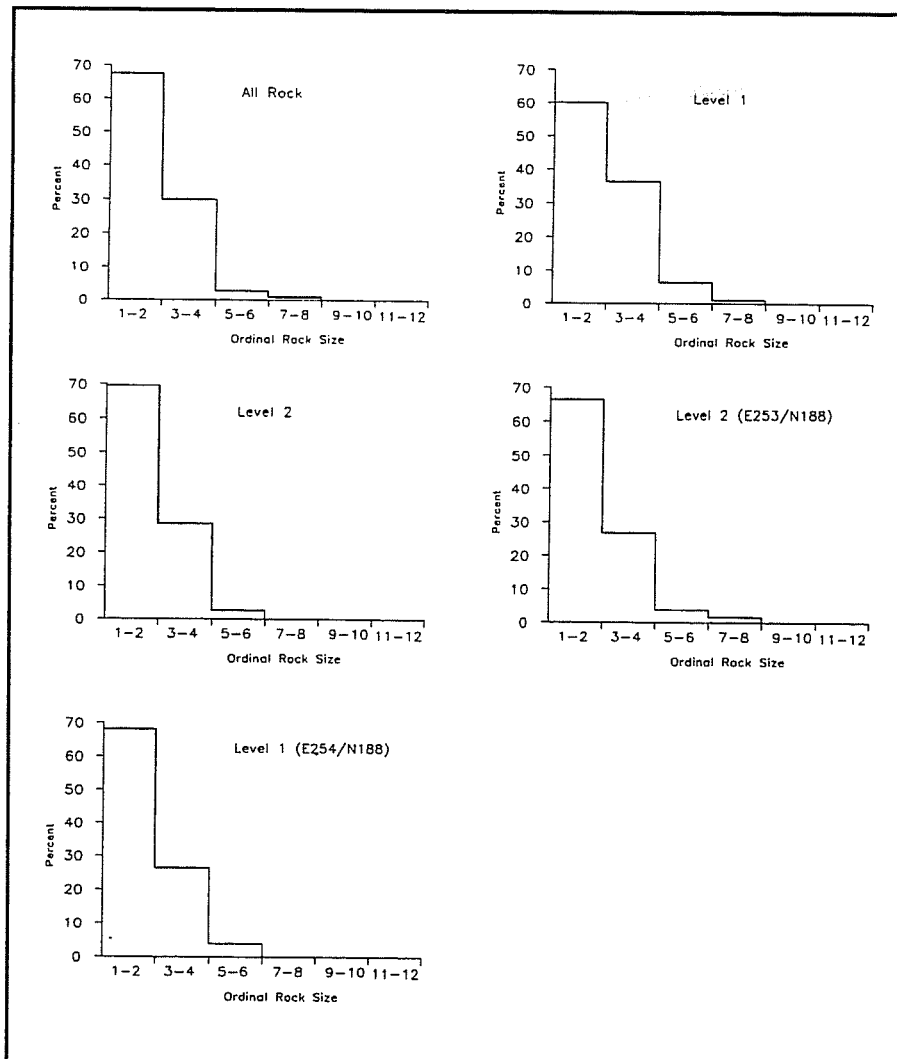

Figure 20. *Frequencies by size class, Block A1, FB 13237.*

at the site it seems unlikely that all of the rocks would have been reused to the extent indicated without being replaced by larger pieces.

In addition to the density and size distribution pattern analysis, frequency of fracturing and frequency of cortex within each size range was

examined. As discussed earlier, with repeated use, rock will fracture into smaller and smaller pieces eventually becoming void of cortex. We have used a high frequency of small rocks within a limited area as an argument for discard events or extensive use of features. If this is indeed the case, a higher frequency of the smaller rocks in heavily used features and discard areas should be fractured and

void of cortex. The frequency of fracturing present and cortex absence within each size range was calculated for each of the features and for all of the non-feature rock from the three excavation blocks at site FB 13237 (Table 9).

Features 40 and 46 do exhibit a high percentage of fracturing and lack of cortex in the small size ranges, indicating the small rocks in these features have been reused. Feature 102 and 103, the two hearth features, have the lowest frequency of overall fracturing and lack of cortex, suggesting a more limited use history for these features. Feature 48, the shallow scatter, and the non-feature rock have similar patterns with less fracturing and more cortex present in the smaller size ranges than the other features.

The deviation of fracturing and cortex patterns from what we had expected in the non-feature and scatter features could be the result of several

factors. It is possible that limestone discolored due to weathering was collected from the excavation blocks and included in the analysis of the Feature 48 and non-feature rock. Because the analysts had to rely strictly on the field notes in order to determine the context of all rock recovered, any rock that exhibited discoloration beyond just a thin weathering layer was considered to be thermally altered. An additional source of non-fractured rock contributing to the analysis is the presence of rock throughout the site that was thermally altered by natural events.

Table 9. FB 13237, Fracture and Cortex Percentages

Size Range	Feature 40 n=346		Feature 46 n=508		Feature 48 n=3209		Feature 98 n=11		Feature 102 n=165		Feature 103 n=55		Non-ft n=11178	
	% frac present	% cortex absent	% frac present	% cortex absent	% frac present	% cortex absent	% frac present	% cortex absent	% frac present	% cortex absent	% frac present	% cortex absent	% frac present	% cortex absent
1-2	81	84	90	86	47	72	0*	0	87	56	13	0	70	54
3-4	80	50	81	56	40	52	25	30	73	35	70	35	68	49
5-6	67	12	71	7	75	21	0**	0	53	8	21	0	68	46
7-8	63	0	57***	0	75	0	—	—	44	0	63***	0	33	12
9-10	42	0	—	—	—	—	—	—	10	0	—	—	31	8
11	—	—	—	—	—	—	—	—	—	0	—	—	0	
Total %	74	44	81	57	61	63	25	30	91	18	38	9	68	36

*no size 1 **no size 6 *** no size 8

FB 12412

Block A2

A total of 100 m² was excavated in this block. Fire-cracked rock and burned caliche were recovered from five levels (6–10) and from two features (3 and 9). Features 3 and 9 consisted of surface scatters of burned caliche with no staining or subsurface presence.

For each unit, density contour plots were generated using the total weight of burned rock in Levels 6 and 7, and Levels 8–10 combined (Figure 21). Caliche and limestone were combined due to small sample size. In Level 6 several high density areas of burned rock are evident. The boundaries for Features 3 and 9 identified on the surface correspond to two of the highest density areas seen on the contour plot. The other high density areas in the northeastern portion of the block appear to be related to these features.

In Level 7, the number of units containing burned rock and the amount of burned rock decreases considerably. There is one area of high density in the northwestern portion of the block that appears to be associated with Feature 3, while the high density of rock weight corresponding to Feature 9 is no

longer evident. This suggests that the burned rock concentration associated with Feature 3 extends into Level 7, but Feature 9 terminates at a shallower depth.

Only a small amount of burned rock was recovered from Levels 8, 9, and 10 (levels were combined due to low weight totals). The limited amount of burned rock recovered from these lower levels suggests that the Feature 3 does not continue into the lower levels.

To explore size patterns in the burned rock in the feature and non-feature areas, percentages were plotted in several histograms (Figure 22). Limestone and caliche were combined for this analysis. Of all the burned rock recovered, 90 percent is in the 1–2 size range, 9 percent is in the 3–4 size range, and 1 percent is in the 5–6 size range.

To consider what appears to be the lowest portion (possible heating element) in Feature 3, we plotted the burned rock recovered from Unit E527/N562 in Level 7. At that provenience 89 percent of the burned rock is in the 1–2 size range and 11 percent is in the 3–4 size range. Much like the block totals, the majority of rock from Feature 3 is small in size.

For Feature 9 we consider the burned rock recovered from two units: E532/N562 and E532/N563 in Level 6. The pattern in rock size is very similar to Feature 3, with 87 percent of the rock falling in the 1–2 size range, 11 percent in the 3–4 size range, and 1 percent in the 5–6 size range.

The pattern for feature and non-feature areas in Block A2 is very similar. Nearly all of the burned rock is small. Attempts to isolate other areas (e.g., Unit E529/N561, Level 6) within the block for comparison reveals much the same pattern, as do patterns between limestone and caliche. Based on the density contour plots, the boundaries for Feature 3 assigned in the field may be too large. It may be more appropriate to consider the high density of burned rock in the north central portion of the block, the area that encompasses all of Feature 9 and the eastern portion of Feature 3, as a single feature. Even then, the rock in this newly defined feature area would be characterized by small burned rocks.

Block A1

A total of 90 m² was excavated in this block. As with the other blocks, total weight of burned rock for each unit was summed by level and plotted in a series of density contour plots (Figure 23). Due to small sample size, caliche and limestone were combined. Four levels (13–16) were excavated, all of which contained burned rock. A single feature, Feature 12, was identified in this block.

Due to the limited number of units excavated as part of Level 13, burned rock weights for this level were combined with those from Level 14. As can be seen from the density contour plot (Figure 23), very little burned rock is present in the upper two levels. Since Feature 12 was identified in the field by staining in these levels, it does not appear on the density contour plot. However, one unit (E505/N511) does show a higher density of burned rock than the surrounding units.

In Level 15, Feature 12, which is described as a basin-shaped hearth pit composed of 95 percent burned caliche, becomes defined by a discrete, high density area of burned rock with very little

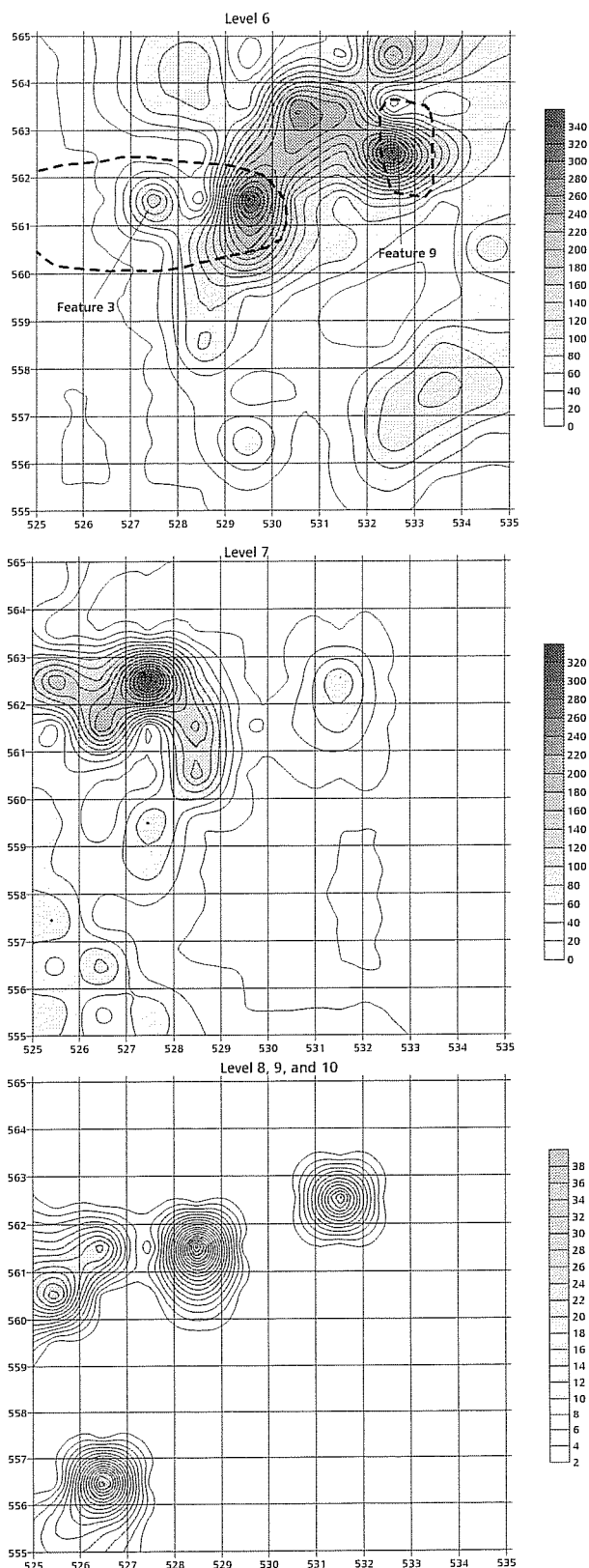

Figure 21. *Density plot by weight, Block A2, FB 12412.*

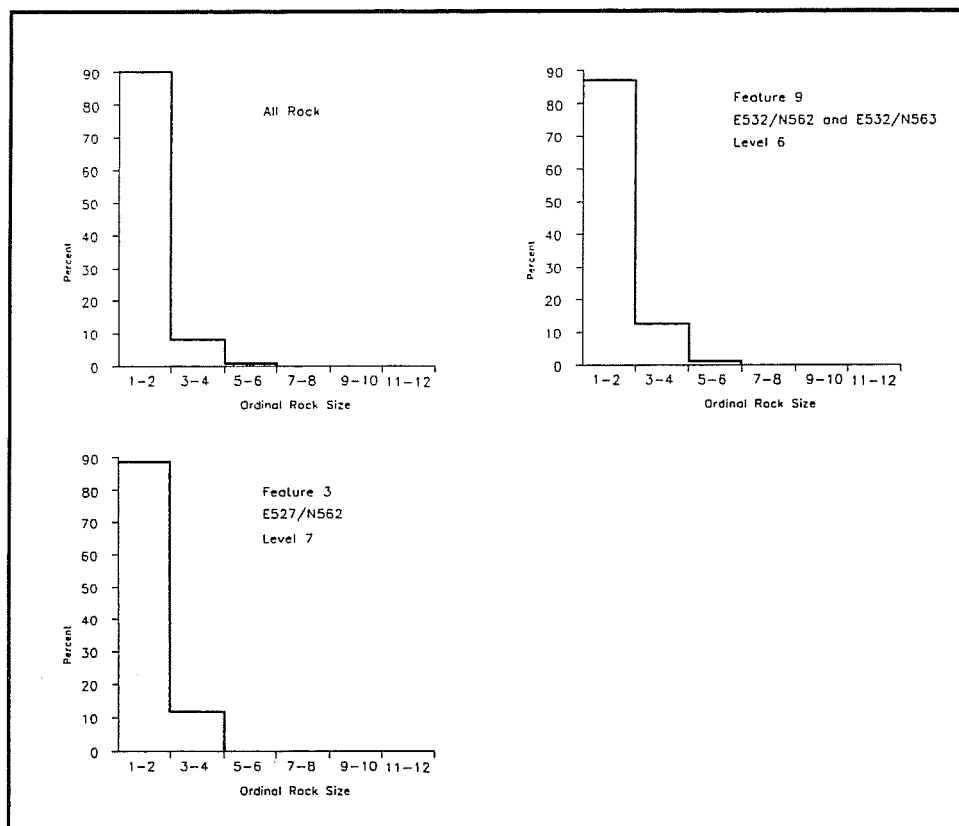

Figure 22. *Frequencies by size class, Block A2, FB 12412.*

burned rock in any of the adjacent units. Limited amounts of burned rock, however, are clearly evident in several areas on the southern side of the block.

In Level 16, Feature 12 is no longer evident. The only burned rock recovered from this level is from Unit E504/N510 in the extreme southern edge of the block. This unit also exhibited burned rock in the level just above. Although this was the only unit to exhibit burned rock concentrations in the same area across multiple levels, it was not assigned a feature number in the field.

To explore differences between Feature 12 and the non-feature densities identified in the density contour plots, size comparisons by provenience were examined. At the block level (all excavation levels combined), 97 percent of the burned rock was in the 1-2 size range. Ninety-nine percent of the Feature 12 rock and caliche was in the 1-2 size range. Further comparisons were unlikely to provide any additional insight beyond the fact that

the majority of the burned rock, regardless of its provenience, is small in size.

The pattern in burned-rock size and distribution identified here is very similar to the pattern identified for feature and non-feature areas in Block A2. Features in Block A2 were defined on the basis of burned rock distributions, with no evidence of charcoal staining or pits. Features in Block A1 were defined by burned rock distributions and charcoal staining. Both blocks have few high-density patterns associated with features and nodes of burned rock present between and around the feature(s). It is interesting to note that

charcoal staining is present in Block A1 in Feature 12 and that this feature has a relatively high-density of burned caliche within the block. However, the size range of burned rock within the feature is almost identical (all small) to the size ranges for the burned rocks throughout the remainder of the block. Without the visible charcoal stained area seen in Feature 12, the block is almost identical in burned rock weight and size patterns for the block containing Features 3 and 9, which are described as amorphous concentrations of burned rock and caliche. This suggests that Features 3 and 9 represent hearth pits, similar to Feature 12, that have since been deflated or disarticulated.

Block B1

A total of 32 m² was excavated in this block. Three levels (4-6) were excavated and one feature (Feature 16) was identified. For pattern recognition analysis, the total weight of burned caliche and limestone was summed by unit and plotted by level as density contour plots (Figure 24).

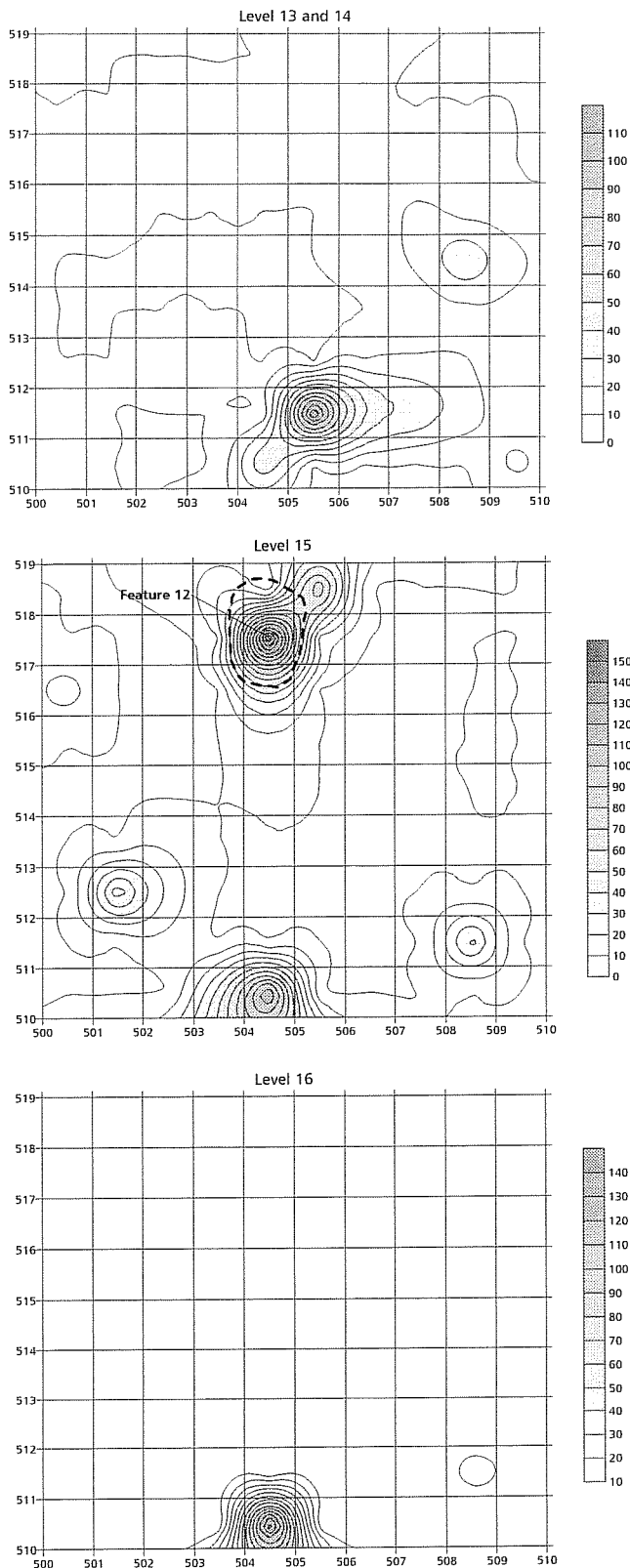

Figure 23. Density plot by weight, Block A1, FB 12412.

Level 4 is characterized by a low density of burned rock scattered over a limited number of units within the level. Two higher density concentrations of burned rock are clearly evident in Units E654/N502 and E657/N504. In Level 5, burned rock was also confined to a small number of units, but Feature 16 becomes evident in Unit E657/N503. In addition, a concentration of burned caliche is apparent in the southern edge of the block in Unit E655/N501. Feature 16 was identified on the surface in the field only by a carbonaceous stain, but after excavation was defined as a rock-lined hearth. In Level 6, any evidence of Feature 16 has begun to disappear and a small amount of burned rock is scattered along the north/northeastern edge of the excavation block.

To explore any patterns in the distribution of burned rock size in feature and non-feature areas, the percentages of burned rock by size-class and provenience was plotted (Figure 25). We first consider the relatively higher density of burned rock evident in two units in Level 4. In the first area (Unit E657/N504), 66 percent of the burned rock is in the 1–2 size range, 25 percent is in the 3–4 size range, and 9 percent is in the 5–6 size range. In the second area in Level 4 (Unit E654/N502), 72 percent of the burned rock is in the 1–2 size range, 14 percent is in the 3–4 size range, and 14 percent is in the 5–6 size range.

For Feature 16, the burned rock recovered from Unit E657/N503 in Level 5 was examined (Figure 25). According to the field notes this level contained the bottom of the feature. At this provenience, 77 percent of the burned rock is in the 1–2 size range, 16 percent is in the 3–4 size range, and 6 percent is in the 5–6 size range. Overall, the pattern in burned-rock size for feature and non-features areas in this block is consistently small. We see no demonstrable differences regarding feature or non-feature proveniences.

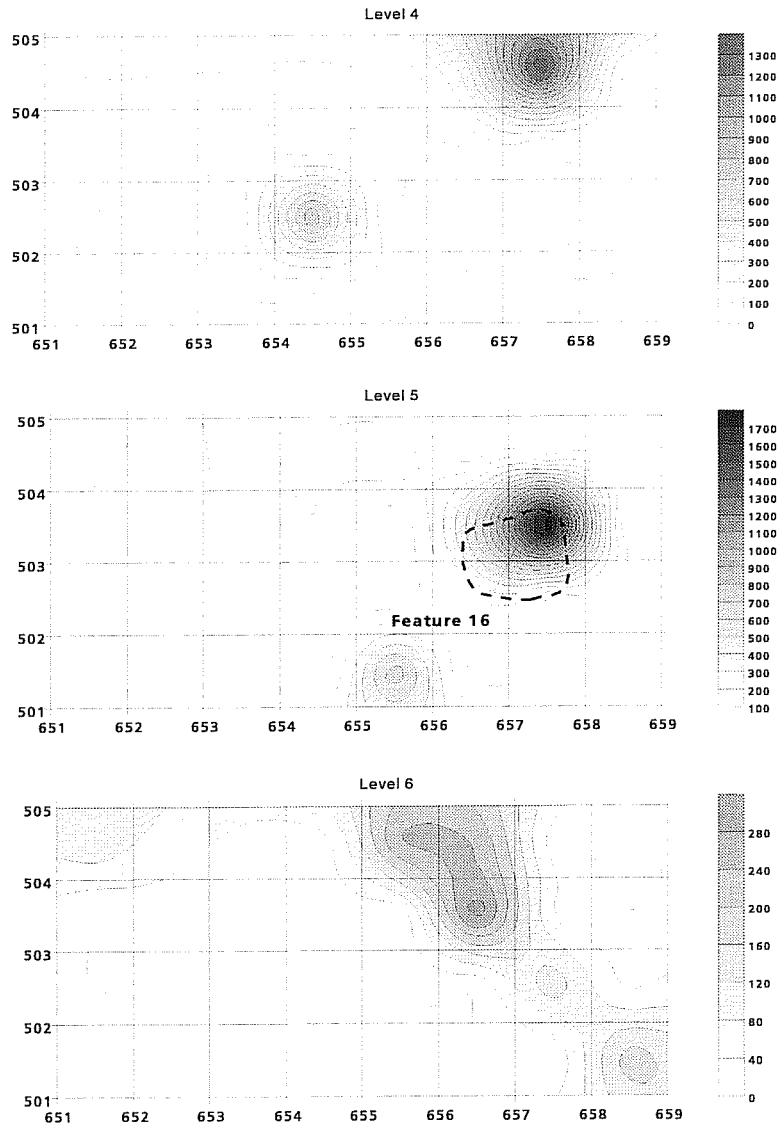

Figure 24. *Density plot by weight, Block B1, FB 12412.*

As with the other blocks on this site, we consistently identify areas that are defined as features based either on the presence of charcoal staining and clusters of burned rock and/or caliche, as with Features 12 and 16, or based entirely on clusters of burned rock, as with Features 3 and 9. In both cases, there are no discernable differences in the size distributions of burned rock from the features and that from the non-feature areas. The intact

features (12 and 16) have the same size distributions as the “deflated” features (3 and 6). Comparison of rock size distribution does not enable us to attempt to determine if high-density areas are discard events, intact features, or deflated features. This pattern of deflated versus non-deflated, though beyond the scope of this analysis, may hint at the dynamic nature of the deposition and erosion in the Transitional Zone.

An alternative method of approaching this problem is to consider the frequency of fractures and cortex remaining on the limestone within the feature and non-feature areas. Seventy-one percent of the total quantity of burned rock on the site was limestone. The percentage of fracturing and rocks without cortex was calculated by size range for each feature and non-feature area (Table 10). All of the non-feature and feature rocks from FB 12412 have high frequencies of fracturing. A higher frequency of the rocks from Features 3 and 9 and the non-feature areas however, still retain some of their cortex suggesting that the small size of the rocks on this site are a reflection of smaller original size as opposed to exhaustive use.

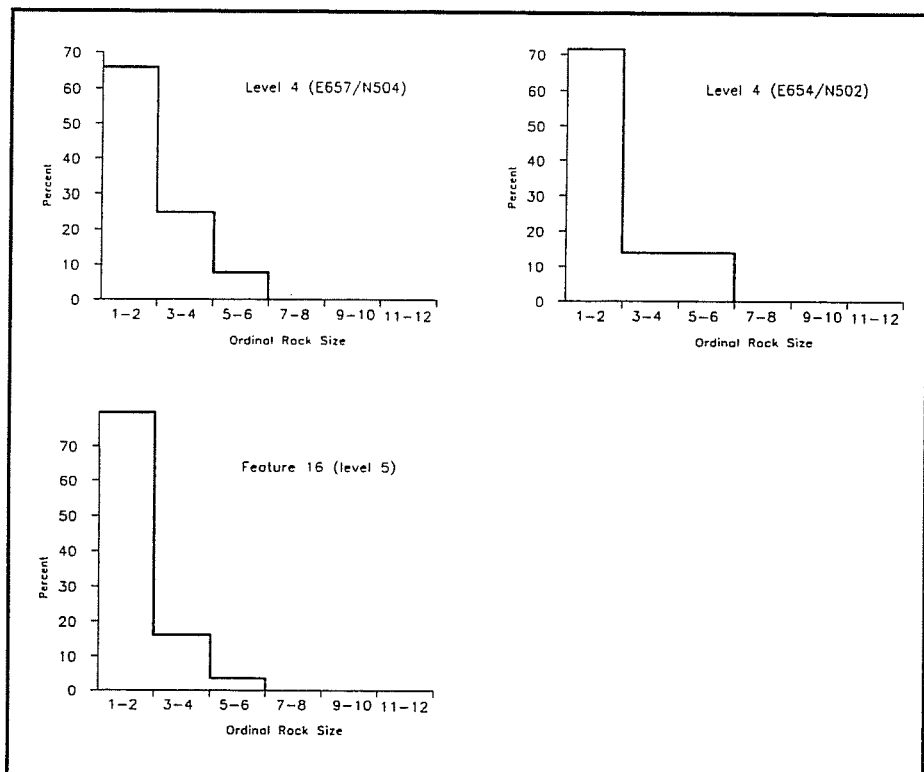

Figure 25. Frequencies by size class, Block B1, FB 12412.

Table 10. FB 12412, Fracture and Cortex Percentages (Limestone Only)

Size Range	Feature 3 n=116		Feature 9 n=101		Feature 12 n=6		Feature 16 n=250		Non-Feature n=250	
	% Fracture Present	% Cortex Absent	% Fracture Present	% Cortex Absent	% Fracture Present	% Cortex Absent	% Fracture Present	% Cortex Absent	% Fracture Present	% Cortex Absent
1-2	97	74	98	74	75	75	100	94	97	89
3-4	92	44	100	58	100	100	100	82	89	55
5-6	0	0	100	50	-	-	100	50	96	34
7-8	-	-	-	-	-	-	-	-	100 (no 7s)	100 (no 7s)
Totals	75	47	99	62	83	83	100	75	95	65

FB 12719

Block B1

A total of 78 m² within five levels (3–7) was excavated in Block B1 to investigate two features (30 and 77). Density contour plots of the burned rock recovered during excavation were constructed using total burned rock weight summed by unit and level (Figure 26). The burned rock recovered from this block included limestone, caliche, and sandstone, all of which were included in the density plots. Due to the low density of burned rock in Level 6, it is combined with Level 7. The horizontal boundaries of Features 30 and 77 are depicted at the level in which they were best defined during excavation.

In Level 3 very little burned rock is present except in the southwestern corner of the block where there is a slight increase in density evident in Unit E284/N304. The southeastern corner and the northernmost row of units were not excavated at this level. In Level 4, the same burned rock density is evident and Feature 77 appears as a small, very dense node. In Level 5 the dense area that was associated with Feature 77 is no longer well defined, and the high-density area to the southeast of Feature 77, evident in Levels 3 and 4, has all but disappeared. In Level 5, a node of higher density of burned rock is evident in Unit E284/N309, but disappears in the underlying level. The high-density area in Unit E284/N309, which appears to be associated with Feature 30, becomes a well-defined node of high-density in Levels 6 and 7.

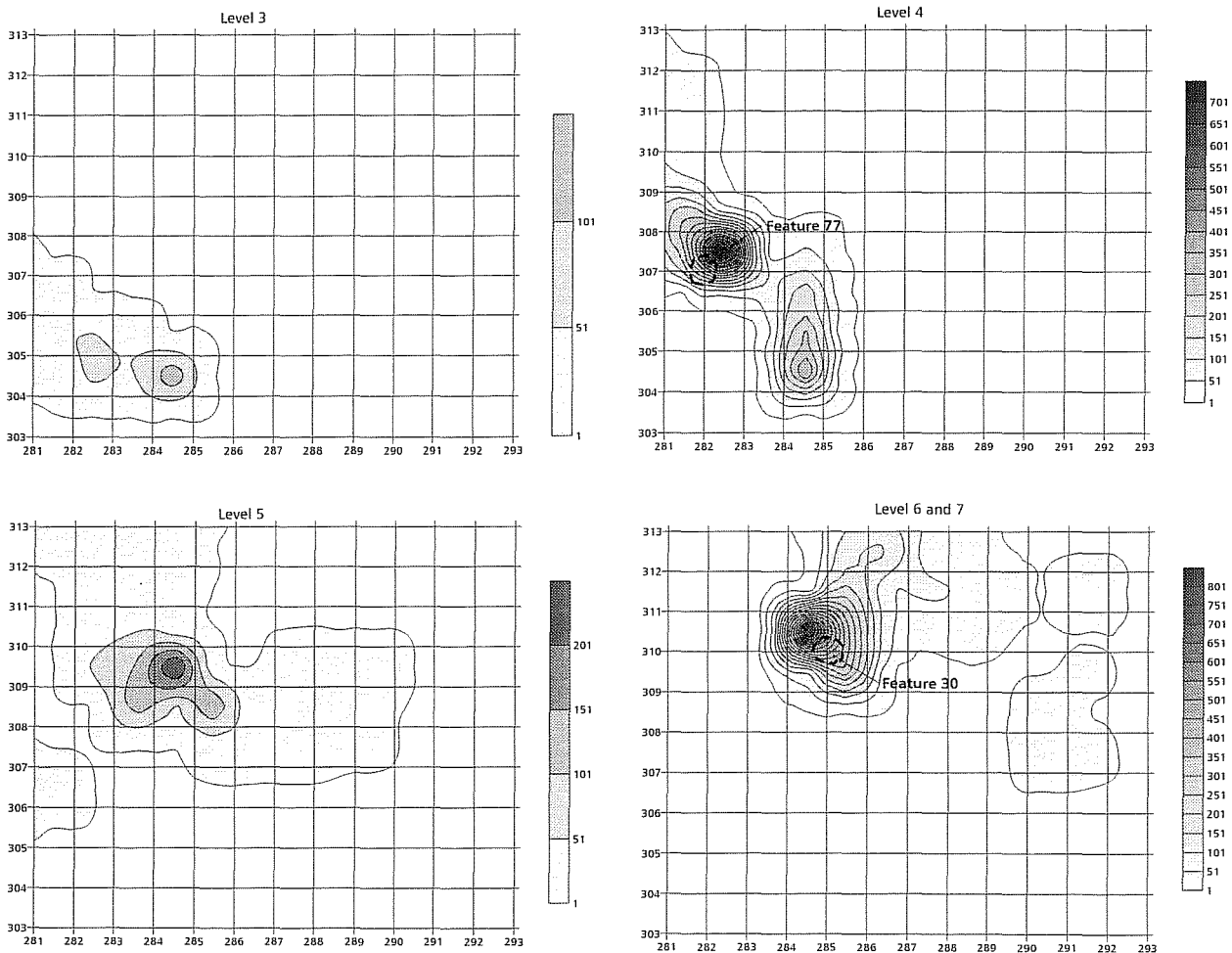

Figure 26. Density plot by weight, Block B1, FB 12719.

The density contour plots of burned-rock weight by excavation levels reveal that feature areas identified in the field are well defined by the presence of high-density nodes, and several areas of high-density not identified as features during excavation are evident between these feature nodes. These areas may be the upper portions of eroded features, or may represent discard events from the use of Features 30 and 77.

To explore patterns identified in the density contour maps discussed above, burned-rock size frequencies in features and non-feature areas were contrasted in a series of histograms (Figure 27). We first consider all burned rock recovered from the block by material type. For limestone, 88 percent of the burned rock recovered is in the 1-2 size range, 9 percent is in the 3-4 size range, and 3 percent in the 5-6 size range. For caliche, 96 percent is in the 1-2 size range, 4 percent is in the 3-4 size range, and less than 1 percent is in the 5-6 size range. At the block level, all recovered burned rock is characterized by small items, regardless of material type.

For Feature 77, we use the burned rock recovered from Level 4 of Unit E282/N307. In this unit and level, where Feature 77 is best defined, 80 percent of the limestone is in the 1-2 size range, 9 percent is in the 3-4 size range, and 11 percent is in the 5-6 size range. For caliche in Feature 77, 100 percent is in the 1-2 size range.

For Feature 30, we use the burned rock recovered from Level 6 of Unit 284/N310. In this provenience, 50 percent of the limestone is in the 1-2 size range, 40 percent is in the 3-4 size range, and 10 percent is in the 5-6 size range. For the caliche recovered from this provenience, 95 percent is in the 1-2 size range, 3 percent is in the 3-4 size range, and 2 percent is in the 5-6 size range.

percent is in the 5-6 size range. Like Feature 77, the majority of the burned caliche recovered from Feature 30 is less than 2.5 cm in diameter. However, the histograms for Features 30 and 77 show quite different patterns of limestone-size distribution. Eighty percent of the burned limestone in Feature 77 is 2.5 cm or less in diameter, while 40 percent of the burned limestone in Feature 30 is between 2.5-4 cm in diameter and 10 percent is between 5.5-10.5 cm in diameter. This may suggest different use-life or functions for the two features.

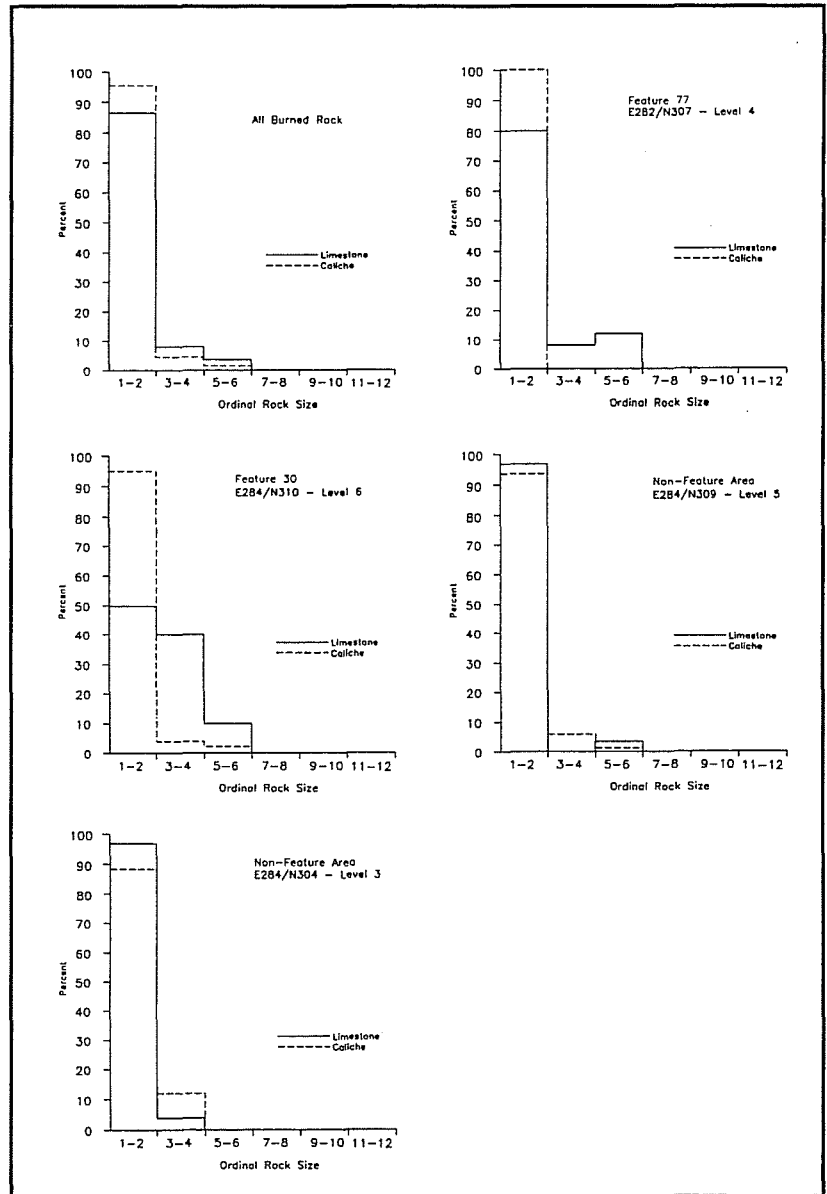

Figure 27. Frequencies by size class, Block B1, FB 12719.

We also consider burned-rock size distributions for two non-feature areas. The first is located in Unit E284/N304 in Level 3. Eighty-eight pieces of limestone and caliche weighing 141.64 g were recovered (Table 11). At this provenience, 97 percent of the limestone recovered is in the 1–2 size range and 3 percent is in the 3–4 size range. For the caliche, 89 percent is in the 1–2 size range and 11 percent is in the 3–4 size range. Interestingly, no burned rock larger than the 3–4 size range was recovered from this provenience. The second area is in Unit E284/N309 in Level 5. In this provenience, 99 pieces of limestone and caliche weighing 280.92 g were recovered. For the limestone, 97 percent was in the 1–2 size range, none was in the 3–4 size range, and 3 percent was in the 5–6 size range. For caliche, 93 percent was in the 1–2 size range, 6 percent was in the 3–4 size range, and 1 percent was in the 5–6 size range (Table 12).

It appears that both non-feature areas identified by weight-density contour maps are characterized by small burned rock, similar to the feature areas. The non-feature areas, however, have a greater frequency of burned limestone smaller than 2.5 cm in diameter. This suggests that the non-feature areas are indeed discard from previous use of Features 30 and/or 77. The percentage of small burned caliche is high in all four proveniences.

The comparison of material types between features reveals that Feature 30 has a much higher percentage of caliche than Feature 77. From Table 13 we see that of the 957.84 g of burned rock recovered from Feature 30, 34 percent (321.74 g) is caliche. In Feature 77 (see Table 13), only 2 percent (21.10 g) of the 944.23 g of burned rock is caliche.

Table 11. Weight and Quantity of Non-feature Burned Rock in Block B1 by Material Type

Provenience	Limestone (g / qty.)	Caliche (g / qty.)	Total
E284/N309 - Level 5	93.03 / 29	187.89 / 70	280.92 / 99
E284/N304 - Level 3	97.75 / 79	43.89 / 9	141.64 / 88
	190.78 / 108	231.78 / 79	

Table 12. Percent of Burned Rock in Each Size Range

Size Range	Feature 30		Feature 77		Unit E284/N304 Level 3		Unit E284/N309 Level 5	
	limestone	caliche	limestone	caliche	limestone	caliche	limestone	caliche
1–2	50	95	80	100	97	89	97	93
3–4	40	3	9	–	3	11	–	6
5–6	10	2	11	–	–	–	3	1

Table 13. Burned Rock Weight by Material from Select Feature Proveniences in Block B1

Feature	Limestone (g)	Caliche (g)	Total
Feature 30 ^a	636.1	321.74	957.84
Feature 77 ^b	923.13	21.10	944.23
	1559.23	342.84	

^a Data from Unit E284/N310, Level 6

^b Data from Unit E282/N307, Level 4.

The high density area in Unit E284/N304, Level 3, consists of 31 percent caliche compared to 67 percent from Unit E284/N309, Level 5 (Table 11). This indicates that the high density node in Unit E284/N303, Level 3, is most likely associated with Feature 77.

Fracture and cortex frequencies are compared for burned limestone only in Table 14. Rocks from Feature 77 are not included in this table as they were not collected or labeled separately and could

not be differentiated from surrounding non-feature rock during attribute analysis. In Feature 30, the one limestone hearth feature on FB 12719, 100 percent of the rocks in all size classes are fractured and over 50 percent of the rocks are void of cortex. The fracture and cortex frequencies of rocks from the structures features compares more favorably with the non-feature surface rock, suggesting the burned rock within the structures represents structure fill and not discrete features within the structures.

Table 14. FB 12719, Fracture and Cortex Percentages (Limestone Only)

Size Range	Feature 30 n=114		Feature 32 n=79		Feature 33 n=76		Feature 34 n=110		Non-Feature n=1551	
	% Fracture Present	% Cortex Absent	% Fracture Present	% Cortex Absent	% Fracture Present	% Cortex Absent	% Fracture Present	% Cortex Absent	% Fracture Present	% Cortex Absent
1-2	100	95	85	65	100	92	89	56	94	89
3-4	100	51	83	62	89	39	100	45	95	55
5-6	100	67	50 (no 6s)	17	100	100	80 (no 6s)	40	98	34
7-8	-	-	50 (no 8s)	50	-	-	-	-	100	100
9-11	-	-	100 (11s only)	100	-	-	-	-	-	-
Totals	100	71	91	69	96	72	92	48	87	82

Block A1

Field investigations in Block A1 involved the excavation of nearly 300 1-x-1-m units. This included the excavation of several pit structures (Features 32, 33, and 34) and large, open areas around the structures. In addition, several features (Features 78, 80, 85, and 89) located on or near the floors of several of the structures were documented. No "true" burned rock features similar to those recorded in Block B1 were noted although a considerable amount of burned rock was recovered from the excavation area. In general, the burned rock recovered from Block A1 was scattered about the surface or within pit structure fill and floors. To explore patterns in rock across the site, density plots of burned rock by material type, weight, and count for excavation units and levels were constructed.

Figure 28A is a density contour plot of the weight of all burned rock from Block A1 summed by unit. Inspection of Figure 28A reveals a continuous scatter of burned rock throughout the excavation area, with noticeable nodes of burned rock in several units. When the structure locations are superimposed onto the density contour plot (Figure 28B) it appears that the three most dense areas of burned rock spatially correspond to the locations of the structures.

Table 15 provides the weight and quantity of burned rock by material type for Block A1. Burned limestone accounts for 60 percent of the total weight of burned rock recovered from this excavation area, burned caliche constitutes about 38 percent, and other materials account for two

percent. However, while limestone accounts for 60 percent of the total rock weight, it makes up only 18 percent of the total number of burned rock specimens, while caliche accounts for 79 percent of the total burned rock count. Other material types comprise approximately three percent of the burned rock count.

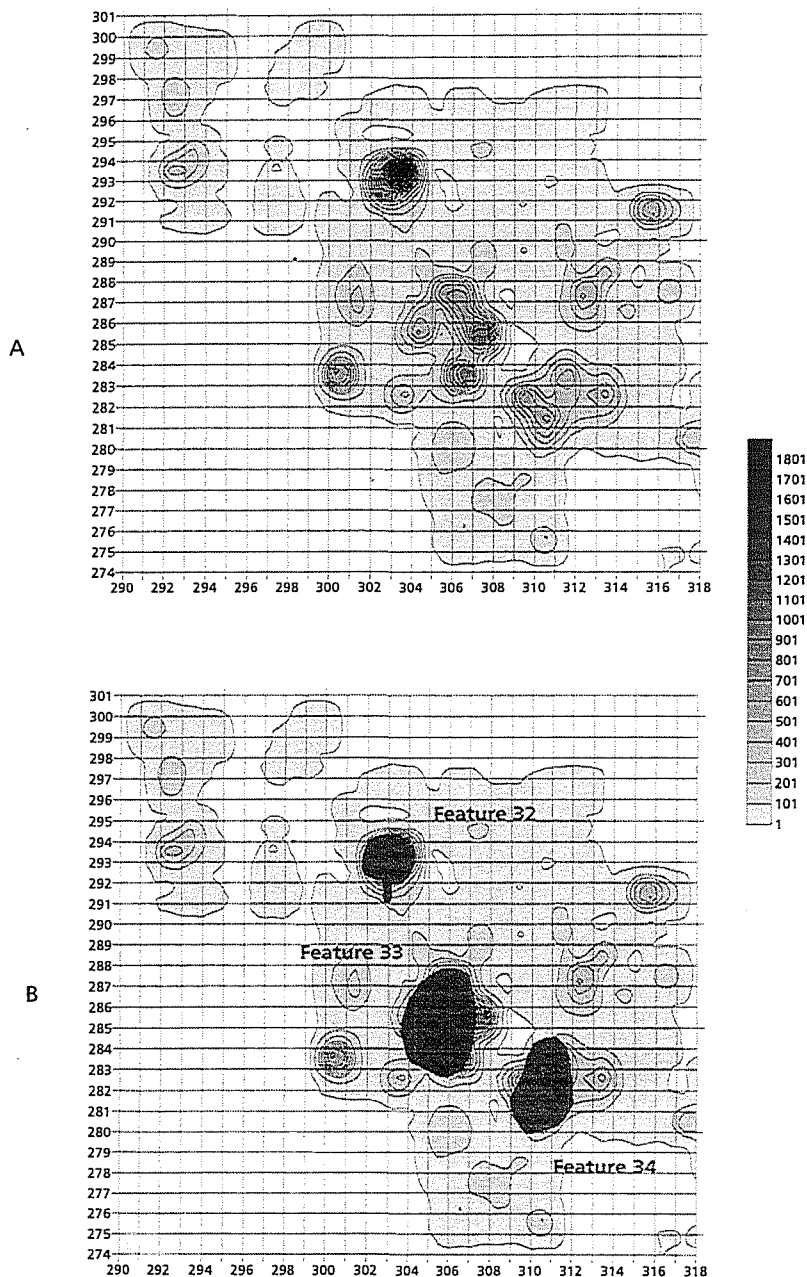

Figure 28. Density plot by weight, Block A1, FB 12719.

Table 15. Total Weight and Quantity of Burned Rock for Block A1

Material Type	Total Weight (g)	Quantity
Limestone	21,711.30	1143
Caliche	13,803.95	4938
Other ^a	679.29	168
	36194.54	6249

^a Other material type includes chert, Rancheria chert, quartzite, rhyolite, sandstone, and granite.

As mentioned above, limestone dominates the block in overall weight, but caliche accounts for more of the total count. This suggests that different patterns than those identified by looking at total weights summed by unit and material type might be expected if we plotted total counts summed by unit and material type. Figure 29 is a plot of the quantity of caliche and limestone summed by unit for Level 1. Not surprisingly, different patterns than those identified by total weight emerge. The limestone plot exhibits less clustering than was evidenced by the total weight of rock summed by unit for the same data set. The pattern produced by looking at counts suggests that limestone is widely and evenly dispersed in low numbers throughout the excavation area. Conversely, the plot for caliche illustrates several high-density areas not evident in the plot based on weight (Figure 28). This suggests that the high-density patterns identified in the weight plot are the result of a small number of rocks.

The patterns in limestone and caliche weight and count reveal that burned caliche occurs as small pieces in a greater number of proveniences across the block (burned caliche occurs in 259 of the nearly 300 units excavated and limestone in only 205), whereas limestone is more spatially restricted and larger in overall rock size. Nevertheless, the overall pattern is a relatively continuous scatter of both burned limestone and caliche throughout the excavation area.

No formal features—discrete locations of burned rock with possible charcoal staining—were identified in Block A1. While several of the features

noted in the floor of the structures had small amounts of burned rock in the fill, the excavators did not note these as burned rock features. The patterns identified in the density contour plots suggest that density and/or count of burned rock might be used to argue for the presence of a burned rock feature not identified in the field.

Figure 30 illustrates the possible remnant features for examples of our two data sets. In the top portion of the figure, the areas of the excavation block containing the highest density of burned limestone by weight is easily distinguished from the surrounding lower-density areas by the peaks in the surface plot. Likewise, the relatively high density areas of burned caliche by total counts (Figure 30b) is also well delineated.

When we consider the actual size of the burned caliche that constitutes the high density areas depicted in Figure 30, most are heavily skewed towards small size categories. For example, of the burned caliche recovered from the high density area in Unit E308/N277, 98 percent of the burned rock is in the 1–2 size range. In other high density areas, such as Units E311/N283 and E292/N296, 97 percent and 98 percent of the burned rock respectively, is in the 1–2 size range. Burned limestone, though characterized by a small percentage of larger size classes, follows much the same pattern.

It is difficult to determine if the high density areas of burned rock identified in the weight and quantity plots are feature locations, as the low density of burned rock in this block guarantees that even a

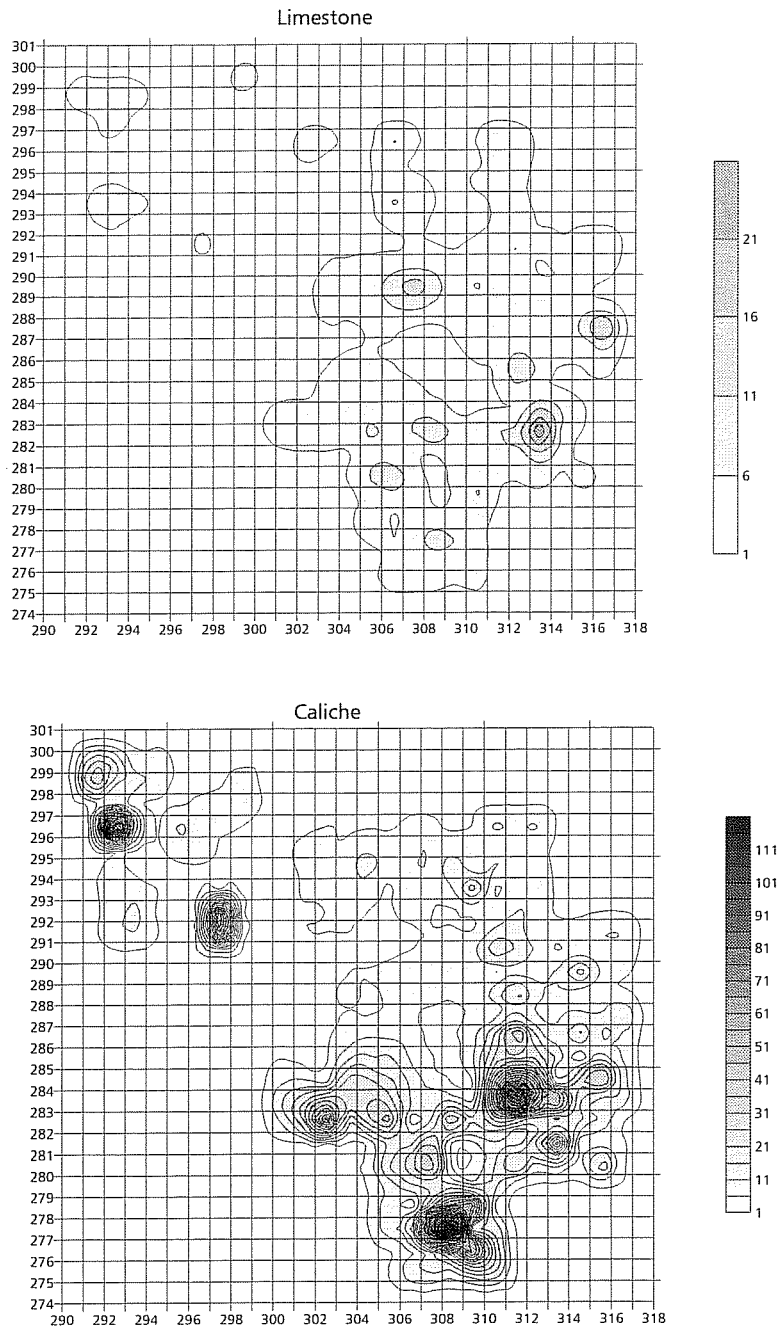

Figure 29. Density plot by count, Block A1, FB 12719.

limited amount of clustering of burned rock will result in the patterns suggestive of features. The lack of charcoal staining with any of the burned rock nodes complicates matters further. However, the excavators noted in their field notes that the upper portion of the site (Level 1) appears to have been slightly deflated, resulting in a condensation of

materials. This possible deflation may account for the lack of charcoal staining.

The frequency of fracturing present and cortex absent for feature and non-feature limestone within each size group is given in Table 16. While frequencies of fracturing from all proveniences are

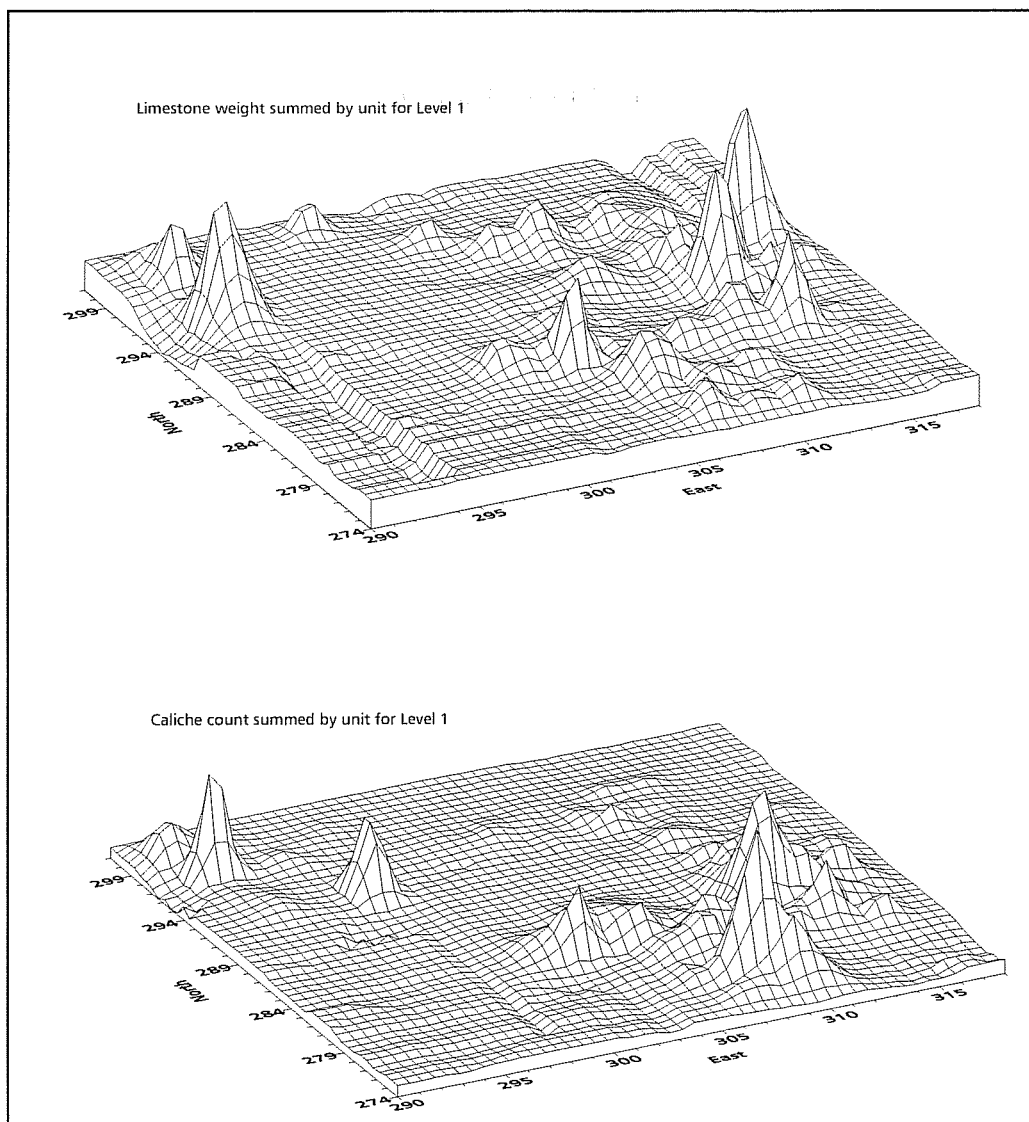

Figure 30. *Three-dimensional surface contour map, Block A1, FB 12719. a. limestone weight; b. caliche count.*

high, 100 percent of the burned limestone from Feature 30—the only articulated cooking feature at FB 12719—is fractured. Seventy to 80 percent of the feature and non-feature rocks are also void of cortex, indicating an extensive amount of reuse. This supports the importance of curated limestone suggested earlier in the analysis.

Table 16. FB 12719, Fracture and Cortex Percentages

Size Range	Feature 30 n=114		Feature 32 n=79		Feature 33 n=76		Feature 34 n=110		Non-feature n=1551	
	% fracture present	% cortex absent	% fracture present	% cortex absent	% fracture present	% cortex absent	% fracture present	% cortex absent	% fracture present	% cortex absent
1-2	100	95	85	65	100	92	89	56	94	60
3-4	100	51	83	62	89	39	100	45	95	72
5-6	100	67	100	33	100	100	80*	40*	98	95
7-8	-	-	100**	100**	-	-	-	-	100	100
9-10	-	-	-	-	-	-	-	-	-	-
11	-	-	100	100	-	-	-	-	-	-
Total %	100	71	94	72	96	77	90	47	97	82

*No size 6

**No size 8

Chapter 6. Summary and Conclusions

This study included the analysis of 29,058 pieces of fire-cracked rock and burned caliche selected from a sample of hundreds of features tested as part of the Hueco Mountain Archaeological Project. Feature and non-feature material included in this analysis were collected from FB 13237 located, on the proximal fan, FB 12719 within the basin area, and FB 12412 situated in the transitional zone between the two. These three sites were selected to allow potential variability in burned rock features in these differing land forms to be observed.

The goal of the analysis was to identify patterns of attribute variability in burned rock that could be used to gauge the amount of reuse and to infer functions of the various features and sites in the sample. Specific burned rock attributes including material type, size, weight, and the presence or absence of fracturing, cortex, and discoloration were recorded and compared in various combinations at course- and fine-grained levels of intensity to address issues of reuse, recycling, feature function, thermally induced morphological variability, and how these variables might relate to specific land forms through time.

From intersite comparisons, a pattern of expedient material selection was identified based on the increasing frequencies of burned caliche utilization at site FB 12412 in the transitional zone and FB 12719 in the basin, despite the accessibility of limestone located no more than 1.5 km away. This suggests that limestone itself had no distinct functional role in the fire-cracked features in this study area. Comparisons of rock size and weight for the total assemblage from each site indicate that over 60 percent of the rocks recovered from each of the three sites is smaller than 2.5 cm in diameter. Burned rock from features at the three sites are

predominately smaller than four centimeters in diameter.

Patterning in feature type was also recognized. Burned-rock features from site FB 13237, located on the rocky proximal fan, include rock-lined hearths, rock-ringed hearths, basin-shaped hearth pits, and burned-rock scatters without discernable pits. Similarly, a basin-shaped hearth pit, a rock-lined hearth, and two burned-rock scatters were identified at site FB 12412 in the transitional zone. Aside from the fire-cracked rock and burned caliche associated with pit-structure fill at site FB 12719 in the basin, actual burned-rock feature types are limited to several small hearth features within the structures and one dish-shaped hearth away from the structures.

The rock-lined pit features identified at FB 13237 and FB 12412 are similar to the roasting and/or steaming ovens described ethnographically by Driver and Massey (1957) and historically by Honea (1962) and Tunnell and Madrid (1990) for processing sotol and other bulbous plant materials. As Reid (1989) and Lundberg and Kotschevar (1965) indicate, steaming in layers of hot rock and moist vegetation gelatinizes plant carbohydrates for increased nutritional value and accessibility. Further replicative experimentation is needed to determine whether the variations in amount and size of the rocks in the features from this study resulted in variations in temperature, overall heating efficiency, and/or cooking time or are a function of the quantity of food being processed.

Patterns relating to the issues of reuse and feature function were identified during intrasite and block level comparisons of feature and non-feature burned rock attributes. Through comparisons of non-feature

and feature size frequencies, weight density plots, and fracture and cortex frequencies areas of extensively reused and subsequently discarded burned rock were identified associated with Features 40 and 46, the rock-lined hearth pits at site FB 13237. These areas are created as larger rocks lining the bottom of the pits become fractured through use and are subsequently removed from the pit and replaced with larger, more energy efficient stones. Thus, the discard areas demonstrate reuse of these cooking apparatus. Again, detailed experimental work to replicate the context and morphology of the features in question is required before estimates of frequency and duration of reuse can be made. Radiocarbon dates from this site reveal several occupational episodes beginning about 4,100 years ago and ending around 700 years before present (note that these dates only include the excavated features and may not be representative of the occupational history of this site as numerous other features on the site were not tested). No functional differences between features was suggested by size/weight comparisons.

The other site along the Piedmont zone is FB 12412. This site is situated topographically lower on the Piedmont than FB 13237, in the Transitional zone between the Piedmont and the basin. Unlike the rocky matrix of the upland portions of the Piedmont where FB 13237 is located, the Transitional zone where FB 12412 is found is almost void of rock.

With the exception of Feature 16, a rock-lined pit, the features at FB 12412 are quite different from those noted for FB 13237. Feature 12 is described as a basin-shaped pit and Features 3 and 9 are concentrations of burned caliche and lime-stone. The burned-rock features at the site do not appear to be the result of deflation, as charcoal staining was noted in numerous area. One variable that may be contributing to this pattern is the presence of caliche in the burned rock assemblage at FB 12412. However, if the features at FB 12412 were intended to function in a manner similar to those at FB 13237, we would expect them to be dominated by limestone, as the latter would have been a better medium for heat transfer than caliche (e.g., Duncan and Doleman 1991).

This apparently is not the case at FB 12412. The small size and limited amount of burned limestone recovered suggest that the larger, still usable stone may have been scavenged from these features, or they represent very different feature types than those documented at FB 13237. The former is impossible to determine, but given that mass quantities of unaltered limestone lie within 100 m of the site, this seems unlikely. The latter is more likely. The lack of rock-lined pits at FB 12412 may indicate a different range of activities for this site and its features. The radiocarbon dates (see sections above) recovered from Features 12 and 16 are within the range of the later feature dates at FB 13237. The exception to this is the Late Archaic date from Feature 46 at site FB 13237.

Non-feature and feature rocks at FB 12412 have the smallest mean size of the three sites in the study although the source of larger limestone rocks is less than 100 m away. The rocks at FB 12412 also have the highest frequency of fracturing yet retain some of their cortex, suggesting that the small size of the rocks on this site is a reflection of smaller original size as opposed to exhaustive reuse. This suggests that smaller rocks were selected from the source, perhaps for ease of transport or for functional reasons. There is some indication of blocky fracturing from the size/weight comparisons of the rocks at this site. These attributes suggests features at FB 12412 may have functioned as open hearths for a range of tasks (see O'Laughlin 1980; Whalen 1980) or may have been associated with stone-boiling activities. Driver and Massey (1957) report that ethnographically stone boiling was the dominant method of food preparation in many areas of North America where pottery was absent and mobility high. Boiling may be a misnomer, however, for as Reid (1989) suggests, simmering is most suitable for stewing meat and rendering oil and grease from seeds and bones. Actual boiling at temperatures above 93°C is only adaptive for exploitation of carbohydrate seeds and roots.

The final site considered in this analysis is FB 12719. This site consists of a number of pit structures and floor and non-floor features. Unlike sites FB 13237 and 12412, this site is situated over one kilometer west of the Piedmont area in the

sandy zone of the central basin. The area is characterized by mesquite stabilized dunes and sheet sands. Other than the occasional small (<2 cm) gravel, no rock source is present in the basin. The only material available for thermal features is the underlying carbonate zone (caliche).

Features from this site consist of one well-defined hearth (Feature 30), three pit structures (Features 32,33, and 34), and several small, poorly defined hearths within the structures. Much like the high-density nodes identified for the sites along the Piedmont, high-density areas adjacent to the bounded features were apparent. While the features and non-feature nodes are clearly distinguishable from the remainder of the excavation block on the bases of burned rock density, they do not display significantly different patterns in rock size. Comparisons of burned rock size (both caliche and limestone) from the bottoms of features with rock from other areas in the block reveals no significant increase in rock size in the features.

By looking at all the burned rock, regardless of material type, we found that the densest burned rock areas by weight are spatially correlated with the location of the pit structures. Analysis of the burned caliche and limestone patterns generated by summing the total weight of burned rock by unit and level reveals that very different patterns could be achieved by performing the same analysis using total counts instead of weights. The patterns generated by total numbers revealed very little patterning in burned limestone and considerable clustering of burned caliche. It also appears that much of the patterning generated by looking at burned rock weights is a result of a small number of rocks as a single piece of burned limestone weighing 500 plus grams can heavily skew a plot. Likewise, large numbers of burned caliche, which appear to be heavily dominated by small pieces at this site, can significantly skew a plot. This is further compounded by the fact that burned rock densities are very low across the site. Just the slightest clustering of burned rock will be manifested as a node in our analysis. As mentioned, the majority of burned rock at this site is small and scattered over a large excavation area.

The presence of burned limestone and other burned non-caliche materials (e.g., quartzite) at the site suggests that non-caliche material may have served a specific functional purpose as they were obviously transported to the site (see Duncan and Doleman 1991). These materials may also have been brought to the site for other purposes (i.e. sandstone for ground-stone tools, quartzite for hammer stones) and eventually recycled as hearth stones. Non-feature rocks consistently weigh less than feature rocks, repeating the pattern established at the other sites for discard rocks; however, the size distribution of these non-feature rocks more closely resembles the distribution from the hearth feature (Feature 30). Size-to-weight comparisons suggests that some of the rock have blocky fracture patterns while others are curvilinear, indicating a variety of functions. The fracture and cortex frequencies of rocks from the structures features compares more favorably with the non-feature surface rock suggesting the burned rock within the structures represents post-abandonment fill and not discrete features within the structures.

In conclusion, the results of the burned analysis has provided insight to the multiple roles that rock may have played in the systems operating in the Jornada. The presence of rock-lined pits in Piedmont zone are evidence that pit baking was taking place along the toes of the Hueco Mountains. Though the ethnobotanical material recovered from these features was limited, the size of the features and the technology suggests that succulents may have been processed, which is indirectly supported by the presence of succulents growing on the Piedmont and adjacent uplands of the Hueco Mountains (see O'Laughlin 1980 for a further discussion of this relationship).

The Transitional and Basin zone features have a more enigmatic function. The absence of rock-lined bases argues against their use as pit-ovens, or earth ovens. Clearly, until we have experimental data on the cooking requirements of certain foods, and more specifically, what one can cook/bake with just a few hundred grams of rock, their function will remain problematic.

The presence of relatively large quantities of limestone at the basin site (FB 12719) attests to the importance of this material in the activities conducted at this site. The importance of limestone as a curated item is further supported by the small size of the limestone recovered from the site; presumably due to reuse. The absence of rock-lined pits at the basin site is also of interest. The presence of pit structures and significant amounts of other artifacts and faunal material suggest some level of sedentism and reuse of this location, yet no rock-lined earth ovens are present at the site (see Whalen 1994). This suggests that if foodstuffs requiring extended cooking times were exploited, these activities took place off site.

The results of this study are a clear step forward in understanding the variability in burned rock features in the Jornada. As more and more data on burned rock features are amassed in the region, variations in feature morphology and burned-rock attributes through time and space may shed light on the role these features played in the prehistoric cultural systems of the region. However, to fully understand much of the variation in burned rock features, it will be necessary to refine excavation techniques and to conduct well controlled experiments to understand the processes that result in this most abundant of archaeological features.

Comments

In this analysis we have attempted to investigate the function and reuse of fire-cracked rock and burned caliche features from three sites in the Hueco Bolson through attribute analysis of the burned rock themselves. The set of attributes selected for this analysis were based on experimental results and examples used successfully in other studies of this kind (Duncan and Doleman 1991; Lintz 1989; Mauldin et al. 1994; etc.). Some of these proved useful in pattern recognition from a sample of this size while others were only practical after modifications. Time and budgetary constraints made recording attributes such as number of fractures and percent of cortex remaining for individual rocks impractical in a sample of this size. Instead, the

presence/absence of fracturing and the presence/absence of cortex was recorded for individual rocks within each size class. Although these modifications somewhat limited the degree of information, the resulting percentages did provide useful comparative data that enabled us to recognize patterns of increased intensities of reuse. Similarly, attempts to record blocky/curvilinear fracturing proved too subjective even though all attribute recording was performed only by the authors. The weight-to-size graphs produce patterns at site FB 12412 that indicate a more angular fracture pattern. The attributes used in this study, however, were not appropriate for the analysis of burned caliche. The friable nature of caliche negates size comparisons unless these observations are made in the field before the pieces are subjected to breakage through transport. Likewise, the fracturing and cortex attributes are not applicable to burned caliche.

While successful in identifying patterned variations between firing temperatures used at the study sites, the analysis of the archaeomagnetic data proved less than successful in identifying patterns of feature reuse. Two factors possibly contributed to the unexpected lack of evidence of multiple reuse of burned rock on our sites. 1) The sample size sent for analysis was too small to produce meaningful patterns. This problem is, at least in part, due to the limited number of large rocks available for testing at FB 12412 and FB 12719. 2) Subsequent firings at higher temperatures will erase any record of previous firing at a lower temperature.

This study was successful in identifying patterns of reuse, an issue relevant to understanding formation processes and land-use histories. And, because the collection and analysis did not focus solely on feature rock, the spatial and attribute analyses were able to identify discard accumulations from density areas not noted during excavation. However, before burned-rock and caliche analyses can be successfully used to infer functional histories of features, comparative, replicable data from experimental studies on local materials must be available. These data should incorporate temperature controls that can be correlated with cooking techniques. Special attributes designed specifically for caliche are also needed.

References Cited and Project Bibliography

- Abbott, J. T., and C. D. Frederick
1990 Proton Magnetometer Investigations of Burned Rock Middens in West-Central Texas: Clues to Formation Process. *Journal of Archaeological Science* 17:535–545.
- Akins, N.
1985 Fire-cracked Rock. In *The Excavation of the Cortez CO₂ Pipeline Project Sites, 1982–1983*, edited by M. P. Marshall, pp 173–177. Office of Contract Archeology, University of New Mexico, Albuquerque.
- Barber, J.
1990 Scottish Burnt Mounds: Variations on a Theme. In *Burnt Offerings: International Contributions to Burnt Mound Archaeology*, compiled by V. Buckley, pp. 98–104. Wordwell, Academic, Dublin, Ireland.
- Barfield, L., and M. Hodder
1987 Burnt Mounds as Saunas and the Prehistory of Bathing. *Antiquity* 61:370–379.
- Bearden, S. E., and J. G. Gallagher
1980 Experimental Thermal Alteration of Dolomite and Limestone. In *Evaluation of Cultural Resources at Brantley Reservoir, Eddy County, New Mexico*, pp. 444–452. Archeology Research Program, Research Report No. 120, Department of Anthropology, Southern Methodist University, Dallas.
- Bellomo, R. V.
1993 A Methodological Approach for Identifying Archaeological Evidence of Fire Resulting from Human Activities. *Journal of Archaeological Science* 20:525–553.
- Binford, L. R.
1978 *Nunamiut Ethnoarchaeology*. Academic Press, New York.
1983 *In Pursuit of the Past: Decoding the Archaeological Record*. Thames and Hudson, New York.
1986 An Alyawara Day: Making Men’s Knives and Beyond. *American Antiquity* 51:547–562.
- Black, S.
1995 Turning Up the Heat on the Archeology of Hot-Rock Features. Paper presented at Workshop on Hot-Rock Features, Council of Texas Archeologists Meeting, Austin.
- Black, S. L., L. W. Ellis, D. G. Creel, and G. T. Goode
1996 Hot Rock Cooking on the Greater Edwards Plateau: Four Burned Rock Midden Sites in West Central Texas. Studies in Archeology, Texas Archeological Research Laboratory, The University of Texas at Austin, *review draft*.
- Blackwelder, E.
1927 Fire as an Agent in Rock Weathering. *Journal of Geology* 35:134–140.

- 1933 The Isolation Hypothesis of Rock Weathering. *American Journal of Science*, 5th Series 26(152):97-113.
- Brink, J. and B. Dawe
 1989 *Final Report of the 1985 and 1986 Field Seasons at Head-Smashed-In Buffalo Jump, Alberta*. Archaeological Survey of Alberta Manuscript Series No. 16, Alberta Culture and Multiculturalism Historical Resources Division, Edmonton, Alberta, Canada.
- Brink, J., M. Wright, B. Dawe, and D. Glau
 1986 *Final Report of the 1984 Season at Head-Smashed-In Buffalo Jump, Alberta*. Archaeological Survey of Alberta Manuscript Series No. 9, Alberta Culture and Multiculturalism Historical Resources Division, Edmonton, Alberta, Canada.
- Buckley, V. M.
 1990 Experiments Using a Reconstructed Fulacht with a Variety of Rock Types: Implications for the Petromorphology of Fulachta Fiadh. In *Burnt Offerings: International Contributions to Burnt Mound Archaeology*, compiled by V. Buckley, pp.170-172. Wordwell, Academic Publishers, Dublin, Ireland.
 1991 Irish Fulachta Fiadh: An Overview. In *Burnt Mounds and Hot Stone Technology*, edited by M. A. Hodder and L. H. Barfield, pp. 3-9. Sandwell Metropolitan Borough Council, West Midlands, England.
- Cain, P. J., S. S. Peng, and E. R. Podnieks
 1975 Rock Fragmentation by High-Frequency Fatigue. Report of Investigations 8020, United States Department of the Interior, Bureau of Mines, Washington D.C.
- Carmichael, D. C.
 1985 *Archeological Excavations at Two Prehistoric Campsites near Keystone Dam, El Paso, Texas*. University Museum Occasional Papers No. 14. New Mexico State University, Las Cruces.
- Cavallo, J.
 1984 Fish, Fires, and Foresight: Middle Woodland Economic Adaptations in the Abbott Farm National Landmark, New Jersey. *North American Archaeologist* 5:111-138.
- Collins, M. B., B. Ellis, and C. Dodt-Ellis
 1990 *Excavations at the Camp Pearl Wheat Site (41KR243): An Early Archaic Campsite on Town Creek, Kerr County, Texas*. Studies in Archeology 6. Texas Archeological Research Laboratory, The University of Texas, Austin.
- Connor, M. A., K. P. Cannon, and D. C. Carlevato
 1989 The Mountains Burnt: Forest Fires and Site Formation Processes. *North American Archaeologist*, Vol. 10 (4):293-310.
- Creel, D. G.
 1991 Assessing the Relationship Between Burned Rock Midden Distribution and Archaic Subsistence in West Central Texas. In *The Burned Rock Middens of Texas: An Archeological Symposium*, edited by T. R. Hester, pp. 33-43. Studies in Archeology 13, Texas Archeological Research Laboratory, The University of Texas, Austin.

- 1986 *A Study of Prehistoric Burned Rock Middens in West Central Texas*. Ph.D. dissertation, University of Arizona, Tucson.
- Dockrill, S. J.
 1991 Geophysical Survey of Burnt Mounds in the Northern Isles: The Magnetic Response. In *Burnt Mounds and Hot Stone Technology*, edited by M. A. Hodder and L. H. Barfield, pp. 35-39. Sandwell Metropolitan Borough Council, West Midlands, England.
- Draper, J., and A. Stanfield
 1987 The Cultural Significance of Fire-cracked Rock at the Ozette Site: A Preliminary Study. Ms. on file, Department of Anthropology, Washington State University, Pullman.
- Driver, H. E., and W. C. Massey
 1957 *Comparative Studies of North American Indians*. Transactions of the American Philosophical Society, Vol. 47, The American Philosophical Society, Philadelphia.
- Duncan, R. B., and W. H. Doleman
 1991 Fire-Cracked Rock Studies. In *Landscape Archeology in the Southern Tularosa Basin, Volume 2, Testing, Excavation, and Analysis*. edited by W. H. Doleman, R. C. Chapman, J. A. Schutt, M. K. Swift, and K. D. Morrison, pp. 317-344. Report No. 185-324E, Office of Contract Archeology, University of New Mexico, Albuquerque.
- Fisher, J. W., and H. C. Strickland
 1989 Ethnoarchaeology Among the Efe Pygmies, Zaire: Spatial Organization of Campsites. *American Journal of Physical Anthropology* 78:473-484.
- Frederick C. D., and J. T. Abbott
 1992 Magnetic Prospection of Prehistoric Sites in an Alluvial Environment: Examples From NW and West-central Texas. *Journal of Field Archaeology* 19:139-153.
- Frison, G. C.
 1983 Stone Circles, Stone-Filled Fire Pits, Grinding Stones and High Plains Archaeology. *Memoir 19, Plains Anthropologist* 28(2):81-91.
- Griggs, D. T.
 1936 The Factor of Fatigue in Rock Exfoliation. *Journal of Geology* 44:781-796.
- Goode, G. T.
 1991 Late Prehistoric Burned Rock Middens in Central Texas. In *The Burned Rock Middens of Texas: An Archeological Symposium*, edited by T. R. Hester, pp. 71-93. Studies in Archeology 13, Texas Archeological Research Laboratory, The University of Texas, Austin.
- Hard, R. J.
 1983 *Excavations in the Caster Range Archeological District in El Paso, Texas*. El Paso Centennial Museum Publications in Anthropology No. 11. The University of Texas at El Paso.

- Hard, R. J. , P. Graeber, J. Manasco, C. Tennis, and K. Thuesen
 1994 Doña Ana Phase Ceramics and Cultural Evolution in the Southern Jornada Mogollon. *Bulletin of the Texas Archeological Society* 62/1991:267–283.
- Hester, T. R.
 1991 Preface. In *The Burned Rock Middens of Texas: An Archeological Symposium*, edited by T. R. Hester, pp. v–vii. Studies in Archeology 13, Texas Archeological Research Laboratory, The University of Texas, Austin.
- Hines, M. H.
 1995 Burned Rock Feature Analysis at the Wind Canyon Site, 41HZ119. Paper presented at Workshop on Hot-Rock Features, Council of Texas Archeologists Meeting, Austin.
- Hodder, M. A.
 1990 Burnt Mounds in the English West Midlands. In *Burnt Offerings: International Contributions to Burnt Mound Archaeology*, compiled by V. Buckley, pp.106–111. Wordwell, Academic, Dublin, Ireland.
- Honea, K. H.
 1962 The Rammadyat of Northwest Africa and the Burned Rock Middens of Texas, *Bulletin of the Texas Archeological Society* 32:317–320.
- Hough, W.
 1926 *Fire as an Agent of Human Culture*. Smithsonian Institution, Washington, D.C.
- House, J. H., and J. W. Smith
 1975 Experiments in Replication of Fire-Cracked Rock. In *The Cache River Archeological Project*, assembled by M. B. Schiffer and J. H. House, pp. 75–80. Research Series No. 8. Arkansas Archeological Survey, Fayetteville.
- Howard, M. A.
 1991 Burned Rock Midden Excavations, Hearths and Botanical Remains. In *The Burned Rock Middens of Texas: An Archeological Symposium*, edited by T. R. Hester, pp. 45–69. Studies in Archeology 13. Texas Archeological Research Laboratory, The University of Texas, Austin.
- Hunter, J. R., and S. J. Dockrill
 1990 Recent Research into Burnt Mounds on Fair Isle, Shetland, and Sanday, Orkney. In *Burnt Offerings: International Contributions to Burnt Mound Archaeology*, compiled by V. Buckley, pp. 62–68. Wordwell, Academic, Dublin, Ireland.
- Ingbar, E. E.
 1985 Analysis of Fire-Cracked Rock and Chipped Stone Assemblages. In *Archeological Testing at the Fairchild Site (LA 45732), Otero County, New Mexico*, edited by R. Anyon, pp. 44–48. Office of Contract Archeology, University of New Mexico, Albuquerque.

- Jackson, M. A.
 1995 A Morphological Analysis of Fire-cracked Rocks from the Northern Rocky Mountain Field School, Kootenai National Forest, Montana. Paper presented at Workshop on Hot-Rock Features, Council of Texas Archeologists Meeting, Austin.
- Johnson, L., Jr.
 1986 A Plague of Phases. *Bulletin of the Texas Archeological Association* 57:1-26.
 1991 *Early Archaic Life at the Sleeper Archaeological Site 41BC65 of the Texas Hill Country, Blanco County, Texas*. Report No. 39. Texas State Department of Highways and Public Transportation, Publications in Archeology, Austin.
- Johnson, L., and G. T. Goode
 1994 A New Try at Dating and Characterizing Holocene Climates, as well as Archeological Periods, on the Eastern Edwards Plateau. *Bulletin of the Texas Archeological Association* 65:1-51.
- Jones, A. E.
 1991 The Geophysical Survey of Burnt Mounds: A Study from Acocks Green, Birmingham. In *Burnt Mounds and Hot Stone Technology*, edited by M. A. Hodder and L. H. Barfield, pp. 31-39. Sandwell Metropolitan Borough Council, West Midlands, England.
- Knepper, D., and M. Petraglia
 1996 Prehistoric Occupation at the Connoquenessing Site, An Upland Setting in the Upper Ohio River Valley. *Archaeology of Eastern North America*, [in press].
- Latas, T. W.
 1992 An Analysis of Fire Cracked Rock: A Sedimentological Approach. In *Deciphering a Shell Midden*, edited by J. K. Stein, pp. 211-237. Academic, New York.
- Larsson, T. B.
 1990 Skärvtenshögar – The Burnt Mounds of Sweden. In *Burnt Offerings: International Contributions to Burnt Mound Archaeology*, compiled by V. Buckley, pp. 142-152. Wordwell, Academic, Dublin, Ireland.
- Leach, J. D.
 1993 Hot Rocks in the Sand. In *Prehistoric and Historic Research Along the Border: Proceedings of the 7th and 8th Jornada-Mogollon Conference*, edited by M. Duran. Human Systems Research. In press.
- Lintz, C.
 1989 Experimental Thermal Discoloration and Heat Conductivity Studies of Caliche from Eastern New Mexico. *Geoarchaeology* 4(4):319-346.
- Lovick, S. K.
 1983 Fire-Cracked Rock as Tools: Wear Pattern Analysis. *Plains Anthropologist* 28(99):41-52.
- Lundberg, D. E., and L. H. Kotschevar
 1965 *Understanding Cooking*. The University Store, University of Massachusetts, Amherst.

- McCourt, W. E.
 1906 *Fire Tests of Some New York Building Stones*. Bulletin 100, Economics and Geology 14. New York State Education Department, Albany.
- McDowell-Loudan, E. E.
 1983 Fire-cracked Rock: Preliminary Experiments to Determine Its Nature and Significance in Archeological Contexts. *The Chesopiean* 21(1):20–20.
- McParland, P.
 1977 Experiments in the Firing and Breaking of Rocks. *Calgary Archaeologist* 5:31–33.
- Mauldin, R.
 1994 Small Sites in Western Texas and Southern New Mexico. *Bulletin of the Texas Archeological Association* 65:185–206.
- Mauldin, R., T. Graves, and M. Bentley
 1994 Small Sites in the Central Hueco Bolson: A Final Report on Project 90-11. Manuscript on file, Directorate of the Environment, Ft. Bliss, Texas. Draft.
- Miller, M. R.
 1989 *Archaeological Excavations at the Gobernadora and Ojasen Sites: Doña Ana Phase Settlement in the Western Hueco Bolson, El Paso County, Texas*. Center for Anthropological Research Report No. 673. New Mexico State University, Las Cruces.
 1990 Archaeological Investigations in the Northern Hills Subdivision: Late Mesilla and Doña Ana Phase Settlement in Northeast El Paso, El Paso County, Texas. Draft final report submitted to Batcho & Kaufman Associates. Cultural Resources Report Number 100, El Paso, Texas.
- Nixon, M. J.
 1990 Some South Cumbrian Burnt Mounds—An Initial Survey. In *Burnt Offerings: International Contributions to Burnt Mound Archaeology*, compiled by V. Buckley, pp. 112–114. Wordwell, Academic, Dublin, Ireland.
- Oakes, Y. R.
 1981 *Prehistoric Subsistence Adaptations on the White Sands Missile Range*. Laboratory of Anthropology Note 277, Museum of New Mexico, Santa Fe.
- O’Connell, J. F.
 1987 Alyawara Site Structure and Its Archaeological Implications. *American Antiquity* 52:74–108.
- O’Laughlin, T. C.
 1980 *The Keystone Dam Site and Other Archaic and Formative Sites in Northwest El Paso, Texas*. Publications in Anthropology No. 8. The University of Texas at El Paso.
- Olive, M., and Y. Taborin
 1989 *Nature et Fonction des Foyers Préhistoriques*. Mémoires du Musée de Préhistoire de France, n° 2, Nemours, France.

- Purdy, B. A.
 1975 Fractures for the Archeologists. In *Lithic Technology*, edited by E. Swanson, pp. 133–141. Mouton, The Hague.
- Prewitt, E. R.
 1991 Burned Rock Middens: A Summary of Previous Investigations and Interpretations. In *The Burned Rock Middens of Texas: An Archeological Symposium*, edited by T. R. Hester, pp. 25–32. Studies in Archeology 13. Texas Archeological Research Laboratory, The University of Texas, Austin.
- Reid, K. C.
 1989 A Material Science Perspective on Hunter-Gatherer Pottery. In *Pottery Technology: Ideas and Approaches*, edited by G. Bronitsky, pp. 167–180. Westview, Boulder.
- Ricklis, R. A., and M. B. Collins
 1994 *Archaic and Late Prehistoric Human Ecology in the Middle Onion Creek Valley, Hays County, Texas*. Studies in Archeology No. 19. Texas Archeological Research Laboratory, The University of Texas at Austin.
- Russell-White, C. J.
 1990a The East Rhins of Galloway. In *Burnt Offerings: International Contributions to Burnt Mound Archaeology*, compiled by V. Buckley, pp. 70–76. Wordwell, Academic, Dublin, Ireland.
 1990b Synthesis. In *Burnt Offerings: International Contributions to Burnt Mound Archaeology*, compiled by V. Buckley, pp. 87–91. Wordwell, Academic, Dublin, Ireland.
- Sanders, P. H., W. Andrefsky, Jr., and S. R. Samuels
 1991 The Calispell Valley Archaeological Project Final Report Volume 2. Project Report Number 16. Center for Northwest Anthropology, Washington State University, Pullman.
- Schutt, J. A., M. R. Binford, R. B. Duncan, and M. K. Swift
 1991 Methods of Lithic and Fire-Cracked Rock Analysis. In *Landscape Archeology in the Southern Tularosa Basin, Volume 2, Testing, Excavation, and Analysis*. edited by W. H. Doleman, R. C. Chapman, J. A. Schutt, M. K. Swift, and K. D. Morrison, pp. 299–313. Report No. 185–324E, Office of Contract Archeology, University of New Mexico, Albuquerque.
- Shiner, J. L., and M. V. Shiner
 1977 Structure and Organization of a Burned Rock Midden: The Indian Creek Site, Real County, Texas. *Plains Anthropologist* 22(2):263–282.
- Takac, P.
 1995 Vectors of Change: Archaeomagnetic Analysis of the Context, Formation, and Function of Limestone Burned Rock Features in Central Texas. Paper presented at Workshop on Hot-Rock Features, Council of Texas Archeologists Meeting, Austin.

- Thoms, A. V.
- 1986 Hot Rocks: The Short-Term Storage of Energy in the Calispell Valley. In *Calispell Archaeological Project Interim Report for 1984 and 1985 Field Seasons*, edited by A. V. Thoms and G. C. Burtchard, pp 447–477. Contributions in Cultural Resource Management No. 10. Center for Northwest Anthropology, Washington State University, Pullman.
 - 1989 The Northern Roots of Hunter-Gatherer Intensification: Camas and the Pacific Northwest. Ph.D. dissertation, Washington State University, Pullman.
- Tunnell, C., and E. Madrid
- 1990 Making and Taking Sotol in Chihuahua and Texas. In *Papers from the Third Symposium on Resources of the Chihuahuan Desert Region*, edited by A. M. Powell, R. R. Hollander, J. C. Barlow, W. B. McGillivray, and D. J. Schmidly, pp. 145–162. Chihuahuan Desert Research Institute, Sul Ross State University, Alpine, Texas.
- Weir, F. A.
- 1976 *The Central Texas Archaic*. Ph.D. dissertation, Washington State University, Pullman.
- Whalen, M. E.
- 1977 *Settlement Patterns of the Eastern Hueco Bolson*. Anthropological Paper No. 4, El Paso Centennial Museum. The University of Texas at El Paso.
 - 1981 *Special Studies in the Archaeology of the Hueco Bolson*. Publications in Anthropology No. 9. El Paso Centennial Museum. The University of Texas at El Paso.
 - 1994 *Turquoise Ridge and the Late Prehistoric Residential Mobility in the Desert Mogollon Region*. University of Utah Anthropological Papers, No. 118, Salt Lake City.
- White, E. M., and L. A. Hannus
- 1983 Weathering and Disintegration of Rocks at Oakwood Lake, South Dakota (39BK7). *Plains Anthropologist* 28(99):53–57.
- White, J. R.
- 1980 A Closer Look at Clusters. *American Antiquity* 45:66–74.
- Williams, G.
- 1990 Burnt Mounds in South-West Wales. In *Burnt Offerings: International Contributions to Burnt Mound Archaeology*, compiled by V. Buckley, pp. 129–140. Wordwell, Academic, Dublin, Ireland.
- Witkind, W. M.
- 1977 An Experiment in Stone Boiling. In *Hop Hill: Culture and Climatic Change in Central Texas*, by J. Gunn and R. Mahula, pp. 205–208. Special Report, No. 5. Center for Archaeological Research, The University of Texas at San Antonio.
- Yellen, J. E.
- 1977 *Archaeological Approaches to the Present: Models for Reconstructing the Past*. Academic, New York.

Appendix A: Burned Rock Data by Site

Key to Codes:

Mat(erial)

1 chert
2 Rancheria chert
3 quartzite
4 limestone
5 rhyolite
6 sandstone
7 granitic
8 basalt
9 vesicular basalt
14 caliche
15 other
(10-13 not encountered)

Size (cm)

1 <1.5
2 1.5-2.5
3 2.5-4
4 4-5.5
5 5.5-8
6 8-10.5
7 10.5-13
8 13-15.5
9 15.5-18
10 18-20.5
11 20.5-23
12 23-25.5

Fr: fractured

NF: non-fractured

Disc P: discoloration present

Disc A: discoloration absent

Cort P: cortex present

Cort A: cortex absent

Comm: comments

Site	Coll #	Feature	Lv	Blk	Mat	Size	Grams	Qty	Fr	NF	Disc P	Disc A	Cort P	Cort A	Comm
12412	100		6	OA2	14	2	32.19	7			7				
12412	100		6	OA2	14	1	0.4	1			1				
12412	100		6	OA2	14	3	22.24	2			2				
12412	101		6	OA2	14	1	3.88	6			6				
12412	101		6	OA2	14	2	6.94	4			4				
12412	101		6	OA2	4	1	1.63	1	1		1		1		
12412	101		6	OA2	14	3	8.2	1			1				
12412	101		6	OA2	4	2	13.1	3	3		3		3		
12412	102		6	OA2	4	4	15.72	1							
12412	102		6	OA2	4	2	100.01	29			29				
12412	102		6	OA2	14	1	40.36	43			43				
12412	102		6	OA2	4	3	66.86	6			6				
12412	103		6	OA2	14	2	20.82	5			5				
12412	103		6	OA2	14	3	6.58	1			1				
12412	103		6	OA2	1	1	0.7	1	1		1			1	
12412	103		6	OA2	14	1	1.14	2			2				
12412	103		6	OA2	4	1	4.62	3	1	2	3		3		
12412	103		6	OA2	4	2	11.99	4	2	2	4		4		
12412	104		6	OA2	4	1	2.82	2		2	2		2		
12412	104		6	OA2	14	2	16.59	6			6				
12412	104		6	OA2	1	1	0.31	1	1		1		1		
12412	104		6	OA2	4	4	28.59	1		1	1		1		
12412	104		6	OA2	4	3	29.35	2	1	1	2		2		
12412	104		6	OA2	14	1	6.06	9			9				
12412	104		6	OA2	4	2	4.88	4	4		4		4		
12412	105		6	OA2	14	1	0.79	2			2				
12412	105		6	OA2	4	1	0.7	2	2		2			2	
12412	105		6	OA2	4	2	7.54	3	3		3		2	1	
12412	105		6	OA2	14	2	3.62	1			1				
12412	105		6	OA2	4	3	17	1	1		1			1	
12412	106		6	OA2	14	1	10.05	17			17				
12412	106		6	OA2	14	2	49.72	26			26				
12412	106		6	OA2	4	3	41.21	3	2	1	3		3		
12412	106		6	OA2	14	3	98.08	7			7				
12412	106		6	OA2	4	1	6.28	7	7		7		1	6	
12412	106		6	OA2	14	4	41.52	1			1				
12412	106		6	OA2	4	4	88.07	1		1	1		1		
12412	106		6	OA2	4	2	21.72	7	7		7		4	3	
12412	107		6	OA2	14	2	22.89	8			8				
12412	107		6	OA2	14	1	2.27	6			6				
12412	108		6	OA2	4	4	71.24	2	2		2		1	1	
12412	108		6	OA2	14	2	37.27	10			10				
12412	108		6	OA2	4	1	0.68	2	2		2			2	
12412	108		6	OA2	4	3	9.23	1	1		1		1		
12412	108		6	OA2	4	2	3.22	3	3		3		1	2	
12412	108		6	OA2	14	3	13.66	2			2				
12412	108		6	OA2	14	4	33.15	1			1				
12412	108		6	OA2	14	1	4.97	7			7				
12412	109		6	OA2	14	4	24.81	1			1				
12412	109		6	OA2	14	2	42.18	14			14				
12412	109		6	OA2	14	3	39.58	14			14				
12412	109		6	OA2	14	1	5.36	6			6				
12412	112		6	OA2	4	2	1.14	1				1		1	
12412	112		6	OA2	4	1	0.92	1	1		1			1	
12412	112		6	OA2	14	1	3.34	6			6				
12412	112		6	OA2	14	2	14.56	6			6				
12412	113		6	OA2	4	2	2.34	1	1		1		1		
12412	113		6	OA2	14	1	7.19	5			5				
12412	113		6	OA2	4	1	2.9	5	5		5		5		
12412	114		7	OA2	14	2	20.53	8			8				
12412	114		7	OA2	4	2	22.7	6	6		6		3	3	
12412	114		7	OA2	14	1	5.46	8			8				
12412	114		7	OA2	4	1	0.96	4	4		4		2	2	
12412	114		7	OA2	14	3	18.25	2			2				
12412	114		7	OA2	4	3	10.36	1	1		1		1		

Site	Coll #	Feature	Lv	Blk	Mat	Size	Grams	Qty	Fr	NF	Disc P	Disc A	Cort P	Cort A	Comm
12412	115		6	OA2	4	3	20.75	1	1		1		1		
12412	115		6	OA2	4	1	0.74	2	2		2			2	
12412	115		6	OA2	14	1	2.71	4			4				
12412	115		6	OA2	14	2	10.59	5			5				
12412	115		6	OA2	4	2	16.8	5	5		5		2	3	
12412	116		6	OA2	4	1	8.79	12	12		12		2	10	
12412	116		6	OA2	4	2	11.03	3	3		3		3		
12412	116		6	OA2	14	1	0.59	1			1				
12412	117		6	OA2	1	1	0.41	1	1					1	
12412	117		6	OA2	4	3	11.55	1	1		1		1		
12412	117		6	OA2	14	2	16.59	8			8				
12412	117		6	OA2	14	1	7.29	9			9				
12412	117		6	OA2	4	4	26.46	1		1	1		1		
12412	117		6	OA2	1	1	2.62	1	1		1		1		
12412	117		6	OA2	4	2	18.85	7	7		7		2	5	
12412	119		6	OA2	4	2	6.56	4	4		4		2	2	
12412	119		6	OA2	14	1	2.89	3			3				
12412	119		6	OA2	4	1	8.55	12	11	1	12		2	10	
12412	119		6	OA2	14	2	21.29	6			6				
12412	119		6	OA2	14	3	36.65	2			2				
12412	119		6	OA2	4	3	12.21	1	1		1			1	
12412	120		6	OA2	4	3	6.55	1	1		1		1		
12412	120		6	OA2	4	1	1.72	1	1		1			1	
12412	120		6	OA2	4	2	16.56	3	3		3		1	2	
12412	120		6	OA2	14	2	6.95	1			1				
12412	120		6	OA2	14	1	1.32	1			1				
12412	121		6	OA2	14	1	0.76	1			1				
12412	121		6	OA2	4	2	5.05	1	1		1		1		
12412	121		6	OA2	14	2	3.9	2			2				
12412	121		6	OA2	14	3	5.5	1			1				
12412	122		6	OA2	4	2	64.93	25	25		25		6	19	
12412	122		6	OA2	4	1	11.5	15	15		15		7	8	
12412	122		6	OA2	1	1	0.24	1	1		1			1	
12412	122		6	OA2	14	1	0.97	2			2				
12412	122		6	OA2	4	3	55.51	3	3		3		2	1	
12412	122		6	OA2	14	2	3.19	2	2		2				
12412	123		6	OA2	4	1	2.78	7	7		7			7	
12412	123		6	OA2	14	1	6.02	6			6				
12412	123		6	OA2	4	2	43.53	15	14	1	15		3	12	
12412	123		6	OA2	14	2	16.35	3			3				
12412	123		6	OA2	4	3	15.45	2	1	1	2		1	1	
12412	124		6	OA2	14	2	20.56	4			4				
12412	124		6	OA2	4	1	2.54	3	3		3		1	2	
12412	124		6	OA2	14	1	2.57	3			3				
12412	125		6	OA2	4	1	5.23	7	7		7		2	5	
12412	125		6	OA2	14	5	46.4	1			1				
12412	125		6	OA2	4	2	11.25	1	1		1			1	
12412	125		6	OA2	14	2	29.65	5			5				
12412	125		6	OA2	14	1	5.45	8			8				
12412	126		6	OA2	14	1	6.63	8			8				
12412	126		6	OA2	14	2	16.26	4			4				
12412	126		6	OA2	4	1	3.82	3	3		3			3	
12412	126		6	OA2	4	2	5.75	3	3		3			3	
12412	126		6	OA2	4	3	29.91	1		1	1		1		
12412	126		6	OA2	14	3	14.23	1			1				
12412	127		6	OA2	14	1	1.2	2			2				
12412	127		6	OA2	4	2	4.64	2	2		2		1	1	
12412	127		6	OA2	14	4	52.12	1			1				
12412	127		6	OA2	4	3	7.97	1	1		1		1		
12412	127		6	OA2	4	1	1.85	2	2		2			2	
12412	127		6	OA2	14	2	29.09	7			7				
12412	128		6	OA2	14	4	46.17	1			1				
12412	128		6	OA2	14	2	23.13	6			6				
12412	128		6	OA2	14	1	2.18	5			5				
12412	129		6	OA2	4	2	14.1	6	6		6		2	4	

Site	Coll #	Feature	Lv	Blk	Mat	Size	Grams	Qty	Fr	NF	Disc P	Disc A	Cort P	Cort A	Comm
12412	129		6	OA2	4	3	44.62	5	3	2	5		4	1	
12412	129		6	OA2	4	1	0.7	1	1		1			1	
12412	129		6	OA2	1	2	2.23	1	1		1			1	
12412	130		6	OA2	14	1	4.45	5			5				
12412	130		6	OA2	14	2	15.18	5			5				
12412	130		6	OA2	14	3	6.71	1			1				+ 1 flake
12412	131		6	OA2	14	1	4.02	2			2				
12412	131		6	OA2	4	2	10.95	5	5		5		1	4	
12412	131		6	OA2	4	3	24.77	3	3		3		1	2	
12412	131		6	OA2	4	4	15.82	1	1		1		1		
12412	131		6	OA2	4	1	9.22	10	10		10			10	
12412	131		6	OA2	1	2	0.95	1			1				
12412	132		6	OA2	14	2	16.98	6			6				
12412	132		6	OA2	4	1	0.57	2	2		2			2	
12412	132		6	OA2	4	2	8.69	3	2	1	3		2	1	
12412	132		6	OA2	14	1	2.68	6			6				
12412	133		6	OA2	14	1	7.94	11			11				
12412	133		6	OA2	4	3	65.32	6	6		6		4	2	
12412	133		6	OA2	4	4	57.53	2	2		2		2		
12412	133		6	OA2	14	2	19.42	5			5				
12412	133		6	OA2	1	2	3.79	2	2		2			2	
12412	133		6	OA2	4	2	64.04	22	22		22		8	12	
12412	133		6	OA2	4	1	14.75	28	28		28		4	24	
12412	133		6	OA2	1	1	0.47	1	1		1			1	
12412	134		6	OA2	4	2	9.34	3	3		3		2	1	
12412	134		6	OA2	4	1	2.66	7	7		7		2	5	
12412	135		6	OA2	4	4	26.78	1		1	1		1		
12412	135		6	OA2	14	2	2.16	1			1				
12412	135		6	OA2	14	1	1.57	2			2				
12412	135		6	OA2	4	2	1.27	1	1		1		1		
12412	136		6	OA2	4	2	13.53	5	5		5		2	3	
12412	136		6	OA2	4	4	20.66	1	1		1		1		
12412	136		6	OA2	14	2	6.91	3			3				
12412	136		6	OA2	4	3	19.55	1		1	1		1		
12412	136		6	OA2	4	1	3.54	7	7		7		2	5	
12412	136		6	OA2	14	1	1.93	4			4				
12412	137		6	OA2	4	1	4.75	10	9	1	10		1	9	
12412	137		6	OA2	4	3	4.22	1	1		1			1	
12412	137		6	OA2	4	2	8.11	3	2	1	3		2	1	
12412	138		6	OA2	14	2	6.74	2			2				
12412	138		6	OA2	14	1	4.97	4			4				
12412	139		6	OA2	4	1	7.18	10	10		10		4	6	
12412	139		6	OA2	14	4	17.13	1			1				
12412	139		6	OA2	14	2	11.31	4			4				
12412	139		6	OA2	4	3	27.51	3	3		3		3		
12412	139		6	OA2	14	1	4.94	4			4				
12412	139		6	OA2	4	2	6.87	2	1	1	2		1	1	
12412	140		6	OA2	4	3	8.69	1	1		1			1	
12412	140		6	OA2	4	1	0.62	1	1		1			1	
12412	140		6	OA2	14	2	8.35	5			5				
12412	140		6	OA2	4	2	11	3	3		3		2	1	
12412	140		6	OA2	14	1	9.51	17			17				
12412	142	9	6	OA2	4	2	5.75	3	3		3		3		
12412	142	9	6	OA2	4	1	3.19	6	6		6		2	4	
12412	142	9	6	OA2	14	2	12.03	5			5				
12412	142	9	6	OA2	14	1	3.15	3			3				
12412	142	9	6	OA2	4	4	10.32	1	1		1			1	
12412	143		6	OA2	4	2	4.16	2	2		2			2	
12412	143		6	OA2	14	1	1.29	2			2				
12412	143		6	OA2	14	2	5.82	4			4				
12412	144		6	OA2	4	3	32.36	2	2		2		1	1	
12412	144		6	OA2	4	3	32.36	2	2		2		1	1	
12412	144		6	OA2	14	1	6.03	10			10				
12412	144		6	OA2	4	5	129.72	2	1	1	2		2		
12412	144		6	OA2	4	1	6.69	11	11		11		2	8	

Site	Coll #	Feature	Lv	Blk	Mat	Size	Grams	Qty	Fr	NF	Disc P	Disc A	Cort P	Cort A	Comm
12412	144		6	OA2	4	4	19.1	1		1	1		1		
12412	144		6	OA2	4	2	40.06	15	14	1	15		4	11	
12412	144		6	OA2	14	2	4	2			2				
12412	144		6	OA2	14	2	4	2			2				
12412	144		6	OA2	14	3	33.09	3			3				
12412	144		6	OA2	4	2	40.06	15	14	1	15		4	11	
12412	144		6	OA2	4	4	19.1	1		1	1		1		
12412	144		6	OA2	14	3	33.09	3			3				
12412	144		6	OA2	4	5	129.72	2	1	1	2		2		
12412	144		6	OA2	14	1	6.03	10			10				
12412	145		6	OA2	14	1	6.21	10			10				
12412	145		6	OA2	14	2	10.19	4			4				
12412	145		6	OA2	4	1	9.83	13	12	1	13		4	9	
12412	145		6	OA2	4	2	24.01	9	8	1	9		3	6	
12412	145		6	OA2	4	4	35.26	3	2	1	3		3		
12412	145		6	OA2	14	3	13.05	1			1				
12412	146	9	6	OA2	14	3	27	2			2				
12412	147	9	6	OA2	4	2	45.94	19	17	2	19		5	14	
12412	147	9	6	OA2	14	2	13.25	5			5				
12412	147	9	6	OA2	4	3	66.03	7	7		7		5	2	
12412	147	9	6	OA2	4	5	201.9	1	1		1		1		
12412	147	9	6	OA2	14	1	14.37	10			10				
12412	147	9	6	OA2	14	3	46.06	4			4				
12412	147	9	6	OA2	4	1	16.11	18	18		18		2	16	
12412	147	9	6	OA2	4	4	39.35	3	3		3			3	
12412	148		6	OA2	4	4	24.2	1	1	0	1		1		
12412	148		6	OA2	4	1	0.83	2	2	0	2		0	2	
12412	148		6	OA2	4	2	19.67	6	5	1	6		2	4	
12412	149		6	OA2	14	1	4.31	9			9				
12412	149		6	OA2	14	3	8.1	1			1				
12412	149		6	OA2	14	2	3.43	3			3				
12412	149		6	OA2	4	2	23.72	6	6		6			6	
12412	149		6	OA2	4	1	2.51	4	4		4		3	1	
12412	149		6	OA2	4	3	25.15	2	2		2		2		
12412	150		6	OA2	14	3	27	2			2				
12412	150		6	OA2	14	2	19.09	11			11				
12412	150		6	OA2	4	3	79.8	6	6		6		3	3	
12412	150		6	OA2	4	1	3.23	5	5		5			5	
12412	150		6	OA2	4	2	11.27	3	3		3			3	
12412	150		6	OA2	14	6	38.07	1			1				
12412	150		6	OA2	14	1	16.52	28			28				
12412	150		6	OA2	14	4	26.52	1			1				
12412	151		6	OA2	4	1	2.72	3	3		3			3	
12412	151		6	OA2	14	1	5.1	6			6				
12412	151		6	OA2	4	2	10.83	4	4		4			4	
12412	151		6	OA2	14	2	9.44	4			4				
12412	152		6	OA2	4	1	0.62	1	1		1			1	
12412	153		6	OA2	4	4	30.75	2	2		2		2		
12412	153		6	OA2	14	2	30.27	10			10				
12412	153		6	OA2	4	2	14.06	6	6	0	4	2	1	5	
12412	153		6	OA2	14	1	19.32	20			20				
12412	153		6	OA2	4	1	0.62	2	2		2			2	
12412	154	9	6	OA2	14	2	22.92	7			7				
12412	154	9	6	OA2	4	1	2.16	4	4		4			4	
12412	154	9	6	OA2	4	5	59.52	1	1		1			1	
12412	154	9	6	OA2	4	2	27.09	9	9		9		4	5	
12412	154	9	6	OA2	14	1	7.96	12			12				
12412	154	9	6	OA2	4	3	34.79	3	3		3		1	2	
12412	156	3	6	OA2	4	1	7.63	13	13		13		1	12	
12412	156	3	6	OA2	14	4	13.23	1			1				
12412	156	3	6	OA2	14	1	11.04	16			16				
12412	156	3	6	OA2	14	2	40.8	14			14				
12412	156	3	6	OA2	14	3	8.54	1			1				
12412	156	3	6	OA2	4	2	23.22	8	8		8		3	5	

Site	Coll #	Feature	Lv	Blk	Mat	Size	Grams	Qty	Fr	NF	Disc P	Disc A	Cort P	Cort A	Comm
12412	156	3	6	0A2	4	3	4.29	1	1		1			1	
12412	157		6	0A2	14	2	5.1	2			2				
12412	157		6	0A2	4	3	8.3	1	1		1		1		
12412	157		6	0A2	14	1	1.06	2			2				
12412	158		6	0A2	4	2	12.54	6	6		6		1	5	
12412	158		6	0A2	4	3	24.68	2	2		2		2		
12412	158		6	0A2	14	1	15.65	17			17				
12412	158		6	0A2	4	4	28.89	1	1		1		1		
12412	158		6	0A2	14	2	13.91	4			4				
12412	158		6	0A2	14	3	9.71	1			1				
12412	158		6	0A2	4	1	5.88	5	5		5	0	2	3	
12412	159	9	6	0A2	14	1	17.24	21			21				
12412	159	9	6	0A2	15	2	27.6	1		1		1	1		quartz
12412	159	9	6	0A2	4	2	23.67	7	7		7		2	5	
12412	159	9	6	0A2	14	6	118.99	1			1				
12412	159	9	6	0A2	14	4	41.82	1			1				
12412	159	9	6	0A2	4	3	29.96	3	3		3		1	2	
12412	159	9	6	0A2	14	3	10.86	1			1				
12412	159	9	6	0A2	1	2	1.97	1	1			1	1		
12412	159	9	6	0A2	4	4	61.57	2	2		2		1	1	
12412	159	9	6	0A2	4	1	3.46	4	4		4			4	
12412	159	9	6	0A2	14	2	37.14	11			11				
12412	160	3	6	0A2	4	4	18.02	1	1		1		1		
12412	160	3	6	0A2	14	2	43.13	13			13				
12412	160	3	6	0A2	14	1	10.35	13			13				
12412	160	3	6	0A2	4	1	1.08	1	1		1		1		
12412	160	3	6	0A2	4	2	11.1	4	4		4			4	
12412	160	3	6	0A2	14	3	17.15	2			2				
12412	161		6	0A2	4	3	10.67	1	1		1		1		
12412	161		6	0A2	4	2	15.45	5	5		5		2	3	
12412	161		6	0A2	14	1	5.34	5			5				
12412	161		6	0A2	4	1	1.5	1	1		1			1	
12412	161		6	0A2	14	4	26.26	1			1				
12412	161		6	0A2	14	2	12.74	5			5				
12412	161		6	0A2	14	3	12.79	1			1				
12412	162		6	0A2	14	1	9.55	7			7				
12412	162		6	0A2	4	1	4.99	5	5		5		2	3	
12412	162		6	0A2	14	2	47.44	10			10				
12412	162		6	0A2	4	2	21.6	9	9		9		2	7	
12412	163		6	0A2	14	1	1.24	1			1				
12412	163		6	0A2	4	2	10.81	4	4		4		3	1	
12412	163		6	0A2	14	2	2.26	1			1				
12412	163		6	0A2	4	1	3.29	5	5		5		2	3	
12412	164		6	0A2	14	2	42.2	10			10				
12412	164		6	0A2	4	2	13	6	6		6		4	2	
12412	164		6	0A2	14	1	11.22	15			15				
12412	164		6	0A2	14	3	9.19	1			1				
12412	165		6	0A2	4	1	6.92	1	1		1			1	
12412	165		6	0A2	4	2	3.11	1	1		1			1	
12412	165		6	0A2	14	2	15.84	6			6				
12412	165		6	0A2	14	1	3.83	8			8				
12412	166		6	0A2	14	2	5.22	1			1				
12412	166		6	0A2	4	3	6.52	1	1		1		1		
12412	166		6	0A2	4	2	21.39	5	5		5		3	2	
12412	166		6	0A2	4	1	1.97	2	2		2		1	1	
12412	166		6	0A2	14	1	3.92	3			3				
12412	167		6	0A2	4	2	3.06	2	2		2		1	1	
12412	167		6	0A2	14	2	3.59	3			3				
12412	167		6	0A2	14	1	1.6	3			3				
12412	167		6	0A2	4	3	12.18	1	1		1			1	
12412	168	9	6	0A2	4	3	10.15	1	1		1		1		
12412	168	9	6	0A2	4	2	2.56	1	1		1		1		
12412	168	9	6	0A2	14	2	21.49	7			7				
12412	168	9	6	0A2	14	1	2.92	6			6				
12412	168	9	6	0A2	4	1	0.51	1	1		1			1	

Site	Coll #	Feature	Lv	Blk	Mat	Size	Grams	Qty	Fr	NF	Disc P	Disc A	Cort P	Cort A	Comm
12412	169		6	0A2	4	1	0.49	1	1		1		1		
12412	170		6	0A2	14	2	28.56	9			9				
12412	170		6	0A2	4	1	1	4	4		4			4	
12412	170		6	0A2	14	1	9.33	13			13				
12412	170		6	0A2	4	2	8.04	3	3		3		2	1	
12412	171	9	6	0A2	4	1	1.57	1	1		1		1		
12412	171	9	6	0A2	14	1	1.49	2			2				
12412	171	9	6	0A2	4	4	34.13	1	1		1		1		
12412	171	9	6	0A2	14	3	13.04	1			1				
12412	171	9	6	0A2	14	2	8.53	3			3				
12412	171	9	6	0A2	4	3	24.24	2	2		2		1	1	
12412	171	9	6	0A2	4	2	7.32	3	3		3		1	2	
12412	172		6	0A2	4	2	10.65	4	4		4			4	
12412	172		6	0A2	14	2	11.62	5			5				
12412	172		6	0A2	14	1	0.81	1			1				
12412	172		6	0A2	14	3	25.82	3			3				
12412	173		6	0A2	14	2	1.99	2			2				
12412	173		6	0A2	4	1	1.05	3	3		3			3	
12412	173		6	0A2	14	1	2.62	5			5				
12412	173		6	0A2	14	3	10.41	1			1				
12412	173		6	0A2	4	3	18.95	2	2		2		2		
12412	173		6	0A2	4	2	2.98	2	2		2		1	1	
12412	174		6	0A2	14	4	29.38	1			1				
12412	174		6	0A2	14	5	94.14	1			1				
12412	174		6	0A2	4	1	0.88	1	1		1			1	
12412	174		6	0A2	4	3	12.82	1	1		1		1		
12412	174		6	0A2	4	2	6.2	2	2		2			2	
12412	174		6	0A2	14	1	8.61	10			10				
12412	174		6	0A2	14	3	48.15	5			5				
12412	174		6	0A2	14	2	29.49	12			12				
12412	175		6	0A2	14	2	47.09	15			15				
12412	175		6	0A2	4	1	4.21	4	4		4			4	
12412	175		6	0A2	4	4	26.23	1			1		1		
12412	175		6	0A2	14	3	28.6	2			2				
12412	175		6	0A2	14	1	6.72	11			11				
12412	175		6	0A2	4	3	15.3	1	1		1			1	
12412	175		6	0A2	4	2	21.06	6	6		6		2	4	
12412	176		7	0A2	4	1	2.14	2	2		2		1	1	
12412	176		7	0A2	14	3	13.76	2			2				
12412	176		7	0A2	14	2	14.21	6			6				
12412	176		7	0A2	4	2	2.03	1	1		1			1	
12412	176		7	0A2	14	1	4.44	5			5				
12412	176		7	0A2	3	1	0.56	1	1			1	1		
12412	178	3	7	0A2	14	1	10.37	15			15				
12412	178	3	7	0A2	14	2	24.36	11			11				
12412	178	3	7	0A2	14	3	12.49	1			1				
12412	178	3	7	0A2	4	3	5.2	1	1		1		1		
12412	178	3	7	0A2	4	2	5.99	2	2		2		1	1	
12412	179		6	0A2	4	1	2.9	2	2		2		1	1	
12412	179		6	0A2	4	2	6.46	2	2		2		2		
12412	179		6	0A2	14	2	9.27	3			3				
12412	179		6	0A2	14	1	4.28	6			6				
12412	180		7	0A2	3	2	6.34	1	1		1		1		
12412	180		7	0A2	14	2	21.12	8			8				
12412	180		7	0A2	14	1	11.42	17			17				
12412	180		7	0A2	14	3	11.81	1			1				
12412	180		7	0A2	4	2	1.11	1	1		1			1	
12412	180		7	0A2	4	1	2.29	3	3		3		1	2	
12412	181	3	7	0A2	4	2	5.43	2	1	1	1		1	1	
12412	181	3	7	0A2	4	1	3.55	5	5		5		2	3	
12412	181	3	7	0A2	3	1	0.44	1	1		1			1	
12412	181	3	7	0A2	4	4	43	2	1	1	1		1	1	
12412	181	3	7	0A2	14	3	21.69	2			2				
12412	181	3	7	0A2	14	2	43.87	21			21				
12412	181	3	7	0A2	14	1	18.26	27			27				

Site	Coll #	Feature	Lv	Blk	Mat	Size	Grams	Qty	Fr	NF	Disc P	Disc A	Cort P	Cort A	Comm
12412	183		6	OA2	14	1	7.23	10			10				
12412	183		6	OA2	4	2	4.29	3	3		3		1	2	
12412	183		6	OA2	14	3	18.11	1			1				
12412	183		6	OA2	14	2	24.46	8			8				
12412	183		6	OA2	3	2	2.98	1	1		1		1		
12412	183		6	OA2	4	3	25.05	1	1		1		1		
12412	183		6	OA2	4	1	3.45	5	5		5		2	3	
12412	184		7	OA2	4	1	0.51	2	2		2		1	1	
12412	184		7	OA2	14	1	7.74	13			13				
12412	184		7	OA2	14	2	10.78	7			7				
12412	184		7	OA2	4	2	3.74	1	1		1		1		
12412	184		7	OA2	4	3	5.23	1	1		1			1	
12412	185		7	OA2	14	1	5.28	7			7				
12412	185		7	OA2	14	2	11.79	5			5				
12412	185		7	OA2	4	1	1	2	2		2			2	1 flake
12412	186	3	7	OA2	1	2	0.7	1	1		1		1		
12412	186	3	7	OA2	4	2	19.38	3	1	2	3		2	1	
12412	186	3	7	OA2	14	2	38.94	17			17				
12412	186	3	7	OA2	14	1	16.04	34			34				
12412	188		7	OA2	14	1	7.71	16			16				
12412	188		7	OA2	14	3	19.06	3			3				
12412	188		7	OA2	4	2	19.02	5	5		5		2	3	
12412	188		7	OA2	3	2	3.05	1	1		1		1		
12412	188		7	OA2	4	1	0.75	2	2		2			2	
12412	188		7	OA2	14	2	25.14	9			9				
12412	189		7	OA2	4	2	14.21	3	3		3		1	2	
12412	189		7	OA2	14	2	16.24	5			5				
12412	189		7	OA2	4	1	1.32	2	2		2			2	
12412	189		7	OA2	14	1	5.73	8			8				
12412	190		6	OA2	4	2	2.93	1	1		1			1	
12412	190		6	OA2	14	1	1.38	1			1				
12412	190		6	OA2	14	1	1.38	1			1				
12412	190		6	OA2	4	1	0.59	1	1		1			1	
12412	190		6	OA2	4	1	0.59	1	1		1			1	
12412	190		6	OA2	14	2	7.98	4			4				
12412	190		6	OA2	14	2	7.98	4			4				
12412	190		6	OA2	4	2	2.93	1	1		1			1	
12412	190		6	OA2	4	3	10.76	1	1		1			1	
12412	190		6	OA2	4	3	10.76	1	1		1			1	
12412	191	3	7	OA2	4	2	16.37	5	5		5		2	3	
12412	191	3	7	OA2	14	3	31.98	4			4				
12412	191	3	7	OA2	14	4	13.98	1			1				
12412	191	3	7	OA2	14	2	68.08	21			21				
12412	191	3	7	OA2	4	3	14.14	1	1		1		1		
12412	191	3	7	OA2	14	1	27.49	45			45				
12412	191	3	7	OA2	4	1	5.13	10	10		10		1	9	
12412	193		7	OA2	14	1	4.25	8			8				
12412	193		7	OA2	4	4	11.17	1	1		1		1		
12412	193		7	OA2	4	3	24.31	1	1		1		1		
12412	193		7	OA2	4	1	1.17	3	3		3			3	
12412	193		7	OA2	4	2	3.06	2	2		2			2	
12412	193		7	OA2	14	2	14.03	5			5				
12412	194		7	OA2	4	2	5.65	3	3		3			3	
12412	194		7	OA2	4	3	33.67	1	1		1		1		
12412	194		7	OA2	14	1	8.75	19			19				
12412	194		7	OA2	4	1	1.94	4	4		4		1	3	
12412	194		7	OA2	14	3	11.93	1			1				
12412	194		7	OA2	14	2	34.56	16			16				
12412	195		7	OA2	14	3	9.96	1			1				
12412	195		7	OA2	14	1	1.13	3			3				
12412	195		7	OA2	14	2	14.87	6			6				
12412	195		7	OA2	4	1	2.27	3	3		3		2	1	
12412	195		7	OA2	4	2	2.4	2	2		2		1	1	
12412	196		7	OA2	14	2	14.1	7			7				
12412	196		7	OA2	4	1	2.2	2	2		2			2	

Site	Coll #	Feature	Lv	Blk	Mat	Size	Grams	Qty	Fr	NF	Disc P	Disc A	Cort P	Cort A	Comm
12412	196		7	0A2	14	3	9.24	2				2			
12412	196		7	0A2	14	1	6.01	10				10			
12412	197		7	0A2	4	1	0.72	1	1			1		1	
12412	197		7	0A2	14	2	13.04	5				5			
12412	197		7	0A2	14	4	11.09	1				1			
12412	197		7	0A2	14	1	6.05	9				9			
12412	197		7	0A2	6	3	4.47	1	1			1		1	no prov.
12412	198	3	6	0A2	14	4	27.94	1				1			
12412	198	3	6	0A2	4	1	1.06	2	2			2		2	
12412	198	3	6	0A2	4	2	5.64	2	2			2		1	1
12412	198	3	6	0A2	14	2	59.09	20				20			
12412	198	3	6	0A2	14	3	40.26	2				2			
12412	198	3	6	0A2	14	1	17.73	31				31			
12412	199		7	0A2	4	2	2.63	1	1			1		1	
12412	199		7	0A2	4	3	5.48	1	1			1		1	
12412	200		7	0A2	14	2	5.67	4				4			
12412	200		7	0A2	14	1	4.12	7				7			
12412	201	3	7	0A2	14	1	10.03	19				19			
12412	201	3	7	0A2	4	1	0.84	2	2			2		1	1
12412	201	3	7	0A2	4	2	2.47	1	1			1		1	
12412	201	3	7	0A2	14	3	2.3	1				1			
12412	201	3	7	0A2	14	2	24.77	10				10			
12412	203		7	0A2	14	2	7.66	2				2			
12412	203		7	0A2	14	1	4.7	8				8			
12412	203		7	0A2	4	2	2.33	1	1			1		1	
12412	204		7	0A2	4	2	3.8	1	1			1		1	
12412	204		7	0A2	14	1	14.92	22				22			
12412	204		7	0A2	14	2	32.6	14				14			
12412	205	3	7	0A2	14	2	47.93	13				13			
12412	205	3	7	0A2	14	1	12.17	16				16			
12412	205	3	7	0A2	4	3	26.21	2	2			2		1	1
12412	205	3	7	0A2	4	2	16.94	7	7			7		2	5
12412	205	3	7	0A2	4	4	29.94	1	1			1		1	
12412	205	3	7	0A2	14	4	9.39	1				1			
12412	205	3	7	0A2	4	1	3.58	4	4			4		4	
12412	205	3	7	0A2	14	3	44.32	5				5			
12412	206		7	0A2	4	4	18.85	1	1			1		1	
12412	206		7	0A2	14	3	34.25	2				2			
12412	206		7	0A2	14	1	17.13	24				24			
12412	206		7	0A2	14	2	16.29	8				8			
12412	207		7	0A2	14	2	32.72	12				12			
12412	207		7	0A2	4	3	11.84	1	1			1		1	
12412	207		7	0A2	14	4	39.66	1				1			
12412	207		7	0A2	4	2	22.77	5	5			5		1	4
12412	207		7	0A2	4	5	68.81	1	1			1		1	
12412	207		7	0A2	14	1	12.6	16				16			
12412	207		7	0A2	4	1	0.49	1	1			1		1	
12412	209	3	7	0A2	14	3	28.08	3				3			
12412	209	3	7	0A2	14	1	6.83	13				13			
12412	209	3	7	0A2	14	4	27.93	2				2			
12412	209	3	7	0A2	4	2	5.05	3	3			3		2	1
12412	209	3	7	0A2	4	1	0.69	1	1			1		1	
12412	209	3	7	0A2	14	2	48.74	17				17			
12412	210	3	8	0A2	14	2	10.12	3				3			
12412	210	3	8	0A2	14	1	1.11	2				2			
12412	211	3	7	0A2	4	3	6.28	1	1			1		1	
12412	211	3	7	0A2	14	1	4.22	6				6			
12412	211	3	7	0A2	14	2	8.73	4				4			
12412	213	3	8	0A2	14	2	18.82	5				5			
12412	213	3	8	0A2	14	1	2.36	4				4			
12412	213	3	8	0A2	14	3	7.92	1				1			
12412	214	3	7	0A2	14	2	41.04	10				10			
12412	214	3	7	0A2	14	3	58.27	6				6			
12412	214	3	7	0A2	4	2	12.56	3	3			3		1	2
12412	214	3	7	0A2	14	1	0.51	6				6			

Site	Coll #	Feature	Lv	Blk	Mat	Size	Grams	Qty	Fr	NF	Disc P	Disc A	Cort P	Cort A	Comm
12412	214	3	7	0A2	4	4	39.17	1	1		1			1	
12412	215		7	0A2	14	1	2.72	4			4				
12412	215		7	0A2	4	2	9.13	3	3		3			3	
12412	215		7	0A2	14	2	20.58	8			8				
12412	215		7	0A2	4	3	15.15	1		1	1		1		
12412	216	3	7	0A2	4	1	0.51	1	1		1			1	
12412	216	3	7	0A2	4	2	9.59	3	3		3		1	2	
12412	216	3	7	0A2	14	1	4.71	6			6				
12412	216	3	7	0A2	4	3	22.64	2	2		2		1	1	
12412	216	3	7	0A2	14	2	16.33	7			7				
12412	216	3	7	0A2	4	4	84.16	1	1		1		1		
12412	217	3	7	0A2	4	1	0.71	1	1		1			1	
12412	217	3	7	0A2	14	2	3.38	3			1				
12412	217	3	7	0A2	14	1	6.79	7			7				
12412	217	3	7	0A2	1	1	1.27	1	1		1		1		
12412	217	3	7	0A2	4	2	4.34	1	1		1			1	
12412	217	3	7	0A2	4	3	4.88	1	1		1			1	
12412	219		7	0A2	14	1	14.39	18	18		18				
12412	219		7	0A2	14	3	12.14	1	1		1				
12412	219		7	0A2	14	4	25.65	1			1				
12412	219		7	0A2	4	2	1.49	1	1		1		1		
12412	219		7	0A2	14	2	33.19	11	11		11				
12412	220		8	0A2	14	4	26.03	1			1				
12412	220		8	0A2	14	1	10.95	15			15				
12412	220		8	0A2	14	2	29.72	11			11				
12412	220		8	0A2	4	1	0.51	1	1		1			1	
12412	220		8	0A2	14	3	11.72	1			1				
12412	221		9	0A2	14	1	1.81	3			3				
12412	221		9	0A2	14	2	6.93	3			3				
12412	222	3	8	0A2	4	2	7.38	3	3		3		1	2	
12412	222	3	8	0A2	14	2	15.89	11			11				
12412	222	3	8	0A2	14	3	11.91	2			2				
12412	222	3	8	0A2	14	1	1.98	3			3				
12412	222	3	8	0A2	4	3	2.99	1	1		1			1	
12412	222	3	8	0A2	4	1	1.13	1	1		1			1	
12412	223	3	8	0A2	4	2	4.14	3	3		3		1	2	
12412	223	3	8	0A2	14	2	9.76	5			5				
12412	223	3	8	0A2	14	1	1.49	3	3		3		1	2	
12412	223	3	8	0A2	14	1	4.8	9			9				
12412	224	3	7	0A2	4	1	1.6	3	3		3		2	1	
12412	224	3	7	0A2	14	1	13.54	19			19				
12412	224	3	7	0A2	4	2	20.39	4	4		4		1	3	
12412	224	3	7	0A2	14	2	39.51	16			16				
12412	224	3	7	0A2	4	5	81.33	1	1		1		1		
12412	224	3	7	0A2	4	3	13.86	1	1		1		1		
12412	224	3	7	0A2	14	3	22.38	1			1				
12412	225		10	0A2	4	1	1.11	1	1		1			1	
12412	225		10	0A2	14	1	0.88	2			2				
12412	225		10	0A2	14	2	1.21	1			1				
12412	226	3	8	0A2	14	3	2.95	1			1				
12412	226	3	8	0A2	14	1	1.28	2			2				
12412	226	3	8	0A2	14	2	7.46	2			2				
12412	227		8	0A2	14	2	6.84	2			2				
12412	227		8	0A2	14	1	2.94	4			4				
12412	227		8	0A2	4	2	0.93	1	1						
12412	228	9	8	0A2	14	4	22.68	1			1				
12412	228	9	8	0A2	14	2	4.96	3			3				
12412	228	9	8	0A2	1	1	0.66	1	1		1			1	
12412	228	9	8	0A2	14	1	0.13	1			1				
12412	229		8	0A2	14	2	16.85	6			6				
12412	229		8	0A2	14	1	20.19	22			22				
12412	230		5	0B1	14	2	16.26	8			11				
12412	230		5	0B1	4	3	33.47	2	2		2		1	1	
12412	230		5	0B1	14	3	8.74	1			1				
12412	230		5	0B1	14	1	30.02	61			61				

Site	Coll #	Feature	Lv	Blk	Mat	Size	Grams	Qty	Fr	NF	Disc P	Disc A	Cort P	Cort A	Comm
12412	230		5	OB1	4	1	22.01	34	34		17		2	32	
12412	230		5	OB1	4	2	64.17	21	21		21		4	17	
12412	232		4	OB1	14	2	12.61	4			4				
12412	232		4	OB1	14	1	12.76	17			17				
12412	232		4	OB1	4	2	48.05	12	12		12		5	7	
12412	232		4	OB1	4	1	11.57	11	11		11		3	8	
12412	232		4	OB1	4	3	13.46	1	1		1			1	
12412	233		5	OB1	4	3	38.14	2	2		2		2		
12412	233		5	OB1	14	1	3.02	10			10				
12412	233		5	OB1	4	1	4.52	6	6		6			6	
12412	233		5	OB1	14	2	11.19	4			4				
12412	233		5	OB1	4	2	9.15	4	4		3	1	1	3	
12412	234		6	OB1	14	1	14.81	20			20				
12412	234		6	OB1	14	2	14.94	6			6				
12412	234		6	OB1	4	4	22.01	1	1		1				
12412	234		6	OB1	4	3	56.28	5	5		5		3	2	
12412	234		5	OB1	4	2	136.53	32	32		32		5	27	
12412	234		5	OB1	4	1	68.89	92	92		92		10	80	
12412	235	16	5	OB1	4	3	35.17	3	3		3			3	
12412	235	16	5	OB1	4	2	83.67	27	27		27		3	24	
12412	235	16	5	OB1	4	1	37.92	66	66		66		3	63	
12412	235	16	5	OB1	14	1	1.92	2			2				
12412	236		5	OB1	4	1	9.65	25	25		25			25	
12412	236		5	OB1	14	1	3.62	5	5		5				
12412	236		5	OB1	4	2	11.81	5	5		5		2	3	
12412	237		5	OB1	4	1	1.43	1	1		1			1	
12412	238		4	OB1	4	3	14.45	1	1		1			1	
12412	238		4	OB1	4	2	27.86	11	11		11		1	10	
12412	238		4	OB1	14	1	3.07	6			6				
12412	238		4	OB1	14	2	1.35	1			1				
12412	238		4	OB1	4	1	5.78	12	12		12			12	
12412	239	16	5	OB1	4	2	25.89	10	10		10			10	
12412	239	16	5	OB1	4	1	6.47	11	11		11			11	
12412	239	16	5	OB1	4	3	55.52	3	3		3		3		
12412	239	16	5	OB1	14	2	7.59	2			2				
12412	240		4	OB1	4	6	480.3	1	1		1		1		
12412	240		4	OB1	4	2	81.18	18	18		15	3	5	13	
12412	240		4	OB1	14	1	8.98	10			10				
12412	240		4	OB1	4	4	123.28	2	2		2			2	
12412	240		4	OB1	4	1	11.47	13	13			13		13	
12412	240		4	OB1	4	5	172	2	2		2		1	1	
12412	240		4	OB1	4	3	157.14	10	10		7	3	1	9	
12412	241		4	OB1	4	1	0.98	3	3			3		3	
12412	241		4	OB1	14	1	0.56	2			2				
12412	241		4	OB1	4	2	3.41	1	1		1		1		
12412	242		5	OB1	4	2	4.15	1	1			1		1	
12412	243		5	OB1	14	2	5.4	3			3				
12412	243		5	OB1	4	2	6.42	4	4		4		1	3	
12412	243		5	OB1	14	1	2.43	10			10				
12412	243		5	OB1	4	1	10.14	18	18			18		18	
12412	244		5	OB1	4	4	17.87	1	1			1		1	
12412	246		4	OB1	4	4	37.19	1	1		1		1		
12412	246		4	OB1	4	1	0.47	1	1			1	1		
12412	246		4	OB1	4	3	40.95	3	3		3		1	2	
12412	246		4	OB1	4	5	353.5	3	3		3		1	2	
12412	247		4	OB1	4	3	110.87	9	9		5	4	1	8	
12412	247		4	OB1	4	2	47.46	9	9		9		1	8	
12412	247		4	OB1	4	1	3.61	5	5			5			
12412	247		4	OB1	4	4	162.75	6	6		6		2	4	
12412	248		5	OB1	4	3	81.96	8	8		8			8	
12412	248		5	OB1	4	1	1.76	3	3		3			3	
12412	248		5	OB1	4	4	37.92	1	1		1		1		
12412	248		5	OB1	4	2	86.39	17	17		17		1	16	
12412	249		5	OB1	4	2	68.06	17	17		17		2	15	
12412	249		5	OB1	4	1	2.66	4	4		4			4	

Site	Coll #	Feature	Lv	Bk	Mat	Size	Grams	Qty	Fr	NF	Disc P	Disc A	Cort P	Cort A	Comm
12412	249		5	OB1	4	3	119.85	9	9		9		1	8	
12412	249		5	OB1	4	4	19.04	1	1		1			1	
12412	250		5	OB1	4	3	39.03	3	3		3			3	
12412	250		5	OB1	4	2	115.37	27	27		27		3	24	
12412	250		5	OB1	4	4	20.34	1	1		1			1	
12412	250		5	OB1	4	1	10.41	9	9		9		1	8	
12412	251		6	OB1	4	1	40.23	7	7		7			7	
12412	251		6	OB1	4	3	17.63	2	1		1			2	
12412	252		5	OB1	4	1	10.73	11	11		11		1	10	
12412	252		5	OB1	4	2	29.78	11	11		11		2	9	
12412	252		5	OB1	4	4	32.83	2	2		2			2	
12412	252		5	OB1	4	3	55.41	4	4		4			4	
12412	253	16	5	OB1	4	3	60.18	3	3		3		1	2	
12412	253	16	5	OB1	4	2	54.05	21	21		21		2	19	
12412	253	16	5	OB1	4	4	67.95	2	2		2			2	
12412	253	16	5	OB1	4	1	12.45	17	17		17			17	
12412	255		5	OB1	4	5	39.86	1	1		1		1		
12412	255		5	OB1	4	6	258.4	1	1		1		1		
12412	255		5	OB1	4	3	28.69	2	2		2			2	
12412	255		5	OB1	4	1	21.33	18	18		18			18	
12412	255		5	OB1	4	4	158.3	5	5		5		1	4	
12412	255		5	OB1	4	2	40.85	11	11		11		1	10	
12412	256		5	OB1	4	8	999.7	1	1		1		1		
12412	256		5	OB1	4	4	112.17	3	3		3		2	1	
12412	256		5	OB1	4	2	36.91	8	8		8		2	6	
12412	256		5	OB1	4	6	378.3	2	2		2		1	1	
12412	256		5	OB1	4	3	31.98	3	3		3		2	1	
12412	256		5	OB1	4	1	8.59	10	10		10			10	
12412	257		5	OB1	4	2	6	1	1		1		1		
12412	257		5	OB1	14	1	1.28	1			1				
12412	258		5	OB1	4	6	126.97	1	1		1		1		
12412	258		5	OB1	4	3	8.08	1	1		1			1	
12412	258		5	OB1	4	4	13.44	1	1		1			1	
12412	258		5	OB1	4	2	37.88	23	23		23		2	19	
12412	261		5	OB1	4	4	18.34	1	1		1		1		
12412	262	16	5	OB1	4	5	89.11	1	1		1		1		
12412	262	16	5	OB1	4	1	0.54	2	2		2			2	
12412	264		5	OB1	4	1	1.03	2	2		2		1	1	
12412	265		5	OB1	4	2	47.49	18	18		18			18	
12412	265		5	OB1	14	1	1.09	1			1				
12412	265		5	OB1	4	3	36.87	4	4		4		1	3	
12412	265		5	OB1	4	1	1.93	2	2		2			2	
12412	266		5	OB1	4	2	10.79	4	4		4			4	
12412	266		5	OB1	14	1	2.64	3			3				
12412	266		5	OB1	4	1	1.72	2	2		2			2	
12412	267		5	OB1	4	2	74.56	25	25		25		3	22	
12412	267		5	OB1	4	4	58.93	2	2		2		1	1	
12412	267		5	OB1	4	3	35.77	4	4		4		1	3	
12412	267		5	OB1	4	1	20.22	35	35		35			35	
12412	268		5	OB1	4	4	15.14	1	1		1			1	
12412	268		5	OB1	4	1	1.1	3	3		3			3	
12412	268		5	OB1	4	3	15.8	2	2		2		1	1	
12412	269		5	OB1	4	1	14.06	14	14		14			14	
12412	269		5	OB1	4	2	17.17	7	7		7		1	6	
12412	269		5	OB1	14	1	2.39	4			4				
12412	270		5	OB1	14	1	1.32	2			2				
12412	270		5	OB1	4	1	14.95	23	23		23		2	21	
12412	270		5	OB1	4	2	43.51	15	15		15		2	13	
12412	271		5	OB1	4	1	1.03	1	1		1			1	
12412	271		5	OB1	1	1	1.32	1	1		1			1	
12412	271		5	OB1	4	2	3.87	1	1		1			1	
12412	271		5	OB1	4	5	26.91	1	1		1		1		
12412	272		5	OB1	4	2	20.46	13	13		13			13	
12412	272		5	OB1	14	1	6.04	15			15				
12412	272		5	OB1	14	3	15.09	1			1				

Site	Coll #	Feature	Lv	Blk	Mat	Size	Grams	Qty	Fr	NF	Disc P	Disc A	Cort P	Cort A	Comm
12412	272		5	OB1	4	1	17.84	35	35		35			35	
12412	272		5	OB1	14	2	8.44	4			4				
12412	272		5	OB1	1	1	0.22	1	1		1			1	
12412	273		5	OB1	14	1	1.58	3			3				
12412	273		5	OB1	4	2	1.19	1	1		1			1	
12412	273		5	OB1	4	1	2.16	3	3		3			3	
12412	274		5	OB1	14	1	2.86	7			7				
12412	274		5	OB1	14	2	2.58	2			2				
12412	274		5	OB1	4	2	51.17	17	17		17			17	
12412	274		5	OB1	4	4	123.64	3	3		3			3	
12412	274		5	OB1	4	6	108.7	1	1		1		1		
12412	274		5	OB1	4	3	32.53	5	5		5		1	4	
12412	274		5	OB1	1	1	0.35	1	1		1			1	
12412	274		5	OB1	4	1	28.24	48	48		48			48	
12412	274		5	OB1	4	5	69.23	1	1		1		1		
12412	275		5	OB1	4	1	1.26	3	3		3			3	
12412	276		5	OB1	4	2	2.47	1	1		1			1	
12412	276		5	OB1	4	2	0.46	3	3		3			3	
12412	277		6	OB1	4	1	2.16	8	8		8			8	
12412	278		6	OB1	4	3	21.2	2	2		2		1	1	
12412	278		6	OB1	4	2	1.67	1	1					1	
12412	278		6	OB1	4	1	2.58	4	4		4			4	
12412	279		6	OB1	4	1	1	1			1				
12412	279		6	OB1	4	1	1.09	4	4		4			4	
12412	279		6	OB1	4	2	1.05	1	1		1			1	
12412	279		6	OB1	4	3	12.31	1	1		1		1		
12412	280		6	OB1	4	2	1.5	2	2		2			2	
12412	281		6	OB1	4	2	1.93	1	1		1			1	
12412	282		6	OB1	4	2	16.78	6	6		6		3	3	
12412	282		6	OB1	4	3	15.5	3	3		3			3	
12412	282		6	OB1	14	1	0.54	1			1				
12412	282		6	OB1	4	1	3.5	4	4		4			4	
12412	283		6	OB1	4	4	19.94	1	1		1		1		
12412	284		6	OB1	4	1	1.68	6	6		6			6	
12412	284		6	OB1	4	2	2.8	2	2		2			2	
12412	284		6	OB1	4	3	17.18	2	2		2		1	1	
12412	284		6	OB1	14	1	0.66	1			1				
12412	285		4	OB1	4	5	350.6	3	3		3		2	1	
12412	285		4	OB1	4	6	416.9	2	2		2		1	1	
12412	285		4	OB1	4	3	40.03	5	5		5		1	4	
12412	285		4	OB1	4	2	20.26	9	9		9			9	
12412	285		4	OB1	4	1	9.61	17	17		17			17	
12412	286		6	OB1	4	2	7.2	3	3		3		1	2	
12412	286		6	OB1	4	3	6.73	1	1		1			1	
12412	286		6	OB1	4	1	3.67	9	9		9			9	
12412	287		6	OB1	4	1	10.39	21	21		21			21	
12412	287		6	OB1	14	3	13.61	1			1				
12412	287		6	OB1	14	2	3.2	2			2				
12412	287		6	OB1	4	2	12.7	5	5		5			5	
12412	289		6	OB1	1	1	0.31	1	1			1		1	
12412	289		6	OB1	14	2	2.35	1			1				
12412	289		6	OB1	4	5	154.87	1	1		1			1	
12412	289		6	OB1	4	1	5.89	9	9		9			9	
12412	289		6	OB1	4	2	21.96	5	5		5			5	
12412	289		6	OB1	14	1	2.36	7			7				
12412	290		6	OB1	4	2	8.21	3	3		3		1	2	
12412	290		6	OB1	4	3	15.06	1	1		1			1	
12412	290		6	OB1	4	1	4.07	6	6		6			6	
12412	291		6	OB1	4	2	10.73	7	7		7			7	
12412	291		6	OB1	4	1	4.58	10	10		10			10	
12412	291		6	OB1	4	3	4.54	1	1		1			1	
12412	291		6	OB1	4	4	25.09	1	1		1			1	
12412	292	16	5	OB1	4	2	10.32	4	4		4		1	3	
12412	292	16	5	OB1	4	1	4.22	18	18		18			18	
12412	292	16	5	OB1	4	3	6.24	1	1		1			1	

Site	Coll #	Feature	Lv	Blk	Mat	Size	Grams	Qty	Fr	NF	Disc P	Disc A	Cort P	Cort A	Comm
12412	545		15	0A1	14	2	4.7	4			4				
12412	545		15	0A1	4	2	1.4	1	1		1			1	
12412	545		15	0A1	14	1	3.27	4			4				
12412	546		14	0A1	14	1	0.36	1			1				
12412	546		14	0A1	14	2	2.73	1			1				
12412	547		14	0A1	14	1	0.64	3			3				
12412	547		14	0A1	4	2	6.38	1	1		1			1	
12412	547		14	0A1	4	1	0.53	1	1		1			1	
12412	548		15	0A1	14	1	2.27	2			2				
12412	548		15	0A1	4	1	0.4	2	2		2			2	
12412	548		15	0A1	4	2	2.22	1	1		1		1		
12412	548		15	0A1	14	2	1.09	1			1				
12412	549		16	0A1	14	1	2	5			5				
12412	549		16	0A1	14	2	2.38	1			1				
12412	550		15	0A1	14	2	31.55	12			12				
12412	550		15	0A1	4	2	36.17	10	10		10		3	7	
12412	550		15	0A1	14	1	18.22	21			21				
12412	550		15	0A1	4	1	28.77	33	33		33			33	
12412	552	12	15	0A1	14	1	0.43	6			6				
12412	553	12	15	0A1	14	1	0.5	2			2				
12412	554		15	0A1	14	1	0.98	2			2				
12412	555		15	0A1	14	3	24.17	3			3				
12412	555		15	0A1	14	2	16.51	5			5				
12412	555		15	0A1	14	1	5.49	6			6				
12412	556		15	0A1	4	3	34.4	2	2		1	1			
12412	556		15	0A1	14	3	12.34	2			2				
12412	556		15	0A1	14	2	9	3			3				
12412	556		15	0A1	14	1	3.02	3			3				
12412	557		16	0A1	14	2	7.87	4			4				
12412	557		16	0A1	14	1	6.82	6			6				
12412	558	12	15	0A1	14	1	1.08	8			8				
12412	559		16	0A1	7	2	1.88	1	1		1		1		
12412	559		16	0A1	14	2	22.32	7			7				
12412	559		16	0A1	4	2	56.76	11	11		11		1	10	
12412	559		16	0A1	4	3	24.66	2	2					2	
12412	559		16	0A1	14	1	18.67	24			24				
12412	559		16	0A1	6	1	1.03	2	2		2			2	
12412	559		16	0A1	4	1	28.67	33	33		33			33	
12412	560		15	0A1	14	1	12.13	21			21				
12412	560		15	0A1	14	3	41.28	2			2				
12412	560		15	0A1	4	1	0.44	1	1		1			1	
12412	560		15	0A1	14	2	25.76	8			8				
12412	561		15	0A1	4	1	1.38	3	3		3			3	
12412	561		15	0A1	14	1	0.98	4			4				
12412	561		15	0A1	4	3	5.18	1	1		1			1	
12412	561		15	0A1	14	2	9.49	4			4				
12412	568		15	0A1	14	1	4.94	10			10				
12412	568		15	0A1	4	1	3.79	1	1		1			1	
12412	569	12	15	0A1	4	1	1.3	1	1		1		1		
12412	569	12	15	0A1	14	2	32.85	16			16				
12412	569	12	15	0A1	4	1	1.3	1	1		1		1		
12412	569	12	15	0A1	4	3	13.53	1	1		1		1		
12412	569	12	15	0A1	14	1	6.47	9			9				
12412	569	12	15	0A1	4	3	13.53	1	1		1		1		
12412	569	12	15	0A1	14	2	32.85	16			16				
12412	569	12	15	0A1	14	1	6.47	9			9				
12412	570		15	0A1	14	2	9.83	6			6				
12412	570		15	0A1	14	1	8.63	16			16				
12412	571	12	15	0A1	14	2	19.3	7			7				
12412	571	12	15	0A1	14	1	18.88	27			27				
12412	574	12	15	0A1	14	2	2.13	2			2				
12412	574	12	15	0A1	4	2	2.89	1		1	1		1		
12412	574	12	15	0A1	14	1	3.4	6			6				
12412	575		15	0A1	14	1	5.4	7			7				
12412	575		15	0A1	14	2	13.76	4			4				

Site	Coll #	Feature	Lv	Bik	Mat	Size	Grams	Qty	Fr	NF	Disc P	Disc A	Cort P	Cort A	Comm
12412	576		6	0B1	4	3	43.45	6	6		6			6	
12412	576		6	0B1	4	1	12.23	23	23		23		1	22	
12412	576		6	0B1	4	5	55.56	1	1			1	1		
12412	576		6	0B1	4	2	28.72	14	14		14	0	1	13	
12412	576		6	0B1	4	4	69.42	4	4		4		2	2	

Site	Coll #	Feature	Lev	Blk	AC	Mat	Sz	Grams	Qty	Frac	NF	Disc P	Disc A	Cort P	Cort A	Comments
12719	512		0	0	281	6	4	11.4	1	1			1	1		
12719	541		0	A1	281	6	1	1.1	1	1			1	1		
12719	618		0	A1	281	6	3	11.3	1	1			1		1	
12719	684		0	A1	281	6	3	7.2	1	1			1	1		
12719	722		0	0	281	6	4	14.1	1	1			1	1		
12719	729		0	0	281	5	4	38.4	1	1		1		1		
12719	730		0	0	281	5	3	12.1	1	1		1		1		
12719	731		0	0	281	6	3	6.1	1	1			1	1		
12719	736		0	0	281	6	2	1.67	1	1			1	1		
12719	738		0	0	281	6	2	4.3	1	1			1	1		
12719	739		0	0	281	6	3	9.7	1	1		1		1		
12719	828		0	0	281	6	5	89.6	1	1			1	1		
12719	830		0	0	281	6	4	22.8	1	1			1	1		
12719	832		0	0	281	7	6	384	1	1		1		1		
12719	1000		3	A1	283	14	3	48.56	2			1	1			
12719	1000		3	A1	283	14	1	0.36	1			1				
12719	1000		3	A1	281	4	3	40.19	3	3		2	1			
12719	1000		3	A1	283	14	2	8.62	4				4			
12719	1000		3	A1	281	5	2	2.88	1	1		1		1		
12719	1000		3	A1	281	4	1	0.8	1		1		1			
12719	1000		3	A1	281	4	2	3.94	2							
12719	1000		3	A1	281	4	4	25.42	1	1		1				
12719	1001		3	A1	281	4	1	0.34	1		1		1			
12719	1001		3	A1	281	4	4	118.8	1	1		1				
12719	1001		3	A1	281	4	2	0.91	1		1		1			
12719	1001		3	A1	281	4	5	101.68	1	1		1		1		
12719	1001		3	A1	281	4	5	75.11	2		2		2			
12719	1002		3	A1	281	4	2	2.49	1	1		1			1	
12719	1002		3	A1	281	4	2	2.52	1	1		1				
12719	1002		3	A1	281	4	2	1.97	1	1		1		1		
12719	1002		3	A1	281	6	2	1.56	1	1		1			1	
12719	1002		3	A1	281	4	2	2.88	1	1			1			
12719	1002		3	A1	283	14	2	8.55	3		3	3				
12719	1002		3	A1	281	4	5	64.98	1	1		1		1		
12719	1002		3	A1	283	14	1	2.13	4		4	4				
12719	1002		3	A1	281	4	4	65.7	3	3		3				
12719	1002		3	A1	281	4	3	20.4	1	1			1			
12719	1002		3	A1	281	4	1	0.42	1		1		1			
12719	1002		3	A1	281	4	2	6.24	1	1		1		1		
12719	1002		3	A1	281	4	1	0.52	1	1		1			1	
12719	1002		3	A1	281	6	2	1.43	1	1		1			1	
12719	1002		3	A1	281	4	2	0.95	1	1		1		1		
12719	1002		3	A1	281	4	1	1.48	1	1		1				
12719	1003		3	A1	281	4	5	315.6	2	2		2				
12719	1003		3	A1	281	4	6	53.96	1	1		1			1	
12719	1003		3	A1	281	4	4	192	3	3		3				
12719	1003		3	A1	281	4	2	6.82	2		2		2			
12719	1003		3	A1	281	4	2	20.07	3	3		3				
12719	1003		3	A1	283	14	2	4.8	2		2	1	1			
12719	1003		3	A1	281	4	3	17.79	2		2		2			
12719	1003		3	A1	281	2	3	12.09	1	1		1		1		
12719	1003		3	A1	283	14	3	37.3	3		2		2			
12719	1003		3	A1	283	14	1	0.8	2		2		2			
12719	1004		3	A1	281	4	3	8.04	1	1			1			
12719	1004		3	A1	281	4	4	25.55	1	1			1			
12719	1004		3	A1	281	6	2	1.67	1		1		1		1	
12719	1004		3	A1	281	4	3	59.39	6	6		6				
12719	1004		3	A1	283	14	2	7.2	4		3	3				
12719	1004		3	A1	281	4	5	190.86	3	3		3				
12719	1004		3	A1	281	4	2	29.58	6	6		6				
12719	1004		3	A1	281	4	4	11.59	1	1		1		1		
12719	1004		3	A1	281	4	5	78.56	1	1			1	1		
12719	1004		3	A1	281	4	4	34.89	1	1		1				
12719	1004		3	A1	281	4	1	3.45	2	2		2				
12719	1004		3	A1	281	4	1	2.29	2		2	2				
12719	1004		3	A1	281	4	6	282.05	2	2		2			2	
12719	1005		3	A1	283	14	1	1.1	1			1				
12719	1005		3	A1	283	14	2	7.8	1			1	1			

Site	Coll #	Feature	Lev	Blk	AC	Mat	Sz	Grams	Qty	Frac	NF	Disc P	Disc A	Cort P	Cort A	Comments
12719	1006		2	A1	283	14	2	1.22	1			1				
12719	1006		2	A1	283	14	3	14.67	1			1				
12719	1006		2	A1	281	4	2	11.29	1	1			1			
12719	1006		2	A1	281	6	3	4.9	1	1		1			1	
12719	1007		2	A1	281	4	3	10.43	2	2		2				
12719	1007		2	A1	283	14	1	0.48	1			1				
12719	1007		2	A1	283	14	2	2.04	1			1				
12719	1008		2	A1	281	4	3	24.28	2	2		2				
12719	1008		2	A1	281	4	2	1.74	1	1		1		1		
12719	1008		2	A1	281	4	1	1.9	2	2		2				
12719	1009		2	A1	283	14	2	2.11	1				1			
12719	1009		2	A1	281	4	2	1.97	1	1		1		1		
12719	1009		2	A1	281	4	1	0.98	1	1			1		1	
12719	1009		2	A1	283	14	1	1.51	1			1				
12719	1009		2	A1	281	4	3	8.42	1	1		1		1		
12719	1009		2	A1	281	7	2	2.28	1	1			1		1	
12719	1009		2	A1	281	4	5	51.11	1	1		1				
12719	1009		2	A1	281	4	1	0.6	1	1		1			1	
12719	1009		2	A1	281	6	1	0.43	1	1		1			1	
12719	1009		2	A1	281	4	2	2.68	1	1		1				2 chert flakes
12719	1010		2	A1	283	14	1	0.33	1			1				
12719	1010		2	A1	281	4	2	4.35	2	2		2				
12719	1010		2	A1	281	4	1	0.54	1	1		1				
12719	1011		3	A1	281	4	2	1.12	1	1		1			1	
12719	1011		3	A1	283	14	1	4.46	10			10				
12719	1011		3	A1	281	4	1	1.02	1	1		1				1 chert debi
12719	1011		3	A1	283	14	3	9.68	1			1				
12719	1011		3	A1	283	14	2	16.67	6			6				
12719	1012		3	A1	283	14	1	0.58	1			1				
12719	1012		3	A1	283	14	3	34.68	1			1				
12719	1012		3	A1	283	14	2	4.34	2			2				
12719	1013		3	A1	283	14	1	1.58	2			2				
12719	1014		4	A1	281	4	1	0.36	1	1		1				
12719	1016		3	A1	281	4	1	0.33	1	1		1			1	
12719	1017		4	A1	281	4	3	5.93	1	1			1		1	
12719	1018		4	A1	283	14	1	0.8	1			1				
12719	1018		4	A1	281	7	2	2.44	1	1			1		1	
12719	1018		4	A1	283	14	2	3.46	1			1				1 flake
12719	1022		3	A1	281	4	4	9.45	1	1		1				
12719	1023		3	A1	283	14	2	3.41	1			1				
12719	1023		3	A1	281	4	3	19.39	2	2		2				
12719	1023		3	A1	283	14	1	0.45	1			1				
12719	1023		3	A1	281	4	2	3.82	1	1		1				
12719	1023		3	A1	281	6	1	0.74	1	1		1		1		
12719	1024		4	A1	281	4	2	5.34	1	1		1				
12719	1024		4	A1	281	4	4	25.89	1	1		1				1 flake
12719	1025		1	A1	281	4	2	5.88	2		2	2				
12719	1025		1	A1	281	4	4	18.95	1		1	1				
12719	1026		1	A1	281	4	3	5.5	1		1	1				
12719	1027		1	A1	283	14	1	0.76	1			1				
12719	1027		1	A1	281	6	2	1.4	1	1			1	1		
12719	1028		1	A1	283	14	2	7.38	2			2				
12719	1029		4	A1	281	4	5	152.78	2	2		2				2 flakes
12719	1031		3	A1	283	14	1	0.36	1			1				
12719	1032		1	A1	283	14	1	0.99	1			1				
12719	1035		2	A1	281	4	2	1.82	1	1		1			1	
12719	1035		2	A1	281	4	5	63.11	1	1		1				
12719	1036		2	A1	281	4	1	3.59	3	3		3		3		
12719	1036		2	A1	283	14	2	8.71	2			2				
12719	1036		2	A1	283	14	1	3.22	6			6				
12719	1037		1	A1	281	4	2	14.54	7	7		7		3	4	
12719	1037		1	A1	281	4	5	55.57	1	1		1		1		
12719	1037		1	A1	281	4	2	4.24	1	1		1		1		
12719	1037		1	A1	281	4	1	0.93	1		1			1		
12719	1037		1	A1	281	4	1	1.22	3	3		3		3		
12719	1037		1	A1	281	4	3	39.91	3	3		3		2	1	
12719	1037		1	A1	283	14	2	6.96	2			2			2	
12719	1037		1	A1	283	14	1	3.99	4			4				

Site	Coll #	Feature	Lev	Blk	AC	Mat	Sz	Grams	Qty	Frac	NF	Disc P	Disc A	Cort P	Cort A	Comments
12719	1038		4	A1	281	4	2	12.64	6	6		6		3	3	
12719	1038		4	A1	281	4	1	1.18	2	2		2			2	
12719	1038		4	A1	281	4	6	4.35	1	1		1			1	
12719	1038		4	A1	283	14	3	7.04	1			1				
12719	1038		4	A1	283	14	2	22.45	6			6				
12719	1038		4	A1	283	14	1	0.73	1			1				
12719	1039		4	A1	281	4	4	45.92	1	1		1		1		
12719	1039		4	A1	281	4	2	8.53	2	2		2		2		
12719	1039		4	A1	281	4	2	6.58	1		1	1		1		
12719	1040		4	A1	281	5	2	1.54	1	1		1			1	
12719	1040		4	A1	283	14	1	0.62	1			1				1 debitage
12719	1041		3	A1	281	4	2	8.29	2	2		2			2	
12719	1041		4	A1	281	4	1	1.9	3	3		3		1	2	
12719	1041		3	A1	281	4	4	35.27	1	1		1			1	1 flake
12719	1042		3	A1	281	4	1	0.84	2	2		2		1	2	2 flakes
12719	1042		3	A1	281	4	3	35.75	3	3		3		3		
12719	1042		3	A1	281	4	4	46.73	1	1		1			1	
12719	1042		3	A1	283	14	2	6.66	2			2				
12719	1042		3	A1	281	1	3	20.74	1	1			1	1		
12719	1042		3	A1	281	4	2	13.81	5	5		5		1	4	
12719	1043		3	A1	283	14	1	2.06	7			7				
12719	1043		3	A1	283	14	2	4.62	2			2				
12719	1044		4	A1	283	14	3	10.18	4			4				
12719	1044		4	A1	283	14	5	54.54	1			1				
12719	1045		4	A1	281	4	4	78.33	1	1		1		1		
12719	1045		4	A1	281	4	1	0.85	4		4	4		4		
12719	1045		4	A1	281	4	2	1.81	1	1		1			1	
12719	1046		4	A1	281	4	4	30.14	1	1		1			1	2 flakes
12719	1046		4	A1	281	4	2	7.56	4	4		4		2	2	
12719	1046		4	A1	281	4	1	1	2	2		2			2	
12719	1046		4	A1	283	14	2	3.06	1			1				
12719	1046		4	A1	283	14	1	1.19	1			1				
12719	1047		2	A1	281	4	4	43.74	1	1		1		1		
12719	1047		2	A1	281	4	1	1.54	1		1	1		1		
12719	1049		2	A1	281	4	2	8.62	3	3		3		2	1	
12719	1049		2	A1	283	14	4	26.39	1			1				
12719	1049		2	A1	281	4	5	119.15	2	2		2		2		
12719	1049		2	A1	281	4	3	14.25	2	2		2		2		
12719	1049		2	A1	281	4	1	0.62	1	1		1			1	
12719	1049		2	A1	283	14	1	6.27	8			8				
12719	1049		2	A1	283	14	2	4.01	2			2				
12719	1050		3	A1	281	4	2	9.82	3	3		1	2		3	
12719	1050		2	A1	283	14	2	9.63	5			5				
12719	1051		3	A1	281	4	2	2.46	1	1		1		1		
12719	1051		3	A1	281	4	3	15.08	1	1		1			1	
12719	1052		2	A1	281	4	3	13.6	1	1		1			1	
12719	1052		2	A1	281	4	4	90.21	1	1		1		1		
12719	1052		2	A1	281	4	2	7.72	3	3		3			3	2 flakes
12719	1053		3	A1	283	14	2	9.48	1			1				
12719	1053		3	A1	281	4	3	2.03	1	1		1		1		
12719	1054		3	A1	281	4	2	7.38	1			1				
12719	1055		3	A1	283	14	1	2.43	4			4				
12719	1055		3	A1	283	4	2	7.16	3			3				2 flakes
12719	1056		2	A1	283	14	1	4.19	5			5				
12719	1056		2	A1	283	14	3	28.37	2			2				
12719	1056		2	A1	283	14	2	33.18	12			12				
12719	1057		3	A1	283	14	1	1.79	2			2				
12719	1057		3	A1	283	14	2	6.91	1	1		1				
12719	1057		3	A1	281	4	3	11.72	1	1		1		1		
12719	1057		3	A1	283	14	3	36.38	2	2		2		2		
12719	1057		3	A1	281	4	1	7.06	9	6	3	9		7	2	
12719	1057		3	A1	281	4	2	44.13	12	12		12		12		
12719	1057		3	A1	281	4	4	37.93	1	1		1		1		
12719	1058		3	A1	283	14	2	2.84	1		1	1				
12719	1059		3	A1	281	4	2	5.86	1	1		1			1	
12719	1059		3	A1	281	4	3	6.6	1	1		1			1	
12719	1060		3	A1	283	14	2	4.53	1			1				
12719	1062		2	A1	283	14	2	8.2	2			2				

Site	Coll #	Feature	Lev	Blk	AC	Mat	Sz	Grams	Qty	Frac	NF	Disc P	Disc A	Cort P	Cort A	Comments
12719	1062		2	A1	283	14	1	0.69	2			2				
12719	1063		2	A1	281	4	3	9.92	1	1		1			1	
12719	1064		4	A1	283	14	2	2.17	1			1				
12719	1066	32	4	A1	281	4	3	24.97	4	4		4		3	1	
12719	1066	32	4	A1	281	4	4	123.57	3	3		3		2	1	
12719	1066	32	4	A1	283	14	3	18.46	2			2				
12719	1066	32	4	A1	281	4	2	50.6	15	15		15		6	9	
12719	1066	32	4	A1	281	4	1	3.71	4	4		4		4		1 flake
12719	1066	32	4	A1	281	4	5	298.48	2	2		2		1	1	
12719	1067	32	4	A1	283	14	1	0.04	2			2				
12719	1068	32	4	A1	283	14	1	0.9	1			2				
12719	1069	32	4	A1	283	14	1	0.71	3			3				
12719	1070	32	4	A1	283	14	1	0.8	1			3				
12719	1070	32	4	A1	283	14	3	13.8	1			3				
12719	1070	32	4	A1	281	4	2	1.38	1	1		1		1		
12719	1070	32	4	A1	281	4	1	0.54	2	2		2			2	
12719	1070	32	4	A1	283	14	2	2	2			1				
12719	1071	32	4	A1	283	14	2	7.02	2			2				
12719	1071	32	4	A1	283	14	4	30.23	1			1				
12719	1071	32	4	A1	283	14	3	16.89	1				1			
12719	1071	32	4	A1	283	14	1	1.8	2			2				
12719	1073	32	4	A1	281	4	1	0.67	1	1		1			1	
12719	1073	32	4	A1	283	14	1	1.13	2			2				
12719	1073	32	4	A1	283	14	4	78.24	1			1				
12719	1073	32	4	A1	283	14	2	2	1			1				
12719	1073	32	4	A1	281	4	4	84.8	1	1		1		1		
12719	1076	32	4	A1	283	14	1	2.26	2			2				
12719	1076	32	4	A1	283	14	2	20.97	2			2				
12719	1079	32	4	A1	283	14	2	1.76	1			1				
12719	1079	32	4	A1	283	14	1	0.4	1			1				
12719	1080		0	A1	281	4	1	3.16	4	4		4		1	3	
12719	1080		0	A1	283	14	1	2.98	3			3				
12719	1080		0	A1	283	14	3	28.3	1			1				
12719	1080		0	A1	281	4	4	17.35	1	1		1		1		
12719	1080		0	A1	281	4	2	24.11	6	6		6		1	5	
12719	1080		0	A1	283	14	2	11.39	4			4				
12719	1081		0	A1	281	4	2	2.94	1	1		1		1		
12719	1081		0	A1	283	14	1	2.63	3			3				
12719	1081		0	A1	283	14	2	10.71	4			4				
12719	1081		0	A1	281	4	4	18.72	1	1		1			1	
12719	1081		0	A1	281	4	1	2.97	4	4		4		1	3	1 chert potlid
12719	1082		2	A1	283	14	4	41.36	1			1				
12719	1082		2	A1	283	14	2	5.6	6			7				
12719	1082		2	A1	281	4	4	62.73	2	2		1	1	1	1	
12719	1083		2	A1	283	14	1	4.87	6			6				
12719	1083		2	A1	281	4	3	12.58	1	1		1			1	
12719	1083		2	A1	283	14	3	23.67	1			1				
12719	1083		2	A1	281	4	2	7.49	3	3		3		2	1	
12719	1083		2	A1	283	14	2	10.67	3			3				
12719	1083		2	A1	281	4	1	1.11	2	2		2			2	
12719	1084		2	A1	281	4	2	4.1	1	1		1			1	
12719	1084		2	A1	281	4	1	3.42	5	5		5		3	2	
12719	1084		2	A1	283	14	2	7.83	4			4				
12719	1084		2	A1	283	14	1	4.9	6			6				
12719	1085		2	A1	283	14	2	4.48	2			2				
12719	1085		2	A1	283	14	1	7.53	14			14				
12719	1085		2	A1	281	4	1	0.73	3	3		2	1		3	
12719	1085		2	A1	281	1	2	7.93	1	1		1			1	
12719	1085		2	A1	281	4	2	1.95	2	2		2		1	1	
12719	1086		2	A1	281	4	4	17.87	1	1		1		1		
12719	1086		2	A1	281	6	2	2.04	1	1			1		1	
12719	1086		2	A1	281	6	2	2.36	1	1			1	1		
12719	1086		2	A1	283	14	4	4.9	1			2				
12719	1086		2	A1	281	4	1	1.43	1	1		1			1	
12719	1086		2	A1	283	14	3	23.5	2			2				
12719	1086		2	A1	281	4	2	9.28	2	2		1	1	1	1	
12719	1086		2	A1	283	14	1	0.5	1			8				
12719	1086		2	A1	281	6	1	0.57	1	1			1		1	

Site	Coll #	Feature	Lev	Blk	AC	Mat	Sz	Grams	Qty	Frac	NF	Disc P	Disc A	Cort P	Cort A	Comments
12719	1086		2	A1	281	6	1	0.43	1	1			1		1	
12719	1086		2	A1	283	14	2	24.4	9			3				
12719	1087		2	A1	281	4	3	12.7	1	1		1			1	
12719	1087		2	A1	281	6	2	2.08	1	1		1			1	
12719	1087		2	A1	283	14	1	3.1	5			1				
12719	1087		2	A1	281	4	4	86.39	3	3		3		2	1	
12719	1087		2	A1	283	14	4	55.6	2	1	7	8				
12719	1087		2	A1	283	14	2	8.9	5			4				
12719	1087		2	A1	281	4	5	85.52	1	1		1		1		
12719	1087		2	A1	281	4	2	3.14	1	1		1			1	
12719	1087		2	A1	281	4	1	0.72	1	1		1			1	
12719	1088		2	A1	283	14	1	6.09	11			11				
12719	1088		2	A1	283	14	2	24.87	9			9				
12719	1088		2	A1	281	4	4	10.25	1	1		1		1		
12719	1090		2	A1	281	4	1	0.73	1	1		1		1		
12719	1090		2	A1	281	6	2	2.58	1	1			1		1	
12719	1090		2	A1	283	14	4	20.72	1	1		1				
12719	1090		2	A1	281	6	1	1.31	1	1			1		1	
12719	1090		2	A1	283	14	1	8.5	7			7				
12719	1090		2	A1	281	4	4	41.28	2	2		2		2		
12719	1090		2	A1	283	14	3	4.7	1	1		1				
12719	1090		2	A1	283	14	2	4.21	2			2				
12719	1091		2	A1	283	14	1	2.91	4			4				
12719	1091		2	A1	281	6	2	2.47	1	1			1		1	
12719	1091		2	A1	283	14	2	19.89	6	2	4	6				
12719	1091		2	A1	281	4	3	15.76	1	1		1		1		1 flake
12719	1091		2	A1	281	6	1	0.48	1	1		1			1	
12719	1091		2	A1	281	4	1	1.36	3	3		3			3	
12719	1091		2	A1	281	4	2	1.94	2	2		2			2	
12719	1092		2	A1	283	14	1	5.91	6			6				
12719	1092		2	A1	283	14	2	25.29	7			7				
12719	1092		2	A1	283	14	3	15.01	1			1				
12719	1093		2	A1	283	14	2	21.24	4			4				
12719	1093		2	A1	283	14	1	0.98	1			1				
12719	1094		0	A1	283	14	5	61.4	1			18				
12719	1094		0	A1	281	4	2	10.08	2	2		2		2		2 flakes
12719	1094		0	A1	281	4	5	329.77	2	2		2		1	1	
12719	1094		0	A1	283	14	1	8.8	11			1				
12719	1094		0	A1	283	14	3	33.6	4			6				
12719	1094		0	A1	283	14	2	29.8	14			1				
12719	1095		4	A1	281	4	3	36.42	2	2		2		1	1	
12719	1095		2	A1	281	4	2	2.31	1	1		1			1	
12719	1095		2	A1	283	14	3	15.7	1			1				
12719	1095		2	A1	283	14	1	7.59	5			5				
12719	1095		2	A1	283	14	2	13.55	5	1	4	5				
12719	1096		4	A1	281	4	3	18.18	1	1		1			1	
12719	1096		4	A1	283	14	2	11.56	3			3				
12719	1099	32	4	A1	281	4	3	52.91	1		1	1		1		
12719	2000	32	4	A1	281	4	1	2.78	9	9		2	7	6	3	
12719	2000	32	4	A1	281	4	3	20.14	1	1			1		1	
12719	2004	32	4	A1	283	14	1	0.9	3			1				
12719	2004	32	4	A1	281	4	2	0.89	1	1			1		1	
12719	2005		3	A1	283	14	1	9.3	16			3				
12719	2005		3	A1	283	14	2	35.8	19			23				
12719	2005		3	A1	283	14	3	36	3			19				1 flake
12719	2005		3	A1	281	6	2	2.2	1	1		1			1	
12719	2005		3	A1	281	6	4	8.76	1	1		1			1	
12719	2005		3	A1	281	4	1	1.95	3	3		1	2		3	
12719	2005		2	A1	281	4	4	11.07	1	1			1		1	2 flakes
12719	2005		3	A1	281	4	3	7.56	1	1			1	1		
12719	2005		3	A1	281	4	2	7.38	4	4		4			4	
12719	2006	33	3	A1	283	14	1	0.47	3			3				3 flakes
12719	2007	33	3	A1	283	14	1	6.11	18			18				
12719	2007	33	3	A1	283	14	2	11.71	9			9				
12719	2007	33	2	A1	281	4	3	37.12	3	2	1	3		2	1	
12719	2007	33	3	A1	281	6	2	1.33	1	1		1			1	
12719	2007	33	3	A1	281	6	1	0.26	1	1		1			1	
12719	2007	33	3	A1	281	6	2	1.81	1	1		1			1	

Site	Coll #	Feature	Lev	Blk	AC	Mat	Sz	Grams	Qty	Frac	NF	Disc P	Disc A	Cort P	Cort A	Comments
12719	2007	33	3	A1	281	4	4	34.75	1	1		1		1		
12719	2007	33	3	A1	281	6	1	0.37	1	1		1			1	
12719	2007	33	2	A1	281	4	2	12.13	3	3		3		2	1	
12719	2007	33	2	A1	281	4	1	0.33	1	1		1			1	
12719	2007	33	3	A1	281	6	3	15.47	1	1		1			1	
12719	2008	33	3	A1	283	14	3	8.61	1			1				
12719	2008	33	3	A1	283	14	2	6.32	5			5				
12719	2008	33	3	A1	283	14	1	6.16	13			13				
12719	2008	33	3	A1	281	4	2	3.77	1	1		1			1	
12719	2009	33	3	A1	283	14	1	0.64	2			1	1			
12719	2009	33	3	A1	283	14	2	5	2			2				
12719	2009	33	3	A1	283	14	4	37.55	2			2				
12719	2009	33	3	A1	283	14	3	11.61	2			2				
12719	2010	33	2	A1	281	4	1	0.44	1	1		1			1	
12719	2010	33	2	A1	281	7	3	7.24	1	1		1	1	1		
12719	2010	33	2	A1	281	4	2	5.01	2	2		1	1		2	
12719	2010	33	2	A1	283	14	3	13.5	1			14				
12719	2010	33	2	A1	283	14	1	6.4	12			2				
12719	2010	33	2	A1	283	14	2	22.24	5			4	1	1		
12719	2011	33	3	A1	281	6	2	1.21	1	1		1	1		1	
12719	2011	33	3	A1	281	4	1	0.38	1	1		1			1	
12719	2011	33	3	A1	281	6	3	3.67	1	1		1		1		
12719	2011	33	3	A1	281	4	3	10.08	2	2		2		1	1	3 flakes
12719	2011	33	3	A1	281	4	2	1.77	1	1		1	1		1	
12719	2011	33	3	A1	283	14	2	16.7	8			12				
12719	2011	33	3	A1	283	14	1	3.3	7			56				
12719	2011	33	3	A1	283	14	3	14.8	2			61				
12719	2011	33	3	A1	283	14	5	77.4	2			2				
12719	2011	33	3	A1	283	14	4	73	2			4				
12719	2012		2	A1	281	7	2	5.2	1	1		1			1	
12719	2012		2	A1	281	7	1	0.52	1	1		1			1	
12719	2012		2	A1	281	7	1	0.68	1	1		1			1	
12719	2012		2	A1	281	6	2	0.87	1	1		1	1		1	
12719	2012		2	A1	281	4	3	13.98	2	2		2		1	1	
12719	2012		2	A1	281	4	4	24.84	1	1		1	1		1	1 lflake
12719	2012		2	A1	281	6	1	0.37	1	1		1			1	
12719	2012		2	A1	283	14	2	4.1	1			2	1			
12719	2012		2	A1	283	14	1	6.4	2			2				
12719	2012		2	A1	281	7	1	0.83	1	1		1			1	
12719	2013		2	A1	283	14	2	6.67	3			3				
12719	2013		2	A1	281	4	4	10.14	1	1		1			1	
12719	2013		2	A1	283	14	5	89.57	1			1				
12719	2013		2	A1	283	14	3	17.49	1			1				
12719	2013		2	A1	281	4	3	10.46	1	1		1			1	
12719	2013		2	A1	283	14	4	41.54	1			1				
12719	2014		2	A1	281	7	1	0.83	1	1		1			1	
12719	2014		2	A1	281	4	3	4.88	1	1		1		1		
12719	2014		2	A1	281	7	1	0.68	1	1		1			1	
12719	2014		2	A1	281	1	1	0.52	1	1		1			1	
12719	2014		2	A1	281	7	1	5.2	1	1		1			1	
12719	2014		2	A1	283	14	1	3.7	11			5				
12719	2014		2	A1	283	14	2	14.2	6			1				
12719	2015		3	A1	283	14	3	17.29	1			1				
12719	2015		2	A1	283	14	1	11.19	18			18				
12719	2015		2	A1	281	6	3	5.46	1	1		1	1	1		
12719	2015		2	A1	281	4	2	1.39	1	1		1			1	
12719	2015		2	A1	283	14	2	16.76	7			7				
12719	2015		2	A1	281	6	1	0.34	1	1		1			1	
12719	2015		2	A1	281	6	2	0.94	1	1		1			1	
12719	2015		2	A1	281	6	1	0.51	1	1		1	1		1	
12719	2016		3	A1	283	14	2	8.1	3			2				
12719	2016		3	A1	283	14	1	6.1	12			6				
12719	2017		3	A1	281	4	2	2.22	1	1		1			1	
12719	2017		3	A1	283	14	2	20.3	5			1	1			
12719	2017		3	A1	281	4	2	16.34	6	6		6			6	
12719	2017		3	A1	283	14	3	29.8	3			13				
12719	2017		3	A1	281	4	4	60.7	2	2		2			2	
12719	2017		3	A1	281	4	6	754.6	2	2		2		1	1	

Site	Coll #	Feature	Lev	Blk	AC	Mat	Sz	Grams	Qty	Frac	NF	Disc P	Disc A	Cort P	Cort A	Comments
12719	2017		3	A1	281	4	1	6.95	13	13		13		1	12	
12719	2017		3	A1	283	14	1	4.2	4			28				
12719	2017		3	A1	281	4	3	35.27	3	3		3		1	2	
12719	2018		2	A1	283	14	2	10.51	4			4				
12719	2018		2	A1	283	14	3	13.89	2			2				
12719	2018		2	A1	283	14	1	2.94	6			6				
12719	2018		2	A1	281	4	5	61.53	1	1			1		1	
12719	2018		2	A1	281	4	4	24.92	1	1		1			1	
12719	2018		2	A1	281	4	1	1.23	4	4		2	2		4	
12719	2018		2	A1	281	4	2	1.85	2	2			2		2	
12719	2018		2	A1	281	6	3	4.74	1	1			1	1		
12719	2020		3	A1	283	14	1	0.77	2			2				
12719	2020		3	A1	283	14	2	12.12	2			2				
12719	2021		1	A1	283	14	2	12.35	2			2				
12719	2021		1	A1	281	4	1	5.07	4	4		3	1	1	3	
12719	2021		1	A1	283	14	1	5.53	7			7				
12719	2021		1	A1	281	6	2	1.97	1	1			1	1		
12719	2021		1	A1	281	4	2	9.42	2	2		1	1		2	
12719	2023		3	A1	281	4	2	1.62	1	1			1	1		
12719	2023		3	A1	283	14	1	1.72	6			6			6	1 debitage
12719	2024		1	A1	281	4	2	2.33	1	1		1		1		
12719	2024		1	A1	281	4	3	7.71	1	1			1	1		
12719	2024		1	A1	281	4	4	46.65	2	2		2		2		
12719	2024		1	A1	281	4	4	44.44	1	1		1		1		
12719	2024		1	A1	281	4	1	0.85	3	3		3			3	
12719	2024		1	A1	281	4	1	0.85	1	1			1		1	
12719	2024		1	A1	283	14	2	28.54	8			8				
12719	2024		1	A1	283	14	1	17.6	29			29				
12719	2024		1	A1	281	4	2	6.14	2	2		2			2	
12719	2025		1	A1	281	6	1	0.9	4	4		4			4	
12719	2025		1	A1	281	4	2	23.95	2	2		1	1		2	
12719	2025		1	A1	281	4	4	29.6	1	1			1	1		
12719	2025		1	A1	281	6	2	4.23	1	1		1			1	
12719	2025		1	A1	283	14	1	8.64	21			21				
12719	2025		1	A1	283	14	2	33.25	10			10				
12719	2025		1	A1	281	7	2	3.04	1	1		1			1	
12719	2025		1	A1	281	4	1	1.72	4	4		4		1	3	
12719	2026		1	A1	281	4	2	6.61	1		1	1		1		
12719	2026		1	A1	283	14	1	3.72	3			3				
12719	2026		1	A1	281	6	2	2.55	1	1			1		1	
12719	2026		1	A1	281	6	1	0.32	1	1			1		1	
12719	2026		1	A1	281	6	3	8.22	1	1			1	1		
12719	2026		1	A1	283	14	2	14.18	5	1	4	5				
12719	2026		1	A1	281	4	4	129.44	2	2		2		2		
12719	2026		1	A1	281	6	3	7.86	1	1			1		1	
12719	2026		1	A1	281	6	2	1.44	1	1			1		1	
12719	2026		1	A1	281	4	5	255.03	1	1			1	1		
12719	2027		1	A1	281	4	1	1.16	1	1			1	1		1 debitage
12719	2027		1	A1	281	6	2	1.2	1	1			1		1	
12719	2027		1	A1	281	6	2	1.52	1	1			1		1	
12719	2027		1	A1	281	6	2	3.17	1	1			1		1	1 flake
12719	2027		1	A1	283	14	2	36.02	9			9				
12719	2027		1	A1	283	14	1	5.51	15			15				
12719	2027		1	A1	283	14	4	26.59	1			1				
12719	2027		1	A1	281	4	2	2.3	2	2			2		2	
12719	2028		1	A1	283	14	1	14.47	16			16				
12719	2028		1	A1	281	4	2	1.03	1	1		1			1	
12719	2028		1	A1	283	14	2	21.1	8	1	7	8			8	
12719	2028		3	A1	283	14	3	33.76	3			3				
12719	2028		1	A1	281	4	3	7.89	1	1		1			1	
12719	2028		1	A1	281	4	1	0.42	1	1		1			1	
12719	2028		1	A1	281	6	1	0.55	1	1			1		1	
12719	2028		1	A1	281	6	2	3.28	1	1			1		1	
12719	2029		3	A1	283	14	2	3.2	1			3				
12719	2029		3	A1	283	14	1	1.4	2			4				
12719	2030		3	A1	281	4	5	115.26	2	2		2		2		
12719	2030		3	A1	281	4	2	6.74	3	3		3			3	
12719	2030		3	A1	283	14	4	31.7	2			7				

Site	Coll #	Feature	Lev	Blk	AC	Mat	Sz	Grams	Qty	Frac	NF	Disc P	Disc A	Cort P	Cort A	Comments
12719	2030		3	A1	281	4	1	2.46	5	5		5			5	
12719	2030		3	A1	283	14	3	66	4			1				
12719	2030		3	A1	283	14	2	50.1	22			3				
12719	2030		3	A1	283	14	5	125.2	2			26				
12719	2030		3	A1	281	4	3	13.52	2	2		2		1	1	
12719	2030		3	A1	283	14	1	14.8	22			2				
12719	2030		3	A1	283	14	6	237.9	1			36				
12719	2031		3	A1	281	4	1	1.59	1	1		1			1	
12719	2031		1	A1	281	4	4	73.64	1	1		1			1	
12719	2031		3	A1	283	14	4	55.9	1			4				
12719	2031		3	A1	283	14	1	0.6	2			8				
12719	2031		3	A1	283	14	2	12.2	4			1				
12719	2031		3	A1	281	7	3	4.03	1	1		1			1	
12719	2031		3	A1	281	4	2	7.47	3	3		3			3	
12719	2032		1	A1	281	6	2	4.1	1	1		1			1	
12719	2032		1	A1	283	14	2	3.25	2			2				
12719	2032		1	A1	281	4	2	24.61	3	3		3		2	1	
12719	2033		3	A1	283	14	2	2.99	1			1				
12719	2033		3	A1	283	14	1	0.17	1			1				
12719	2037		3	A1	283	14	1	0.13	7			7				
12719	2038		3	A1	283	14	2	5.2	2			1				
12719	2038		3	A1	283	14	1	2.2	7			11				
12719	2038		3	A1	281	7	1	0.27	1	1		1			1	
12719	2040		3	A1	281	6	2	0.81	1	1		1			1	
12719	2040		3	A1	281	6	2	3.2	1	1		1			1	
12719	2040		3	A1	281	4	3	58.88	1		1	1		1		
12719	2040		3	A1	281	6	1	0.37	1	1		1			1	
12719	2040		3	A1	281	4	1	2.4	6	6		6			6	3 flakes
12719	2040		3	A1	283	14	2	3.5	1			8				
12719	2041		3	A1	283	14	4	49	1			1				
12719	2041		3	A1	283	14	2	23.2	9			14				
12719	2042		3	A1	283	14	2	19.22	6			6				
12719	2042		3	A1	283	14	1	8.62								check 4 QTY
12719	2042		3	A1	283	14	3	11.54	1			1				
12719	2043		3	A1	281	4	1	1.62	2	2		1	1	1		2 flakes
12719	2043		3	A1	281	4	4	26.64	1	1		1	1			
12719	2043		3	A1	283	14	2	8.86	3	1	2	3		3		
12719	2043		3	A1	281	4	2	7.52	2	2		2		2		
12719	2043		3	A1	283	14	1	0.68	2			2				
12719	2045		3	A1	281	4	2	1.23	1	1		1		1		
12719	2045		3	A1	283	14	1	0.35	1			1				
12719	2046		3	A1	281	4	1	0.97	2	2		1	1	1		
12719	2046		3	A1	281	6	3	5.3	1	1		1			1	
12719	2046		3	A1	281	4	2	5.34	2	2		2		2		
12719	2046		3	A1	281	6	2	1.1	1	1		1			1	
12719	2046		3	A1	283	14	1	1.62	3			3				
12719	2046		3	A1	281	6	2	3.13	1	1		1		1		
12719	2047		3	A1	283	14	1	0.7	2			2				
12719	2048		3	A1	283	14	1	8.31	9			9				
12719	2048		3	A1	283	14	3	61.47	4			4				
12719	2048		3	A1	283	14	5	88.04	1			1				
12719	2048		3	A1	283	14	2	150.72	33			33				
12719	2048		3	A1	283	14	4	171.15	4			4				
12719	2048		3	A1	281	4	1	1.42	2	2		2			2	
12719	2048		3	A1	281	4	3	6.16	1	1		1			1	
12719	2048		3	A1	281	6	1	0.73	1	1		1	1		1	
12719	2048		3	A1	281	4	2	10.99	5	5		5		1	4	
12719	2049		3	A1	283	14	2	26.49	8			8				
12719	2049		3	A1	283	14	1	3.76	3			3				
12719	2049		3	A1	283	14	3	8.88	1			1				
12719	2050		3	A1	283	14	2	0.89	1			1				
12719	2050		3	A1	281	6	2	1.38	1	1		1		1	1	
12719	2050		3	A1	283	14	1	4.3	6			6				
12719	2050		3	A1	283	14	3	12.62	2			2				
12719	2051		2	A1	283	14	1	4	7			7				
12719	2051		2	A1	283	14	2	20.74	2			2				
12719	2051		2	A1	283	14	2	20.46	9			9				
12719	2100	32	0	A1	283	14	1	1.72	4			4				

Site	Coll #	Feature	Lev	Blk	AC	Mat	Sz	Grams	Qty	Frac	NF	Disc P	Disc A	Cort P	Cort A	Comments
12719	2100	32	0	A1	281	4	4	44.64	1	1			1		1	
12719	2100	32	0	A1	283	14	3	6.95	1			1				
12719	2100	32	0	A1	281	4	3	59	2	1	1		2	1	1	
12719	2100	32	0	A1	283	14	2	1.79	2			2				
12719	2101	33	0	A1	283	14	3	16	2			1				
12719	2101	33	0	A1	283	14	1	26	69			71				
12719	2101	33	0	A1	283	14	2	82.2	30			4				
12719	2102		3	A1	283	14	1	0.65	2			2				
12719	2102		3	A1	281	4	2	1.99	1	1		1		1		
12719	2102		3	A1	283	14	2	6.98	2			2				
12719	2102		3	A1	281	4	5	85.67	1	1		1		1		1 flake
12719	2103		3	A1	283	14	1	3.4	6			6				
12719	2103		3	A1	283	14	2	9.22	4			4				
12719	2104		3	A1	281	4	3	7.16	1	1		1			1	
12719	2104		3	A1	283	14	1	0.44	2			2				
12719	2104		3	A1	281	4	2	2.14	1		1		1		1	
12719	2105		3	A1	283	14	1	1.63	1			1				
12719	2106		3	A1	283	14	1	0.61	1			1				
12719	2108	32	5	A1	283	14	3	5.91	1			1				
12719	2108	32	5	A1	281	6	1	0.38	1	1			1		1	
12719	2108	32	5	A1	283	14	2	4.96	2			2				
12719	2109	32	5	A1	283	14	1	1.18	4			4				
12719	2110	32	5	A1	283	14	1	0.6	1			4				
12719	2112		3	A1	281	4	1	0.15	1	1		1			1	1 flake
12719	2112		5	A1	281	6	4	20.9	1	1		1		1		
12719	2112		3	A1	281	4	2	3.09	1	1		1			1	
12719	2112		3	A1	281	4	3	3.8	1	1		1			1	
12719	2112		3	A1	283	14	1	1.76	4			4				
12719	2112		3	A1	283	14	2	3.45	3			3				
12719	2112		3	A1	283	14	3	3.89	1			1				
12719	2114		3	A1	283	14	1	1.98	9			9				
12719	2114		3	A1	281	4	2	13.88	3	3		3		1	2	
12719	2114		3	A1	281	4	1	1.79	6	6		4	2		6	
12719	2114		3	A1	283	14	2	5.92	3			3				
12719	2114		3	A1	281	4	3	13.66	1	1		1		1		
12719	2116	32	5	A1	283	14	1	0.47	5			5				
12719	2116	32	5	A1	281	6	3	8.1	1	1		1			1	
12719	2119		3	A1	281	4	3	4.31	1	1		1			1	
12719	2119		3	A1	281	4	2	0.97	1	1		1			1	
12719	2119		3	A1	281	4	4	31.05	2	2		2			2	
12719	2120		3	A1	283	14	1	2	7			7				
12719	2125	32	5	A1	283	14	1	0.94	1			1				
12719	2126		5	A1	283	14	1	2.6	4			1				
12719	2126		5	A1	281	4	1	0.51	1	1		1			1	
12719	2127	32	5	A1	283	14	3	6.5	1			3				
12719	2127	32	5	A1	283	14	6	261.3	1			49				
12719	2127	32	5	A1	281	4	1	0.84	2	2		2			2	
12719	2127	32	5	A1	281	4	3	8.86	1	1		1		1		2 flakes
12719	2127	32	5	A1	281	4	2	1.76	1	1		1			1	
12719	2128		1	A1	283	14	1	1.54	4			4				
12719	2128		1	A1	283	14	2	2.6	1			1				
12719	2129		1	A1	283	14	1	0.57	3			2				
12719	2130		1	A1	281	4	3	31.04	1	1		1			1	
12719	2130		1	A1	283	14	1	1.42	4			4				
12719	2130		1	A1	281	4	6	433	1	1		1		1		
12719	2140		1	A1	283	14	2	3.89	3			3				
12719	2140		1	A1	283	14	1	0.41	1			1				
12719	2140		1	A1	283	14	3	25.18	3			3				
12719	2141		1	A1	283	14	1	1.61	2			2				
12719	2141		1	A1	283	14	2	5.43	2			2				
12719	2142		1	A1	283	14	1	1.09	4			4				
12719	2144		1	A1	281	4	2	2.33	1	1		1		1		
12719	2144		1	A1	283	14	2	5.13	1			1				
12719	2147		1	A1	283	14	1	1.14	3			3				
12719	2149		1	A1	283	14	2	1.53	1			1				
12719	2152		1	A1	281	4	3	6.56	1	1		1		1		
12719	2153		1	A1	281	4	5	255.1	1	1		1			1	
12719	2153		1	A1	283	14	2	2.05	1			1				

Site	Coll #	Feature	Lev	Blk	AC	Mat	Sz	Grams	Qty	Frac	NF	Disc P	Disc A	Cort P	Cort A	Comments
12719	2153		1	A1	283	14	1	0.31	1							
12719	2154		5	A1	283	14	2	11.14	5							
12719	2154		5	A1	283	14	3	10.38	1							
12719	2154		5	A1	283	14	1	6.96	14							
12719	2155	32	5	A1	283	14	2	5.2	2							
12719	2155	32	5	A1	283	14	1	2	3							
12719	2155	32	5	A1	281	4	3	13.07	2	2					2	
12719	2156		2	A1	281	4	3	9.63	1	1					1	
12719	2156		2	A1	281	4	1	0.87	1	1				1		
12719	2156		2	A1	283	14	2	16.5	4							
12719	2156		2	A1	283	14	1	5.2	8							
12719	2156		2	A1	281	4	5	88.81	1	1			1		1	
12719	2156		2	A1	281	4	4	18.55	1	1			1		1	
12719	2156		2	A1	281	4	3	11.21	1	1			1	1		
12719	2158		1	A1	283	14	2	19.07	5				5			
12719	2161		1	A1	281	4	1	1.23	1	1			1		1	
12719	2161		1	A1	281	4	6	14.86	1	1			1		1	
12719	2164		1	A1	283	14	3	4.64	1				1			
12719	2166	33	3	A1	283	14	1	3	5							
12719	2166	33	3	A1	283	14	2	4.1	1				5			
12719	2166	33	3	A1	281	4	3	5.53	1	1			1		1	
12719	2166	33	3	A1	281	4	2	1.4	1	1			1	1		
12719	2169		4	A1	283	14	1	6.78	15				15			
12719	2169		4	A1	283	14	5	59.28	1				1			
12719	2169		4	A1	281	4	4	24.44	1	1			1		1	
12719	2169		4	A1	281	3	4	10.4	1	1			1	1		
12719	2169		4	A1	283	14	4	46.46	1				1			
12719	2169		4	A1	283	14	2	16.11	5				5			
12719	2170	33	4	A1	283	14	1	5.6	13				15			
12719	2171	32	5	A1	281	6	4	34.4	1	1			1	1		
12719	2172		1	A1	283	14	2	62.7	21				22			
12719	2172		1	A1	283	14	3	27.7	2				2			
12719	2172		1	A1	283	14	1	25.9	42				52			
12719	2174		1	A1	281	4	5	259.4	1	1			1		1	
12719	2178	32	5	A1	281	6	2	1.53	1	1			1		1	
12719	2178	32	5	A1	283	14	3	17.6	2				13			
12719	2178	32	5	A1	283	14	1	1.3	2				2			
12719	2178	32	5	A1	283	14	2	11.7	5				6			
12719	2178	32	5	A1	281	6	1	0.1	1	1			1		1	
12719	2179	32	5	A1	283	14	2	6.6	3				1			
12719	2179	32	5	A1	283	14	1	5.5	9				24			
12719	2180	33	4	A1	281	4	6	706.2	2	2			2		2	
12719	2180	33	4	A1	281	4	5	304.5	1	1			1		1	
12719	2180	33	4	A1	283	14	3	77.9	8				3			
12719	2180	33	4	A1	283	14	1	9.9	15				23			
12719	2180	33	4	A1	283	14	2	43	17				25			
12719	2180	33	4	A1	281	4	2	7.64	1	1			1		1	
12719	2180	33	4	A1	283	14	4	61.4	2				10			
12719	2181	33	4	A1	283	14	1	0.61	4				4			
12719	2183	33	3	A1	283	14	2	8.4	3				1			
12719	2183	33	3	A1	281	4	3	45.55	1	1			1	1		
12719	2183	33	3	A1	283	14	1	4.5	4				1			
12719	2183	33	3	A1	283	14	3	8.8	1				5			
12719	2184	33	3	A1	283	14	1	1.79	3				3			
12719	2184	33	3	A1	281	6	4	12.4	1	1			1	1		
12719	2185		1	A1	283	14	2	31.38	17				17			
12719	2185		1	A1	283	14	3	7.31	1				1			
12719	2185		1	A1	281	4	2	1.6	1	1			1		1	
12719	2185		1	A1	283	14	1	19.48	45				45			
12719	2186		1	A1	283	14	1	2.77	10				10			
12719	2186		1	A1	283	14	2	5.37	4				4			
12719	2191	32	5	A1	283	14	1	3.3	6				6			
12719	2191	32	5	A1	283	14	2	25.42	8				8			
12719	2192		1	A1	283	14	1	1.91	9				9			
12719	2194		1	A1	283	14	1	0.44	5				5			
12719	2195		1	A1	283	14	1	0.4	2				2			
12719	2196		1	A1	283	14	1	2.23	2	1	1		2			
12719	2196		1	A1	283	14	2	1.74	1				1			

Site	Coll #	Feature	Lev	Blk	AC	Mat	Sz	Grams	Qty	Frac	NF	Disc P	Disc A	Cort P	Cort A	Comments
12719	2196		1	A1	281	6	2	1.9	1	1			1		1	
12719	2197		1	A1	283	14	1	0.13	1			1				
12719	2199		1	A1	283	14	3	3.67	1	1		1				
12719	2199		1	A1	283	14	5	62.12	1			1				
12719	2199		1	A1	283	14	1	0.6	1	1		1				
12719	2199		1	A1	281	4	3	22.03	1	1		1		1		
12719	2199		1	A1	283	14	1	0.81	1	1		1				
12719	2201	32	6	A1	283	14	1	28.31	40			40				
12719	2201	32	6	A1	283	14	3	20.83	3			3				
12719	2201	32	6	A1	283	14	2	65.41	22			22				
12719	2201	32	6	A1	281	4	11	1963.9	1	1		1		1		
12719	2201	32	6	A1	281	4	3	19.7	1	1		1			1	
12719	2201	32	6	A1	281	4	4	43.87	1		1	1		1		
12719	2201	32	6	A1	283	14	5	128.92	1			1				
12719	2202	32	6	A1	281	1	3	20.7	1			1		1		
12719	2203		1	A1	281	4	5	126.99	1	1		1		1		
12719	2203		1	A1	281	4	3	5.1	1	1		1			1	
12719	2203		1	A1	281	4	4	12.75	1	1		1	1		1	
12719	2203		1	A1	283	14	2	6.26	1			1				
12719	2205		1	A1	281	6	2	1.7	1	1		1		1		
12719	2205		1	A1	281	6	2	2.3	1	1		1		1		
12719	2206		1	A1	283	14	1	1.16	2			2				
12719	2206		1	A1	283	14	2	1.49	1			1				
12719	2207		1	A1	283	14	1	0.62	1			1				
12719	2208		1	A1	283	14	1	0.32	2			2				
12719	2209		1	A1	283	14	1	17.03	56			56				
12719	2209		1	A1	283	14	2	18.03	9			9				
12719	2209		1	A1	283	14	3	13.92	2			2				
12719	2210			A1	281	4	2	4.35	1	1		1			1	
12719	2210		1	A1	281	4	3	5.76	1	1		1	1	1		1 flake
12719	2210		1	A1	283	14	3	20.62	3			3				
12719	2210		1	A1	283	14	2	47.31	18			18				
12719	2210		1	A1	283	14	1	34.21	54			54				
12719	2214	32	6	A1	281	6	2	1.02	1	1		1		1		
12719	2214	32	6	A1	283	14	1	7.5	12			3				
12719	2214	32	6	A1	281	4	5	64.49	1	1		1		1		2 flakes
12719	2214	32	6	A1	283	14	2	4.6	2			42				
12719	2214	32	6	A1	281	4	2	0.39	1	1		1			1	
12719	2215		1	A1	281	4	2	5.94	1	1		1		1		1 flake
12719	2215		1	A1	281	4	1	0.76	1	1		1			1	
12719	2215		1	A1	283	14	2	17.7	8			8				
12719	2215		1	A1	283	14	1	9.8	28			28				
12719	2216		1	A1	283	14	2	4.95	2			2				
12719	2216		1	A1	283	14	1	2.38	10			10				
12719	2217		1	A1	283	14	1	5.34	11			11				
12719	2220		1	A1	281	4	3	27.05	1		1	1		1		1debitage(core?)
12719	2220		1	A1	283	14	2	2.04	1			1				
12719	2220		1	A1	281	4	1	1.07	1	1		1		1		
12719	2222		1	A1	283	14	3	13.03	1			1				
12719	2223		1	A1	281	4	2	2.27	1	1		1			1	
12719	2223		1	A1	283	14	1	2.43	4			4				
12719	2224		1	A1	283	14	1	0.58	2			2				
12719	2224		1	A1	283	14	2	4.24	1			1				
12719	2225		1	A1	283	14	1	7.38	18			18				
12719	2225		1	A1	283	14	3	131.6	1			1				
12719	2225		1	A1	283	14	2	17.12	6			6				
12719	2225		1	A1	281	4	5	46.72	1	1		1		1		1 flake
12719	2226		1	A1	283	14	1	4.97	14			14				
12719	2226		1	A1	281	4	8	70.7	1	1		1			1	
12719	2226		1	A1	283	14	2	5.31	2			2				
12719	2227	32	6	A1	283	14	5	98.3	1			3				
12719	2227	32	6	A1	281	4	3	9.74	1	1		1		1		
12719	2227	32	6	A1	281	4	2	2.1	1	1		1			1	
12719	2228	33	3	A1	281	4	2	9.81	1	1		1			1	
12719	2228	33	3	A1	283	14	1	4.21	8			8				
12719	2229	33	3	A1	281	6	1	0.1	1	1		1		1		
12719	2229	33	3	A1	283	14	1	0.44	3			3				
12719	2230	33	3	A1	283	14	1	0.9	2			2				

Site	Coll #	Feature	Lev	Blk	AC	Mat	Sz	Grams	Qty	Frac	NF	Disc P	Disc A	Cort P	Cort A	Comments
12719	2230	33	3	A1	283	14	2	5.82	5			5				
12719	2230	33	3	A1	283	14	3	8.98	1			1				1 flake
12719	2231	78	7	A1	283	14	2	10.74	2			2				
12719	2231	78	7	A1	283	14	1	1.01	5			5				
12719	2232	78	7	A1	283	14	1	0.4	3			3				
12719	2237	32	6	A1	283	14	3	6.15	1			1				
12719	2237	32	6	A1	283	14	1	3.27	8			8				
12719	2237	32	6	A1	283	14	2	8.18	6			6				
12719	2238			A1	283	14	2	2.93	3			3				
12719	2238			A1	283	14	1	3.46	9			9				
12719	2238			A1	283	14	3	8.89	1			1				
12719	2239			A1	283	14	3	20.64	2			2				
12719	2239			A1	283	14	1	0.63	2			2				
12719	2240		1	A1	283	14	2	7.99	5			5				
12719	2240		1	A1	283	14	1	1.06	6			6				
12719	2240		1	A1	281	6	1	0.1	1	1			1		1	
12719	2241		1	A1	283	14	1	5.03	6			6				
12719	2241		1	A1	283	14	2	0.86	1			1				
12719	2242		1	A1	283	14	3	25.38	1			1				
12719	2242		1	A1	283	14	1	3.4	2			2				
12719	2242		1	A1	283	14	2	12.61	4			4				
12719	2242		1	A1	281	4	3	12.6	1	1		1		1		
12719	2242		1	A1	281	4	4	153.95	3	3		2	1	2	1	
12719	2242		1	A1	281	4	5	48.96	1	1			1	1		
12719	2242		1	A1	281	4	2	9.91	1	1			1	1		
12719	2243		1	A1	283	14	2	11.55	4			4				
12719	2245		1	A1	283	14	2	10.11	3			3				
12719	2245		1	A1	283	14	1	5.32	10			10				
12719	2245		1	A1	281	4	4	35.57	1	1				1		
12719	2246		1	A1	283	14	2	3.84	1			1				
12719	2246		1	A1	283	14	1	1.57	2			2				
12719	2247		1	A1	283	14	1	17.49	30			30				
12719	2247		1	A1	283	14	2	42.04	12			12				
12719	2248		1	A1	281	4	5	148.16	2	2		1	1	1	1	
12719	2248		1	A1	283	14	1	3.35	8			8				
12719	2248		1	A1	283	14	2	11.49	5			5				
12719	2248		1	A1	281	4	2	11.63	2	1	1	2		2		
12719	2249		1	A1	283	14	3	59.9	4			4				
12719	2249		1	A1	283	14	4	51.91	1			1				
12719	2249		1	A1	281	4	4	39.97	1	1		1		1		
12719	2249		1	A1	283	14	2	8.44	2			2				
12719	2249		1	A1	281	4	6	453.2	1	1		1		1		
12719	2249		1	A1	281	4	5	111.18	1	1		1		1		
12719	2249		1	A1	281	4	3	41.6	2		2	2		2		
12719	2250		1	A1	283	14	1	0.99	4			4				
12719	2250		1	A1	283	14	2	3.99	1			1				
12719	2251		1	A1	281	4	3	19.89	1	1		1		1		
12719	2251		1	A1	283	14	2	14.72	5			5				
12719	2251		1	A1	283	14	1	8.55	13			13				
12719	2251		1	A1	281	4	2	5.27	2	2		2		2		
12719	2252		1	A1	283	14	2	4.84	1			1				
12719	2252		1	A1	283	14	1	3.02	3			3				
12719	2252		1	A1	281	4	3	11.69	1	1		1			1	
12719	2253	33	5	A1	283	14	2	8.16	3			3				
12719	2253	33	5	A1	283	14	3	26.38	2			2				
12719	2253	33	5	A1	283	14	1	10.6	10			10				
12719	2254	33	5	A1	283	14	2	5	2			2				
12719	2254	33	5	A1	283	14	5	164.9	1			1				
12719	2255	33	5	A1	283	14	2	5.76	1	1		1				
12719	2255	33	5	A1	283	14	1	0.16	1			1				
12719	2256	33	5	A1	283	14	6	119.01	1			1				
12719	2256	33	5	A1	281	4	4	26.26	1	1		1			1	
12719	2257	33	5	A1	283	14	2	9.05	2			2				
12719	2257	33	5	A1	283	14	1	5.39	7			7				
12719	2257	33	5	A1	283	14	3	42.34	2			2				
12719	2257	33	5	A1	281	4	1	0.12	1	1		1		1		
12719	2257	33	5	A1	281	4	2	1.04	1	1		1		1		
12719	2258	33	5	A1	283	14	1	3.2	5			4				

Site	Coll #	Feature	Lev	Blk	AC	Mat	Sz	Grams	Qty	Frac	NF	Disc P	Disc A	Cort P	Cort A	Comments
12719	2258	33	5	A1	283	14	4	14	1			3				
12719	2259	33	5	A1	283	14	2	26.9	12			29				
12719	2259	33	5	A1	283	14	1	16.2	22			17				
12719	2259	33	5	A1	281	6	2	2.3	4	4			4		4	
12719	2259	33	5	A1	283	14	3	33.4	3			3				
12719	2259	33	5	A1	281	6	2	1.9	1	1			1		1	
12719	2259	33	5	A1	281	4	2	3.2	1	1		1			1	
12719	2259	33	5	A1	281	4	1	2.82	6	6		6		2	4	
12719	2259	33	5	A1	281	4	4	55.53	1	1		1		1		
12719	2261		1	A1	281	4	2	4.55	3	2	1	2	1	3		
12719	2261		1	A1	283	14	2	4.4	2			3				
12719	2261		1	A1	283	14	1	6	12			1				
12719	2261		1	A1	281	4	3	7.99	1	1		1		1		3 flakes
12719	2261		1	A1	281	4	1	0.96	2	2		2			2	
12719	2262		1	A1	281	4	4	86.35	1	1			1	1		
12719	2262		1	A1	281	4	2	4.85	1	1		1		1		
12719	2262		1	A1	283	14	2	5.19	2			2				
12719	2262		1	A1	283	14	1	3.46	7			7				
12719	2263		1	A1	283	14	1	22.68	44			44				
12719	2263		1	A1	281	4	5	84.12	1	1		1		1		
12719	2263		1	A1	283	14	2	17.79	2			2				
12719	2263		1	A1	281	4	2	10.49	6	6		6		5	1	
12719	2263		1	A1	281	4	3	33.01	2	1	1	2		2		
12719	2263		1	A1	281	4	1	2.37	5	5		5		1	4	
12719	2263		1	A1	283	14	2	22.52	10			10				
12719	2263		1	A1	281	4	4	32.12	1	1		1		1		
12719	2263		1	A1	281	6	3	5.6	1	1			1	1		
12719	2265		1	A1	283	14	2	2.64	2			2				
12719	2265		1	A1	283	14	1	2.25	4			4				
12719	2266		1	A1	281	4	3	12.68	2	2		2		2		
12719	2266		1	A1	283	14	3	17.07	2			2				
12719	2266		1	A1	283	14	4	28.96	1			1				
12719	2266		1	A1	283	14	2	7.73	4			4				
12719	2266		1	A1	281	4	2	56.26	1	1		1		1		
12719	2266		1	A1	281	4	2	1.24	1	1		1			1	
12719	2266		1	A1	283	14	1	2.5	4			4				
12719	2267		1	A1	283	14	1	0.1	2			2				
12719	2268		1	A1	283	14	1	15.83	37			37				
12719	2268		1	A1	281	6	2	2.3	1	1			1	1		
12719	2268		1	A1	283	14	3	3.84	1			1				
12719	2268		1	A1	281	4	2	10.82	4	4		4		2	2	
12719	2268		1	A1	281	4	1	0.9	2	2		2		2		
12719	2268		1	A1	281	4	5	88.72	1	1		1		1		
12719	2268		1	A1	281	4	3	21.44	2	2		2		1	1	
12719	2268		1	A1	283	14	2	21.14	14			14				
12719	2269		1	A1	283	14	1	2.57	10			10				
12719	2269		1	A1	281	4	2	2.94	2	2		2			2	
12719	2269		1	A1	281	4	1	1.23	1		1	1		1		
12719	2269		1	A1	281	6	1	0.4	1	1			1		1	
12719	2269		1	A1	283	14	2	8.88	4			4				
12719	2270	33	5	A1	281	4	4	66.86	2	2		2		1	1	
12719	2270	33	5	A1	281	4	1	0.59	2	2		2			2	3 flakes
12719	2270	33	5	A1	283	14	1	3.2	4			13				
12719	2270	33	5	A1	283	14	4	16.5	1			1				
12719	2270	33	5	A1	283	14	2	20	4			1				
12719	2270	33	5	A1	283	14	3	20.4	2			32				
12719	2270	33	5	A1	281	4	2	1.57	1	1		1			1	
12719	2271	33	5	A1	281	4	4	16.4	1	1		1			1	
12719	2271	33	5	A1	283	14	1	1.38	4			4				
12719	2272	33	5	A1	281	4	1	3.3	5	5		5		1	4	
12719	2272	33	5	A1	283	14	2	8.7	2			3				
12719	2272	33	5	A1	283	14	4	12	1			6				
12719	2272	33	5	A1	281	4	4	150.75	2	1	1	2		2		
12719	2272	33	5	A1	281	4	2	10.47	4	4		4		2	2	
12719	2272	33	5	A1	283	14	1	6.1	8			1				
12719	2273	33	5	A1	283	14	1	5.7	8			8				
12719	2274		1	A1	281	4	2	19.56	5	3	2	5		3	2	
12719	2274		1	A1	281	4	4	155.99	1	1		1		1		

Site	Coll #	Feature	Lev	Blk	AC	Mat	Sz	Grams	Qty	Frac	NF	Disc P	Disc A	Cort P	Cort A	Comments
12719	2274		1	A1	283	14	1	0.5	1			9				
12719	2274		1	A1	283	14	2	2	1			15				
12719	2275		1	A1	283	14	2	6.08	2			2				
12719	2276		1	A1	283	14	2	1.66	1			1				
12719	2276		1	A1	283	14	1	4.49	4			4				
12719	2277		1	A1	283	14	2	20.28	7			7				
12719	2277		1	A1	283	14	1	7.02	17			17				
12719	2277		1	A1	281	4	1	0.65	1	1		1			1	
12719	2278		1	A1	281	4	2	7.32	3			3		2	1	
12719	2278		1	A1	281	4	4	40.92	1		1	1		1		
12719	2278		1	A1	283	14	2	24.02	8			8				
12719	2278		1	A1	283	14	1	7.1	12			12				
12719	2278		1	A1	281	4	5	22.25	1	1		1		1		
12719	2278		1	A1	283	14	3	15.36	2			2				
12719	2279		1	A1	283	14	2	2.83	2			2				
12719	2279		1	A1	281	4	2	2.13	1	1			1			
12719	2279		1	A1	281	4	3	4.68	2	2			2	1	1	
12719	2280		1	A1	283	14	2	6.7	3			2				
12719	2280		1	A1	283	14	1	2.76	8			8				
12719	2280		1	A1	283	14	3	7.3	1			1				
12719	2280		1	A1	281	4	4	14.68	1	1		1			1	
12719	2283	33	6	A1	283	14	2	9	3			1				
12719	2283	33	6	A1	283	14	1	3	3			2				
12719	2284	33	6	A1	281	4	1	0.73	2	2		2			2	
12719	2287	33	6	A1	283	14	2	2.9	3			16				
12719	2287	33	6	A1	281	4	2	3.7	1	1		1		1		
12719	2287	33	6	A1	283	14	4	20.8	1			2				
12719	2287	33	6	A1	283	14	3	8.6	1			3				
12719	2288		1	A1	281	4	2	4.2	1	1			1	1		1 flake
12719	2288		1	A1	283	14	1	6.12	12			12				
12719	2288		1	A1	283	14	2	13.92	4			4				
12719	2289		1	A1	283	14	1	1.11	6			6				
12719	2289		1	A1	283	14	2	0.99	1			1				
12719	2290		1	A1	281	4	2	2.08	1	1		1		1		
12719	2290		1	A1	283	14	1	0.8	1			1				
12719	2291	34	3	A1	283	14	1	10.2	11			83				
12719	2291	34	3	A1	281	4	4	50.41	1	1		1		1		
12719	2291	34	3	A1	283	14	4	88.5	1			104				
12719	2291	34	3	A1	283	14	3	18	3			29				
12719	2291	34	3	A1	283	14	2	12	6			4				
12719	2291	34	3	A1	281	4	3	10.69	1	1		1		1		
12719	2291	34	3	A1	281	4	2	15.43	2	2		2		2		
12719	2292	34	3	A1	281	4	1	0.84	2	2		2			2	
12719	2293	34	3	A1	281	4	2	0.91	1		1	1		1		1 flake
12719	2293	34	3	A1	281	4	1	0.36	1	1		1		1		
12719	2294	34	3	A1	283	14	2	2.3	1			11				
12719	2294	34	3	A1	283	14	1	1	1			20				
12719	2294	34	3	A1	281	4	5	229.1	1	1		1		1		
12719	2294	34	3	A1	281	4	2	10.84	3	3		3			3	
12719	2294	34	3	A1	281	4	3	19.66	2	2		2		1	1	
12719	2294	34	3	A1	281	4	1	1.07	1	1		1		1		
12719	2295	34	1	A1	283	14	1	4.75	20			20				
12719	2295	34	1	A1	283	14	4	36.32	1			1				
12719	2295	34	1	A1	281	4	2	4.8	2	1	1	2		2		
12719	2295	34	1	A1	283	14	3	10.82	2			2				
12719	2295	34	1	A1	283	14	2	10.97	4			4				
12719	2296	34	1	A1	283	14	1	11.57	19			19				
12719	2296	34	1	A1	281	4	3	22.18	2	2		2		1	1	
12719	2296	34	1	A1	281	4	4	31.88	1	1		1			1	
12719	2296	34	1	A1	283	14	2	13.98	4			4				
12719	2297	34	1	A1	283	14	2	11.8	4			4				
12719	2297	34	1	A1	283	14	1	1.3	2			2				
12719	2297	34	1	A1	283	14	4	35.1	2			4				
12719	2298	34	1	A1	281	6	1	0.42	1	1			1		1	
12719	2298	34	1	A1	283	14	1	3	4			67				
12719	2298	34	1	A1	281	6	1	0.6	1	1			1		1	
12719	2298	34	1	A1	281	6	3	4.1	1	1			1		1	
12719	2298	34	1	A1	281	4	2	10.22	4	4		4		3	1	

Site	Coll #	Feature	Lev	Blk	AC	Mat	Sz	Grams	Qty	Frac	NF	Disc P	Disc A	Cort P	Cort A	Comments
12719	2298	34	1	A1	281	7	1	0.05	1	1			1		1	
12719	2298	34	1	A1	283	14	2	15.2	4			16				
12719	2298	34	1	A1	283	14	4	21.9	1			4				
12719	2298	34	1	A1	281	4	4	33.58	2	2		2		1	1	
12719	2298	34	1	A1	281	4	3	3.2	1	1		1		1		
12719	2298	34	1	A1	281	4	3	14.49	1	1		1		1		
12719	2298	34	1	A1	281	4	1	0.14	1	1		1		1		
12719	2299	34	1	A1	283	14	4	56.47	2			2				
12719	2299	34	1	A1	283	14	1	8.7	8			9				
12719	2299	34	1	A1	281	4	3	49.64	3	3		3		2	1	
12719	2299	34	1	A1	283	14	5	167.73	2			2				
12719	2299	34	1	A1	283	14	1	32.91	60			60				
12719	2299	34	1	A1	283	14	2	17.6	3			1				
12719	2299	34	1	A1	281	4	4	38.16	1	1		1		1		
12719	2299	34	1	A1	281	4	2	12.76	3	3		3		3		
12719	2300		1	A1	283	14	1	21.4	57			57				
12719	2300		1	A1	283	14	3	19	2			2				
12719	2300		1	A1	283	14	4	55.12	2			2				
12719	2300		1	A1	283	14	2	27.1	12			12				
12719	2300		1	A1	281	4	2	5.13	1	1		1			1	
12719	2300		1	A1	281	7	1	0.35	1	1		1	1		1	
12719	2301		1	A1	283	14	3	58.23	2	2		2	1	1		
12719	2301		1	A1	283	14	2	45.26	20			20				
12719	2301		1	A1	283	14	4	32.68	1			1				
12719	2301		1	A1	283	14	1	44.39	93			93				
12719	2301		1	A1	283	14	5	131.38	2			2				
12719	2301		1	A1	281	6	2	2.1	1	1		1	1		1	
12719	2301		1	A1	281	6	1	0.5	1	1		1			1	
12719	2301		1	A1	281	4	6	184.45	1	1		1		1		
12719	2301		1	A1	283	14	3	42.02	3			3				
12719	2302		1	A1	283	14	2	7.97	5			5				
12719	2302		1	A1	283	14	4	16.14	1			1				
12719	2302		1	A1	281	4										1 flake
12719	2302		1	A1	283	14	1	23.28	41			41				
12719	2302		1	A1	281	7	1	0.3	1	1		1	1		1	
12719	2303		1	A1	283	14	2	13.97	3			3				
12719	2303		1	A1	283	14	1	1.21	3			3				
12719	2305		1	A1	283	14	1	0.71	2			2				
12719	2306		1	A1	283	14	3	7.17	1			1				
12719	2306		1	A1	283	14	1	1.11	2			2				
12719	2306		1	A1	281	7	1	0.27	1	1		1	1		1	
12719	2307		1	A1	281	4	1	0.24	1	1		1			1	
12719	2307		1	A1	281	4	2	0.91	1	1		1			1	1 flake
12719	2307		1	A1	281	6	2	5.58	1	1		1	1		1	
12719	2308		1	A1	281	4	5	26.84	1	1		1	1		1	
12719	2308		1	A1	281	4	3	6.67	1	1		1			1	
12719	2308		1	A1	281	4	2	6.19	2	2		2			2	
12719	2308		1	A1	281	6	1	1.1	1	1		1	1		1	
12719	2308		1	A1	281	4	7	282.1	1	1		1			1	
12719	2309		1	A1	281	6	2	2.1	1	1		1	1		1	
12719	2310		1	A1	281	4	3	28.15	2	2		2		1	1	
12719	2310		1	A1	281	4	2	6.58	1	1		1			1	
12719	2311		1	A1	281	4	2	2.49	1	1		1		1		
12719	2312		1	A1	283	14	1	3.7	4			4				
12719	2312		1	A1	283	14	2	4.04	2			2				
12719	2312		1	A1	281	4	1	0.75	2	2		2			2	1 flake
12719	2313	33	5	A1	283	14	1	0.63	3			3				3 flakes
12719	2314	33	5	A1	281	4	2	5.6	4	4		4		2	2	
12719	2314	33	5	A1	283	14	4	47.32	2			2				
12719	2314	33	5	A1	283	14	1	59.98	63			63		1	62	
12719	2314	33	5	A1	281	4	1	2.93	4	4		4			4	
12719	2314	33	5	A1	283	14	3	98.27	12			12				
12719	2314	33	5	A1	283	14	2	92.81	30			30				
12719	2314	33	5	A1	283	14	5	65.52	1			1				
12719	2316	33	5	A1	283	14	1	42.46	44			44				
12719	2316	33	5	A1	283	14	5	54.13	1			1				1 flake
12719	2316	33	5	A1	283	14	3	19.2	3			3				
12719	2316	33	5	A1	283	14	4	41.06	2			2				

Site	Coll #	Feature	Lev	Blk	AC	Mat	Sz	Grams	Qty	Frac	NF	Disc P	Disc A	Cort P	Cort A	Comments
12719	2316	33	5	A1	283	14	2	78.71	21			21				
12719	2318	33	5	A1	281	6	2	0.8	1	1			1		1	
12719	2320	33	5	A1	283	14	3	12.08	1			1				
12719	2320	33	5	A1	281	4	1	0.43	2	2		2			2	
12719	2320	33	5	A1	281	4	2	0.72	1	1		1			1	
12719	2320	33	5	A1	283	14	5	70.05	1			1				
12719	2320	33	5	A1	283	14	6	68.93	1			1				
12719	2320	33	5	A1	283	14	4	111.66	3			3				
12719	2320	33	5	A1	283	14	2	1.85	1			1				
12719	2321		1	A1	283	14	1	4.7	8			8				
12719	2321		1	A1	281	4	4	72.82	1	1		1		1		
12719	2321		1	A1	281	4	2	4.81	2	2		1	1	1	1	
12719	2321		1	A1	283	14	3	15.65	2			2				
12719	2321		1	A1	283	14	2	7.18	3			3				
12719	2321		1	A1	283	14	4	51.52	1			1				
12719	2321		1	A1	281	4	1	1.5	2	2		2		1	1	
12719	2322		1	A1	283	14	2	7.53	2			2				
12719	2322		1	A1	281	4	6	558.9	1	1		1		1		
12719	2322		1	A1	283	14	1	1.95	2			2				
12719	2323		1	A1	281	4	4	39.41	1	1		1			1	
12719	2323		1	A1	283	14	4	13.38	1			1				
12719	2323		1	A1	281	4	2	1.16	1	1			1		1	
12719	2323		1	A1	283	14	1	2.1	3			3				
12719	2323		1	A1	283	14	2	9.18	3			3				
12719	2324		1	A1	281	4	3	11.9	1		1		1	1		
12719	2324		1	A1	283	14	2	1.74	1			1				
12719	2324		1	A1	283	14	1	6.16	14			14				
12719	2324		1	A1	281	4	1	1.88	2	1	1	2			2	2 flakes
12719	2324		1	A1	281	4	4	63.16	1	1		1			1	
12719	2325		1	A1	283	14	1	24.22	45			45				
12719	2325		1	A1	283	14	3	22.47	3			3				
12719	2325		1	A1	283	14	2	39.94	14			14				
12719	2326		1	A1	281	4	2	5.06	2	2		2		1	1	
12719	2326		1	A1	281	4	4	30.01	1	1		1			1	
12719	2326		1	A1	281	6	2	3.89	2	2			2	1	1	
12719	2326		1	A1	283	14	1	16.4	28			28				
12719	2326		1	A1	283	14	2	34.82	14			14				
12719	2326		1	A1	283	14	3	20.32	3			3				
12719	2326		1	A1	281	6	3	10	1	1			1		1	
12719	2326		1	A1	281	4	1	0.26	1	1		1			1	
12719	2327		1	A1	281	4	2	3.9	1	1		1		1		
12719	2327		1	A1	281	4	4	46.7	1	1		1			1	
12719	2327		1	A1	283	14	2	9.48	4			4				
12719	2327		1	A1	283	14	4	18.88	1			1				
12719	2327		1	A1	281	4	6	79.99	1	1		1		1		
12719	2327		1	A1	281	4	5	137.99	1	1		1			1	
12719	2327		1	A1	283	14	3	13.13	2			2				
12719	2327		1	A1	283	14	1	3.24	6			6				
12719	2328		1	A1	283	14	2	16.16	7			7				
12719	2328		1	A1	283	14	3	9.64	2			2				
12719	2328		1	A1	283	14	1	5.42	9			9				
12719	2328		1	A1	281	4	1	1.31	1	1		1			1	
12719	2328		1	A1	283	14	4	35.53	1			1				
12719	2329		1	A1	283	14	3	5.47	1			1				
12719	2329		1	A1	283	14	6	141.11	1			1				
12719	2329		1	A1	283	14	1	10.74	17			17				
12719	2329		1	A1	283	14	2	14.39	7			7				
12719	2329		1	A1	281	4	3	21.87	2	2		2			2	
12719	2329		1	A1	281	6	2	6.4	2	2			2		2	
12719	2329		1	A1	281	4	2	18.03	5	4	1	5		1	4	
12719	2329		1	A1	281	4	1	2.9	6	6		6			6	
12719	2330	34	3	A1	281	4	2	2.84	1	1		1			1	
12719	2331	34	3	A1	283	14	2	229.41	59			59				
12719	2331	34	3	A1	283	14	3	115.67	12			12				
12719	2331	34	3	A1	281	4	2	13.94	5	5		5		5		
12719	2331	34	3	A1	283	14	5	319.94	3			3				
12719	2331	34	3	A1	283	14	4	51.61	2			2				
12719	2331	34	3	A1	281	4	1	7.85	7	7		7		1	6	

Site	Coll #	Feature	Lev	Blk	AC	Mat	Sz	Grams	Qty	Frac	NF	Disc P	Disc A	Cort P	Cort A	Comments
12719	2331	34	3	A1	283	14	7	544.2	1			1				
12719	2331	34	3	A1	283	14	1	87.39	94			94				
12719	2333	34	3	A1	283	14	3	26.8	2			2				
12719	2333	34	3	A1	283	14	4	54.33	1			1				
12719	2333	34	3	A1	283	14	1	4.48	4			4				
12719	2333	34	3	A1	283	14	2	39.83	11			11				
12719	2333	34	3	A1	283	14	5	178.43	2			2				
12719	2334	34	3	A1	281	4	1	0.36	1	1		1			1	
12719	2334	34	3	A1	283	14	1	0.87	1			1				
12719	2335	34	3	A1	281	4	2	2.04	1	1		1			1	
12719	2335	34	3	A1	281	4	1	0.4	1		1	1		1		
12719	2335	34	3	A1	283	14	1	10.45	10			10				
12719	2335	34	3	A1	283	14	2	34.71	10			10				
12719	2335	34	3	A1	283	14	4	86.71	2			2				
12719	2340	34	3	A1	283	14	2	171.46	35			35				
12719	2340	34	3	A1	283	14	1	38.92	30			30				
12719	2340	34	3	A1	281	4	1	3.85	3	2	1	3		1	2	
12719	2340	34	3	A1	281	4	5	133.25	1		1	1		1		
12719	2340	34	3	A1	281	4	3	19.5	3	3		3		1	2	
12719	2340	34	3	A1	281	4	4	15.6	1	1		1		1		
12719	2340	34	3	A1	283	14	3	178.75	11			11				
12719	2340	34	3	A1	283	14	4	105.47	4			4				
12719	2340	34	3	A1	281	4	2	20.09	7	6	1	7		6	1	
12719	2341		2	A1	283	14	1	2.89	9			9				
12719	2341		2	A1	283	14	2	3.48	2			2				
12719	2341		2	A1	281	4	3	14.06	1	1			1	1		
12719	2342		2	A1	283	14	2	3.76	2			2				
12719	2342		2	A1	283	14	1	1.14	2			2				
12719	2343		3	A1	283	14	1	1.51	2			2				
12719	2345		3	A1	283	14	1	3.23	5			5				
12719	2345		3	A1	281	4	1	0.78	1	1			1		1	
12719	2346		3	A1	283	14	3	11.13	1			1				
12719	2346		3	A1	281	4	2	3.95	1	1			1	1		
12719	2346		3	A1	283	14	1	2.8	20			20				
12719	2346		3	A1	283	14	2	7.85	3			3				
12719	2347		4	A1	283	14	2	1.99	2			2				
12719	2347		4	A1	283	14	1	4.59	12			12				
12719	2348		5	A1	283	14	1	0.74	3				3			
12719	2349		4	A1	281	4	2	1.08	1	1		1			1	
12719	2349		3	A1	283	14	2	7.53	3			3				
12719	2349		3	A1	281	4	1	0.48	1	1		1			1	
12719	2349		3	A1	283	14	1	6.17	17			17				
12719	2350		3	A1	281	7	2	0.85	1	1		1			1	
12719	2350		4	A1	283	14	1	3.47	11			11				
12719	2350		4	A1	283	14	2	1.03	1			1				
12719	2350		3	A1	281	7	1	0.97	2	1	1	2			2	
12719	2351	34	3	A1	281	4	2	1.06	1	1		1			1	
12719	2352	34	4	A1	281	4	2	5.4	1		1	1		1		
12719	2352	34	4	A1	283	14	4	48.37	2			2				
12719	2352	34	4	A1	283	14	1	22.9	32			32				
12719	2352	34	4	A1	283	14	2	112.85	37			37				
12719	2352	34	4	A1	283	14	3	76.52	9			9				
12719	2352	34	4	A1	283	14	5	161.24	2			2				
12719	2352	34	4	A1	281	4	3	25.26	1	1		1		1		
12719	2352	34	4	A1	281	4	2	14.79	5	3	2	5		4	1	
12719	2352	34	4	A1	281	4	1	0.43	1	1		1			1	
12719	2353	34	3	A1	283	14	1	2.31	4			4				
12719	2353	34	3	A1	283	14	2	0.84	1			1				
12719	2353	34	3	A1	283	14	3	40.9	3			3				
12719	2354	80	4	A1	281	4	1	0.51	2	2		2			2	
12719	2358	33	4	A1	283	14	2	4.88	2			2				
12719	2358	33	4	A1	283	14	1	3.01	8			8				
12719	2358	33	4	A1	281	4	1	0.27	3	3		3			3	other
12719	2358	33	4	A1	281	4	2	3.74	1	1		1		1		
12719	2359	33	4	A1	283	14	2	35.36	10			10				
12719	2359	33	4	A1	283	14	3	72.08	4			4				
12719	2359	33	4	A1	283	14	1	12.78	22			22				
12719	2359	33	4	A1	283	14	6	353.7	2			2				

Site	Coil #	Feature	Lev	Blk	AC	Mat	Sz	Grams	Qty	Frac	NF	Disc P	Disc A	Cort P	Cort A	Comments
12719	2359	33	4	A1	281	6	2	0.6	1	1		1		1		
12719	2359	33	4	A1	281	4	4	55.75	1	1		1			1	
12719	2359	33	4	A1	283	14	4	56.2	2			2				
12719	2359	33	4	A1	283	14	5	244.5	3			3				
12719	2361	33	4	A1	283	14	5	430.46	3			3				
12719	2361	33	4	A1	281	4	2	1.17	1	1		1			1	
12719	2361	33	4	A1	283	14	1	7.44	14			14				
12719	2361	33	4	A1	283	14	2	38.8	9			9				
12719	2361	33	4	A1	283	14	6	198.3	1			1				
12719	2361	33	4	A1	281	4	3	9.86	1	1		1		1		
12719	2361	33	4	A1	283	14	3	125.55	8			8				
12719	2361	33	4	A1	283	14	4	167.59	4			4				
12719	2362	33	4	A1	283	14	2	1.06	1			1				
12719	2362	33	4	A1	283	14	1	1.51	3			3				
12719	2362	33	4	A1	281	4	1	0.03	1	1		1			1	
12719	2362	33	4	A1	283	14	3	10.54	1			1				
12719	2363	33	4	A1	281	7	1	0.27	1	1			1		1	
12719	2363	33	4	A1	283	14	4	19.81	1			1				
12719	2363	33	4	A1	283	14	2	29.23	10			10				
12719	2363	33	4	A1	283	14	1	7.66	14			14				
12719	2364	33	4	A1	283	14	1	0.74	2			2				
12719	2364	33	4	A1	281	4	1	0.68	1	1		1			1	
12719	2365	33	4	A1	283	14	1	6.26	9			9				
12719	2365	33	4	A1	283	14	2	19.56	8			8				
12719	2365	33	4	A1	283	14	3	16.37	2			2				
12719	2366		1	A1	283	14	6	10.88	1			1				
12719	2366		1	A1	283	14	1	17.46	22			22				
12719	2366		1	A1	281	4	2	4.12	2	2		2		2		
12719	2366		1	A1	281	4	1	2.8	5	5		5		3	2	
12719	2366		1	A1	281	4	3	26.12	1	1		1		1		
12719	2366		1	A1	283	14	2	50.66	13			13				
12719	2367		1	A1	281	4	4	37.84	1	1		1		1		
12719	2367		1	A1	283	14	1	5.62	12			12				
12719	2367		1	A1	283	14	2	5.84	1			1				
12719	2367		1	A1	281	4	3	35.53	1	1		1			1	
12719	2368		1	A1	283	14	3	6.06	1			1				
12719	2368		1	A1	283	14	2	7.86	4			4				
12719	2368		1	A1	283	14	1	3.96	9			9				
12719	2368		1	A1	283	14	4	25.16	1			1				
12719	2369		1	A1	283	14	1	7.46	14			14				
12719	2369		1	A1	283	14	2	19.99	5			5				
12719	2369		1	A1	283	14	3	14.15	1			1				
12719	2370		1	A1	283	14	3	11.77	1			1				
12719	2370		1	A1	281	4	2	3.84	1	1		1			1	
12719	2370		1	A1	283	14	1	7.04	16			16				
12719	2370		1	A1	281	4	2	85.35	1	1		1			1	
12719	2370		1	A1	283	14	2	4.39	2			2				
12719	2370		1	A1	281	7	5	168.82	1	1		1		1		
12719	2371		1	A1	283	14	4	16.85	1			1				
12719	2371		1	A1	283	14	1	2.72	4			4				
12719	2371		1	A1	283	14	3	14.09	1			1				
12719	2371		1	A1	281	4	2	1.9	1	1		1			1	
12719	2371		1	A1	281	6	1	0.87	1	1			1		1	
12719	2372		1	A1	281	4	5	85.18	1	1		1			1	
12719	2372		1	A1	281	4	3	6.22	1	1		1		1		
12719	2372		1	A1	283	14	2	27.65	15			15				2 flakes
12719	2372		1	A1	283	14	1	19.96	43			43				
12719	2373		1	A1	281	4	2	7.6	2	2		2		1	1	
12719	2373		1	A1	281	4	1	3.24	4	4		4			4	
12719	2373		1	A1	283	14	2	16.72	6			6				
12719	2374		1	A1	283	14	1	6.51	10			10				
12719	2374		1	A1	283	14	3	13.83	1			1				
12719	2374		1	A1	283	14	1	20.68	52			52				
12719	2374		1	A1	281	6	3	3.5	1	1			1	1		
12719	2374		1	A1	283	14	2	12.41	5			5				
12719	2375		1	A1	281	4	2	6.32	1	1		1		1		
12719	2375		1	A1	283	14	1	6.64	14			14				
12719	2375		1	A1	283	14	2	8.46	5			5				

Site	Coll #	Feature	Lev	Blk	AC	Mat	Sz	Grams	Qty	Frac	NF	Disc P	Disc A	Cort P	Cort A	Comments
12719	2376		1	A1	281	4	4	33.68	1	1		1		1		
12719	2376		1	A1	283	14	1	22.01	42			42				
12719	2376		1	A1	283	14	2	15.2	7			7				
12719	2377		1	A1	283	14	2	38.61	18			18				
12719	2377		1	A1	281	4	1	1.35	3	3		3			3	
12719	2377		1	A1	283	14	3	15.86	2			2				
12719	2377		1	A1	281	4	3	23.97	2	2		2		1	1	
12719	2377		1	A1	283	14	1	51.14	102			102				
12719	2377		1	A1	281	4	2	20.85	6	6		6		1	5	
12719	2378		1	A1	283	14	2	34.84	11			11				
12719	2378		1	A1	283	14	3	10.82	1			1				
12719	2378		1	A1	283	14	1	13.97	22			22				
12719	2378		1	A1	281	4	2	8.62	1	1		1		1		
12719	2378		1	A1	281	4	1	2.72	1	1		1		1		
12719	2379		1	A1	281	4	4	53.88	1	1		1		1		
12719	2379		1	A1	283	14	1	2.91	7			7				
12719	2379		1	A1	283	14	2	4.62	2			2				
12719	2379		1	A1	281	4	2	8.29	1	1		1			1	
12719	2380		1	A1	283	14	1	29.53	35			35				
12719	2380		1	A1	283	14	2	45.09	22			22				
12719	2380		1	A1	283	14	3	30.34	3			3				
12719	2381		1	A1	283	14	1	4.64	8			8				
12719	2381		1	A1	283	14	2	6.35	3			3				
12719	2381		1	A1	281	4	3	8.24	1	1		1			1	
12719	2381		1	A1	281	4	1	1.02	1	1		1		1		
12719	2382		1	A1	283	14	1	6.65	8			8				
12719	2382		1	A1	283	14	2	10.66	5			5				
12719	2382		1	A1	281	4	2	7.21	2	2		2		2		
12719	2383		1	A1	283	14	3	11.73	2			2				
12719	2383		1	A1	283	14	1	5.85	16			16				
12719	2383		1	A1	281	4	2	3	1	1		1			1	
12719	2383		1	A1	283	14	2	5.2	2			2				
12719	2384		1	A1	281	4	5	108.78	1	1		1			1	
12719	2384		1	A1	281	4	3	4.16	1	1		1			1	
12719	2384		1	A1	283	14	1	3.38	4			4				
12719	2385		1	A1	283	14	2	8.86	2			2				
12719	2386		1	A1	283	14	2	7.44	3			3				
12719	2386		1	A1	283	14	1	3.72	7			7				
12719	2386		1	A1	283	14	3	6.79	1			1				
12719	2388		1	A1	283	14	2	2.08	1			1				
12719	2389		1	A1	283	14	1	1.4	3			3				
12719	2390		1	A1	283	14	1	1.38	4			4				
12719	2391	34	3	A1	283	14	1	0.59	1			1				
12719	2391	34	3	A1	283	14	2	1.62	1			1				
12719	2392	34	3	A1	283	14	1	83.5	88			88				
12719	2392	34	3	A1	283	14	7	261.1	1			1				
12719	2392	34	3	A1	283	14	4	183.8	7			7				
12719	2392	34	3	A1	283	14	6	172.4	1			1				
12719	2392	34	3	A1	283	14	5	718.4	9			9				
12719	2392	34	3	A1	283	14	2	271.3	85			85				
12719	2392	34	3	A1	281	4	5	90.42	1	1		1			1	
12719	2392	34	3	A1	281	4	6	1.96	1	1		1			1	
12719	2392	34	3	A1	281	4	2	3.86	2	2		2			2	
12719	2392	34	3	A1	281	4	4	100.44	2	2		2		1	1	
12719	2392	34	3	A1	281	4	3	20.33	3	3		2	1	2	1	
12719	2392	34	3	A1	283	14	3	183.6	17			17				
12719	2393	34	3	A1	283	14	1	2.22	5			5				
12719	2394	34	3	A1	281	4	1	1.1	2	2		2			2	
12719	2394	34	3	A1	283	14	1	14.4	19			19				
12719	2394	34	3	A1	283	14	8	665.5	1			1				
12719	2394	34	3	A1	283	14	5	148.6	1			1				
12719	2394	34	3	A1	283	14	4	139	4			4				
12719	2394	34	3	A1	281	4	2	2.02	1	1		1			1	i n same bag as 28
12719	2394	34	3	A1	283	14	3	112.8	7			7				
12719	2394	34	3	A1	283	14	6	332.3	1			1				
12719	2394	34	3	A1	283	14	2	58.5	17			17				
12719	2395	34	3	A1	281	4	2	4.48	2	2		2			2	
12719	2395	34	3	A1	281	4	4	58.4	1	1		1			1	

Site	Coll #	Feature	Lev	Blk	AC	Mat	Sz	Grams	Qty	Frac	NF	Disc P	Disc A	Cort P	Cort A	Comments
12719	2395	34	3	A1	281	4	3	11.9	1	1		1			1	
12719	2395	34	3	A1	283	14	5	401.7	3			3				
12719	2395	34	3	A1	283	14	3	166.5	14			14				
12719	2395	34	3	A1	283	14	2	118	32			32				
12719	2395	34	3	A1	283	14	1	27.6	27			27				
12719	2395	34	3	A1	283	14	6	189.6	1			1				
12719	2395	34	3	A1	283	14	4	269.2	10			10				
12719	2395	34	3	A1	281	4	5	64.35	1	1		1		1		
12719	2396	34	3	A1	283	14	1	0.34	2			2				
12719	2397	34	3	A1	281	4	2	3.01	1	1		1			1	
12719	2397	34	3	A1	281	4	4	18.84	1	1		1			1	
12719	2397	34	3	A1	281	4	3	16.4	2	2		2		2		
12719	2397	34	3	A1	281	4	1	0.38	2	2		2			2	
12719	2397	34	3	A1	283	14	2	75.98	20			20				
12719	2397	34	3	A1	283	14	1	21.7	31			31				
12719	2397	34	3	A1	283	14	6	196.2	1			1				
12719	2397	34	3	A1	283	14	3	90.4	6			6				
12719	2397	34	3	A1	283	14	5	146.1	2			2				
12719	2397	34	3	A1	283	14	4	175.7	4			4				
12719	2398	34	3	A1	283	14	3	18.57	1			1				
12719	2398	34	3	A1	283	14	4	28.58	1			1				
12719	2398	34	3	A1	283	14	2	1.09	1			1				
12719	2398	34	3	A1	283	14	1	5.53	8			8				
12719	2400	34	3	A1	281	3	2	1.06	1	1		1		1		
12719	2400	34	3	A1	281	4	2	10.06	3	3		3			3	
12719	2400	34	3	A1	281	4	4	35.12	2	2		2		1	1	
12719	2400	34	3	A1	283	14	4	130.5	4			4				
12719	2400	34	3	A1	283	14	1	29.62	41			41				
12719	2400	34	3	A1	283	14	2	82.09	24			24				
12719	2400	34	3	A1	283	14	3	69.19	4			4				
12719	2400	34	3	A1	281	4	3	11.33	1	1		1			1	
12719	2400	34	3	A1	281	4	3	57.84	2	2		2			2	
12719	2400	34	3	A1	283	14	5	514	4			4				
12719	2401	34	3	A1	283	14	1	1.25	3			3				
12719	2402	34	3	A1	281	6	2	2.46	1	1		1			1	
12719	2402	34	3	A1	283	14	9	613.2	1			1				
12719	2402	34	3	A1	283	14	5	550	5			2	3			
12719	2402	34	3	A1	283	14	6	438.5	3			2	1			
12719	2402	34	3	A1	283	14	1	17.35	16			16				
12719	2402	34	3	A1	283	14	3	98.31	10			2	8			
12719	2402	34	3	A1	283	14	2	44.33	13			8	5			
12719	2402	34	3	A1	281	4	5	144.44	1	1		1			1	
12719	2402	34	3	A1	283	14	4	36.85	2			1	1			
12719	2402	34	3	A1	283	14	7	705.7	2			2				
12719	2403	34	3	A1	281	4	4	55.11	1	1		1		1		
12719	2403	34	3	A1	283	14	3	14.87	1			1				
12719	2403	34	3	A1	283	14	1	6.42	7			7				
12719	2405	34	3	A1	283	14	1	4.48	6			6				
12719	2405	34	3	A1	283	14	5	56.78	1			1				
12719	2405	34	3	A1	281	4	2	2.72	1	1		1			1	
12719	2405	34	3	A1	281	6	1	0.47	1	1		1		1		
12719	2405	34	3	A1	283	14	2	52.46	11			8	3			
12719	2406	33	5	A1	283	14	2	18.32	4			4				
12719	2406	33	5	A1	283	14	1	1.44	2			2				
12719	2408	33	5	A1	283	14	2	22.04	5			5				
12719	2408	33	5	A1	283	14	1	17.51	33			33				
12719	2408	33	5	A1	283	14	3	31.33	3			3				
12719	2408	33	5	A1	283	14	4	18.37	1			1				
12719	2408	33	5	A1	281	6	3	9.55	1	1		1		1		
12719	2408	33	5	A1	281	6	2	16.1	1	1		1			1	
12719	2408	33	5	A1	283	14	5	110.91	2			2				1 flake
12719	2409	33	5	A1	283	14	1	0.47	2			2				
12719	2409	33	5	A1	283	14	2	2.44	2			2				
12719	2410	33	5	A1	283	14	3	24.19	3			3				
12719	2410	33	5	A1	283	14	5	236.9	3			3				
12719	2410	33	5	A1	283	14	2	38.89	14			14				
12719	2410	33	5	A1	281	6	1	0.26	4	4		4			4	
12719	2410	33	5	A1	283	14	4	32.7	1			1				

Site	Coll #	Feature	Lev	Blk	AC	Mat	Sz	Grams	Qty	Frac	NF	Disc P	Disc A	Cort P	Cort A	Comments
12719	2410	33	5	A1	283	14	1	15.53	25			25				
12719	2411	33	5	A1	283	14	1	3.33	4			4				
12719	2412	33	5	A1	283	14	1	26.56	33			33				
12719	2412	33	5	A1	281	4	1	0.73	1	1		1			1	
12719	2412	33	5	A1	281	4	4	59.63	1	1		1		1		
12719	2412	33	5	A1	283	14	4	84.35	2			2				
12719	2412	33	5	A1	283	14	6	259.2	1			1				
12719	2412	33	5	A1	283	14	3	59.33	6			6				
12719	2412	33	5	A1	283	14	2	20.08	8			8				
12719	2414		1	A1	281	4	5	127.82	4	4		4			4	
12719	2414		1	A1	283	14	1	2.18	4			4				
12719	2415		1	A1	283	14	2	2.39	1			1				
12719	2415		1	A1	283	14	1	0.6	3			3				
12719	2416		1	A1	283	14	1	0.61	2			2				
12719	2416		1	A1	283	14	2	4.22	1			1				
12719	2417		1	A1	283	14	1	2.16	4			4				
12719	2418		1	A1	281	4	2	2.94	1	1		1			1	
12719	2418		1	A1	281	4	4	14.67	1	1		1			1	
12719	2418		1	A1	283	14	1	1.83	4			4				
12719	2418		1	A1	281	4	3	11.35	1	1		1			1	
12719	2418		1	A1	283	14	2	17.91	4			4				
12719	2419		1	A1	283	14	1	5.74	5			5				
12719	2419		1	A1	283	14	2	3.46	2			2				
12719	2420		1	A1	283	14	1	0.23	1			1				
12719	2420		1	A1	283	14	2	3.4	1			1				
12719	2421		1	A1	283	14	1	1.86	2			2				
12719	2421		1	A1	283	14	2	8.59	3			3				
12719	2422		1	A1	283	14	1	0.34	1			1				
12719	2422		1	A1	283	14	2	3.9	2			2				
12719	2423		1	A1	281	4	2	3.94	2	2		2		2		
12719	2423		1	A1	281	4	1	2.38	2		2	2		2		
12719	2423		1	A1	281	4	3	38.89	2	1	1	2		2		
12719	2424		1	A1	281	4	2	6.03	1	1		1		1		
12719	2424		1	A1	283	14	1	0.77	6			6				
12719	2424		1	A1	283	14	2	3.79	2			2				
12719	2426		1	A1	283	14	2	5.95	1			1				
12719	2426		1	A1	281	4	4	84.99	2	2		2		1	1	
12719	2426		1	A1	283	14	1	4.29	9			9				
12719	2427		1	A1	283	14	1	0.56	3			3				
12719	2428		1	A1	281	4	1	1.05	1	1		1		1		
12719	2428		1	A1	283	14	2	1.89	1			1				
12719	2428		1	A1	283	14	1	4.67	25			25				
12719	2428		1	A1	281	4	5	98.77	1	1		1		1		
12719	2429		1	A1	283	14	1	0.35	2			2				
12719	2430		1	A1	283	14	4	10.72	1			1				
12719	2430		1	A1	283	14	1	5.77	28			28				
12719	2431		1	A1	283	14	2	2.16	2			2				
12719	2431		1	A1	281	4	2	4.29	1	1		1		1		
12719	2431		1	A1	283	14	3	31.98	2			2				
12719	2431		1	A1	283	14	1	2.02	4			4				
12719	2431		1	A1	281	4	4	85.85	1	1		1		1		
12719	2432		1	A1	283	14	1	0.98	1			1				
12719	2432		1	A1	283	14	3	5.08	1			1				
12719	2432		1	A1	281	4	2	1.62	1	1		1	1	1		
12719	2432		1	A1	281	4	1	2.35	5	4	1	5		3	2	
12719	2432		1	A1	281	4	4	14.66	1	1		1		1		
12719	2433		1	A1	283	14	2	1.96	1			1				
12719	2433		1	A1	283	14	1	0.98	2			2				
12719	2434		1	A1	283	14	2	2.87	2			2				
12719	2435		1	A1	283	14	1	0.28	1			1				
12719	2435		1	A1	283	14	3	9.22	1			1				
12719	2436		1	A1	283	14	1	4.08	13			13				
12719	2436		1	A1	283	14	3	23.45	2			2				
12719	2436		1	A1	283	14	2	20.75	5			5				
12719	2438		1	A1	283	14	1	0.85	1			1				
12719	2438		1	A1	283	14	2	3.84	1			1				
12719	2439		1	A1	283	14	2	4.47	1			1				
12719	2439		1	A1	283	14	1	0.76	1			1				

Site	Coll #	Feature	Lev	Blk	AC	Mat	Sz	Grams	Qty	Frac	NF	Disc P	Disc A	Cort P	Cort A	Comments
12719	2440		1	A1	283	14	1	1.47	1			1				
12719	2441		1	A1	283	14	2	1.9	1			1				
12719	2441		1	A1	281	4	3	2.86	1	1		1			1	
12719	2441		1	A1	283	14	1	1.3	3			3				
12719	2441		1	A1	283	14	3	9.05	1			1				
12719	2442		1	A1	283	14	1	2.98	7			7				
12719	2442		1	A1	283	14	2	11.94	4			4				
12719	2443		1	A1	283	14	3	9.62	1			1				
12719	2443		1	A1	283	14	4	29.5	1			1				
12719	2443		1	A1	283	14	2	5.32	1			1				
12719	2443		1	A1	283	14	1	1.06	1			1				
12719	2445		1	A1	283	14	1	0.29	1			1				
12719	2445		1	A1	281	4	3	49.75	2	2		2		2		
12719	2445		1	A1	281	4	1	1.24	1	1		1		1		
12719	2446		1	A1	283	14	2	1.09	1			1				
12719	2447		1	A1	283	14	2	1.63	1			1				
12719	2447		1	A1	281	4	4	37.53	1	1		1		1		
12719	2447		1	A1	281	4	5	143.41	1	1		1		1		
12719	2449		1	A1	283	14	1	1.01	3			3				
12719	2449		1	A1	283	14	2	6.31	1			1				
12719	2449		1	A1	281	4	2	2.14	2			2				
12719	2450		1	A1	281	4	3	20.28	2	2		2		1	1	
12719	2450		1	A1	281	4	2	12.88	3	3		3	3	2	1	
12719	2450		1	A1	281	4	1	0.15	2	2		2		1	1	
12719	2450		1	A1	283	14	1	0.73	4			4				
12719	2451		1	A1	281	4	3	39.87	1		1	1		1		
12719	2451		1	A1	283	14	5	43.35	1			1				
12719	2452		1	A1	283	14	1	0.9	3			3				
12719	2452		1	A1	283	14	2	3.71	2			2				
12719	2453		1	A1	283	14	2	5.61	2			2				
12719	2453		1	A1	281	4	2	4.42	3	3		3		1	2	
12719	2453		1	A1	283	14	1	1.23	2			2				
12719	2453		1	A1	283	14	3	22.5	1			1				
12719	2453		1	A1	281	4	3	7.13	1	1		1			1	
12719	2454		1	A1	281	4	4	104.09	1		1	1		1		
12719	2454		1	A1	283	14	1	2.39	2			2				
12719	2455		1	A1	281	4	3	15.49	1	1		1		1		
12719	2456		1	A1	283	14	1	4.78	8			8				
12719	2456		1	A1	283	14	2	5.01	1			1				
12719	2456		1	A1	281	4	1	1.8	1	1		1	1	1		
12719	2457		1	A1	283	14	2	2.94	1			1				
12719	2459		1	A1	283	14	2	5.98	1			1				
12719	2459		1	A1	281	4	2	2.49	1	1		1		1		
12719	2459		1	A1	281	4	5	93.03	1	1		1		1		
12719	2460		1	A1	283	14	1	1.2	3			3				
12719	2461		1	A1	283	14	1	0.49	1			1				
12719	2461		1	A1	281	4	3	15.05	1	1		1		1		
12719	2461		1	A1	281	4	2	5.64	2	2		2		1	1	
12719	2462			A1	283	14	2	14.3	3			3				
12719	2462			A1	283	14	1	5.51	26			26				
12719	2463		4	A1	281	4	4	33.39	1	1		1		1		
12719	2463		4	A1	283	14	3	83.33	7			7				
12719	2463		4	A1	281	4	2	0.62	1	1		1			1	
12719	2463		4	A1	283	14	1	18.06	30			30				
12719	2463		4	A1	283	14	4	280.2	5			5				
12719	2463		4	A1	283	14	2	150.91	42			42				
12719	2463		4	A1	283	14	2	14.3	3			3				
12719	2463		4	A1	283	14	6	426.7	2			2				
12719	2463		4	A1	283	14	5	376.9	6			6				
12719	2464		4	A1	283	14	1	3.28	12			12				
12719	2464		4	A1	283	14	2	3.96	2			2				
12719	2465		5	A1	283	14	1	1.41	4			4				
12719	2466	89	4	A1	283	14	2	18.2	4			4				
12719	2466	89	4	A1	283	14	1	9.66	16			16				
12719	2466	89	4	A1	283	14	3	7.87	1			1				
12719	2466	89	4	A1	283	14	4	18.13	1			1				
12719	2467	89	4	A1	283	14	3	8.09	1			1				
12719	2467	89	4	A1	283	14	1	6.94	10			10				

Site	Coll #	Feature	Lev	Blk	AC	Mat	Sz	Grams	Qty	Frac	NF	Disc P	Disc A	Cort P	Cort A	Comments
12719	2471		1	A1	283	14	2	3.91	1			1				
12719	2471		1	A1	283	14	1	0.39	1			1				
12719	2475		1	A1	283	14	1	0.94	4			4				
12719	2475		1	A1	281	6	1	0.39	1	1		1			1	
12719	2476		1	A1	283	14	1	2.4	2			2				
12719	2477		1	A1	281	4	3	8.53	1	1		1			1	
12719	2477		1	A1	281	4	2	6.15	3	3		3			3	
12719	2477		1	A1	283	14	1	2.99	9			9				
12719	2477		1	A1	283	14	2	4.51	3			3				
12719	2477		1	A1	281	4	4	47.71	1	1		1			1	
12719	2478		1	A1	281	4	4	45.68	2	2		2			2	
12719	2478		1	A1	283	14	1	6.53	10			10				
12719	2478		1	A1	283	14	2	10.12	3			3				
12719	2478		1	A1	283	14	3	9.76	1			1				
12719	2479		1	A1	281	4	3	4.27	1	1		1			1	
12719	2479		1	A1	283	14	1	8.02	26			26				
12719	2479		1	A1	283	14	2	2.7	3			3				
12719	2480		1	A1	281	7	1	0.69	1	1			1		1	
12719	2480		1	A1	281	7	2	2.85	1	1			1		1	
12719	2480		1	A1	281	4	2	5.09	2	2		2		1	1	
12719	2480		1	A1	281	4	1	0.51	1	1		1			1	
12719	2480		1	A1	281	4	3	15.14	1	1		1			1	
12719	2480		1	A1	281	4	4	79.14	2	2		2		1	1	
12719	2480		1	A1	281	4	5	70.04	1	1		1			1	
12719	2480		1	A1	283	14	6	157.4	1			1				
12719	2480		1	A1	283	14	2	7.88	1			1				
12719	2480		1	A1	283	14	1	6.33	18			18				
12719	2481		1	A1	281	4	2	1.24	1	1		1		1		
12719	2481		1	A1	283	14	2	33.49	8			8				
12719	2481		1	A1	283	14	1	10.02	14			14				
12719	2481		1	A1	283	14	3	29.45	1			1				
12719	2481		1	A1	281	4	2	0.63	1	1			1		1	
12719	2481		1	A1	281	4	4	81.93	2	2		2			2	
12719	2481		1	A1	281	4	3	20.65	3	3		3		1	2	
12719	2481		1	A1	281	4	1	3.03	4	4		4		1	3	
12719	2482		1	A1	283	14	2	27.12	11			11				
12719	2482		1	A1	283	14	1	16.77	32			32				
12719	2482		1	A1	281	6	1	0.99	2	2		2			2	
12719	2482		1	A1	281	4	2	5.01	3	3		3			3	
12719	2483		1	A1	283	14	2	6.82	2			2				
12719	2483		1	A1	281	4	5	128.41	1	1		1			1	
12719	2483		1	A1	283	14	1	1.8	4			4				
12719	2483		1	A1	283	14	3	14.71	1			1				
12719	2483		1	A1	283	14	4	37.69	1			1				
12719	2484		1	A1	281	4	3	23.15	2	2		2			2	
12719	2484		1	A1	283	14	1	6.48	9			9				
12719	2484		1	A1	281	4	4	89.24	1	1		1			1	
12719	2484		1	A1	283	14	2	17.44	4			4				
12719	2484		1	A1	281	4	2	2.38	1	1		1			1	
12719	2484		1	A1	283	14	3	34.77	3			3				
12719	2485		1	A1	281	4	3	14.12	1	1		1			1	
12719	2485		1	A1	283	14	1	5.32	12			12				
12719	2485		1	A1	283	14	2	2.86	2			2				
12719	2485		1	A1	281	4	7	7.12	1	1		1			1	
12719	2485		1	A1	281	4	2	5.54	1	1		1			1	
12719	2486		1	A1	281	4	2	8.8	3	3		3		1	2	
12719	2486		1	A1	283	14	2	4.9	2			2				
12719	2486		1	A1	281	4	3	54.37	2	2		2			2	
12719	2486		1	A1	281	6	5	4.97	1	1			1	1		
12719	2486		1	A1	283	14	1	6.54	9			9				
12719	2487		1	A1	281	4	1	1.21	1	1		1			1	
12719	2487		1	A1	281	6	2	0.82	1	1		1		1		
12719	2487		1	A1	283	14	2	14.15	6			6				
12719	2487		1	A1	283	14	1	14.26	31			31				
12719	2487		1	A1	281	4	2	8.87	3	3		3			3	1 flake
12719	2487		1	A1	281	6	1	0.15	1	1		1			1	
12719	2488		1	A1	283	14	3	11.41	1			1				
12719	2488		1	A1	283	14	2	7.62	4			4				

Site	Coll #	Feature	Lev	Blk	AC	Mat	Sz	Grams	Qty	Frac	NF	Disc P	Disc A	Cort P	Cort A	Comments
12719	2488		1	A1	283	14	1	15.45	21			21				
12719	2488		1	A1	281	4	3	20.43	2	2		2			2	
12719	2488		1	A1	281	4	4	54.9	1	1		1		1		
12719	2488		1	A1	281	6	3	6.35	1	1		1		1		
12719	2490		1	A1	283	14	2	5.3	1			1				
12719	2490		1	A1	281	4	1	1.12	1	1		1			1	
12719	2490		1	A1	281	6	2	3.77	1	1		1		1		
12719	2490		1	A1	281	4	2	6.21	3	3		3			3	
12719	2491		1	A1	283	14	2	7.03	3			3				
12719	2491		1	A1	281	4	3	16.05	1	1		1			1	
12719	2491		1	A1	281	4	1	0.81	1	1		1			1	
12719	2491		1	A1	283	14	1	2.79	6			6				
12719	2492		2	A1	821	4	2	2.08	1	1		1			1	
12719	2492		2	A1	281	4	1	1.11	2	2		2		1	1	
12719	2492		2	A1	283	14	1	3.57	5			5				
12719	2493		2	A1	283	14	1	4.44	5			5				
12719	2493		2	A1	281	4	3	15.44	1	1		1		1		
12719	2493		2	A1	281	4	4	11.54	1	1		1			1	
12719	2493		2	A1	283	14	2	1.11	1			1				
12719	2493		2	A1	283	14	3	14.87	1			1				
12719	2494		2	A1	281	4	1	0.21	1	1		1			1	
12719	2494		2	A1	283	14	3	9.58	1			1				
12719	2494		2	A1	283	14	1	2.82	3			3				
12719	2494		2	A1	281	4	2	3.57	2	2		2			2	
12719	2495		2	A1	283	14	1	5.21	12			12				
12719	2495		2	A1	281	4	1	1.4	1	1		1			1	
12719	2496		1	A1	283	14	1	3.98	10			10				
12719	2496		1	A1	283	14	2	12.96	6			6				
12719	2496		1	A1	281	4	4	50.16	1	1		1		1		
12719	2496		1	A1	281	4	2	4.28	2	2		2		1	1	
12719	2496		1	A1	281	4	1	1.38	3	3		3			3	
12719	2497		2	A1	281	4	1	1.13	3	3		3			3	
12719	2497		2	A1	283	14	2	14.24	2			2				
12719	2497		2	A1	283	14	1	6.1	10			10				
12719	2498		2	A1	281	4	2	8.45	3	3		3		1	2	
12719	2498		2	A1	281	4	1	2.59	2	2		2		1	1	
12719	2498		2	A1	283	14	1	2.86	10			10				
12719	2498		2	A1	283	14	2	3.99	2			2				
12719	2499			A1	281	6	1	0.91	1	1		1			1	
12719	2499			A1	283	14	1	5.84	9			9				
12719	2499			A1	281	4	1	0.54	3	3		3			3	
12719	2500	85	7	A1	281	6	1	0.21	2	2		2			2	
12719	2500	85	7	A1	283	14	1	4.9	9			9				
12719	2500	85	7	A1	283	14	2	2.72	2			2				
12719	2501	85	7	A1	283	14	2	5.94	3			3				
12719	2501	85	7	A1	283	14	1	4.88	4			4				
12719	2503	32	5	A1	281	4	2	2.21	2	2		2			2	
12719	2503	32	5	A1	283	14	1	3.15	4			4				
12719	2504	32	6	A1	281	4	1	0.07	1	1		1			1	
12719	2504	32	6	A1	283	14	1	1.14	4			4				
12719	2505	32	6	A1	283	14	2	1.32	1			1				
12719	2506	32	5	A1	281	4	1	0.55	1	1		1			1	
12719	2506	32	7	A1	281	4	2	3.08	1	1		1		1		
12719	2506	32	7	A1	283	14	1	3.26	6			6				
12719	2508	32	5	A1	281	4	1	0.92	1	1		1			1	
12719	2508	32	5	A1	281	4	4	26.11	1	1		1		1		
12719	2508	32	5	A1	283	14	2	12.69	5			5				
12719	2508	32	5	A1	283	14	4	43.26	1			1				
12719	2508	32	5	A1	283	14	1	5.91	9			9				
12719	2508	32	5	A1	283	14	3	8.53	1			1				
12719	2510	32	6	A1	283	14	8	832	1			1				
12719	2510	32	6	A1	283	14	4	31.48	1			1				
12719	2510	32	6	A1	283	14	4	45.67	3			3				
12719	2510	32	6	A1	283	14	1	18.01	26			26				
12719	2510	32	6	A1	283	14	2	11.8	5			5				
12719	2510	32	6	A1	283	14	3	8.56	2			2				
12719	2512	32	7	A1	283	14	3	5.55	1			1				
12719	2512	32	7	A1	283	14	1	3.29	5			5				

Site	Coll #	Feature	Lev	Blk	AC	Mat	Sz	Grams	Qty	Frac	NF	Disc P	Disc A	Cort P	Cort A	Comments
12719	2512	32	7	A1	283	14	2	13.32	3			3				
12719	2513	32	5	A1	281	4	1	1.16	1	1		1			1	
12719	2513	32	5	A1	281	4	3	14.21	1	1		1			1	
12719	2513	32	5	A1	283	14	2	6.45	2			2				
12719	2513	32	5	A1	283	14	3	4.32	1			1				
12719	2513	32	5	A1	283	14	1	1.38	1			1				
12719	2516	32	5	A1	283	14	1	16.1	15			15				
12719	2516	32	5	A1	283	14	2	24.98	9			9				
12719	2516	32	5	A1	281	4	1	0.68	2	2		2			2	
12719	2516	32	5	A1	281	4	2	2.58	2	2		2			2	
12719	2516	32	5	A1	283	14	3	35.15	2			2				
12719	2517		2	A1	281	4	2	3.03	1	1		1		1		
12719	2517		2	A1	283	14	3	4.2	1			1				
12719	2517		2	A1	281	4	5	115.46	1	1		1			1	1 flake
12719	2517		2	A1	283	14	2	3.6	2			2				
12719	2517		2	A1	283	14	1	2.41	3			3				
12719	2518		2	A1	283	14	1	2.66	4			4				
12719	2518		2	A1	281	6	4	19.1	1	1		1		1		
12719	2518		2	A1	281	4	1	0.53	1	1		1			1	
12719	2518		2	A1	283	14	2	1.54	1			1				
12719	2519	32	6	A1	283	14	3	23.6	2			2				
12719	2519	32	6	A1	281	4	2	9.86	2	2		2		1	1	
12719	2519	32	6	A1	283	14	2	26.85	7			7				
12719	2519	32	6	A1	283	14	1	30.33	33			33				
12719	2519	32	6	A1	281	4	1	0.84	2	2		2			2	
12719	2519	32	6	A1	281	4	7	643.2	1	1		1			1	
12719	2520	32	7	A1	283	14	2	4.66	2			2				
12719	2520	32	7	A1	281	7	2	2.1	1	1		1			1	
12719	2520	32	7	A1	283	14	3	17.19	1			1				
12719	2520	32	7	A1	283	14	1	5.58	7			7				
12719	2521		1	A1	283	14	4	29.2	1			1				
12719	2521		1	A1	281	4	4	17.18	1	1		1			1	
12719	2521		1	A1	283	14	2	11.04	3			3				
12719	2521		1	A1	283	14	1	1.05	3			3				
12719	2522		1	A1	281	4	2	124.36	1	1		1		1		
12719	2522		1	A1	283	14	2	1025	4			4				
12719	2522		1	A1	283	14	1	6.31	9			9				
12719	2523		2	A1	283	14	3	19.36	2			2				
12719	2523		2	A1	283	14	1	22.59	31			31				
12719	2523		2	A1	283	14	2	26.59	7			7				
12719	2523		2	A1	281	4	2	2.48	1	1		1			1	
12719	2523		2	A1	281	4	4	81.18	1	1		1		1		
12719	2523		2	A1	281	4	1	1.27	3	3		3		1	2	
12719	2524		2	A1	283	14	1	6.06	6			6				
12719	2524		2	A1	281	4	1	1.37	1	1		1			1	
12719	2524		2	A1	281	4	2	4.19	1	1		1			1	
12719	2524		2	A1	283	14	2	15.6	6			6				
12719	2524		2	A1	281	6	2	2.43	1	1		1		1		
12719	2524		2	A1	283	14	3	30.13	3			3				
12719	2525		2	A1	281	4	3	4.72	1	1		1			1	
12719	2525		2	A1	281	6	2	1.95	1	1			1	1		
12719	2525		2	A1	283	14	2	14.63	7			7				
12719	2525		2	A1	283	14	4	51.99	1			1				
12719	2525		2	A1	283	14	1	19.58	30			30				
12719	2525		2	A1	281	4	2	1.1	1	1		1			1	
12719	2526		2	A1	281	4	2	0.87	1	1		1			1	
12719	2526		2	A1	281	4	5	27.56	1	1		1			1	
12719	2526		2	A1	283	14	4	45.55	2			2				
12719	2526		2	A1	283	14	1	12.86	15			15				
12719	2526		2	A1	283	14	5	155.22	2			2				
12719	2526		2	A1	283	14	2	13.57	4			4				
12719	2526		2	A1	281	4	3	39.35	2	2		2		1	1	
12719	2527		3	A1	283	14	3	28.03	1			1				
12719	2527		3	A1	283	14	2	42.59	4			4				
12719	2527		3	A1	281	4	4	52.67	1	1		1		1		
12719	2527		3	A1	281	4	2	3.33	2	2		2			2	
12719	2527		3	A1	283	14	1	12.17	15			15				
12719	2528		4	A1	283	14	3	16.52	2			2				

Site	Coll #	Feature	Lev	Blk	AC	Mat	Sz	Grams	Qty	Frac	NF	Disc P	Disc A	Cort P	Cort A	Comments
12719	2528		4	A1	281	7	1	1.01	2	2		2			2	
12719	2528		4	A1	281	4	3	8.45	1	1		1			1	
12719	2528		4	A1	283	14	2	9.57	4			4				
12719	2528		4	A1	283	14	1	6.47	14			14				
12719	2529		3	A1	283	14	5	76.1	1			1				
12719	2529		3	A1	281	4	2	4.04	1	1		1			1	
12719	2529		3	A1	281	4	3	14.2	2	2		2			2	
12719	2529		3	A1	283	14	4	44.08	2			2				
12719	2529		3	A1	283	14	1	4.99	8			8				
12719	2529		3	A1	283	14	2	5.77	4			4				
12719	2530		2	A1	283	14	3	27.83	2			2				
12719	2530		2	A1	283	14	1	12.66	12			12				
12719	2530		2	A1	281	4	4	52	2	2		2		1	1	
12719	2530		2	A1	281	4	2	2.68	1	1		1		1		
12719	2530		2	A1	281	4	5	55.27	1	1		1		1		
12719	2530		2	A1	283	14	2	32.79	11			11				
12719	2530		2	A1	281	6	3	2.65	1	1			1	1		
12719	2530		2	A1	281	4	3	28.82	1	1		1		1		
12719	2530		2	A1	283	14	5	30.01	1			1				
12719	2531		2	A1	283	14	5	109.58	1			1				
12719	2531		2	A1	283	14	2	27.24	6			6				
12719	2531		2	A1	283	14	1	17.36	28			28				
12719	2531		2	A1	281	4	1	1.78	1	1		1			1	
12719	2531		2	A1	281	6	2	2.56	1	1			1	1		
12719	2531		2	A1	281	4	5	58.67	1	1		1			1	
12719	2531		2	A1	281	4	2	6.88	2	2		2			2	
12719	2531		2	A1	283	14	4	28.32	1			1				
12719	2532		2	A1	281	4	2	8.76	2	2		2			2	1 flake
12719	2532		2	A1	281	4	1	0.99	3	3		1	2		3	
12719	2532		2	A1	283	14	2	9.51	4			4				
12719	2532		2	A1	283	14	3	16.02	1			1				
12719	2532		2	A1	283	14	1	10.32	21			21				
12719	2533		2	A1	281	4	5	67.46	1	1		1		1		
12719	2533		2	A1	281	4	3	22.52	1	1		1			1	
12719	2533		1	A1	283	14	3	4.92	1			1				
12719	2533		2	A1	281	4	1	1.06	2	2		2			2	
12719	2533		2	A1	283	14	4	46.8	2			2				
12719	2533		1	A1	283	14	2	22.49	10			10				
12719	2533		1	A1	283	14	1	36.44	66			66				
12719	2533		2	A1	281	6	1	0.46	1	1			1		1	
12719	2533		2	A1	281	6	1	0.37	1	1			1		1	
12719	2534		1	A1	283	14	2	14.75	5			5				
12719	2534		1	A1	281	4	2	4.11	1	1		1			1	
12719	2534		1	A1	281	4	1	0.6	1	1		1			1	
12719	2534		1	A1	281	4	5	42.97	1	1		1			1	
12719	2534		1	A1	283	14	1	15.87	16			16				
12719	2534		1	A1	281	6	2	6.45	1	1			1	1		
12719	2535		2	A1	281	6	1	0.35	1	1			1		1	
12719	2535		2	A1	281	6	2	4.16	1	1			1		1	
12719	2535		2	A1	281	6	2	2.6	1	1			1		1	
12719	2535		2	A1	281	4	1	2.57	3	3		3			3	
12719	2535		2	A1	281	7	2	1.3	1	1			1		1	
12719	2535		2	A1	283	14	1	18.17	29			29				
12719	2535		2	A1	281	4	2	3.83	1	1		1		1		
12719	2535		2	A1	283	14	2	11.49	5			5				
12719	2536		1	A1	281	4	1	2.62	2	2		2		1	1	
12719	2536		1	A1	281	4	2	4.64	2	2		2		1	1	
12719	2536		1	A1	283	14	2	24.25	9			9				
12719	2536		1	A1	283	14	1	29.68	57			57				
12719	3000		3	B1	281	4	1	0.68	2		2	2		2		
12719	3000		3	B1	283	14	1	1.08	6			6				
12719	3000		3	B1	283	14	2	5.32	2			2				
12719	3001		3	B1	283	14	2	4.39	1			1				
12719	3001		3	B1	283	14	3	30.18	3			3				
12719	3001		3	B1	281	4	1	3.33	7	7		7		7		
12719	3001		3	B1	281	4	2	4.38	2	2		2		1	1	
12719	3001		3	B1	281	4	3	15.88	2	2		2		2		
12719	3001		3	B1	283	14	1	4.16	19			19				

Site	Coll #	Feature	Lev	Blk	AC	Mat	Sz	Grams	Qty	Frac	NF	Disc P	Disc A	Cort P	Cort A	Comments
12719	3002		3	B1	283	14	2	21.2	7			7				
12719	3002		3	B1	283	14	3	8.32	1			1				
12719	3002		3	B1	283	14	1	9.05	25			25				
12719	3002		3	B1	281	4	1	4.76	8		8	8		8		
12719	3002		3	B1	281	4	2	4.28	1		1	1		1		
12719	3003		3	B1	283	14	2	17.3	5			5				
12719	3003		3	B1	283	14	3	28.17	3			3				
12719	3003		3	B1	283	14	1	9.03	18			18				
12719	3004		3	B1	283	14	1	5.52	6			6				
12719	3004		3	B1	283	14	3	8.62	2			2				
12719	3004		3	B1	283	14	2	27.57	8			8				
12719	3005		4	B1	283	14	2	18.95	10			10				
12719	3005		4	B1	283	14	3	5.36	1			1				
12719	3005		4	B1	281	4	3	9.72	1		1	1		1		
12719	3005		4	B1	281	4	1	2.58	9	8	1	9		8	1	
12719	3005		4	B1	283	14	1	6.84	21			21				
12719	3006		4	B1	283	14	1	8.49	23			23				
12719	3006		4	B1	281	4	5	817.7	4	4		4		4		from same rock
12719	3006		4	B1	281	4	4	51.41	2	2		2		2		
12719	3006		4	B1	281	4	1	9.69	22	22		22		7	15	
12719	3006		4	B1	283	14	2	12.61	7			7				
12719	3006		4	B1	281	4	3	7.94	1	1		1		1		
12719	3006		4	B1	281	4	2	36.39	6	6		6		4	2	
12719	3007		4	B1	281	4	1	6.71	15	15		15		9	6	
12719	3007		4	B1	281	4	2	6.78	2	2		2		2		
12719	3007		4	B1	283	14	1	9.85	18			18				
12719	3007		4	B1	281	4	4	162.98	2	2		2		2		
12719	3007		4	B1	281	4	3	7.65	2	2		2		1	1	
12719	3007		4	B1	283	14	2	35.21	13			13				
12719	3008		4	B1	281	4	3	15.83	2	2		2		2		
12719	3008		4	B1	281	4	1	2	6	6		6		4	2	
12719	3008		4	B1	281	4	2	10.65	2	2		2		2		
12719	3008		4	B1	281	4	6	187.42	1	1		1		1		
12719	3008		4	B1	283	14	2	19.55	8			8				
12719	3008		4	B1	283	14	1	5.66	14			14				
12719	3009		4	B1	283	14	2	18.29	4			4				
12719	3009		4	B1	283	14	3	12.02	1			1				
12719	3009		4	B1	281	4	2	7.83	1	1		1			1	
12719	3009		4	B1	283	14	1	7.4	17			17				
12719	3009		4	B1	283	14	4	30.3	1			1				
12719	3010		3	B1	281	4	1	5.62	16	14	2	16		4	12	
12719	3010		3	B1	283	14	2	22.56	10			10				
12719	3010		3	B1	281	4	2	14.78	6	2	4	6		6		
12719	3010		3	B1	283	14	1	2.51	16			16				
12719	3011		3	B1	281	4	1	5.23	12	9	3	12		7	5	
12719	3011		3	B1	283	14	3	7.07	1			1				
12719	3011		3	B1	283	14	2	14.25	5			5				
12719	3011		3	B1	283	14	1	5.65	23			23				
12719	3012		4	B1	281	4	2	3.26	1							
12719	3012		4	B1	283	14	1	8.14	17			17				
12719	3012		4	B1	283	14	2	12.34	4			4				
12719	3012		4	B1	283	14	4	14.53	1			1				
12719	3012		4	B1	281	4	1	1.31	3	3		3		1	2	
12719	3012		4	B1	283	14	3	20.7	2			2				
12719	3013		4	B1	281	4	2	5.38	3	2	1	3		2	1	
12719	3013		4	B1	281	4	1	1.53	10	9	1	8	2	2	8	
12719	3013		4	B1	283	14	1	4.16	12			12				
12719	3013		4	B1	283	14	2	14.74	5			5				
12719	3014		3	B1	281	4	1	26.2	71	71		71		71		
12719	3014		3	B1	283	14	1	2.95	5			5				
12719	3014		4	B1	281	4	6	258.3	1	1		1		1		
12719	3014		3	B1	283	14	4	32.49	1			1				
12719	3014		3	B1	283	14	2	8.45	3			3				
12719	3014		3	B1	281	4	2	21.13	6	6		6		6		
12719	3014		3	B1	281	4	4	35.95	4	4		4		4		
12719	3014		4	B1	281	4	5	131.96	1	1		1		1		
12719	3014		3	B1	281	4	3	14.47	1	1		1		1		
12719	3015		4	B1	283	14	2	10.05	7			7				

12719 3015

Site	Coll #	Feature	Lev	Blk	AC	Mat	Sz	Grams	Qty	Frac	NF	Disc P	Disc A	Cort P	Cort A	Comments
12719	3015		4	B1	281	4	5	58.9	1	1		1		1		
12719	3015		4	B1	281	4	2	53.46	15	15		15		15		
12719	3015		4	B1	283	14	1	4.33	15			15				
12719	3015		4	B1	283	14	3	14.99	2			2				
12719	3015		4	B1	281	4	1	32.04	87	87		87		87		
12719	3015		4	B1	281	4	4	64.28	2	2		2		2		
12719	3015		4	B1	281	4	3	30.84	4	4		4		4		
12719	3016		4	B1	283	14	1	5.3	20			20				
12719	3016		4	B1	281	4	6	158.57	1	1		1		1		
12719	3016		4	B1	281	4	5	16.72	1	1		1			1	
12719	3016		4	B1	283	14	2	3.44	2			2				
12719	3016		4	B1	281	4	2	4.82	1	1			1	1		
12719	3016		4	B1	281	4	1	5.57	11	11		11		11		
12719	3017		4	B1	281	4	1	7.44	10	10		10		10		
12719	3017		4	B1	281	4	2	4.01	1	1		1		1		
12719	3017		4	B1	281	4	3	40.73	2	2		2		2		
12719	3017		4	B1	283	14	2	6.72	4			4				
12719	3017		4	B1	283	14	1	4.43	12			12				
12719	3018		5	B1	283	14	1	1.34	6			6				
12719	3018		5	B1	283	14	2	1.68	2			2				
12719	3018		5	B1	281	4	2	0.46	1	1		1		1		
12719	3018		5	B1	281	4	3	18.95	2	2		2		2		
12719	3018		5	B1	281	4	1	2.43	9	9		9		3	6	
12719	3019		5	B1	283	14	1	2.24	6			6				
12719	3019		5	B1	281	4										
12719	3019		5	B1	283	14	2	2.63	1			1				
12719	3019		5	B1	283	14	3	6.14	1			1				
12719	3020		5	B1	281	4	1	4.19	3	3		3		2	1	
12719	3020		5	B1	283	14	2	8.79	2			2				
12719	3020		5	B1	283	14	1	1.98	6			6				
12719	3021		5	B1	281	4	1	0.61	3	3		3			3	
12719	3021		5	B1	283	14	1	3.2	5			5				
12719	3022		5	B1	281	4	1	0.99	1	1		1			1	
12719	3022		5	B1	283	14	2	1.57	1	1		1			1	
12719	3022		5	B1	281	4	2	1.81	1	1		1			1	
12719	3022		5	B1	283	14	1	1.31	5	5		5			5	
12719	3023		5	B1	283	14	2	1.41	1			1				
12719	3023		5	B1	281	4	1	2.76	4	4		4			4	
12719	3023		5	B1	281	6	2	2.7	1	1			1	1		
12719	3023		5	B1	281	4	2	17.7	3	3		3		1	2	
12719	3023		5	B1	283	14	1	0.92	3			3				
12719	3023		5	B1	281	4	3	20.1	1		1	1		1		
12719	3024		5	B1	283	14	1	3.48	6			6				
12719	3024		5	B1	281	4	1	2.71	3	3		3			3	
12719	3025		5	B1	281	4	2	13.28	4	4		4		2	2	
12719	3025		5	B1	283	14	2	8.03	5			5				
12719	3025		5	B1	281	6	1	0.91	2	2		2			2	
12719	3025		5	B1	283	14	1	6.94	20			20				
12719	3025		5	B1	281	4	1	3.28	6	6		6			6	
12719	3025		5	B1	281	4	5	114.62	1	1		1		1		
12719	3026		5	B1	281	4	1	3.52	6	6		6			6	
12719	3026		5	B1	281	4	2	5.48	2	2		2		1	1	
12719	3026		5	B1	281	6	2	1.23	1	1		1			1	
12719	3026		5	B1	283	14	2	5.49	3			3				
12719	3026		5	B1	281	4	2	10.96	1	1		1		1		
12719	3026		5	B1	283	14	1	10.78	32			32				
12719	3027		5	B1	281	4	4	76.81	1	1		1		1		
12719	3027		5	B1	281	4	2	6.82	3	3		3		1	2	
12719	3027		5	B1	283	14	2	15	5			5				
12719	3027		5	B1	283	14	1	6.11	13			13				
12719	3027		5	B1	283	14	3	6.1	1			1				
12719	3027		5	B1	281	4	3	16.58	1	1		1		1		
12719	3027		5	B1	281	4	1	3.6	8	8		8			8	
12719	3028		4	B1	283	14	1	5.02	8			8				
12719	3028		4	B1	281	4	1	8.18	11	11		11		1	10	
12719	3028		4	B1	283	14	2	24.39	6			6				
12719	3029		5	B1	283	14	1	5.68	17			17				
12719	3029		5	B1	283	14	3	11.46	1			1				

Site	Coll #	Feature	Lev	Blk	AC	Mat	Sz	Grams	Qty	Frac	NF	Disc P	Disc A	Cort P	Cort A	Comments
12719	3029		5	B1	281	4	2	4.08	2	2		2			2	
12719	3029		5	B1	283	14	2	9.59	6			6				
12719	3029		5	B1	281	4	1	0.84	4	4		4			4	
12719	3029		5	B1	281	4	4	32.2	1	1		1		1		
12719	3030		5	B1	283	14	1	6.7	19			19				
12719	3030		5	B1	281	4	3	27.21	2	2		2		2		
12719	3030		5	B1	283	14	2	13.63	7			7				
12719	3030		5	B1	281	4	2	4.05	2	2		2			2	
12719	3030		5	B1	281	4	1	2.95	9	9		9			9	
12719	3030		5	B1	281	4	4	36.17	1	1		1		1		
12719	3031		5	B1	281	4	1	2.84	9	9		9			9	
12719	3032		4	B1	283	14	1	5.29	11			11				
12719	3032		4	B1	283	14	2	9	3			3				
12719	3032		4	B1	283	14	3	9.43	1			1				
12719	3032		4	B1	281	4	1	3.77	6	6		6		1	5	
12719	3033		6	B1	281	4	2	1.45	1	1		1		1		
12719	3033		6	B1	281	4	3	14.45	1	1		1		1		1 flake
12719	3033		6	B1	281	4	1	0.53	3	3		3			3	
12719	3034		5	B1	283	14	2	13.02	6			6				
12719	3034		5	B1	281	4	1	1.82	9	9		9			9	
12719	3034		5	B1	283	14	1	5.67	14			14				
12719	3034		5	B1	281	4	2	3.15	2	2		2			2	
12719	3035		6	B1	281	4	1	0.33	2	2		2			2	
12719	3035		6	B1	281	4	2	4.98	1	1		1		1		
12719	3036		5	B1	283	14	1	3.05	11			11				
12719	3036		5	B1	281	4	3	20.54	1	1		1		1		
12719	3036		5	B1	281	4	1	4.29	10	10		10			10	
12719	3036		5	B1	281	4	2	5.76	5	5		5			5	
12719	3036		5	B1	283	14	2	6.12	1			1				
12719	3038		4	B1	281	4	2	1.97	2	2		2		1	1	
12719	3038		4	B1	283	14	2	5.13	3			3				
12719	3038		4	B1	281	4	1	1.21	4	4		4			4	
12719	3038		4	B1	283	14	1	5.85	10			10				
12719	3039		5	B1	283	14	2	11.91	3			3				
12719	3039		5	B1	283	14	4	18.89	1			1				
12719	3039		5	B1	281	4	1	2.05	5	5		5		1	4	
12719	3039		5	B1	281	6	1	0.22	1	1		1			1	
12719	3039		5	B1	283	14	1	1.59	7			7				
12719	3040		5	B1	283	14	2	11.23	3			3				
12719	3040		5	B1	281	4	1	2.53	6	6		6			6	
12719	3040		5	B1	283	14	1	2.62	10			10				
12719	3040		5	B1	281	4	2	0.88	1	1		1			1	
12719	3041		5	B1	281	4	4	35.05	1	1		1		1		
12719	3041		5	B1	281	4	1	1.68	4	4		4			4	
12719	3041		5	B1	281	4	2	5.48	4	4		4			4	
12719	3042		5	B1	283	14	1	6.06	13			13				
12719	3042		5	B1	281	6	5	25.04	1	1		1			1	
12719	3042		5	B1	283	14	2	8.61	3			3				
12719	3042		5	B1	283	14	4	15.92	1			1				
12719	3043		5	B1	281	4	3	16.35	5	5		5		5		
12719	3043		5	B1	281	6	2	1.85	1	1		1			1	
12719	3043		5	B1	283	14	1	0.83	5			5				
12719	3043		5	B1	281	4	2	5.5	1	1		1		1		
12719	3043		5	B1	283	14	2	1.08	1			1				
12719	3043		5	B1	281	4	1	5.21	7	7		7			7	
12719	3044		5	B1	281	4	1	4.64	12	12		12			12	
12719	3044		5	B1	283	14	1	10.33	30			30				
12719	3044		5	B1	283	14	3	11.76	1			1				
12719	3044		5	B1	283	14	2	4.64	2			2				
12719	3044		5	B1	281	4	2	7.26	4	4		4			4	
12719	3045		5	B1	283	14	3	18.82	1			1				
12719	3045		5	B1	283	14	2	9.5	3			3				
12719	3045		5	B1	283	14	1	3.62	7			7				
12719	3045		5	B1	281	6	2	1.2	1	1		1	1	1		
12719	3045		6	B1	281	4	1	1.38	4	4		4			4	
12719	3045		5	B1	281	4	2	3.41	2	2		2			2	
12719	3046		6	B1	281	4	1	9.09	18	18		18			18	
12719	3046		6	B1	281	4	5	126.45	1	1		1		1		

Site	Coll #	Feature	Lev	Blk	AC	Mat	Sz	Grams	Qty	Frac	NF	Disc P	Disc A	Cort P	Cort A	Comments
12719	3046		6	B1	281	4	3	8.57	1	1		1		1		
12719	3046		6	B1	281	4	2	25.01	6	6		6			6	
12719	3046		6	B1	283	14	1	16.4	45			45				
12719	3046		6	B1	283	14	3	34.68	3			3				
12719	3046		6	B1	283	14	2	12.52	4			4				
12719	3047		6	B1	283	14	1	6.08	22			22				
12719	3047		6	B1	283	14	2	10.31	4			4				
12719	3047		6	B1	281	4	2	7.63	1	1		1			1	
12719	3047		6	B1	281	4	3	30.42	1	1		1			1	
12719	3047		6	B1	281	4	4	82.36	2	2		2		1	1	
12719	3047		6	B1	281	4	1	6.76	10	10		10			10	
12719	3048		6	B1	281	4	2	7.78	2	2		2		1	1	
12719	3048		6	B1	283	14	1	5.22	14			14				
12719	3048		6	B1	281	4	1	3.38	6	6		6			6	
12719	3048		6	B1	281	4	4	26.77	1	1		1		1		
12719	3049		6	B1	283	14	2	11.82	6			6				
12719	3049		6	B1	281	4	1	2.44	2	2		2			2	
12719	3049		6	B1	281	4	5	140.84	1	1		1		1		
12719	3049		6	B1	283	14	1	7.39	22			22				
12719	3050		6	B1	281	4	1	0.91	1	1		1			1	
12719	3050		6	B1	283	14	3	11.88	1			1				
12719	3050		6	B1	281	4	4	42.61	2	2		2			2	
12719	3050		6	B1	283	14	1	4.44	11			11				
12719	3050		6	B1	283	14	2	7.76	2			2				
12719	3051		6	B1	281	4	1	0.52	1	1		1			1	
12719	3051		6	B1	283	14	2	4.81	4			4				
12719	3051		6	B1	283	14	1	2.97	9			9				
12719	3051		6	B1	281	4	3	6.93	1	1		1			1	
12719	3051		6	B1	281	4	2	4.83	1	1		1			1	
12719	3052		6	B1	283	14	2	4.22	1			1				
12719	3052		6	B1	281	4	5	45.25	1	1		1			1	
12719	3052		6	B1	283	14	1	1.07	3			3				
12719	3052		6	B1	281	6	1	1.74	2	2		2			2	
12719	3053		6	B1	283	14	1	1.53	2			2				
12719	3053		6	B1	281	4	2	4.05	1	1		1		1		
12719	3054		6	B1	281	4	1	0.23	1	1		1			1	
12719	3054		6	B1	283	14	2	7	2			2				
12719	3055		6	B1	283	14	1	1.43	3			3				
12719	3058		6	B1	281	4	4	12.28	1	1		1		1		
12719	3058		6	B1	283	14	1	2.87	4			4				
12719	3060		6	B1	283	14	1	0.44	4			4				
12719	3063		6	B1	283	14	1	1.61	5			5				
12719	3063		6	B1	281	4	1	3.11	4	4		4			4	
12719	3064		6	B1	281	4	2	12.11	2	2		2			2	
12719	3064		6	B1	283	14	1	0.53	2			2				
12719	3064		6	B1	281	4	1	1.04	1	1		1			1	
12719	3065		6	B1	283	14	1	1.82	7			7				
12719	3066		6	B1	283	14	1	1.38	1			1				
12719	3066		6	B1	283	14	3	8.63	1			1				
12719	3066		6	B1	283	14	2	2.41	2			2				
12719	3067		5	B1	283	14	1	1.6	10			10				
12719	3067		5	B1	283	14	3	13.46	1			1				
12719	3068		6	B1	283	14	2	4.87	1			1				
12719	3068		6	B1	283	14	1	3.38	7			7				
12719	3069		5	B1	283	14	1	2.81	3			3				
12719	3070		5	B1	283	14	1	2.69	7			7				
12719	3070		5	B1	283	14	2	5.36	2			2				
12719	3071		6	B1	283	14	4	36.63	1			1				
12719	3071		6	B1	283	14	2	3.17	1			1				
12719	3071		6	B1	283	14	3	13.19	2			2				
12719	3071		6	B1	283	14	1	1.95	5			5				
12719	3072		5	B1	281	4	2	4.17	1	1		1			1	
12719	3072		5	B1	281	4	1	1.95	2	2		2			2	
12719	3072		5	B1	283	14	2	5.83	2			2				
12719	3072		5	B1	283	14	1	0.26	1			1				
12719	3072		5	B1	281	4	3	15.17	1	1		1		1		
12719	3074	30	6	B1	281	4	1	6.03	9	9		9			9	
12719	3074	30	6	B1	281	4	5	142.59	1	1		1		1		

Site	Coll #	Feature	Lev	Blk	AC	Mat	Sz	Grams	Qty	Frac	NF	Disc P	Disc A	Cort P	Cort A	Comments
12719	3074	30	6	B1	281	4	2	41.94	7	7		7		2	5	
12719	3074	30	6	B1	283	14	2	14.18	4			4				
12719	3074	30	6	B1	283	14	1	9.61	20			20				
12719	3074	30	6	B1	281	4	6	141.08	1	1		1			1	
12719	3075	30	6	B1	281	4	4	144.8	5	5		5		2	3	
12719	3075	30	6	B1	281	4	3	79.16	7	7		7		2	5	
12719	3075	30	6	B1	281	4	5	363.4	3	3		3		2	1	
12719	3075	30	6	B1	281	4	2	37.72	13	13		13			13	
12719	3075	30	6	B1	283	14	4	38.21	1			1				
12719	3075	30	6	B1	283	14	3	19.4	1			1				
12719	3075	30	6	B1	283	14	5	212.8	1			1				
12719	3075	30	6	B1	283	14	2	27.33	12			12				
12719	3075	30	6	B1	283	14	1	21.02	45			45				
12719	3075	30	6	B1	281	4	1	11.02	12	12		12			12	
12719	3076	30	6	B1	281	4	3	52.94	4	4		4		2	2	
12719	3076	30	6	B1	281	4	5	49.14	1	1		1		1		
12719	3076	30	6	B1	281	4	4	21.46	1	1		1		1		
12719	3076	30	6	B1	281	4	2	21.38	5	5		5			5	
12719	3076	30	6	B1	283	14	5	154.37	2			2				
12719	3076	30	6	B1	283	14	1	22.9	51			51				
12719	3076	30	6	B1	283	14	2	7.55	4			4				
12719	3076	30	6	B1	281	4	1	11.55	14	14		14			14	
12719	3077	30	6	B1	281	4	4	34.24	1	1		1		1		
12719	3078	30	6	B1	281	4	4	34.12	1	1		1		1		
12719	3079	30	5	B1	281	4	1	12.45	20	20		20		2	18	
12719	3079	30	5	B1	281	4	5	55.89	1	1		1			1	
12719	3079	30	5	B1	283	14	2	10.17	5			5				
12719	3079	30	5	B1	283	14	5	120.06	1			1				
12719	3079	30	5	B1	283	14	1	25.01	60			60				
12719	3079	30	5	B1	283	14	3	32.65	4			4				
12719	3079	30	5	B1	281	4	2	24.69	8	8		8			8	
12719	3088		6	B1	283	14	1	2.93	2			2				
12719	3089		6	B1	283	14	1	2.98	2			2				
12719	3090		7	B1	283	14	3	7.07	1			1				
12719	3090		7	B1	283	14	2	1.19	1			1				
12719	3090		7	B1	283	14	1	1.1	3			3				
12719	3095	77	5	B1	283	14	2	9.23	2			2				
12719	3095	77	5	B1	283	14	3	8.31	1			1				
12719	3096		4	B1	281	4	2	2.87	1	1		1			1	
12719	3096		4	B1	283	14	1	0.72	2			2				
12719	3097		5	B1	283	14	3	16.49	1			1				
12719	3097		5	B1	281	4	2	8.88	1	1		1			1	
12719	3097		5	B1	283	14	1	0.24	1			1				
12719	3097		5	B1	283	14	2	6.89	1			1				
12719	3098	32	6	A1	283	14	1	0.1	1			1				
12719	3099		1	A1	283	14	1	1.78	1			1				
12719	3099		1	A1	283	14	2	9.79	2			2				
12719	3099		1	B1	281	4	2	2.43	1	1		1	1	1		
12719	3099		1	A1	281	4	2	5.77	1	1		1			1	
12719	3099		1	A1	283	14	5	93.15	1			1				
12719	3099		1	A1	281	4	3	14.71	1	1		1			1	
12719	4001		1	A1	283	14	4	10.02	1			1				
12719	4001		1	A1	283	14	2	17.57	5			5				
12719	4001		1	A1	281	4	1	0.83	1	1		1			1	
12719	4001		1	A1	283	14	1	9.79	22			22				
12719	4001		1	A1	281	6	3	5.88	1	1		1	1	1		
12719	4001		1	A1	281	4	2	6.59	1	1		1		1		
12719	4001		1	A1	281	4	3	23.99	1	1		1		1		
12719	4002		1	A1	281	4	2	5.19	3	3		3			3	
12719	4002		1	A1	283	14	3	129.58	12			12				
12719	4002		1	A1	281	6	3	2.87	1	1		1		1		
12719	4002		1	A1	281	4	2	23.02	8	8		8			8	
12719	4002		1	A1	281	4	1	2.43	7	7		7			7	
12719	4002		1	A1	281	4	3	10.36	1	1		1		1		
12719	4002		1	A1	283	14	4	219.9	9			9				
12719	4002		1	A1	283	14	2	166.83	52			52				
12719	4002		1	A1	283	14	1	78.94	89			89				
12719	4002		1	A1	281	4	4	64.37	3	3		3				

Site	Coll #	Feature	Lev	Blk	AC	Mat	Sz	Grams	Qty	Frac	NF	Disc P	Disc A	Cort P	Cort A	Comments
12719	4002		1	A1	283	14	5	144.77	2			2				
12719	4003		1	A1	281	4	1	0.65	1	1		1			1	
12719	4003		1	A1	281	6	1	0.87	1	1		1			1	
12719	4004		1	A1	283	14	2	5.86	3			3				
12719	4004		1	A1	281	4	2	5	2	2		2			2	
12719	4004		1	A1	281	4	1	0.2	2	2		2			2	
12719	4004		1	A1	283	14	3	13.08	1			1				
12719	4004		1	A1	283	14	1	1.5	4			4				
12719	4004		1	A1	281	4	4	72.61	2	2		2			2	
12719	4005		1	A1	283	14	1	3.46	4			4				
12719	4005		1	A1	283	14	2	4.36	2			2				
12719	4006		1	A1	283	14	1	96.61	92			92				
12719	4006		1	A1	283	14	6	237.8	1			1				
12719	4006		1	A1	283	14	5	105.94	2			2				
12719	4006		1	A1	283	14	2	81.78	29			29				
12719	4006		1	A1	283	14	3	84.94	10			10				
12719	4006		1	A1	281	6	2	2.39	1	1		1			1	
12719	4006		1	A1	281	4	2	21.96	7	7		7			7	
12719	4006		1	A1	281	4	5	178.84	1	1		1				
12719	4006		1	A1	281	4	4	81.14	2	2		1	1	1	1	
12719	4006		1	A1	281	4	1	9.51	14	14		14			14	
12719	4006		1	A1	281	4	3	56.04	4	4		4			4	
12719	4010		2	A1	283	14	1	6.99	12			12				
12719	4010		2	A1	283	14	2	2.56	2			2				
12719	4010		2	A1	281	4	2	8.63	3	3		3			3	
12719	4010		2	A1	281	4	4	63.49	2	2		2			2	
12719	4014		3	A1	283	14	1	6.98	7			7				

Site	Coll #	Feature	Lv	Blk	AC	Mat	Sz	Grams	Qty	Fr	NF	Disc P	Disc A	Cort P	Cort A	Comm
13237	123				281	4	4	974.8	31	16	15	31		31		
13237	123				281	4	5	314.8	5	5		5		5		
13237	123				281	4	1	18.37	21	15	6	21		11	10	
13237	123				281	4	2	356.3	80	18	62	80		80		
13237	123				281	4	3	890.4	77	30	47	77		77		
13237	190	45			281	6	3	9.82	1	1		1		1		
13237	500		2	B1	281	4	4	177.4	4	4				4		
13237	500		2	B1	281	4	3	212.3	21	11	10	21		12	9	
13237	500		2	B1	281	4	2	117.8	38	38		38		13	25	
13237	501		2	B1	281	4	3	154.85	15	13	2	15		8	7	
13237	501		2	B1	281	4	1	20.98	34	25	9	34		11	14	
13237	501		2	B1	281	4	2	100.19	35	15	20	35		25	10	
13237	502		2	C1	281	4	4	69.3	1	1		1		1		
13237	502		2	C1	281	4	2	67.7	21	16	5	21		7	14	
13237	502		2	C1	281	4	3	95.5	10	7	3	7		6	4	
13237	503		2	B1	281	4	5	901.4	11	5	6	11		9	2	
13237	503		2	B1	281	4	4	207.7	6	2	4	6		4	2	
13237	503		2	B1	281	4	1	30.92	29	29		29		5	24	
13237	503		2	B1	281	4	2	226	49	31	18	49		31	18	
13237	503		2	B1	281	4	3	458	37	25	12	37		19	18	
13237	507		2	B1	281	4	6	253.1	1	1			1	1		
13237	507		2	B1	281	4	5	482.7	2	2		1	1	1	1	
13237	507		2	B1	281	4	2	71.54	18		18	18		18		
13237	507		2	B1	281	4	3	66.05	4	2	2	4		3	1	
13237	507		2	B1	281	4	4	231.1	7	7		7			7	
13237	510		2	B1	281	4	6	622.6	1		1	1		1		
13237	510		2	B1	281	4	4	222.7	9	2	7	9		4	5	
13237	510		2	B1	281	1	4	100.7	1	1		1		1		
13237	510		2	B1	281	4	2	79.42	25	13	12	25			25	
13237	510		2	B1	281	4	3	93.95	9	2	7	9		1	8	
13237	511		2	B1	281	4	6	402.1	2	1	1	2		2		
13237	511		2	B1	281	4	7	418.4	1		1	1		1		
13237	511		2	B1	281	4	5	866.7	8	5	3	6	2	6	2	
13237	511		2	B1	281	4	1	12.16	19	19		19			19	
13237	511		2	B1	281	4	2	186.5	54	43	11	54		15	39	
13237	511		2	B1	281	4	4	660.3	21	15	6	21		12	9	
13237	511		2	B1	281	4	3	370.58	37	25	12	36	1	22	15	
13237	512		2	B1	281	4	5	277.8	5	2	3	3	2	5		
13237	512		2	B1	281	4	4	535.5	16	6	10	16		16		
13237	512		2	B1	281	4	1	1.05	1	1		1			1	
13237	512		2	B1	281	4	2	77.51	15	7	8	13	2	7	8	
13237	512		2	B1	281	4	3	433.8	28	19	9	16	12	25	3	
13237	515		2	B1	281	4	4	143.14	5	4	1	2	3	2	3	
13237	515		2	B1	281	4	2	87.3	19	13	6	10	9	1	18	
13237	515		2	B1	281	4	1	4.45	3	2	1	2	1		3	
13237	515		2	B1	281	4	3	74.9	7	5	2	7		1	6	
13237	516		2	B1	281	4	5	59.11	1	1		1		1		
13237	516		2	B1	281	4	6	272.9	1	1		1		1		
13237	516		2	B1	281	4	4	196.4	8	8		3	5	3	5	
13237	516		2	B1	281	4	1	2.45	5	5		5		1	4	
13237	516		2	B1	281	1	2	3.97	1	1		1		1		
13237	516		2	B1	281	4	3	102.51	13	13		8	5	2	11	
13237	516		2	B1	281	4	2	83.48	31	31		25	6	1	30	
13237	517		2	B1	281	4	5	230.4	5	5		3	2	3	2	
13237	517		2	B1	281	4	6	533.3	2	2			2	2		
13237	517		2	B1	281	4	2	89.36	27	27		25	2	4	23	
13237	517		2	B1	281	4	1	9.79	11	11		3	8	3	8	
13237	517		2	B1	281	4	4	231.8	11	11		4	7	1	10	
13237	517		2	B1	281	4	3	134.08	14	14		13	1	4	10	
13237	518		2	B1	281	4	5	484.1	7	7		3	4	3	4	
13237	518		2	B1	283	14	2	4.04	1			1				
13237	518		2	B1	281	4	2	251.5	63	61	2	38	23	7	56	
13237	518		2	B1	281	4	1	43.43	41	40	1	31	10	2	39	
13237	518		2	B1	281	4	4	592.6	21	21		8	13	3	18	
13237	518		2	B1	281	4	3	309.9	28	28		15	9	3	25	
13237	519		2	B1	281	4	4	100.3	27	25	2	15	12	6	21	
13237	519		2	B1	281	4	5	639.6	8	7	1	4	4	1	7	
13237	519		2	B1	281	4	1	19.04	18	18		15	3	2	16	
13237	519		2	B1	281	1	2	2.72	1	1		1		1		

Site	Coll #	Feature	Lv	Blk	AC	Mat	Sz	Grams	Qty	Fr	NF	Disc P	Disc A	Cort P	Cort A	Comm
13237	519		2	B1	281	4	3	523.1	43	41	2	18	25	2	41	
13237	519		2	B1	281	4	2	268.7	63	62	1	46	17	3	60	
13237	520		3	B1	281	4	5	333	3	3		1	2	2	1	
13237	520		3	B1	281	4	4	676.6	18	18		16	2	4	14	
13237	520		3	B1	281	4	2	334.4	70	68	2	57	13	6	64	
13237	520		3	B1	281	4	1	22.48	18	18		18		1	17	
13237	520		3	B1	281	4	3	420.2	31	31		23	8	7	24	
13237	521		3	B1	281	4	5	162	3	3		2	1	2	1	
13237	521		3	B1	281	4	7	780.5	1		1	1		1		
13237	521		3	B1	281	4	4	47.22	3	3		3			3	
13237	521		3	B1	281	4	1	22.16	20	20		19	1	1	19	
13237	521		3	B1	281	1	4	25.52	1	1		1		1		
13237	521		3	B1	281	4	3	209.6	23	22	1	21	2	4	19	
13237	521		3	B1	281	4	2	123.62	36	36		34	2	5	31	
13237	522		3	B1	281	4	6	508.1	1	1		1		1		
13237	522		3	B1	281	4	7	488.4	1	1		1		1		
13237	522		3	B1	281	4	5	1503.9	14	14		14		14		
13237	522		3	B1	281	4	2	192	48	26	22	48		11	37	
13237	522		3	B1	281	4	1	15.48	27	25	2	27		3	24	
13237	522		3	B1	281	4	4	774	22	19	3	22		22		
13237	522		3	B1	281	4	3	445.9	35	24	11	35		7	28	
13237	523		3	B1	281	4	6	165	1	1		1		1		
13237	523		3	B1	281	4	7	1208.4	3	2	1	3		3		
13237	523		3	B1	281	4	5	400.5	7	3	4	7		7		
13237	523		3	B1	281	4	2	159.07	47	21	26	47		33	14	
13237	523		3	B1	281	4	1	14.33	11	2	9	11		10	1	
13237	523		3	B1	281	4	4	618.5	14	9	5	14		10	4	
13237	523		3	B1	281	4	3	323.2	30	15	15	38	2	28	2	
13237	524		3	B1	281	4	5	49.45	1	1		1		1		
13237	524		3	B1	281	4	4	110.16	4		4	4		4		
13237	524		3	B1	281	4	2	106.3	36	7	29	36		36		
13237	524		3	B1	281	4	1	16.55	19	3	16	19		19		
13237	524		3	B1	281	4	3	177.8	23	6	17	23		20	3	
13237	525		3	B1	281	4	6	1165	3	1	2	3		3		
13237	525		3	B1	281	4	7	536.8	1		1	1		1		
13237	525		3	B1	281	4	5	612.5	6	2	4	6		5	1	
13237	525		3	B1	281	4	2	128.3	26	15	11	26		17	9	
13237	525		3	B1	281	4	1	1.57	1	1		1			1	
13237	525		3	B1	281	4	4	750.5	18	5	13	18		16	2	
13237	525		3	B1	281	4	3	501.5	29	6	23	29		24	5	
13237	526		3	B1	281	4	5	484.7	5	5		4	1	4	1	
13237	526		3	B1	281	4	4	375.9	15	12	3	12	3	5	10	
13237	526		3	B1	281	4	7	433.7	1	1		1		1		
13237	526		3	B1	281	4	6	187.7	1	1		1		1		
13237	526		3	B1	281	1	5	87.84	1	1			1	1		
13237	526		3	B1	281	1	4	80.65	1	1		1		1		
13237	526		3	B1	281	1	3	30.05	2	2		2		2		
13237	526		3	B1	281	4	3	422.4	42	40	2	38	4	10	32	
13237	526		3	B1	281	4	2	176.57	47	45	2	47		8	39	
13237	526		3	B1	281	4	1	21.86	20	20		20		1	19	
13237	527		3	B1	281	4	5	171.1	3	2	1	3		2	1	
13237	527		3	B1	281	4	6	551.3	3	3		2	1	2	1	2 FLKS
13237	527		3	B1	281	4	5	1025.9	14	14		10	4	6	8	
13237	527		3	B1	281	4	2	958.6	277	275	2	274	3	42	235	
13237	527		3	B1	281	4	1	185.64	221	220	1	218	3	14	207	
13237	527		3	B1	281	4	4	668.2	27	27		24	3	9	18	
13237	527		3	B1	281	4	3	1002.8	90	85	5	85	5	27	63	
13237	528		3	B1	281	4	5	3098	4	2	2	4		4		
13237	528		3	B1	281	4	6	346.1	2	1	1	2		2		
13237	528		3	B1	281	4	2	886.6	219	171	48	219		85	134	
13237	528		3	B1	281	4	1	167	191	191		191			191	
13237	528		3	B1	281	4	4	879	27	11	16	27		22	5	
13237	528		3	B1	281	4	3	816.2	65	24	41	65		46	19	
13237	529		3	B1	281	4	5	223.5	2	1	1	2		2		
13237	529		3	B1	281	4	4	384.1	14	8	6	14		6	8	
13237	529		3	B1	281	4	1	7.63	14	14		14			14	
13237	529		3	B1	281	4	2	707.8	292	292		292			292	
13237	529		3	B1	281	4	3	642.5	58	19	39	58		41	17	
13237	538		4	B1	281	1	5	278.7	1	1		1		1		

Site	Coll #	Feature	Lv	Blk	AC	Mat	Sz	Grams	Qty	Fr	NF	Disc P	Disc A	Cort P	Cort A	Comm
13237	543		4	B1	281	4	1	127.26	145	145		145			145	
13237	543		4	B1	281	4	4	112.6	4	4		4		4		
13237	543		4	B1	281	4	2	402.6	102	9	93	102		95	7	
13237	543		4	B1	281	4	3	287.4	24	4	20	24		21	3	
13237	544		4	B1	281	4	6	544.4	2	2		2		2		
13237	544		4	B1	281	4	5	133.2	2	2		2		2		
13237	544		4	B1	281	4	3	218.7	20	8	12	20		20		
13237	544		4	B1	281	4	2	133.4	44	3	41	44		44		
13237	544		4	B1	281	4	4	126.4	6	4	2	6		2	4	
13237	545		4	B1	281	4	5	90.5	2	1	1	2		2		
13237	545		4	B1	281	4	6	109.3	1	1		1		1		
13237	545		4	B1	281	4	2	187.6	50	16	34	50		11	39	
13237	545		4	B1	281	4	1	19.4	21	21		21		3	18	
13237	545		4	B1	281	4	4	177.9	8	1	7	8		5	3	
13237	545		4	B1	281	4	3	281.9	21	7	17	21		7	14	
13237	546		4	B1	281	4	5	55.1	2	1	1	2		1	1	
13237	546		4	B1	281	4	6	498.8	2	1	1	2		2		
13237	546		4	B1	281	4	2	326.5	79	15	64	79		13	66	
13237	546		4	B1	281	4	1	81	86	77	9	86		20	66	
13237	546		4	B1	281	4	4	93.7	4	3	1	4		2	2	
13237	546		4	B1	281	4	3	340.8	28	3	25	28		9	19	
13237	547		4	B1	281	4	4	207.2	8	4	4	8		5	3	
13237	547		4	B1	281	4	2	147.1	40	12	28	40		7	33	
13237	547		4	B1	281	4	1	32.98	34	34		34		4	30	
13237	547		4	B1	281	4	3	187.4	15	4	11	15		3	12	
13237	548		4	B1	281	4	5	19.87	1	1		1			1	
13237	548		4	B1	281	4	6	486	3	3		3		3		
13237	548		4	B1	281	4	4	32.79	1	1		1		1		
13237	548		4	B1	281	4	2	330.1	95	91	4	90	5	18	77	
13237	548		4	B1	281	4	1	65.59	90	64	26	90		6	84	
13237	548		4	B1	281	4	3	397.4	45	7	38	45		10	35	
13237	548		4	B1	281	4	2	370.2	124	14	110	124		18	106	
13237	549		4	B1	281	4	5	171.1	3	2	1	3		2	1	
13237	549		4	B1	281	4	9	762.9	1	1		1		1		
13237	549		4	B1	281	4	2	330.1	95	91	4	90	5	18	77	
13237	549		4	B1	281	4	1	176.3	64	59	5	64		13	51	
13237	549		4	B1	281	4	3	406.1	34	32	2	32	2	14	20	
13237	549		4	B1	281	4	4	286.9	10	8	2	10		6	4	
13237	550		4	B1	281	4	5	197.3	3	2	1	3		1	2	
13237	550		4	B1	281	4	4	415.7	14	3	11	14		6	8	
13237	550		4	B1	281	4	1	134.72	159	132	27	159		6	153	
13237	550		4	B1	281	4	2	579.7	131	33	98	131		13	118	
13237	550		4	B1	281	4	3	561.6	50	9	41	50		12	38	
13237	554		4	B1	281	4	5	175.5	3	3		3		3		
13237	554		4	B1	281	4	4	232.8	11	9	2	11		7	4	
13237	554		4	B1	281	4	2	644	211	208	3	207	4	50	161	
13237	554		4	B1	281	4	1	278.7	80	76	4	80		31	49	
13237	554		4	B1	281	4	3	363.6	39	33	6	38	1	12	27	
13237	555	46	3	B1	281	4	2	6.23	3	3		3			3	
13237	555	46	3	B1	281	4	1	0.24	1	1		1			1	
13237	555	46	3	B1	281	4	1	1.16	1	1		1			1	
13237	556	46	3	B1	281	4	7	2698.4	3	1	2	3		3		
13237	556	46	3	B1	281	4	6	2398.6	6	3	3	6		6		
13237	556	46	3	B1	281	4	5	243.8	2	2		2		1	1	
13237	556	46	3	B1	281	4	4	143.75	5	3	2	5		3	2	
13237	556	46	3	B1	281	4	3	77.77	8	2	6	8		3	5	
13237	556	46	3	B1	281	4	2	15.44	5	3	2	5		1	4	
13237	557	46	3	B1	281	4	3	33.67	4	3	1	4			4	
13237	557	46	3	B1	281	4	2	44.1	16	2	14	16		2	14	
13237	557	46	3	B1	281	4	1	1.62	2	2		2		1	1	
13237	558	46	3	B1	281	4	7	2455.1	5	3	2	5		5		
13237	558	46	3	B1	281	4	6	474.5	2	1	1	2		2		
13237	558	46	3	B1	281	4	5	845	7	6	1	7		3	4	
13237	558	46	3	B1	281	4	4	329.7	14	11	3	14		8	6	
13237	558	46	3	B1	281	4	3	350.8	27	23	4	27		13	14	
13237	558	46	3	B1	281	4	2	3.27	1	1		1			1	
13237	558	46	3	B1	281	4	2	78.57	12	11	1	11	1	4	7	
13237	558	46	3	B1	281	4	1	4.79	5	5		5			5	
13237	560		3	B1	281	4	1	117.39	150	96	54	150		6	144	

Site	Coll #	Feature	Lv	Blk	AC	Mat	Sz	Grams	Qty	Fr	NF	Disc P	Disc A	Cort P	Cort A	Comm
13237	560		3	B1	281	4	2	702.2	209	9	200	209		14	185	
13237	560		3	B1	281	4	3	557.3	50	4	46	50		14	36	
13237	560		3	B1	281	4	6	106.5	1		1	1		1		
13237	560		3	B1	281	4	4	458	15	4	11	15		7	8	
13237	560		3	B1	281	4	5	125.6	2	2		2		2		
13237	562	98	3	B1	281	4	2	5.2	2		2	2			2	
13237	562	98	3	B1	281	4	4	30.66	2		2			2		
13237	563	46	3	B1	281	4	5	64.8	1	1		1		1		
13237	563	46	3	B1	281	4	1	154.2	59	59		57	2	4	55	
13237	563	46	3	B1	281	4	7	326.4	1	1		1		1		
13237	563	46	3	B1	281	4	2	629.7	62	59	3	60	2	26	36	
13237	563	46	3	B1	281	4	4	31.81	13	11	2	11	2	8	5	
13237	563	46	3	B1	281	4	3	559.2	54	52	2	53	1	16	38	
13237	566	98	3	B1	281	4	2	6.26	2		2	2		1	1	
13237	566	98	3	B1	281	4	3	14.46	2	1	1	2		2		
13237	566	98	3	B1	281	4	4	53.02	2		2	2		2		
13237	566	98	3	B1	281	4	5	28.49	1		1	1		1		
13237	567		3	B1	281	4	4	490.8	21	21		18	3	13	8	
13237	567		3	B1	281	4	3	734.2	65	65		62	3	20	45	
13237	567		3	B1	281	4	2	857	222	219	3	218	4	36	186	
13237	567		3	B1	281	4	7	476	1	1		1		1		
13237	567		3	B1	281	4	6	1007	4	4		4		4		
13237	567		3	B1	281	4	5	790.6	8	6	2	8		4	4	
13237	567		3	B1	281	4	1	146.9	143	142	1	143		6	137	
13237	568		4	B1	281	1	1	0.4	1	1		1		1		
13237	568		4	B1	281	4	1	137.8	122	46	76	47	75	7	115	
13237	568		4	B1	281	4	2	208.1	68	38	30	65	3	14	54	
13237	568		4	B1	281	4	6	221.5	1	1		1		1		
13237	568		4	B1	281	4	4	375.1	12	12		5	7	4	8	
13237	568		4	B1	281	4	3	156.1	18	18		10	8	3	15	
13237	568		4	B1	281	4	5	91	1	1		1		1		1 FLK
13237	569		4	B1	281	4	4	716.2	23	4	19	23		10	13	
13237	569		4	B1	281	4	3	587.8	60	9	51	60		12	48	
13237	569		4	B1	281	4	2	822.9	241	22	219	241		29	190	
13237	569		4	B1	281	4	1	148.8	167	23	144	167		6	138	
13237	569		4	B1	281	1	2	4.19	1		1	1		1		
13237	569		4	B1	281	4	5	130.7	2		2	2		2		
13237	570		4	B1	281	4	6	219.4	1	1		1		1		
13237	570		4	B1	281	4	2	309.4	92	89	3	90	2	14	78	
13237	570		4	B1	281	4	1	62.6	68	67	1	67	1	4	63	
13237	570		4	B1	281	4	3	451.7	35	1	34	35		5	30	
13237	570		4	B1	281	4	4	476.9	14	12	2	13	1	6	8	
13237	570		4	B1	281	4	5	140.9	2	2		2		1	1	
13237	571	46	4	B1	281	4	1	0.9	2	2		2		1	1	
13237	571	46	4	B1	281	4	2	4.7	3	3		3		3		
13237	571	46	4	B1	281	4	4	31.3	1	1		1		1		
13237	572	46	4	B1	281	4	1	7.3	9	6	3	9		2	7	
13237	572	46	4	B1	281	4	2	8.6	3	3		3		2	1	
13237	572	46	4	B1	281	4	3	33	3	3		3		1	2	
13237	572	46	4	B1	281	4	4	17.6	1	1		1		1		
13237	572	46	4	B1	281	4	6	1262.2	2	2		2		2		
13237	572	46	4	B1	281	4	7	4222.3	7	3	4	7		7		
13237	573	46	4	B1	281	4	1	2.1	3	3		3			3	
13237	573	46	4	B1	281	4	2	33.3	9	8	1	9		3	6	
13237	573	46	4	B1	281	4	3	24.1	3	3		3		1	2	
13237	574		4	B1	281	4	5	3828.5	26	23	3	26		26		
13237	574		4	B1	281	4	6	11409.3	24	12	12		24	24		
13237	574		4	B1	281	4	7	10114.4	13	9	4	13		13		
13237	574		4	B1	281	4	4	959	27	24	3	27		12	15	
13237	574		4	B1	281	4	3	347	24	10	14	24		9	15	
13237	574		4	B1	281	4	2	74.5	29	26	3	29		3	26	
13237	600		3	C1	281	4	4	476.7	10	5	5	10		8	2	
13237	600		3	C1	281	4	5	719.4	6	5	1	6		6		
13237	600		3	C1	281	4	3	133.5	7	4	3	7		4	3	
13237	600		3	C1	281	4	1	11.58	12	12		12			12	
13237	600		3	C1	281	4	2	7	4	4		4		1	3	
13237	601		3	C1	281	4	4	405.2	13	13		12	1	1	12	
13237	601		3	C1	281	4	5	443.1	5	5		5		3	2	
13237	601		3	C1	281	4	7	530	1	1		1		1		

Site	Coll #	Feature	Lv	Blk	AC	Mat	Sz	Grams	Qty	Fr	NF	Disc P	Disc A	Cort P	Cort A	Comm
13237	601		3	C1	281	4	3	170.4	13	13		10	3	2	11	
13237	601		3	C1	281	1	2	4.1	1	1		1		1		
13237	601		3	C1	281	4	1	16.3	16	15	1	15	1	1	15	
13237	601		3	C1	281	4	2	177.2	47	47		36	11	3	44	
13237	602		3	C1	281	4	4	249.9	7	4	3	7		6	1	
13237	602		3	C1	281	4	5	152.7	2	2		2		1	1	
13237	602		3	C1	281	4	1	1.8	1	1		1			1	
13237	602		3	C1	281	4	3	53.7	3	3		3		1	2	
13237	603		3	C1	281	4	4	615	15	14	1	15		3	12	
13237	603		3	C1	281	4	5	750.5	7	4	3	6	1	5	2	
13237	603		3	C1	281	4	7	445.1	1	1		1			1	
13237	603		3	C1	281	4	3	411	27	24	3	27		5	22	
13237	603		3	C1	281	1	2	3.1	1	1		1			1	
13237	603		3	C1	281	4	1	11	13	12	1	13			13	
13237	603		3	C1	281	4	2	108.6	29	27	2	29		2	27	
13237	604		3	C1	281	4	1	22.7	33	33		33		1	32	
13237	604		3	C1	281	4	6	542.5	2	2		2		1	1	
13237	604		3	C1	281	4	7	1433.6	2	2		2		2		
13237	604		3	C1	281	4	8	1041.2	1	1		1			1	
13237	604		3	C1	281	4	5	1143.7	8	7	1	8		5	3	
13237	604		3	C1	281	4	2	199.1	44	43	1	44		4	40	
13237	604		3	C1	281	4	3	371.5	30	28	2	30		4	26	
13237	604		3	C1	281	4	4	1061.6	28	27	1	27	1	7	21	
13237	605		3	C1	281	4	3	232.9	17	15	2	15	2	4	13	
13237	605		3	C1	281	4	2	143.8	30	27	3	29	1	3	27	
13237	605		3	C1	281	4	1	33.7	33	33		33			33	
13237	605		3	C1	281	4	7	644.9	1		1	1		1		
13237	605		3	C1	281	4	5	1760.5	13	9	4	12	1	8	5	
13237	605		3	C1	281	4	4	402.1	12	11	1	7	5	4	8	
13237	606		3	C1	281	4	6	1132.5	5	5		5		3	2	
13237	606		3	C1	281	4	5	1746.7	19	18	1	17	2	5	14	
13237	606		3	C1	281	4	8	1025.8	1	1		1		1		
13237	606		3	C1	281	4	7	388.3	1	1		1		1		
13237	606		3	C1	281	4	2	103.7	23	23		22	1	1	22	
13237	606		3	C1	281	4	1	20.2	18	18		17	1	1	17	
13237	606		3	C1	281	4	4	685.7	20	20		19	1	4	16	
13237	606		3	C1	281	4	3	470.4	31	31		29	2	4	27	
13237	607		4	C1	281	4	6	2727.6	9	5	4	9		7	2	
13237	607		4	C1	281	4	5	2165.6	19	12	7	17	2	14	5	
13237	607		4	C1	281	4	9	955.8	1		1	1		1		
13237	607		4	C1	281	4	7	1036.2	2	1	1	2		2		
13237	607		4	C1	281	4	2	198.5	44	42	2	43	1	3	41	
13237	607		4	C1	281	4	1	26.5	17	14	3	17		3	14	
13237	607		4	C1	281	4	4	1274.7	28	26	2	25	3	8	20	
13237	607		4	C1	281	4	3	373.8	29	29		28	1	4	25	
13237	608		4	C1	281	4	4	653.7	18	16	2	16	2	9	9	
13237	608		4	C1	281	4	5	375.3	5	5		5		2	3	
13237	608		4	C1	281	4	6	1256.8	5	3	2	5		3	2	
13237	608		4	C1	281	4	3	211.5	13	13		13		7	6	
13237	608		4	C1	281	4	1	10.3	8	8		8			8	
13237	608		4	C1	281	4	2	9.6	1	1		1		1		
13237	608		4	C1	281	4	2	61.1	13	13		13		2	11	
13237	609		4	C1	281	4	6	1850.1	7	5	2	7		6	1	
13237	609		4	C1	281	4	5	1617.6	10	8	2	10		7	1	
13237	609		4	C1	281	4	10	1083.1	1	1		1		1		
13237	609		4	C1	281	4	7	2601.3	4	2	2	4		4		
13237	609		4	C1	281	4	2	245.3	63	59	4	62	1	9	54	
13237	609		4	C1	281	4	1	61.6	78	78		78		4	74	
13237	609		4	C1	281	4	4	841.4	26	26		26		6	20	
13237	609		4	C1	281	4	3	512.7	40	40		38	2	6	34	
13237	610		4	C1	281	4	7	609.9	1	1		1		1		
13237	610		4	C1	281	4	6	2201.5	8	3	5	8		6	2	
13237	610		4	C1	283	14	2	7.9	2			2				
13237	610		4	C1	283	14	5	116.1	1			1				
13237	610		4	C1	283	14	4	75.6	2			2				
13237	610		4	C1	281	4	2	119.3	25	9	16	25		5	20	
13237	610		4	C1	281	4	1	5.1	6	6		6			6	
13237	610		4	C1	281	4	3	386.3	26	20	6	26		9	17	
13237	610		4	C1	281	4	5	2826.1	21	12	9	21		12	9	

Site	Coll #	Feature	Lv	Blk	AC	Mat	Sz	Grams	Qty	Fr	NF	Disc P	Disc A	Cort P	Cort A	Comm
13237	610		4	C1	281	4	4	890.3	17	11	6	17		13	4	
13237	611		4	C1	281	4	4	1243	20	14	6	20		10	10	
13237	611		4	C1	281	4	5	1708.4	14	12	2	14		7	7	
13237	611		4	C1	281	4	3	502	30	12	18	30		9	21	
13237	611		4	C1	281	4	1	45.4	49	24	25	49		4	45	
13237	611		4	C1	281	4	2	293.6	67	30	37	67		6	63	
13237	612		4	C1	281	4	5	1127.1	12	12		12		5	7	
13237	612		4	C1	281	4	6	347.2	2	2		2		1	1	
13237	612		4	C1	281	4	7	801.2	2	2		2		2		
13237	612		4	C1	281	4	4	766.9	18	18		18		9	9	
13237	612		4	C1	281	4	1	21.2	14	14		14		1	13	
13237	612		4	C1	281	4	2	103.5	21	20	1	21		5	16	
13237	612		4	C1	281	4	3	452.2	26	25	1	26		5	21	
13237	613		4	C1	281	4	7	1410.2	2	2		2		2		
13237	613		4	C1	281	4	6	1387.1	3		3	3		3		
13237	613		4	C1	281	4	11	7779.1	2		2	2		2		
13237	613		4	C1	281	4	8	2671.1	2	1	1	2		2		
13237	613		4	C1	281	4	5	519.5	3	2	1	3		3		
13237	613		4	C1	281	4	2	78.4	27	17	10	25	2	8	19	
13237	613		4	C1	281	4	1	11.7	17	12	5	17			17	
13237	613		4	C1	281	4	4	159.6	5	3	2	5		4	1	
13237	613		4	C1	281	4	3	72.3	7	4	3	7		1	6	
13237	614		4	C1	281	4	4	155.3	5	4	1	5		4	1	
13237	614		4	C1	281	4	5	323.5	2	1	1	2		2		
13237	614		4	C1	281	4	6	220.3	1		1	1		1		
13237	614		4	C1	281	4	1	3.3	5	4	1	5		1	4	
13237	614		4	C1	281	4	2	91.3	22	8	14	22		6	16	
13237	614		4	C1	281	4	3	219.3	11	4	7	11		6	5	
13237	615		4	C1	281	4	3	24.5	2	2		2		1	1	
13237	615		4	C1	281	4	4	180	5	3	2	5		4	1	
13237	615		4	C1	281	4	1	9.8	14	13	1	14		2	12	
13237	615		4	C1	281	4	2	30.6	13	12	1	13		4	9	
13237	615		4	C1	281	4	5	98.1	2	2		1	1	1	1	
13237	616		4	C1	281	4	4	90	5	3	2	5	1	1	4	
13237	616		4	C1	281	4	5	351.2	1		1	1		1		
13237	616		4	C1	281	4	6	445.3	1	1		1		1		
13237	616		4	C1	281	4	1	14.9	8	5	3	8			8	
13237	616		4	C1	281	4	2	80.4	16	12	4	16		14	2	
13237	616		4	C1	281	4	3	88.6	7	4	3	7		3	4	
13237	617		4	C1	281	4	4	119.8	5	5		5		2	3	
13237	617		4	C1	281	4	5	237.7	2	2		2		1	1	
13237	617		4	C1	281	4	3	36.9	3	3		3		1	2	
13237	617		4	C1	281	4	1	8.9	10	10		10		2	8	
13237	617		4	C1	281	4	2	44.5	11	10	1	11		3	8	
13237	618		4	C1	281	4	4	14.5	1	1		1		1		
13237	618		4	C1	281	4	3	64.2	8	8		8		3	5	
13237	618		4	C1	281	4	2	57.1	16	16		16		3	13	
13237	618		4	C1	281	4	1	5.3	11	11		11			11	
13237	619		4	C1	281	4	3	169.9	11	8	3	11		5	6	
13237	619		4	C1	281	4	4	48.5	2		2	2		1	1	
13237	619		4	C1	281	4	1	2	2	2		2			2	
13237	619		4	C1	281	4	2	53.7	10	4	6	10		4	6	
13237	619		4	C1	281	4	5	103.5	1	1		1			1	
13237	620		4	C1	281	4	4	1229.5	31	30	1	31		9	22	
13237	620		4	C1	281	4	5	596.9	6	6		6		4	2	
13237	620		4	C1	281	4	6	248.3	2	2		2		2		
13237	620		4	C1	281	4	1	23.1	27	26	1	27		3	24	
13237	620		4	C1	281	4	2	110	25	25		25		6	19	
13237	620		4	C1	281	4	3	314.2	22	19	3	21	1	9	13	
13237	623		4	C1	281	4	3	164.7	14	3	11	14		4	10	
13237	623		4	C1	281	4	4	128.7	3	3		3			3	
13237	623		4	C1	281	4	1	1.8	1	1		1			1	
13237	623		4	C1	281	4	2	50.1	14	7	7	14		1	13	
13237	624		4	C1	281	4	1	5.9	4	4		4			4	
13237	624		4	C1	281	4	5	592.5	5	5		5		4	1	
13237	624		4	C1	281	4	6	395.3	2	2		2		2		
13237	624		4	C1	281	4	4	99.2	5	5		5		2	3	
13237	624		4	C1	281	4	3	117.6	8	8		8		3	5	
13237	624		4	C1	281	4	2	23.7	7	7		6	1	3	4	

Site	Coll #	Feature	Lv	Blk	AC	Mat	Sz	Grams	Qty	Fr	NF	Disc P	Disc A	Cort P	Cort A	Comm
13237	625		4	C1	281	4	4	929.1	28	28		28		11	17	
13237	625		4	C1	281	4	5	1044.6	11	11		11		7	4	
13237	625		4	C1	281	4	2	283.8	61	59	2	61		11	50	
13237	625		4	C1	281	4	3	606	42	42		42		10	32	
13237	625		4	C1	281	4	1	26.1	23	23		23		3	20	
13237	625		4	C1	281	1	1	1.3	1	1		1			1	
13237	625		4	C1	281	4	6	306.2	2	2		2		2		
13237	625		4	C1	281	4	7	673.6	1		1	1		1		
13237	635		4	C1	281	4	6	375	2		2	2		2		
13237	635		4	C1	281	4	7	807.9	1	1		1		1		
13237	635		4	C1	281	4	1	47.6	75	26	39	75			75	
13237	635		4	C1	281	4	5	2021.3	17	10	7	17		8	9	
13237	635		4	C1	281	4	2	558.8	147	38	109	147		10	137	
13237	635		4	C1	281	4	3	742.1	41	18	33	41		10	31	
13237	635		4	C1	281	4	4	1141.4	33	21	12	33		13	20	
13237	636		5	C1	281	4	6	136.9	1	1		1		1		
13237	636		5	C1	281	4	3	83.1	6	5	1	6		3	3	
13237	636		5	C1	281	4	1	8.5	9	9		9		2	7	
13237	636		5	C1	281	4	2	29.4	7	7		7		3	4	
13237	638		5	C1	281	4	5	379.3	4	4		4		3	1	
13237	638		5	C1	281	4	6	148.5	1		1	1		1		
13237	638		5	C1	281	4	7	239.1	1	1		1		1		
13237	638		5	C1	281	4	4	299.4	9	8	1	7	2	1	6	
13237	638		5	C1	281	4	1	9.4	12	12		12		2	10	
13237	638		5	C1	281	1	2	3.9	1	1		1		1		
13237	638		5	C1	281	4	3	188.3	13	13		13		7	6	
13237	638		5	C1	281	4	2	18.9	9	9		9		3	6	
13237	639		5	C1	281	4	4	90.1	3	3		3		1	2	
13237	639		5	C1	281	4	5	99.7	1	1		1		1		
13237	639		5	C1	281	4	7	867.1	1	1		1		1		
13237	639		5	C1	281	4	3	71.1	9	8	1	9		4	5	
13237	639		5	C1	281	1	4	57.5	2	2		2		1	1	
13237	639		5	C1	281	1	2	2.1	1	1		1		1		
13237	639		5	C1	281	4	2	64.4	14	13	1	14		5	9	
13237	639		5	C1	281	4	1	6.3	6	6		6			6	
13237	640		5	C1	281	4	6	882.5	2	2		2		2		
13237	640		5	C1	281	4	10	5443.2	1		1	1		1		
13237	640		5	C1	281	4	4	397.3	9	6	3	9		4	5	
13237	640		5	C1	281	4	1	9	9	6	3	9			9	
13237	640		5	C1	281	4	2	87.7	19	11	8	19		3	16	
13237	640		5	C1	281	4	3	253.3	20	10	10	20		3	17	
13237	641		5	C1	281	4	4	185.4	5	3	2	5		4	1	
13237	641		5	C1	281	4	5	551.5	5	4	1	5		5		
13237	641		5	C1	281	4	6	1697.1	3	1	2	3		3		
13237	641		5	C1	281	4	1	6.2	7	6	1	7		2	5	
13237	641		5	C1	281	4	2	78.4	19	16	3	19		6	13	
13237	641		5	C1	281	4	3	43	2	2		2		2		
13237	642		5	C1	281	4	4	263.3	10	4	6	10		3	7	
13237	642		5	C1	281	4	5	458	5	3	2	5		1	4	
13237	642		5	C1	281	4	2	95.6	18	13	5	18		3	15	
13237	642		5	C1	281	4	3	298.9	16	8	8	16		6	10	
13237	643		5	C1	281	4	2	370.7	57	16	41	57		12	45	
13237	643		5	C1	281	4	1	60.5	47	21	26	47		5	42	
13237	643		5	C1	281	4	6	3042.5	7	5	2	7		6	1	
13237	643		5	C1	281	4	7	1813.8	3	2	1	3		3		
13237	643		5	C1	281	4	5	2862.7	17	11	8	17		9	8	
13237	643		5	C1	281	4	3	794	41	24	17	41		19	22	
13237	643		5	C1	281	4	4	1226.4	25	21	4	25		13	12	
13237	644		5	C1	281	4	8	3359.3	3			3		3		
13237	644		5	C1	281	4	7	5686.2	9	3	6	9		9		
13237	644		5	C1	281	4	10	2183.6	1		1	1		1		
13237	644		5	C1	281	4	9	3475.2	2		2	2		2		
13237	644		5	C1	281	4	6	4160.1	12	4	8	12		12		
13237	644		5	C1	281	4	3	209.2	14	11	3	14		10	4	
13237	644		5	C1	281	4	2	41.4	13	13		13		3	10	
13237	644		5	C1	281	4	5	1964.4	16	8	8	15	1	14	2	
13237	644		5	C1	281	4	4	743.7	19	8	11	19		16	3	
13237	644		5	C1	281	4	1	8.2	8	8		8			8	
13237	650		5	C1	281	4	5	1677.7	18	14	4	18		11	7	

Site	Coll #	Feature	Lv	Blk	AC	Mat	Sz	Grams	Qty	Fr	NF	Disc P	Disc A	Cort P	Cort A	Comm
13237	650		5	C1	281	4	6	90.2	1	1		1		1		
13237	650		5	C1	281	1	3	14.8	1	1		1		1		
13237	650		5	C1	281	4	4	1138.8	27	21	6	27		18	9	
13237	650		5	C1	281	4	2	86.8	20	20		20		6	14	
13237	650		5	C1	281	4	1	10	7	7		7		2	5	
13237	650		5	C1	281	4	7	345.5	1	1		1		1		
13237	650		5	C1	281	4	3	184.1	12	10	2	12		6	6	
13237	652		5	C1	281	4	4	1206.7	26	7	19	26		26		
13237	652		5	C1	281	4	5	3817.8	24	15	9	24		20	4	
13237	652		5	C1	281	4	2	244.1	60	23	37	60		9	51	
13237	652		5	C1	281	4	3	680.3	43	7	36	43		21	22	
13237	652		5	C1	281	4	7	859.6	1		1	1		1		
13237	652		5	C1	281	4	8	569.7	1	1		1		1		
13237	652		5	C1	281	4	6	2888.4	8	6	2	8		8		
13237	652		6	C1	281	4	1	38.7	38	15	23	38			38	
13237	653		5	C1	281	4	2	107	20	19	1	20		3	17	
13237	653		5	C1	281	4	1	9.7	12	12		12			12	
13237	653		5	C1	281	4	6	127	1	1		1		1		
13237	653		5	C1	281	4	5	461.1	7	3	4	7		1	6	
13237	653		5	C1	281	4	4	635.8	17	15	2	17		6	11	
13237	653		5	C1	281	4	3	120.3	11	9	2	11		2	9	
13237	654		5	C1	281	1	1	0.8	1	1		1		1		
13237	654		5	C1	281	4	2	2.7	1	1		1			1	
13237	654		5	C1	281	4	1	0.6	3	3		3			3	
13237	654		5	C1	281	4	4	10.7	1	1		1		1		
13237	654		5	C1	281	4	3	13.1	1	1		1		1		
13237	659		6	C1	281	1	1	0.05	1	1		1			1	
13237	659		6	C1	281	4	1	0.54	5	5		5			5	
13237	659		6	C1	281	4	2	0.66	1	1		1			1	
13237	660	40	6	C1	281	4	3	15.3	1	1		1			1	
13237	660	40	6	C1	281	4	2	5.3	2	2		2			2	
13237	660	40	6	C1	281	4	1	0.6	3	3		3			3	
13237	660	40	6	C1	281	4	5	87.4	1	1		1		1		1 FLK
13237	661	40	5	C1	281	4	1	1.2	2	2		2			2	
13237	661	40	6	C1	281	4	2	36	10	10		10			10	
13237	661	40	6	C1	281	4	3	160.5	13	10	3	13		9	4	
13237	661	40	6	C1	281	4	4	170.6	7	7		7		6	1	
13237	661	40	6	C1	281	4	5	1551.5	10	8	2	10		10		
13237	661	40	6	C1	281	4	6	2374.8	7	6	1	7		7		
13237	661	40	6	C1	281	4	7	467.1	1	1		1		1		
13237	661	40	6	C1	281	4	8	3156.2	3	2	1	3		3		
13237	661	40	6	C1	281	4	9	7270.2	5	3	2	5		5		
13237	661	40	6	C1	281	4	10	3513.1	1		1	1		1		
13237	663	102	5	C1	281	4	5	550	7	3	4	7		6	1	
13237	663	102	5	C1	281	4	3	17.3	2	2		2			2	
13237	663	102	5	C1	281	4	4	76.2	2	2		2		2		
13237	666	102	5	C1	281	4	1	0.4	1	1		1			1	
13237	666	102	5	C1	281	4	2	9.6	4	4		4		1	3	
13237	666	102	5	C1	281	4	3	59.8	3	2	1	3		2	1	
13237	666	102	5	C1	281	4	4	217.4	3	2	1	3		3		
13237	666	102	5	C1	281	4	5	637	7	5	2	7		5	2	
13237	666	102	5	C1	281	4	6	1621.8	7	5	2	7		5	2	
13237	666	102	5	C1	281	4	7	602.6	2	1	1	2		2		
13237	666	102	5	C1	281	4	8	2211.3	2	1	1	2		2		
13237	666	102	5	C1	281	4	9	5077.4	3		3	3		3		
13237	668	102	5	C1	281	4	6	483.7	2	1	1	2		2		
13237	668	102	5	C1	281	4	5	405.9	5	5		5		5		
13237	668	102	5	C1	281	4	1	4.2	7	7		7		2	5	
13237	668	102	5	C1	281	4	3	68.8	5	4	1	4	1	3	2	
13237	668	102	5	C1	281	4	2	5.3	2	2		2			2	
13237	668	102	5	C1	281	4	4	551.7	14	9	5	14		7	7	
13237	669	103	5	C1	281	4	5	2657.4	14	3	11	14		14		
13237	669	103	5	C1	281	4	1	6.3	5		5	5		5		
13237	669	103	5	C1	281	4	2	12.7	4	1	3	4		4		
13237	669	103	5	C1	281	4	6	3460.7	10	2	8	10		10		
13237	669	103	5	C1	281	4	3	15.5	1	1		1		1		
13237	669	103	5	C1	281	4	4	169.6	3	2	1	3		2	1	
13237	669	103	5	C1	281	4	7	6273.2	8	5	3	8		8		
13237	669	103	5	C1	281	4	3	95.5	10	7	3	10		6	4	

Site	Coll #	Feature	Lv	Blk	AC	Mat	Sz	Grams	Qty	Fr	NF	Disc P	Disc A	Cort P	Cort A	Comm
13237	672		5	C1	281	1	1	1.1	1	1		1			1	
13237	672		5	C1	281	4	9	4914.1	3	1	2	3		3		
13237	672		5	C1	281	4	2	94.9	20	20		17	3	8	12	
13237	672		5	C1	281	4	1	9.9	10	10		10		1	9	
13237	672		5	C1	281	4	8	5241.1	5	1	4	5		5		
13237	672		5	C1	281	4	5	3989.9	31	12	19	30	1	28	3	
13237	672		5	C1	281	4	4	776.5	17	8	9	17		12	5	
13237	672		5	C1	281	4	7	5289.8	8	6	2	8		8		
13237	672		5	C1	281	4	6	4165.6	14	5	9	14		14		
13237	672		5	C1	281	4	3	268.6	18	17	1	15	3	7	11	
13237	673	40	5	C1	281	4	5	109.6	1		1	1		1		
13237	673	40	5	C1	281	4	4	30.1	2		2	2			2	
13237	673	40	5	C1	281	4	3	13.8	2		2	2			2	
13237	673	40	5	C1	281	4	2	44.3	12	6	6	12		2	10	
13237	673	40	5	C1	281	4	1	7.7	8	8		8			8	
13237	674	40	5	C1	281	4	10	3252.1	1		1	1		1		
13237	674	40	5	C1	281	4	9	4471.2	2		2	2		2		
13237	674	40	5	C1	281	4	8	5793	3		3	3		3		
13237	674	40	5	C1	281	4	7	3830.6	6	4	2	6		6		
13237	674	40	5	C1	281	4	6	3064.2	10	5	5	10		10		
13237	674	40	5	C1	281	4	5	1428.5	12	9	3	12		9	3	
13237	674	40	5	C1	281	4	4	200	3	2	1	3		2	1	
13237	674	40	5	C1	281	4	3	55.3	5	5		5		3	2	
13237	674	40	5	C1	281	4	2	20.14	10	7	3	10		3	7	
13237	674	40	5	C1	281	4	1	13.8	16	7	9	16		4	12	
13237	676		5	C1	281	4	3	203.7	16	15	1	16		5	11	
13237	676		5	C1	281	4	6	1740.4	7	4	3	7		7		
13237	676		5	C1	281	4	5	1449.2	12	8	4	12		9	3	
13237	676		5	C1	281	4	7	2084.8	3	1	2	3		3		
13237	676		5	C1	281	4	9	4051.8	3	1	2	3		3		
13237	676		5	C1	281	4	8	407.6	1		1	1		1		
13237	676		5	C1	281	4	2	148.1	38	36	2	38		10	28	
13237	676		5	C1	281	4	11	3310.9	1		1	1		1		
13237	676		5	C1	281	4	4	298.3	10	10		10		4	6	
13237	676		5	C1	281	4	1	40.2	35	35		35		4	31	
13237	677		5	C1	281	4	1	21.2	33	22	11	33		9	24	
13237	677	40	5	C1	281	4	7	9603	14	10	4		14	14		
13237	677	40	5	C1	281	4	4	739.7	15	11	4	15		10	5	
13237	677	40	5	C1	281	4	5	2286.5	13	10	3	13		12	1	
13237	677	40	5	C1	281	4	2	40	11	8	3	11		6	5	
13237	677	40	5	C1	281	4	3	103.5	7	6	1	7		3	4	
13237	677	40	5	C1	281	4	8	13747.2	11	7	4	11		11		
13237	677	40	5	C1	281	4	9	6775.2	3	2	1	3		3		
13237	677	40	5	C1	281	4	6	11967.8	31	20	11	31		31		
13237	679	102	5	C1	281	4	2	1	1		1	1		1		
13237	679	102	5	C1	281	4	4	178.5	6	2	4	6		5	1	
13237	679	102	5	C1	281	4	5	1714.9	11	5	6	11		11		
13237	679	102	5	C1	281	4	9	1281.5	2	1	1	2		2		
13237	679	102	5	C1	281	4	7	6284.1	10	4	6	10		10		
13237	679	102	5	C1	281	4	6	3651.2	11	6	5	11		11		
13237	679	102	5	C1	281	4	10	3038.2	2		2	2		2		
13237	681	102	5	C1	281	4	1	1.3	1	1		1		1		
13237	681	102	5	C1	281	4	5	1127	9	4	5	9		8	1	
13237	681	102	5	C1	281	4	3	29.6	3	3		3		3		
13237	681	102	5	C1	281	4	2	13.9	4	2	2	4		4		
13237	681	102	5	C1	281	4	6	5399.6	15	5	10	15	1	15		
13237	681	102	5	C1	281	4	7	3560.6	6		6	6		6		
13237	681	102	5	C1	281	4	8	3538	3	2	1	3		3		
13237	681	102	5	C1	281	4	10	6786.7	3		3	3		3		
13237	705	48	2	A1	281	4	4	191.2	6	4	2	6		6		
13237	705	48	2	A1	281	4	5	278	3	2	1	3		3		
13237	705	48	2	A1	281	4	6	469.4	1	1		1		1		
13237	705	48	2	A1	281	4	1	23	25	13	12	25		8	17	
13237	705	48	2	A1	281	4	2	150.3	40	11	29	40		35	5	
13237	705	48	2	A1	281	4	3	211.5	16	4	12	16		8	8	
13237	706	48	1	A1	281	4	3	38.9	3		3	3		3		
13237	706	48	1	A1	281	4	4	14	1	1		1		1		
13237	706	48	1	A1	281	4	1	1.8	2	2		2			2	
13237	706	48	1	A1	281	4	2	12.5	2	1	1	2		1	1	

Site	Coll #	Feature	Lv	Blk	AC	Mat	Sz	Grams	Qty	Fr	NF	Disc P	Disc A	Cort P	Cort A	Comm
13237	707	48	1	A1	281	4	4	134.5	6	5	1	6		6		
13237	707	48	1	A1	281	4	5	144.9	3	3		3		3		
13237	707	48	1	A1	281	4	3	4.5	1		1	1		1		
13237	707	48	1	A1	281	4	1	1.12	3	3		3		3		
13237	707	48	1	A1	281	4	2	22.2	5	4	1	5		3	2	
13237	708	48	2	A1	281	4	4	239.5	9	2	7	9		9		
13237	708	48	2	A1	281	4	5	55.3	1		1	1		1		
13237	708	48	2	A1	281	4	2	61.2	14	4	10	14		14		
13237	708	48	2	A1	281	4	3	183.1	15	3	12	15		15		
13237	709	48	1	A1	281	4	3	37.6	3	2	1	3		3		
13237	709	48	1	A1	281	4	2	25.4	4	2	2	4		4		
13237	709	48	1	A1	281	4	1	0.37	1	1		1		1		
13237	710	48	1	A1	281	4	4	40.3	3		3	3		3		
13237	710	48	1	A1	281	4	5	444.1	3	3		3		3		
13237	710	48	1	A1	281	4	3	54.8	6	3	3	6		2	4	
13237	710	48	1	A1	281	4	1	5.1	12	9	3	12		4	8	
13237	710	48	1	A1	281	4	2	116.7	31	8	23	31		6	25	
13237	711	48	1	A1	281	4	3	102.1	8	1	7	8		5	3	
13237	711	48	1	A1	281	4	2	48.2	10	3	7	10		1	9	
13237	711	48	1	A1	281	4	1	4.5	6	3	3	6		3	3	
13237	711	48	1	A1	281	4	4	126.2	2		2	2		2		
13237	711	48	1	A1	281	4	7	664.6	1		1	1		1		
13237	711	48	1	A1	281	4	6	477.4	1	1		1		1		
13237	711	48	1	A1	281	4	5	102.8	1	1		1		1		
13237	712	48	1	A1	281	4	5	309.9	6	4	2	6		5	1	
13237	712	48	1	A1	281	4	6	190.7	1	1		1		1		
13237	712	48	1	A1	281	6	2	7.3	1	1		1			1	
13237	712	48	1	A1	281	4	4	493.9	19	15	4	17	2	11	8	
13237	712	48	1	A1	281	4	1	9	9	9		9			9	
13237	712	48	1	A1	281	4	2	126.6	29	26	3	29		6	23	
13237	712	48	1	A1	281	4	3	277.5	25	19	6	25		12	13	
13237	713	48	1	A1	281	4	5	677.7	4	4		4		3	1	
13237	713	48	1	A1	281	4	6	75.6	1	1		1		1		
13237	713	48	1	A1	281	4	7	974.1	1	1		1		1		
13237	713	48	1	A1	281	4	4	86.1	4	3	1	4		2	2	
13237	713	48	1	A1	281	4	1	26	22	22		22			22	
13237	713	48	1	A1	281	4	2	58.1	16	16		16		4	12	
13237	713	48	1	A1	281	4	3	94.5	10	9	1	10		3	7	
13237	714	48	1	A1	281	4	4	211.8	10	7	3	10		5	5	
13237	714	48	1	A1	281	4	5	134.8	1	1		1		1		
13237	714	48	1	A1	281	4	7	806.6	1	1		1		1		
13237	714	48	1	A1	281	4	1	10.3	8	7	1	8		2	6	
13237	714	48	1	A1	281	4	2	92	26	21	5	26		9	12	
13237	714	48	1	A1	281	4	3	278	22	15	7	22		15	7	
13237	715	48	2	A1	281	4	3	819.5	63	12	51	63		63		
13237	715	48	2	A1	281	4	4	518.3	18	5	13	18		18		
13237	715	48	2	A1	281	4	1	68	79		79	79		79		
13237	715	48	2	A1	281	4	2	627.7	156	13	143	156		156		
13237	716	48	2	A1	281	4	3	763.8	64	50	14	64		28	36	
13237	716	48	2	A1	281	4	2	704.4	174	162	12	174		34	140	
13237	716	48	2	A1	281	4	1	200.7	181	178	3	180	1	13	168	
13237	716	48	2	A1	281	4	6	141.1	1		1	1		1		
13237	716	48	2	A1	281	4	5	191.9	2	1	1	2		2		
13237	716	48	2	A1	281	4	4	585.7	23	15	8	23		16	7	
13237	717	48	2	A1	281	4	4	447.9	16	6	10	16		4	12	
13237	717	48	2	A1	281	4	5	215.3	4	4		4		4		
13237	717	48	2	A1	281	4	3	580.5	45	17	28	45		9	36	
13237	717	48	2	A1	281	4	1	66.9	71	16	55	71		8	63	
13237	717	48	2	A1	281	4	2	363.2	83	10	73	83		10	73	
13237	718	48	2	A1	281	4	4	889.8	26	14	12	26		2	24	
13237	718	48	2	A1	281	4	5	231.6	4	3	1	4		4		
13237	718	48	2	A1	281	4	3	619.8	41	25	16	41		38	3	
13237	718	48	2	A1	281	4	1	82.7	58	48	10	58		17	41	
13237	718	48	2	A1	281	4	2	406.7	76	63	13	76		21	55	
13237	719	48	2	A1	281	4	4	275.3	8	1	7	8		4	4	
13237	719	48	2	A1	281	4	5	400.7	5	5		5		3	2	
13237	719	48	2	A1	281	4	6	570.1	2	2		2		2		
13237	719	48	2	A1	281	4	1	9.5	9	5	4	9		2	7	
13237	719	48	2	A1	281	4	2	57.4	15	6	9	15		8	7	

Site	Coll #	Feature	Lv	Blk	AC	Mat	Sz	Grams	Qty	Fr	NF	Disc P	Disc A	Cort P	Cort A	Comm
13237	719	48	2	A1	281	4	3	211.7	16	6	10	16		3	13	
13237	720	48	2	A1	281	4	4	369.3	9	5	4	9		6	3	
13237	720	48	2	A1	281	4	5	333.2	3	2	1	3		2	1	
13237	720	48	2	A1	281	4	7	743.2	1	1		1		1		
13237	720	48	2	A1	281	4	1	6.1	5	5		5		2	4	
13237	720	48	2	A1	281	4	2	22.7	4	4		4		4		
13237	720	48	2	A1	281	4	3	87.6	6	5	1	6		6		
13237	721	48	2	A1	281	4	4	884.5	27	7	20	27		9	18	
13237	721	48	2	A1	281	4	5	569.5	8	4	4	8		3	5	
13237	721	48	2	A1	281	4	3	633.9	47	12	35	47		8	39	
13237	721	48	2	A1	281	4	1	93.4	79	22	557	79		11	68	
13237	721	48	2	A1	281	4	2	549.3	123	21	102	123		10	113	
13237	722	48	2	A1	281	4	4	859.1	28	5	23	28		10	18	
13237	722	48	2	A1	281	4	5	957.3	13	5	18	18		8	5	
13237	722	48	2	A1	281	4	3	757.5	68	12	56	68		14	54	
13237	722	48	2	A1	281	4	1	33.5	31	8	23	31		5	26	
13237	722	48	2	A1	281	4	2	383.9	82	18	64	82		14	54	
13237	723	48	2	A1	281	4	4	276.1	7	1	6	7		7		
13237	723	48	2	A1	281	4	3	46.9	3	1	2	3		2	1	
13237	723	48	2	A1	281	4	2	18.8	7	6	1	7		3	4	
13237	723	48	2	A1	281	4	9	573.7	1		1	1		1		
13237	723	48	2	A1	281	4	7	1209.4	2	2		2		2		
13237	723	48	2	A1	281	4	5	483	6	5	1	6		5	1	
13237	724	48	2	A1	281	4	4	872.8	30	20	10	30		14	16	
13237	724	48	2	A1	281	4	5	247.5	5	2	3	4	1	4	1	
13237	724	48	2	A1	281	4	3	1059.2	92	74	18	92		31	61	
13237	724	48	2	A1	281	4	1	46	42	39	3	41	1	3	36	
13237	724	48	2	A1	281	4	2	450.6	119	110	9	119		28	82	
13237	725	48	2	A1	281	4	4	728.4	22	4	18	22		15	7	
13237	725	48	2	A1	281	4	5	702.6	6	1	5	6		6		
13237	725	48	2	A1	281	4	7	1241.2	2	1	1	2		2		
13237	725	48	2	A1	281	4	1	55.2	74	16	58	74		8	66	
13237	725	48	2	A1	281	4	2	758.2	109	21	88	109		19	90	
13237	725	48	2	A1	281	4	3	879.4	64	6	58	64		23	41	
13237	726	48	2	A1	281	4	4	491.9	21	4	17	21		7	14	
13237	726	48	2	A1	281	4	5	235.56	6	1	5	6		6		
13237	726	48	2	A1	281	4	3	566.9	53	4	49	53		10	43	
13237	726	48	2	A1	281	4	1	75.5	74	6	68	74		6	68	
13237	726	48	2	A1	281	4	2	377.4	88	3	85	88		4	84	
13237	727	48	2	A1	281	4	4	440.5	18	2	16	18		7	11	
13237	727	48	2	A1	281	4	5	249.5	5	3	2	5		4	1	
13237	727	48	2	A1	281	4	6	146.7	2	2		2			2	
13237	727	48	2	A1	281	4	1	21.2	19	1	18	19		4	15	
13237	727	48	2	A1	281	4	2	235.9	49	5	44	49		18	37	
13237	727	48	2	A1	281	4	3	607.4	45	2	43	45		16	29	

Appendix B: Archaeomagnetic Analysis of Burned Rocks from Fort Bliss

Wulf Gose

Department of Geological Sciences, The University of Texas at Austin

Methods

Twenty-four cores (one-inch diameter) were drilled for archaeomagnetic analysis from rock samples collected at Fort Bliss (Table B1). Two preliminary samples were assigned laboratory numbers (1 and 2), the others were given letter designations (A-T).

All samples were thermally demagnetized in 50° increments from 150°C to 550°C. The magnetic remanence was measured after each heating step with a superconducting magnetometer. When plotted in a vector component diagram, discrete components of magnetization are indicated by three or more co-linear points. For the samples used in this study, a change in trend usually corresponds to the maximum heating temperature which the rock attained during cultural use. Data for all tested samples are given in the addendum.

Results

Because the rock samples were not oriented when collected, archaeomagnetic measurements cannot yield any information concerning past rock orientations such as whether a rock has remained undisturbed since the last heating and was part of a fireplace. The information that can be obtained is an estimate of the maximum temperature the rock experienced during its heating in a fire place.

The data for rock M are depicted in Figure B-1.¹ The distinct change in trend after thermal demagnetization to 400°C is interpreted to indicate the temperature of heating in a fire place. Rock K suggests heating to 350°C (Figure B2). Rock A contains only one component of magnetization (Figure B3) which implies that this rock experienced temperatures in excess of 550°C. Three components of magnetization can be identified in rock T (Figure B4). Component 1 is revealed between NRM (natural remanent magnetization) and 200°C, component 2 is present in the 200°C to 300°C interval, and component 3 is identified between 300°C and 550°C. Component 1 is interpreted as magnetic contamination, i.e. a magnetization acquired after the sample had been collected. Component 2 is interpreted as being due to cultural heating, and the high temperature component is the original geological magnetization.

Figure B-5 shows a histogram of the approximate temperatures to which these rocks were heated.

¹For all vector component diagrams, the crosses are the projection onto the N-E-S-W plane, the open squares the projection onto the Up-Down-Horizontal plane. The intensity of the NRM is given in units of Ampere/meter. The numbers along the trajectories indicate the demagnetization temperatures in °C. A linear trend of three or more data points defines a stable component of magnetization.

Table B1. Fire-cracked Rock from Fort Bliss

Site	Block	Feature	Collection No.	Lab Designation	Max. Temp (C)	Magnetic Vector
FB12412	A2		203	A	> 550°	single
			203	K	350°	single
	B1		256	Q	-	multiple
			256	Shattered		
FB12719	A1	32	2201	E	350°	single
		33	2180	I	300°	single
			2180	L	375°	single
			2322	T	300°	single
			3006	Shattered		
			2017	Shattered		
FB13237	C1	40	661	B	325°	single
			677	C	350°	single
			660	1	500°	single
			674	2	250°-450°	multiple
		102	681	F	450°	single
		103	669	J	350°	single
			613	D	500°	single
			604	H	450°	single
	B1		46	572	M	450°
		556		N	> 500°	multiple
		511		S	350°	multiple
	A1	48	713	G	450°	single
			723	O	450°	multiple
			725	P	350°	single

About half the samples (n=10) experienced temperatures of 350°C or less while the rest (n=11) were heated to 450°C or higher. Samples from the Camp Pearl Wheat site (41KR243) exhibited a similar dual temperature distribution (Gose 1990). Chemical analysis of those samples indicated that the cooler rocks were used for plant processing, whereas the hotter rocks yielded clear evidence of meat cooking. Whether such an interpretation may apply to the rocks from Fort Bliss cannot be ascertained without the proper organic geochemical analysis.

Reference

- Gose, W.
 1990 Data from Archeomagnetic Analysis. In *Excavations at the Camp Pearl Wheat Site (41KR243)*, edited by M. B. Collins, B. Ellis, and C. Dodt-Ellis, pp. 115-124. Studies in Archeology 6. Texas Archeological Research Laboratory, The University of Texas at Austin.

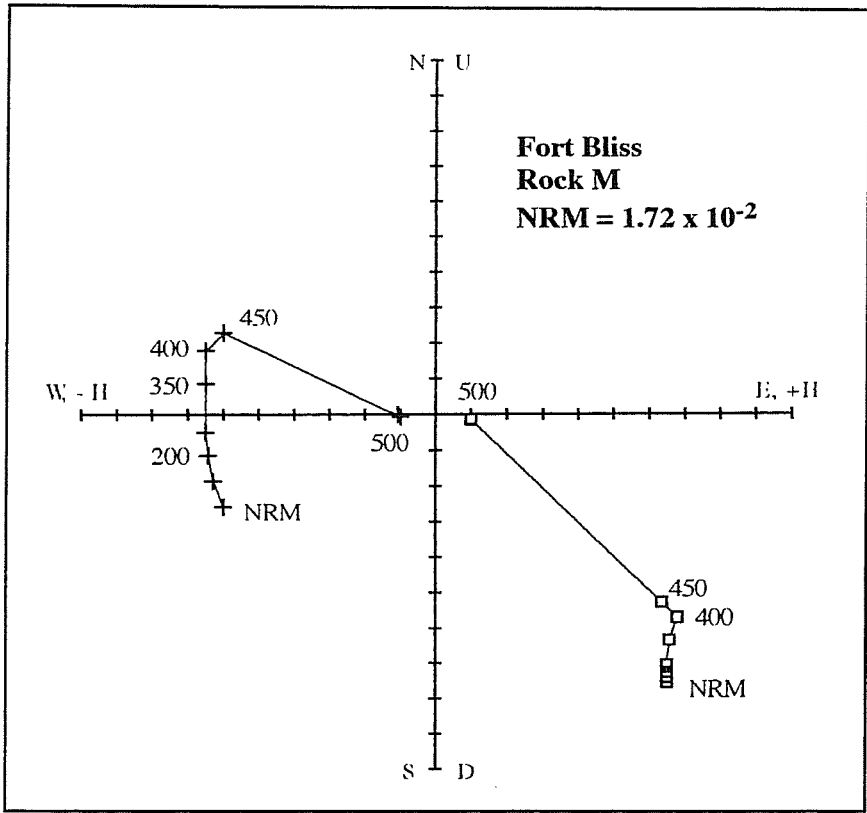

Figure B1. Vector component diagram for rock M.

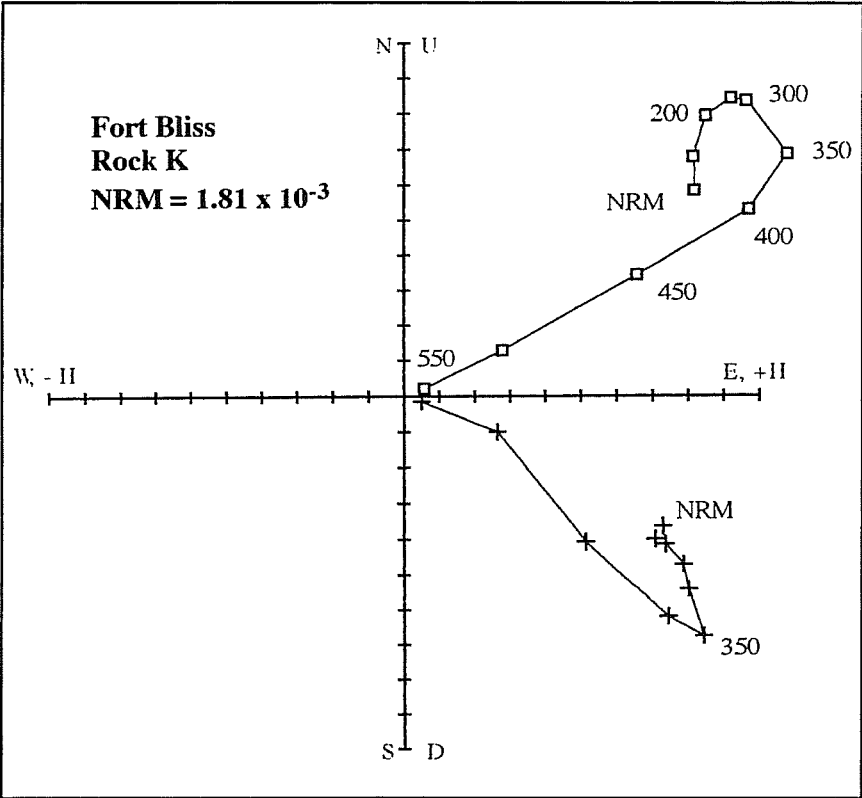

Figure B2. Vector component diagram for rock K.

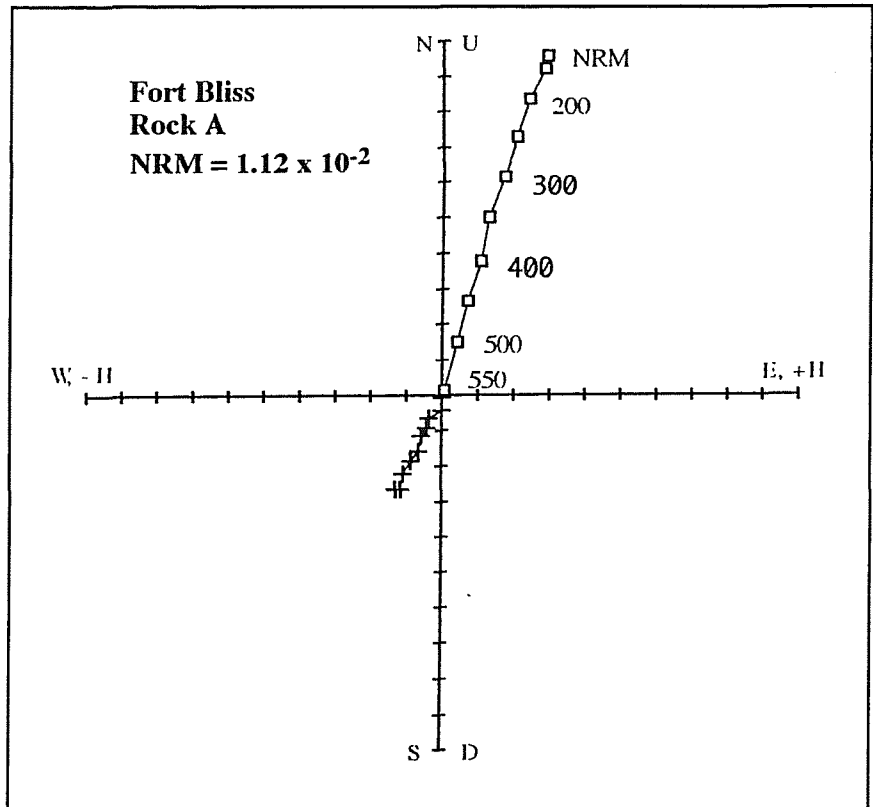

Figure B3. *Vector component diagram for rock A.*

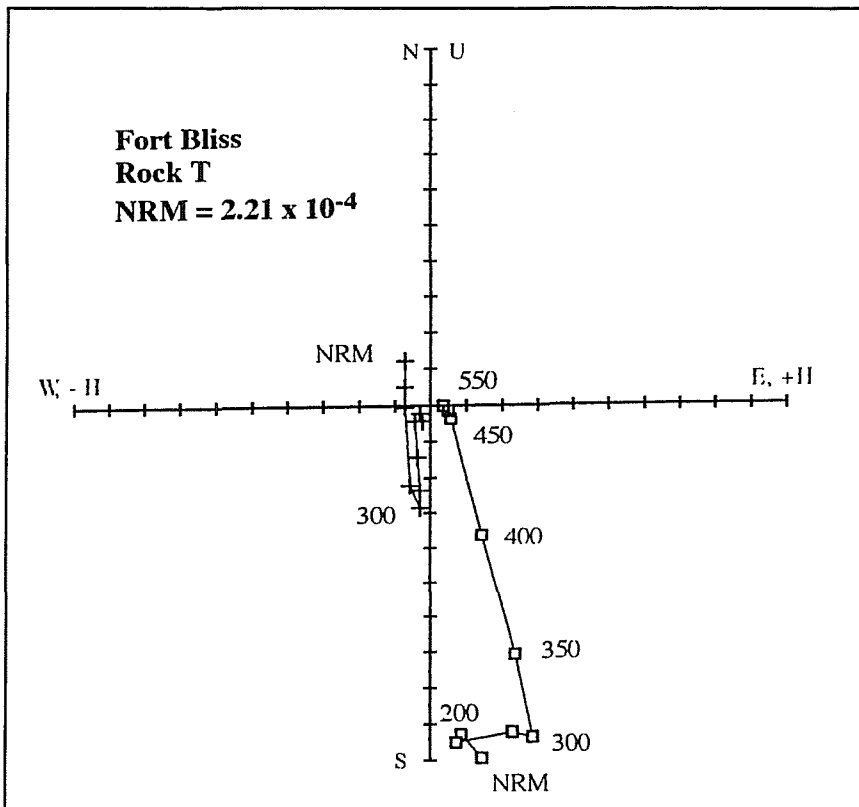

Figure B4. *Vector component diagram for rock T.*

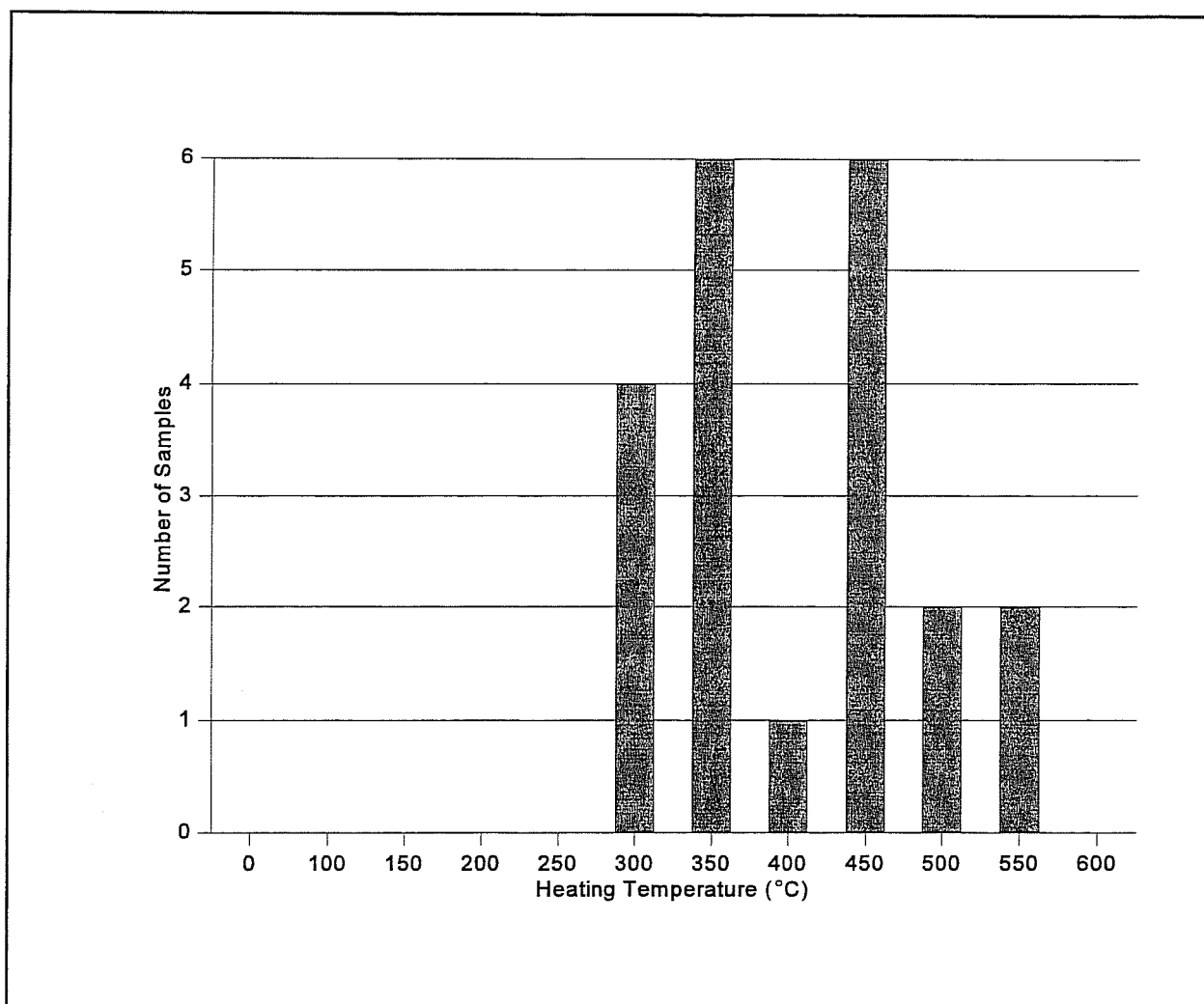
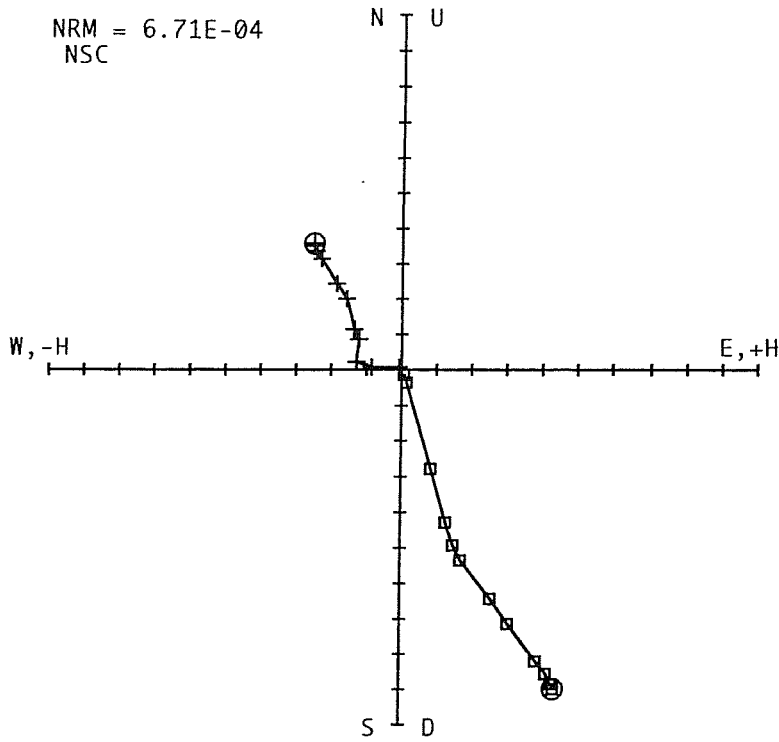

Figure B5. Histogram of magnetically estimated temperatures of heating of burned rocks from Fort Bliss. The bimodal distribution may indicate different usage.

Addendum: Sample Data

NRM = 6.71E-04
NSC



BLISS STEP	DECL	INCL	AMP
1 NRM	325.2	64.1	1.00
2 TD150	324.3	64.1	0.98
3 TD200	323.8	64.3	0.95
4 TD250	323.8	64.8	0.91
5 TD300	323.0	66.8	0.78
6 TD350	321.5	68.5	0.69
7 TD400	309.7	72.0	0.56
8 TD450	305.5	73.3	0.51
9 TD500	280.8	73.4	0.45
10 TD550	276.6	72.6	0.29
11 TD575	299.8	70.7	0.04
12 TD600	303.6	68.1	0.02

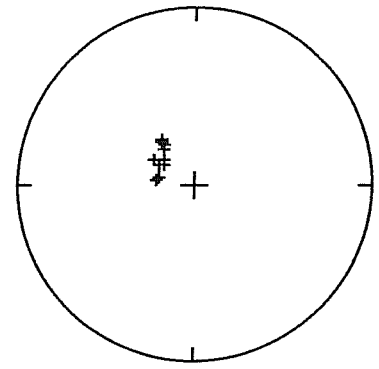

INTENSITY VS. DEMAGNETIZATION

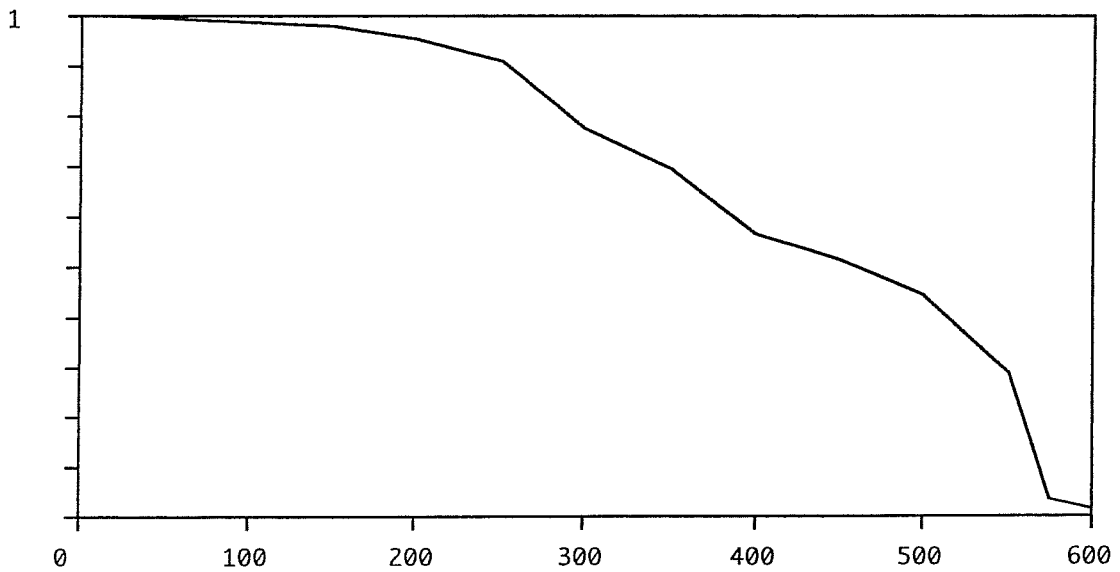

NRM = 2.45E-04
NSC

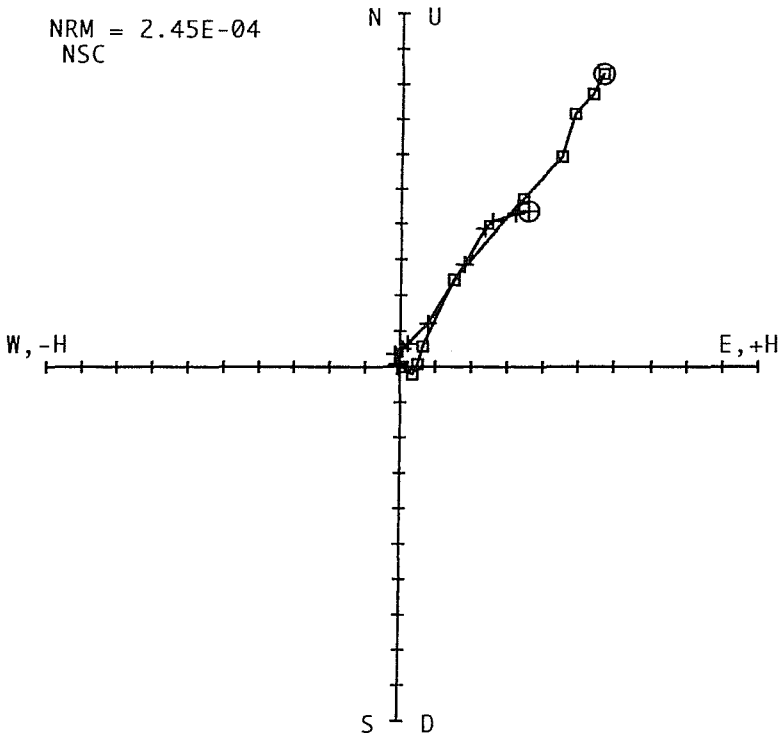

BLISS 2		DECL	INCL	AMP
STEP				
1	NRM	39.3	-55.8	1.00
2	TD150	37.0	-55.1	0.94
3	TD200	32.3	-56.1	0.86
4	TD250	31.7	-52.8	0.75
5	TD300	32.3	-54.3	0.58
6	TD350	33.4	-58.3	0.28
7	TD400	16.7	-40.1	0.09
8	TD450	12.6	-9.8	0.05
9	TD500	337.4	31.2	0.04
10	TD550	288.4	11.0	0.01
11	TD575	349.4	32.1	0.01
12	TD600	313.1	17.0	0.01

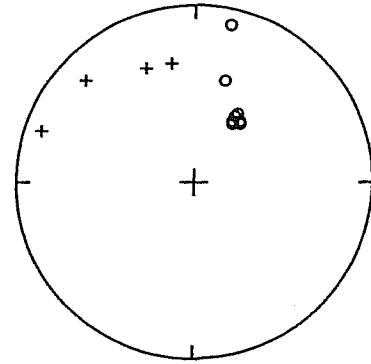

INTENSITY VS. DEMAGNETIZATION

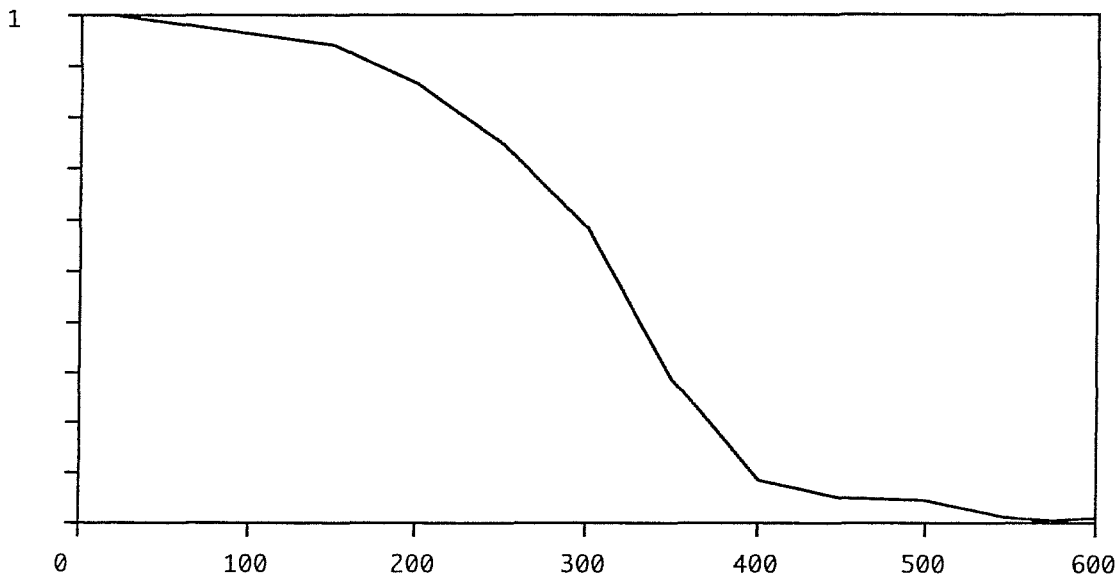

NRM = 1.12E-04
NSC

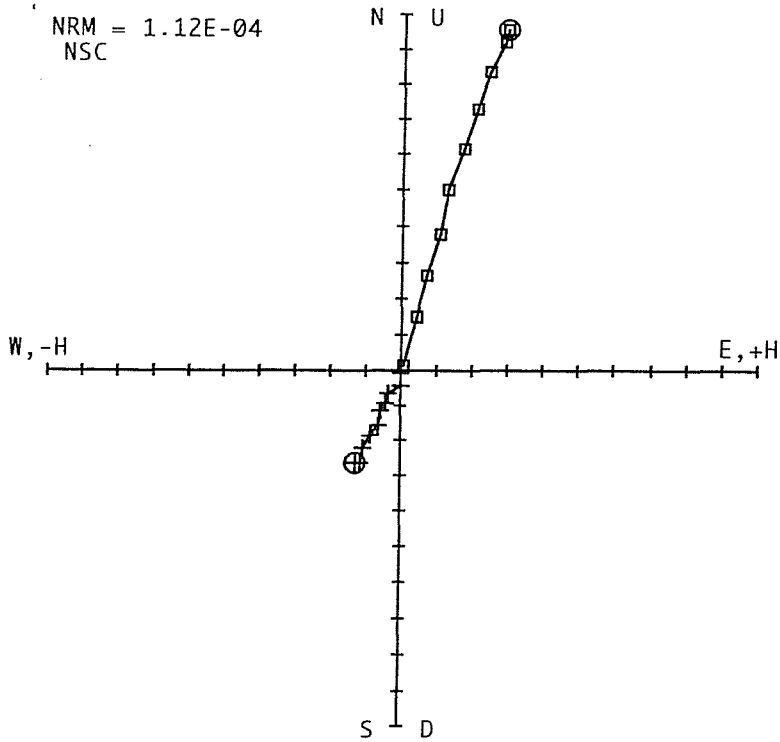

BLISS STEP	A	DECL	INCL	AMP
1	NRM	205.5	-72.8	1.00
2	TD150	203.4	-72.8	0.97
3	TD200	205.4	-73.8	0.87
4	TD250	204.3	-74.3	0.76
5	TD300	203.1	-74.5	0.64
6	TD350	207.6	-75.7	0.52
7	TD400	204.2	-74.6	0.39
8	TD450	208.4	-75.1	0.27
9	TD500	184.2	-73.5	0.16
10	TD550	204.6	-69.1	0.02

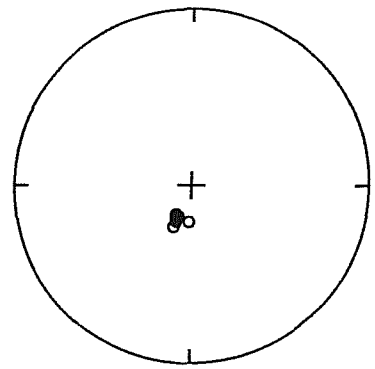

INTENSITY VS. DEMAGNETIZATION

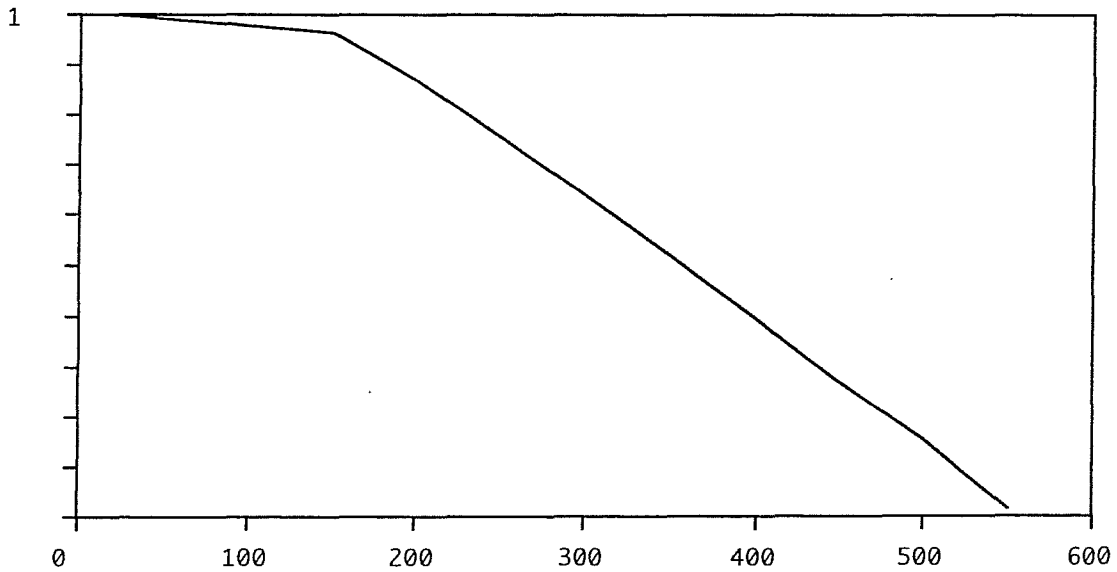

NRM = 2.04E-06
NSC

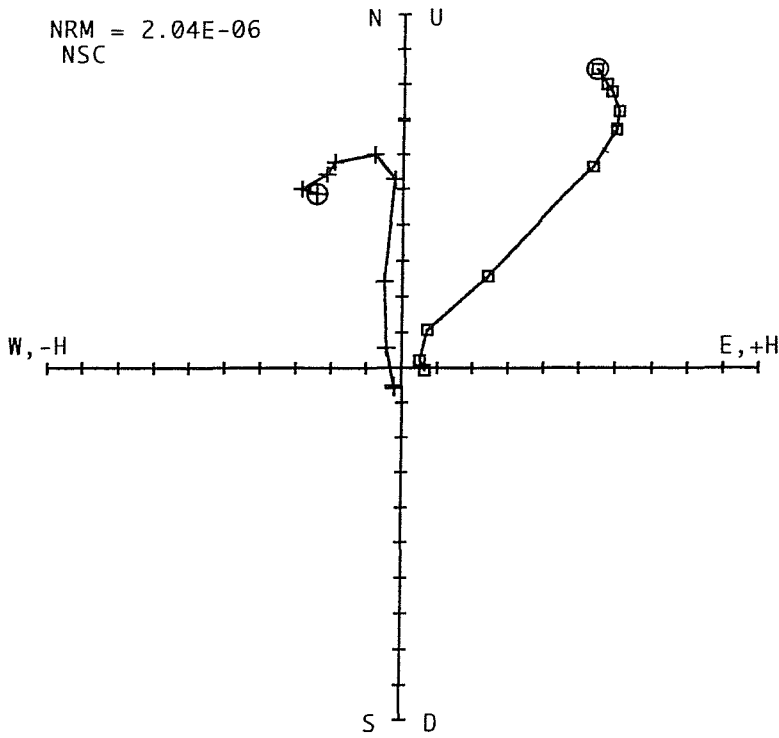

BLISS STEP	B	DECL	INCL	AMP
1	NRM	333.7	-57.1	1.00
2	TD150	330.2	-54.3	0.99
3	TD200	338.6	-53.1	0.97
4	TD250	341.3	-49.8	0.94
5	TD300	352.4	-48.1	0.90
6	TD350	357.7	-46.5	0.77
7	TD400	348.5	-46.1	0.35
8	TD450	321.1	-54.6	0.13
9	TD500	200.7	-21.1	0.06
10	TD550	200.7	3.9	0.06

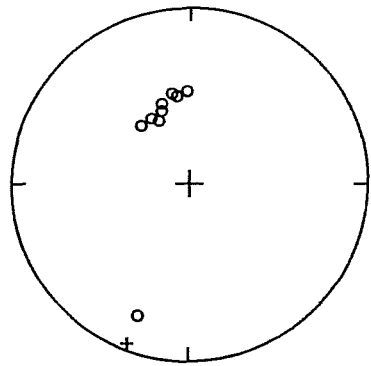

INTENSITY VS. DEMAGNETIZATION

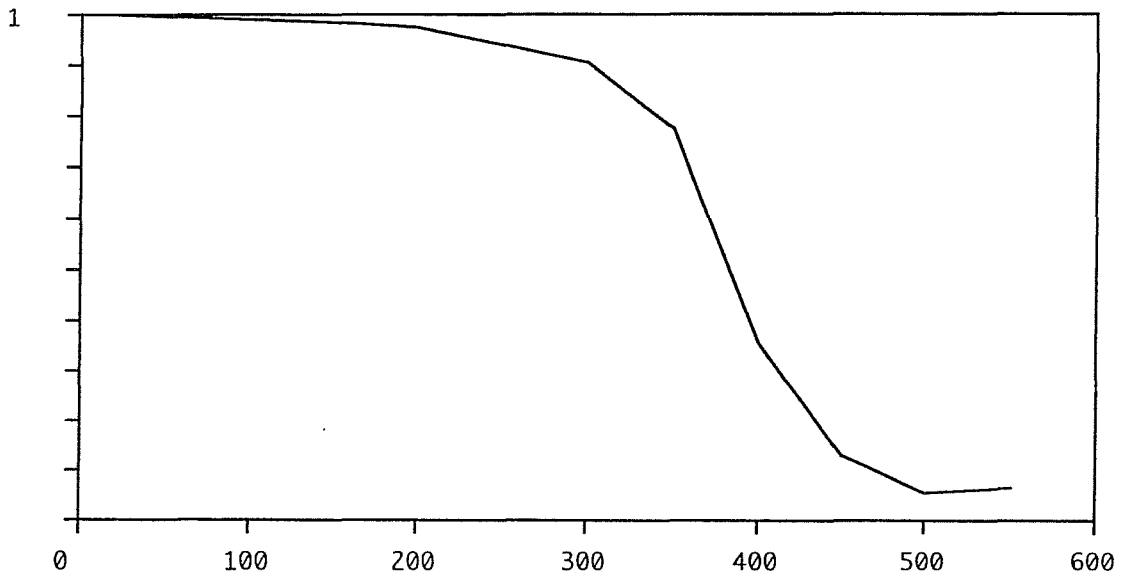

NRM = 1.95E-06
NSC

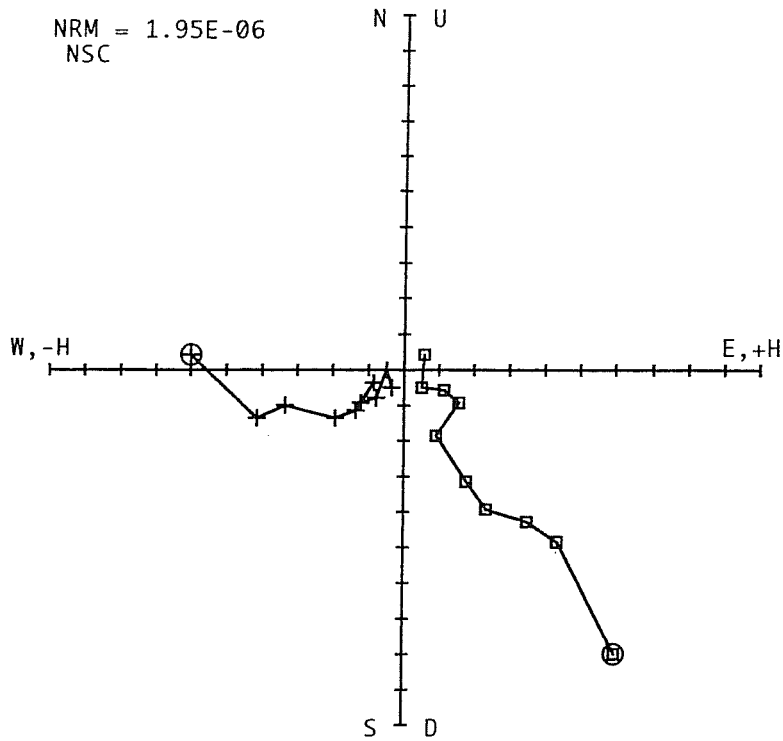

BLISS STEP	C	DECL	INCL	AMP
1	NRM	274.3	53.0	1.00
2	TD150	251.5	48.4	0.65
3	TD200	253.1	50.8	0.56
4	TD250	233.8	59.1	0.46
5	TD300	229.9	60.4	0.36
6	TD350	249.1	62.7	0.20
7	TD400	233.1	30.3	0.18
8	TD450	224.2	27.0	0.12
9	TD500	266.8	44.8	0.07
10	TD550	218.4	-35.1	0.07

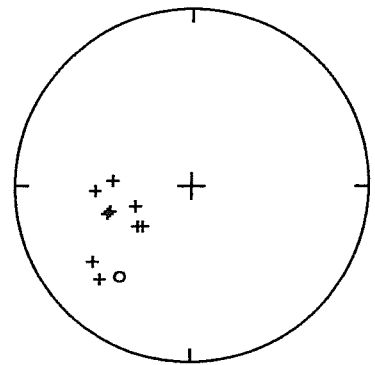

INTENSITY VS. DEMAGNETIZATION

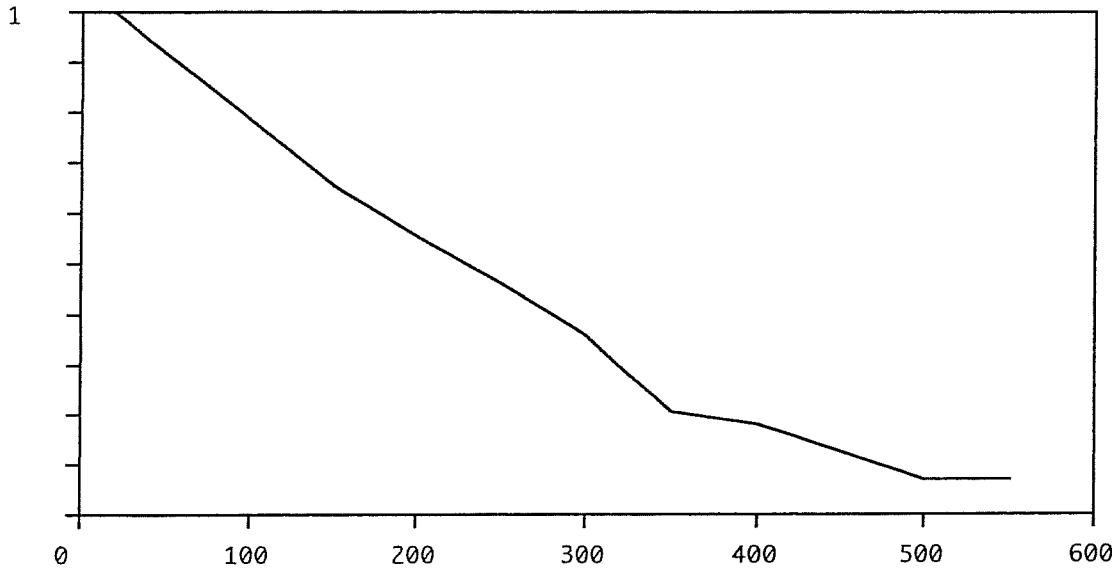

NRM = 3.43E-07
NSC

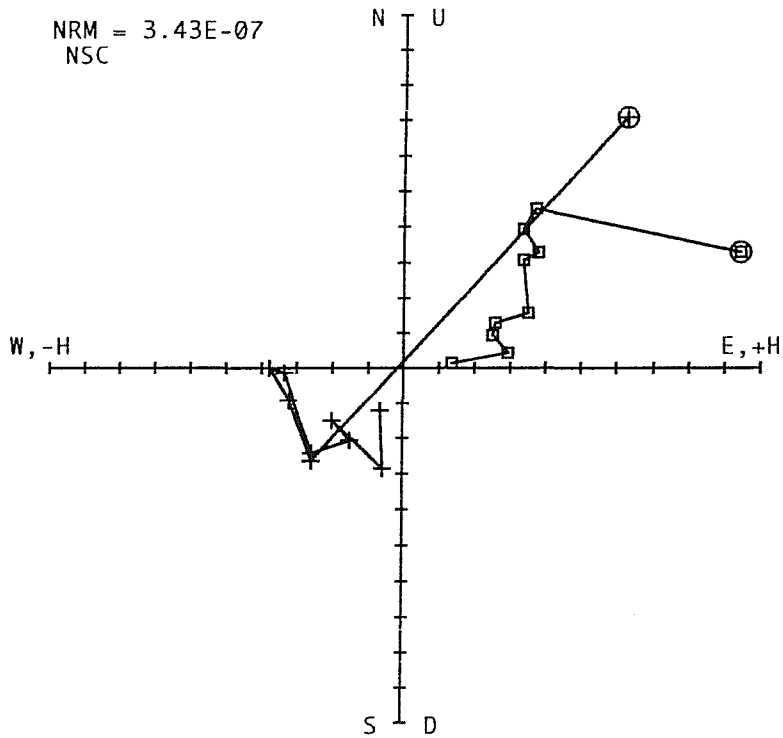

BLISS STEP	D	DECL	INCL	AMP
1	NRM	41.5	-19.2	1.00
2	TD150	224.1	-50.9	0.58
3	TD200	253.8	-49.6	0.52
4	TD250	270.2	-41.1	0.50
5	TD300	267.5	-42.7	0.45
6	TD350	226.4	-23.7	0.38
7	TD400	216.2	-26.8	0.29
8	TD450	233.0	-20.7	0.27
9	TD500	191.0	-8.1	0.29
10	TD550	208.6	-6.8	0.14

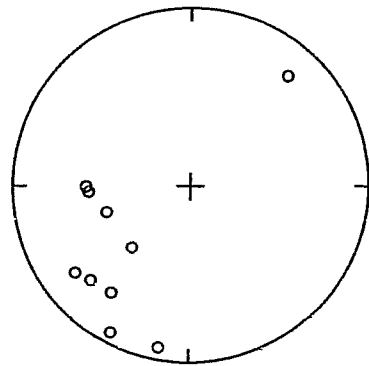

INTENSITY VS. DEMAGNETIZATION

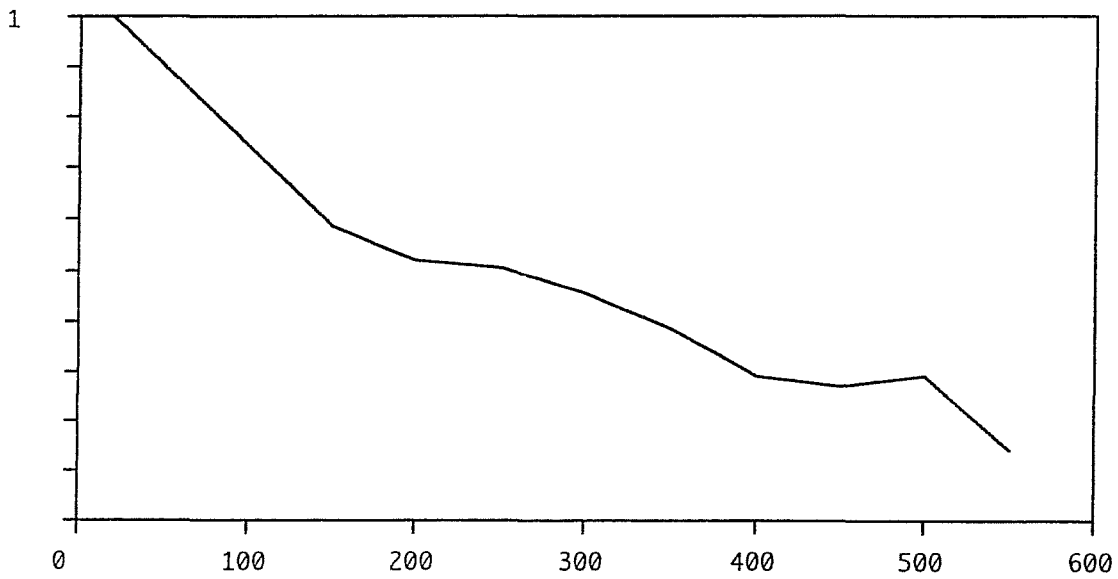

NRM = 6.30E-07
NSC

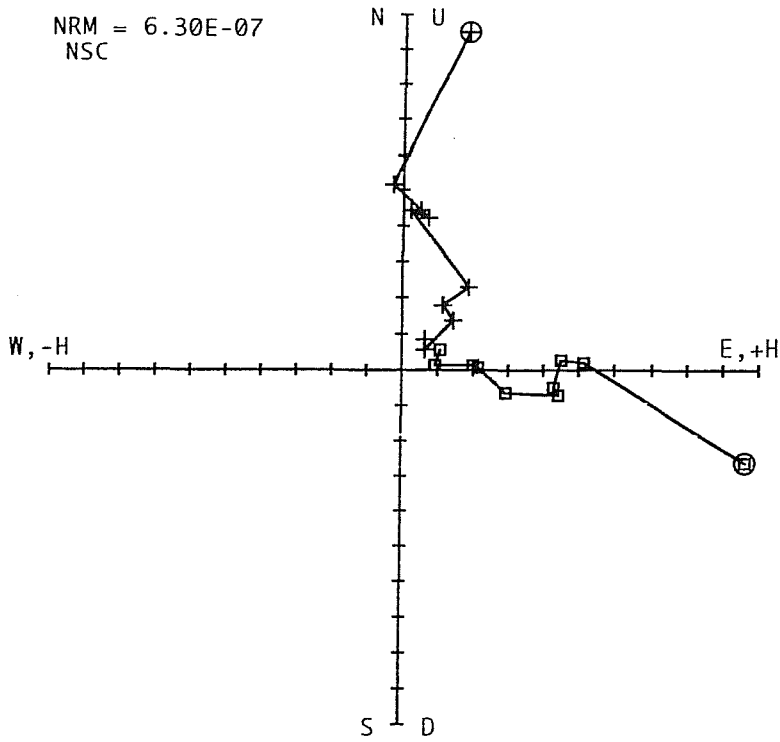

BLISS STEP	EE DECL	INCL	AMP
1	NRM 10.8	15.2	1.00
2	TD150 357.0	-2.5	0.52
3	TD200 6.2	-4.1	0.45
4	TD250 10.0	6.3	0.43
5	TD300 3.2	8.8	0.45
6	TD350 38.3	12.4	0.30
7	TD400 32.0	-2.9	0.21
8	TD450 47.4	-4.9	0.20
9	TD500 48.3	-9.7	0.09
10	TD550 37.2	-29.0	0.12

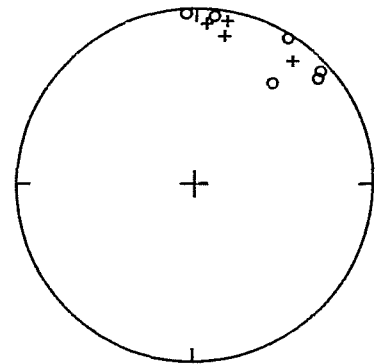

INTENSITY VS. DEMAGNETIZATION

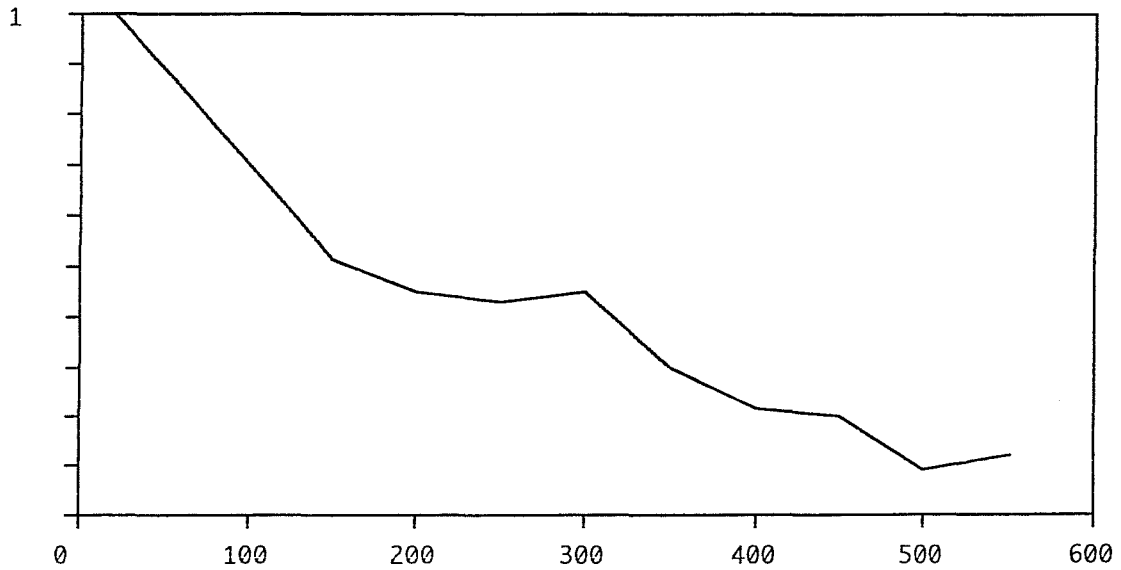

NRM = 7.22E-07
NSC

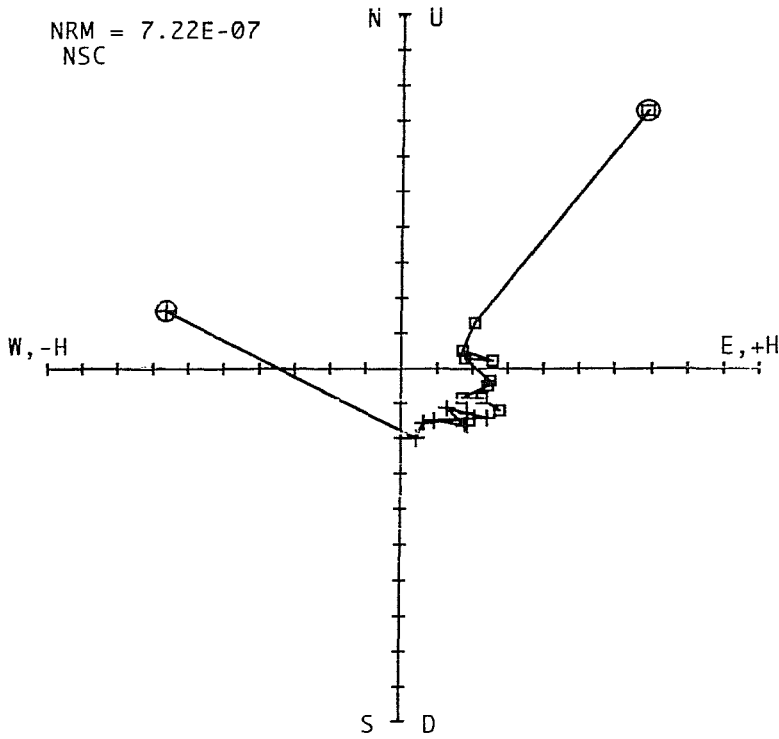

BLISS STEP	F	DECL	INCL	AMP
1	NRM	284.0	-46.7	1.00
2	TD150	167.4	-31.9	0.24
3	TD200	156.9	-16.5	0.18
4	TD250	124.0	-4.1	0.25
5	TD300	147.5	-9.6	0.18
6	TD350	131.5	7.6	0.25
7	TD400	132.8	11.0	0.25
8	TD450	132.4	26.5	0.19
9	TD500	125.1	20.2	0.24
10	TD550	120.3	23.7	0.30

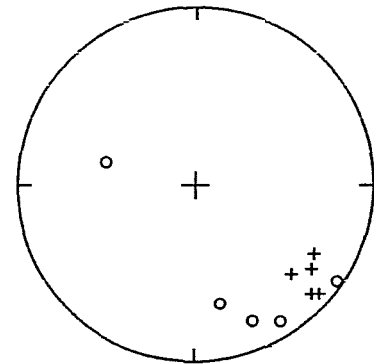

INTENSITY VS. DEMAGNETIZATION

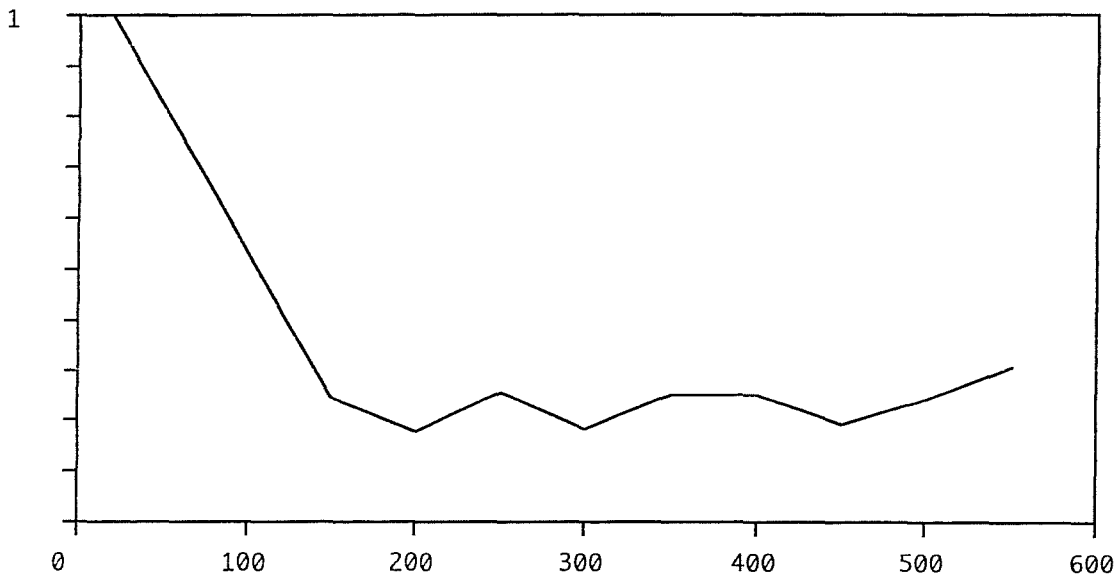

NRM = 4.61E-06
NSC

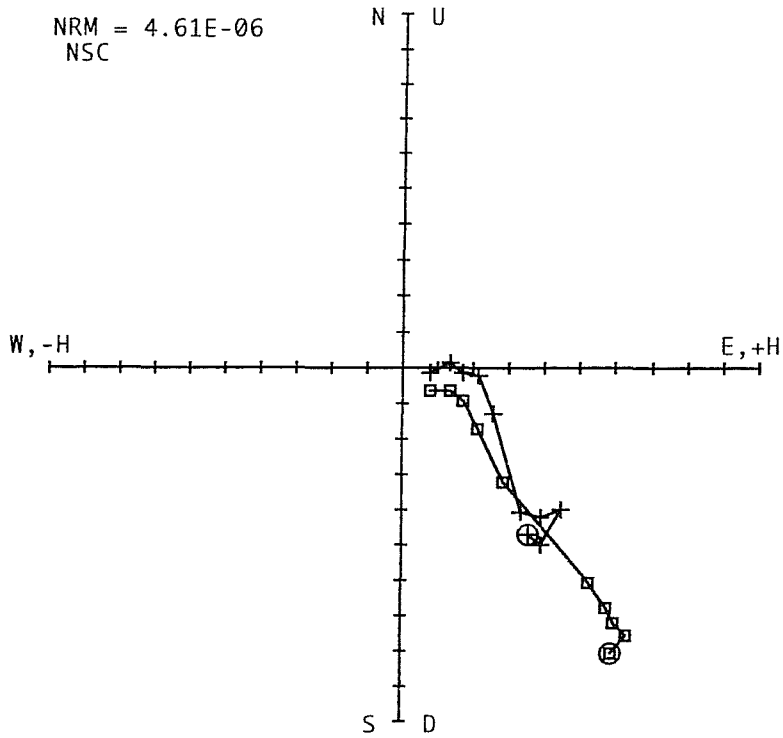

BLISS STEP	G	DECL	INCL	AMP
1	NRM	142.7	53.8	1.00
2	TD150	142.1	50.0	0.99
3	TD200	131.7	50.3	0.94
4	TD250	137.1	49.5	0.89
5	TD300	140.8	49.0	0.81
6	TD350	116.1	48.3	0.43
7	TD400	94.9	38.3	0.27
8	TD450	93.6	28.9	0.20
9	TD500	85.2	25.7	0.15
10	TD550	102.0	38.7	0.10

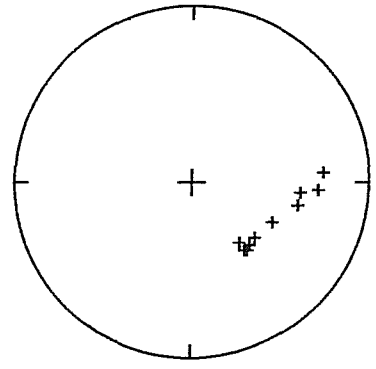

INTENSITY VS. DEMAGNETIZATION

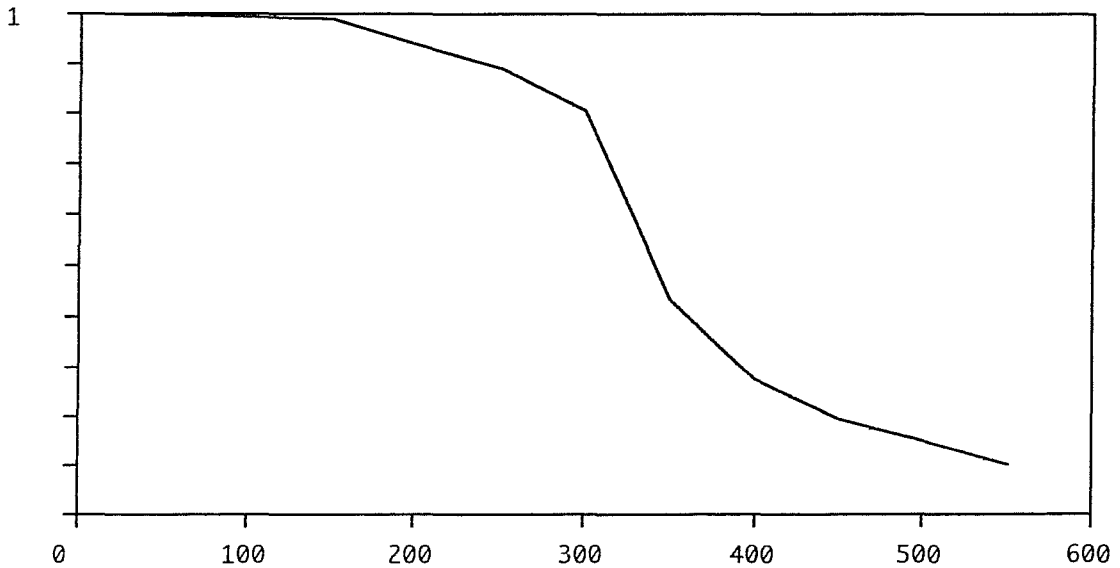

NRM = 1.92E-06
NSC

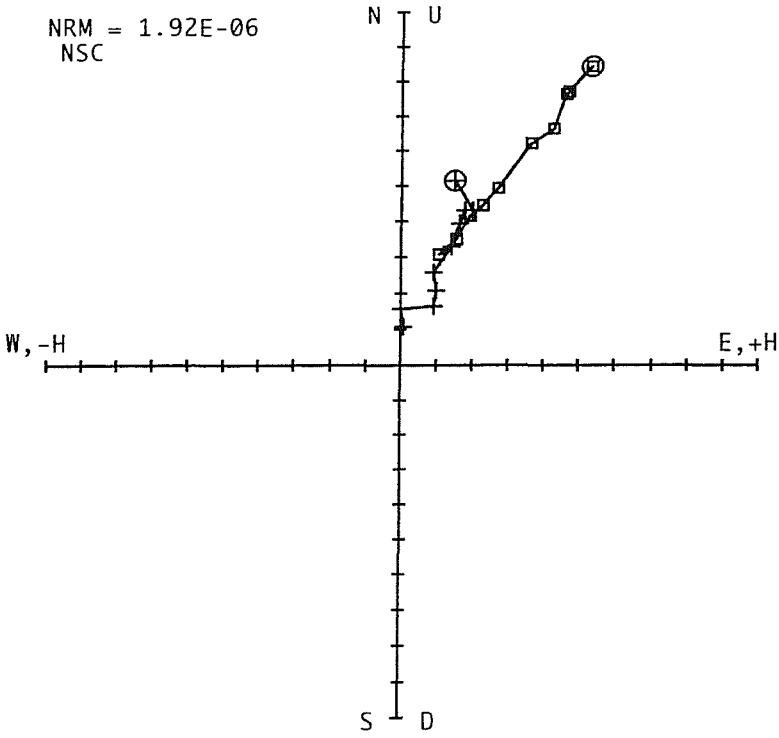

BLISS STEP	H	DECL	INCL	AMP
1	NRM	16.2	-57.5	1.00
2	TD150	25.3	-58.6	0.91
3	TD200	22.8	-58.6	0.90
4	TD250	22.3	-57.4	0.79
5	TD300	23.8	-59.9	0.72
6	TD350	19.8	-61.0	0.56
7	TD400	26.5	-62.4	0.50
8	TD450	28.5	-65.5	0.46
9	TD500	359.8	-65.3	0.38
10	TD550	5.5	-71.0	0.32

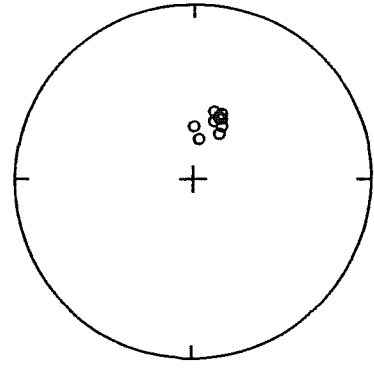

INTENSITY VS. DEMAGNETIZATION

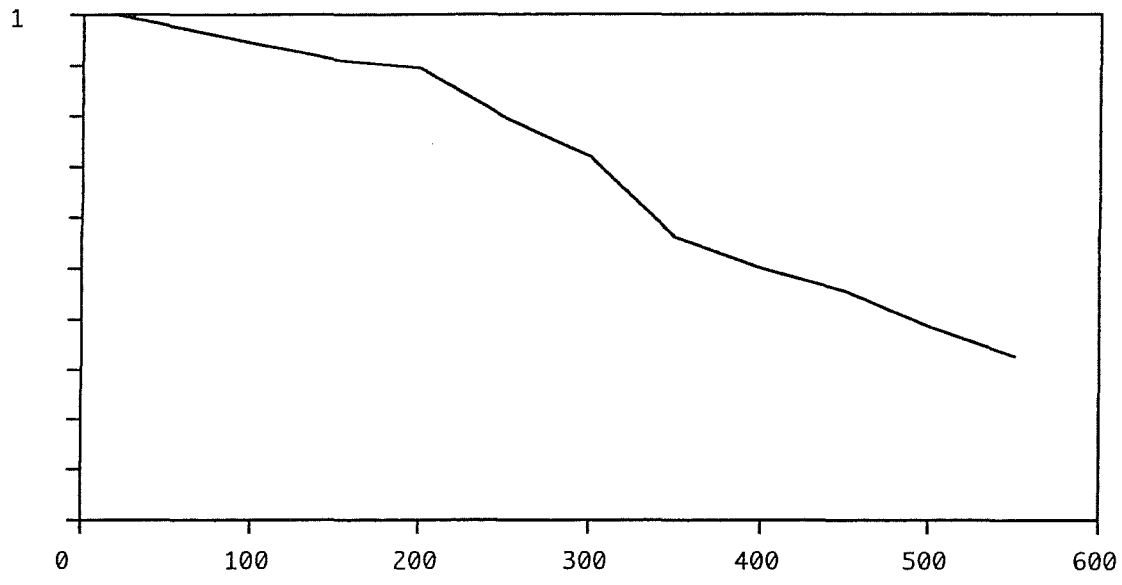

NRM = 2.82E-06
NSC

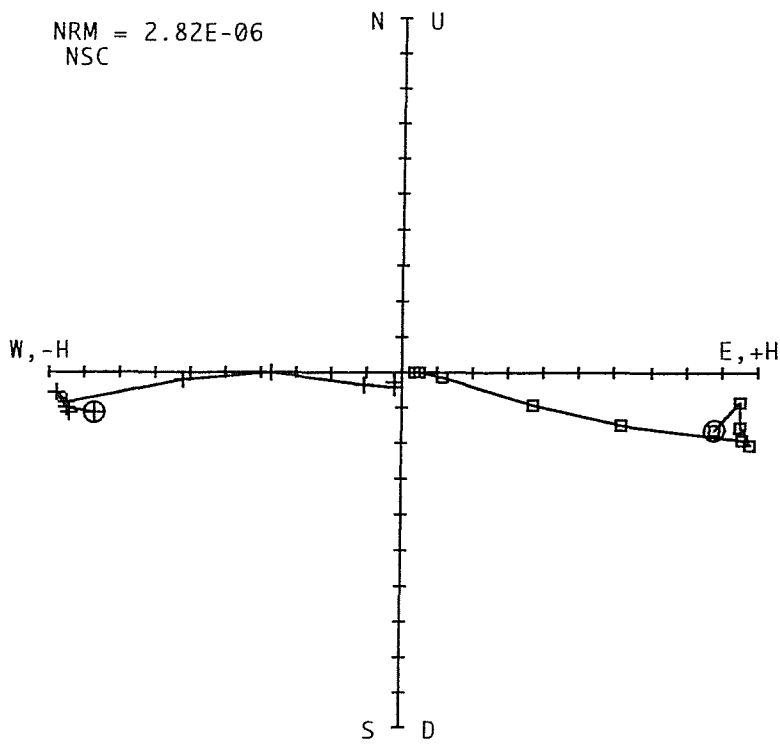

BLISS STEP	I	DECL	INCL	AMP
1	NRM	262.4	10.5	0.90
2	TD150	263.8	5.1	0.96
3	TD200	263.3	9.4	0.96
4	TD250	266.6	12.0	1.00
5	TD300	264.9	11.2	0.97
6	TD350	268.3	13.4	0.64
7	TD400	269.7	13.7	0.38
8	TD450	252.9	8.5	0.12
9	TD500	208.7	0.1	0.05
10	TD550	219.1	1.3	0.03

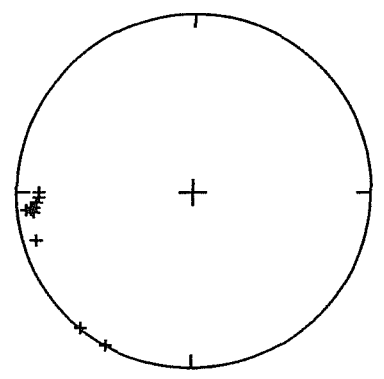

INTENSITY VS. DEMAGNETIZATION

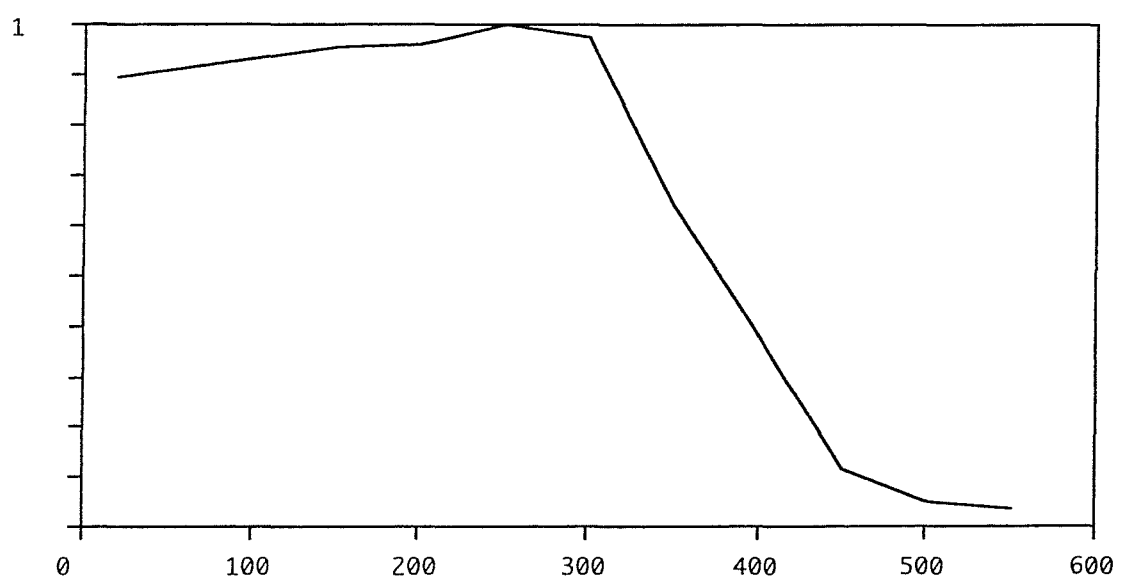

NRM = 7.42E-07
NSC

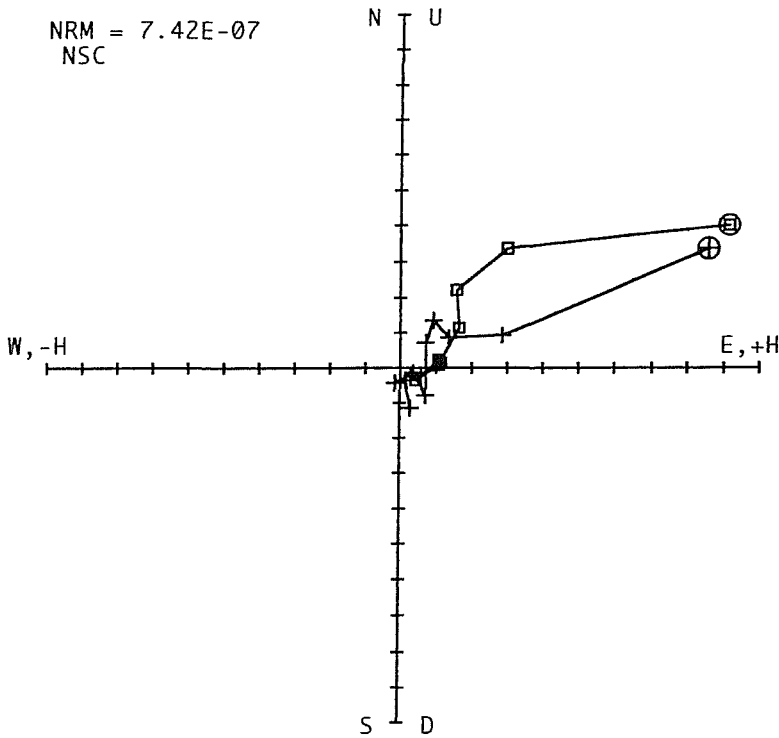

BLISS STEP	J	DECL	INCL	AMP
1	NRM	68.7	-23.5	1.00
2	TD150	71.5	-48.2	0.45
3	TD200	56.7	-53.9	0.27
4	TD250	35.2	-34.2	0.20
5	TD300	45.1	-4.3	0.10
6	TD350	136.3	-10.7	0.11
7	TD400	116.1	39.1	0.05
8	TD450	201.6	15.2	0.05
9	TD500	162.6	41.1	0.05
10	TD550	166.5	-6.7	0.12

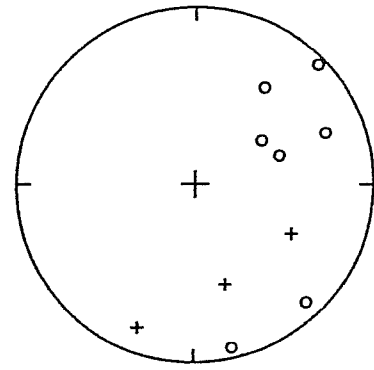

INTENSITY VS. DEMAGNETIZATION

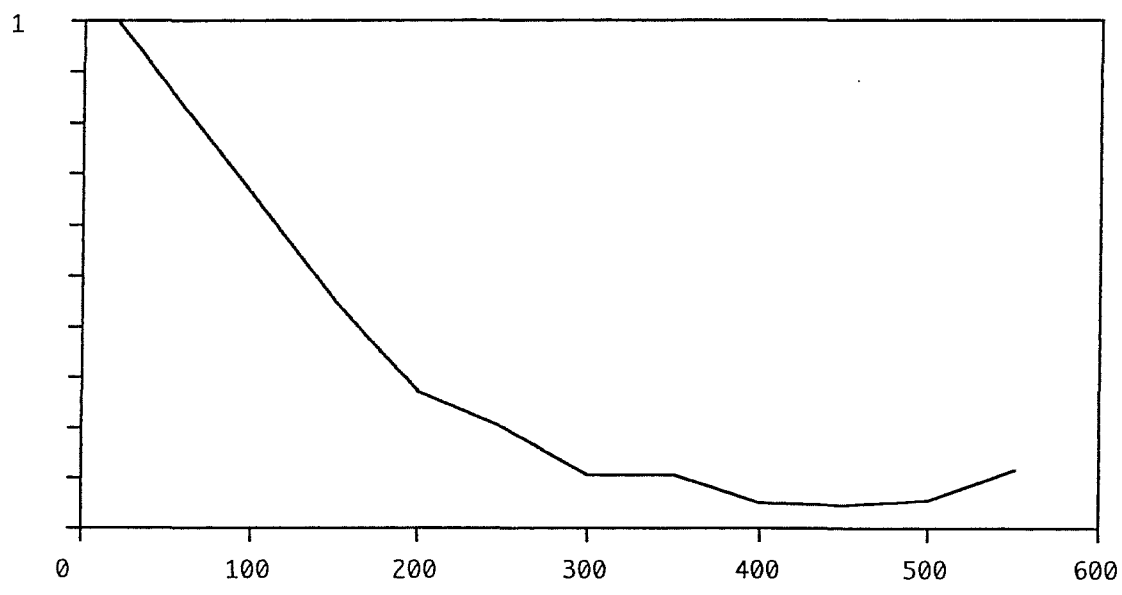

NRM = 6.91E-06
NSC

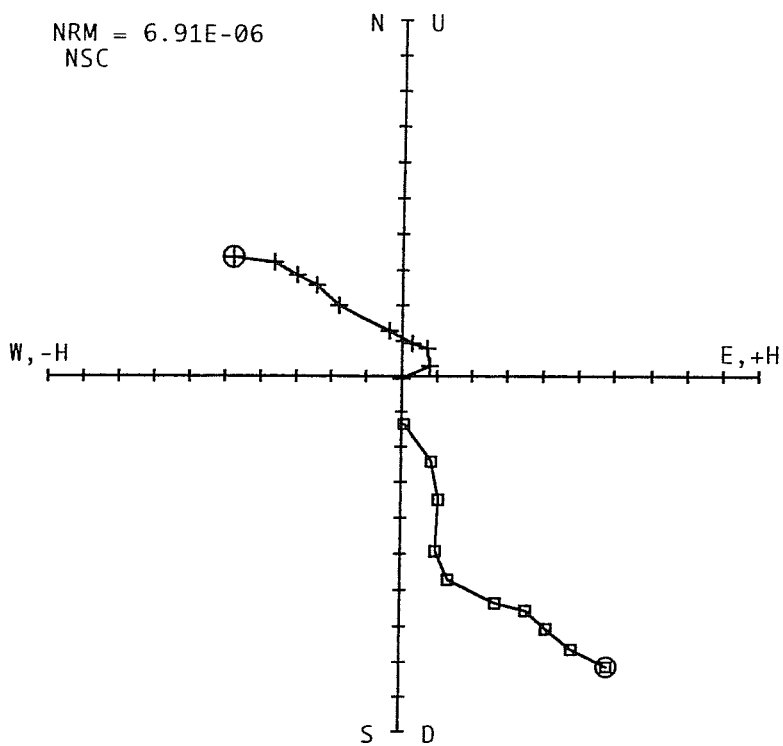

BLISS STEP	L	DECL	INCL	AMP
1	NRM	304.9	54.2	1.00
2	TD150	311.5	57.6	0.91
3	TD200	313.5	59.8	0.82
4	TD250	316.1	61.5	0.75
5	TD300	318.7	67.1	0.69
6	TD350	343.5	76.7	0.59
7	TD400	16.7	78.9	0.50
8	TD450	41.6	72.7	0.37
9	TD500	68.4	70.4	0.26
10	TD550	177.1	87.5	0.14

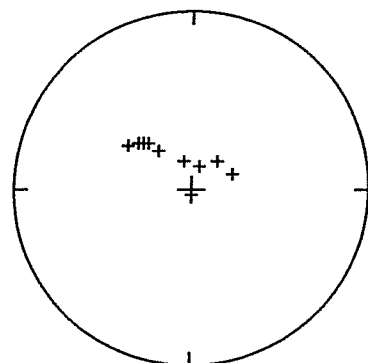

INTENSITY VS. DEMAGNETIZATION

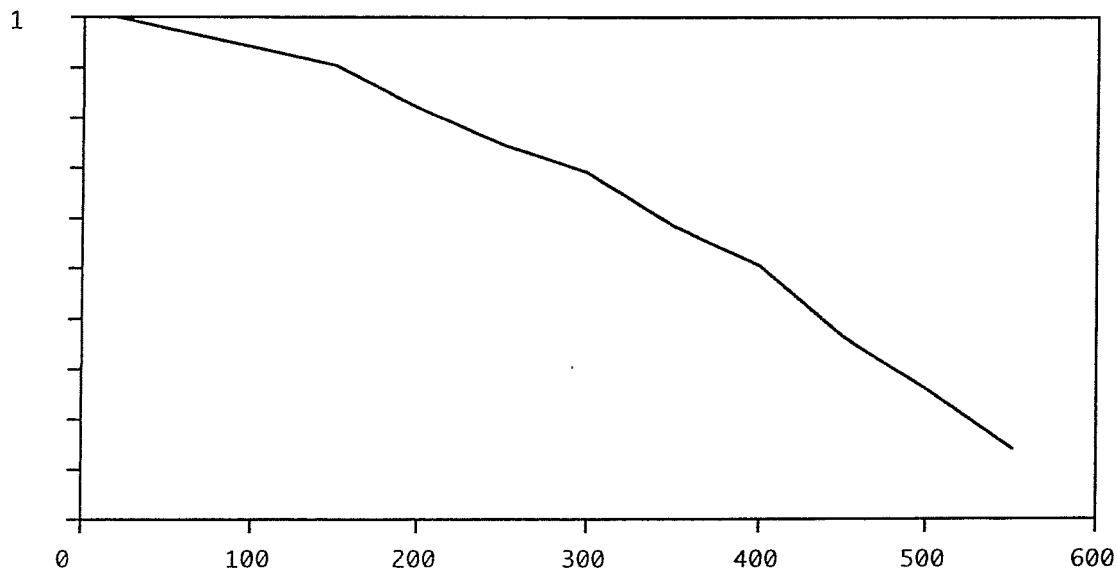

NRM = 1.72E-04
NSC

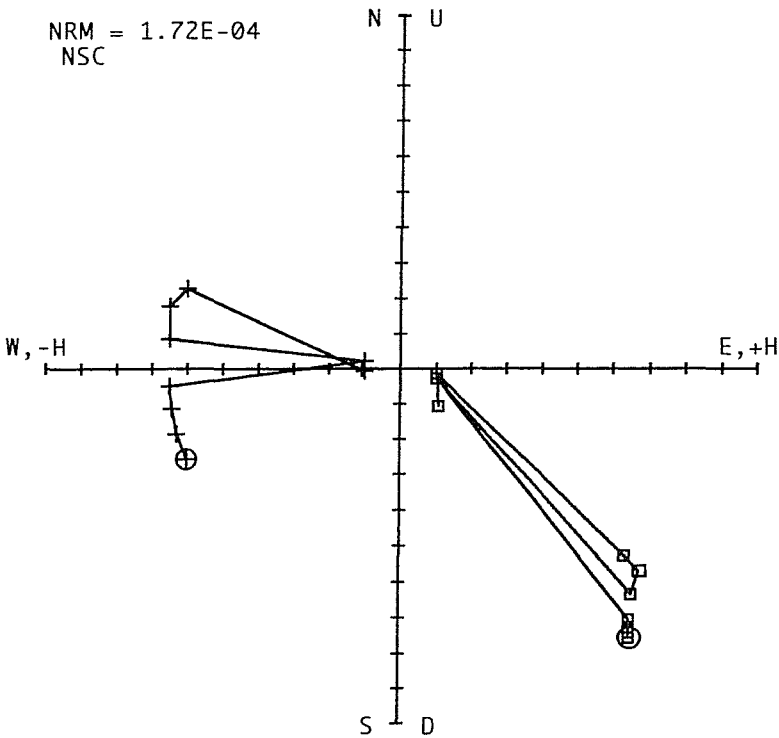

BLISS STEP	M	DECL	INCL	AMP
1	NRM	246.7	49.5	1.00
2	TD150	253.4	48.7	0.99
3	TD200	259.9	48.1	0.98
4	TD250	265.9	47.3	0.96
5	TD300	283.1	14.0	0.11
6	TD350	277.3	43.9	0.91
7	TD400	285.3	40.4	0.89
8	TD450	290.8	39.6	0.83
9	TD500	265.5	7.1	0.10
10	TD550	268.2	44.8	0.15

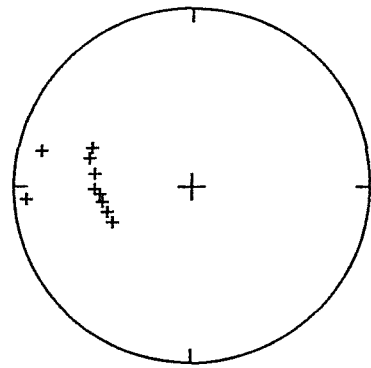

INTENSITY VS. DEMAGNETIZATION

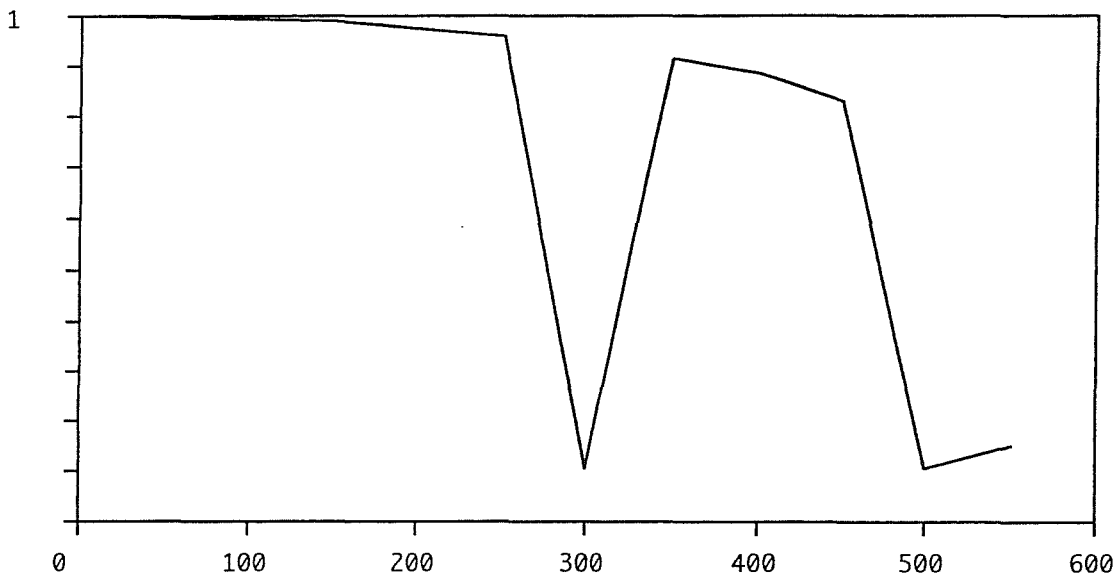

NRM = 2.29E-05
NSC

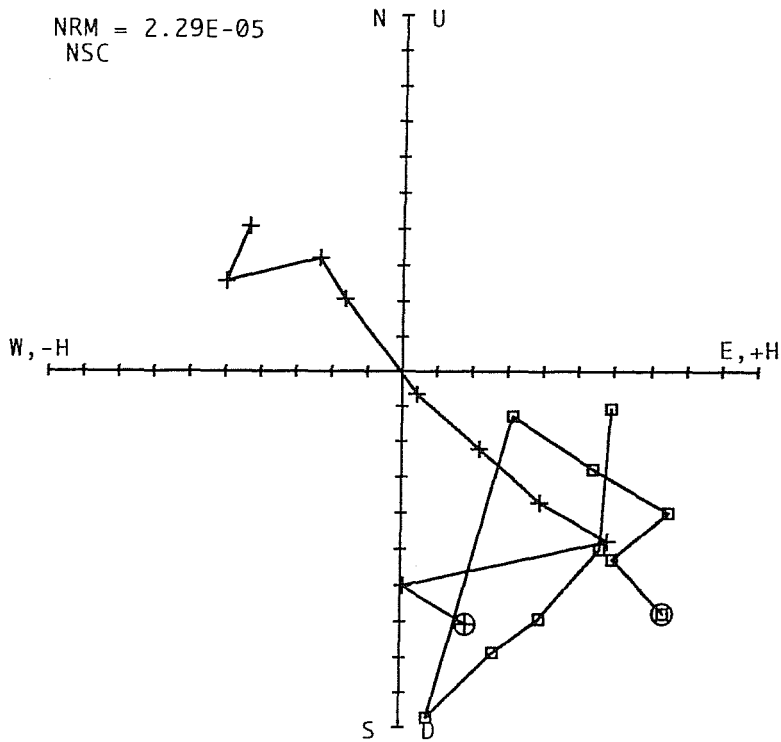

BLISS STEP	N	DECL	INCL	AMP
1	NRM	165.1	42.9	1.00
2	TD150	179.3	41.3	0.80
3	TD200	129.2	28.0	0.85
4	TD250	133.8	27.0	0.61
5	TD300	134.6	22.7	0.34
6	TD350	147.2	85.6	0.98
7	TD400	321.5	71.5	0.83
8	TD450	323.8	60.3	0.80
9	TD500	297.2	41.5	0.75
10	TD550	313.1	10.1	0.60

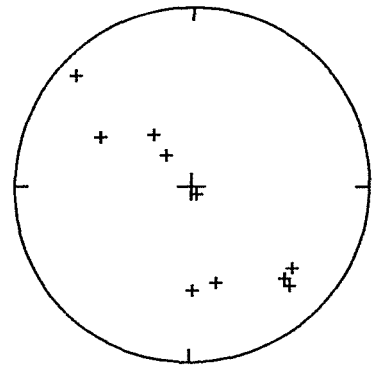

INTENSITY VS. DEMAGNETIZATION

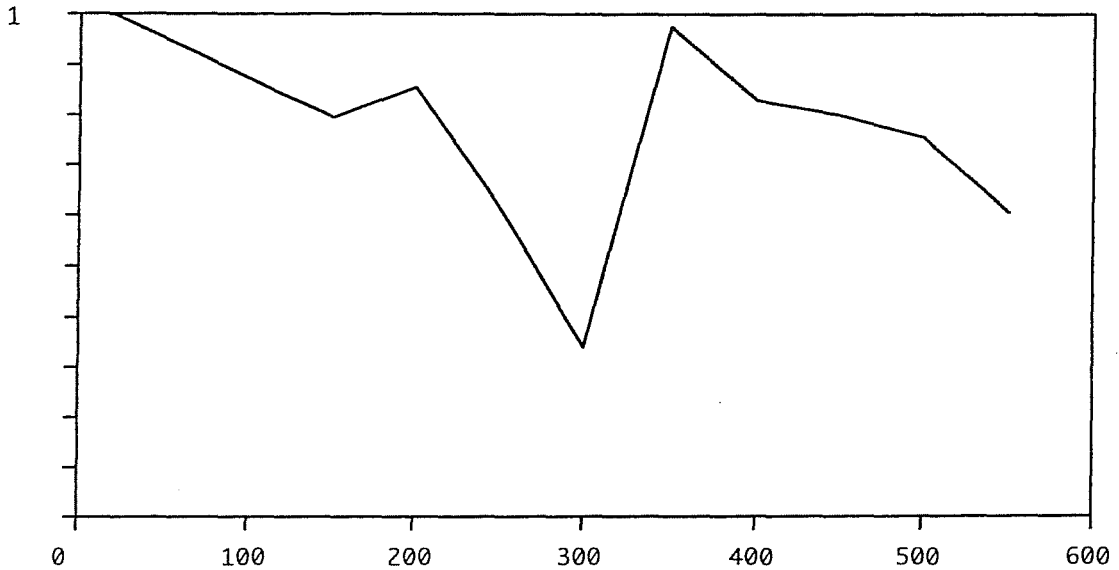

NRM = 1.27E-06
NSC

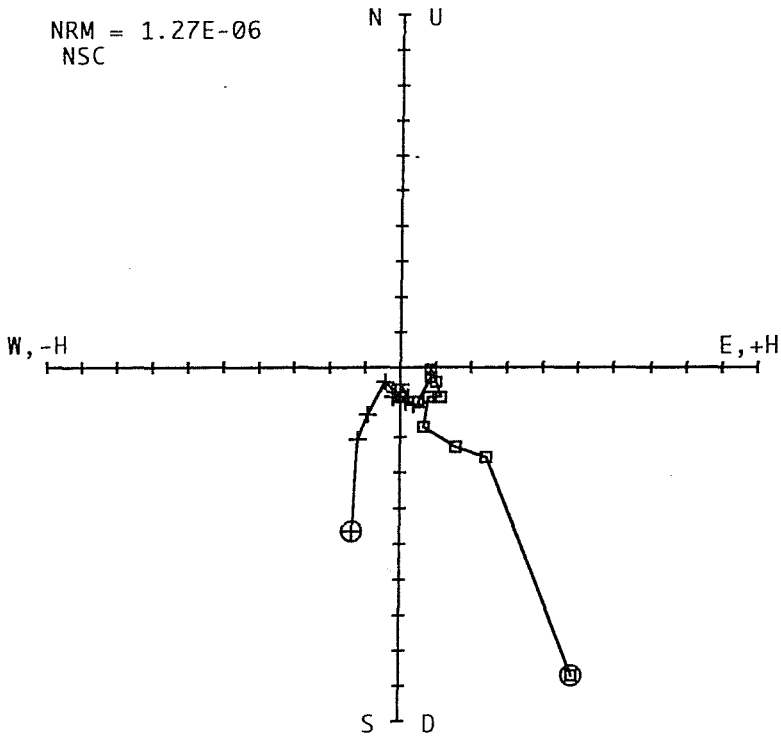

BLISS	0			
STEP	DECL	INCL	AMP	
1	NRM	196.3	60.9	1.00
2	TD150	209.7	46.9	0.35
3	TD200	213.9	55.0	0.28
4	TD250	226.8	69.7	0.18
5	TD300	191.7	49.5	0.12
6	TD350	162.4	36.5	0.14
7	TD400	170.8	24.5	0.11
8	TD450	195.6	4.5	0.09
9	TD500	163.3	20.2	0.09
10	TD550	177.8	61.6	0.11

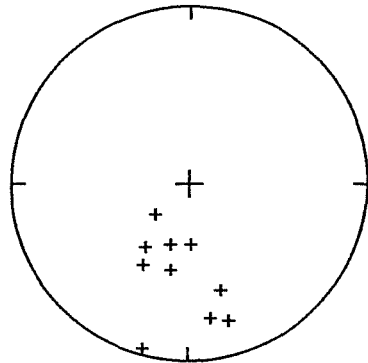

INTENSITY VS. DEMAGNETIZATION

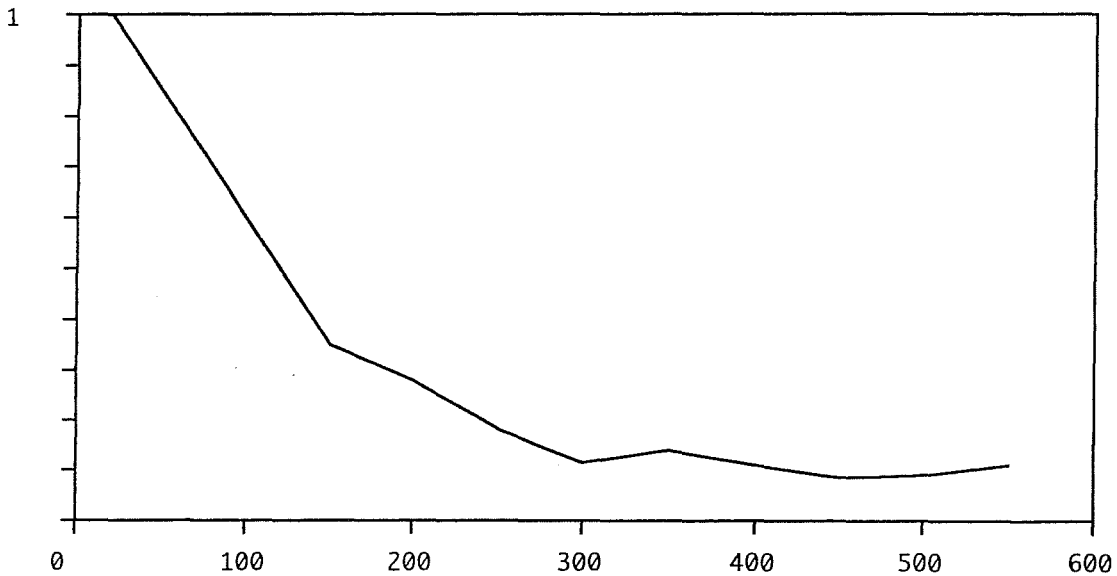

NRM = 1.27E-04
NSC

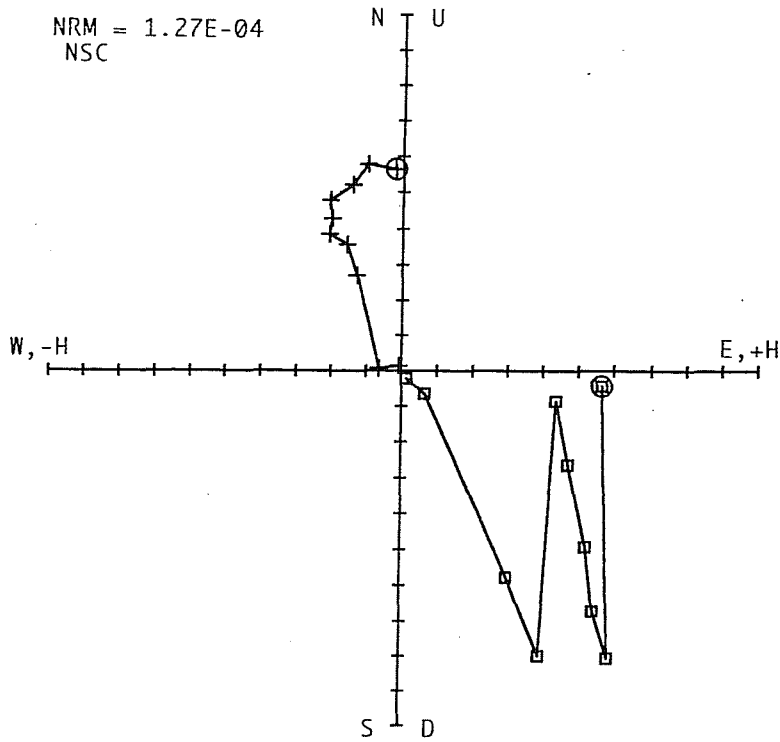

BLISS STEP	P	DECL	INCL	AMP
1	NRM	357.6	4.2	0.57
2	TD150	350.1	54.0	1.00
3	TD200	345.0	51.2	0.86
4	TD250	336.4	43.7	0.72
5	TD300	335.0	29.4	0.54
6	TD350	332.1	11.2	0.45
7	TD400	336.3	64.0	0.89
8	TD450	334.5	62.6	0.65
9	TD500	275.7	43.6	0.09
10	TD550	327.1	49.1	0.03

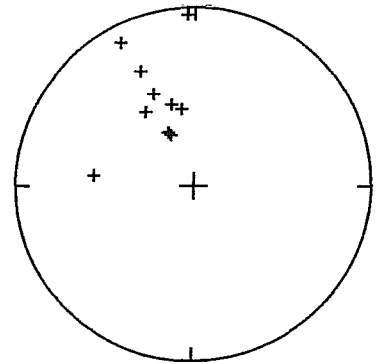

INTENSITY VS. DEMAGNETIZATION

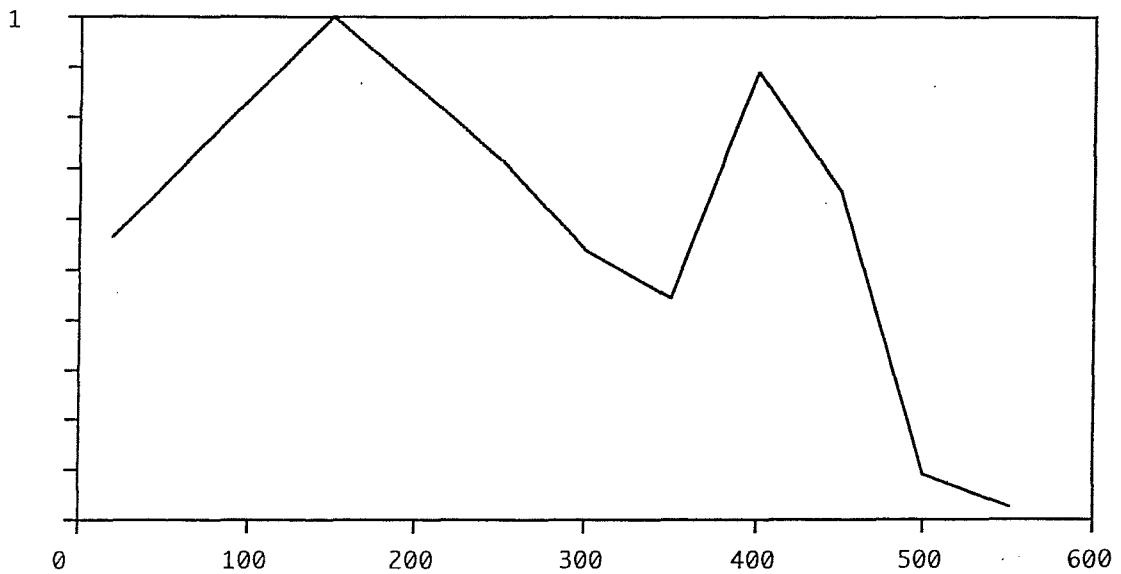

NRM = 2.46E-06
NSC

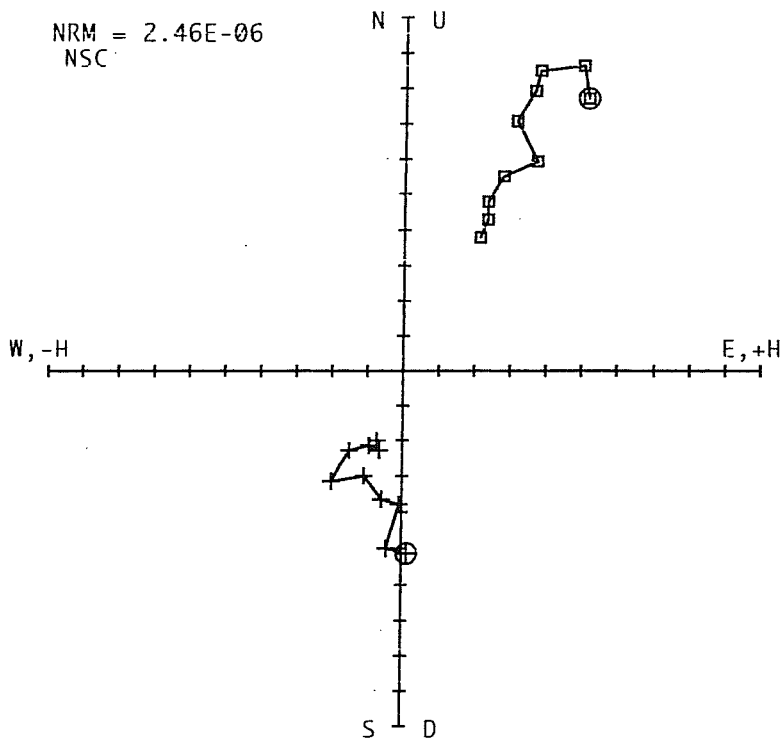

BLISS	Q	DECL	INCL	AMP
STEP				
1	NRM	178.6	-56.2	0.92
2	TD150	184.7	-59.9	1.00
3	TD200	181.4	-65.8	0.93
4	TD250	188.5	-65.3	0.87
5	TD300	199.7	-66.0	0.77
6	TD350	211.9	-58.0	0.70
7	TD400	213.1	-63.3	0.61
8	TD450	203.9	-63.6	0.53
9	TD500	195.9	-61.2	0.49
10	TD550	200.5	-60.6	0.43

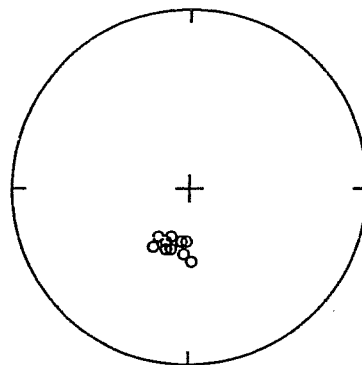

INTENSITY VS. DEMAGNETIZATION

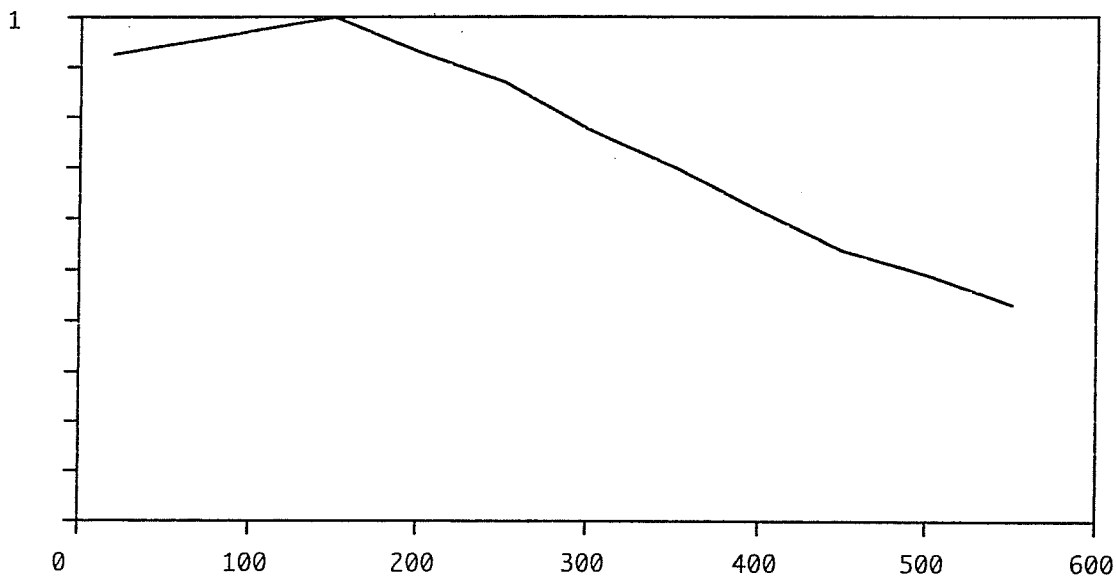

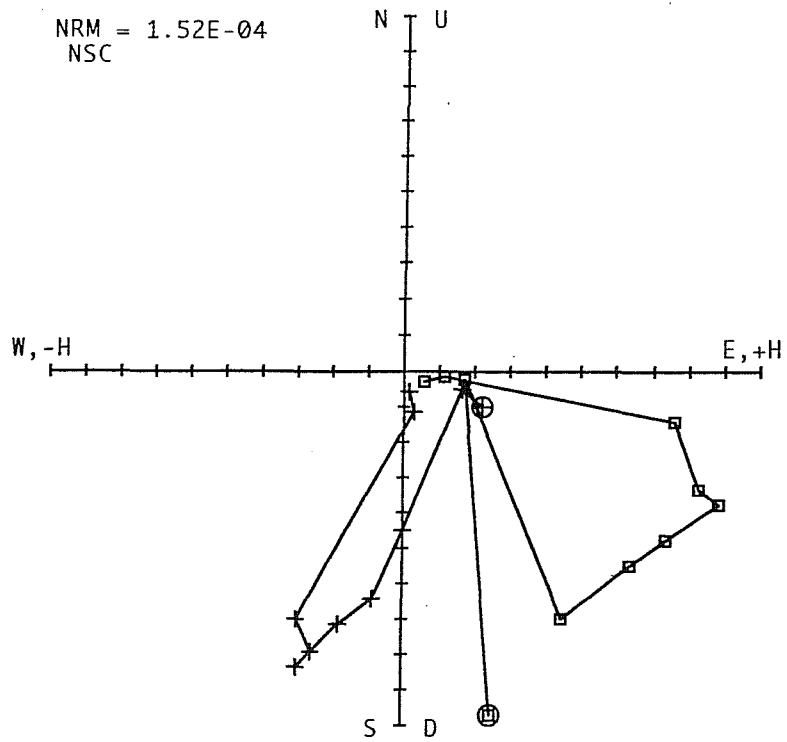

BLISS STEP	S	DECL	INCL	AMP
1	NRM	114.3	75.7	1.00
2	TD150	108.3	8.2	0.17
3	TD200	180.4	57.3	0.83
4	TD250	187.5	40.5	0.85
5	TD300	194.0	33.0	0.88
6	TD350	199.8	23.2	0.96
7	TD400	197.8	22.1	0.90
8	TD450	203.4	10.4	0.77
9	TD500	167.3	7.5	0.11
10	TD550	169.6	26.3	0.07

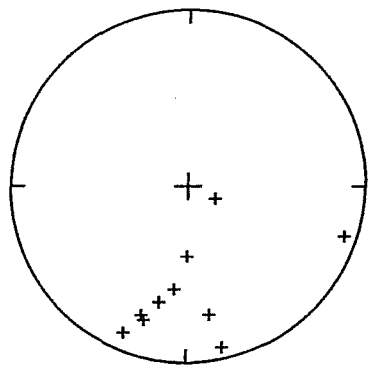

INTENSITY VS. DEMAGNETIZATION

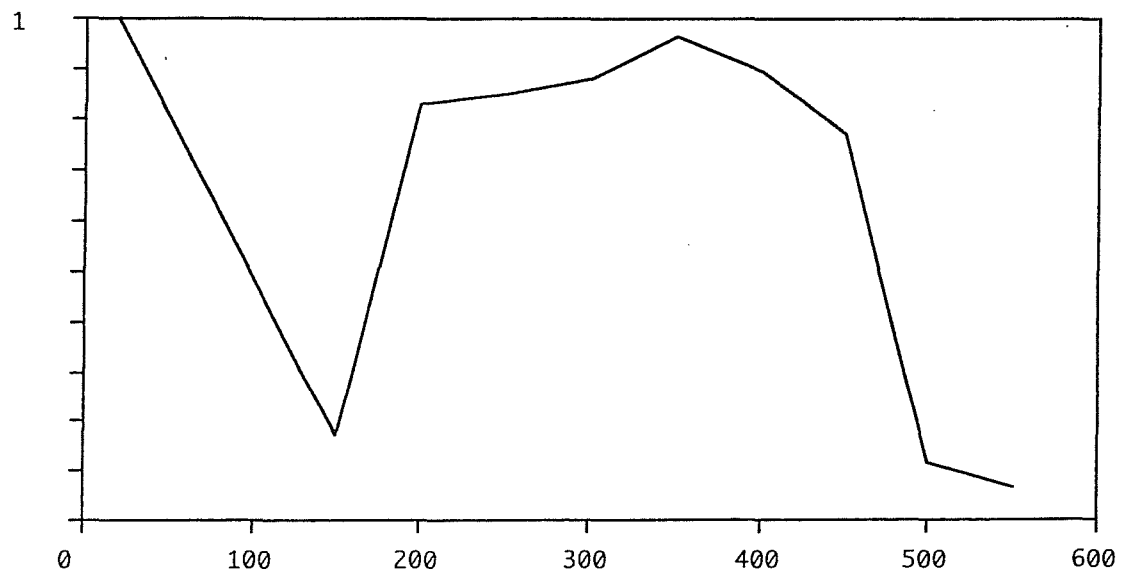

NRM = 2.21E-06
NSC

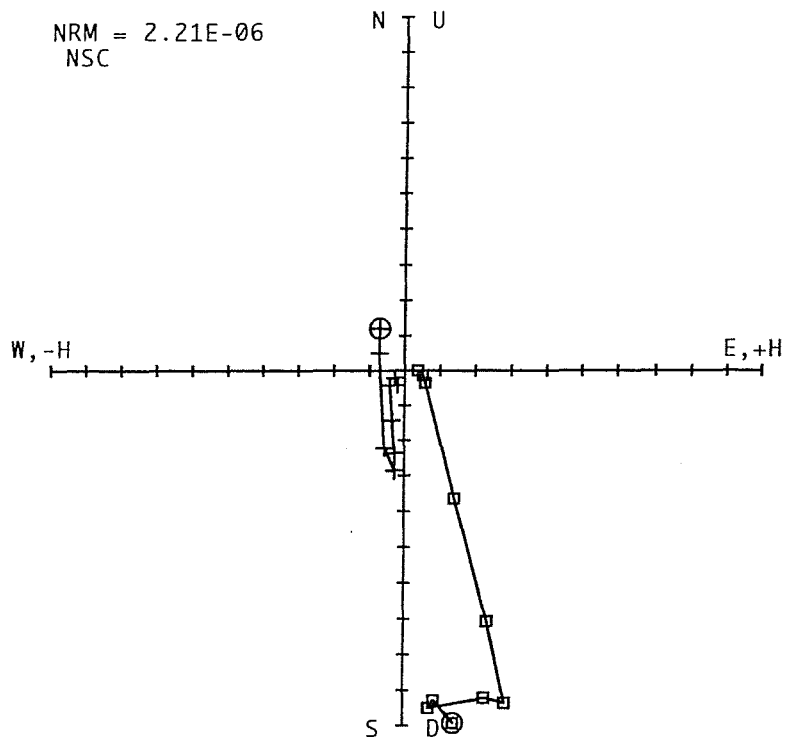

BLISS STEP	T	DECL	INCL	AMP
1	NRM	328.6	82.0	1.00
2	TD150	304.0	84.8	0.93
3	TD200	269.7	85.7	0.95
4	TD250	195.1	76.2	0.95
5	TD300	185.2	72.9	0.98
6	TD350	186.7	71.5	0.75
7	TD400	194.2	68.3	0.39
8	TD450	224.5	32.6	0.07
9	TD500	206.4	14.9	0.05
10	TD550	229.4	-0.3	0.03

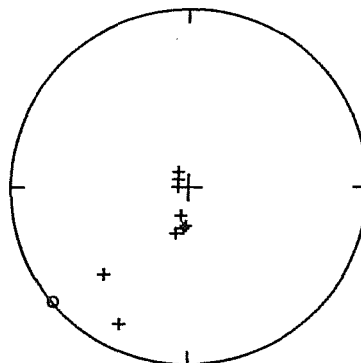

INTENSITY VS. DEMAGNETIZATION

