

University of New Hampshire
University of New Hampshire Scholars' Repository

Center for Coastal and Ocean Mapping

Center for Coastal and Ocean Mapping

9-2011

A Method for Field Calibration of a Multibeam Echo Sounder

Carlo Lanzoni

University of New Hampshire, Durham

Thomas C. Weber

University of New Hampshire, Durham, thomas.weber@unh.edu

Follow this and additional works at: <https://scholars.unh.edu/ccom>

 Part of the [Oceanography and Atmospheric Sciences and Meteorology Commons](#)

Recommended Citation

Lanzoni, Carlo and Weber, Thomas C., "A Method for Field Calibration of a Multibeam Echo Sounder" (2011). *IEEE Oceans*. 805.
<https://scholars.unh.edu/ccom/805>

This Conference Proceeding is brought to you for free and open access by the Center for Coastal and Ocean Mapping at University of New Hampshire Scholars' Repository. It has been accepted for inclusion in Center for Coastal and Ocean Mapping by an authorized administrator of University of New Hampshire Scholars' Repository. For more information, please contact nicole.hentz@unh.edu.

A Method for Field Calibration of a Multibeam Echo Sounder

J. C. Lanzoni, T. C. Weber
Center for Ocean and Coastal Mapping/Joint Hydrographic Center
University of New Hampshire
Durham, NH 03824 USA

Abstract- The use of multibeam echo sounders (MBES) has grown more frequent in applications like seafloor imaging, fisheries, and habitat mapping. Calibration of these instruments is important for understanding and validating the performance of MBES. For echo sounders in general, different calibration methodologies have been developed in controlled environments such as a fresh water tank and in the actual field of operation. While calibration in an indoor tank facility can bring excellent results in terms of accuracy, the amount of time required for a complete calibration can become prohibitively large. A field calibration can reveal the actual radiation beam pattern for ship-mounted sonar systems, accounting for acoustic interferences which may be caused by objects around the installed transducers. The standard target method is a common practice for field calibration of split-beam echo sounders. However, when applied to a Mills Cross MBES, this method does not provide means to determine the alongship angle of the target, since the receiver transducer is a line array. A method to determine the combined transmit/receive radiation beam pattern for a ship-mounted multibeam system was developed and tested for a Reson Seabat 7125 MBES inside the fresh water calibration tank of the University of New Hampshire. This calibration methodology employs a tungsten carbide sphere of 38.1 mm diameter as target and a Simrad EK60 split-beam sonar system to provide athwartship and alongship angular information of the target sphere position. The multibeam sonar system was configured for 256 beams equi-angle mode at an operating frequency of 200 kHz; the split-beam system was set to work passively at the same frequency. A combined transmit/receive beam pattern was computed for an athwartship angular range between -6° and $+6^\circ$ and an alongship angular range between -1° and $+3^\circ$. The limited angular range of the measurements is due to the -3 dB beamwidth of 7.1° in the athwartship and alongship directions of the split-beam sonar system coupled with the alongship offset of 1.6° between the maximum response axes (MRA) of the two sonar systems. Possible acoustic interferences caused by the monofilament line used to suspend the target sphere in the water column were found in the measurements for alongship angle values less than -1° . Beam pattern measurements for the combined transmit/receive beam pattern at a distance of 8 m show a -3 dB beamwidth of 1.1° in the athwartship direction and a -3 dB beamwidth of 2.0° in the alongship direction for the most inner beams. The dynamic range for the measurements was approximately of -40 dB.

I. INTRODUCTION

Multibeam echo sounders (MBES) are typically employed to make measurements of depth, target range, and to infer target characteristics based on the intensity of the backscattered signals. The interpretation of these signals

relies on proper calibration of the multibeam system. We are concerned here with calibrations that aid in the interpretation of backscattered intensity. Different procedures have been developed to calibrate sonar systems in general. Acoustic calibrations performed in tank facilities, like the one described in [1], can determine radiation beam patterns with exceptional accuracy. However, the requirement to uninstall the system and the large amount of time necessary for a complete conventional tank calibration makes this methodology unviable in many cases. In addition, this methodology does not account for possible mount-related acoustic interferences for ship-mounted systems.

Field calibration employing the standard target method, as described in [2], is commonly used to calibrate split-beam systems for their ability to resolve the angular position of the target in both alongship and athwartship directions. However, the receive transducer of a Mills Cross MBES is a line array and can only determine the athwartship angular position of the target, making the standard target method less effective for field calibration.

A field calibration methodology for a 200 kHz Reson 7125 MBES employing a Simrad EK60 split-beam echo sounder and a tungsten carbide target sphere of 38.1 mm diameter is presented here. This approach is similar to the standard target method, but uses the split-beam echo sounder to determine the sphere position relative to the MBES. This methodology tested in the acoustic tank of Chase Ocean Engineering Laboratory at the University of New Hampshire. The dimensions of the acoustic tank are 18 m long, 12 m wide, and 6 m deep, allowing combined transmit/receive beam pattern measurements for ranges up to 8 m using this methodology.

Methodology Overview

The split-beam transducer, a 200 kHz Simrad ES200-7C, was temporarily mounted adjacent to the multibeam transducers and was used to provide the target sphere angular position in both athwartship and alongship directions. The target sphere, with target strength of -39 dB at 200 kHz, was suspended in the water column by a 30 lbs. test monofilament line at a range of approximately 8 m. The MBES was configured for 256 equi-angle mode at an operating frequency of 200 kHz; the split-beam system was set to operate passively at the same frequency, triggered by the MBES. The split-beam transducer was adjusted to have its maximum response

axis (MRA) aligned with the MRA of the MBES at the target range. Fig. 1 shows the calibration methodology overview and fig. 2 shows the detail of the alignment of the MRAs of both systems. According to the MBES manufacturer specifications, its -3 dB beamwidth is 1° in the athwartship direction and 2° in alongship direction. The -3 dB beamwidth of the split-beam system is of 7.1° in both athwartship and alongship directions, which limits the angular range of the beam pattern measurements.

Beamformed data are recorded by the MBES and used to compute the target range from the MBES and the amplitude of the return signals corresponding to the target position. Data recorded by the split-beam system are used to compute the corresponding athwartship and alongship angular coordinates of the target sphere. Target angles in the MBES coordinate system are derived from the raw split-beam angle and range measurements and knowledge of the positional offsets between the split-beam and MBES transducers.

The MBES is used to trigger the split-beam system for the purpose of synchronization. However, a small time delay can be expected between the start of acquisition time of each system. To minimize this delay and account for possible missing pings on the recorded data from both systems, the two systems were synchronized using the Network Time Protocol (NTP) on a point-to-point network. Fig. 3 shows the block diagram employed in the tests.

Setup in the Acoustic Tank

The transducers of both sonar systems were installed in a rigid metallic structure as depicted by fig. 4. The split-beam transducer is placed on the y-axis of the multibeam system, with a separation distance of 0.955 m between their geometric centers. This distance was chosen to be short enough to keep the mounting structure rigid to minimize possible mechanical vibrations and flexing, while avoiding acoustic interferences between the two systems. The mounting structure was held by a carbon fiber pole, fixed at the gravity center of the mount and attached to the main bridge of the tank. The EK60 transducer was aligned so that its MRA would intercept the multibeam MRA at a distance of 8 m.

The positions of the transducers and the target sphere in the tank were chosen to avoid the effects of acoustic signals reflected from the water surface, the bottom, and the walls of the tank during the tests. The transducers were placed in the tank at 2 m from the back wall, at 9 m from each of the sidewalls, and at the mid-depth of the tank. Ideally, the range of the target sphere should be large enough to achieve measurements in the far-field of the transducers. However, having the tank side walls at 9 m of range and working with transmitted signals with pulse lengths of $300 \mu\text{s}$ (0.45 m of length in water) would allow the target sphere to be at a maximum range of 8 m. The target sphere was manually swept on the region of interest by a person holding the monofilament line on the small cart over the bridge during the

beam pattern measurements. Fig. 5 shows the described setup in the acoustic tank.

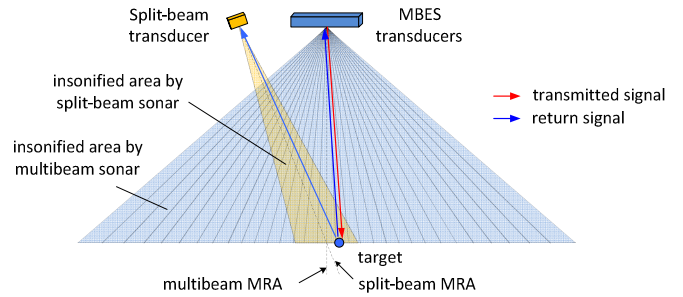

Figure 1. Field calibration methodology overview.

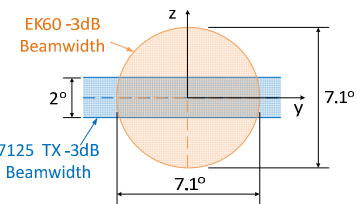

Figure 2. MRAs alignment detail.

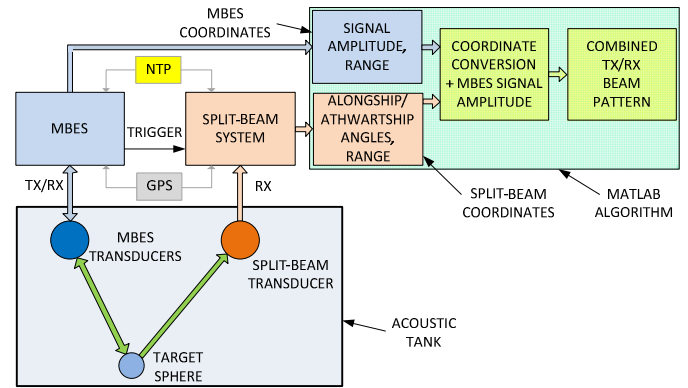

Figure 3. Field calibration methodology: block diagram.

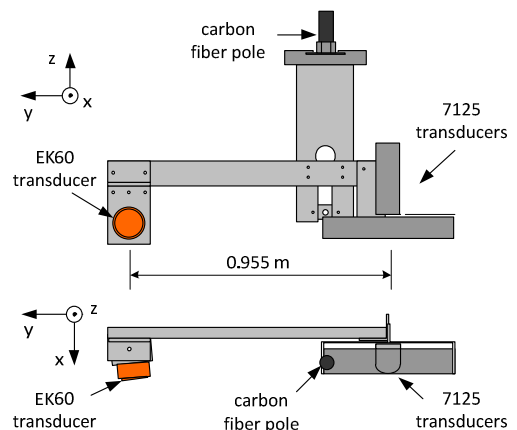

Figure 4. Transducers mount.

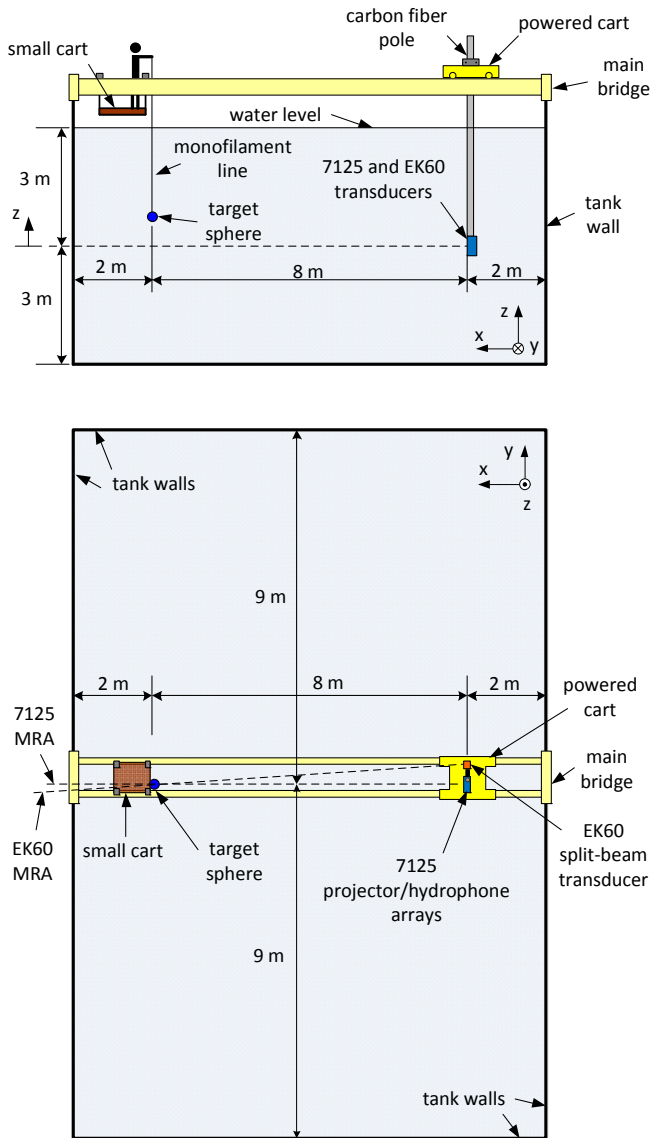

Figure 5. Setup in the acoustic tank setup.

II. SPLIT-BEAM ECHO SOUNDER ACCURACY TESTS

The performance of the field calibration methodology described here strongly depends on the accuracy of the auxiliary sonar system in providing the angular values corresponding to the target sphere position during the calibration measurements. For this reason, tests to investigate the performance of the split-beam echo sounder were conducted employing the same configuration of both systems used in the calibration measurements. The target sphere was positioned in a grid of known athwartship and alongship angles ranging from -6° to $+6^\circ$ in 0.5° increments (in MBES coordinates) and measurements were collected employing 50 pings for each position. The angular measurements provided by the split-beam system were averaged and compared with the corresponding actual values.

Fig. 6 and fig. 7 present the plots of the error values in the split-beam measurements for athwartship and alongship angles, respectively, employing the MBES in active mode and the split-beam system in passive mode. These plots show only the regions of corresponding error values smaller than 0.5° . For the angular region inside the -3 dB beamwidth range of the split-beam system ($\pm 3.55^\circ$ in both alongship and athwartship directions), the athwartship angle error values vary between $\pm 0.2^\circ$, with smaller angle error values for angular positions closer to the MRA of the split-beam system. The alongship angle error values vary between 0° to 0.3° for alongship angles between -0.3° to $+3.5^\circ$. For alongship angles between -0.3° to -3.5° , the alongship angle error values range from 0° to more than 1° .

Fig. 8 and fig. 9 show the standard deviation of these measurements corresponding to athwartship and alongship angles, respectively. For the athwartship angles the standard deviation values are less than 0.1° for most of the angular range and smaller than 0.2° for alongship angle values higher than -1° . The higher values of alongship error and standard deviation for the region of alongship angle values smaller than -1° suggest that the monofilament line used to suspend the target sphere in the water column may cause acoustic interference in the measurements made by the split-beam echo sounder.

Tests employing the split-beam transducer mounted up-side down (rotation of 180° relative to its original position) revealed larger alongship errors for positive values of alongship angles and smaller alongship errors for negative values, also indicating possible acoustic interference from the monofilament line. Similar tests employing a thinner monofilament line (6 lbs. test) to hold the target sphere produced results with smaller angular error amplitudes and standard deviation values. The results from these tests reinforce the hypothesis that there is acoustic interference caused by the monofilament line used to hold the target sphere for alongship angles less than -1° .

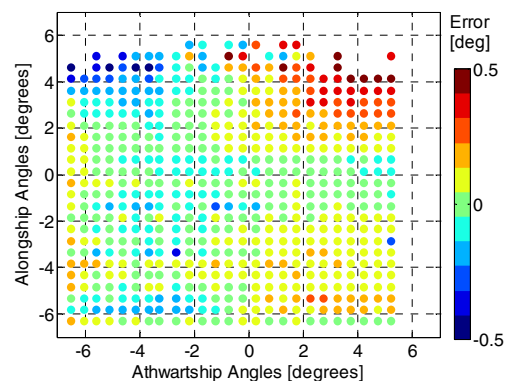

Figure 6. Split-beam accuracy test: athwartship error smaller than 0.5° .

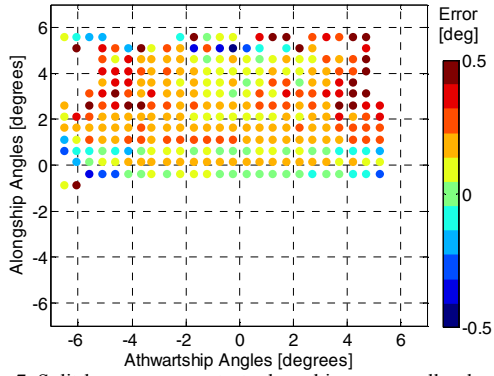

Figure 7. Split-beam accuracy test: alongship error smaller than 0.5° .

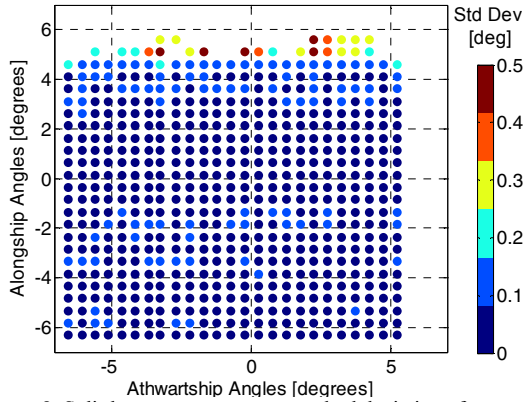

Figure 8. Split-beam accuracy test: standard deviation of measured athwartship angles.

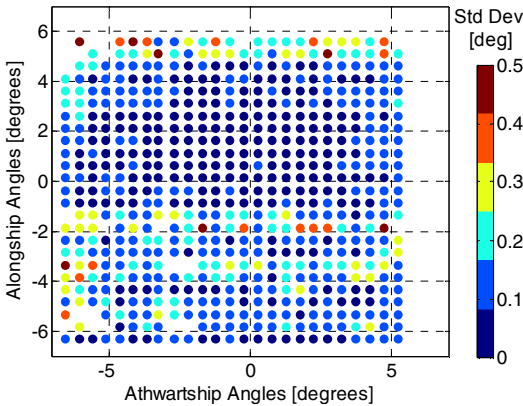

Figure 9. Split-beam accuracy test: standard deviation of measured alongship angles.

III. BEAM PATTERN MEASUREMENTS PROCEDURE

A beam pattern calibration procedure needs to be conducted in the linear region of operation of the MBES under test. If the region of operation is nonlinear, the measured radiation beam pattern can become deformed from its actual values, where smaller amplitudes would appear more amplified than higher ones, as discussed in [1] and in more detail in [3]. This calibration used here employed measurements to determine

proper settings for transmitted power and receive gain for the MBES to operate in a linear range using the methodology described in [3]. The target sphere was placed at the MRA of the MBES at a range of 8 m and measurements were collected for power values ranging from 170 dB to 220 dB in 1 dB increments and gain values ranging from 0 to 80 dB in 5 dB increments. The magnitude of the signal returns corresponding to the target sphere (recorded by the MBES) were used to compute the gain curves which allowed the determination of proper settings for transmitted power and receive gain at the multibeam system.

Fig. 10 shows the gain curves for beam 129 computed from the transmit power and receive gain tests. The linear fit on the 40 dB gain curve (black line) shows that the point on this curve corresponding to a power setting of 220 dB is below the 1 dB compression point, making these values of transmitted power and receive gain settings appropriate for the beam pattern measurements with the described configuration.

This calibration methodology is applied in two parts: i) collection of measurements with the target sphere at the MBES MRA, and ii) collection of measurements with the target sphere sweeping an area containing the angular limits of interest at approximately constant distance from the transducers. The first part is necessary to determine the angle offset in the athwartship direction between the MRAs of the two sonar systems and the time delay between their triggers. Since the beam pattern is a relative measurement, the determination of the angle offset in the alongship direction between the MRAs of the two systems is not required for the described configuration. The alongship angle offset in the resulting beam pattern of the MBES is subtracted at a final stage of the data processing. The second part of the calibration procedure uses the resulting data from the first part to calculate the athwartship and alongship angular values corresponding to the target sphere position in the MBES coordinates. These data are then employed in the computation of the combined transmit/receive radiation beam pattern of the MBES. The measurements for the second part of the procedure were performed by manually moving the target sphere up and down, covering the athwartship and alongship angular region from -6° to $+6^\circ$, as depicted by fig. 11. The main settings for the MBES and for the split-beam system employed in the beam pattern measurements are given in table I and table II, respectively.

The first results from the beam pattern measurements revealed some inconsistencies which can be observed in the beam pattern plot of fig. 12. The alongship angular region from 0° to $+1^\circ$ contains denser data population than other regions, which could be an evidence of acoustic interference caused by the monofilament line. These inconsistencies were investigated by inspecting the data provided from the records of the split-beam system.

The plot of measured alongship angles shown by figure 13 presents regions of noisy values for certain time index regions. These noisy regions were identified manually by inspection of

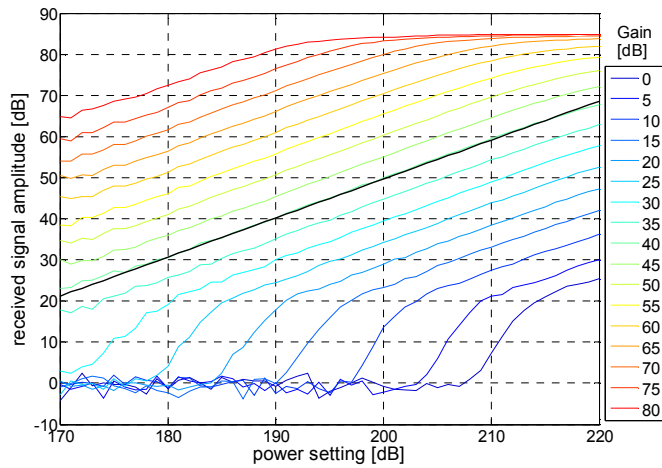

Figure 10. RESON 7125 gain curves – beam 129.

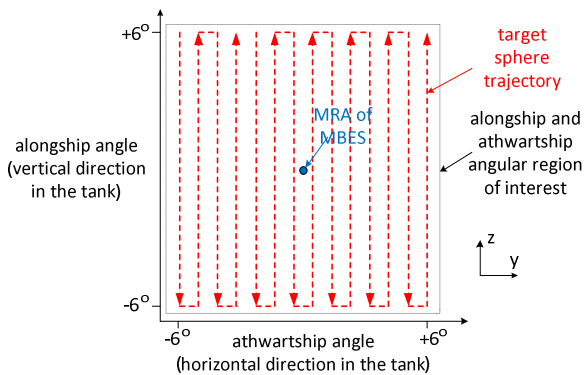

Figure 11. Target sphere trajectory during the beam pattern measurements.

TABLE I
7125 SETTINGS FOR BEAM PATTERN MEASUREMENTS

Power Mode	Power (dB)	Gain (dB)	Pulse Length (μ s)	Range (m)	Sound Velocity (m/s)
Active	220	40	260	1490	1490

TABLE II
EK60 SETTINGS FOR BEAM PATTERN MEASUREMENTS

Power Mode	Pulse Length (μ s)	Surface Range (m)	Sound Velocity (m/s)	Single Target Detection
Passive	256	Start: 0 Range: 12	1490	Min. Threshold: -60 Min. Echolength: 0.6 Max. Echolength: 1.8 Max. Phase Dev.: 12 Max. Gain Comp.: 6 Min. Echospacing: 1

the alongship angle data and discarded. After this data cleaning stage, the radiation beam pattern of the MBES was computed and plotted again. The alongship offset of 1.6° was determined by inspection of this plot and used to compute the final radiation beam pattern of the multibeam system. Fig. 14 shows the resulting beam pattern plot of the MBES corresponding to beam 129 without data interpolation and fig. 15 shows the corresponding plot applying data interpolation.

Fig. 16 and fig. 17 present the plots employed to determine the -3 dB beamwidth of MBES in the athwartship and alongship directions, respectively. These values are of 1.1° and 2.0° , respectively, agreeing with the manufacturer specifications. Side-lobes in the measured radiation beam pattern are present but difficult to completely resolve due to the dynamic range of the measurements, which is close to -40 dB.

The resulting radiation beam pattern plot is limited in the athwartship direction by the beam sensitivity of the split-beam system. The limitation in the alongship direction, however, is due to the combination of this beam sensitivity, the alongship angle offset of 1.6° between the systems, and the acoustic interferences which are believed to be caused by the monofilament line for the lower values of alongship angles.

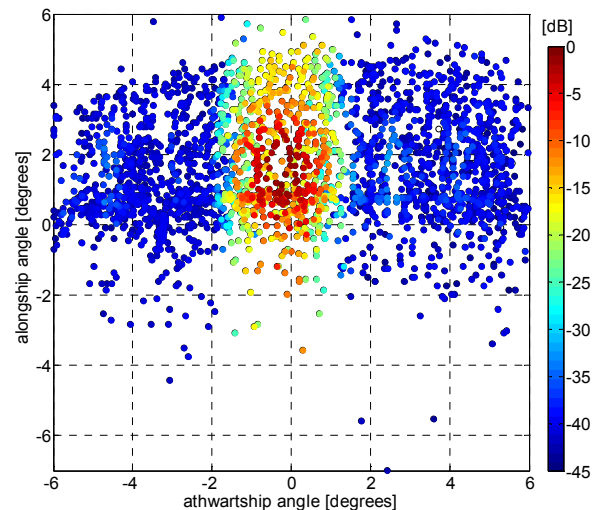

Figure 12. RESON 7125 beam pattern – beam 129 (first results).

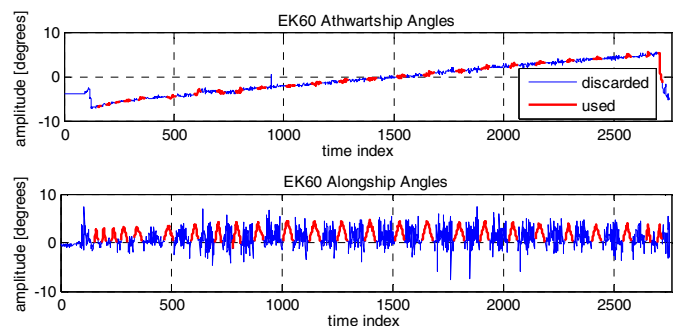

Figure 13. Split-beam angles – data cleaning.

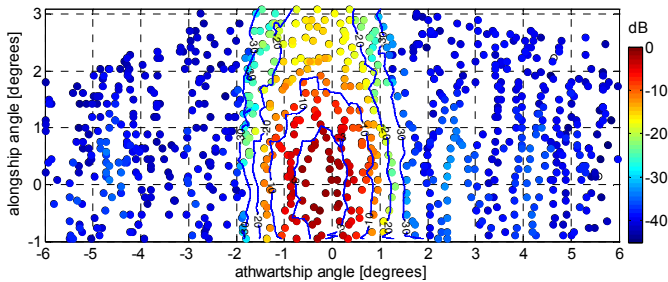

Figure 14. RESON 7125 beam pattern – beam 129, without data interpolation.

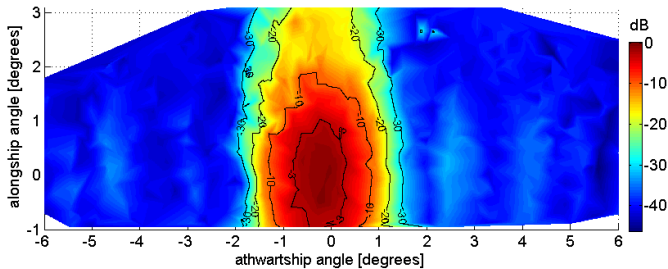

Figure 15. RESON 7125 beam pattern – beam 129, with interpolated data.

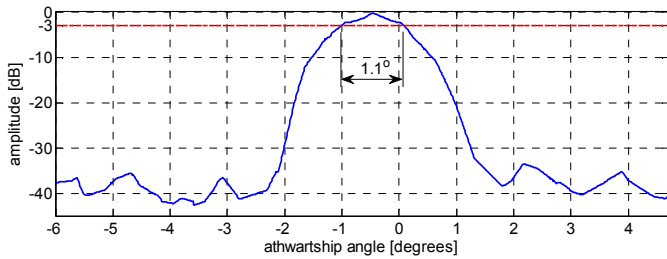

Figure 16. -3 dB beamwidth, athwartship direction – beam 129.

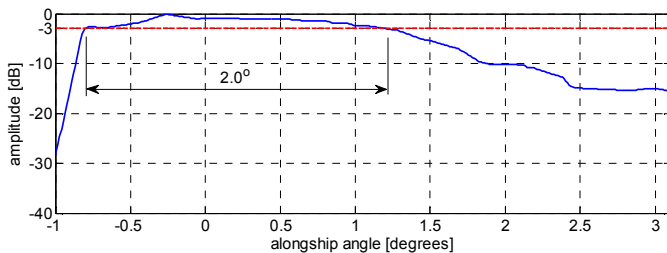

Figure 17. -3 dB beamwidth, alongship direction – beam 129.

IV. CONCLUSION

A field calibration methodology for multibeam echo sounders employing a split-beam sonar system and a standard target was developed and tested in the acoustic tank at the University of New Hampshire for the acoustic range of 8 m. In this methodology, the split-beam system is used to provide the coordinates of a standard target in athwartship and alongship angles necessary to compute a combined transmit/receive radiation beam pattern of the MBES. The tests employed a Simrad EK60 system with a 200 kHz split-

beam transducer and a tungsten carbide target sphere of 38.1 mm diameter (WC 38.1) to calibrate a Reson Seabat 7125 MBES. The multibeam system was set to operate at a frequency of 200 kHz and configured for 256 beams equi-angle mode; the split-beam echo sounder was set to work passively at the same frequency.

Tests of the accuracy of the target angle estimates were conducted to evaluate the performance of the split-beam system using the beam pattern measurements configuration (MBES active/split-beam system passive). It was verified that for the angular range inside the -3 dB beamwidth of the split-beam system ($\pm 3.55^\circ$ in both athwartship and alongship directions) the error for athwartship angles was in the range of $\pm 0.2^\circ$, with smaller error values for positions closer to the MRA of the split-beam system. Inside this same angular range, alongship angle error values vary from 0° to 0.3° for alongship angles from -0.3° to $+3.5^\circ$ and from 0° to more than 1° for alongship angles from -0.3° to -3.5° . The larger alongship error values found for measured alongship angles smaller than -0.3° lead to the suspicion that the 30 lbs. test monofilament line used to suspend the target sphere in the water column could be causing acoustic interferences in the measurements. The possibility of acoustic interference from the monofilament line, a hypothesis supported by subsequent testing, may be due to the particular configuration used here, where the MRAs of both sonar systems were pointed parallel to the water level (horizontally) and approximately perpendicular to the monofilament line. Different results may be observed for ship-mounted transducers where the configuration of the monofilament line would be different than the one used in the tests described here.

The calibration measurements allowed the computation of a combined transmit/receive radiation beam pattern of the MBES for the athwartship range from -6° to $+6^\circ$ and for the alongship range from -1° to $+3^\circ$. The limited angular range of the measurements is due to the -3 dB beamwidth of 7.1° in alongship and athwartship directions of the split-beam system, coupled with the alongship offset of 1.6° between the MRA of the two systems and possible acoustic interferences caused by the monofilament line in the measurements for alongship angles smaller than -1° . The computed radiation beam pattern shows a -3 dB beamwidth of 1.1° in the athwartship direction and a -3 dB beamwidth of 2.0° in the alongship direction for the most inner beams, agreeing with the manufacturer specifications. The dynamic range for the measurements was of approximately -40 dB, limiting the ability to resolve side-lobes.

This aided standard sphere method is a potential candidate for field calibration of multibeam sonars. The results shown here may be improved for field calibration by reducing angular offsets between MRAs of both systems and also by using a thinner monofilament line to avoid acoustic interferences. Despite the restriction in the covered angular region and reduced angular accuracy when compared to a conventional tank calibration procedure, it offers the

advantage of being applicable to ship-mounted systems operating in the field, with significant reduced operation time.

ACKNOWLEDGMENT

The following are thanked for their participation in the calibration experiments: P. Lavoie, V. Schmidt, K. Jerram, University of New Hampshire. Reson is thanked for lending the multibeam system for use in the calibration experiments. The authors also thank Simrad for their assistance with the split-beam system.

REFERENCES

- [1] J.C. Lanzoni and T.C. Weber, "High-resolution Calibration of a Multibeam Echo Sounder", Proc. MTS/IEEE Oceans 2010 Conf., Sep. 20-23, Seattle, WA.
- [2] Foote K, Knudsen H, Vestnes G, MacLennan D, Simmonds E (1987), Calibration of Acoustic instruments for fish density estimation, *ICES Coop. Res. Rep. 144*, 81 p.
- [3] S.F. Greenaway and T.C. Weber, "Test Methodology for Evaluation of Linearity of Multibeam Echosounder Backscatter Performance", Proc. MTS/IEEE Oceans 2010 Conf., Sep. 20-23, Seattle, WA.
- [4] K.G. Foote, D. Chu, T.R. Hammar, K.C. Baldwin, L.A. Mayer, L.C. Hufnagle, Jr., and J.M. Jech, "Protocols for Calibrating Multibeam Sonar," J. Acoust. Soc. Am., vol. 114, pp. 2013-2027, 2005.
- [5] W.S. Burdic, "Underwater Acoustic System Analysis," 2nd ed., Prentice Hall, New Jersey, 1991.
- [6] Meinberg, *Network Time Protocol (NTP)*, [Online], Available: <http://www.meinberg.de/english/info/ntp.htm>.
- [7] T.K. Stanton and D. Chu, "Calibration of Broadband Active Acoustic Systems Using a Single Spherical Target," J. Acoust. Soc. Am. 124, 128-136, 2008.
- [8] D. Chu, K.G. Foote, L.C. Hufnagle, Jr., T.R. Hammar, S.P. Liberatore, K.C. Baldwin, L.A. Mayer, and A. McLeod, "Calibrating a 90-kHz Multibeam Sonar," Proc. MTS/IEEE Oceans 2003 Conf., Sep. 22-26, San Diego, CA, pp. 1633-1636.
- [9] T. R. Hammar, K. G. Foote, and S. P. Liberatore, "Advances in developing a high-frequency sonar calibration facility," Proc. MTS/IEEE Oceans 2003 Conf., pp. 1622-1624.
- [10] K. C. Baldwin, L. Mayer, A. McLeod, and J. Millar, "Acoustic transducer calibration system," Proc. MTS/IEEE Oceans 2003 Conf., pp. 2093-2099.
- [11] K.G. Foote, "Maintaining Precision Calibrations with Optimal Copper Spheres," J. Acoust. Soc. Am. 73, 1054-1063 (1983).
- [12] D. Chu, K.G. Foote, and L.C. Jr. Hufnagle, "Measurement of Multibeam Sonar Directivity Patterns," Proc. MTS/IEEE Oceans 2002 Conf., Oct. 29-31, vol. 3, pp. 1411-1414.
- [13] G.C. Gaunard, "Sonar Cross Section of Bodies Partially Insonified by Finite Sound Beams," IEEE J. Ocean. Eng. OE-10, 213-230, 1985.
- [14] K.G. Foote and D.N. MacLennan, "Comparison of Copper and Tungsten Carbide Calibration Spheres," J. Acoust. Soc. Am. 75, 612-616, 1984.
- [15] R. Hickling, "Analysis of Echoes from a Solid Elastic Sphere in water," J. Acoust. Soc. Am. 34, 1582-1592, 1962.
- [16] F.E. Tichy, H. Solli, and H. Klaveness, "Non-linear Effects in a 200-kHz Sound Beam and the Consequences for Target-strength Measurement," ICES Journal of Marine Science, 60, 571-574, 2003.
- [17] Y. Miyahana, K. Ishii, and M. Furusawa, "Spheres to Calibrate Echo Sounders at Any Frequency," Nippon Suisan Gakkaishi, 59(6), 933-942, 1993.