

University of New Hampshire  
**University of New Hampshire Scholars' Repository**

---

Law Faculty Scholarship

University of New Hampshire – School of Law

---

2001

# On-line Tutorial Project: Intellectual Property in E-Commerce

William J. Murphy

*University of New Hampshire School of Law, [william.murphy@law.unh.edu](mailto:william.murphy@law.unh.edu)*

Follow this and additional works at: [https://scholars.unh.edu/law\\_facpub](https://scholars.unh.edu/law_facpub)

 Part of the [Business Commons](#), [Intellectual Property Law Commons](#), and the [Software Engineering Commons](#)

---

## Recommended Citation

Intellectual Property in E-Commerce, [http://www.ipmall.info/hosted\\_resources/pubspapers/WIPO.pdf](http://www.ipmall.info/hosted_resources/pubspapers/WIPO.pdf)

This Article is brought to you for free and open access by the University of New Hampshire – School of Law at University of New Hampshire Scholars' Repository. It has been accepted for inclusion in Law Faculty Scholarship by an authorized administrator of University of New Hampshire Scholars' Repository. For more information, please contact [ellen.phillips@law.unh.edu](mailto:ellen.phillips@law.unh.edu).

On-line Tutorial Project 

# Intellectual Property in E-Commerce

Prepared for

World Intellectual Property Organization's

**Worldwide Academy**

[www.wipo.int/academy/en/](http://www.wipo.int/academy/en/)

by Franklin Pierce Law Center



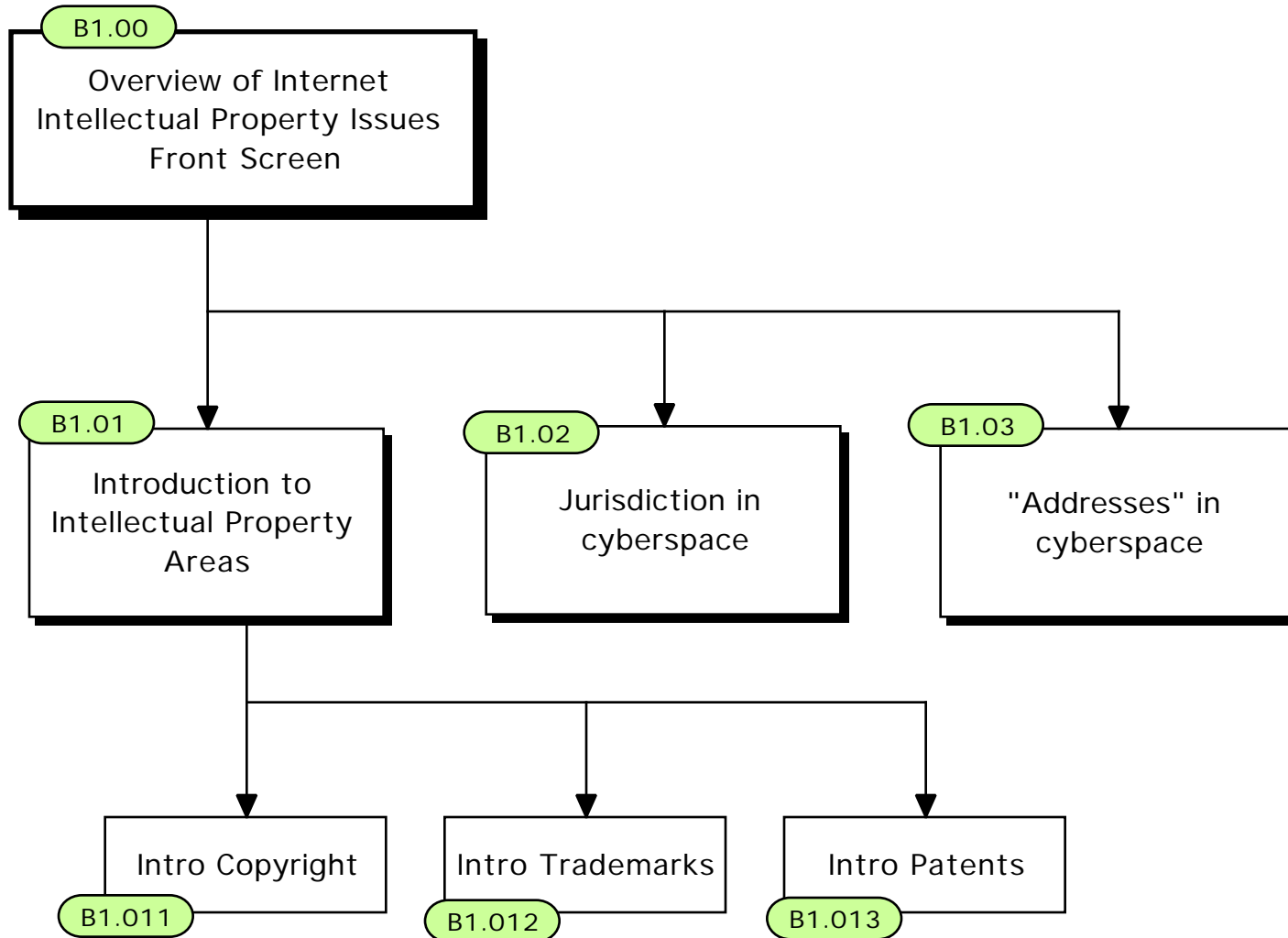

**Overview of Internet Intellectual Property Issues Front Screen****B1.00**

Copyrights, Trademarks and Patents make up most of the area of law known as Intellectual Property. Intellectual Property's importance in Electronic Commerce is difficult to overstate. The Internet has been defined as a global network of networks through which computers communicate by sending information in packets, and each network consists of computers connected by cables or wireless links. It is the Intellectual Property laws of Copyright, Trademark and Patents that are attempting to harmonize the effects that E-Commerce and the Internet have had on the individual's ability to access and use this information. It should be remembered that most countries have their own systems for patents, copyrights and trademarks, but thanks to international coordination and agreement facilitated by the [World Intellectual Property Organization \(WIPO\)](#) these legal regimes are basically similar in structure and approach. This course will focus on the intellectual property laws of the United States, currently the single largest e-commerce marketplace, with supplemental references to other legal regimes where useful.

**Introduction to Intellectual Property Areas****B1.01**

While E-Commerce is largely based in contract and commercial law, intellectual property law plays an important role in the success of E-Commerce. The various forms of intellectual property protection – copyrights, trademarks and patents – each contribute to the success of E-Commerce by protecting intangible assets valuable to business.

Copyrights protect the content of both websites and the material transmitted over those websites.<sup>1</sup> Trademarks protect the valuable symbols and phrases that distinguish

businesses and increase loyalty.<sup>2</sup> Patents protect the functionality of the software and the methods underlying much of E-Commerce.<sup>3</sup>

## **Introduction to Intellectual Property Areas - Copyright**

### **B1.011**

Copyright gives authors or artists the legal right to exclude others from using their works. Copyright arises automatically when a protectable work has been fixed in any tangible medium, whether the medium is canvas, paper or computer hard drive. In the scope of E-Commerce, it is fundamental to understand that copyright is protected upon creation. When an author or artist etches a drawing, writes a story or creates a software program, such work is subject to protection under the copyright laws. Such works are subject to copyright protection and not automatically protected because the work must pass the initial threshold standards of "creativity" and "originality." These threshold standards are very low, but not so low as to allow listings in phone books to be copyrightable. See Feist Publications. Copyrightable subject matter includes: literary works (computer software code is included here); musical works with accompanying words; dramatic works with accompanying music; pantomimes and choreographic works; pictorial, graphic and sculptural works; sound recordings; and architectural works.

## **Introduction to Intellectual Property Areas - Trademark**

### **B1.012**

A trademark is either a word, phrase, symbol or design, or combination of words, phrases, symbols or designs, which identifies and distinguishes the source of the goods or services of one party from those of others. A service mark is the same as a trademark except that it identifies and distinguishes the source of a service

rather than a product. A trademark conveys to the consuming public information regarding the source of the goods or services identified in the trademark. Certain types of marks are stronger than other marks: Arbitrary marks (APPLE® for computers) are very strong; Coined marks (EXXON® for gasoline) are also very strong; Suggestive marks (WEIGHT WATCHERS® for diet food products) are protectable because they require a mental leap to connect the meaning of the mark with the goods; Descriptive marks (CHAP STICK® for lip balm) are not protectable, unless secondary meaning has attached; Generic terms (PROGRAM for computer software) are unprotectable because competitors need to use the words to describe the product.

**Introduction to Intellectual Property Areas - Patent**  
**B1.013**

A patent is the grant of a property right, which in the United States is issued to the inventor by the [United States Patent and Trademark Office \(USPTO\)](#). The term of a new patent is 20 years from the date on which the application for the patent was filed in the United States or, in special cases, from the date an earlier related application was filed, subject to the payment of maintenance fees. Patent grants in the United States are effective only within the United States, U.S. territories, and U.S. possessions.

The right conferred by the United States patent grant is, in the language of the *statute* and of the grant itself, “the right to exclude others from making, using, offering for sale, or selling” the invention in the United States or “importing” the invention into the United States. What is granted is not the right to make, use, offer for sale, sell or import, but the right to exclude others from making, using, offering for sale, selling or importing the invention.

**Jurisdiction in Cyberspace****B1.02**

The internet is an amalgam of computer networks spanning the world.<sup>4</sup> The transnational nature of the internet poses a significant concern to E-Commerce. An order may be placed in one country, with the transmission containing that order careening through a dozen other countries as it finds its way to the country where the merchant resides. Such a situation opens the door to a confusing jurisdictional situation. One court noted that the internet is “wholly insensitive to geographic distinctions.”<sup>5</sup>

Jurisdiction resides where an act takes place, since that is where the harm giving rise to a lawsuit occurs. But where does an internet based act take place? In our example above, surely the jurisdictions in which the buyer and seller live have a more substantial claim to jurisdiction than does the countries through which the information packets merely traveled. These issues are discussed in the section on Copyright Jurisdiction.<sup>6</sup>

Enforcement of a country’s rules depends largely upon the connection of transactions with that country. Jurisdiction will not attach if a person merely posts a website where a person from another country/state simply can access the site. But if that same website begins to send marketing data or interact with the recipient in other ways, the owner may be subject to the jurisdiction of the end users state/country. If a website is taking orders over their website and shipping goods to the end users home state/country, the website owner will again be subject to jurisdiction. There have been website operators who attempt to contract their way out of jurisdiction by having the customer agree to jurisdiction only in the website’s state/country.



**Addresses in Cyberspace****B1.03**

In order for the information flow to operate on the Internet, there needs to be a system that uniquely describes the “location” of the digital sender and receiver.

### ICANN’s Control of Domain Name System

Many countries outside the United States are angered by ICANN’s “Americanization” of the internet. Although ICANN is a multinational nonprofit entity, it has been charged with favoring US interests. Early in 1998 “A Proposal to Improve Technical Management of Internet Names and Addresses,” commonly referred to as the Green Paper, was released by U.S. Department of Commerce and the National Telecommunications and Information Agency (NTIA). The Green Paper set out four parameters to guide the evolution of the domain name system: 1) stability, 2) competition, 3) private bottom-up coordination, and 4) representation. It was this paper, and the ideas expressed in it, that led the way for the creation and establishment of ICANN.

The Green Paper identified four Domain Name System (DNS) functions to be performed by the new entity on a coordinated, centralized basis in order to ensure that the Internet runs smoothly: (1) Set policy for and direct the allocation of IP number blocks; (2) Oversee the operation of the Internet root server system; (3) Oversee policy for determining the circumstances under which new top level domains would be added to the root system; (4) Coordinate the development of the other technical protocol parameters as needed to maintain universal connectivity on the Internet. The Green Paper proved to the

administrators of the Internet that change was necessary in order to cement the Internet's role as the commerce and communication medium of the future.

Although these functions have been identified, it has been argued that ICANN and its role of policing domain names, has an American slant to it. Although ICANN has representatives from every continent, and conducts hearings and committee discussions over the internet and around the world, internet users from around the world believe that ICANN is misusing its power to control domain names.

In November of 2000, ICANN released seven new Top Level Domains (TLD's): **.aero;** **.biz;** **.coop;** **.info;** **.museum;** **.name;** **.pro**. These will attempt to alleviate the pressures on the current TLD's, .com, .net., .edu, .org. These TLD's will not be available until later in 2001, but speculators are currently registering web addresses with the new TLD's in hopes of making money upon the sale of the addresses to companies desiring the name. It has not been decided how ICANN will control this 'cybersquatting' that will inevitably occur, but you be assured that the internet world will be watching.

---

#### REFERENCES (to be hyperlinked from text)

<sup>1</sup> *See* Copyrights

<sup>2</sup> *See* Trademarks

<sup>3</sup> *See* Patents

<sup>4</sup> *See* History of E-Commerce.

<sup>5</sup> *American Library Association v. Pataki*, 969 F. Supp. 160.

---

<sup>6</sup> *See Copyright Jurisdiction*

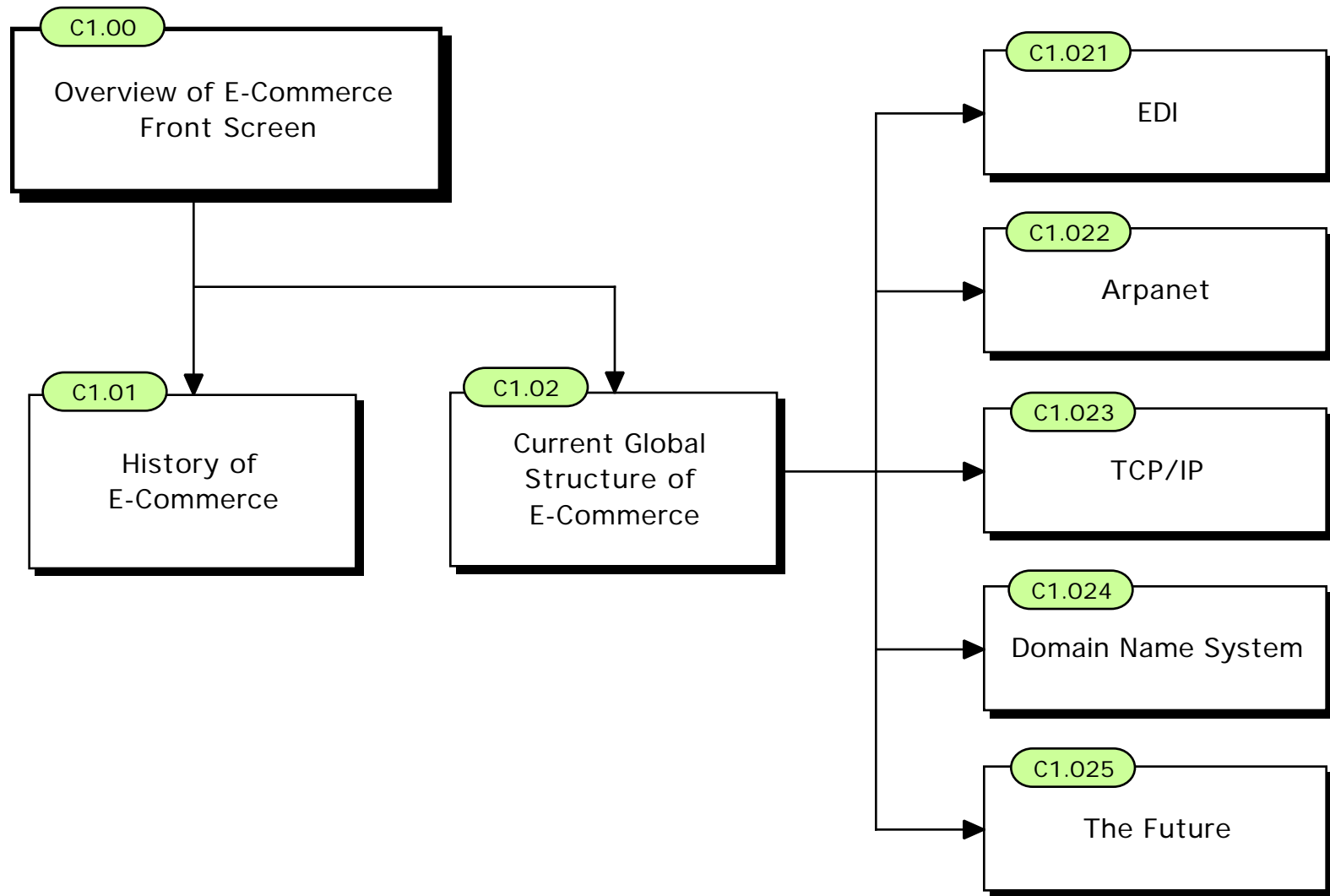

**Overview of E-Commerce****C1.00**

As Michael Dertouzos puts it in his foreward to Tim Berners-Lee's book, Weaving the Web, "Technology is an inseparable child of humanity and that for true progress to occur, the two must walk hand in hand, with neither one acting as servant to the other." E-Commerce has become one of the fastest growing and most important aspects of Technology and will have enormous effects on the future of technology and humanity.

**History of E-Commerce****C1.01**

1992 saw the release of Tim Berner-Lee's World Wide Web. It was with the World Wide Web that the world really began to see the development of E-Commerce as we know it today. By 1994 corporations like Pizza Hut began to take orders for pizza over their website, showing that the World Wide Web was truly beginning to take hold as a commercially viable endeavor. It was also in this year that the first commercially successful web browser, Mosaic, became available. Marc Andreessen spearheaded its creation which allowed for point-and-click access to the World Wide Web. Mosaic was adapted by Marc Andreessen and Jim Clark into the downloadable Netscape browser. The software was downloadable over the World Wide Web, which made the simple to use browser available to customers everywhere for free.

With easy navigation of the World Wide Web and the number of personal computers in use increasing daily, the E-Commerce Boom was well on its way. Over the next couple of years commercial entities began to realize the importance of having their presence on the Web.

In 1997 DSL (Digital Subscriber Line) service was rolled out in California. This service allowed customers to connect to the internet at speeds fifty times faster than the typical modem dial up speed of 28.8 kilobits per second. It is this continual connection to the Internet, which increases use and drives greater commerce.

1998 saw E-Commerce take off, as companies were selling their services and goods over the Web and accessing clients that they never had access to before the Web. 1998 also saw the privatization of an important aspect of the Web. ICANN (Internet Corporation for Assigned Names and Numbers) was formed in October of 1998. ICANN is a non-profit, private-sector corporation formed by a broad coalition of the Internet's business, technical, academic, and user communities. ICANN has been recognized by the U.S. and other governments as the global consensus entity to coordinate the technical management of the Internet's domain name system, the allocation of IP address space, the assignment of protocol parameters, and the management of the root server system.

In 1999 Napster and its creator, Sean Flemming, came into the scene. Napster allowed music files to be transferred over the Web by converting them into MP3 files. This software turned the recording industry on its head and copyright owners everywhere were concerned with the possible ramifications that Pier-to-Pier software may have.

### **Current Global Structure of E-Commerce**

#### **C1.02**

Today the Internet is defined as a global network of networks through which computers communicate by sending information in packets, and each network consists of computers

connected by cables or wireless links. In 1962 there was no such mechanism and Paul Baran was commissioned by the United States Air Force to determine how the Air Force could maintain command and control over missiles and bombers after a nuclear attack. Baran decided that a decentralized network was necessary in order to route around destroyed networks so a counter-attack would be possible. Baran proposed a packet switched network:

"Packet switching is the breaking down of data into datagrams or packets that are labeled to indicate the origin and the destination of the information and the forwarding of these packets from one computer to another computer until the information arrives at its final destination computer. This was crucial to the realization of a computer network. If packets are lost at any given point, the message can be resent by the originator."

It was this overriding concern for national security that created the initial parameters that the Internet and E-Commerce are built on.

### **Electronic Data Interchange (EDI)**

C1.021

In 1968 Electronic Data Interchange (EDI) emerged, allowing companies to deal electronically with each other. But there was no guarantee that all the EDI formats would be compatible, and often they were not. It was not until almost twenty years later that problem was addressed. EDI is defined as the electronic transfer between computers of computer processable data using an agreed standard to structure the data. EDI's use is

growing with the E-Commerce and is becoming an inseparable part of the E-Commerce equation. EDI's purpose has been stated as attempting to create boundaryless relationships between businesses conducting business electronically. It creates such relationships by taking manually prepared forms and translating the data into a standard electronic format from which it transmits that data.

**ARPANET****C1.022**

In 1969 the Advanced Research Projects Agency (ARPA), which was under the United States Department of Defense, linked four nodes together: University of California at Los Angeles, Stanford Research Institute, University of California at Santa Barbara, and the University of Utah. The universities were networked together with fifty kilobits/second circuits. The network was called ARPANET.

**TCP/IP****C1.023**

In 1973 development began on the protocol which was later known as TCP/IP. Transmission Control Protocol allowed one computer to send the other computer a continuous stream of information by breaking it down into packets and reassembling the information at the other end, resending any packets that get lost in transmission. TCP uses Internet Protocol, IP, to send the packets. This discovery allowed diverse computer networks to be connected and communicate with one another.



**Domain Name System****C1.024**

In 1983 DNS, the Domain Name System, was created at the University of Wisconsin. This system made navigation of the Internet easier, as the users did not have to remember the IP numbers, instead they could use easy to remember names.

The next year, 1984, saw the creation of the ASC X12 standard, which allowed more electronic dealings between companies. This standard became a reliable means to handle large number of EDI transactions. This was an important moment in the early days of E-Commerce.

From 1985 to 1990, the Internet information backbone saw tremendous increase in bandwidth. It was upgraded from T-1 lines to T-3 lines, which allowed more access to a greater number of users.

**The Future****C1.025**

In 1990, almost thirty years after the beginning of the Internet, Tim Berners-Lee implements a new hypertext system for efficient information access. As Berners-Lee puts it in his book, *Weaving the Web*: "The art was to define the few basic, common rules of 'protocol' that would allow one computer to talk to another, in such a way that when all computers everywhere did it, the system would thrive, not break down." This hypertext system was the precursor to Berners-Lee's World Wide Web.

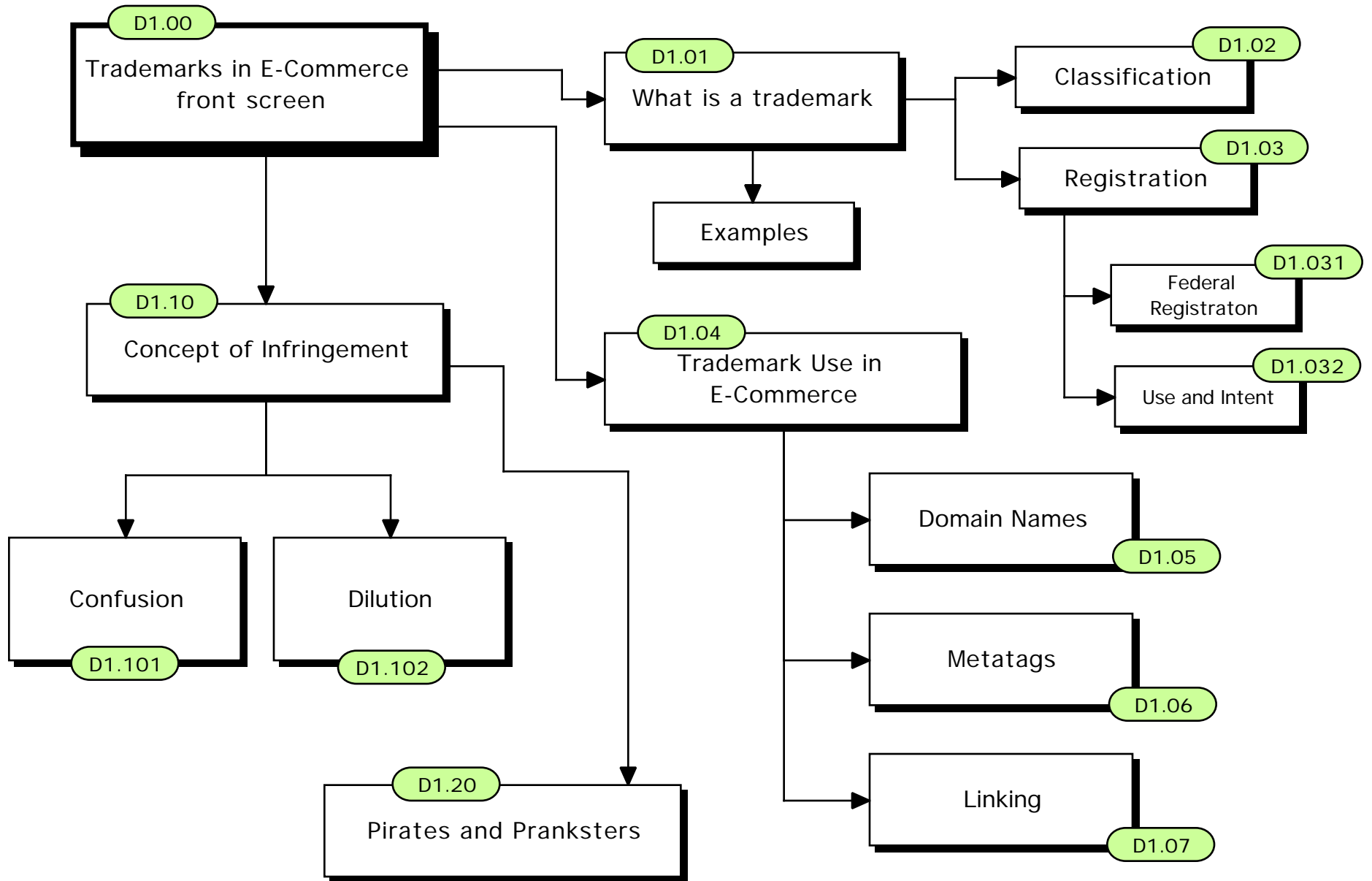

**Trademarks in E-Commerce Front Screen****D1.00**

Trademarks are vital tools for electronic commerce. They provide the trademark owner with the exclusive right to use the mark in connection with certain goods or services. These exclusive rights allow the trademark holder to build up the goodwill and reputation of their products. A trademark signifies that all goods bearing the mark come from the same source and are of a particular level of quality. It also allows consumers to identify the goods or services of one company from those of another.

When a trademark is used over the Internet, it is potentially accessible by viewers world wide. Businesses are realizing that their on-line identities are potentially valuable resources and must be protected accordingly. This is evidenced by the fact that United States Patent and Trademark Office trademark registrations have increased significantly over the past few years, in correlation with exponential growth in electronic commerce. However, business owners must be aware of the legal challenges accompanying Internet use of trademarks. Electronic businesses must protect valuable intangibles, such as domain names and metatags. Companies should know what constitutes a valid trademark and be prepared to enforce their trademark rights over the Internet. They must also be aware of methods to detect further infringement and what remedies are available.

An additional issue confronting electronic commerce is that many e-businesses must use other company's trademarks on their websites. This might be done to show that certain products are available from their corporation. (For example Wal-mart® might use numerous trademarks, such as Colgate®, Dove® and Hanes® on their websites, without infringing those marks. This legitimate use is merely to denote that products carrying



those trademarks are available through their store.). Companies must be aware of the limits of this allowable use.

Conducting business over the Internet also raises jurisdictional issues, with each country potentially applying its own laws and regulations to the medium. Trademark rights in one country do not generally confer any rights to use that mark in another country. Many countries have developed their own trademark laws that are typically enforceable only within that country. Thus, if an e-business wishes to protect their intellectual property rights abroad, they may have to rely on the trademark laws of another nation. For example, under U.S. law, prior use of a trademark in a foreign nation does not establish priority of use in the United States.

Interesting legal questions begin to arise when companies attempt to use or establish trademarks in electronic commerce, such as: Is this trademark protectable? What can be registered? What is infringement? Is the potential trademark inherently distinctive? If not, has it acquired the requisite secondary meaning? Is this mark confusingly similar to other trademarks in the marketplace? Is the company using another person's trademark or service mark on their website? Can a domain name be used as a trademark? When are two domain names confusingly similar? Is this similarity diverting business away from another site? When does this divergence constitute infringement of a trademark? Is the trademark being used commercially? May another company's mark be used in metatags? Is it possible to link a website to another? Is a license required to do so? Is the use of this trademark "fair use"? How will trademark use in e-commerce be monitored?

This module will answer these common questions, by addressing [what a trademark is](#) and [how it is used in electronic commerce](#) including domain names, metatags and linking. It

will also explain the [concept of trademark infringement](#) , and various causes of action for trademark infringement.

### **What is a Trademark**

#### **D1.01**

A trademark is a property right in symbolic information. A trademark serves many functions. It distinguishes the goods or services of one company from those of another by providing the trademark owner with the exclusive right to use the mark in connection with certain goods or services. A trademark signifies that all goods bearing the mark come from the same source. It also serves as a form of advertising and as indicia of a particular level of quality.

A trademark is defined, in Section 45 of the Lanham Trade-Mark Act, as being any word, name, symbol or device or combination thereof that is used by a person or in which a person has a bona fide intention to use in commerce to identify and distinguish his or her goods, including a unique product, from those manufactured or sold by others and to indicate the source or the goods, even if that source is unknown.<sup>1</sup>

A service mark is defined as any word, name, symbol, or device, or any combination thereof used by a person or which a person has a bona fide intent to use in commerce to identify and distinguish the services of one person, including a unique service, from the services of others, even if that source is unknown.<sup>2</sup>

### **Classification of Trademarks**

#### **D1.02**

Trademarks are classified along a continuum from strongest to weakest; fanciful, arbitrary, suggestive, descriptive and generic.<sup>3</sup> A fanciful mark is a coined word or phrase that is entitled to the highest degree of trademark protection (Kodak for the sale of cameras). Arbitrary marks are composed of real words that do not allude to what the product is (Snickers for candy bars). Suggestive marks require thought and perception to reach a conclusion as to the nature of the goods (VISA for credit card services).

Descriptive marks actually describe the goods or services offered (Microsoft Internet Explorer) and must acquire secondary meaning in order to qualify for TM protection.

Geographic marks are descriptive of origin and need to acquire secondary meaning in order to be protected (New York Bagel Co.). A Generic mark is a word that has come to be understood as referring to the genus of which a particular product is a species.

Generic marks denote a common term for the product and may not be protected by trademark law. (For example, no one may own a trademark in “light beer” in conjunction with the sale of beer).<sup>4</sup>

The scope of trademark protection under United States law (the [Lanham TradeMark Act](#)) depends on whether a mark is registerable. Registerability, in turn, depends on whether the mark is inherently distinctive (accorded the highest protection) or non-inherently distinctive (receiving the weakest protection).<sup>5</sup>

Fanciful, arbitrary, and suggestive marks are inherently distinctive and are entitled to federal trademark protection (Amazon.com, for the on-line sale of books and music, is an inherently distinctive mark).

Descriptive marks are non-inherently distinctive and must acquire secondary meaning to be entitled to federal protection.<sup>6</sup> Secondary meaning is a new meaning that attaches to a

non-inherently distinctive mark, by which customers learn to associate that mark as identifying a single commercial source (America On-Line is a descriptive mark for on-line services.). Secondary meaning is established based upon a substantial showing that the public has come to associate a descriptive mark with a particular company.<sup>7</sup> This is demonstrated through evidence of sufficient sales success, marketing and exclusive use of the mark.<sup>8</sup> However, the determination of secondary meaning is made upon the effectiveness of promotional efforts, not the extent of those efforts.

Generic marks are not protectable, even if they acquire secondary meaning.<sup>9</sup> (America On-line's "Buddy List" was recently found to be generic<sup>10</sup>). Secondary meaning in a generic mark is de facto secondary meaning. Although consumers may identify the word with a single source, this has no legal significance, because the word has already been deemed generic. If a trademark owner does not properly police their trademark and use it in the trademark sense, not as the term for a product, the owner risks losing the mark to genericism (escalator, trampoline and aspirin were all once trademarks, but came to be known as the common names for the products).<sup>11</sup>

## **Registration of Trademarks**

### **D1.03**

The existence of a trademark in the United States is not dependent on registration with a governmental body. Unregistered trademarks may acquire common law rights merely through use of the mark on or in connection with goods. If a mark is not federally registered, factors that might be considered in determining ownership are: which party invented and first used the mark with a product, which party controlled the quality of the product and with whom does the public identify this mark.<sup>12</sup>



**Federal Registration of Trademarks**

D1.031

A federal registration is not required to begin using a trademark, or even to allege rights in a trademark, in the United States. Federal registration on the [principle register](#) does, however, secure certain benefits for trademark owners. Federal registration creates a presumption of validity of the trademark. If a mark is merely a common law mark, the rights in that trademark only extend to the area of actual use. If the mark is federally registered with the U.S. Patent and Trademark Office, those rights extend nationally. Additionally, a federally registered mark may be entitled to enhanced damages in an infringement suit. More importantly, only a federally registered mark may use the ® symbol (common law mark owners may, however, use the TM symbol).

A trademark owner may apply for a Federal Registration through the [United States Patent and Trademark Office](#) <link to U.S. PTO website>. The trademark owner may be an individual, partnership, corporation, business trust or any legal entity (A division of a corporation is not a legal entity. Thus, the Software Division of Very Big Corp. may not register any software trademarks; the trademarks must be registered by Very Big Corp.).

**Use and Intent to Use**

D1.032

In the United States, federal trademark ownership is established through use of, or intent to use, the mark in commerce. A use based applicant may file for registration on the principle register by paying a filing fee and filing in the U.S. PTO an application and a verified statement along with specimens or facsimiles of the mark.<sup>13</sup> A mark owner wishing to file an intent to use application must have a bona fide intent to use the mark in

commerce, and conform to the same requirements as a use based applicant, except that a specimen is not required.<sup>14</sup> However, no federal registration will issue until the mark is actually used in commerce and a specimen is submitted to the US PTO.<sup>15</sup>

## Trademarks in E-Commerce

### D1.04

According to the United States Patent and Trademark Office Examination Guide for Domain Names (Examination Guide No.2-99), when a trademark is composed of a domain name neither the **URL**(<http://www.>) nor the **TLD** (.com, .org, .net, .edu) have any significance as an indication of source, since they must be used by every Internet site as part of an address.<sup>16</sup>

Applications for trademarks consisting of domain names must meet the same requirements as all federally registered marks, thus, adding “.com” to an otherwise unprotectable trademark does not render the mark protectable. If a proposed mark consists of a TLD combined with a descriptive term (such as bookstore.com) the Patent and Trademark Office should refuse registration.<sup>17</sup> If a proposed mark consists of a generic term for the goods or services and a TLD, the U.S. PTO examining attorney must refuse registration<sup>18</sup>.

The length of trademark protection varies from country to country. In the United States, trademarks (unlike copyrights<[link to © Section](#)> or patents <[link to patent section](#)>) have the possibility of being renewed indefinitely. The term of a federally registered mark is 10 years, renewable every ten years upon timely payment of fees (however, between the fifth and sixth years of use an affidavit of continued use must be filed or the registration is canceled).<sup>19</sup>

U.S. trademarks must continually be used in commerce or they will be deemed abandoned. If a mark goes through three years of non-use, this is prima facie evidence of abandonment of the mark.<sup>20</sup> Additionally, if a company licenses their mark to another business without ensuring that proper quality control is conducted, that may constitute abandonment of a trademark. If a trademark is assigned without the corresponding goodwill, that constitutes an assignment in gross, and the assignment will be invalid.

If the U.S. Patent and Trademark Office determines that a mark is not entitled to federal trademark registration, the mark may be registered on the **Supplemental Register**. Marks that are not registerable on the principal register, may be registered on the supplemental register if they are “capable of distinguishing the applicant’s good or services”.<sup>21</sup> Registration on the Supplemental registration entitles the claimant to litigate their mark in Federal courts, to publish their mark to others (so it may serve some evidentiary purpose in court) and, after five years of use a mark may be transferred to the principal register.

A mark duly registered in the country of origin of a foreign applicant may also be registered in the United States. Many countries do not require initial use of a trademark before filing for a registration and the United States government has recognized this. Therefore, an owner of a foreign trademark who wishes to register their mark in the United States may do so without alleging actual use of the mark within the United States. However, foreign applicants are still subject to the continued use requirements of the Lanham Act and after five years, must file an affidavit showing actual use of the trademark.<sup>22</sup>

Most countries have individual systems for protecting trademarks, through a Register of Trademarks. In order to be afforded protection in individual countries a trademark owner must register their mark in each country in which they wish to protect their mark, which can be time consuming and costly. The World Intellectual Property Organization does, however, maintain a system of international trademark registration. Two treaties, the Madrid Protocol and the Madrid Agreement Concerning International Registration of Marks <link to Madrid treaties>, govern this process. Members of the Madrid Protocol can apply for international trademark protection based upon a national application. The international application is then filed with WIPO.

## **Domain Names**

### **D1.05**

Much like any other source identifier in the world of trademark law, the **domain name** can be used as a symbol of a company's goodwill. In the realm of e-commerce, a company's domain name choice can be a key marketing tool, if not the most important aspect of a company's presence on the net.<sup>23</sup> Users regularly try to guess a company's Internet location by typing the name of the company followed by the .com **top level domain name**.<sup>24</sup> It therefore goes without saying that the proper domain name is a vital element to e-commerce success.

Domain name registration is performed by several entities worldwide but none have the presence and size of the Internet Corporation for Assigned Names and Numbers (ICANN). Formed in October 1998, is a non-profit, private-sector corporation formed by a broad coalition of the Internet's business, technical, academic, and user communities. ICANN has been recognized by the U.S. and other governments as the global consensus

entity to coordinate the technical management of the Internet's domain name system, the allocation of IP address space, the assignment of protocol parameters, and the management of the root server system.<sup>25</sup> The purpose of ICANN is to replace the system of *ad hoc* management of Internet resources in a manner more attuned to the needs of a growing information and commercial medium. As businesses worldwide began to realize the economic potential of the Internet, it became apparent that the creation of a technical management and policy development body that is more formalized in structure, more transparent, more accountable, and more fully reflective of the diversity of the world's Internet communities was necessary.<sup>26</sup>

On 26 August 1999, ICANN's Board adopted a Uniform Domain Name Dispute Resolution Policy ("UDRP") for all registrars serving the .com, .net, and .org TLDs which came in effect on 3 January 2000. This policy has also been adopted by certain managers of country-code TLDs (.nu, .tv, .ws). The United States has signed a Memorandum of Understanding with ICANN.<sup>27</sup> Under the UDRP, most types of trademark-based domain name disputes must be resolved by agreement, court action, or arbitration before a registrar will cancel, suspend, or transfer a domain name. In order to invoke the policy, a trademark owner should either (a) file a complaint in a court of proper jurisdiction against the domain name holder, or where an appropriate in-rem action concerning the domain name can be brought, or (b) in cases of abusive registration, submit a complaint to an approved dispute-resolution service provider.<sup>28</sup>

The principal legal concerns surrounding domain names are: (1) the pirating of names, usually through **SLD** registrations within the .com TLD of a well-known or famous company; (2) the SLD registration of misspelled popular brands; (3) despite the efforts

of ICANN, there are still other registries in the world that register confusingly similar marks in various country code TLDs.<sup>29</sup>

In *Planned Parenthood Fed'n of Am. v. Bucci*,<sup>30</sup> plaintiff, a nonprofit, reproductive health care organization, registered the service mark Planned Parenthood on the Principal Register of the U.S. Patent and Trademark Office. Defendant, a host of a daily radio program and an active participant in the anti-abortion movement, registered the domain name *plannedparenthood.com* with a corporation that administered the assignment of domain names on the Internet. After registering the name, defendant set up a Web site and home page under the same name. Plaintiff alleged that defendant used plaintiff's mark with the specific intent to damage plaintiff's reputation and to confuse unwitting users of the Internet. The court held that the Lanham Act, 15 U.S.C.S. § 1114, was applicable and that a significant likelihood of confusion existed. Thus, injunctive relief in favor of plaintiff was appropriate. The court granted plaintiff's motion for a preliminary injunction because defendant's use of plaintiff's trademark was subject to the Lanham Act and there was a likelihood of confusion arising from defendant's use of plaintiff's trademark.

Since the implementation of the domain name system, the Patent and Trademark Office (PTO) has received a growing number of applications for marks composed of domain names. While the majority of domain name applications are for computer services such as Internet content providers (organizations that provide web sites with information about a particular topic or field) and online ordering services, a substantial number are for marks used on other types of services or goods.<sup>31</sup> Applications for registration of marks consisting of domain names are subject to the same requirements as all other applications for federal registration.<sup>32</sup>

If federal trademark registration is desired in the United States for a domain name, an applicant must take into consideration the following situations:<sup>33</sup>

- Advertising one's own products or services on the Internet is not a service. Businesses doing so cannot register a domain name used to identify that activity.
- If a mark is composed solely of a TLD for domain name registry services, federal registration should be refused because the TLD would not be seen as a mark
- Geographic matter may be merely descriptive of services provided on the Internet
- If a mark is composed by a surname and a TLD, no registration will be allowed because the mark is merely a surname
- If a proposed mark is composed of merely descriptive terms combined with a TLD, registration will be refused on the grounds that the mark is merely descriptive
- Marks containing the phonetic equivalent of a TLD are treated in the same manner as marks composed of a regular TLD. For example, the mark XYZ DOTCOM would require the applicant to disclaim the TLD “.COM” rather than the phonetic equivalent “DOTCOM”

<Link to>WIPO – Domain Name Dispute Resolution Service (\*)

<Link to> § 43(d) Cybersquatting Consumer Protection Act (\*)

## **MEtatags**

### **D1.06**

**Meta tag** use in web page development has created new legal problems for unfair competition and trademarks in e-commerce, particularly as the web becomes an

increasingly important medium for transacting business. When a web user enters information into a **search engine**, they are seeking to find web pages related to those search terms. A search engine will send out a spider to retrieve as many documents as possible. Using an indexer, the search engine will read the documents and create an index based on the words contained in each document and determine the relevance to the user's search. The search engine examines the text in the **meta tags**. Search engines can assign greater weight to meta tag text which appears at the beginning of most web pages. In fact, most search engines do not distinguish meta tags from the ordinary text on a web page.

This system of retrieval and web page design was originally intended to control web page design and the appearance of web pages. This purpose quickly expanded into providing a means for web sites to describe the true purpose and nature of their pages thereby assisting web users in finding web sites highly relevant to their searches.<sup>34</sup> Today, another purpose exists for meta tags; parties have used misleading terms in the hidden meta tags in order to increase traffic to their web sites. Often times, these tags are completely irrelevant to the search, providing for inaccurate search results. More significantly in terms of trademark use in e-commerce, meta tags have been used to misdirect or even trick potential customers to a competitor's web site (also referred to as "manipulative metatagging") and problems in trademark infringement and unfair competition have ensued.

The first case in the United States that held a court enjoined a party from using misleading terms in their hidden text and or meta tags on a website was *Playboy, Enterprises, Inc. v. Calvin Designer Label*.<sup>35</sup> The court entered a preliminary injunction enjoining defendant's websites, "www.playboyxxx.com" and "playmatelive.com" and



repeated use of the “Playboy,” “Playboy Magazine,” and “Playmate” trademarks in the defendant’s meta tags. The defendant had been embedding these trademarked terms several hundred times on web pages in black type on black background so users could not see the reason why the search engines were truly picking up the site. As a result, the defendant’s web sites had appeared at the top of most search engine results, often times even before the plaintiff’s site <playboy.com>.

The law firm of Oppedahl & Larson, an intellectual property firm and owner of the domain name “patents.com” filed a complaint alleging common law unfair competition and trademark violation and violation of Lanham Act Sections 43(a)(unfair competition) and 43(c)(trademark dilution) after discovering that defendants had used the words “Oppedahl” and “Larson” in the keywords field of their web pages in order to divert web users to their sites.<sup>36</sup> The parties eventually reached a settlement agreement in which the defendant agreed not to use the plaintiff’s trademarks in its web pages or meta tags without the plaintiff’s prior authorization. Therefore, U.S. courts still have not had an opportunity to speak on a pure meta tags case yet.

In the case of *Brookfield Communications, Inc. v. West Coast Entertainment Corp.*,<sup>37</sup> Brookfield sought to protect its trademark in its "MovieBuff" software, which provides entertainment-industry information. Brookfield had created a website offering an Internet-based searchable database under the "moviebuff" mark. The defendant, West Coast, a video rental store chain, registered a site at "moviebuff.com" which also contained a searchable entertainment database. The Court of Appeals for the 9<sup>th</sup> Circuit applied the doctrine of initial interest confusion and enjoined West Coast from using any term confusingly similar to plaintiff’s “moviebuff” in the meta tags. The Court believed that use of Brookfield’s mark would redound to West Coast’s financial benefit.<sup>38</sup> Not all

U.S. Circuits have adopted this approach. The Court of Appeals for the Ninth Circuit was the first federal court to address how manipulative meta tagging can cause trademark infringement and unfair competition.

In each of these cases, the defendant was using the plaintiff's mark in bad faith to trick Internet users into visiting defendant's website, believing either that they were visiting plaintiff's website or that the defendant's website was sponsored by the plaintiff.

Playboy Enterprises has not always been successful in litigating meta tags cases. In *Playboy Enterprises, Inc. v. Welles*,<sup>39</sup> Playboy sought to enjoin Terri Welles, former "Playmate of the Month" and "Playmate of the Year", from utilizing the trademarked terms "Playboy" and "Playmate" in the meta tags of Welles's website. The court denied the injunction, holding that use of the trademarked terms in the meta tags is a fair use. The court was reluctant to label this as trademark infringement because the defendant had been using the plaintiff's trademarks in a good faith effort to index the content of her website. The use of the meta tags had been kept from view of the web user and existed solely to provide a search engine with a clearer indication of the web page content. The court further noted that a web site may also reference the legitimate editorial uses of the term Playboy contained in the text of the defendant's web site.<sup>40</sup>

Fair use defense protects a subsequent user's use of a personal name designation "if the name is used solely to indicate truthfully the named person's connection with the goods, services, or business."<sup>41</sup> Applying this general rule to the meta tag context, Professor McCarthy states: "The fair use defense applies . . . if another's trademark is used in a meta tag solely to describe the defendant or defendant's goods or services . . . ."<sup>42</sup>

It is vital to understand that meta tags are “reactive” to a user’s inquiry. Meta tags depend on the chosen term already in the mind of the user and do not serve to alter user’s identification of a particular mark with a particular product or business.<sup>43</sup> It is primarily an issue of consumer confusion. Since *Brookfield*, two federal courts have addressed manipulative meta tagging claims.<sup>44</sup>

## Linking

### D1.07

One of the fundamental innovations of the Internet is its ability to seamlessly connect multiple documents and elements. E-commerce is better served when a business can connect a user to all the necessary components of a transaction. For example, an Internet travel agency not only can provide the user a means to book a flight, but the web site can connect the purchaser to other web pages (whether **internal** or **external**) so that he may also secure hotel accommodations and even a rental car. This is made possible by tools known as **links** and **frames**.

The practice of **deep linking** has given rise to new legal disputes involving trademark owners in the form of infringement and dilution actions. On April 28, 1997, Ticketmaster filed a complaint against Microsoft in federal district court in California, alleging that Microsoft's falsely, deceptively and misleadingly representing its association, connection or affiliation with Ticketmaster and the operation of Ticketmaster's business in Microsoft's website and its advertising. Furthermore, Ticketmaster asserted a claim pursuant to 15 U.S.C. §§ 1125(c), 1117 and 1116, with respect to the dilution of Ticketmaster's trademarks caused by Microsoft's unlawful use of said trademarks.<sup>45</sup> Microsoft had been linking users from its own web page in search of tickets to Seattle-

area sports and entertainment events directly to the page of the Ticketmaster site where such tickets could be ordered.

This case has not yet been decided, but the complaint serves as an indicator of the specific aspects of the law at issue. Without injury, Ticketmaster's claims would be groundless. Therefore, it was necessary for Ticketmaster to allege dilution of trademark, deceptive and misleading representation of association, and economic loss among other things, stemming from Microsoft's deep linking into its web site. The Ticketmaster web site contains advertisements and other content designed to generate revenues. Allowing deep links to direct consumers directly to what they are looking for circumvents these aspects of the Ticketmaster web site.

Frames can be useful in subordination of documents or establishing an active table of contents. The concern with framing is similar to that of linking. A framing site captures entire web pages from another site into a window on the original site (often times reducing the size of the captured site and any advertisements associated with it). The ability to direct users from one site to another using hypertext reference links underpins Internet commerce and although under some circumstances a party linking to or framing another's site may seek permission, this isn't the norm.<sup>46</sup> Additional problems arise when the framing cuts off the advertising of the linked-to website, or when the framing site surrounds the framed site with its own advertisements. Also, users may not be aware that the framed page belongs to an outside (3<sup>rd</sup>) party.

In the case of *Washington Post Co. v. Total News Inc.*,<sup>47</sup> framing was involved. The Total News home page used a table of contents in one frame and a main frame where all the news was displayed. Among others, Washington Post, Reuters and CNN alleged

trademark infringement, false designation of origin and unfair competition. The parties settled and Total News agreed to cease framing the plaintiff's web sites in exchange for authorization to link to their sites using hypertext reference links (text only). Each plaintiff was thereby allowed to revoke permission to a link to its site from Total News. If the defendant refuses to remove the link, in order to have the link removed the plaintiff must convince a court that the link is an impermissible violation of rights of intellectual property.

*Total News* demonstrates a fundamental difference between framing and linking with regards to advertising. Through the use of framing, the framing site's revenue generating advertisements are substantially more visible to the consumer than those of the framed site.<sup>48</sup> Through the use of linking (as provided in the settlement), advertising is not obscured at all and remains undisturbed the way the web site intended it. When sites are linked rather than framed, the link can enhance the revenues of both sites, providing additional consumers through the links.<sup>49</sup>

In all situations where a person has diverted or is attempting to divert web traffic from a trademark owner's web site, the First Amendment must be carefully measured against the conduct. Also, fair use considerations are also applicable. *See New Kids on the Block v. News America Publishing, Inc.*<sup>50</sup> The 9<sup>th</sup> Circuit has adopted a 3-part nominal fair use test where a commercial defendant uses the plaintiff's mark in describing the defendant's product or service:

- (1) the defendant's product or service is not readily identifiable without use of the mark;
- (2) only so much of the mark as is reasonably necessary to identify the product or service is used

(3) the user does nothing with the mark that suggests sponsorship or endorsement by the trademark holder

These issues have lead some trademark owner's who operate web site to adopt policies of "no linking" but it is questionable if this is the solution.<sup>51</sup> Once an owner has put up a web site, if the goal is to attract users to come and browse the page and consequently link to it a "no linking" policy would seem to cut against this business objective. From an e-commerce perspective, the goal is to attract consumers to the web site but this is at odds with the potential trademark issues established above; namely trademark dilution, confusion, deceptive and misleading representation. One proposed solution which will allow a trademark owner to protect his intellectual property and encourage users to visit the web sites is to allow people to link to the web site using trademarks in plain text only. In doing so, the trademark user will not allow users to use a graphical logo of the trademark.<sup>52</sup> It is also possible for a trademark owner to create a separate logo that can be licensed to people who wish to link to its site – often times an icon to be used as a click-on link.<sup>53</sup>

## **Trademark Infringement**

### **D1.10**

Infringement of a United States trademark is covered by Sections 32 and 43(a) of the Lanham Act. <Link to Act> Registered Trademarks are protected by section 32 of the Lanham Act. Unregistered marks are protected under Section 43 (a) of the Act, commonly referred to as an "unfair competition" cause of action.

There are two general theories of trademark protection. LOC infringement (which utilizes a likelihood of consumer confusion analysis)[<link to LOC Section>](#) and dilution[<link to Dilution section>](#), which is a cause of action distinct from infringement.

## **Confusion**

### **D1.101**

To establish a trademark infringement case under Section 32 [<link to Statute>](#) of the Lanham Act, a plaintiff must establish that the defendant is using a mark in commerce that is identical or confusingly similar to a validly protectable registered trademark.<sup>54</sup>

The Lanham Act also provides a cause of action for unregistered trademarks as well as trade dress in §43 (a)[<link to statute>](#), commonly referred to as the “unfair competition” statute. Section 43(a) provides rights against unfair trade practices, such as false or misleading representations of fact likely to cause confusion as to affiliation.<sup>55</sup> The Section also protects against false or misleading advertising.<sup>56</sup> The plaintiff in an unfair competition case must prove that defendant used false or misleading statements of fact; that the statement had the capacity to mislead consumers and was likely to influence their purchasing decisions; that defendant's goods were used in interstate commerce; and that the plaintiff is likely to be injured as a result.<sup>57</sup>

A “fair use” defense is provided in the Lanham Act [<link to statute>](#). The statutory fair use defense dictates that when an alleged infringing mark is used in good faith, to describe a product rather than to identify it with a particular source, then that use constitutes fair use.<sup>58</sup> The rationale for this rule is that a trademark holder “cannot

appropriate a descriptive term for his exclusive use and so prevent others from accurately describing a characteristic of their goods.”<sup>59</sup>

## **Dilution**

### **D1.102**

Dilution is the lessening of the capacity of a famous mark to identify and distinguish goods and services, regardless of the presence or absence of (1) competition between the owner of the famous mark and other parties, or (2) likelihood of confusion, mistake or deception. [<link to Lanham Act>](#) Under the Lanham Act, dilution is a separate claim from infringement.[<link to Dilution Section>](#)

The Lanham Act defines three statutory defenses to dilution. These defenses are: fair use of a famous mark by another person in comparative commercial advertising or promotion to identify the competing goods or services of the owner of the famous mark; non-commercial use of a mark; and all forms of news reporting and news commentary. [<link to statute>](#)

In 1999, the United States Congress enacted the Anti-cybersquatting Consumer Protection Act [<link to Anti-Cybersquatting Act Stuff>](#). The Act was directed at preventing cyberquatting and protecting domain names [<link to Domain Name Section>](#) over the Internet. The Anticybersquatting Act is an additional cause of action under the Lanham Act (Section 43(d)), and is applicable to all valid “mark” owners.

Trademark owners whose rights have been violated over the Internet have various remedies available to them, provided that they meet certain statutory requirements. What remedy is available to the trademark owner may depend on where the trademark owner is



able to assert jurisdiction over the infringer. <link to jurisdiction section> Additionally, companies must be aware of the jurisdictional ramifications of offering products worldwide.

### Trademark Pirates and Pranksters

#### D1.20

The first trademarks cases in the United States that dealt with parody issues resulted in decisions all over the legal landscape. This was particularly true considering the First Amendment free speech issues that emerged in parody. Some courts were willing to ascribe more protection through the First Amendment than others as a form of artistic expression. On one hand, enjoining trademark parody points to regulation of misleading commercial speech. On the other hand, not all communication is commercial, or possibly, the communication embodies both commercial and non commercial components.

In *Coca-Cola Co. v. Gemini Rising, Inc.*,<sup>60</sup> the Coca-Cola logo was used on a poster including the words “Enjoy Cocaine.” The court noted that because the mark was so varied and widespread in its use and familiarity, it seemed likely that injury would occur. The court balanced the hardships between the defendant’s freedom of speech and the plaintiff’s commercial livelihood and ruled in favor of Coca-Cola under likelihood of confusion analysis. <link to LoC>. The court distinguished this case from *United States v. Personality Posters Mfg. Co.*<sup>61</sup> which held that a poster depicting a pregnant girl wearing a Girl Scout uniform in conjunction with the Scout motto “Be Prepared” did not create a likelihood of confusion. The reasons for distinguishing the case was more evident in *Chemical Corp. of America v. Anheuser-Busch Inc.*<sup>62</sup> where the court held

that the threat of financial loss to the Budweiser beer mark was due to the peculiarly unwholesome association of ideas when the word “bugs” was substituted in the slogan for the word “Bud” referring to a food product.

Many times the parody associates a mark with sexual and drug-related issues.<sup>63</sup> Often times, courts are willing to use state antidilution statutes even under the likelihood that the plaintiff’s mark will not be confused with the defendant’s parody. In *Dallas Cowboys Cheerleaders, Inc. v. Pussycat Cinema, Ltd.*,<sup>64</sup> confusion was determined to be likely that had a tendency to impugn the plaintiff and injure plaintiff’s business reputation. The court enjoined defendant from using what the consumer would be reminded of as a Dallas Cowboy Cheerleader in its sexually explicit film. The court reasoned that it was likely that in the future, consumers would be reminded of the film when encountering plaintiff’s mark and that the belief that plaintiff either sponsored or approved of such use of its mark was adequate to support the ruling.

In an 8<sup>th</sup> Circuit decision, *Mutual of Omaha Insurance v. Novak*,<sup>65</sup> the court found that the factors were properly weighed in finding of a likelihood of confusion. The court held that the trademark was strong, defendant's design was very similar to plaintiff's, defendant put design on similar merchandise, there was little or no direct competition, and defendant did not pass off goods as plaintiff's. The court addressed the medium of expression issue, indicating that if the parody use of plaintiff’s mark was expressed in other avenues, namely book or film (rather than on t-shirts for sale), the result may not have been infringement. In order to prove a prima facie case for dilution under the Dilution Act, a plaintiff must prove that the "defendant is making commercial use" of his or her mark. <**Link to Amanda – Dilution**> Here, the defendant put the plaintiff’s

design into commercial use, therefore creating stronger grounds for infringement and dilution actions.

In *L.L. Bean v. Drake Publishers*,<sup>66</sup> the court held that denying parodists the opportunity to poke fun at symbols and names which have become woven unto the fabric of our daily life would constitute a serious curtailment of a protected right of expression.<sup>67</sup> Drake Publishers owns *High Society*, a monthly periodical featuring adult erotic entertainment. Its October 1984 issue contained a two-page article entitled "L.L. Bean's Back-To-School-Sex-Catalog." The article was labeled on the magazine's contents page as "humor" and "parody." The article displayed a facsimile of Bean's trademark and featured pictures of nude models in sexually explicit positions using "products" that were [\*\*2] described in a crudely humorous fashion.

There is a difference between this case and *Chemical Corp. of America* in that the entire business of Drake Publishers does not ride on this parody, it simply has incorporated the parody of the plaintiff's mark *within* its magazine. Chemical used the plaintiff's mark in an advertising sense, solely to attract consumers to its products. A cause of action for dilution and/or infringement would be better supported if Drake had used the L.L. Bean name and symbol on the cover of its magazine, that is to help *sell* its magazine. If the plaintiff and defendant are engaged in selling in competing products and the defendant has made use of the plaintiff's mark or symbol in a similar way, this poses a significant problem.<sup>68</sup> Although it is well established that an advertiser may use a competitor's trademark for the purpose of comparing its products directly to those of the competitor, no uniform rule exists where the comparative advertiser not only uses the competitor's mark but alters it.<sup>69</sup>

In *Cliffs Notes v. Bantam Doubleday Publishing*,<sup>70</sup> the defendant produced a one-time parody of plaintiff's Cliffs Notes called Spy Notes. The court vacated the injunction against defendant because public interest in freedom of expression outweighed the slight risk of consumer confusion in the publication of the parody based upon the plaintiff's product, therefore, the trial court's extreme remedy of pre-publication injunction was without merit. The trade dress among the two products was almost entirely the same. The court reasoned that the parody can draw the original trademark to the mind of the consumer, but if the consumer knows it is not the real thing, there is no claim for which relief can be granted. If parody is allowed to exist, it must give way to the parodist's need to use the plaintiff's mark in some way in order to convey a certain message. These lines of cases help to determine where courts have and will draw the line as to what is acceptable and unacceptable use of trademark.

The court noted in *White v. Samsung Electronics America, Inc.*, the vibrancy of culture depends upon the existence of a right to draw ideas from the public domain, and the right to mock cultural icons for both commercial and entertainment purposes.<sup>71</sup> While it is true that intellectual property law, through trademarks, has created personae and identifiers, the consumers are the reason why some have achieved another level: icon status. One of the world's most recognized marks, Coca-Cola, is an example - it's presence is symbolic of the United States just like the American flag. To deny the public the use of icons, such as Coca-Cola, would be to ignore the public's role in the creation of these images in the first place.

In October 1997, MasterCard International launched its "Priceless" campaign. To date, the campaign has reached over 48 countries and used in 22 languages. The campaign has been considered one of the most successful advertising campaigns in the world.

MasterCard International has the most comprehensive portfolio of payment brands in the world with more than 1 billion MasterCard®, Cirrus®, and Maestro® logos in circulation today.<sup>72</sup> In 1999, gross dollar volume exceeded US \$727 billion.

In 2000, MasterCard filed a lawsuit against Ralph Nader, US Presidential Candidate and his campaign committee, seeking an injunction to stop promotional advertisements misappropriating MasterCard's "Priceless" campaign. MasterCard complained that the parody was commercial in nature and mislead television viewers into believing the company endorsed Nader's campaign. The case was settled and the fervor over the issue passed as the election drew to a close.

Cases like *MasterCard v. Nader* will continue to emerge. As the line between commercial and non-commercial speech becomes increasingly blurred, a search for a standard is on. Most significantly, as the Internet has changed the dynamic of First Amendment freedom of speech, so too will it effect how the nexus is defined between trademark use and parody in the electronic commerce medium.

In conclusion, there are 4 fundamental aspects to consider when dealing with trademark use and parody.

1. Courts are slightly more protective of trademarks for food and beverages. The interest in protecting the public is elevated in such a way that deference generally applies.
2. If a parodist does not need to use a plaintiff's mark in order to get the point across, courts will generally issue an injunction from such use.
3. If the plaintiff and defendant's products are competing in the marketplace and the defendant alters or manipulates the plaintiff's mark, court will strictly apply the law, generally leaning in favor of plaintiffs.

4. Analyze the type of medium/media involved. If it is a classic medium (e.g., books, magazines and film), the First Amendment freedom of speech usually prevails.

Numerous commentators have questioned whether or not the Internet is a **push** or a **pull media**. More traditional pull media include magazines, books and film, where heightened First Amendment protection is acknowledged. More traditional push media include radio and television where there are less First Amendment freedom of speech rights, particularly for broadcasters. No case has yet determined this issue in the courts.

---

REFERENCES for module 3 (To be hyperlinked from text)

<sup>1</sup> 15 U.S.C. § 1127; Lanham Act §45 (1946).

<sup>2</sup> *Id.*

<sup>3</sup> *Abercrombie & Fitch Co. v. Hunting World, Inc.*, 537 F.2d 4, 9 (2d Cir. 1976).

<sup>4</sup> *Id.*

<sup>5</sup> *Id.* at 11.

<sup>6</sup> 15 U.S.C. §1052(e); Lanham Act, §2(e) (1946).

<sup>7</sup> *Bigstar Entertainment, Inc. v. Next Big Star Inc.*, 105 F.Supp.2d 185, 196 (S.D.N.Y. 2000).

<sup>8</sup> *Id.*

<sup>9</sup> 1 J. Thomas McCarthy, *McCarthy on Trademarks and Unfair Competition* (4<sup>th</sup> ed.) §12:47 at 12-92.

<sup>10</sup> *America Online, Inc. v. AT&T Corp.*, 64 F.Supp. 549 (EDVa 1999).

<sup>11</sup> 15 U.S.C. §1064; Lanham Act, §14(3).

<sup>12</sup> *GAF Broadcasting CO. v. Caswell-Massey Co.*, 215 U.S.P.Q. 654 (T.T.A.B. 1982).

<sup>13</sup> 15 U.S.C. §1051(1)(a)(1); Lanham Act §1(a)(1) (1946).

<sup>14</sup> 15 U.S.C. § 1051; Lanham Act §1(b)(1).

<sup>15</sup> *Id.*

<sup>16</sup> United States Patent and Trademark Office, Examination Guide No.2-99.

<sup>17</sup> 15 U.S.C. §1052(e)(1); Lanham Act § 2(e)(1).

<sup>18</sup> Id. at §1052(f); §2(f).

<sup>19</sup> CITE for REG DATES

<sup>20</sup> 15 U.S.C. §1127; Lanham Act §45.

<sup>21</sup> 15 U.S.C. §1091; Lanham Act §23.

<sup>22</sup> 15 U.S.C. § 1126(e); Lanham §44 (e).

<sup>23</sup> Sally M. Abel, *Trademark Issues in Cyberspace: The Brave New Frontier*, 5 Mich. Telecomm. Tech. L. Rev. 91 at 92 (1999)

<sup>24</sup> Id.

<sup>25</sup> ICANN Fact Sheet <<http://www.icann.org/general/fact-sheet.htm>>

<sup>26</sup> Id.

<sup>27</sup> Memorandum of Understanding between the U.S. DOC and ICANN

<<http://www.ntia.doc.gov/ntiahome/domainname/icann-memorandum.htm>>

<sup>28</sup> ICANN Uniform Domain Name Dispute Resolution Policy

<<http://www.icann.org/udrp/?udrp.htm>> A list of approved dispute resolution service providers is available here.

<sup>29</sup> 5 Mich. Telecomm. Tech. L. Rev. 91 at 93

<sup>30</sup> No. 97 Civ. 0629, 1997 U.S. Dist. LEXIS 3338 (S.D.N.Y. Mar. 19, 1997)

<sup>31</sup> PTO Examination Guide No. 2-99, Marks composed, in whole or in part, of domain names

<<http://www.uspto.gov/web/offices/tac/notices/guide299.htm>>

<sup>32</sup> Id.

<sup>33</sup> Id.

<sup>34</sup> See Marcelo Halpern. *Meta-Tags: Effective Marketing or Unfair Competition?*, *Cyberspace Lawyer*, Oct. 1997.

<sup>35</sup> 985 F. Supp. 1220 (N.D. Cal. 1997)

<sup>36</sup> No. 97-Z-1592, 1998 U.S. Dist. LEXIS 18359 (D. Colo. Feb. 6, 1998) (consent judgment) This case is often referred to as a 'pure meta tags case' because the defendants' sole alleged wrongful conduct was their use of the plaintiff's trademark among their meta tags.

<sup>37</sup> 174 F.2d 1036 (9<sup>th</sup> Cir. 1999)(relying on *Mobil Oil Corp. v. Pegasus Petroleum Corp.*, 818 F.2d 254, 257-58 (2d Cir. 1987)). At least two courts in the Second Circuit have analyzed a trademark case involving meta tags by applying the initial interest confusion doctrine. Also, the Fifth and Seventh Circuits have adopted this doctrine.

<sup>38</sup> *id.* at 1065

<sup>39</sup> 7 F. Supp. 2d 1098 (S.D. Cal. 1998)

<sup>40</sup> *id.* at 1104

<sup>41</sup> Restatement (Third) of Unfair Competition § 28 cmt. a (1995)

<sup>42</sup> 4 J. Thomas McCarthy, McCarthy on Trademarks and Unfair Competition, § 25:69 at 25-137 (4th ed. 1999)

<sup>43</sup> See 50 Hasting L.J. 1333, 1354

<sup>44</sup> *SNA, Inc. v. Array*, 51 F. Supp. 2d 554 (E.D. Pa. 1999)(Held that defendants intentionally use plaintiffs' mark in this way to lure internet users to their site instead of SNA's official site. This is true whether the meta tagging is visible or hidden in the code, and no matter what the web site's domain name is),

*The New York State Society of Certified Public Accountants v. Eric Louis Associates, Inc.*, 79 F. Supp. 2d 331 (S.D.N.Y. 1999)(Applying the initial interest confusion theory, the court ruled that that the defendant's use of the "nysscpa.com"



domain name and the "NYSSCPA" meta tag created initial interest confusion sufficient to satisfy the Lanham Act's requirement)

<sup>45</sup> Complaint, *Ticketmaster v. Microsoft*, 97 Civ. 3055 (C.D. Cal. April 28, 1997), can be found at <[www.jmls.edu/cyber/cases/ticket.html](http://www.jmls.edu/cyber/cases/ticket.html)>

<sup>46</sup> Sally M. Abel, *Trademark Issues in Cyberspace: The Brave New Frontier*, 5 Mich. Telecomm. Tech. L. Rev. 91, 123 (1999)

<sup>47</sup> No. 97 Civ. 1190 (PKL)(S.D.N.Y. filed February 20, 1997)

<sup>48</sup> 5 Mich. Telecomm. Tech. L. Rev. 91, 124

<sup>49</sup> *Id.* at 125

<sup>50</sup> 971 F.2d 302 (9<sup>th</sup> Cir. 1992)

<sup>51</sup> In a display of technology fighting technology, CNN, USA Today and other new organizations have employed the use of a technological tool to kick out or de-frame since the *Total News* case. When a web user comes onto their page through a framed reference page, the software will automatically de-frame and kick the user out onto a full screen version of their page.

<sup>52</sup> Panel Discussion, *Link Law on the Internet*, 38 IDEA: J.L. & Tech. 197, 227 (1998)

<sup>53</sup> *Id.*

<sup>54</sup> 15 U.S.C.A. Sec. 1125(a); Lanham Act § 43(a).

<sup>55</sup> 15 U.S.C. §1125(a)(1)(A); Lanham Act § 43(a)(1)(A).

<sup>56</sup> 15 U.S.C. §1125(a)(1)(B); Lanham Act § 43(a)(1)(B).

<sup>57</sup> *Id.*

<sup>58</sup> 15 U.S.C. §1115 (b)(4); Lanham Act §33(B)(4).

<sup>59</sup> *Playboy Enterprises, Inc. v. Terri Welles*, 7 F.Supp. 2d 1098 (S.D. Cal. 1998).

<sup>60</sup> 346 F. Supp. 1183 (E.D.N.Y. 1972)

<sup>61</sup> 304 F. Supp. 1228 (S.D.N.Y. 1969)

<sup>62</sup> 306 F.2d 433 (5<sup>th</sup> Cir. 1962).

<sup>63</sup> *General Electric Co. v. Alumpa Coal Co.*, 205 U.S.P.Q. 1036 (D.C. Mass. 1979)(defendant's use of GE logo and name in a sexual way – “Genital Electric” – to market and sell underwear was enjoined)

*Edgar Rice Burroughs, Inc. v. Manns Theaters*, 195 U.S.P.Q 159 (C.D. Cal. 1976)(court held under a likelihood of confusion analysis that the adult movie entitled “Tarz & Jane & Boy & Cheeta” would likely confuse and/or dilute the plaintiff's mark TARZAN, even in the face of open disclosure by defendant of non-affiliation)

<sup>64</sup> Enter citation

<sup>65</sup> 836 F.2d 397 (8<sup>th</sup> Cir. 1987)

<sup>66</sup> 811 F.2d 26 (1<sup>st</sup> Cir. 1987)

<sup>67</sup> Id. at 34

<sup>68</sup> See *Deere & Co. v. MTD Products, Inc.*, 41 F.3d 39 (2d Cir. 1994)(Affirming the preliminary injunction holding animated version of trade mark and commercial was a likely violation of anti-dilution statute because it posed the risk that consumers would likely attribute unfavorable characteristics to the mark and ultimately associate the mark with inferior goods and services.) The District Court considered this case of first impression most notably because MTD's commercial creates a likelihood of dilution involving neither blurring nor tarnishing as those terms have generally been understood. <[link to Blurring and Tarnishing sections under Dilution - Amanda](#)>

<sup>69</sup> Id. at 46

<sup>70</sup> 886 F.2d 490 (2d Cir. 1989)

<sup>71</sup> *White v. Samsung Elecs. Am., Inc.*, 989 F.2d 1512 (9<sup>th</sup> Cir. 1992), *cert. denied*, 113 S. Ct. 2443 (1993)

<sup>72</sup> <http://www.mastercard.com>

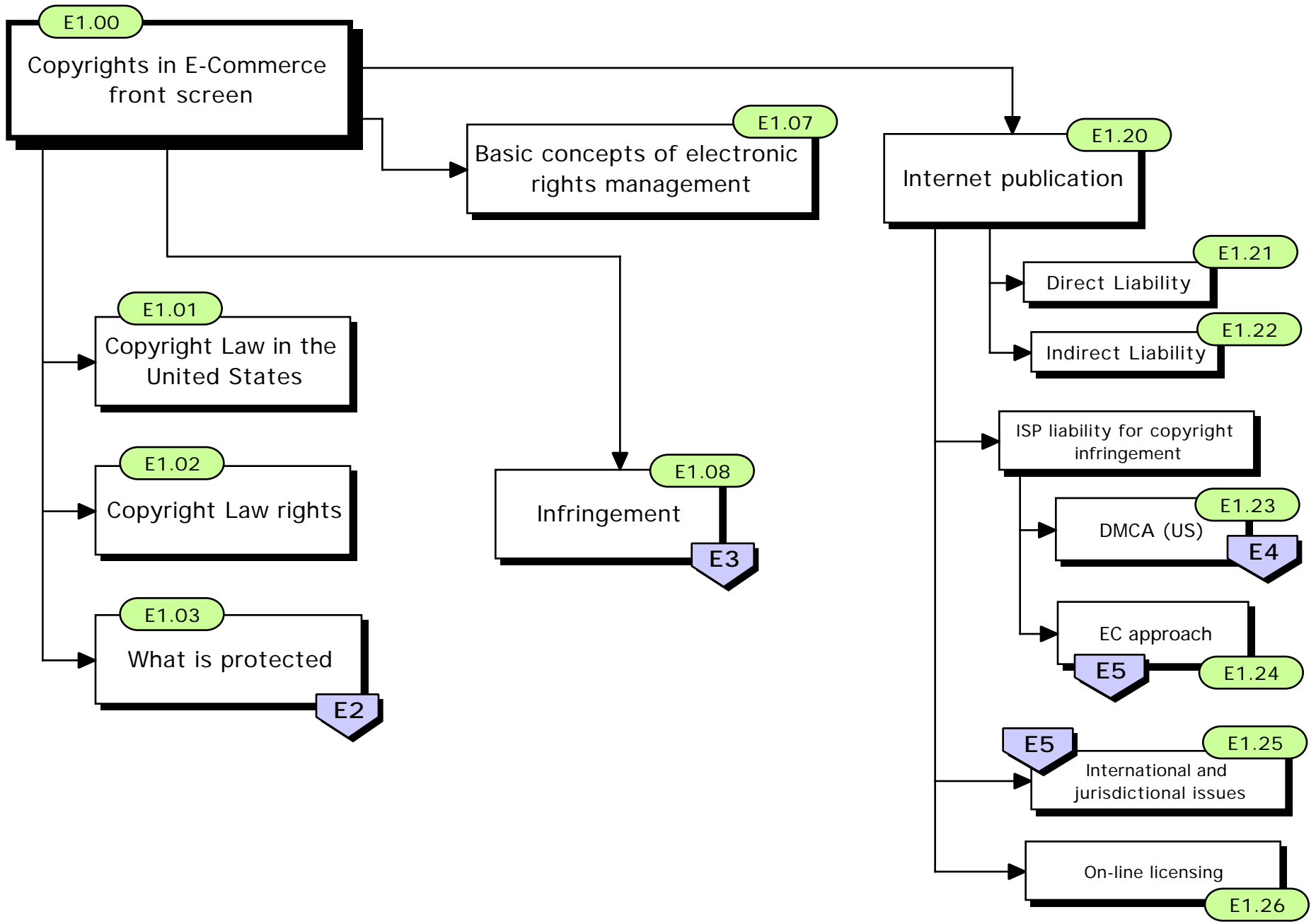

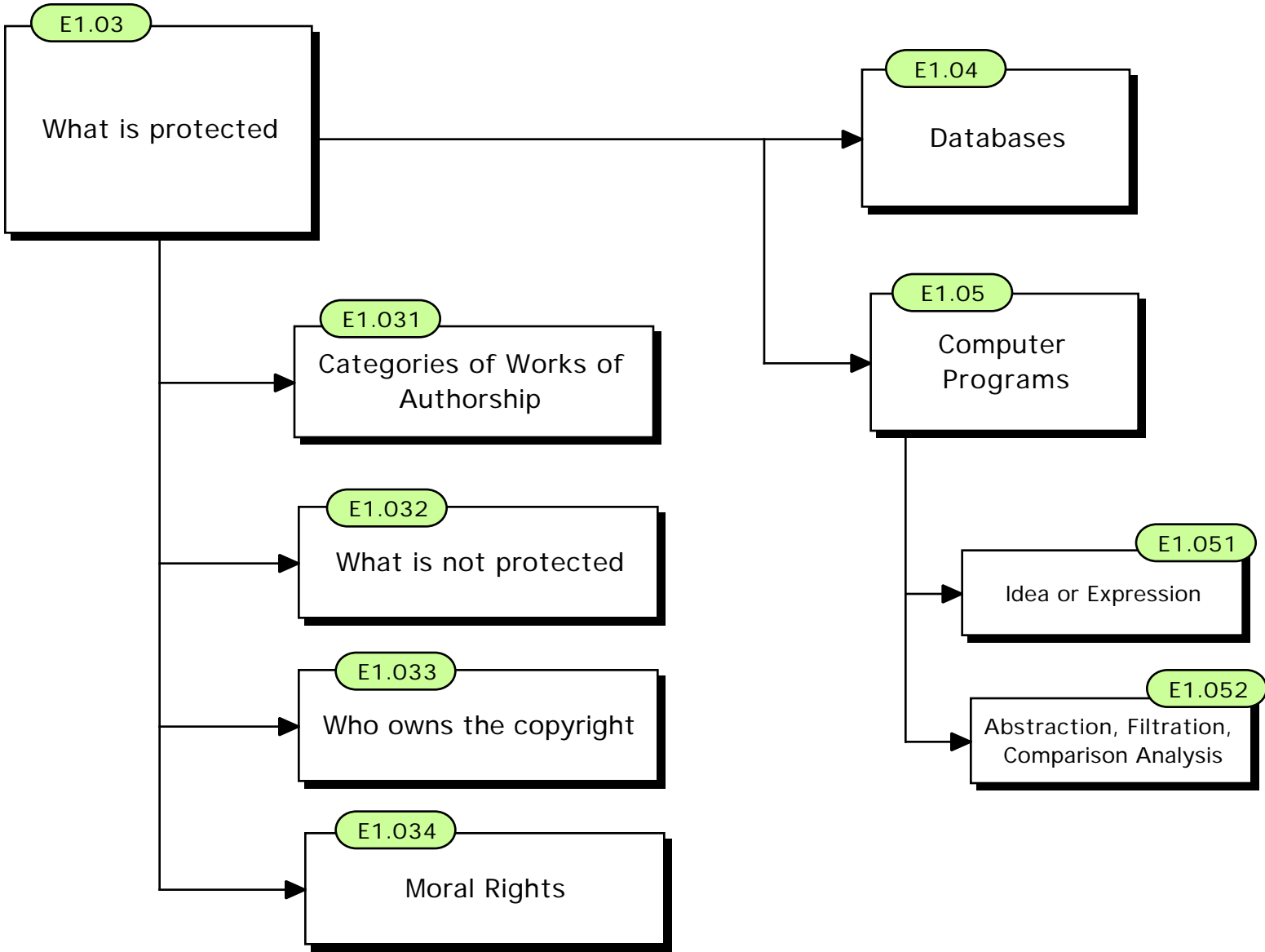

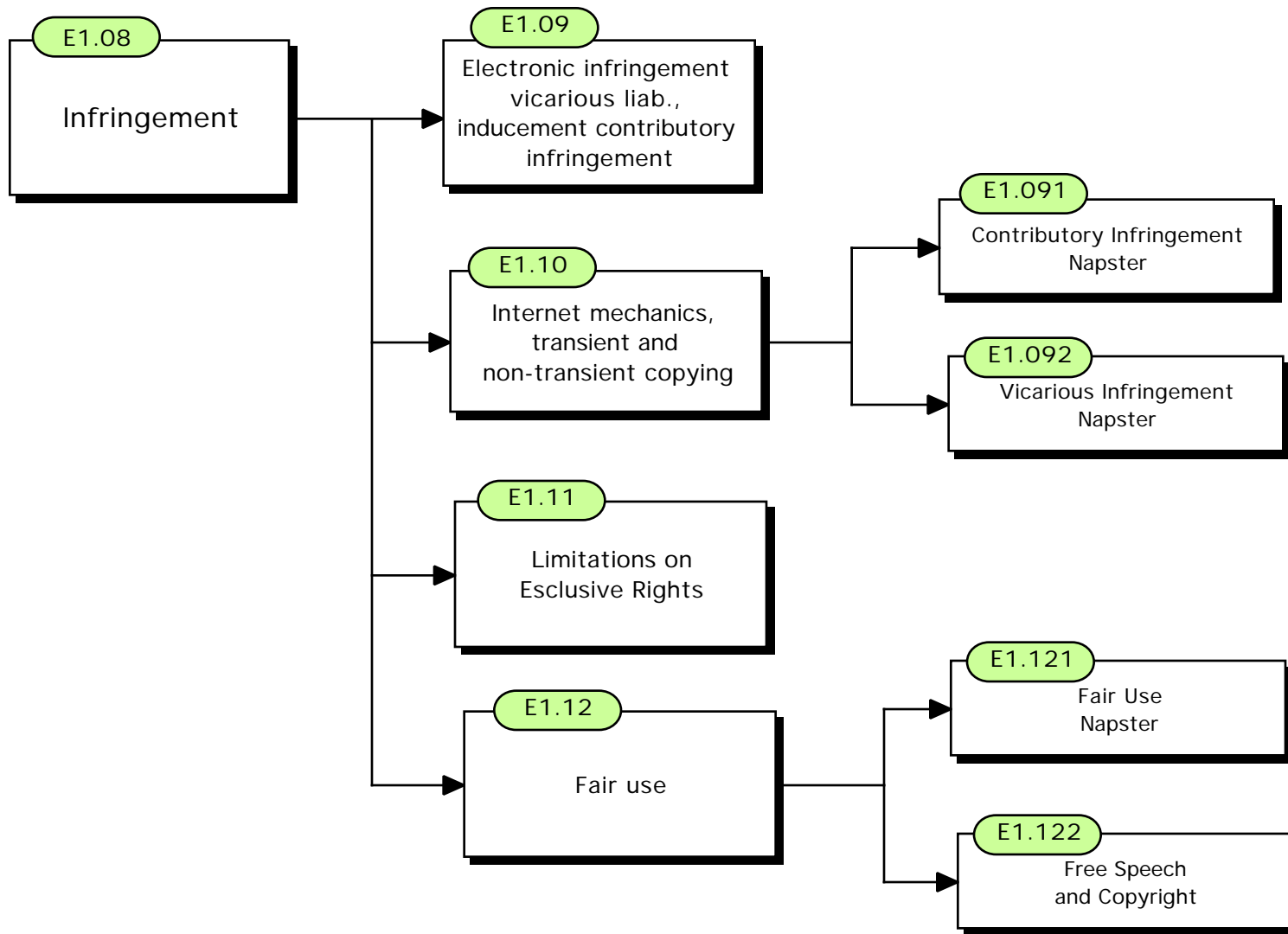

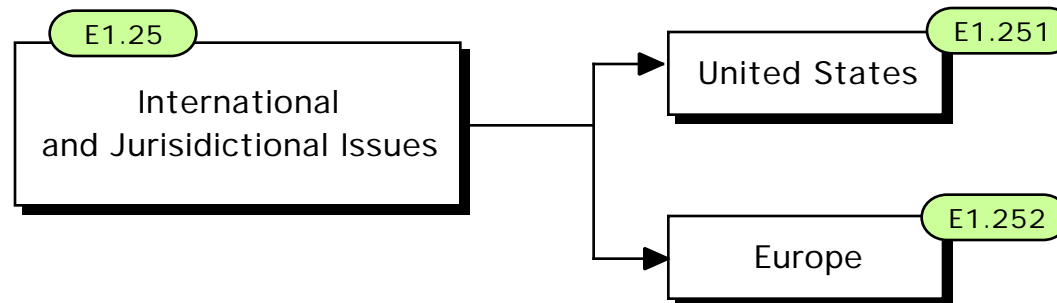
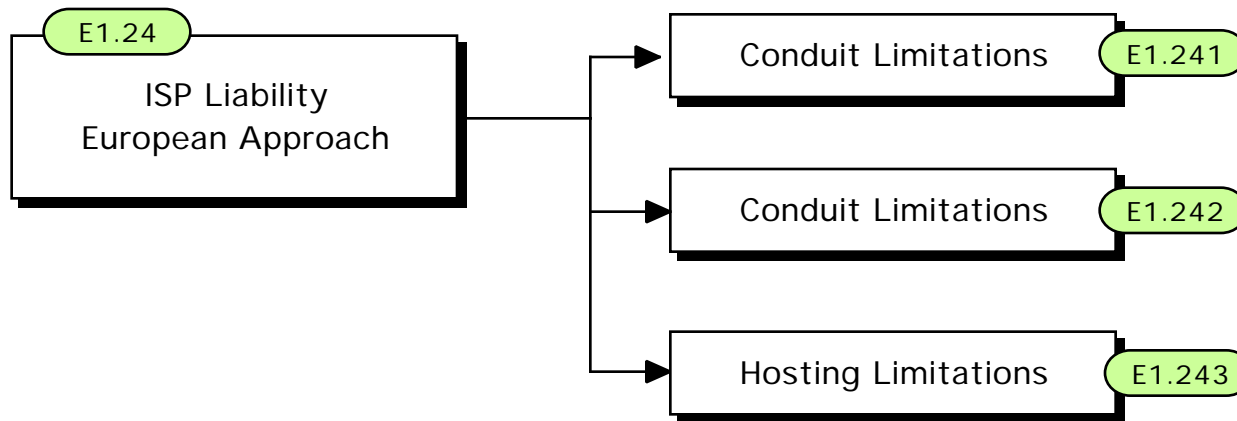

**Copyrights in E-Commerce Front Screen****Module E1.00**

Web sites are compilations of various components. Much of the material that is used to create or that is found on web sites, such as photographs, text, artwork, and audio components, are copyrightable. Businesses that choose to create an Internet presence for themselves need to be aware of how copyright law works and affects material on the web. For e-commerce businesses, a primary source of protection for their intellectual property is copyright law. Material that can be protected through copyright law includes the software that runs programs on the web site, the text and photos on the page, audio components, and databases.

[Graphic illustrating the components]

**Overview of Copyrights Protection in the United States****Module E1.01**

The [Copyright Right Act of 1976<sup>1</sup>](#) ([Copyright Act](#)) governs copyright law in the United States. Works protected by the Copyright Act include, literary works, musical works, dramatic works, pantomimes, choreographic works, pictorial, graphic, and sculptural works, motion pictures and other audiovisual works, sound recordings, and architectural works.<sup>2</sup> To receive protection in any of these categories, the work must be original and fixed in a tangible medium.<sup>3</sup>

Copyright protection exists from the time of creation. Therefore, federal registration is not necessary to receive protection. However, in the United States there are benefits to federal registration with the Copyright Office. For example, registration is a necessary prerequisite to receive statutory damages and costs and attorney's fees.<sup>4</sup>

**Copyright Holder's Rights**

## Module E1.02

The copyright holder is entitled to the following exclusive rights<sup>5</sup>:

- The right to reproduce.<sup>6</sup> This exclusive right gives the copyright owner the right to copy, duplicate or imitate the copyrighted work in a fixed form. For example, reproducing text in computer format or scanning photos for use on a web site would be within the copyright owner's right of reproduction. When creating a web site, material must be uploaded to a server, constituting reproduction. The transmission of material over the Internet also implicates the reproduction right because copies are temporarily stored on computers accessing the site.
- The right to create derivative works.<sup>7</sup> This right gives the copyright owner the right to recast, transform, adapt, or simply modify a preexisting work. Creating a sequel to a computer program or digitally altering artwork or photos would fall within the right to create derivative works.
- Distribution right.<sup>8</sup> This right gives the copyright owner the right to distribute copies to the public by sale, rental, or lease. Although there is some dispute over whether internet distribution implicates this right, e-businesses who want to be err on the safe side should include this right when licensing copyrighted content to distribute, such as music or software.
- Public performance right.<sup>9</sup> The performance right gives the copyright owner the right to perform the copyrighted work publicly. To perform means to “recite, render, play, dance, or act [the work], either directly or by means of any device or process.”<sup>10</sup> For example, an e-business that places a video clip on its web site would be exercising the performance right of the work.



- Public display right.<sup>11</sup> The public display right gives the copyright owner the right to display copyrighted materials publicly. For example, a web site that displays any text or photographs would be exercising its display right.
- Public performance right for sound recordings.<sup>12</sup> This right covers the digital audio transmission of sound recordings. This right may be exercised by offering audio sampling clips of audio files on a web site.<sup>13</sup>

### **What is protected – Original Works of Authorship**

#### Module E1.03

United States copyright law protects “original works of authorship” fixed in a tangible medium.<sup>14</sup> As explained by the United States Supreme Court, “The *sine qua non* of copyright is originality.”<sup>15</sup> The [United States Copyright Act](#) leaves the word “original” undefined. The Supreme Court has interpreted “original” to mean that the work is original to the author and possesses a minimal level of creativity.<sup>16</sup>

A work is original to the author if it is *not* copied from another work. As Judge Learned Hand explained:

Borrowed the work must indeed not be, for a plagiarist is not himself pro tanto an ‘author’; but if by some magic a man who had never known it were to compose anew Keats's Ode on a Grecian Urn, he would be an ‘author,’ and, if he copyrighted it, others might not copy that poem, though they might of course copy Keats’s.<sup>17</sup>

Even if two works are substantially similar, if the second author did not copy the preexisting work, either intentionally or unintentionally, both works would be may receive copyright protection.<sup>18</sup>

The amount of creativity required in a work to qualify for copyright protection is minimal.<sup>19</sup> Further, the originality requirement does not mean that the work has to be novel, as in patent law.<sup>20</sup> Rather, to meet the requirement, the work must simply show some spark of creativity, no matter how crude or obvious.<sup>21</sup>

### **Categories of Works of Authorship**

Module E1.031

The Act divides “[works of authorship](#)”<sup>22</sup> into the various categories.<sup>23</sup> Following are the individual categories and examples of each:

- (1) Literary works. Literary works are those that are expressed in “words, numbers, or other verbal or numerical symbols or indicia,”<sup>24</sup> such as books, cards, and manuscripts.
- (2) Musical works. These works include any type of music such as melodies and orchestral pieces.
- (3) Dramatic works. Dramatic works include works such as plays and stage performances.
- (4) Pantomime and choreographic works. These works include mime works and styles of dance.
- (5) Pictorial, graphic, and sculptural works. These works include two or three-dimensional works of fine, graphic, and applied art, photographs, art reproductions, maps, architectural plans, etc.
- (6) Motion pictures and other audiovisual works. Such works consist of a series of related images that impart an impression of motion and that are “intrinsically intended

to be shown by use of machines or devices such as projectors.”<sup>25</sup> Examples include movies, videos, and interactive multimedia works.

- (7) Sound recordings. The fixation of any sound, such as musical or spoken sounds results in a sound recording. Sound recordings do not include the sounds accompanying a motion picture or other audiovisual work.<sup>26</sup>

For any work that falls in any of the above categories, to be copyrightable it must meet the originality and fixation requirements.

### **What is not protected**

#### Module E1.032

Original works of authorship include expressions, meaning that the work must be able to be “perceived, reproduced, or otherwise communicated.”<sup>27</sup> Copyright only protects expression. Making this clear in the statute, the Act also expressly states what cannot qualify for copyright protection. As set forth in § 102 of the [Copyright Act](#), copyrightable works *do not* include ideas, procedures, processes, systems, methods of operation, concepts, principles, or discovery.<sup>28</sup> Other things that do not qualify for copyright protection include titles of works,<sup>29</sup> facts,<sup>30</sup> works prepared by the United States federal government,<sup>31</sup> and works in the public domain.<sup>32</sup>

Works in the public domain are no longer protected by copyright.<sup>33</sup> Such works may be used without obtaining permission from the author. However, if a derivative work incorporates or is based on public domain material, copyright protection may exist. Although the public domain material remains to be unprotected, the new or added original material added by the author of the derivative work may qualify for copyright protection.<sup>34</sup>

A key concept of copyright law is that ideas may not be protected. This makes it necessary to separate the idea from the expression in order to determine what is and is not capable of being protected by copyright law. Separating the idea from the expression is easy in some cases. For example, the idea of a woman sitting on a park bench is not capable of receiving copyright protection. No one author can claim ownership over the idea. However, the expression of the idea in a photograph, in text, or in a painting could be protected and the author could exercise his exclusive rights to protect his expression of the thought. Separating the idea from the expression becomes more difficult when dealing with copyrightable works such as [computer programs](#)<sup>35</sup> and [databases](#).<sup>36</sup>

### **Who owns the copyright**

Module E1.033

Initial ownership of a copyright initially vests in the author.<sup>37</sup> Although the author or authors are usually the people who created the work, the Act recognizes an exception for “Works Made for Hire.”<sup>38</sup> A work made for hire is defined in the Act as: 1) a work prepared by an employee within the scope of his or her employment; or 2) a work specially ordered or commissioned.<sup>39</sup> The author of a work made for hire is the employer or other person for whom the work was prepared, unless the parties agree otherwise in writing.<sup>40</sup>

The copyright of a work prepared by an employee within the scope of employment belongs to the employer.<sup>41</sup> However, sometimes it may be difficult to determine whether or not the work was created within the scope of employment. It may also be difficult to determine if the person who created the work was an employee.

Factors to consider in distinguishing between employees and non-employees are derived from agency law.<sup>42</sup> These factors the hiring party's right to control the creation of the work, the skill required to make the work, whether the hired party received benefits, how the hiring party treated tax issues, as well as whether the hiring party could assign more projects to the hired person.<sup>43</sup>

Under the second category of works made for hire, there are only nine categories of that qualify to be a "specially commissioned" work. Those nine factors include (1) a contribution to a collective work; (2) a part of a motion picture or other audiovisual work; (3) a translation; (4) a supplementary work; (5) a compilation; (6) an instructional text; (7) a test; (8) answer material for a test and; (9) an atlas.<sup>44</sup> However, if a work falls into one of the above categories, in order to qualify as a work made for hire, the parties must "expressly agree in a written instrument signed by them that the work shall be considered a work made for hire."<sup>45</sup> Note that both parties must sign this agreement.<sup>46</sup>

Works made for hire are especially important for e-commerce businesses. With the amount of work that most likely will be outsourced – such as web page design and software development – it is important to determine who is the owner of the work. The owner of the copyright, not the owner of the physical good, will be the one entitled to the exclusive rights granted by the copyright. If a business doesn't retain the rights to the materials that it outsourced, either through the work made for hire doctrine or contractual assignment, the business runs the risk of its software, designs, and the like being used by or sold to other business by the true copyright owner.

With ownership of the copyright, the copyright holder is entitled to the exclusive rights granted in § 106 of the Act. As discussed in the course module "[Copyrights in E-](#)

[Commerce](#)<sup>47</sup> those rights include the right to reproduce, the right to prepare derivative works, the right to distribute, the right to perform the work publicly, and the right to display the copyrighted work publicly, and the public performance right of sound recordings.

### **Moral Rights**

Module E1.034

Other countries outside of the United States recognize an author's moral rights.<sup>48</sup> Moral rights generally include the right of integrity, the right of paternity, and the right of disclosure.<sup>49</sup> The right of integrity is the author's right to not have his work mutilated or distorted. The right of integrity gives the author the right to be acknowledged as the author of the work. Finally, the author's right of disclosure gives the author the right to decide when and in what form the work will be presented to the public.<sup>50</sup>

The United States has never adopted a comprehensive version of moral rights into federal copyright law. However, § 106A does protect the "Rights of Attribution and Integrity" for an author's of work of visual art.<sup>51</sup> This section gives the author of such a work more control over the use of the work.

The section grants the author the right to claim authorship of that work and to prevent the use of his name as the author of any work that he did not create. The author of a work of visual art will also have the right to prevent use of his name in conjunction with his work if the work has been distorted, mutilated or modified in such a way that would be prejudicial to his honor or reputation. The author can also prevent intentional destruction of a work that is of "recognized stature," subject to certain limitations. The rights granted

in § 106(A) are personal to the author, meaning that even if the copyright owner is different than the author, the author will retain the rights. However, the rights may be waived.<sup>52</sup>

Through various state and federal laws, the United States also provides for other protections similar to the moral rights granted in other countries.<sup>53</sup> For example, some protection may be found through state unfair competition laws or certain state statutes that recognize the moral rights of authors of visual works of art.<sup>54</sup>

<b>Database</b> Module E1.04
---------------------------------

A database, whether computerized or not, may be protected under [United States Copyright Act](#) as a compilation. A “compilation” is defined in the Act as “a work formed by the collection and assembling of preexisting materials or of data that are selected, coordinated, or arranged in such a way that the resulting work as a whole constitutes an original work of authorship.”<sup>55</sup> Although compilations are protected, copyright does not protect the effort used to compile the information, nor any public domain material, such as facts, that may be used in the compilation.<sup>56</sup>

The elements of a compilation that are eligible for copyright protection include the original elements that the author adds to the uncopyrightable material.<sup>57</sup> Such original elements may include the author’s judgment in selection and arrangement.<sup>58</sup> However, in order to be copyrightable, the elements the author added must meet the minimal standard of originality required for any work of authorship to be protected under copyright.<sup>59</sup> If the

added elements of the material lack sufficient originality, meaning a *de minimus* amount of creativity, copyright protection will not be available.<sup>60</sup>

In [\*Feist Publications, Inc. v. Rural Telephone Service\*](#), the court held that copyright protection only extends to elements of a compilation that meet the originality requirement.<sup>61</sup> Rejecting the “sweat of the brow”<sup>62</sup> doctrine, the Court discussed the tension between the proposition that facts are *not* copyrightable and the proposition that compilations of facts generally are copyrightable. The Court explained that the touchstone of copyright law is originality.<sup>63</sup> Facts are not copyrightable because they are not created, rather they are discovered and are in the public domain.<sup>64</sup> The copyright that is afforded to compilations is limited to the original elements that the author adds to the uncopyrightable material.<sup>65</sup>

Compilations are often the result of much skill and effort. The holding in *Feist* means that no matter how much work is spent compiling facts, once compiled, anyone can use those facts. In the case of computerized databases, this is slightly troubling because the digital material is easily copied. However, to further the purpose of copyright (which is to promote the progress of useful arts and science) it is necessary to *not* protect factual data, and rather only provide protection for original elements, such as the arrangement and selection. In effect, copyright law protects only works of authorship that contain a modicum of creativity, not the effort that was put into making a work.<sup>66</sup>

In order to protect database information, businesses cannot rely on copyright law for complete protection. Instead, a business that would like to set up a database and protect the information it compiles, should look to other areas of the law, such as trade secret



law, contract law, and unfair competition.<sup>67</sup> Although these areas will also offer limited protection, they may provide the type of protection for which the business is looking.<sup>68</sup>

A directive passed in 1996 by the European Union gives somewhat different protection to computer databases than United States copyright law.<sup>69</sup> The directive is similar in that it only provides protection to the selection and arrangement of the factual content.

However, the directive also gives a sui generis right in the contents of the databases. This right gives the maker of the database the right “to prevent unauthorized extraction or re-utilization” of the database contents for commercial purposes. This protection lasts for a period of 15 from the date the database was made available to the public. The directive also recognizes exceptions such as the ability to extract insubstantial amounts of information if the source is acknowledged.<sup>70</sup>

### **Computer Programs**

#### **Module E1.05**

Despite the differences between computer programs and more traditional copyrightable works like books and art, the [United States Copyright Act](#) recognizes computer programs as copyrightable subject matter. As defined in § 101 of the Act, computer programs are a “set of statements or instructions to be used directly or indirectly in a computer in order to bring about a certain result.”<sup>71</sup> Software can be “fixed” in a numerous ways such as, source code, object code, diskettes, CD-ROMs, shareware available to be downloaded from the Internet, semi-conductor chips, etc.<sup>72</sup>

It is well settled in United States law that the literal elements of a computer program are protectable.<sup>73</sup> The literal elements of software, include the object and source code.

Although unintelligible to humans, code does qualify as a literary work.<sup>74</sup> This is because the definition of a literary work protects the ones and zeros of the computer code.

Further, a program embedded on ROM is also protectable because the embedded program clearly meets the fixation requirement.<sup>75</sup> Additionally, computer operating systems are also copyrightable.<sup>76</sup> Despite the copyrightability of these elements, the scope of protection afforded to computer programs is difficult to determine.

### **Idea or Expression in Computer Programs**

Module E1.051

One of the most difficult problems in determining the scope of protection available to software is the separation of the idea behind the program, which is not protectable, from the expression, which is protectable. As with any work of authorship copyright protection only extends to the expression of the work, not the idea behind the work. This is extremely important when determining the scope of protection for computer programs.

The Third Circuit in the United States was the first court in the United States to address the issue of whether non-literal copying of a computer program constituted infringement. In *Whelan Associates, Inc. v. Jaslow Dental Laboratory, Inc.*,<sup>77</sup> the court identified the program's idea broadly as being the purpose of the program and the structure of the program to be protectable expression.<sup>78</sup> The court awarded protection to not just the code, but to the structure, sequence, and organization of the software that was not necessary to the function or purpose of the program.<sup>79</sup>

**Abstraction, filtration and comparison analysis**

## Module E1.052

In determining what elements of a program may be protected under copyright law and which elements are not protected, the court in *Computer Associates International v. Altai, Inc.*<sup>80</sup> adopted the abstraction, filtration analysis.<sup>81</sup> While it was well settled that literal elements of computer programs, such as object code and source code could be protected through copyright law, the court addressed the question of whether the non-literal elements, meaning elements other than computer code, could also be protected.<sup>82</sup>

The *Altai* analysis involved three stages: abstraction, filtration and comparison. The first step is similar to reverse engineering. The court dissected the program structure to determine each level of abstraction contained within it. The levels began with the code and ended with the ultimate function of the program.<sup>83</sup> After the court isolated the various levels of the computer program, the court filtered out the elements of the program dictated by efficiency and elements dictated by external factors.<sup>84</sup> Once those elements were identified, whatever was remaining was found to be eligible for protection. The court will then compare the remaining elements to those of the infringing program.<sup>85</sup> In *Altai*, the court found that there was no infringement. However, the court also noted that copyright infringement actions concerning computer programs were highly fact specific and would vary according to the amount of protectable expression found in each program.<sup>86</sup>

**Website Look and feel**

Module E1.06

**Electronic Rights Management**

Module E1.07

A copyright in a work entitles the owner to a bundle of exclusive rights. With that bundle of rights, a copyright owner has the ability to grant any one or all of his exclusive rights to another. The owner may choose to divide the bundle of rights any way that the copyright holder sees fit.

With the Internet, there are more avenues for which exclusive rights can be used. For example, the author of a book would have the general exclusive rights granted by copyright. The author would have the right of reproduction, distribution, the right to create a derivative work, etc. According to the author's wishes, the author could grant the right of reproduction and distribution to a traditional book publisher for the book to be printed in hard copy form. The author could also grant the same rights of reproduction and distribution to a web developer for publication on the internet. In addition to publication and distribution, the author could grant the right to create a derivative work to the maker of an interactive CD-ROM, the maker of a movie, or someone wanting to write a sequel. This demonstrates that the original copyright owner may choose to split up his exclusive rights not only according to the separate rights themselves but also based on numerous things, for example market and medium.

This ability to split up rights in numerous ways creates a problem for people who may want to obtain authorization to use a copyrighted work. The time and expense in tracking down the owner of the specific right to which a company is interested in obtaining can be immense.<sup>87</sup> Because the copyright holder has the ability to split up the rights for one work, tracking down or determining the proper owner to a specific right may be difficult. In order to clear the use of material, businesses need to begin the clearance process early. Not only may licensing the rights take a long time in itself, but just finding the owner can be time consuming.<sup>88</sup> The time consuming process of clearing rights can also be quite costly. Rights will be more expensive the shorter the time you have to negotiate. Further, the license fees themselves may be expensive.<sup>89</sup>

When clearing the rights to use a copyrighted material with a license, general steps a company should take include identifying what aspect of the copyrighted work it wants to license, the rights that it will need for the planned use, and whether sublicensing and subsidiary rights are needed.<sup>90</sup> It will also want to make sure that the use of the material will not infringe upon rights outside of copyright law, such as trademark rights, the right to privacy or publicity.<sup>91</sup>

To increase the amount of control over copyrighted works, content owners, in the past, have brought together the rights of many parties.<sup>92</sup> For example, the [American Society for Composers, Authors and Publisher \(ASCAP\)](#) and [Broadcast Music, Inc. \(BMI\)](#) handle the nonperformance dramatic rights licenses for their members.<sup>93</sup> The [Harry Fox Agency](#) is responsible for the mechanical rights of numerous music publishers.

There has been a recent movement to increase the amount of control content owners have over their works. This is because the new digital world is presenting new problems in the

licensing. For example, licensees want more rights in a work than in the past, such as digital distribution rights in addition to the traditional print distribution rights. This is creating pricing problems because there is no product yet on which to base the licensing price. This is especially true with the uncertainty concerning the effect that digital works will have on revenue.<sup>94</sup>

One solution to the problem that digital media has presented for licensing is to create electronic copyright management systems.<sup>95</sup> These systems would then handle “author payments and licenses.”<sup>96</sup> In such a system, authors would grant their exclusive rights to an online licensing entity. The licensing entity then would be able to grant the exclusive rights to any person wishing to license the rights. The prices for different uses could be agreed upon up front. The web site clearinghouse could then allow users to license the work directly from the web site for the particular use that it wants.<sup>97</sup>

As with traditional methods of licensing, electronic copyright management systems also face difficulties. For example, the problem still exists with regard to the divisibility of the bundle of rights granted through copyright protection. In addition determining the owners of certain rights could be difficult for the creation of the system. This is because the right can be passed contractually, statutorily, as well as intestate.

The [World Intellectual Property Organization](#) has also explored the benefits of electronic rights management. Electronic Copyright Management Systems can promote the public interest, making it easier for people to properly clear rights before using copyrighted works unlawfully. The basic methods of rights management systems identify content and the rights owners of the content, a method for licensing the content, a method for tracking

the use of the work after the licensing has occurred, and a method for ensuring that the rights holders are duly compensated for the use of the work.<sup>98</sup>

One such model in the United States is the [Publication Rights Clearinghouse \(PRC\)](#), which is a project of the [National Writers Union](#). [PRC](#) acts as a licensing agent of authors' "secondary rights to their previously published articles."<sup>99</sup> To do this, writers give their permission to [PRC](#). [PRC](#) can then license secondary users of the works, collect the copyright fees, and then distribute the fees to the appropriate author.<sup>100</sup>

Another similar organization is the [Media Photographers Copyright Agency \(MPCA\)](#), which is a project of the American Society of Media Photographers. The [MPCA](#) operates as a licensing agent, rather than a stock agent. The organization will make pricing recommendations, however, pricing remains in the control of the photographer. The [MPCA](#) holds files in a scanned database and then can distribute the material online.<sup>101</sup> The mission of the organization is to use technology for the benefit of photographers and their clients and reduce transaction costs.<sup>102</sup>

In Canada, [The Electronic Rights Licensing Agency \(TERLA\)](#) is a similar organization. [TERLA](#) works to provide web publishers, database companies, and multimedia producers the licenses they need, as well as to make sure that the creators of the works are compensated.<sup>103</sup> Unlike [PRC](#) and [MPCA](#), [TERLA](#) represents not just one genre of authors, rather, it represents writers, photographers and illustrators.<sup>104</sup>

With the move toward such systems, determining the owners of rights and licensing the rights most likely will become easier, as well as more efficient.

**Copyright Infringement**

## Module E1.08

If a third party violates any of the exclusive rights granted to a copyright owner, the third party has infringed upon the rights of the copyright holder. E-commerce businesses need to be aware of and respect the rights of copyright holders on the Internet. Unfortunately, due to the ease of copying, distributing, and displaying material via the Internet, it is easy to forget that simple acts may be infringing another's copyright.

To sustain an action for infringement, the copyright owner must prove that he owns a valid copyright and that the defendant copied the work. Further, the copying must be an inappropriate appropriation of the material.<sup>105</sup> To bring an action in the United States, any United States copyright owner must have registered the copyright with the Copyright Office.<sup>106</sup> Registration is not necessary for foreign copyright owners. Further, timely filing of a copyright registration will entitle the copyright owner to statutory damages and attorney's fees.<sup>107</sup>

In a copyright infringement action, only the legal owner of the exclusive right that was violated has standing to sue.<sup>108</sup> Mere licensees of a copyright do not have standing to sue. Therefore, e-commerce businesses need to make sure that they retain the copyright in their works in order to be able to bring suit against infringers. This becomes especially important when hiring people outside of the business to create and develop materials for the e-commerce web site.



Once the plaintiff proves ownership of a valid copyright, it is necessary to show that the defendant copied the work. Courts have adopted the substantial similarity standard to determine if a work has been copied. This is because if copyright protection only protected an exact replica of a work, protected works would be legally copied with only making a few minor changes.<sup>109</sup> To afford broader protection to copyrighted works, courts analyze works to determine how similar the works are to each other. Depending on the work, courts have compared individual notes of a song, to plots of plays.

It is important to remember that even if substantial similarity exists, if the work was independently created than there can be no infringement. If the defendant did not have access to the work, there can be no infringement because independent creation is allowed in copyright.<sup>110</sup> This has led many computer software companies to use “clean-room” techniques.<sup>111</sup> These techniques involve splitting the development team into two groups. One group thoroughly studies the program that the company wishes to copy. From the study, the group determines what ideas make up the program. The ideas are then passed to the second group that has never had access to the original program. The second group is then responsible for the development of the alternative program.<sup>112</sup>

Even if a third party used a portion of the original work, the use may fall within the “[fair use](#)”<sup>113</sup> defense. The fair use defense was created to allow third parties to use copyrighted works in a reasonable manner without the consent of the copyright owner.<sup>114</sup> The defense is only relevant after the plaintiff has demonstrated that the defendant copied the original work and that a substantial similarity exists between the two works.

Fair use is recognized in the Act in § 107. Activities that may receive protection under the fair use defense include criticism, comment, news reporting, teaching, scholarship, or

research.<sup>115</sup> The examples listed in the preamble to §107 are not meant to be an exhaustive list, as evidenced by the statutory language of “including” and “such as.” For example, parodies that have incorporated portions of the original work have found protection under the fair use defense, even though “parody” is not expressly listed in the statute.

The statute also gives four factors that the court must consider when analyzing whether the third party’s use was indeed fair. Those four factors include (1) the purpose and character of the work; (2) the nature of the copyrighted work; (3) the amount and substantiality used; and (4) the effect of use on the market.<sup>116</sup> Although the statute lists these four factors expressly, the analysis does not need to be limited to these factors.

In addition to the fair use defense, copyright infringement is also subject to other defenses, such as whether the statute of limitations has run and abandonment. Section 507 of the Act sets the statute of limitations at three years for civil actions and five years for criminal. The statute runs from the date “the claim accrued” for civil actions, and from the date the “cause of action” arose for criminal actions.<sup>117</sup>

Further, if the defendant can counter the plaintiff’s claim of ownership in the copyright, the infringement claim will be defeated. For example, a copyright holder that abandons its copyright, also abandons all right to bring any infringement action. Abandonment requires intent of the copyright owner to abandon the rights in the mark.<sup>118</sup> This can be proved by an overt act that shows such intent.<sup>119</sup>

Copyright infringement is a strict liability rule. Therefore, in general innocent infringement is not a defense to finding of liability. The limited exception to this rule is if the infringer relied in good faith on a copyright notice error.<sup>120</sup>

Although most copyright infringement actions are civil, copyright infringement may also be a criminal act.<sup>121</sup> Section 506 of the Act sets forth two types of activities that are subject to criminal liability.

- (8) First, any person who intentionally infringes a copyright for “commercial advantage or private financial gain” will be criminally liable.
- (9) Secondly, any person who willfully infringes a copyright “by the reproduction or distribution, including by electronic means, during any 180-day period, or 1 or more copies or phonorecords, or more copyrighted works, which have a total retail value of more than \$1,000” is criminally liable for such actions.<sup>122</sup>

Once infringement has been proven, the copyright owner will be entitled to various remedies such as an injunction, actual damages and the profits of the infringer. If registration was proper or if elsewhere available in the Act, the copyright owner may choose to receive statutory damages and attorney’s fees and court costs.

Technology today makes infringing other peoples' works much easier. The Internet provides many tools for copying, displaying, and distributing. Any e-commerce business will want to be sure that it clears all rights with the copyright owner before using another's work. In addition, it will want to make sure that it owns the rights in any work that has been created by people outside of the business. Doing so, will help the business to avoid making it self liable for infringement, but also able to protect itself against the infringement of others.

### **Vicarious Liability, Inducement and Contributory Infringement**

Module E1.09

E-commerce businesses must be aware that traditional notions of contributory infringement and vicarious liability are applicable to internet activities. The United States recently addressed this issue in the case of [\*A & M Records, Inc. v. Napster, Inc.\*](#)<sup>123</sup> In the Napster case, record companies and music publishers brought a copyright infringement action against Napster, an internet site that allows its users to exchange digital audio files via its service. The plaintiffs in the case alleged that Napster was liable for contributory infringement as well as vicarious liability.<sup>124</sup>

### **Contributory Infringement - Napster**

Module E1.091

Liability will exist for contributory infringement if the defendant knowingly encourages and actively induces the infringing behavior.<sup>125</sup> In a motion for preliminary injunction the District Court ruled that the plaintiffs most likely would not prevail on the claim. The Ninth Circuit Court of Appeals affirmed.<sup>126</sup>

The first element of contributory infringement is that the defendant knows or has reason to know of the directly infringing activity.<sup>127</sup> In [Napster](#) the court explained that if a computer system operator has no specific information that could identify infringing activity, the system operator cannot be held liable. However, if the system operator knows about infringing material available through its services and fails to “purge such material from the system, the operator knows of and contributes to infringement.” In [Napster](#) the court held that the record supported a finding that Napster had sufficient knowledge of the demonstrated infringing activity.<sup>128</sup>

In addition to knowledge, the to be liable for contributory infringement the defendant must also encourage or contribute to the direct infringement.<sup>129</sup> The [Napster](#) court found that Napster's services did just that. The court agreed with the lower court that Napster “provides ‘the site and facilities’ for direct infringement.”<sup>130</sup> The Court of Appeals found that the lower court did not err in finding a likelihood of success on the merits for a contributory infringement claim.<sup>131</sup>

### **Vicarious Infringement - Napster**

Module E1.092

The plaintiff's in [Napster](#) also alleged that Napster engaged in vicarious copyright infringement. Vicarious liability occurs when the defendant has the ability to supervise the infringing activity and also has a direct financial interest in the infringing activities.<sup>132</sup> Although Napster provided free services, the court found that a financial benefit exists when the infringing material is a draw to customers. In this case, Napster's future revenue depended on increasing its customer base. Because copyrighted material was

what drew customers to the site, the court found that Napster did have a direct financial interest in the infringing activity.<sup>133</sup>

Napster's ability to block users' access to the site for infringing activity was evidence of Napster's ability to supervise. Napster had an explicit policy that explained to its users that it could refuse access to the site for violation of any law.<sup>134</sup> In order to escape vicarious liability, the defendant must police activities to the fullest extent. It cannot "turn a blind eye" to the activity. The court found that Napster had the right and the power to supervise and police the use of its system, and that Napster failed to do so. For this reason, the court held that the plaintiffs had established likelihood of success on the merits for vicarious liability.<sup>135</sup>

Napster demonstrates that web site operators must comply with copyright laws. Further, the case demonstrates how contributory liability and vicarious liability for copyright infringement are applied to the Internet. E-commerce businesses need to be aware of the principle that even if they are not directly engaged in infringing acts, if the users of their sites are engaged in such acts, liability may be imputed to them.

### **Transient Copying**

#### Module E1.10

A copyright owner's exclusive right of reproduction is violated when an unauthorized copy is made of the work. When using computer software or browsing the Internet, a computer makes many "copies" which may violate a copyright owner's reproduction right. For example, computer cache duplicates information retrieved from the web server. It then maintains an identical reproduction of the information for subsequent

retrieval.<sup>136</sup> Such duplication of material on cache may violate the copyright owner's right of reproduction.

Information can be stored in cache in two ways, either on a hard disk or in RAM. It is clear that placing material onto a hard disk constitutes a copy. It has also been found to violate the reproduction right when a computer program has been stored on RAM.<sup>137</sup>

However, most copyright attorneys believe that it is not necessary to obtain permission from the copyright owner when information is temporarily downloaded into RAM.<sup>138</sup>

Although, when cached information is stored for longer than a transitory time, there is a question as to whether liability exists. One court has held that material stored for 11 days was enough to become sufficiently fixed. This is because the information was fixed from the moment the information was stored.<sup>139</sup>

In *MAI Systems Corp. v. Peak*,<sup>140</sup> the Ninth Circuit court held that storage in RAM was sufficient to create an infringing copy under the Act. In *MAI*, the defendant was a computer maintenance service for MAI's customers. MAI filed for copyright infringement alleging that Peak made unauthorized copies of the software when Peak effectively turned on the computers and the software was copied into RAM. The court found that copying software into RAM did constitute a copy because it could be "perceived, reproduced, or otherwise communicated."<sup>141</sup>

Digital storage of works other than computer programs also appear to create a copy under the Act. For example, in *UMG Recordings, Inc. v. MP3.com, Inc.*,<sup>142</sup> the court determined it was clear that the MP3.com had infringed the plaintiff's copyrights.<sup>143</sup> MP3.com allowed its subscribers to store recordings that the subscriber owned on its web site so that the subscriber could access the material on the Internet elsewhere. So that it

could fulfill the service it promised, MP3.com purchased thousands of CDs and then copied the recordings onto its servers. Obviously, MP3.com violated the reproduction right of the copyright holder. Consequently, MP3.com unsuccessfully asserted a fair use defense.<sup>144</sup>

Similarly, in *Phillips v. Kidsoft, L.L.C.*,<sup>145</sup> the court found that the digital copies that were made of a book and then posted on the Internet infringed upon the rights of the copyright holder. In *Kidsoft*, the plaintiff was the author and artist of a maze book designed for children. *Kidsoft* scanned the author's works into a computer and then published the digital versions on its web site. Not only was the scanning of the maze found to be an infringing copy, but also the copy that was posted to the web site.<sup>146</sup>

In order to use a copyrighted work, a business should seek permission from the copyright owner. Without a copyright clearance from the owner, use will infringe the exclusive rights granted by copyright. However, even if no permission is obtained, it is possible to fall within one of the exceptions listed in §§ 107-120 of the United States Copyright Act (the Act).

With regard to computer programs, § 117 carves out limitations to the copyright holder's exclusive rights. For example, § 117(a) of the Act provides that it is not infringement if the owner of the computer program makes another copy of the program, as long as the new copy or adaptation is essential to the use of the program "in conjunction with a machine," as long as it is not used in any other manner. It is also permissible for the owner to make a copy for archival purposes. However, an archival copy must be destroyed if the owner no longer rightfully owns the program. Also, in accordance with §



117 (b), the owner of the computer program is able to sell the copy it made only with the sale of the original from which it was copied.<sup>147</sup>

With respect to ephemeral copies of computer programs, such as in RAM, § 117(c) provides a repair and maintenance exception for computer programs. Specifically, 117(c) allows a copy to be made if the copy is made “solely by virtue of the activation of a machine that lawfully contains an authorized copy of the computer program” for maintenance and repair purposes. This exception only applies to copies made in RAM memory during hardware maintenance.

Section 117(c) effectively overrules [MAI](#) by allowing an exception for computer repair or maintenance.<sup>148</sup> Note that § 117(b) only applies to hardware maintenance and not software maintenance.<sup>149</sup> Section 117 allows for maintenance and for owners to create back-up copies, but no more.<sup>150</sup> The limitation of the rights of reproduction and adaptation protect the rights of the copyright owner. However, the limitations also allow for computer owners to use the copyrighted computer programs without infringing the copyright owner’s rights.

The [Digital Millennium Copyright Act \(DMCA\)](#)<sup>151</sup> also addresses the new issues concerning copying and computer technology. Section 512 of the [DMCA](#) creates four limitations on liability for copyright infringement by online service providers. Two of the limitations, among others, include transitory communications and system caching.

With respect to transitory communications, the [DMCA](#) limits the liability of an online service provider when the provider is simply a conduit for the data. This means that if the provider is merely allowing for data transmission from one point to another at a third

party's request the provider will generally not be imposed.<sup>152</sup> The limitations apply to the transmitting, routing, or providing connections for, as well as the "transient storage of that material" in the course of the transmission.<sup>153</sup> In order to qualify, the transmission must be in accordance with the following factors:

- (1) The transmission must be initiated by a person other than the service provider;
- (2) The act must be carried out through an *automatic technical process*, meaning that it cannot be at the selection of the provider;
- (3) The provider cannot select the recipients of the material;
- (4) Any copy made during the storage or transmission cannot be retained on the system or accessible to anyone other than the recipients, or for a period longer than is reasonably necessary for the transmission to the recipients; and
- (5) The provider can make no modifications to the content.<sup>154</sup>

An online service provider will also not be held liable for intermediate and temporary storage of material on a system or network operated by the service provider if the material was made available on the network by someone other than the provider to be available at the request of another

E-commerce businesses need to be aware that unless the use of a copyrighted program falls within any of the limitations to the copyright holder's exclusive rights listed in §§ 107-120, or if the user falls within the definition of an online service provider, any digital copy made will most likely violate the copyright holder's reproduction right. To avoid liability, the use that falls outside of the exceptions should always be authorized by the copyright owner.

**Limitations on Exclusive Rights**

## Module E1.11

Sections 107-120 of the [United States Copyright Act](#) list a number of limitations to the exclusive rights granted to the copyright holder. For example, § 109, also known as the “first sale doctrine” allows the owner of a protected work (rather than the owner of the copyright) to distribute, sell or otherwise dispose of the work without permission from the copyright owner.<sup>155</sup> One of the most important limitations involves the concept of “fair use.”

**Fair Use**

## Module E1.12

Even if a third party without authorization uses or copies a copyrighted work, the use may be protectable under the equitable defense of fair use. Section 107 sets forth the fair-use exception to a copyright holder’s rights. Use of a work for purposes “such as criticism, comment, news reporting, teaching, (including multiple copies for classroom use), scholarship, or research, is not an infringement of copyright” if the use is fair. The Act provides four factors that must be considered to determine whether the use of the material qualifies as being fair. Those four factors include:

- (1) the purpose and character of the use, including whether such use is of a commercial nature or is for nonprofit educational purposes;
- (2) the nature of the copyrighted work
- (3) the amount and substantiality of the portion used in relation to the copyrighted work as a whole; and
- (4) the effect of the use upon the potential market for or value of the copyrighted work.<sup>156</sup>

Courts are not limited by these factors. Therefore, a court may consult other factors to determine the nature of the use.

**Fair Use – the Napster Case**  
Module E1.13

The fair use analysis was analyzed in the digital context in [A & M Records, Inc. v. Napster](#).<sup>157</sup> In [Napster](#), Napster raised a fair use defense, claiming that the uses of the service were “fair.” The fair uses that Napster identified included sampling, temporary copying, and space-shifting.<sup>158</sup>

The court first addressed the purpose and character of the use. This factor focuses on whether the new work is transformative. In other words, the court will look to the new work to and determine if it added anything new to the original or instead if it served as a replacement for the original.<sup>159</sup> The less transformative the use, the less likely the use will be deemed fair. In [Napster](#), because the service allowed users to simply transfer digital copies of music files to a new medium, the use was nontransformative, weighing against a finding of fair use.<sup>160</sup>

In analyzing the purpose and character, the court will also look as to whether the use was commercial or noncommercial.<sup>161</sup> If the use is primarily commercial, the factor will weigh against the finding of fair use. In [Napster](#), Napster offered its service for free. However, the court found that the services were still used for a commercial use. A direct economic benefit is not needed to show commercial use. Rather, it is enough to show that the defendant is providing something for free, for which the users would normally

have to pay. Napster's free service allowed users to obtain copies of materials that they would normally have to buy. This made the service commercial in nature.<sup>162</sup>

The court next addressed the nature of the work.<sup>163</sup> The court looks at how creative a work is in determining whether the use is fair. The more expressive the work, the more protection it will be afforded. Likewise, if the work consists of something such as facts the less protection is given. In *Napster*, the court found that the digital music files that were being traded were creative works, and therefore entitled to much protection.<sup>164</sup>

The court next addressed the amount of the original work that the *Napster* used.<sup>165</sup> When addressing this factor, the result will vary depending on the nature of the work. For example, using just enough to evoke the image of the original material may be considered fair use. However, even if the entire work is used, the use may still be considered fair. This factor depends on the how the original work was used. In *Napster*, entire files were being downloaded. For this reason, the court found that the portion used weighed against a finding of unfair use.<sup>166</sup>

The last factor mentioned in the statute is the market effect of the disputed use. If a use reduces the market and therefore profitability for the original copyright holder, the second-comer's use of the material is most likely unfair. In *Napster*, the court found that the service reduced the CD sales among college students, and thereby harmed the plaintiffs. In addition, although the plaintiffs weren't currently in the market of digital downloads, Napster's use was found to create a barrier for the plaintiffs to enter the market.<sup>167</sup>

In addition to the above factors, the court also considered the uses that Napster argued to be fair. Napster argued that the users were sampling music before deciding whether to buy the recording, and that such use fair. Napster also argued that it was fair use for its users to engage in space-shifting, meaning that they were downloading songs they already used in order to listen to the files on their computers.<sup>168</sup>

After analyzing individual factors, the court then balanced the factors against each other. No one factor is determinative of fair use. In *Napster*, the court found that the plaintiffs would most likely prevail in showing that the use was not fair.<sup>169</sup>

### **Free Speech and Copyright**

#### Module E1.14

The First Amendment of the United States Constitution states in part that “Congress shall make no law . . . abridging the freedom of speech.”<sup>170</sup> The separation of the idea from the expression of a copyrighted work enables courts to find a balance between a person’s right to freely express his own ideas and a person’s right to copy the ideas of another. The courts effectively allow access and use of ideas, but protect the expression. As long as protection of the expression does not prevent further expression of the idea, the First Amendment right to free speech is not implicated.

As listed in § 107, news reporting, commentary and criticism are listed as possible fair uses. These activities clearly fall within the protection afforded by the First Amendment.<sup>171</sup> In determining whether such uses are fair the courts will look at the four factors set forth in § 107. In such cases though, the courts will especially consider the amount of the copyrighted material that was used. Generally, courts will analyze the use

to make sure that the amount copied was only as much as was needed for the purpose.<sup>172</sup>

For example, a critic would not be able to reprint a book in its entirety just to criticize the author's writing style. In such a case, a carefully selected short passage probably would be sufficient for the critic to make his point.<sup>173</sup>

E-commerce businesses need to understand the fair use defense. Past United States cases are instructive on activities which have been found to be fair use even if the subject matter does not address high technology and internet issues. Today's technology makes copying copyrighted works easier than ever before. For this reason, if a company decides to copy another's work from the internet or elsewhere, the company should make sure that its use is fair by looking at the factors expressed in the Act, as well as elsewhere, such as in case law.

---

REFERENCES FOR MODULE 4 (To be hyperlinked from text)

<sup>1</sup> [HYPERLINK TO UNITED STATES COPYRIGHT ACT](#)

<sup>2</sup> 17 U.S.C. § 102.

<sup>3</sup> *Id.*

<sup>4</sup> 17 U.S.C. § 412.

<sup>5</sup> 17 U.S.C. § 106.

<sup>6</sup> § 106(1).

<sup>7</sup> § 106(2).

<sup>8</sup> § 106(3).

<sup>9</sup> § 106(4).

<sup>10</sup> 17 U.S.C. § 101 (“perform”).

<sup>11</sup> § 106(5).

- <sup>12</sup> § 106(6).
- <sup>13</sup> J. DIANNE BRINSON & MARK F. RADCLIFFE, INTERNET LAW AND BUSINESS HANDBOOK 341 (The Roberts Group 2000) (1996).
- <sup>14</sup> 17 U.S.C. § 102.
- <sup>15</sup> Feist Publications, Inc. v. Rural Tel. Serv. Co., Inc., 499 U.S. 340, 345 (1991).
- <sup>16</sup> *Id.*
- <sup>17</sup> Sheldon v. Metro-Goldwyn Pictures Corporation, 81 F.2d 49, 54 (2d 1936).
- <sup>18</sup> *Feist*, 499 U.S. at 346.
- <sup>19</sup> *Id.* at 345.
- <sup>20</sup> *Id.*
- <sup>21</sup> *Id.*
- <sup>22</sup> **HYPERLINK TO SECTION 102 OF THE COPYRIGHT ACT**
- <sup>23</sup> § 102
- <sup>24</sup> 17 U.S.C. § 101 (“literary works”).
- <sup>25</sup> § 101 (“audiovisual works”).
- <sup>26</sup> § 101 (“sound recordings”).
- <sup>27</sup> 17 U.S.C. § 102
- <sup>28</sup> *Id.*
- <sup>29</sup> Copyright Office, *Copyright Office Circular No. 34*, (visited March 20, 2000) <<http://www.loc.gov/copyright/circs/>>.
- <sup>30</sup> Feist Publications, Inc. v. Rural Tel. Serv. Co., Inc., 499 U.S. 340, 348 (1991).
- <sup>31</sup> 17 U.S.C. § 105
- <sup>32</sup> BLACK’S LAW DICTIONARY 1243 (7th ed. 1999).
- <sup>33</sup> *Id.*
- <sup>34</sup> MARSHALL LEAFFER, UNDERSTANDING COPYRIGHT LAW § 2.10(B) (3d ed. 1999).
- <sup>35</sup> **HYPERLINK TO COMPUTER PROGRAM/SOFTWARE SECTION**
- <sup>36</sup> **HYPERLINK TO DATABASE SECTION**
- <sup>37</sup> 17 U.S.C. § 201 (1994).



[38](#) 17 U.S.C. § 201(b).

[39](#) § 101 (“works made for hire”).

[40](#) § 201(b).

[41](#) § 201.

[42](#) Community for Creative Non-Violence v. Reid, 490 U.S. 730, 751 (1989).

[43](#) *Id.*

[44](#) § 101 (“works made for hire”).

[45](#) *Id.*

[46](#) § 101.

[47](#) **HYPERLINK TO COPYRIGHTS IN E-COMMERCE SECTION**

[48](#) UNDERSTANDING COPYRIGHT, *supra* note 21, at § 8.28.

[49](#) *Id.*

[50](#) *Id.*

[51](#) “A work of visual art is –

(1) a painting, drawing, print, or sculpture, existing in a single copy, in a limited edition of 200 copies of fewer that are signed and consecutively numbered by the author, or in the case of a sculpture, in multiple cast, carved or fabricated sculptures of 200 or fewer that are consecutively numbered by the author and bear the signature or other identifying mark of the author; or

(2) a still photographic image produced for exhibition purposes only, existing in a single copy that is signed by the author, or in a limited edition of 200 copies or fewer that are signed and consecutively numbered by the author.

A work of visual art does not include-

(A)(i) any poster, map globe, chart, technical drawing, diagram, model, applied art, motion picture or other audiovisual work, book, magazine, newspaper, periodical, data base, electronic information service, electronic publication, or similar publication;

(ii) any merchandising item or advertising, promotional, descriptive, covering, or packaging material or container;

---

(iii) any portion of part of any item described in clause (i) or (ii).” § 101 (“work of visual art”).

[52](#) 17 U.S.C. § 106(A).

[53](#) UNDERSTANDING COPYRIGHT, *supra* note 21, at § 8.28.

[54](#) *Id.*

[55](#) 17 U.S.C. § 101 (“compilation”)

[56](#) Paul Katz & Charles Kim, *Database Protection: The Post-Feist Facts of Life*, 18 NO. 1 INTELL. PROP. L. NEWSL. 8, 8-9 (Fall 1999).

[57](#) *Feist Publications, Inc. v. Rural Tel. Serv. Co., Inc.*, 499 U.S. 340, 349 (1991).

[58](#) *Id.* at 348.

[59](#) *Id.*

[60](#) *Id.*

[61](#) *Id.* at 349.

[62](#) The “sweat of the brow” doctrine refers to protection that had been given to works because of the amount of work that had been invested into the creation of the work. After *Feist*, the “sweat of the brow” doctrine no longer can provide the creator of a work with protection based solely on the amount of effort that goes into it, if the work lacks the requisite originality. *See Feist*, 499 U. S. at 359-60.

[63](#) *Id.*

[64](#) *Id.* at 348.

[65](#) *Id.*

[66](#) *Id.* at 359-60.

[67](#) Katz, *supra* note 2, at 8.

[68](#) *Id.*

[69](#) LEE B. BURGUNDER, LEGAL ASPECTS OF MANAGING TECHNOLOGY 257 (2d 2001).

[70](#) *Id.*

[71](#) 17 U.S.C. § 101 (“computer program”)

[72](#) NIMMER ON COPYRIGHT § 27.01 (2000)

- [73](#) MARSHALL LEAFFER, UNDERSTANDING COPYRIGHT LAW § 3.4 (3d ed. 1999).
- [74](#) Apple Computer, Inc. v. Franklin Computer Corp., 714 F.2d 1240, 1249 (3d Cir. 1983).
- [75](#) *Id.*
- [76](#) *Id.* at 1253-1254.
- [77](#) 797 F.2d 1222 (3d Cir. 1986).
- [78](#) *Id.* at 1238-39.
- [79](#) *Id.* at 1239.
- [80](#) 982 F.2d 693 (2d Cir. 1992).
- [81](#) *Id.* at 706.
- [82](#) *Id.*
- [83](#) *Id.* at 707.
- [84](#) *Id.*
- [85](#) *Computer Associates Intl v. Altai, Inc.*, 982 F.2d 693, 710 (2d Cir. 1992).
- [86](#) *Id.* at 715.
- [87](#) WIPO Electronic Commerce, Primer on Electronic Commerce and Intellectual Property Services, V. Digital Delivery of Intellectual Property Services ¶ 268 (visited March 20, 2001) <<http://ecommerce.wipo.int/primer/section5.html>> (hereinafter “WIPO Electronic Commerce”)
- [88](#) J. DIANNE BRINSON & MARK F. RADCLIFFE, INTERNET LAW AND BUSINESS HANDBOOK 145-46 (2000).
- [89](#) *Id.*
- [90](#) *Id.* at 147-48.
- [91](#) *Id.*
- [92](#) COMPUTER SCIENCE AND TELECOMMUNICATIONS BOARD & NATIONAL RESEARCH COUNCIL, THE DIGITAL DILEMMA 67 (2000)
- [93](#) INTERNET LAW AND BUSINESS HANDBOOK *supra* note 2, at 335 (2000).
- [94](#) THE DIGITAL DILEMMA, *supra* note 6, at 67.

- [95](#) *Id.*
- [96](#) *Id.*
- [97](#) *Id.*
- [98](#) WIPO Electronic Commerce, *supra* note 1, at ¶ 269.
- [99](#) National Writers Union, *About the Publications Rights Center*, (visited March 20, 2001)  
<<http://www.nwu.org/prc/prcabout.htm>>
- [100](#) *Id.*
- [101](#) Media Photographers' Copyright Agency, *MPCA Overview* (visited March 20, 2001)  
<<http://www.mpca.com/pages/overview.html>>
- [102](#) Media Photographers' Copyright Agency, *MPCA Mission* (visited March 20, 2001)  
<<http://www.mpca.com/pages/mission.html>>.
- [103](#) The Electronic Rights Licensing Agency, *About TERLA* (visited March 20, 2001)  
<<http://www.terla.com/aboutus.html>>.
- [104](#) *Id.*
- [105](#) MARSHALL LEAFFER, UNDERSTANDING COPYRIGHT LAW § 9.2 (3d ed. 1999).
- [106](#) 17 U.S.C. § 411.
- [107](#) 17 U.S.C. § 412.
- [108](#) 17 U.S.C. § 501(b)
- [109](#) *See Nichols v. Universal Pictures Corp.*, 45 F.2d 119 (2d 1930).
- [110](#) *See Sheldon v. Metro-Goldwyn Pictures Corporation*, 81 F.2d 49, 54 (2d 1936).
- [111](#) LEE B. BURGUNDER, LEGAL ASPECTS OF MANAGING TECHNOLOGY 284 (2d 2001).
- [112](#) *Id.* at 284-285.
- [113](#) **HYPERLINK TO FAIR USE SECTION**
- [114](#) MARSHALL LEAFFER, UNDERSTANDING COPYRIGHT LAW § 10.1 (3d ed. 1999).
- [115](#) 17 U.S.C. § 107.
- [116](#) *Id.*
- [117](#) 17 U.S.C. § 507.
- [118](#) UNDERSTANDING COPYRIGHT, *supra* note 1, at § 10.21.

- [119](#) *Id.*
- [120](#) *Id.*; see 17 U.S.C. § 406(a).
- [121](#) J. DIANNE BRINSON & MARK F. RADCLIFFE, INTERNET LAW AND BUSINESS HANDBOOK 7 (2000).
- [122](#) 17 U.S.C. § 506
- [123](#) 239 F.3d 1004 (9th Cir. 2001).
- [124](#) *Id.* at 1019.
- [125](#) *Id.*
- [126](#) *Id.*
- [127](#) *Id.* at 1020.
- [128](#) *A&M Records, Inc. v. Napster, Inc.*, 239 F.3d 1004, 1022 (9th Cir. 2001).
- [129](#) *Id.*
- [130](#) *Id.*
- [131](#) *Id.*
- [132](#) *Id.*
- [133](#) *Id.* at 1023.
- [134](#) *A&M Records, Inc. v. Napster, Inc.*, 239 F.3d 1004, 1033 (9th Cir. 2001)
- [135](#) *Id.* at 1024.
- [136](#) Richard S. Vermut, *File Caching on the Internet: Technical Infringement or Safeguard for Efficient Network Operation*, 4 J. INTELL. PROP. L. 273, 316 (Spring, 1997).
- [137](#) *MAI Systems Corp. v. Peak*, 991 F.2d 511 (9th Cir, 1993).
- [138](#) J. DIANNE BRINSON & MARK F. RADCLIFFE, INTERNET LAW AND BUSINESS HANDBOOK 131 (2000).
- [139](#) *Id.* at 318 (referring to *Religious Tech. Ctr. V. Netcom On-Line Comm. Serv., Inc.*, 907 F. Supp. 1361, 1368 (N.D. Cal. 1995).
- [140](#) 991 f.2d 511 (9th Cir, 1993).
- [141](#) *Id.* at 519.
- [142](#) 92 F. Supp. 2d 349 (S.D.N.Y. 2000).

- [143](#) *Id.* at 350
- [144](#) *Id.*
- [145](#) 52 U.S.P.Q.2d 1102 (D. Md. 1999).
- [146](#) *Id.*
- [147](#) 17 U.S.C. § 117.
- [148](#) MARSHALL LEAFFER, UNDERSTANDING COPYRIGHT LAW § 8.10 (3d ed. 1999).
- [149](#) *Id.*
- [150](#) 17 U.S.C. § 117.
- [151](#) **HYPERLINK TO DMCA**
- [152](#) 17 U.S.C. § 512.
- [153](#) *Id.*
- [154](#) *Id.*
- [155](#) 17 U.S.C. § 109.
- [156](#) 17 U.S.C. § 107.
- [157](#) 239 F. 3d 1004 (9th Cir. 2001).
- [158](#) *Id.* at 1014.
- [159](#) *Id.* at 1015.
- [160](#) *Id.*
- [161](#) *Id.*
- [162](#) *Id.*
- [163](#) *Id.* at 1016.
- [164](#) *Id.*
- [165](#) *Id.*
- [166](#) *Id.*
- [167](#) *Id.* at 1016-1017.
- [168](#) *Id.* at 1014. Space-shifting has been found to be fair use in other circumstances. See *Recording Indus. Ass'n of Am. v. Diamond Multimedia Sys., Inc.*, 180 F.3d 1072, 1079 (9th Cir.1999).

[169](#) *Id.* at 1019.

[170](#) U.S. CONST. AMEND. I.

[171](#) 17 U.S.C. § 107.

[172](#) *See* MARSHALL LEAFFER, UNDERSTANDING COPYRIGHT LAW § 10.18 (3d ed. 1999).

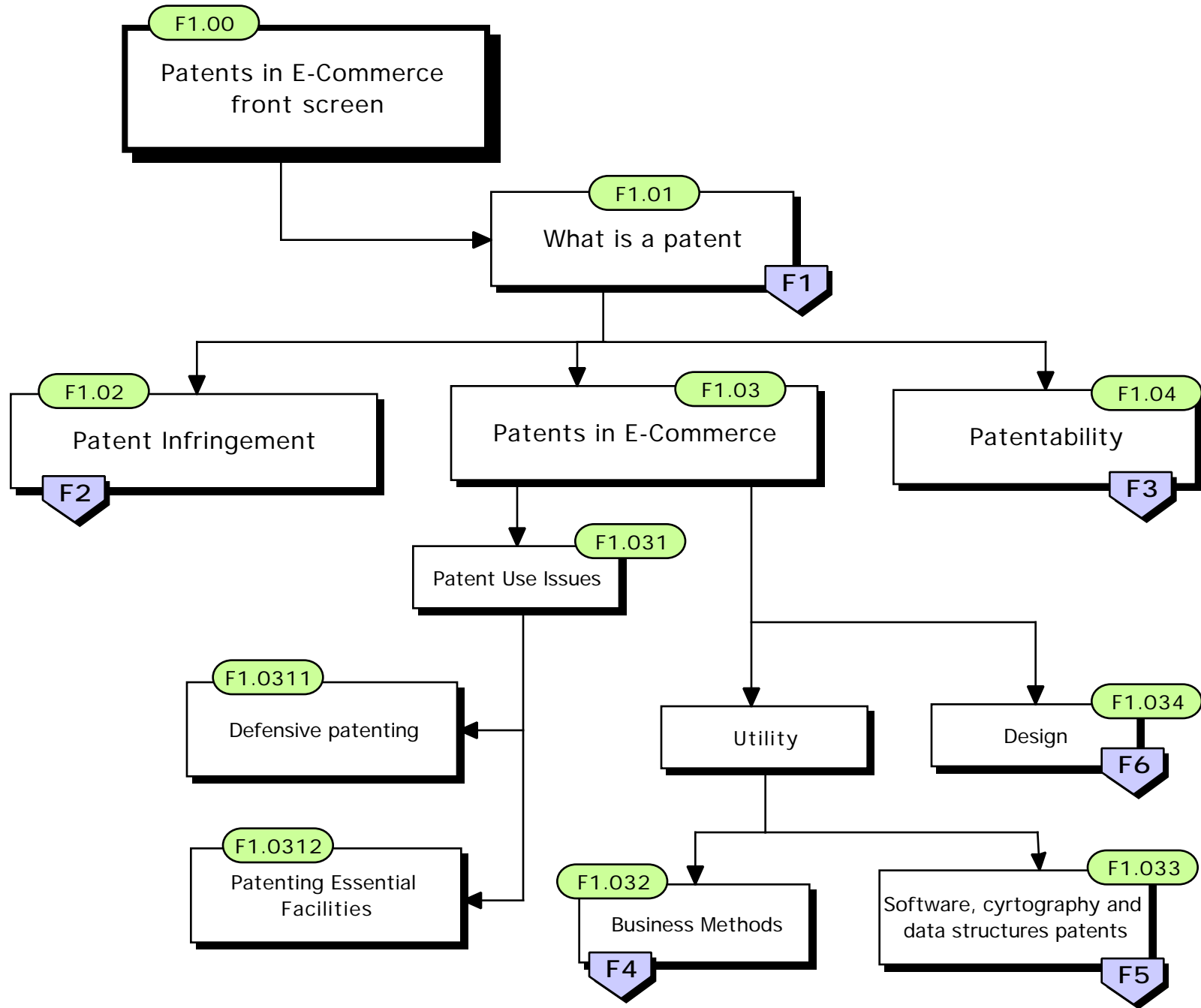



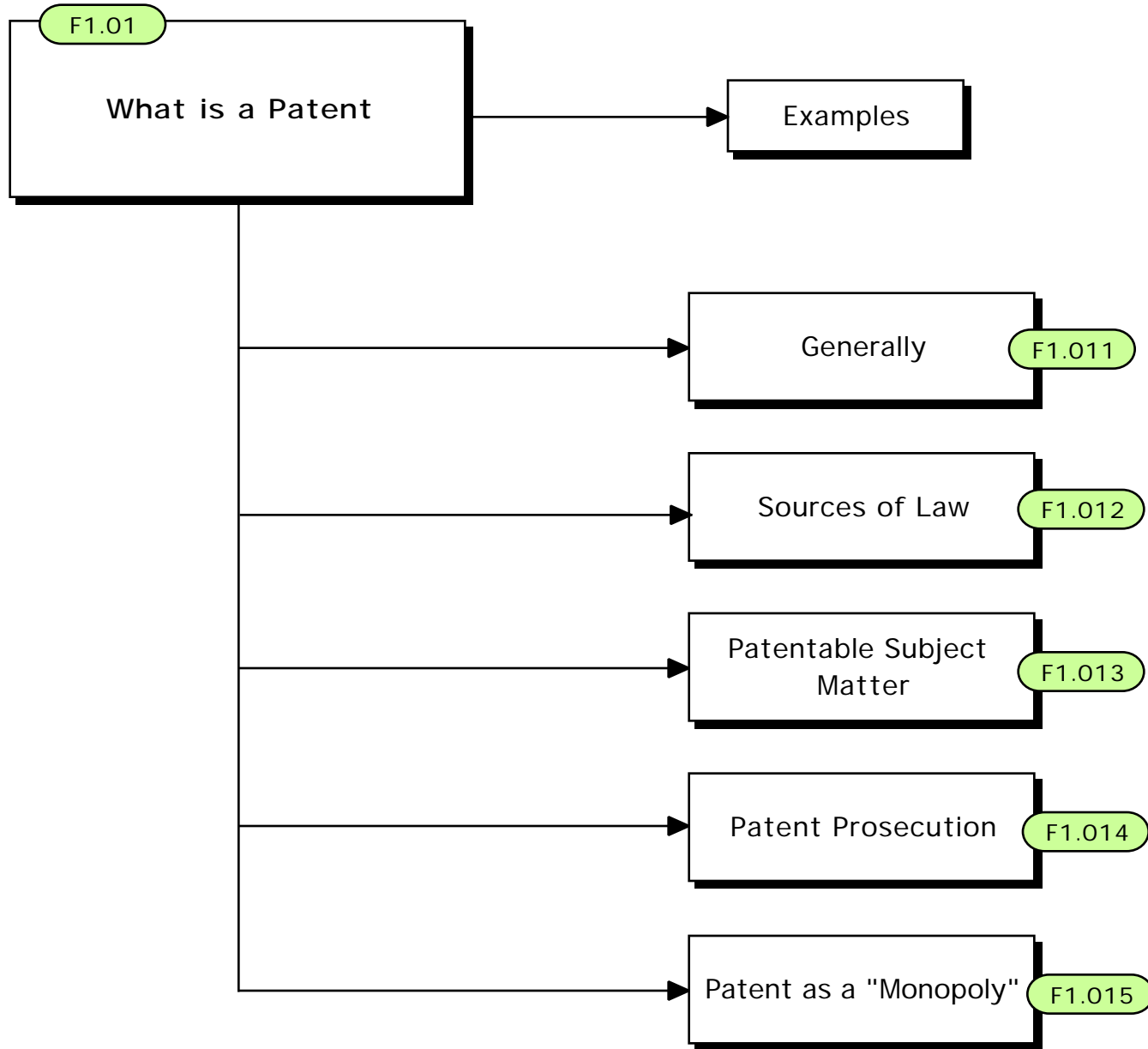

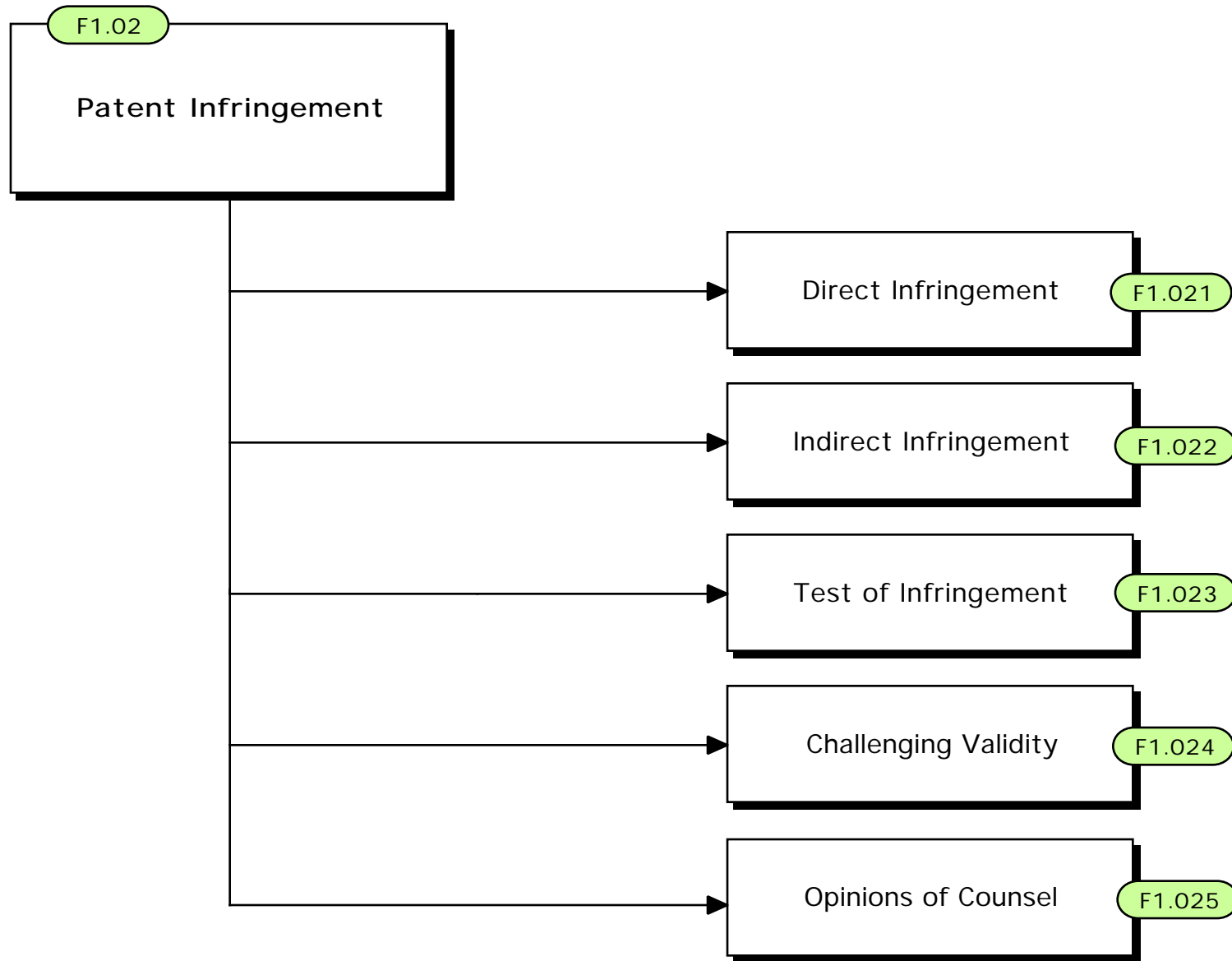



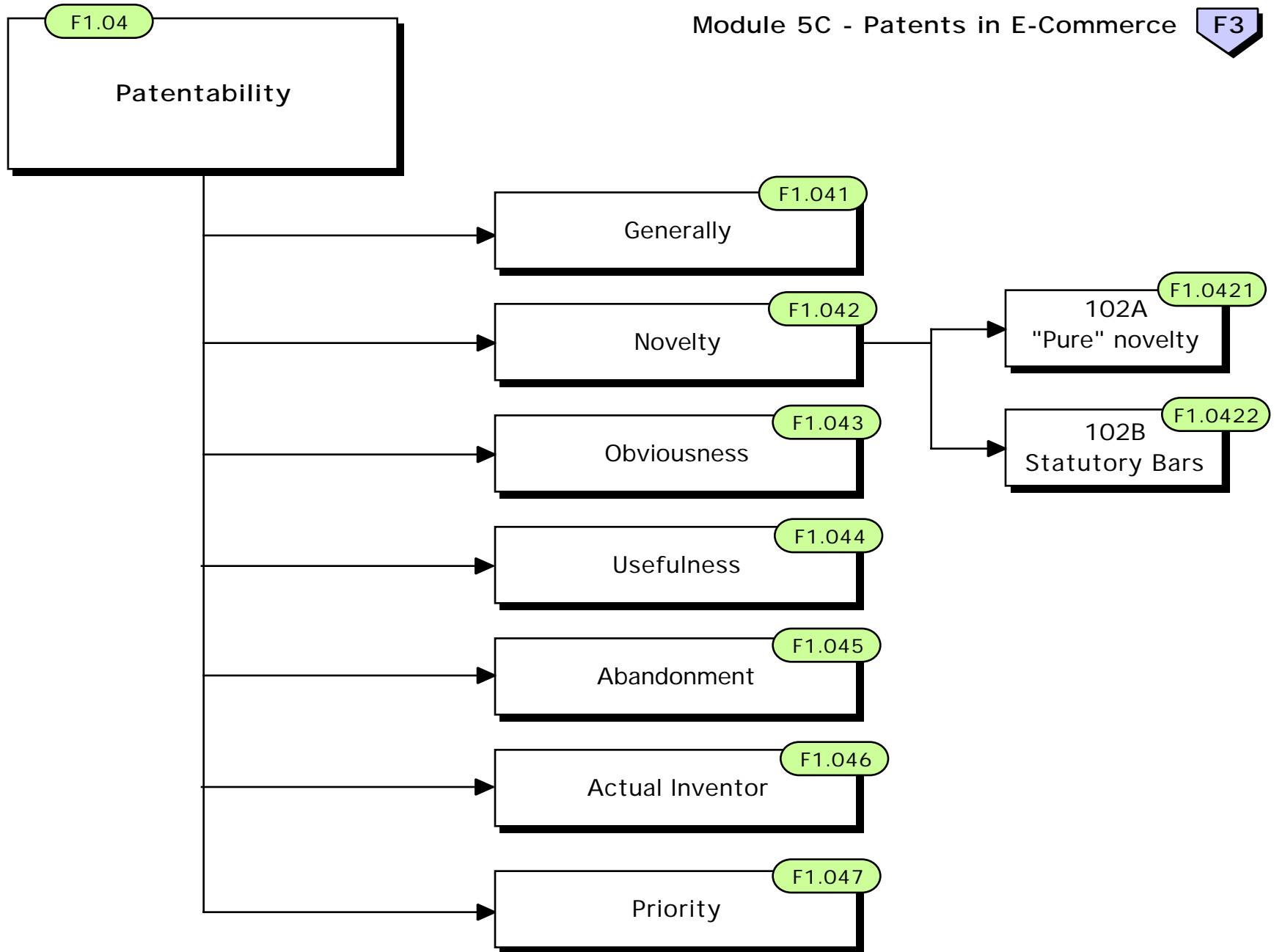

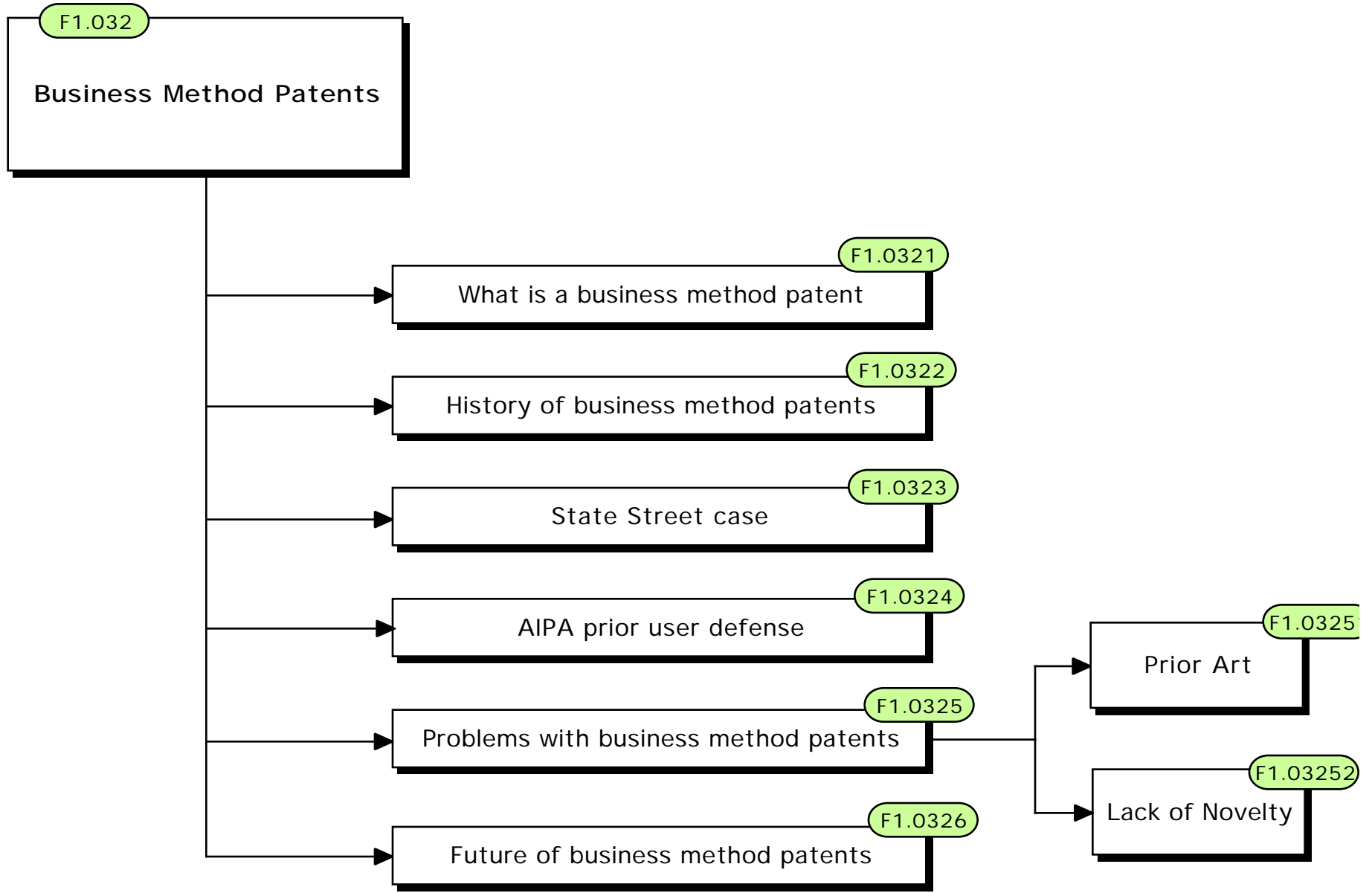

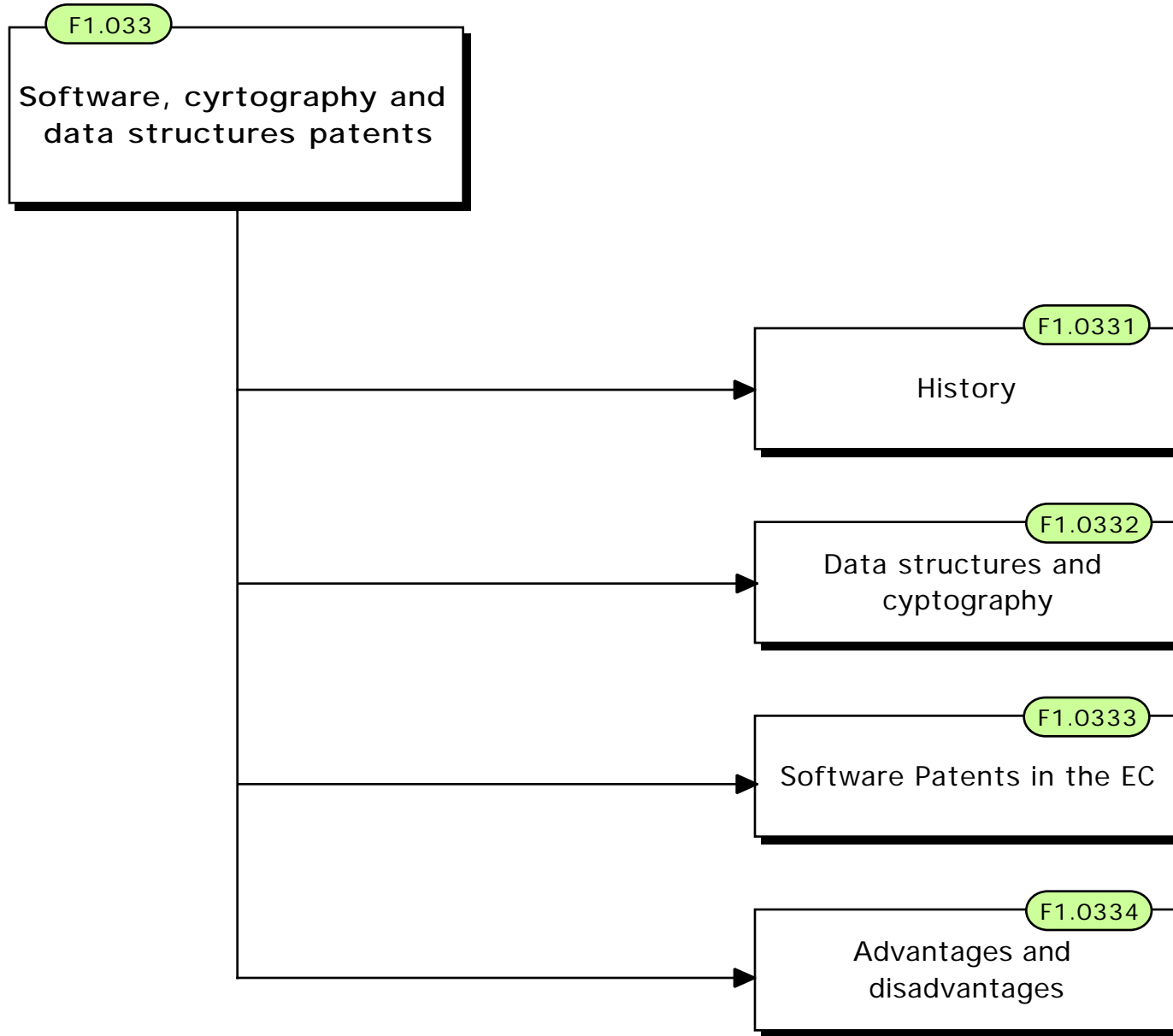

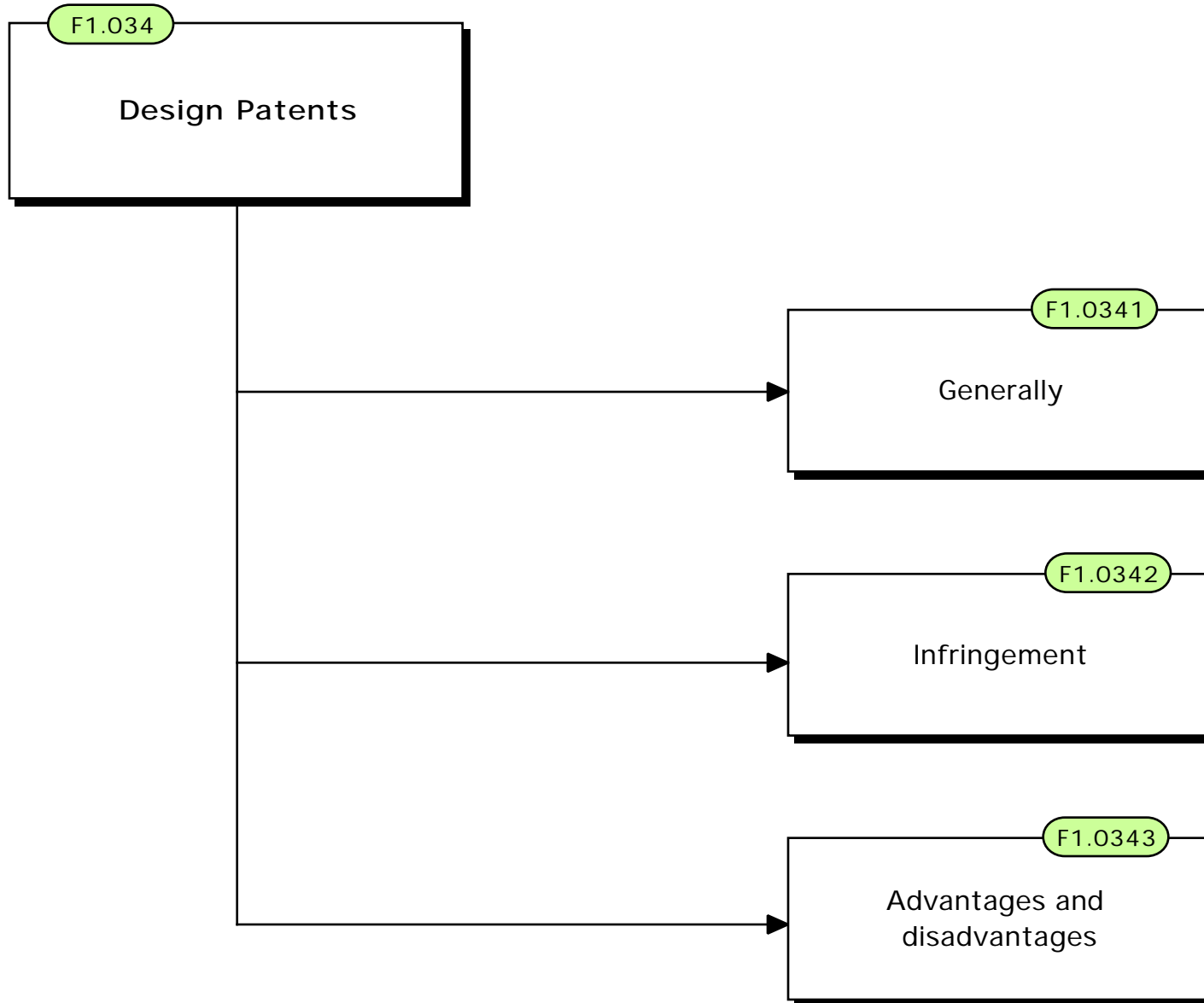

**Patents in E-Commerce Front Screen****F1.00**

Patents provide an increasingly important form of protection for intellectual property in the E-Commerce arena. This module teaches the basic principles of patent law in the United States system of patents, though references are made to systems from other countries where appropriate.

This module is intended to provide the non-patent practitioner with an appreciation for some of the issues found in patent law. Please note, however, that patent law is a highly specialized field, with its own bar. This course is not intended to cover the very particular nuances of this specialty practice area, but instead should give awareness of the central principles of patent law. Accordingly, please consult a registered patent attorney to obtain advice on specific patent issues.

E-Commerce has increasingly become accustomed to using patents. Patents protect the methods of implementing E-Commerce solutions, for example the Priceline '207 patent on dutch auctioning. Patents protect the software underpinning E-Commerce transactions, for example [{link to example}](#). And patents protect the graphical representations associated with E-Commerce, for example [{link to example}](#). As you can see, patents are important to the success of E-Commerce.<sup>1</sup>

Several offline sources are helpful to the patent practitioner and should be reviewed for more detailed information. The seminal work on the subject of patents is Chism on Patents.<sup>2</sup> Professor Chism's reputation in the patent field is virtually unsurpassed. An indispensable resource for any patent practitioner is the Manual of Patent Examining



Procedure (MPEP)<sup>3</sup> produced by the USPTO. Software Patents<sup>4</sup>, by Gregory Stobbs, is a wonderful source for in depth review of that subject. The USPTO maintains a website with valuable information for the public and the practitioner. In addition to information, the website provides the ability to search patents and trademarks and to electronically file applications. While many other sources, too numerous to list, are helpful to understanding the material, these sources deserve particular note.

Though you may cover the material in the order of your choosing, the course material has been designed to be studied in the following order.

{insert flow chart of the module with active links to that material?}

### **What is a Patent - Generally**

#### **Module F1.011**

A patent is a right which the government grants to an inventor permitting him to exclude others from making, using, selling, offering for sale, or importing the invention for a limited time within the territory of that government.<sup>5</sup> You may obtain a patent on any “new, useful process, machine or composition of matter, or any new and useful improvements thereof.”<sup>6</sup>

While a patent grants the right to exclude others from the making, using, selling, offering for sale or importing of a thing or process for a limited time, it does not grant the patent holder the right to make, use, sell, offer for sale or import that thing or process.

Accordingly, the patentee can only so act if no other person has the legal right to exclude the patentee. The courts have reasoned that inventors possess the inherent right to exploit their invention, and therefore the congressional grant of patent protection served only to

exclude others from the right the inventor already possessed.<sup>7</sup> Because patents convey an exclusionary right, cross-licensing has become an increasingly popular use of patents.<sup>8</sup>

Unlike other forms of intellectual property, patents do not exist without a governmental grant. Contrast this grant requirement with copyright, trademark and trade secrets. Each of those intellectual property rights exists without the necessity of governmental sanction. For copyrights and trademarks, additional benefits are gained when they are registered with the government, though registration is not necessary for their existence. The patent grant is authorized by the United States Constitution, which gave Congress the authority to implement patent protection for the advancement of “science and the useful arts.”<sup>9</sup> Today the term “useful arts” is generally understood to mean the technological arts,<sup>10</sup> though increasingly what would appear to be non-technical subjects are being patented.<sup>11</sup>

The patent grant is given to the inventor in exchange for the inventor placing something new into the public domain. At the conclusion of the grant period, now 20 years from filing of the application for utility patents, the patented invention is placed in the public domain, free for anyone to use. This policy of consideration or quid pro quo underlies much of the restrictions on patentability.<sup>12</sup>

There are three types of patents: utility, design and plant. Utility patents cover useful things and processes. Design patents protect “decorative arts,” or artistic expressions. Plant patents grant rights regarding plant species and hybrids. Of these types, utility patents are of primary concern to the E-Commerce practitioner. Accordingly, utility

patents will be focus of this discussion, and the term “patent” should be read to mean “utility patent” unless stated otherwise.

Patents are limited grants of authority defined by the four corners of the claims, much the same way that a parcel of real property is defined by the metes and bounds of its borders. This limitation is necessitated by the Patent Act’s purpose of only granting protection for a specific invention that will add to the public knowledge. By carefully limiting the patent, others are encouraged to further add to the public knowledge by developing related or alternative inventions. One exception to this four corner’s doctrine is the doctrine of equivalents, which is discussed in the section on Infringement.<sup>13</sup>

Most countries utilize a first to file system, where the person who files the first patent application prevails over all others, even one who invented the thing or process before the filer. The United States uses a first to invent system, however. Due to this filing difference, it is possible for a subsequent inventor to receive a patent in one country, for example Japan, while a prior inventor receives a patent on the same invention in the United States.

### **What is a Patent – Sources of Law**

#### Module F1.012

Patents in the United States are governed by four primary sources of law: the United States Constitution<sup>14</sup>, Title 35 of the United States Code (the Patent Act)<sup>15</sup>, Title 37 of the Code of Federal Regulations<sup>16</sup> and the Manual of Patent Examining Procedure (MPEP).<sup>17</sup> Patents are administered by the United States Patent and Trademark Office (USPTO). Similar governmental entities which administer patents are found in other nations around the world.

Patent matters are tried in a federal district court having jurisdiction over the parties. Appeals of patent cases are taken to the Court of Appeals for the Federal Circuit (CAFC or Federal Circuit), which has exclusive jurisdiction of patent matters. The Federal Circuit is the successor court to the Court of Customs and Patent Appeals (CCPA). Due to its specialized knowledge, the Federal Circuit is generally given great deference by other courts. The only appeal from the Federal Circuit is to the Supreme Court.

### **What is a Patent – Patentable Subject Matter**

#### Module F1.013

Any new, useful and nonobvious thing or process under the sun, or any new, useful and nonobvious improvement thereof, that is made by man is patentable. This statement incorporates several tests of patentability. Briefly, an invention must fall within a statutory classification of patentable subject matter, be new, be nonobvious, and be useful, before it can be patented. Patentability is discussed in more detail in [another module](#).<sup>18</sup>

### **What is a Patent – Patent Prosecution**

#### Module F1.014

The process of applying for a patent is called patent prosecution. The process begins with the submission of a patent application – a highly technical document. The most important portion of the application is the specification. Section 112 {[popup link to that section](#)} sets forth the requirements of the specification, which is further divided into two parts: (1) a description of the claimed invention sufficient to allow one skilled in the art to practice the invention, including the best mode of practicing the invention, and (2) the claims, which set the boundaries of the claimed invention. A patent examiner selected

for their knowledge of the subject matter reviews the patent application to determine if a patent should issue for the invention.

Patents are grouped in classes which categorize the invention. A patent examiner, after a preliminary examination of the application, makes a determination as to which class that particular patent application belongs and then conducts a search of the prior art in that class and in analogous classes.

The denial of a patent application can be contested within the USPTO before the Board of Patent Appeals and Interferences. If the application denial is upheld in the USPTO, an appeal can be taken to a United States District Court.

The patent applicant has a duty to prosecute the application with candor, good faith and honesty.<sup>19</sup> It cannot be stressed enough how important this requirement has become, as a finding of inequitable conduct will invalidate the patent.<sup>20</sup> Inequitable conduct is found when there is an affirmative misrepresentation of material fact, failure to disclose material information, or submission of false material information, combined with an intent to deceive.<sup>21</sup> When submission of false material fact or omission is found, the test for inequitable conduct requires a balancing of materiality of the representation and the intent. If the materiality is great, less intent will be required; if the intent is strong, less materiality will need to be shown.<sup>22</sup>

A typical patent prosecution takes 18 to 24 months. A patent application can be expedited (or “made special”), however, in some circumstances. Conditions for making an application special are set forth in Section 708.02 of the MPEP. Of the situations that

can lend an application to being made special, three are particularly relevant to E-Commerce: manufacture, infringement and new applications. If an applicant has the resources and ability to quickly manufacture the invention and assures the USPTO that it will begin manufacture of the product immediately after receiving the patent, the application may be made special. If an applied for patent is being unquestionably infringed, the application may be made special. If this application is the first application for an invention, all the claims relate to one invention only and a detailed discussion of all the prior art references is made, the application may be made special. Each of the forgoing situations also requires the filing of an additional fee, a comprehensive prior art search by the applicant and provision of the most relevant pieces of prior art to the USPTO.

Once a patent issues, maintenance fees must be paid on utility patents, though not on design patents. These payments are due at specific times during the life of the patent. Failure to pay the fees will result in the patent terminating before the end of the 20 year period.

### **What is a Patent - Patent as “monopoly”**

#### Module F1.015

It is often said that a patent grants a legal monopoly. This statement can be considered true in the sense that a patentee receives the right to exclude others from the invention, thereby barring competition from entering the market as to that invention alone. Accordingly, it could be said that the patent does not create a monopoly but does maintain a monopoly in that product.

Consider, however, that a competitor may make or market a similar, non-infringing product that directly competes with the patentee. It is therefore an extremely limited monopoly, directed toward a specific product rather than a market. Such a monopoly is not the kind usually prohibited by our laws. This form of monopoly is called a property monopoly. It is the same sort of monopoly that you have in the automobile in your driveway or the clothes you are wearing. A property monopoly is quite different from an economic monopoly. [{link to definition of economic monopoly}](#)

Property monopolies are limited and do not allow a person to act to the injury of others. A property monopoly in an automobile does not give one the right to exceed the speed limit. The same holds true for patent monopolies. Even though the patent holder is given a limited legal monopoly, the patent holder may not act anti-competitively. Anti-competitive behavior often involves tying access to the patented invention to a non-patented invention or service, thereby impermissibly expanding the power to exclude others from a market. Any act prohibited by the antitrust laws can constitute misuse of the patent right, as patent does not exempt one from the Sherman Act.<sup>23</sup> Anti-competitive conduct may render a patent unenforceable under the doctrine of misuse.<sup>24</sup>

### **Patent Infringement**

Module F1.02

Patents can be infringed in two ways: directly and indirectly. In the United States patent infringement is a federal matter to be tried in a federal district court. [{this screen should have hyperlink buttons to the five following modules; direct infringement, indirect infringement, test of infringement, challenging validity and opinions of counsel}](#)

**Direct Infringement****Module F1.021**

Direct infringement is prohibited by Section 271(a) [{ link to 271\(a\)}](#)

As noted earlier, a patent grants the patentee the right to exclude others from making, using, selling, offering for sale, or importing the patented invention within the territory of the United States. Consequently, direct infringement is the making, using, selling, offering for sale, or importing of a patented invention without the permission of the patent holder.

Motive or intent is immaterial to proving direct infringement. The only relevant inquiry is whether the potentially infringing invention is described by the patent. Intent is extremely important in determining damages, however.<sup>25</sup> Just as intent is irrelevant, access to the patented invention is not required, as it is in copyright infringement.

Issuance of a patent puts the world on constructive notice that the invention is patented, but a patent holder still has the duty to mark the invention as patented. If the patent holder fails to mark the invention as patented, infringement will be found but no damages will be recoverable unless it is shown that the infringer had actual knowledge the patent existed.

It is often the case that a patent, particularly an improvement patent, infringes on another patent. When such a situation occurs, the invention cannot be practiced without consent from the infringed patent holder. This situation is becoming increasingly common as companies increase their patent portfolios for both offensive and defensive reasons. Offensively, patents protect a company's own intellectual property rights. Defensively,



patents block competitors and prevent a company from being shut out of market.<sup>26</sup>

Cross licensing is becoming an increasingly desirable alternative to litigating patent infringement cases.

Some copying of the patented invention will be allowed, though the permissible scenarios are quite limited. While practicing the patented invention for purely experimental or philosophical purposes, without economic motivation or advantage whatsoever, is an exception to infringement, the exception is extremely narrow.<sup>27</sup> In a process called a design around, a non-infringing product can be made from the patented invention. It is inherent in the ability to so design a product is that the copying of a patent holder's invention for purposes of designing a competing, non-infringing product is not illicit copying.<sup>28</sup> Almost any other duplication of the patented invention will be considered infringement.

### **Indirect Infringement**

Module F1.022

Indirect infringement is prohibited by Section 271(b) and (c). {pop up link to section 271}

As noted above, direct infringement is the making, using, selling, offering for sale, or importing of a patented invention. Those that assist direct infringers, such as by supplying parts or by encouraging them to infringe, may be liable as indirect infringers. Contributory infringement and active inducement are the two forms of indirect infringement.

In contributory infringement, a party supplies or offers to supply a component used to infringe a patent. Unlike in direct infringement, knowledge is a required element here. The alleged contributory infringer must know, or should have known, that his actions lead to the infringement of a patent.<sup>29</sup> If a component can have use only in a patented product, a strong case is provided for contributory infringement. Provision of a good with substantial noninfringing uses does not in itself constitute infringement.

Another form of indirect infringement is active inducement. Intent to cause another to violate the patent in question is required to prove this form of infringement.<sup>30</sup> Such a situation may arise, for example, when a distributor encourages a supplier to produce a product known to infringe a patent. Active inducement has occurred whether or not the distributor sells the product.

### **Test of Infringement**

#### Module F1.023

Determination of direct infringement is a two step process: determining what the patent covers and determining if the alleged infringing product encroaches on that patent.<sup>31</sup> The determination of what the claims of the patent cover is within the province of the judge and is determined through a pretrial procedure called a Markman hearing.<sup>32</sup> If the infringing invention falls within the scope of the claims, literal infringement is found. If not, infringement may still be found by virtue of the doctrine of equivalents.

Literal infringement occurs when an alleged infringing invention is completely described by and falls within the claims listed in a patent. As noted above, this determination is made by the court, not a jury. The requirement that the alleged infringing invention be

completely described by the claims to a patent is called the identity requirement. The concept of literal infringement and anticipation are directly linked: that which infringes, if later, anticipates, if prior.

Knowing literal infringement is rare (though recall that knowledge is not an element of the test for direct infringement). Most savvy competitors instead attempt to gain the advantage of the patented invention by creating a similar invention in a process called a design around. In a design around a company examines a patent seeking a non-infringing manner of duplicating the function or product of that patent. If literal infringement is not found, the invention can be evaluated under the doctrine of equivalents, a far more likely scenario as competitors attempt to design around patents.

Under the doctrine of equivalents, infringement will be found when the alleged infringing invention performs the identical function in substantially the same way to achieve substantially the same result as the patented invention.<sup>33</sup> This is often called the function-way-result test. Further, this determination is to be made after evaluating the whole structure, rather than on a component by component basis, and is a factual inquiry. The policy underlying the doctrine is to protect inventions when otherwise a minor modification to an invention would render a patent moot. The policy preserves the valuable patent monopoly from freeloaders.

### **Challenging Validity**

Module F1.024

An interference is an office action in the USPTO between the applicant and one who opposes the application. The procedure establishes the first inventor of an invention. Interferences have the potential of extending the time for obtaining a patent by several

years. These proceedings are quite technical and almost constitute a specialty practice within the specialty practice of patent law.

Three concepts are central to priority: conception, reduction to practice, and diligence. Conception is the time when an inventor first mentally realizes an invention. As a matter of evidence, some extrinsic documentation is required to prove the conception. Such evidence could take the form of an invention disclosure statement or a simple note known to another at the time of writing. If no evidence can be found to support an earlier date of conception, the date of filing the application is considered to be the date of conception. This is known as constructive conception.

Reduction to practice occurs when the thing is first physically created or the process is first performed. Unless evidence of a different date of reduction to practice is established, the date of filing the application is considered to be the date of reduction to practice. This is known as constructive reduction to practice.

An inventor must be diligent in filing a patent application. As has been repeatedly noted, an inventor must not sleep on his rights. If one inventor first conceives of an invention but a later conceptualizer first reduces to practice the invention, the first inventor must show that he has taken diligent steps to achieve a reduction to practice. Experimentation in an effort to perfect the invention is one form of acceptable diligence.

Pursuant to Article 60(2), the European Patent Convention is a first to file system. The term “priority” should not be used in this regard under the European system. That system uses the term to mean a relation-back to a previously filed application.

**Opinions of Counsel****Module F1.025**

It is advisable to obtain an infringement opinion from competent patent counsel before producing an invention that possibly could be infringing, particularly in light of the intricacies of the doctrine of equivalents. In addition to decreasing the likelihood of producing an infringing product, a well considered opinion letter will insulate the alleged infringer from treble damages under Section 284 {link to popup window of Section 284} and attorney's fees under Section 285 {link to popup window of Section 285} available for willfully infringing a patent. A carefully considered opinion letter provides a reasonable basis for believing one's actions are lawful. Therefore, no wilful infringement can be found.

Opinions of counsel are often useful in designing around a patent. In the typical scenario, a company produces a prototype of a product similar to a patented product. The company then submits the prototype and the patented product to a patent attorney. The patent attorney, preferably outside counsel, examines the two inventions to determine if, in his opinion, infringement is likely. If infringement is unlikely, the patent attorney issues a favorable opinion letter. Should the product be likely to infringe, the company would be well served by revising the product and seeking an opinion from a second patent attorney not associated with the first patent attorney and who has not evaluated a previous version of the invention. By allowing competent patent counsel to evaluate the inventions for infringement, the likelihood of producing an infringing product, as well as the likelihood of enhanced damages being awarded if infringement is found, is greatly decreased.

**Patentability****Module F1.04**

The Supreme Court of the United States has adopted the Congressional declaration that “anything under the sun that is made by man” is patentable.<sup>1</sup> Though this notion expresses the wide breadth of patentable subject matter, it should be read in conjunction with [Section 101](#) of the Patent Act, which states:

“Whoever invents or discovers any new and useful process, machine, manufacture, or composition of matter, or any new and useful improvement thereof, may obtain a patent therefor, subject to the conditions and requirements of this title.”

[\[this screen should have hyperlink buttons to the seven following modules: 1. generally, 2. Novelty, 3. Obviousness, 4. Usefulness, 5. Abandonment, 6. Actual Inventor, 7. Priority\]](#)

**Patentability - Generally****Module F1.041**

This section sets forth the four statutory categories of patentable subject matter: processes, machines, manufactures and compositions of matter. Machines, manufactures and compositions of matter are often grouped together as things, leaving two broad categories: things and processes. It is not necessary, however, for the inventor to specify which into category the invention fits, so long as the invention does fit into at least one category.

Incorporating Section 101 into the Chakrabarty quote above, a more accurate statement would be as follows: any new and useful thing or process under the sun, or any new and

useful improvement thereof, made by man is patentable. This statement conveys the wide scope of the Patent Act as enacted by Congress.

While this definition is broad, it is not all-encompassing. That which is outside the definition can be generally categorized as abstract ideas, laws of nature and natural phenomena.<sup>2</sup> Since these cannot be invented, only discovered, they are outside the scope of patent protection. Practical applications derived from these excluded areas are patentable subject matter, of course.

In the realm of E-Commerce, two patentable subject matter areas are particularly important: business methods and software. An additional important patentable subject matter area is found in design patents, where graphical icons and other screen visuals may be found protectable.

An invention is examined to determine if it can be categorized in one or more of the categories of patentable subject matter. Once an invention has been found to be within a patentable subject matter category, it is examined for novelty, nonobviousness, and usefulness.

### **Patentability - Novelty**

Module F1.042

A patent will not issue if an invention is not new. As stated earlier, a patent is issued in exchange for placing something new into the public domain. Without novelty, consideration fails for the social contract that is a patent. There would be no quid pro quo, as society would receive nothing in exchange for its grant of limited monopoly.

Prior art is a term that refers to all inventions and knowledge available prior to the issuance of a patent. This knowledge includes all patents and publications, together with that which would be obvious or ordinarily known to one skilled in the art.<sup>34</sup> A particular piece of prior art is referred to as a prior art reference.

Defining whether a prior art reference is the same thing or process as the invention is a necessary precursor to determining novelty. This is called the identity requirement, as the examiner seeks to determine if two things or processes share a common identity.

The invention is said to be “anticipated,” and therefore lacks novelty, if a single prior art reference discloses each and every element of the claimed invention.<sup>35</sup> Anticipation is closely related to infringement. That which infringes if later, anticipates if earlier.<sup>36</sup>

Anticipation also occurs when a single prior art reference “discloses the claimed invention such that a skilled artisan could take its teachings in combination with his own knowledge of the particular art and be in possession of the invention.”<sup>37</sup> In other words, the prior art reference must be sufficiently detailed to “enable” one skilled in the art to be in possession of or practice the invention.<sup>38</sup> To be enabled to practice or be in possession of the invention means simply that the prior art reference conveys sufficient knowledge, together with that knowledge ordinarily possessed by one skilled in the art, to make the thing or use the process defined by the patent application.

Beyond anticipation, the determination of novelty is made pursuant to several sections of the Patent Act. Section 102(a) is concerned with actual novelty. Section 102(b) describes the statutory bars to patentability.



**Patentability - Actual or Pure Novelty****Module F1.0421****Section 102(a) - Actual Novelty**

A person shall be entitled to a patent unless-- (a) the invention was known or used by others in this country, or patented or described in a printed publication in this or a foreign country, before the invention thereof by the applicant for patent

Each of the 102(a) requirements furthers the Patent Act's policy of only granting patents to novel inventions. Once an invention enters the public domain, it cannot be withdrawn.

*...known by others...*

The phrase "known by others" has been interpreted to mean publicly known by others.<sup>39</sup> Confidential or secret knowledge by others is generally held to be insufficient to bar patent issuance. Because of the knowledge requirement, great care should be taken to preserve a confidential relationship among all persons with access to the invention. Failure to do so may result in the knowledge of that person being considered public knowledge, thereby causing a loss of patentability. It is accordingly advisable to have each individual who may come into contact with an invention subjected to confidentiality requirements. This may be done through the employment contract or through a separate confidentiality agreement. By the plain language of the statute, this requirement is limited to knowledge in the United States. The limitation to knowledge in the United States is based in part on the antiquated notion that knowledge outside the United States is not readily and immediately accessible to those in the United States. With the various forms of instantaneous communications that exist today, including the internet,

telephonic communications, facsimile, and worldwide express package delivery services, the rationale behind this limitation has eroded.<sup>40</sup>

*...used by others...*

The phrase “used by others” has been interpreted to mean the absence of affirmative acts to conceal, whether actually used by others or not.<sup>41</sup> Use of the invention in an unsecure place, such as an open field, has been held to be use by others.<sup>42</sup> Use of the invention in a secure office building is generally not use by others. Note that this applies only to the completed invention (the invention reduced to practice) and experimental use - or testing - is excepted.<sup>43</sup> This requirement is limited to use within the United States, though the same reservation stated for knowledge above applies to use as well.

*...patented in this or a foreign country...*

This section’s requirement has been generally held to bring only the invention as defined in the claims, rather than in the entire patent, into the realm of prior art. Some courts have abandoned this “claims only” principle, however. The definition of a patent under this section is relevant to determining what foreign grants are covered. The requirements for receiving a patent vary from country to country. Additionally, the types of patent-like protection vary from utility models without rights to exclude to full patents as defined in the Patent Act.<sup>44</sup> Any foreign document granting “a patent right to exclude others from producing, using or selling the invention, process, or article for a specified period of time” is considered a patent for purposes of this section.<sup>45</sup>

*...described in a printed publication in this or a foreign country...*

Patents in the United States and in some foreign countries are published. Pursuant to this subsection, the entirety of a published patent, not just the invention as described in the claims, becomes prior art that could defeat a patent application. In addition to patents, any document created for the public and accessible to the public is a printed publication counted as prior art. Printed publication requires only enough distribution to make it part of the art; even limited distributed catalogues have been held to meet this definition.<sup>46</sup> Publication is “public” when it becomes accessible to at least one member of the general public. A document published to a small group under confidential conditions – sometimes even implied confidentially – is not a public publication, however. Such a situation most commonly occurs when an article describing the invention is submitted for publication. The article is only deemed to be public when the magazine or publication reaches the general public, as opposed to the publisher’s staff.<sup>47</sup>

**Patentability - Novelty – statutory bars**  
Module F1.0422

### **Section 102(b) - Statutory Bars**

A person shall be entitled to a patent unless-- (b) the invention was patented or described in a printed publication in this or a foreign country or in public use or on sale in this country, more than one year prior to the date of the application for patent in the United States

Section 102(b) concerns “statutory bars” to patentability. These bars support the Patent Act’s policy of not allowing an extension of the patent monopoly beyond the prescribed period (20 years from the date of application for utility patents). After the one year period described in 102(b), the invention is deemed to have moved into the public domain and is no longer patentable.

The definition of invention is broader under 102(b) than under 102(a). While 102(a) required that the prior art sufficiently disclose the invention such that one skilled in the art could reproduce it, 102(b) requires only substantial similarity or differences insufficient to amount to a patentable improvement between the two.<sup>48</sup> This requirement is designed to prohibit the inventor, or another, from making minor changes to an otherwise unpatentable invention and thereafter seeking a patent.

*...patents and printed publications...*

This section is similar to 102(a), with the core difference being the effective date. Under 102(a), a patent will not issue if a printed publication or patent anticipates the invention, with the critical date being the date of invention. Under 102(b), however, the critical date is one year prior to the date of the patent application. Importantly, the inventor's own publications made more than a year prior to applying for a patent can cause the invention to become unpatentable.

*...in public use...*

Absent secrecy agreements, the use of the invention in public, even if not easily noticed or not noticed at all, is public use that will bar patent issuance if occurring more than a year before the patent application.<sup>49</sup> In addition to secrecy, control over the invention is a key concern of courts, with more control leading to a less likely determination the invention is unpatentable.<sup>50</sup> Experimental use, however, is generally not public use.<sup>51</sup> The policy underlying the public use/on sale bar goes to the heart of the patent right. As noted earlier, a patent is given in exchange for something new being placed in the public domain. If the invention has been in the public for more than a year, it becomes part of the public domain. That which was given to the public cannot thereafter be withdrawn

and patented. There would be no quid pro quo in exchange for the grant of the patent monopoly.<sup>52</sup> In a contest between two inventors, one of whom has kept an invention secret from the public yet financially benefitted from it and one of whom has promptly filed for patent protection, the law favors the inventor who shares the knowledge with the public.<sup>53</sup>

*...on sale...*

Closely related to public use, and often intertwined therewith, is the on sale bar. This bar is established when the invention is sold or offered for sale more than a year before the current application. An offer for sale requires the availability of invention and an offer of it for sale.<sup>54</sup> Whether an actual sale occurs is immaterial. Additionally, the offer for sale must be for commercial gain, not experimental development.<sup>55</sup> The totality of the circumstances should be evaluated and the policy underlying the statutory bar should be considered.<sup>56</sup> That policy dictates the period of exclusivity granted by a patent should not be extended by the withholding from the public of the invention. The policy is served by requiring the inventor to file for patent application no later than one year after the invention is put to public use or put on sale.

### **Patentability - Obviousness**

Module F1.043

To be nonobvious, an invention must be something more than a modification of a previous invention which would have been obvious to a person of ordinary skill in the industry or trade at the time of the invention. [Section 103](#) presents the requirement for nonobviousness.

Four factual inquiries were established by the Supreme Court of the United States in *Graham v. John Deere*<sup>57</sup>: (1) what is the scope and contents of the prior art, (2) what are the differences between the prior art and the claims in issue, (3) what is the level of ordinary skill in the pertinent art, and (4) are there any secondary considerations.

To establish the prima facie case of obviousness, three factors must be shown. First, there must be some suggestion or motivation, either in the references themselves or in the knowledge generally available to one of ordinary skill in the art, to modify the reference or to combine reference teachings. Second, there must be a reasonable expectation of success. Finally, the prior art reference (or references when combined) must teach or suggest all the claim limitations.<sup>58</sup>

In regards to the knowledge generally available to one of ordinary skill in the art, one should look to common knowledge in the art, common sense, a known business principle, art-recognized equivalents, or legal precedent established by prior case law.

This evaluation of obviousness must be made at the time of the invention, not afterwards with the assistance of hindsight. The legal conclusion of obviousness must be based on the existence of the prior art, not the current art. If the prior art does not suggest that a potential invention should be investigated or if it suggests a potential invention is impossible, that invention is not considered obvious, regardless of how simple the invention may seem immediately after having been invented.

**Patentability - Usefulness****Module F1.044**

An invention is useful if it has a useful purpose, actually works and is not frivolous, immoral or promotes fraud. The invention must have a known purpose; inventions that have no known use have been found unpatentable. While an invention must work, it is not necessary for purposes of usefulness that it work perfectly, or even better than other inventions already in existence. Nor is it even required to accomplish all the things it claims. Accomplishment of at least one stated objective is sufficient to establish usefulness.<sup>59</sup>

Inventions that are found to have no purpose other than an illegal, immoral or fraudulent purpose are denied patents. Justice Story, in an often quoted passage, stated that inventions “injurious to the well-being, good policy, or sound morals of society” are not patentable.<sup>60</sup> Justice Story went on to provide examples of unpatentable inventions: “a new invention to poison people, or to promote debauchery, or to facilitate private assassination.”<sup>61</sup>

An example of denial for fraud is found in *Rickard v. Du Bon*, where a patent application for applying spots to the outer wrapper of a tobacco leaf was found fraudulent.<sup>62</sup> The spots were indicative of a particularly high quality of tobacco whose reputation the applicant wished to acquire. Denying the application, the Court stated that “congress did not intend to extend protection to those which confer no other benefit upon the public than the opportunity of profiting from deception and fraud.”<sup>63</sup>

The legal current may be changing, however, as the Federal Circuit has recently held a patent not invalid solely because it was designed to deceive customers into

thinking it was a different product, noting that such mild deception is a common practice in today's marketplace.<sup>64</sup> That court went on to declare the immoral or illegal purpose exclusion had not been broadly construed in many years.

### **Patentability - Abandonment**

Module F1.045

Once an invention passes into the public domain, it cannot be patented. [Section 102\(c\)](#) provides that a patent may not be obtained once an invention is abandoned. There is little litigation on this subsection, as it overlaps substantially with the statutory bars of 102(b). Those bars with their firm deadlines of one year are typically easier to prove than 102(c) abandonment. Of course, if a clear and overt act of abandonment takes place less than one year before application it may be productive to proceed under 102(c).

### **Patentability - Actual Inventor**

Module F1.046

Pursuant to [Section 102\(f\)](#), only an actual inventor can apply for a patent. It is common practice for employers to require employees as part of the employment agreement to assign to the employer all patent rights developed while an employee. Nevertheless, the employee must be the one to file for and prosecute the patent. If more than one person jointly created the invention, they are to jointly file for the patent pursuant to [Section 116](#). Should it not be possible to find the actual inventor, [Section 118](#) provides a method of applying for the patent right. Additionally, death of the actual inventor is covered by [Section 117](#).

The actual inventor requirement is not present in the European Patent Convention. Article 58 of that convention permits any natural or legal person to file a patent



application. Article 60 qualifies this right by requiring the actual inventor of his successor in title to file the application.

### **Patentability - Priority**

#### **Module F1.046**

As noted in an earlier module, the United States is a first to invent, rather than a first to file, patent system. Priority is the determination of who first invented a particular invention. [Section 102\(g\)](#) establishes the rules for determining priority of invention. A person shall be entitled to a patent unless--

(g) (1) during the course of an interference conducted under section 135 or section 291, another inventor involved therein establishes, to the extent permitted in section 104, that before such person's invention thereof the invention was made by such other inventor and not abandoned, suppressed, or concealed, or (2) before such person's invention thereof, the invention was made in this country by another inventor who had not abandoned, suppressed, or concealed it. In determining priority of invention under this subsection, there shall be considered not only the respective dates of conception and reduction to practice of the invention, but also the reasonable diligence of one who was first to conceive and last to reduce to practice, from a time prior to conception by the other.

### **Patent Uses**

#### **Module F1.031**

Now that an understanding of the nature of patents has conveyed, we can look to practical applications of patents in E-Commerce. E-Commerce across the internet will continue to grow. There are many traditional and non-traditional uses for patents in this rapidly developing sector.

The software that runs E-Commerce is a prime target for patenting. So long as the software achieves a useful result and meets all the traditional tests for patentability, a software patent is obtainable.

The processes used by software for executing a particular commerce-related task could be patentable as a business method. Consider for example the various shopping systems that have received business method patents.

The graphical representations and icons used in the E-Commerce programs may be eligible for design patent protection. Activities such as these represent traditional uses of the patent power.

Two non-traditional issues of patents particularly deserve discussion: defensive patents and essential facilities. Defensive patenting occurs when a patent is obtained primarily for the purpose of excluding others from an invention, without specifically intending to practice the invention oneself, or when patent is obtained primarily to be used as a bargaining chip in negotiating a license to another's patent. The essential facilities doctrine is implicated when one controls a core technology.

[Defensive Patents {link}](#)

[Essential Facilities {link}](#)

<b>Defensive Patents</b>
--------------------------

Module F1.0311
----------------

As has been noted, patents can be used offensively and defensively. One use of patents defensively occurs when a patent is cross-licensed as a win-win solution to a claim of

patent infringement. Patent infringement cases are generally high stakes/high risk affairs. By cross licensing patents, both parties can save face and bring home a positive asset rather than a court's judgment.

Another manner in which patents may be used defensively is by patenting non-essential technology. A company may obtain a patent on an invention that is not directly relevant to its business strategy. This type of patent protection is being increasingly sought for use in cross licensing. This process may also be viewed as a strategic use, rather than a tactical use, of patents.<sup>65</sup>

While the non-essential invention may not be directly relevant to a company's business strategy, that invention could very well be core to a competitor's strategy. Should the situation arise where the competitor holds a patent or other intellectual property right the first company desires, a situation ripe for cross licensing exists. This is also known as the "rainy day" scenario.<sup>66</sup> By licensing each other rights to use the intellectual property each desires, the companies build a working relationship and increase the value of their intellectual property portfolio.

Even if a cross license is not acquired, simply licensing out the patent may provide an attractive source of income for the company and fund additional research and development. Additionally, the utilization of the intellectual property rights tends to invigorate and stimulate further development of inventions within the research and development department of the company.

Another reason to defensively patent is to protect the market from monopolization by another. The situation may arise where one feels an invention should not be controlled

by anyone. Unless steps are taken to acquire that property and dedicate it to the public through an open license or otherwise, a competitor with other goals may obtain the exclusive rights to that invention.

Finally, a patent can be a useful source of collateral, particularly for relatively new companies that do not have the proven track record often required for high stakes financing. By leveraging this asset, a patent holder can expand into new markets.

### **Patents and Essential Facilities**

#### **Module F1.0312**

With the number of patents being issued, and the lack of a competent prior art history against which to compare applications, it is inevitable that some of the core technologies of E-Commerce will receive patents. Once this happens, the question arises: should the patent holder be forced to allow others a compulsory license to the invention? One such manner in which this might happen is through the doctrine of essential facilities.

The essential facilities doctrine is an antitrust concept requiring some entities to allow others access to an asset controlled by those entities when it would be impractical, if not impossible, to duplicate that asset.<sup>67</sup> The most common instances of essential facilities occur in the field of common carriers. In the Terminal Railroad Association case, the Supreme Court forced a combination of railroads in St. Louis to allow other railroads access to their facilities. The doctrine has been used to compel the Associated Press to cease discriminatory admissions,<sup>68</sup> to compel a power company to sell energy,<sup>69</sup> and to force a competitor to share access to a ski resort.<sup>70</sup>

This doctrine has been criticized, however. It has been said that the Court has never issued a truly logical and workable essential facilities doctrine.<sup>71</sup> Further, as this doctrine is an antitrust principle, it must be established that an impermissible economic monopoly power exists. Since a patent is a government sanctioned property monopoly, absent anticompetitive behavior or other misuse, a court would have no authority to exercise this principle. For the government to impose this doctrine on an otherwise lawful patent holder would implicate the takings clause, requiring the government to compensate the one from whom the asset was taken or devalued.

### **Utility Patents – Business Method Patents**

#### **Module F1.032**

Business method patents have set the patent industry on its head and whipped the media in a frenzy. Business method patents are fast becoming one of the most important means of protecting E-Commerce assets. As such, the E-Commerce practitioner should have an understanding of the potential benefits and liabilities of these process patents.

As we learned in Patentability, a process is patentable subject matter.<sup>72</sup> A process is a series of steps or a method of producing a result, and business method patents are a type of process utility patents.

### **What are Business Method Patents**

#### **Module F1.0321**

Business methods have yet to be adequately defined. Representative Howard Berman introduced into the 106<sup>th</sup> session of Congress a bill which defined business methods.<sup>73</sup> Though it has not become law, the Berman bill is looked to by patent practitioners as informative. There, a business method is defined quite broadly and includes matters not relevant to E-Commerce. The definition is as follows:

- (1) a method of:
  - (A) administering, managing or otherwise operating an enterprise or organization, including a technique used in doing or conducting business; or
  - (B) processing financial data;
- (2) any technique used in athletics, instruction, or personal skills; and
- (3) any computer-assisted implementation of a systematic means described in paragraph (1) or a technique described in paragraph (2).

Of particular interest to the E-Commerce practitioner is the computer-implemented business method patent. While there is no universally accepted definition, such patents utilize a process to bring about a tangible and useful result relevant to business or commerce by use of a computer. The origin of business method patents predates computer technology, however, and primarily revolves around financial services.

While the term “business method patent” has never been fully defined by a court, the USPTO has issued guidelines that assist examiners in evaluating claims to this type of invention. The USPTO directs that these claims be categorized under Class 705: Data Processing: Financial, Business Practice, Management, or Cost/Price Determination. This class includes monetary exchanging, data processing, electronic shopping, auction systems and business cryptography, among other topics, and is informative of the types of methods protect able.

### **History of Business Method Patents**

Module F1.0322

The first patent that could be categorized as a business method patent was issued in 1799 for detecting counterfeit currency. Paper based business method patents continued to be issued for the next hundred years.

In 1889, the forerunner of IBM patented a method for tabulating statistical information using a machine. The machine used for tabulating was also patented. This method patent is considered the first automated business method patent. Patents began to be issued both for the processes of automated business methods and the machines upon which they ran, as early machines had to be specifically designed to handle such matters. With the advent of the integrated circuit and personal computers, however, specifically designing machines to process business methods was no longer necessary.

Due to the incredible growth of information technology and increased flexibility and programmability of today's computer technology, automated business methods can be accomplished independent of a machine specifically designed for that process. As such, these business methods now stand on their own, freed from the constraints of specifically designed mechanical systems. The growth of patents in this field should be seen as the result of the conjunction of increased ability, through better technology, and increased awareness, due in part to the much publicized *State Street* decision and high profile patents such as Amazon.com's Oneclick.

This evolutionary growth description is representative of the USPTO's current position on business method patents. Such has not always been the case, however. Citing to cases including the seminal *Hotel Security Checking*,<sup>74</sup> for most of the century the USPTO and courts had consistently rejected claims for methods of doing business.

The *State Street* Court indicated that all previous rejections of such claims by the courts were not attributable to a business method exception. Rather, each rejection was for some other recognized reason such as novelty or obviousness. Only after *State Street* “clarified” the Court’s position on business method patents were such patents considered proper by many. It should be noted, however, that the 1996 revision to the MPEP, two years prior to *State Street*, removed the automatic business method exception from the vernacular of the USPTO examiners, though acceptance of those forms of patents was not guaranteed.

<b>State Street Case</b> Module F1.0323
--

The case that opened the flood gates to business method patents was *State Street*.<sup>75</sup> This case involved a software program that analyzed the pooling of mutual fund assets for joint investment in a single portfolio. The program provided complete information as to the assets and expenses allocated to each subsidiary fund. In holding that the software and the business method could be patented, the federal circuit explicitly dispelled the notion that business methods are unpatentable.

Before *State Street*, it had been the position of the USPTO that most such applications should be denied, as they were considered mathematical algorithms - an abstract idea - and therefor not patentable subject matter. The court noted, however, that business method patents were not new, but rather had existed for over a hundred years, with many patents having been issued in this area.

The court carefully distinguished each of the cases typically cited as establishing a business method exception. The court determined that each of those cases actually struck



down a business method patent for more basic reasons, such as novelty or obviousness. Accordingly, the court determined there was no business method exception to patentability. Instead, the court reasoned that business method patents should be subjected to the same requirements as any other process or method patent. In so doing, the court allowed both the business method and software claims in this case to stand.

Whether business methods were a new type of patent or not, the practical effect of *State Street's* sanctioning of business method patents was to cause an explosion of that type of patent applications and increase acceptance of such patent applications by the USPTO. Subsequently, the USPTO issued a White Paper on business method patents affirming its acceptance of those patents.

<p><b>AIPA Prior User Defense</b> Module F1.0324</p>
--

The American Inventors Protection Act (AIPA) was enacted shortly after the *State Street* decision. One portion of the Act provides for a Prior User Defense to infringement actions. Under this provision, one does not infringe a patent if he in good faith reduced to practice the business method at least one year prior to the application date and then used the business method in commerce before the application date.

The provision is aimed at those businesses who were using a business method prior to another's application for a patent on that business method. Of course, regardless of this section, proof that one other than the inventor was using the business method prior to the application date can invalidate the patent under Section 102.

The purpose behind this section seems two fold. First, Congress sought to convey its concern that business method patents would issue to subsequent users to the detriment of a previous user. Second, Congress may have sought to protect business method patents from invalidation on the basis of another having used that method. With this prior user defense ensuring a prior user can continue in business without worry of infringement, that prior user has no economic motivation to contest the patent, which can be an extremely expensive endeavor. Such a contest, if successful, would result in that patent being invalidated. Accordingly, this defense may be viewed as Congressional approval of business method patents.

**Problems with Business Method Patents**

Module F1.0325

[Link to Lack of Prior Art Module E1.03251](#)[Link to Lack of Novelty and Nonobviousness Module E1.03252](#)**Problems – Lack of Prior Art**

Module F1.03251

Any “new” (or perhaps “rediscovered”) class of invention will inevitably run into the problem of lack of prior art. Without previously issued patents or another rich prior art library against which the applied for patent can be compared, some patents will issue when perhaps they should not. The most commonly cited example is Priceline.com’s ‘207 patent,<sup>76</sup> which covers, in effect, reverse auctioneering, or dutch auctions.

The U.S. Treasury Department uses the dutch auction method to sell billions of dollars worth of securities every year. Quickly perishable goods are sold using this method all around the world. It is notable that the application does not use either “reverse auctioneering” or “dutch auction” to describe the process. It has been conjectured that

perhaps this omission was purposeful to take advantage of the lack of prior art issue.<sup>77</sup> Of course Priceline.com's '207 patent is but one example of patents questionable due to inadequate prior art comparisons.

Another reason prior art is lacking in this field goes to the nature of the subject field. Unlike scientists and engineers, who publish their data in journals and at conferences for criticism and comment, businessmen are not as accustomed to publishing their ideas. Accordingly, there is a distinct lack of material against which to compare a patent application. The problem is compounded by the background and training of the examination corp, most of whom come from scientific backgrounds rather than business backgrounds and are not as familiar with these topics as they are more the traditional scientific and technical areas. The USPTO has announced initiatives designed to alleviate this problem, however.<sup>78</sup>

**Problems – Lack Novelty and Nonobviousness**  
Module F1.03252

Most, but certainly not all, patent practitioners would agree generally that the category of business methods should be considered patentable subject matter - it is a process. The more important and divisive question, however, is whether a business method patent application exhibits novelty and nonobviousness. Particularly, is the application to the online world of a known "offline" business concept a novel application? Or would such an application be obvious to one skilled in the art?

Looking again at Priceline.com's '207 patent, the patented business method was used by others offline, including the USPTO's fellow governmental agency, the Treasury Department. Examine Amazon.com's Oneclick patent. Could not that patent be an

obvious application to the internet of the practice known for hundreds of years in small shops of identifying a customer once and retaining that information for delivering or charging the selected goods without asking for the information each time the customer visits the shop? It has been stated numerous times that the Patent Act is designed to reward those that contribute something new to society. Should the application of an old concept to a new medium rise to the level of novel and nonobvious?

The core question is whether the USPTO should reward those that arrive first at a place already identified and desired, rather than at a place theretofore undiscovered. The patent laws will continue to wrestle with these issues for some time, as they find the balance necessary to foster the innovation the patent laws are enacted to promote. It is anticipated that substantial litigation will ensue over business method patents. Only then will these questions be answered and that balance found.

### **Future of Business Method Patents**

Module F1.0326

One should be cautiously optimistic about business method patents. Clearly they are now patentable subject matter, and the savvy practitioner should take advantage of this opportunity.

Under the doctrine of *stare decisis*, it would be exceedingly unusual for the courts to take these patent rights away from the public now that the door has been opened. Congress, however, does possess the power to clarify and change the patent laws. It is not unthinkable that such a modification of the patent laws could take place in the near

future. Indeed, as the United States continues to revise its intellectual property laws to conform with international treaty standards, business method patents could be addressed.

<sup>79</sup>Until this occurs, the competent patent attorney should consider advising clients who possess a business method meeting the statutory requirements of patentability to protect that intellectual property right through all prudent currently available avenues. Of course, whether to patent an invention is a business decision that should be made by businessmen, not attorneys, after full consideration of the benefits and detriments of so doing. As noted above, there is a possibility of extensive litigation regarding business method patents. This factor should be brought to the attention of the client for its consideration.

### **Utility Patents – Software Patents**

Module F1.033

While copyright and trade secret continue to be important methods of protecting software, software patents are becoming increasingly common in the United States. Patenting software has certain advantages over other forms of intellectual property protection and warrants thoughtful consideration.

### **History of Software Patents**

Module F1.0331

As discussed in the section on patentability, mathematical algorithms are not patentable, just as abstract ideas and scientific principles are not patentable. The courts have consistently held, however, that “a novel and useful structure created with the aid of knowledge of scientific truth may be” patentable.<sup>80</sup>

The first Supreme Court decision involving a software patent was *Gottschalk v. Benson*.<sup>81</sup> That case struck down a software patent, though the Court expressly stated it was not holding all software unpatentable. The particular software in that case was found to be so broad that it amounted to a patent on the mathematical algorithm underpinning it. Since all software is based on mathematical algorithms, the Court's ruling had a chilling effect on the patenting of software. Software patenting was further chilled by *Parker v. Flook*.<sup>82</sup> Again, the Court struck down a software patent, claiming that a mere method of calculation is unpatentable.

In the same manner that *State Street* flung open the door to business method patents, *Diamond v. Diehr*<sup>83</sup> established software patents as viable. In *Diamond*, the Court upheld the patentability of software. Factually, *Flook* and *Diamond* are quite close. The principle difference between the two cases appears to be *Diamond*'s involvement of a physical transformation as part of the process. While *Flook*'s process only produced a number, *Diamond*'s process took a number calculated by the process and used it to make a change in the environment. It is this physical transformation element that patent writers have used to successfully prosecute software patents. The physical transformation need not be significant. Even changing the appearance of a line on a screen was held to be patentable in *In re Alappat*.<sup>84</sup> In that case, changing the appearance produced a more visually appealing image, thereby performing a useful task. Further, the *Alappat* court rejected the notion that mathematical algorithms are per se unpatentable, though it didn't go so far as to say they were per se patentable.

*State Street* went even further than *Diamond* in opening software to patentability. The physical transformation requirement of *Diamond* was not present in the software that was

the subject of the *State Street* case. Nevertheless, the Federal Circuit upheld the patentability of the software in question. The software was held to produce a “useful, concrete and tangible result.” That result was simply a number, though it was a number with a useful and practical application. Perhaps courts are beginning to understand that in today’s economy, numbers are often more important than the physical items they represent and that the purpose behind the patent laws is not served by excluding inventions solely because they relate to numbers. *State Street* is more fully discussed in the section on business method patents.<sup>85</sup>

The patentability of software can be stated no more clearly than as declared by the Federal Circuit in *AT&T Corp. v. Excel Communications, Inc.*: “it is now clear that computer-based programming constitutes patentable subject matter so long as the basic requirements of § 101 are met.”<sup>86</sup> Of course, all other requirements of the Patent Act must be met to attain patentability. The court also clarified that physical transformation was not a requirement but was merely one example of how a mathematical algorithm can be directed to a useful application.

After *State Street* and *AT&T*, a computer program is now considered patentable subject matter, so long as it incorporates a process to achieve a specific purpose.<sup>87</sup> Of course it must still meet the requirements of novelty, nonobviousness and usefulness. While the *State Street* decision eliminated the requirement that a physical transformation take place, such a transformation is strong evidence of patentability and a prudent practitioner should consider drafting the claims to take advantage of this fact, if so permitted by the invention. If a mathematical algorithm is prevalent in the process, the claims should not be so broad as to exclude any other use of that algorithm.

**Data Structures and Cryptography****Module F1.0332**

Related to software patents are data structures. Data structures are frameworks for organizing and representing information used by an application program. A database is an example of a data structure. Prior to the Federal Circuit's decision in *In re Lowry*,<sup>88</sup> the USPTO had traditionally rejected claims to data structures on the "printed matter rejection" principle. The USPTO asserted that data structures are analogous to printed matter that is not functionally related to the substrate, or in other words, no different from writing words on a page and seeking to patent the page.

Under the *Lowry* decision, data structures may be patentable, so long as protection is sought for the structure itself and not the information contained therein. It is important to remember that a data structure is such a broad concept it can be seen in both patentable and nonpatentable subject matter patent applications.<sup>89</sup> The determination of patentability will be made on the whole application, but the mere fact of claiming a data structure will not cause the application to be automatically rejected.

**Software Patents in the European Community****Module F1.0333**

The European Patent Convention states that programs for computers will not be regarded as inventions.<sup>90</sup> Despite this seemingly broad statement, the Guidelines published by the European Patent Office state that a computer program that has a technical effect may be patentable, even though the program in the abstract is not. This technical effect applies to both physical results (such as controlling a robotic arm) and practical effects (such as better allocation of resources between memory segments).<sup>91</sup> Perhaps this distinction is



best described as the program in and of itself not being patentable, but a program designed to accomplish a task being patentable. This distinction goes to the heart of most patent systems, which make inventions patentable because they are useful, not simply because they were invented.

Case law suggests this distinction. Decision T208/84 considers the differences between mathematical algorithms and technical process.<sup>92</sup> A mathematical algorithm merely manipulates a number, and as such is an abstract concept. The application of this algorithm to a physical entity (which can include an image stored as an electric signal) is a technical process that can be patented. That which would be patentable under other patent rules is not excluded from patentability solely because it is implemented on a computer.<sup>93</sup>

### **Advantages and Disadvantages of Software Patents**

Module F1.0334

Patent protection provides stronger protection of a company's software intellectual property than does copyright and trade secret, the two most commonly used methods of protecting software.

With a patent, it is not necessary to show access to prove infringement, as it is in copyright, which requires proof of copying.<sup>94</sup> Copyright only protects the expression, not the underlying functional aspect of the software. This element is particularly important in the software industry, where a "clean room" can be used to ensure no actual copying occurs. Patents provide protection for the process, and thereby in a limited sense the function, of the software. Accordingly, an original work, that is to say a non-copied

work, which does substantially the same thing in substantially the same way would not violate a copyright but would violate a patent. As you can see, patents are a more robust form of protection.

Protecting trade secrets is frightfully difficult in this era of high employee turnover and instant widespread dissemination of information. Patents are not extinguished by dissemination of the principles behind them. Indeed, the purpose of the patent laws are to increase the knowledge base of society. Accordingly, one need not worry a mobile or disgruntled employee will destroy the intellectual property right.

Copyright duration varies according to several factors, which are discussed in the section on copyrights.<sup>95</sup> Trade secret protection lasts so long as the information remains secret. While the patent term is far shorter than a copyright, it is sufficiently long for the subject matter involved. The patent term, 20 years, far exceeds the useful life of a software product today, so limited duration need not be an issue.

One substantial disadvantage to patents is the time required to prosecute the application. No patent protection is available until a patent issues, though damages will relate back to the application date if a patent does issue. A patent application is typically ruled upon within 18-24 months. With the rapidly evolving software market, such time delays may pose significant barriers to effective software patenting. As discussed earlier, there are options for accelerating patent applications in the USPTO which may alleviate some of these concerns.<sup>96</sup>

A second substantial disadvantage to patents is the high cost associated with patent prosecution. Securing a patent costs significantly more than other intellectual property

rights. Costs associated with software patents, and patents generally, can be placed in three categories: (1) application preparation, (2) prosecution, and (3) prior art searches.<sup>97</sup> Preparation of an application can cost from \$7,000 to over \$100,000, with the average being \$10,000 to \$30,000. The average cost of prosecuting the application before the patent office is \$10,000 to \$20,000. Costs of conducting prior art searches range from \$2,000 to \$20,000. With an average minimum cost of obtaining a software patent being around \$20,000 and \$100,000 not being unusual, it is understandable why some companies may not want to patent their software. When considered in context of the typical research and development, marketing and production budgets, however, the additional cost of securing a patent is often not as significant as might seem at first glance. This is particularly true when weighed against the advantages conferred by patent protection.

Despite these disadvantages, many companies have determined that their intellectual property is best protected by software patents. IBM, Motorola and Microsoft in particular have vast patent portfolios, covering both products and processes.<sup>98</sup> In the aggressive field of software, one might consider patenting if for no other reason than as a tool to defend against claims of infringement by competitors.<sup>99</sup>

Of course bundling several types of intellectual property rights for a given invention is typically the best method of protecting an invention. Consider, for example, patenting the functionality of a program while copyrighting its appearance - its look and feel, as well as trademarking any logo displayed on the screen.

**Design Patents - Generally****Module F1.0341**

Pursuant to [Section 171](#), design patents may be obtained for “new, original and ornamental design for an article of manufacture.”<sup>100</sup> Note that unlike a utility patent, usefulness, or utility, is not required. In fact, a showing of usefulness or utility will defeat an application for a design patent if the design is solely or principally dictated by considerations of function.<sup>101</sup> Design patent protection can be obtained only for the configuration and the surface ornamentation of an article.

To be protected, the design must be in an article of manufacture. Courts have held that a “manufacture is anything made ‘by the hands of man’ from raw materials, whether literally by hand or by machinery or art.”<sup>102</sup> Further, the protection need not extend to the entire article, but can be limited to a part of the article.<sup>103</sup>

The definition of “an article of manufacture” as it relates to computer technology has been debated. In 1988, Xerox received design patents for display screen icons. In 1989, Xerox was denied design patents for the same type of icons on the basis that they were not in an article of manufacture. Such rejections continued until 1996, when the USPTO issued guidelines which clarified that images on a computer display were considered to be in an article of manufacture. With these guidelines, icons and other graphical representations were clearly opened to patentability.

The tests for novelty and nonobviousness are the same for design patents as for utility patents.<sup>104</sup> An additional requirement of design patents is ornamentality. The concept of ornamentality requires aesthetic skill and artistic conception, not mere avoidance of

functionality. This is not to say that an item must be a work of “fine art.” All that is required is that the article possess “more grace and pleasing appearance than existed in the prior art.”<sup>105</sup>

It is also required that the design not be offensive. Under this policy, the USPTO rejects obscene applications, such as one describing a key holder containing a biologically complete reproduction of the human body.<sup>106</sup> Courts have not directly ruled on this issue, though the current trend may suggest such a rejection is not proper.<sup>107</sup>

As noted earlier, functionality may defeat an application for a design patent. If a design is dictated by functional considerations, even if it could have been less gracefully arranged, the design will be held unpatentable.<sup>108</sup> Mixed elements, some of which are functional in nature, do not necessarily defeat an application. The application is defeated on this issue only if the functional elements dominate the design and are principally responsible for its patentability.<sup>109</sup>

Other patent systems do not provide for design patents. The European patent system rejects such patents, as they do not meet the requirement of being a useful invention. Instead, trade dress laws (called design laws there) serve to protect this type of intellectual property.

### **Design Patents - Infringement**

Module F1.0342

General principles of infringement discussed earlier apply to design patents as well.<sup>110</sup> Accordingly, a party may infringe directly or indirectly and literally or by the doctrine of

equivalents. A concept related to the doctrine of equivalents is found in “colorable imitation”

An additional remedy is available specifically for design patent infringement. [Section 289](#) provides that anyone who without authority uses the design or a “colorable imitation thereof” on an article for sale shall be liable to the extent of his profit. This remedy is in addition to all other remedies available for patent infringement. The language referring to colorable imitations underscores the principle that minor changes to a design often confuse the public and should be considered infringement.

In a manner somewhat similar, but not identical, to trademark infringement,<sup>111</sup> designs that are substantially similar to a patented design in the eyes of an ordinary observer are held to infringe.<sup>112</sup> This substantial similarity test is shaped by several principles. First, if the initial impression the article gives is that of similarity, there is a strong likelihood of infringement. Second, the items need not be compared side by side, as a consumer would likely not make such minute comparisons. Third, the similarity between the items must be attributable to the novelty of the patented design. Fourth, the similarity must relate to the design as described in the patent claim, as opposed to the commercial embodiment. Fifth, the similarity must be based on the non-functional features of the design to support a finding of infringement.

### **Design Patents – Advantages and disadvantages**

Module F1.0343

Design patents have a far shorter term than the other intellectual property regimes.

Design patents last for only 14 years from issuance, after which time anyone can copy the

design, absent coverage of the design by another intellectual property right. Copyright terms vary depending on the author of the work, but generally lasts for over three quarters of a century.<sup>113</sup> Trademarks remain valid for so long as the rights are properly preserved, which could mean indefinite protection.<sup>114</sup>

Design patents must be successfully prosecuted before any rights to the design vest. If an interference is declared, many years can pass before a patent issues and a right to sue under the design patent accrues. Copyright vests immediately upon the design being set in a tangible medium, though registration requires affirmative steps. Trademark rights are acquired according to varied principles, depending on the type of mark, and can take less or more time to vest than design patents.

Design patents are the most expensive of these three principle forms of intellectual property protection. It almost always costs thousands of dollars to obtain a design patent, while a copyright can usually be obtained for a few hundred dollars. Trademark is also far less expensive. This barrier only exists for the individual or small company, however. Indeed, it can be seen as an advantage to a large company, which can afford higher attorneys fees for obtaining and defending design patents.

The interface between copyright and design patents is discussed in *Maxer v. Stein*.<sup>115</sup> For some time, it was thought that one had to elect between a copyright or a design patent. It has since been made clear that there is no such doctrine of election.<sup>116</sup>

Regarding trademarks, the courts have not found an election doctrine between design patents and trademark. In the recently decided *Traffix v. MDI*<sup>117</sup>, the Court, while noting that a utility patent was strong proof of functionality, expressly did not decide the issue of

whether the grant of a patent in itself would bar a trademark or trade dress claim. The Court has in the past, however, noted the trade dress could be the subject of design patents.<sup>118</sup>

If possible, the best alternative is to seek multiple forms of protection. Consider obtaining a strong design patent while contemporaneously copyrighting the same item, thereby gaining protection before the design patent is granted and after the expiration of the design patent. Additionally, once secondary meaning has been established with a design patent, consider filing for trademark/trade dress protection.

---

#### REFERENCES (to be hyperlinked from text)

- 1 [Link to Importance module](#)
- 2 Donald S. Chism, *Chism on Patents: A Treatise on the Law of Patentability, Validity and Infringement*, Lexis Publishing, 2000.
- 3 *Manual of Patent Examining Procedure (MPEP)*, 7<sup>th</sup> Ed., revised, (2000), US Department of Commerce, Patent and Trademark Office.
- 4 Gregory A. Stobbs, *Software Patents*, 2<sup>nd</sup> Ed., Aspen Law & Business, 2000.
- 5 *See* Section 154 {pop up link to 154}.
- 6 35 U.S.C. 101.
- 7 *King Instrument Corp. v. Perego*, 65 F.3d 941, *reh'd denied*, 72 F.3d 855, *cert. denied*, 116 S.Ct. 1675 (1996).
- 8 *See* Defensive Patenting {link}.
- 9 US Constitution, Article I, Section 8, Clause 8.
- 10 *See* John Thomas, *The Patenting of the Liberal Professions*, 40 B.C. Law. Rev. 1139 (1999).
- 11 *See* Business Method Patents {link to it}
- 12 *See* Patentability {link to it}
- 13 *See* Infringement {link}
- 14 US Constitution, Article I, Section 8 {popup link}.
- 15 *See* 35 USC 100 et seq.
- 16 *See* Title 17 CFR, Chapter I et seq.



- 17 *See* MPEP
- 18 *See* Patentability
- 19 *Life Technologies, Inc. v. Clontech Laboratories, Inc.*, 224 F.3d 1320 (Fed. Cir. 2000).
- 20 *Id.*
- 21 *Purdue Pharma L.P. v. Boehringer Ingelheim GMBH*, 237 F.3d 1359 (Fed. Cir. 2001).
- 22 *Monon Corp. v. Stoughton Trailers, Inc.*, 239 F.3d 1253 (Fed. Cir. 2001).
- 23 *U.S. v. Line Material Co.*, 68 S.Ct. 550 (1948).
- 24 *Morton Salt Co. v. G.S. Suppiger Co.*, 314 U.S. 488.
- 25 *Florida Prepaid Postsecondary Education Expense Board v. College Savings Bank*, 119 S.Ct 2199 (1999).
- 26 *See* Defensive Patenting {link}.
- 27 *Roche Products v. Bolar Pharmaceutical Co.*, 733 F.2d 858 (Fed. Cir. 1984).
- 28 *See, eg., Read Corp. v. Portec, Inc.*, 970 F.2d 816 (Fed. Cir.1992).
- 29 *Aro Mfg. Co. v. Convertible Top Replacement Co.*, 377 U.S. 476 (1964).
- 30 *Manville Sales Corp. v. Paramount Systems, Inc.*, 917 F.2d 544 (Fed. Cir. 1990).
- 31 *Markman v. Westview Instruments, Inc.*, 116 S.Ct. 1384 (1996).
- 32 *Markman*.
- 33 *Caterpillar Inc v. Deere & Co.*, 224 F.3d 1374 (Fed. Cir. 2000).
- 34 *See* Blacks Law Dictionary, “art.”
- 35 *Structural Rubber Products Co. v. Park Rubber Co.*, 749 F.2d 707 (Fed. Cir. 1984),  
\_\_\_\_\_.
- 36 *See* Infringement {link}.
- 37 *In re Graves*, 69 F.3d 1147 (Fed. Cir. 1995), *quoting In re LeGrice*, 301 F.2d 929 (C.C.P.A. 1962), internal quotations omitted.
- 38 *Seymour v. Osborne*, 78 U.S. (11 Wall.) 516 (1870).
- 39 *National Tractor Pullers Ass’n v. Watkins*, 205 U.S.P.Q. (BNA) 892 (N.D. Ill. 1980).
- 40 Chisum, Foreign Activity: Its Effect on Patentability under United States Law, 11 Int’l Rev. Indus. Prop. & Copyright L. 26 (1980).
- 41 *W.L. Gore & Assoc. v. Garlock, Inc.*, 721 F.2d 1540 (Fed. Cir. 1983).
- 42 *Rosaire v. Baroid Sales Division, National Lead Co.*, 218 F.2d 72 (5<sup>th</sup> Cir 1955).
- 43 *Rosaire*.

- 
- 44 For an overview of the various forms of patent protections throughout the world, *see* World Patent Law and Practice, Volume 2, Chapter 1, Lexis Publishing 2000.
- 45 *Reeves Brothers v. United States Laminating Corp.*, 282 F. Supp. 118 (E.D.N.Y. 1966), *aff'd*, 417 F.2d 869 (2d Cir. 1969).
- 46 *Jockmus v. Leviton*, 28 F.2d 812 (2d Cir. 1928). (“While it is true that the phrase, ‘printed publication,’ presupposes enough currency to make the work part of the possessions of the art, it demands no more. A single copy in a library, though more permanent, is far less fitted to inform the craft than a catalogue freely circulated, however ephemeral its existence; for the catalogue goes direct to those whose interests make them likely to observe and remember whatever it mayb contain that is new and useful.”)
- 47 *In re Schlittler*, 234 F.2d 882 (C.C.P.A. 1956).
- 48 *Dix-Seal Corp. v. New Haven Trap Rock Co.*, 236 F. Supp. 914 (D. Conn. 1964), *quoting* 1 Walker, Patents, 355-56 (Dellers ed. 1937).
- 49 *Egbert v. Lippmann*, 104 U.S. 333 (1881) (“some inventions are by their very character only capable of being used where they cannot be seen or observed by the public eye” and such use is public use).
- 50 *Moleculon Research Corp. v. CBS, Inc.* 793 F.2d 1261 (Fed. Cir. 1986).
- 51 For a list of factors to consider in determining whether a use is experimental, *see* *Lough v. Brunswick Corp.*, 86 F. 3d 1113 (Fed. Cir. 1996).
- 52 *Pennock v. Dialogue*, 27 U.S. 1 (1829).
- 53 *W.L. Gore & Associates v. Garlock, Inc.*, 721 F.2d 1540 (Fed. Cir. 1983).
- 54 *FMC Corp. v. Hennessy Industries*, 650 F. Supp. 688 (N.D. Ill. 1986).
- 55 *UMC Electronics Co. v. United States*, 816 F.2d 647 (Fed. Cir. 1987).
- 56 *Mahurkar v. Impra, Inc.*, 71 F.3d 1573 (Fed. Cir. 1995).
- 57 *Graham v. Jhn Deere*, 383 U.S. 1 (1966).
- 58 United States Patent and Trademark Office Formulating and Communicating Rejections Under 35 USC 103 for Applications Directed to Computer-Implemented Business Method Inventions (Rejection under 103).
- <sup>59</sup> *Raytheon Co. v. Roper Corp.*, 724 F.2d 951 (Fed. Cir. 1983), *cert denied*, 469 U.S. 835 (1984).
- <sup>60</sup> *Lowell v. Lewis*, 15 F. Cas. 1018 (C.C.D. Mass. 1817).
- <sup>61</sup> *Id.*
- <sup>62</sup> *Rickard v. Du Bon*, 103 F. 868 (2d Cir. 1900).

<sup>63</sup> 103 F. at 873.

<sup>64</sup> *Juicy Whip, Inc. v. Orange Bang, Inc.*, 185 F.3d 1364 (Fed. Cir. 1999).

<sup>65</sup> George H. Gates and Jason S. Feldmar, Internet Patents, Fourth Annual Internet Law Institute, PLI 2001.

<sup>66</sup> Wayne M. Kennard, Software Patents and the Internet, Fourth Annual Internet Law Institute, PLI 2001.

<sup>67</sup> Abbott B. Lipsky, Jr. and J. Gregory Sidak, Essential Facilites, 51 Stan. L. Rev. 1187.

<sup>68</sup> *Associated Press v. United States*, 326 U.S. 1 (1945).

<sup>69</sup> *Otter Tail Power Co., v. Untied States*, 410 U.S. 366 (1973).

<sup>70</sup> *Aspen Skiing Co. v. Aspen Highlands Skiing Corp.*, 472 U.S. 585 (1985).

<sup>71</sup> Phillip Areeda, Essential Facilites: an Epithet in Need of Limiting Principles, 58 Antitrust L.J. 841.

<sup>72</sup> See Patentability {link}.

<sup>73</sup> 106<sup>th</sup> Congress, HR 5364.

<sup>74</sup> *Hotel Security Checking Co. v. Lorraine Co.*, 160 F.467 (2d. Cir. 1908).

<sup>75</sup> *State Street Bank & Trust Co. vs. Signature Financial Group, Inc.*, 149 F.3d 1368 (Fed. Cir. 1998).

<sup>76</sup> Link to Examples

<sup>77</sup> Dreyfuss, Rochelle Cooper, "Examining State Street Bank: Developments in Business Method Patenting," IT-Law Journal Computer und Recht International, February 2001.

<sup>78</sup> USPTO White Paper on Business Methods.

<sup>80</sup> *MacKay Radio & Telegraph Co. v. Radio Corp. of America*, 306 U.S. 86 (1939).

<sup>81</sup> *Gottschalk v. Benson*, 409 U.S. 63 (1972).

<sup>82</sup> *Parker v. Flook*, 437 U.S. 584 (1978).

<sup>83</sup> *Diamond v. Diehr*, 450 U.S. 175 (1981).

<sup>84</sup> *In re Alappat*, 33 F.3d 1526 (Fed. Cir. 1994).

<sup>85</sup> *See* Business Method Patents {link}

<sup>86</sup> *AT&T Corp. v. Excel Communications, Inc.*, 172 F.3d 1352 (Fed. Cir. 1999), *cert. denied*, 120 S.Ct. 368 (1999).

<sup>87</sup> MPEP 2106.

<sup>88</sup> *In re Lowrey*, 32 F.3d 1579 (Fed. Cir. 1994).

<sup>89</sup> For examples of patents not being upheld see *In re Warmerdam*, 33 F.3d 1354 (Fed. Cir. 1994) and *In re Trovato*, 48 F.3d 1376 (Fed. Cir. 1994).

<sup>90</sup> European Patent Convention, Article 52(1).

<sup>91</sup> *See* Guidelines for Examination in the European Patent Office, 1987 E.P.O.R. 66, *cited in* Denis Kelleher and Karen Murray, *IT Law in the European Union*, 1999 Sweet & Maxwell.

<sup>92</sup> *Cited in* Gerald Paterson, *The European Patent System: the Law and Practice of the European Patent Convention*, 1992 Sweet and Maxwell.

<sup>93</sup> Gerald Paterson, *The European Patent System: the Law and Practice of the European Patent Convention*, 1992 Sweet and Maxwell.

<sup>94</sup> *See* Patent Infringement. {link}

<sup>95</sup> *See* Copyrights {link}

<sup>96</sup> *See* What is a Patent {link}

<sup>97</sup> Wayne M. Kennard, *Software Patents and the Internet*, Fourth Annual Internet Law Institute, PLI 2001.

<sup>98</sup> *See* Software Patents (Stobbs presents several Microsoft patents as examples of a portfolio).

<sup>99</sup> *See* Defensive Patenting {link}

<sup>100</sup> 35 USC 171

<sup>101</sup> *Power Controls Corp. v. Hybrinetics*, 806 F.2d 234 (Fed.Cir.1986).

<sup>102</sup> *In re Hruby* (1967), 373 F.2d 997 (CCPA 1967) at 1000.

<sup>103</sup> *In re Zahn*, 617 F.2d 261 (CCPA 1980).

<sup>104</sup> See Patentability {link}

<sup>105</sup> *In re Koehring*, 37 F.2d 421 (CCPA 1930), at 422.

<sup>106</sup> *In re Finch*, 535 F.2d 70 (CCPA 1976) (the court did not rule on the issue of offensiveness, affirming the disallowance on grounds of obviousness without discussing offensiveness, but stating in dicta that it was the court's opinion the subject patent was not patentable subject matter due to its offensiveness, as it could give cause to disrespect the government which sanctioned such an item).

<sup>107</sup> See Patentability.{link it}

<sup>108</sup> *In re Carletti*, 328 F.2d 1020 (CCPA 1964).

<sup>109</sup> *Barofsky v. General Elec. Corp.*, 396 F.2d 340 (9<sup>th</sup> Cir. 1966).

<sup>110</sup> See Infringement {link}

<sup>111</sup> See Trademarks {link}

<sup>112</sup> *Gorham Mfg. Co. v. White*, 81 U.S. 511 (1872).

<sup>113</sup> See Copyrights {link}

<sup>114</sup> See Trademarks {link}

<sup>115</sup> *Maxer v. Stein*, 347 U.S. 201 (1954).

<sup>116</sup> *In re Yardley*, 493 F.2d 1389 (CCPA 1974). See also 37 CFR 1.71(d) and (e) and 1.84(o).

<sup>117</sup> *Traffix Devices, Inc. v. Marketing Displays, Inc.*, 2001 U.S. LEXIS 2457 (March 20, 2001).

<sup>118</sup> *Bonito Boats, Inc. v. Thundercraft Boats, Inc.*, 489 U.S. 141.