

University of New Hampshire
University of New Hampshire Scholars' Repository

Space Science Center

Institute for the Study of Earth, Oceans, and Space
(EOS)

10-1995

Development of an orthogonal-stripe CdZnTe gamma radiation imaging spectrometer

John R. Macri

University of New Hampshire - Main Campus, John.Macri@unh.edu

Boris A. Apotovsky

DIGIRAD

J F. Butler

DIGIRAD

M L. Cherry

Louisiana State University - Baton Rouge

Brian K. Dann

University of New Hampshire - Main Campus

See next page for additional authors

Follow this and additional works at: <https://scholars.unh.edu/ssc>

 Part of the [Astrophysics and Astronomy Commons](#)

Recommended Citation

Macri, J.R.; Apotovsky, B.A.; Butler, J.F.; Cherry, M.L.; Dann, B.K.; Drake, A.; Doty, F.P.; Guzik, T.G.; Larson, K.; Mayer, M.; McConnell, M.L.; Ryan, J.M., "Development of an orthogonal-stripe CdZnTe gamma radiation imaging spectrometer," Nuclear Science Symposium and Medical Imaging Conference Record, 1995., 1995 IEEE , vol.1, no., pp.174,178 vol.1, 21-28 Oct 1995.

This Conference Proceeding is brought to you for free and open access by the Institute for the Study of Earth, Oceans, and Space (EOS) at University of New Hampshire Scholars' Repository. It has been accepted for inclusion in Space Science Center by an authorized administrator of University of New Hampshire Scholars' Repository. For more information, please contact nicole.hentz@unh.edu.

Authors

John R. Macri, Boris A. Apotovsky, J F. Butler, M L. Cherry, Brian K. Dann, A Drake, F P. Doty, T G. Guzik, K Larson, M Mayer, Mark L. McConnell, and James M. Ryan

Development of an Orthogonal-Stripe CdZnTe Gamma Radiation Imaging Spectrometer

J.R. Macri¹, B.A. Apotovsky³, J.F. Butler³, M.L. Cherry², B.K. Dann¹, A. Drake¹
 F.P. Doty³, T.G. Guzik², K. Larson¹, M. Mayer¹, M.L. McConnell¹, J.M. Ryan¹

¹ Space Science Center, University of New Hampshire, Durham, NH 03824 USA

² Department of Physics and Astronomy, Louisiana State University, Baton Rouge, LA 70803 USA

³ DIGIRAD, San Diego, CA 92121-2410 USA

Abstract

We report performance measurements of a sub-millimeter resolution CdZnTe strip detector developed as a prototype for astronomical instruments operating with good efficiency in the 30-300 keV photon energy range. The prototype is a 1.4 mm thick, 64×64 contact stripe CdZnTe array of 0.375 mm pitch in both dimensions. Pulse height spectra were recorded in orthogonal-stripe coincidence mode which demonstrate room-temperature energy resolution < 10 keV (FWHM) for 122 keV photons with a peak-to-valley ratio $> 5:1$. Good response is also demonstrated at higher energies using a coplanar grid readout configuration. Spatial resolution capabilities finer than the stripe pitch are demonstrated. We present the image of a ^{133}Ba source viewed through a collimator slit produced by a 4×4 stripe detector segment. Charge signals from electron and hole collecting contacts are also discussed.

I. INTRODUCTION

The next step in the development of hard x-ray telescopes for astronomical imaging will require improvements both in angular resolution and in energy resolution. Refs. [1, 2]. A common approach to imaging at these energies involves coded aperture imaging techniques, where the angular resolution depends directly on the spatial resolution of the detector plane. Ref. [3]. Imaging detectors constructed of CdZnTe, Refs. [4, 5, 6, 7, 8], represent a strong candidate technology for achieving both improved angular and energy resolution with

high stopping power in compact packages operating without the need for cryogenic cooling.

II. PROTOTYPE STRIP DETECTOR

The prototype strip detector, manufactured by DIGIRAD of San Diego, CA consists of a monolithic $\text{Cd}_{0.9}\text{Zn}_{0.1}\text{Te}$ substrate measuring 26×26 mm by 1.4 mm thick with 64 parallel gold stripe contacts and two guard stripes orthogonally patterned on each surface. The stripe pitch and thus pixel definition is 0.375 mm in both dimensions, with an effective imaging area of 576 mm^2 . The CdZnTe array is mounted in a PCB carrier with contacts to all stripes in a standard pin grid array pattern to facilitate safe handling and testing in a variety of configurations.

III. TEST SETUP

Figure 1 illustrates the laboratory setup for the prototype strip detector tests. Conventional laboratory electronics (charge sensitive preamplifiers, NIM and CAMAC amplifiers and ADCs) read out the signals and record the data. All stripes on each detector surface are biased to assure a uniform electric field in the CdZnTe. Three neighboring contact stripes on each surface (X1, X2, X3 and Y1, Y2, Y3) are selected for signal processing. Signals from the middle stripe of the three stripes on each surface (X2 and Y2) are directed to a lower level discriminator and coincidence logic that in turn provides a strobe to the ADC. Six pulse heights are recorded for each registered event.

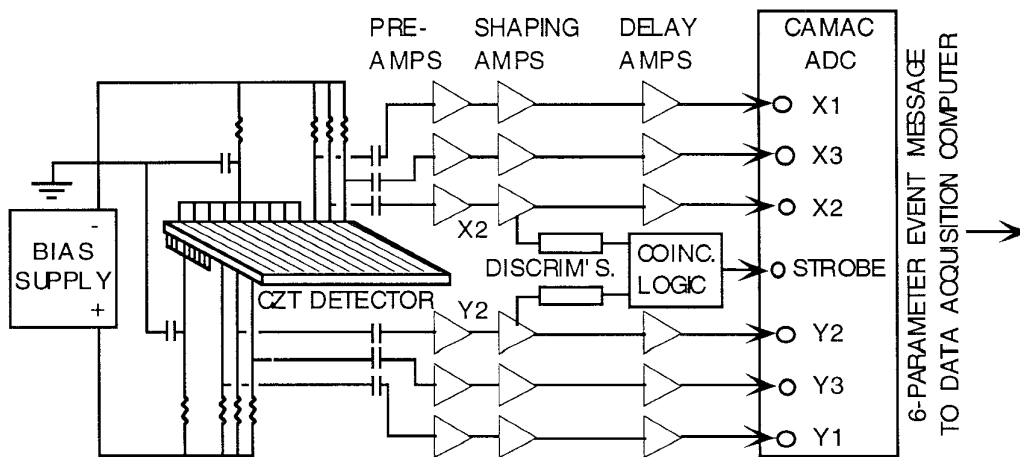

Figure 1. Test setup (orthogonal stripe coincidence mode)

The detector was uniformly illuminated from the negatively-biased side and all measurements were performed at room temperature.

IV. TEST RESULTS

A. Energy response (orthogonal -stripe coincidence mode)

Figure 2 illustrates the response of a single stripe (Y2 in our setup) to 122 keV photon interactions along its full length. The response has characteristics similar to those of a more conventional single-contact CdZnTe slab detector where a broad distribution of events with pulse heights below the photopeak is observed. Ref. [4].

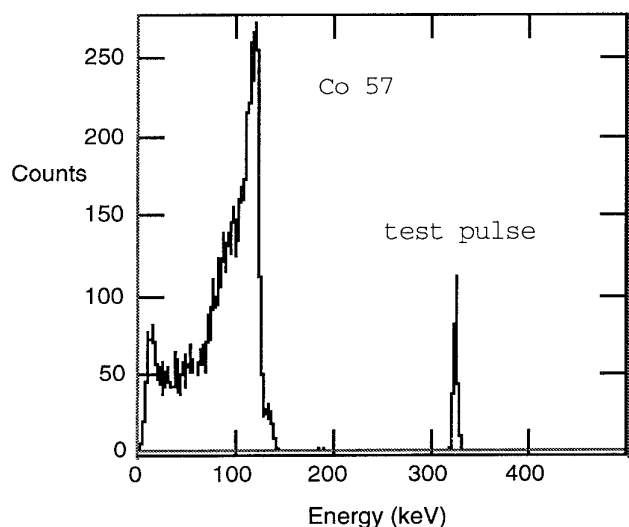

Figure 2. ^{57}Co response. Single stripe, ungated by coincidence with a stripe in the orthogonal dimension. 26 mm length, 0.375 mm width.

The energy response of the stripe is considerably improved, however, when events are localized along its length by requiring a trigger coincidence with an orthogonal contact stripe (X2) on the detector's opposite surface. We call the overlapping area of the two orthogonal stripes a "pixel." Figure 3 is the response at 122 keV of this 0.375×0.375 mm "pixel" defined by the X2-Y2 stripe coincidence.

Using this technique we have demonstrated strip detector "pixel" spectra exhibiting well defined photopeaks across the energy range from 30 to 662 keV. Ref. [4]. The response compares well to that of a similar size pixel from a pixel array detector reported in Ref. [9] although the energy resolution with the strip detector is not as good.

As described in Refs. [10, 11] for pixel geometries, careful segmenting of the contacts reduces the effects of hole trapping on the output. This "small pixel effect" results in energy spectra with significantly improved photopeak definition. Our results suggest that similar arguments can be applied to strip detectors.

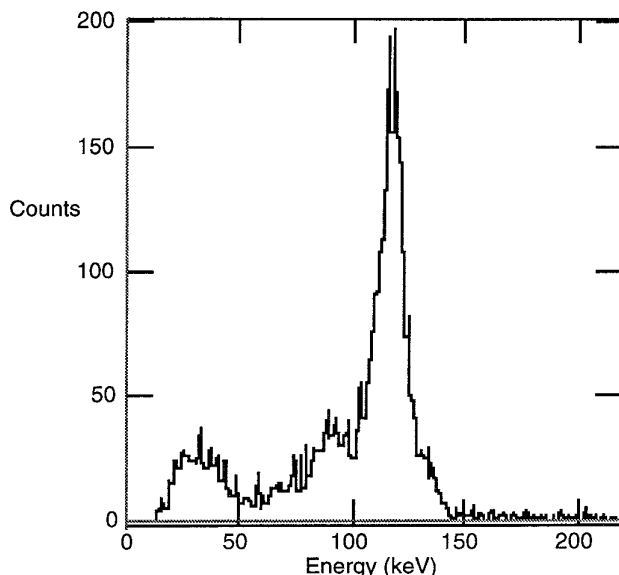

Figure 3. ^{57}Co response. Single "pixel", 0.375×0.375 mm, defined by X-Y coincidence. FWHM: 9.8 keV at 122 keV (test pulse 5.5 keV, not shown).

B. Signal distribution and summing of signals

Further data analysis reveals the potential for both improved position determination and energy response. Figure 4a is an event-by-event scatter plot of the pulse height from stripe Y1 vs. the corresponding pulse height measured from Y3, the neighboring stripe on the other side of the trigger stripe, Y2.

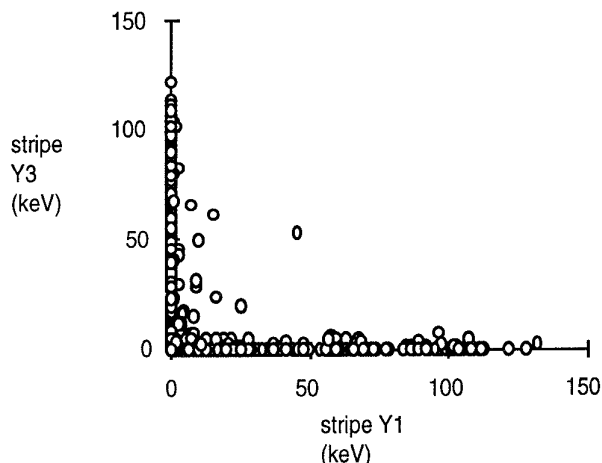

Figure 4a. Event-by-event distribution of ^{57}Co signal among stripes adjacent to the coincidence trigger stripe, Y2

The data indicate that for most events this charge is either fully collected on the trigger stripe or shared with one, but not both, of its neighbors.

Figure 4b. is a scatter plot of the trigger stripe pulse height (Y2) vs. the sum of the pulse heights from it's two neighbors (Y1+Y3).

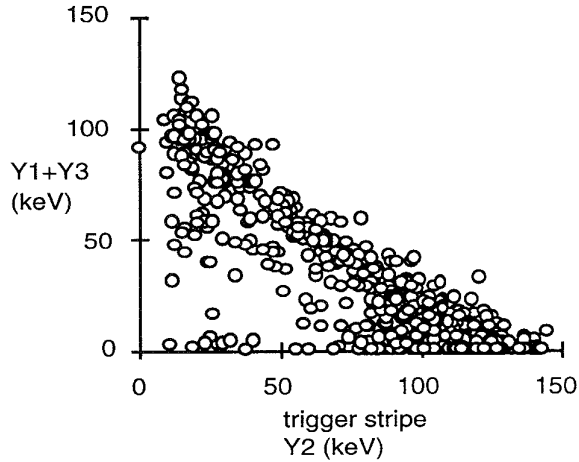

Figure 4b. Event-by-event distribution illustrating ^{57}Co signal sharing between the trigger stripe, Y2, and its neighbors

We see in Figure 4b that the full charge signal from 122 keV photon interactions triggering the central trigger stripe is shared between the trigger stripe and its nearest neighbors. These observations suggest that by 1) using the neighboring stripe pulse heights the strip detector data can be used to locate individual events more precisely than the 0.375 mm stripe pitch and 2) summing the signal contributions from neighboring stripes the strip detector can provide a more efficient total energy measurement of each event.

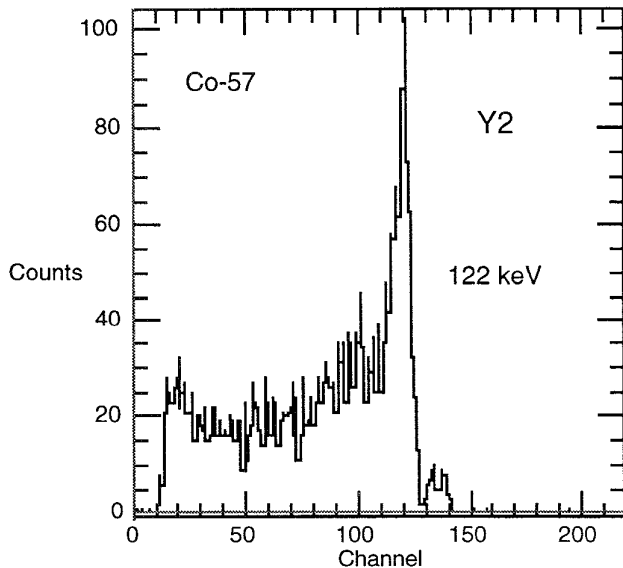

Figure 5a. 3355 ^{57}Co events. Distribution of trigger stripe (Y2) pulse height only. Single "pixel" defined by X2-Y2 coinc.

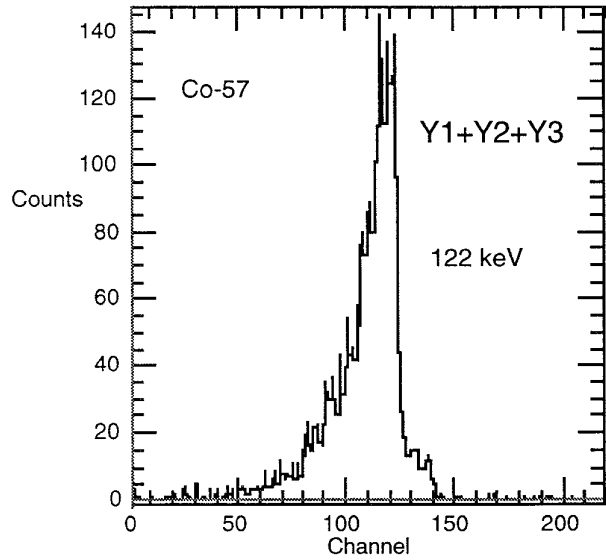

Figure 5b. Same 3355 ^{57}Co events. Distribution of sum of pulse heights, trigger stripe plus adjacent stripes.

Figures 5a and 5b show the ^{57}Co response of a single trigger stripe (Y2) in coincidence and the distribution of these same events when the pulse heights of the two adjacent neighbors (Y1 and Y3) are added. Summing the signal significantly enhances the population of the photopeak. The energy resolution is, however, degraded in this test since the separate amplifier gains were not optimally matched and noise from all three amplifier channels was present. Similar distributions were recorded in laboratory tests over the 30 to 662 keV energy range. Ref. [4].

C. Energy response (coplanar grid configuration)

Figure 6 is a ^{137}Cs spectrum obtained from 8 consecutive stripes of the prototype strip detector using a coplanar grid approach adapted from that described in Ref. [12]. By applying the coplanar grid technique the effects of poor hole collection are compensated yielding dramatic improvement in the energy response.

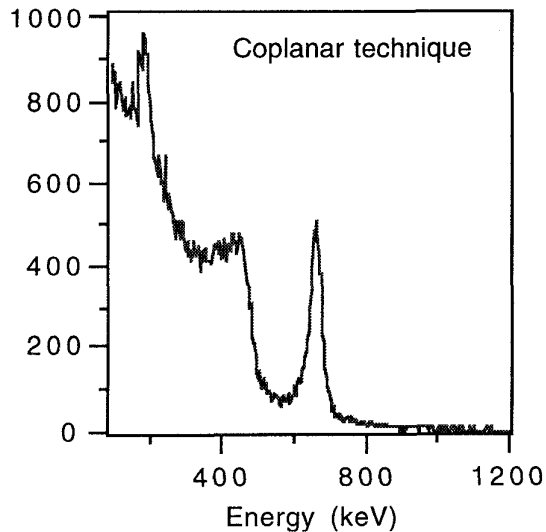

Figure 6. ^{137}Cs response. Spectrum from eight consecutive stripes of the prototype strip detector operating in coplanar grid mode. FWHM: 39 keV at 662 keV.

D. Imaging

The test setup was expanded to eight channels to read out a 4×4 stripe, 16 "pixel", region of the strip detector for an imaging demonstration. In addition to the slow signal processing chain illustrated in Figure 1, each channel now includes a fast signal processing chain with a timing filter amplifier and a level discriminator.

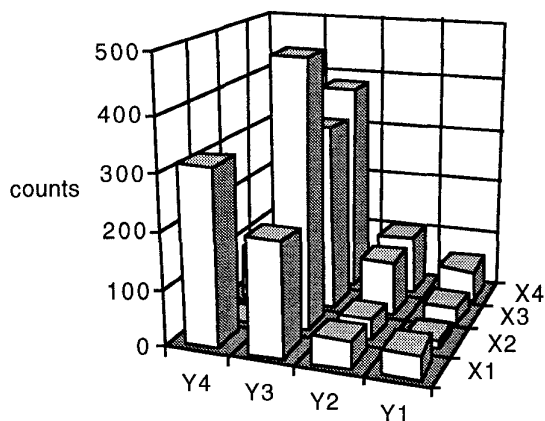

Figure 7. 4×4 stripe image of ^{133}Ba source viewed through a 0.33 mm wide slit in a tungsten collimator. Stripe pitch is 0.375 mm.

With this modification to the setup an X-Y coincidence in any "pixel" will trigger the ADC for event processing thus establishing a small detector region configured for imaging.

Figure 7 is the image of a ^{133}Ba source viewed by this detector region through a slit in a tungsten collimator. The 0.33 mm wide collimator slit runs across the imaging region at a slight angle relative to the electron collecting (Y) stripes.

Finer imaging demonstrations will require improved source/collimator configurations and more channels of lower noise readout electronics than are presently available in our laboratory.

E. Charge signals

The rise times and shapes of signals from the charge sensitive preamplifiers are indicators of the depth of the interaction within the detector as governed by the charge transport and collection mechanisms. Careful study of these signals and modeling of the mechanisms for CdZnTe strip detectors as discussed in Ref. [13] is important for further development of these detectors and their associated electronics. Figure 8 shows coincident electron and hole signal traces for one event. Electron signal rise times in this set of observations, which used an uncollimated ^{137}Cs source with a 200 volt detector bias, ranged from 50-400 n.sec. For hole signals the observed range was 50- 2000 n.sec.

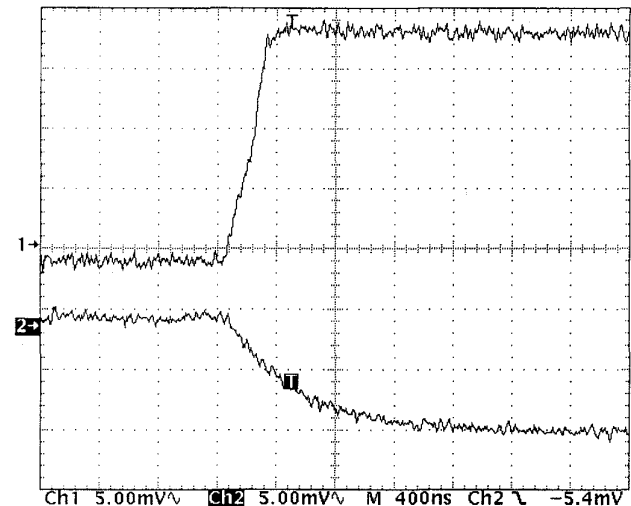

Figure 8. Charge sensitive preamplifier (Ortec model 142A, inverting) outputs for coincident electron (upper trace) and hole (lower trace) signals. Time scale is 400 n.sec/div.

V. CONCLUSIONS

The performance capabilities of CdZnTe strip detectors are well suited to applications in gamma-ray imaging spectrometers. They have good stopping power as well as good energy and spatial resolution as demonstrated here with available laboratory electronics. Good energy response with clear photopeaks in the 30 keV to 662 keV range as well as energy resolution < 10 keV FWHM at 122 keV and spatial resolution < 0.375 mm have been achieved. An $N \times N$

orthogonal stripe detector module requires $2N$ signal processing channels and can achieve performance comparable to pixel detectors requiring N^2 channels.

In addition to seeking finer energy resolution and imaging demonstrations we are investigating charge transport and signal characteristics for electrons and holes, the uniformity of the detector's response, its timing characteristics and its efficiency in the X-Y coincidence mode. These experiments are in progress and will be reported later.

The goal of developing these detectors is to employ them in large area imaging planes as the central element of hard x-ray astronomical telescopes. A big challenge is to implement such detectors in compact modules that include signal processing electronics with appropriate analog, timing and digital functions.

VI. ACKNOWLEDGMENTS

This work is supported by a 1993 Supporting Research and Technology grant under NASA's High Energy Astrophysics Gamma Ray Astronomy Research and Analysis program.

We thank Dr. Brad Barber at the University of Arizona Health Sciences Center and Dr. Louis-André Hamel at the University of Montreal for helpful discussions.

VII. REFERENCES

- [1] M. L. Cherry, et al., "A New Balloon-Borne Detector for High Angular Resolution Hard X-Ray Astronomy", in *Proceedings, 24th International Cosmic Ray Conference*, Rome, August 1995.
- [2] A. Parsons, et al., "Room Temperature CdZnTe and HgI₂ Detectors for Hard X-Ray Astrophysics", in *Conference Record, IEEE NSS, 94CH35762*, Vol. 2 (1994) 781.
- [3] G.K. Skinner, "Imaging of Cosmic X-Ray Sources Using Coded Mask Techniques", *Nucl. Instr. and Meth.*, 221 (1984) 33, .
- [4] J. M. Ryan et al., "Large area sub-millimeter resolution CdZnTe strip detector for astronomy", in *Proceedings, SPIE-International Symposium on Optical Science Engineering and Instrumentation*, San Diego, CA, July 1995.
- [5] F. P. Doty, et al., "Properties of CdZnTe crystals grown by a high pressure Bridgman method", in *Proc. 1991 U. S. Workshop on the Physics and Chemistry of HgCdTe and Other II-VI Compounds, Journal of Vacuum Science and Technology B*10 (1992) 1418,
- [6] J. F. Butler, et al., "Progress in Cd_{1-x}Zn_xTe radiation detectors", in *Proc. Semiconductors for room temperature radiation detector applications, Mat. Res. Soc.* 302 (1993) 497, .
- [7] F. P. Doty, et al., "X-Ray and Gamma Ray Imaging with Monolithic CdZnTe Detector Arrays", in *Proceedings, SPIE-OE/Aerospace Sensing*, 1945 (1993) 145.
- [8] R. Polichar, et al., "Development of CdZnTe energy selective arrays for industrial and medical radiation imaging", *Nucl. Instr. and Meth A* 353 (1994) 349,
- [9] F. P. Doty, et al., "Pixellated CdZnTe detector arrays", *Nucl. Instr. and Meth A* 353 (1994) 356,
- [10] H. H. Barrett, J. E. Eskin and H. B. Barber, "Charge transport in arrays of semiconductor gamma-ray detectors", *Phys. Rev. Lett.* 75(1) (1995) 156.
- [11] L.A. Hamel, S. Paquet, "Charge transport and signal generation in CdTe pixel detectors", in *Proceedings of 9th International Workshop on Room Temperature Semiconductor X and Gamma Ray Detectors, Associated Electronics and Applications*, Grenoble, France, September 1995, to be published.
- [12] P. N. Luke, *IEEE Trans. Nucl. Sci.* Vol.42, no.4 (1995) 207
- [13] L.A. Hamel, et al., "Signal Generation in CZT Strip Detectors", in *Conference Record, IEEE NSS*, San Francisco, CA, October 1995, to be published.