

Georgia State University
ScholarWorks @ Georgia State University

Biology Dissertations

Department of Biology

7-28-2009

The Neuroendocrinology of Seasonal Aggression in Female Syrian Hamsters

Stephanie Gutzler

Follow this and additional works at: https://scholarworks.gsu.edu/biology_diss

 Part of the [Biology Commons](#)

Recommended Citation

Gutzler, Stephanie, "The Neuroendocrinology of Seasonal Aggression in Female Syrian Hamsters." Dissertation, Georgia State University, 2009.

https://scholarworks.gsu.edu/biology_diss/61

This Dissertation is brought to you for free and open access by the Department of Biology at ScholarWorks @ Georgia State University. It has been accepted for inclusion in Biology Dissertations by an authorized administrator of ScholarWorks @ Georgia State University. For more information, please contact scholarworks@gsu.edu.

THE NEUROENDOCRINOLOGY OF SEASONAL AGGRESSION
IN FEMALE SYRIAN HAMSTERS

by

STEPHANIE GUTZLER

Under the Direction of Dr. H. Elliott Albers

ABSTRACT

Aggression is a feature of many clinical disorders including autism, Alzheimer's disease, bipolar disorder, and schizophrenia. The available treatment options act to prevent impulsive aggression through modulation of GABAergic and dopaminergic pathways which come with metabolic and dyskinetic side effects. The mechanism underlying aggressive motivation, however, has not been elucidated. In addition, previous studies have been heavily biased towards males of various species. Mimicking changes in day length, or photoperiod, in the laboratory is a natural manipulation used to examine seasonal changes in aggressive behavior in many species. In response to the reduction in the duration of light exposure, animals undergo gonadal regression and become reproductively quiescent. During this non-breeding season in male photoperiod-responsive animals, aggressive behavior increases significantly. Although studies have shown

offensive aggression remains elevated in female rodents, seasonal regulation of this behavior in females has not been thoroughly studied. The neuropeptide arginine-vasopressin (AVP) has been implicated in the facilitation of aggressive behavior in male rodents and fishes; therefore, it is useful to examine AVP as a modulator of seasonal aggression in females. Because the actions of AVP in female social behavior may be hormonally-dependent, we investigated the hormonal mechanisms that regulate the expression of AVP receptors and the behavioral actions of AVP on aggression. In addition to changes in gonadal steroid hormones during the non-breeding season, we identified photoperiod-dependent alterations in adrenal hormone secretion as AVP plays a role in regulation of hypothalamic-pituitary-adrenal axis (HPA) activity and anxiety-like behaviors in animal models.

INDEX WORDS: Seasonal aggression, Arginine-vasopressin, HPA, Photoperiod, Steroid hormones

THE NEUROENDOCRINOLOGY OF SEASONAL AGGRESSION
IN FEMALE SYRIAN HAMSTERS

by

STEPHANIE GUTZLER

A Dissertation Submitted in Partial Fulfillment of the Requirements for the Degree of

Doctor of Philosophy
in the College of Arts and Sciences
Georgia State University

2009

Copyright by
Stephanie Gutzler
2009

THE NEUROENDOCRINOLOGY OF SEASONAL AGGRESSION
IN FEMALE SYRIAN HAMSTERS

by

STEPHANIE GUTZLER

Major Professor: H. Elliott Albers, Ph.D.

Committee: Timothy J. Bartness, Ph.D.
Anne Murphy-Young, Ph.D.
Larry J. Young, Ph.D.

Electronic Version Approved:

Office of Graduate Studies
College of Arts and Sciences
Georgia State University
August 2009

DEDICATION

This dissertation is dedicated to *Mary Karom*, without whom none of this work would have ever come to fruition. Thank you for teaching me countless lessons in the laboratory, but also for always lending an ear (for my endless venting) or a shoulder to cry on. For the past six years, you have always been honest in your opinions regarding my work and ideas. Thank you for providing laughter through the good, the bad, and (sometimes) the ugly. You have been a pleasure to work with and are truly one of the most talented scientists I have ever met as well as one of my best friends.

ACKNOWLEDGEMENTS

Thank you to my family and friends, your support and belief that I could be successful got me through these past six years. My parents, Arthur and Joanne Gutzler, you've inspired me to be to try to become the best person that I know how and I hope I have done well by you. My brother, Aaron, you have been supportive every step of the way yet always manage to remind me not to take myself too seriously. You never cease to make me laugh when I have needed it the most. To my friends "from home", especially Carey Brown, Lou Haverty, Greg McGlone, Theresa Nguyen, Jim Ronan, and Gen Sloan, every time any of us visit each other it's as if no time has passed at all. The friends I have made "down here", particularly Lindsay Gurbacki, Nicole Hines, and Tami Menard, you have supported me in every state of mind, including my Philadelphia sports-induced episodes of mania. My boyfriend, Bryan Hoey, I could never have finished this degree without your support.

Thank you to the Kell Hall crew past and present: Laura Been, Emily Bruggeman, Dr. Kelli Adams-Duncan, Dr. Desiree Krebs-Kraft, Dr. Stacie Lin-Taylor, Pam Maras, Joe Normandin, and Amy Ross. Dr. Ed Rodgers, you have been the big brother I never had during these past 6 years. Thank you for your never-ending patience with my incessant questioning about every aspect of graduate school and life outside the lab. To the lovely ladies I worked with as a BGSA representative: Dr. Jeanetta Holley, Dr. Trudy Tucker, and Christie Carter, thank you all for being optimistic, flexible, and fun to work with.

Thank you to the faculty and staff of the Biology Department at Georgia State University for your support of me both as a student and as a person. A special thank you to LaTasha Morrison-Warren, I don't know what I would've done without you to tell me what I needed to hand in and when it needed to be there. Additional thanks to Dr. Ann Massey and Kathy

Rockwell, the best TA Coordinators a girl could ask for! I have also had the pleasure of working with two committees throughout my time in the Biology program. My qualifying exam committee, Drs. Timothy Bartness, Charles Derby, and Kyle Frantz, you pushed me to the limits of my abilities during the months we worked together. Thank you for showing me that I still had a lot to learn and encouraging me to believe that my goals were, not only possible, but within reach. A big thank you to my dissertation committee; each of you has influenced my education in the most positive ways possible. Dr. Tim Bartness, there's a reason I've had you on every committee. I know with you around I'll never forget that I'm actually trying to disprove my hypothesis (and to sleep with said hypothesis, but not marry it!). Dr. Anne Murphy-Young, you are one of the most talented teachers I've ever had and I appreciate your encouragement through every step of my career at GSU. Dr. Larry Young, you've taught me to be confident and aware of my abilities. Your insight has provided numerous "ah-ha" moments for me in our discussions. To Dr. Elliott Albers, my advisor, thank you for giving me the opportunity to work in your lab even though it meant taking on a crazy student that wanted to study females, four days estrous cycles and all.

Last, but not least, thank you to Dr. Kurt Wallen, my advisor in Psychology at Neumann College, who encouraged me to take on a double major, apply to summer research programs, and finally, attend graduate school. Our visits today are still as educational and inspiring as they were all those years ago when I was a college freshman.

TABLE OF CONTENTS

ACKNOWLEDGEMENTS	v
LIST OF TABLES	ix
LIST OF FIGURES	x
LIST OF ABBREVIATIONS	xii
CHAPTER	
1. GENERAL INTRODUCTION	1
Sex differences in aggression and clinical significance	2
Vasopressin, hormones, and aggression	4
The role of the pineal gland in photoperiod responsiveness	8
Seasonal effects on hormone production and aggressive behavior	9
Specific aims: Seasonal effects on neuroendocrinology of aggression	11
2. PHOTOPERIOD REGULATION OF V1A RECEPTOR BINDING DENSITIES AND BEHAVIORAL ROLE OF V1A RECEPTORS ON AGGRESSION	14
Abstract	14
Introduction	15
Materials and methods	17
Results	27
Discussion	40
Supplemental experiments	44
Acknowledgements	49
3. PHOTOPERIOD REGULATION OF ADRENAL HORMONE SECRETION AND AGGRESSION IN FEMALE SYRIAN HAMSTERS	51
Abstract	51

Introduction	51
Materials and methods	55
Results	60
Discussion	71
Acknowledgements	78
4. GENERAL DISCUSSION	79
Vasopressin and aggression	80
Photoperiod-dependent changes in adrenal androgen secretion	82
Photoperiod-dependent changes in behavioral responsiveness to estradiol	84
A proposed neuroendocrine model of female aggressive behavior	85
LITERATURE CITED	91
APPENDIX: CURRICULUM VITAE	103

LIST OF TABLES

Table 2.1:	Criteria used to score aggressive behavior	23
Table 2.2:	Effects of estrous cycle state on estradiol concentrations (mean \pm s.e.m.)	26
Table 2.3:	Areas quantified for V1aR binding densities over the course of the four-day estrous cycle (mean \pm s.e.m.)	30
Table 2.4:	Effects of photoperiod on estradiol concentrations (mean \pm s.e.m.)	30
Table 3.1:	Criteria used to score aggressive behavior & intensity	58
Table 3.2:	Concentrations of estradiol, DHEA, and DHEAS during the estrous cycle (mean \pm s.e.m.)	61
Table 3.3:	Estradiol concentrations of LP and SP treatment groups (mean \pm s.e.m.)	62

LIST OF FIGURES

Figure 2.1:	V1aR binding densities vary throughout the estrous cycle in different regions of the limbic system.	28
Figure 2.2:	V1aR binding densities in subregions of the limbic system increase in response to short photoperiod conditions.	31
Figure 2.3:	Representative autoradiographs from females housed in either LP or SP conditions.	32
Figure 2.4:	Administration of the V1aR antagonist, 45 μ M Manning compound, into the AH showed increased aggression compared to microinjection of saline.	34
Figure 2.5:	Dose-response curve for the effects of Manning compound on measures of aggression in female Syrian hamsters.	35
Figure 2.6:	Aggression does not vary in a dose-dependent manner in response to AVP administration.	38
Figure 2.7:	The effects of AVP and the V1aR antagonist on aggression are not photoperiod-dependent.	39
Figure 2.8:	Manning compound elicits increases in aggression on proestrus.	46
Figure 2.9:	The V1aR antagonist does not show an effect on lordosis behavior on the day of estrus.	48
Figure 3.1:	Effects of photoperiod on circulating DHEA, DHEAS, and cortisol concentrations across time.	63
Figure 3.2:	Effects of photoperiod and treatment on the duration of social behavior and the latency to attack.	65
Figure 3.3:	Effects of photoperiod and treatment on the duration of aggression and the duration of high and low intensity aggression.	66
Figure 3.4:	Effects of photoperiod and treatment on the percentages of high and low intensity aggression.	68
Figure 3.5:	Effects of photoperiod and treatment on attack number and duration per attack.	70
Figure 3.6:	Adrenal hormone concentrations following an aggressive encounter.	72

- Figure 4.1: AVP modulates sexual behavior as a function of hormonal fluctuations during the estrous cycle. 87
- Figure 4.2: A proposed mechanism that regulates aggression in female hamsters during the non-breeding season. 90

LIST OF ABBREVIATIONS

ADX	Adrenalectomized
AH	Anterior Hypothalamus
AVP	Arginine-vasopressin
BNST	Bed nucleus of the stria terminalis
CeA	Central amygdale
DHEA	Dehydroepiandrosterone
DHEAS	Dehydroepiandrosterone sulfate
E ₂	Estradiol
EB	Estradiol benzoate
ER	Estrogen receptor
ERE	Estrogen response element
GABA	Gamma-aminobutyric acid
GDX	Gonadectomized
GPCR	G-protein coupled receptor
HPA	Hypothalamic-pituitary-adrenal axis
HPG	Hypothalamic-pituitary-gonadal axis
LP	Long photoperiod
LS	Lateral septum
MPOA	Medial preoptic area of the hypothalamus
OVX	Ovariectomized
SON	Supraoptic Nucleus
SP	Short photoperiod

T	Testosterone
V1aR	V1a receptors
V1bR	V1b receptors
VLH	Ventrolateral hypothalamus

CHAPTER 1: GENERAL INTRODUCTION

Aggression is a social behavior that is carried out with the intent to harm a target (Moyer, 1976). In the general population, men tend to exhibit more physical aggression compared to women, including homicides and violent crimes (Maccoby and Jacklin, 1974). Overall, adult female aggression mainly affects victims socially and psychologically, with women showing tendencies to utilize aggression as a form of social manipulation. While members of both sexes possess the abilities to exhibit many forms of aggression, these gender-based discrepancies support the idea that the expression of the majority of aggressive behaviors may be sex-specific. From an anthropological standpoint, these differences may be based on strategies that enhance access to mates and resources necessary for reproductive success. Over time, societal definitions of gender-typical behaviors have determined that dominance is an important male characteristic but not a desired trait in females (Dawson and McIntosh, 2006). Males are more likely to attain and display their dominance through physical aggression whereas females utilize indirect aggression to promote a desired outcome. Furthermore, aggression is a context-dependent behavior and is most often characterized as reactive or proactive in human subjects (Lopez-Duran et al., 2008; Connor et al., 2003). Analogous to this characterization, the terms defensive and offensive are also widely used to discuss aggression in non-human animals (for review: Blanchard et al., 2003; Blanchard and Blanchard, 1988). These categorizations allow researchers to specify and operationally define the contexts and components of aggression which they wish to observe. A major goal that the experiments included in this dissertation set out to accomplish was to develop a more thorough method for analyzing aggression in rodents than currently exists. Specifically, this dissertation focuses on investigating the neural, hormonal, and behavioral components of female territorial aggression as impacted by photoperiod. Studies

performed in male rodents and birds will also be discussed due to their contributions in the formation of my hypotheses.

Sex differences in aggression and clinical significance

Many studies support the idea that the neural and hormonal mechanisms that control aggression are sexually dimorphic. For example, estradiol plays a facilitatory role in seasonal aggression in males of various species (Trainor et al., 2007; Soma et al., 2000) but yields no effect on aggressive behavior in SP-housed females (Scotti et al., 2007; Elliott and Nunez, 1992). While there is a commonality between the brain regions that regulate aggression between males and females (Joppa et al., 1995; Kollack-Walker and Newman, 1995), there may be differences in the roles of hormones and neuropeptides responsible for activation or inhibition of these regions. To add to this complexity, female aggression across species takes on many forms due to context, i.e. maternal aggression (Erskine et al., 1978; Mayer and Rosenblatt, 1987), and is subject to regulation by hormones released in response to parturition, i.e. oxytocin (for review, Leng et al., 2008), as well as fluctuations of ovarian hormones throughout the four-day rodent estrous cycle (Takahashi and Lisk, 1983; Ciaccio et al., 1979; Floody and Pfaff, 1977).

Clinically, aggression is often a product of many psychiatric disorders including schizophrenia (Amore et al., 2008), bipolar disorder (Garno et al., 2008), autism (Malone and Waheed, 2009), and dementia (Brodsky et al., 2003). Impulsive aggression may also be a side effect due to traumatic brain injury (Johansson et al., 2008). In many of these cases, antipsychotic pharmaceuticals are used to reduce aggressive behaviors by targeting the receptor subtypes of several neurotransmitter systems including serotonin, dopamine and gamma-aminobutyric acid (GABA) (for review: Miczek et al., 2002). Aggressive behavior is most commonly treated with antipsychotics, such as risperidone and clozapine, which frequently cause

side effects such as weight gain and dyskinesia (Weinbrenner et al., 2009; Ertugul and Meltzer, 2003).

More recent studies have started to focus on the antecedents of aggressive behaviors, attempting to determine the state of the individual in order to prevent aggressiveness rather than trying to mask the expression of aggression as a symptom through inhibiting activity. For example, drugs that target the arginine-vasopressin (AVP) neurotransmitter system may provide relief of anxiety-related feelings and behaviors that precede displays of aggression. Recent work in rodent models has determined that antagonists of the vasopressin V1a and V1b receptor subtypes reduce aggression and anxiety in rodent models (Bleickardt et al., 2009; for review: Simon et al., 2008; Hodgson et al., 2007; Blanchard et al., 2005). In particular, antagonism of V1b receptors (V1bR) has been associated with reductions in stress-induced concentrations of adrenocorticotrophin hormone (ACTH) released from the pituitary, supporting the idea that hormonal responses to anxiety are regulated through central actions of vasopressin (Serradeil-Le Gal et al., 2005). One major downfall of this research, however, is that many of these studies have either used exclusively male subjects or have neglected to analyze possible sex differences in behavioral responses to antagonism of vasopressin receptors. One notable exception to this statement is a study done by Bielsky et al. (2004) that demonstrated significant reductions in anxiety-like behavior in male V1aR knock-out (V1aRKO) mice which was followed up by Bielsky et al. (2005) confirming that this same reduction was not observed in female V1aRKO mice. This series of studies supports the idea that the central actions of AVP may be sexually dimorphic. Lending further support to this hypothesis are the sexual dimorphisms that exist in the AVP projections throughout the brain in rats and hamsters (for a review: de Vries and Panzica, 2006; Delville et al., 1994). In particular, male golden hamsters possess greater AVP-

immunoreactivity in subdivisions of the supraoptic nuclei (SON) as well as amounts of AVP detected in the hypothalamus and pituitary (Delville et al., 1994). Experimental investigation of possible sex differences in the mechanisms that regulate aggression may elucidate novel sex-specific treatment options and prevent side effects or hormonal disturbances in female patients that may result from pharmaceutical administration.

Vasopressin, hormones, and aggression

Vasopressin is a nonapeptide synthesized in the magnocellular and parvocellular neurons in the supraoptic and paraventricular nuclei of the hypothalamus (for reviews see: Birnbaumer, 2000; Barberis et al., 1998). There are three subtypes of AVP receptors: V1a, V1b, and V2. The actions of the V2 receptor subtype are localized in the kidney and are critical to its antidiuretic effects, while the V1a and V1b receptor subtypes are expressed both centrally and peripherally. AVP receptors belong to the superfamily of G-protein coupled receptors (GPCR) and are specifically coupled to G proteins of the Gq/G11 family (for a review: Barberis et al., 1998).

Across many species, the role of vasopressin (AVP) in a variety of social behaviors has been investigated extensively in hamsters (Cooper et al., 2005; Delville et al., 1996; Hennessey et al., 1994; Potegal and Ferris, 1990; Ferris and Potegal, 1988) and other species (Beiderbeck et al., 2007; Wersinger et al., 2007, Veenema et al., 2006; Bielsky et al., 2005; Hammock and Young, 2005). As a regulatory site for many relevant social behaviors, subregions of the hypothalamus have been implicated in flank marking and aggression in Syrian hamsters. Flank marking is a stereotyped scent-marking behavior performed by rubbing the sebaceous glands located on the dorsolateral flanks against vertical objects (Johnston, 1975). While both male and female hamsters display this behavior, females mark at greater frequencies in response to a conspecific odor (Albers and Prishkolnik, 1992). In addition to odor-stimulation, microinjection

with AVP in various hypothalamic sites induces intense bouts of flank marking (Ferris et al., 1984) and antagonism of V1a receptors attenuates the response (Albers et al., 1986), namely in the medial preoptic-anterior hypothalamus (MPOA-AH). Aggressive behavior, however, is thought to be regulated in a subregion of the AH posterior to this site. For example, in male Syrian hamsters, treatment with a specific V1aR antagonist in the AH reduces aggressive behavior towards a conspecific in a neutral arena (Potegal and Ferris, 1990; Ferris and Potegal, 1988). In addition, administration of a small dose of AVP into the AH of “trained fighters” is associated with a significant decrease in the latency to attack as well as an increase in the number of bites in the presence of an intruder conspecific (Ferris et al., 1997). Interestingly, aggression is also an example of a behavior shown at greater frequencies by female hamsters (Floody, 1983; Payne and Swanson, 1970). Differences in the vasopressin system, specifically in the regions controlling flank marking and aggression, have been well studied but the role of AVP in female territorial aggression has not been investigated.

It is not surprising that due to the documented sex differences in social behaviors that many studies have investigated the influence of hormones on vasopressin immunoreactivity, receptor densities and gene expression. For example, gonadectomy of male and female hamsters significantly reduces flank marking behavior while hormone replacement restores the behavior (Albers and Prishkolnik, 1992). The sex difference, however, is maintained with females consistently marking more in response to male stimulus scent regardless of estrous cycle stage. The greatest frequencies of flank marking in both sexes were in response to treatment with testosterone which suggests that sex differences in the behavior are not due to concentrations of circulating gonadal steroids (Albers and Prishkolnik, 1992). Conversely, the effects of gonadectomy on aggression are also subject to sex differences as a reduction in aggression in

males of many species occurs following castration (for a review: Soma et al., 2008; Hume and Wynne-Edwards, 2005; Potegal et al., 1980; Peters et al., 1972), while in females some studies have shown that aggressive behavior increases (Lisk and Nachtigall, 1988; Meisel et al., 1988; Fraile et al., 1987; Ciaccio et al., 1979; Vandenberg, 1971). Because both flank marking and aggressive behavior are impacted by gonadal hormones and vasopressin, much work has been dedicated to determining whether gonadal hormones elicit their effects on social behaviors through altering levels of AVP or its receptors.

Studies have shown that gonadal hormones influence behavioral responsiveness to vasopressin in the hypothalamus. Microinjection of AVP into the MPOA-AH of male Syrian hamsters stimulated flank marking in a dose-dependent manner in castrated males, but significantly higher amounts of flank marking were observed in castrates that received T implants (Albers et al., 1988). Castration also significantly reduces the amount of flank marking observed in response to microinjection of AVP into the central gray, however, T replacement is not sufficient to restore behavioral-induction by AVP in this region (Albers and Cooper, 1995). AVP-induction of aggressive behavior via microinjection into the ventrolateral hypothalamus is also T-dependent (Delville et al., 1996). AVP-immunoreactivity (AVP-i.r.), however, does not change following castration or exposure to short photoperiod conditions (Albers et al., 1991).

In females, the relationship between estradiol and AVP responsiveness has been well-studied. A study by Huhman and Albers (1993) found that ovariectomized (OVX) females implanted with estradiol-filled Silastic capsules flank marked significantly more in response to AVP than OVX females implanted with empty capsules. Intact, cycling female hamsters show fluctuations in flank marking comparable with cyclic fluctuations in hormones, with the lowest amounts of flank marking behavior occurring on the day of behavioral estrus (Albers et al.,

1996). Interestingly, AVP-i.r. does not change as a function of the hamster estrous cycle in the brain regions examined in Huhman and Albers (1993) which included the bed nucleus of the stria terminalis (BNST), paraventricular nucleus (PVN), supraoptic nucleus (SON), and the medial preoptic area (MPOA). Together, these studies support the idea that natural hormone-dependent changes in flank marking are not a product of a change in availability of vasopressin.

While many earlier studies tested whether AVP-i.r. was associated with hormone-dependent differences in behavioral responsiveness to AVP, studies in the last ten to fifteen years have focused on the effects of gonadal hormones on V1a receptor densities. A study done in male Syrian hamsters concluded that castration reduced V1aR binding densities in the posterior portion of the preoptic area/anterior hypothalamic continuum, a component of the MPOA-AH region, as well as the ventrolateral hypothalamus (Johnson et al., 1995). More recently, Young et al. (2000) investigated the effects of androgen on V1aR receptor binding densities and V1aR mRNA and found that castration significantly reduced both in the ventromedial portion of the medial preoptic nucleus (MPN) and portions of the MPOA adjacent to this nucleus. Additional sites that were analyzed included the lateral septum (LS) and bed nucleus of the stria terminalis (BNST), which showed abundant V1aR binding and mRNA signals, but only binding in the BNST showed a reduction following castration (Young et al., 2000).

To date, few studies have documented the effects of ovarian hormones on V1aR expression in females and none have explored the role of these receptors in female aggression. A study done by Delville and Ferris (1995) demonstrated that ovariectomy of female hamsters nearly abolished V1aR binding in the VLH, a site where AVP has been shown to stimulate aggression in males. In rats, estrogen treatment following ovariectomy increased V1aR mRNA in the anteroventral portion of the periventricular nucleus (PVNav) (Kalamatianos et al., 2004).

More recently, Caldwell and Albers (2004) determined that V1aR binding densities did not vary across the estrous cycle in brain areas of the flank marking and aggression circuits in intact female hamsters, but short photoperiod (SP) housing was associated with reductions in binding densities. The conclusions of each of these studies do not paint a clear picture of how ovarian hormones may regulate V1aR. It is possible that some anatomical regions show more sensitivity to ovarian hormones than others, for example, the VLH, or that there is differential expression within subareas of major regions, i.e. the PVNav. It is interesting, however, to note that these studies associated low estradiol concentrations, as in SP-housed or OVX females, with low V1aR binding densities. Low circulating concentrations of estradiol have been associated with heightened aggression and lead to the hypothesis that V1aR are not associated with stimulation of aggressive behavior in female hamsters. One of the goals of this dissertation was to further quantify V1aR binding densities across subareas of the regions implicated in aggression, and further, to characterize the role of AVP in this behavior.

The role of the pineal gland in photoperiod responsiveness

Animal models that are seasonal breeders provide a means to investigate aggressive behavior without the confound of circulating gonadal hormones, as reproductive quiescence occurs during the winter months in response to increased melatonin secretion from the pineal gland (for review: Tamarkin et al., 1985). The brain responds to changes in the environment through transduction of stimuli such as the duration of light exposure. These seasonal conditions can be mimicked in the laboratory by housing animals in short photoperiod (SP) conditions to represent the decrease in light exposure that accompanies the winter months in the natural environment (<12.5 h of light). Conversely, laboratory conditions that mimic the summer-like environment (>12.5 h of light) are known as long photoperiod (LP).

Concentrations of melatonin in plasma of seasonally-responsive animals are consequently decreased during the periods of longer day length seen in LP. Melatonin is necessary and sufficient for the transduction of the photoperiod signal as removal of the pineal gland attenuates the effect of reduced light exposure (for a review: Goldman, 2001). Rodent and avian species provide seasonally-responsive models in which to investigate mechanisms and relationships of photoperiod-driven changes in the brain, endocrinology, and behavior.

One such animal model that can be utilized in the laboratory to investigate seasonal regulation of hormonal and neural effects on aggression is the Syrian hamster. Though the reproductive abilities of these rodents are diminished in the winter months, the ability to express aggressive behaviors is maintained (Jasnow et al., 2000; Fleming et al., 1988). In male hamsters, studies have shown that aggression increases in hamsters housed in SP conditions compared to aggression that is displayed by animals maintained in LP conditions (Jasnow et al., 2000). In female hamsters, ratios of offensive to defensive behaviors have been identified as significantly greater in SP-housed animals compared to those housed in LP (Fleming, et al., 1988). This seasonal responsiveness translates to changes in the brain as well as the production of hormones and provides an avenue to explore how the environment impacts animals at these levels to produce behavioral alterations.

Seasonal effects on hormone production and aggressive behavior

Seasonal changes in the environment can yield profound changes in the endocrine physiology and behavior of many animals (for a review: Bartness et al., 1993). One critical component of the physiological homeostasis of many animals is the plasticity of the brain and the endocrinology it controls. This neural plasticity provides the framework for many feedback mechanisms that aid metabolic, reproductive, and behavioral processes. Because the endocrine

profile of an animal is critical to his/her expression of various social behaviors, including affiliation and reproduction, it follows that alterations in the hormonal state of an animal also affect these behavioral displays. For example, a female rodent will display receptive behavior towards a conspecific male once every four days in response to tactile stimulation. The optimal concentrations of ovarian hormones, estrogen and progesterone, therefore, serve to inhibit aggressive responding and, instead, stimulate sexual behavior (Takahashi and Lisk, 1985). This complex control of sexual motivation is absent in male rodents who are consistently available for consummation in the presence of a receptive female during the breeding season. Thus, in LP conditions, fluctuations in female hormone production throughout the four-day estrous cycle of the Syrian hamster impact the neural circuits that determine whether an animal will exhibit aggressive or sexual behaviors. In response to SP conditions, female Syrian hamsters undergo gonadal regression rendering them acyclic (Seegal and Goldman, 1975). The cyclic fluctuations of estradiol and progesterone are no longer maintained, but large diurnal fluctuations in serum gonadotropins are observed (Seegal and Goldman, 1975).

Following SP-induced acyclicity, female Syrian hamsters maintain an elevated state of aggression in response to a male or female conspecific (Elliott and Nunez, 1992; Fleming et al., 1988). Additionally, Fleming et al. (1988) determined that the ratios of offensive to defensive behaviors expressed by SP females were significantly greater than those shown by LP females. A study in females of a closely related species, Siberian hamsters, demonstrated that SP housing yielded the opposite effect on circulating estradiol (Scotti et al., 2007). Furthermore neither ovariectomy of both LP- and SP-housed females, nor treatment with estradiol and progesterone, affected any measure of aggression. Together, these studies suggest aggression in SP-housed females is independent of circulating gonadal steroids. The mechanism responsible for

maintenance of elevated aggression in SP conditions has not yet been elucidated, but may be regulated by an extragonadal source, such as the adrenal glands.

Specific aims: Seasonal effects on neuroendocrinology of aggression

Presently, it is thought that ovarian hormones play a major role in the inhibition of aggressive behavior in females, as studies have shown that ovariectomy increases aggression and treatment with estradiol attenuates the behavior (Carter et al., 1973; Ciaccio et al., 1979; Lisk & Nachtigall, 1988). Other studies have reported that ovariectomy has no effect on aggressive behavior (Takahashi and Lisk, 1983) or that ovariectomy reduces aggressive behavior (Payne and Swanson, 1972, 1971). To explain the reduction in sexual behavior that is accompanied by a consistent state of aggression in SP conditions, some studies have suggested that perhaps there is a reduction in sensitivity of estrogen receptors (ER) (Mangels et al., 1998; Badura and Nunez, 1989). An alternative explanation to this ER-driven hypothesis, however, is the possibility that photoperiod-dependent changes in vasopressin V1aR densities may contribute to the maintenance of aggression in SP-housed animals. To our knowledge, with the exception of a recent report by Nephew and Bridges (2008) which investigated the effects of a V1aR antagonist on maternal aggression, virtually nothing is known about the role of AVP in female aggression. More specifically, the role of vasopressin as a mediator of seasonal aggression in female hamsters has not been investigated. Chapter 2 of this dissertation includes a variety of studies performed to accomplish two major goals: a.) to investigate the role of vasopressin in female territorial aggression, and b.) to determine whether ovarian hormones regulate V1aR densities. We use photoperiod as a model for seasonal alterations in hormones and quantifiable changes in V1aR as well as to test the hypothesis that vasopressin affects female territorial aggression in a photoperiod-dependent manner.

A thorough review of the literature on female aggression reveals a lack of consistency on how the components of aggression are quantified. The reduction in sensitivity to estradiol in SP conditions has been documented (Elliott and Nunez, 1992; Badura and Nunez, 1988, Badura et al., 1987); however, whether this photoperiod-dependent effect is accompanied by increases in components of aggressive behavior has not been identified. Previous studies have confirmed that exposure of SP-housed, estradiol benzoate-treated female hamsters to a conspecific, sexually mature male results in an aggressive encounter quantified by the latency to attack (Elliott and Nunez, 1992; Badura and Nunez, 1989). Additionally, a study by Fleming et al. (1988) reported that SP-housed females attack same-sex conspecifics at equal frequencies compared to LP-housed females; however, animals housed in SP display reduced amounts of defensive behaviors. Chapter 3 of this dissertation aimed to quantify the photoperiod-dependent alterations in components of female aggression, such as the duration of high- and low- intensity aggression.

While it is clear that melatonin yields critical effects on the adrenal glands necessary for the physiological and behavioral changes associated with SP in various species (Demas et al., 2004; Paterson and Vickers, 1981), the impact of seasonal changes in adrenal hormones has not been investigated in female Syrian hamsters. Previous work in birds and Siberian hamsters support the idea that adrenal hormones, in particular dehydroepiandrosterone (DHEA), maintain elevated territorial aggression during the non-breeding season (Demas et al., 2004; Soma and Wingfield, 2001). A recent study in male Syrian hamsters confirmed that circulating concentrations of DHEA are, in fact, significantly higher following thirteen weeks of SP housing (Caldwell et al., 2008). The sulfated form of DHEA, DHEAS, has also been associated with increased levels of aggression in male mice (Nicolas et al., 2001), but to date, there is no information on whether photoperiod impacts the concentrations of this hormone. The adrenal

glands also secrete cortisol, a major glucocorticoid critical for HPA activity. The studies contained in Chapter 3 of this dissertation include investigation of photoperiod-dependent changes in the circulating adrenal hormones of interest, specifically DHEA, DHEAS, and cortisol in female Syrian hamsters. In addition to identifying hormonal changes associated with SP-exposure, we also examine whether estradiol affects the components of aggression in a photoperiod-dependent manner. We further compare the behavioral profiles of our EB-treated, sham-operated, and ovariectomized groups with their circulating adrenal hormone concentrations following an aggressive encounter.

Finally, Chapter 4 summarizes the findings of the studies contained in this dissertation and provides a theoretical model of how day length is transduced into changes in HPA and HPG activity to induce photoperiod-dependent changes in social behavior in females with a focus on aggression.

CHAPTER 2: PHOTOPERIOD REGULATION OF V1A RECEPTOR BINDING DENSITIES AND BEHAVIORAL ROLE OF V1A RECEPTORS ON AGGRESSION

Abstract

Aggression during the breeding season for female Syrian hamsters is dependent on estrous cycle stage. On the first day of diestrus (D1), females show the greatest levels of aggression. This behavior decreases as the animal approaches the day of sexual receptivity. The hormonal explanation for this decrease in aggression is that ovarian hormones increase following D1. During the non-breeding season, ovarian hormone production is significantly reduced and animals display a state of heightened aggression in conspecific encounters. Seasonal effects on hormones and behavior can be mimicked in the laboratory by housing animals in either summer-like, long photoperiod (LP) (>12.5 h of light per day) or winter-like, short photoperiod (SP) (<12.5 h of light per day). In the present study, we asked whether differences in V1a receptors (V1aR), shown to facilitate aggression in male hamsters, existed in subregions in the neural circuitry of female aggression dependent upon estrous cycle state or seasonality. We report that V1aR densities vary differentially throughout the aggression neural circuit. To determine the behavioral relevance of photoperiod-dependent differences in V1aR densities, we tested the ability of AVP and a V1aR antagonist to alter aggression in both LP and SP females. In LP females, we tested multiple doses of the V1aR antagonist and AVP to establish dose-response curves. Contrary to our hypothesis, a V1aR antagonist injected into the anterior hypothalamus (AH) increased aggression in a dose-dependent manner, with the exception of the highest dosage, which yielded no difference in aggression compared to all other treatments. AVP did not affect aggression in a dose-dependent manner, but significantly lower levels of aggression were found at the 0.9 μ M dosage. Comparisons of pharmacological manipulations in LP- and

SP-housed females revealed that photoperiod did not alter behavioral response to either the V1aR antagonist or AVP injection. These data suggest that V1aR play a role in aggressive behavior, but that photoperiod-dependent differences in aggression may be independent of changes in V1aR in the AH.

Introduction

The neuropeptide arginine-vasopressin (AVP) mediates many social behaviors in animals of both sexes across a variety of species (for review: Albers and Bamshad, 1998; Caldwell et al., 2008; Donaldson & Young, 2008). In particular, the relationship between aggression and AVP has been well-established in males of many rodent species such as hamsters (Albers et al., 2006; Cooper et al., 2005), mice (Bester-Meredith & Marler, 2001; Wersinger et al., 2002) and rats (Ferris, 2008; Veenema & Neumann, 2008). In male Syrian hamsters (*Mesocricetus auratus*), blocking the actions of AVP in the anterior hypothalamus (AH) via administration of a specific antagonist attenuates aggression (Ferris and Potegal, 1988; Potegal and Ferris, 1990). Conversely, microinjection of AVP into the AH was associated with an increase in the number of bites compared to when animals were administered a vehicle injection (Ferris et al., 1997). Additionally, AVP microinjection into the ventrolateral aspect of the hypothalamus (VLH) facilitates aggressive behavior in a hormone-dependent manner (Delville et al., 1996). To extend the evidence that the actions of AVP are hormone-dependent in males, V1aR mRNA expression in the medial preoptic nucleus (MPN) and V1aR binding densities in the bed nucleus of the stria terminalis (BNST), medial preoptic area (MPOA), and MPN change in a testosterone-dependent manner (Young et al., 2000). Brain areas that have reciprocal connection with the AH also show increased c-fos expression in male hamsters following an offensive encounter with a conspecific, including the BNST, medial amygdala (MeA), and VLH (Delville et al., 2000).

Seasonality impacts gonadal steroid hormones and V1aR binding densities in male and females leading to the assumption that V1aR binding decreases due to the change in day length, or photoperiod, as a result of the reductions in circulating testosterone (T) (Caldwell et al., 2008) and estradiol (E₂) (Caldwell and Albers, 2004). This positive correlation between estradiol and V1aR is further supported by data from ovariectomized rats that shows increased V1aR mRNA expression in the anteroventral periventricular nucleus following estrogen replacement (Kalamatianos et al., 2004). While AVP in this particular area influences the onset of reproductive behavior in rats, E₂ replacement in female Syrian hamsters has been shown to alter AVP-induced flank marking behavior initiated in the MPOA-AH region (Huhman and Albers, 1993). Ovariectomized (OVX) female hamsters treated with estradiol benzoate (EB) show reduced aggression compared to their OVX, non-treated counterparts (Gutzler et al., in review; Lisk and Nachtigall, 1988; Ciaccio et al., 1979). EB treatment does not, however, elicit the same reduction in SP-housed females, nor does ovariectomy of LP-housed hamsters increase ratios of offensive to defensive behaviors to SP-like levels (Fleming et al., 1988). In the present study, therefore, we aimed to determine whether photoperiod-dependent differences in responsiveness to AVP exist with regard to aggressive behavior.

The behavioral responsiveness of this peptide in the AH has not been investigated with respect to territorial aggression in LP cycling females or SP acyclic female hamsters; thus, the role of AVP in aggressive behavior overall in female Syrian hamsters is not well understood. We performed a series of experiments to test the hypothesis that aggression in female Syrian hamsters is affected by the actions of AVP, specifically through the V1aR in the AH. The purpose of our first experiment was to determine if there are cycle-dependent changes in V1aR in brain regions involved in aggressive behavior. This was accomplished through quantification

of V1aR densities from females at different stages of the four-day estrous cycle. In experiment 2, we examined whether photoperiod-dependent changes in V1aR also exist in the aggression neural circuit.

In experiments 3 and 4, to assess the behavioral importance of V1aR for aggression, we examined the effects of a V1aR antagonist microinjected into the AH on aggression on the first day of diestrus (D1) in LP females. We chose D1 because aggressive behavior is highest on this day (Floody and Pfaff, 1977). Based on what has been shown in male hamsters, we predicted we would see an inhibition of aggression after administration of the V1aR antagonist. In our fifth experiment, we additionally tested the dose-response effects of AVP microinjected into the AH on D1. Finally, in our sixth experiment, to determine whether observed photoperiod-dependent changes in the AH translated to a difference in responsiveness to a V1aR antagonist or AVP on aggression, we microinjected each drug in a counterbalanced manner to animals housed in either LP or SP.

Materials and methods

Animals and housing

Adult female Syrian hamsters (Charles River Laboratories: Wilmington, MA), were maintained in reverse light cycles to mimic “summer-like” long photoperiod (14:10, L:D) or “winter-like” short photoperiod (8:16, L:D). Animals weighed 120-140 g at the start of the experiment and were housed individually in polycarbonate cages (40 x 20 x 20 cm) with corncob and cotton bedding materials and wire mesh tops. Food (Purina Rodent Chow) and water were provided ad libitum. All animal experiments were approved by the Georgia State University Institutional Animal Care and Use Committee. Protocols were also in compliance with the National Institutes of Health Guide for Care and Use of Laboratory Animals.

Experiment 1

Sixteen female hamsters were obtained and single-housed in long photoperiod (LP) conditions (14:10, L:D). To monitor estrous cycles, females were exposed to a sexually experienced male hamster and determined to be sexually receptive or non-receptive by the presence or absence of the lordosis response. Studies in our laboratory have shown no differences on V1aR densities in any brain region implicated in aggressive behavior in response to male stimulation (Eidson et al., 2007) compared to manual examination of vaginal secretions known as the Orsini method (Orsini, 1961). Females portraying a consistent 4-day estrous cycle for 2-4 consecutive cycles were selected for data collection. Estrous cycle days were differentiated as: days 1 and 2 of diestrus (D1 and D2); 3rd day, proestrus (P); the final day and state of receptivity, estrus (E). Groups were broken up by cycle day to represent each of the four days of the estrous cycle (D1, n=4; D2, n=4; P, n=4; E, n=4). On the appropriate cycle days, females were sacrificed at approximately the same time by the methods described below. Blood was collected and brains were extracted and fast-frozen on dry ice. V1a receptors were quantified using autoradiography techniques and comparisons were made across the estrous cycle.

Experiment 2

Twenty-four animals were single-housed for 2 weeks in LP. Following this acclimation period, one half of the animals were moved into short photoperiod (SP) conditions (8:16, L:D) (n=12) while the other half remained in LP. As expected, after approximately 8 weeks, SP-housed females were acyclic and no longer displayed the lordosis response to a stimulus male. Any females that continued to display receptivity after 8 weeks despite exposure to SP conditions were dropped from the study. Similar to experiment 1, females were euthanized (3

per cycle day in LP) and blood and brains collected. Brains were fast-frozen on dry ice, sectioned on a cryostat, and processed for V1aR autoradiography. Comparisons were made between V1aR densities from LP and SP females.

Experiment 3

Thirty-six female hamsters were individually housed in LP and monitored for cyclicity as described in Experiments 1 and 2. After at least two consistent estrous cycles, half of the animals (n=18) were implanted with cannulae aimed at the AH while the other half were reserved as intruders. The experimental animals received either microinjections of 45 μ M Manning compound or injections of saline vehicle in a counterbalanced manner prior to behavioral testing. The purpose of this portion of the experiment was to determine whether blocking V1aR in the AH altered the expression of aggression on D1 significantly from control levels.

Microinjections were administered directly into the AH in volumes of 200 nl using a Hamilton syringe and a 15-mm, 32-gauge microinjection needle attached to silastic tubing (PE20, Dow Corning, Midland, MI). Previous studies indicate the necessity of waiting at least one hour after microinjection with Manning compound (Ferris et al., 1985; Nephew and Bridges, 2008). For this reason, one hour after microinjection a cycle-matched female intruder was placed in the experimental female's resident cage. Behavioral tests were videotaped for the 5 minute testing duration. Blood was collected for E₂ radioimmunoassay and brains extracted for site verification.

Experiment 4

Thirty female Syrian hamsters were housed individually in LP conditions and estrous cycles monitored as previously described. Following the establishment of 2-4 consecutive

estrous cycles, half of the animals (n=15) were surgically implanted with steel gauge cannulae aimed at the AH. The remaining 15 animals did not undergo surgery but served as intruders during behavioral testing. Following three days of recovery from surgery, estrous cycles were monitored until all animals had shown, again, at least two consistent four-day cycles.

Our preliminary studies indicated a trial effect after four days of behaviorally testing aggression (Gutzler, Karom, Albers, unpublished observations). One problem that contributes to this is alteration of intruder behavior following 4 successive aggressive encounters with a resident. To address this issue most efficiently in this experiment, we reduced the number of encounters per animal to two. Half of the animals (n=8) received injections of 90 and 22.5 μM Manning compound and the remainder (n=8) received 45 and 11.25 μM to establish whether there was a dose-dependent effect of a V1aR antagonist on aggressive behavior on D1. Concentrations of the Manning compound (Sigma Aldrich, V2255) were obtained through serial dilution with saline.

Experiment 5

Thirty-two female Syrian hamsters were obtained, housed, and estrous cycles determined by the same methods detailed in Experiment 1. Housing conditions for all animals in this experiment were solely LP (14:10, L:D). Following the establishment of regular estrous cycles, half of the animals (n=16) were surgically implanted with cannulae aimed at the AH. The remaining 16 did not undergo surgery, but were used as intruders during behavioral testing. Following three days of recovery, estrous cycles were monitored until all animals had shown at least two consistent four-day cycles. Two groups of females (n=8 per group) received either 0.009 and 0.9 μM or 0.09 and 9.0 μM in a counterbalanced fashion. Additionally, we chose 5 females randomly between both groups to receive a microinjection of saline in addition to

treatments with 2 dosages of AVP. The purpose of this was to provide a baseline comparison while preventing the possibility of a trial effect. Behavioral testing, again, took place on D1 of the cycle. Immediately following the microinjection of AVP or saline, a cycle-matched female was placed into the resident cage of the experimental female. All treatments were counterbalanced and videotaped tests were scored for measures of aggression. Animals were euthanized on the last day of testing. Blood and brains were collected for radioimmunoassay and site verification.

Experiment 6

Thirty-six female hamsters were obtained and housed individually in LP conditions (14:10, L:D) as described above for 2 weeks. After initial acclimation, twenty females were moved into SP conditions (8:16, L:D) and sixteen remained in LP housing. At week 6, female intruders (n=36) were obtained and individually housed in LP for the duration of the experiment. Two weeks after intruders arrived, and at week 8 of housing for experimental females, all animals were bilaterally ovariectomized to control for gonadal status, and to ensure that any observed differences were a result of photoperiod. Three weeks following ovariectomy, experimental animals (n=36) were surgically implanted with guide cannulae aimed at the AH. Two weeks after stereotaxic surgery, behavioral testing began.

All animals received 3 injections: saline, 45 μ M Manning compound, and 0.9 μ M AVP. Injections were performed in a counterbalanced manner and Manning compound was, again, administered one hour prior to the behavioral test. Following the last behavioral test, blood was collected for estradiol radioimmunoassay. Brains were also collected and injection sites verified.

Surgical procedures

In experiment 6, experimental animals (n=36) and intruders (n=36) were anesthetized with isoflurane, given a subcutaneous injection of the analgesic, ketoprophen (5 mg/kg), and bilaterally ovariectomized. Following removal of the ovaries and suture of the incision, a silastic capsule filled with estradiol benzoate (EB) was subcutaneously implanted in the scapular region (Faruzzi et al., 2005; Gutzler et al., in review). The implantation of a single EB-containing capsule has, in our lab, provided females with circulating concentrations of E₂ approximate to those seen during the D1 stage of the estrous cycle. The capsules were made of Silastic brand medical grade tubing (0.062 in i.d. x 0.125 in o.d.). They were 10 mm in length, filled with 5 mm of EB, and sealed with Factor II 6382 RTV Silicone and Elastomer. Skin was repaired using a non-irritating tissue adhesive at the site of incision.

In experiments 3-6, females were anesthetized with sodium pentobarbital (50 mg/kg) and stereotaxically implanted unilaterally with 4-mm, 26-gauge guide cannulae aimed at the AH (from bregma; AP +1.0; ML +1.8; DV -3.5 ventral to dura; 8°). This area of the AH has been implicated in aggression in males (Ferris et al., 1997; Delville et al., 2000). Cannulae were secured to the skull with 11-mm wound clips and OrthoJet dental compound. Obturators were inserted into the cannulae to prevent clogging. After 2 weeks of recovery, behavioral testing began. During these 2 weeks, estrous cycles were monitored in intact females housed in LP for experiments 3-5. This two-week period also served as additional recovery time for OVX animals in experiment 6.

Following each surgical procedure, animals were given a subcutaneous 1-mL injection of saline to prevent any dehydrating effects of surgery. After cannulation, re-wetting eye drops were also administered to try to minimize any discomfort.

Behavioral testing

Cages of resident females were not changed for at least a week prior to behavioral testing (Cooper et al., 2005). All encounters lasted 5 minutes and were videotaped. Behavioral scoring was done by an observer blind to the treatment. We quantified the latency to initial attack, duration of aggressive behavior, duration of social/non-social behaviors, duration of defensive behavior, and the number of attacks, as defined in Table 2.1.

Table 2.1: Criteria used to score aggressive behavior

Behavior	Definition
Latency to initial attack	Attack defined as biting/pushing conspecific onto side to initiate roll fight
Number of attacks	Attack defined as biting/pushing conspecific onto side
Duration of aggression	Attack biting/roll fighting; Offensive “push” behavior, chase behavior, pinning the subordinate
Duration of social behavior	Scored when animals are in contact with each other; includes nose-to-nose investigation or non-aggressive “following” behavior/olfactory investigation, grooming flanks
Duration of non-social behavior	Scored when animals are investigating the cage, sitting, “escape” behavior (trying to climb out of the cage, but not out of fear or submission), grooming of face and head
Duration of defensive behavior	Tail-up posture, pinned on the ground, defensive posturing (hands up, protecting self), flee

Blood/tissue collection

In experiment 1, following 2 weeks of consistent estrous cycle observation, animals were divided into 4 groups by estrous cycle day (n=4 for all groups). Animals were administered a lethal dose of sodium pentobarbital (0.4 ml of 50 mg/ml) between 1 and 3 hours after lights out. Blood was drawn from the caudal vena cava for estradiol radioimmunoassay (RIA) and the brains were removed and fast frozen on dry ice. In experiment 2, after 10 weeks of exposure to LP or SP conditions (n = 12 for each group), the same procedure was utilized to collect brains and blood from each animal. Brains were stored at -80 °C until they were sectioned at 20 µm on

a cryostat at 20 °C and thaw-mounted on Superfrost Plus slides (Fisher Scientific, Pittsburgh, PA, USA). Sectioning was done in serial, placing alternate sections on separate slides. Brains were sectioned from the rostral lateral septum through the caudal periaqueductal gray (Figs. 18 – 36 of the hamster stereotaxic atlas; Morin and Wood, 2001) and slides stored at -80 °C.

In experiments 3-6, site verification was required following microinjection studies. Animals were euthanized on the last day of behavioral testing with a lethal dosage of sodium pentobarbital (0.4 mL of 50 mg/kg). Blood was collected as described above and assayed for estradiol. Brains were extracted and stored in 10% formalin at 4°C for at least 24 hours before sectioning. Coronal sections (50 µM) were obtained using a vibratome and placed on Superfrost slides (Fisher Scientific; Pittsburgh, PA). Injection sites were determined using light microscopy and referenced to the hamster stereotaxic atlas (Morin & Wood, 2001). Animals with injection sites outside of the AH were dropped from statistical analysis.

Radioligand receptor autoradiography

One set of slide-mounted sections was processed for V1aR binding using a linear [¹²⁵I]V1a antagonist (New England Nuclear) as described previously in studies of Syrian hamsters (e.g. Cooper et al., 2005; Caldwell and Albers, 2004). Briefly, sections were brought to room temperature and fixed in 0.1% paraformaldehyde (pH 7.4) for 2 min. Next, sections were pre-incubated twice for 10 min each in 50 mM Tris buffer (pH 7.4). Sections were then incubated for 60 min in 50 pM ¹²⁵I V1a receptor antagonist in 50 mM Tris buffer (pH 7.4) with 10 mM MgCl₂, 0.1% bovine serum albumin, and 0.05% bacitracin. Following incubation, unbound ligand was removed with two 5 min washes and one 35 min wash in 50 mM Tris buffer with 10 mM MgCl₂. Sections were then dipped into cold (4° C) distilled water and blown dry

with cool air. The processed slides were placed into X-ray cassettes and exposed to Kodak Bio-Max MR (Kodak, Rochester, NY, USA) film for 72 hours then developed.

Quantification of V1a receptor binding

Receptor binding was quantified by establishing standard curves using [¹²⁵I] microscales (Amersham Biosciences, Piscataway, NJ, USA) that had been placed into the X-ray cassettes with the radiolabeled sections. Using cresyl violet-stained sections adjacent to those used for autoradiography, we identified the dorsal and intermediate portions of the lateral septum (LSd and LSi, respectively), dorsomedial portion of the bed nucleus of the stria terminalis (BNSTdm), anterointermediate bed nucleus of the stria terminalis (BNSTai), anterior and posterior portions of the medial preoptic area (MPOAa and MPOAp), anterior and posterior portions of the medial preoptic nucleus (MPNa and MPNp), anterior portion of the anterior hypothalamus (AHa) as well as the posterior portion of this region (AHp), capsular portion of the central amygdala (CeA), the nucleus of the CeA, the ventromedial hypothalamus (VMH), and the dorsal, medial, and lateral portions of the periaqueductal gray (PAG). These brain regions were selected based on their roles in aggressive and sexual behaviors (Delville et al., 2000; Joppa et al., 1995). Binding densities were analyzed using Scion Image software (NIH). Background binding was subtracted from the measurements and optical densities were converted to disintegrating units per minute per unit milligram tissue equivalent using a standard curve that was established with the [¹²⁵I] microscales placed in the X-ray cassettes. Within each anatomical area, optical densities were quantified using a box 0.35 mm x 0.35 mm on three sections (for each region) and averaged.

Radioimmunoassay

Estradiol RIA was necessary for estrous cycle (Exp. 1) and photoperiod comparisons (Exp. 2). In experiments 3 and 4, E₂ concentrations were used as a validation that females were, in fact, in diestrous. To determine estrous cycle verifications, RIA results were validated and compared against laboratory criteria for cyclic E₂ concentrations. Table 2.1 shows serum concentrations of E₂ from each day of the estrous cycle as obtained from animals in Experiment 1.

Table 2.2: Effects of estrous cycle state on estradiol concentrations (mean + s.e.m.)

Cycle Day	Estradiol (pg/ml)
Diestrus 1	230.64 ± 4.04
Diestrus 2	258.26 ± 23.87
Proestrus	664.69 ± 57.21*
Estrus	239.52 ± 14.85

* p ≤ 0.001

Serum was separated following centrifugation and stored at -20 °C until the time of processing. Samples were assayed for estradiol using a commercial solid phase RIA kit DSL-43100 (Beckman Coulter Diagnostic Systems Laboratories, Inc., Webster, TX) according to kit instructions. The linearity of dilution was used to validate the kit and yielded 94% recovery. The interassay reliability was 4%. The intra-assay reliability was 2.5%. The sensitivity of the assay was 3.19-1500 pg/ml. The cross-reactivity with 17β-estradiol was 100% and with other related compounds was less than 1%.

Statistical analyses

All data are presented as mean ± s.e.m. In experiment 1, E₂ RIA and receptor binding densities were analyzed using a one-way analysis of variance (ANOVA) with cycle day as the independent variable. When appropriate, *post-hoc* analysis was done using Tukey HSD tests. In experiment 2, independent samples t-tests were used to determine whether there were significant

differences in estradiol concentrations and within brain regions as a function of photoperiod. A result was considered statistically significant if $p \leq 0.05$. Estradiol concentrations are reported in picograms per milliliter of serum (pg/ml) and receptor densities are reported as disintegrating units per minute per milligram of tissue (dpm/mg).

In experiments 4 and 5, ANOVAs were used to compare the effects of the four concentrations of the V1aR antagonist and AVP, respectively, on our behavioral measures of aggression. In experiment 3, which tested the V1aR antagonist against saline, we used a dependent-samples t-test for each measure of aggression.

Experiment 6 was analyzed using a 2 X 3 ANOVA with photoperiod and treatment as independent variables. When a significant difference was detected, a Tukey's HSD test was used to analyze specific comparisons *post-hoc*. A Levene's test for homogeneity of variance detected a violation of this assumption in the analysis of defensive behavior. A Chi-Square analysis was then utilized to determine differences in observed frequencies. All analyses were performed using SPSS software (SPSS, Chicago, IL). For all statistical analyses, a result was considered statistically significant if $p \leq 0.05$.

Results

Experiment 1: Measurement of V1aR binding densities across the estrous cycle

Serum estradiol concentrations on proestrus (P) were significantly greater than samples collected on diestrus 1 (D1), diestrus 2 (D2), and estrus (E) ($F_{3,15} = 43.78$, $p \leq 0.001$) (Table 2.2). As shown in Figure 2.1a, significantly higher V1aR binding density was found in the intermediate portion of the LS on estrus when compared to D1 ($F_{3,15} = 3.93$, $p \leq 0.05$). In the anterointermediate portion of the BNST, however, V1aR binding density was significantly greater on D1 compared to each of the other cycle days as shown in Figure 2.1b ($F_{3,15} = 6.23$, $p \leq$

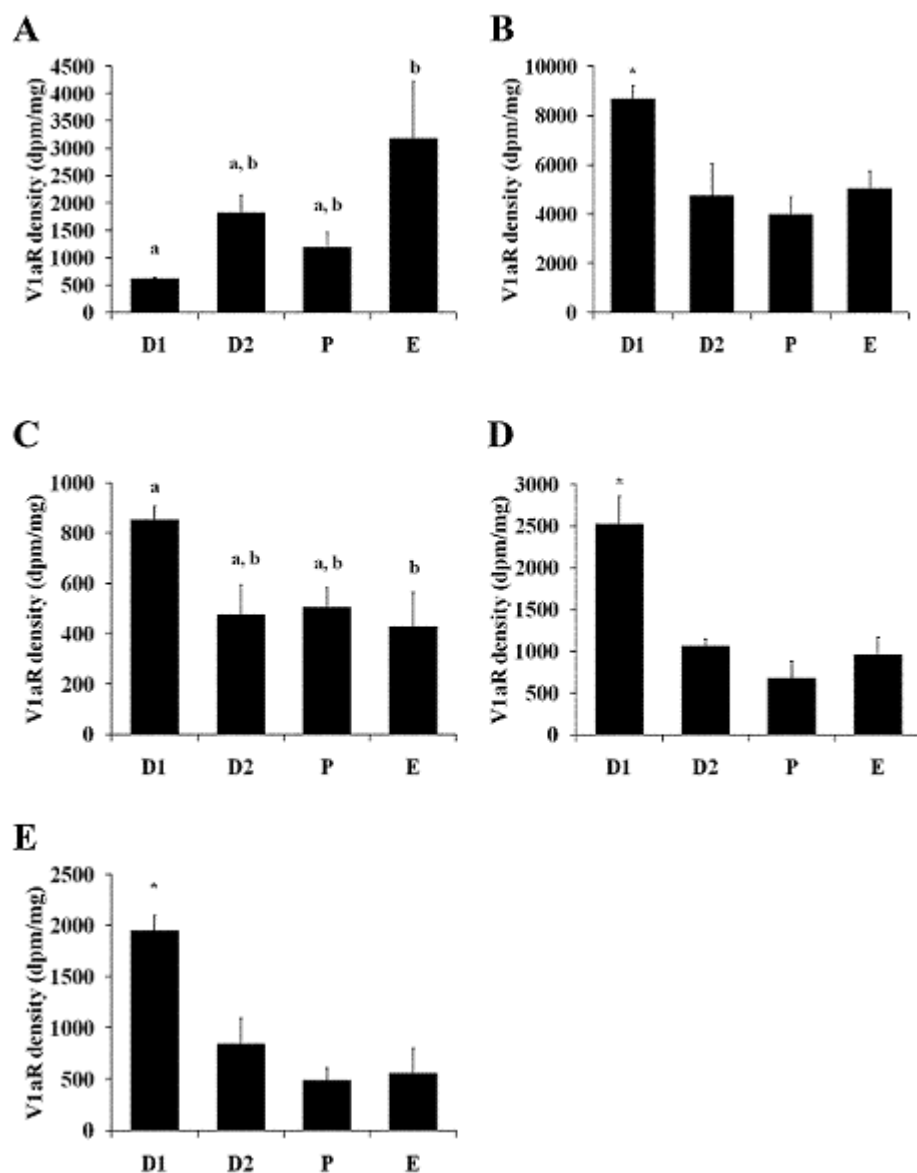

Figure 2.1: V1aR binding densities vary throughout the estrous cycle in different regions of the limbic system. Densities reported in decays per minute per milligram of tissue for the (dpm/mg) A.) intermediate portion of the LS, B.) anterointermediate portion of the BNST, C.) anterior portion of the MPOA, D.) anterior portion of the MPN, and E.) posterior portion of the MPN.

0.01). Figure 2.1c demonstrates that in the anterior portion of the MPOA, D1 showed higher V1aR binding than brains collected on the other days of the cycle, but differed only significantly from those taken on estrus ($F_{3,15} = 3.72, p \leq 0.05$). Similarly, D1 was associated with the highest V1aR binding densities in the anterior and posterior portions of the medial preoptic nucleus (Fig. 2.1d and 2.1e) when compared to D2, P, and E (anterior MPN - $F_{3,15} = 13.70, p \leq 0.001$, posterior MPN - $F_{3,15} = 11.60, p = 0.001$).

Table 2.3 includes V1aR binding densities from other subregions of the limbic system that were counted. Among these, there were no significant differences found as a function of the estrous cycle in the dorsal LS ($F_{3,15} = 2.74, p > 0.05$), the dorsomedial BNST ($F_{3,15} = 1.22, p > 0.05$), the posterior MPOA ($F_{3,15} = 2.30, p > 0.05$), both the anterior and posterior portions of the AH (anterior AH - ($F_{3,15} = 2.17, p > 0.05$; posterior AH - $F_{3,15} = 1.25, p > 0.05$) and both the capsular portion of the CeA ($F_{3,15} = 0.82, p > 0.05$) and the nucleus of the CeA ($F_{3,15} = 1.18, p > 0.05$). We extended our regions of interest into the sexual behavior circuit. When we compared V1aR binding densities in the VMH, we found that brains collected on D1 showed a strong trend to have higher binding densities than those collected on P and E ($F_{3,15} = 3.66, p = 0.06$). Furthermore, we examined the dorsal, lateral, and medial subregions of the PAG and found no significant differences as a function of estrous cycle state (dPAG - $F_{3,15} = 2.39, p > 0.05$; lPAG - $F_{3,15} = 0.92, p > 0.05$; mPAG - $F_{3,15} = 1.29, p > 0.05$).

Experiment 2: Measurement of V1aR binding densities following exposure to long and short photoperiods

As expected, serum estradiol concentrations decreased significantly after exposure to short photoperiod compared to long photoperiod ($t_{22} = 4.19, p \leq 0.001$) (Table 2.4). We selected subregions of areas involved in aggression based on the results of experiment 1, namely the areas

Table 2.3: Areas quantified for V1aR binding densities over the course of the four-day estrous cycle (mean \pm s.e.m.)

Brain Area	Cycle Day			
	Diestrus 1	Diestrus 2	Proestrus	Estrus
LSi	627.5 \pm 7.22 ^a	1833.25 \pm 307.91 ^{a, b}	1189.5 \pm 262.64 ^{a, b}	3185 \pm 1033.66 ^b
LSd	411 \pm 34.06	1428.25 \pm 648.84	229 \pm 72.95	384 \pm 116.41
BNSTai	8688.5 \pm 512.98 [*]	4767.75 \pm 1262.06	3993.25 \pm 675.08	5043.25 \pm 705.58
BNSTdm	5346.5 \pm 687.34	4451.25 \pm 1533.26	3531.25 \pm 672.72	3041.25 \pm 379.31
MPOAa	853.5 \pm 52.83 ^a	476.5 \pm 119 ^{a, b}	505.5 \pm 75.72 ^{a, b}	430.75 \pm 132.92 ^b
MPOAp	1369 \pm 77.36	883.5 \pm 438.98	1296 \pm 371.69	392.5 \pm 121.07
MPNa	2526.5 \pm 330.53 [*]	1066.25 \pm 80.91	674.25 \pm 204.23	959.5 \pm 208.85
MPNp	1952.5 \pm 146.36 [*]	846.75 \pm 252.04	491 \pm 115.51	559.5 \pm 245.33
Aha	363.5 \pm 32.62	953.25 \pm 506.74	324.75 \pm 70.15	471.75 \pm 78.87
AHp	245.5 \pm 25.11	611.75 \pm 224.84	388 \pm 151.63	141.25 \pm 48.79
CeAc	4586 \pm 1214.75	3890.25 \pm 1178.64	2847.5 \pm 491.62	3058.25 \pm 133.13
CeAn	1964.5 \pm 512.98	1888.5 \pm 412.91	2409.5 \pm 216.03	1458.25 \pm 189. 76

a, b, or * indicate significance at $p \leq 0.05$

that shown the greatest variation due to estrous cycle stage, taken together with the results of a study previously done in our laboratory (Caldwell and Albers, 2004). The Caldwell and Albers (2004) study detailed binding densities in common areas of interest such as the MPN and CeA, therefore, we focused on the LSi, BNSTai, MPOAa, and AHp in the present study. As shown in Figure 2.2a, in both the intermediate LS and the anterointermediate BNST, V1aR binding densities significantly increased after exposure to short photoperiod (LSi - $t_{22} = 4.34$, $p \leq 0.001$); BNSTai - $t_{22} = 3.60$, $p \leq 0.01$). Short photoperiod also increased V1aR binding densities in the anterior MPOA ($t_{20} = 4.32$, $p \leq 0.001$) and the posterior AH ($t_{14} = 4.36$, $p = 0.001$) (Figure 2.2b). Representative autoradiographs illustrating V1aR-selective radioligand binding in brains from long and short-photoperiod housed female hamsters are shown in Figure 2.3.

Table 2.4: Effects of photoperiod on estradiol concentrations (mean \pm s.e.m.)

Photoperiod	Estradiol (pg/ml)
Long Photoperiod	381.72 \pm 63.34
Short Photoperiod	113.56 \pm 9.65 [*]

* $p \leq 0.001$

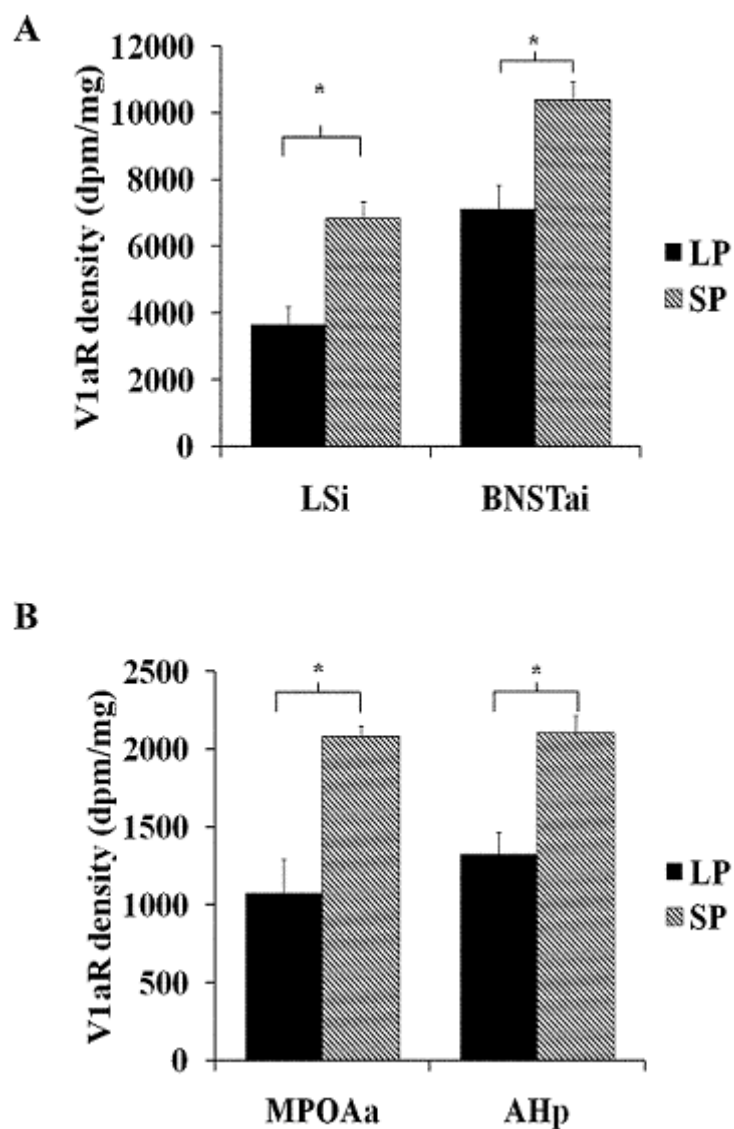

Figure 2.2: V1aR binding densities in subregions of the limbic system increase in response to short photoperiod conditions. A.) The intermediate portion of the LS and the antero-intermediate portion of the BNST show greater V1aR binding densities in response to SP as do, B.) the anterior portion of the MPOA and the posterior AH.

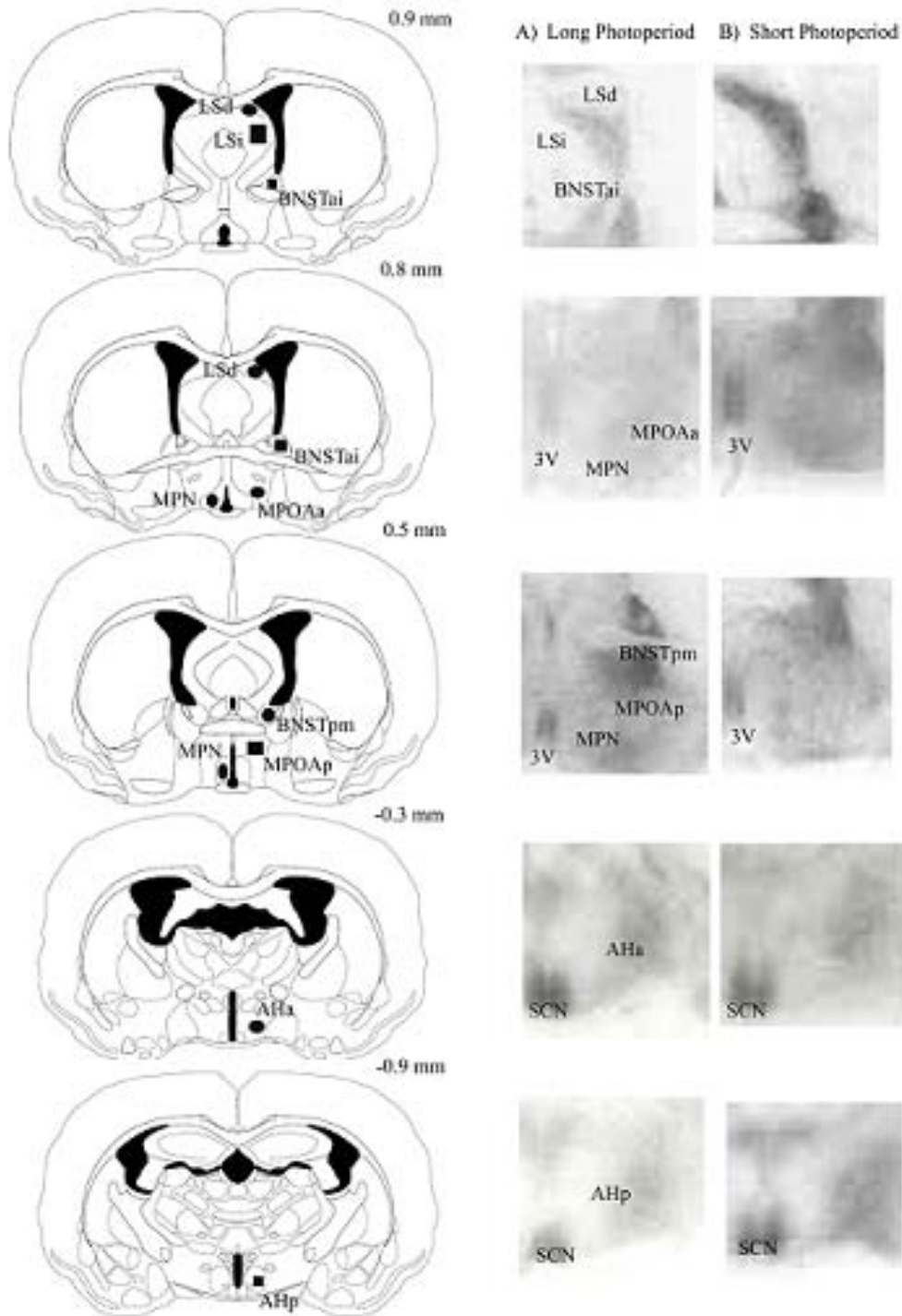

Figure 2.3: Representative autoradiographs from females housed in either LP or SP conditions.

Experiment 3: Effects of V1aR antagonist on aggression

There were no significant differences in the durations of non-aggressive social behavior ($t_{30} = 1.09$, $p > 0.05$), non-social behavior ($t_{30} = 0.12$, $p > 0.05$) or defensive behavior ($\chi^2_{(1)} = 0.16$, $p > 0.05$) between the injection of V1aR antagonist and injection of saline. In contrast, as shown in Figures 2.4a and b, the V1aR antagonist significantly reduced the latency to attack ($t_{30} = 2.23$, $p = 0.03$) and significantly increased the duration of aggressive behavior ($t_{30} = -2.43$, $p = 0.02$) when compared to saline. There was also a strong trend ($t_{30} = -1.88$, $p = 0.07$) that the V1aR antagonist increased the number of attacks when compared to saline (Fig 2.4c). E_2 concentrations were 201.99 ± 28.64 pg/ml (mean \pm s.e.m.) which are similar to those seen on diestrus 1.

Experiment 4: Effects of different concentrations of V1aR antagonist on aggression

Comparing the latency to attack across treatment groups as shown in Figure 2.5a ($F_{3,24} = 5.65$, $p = 0.004$), the 90 μ M dosage resulted in a latency to attack that was significantly higher than the 45 μ M ($p = 0.013$) and 22 μ M ($p = 0.008$) doses. Significant differences were also found in the duration of aggression ($F_{3,24} = 5.88$, $p = 0.004$) (Fig. 2.5b), with the 45 μ M dose having longer durations than either the 90 μ M or 11.25 μ M doses ($p = 0.008$ and $p = 0.03$, respectively). The 22.5 μ M dose also yielded a significantly longer aggression duration compared to the 90 μ M dose ($p = 0.05$). The number of attacks significantly differed by treatment ($F_{3,24} = 7.22$, $p = 0.001$) as shown in figure 2.5c. Here also, the 45 and 22.5 μ M doses produced significantly more attacks than the 90 μ M dose ($p = 0.003$ and $p = 0.009$, respectively). In comparison to the 11.25 μ M dose, only the 45 μ M concentration had a significant larger number of attacks than the other concentrations ($p = 0.04$). The 22.5 μ M dose also produced more attacks than the 11.25 and 90 μ M doses however this difference approached but did not reach statistical significance ($p = 0.10$).

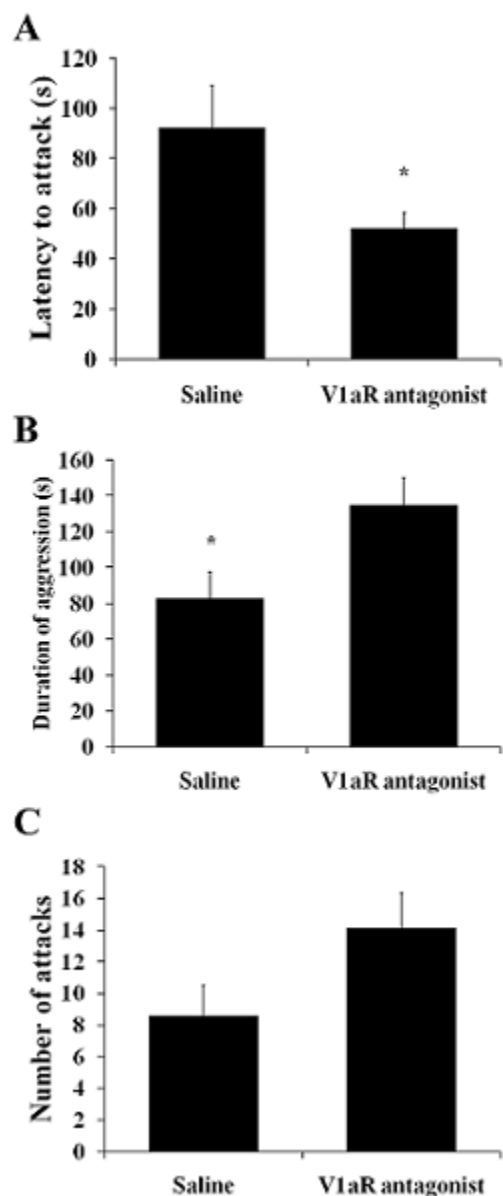

Figure 2.4: Administration of the V1aR antagonist, 45 μ M Manning compound, into the AH showed increased aggression compared to microinjection of saline. A.) The antagonist significantly reduced the latency to attack, B.) The V1aR antagonist, Manning compound, significantly increased the duration of aggression, and C.) While the difference was not statistically significant, the V1aR antagonist increased the number of attacks by approximately 60%.

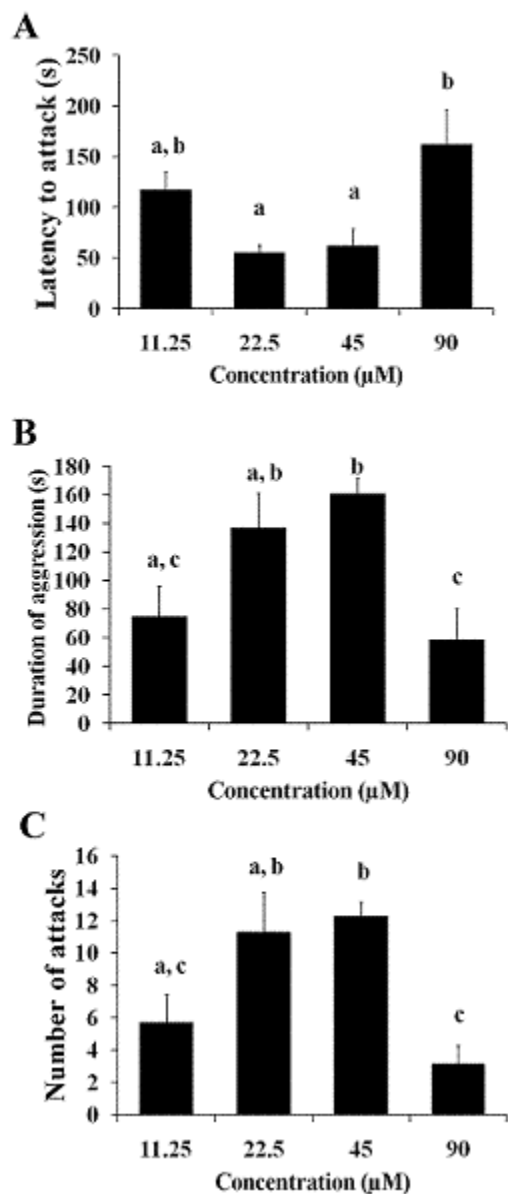

Figure 2.5: Dose-response curve for the effects of Manning compound on measures of aggression in female Syrian hamsters. A.) The latency to attack was significantly lower at the intermediate doses, 22.5 and 45 μM , compared to the lowest, 11.25 μM and highest, 90 μM . B.) The duration of aggression was the highest at 45 μM compared to the 11.25 and 90 μM doses. C.) The number of attacks was significantly higher at 45 μM compared to the highest and lowest doses, as well.

Interestingly, no significant differences were found in the amount of defensive behavior across treatments ($\chi^2_{(3)}=2.86$, $p>0.05$). E₂ concentrations were 141.57 ± 11.2 pg/ml (mean \pm s.e.m.) which are similar to those seen on diestrus 1.

Experiment 5: Effect of AVP on aggression

No significant differences in the duration of social behavior across groups were observed ($F_{4, 28} = 0.13$, $p=0.971$). However, the duration of non-social behavior differed significantly ($F_{4, 28} = 4.36$, $p\leq 0.001$). The duration of non-social behavior following injection of 0.009 μ M AVP was significantly shorter than following either the 0.09 μ M dose and 9.0 μ M dose ($p=0.02$ for both). There was not a dose-dependent effect of treatment on the latency to attack (Fig. 2.6a), however, a significant difference was detected ($F_{4, 28} = 13.34$, $p\leq 0.001$). The 0.9 μ M dosage yielded significantly higher latencies than all other groups ($p\leq 0.05$ for all cases). Interestingly, although latency to attack was only affected by the 0.9 μ M dose, a significant treatment effect was found in a comparison of aggression durations ($F_{4,28} = 7.40$, $p\leq 0.001$) (Fig. 2.6b). The 0.09 μ M stimulated longer durations of aggression compared to the other doses of AVP ($p\leq 0.05$ for all cases), but not saline ($p>0.05$). The durations following saline injection only differed significantly from the 0.9 μ M AVP dose ($p=0.04$), but because this dose was associated with the least amount of aggression, this was not a surprising result.

A significant treatment effect was detected in the analysis of the number of attacks per 5 minute behavioral test ($F_{4, 28} = 5.25$, $p=0.003$) (Fig. 2.6c). The 0.09 μ M AVP administration lowered the number of attacks significantly compared to the 0.9 μ M ($p=0.003$) and 9.0 μ M ($p=0.018$) doses. There were no differences between any dosage of AVP and saline treatment, although a trend was detected between the 0.9 μ M AVP and saline ($p=0.095$). A trend was also found in comparing the two lowest doses ($p=0.085$), with the 0.09 μ M associated with a greater

mean number of attacks compared to the 0.009 μM AVP dose. Defensive behavior varied with treatment ($F_{4,28} = 4.92$, $p=0.004$), but the only significant differences occurred between the 0.09 μM AVP dose, which was associated with a high level of aggression overall, and the 0.9 and 9.0 μM AVP treatments ($p=0.012$ and 0.016 , respectively). Serum E_2 concentrations validated that our experimental females were in the D1 stage of the cycle when tested with a dosage of AVP or saline, (176.40 ± 10.42 pg/ml; mean \pm s.e.m.).

Experiment 6: Photoperiod length and the effects of the V1aR antagonist and AVP on aggression

Estradiol concentrations did not significantly differ between LP- and SP-housed females that received an EB-filled capsule following ovariectomy ($t_{27} = 1.57$, $p>0.05$). The mean E_2 concentration for the LP group was 150.0 ± 4.6 pg/ml and for the SP group was 161.4 ± 5.2 pg/ml (mean \pm s.e.m.). Neither photoperiod, treatment, nor an interaction of the two, significantly altered social ($p>0.05$) and non-social behaviors ($p>0.05$) nor was there a significant interaction between photoperiod and treatment. There was a significant main effect of treatment ($F_{2,86} = 10.29$, $p\leq 0.001$), but not of photoperiod ($p>0.05$) on the latency to attack (Fig 2.7a). No significant interaction between treatment and photoperiod detected in the latency to attack. The V1aR antagonist, Manning compound, significantly reduced the latency to attack compared to the saline and AVP treatments ($p\leq 0.01$). A main effect of treatment was found on the total duration of aggression ($F_{2,86} = 14.48$, $p\leq 0.001$) (Fig. 2.7b). Treatment with the V1aR antagonist resulted in significantly longer durations of aggression compared to saline or AVP ($p\leq 0.05$). No main effect of photoperiod was found, nor was there any interaction between treatment and photoperiod on the duration of aggression ($p>0.05$). There was a significant main effect of treatment on the number of attacks ($F_{2,86} = 8.46$, $p\leq 0.001$) (Fig. 2.7c). There was no

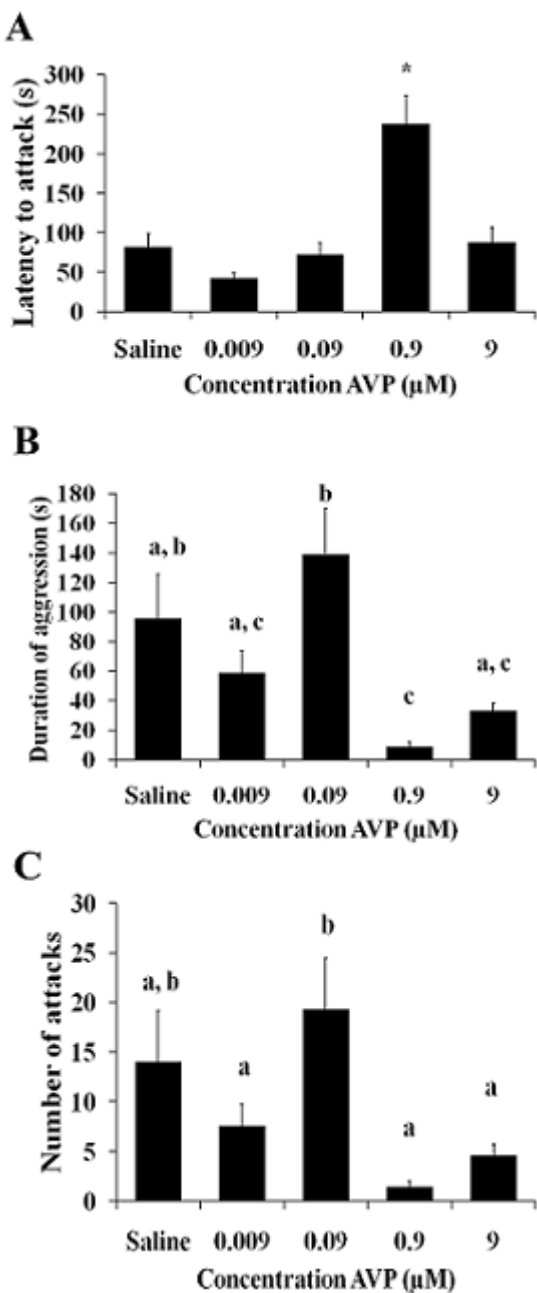

Figure 2.6: Aggression does not vary in a dose-dependent manner in response to AVP administration. A.) Only the 0.9 μM dose of AVP is associated with a significantly greater latency to attack compared to the other treatments. B.) The 0.09 μM AVP injection yielded greater durations of aggression compared to other doses of AVP, but not saline. C.) The number of attacks was the greatest when animals received 0.09 μM AVP and was reduced at the higher doses, but no significance was detected from saline.

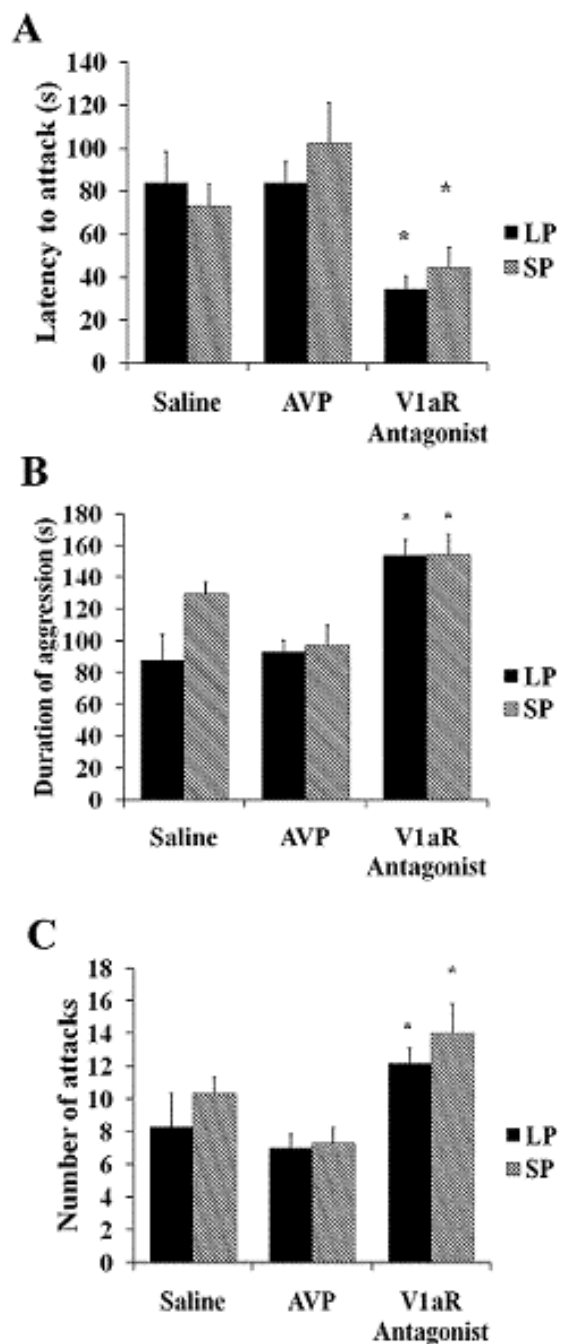

Figure 2.7: The effects of AVP and the V1aR antagonist on aggression are not photoperiod-dependent. A.) The V1aR antagonist, 45 μ M of Manning compound, significantly decreased the latency to attack in both LP- and SP-housed females. B.) The duration of aggression significantly increased in response to treatment with the V1aR antagonist in both photoperiod conditions. C.) Significant increases were detected in the number of attacks performed by females in LP- and SP-housing following treatment with the V1aR antagonist.

main effect of photoperiod or an interaction between photoperiod and treatment on the number of attacks ($p>0.05$). There was also a significant main effect of treatment on the duration of defensive behavior ($\chi^2_{(2)}=7.93, p=0.019$) but no main effect of photoperiod ($\chi^2_{(1)}=0.067, p>0.05$) or interaction between treatment and photoperiod ($\chi^2_{(5)}=6.91, p>0.05$). Injections of AVP produced significantly greater frequencies of defensive behavior compared to Manning and saline ($p\leq 0.05$).

Discussion

The primary purpose of the present study was to determine whether AVP affected aggression in female hamsters through the V1aR subtype. Initially, we hypothesized that if this were the case, variations in aggression throughout the estrous cycle could be explained by cycle-dependent changes in V1aR binding throughout subregions of brain areas implicated in aggressive behavior. In experiment 1, females sacrificed on the day of estrus showed significantly greater V1aR binding densities in the LSi than D1 females, while females from D2 and P had intermediate levels of binding. On the contrary, in the BNSTai, females on D1 showed significantly greater V1aR binding densities compared to any other cycle day. This was also true in the anterior and posterior portions of the MPN, while in the anterior MPOA, the higher levels of binding on D1 only significantly differed from estrus females. These results, however, are consistent with findings that report the greatest amounts of flank marking behavior on D1 (Albers et al., 1996). A previous study from our laboratory showed no estrous cycle-dependent differences in V1aR binding densities in other subregions of the areas we examined (Caldwell and Albers, 2004). The subregions examined in this study included the LSd, BNSTdm, posterior portion of the MPOA, anterior portion of the AH, nucleus of the CeA. Taken together, cycle-dependent differences in the subregions examined in the present study and the absence of such in

the previous study suggest the idea that subregions of the aggression neural circuit are regulated differentially by estrous cycle state. Our primary target of aggressive behavior, the AH, did not show any estrous cycle-dependent differences in V1aR binding densities. This suggests that hormone-dependent changes in female aggression that have been reported are not be mediated by an AVP V1aR-driven mechanism in the AH.

We assessed whether photoperiod impacts V1aR binding in the subregions of the aggression circuit. In experiment 2, housing in short photoperiod (SP) conditions induced acyclicity in all of our animals as expected. Surprisingly, these conditions were associated with significantly greater V1aR binding densities in the LSi, BNSTai, anterior MPOA, and posterior AH than densities from LP-housed females. These subregions differ from others in the same neuroanatomical areas, as previous quantification of the LSd and anterior AH did not result in significant photoperiod-driven changes in V1aR binding densities (Caldwell and Albers, 2004). Additionally, the BNSTdm and posterior MPOA showed significantly lower changes in V1aR binding densities following 10 weeks of SP housing. The present results, together with the aforementioned study by Caldwell and Albers (2004), suggest that V1aR binding densities are also differentially regulated by photoperiod throughout the aggression neural circuit. This regulation, however, does not appear to be solely estrogen-dependent.

To determine the behavioral role of V1aR in the AH, in experiment 3, we administered a selective V1aR antagonist directly into the site on D1 of the estrous cycle. We found a significant decrease in latency to attack when animals were given Manning compound compared to when they were given saline. Further, the duration of aggression was also significantly higher when animals were administered Manning. While the comparison did not reach statistical significance, V1aR blockade was, on average, associated with almost two-fold the number of

attacks compared to saline treatment. In the present study we also determined that intermediate doses of Manning compound elicited the greatest amounts of aggression compared to a lower dose and a higher dose. The ability of Manning compound to increase aggression when administered directly into the AH of female Syrian hamsters is in direct contrast to what has been shown to occur in males (Ferris and Potegal, 1988; Potegal and Ferris, 1990). Although these data are the first, to our knowledge, to show the behavioral effects of blocking V1aR on territorial aggression in female hamsters, the sexual dimorphisms of the vasopressin system are well-established in hamsters (e.g. Delville and Ferris, 1995). Additionally, AVP did not inhibit aggression in a dose-dependent manner. In fact, only one dosage of AVP, 0.9 μM , significantly lowered measures of aggression compared to saline.

The ability of V1aR antagonism to increase aggression in females can be extended beyond reproductively active animals. A recent study showed that intracerebroventricular (icv) administration of Manning compound increased maternal aggression in lactating rats (Nephew and Bridges, 2008). The results of this study support our findings, as the effect of Manning compound was most effective at an intermediate dose. Administration of AVP did not yield the reverse effect on all measures of aggression, inhibiting aggression only through an increase in the latency to attack.

To test whether AVP would have the reverse effect in the AH on aggression, we had previously tested a low dose (0.09 μM) of AVP on aggression in the AH and found no difference compared to aggression following an injection of saline (Gutzler, Karom, Albers, unpublished observations). Here we reported the results of a range of doses of AVP, but we did not find a dose-dependent inhibition of aggression.

To examine whether the effects of Manning compound and AVP are photoperiod-dependent, experimental animals were ovariectomized and given estradiol replacement to isolate the effects of photoperiod on behavioral responsiveness. The V1aR antagonist, Manning compound, decreased the latency to attack compared to AVP and saline in both LP- and SP-housed female hamsters. The durations of aggression and numbers of attacks were also both significantly higher in both photoperiods compared to when animals received either AVP or saline injections. The absence of a photoperiod-dependent effect of V1aR antagonism on aggression suggests that the role of AVP on aggression is conserved regardless of reproductive status. This result is consistent with the finding that photoperiod does not affect AVP-i.r. in the LS, BNST, and MPOA-AH of males hamsters (Albers et al., 1991), and also, with a recent report published by Caldwell et al. (2008) that shows no change in the affinity of V1aR due to photoperiod.

The inability of AVP to significantly and consistently inhibit aggression suggests, from the presented data, that AVP does not solely play a critical role in aggression. Many studies have shown that treatment with AVP reliably induces flank marking behavior in males and females in a hormone-dependent manner (Albers et al., 1988; Huhman and Albers, 1993). Additionally, microinjections of AVP into the MPOA-AH of female hamsters have been associated with initiation of lordosis in the presence of a male conspecific (Albers and Rawls, 1989) and without a male present (Huhman and Albers, 1993). Surprisingly, administration of the V1aR antagonist does not disrupt the lordosis reflex in intact females on the day of estrus (Gutzler, Karom, Albers, unpublished observations). Estradiol, however, has been shown *in vitro* to stimulate AVP release from the supraoptic nuclei (SON) of the hypothalamus (Wang et al., 1995). Peak E₂ levels occur on the night of proestrus, preceding sexual receptivity. An

increase in E_2 , therefore, may stimulate an increase in AVP release on proestrus, allowing AVP to play a role as a modulator in the reduction of aggressive behavior in order to facilitate the proceptive and receptive behavior of females on the day of estrus.

The present findings support the idea that a sex difference exists for the role of AVP on aggression. Furthermore, while AVP alone may not be sufficient in the AH to reduce aggression in females, it may serve to modulate aggression possibly through V1aR-mediated actions on GABA- and glutamate- containing projections into the areas that facilitate various social behaviors (e.g. Bamshad et al., 1996).

Supplemental experiments

V1a receptor antagonism in the anterior hypothalamus on the day of proestrus tends to increase aggression, but to a lesser magnitude than on D1

Although estradiol (E_2) does not appear to regulate V1aR binding densities in the AH in a linear fashion, the possibility that the effects of antagonism of V1aR are dependent upon estrus cycle state still exist. Females show high levels of territorial aggression on the three days prior to sexual receptivity (Floody and Pfaff, 1977). This study also reported that the number of times an animal bites, however, decreases as E_2 concentrations rise. Prior to the day of sexual receptivity, or estrus, is proestrus when E_2 concentrations are at their peak. The hormonal state of the animal elicits behaviors such as vaginal marking, thought to be performed as a way to attract potential mates (Johnston and Kwan, 1984). Previous studies in our laboratory tested only intact females on the first day of diestrus (D1), when E_2 concentrations are the lowest of the cycle, or ovariectomized females that received an estradiol benzoate (EB) implant to maintain D1 concentrations. We hypothesized that despite higher circulating E_2 concentrations on proestrus, V1aR antagonism in the AH would be sufficient to increase aggression.

To test the prediction that the V1aR antagonist, Manning compound, would increase aggression on proestrus we monitored estrous cycles of ten female hamsters that were individually housed in long photoperiod conditions. We used the methods described previously in this chapter to administer either 45 μ M of Manning compound or saline directly into the AH on the day of proestrus. Experimental females served as the resident in the resident-intruder paradigm and tested for aggression.

Surprisingly, the V1aR antagonist did not significantly affect aggressive behavior in proestrus females. The tendency to show increased aggression was displayed, but was not statistically significant (Fig 2.8A-C). These data suggest that blocking V1aR affects aggression, but that the magnitude of this effect is controlled by the hormonal state of the animal. Previous studies support the idea that increased concentrations of circulating estradiol on the day of proestrus, for example, influences the expression of V1aR mRNA (Kalamatianos et al., 2004; Funabashi et al., 2000). Estradiol-mediated regulation of V1aR expression may contribute to the brain's responsiveness to the antagonist.

Blockade of V1a receptors on the day of estrus is not sufficient to disrupt lordosis behavior

We hypothesized that V1aR may inhibit aggressive behaviors in order to allow the animal to effectively display lordosis. We initially expected, therefore, that antagonism of V1aR would disrupt the lordosis response, and further, initiate aggression. Alternatively, if the hypothesis is correct that the antagonist does not have as great an effect on aggression as the estrous cycle progresses due to the hormonal state of the animal, then we may observe no effectiveness of the antagonist at all on the day of receptivity.

To test these possibilities, we microinjected the V1aR antagonist and saline in counterbalanced manner into the AH on the day of sexual receptivity, estrus. Females were

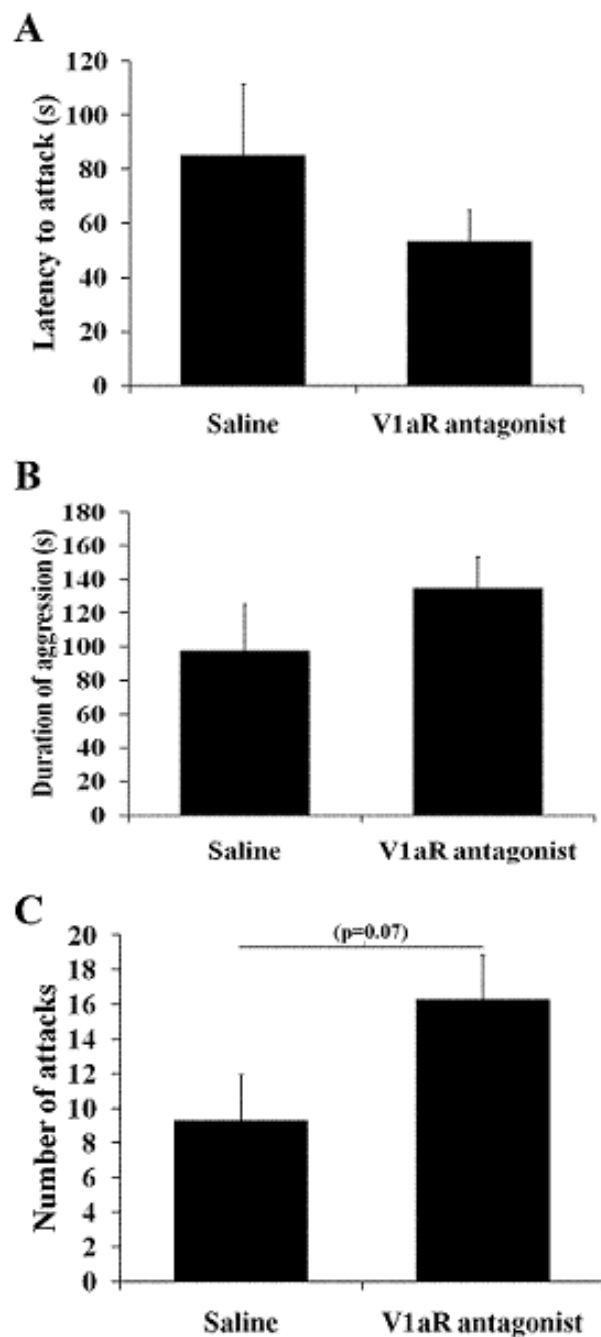

Figure 2.8: Manning compound elicits increases in aggression on proestrus. A.) The latency to attack is reduced after administration of Manning compound, but this effect is not significant. B.) Duration of aggression also tends to be higher when females were given the V1aR antagonist. C.) A trend towards a treatment effect was found in comparison of the number of attacks. Microinjections of the V1aR antagonist yielded greater numbers of attacks than saline microinjection.

behaviorally tested in a resident-intruder paradigm with a female conspecific in the D1 stage of the estrous cycle. We expected that matching receptive females with intruders in the most aggressive stage of their cycle would give the greatest scenario in which to induce aggression.

There were no differences due to treatment in any behavioral measurement. The V1aR antagonist did not inhibit the lordosis response in any way ($p>0.05$ for all measures). The latency to initiate lordosis, total duration of lordosis, and number of lordosis displays were all quantified (Figures 2.9A-C).

The hormonal state of the animal determines the ability of the V1aR antagonist to affect aggression

In the heightened state of territorial aggression that accompanies the first day of diestrous, antagonism of the V1aR in the AH further increases aggression. Estradiol concentrations increase on proestrus, primarily to contribute to the induction of progesterone receptor expression in the brain. Other behavioral changes that occur from the diestrous state to proestrus include decreases in flank marking behavior (Albers et al., 1996) and increases in vaginal marking (Lisk and Nachtigall, 1988). Territorial aggression is still displayed during this phase, but not as frequently or as quickly as it is in diestrous. Additionally, our data suggests that antagonism of the V1aR in the AH does not as readily increase aggression during proestrus compared to diestrous.

Cycle-dependent differences in antagonist effectiveness are not related to V1aR binding densities

In the previous chapter, we reported differences exist in V1aR binding densities between the brains of D1 females and brains taken from females during the remaining three cycle days. We concluded that a linear relationship between progression of the estrous cycle and V1aR

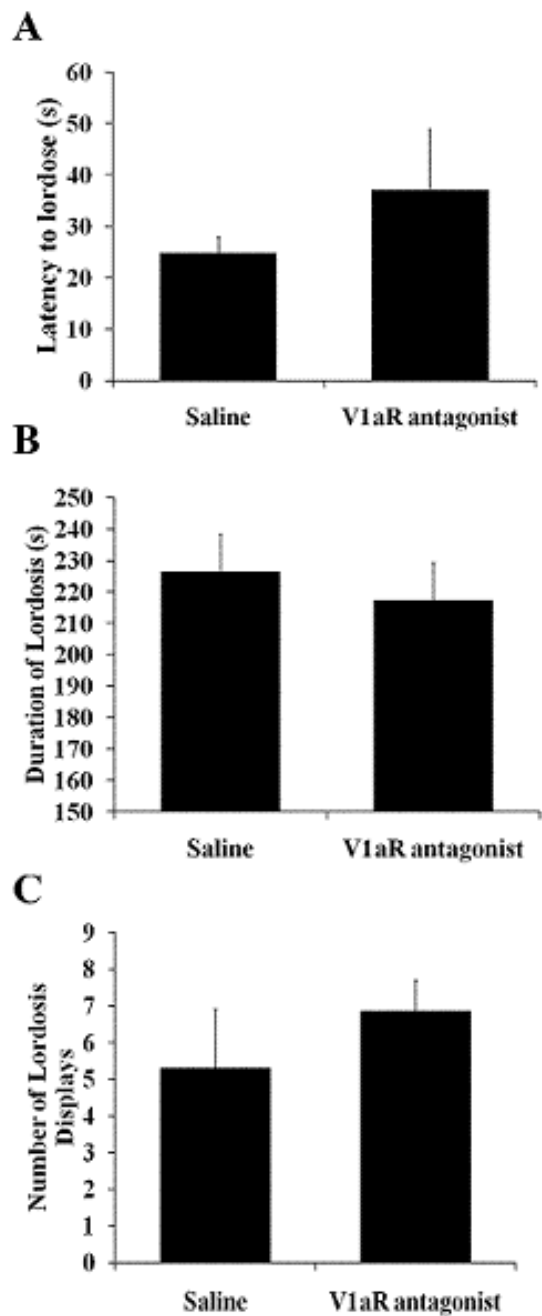

Figure 2.9: The V1aR antagonist does not show an effect on lordosis behavior on the day of estrus. A.) The latency to initiate the lordosis response in the presence of a female conspecific was not affected by treatment. B.) The duration of lordosis overall was also not altered by the V1aR antagonist. C.) The number of lordosis displays did not differ as a result of saline and V1aR antagonist microinjections.

binding densities does not exist. In the BNST and MPN, however, D1 females possessed significantly higher V1aR binding densities compared to any other cycle day. These sites have been implicated as critical to the onset and maintenance of lordosis behavior (Delville et al., 2000). Additionally, following the day of receptivity, a decline in progesterone may yield cause for closer examination to investigate the hormonal basis for the fluctuation of these densities. Progesterone receptors are colocalized with AVP in the BNST of female rats (Auger and De Vries, 2002). The increase in V1aR binding densities in this area of D1 hamsters, combined with the behavioral effects of the antagonist in the AH, lead to the hypothesis that decreases in AVP on D1 lead to up-regulation of this receptor subtype. An increase in V1aR binding densities is also evident in the LS on the day of estrus. Studies in hamsters and rats lend support to the hypothesis that of disinhibition of areas such as the VMH facilitates the lordosis response (Frye, 2001; Luine et al., 1999; Caldwell and Clemens, 1986; Malsbury et al., 1980). Thus, on the day of estrus, an increase in densities of V1aR on GABAergic projections to areas of sexual behavior that are tonically inhibited during the non-receptive cycle days may contribute to the facilitation of the lordosis response. To further investigate the hormonal control of V1aR binding densities, comparisons with intact, non-cycling females are necessary. Seasonal changes in these receptors may also correspond with seasonal changes in female aggressive behavior.

Acknowledgements

This work was supported by NIH Grant MH62641 and NSF IBN 9876754 awarded to H.E.A. Portions of this work were presented at the 2004 and 2007 meetings of the Society for Neuroscience (San Diego, CA), as well as the 2005 (Austin, TX) and 2007 meetings (Monterey, CA) of the Society for Behavioral Neuroendocrinology

Portions of this chapter will be submitted as: Gutzler, S.J., Karom, M., Erwin, W.D., Albers, H.E. Antagonism of V1a receptors in the anterior hypothalamus of female Syrian hamsters increases aggression, but not in a photoperiod-dependent manner. *Pharm Biochem Behav.*

CHAPTER 3: PHOTOPERIOD REGULATION OF ADRENAL HORMONE SECRETION AND AGGRESSION IN FEMALE SYRIAN HAMSTERS

Abstract

Seasonal changes in the length of the daily photoperiod induce significant changes in social behavior. Hamsters housed in winter-like short photoperiods (SP) can express significantly higher levels of aggression than hamsters housed in long photoperiods (LP) that mimic summer. The mechanisms responsible for increasing aggressiveness in SP exposed female hamsters are not well understood but may involve seasonal changes in the endocrine system. In experiment 1, the effects of SP exposure on the circulating levels of three adrenal hormones was determined. Short photoperiod exposure was found to significantly depress the circulating levels of cortisol and the adrenal androgen dehydropiandrosterone (DHEA) but significantly increased the circulating levels of the sulfated form of DHEA, DHEAS. Experiment 2 examined the effects of gonadal hormones on several different measures of aggression including its intensity in females housed in both long and short photoperiod. Exposure to SP resulted in high levels of aggression regardless of the endocrine state of the animal or the measure used to quantify aggression. In contrast, administration of estradiol to hamsters housed in LP significantly reduced aggression. The data of the present study support the hypothesis that SP-housed females are more aggressive than LP-housed females because SP exposure renders females insensitive to the aggression-reducing effects of ovarian hormones.

Introduction

Seasonal changes in the duration of the daily photoperiod induce profound seasonal changes in the physiology and behavior of many species. A variety of avian and rodent species display seasonal alterations in a wide range of variables including reproduction, metabolism,

immunity, body weight, and pelage color (for reviews see Bartness et al., 1993 and Leska and Dusza, 2007). For example, Syrian hamsters (*Mesocricetus auratus*) exposed to long, summer-like photoperiods (LP) containing more than 12.5 h of light/day maintain their ability to reproduce. However, exposure to short photoperiods (SP) containing less than 12.5 h of light/day for 6-8 weeks inhibits their capacity to reproduce by inducing a state of reproductive quiescence like that seen during winter conditions (Seegal and Goldman, 1975; Turek et al., 1975). In males, SP induces a dramatic regression in the size of the testes and significant reductions in circulating testosterone (T) (Turek et al., 1975) while in females, SP results in significant reductions in ovarian mass and in the circulating concentrations of estradiol (Jorgenson and Schwartz, 1985; for review: Nelson et al., 1990).

It is not surprising that exposure to short photoperiods can also produce substantial alterations in the social behavior of seasonal breeding species. In association with the decline in reproductive capacity following SP-exposure, the expression of aggression is dramatically heightened in SP-exposed male rodents despite the significant reductions in the circulating levels of gonadal hormones. Studies in both male Syrian hamsters (Jasnow et al., 2002; Garrett and Campbell, 1980) and Siberian hamsters (*Phodopus sungorus*) (Jasnow et al., 2000) have reported substantial increases in aggression in response to SP exposure. The mechanisms responsible for the elevated levels of aggression that occur in short photoperiod are not known. However, it seems unlikely that gonadal androgens play a significant role in mediating the seasonal changes in aggression since SP exposure substantially reduces testes function and circulating levels of testosterone.

In female Syrian hamsters, the effect of photoperiod on aggressiveness is less clear than in males. In LP-housed females exhibiting spontaneous estrous cycles, the duration of offensive

aggression was found to be similar to that of SP-housed anestrus females regardless of whether the opponents were SP- or LP-housed females (Fleming et al., 1988). However, SP-housed females displayed significantly shorter durations of defensive behavior than LP-housed females. In another study, no differences were found between LP- and SP-housed ovariectomized (OVX) females in the percentage of animals that attacked male or female LP-housed opponents (Elliott & Nunez, 1992). However, when LP- and SP- housed (OVX) females were administered various combinations of estradiol and progesterone, the percentage of SP-housed females that attacked their opponents was significantly greater than the percentage of LP-housed females administered the same hormone treatments. In LP, OVX hamsters display high levels of aggressive behavior and there is a substantial body of evidence that aggression levels vary over the estrous cycle suggesting that ovarian hormones can significantly alter aggressiveness (Ciaccio et al., 1979; Floody & Pfaff, 1977; Fraile et al., 1987; Meisel et al., 1988; Payne & Swanson, 1972; Takahashi & Lisk, 1983; Vandenberg, 1971). In addition, administration of estradiol to OVX females housed in LP has been found to either reduce aggression (Carter et al., 1973; Ciaccio et al., 1979; Lisk & Nachtigall, 1988) or have no effect on aggression (Fraile et al., 1987; Meisel et al., 1988; Payne & Swanson, 1972; Vandenberg, 1971), while estradiol combined with progesterone or progesterone alone has been consistently found to reduce aggression (Ciaccio et al., 1979; Floody and Pfaff, 1977; Meisel et al., 1988; Meisel & Sterner, 1990; Elliott & Nunez, 1992). Taken together, these data suggest the possibility that SP exposure increases aggression by altering levels of ovarian hormones (e.g., reducing estradiol) or by reducing the ability of ovarian hormones to reduce aggression. If so, then gonadally intact SP-housed, OVX SP-housed and OVX LP-housed hamsters should display significantly higher levels of aggression than intact LP-housed hamsters displaying estrous cyclicity. However, in a

study examining this question the results were equivocal (Fleming, et al, 1988). Although intact LP-housed females displayed significantly shorter durations of aggression when tested with LP-housed opponents than intact SP-housed females tested with SP-housed opponents, no differences in the duration of aggression were observed between intact and OVX LP- or SP-housed females. Thus, it remains unclear whether increased aggression in SP-housed females is simply due to the lack of circulating ovarian hormones in Syrian hamsters.

In female Siberian hamsters, SP exposure significantly increases aggression in gonadally intact hamsters, but surprisingly, does not significantly reduce circulating levels of estradiol (Scotti et al., 2007). However, when OVX hamsters housed in LP or SP were implanted with Silastic capsules containing estradiol for four weeks, aggression was reduced. Thus, in Siberian hamsters, estradiol appears to reduce aggression whether hamsters are housed in LP or SP, while in Syrian hamsters housed in SP administration of ovarian hormones appears to have no effect on aggression. One purpose of the present study was to re-examine whether SP exposure increases aggression in Syrian hamsters by altering levels of ovarian hormones (e.g., reducing estradiol) or by reducing the ability of ovarian hormones to reduce several different measures of aggression including its intensity.

Another endocrine gland that may be involved in regulating seasonal changes in aggression is the adrenal. Studies in birds and hamsters suggest adrenal hormones, specifically hormones secreted by the adrenal cortex, may play a critical role in regulating seasonal changes in aggression. In male birds, there is evidence that the aromatization of the adrenal androgen dehydroepiandrosterone (DHEA) into estrogen is involved in the seasonal changes in aggression (Soma and Wingfield, 2001; Soma et al., 2000). In male Syrian and Siberian hamsters, melatonin secretion during short photoperiod exposure has been shown to increase aggression

(Demas et al., 2004; Jasnow et al., 2002). There is evidence that melatonin-induced aggression is mediated by hormones secreted from the adrenal cortex since complete adrenalectomy, but not removal of the adrenal medulla, significantly reduced melatonin-induced aggression (Demas et al., 2004). There is also evidence that DHEAS, the sulfated form of DHEA, is associated with the facilitation of aggression in male mice (Nicolas et al., 2001). Taken together, these data suggest that hormones originating from the adrenal cortex may be involved in regulating the seasonal variations in aggression.

Little is known about the factors that regulate the circulating levels of adrenal cortical hormones such as DHEA and DHEAS in mammals. In male Syrian hamsters, exposure to SP significantly increases the circulating concentrations of DHEA when compared to hamsters housed in LP (Caldwell et al., 2008). In the present study, we evaluated whether there are seasonal changes in the circulating levels of DHEA, DHEA-S as well as cortisol in female Syrian hamsters and the circulating levels of these hormones following aggressive interactions.

Materials and methods

Animals and housing conditions

Adult female Syrian hamsters (Charles River Laboratories: Wilmington, MA) were maintained in reverse light cycles to mimic “summer-like” long photoperiod (LP) (14:10, L:D) or “winter-like” short photoperiod (SP) (8:16, L:D). Animals weighed 120-140 g at the start of the experiment and were housed individually in polycarbonate cages (40 x 20 x 20 cm) with corncob and cotton bedding materials and wire mesh tops. Food (Purina Rodent Chow) and water were provided ad libitum. All experimental protocols were approved by the Georgia State University Institutional Animal Care and Use Committee.

Experiment 1

Female hamsters were individually housed in LP (n=35) or SP (n=40) conditions for 10 weeks. Throughout the 10-week period, estrous cycles were monitored by the examination of post-ovulatory secretions. The estrous cycles of SP-housed hamsters ceased following 10 weeks of exposure to short photoperiod. Females were euthanized in groups at hourly intervals from three hours prior to the onset of the dark phase until four hours into the dark phase. At the time of sacrifice, females were deeply anesthetized with sodium pentobarbital and blood was collected from the inferior vena cava. In LP-housed females the stage of the estrous cycle on the day of sacrifice was recorded.

Experiment 2

Fifty adult female hamsters were individually housed in LP or SP as described above. Estrous cycles were monitored throughout the experiment by examination of postovulatory discharge. At week six, 50 female intruders were individually housed in LP conditions. Two weeks after intruders had acclimated to housing conditions, and after eight weeks of photoperiod exposure experimental animals were further subdivided into the following groups. One-third of experimental females in both photoperiod conditions were bilaterally ovariectomized (OVX) and subcutaneously implanted in the scapular region with two Silastic capsules filled with estradiol benzoate (OVX + EB) (Sigma, St. Louis, MO). Another one-third were OVX and implanted with two empty Silastic capsules (OVX). The remaining experimental animals received an incision in the muscle tissue that was subsequently sutured, but OVX and implantation of capsules were not performed (sham group). Intruder females (n=50) were OVX and implanted with one capsule of EB. Four weeks following surgery, animals were tested using the resident-

intruder paradigm. Immediately following the behavioral test, animals were sacrificed and blood drawn from the inferior vena cava.

Ovariectomies and hormonal manipulations

All females were deeply anesthetized with sodium pentobarbital (50 mg/kg). Prior to surgery, animals were given a subcutaneous injection of the analgesic, ketaprophen (5 mg/kg). Previous studies in our laboratory have shown that implantation of one 10 mm EB-filled Silastic capsule (0.062 in i.d. x 0.125 in o.d.) produces an average of 180 pg/ml of circulating estradiol. Each 10 mm Silastic capsule was filled with 5 mm of EB, and sealed with Factor II 6382 RTV Silicone and Elastomer as previously described (Faruzzi et al., 2005). Using this approach we targeted this amount of circulating hormone in our intruder females to approximate the amount of estradiol in a diestrous female. The experimental females were implanted with 2 EB-filled capsules in order to double this concentration. Following surgery, skin incisions were repaired using tissue adhesive and animals received 1 ml of physiological saline to prevent surgery-induced dehydration.

Behavioral testing

After five weeks of recovery, experimental females were tested for aggression using the resident-intruder paradigm. The intruders were approximately the same weight as the experimental hamsters (intruders: 145.9 ± 1.9 g; experimental: 142.6 ± 2.6 g). The cages of experimental females were not changed for two weeks prior to testing. Five minute tests occurred between two and three hours after the onset of the dark phase. Sham-OVX hamsters were tested on diestrus 1. All tests were videotaped, and the behavior was scored by a scorer blind to the treatment of the experimental animal. The latency to attack and the number of attacks were quantified for each test period. In addition, the total duration of social, non-social,

submissive and defensive, or aggressive behavior was recorded for each test. Because the intensity of aggression appeared to differ in some of the experimental groups we further categorized aggressive behavior as either low intensity or high intensity (Table 3.1). Several behavioral tests (n=5) were terminated prior to five minutes because of the intensity of the aggression was likely to lead to injury. As a result, we also analyzed the duration of high and low intensity aggression as a percentage of the duration of the test period, i.e., the duration of time from the beginning of the test until the test was terminated because of the intensity of aggression or until five minutes of testing was completed. Defensive behavior was quantified using the criteria of Fleming et al., 1988. Experimental animals were euthanized immediately following the behavioral test.

Table 3.1: Criteria used to score aggressive behavior & intensity

Behavior	Definition
Latency to initial attack	Attack defined as biting/pushing conspecific onto side to initiate roll fight
Number of attacks	Attack defined as biting/pushing conspecific onto side
Duration of high intensity aggression	Attack biting/roll fighting
Duration of low intensity aggression	Offensive “push” behavior, chase behavior, pinning the subordinate
Average duration per attack	Duration of high intensity aggression divided by the number of attacks
Duration of social behavior	Scored when animals are in contact with each other; includes nose-to-nose investigation or non-aggressive “following” behavior/olfactory investigation, grooming flanks
Duration of non-social behavior	Scored when animals are investigating the cage, sitting, “escape” behavior (trying to climb out of the cage, but not out of fear or submission), grooming of face and head
Duration of defensive behavior	Tail-up posture, pinned on the ground, defensive posturing (hands up, protecting self), flee

Radioimmunoassay

Serum was separated following centrifugation and stored at -20 °C until the time of processing. Assay kits were purchased from Beckman Coulter Diagnostic Systems Laboratories (Webster, TX) for E₂, DHEA, and DHEAS. Following the determination of E₂, DHEA and DHEAS in experiment 1, we measured cortisol with the remaining serum samples (n=31 s). In Experiment 2, in addition to E₂, DHEA, and DHEAS, cortisol was determined in samples from all animals.

Serum E₂ concentrations were assessed using an active RIA kit (DSL 43100). The linearity of dilution was used to validate the kit and yielded 94% recovery. The interassay reliability was 6%. The intraassay reliability was 2%. The sensitivity of the assay was 3.19-1500 pg/ml. The cross-reactivity with 17 β -estradiol was 100% and with other related compounds was less than 1%.

Serum DHEA concentrations were assessed using an active RIA kit (DSL 9000). The linearity of dilution was 87% recovery. The interassay reliability was 5% and intraassay reliability, 4%. The sensitivity of the assay was 0.16-8.65 ng/ml. The cross-reactivity with DHEA was 100% but less than 1% or non-detectable for other related compounds.

An active RIA kit was also used to quantify serum DHEAS concentrations (DSL 3500). The linearity of dilution was 94%. The inter- and intra-assay reliabilities were 4% and 2%, respectively. The sensitivity of this assay was 0.4-61.52 μ g/dL. The cross-reactivity with DHEAS was 100% and with DHEA was 41%. For other related compounds, the cross-reactivity was less than 7.3% or non-detectable.

Finally, to determine circulating cortisol concentrations, we used an active RIA kit (DSL 2100). The linearity of dilution was 93%. Interassay reliability was 2% and the intraassay

reliability was 3%. The sensitivity was 0.08-100.99 $\mu\text{g/dL}$. The cross-reactivity with cortisol was 100%, with prednisolone was 33.3%, and with less than 10% with any other related compounds.

Statistical analyses

All statistical analyses were performed with the Statistical Package for the Social Sciences (SPSS) version 11.0. Females that did not respond to SP conditions ($n=2$) were dropped from the study. Differences in E_2 , DHEA, and DHEAS across the estrous cycle were examined using a one-way ANOVA. Tukey's HSD test was used for *post hoc* analysis when a significant difference was detected as a result of estrous cycle stage. Mean E_2 concentrations for each photoperiod were further analyzed for differences using an independent-samples t test. Additionally, we analyzed whether differences occurred in circulating cortisol, DHEA, and DHEAS using time and photoperiod as independent variables. These data were analyzed using a two-factor, independent-samples analysis of variance (ANOVA). In Experiment 2, a two-factor ANOVA was again used to determine whether differences in aggressive behavior existed as a result of treatment or photoperiod, or an interaction of the two. Where significance was indicated, the data were analyzed *post hoc* with Tukey's HSD test. $P \leq 0.05$ was considered significant for all analyses. Defensive behavior was analyzed with a Chi-Square analysis because of the lack of homogeneity of variance according to the Levene's test.

Results

Experiment 1: Basal concentrations of adrenal hormones vary in response to photoperiod.

Females housed in SP had circulating levels of estradiol of 131.0 ± 3.5 pg/ml while hamsters housed in LP had circulating levels of 369.6 ± 33.6 pg/ml. These differences were statistically significant ($t(71) = -7.36$, $p \leq 0.001$). Significant differences were also found in

estradiol when LP females were compared across the stages of the estrous cycle ($F_{3,31}=5.77$, $p=0.003$) (Table 3.2).

Table 3.2: Concentrations of estradiol, DHEA, and DHEAS during the estrous cycle (mean \pm s.e.m.)

Estrous Cycle Stage	Estradiol (pg/ml)	DHEA (nmol/L)	DHEAS (nmol/L)
Diestrus 1	241.82 \pm 13.06 ^a	1.22 \pm 0.04	72.41 \pm 9.01 ^b
Diestrus 2	261.68 \pm 26.79 ^{a,b}	1.23 \pm 0.05	81.61 \pm 10.20 ^{a,b}
Proestrus	499.62 \pm 72.09 ^c	1.29 \pm 0.04	81.65 \pm 7.31 ^{a,b}
Estrus	461.39 \pm 78.9 ^{b,c}	1.54 \pm 0.18	120.06 \pm 17.53 ^a

a, b, or c = $p \leq 0.05$

The highest estradiol concentrations were found in proestrus females compared to females on either day of diestrus ($p \leq 0.05$). On diestrus 1 females also had significantly lower estradiol concentrations compared to females on estrus ($p=0.04$). There was a trend for differences in DHEA concentrations across the stages of the estrous cycle, however this trend did not reach statistical significance ($p=0.08$). In contrast, significant differences in DHEAS concentrations were observed across the stages of the estrous cycle ($F_{3,31}=3.48$, $p=0.028$). Specifically, DHEAS concentrations were higher on the day of estrus compared to diestrus 1 ($p=0.023$). Trends were detected between concentrations of DHEAS on estrus and the remaining days of the estrous cycle, diestrus 2 and proestrus ($p=0.13$ and $p=0.09$, respectively).

There were main effects of photoperiod on both DHEA ($F_{1,57}=17.80$, $p \leq 0.001$) (Fig 3.1A) and DHEAS ($F_{1,57}=12.30$, $p=0.001$) (Fig 3.1B). DHEA concentrations were significantly higher in LP-housed females, while circulating DHEAS levels were higher in the SP-housed group. No effect of time was found, nor was any interaction of time and photoperiod indicated ($p > 0.05$). There was no main effect of photoperiod on cortisol concentrations ($p > 0.05$), but there was a main effect of time ($F_{3,23}=3.43$, $p=0.034$) (Fig 3.1C). There was also an interaction between photoperiod and time ($F_{3,23}=3.03$, $p=0.05$). LP-housed females had higher

concentrations of cortisol compared to their SP-housed counterparts at the time points representing 2 and 3 hours after the onset of the dark phase. SP-housed females did not show the same fluctuation in cortisol as LP-housed females.

Experiment 2: Effects of treatment and photoperiod on agonistic behavior

The circulating concentrations of estradiol in each group can be seen in Table 3.3. As expected, there was a main effect of treatment on estradiol concentrations ($F_{2, 40}=87.75$, $p\leq 0.001$), but there was no main effect of photoperiod on estradiol concentrations ($F_{1, 40}=0.44$, $p=0.511$). A significant interaction was detected between photoperiod and treatment ($F_{2, 40}=5.85$, $p=0.006$). Females implanted with EB-filled or empty capsules had no differences in estradiol as a function of photoperiod ($p>0.05$), but LP-housed sham females on diestrous 1 had significantly higher concentrations of estradiol compared to SP-housed sham females ($p=0.05$).

Table 3.3: Estradiol concentrations of LP and SP treatment groups (mean \pm s.e.m.)

Photoperiod	Treatment	Estradiol (pg/ml)
Long Photoperiod	Sham	219.12 \pm 11.75 ^a
	EB	319.93 \pm 20.40 ^b
	Empty	139.43 \pm 5.13 ^c
Short Photoperiod	Sham	149.19 \pm 9.90 ^c
	EB	358.84 \pm 25.07 ^b
	Empty	144.45 \pm 12.17 ^c

An analysis of non-aggressive social behaviors (Fig 3.2A), i.e. contact time between resident and intruder, revealed a main effect of treatment ($F_{2, 40}=5.22$, $p=0.01$) but no main effect of photoperiod ($F_{1, 40}=0.42$, $p=0.52$). There was also no interaction between photoperiod and treatment ($F_{2, 40}=1.72$, $p=0.19$). Surprisingly, SP-housed sham females had greater durations of non-aggressive social behavior compared to SP-housed OVX females ($p=0.02$). The duration of defensive behavior was also quantified and no significant differences ($\chi^2_{(2)}=3.11$, $p=0.2$) were observed across groups. In the LP group, the durations of defensive behavior for the sham,

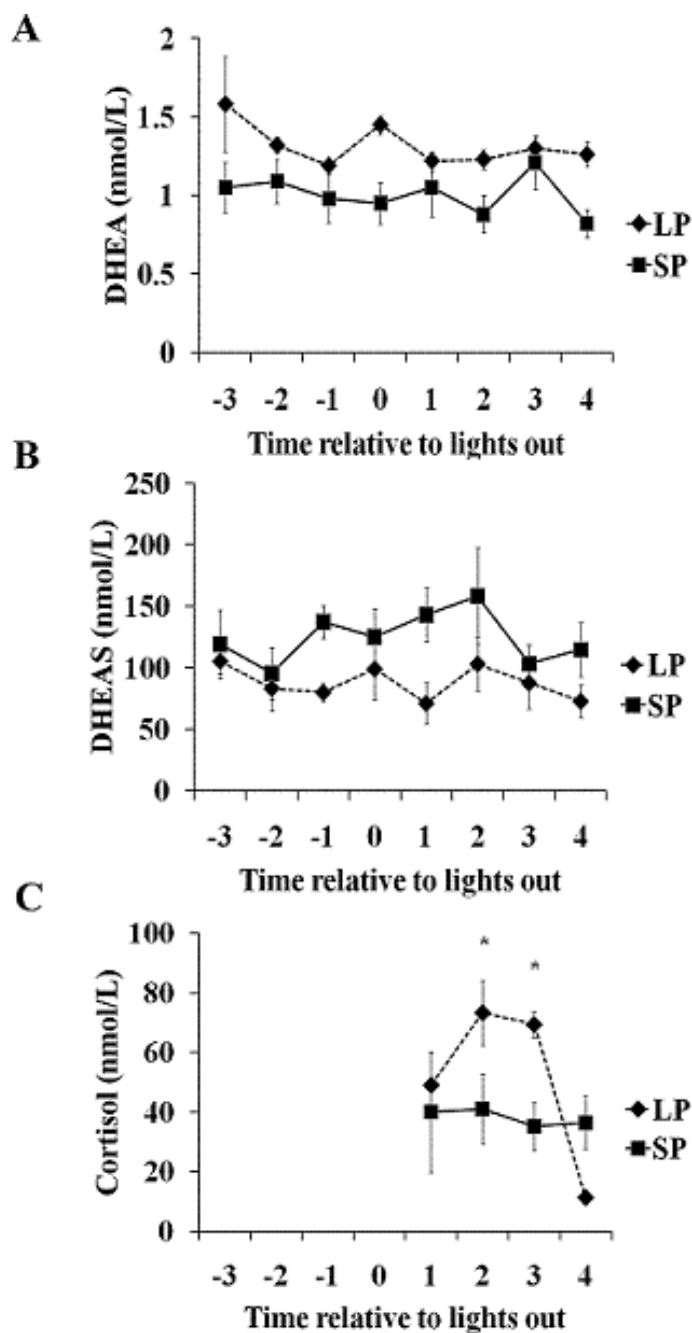

Figure 3.1: Effects of photoperiod on circulating DHEA, DHEAS, and cortisol concentrations across time. A.) A main effect of photoperiod was found on DHEA concentrations ($p \leq 0.001$), B.) There was a main effect of photoperiod of DHEAS concentrations ($p = 0.001$), but not of time nor an interaction of photoperiod and time ($p > 0.05$). C.) Cortisol concentrations were not significantly different as a result of photoperiod ($p > 0.05$), but a significant effect of time was detected ($p = 0.03$) as well as an interaction of photoperiod and time ($p = 0.05$). Post-hoc comparisons show significantly higher cortisol concentrations in LP females than SP females sacrificed two and three hours after the onset of the dark phase.

OVX and OVX + EB groups were 8.7 ± 7.1 sec (mean \pm SEM), 48.8 ± 31.1 and 63.5 ± 33.7 , respectively. In the SP group, the durations of defensive behavior for the sham, OVX and OVX + EB groups were 14.4 ± 10.7 , 38.8 ± 21.8 and 0 ± 0 , respectively.

There was a significant main effect of treatment ($F_{2,39}=11.04$, $p \leq 0.001$) and photoperiod ($F_{1,39}=12.53$, $p=0.01$) on latency to attack, as well as a significant interaction between the two ($F_{2,39}=10.93$, $p \leq 0.001$) (Fig 3.2B). LP-housed, EB-treated OVX females had a significantly higher latency to attack than any other group ($p \leq 0.001$ in all cases). There was a main effect of photoperiod ($F_{1,40}=6.26$, $p=0.02$) and treatment ($F_{2,40}=3.44$, $p=0.04$) on the total duration of aggression (Fig 3.3A). An interaction between photoperiod and treatment approached, but did not reach, statistical significance ($F_{2,40}=2.95$, $p=0.06$). OVX hamsters administered EB and housed in LP had significantly shorter durations of aggression than OVX hamsters housed in LP but not given EB ($p=0.05$). LP-housed sham females did not have significantly longer durations of aggression than EB-treated OVX females ($p=0.10$). Overall, SP-housed females had longer durations of aggressive behavior. This effect is particularly evident in comparing LP-housed, EB-treated OVX females to the SP-housed OVX females given empty capsules, and the SP-housed, EB-treated OVX females ($p \leq 0.05$ for both comparisons). Interestingly, post hoc analysis did not detect a statistical difference in the total duration of aggression between LP-housed, EB-treated OVX females and the SP sham group ($p=0.13$). Because the intensity of aggression appeared to be particularly high in SP-housed females we also examined the duration of high intensity and low intensity aggression (see Table 3.1). SP-housed females had greater durations of high intensity aggression (Fig 3.3B) compared to LP-housed females, as evidenced by a significant main effect of photoperiod ($F_{1,40}=19.99$, $p \leq 0.001$). In addition, a main effect of treatment was detected ($F_{2,40}=4.69$, $p=0.015$), but there was no interaction ($F_{2,40}=1.13$, $p=0.33$).

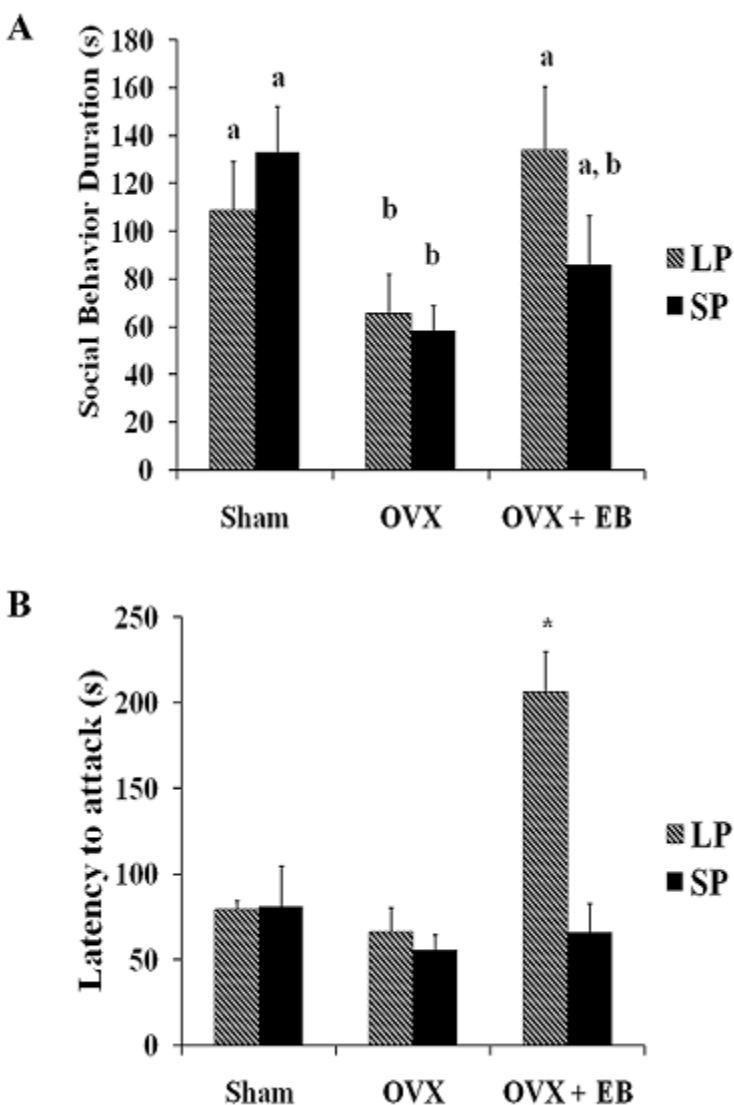

Figure 3.2: Effects of photoperiod and treatment on the duration of social behavior and the latency to attack. A.) A main effect of treatment revealed that OVX females exhibited significantly lower durations of social behavior than sham females ($p=0.01$), but there was no main effect of photoperiod. B.) In LP, females that were OVX and given EB treatment displayed significantly longer latencies to attack compared to all other groups reflecting differences due to photoperiod, time, and an interaction of the two ($p\leq 0.001$ for each).

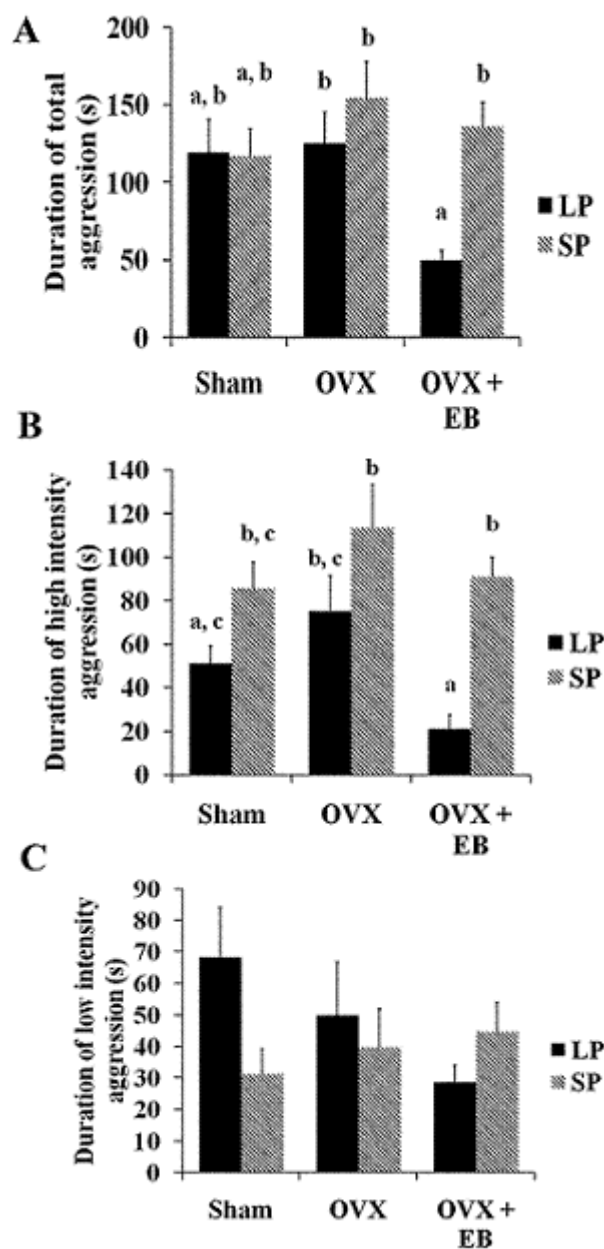

Figure 3.3: Effects of photoperiod and treatment on the duration of aggression and the duration of high and low intensity aggression. A.) Sham and OVX females did not display photoperiod-dependent differences in total duration of aggression while EB significantly reduced this duration only in LP-housed females ($p \leq 0.05$). B.) Main effects of treatment and photoperiod were detected ($p \leq 0.05$ for both) on the duration of high intensity aggression, but the duration of high intensity aggression was only attenuated by EB treatment in LP-housed females. C.) No significant differences in the duration of low intensity aggression were detected due to photoperiod, treatment, or an interaction between photoperiod and treatment ($p > 0.05$).

In LP-housed OVX females, administration of EB resulted in significantly shorter duration of high intensity aggression compared to OVX LP-housed females implanted with empty capsules ($p=0.05$). However, the duration of high intensity aggression in LP-housed sham females was not significantly different from either of the LP-housed OVX groups ($p>0.05$). The duration of high intensity aggression in LP-housed EB-treated OVX females was also significantly shorter than in all SP-housed groups ($p\leq 0.05$ for all cases). Conversely, there was no main effect of photoperiod ($F_{1,40}=1.11$, $p>0.05$) or treatment ($F_{2,40}=0.60$, $p>0.05$) on the duration of low intensity aggression (Fig 3.3C). The interaction of photoperiod and treatment was not statistically significant, but a trend was detected ($F_{2,40}=2.38$, $p=0.11$). Five of the behavioral tests had to be terminated prior to their completion because it seemed likely that the hamsters would be injured. As a result, we also calculated high intensity aggression and low intensity aggression as a percentage of the total duration of aggression (Fig 3.4A & B). Using this approach, there was a significant main effect of photoperiod on the percentage of high intensity aggression ($F_{1,39}=17.86$, $p\leq 0.001$). No main effect of treatment ($F_{2,39}=2.4$, $p=0.10$) or interaction of photoperiod and treatment ($F_{2,39}=2.26$, $p=0.10$) were detected. However, SP-housed EB-treated OVX females spent a significantly greater portion of their duration of aggression in a high intensity encounter compared to LP-housed, EB-treated OVX females ($p=0.04$). Furthermore, LP-housed EB-treated OVX animals had significantly less of their total aggression time in a high intensity interaction compared to all SP-housed groups ($p\leq 0.05$ for all cases). SP-housed sham females also had greater percentages of high intensity aggression compared to LP-housed sham females ($p=0.019$). There was a main effect of photoperiod on the percentage of low intensity aggression ($F_{1,40}=14.27$, $p=0.001$), but no main effect of treatment ($F_{2,40}=2.11$, $p=0.13$) or interaction ($F_{2,40}=1.60$, $p=0.22$). LP-housed EB-treated OVX females had

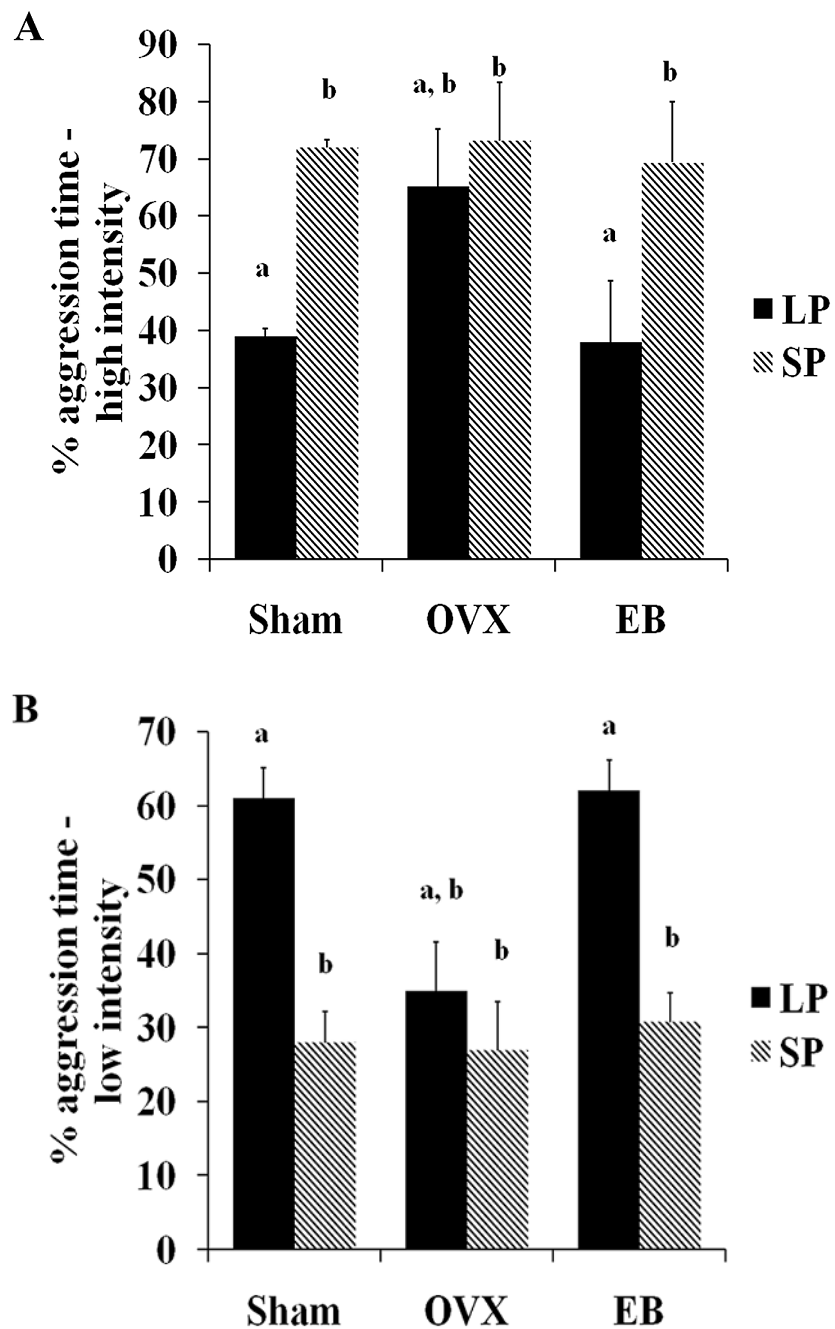

Figure 3.4: Effects of photoperiod and treatment on the percentages of high and low intensity aggression. A.) There was a significant main effect of photoperiod on the percentage of total aggression time spent in high intensity aggression ($p \leq 0.001$). EB treatment did not attenuate this effect in either photoperiod. B.) There was a statistically significant main effect of photoperiod on the percentage of total aggression time spent in low intensity aggression ($p = 0.001$). LP-housed females spent a greater portion of time spent in an aggressive interaction at a low intensity, however no differences were detected due to treatment or an interaction of photoperiod and treatment ($p > 0.05$).

significantly higher percentages of low intensity aggression compared to SP-housed OVX ($p=0.02$) and sham females ($p=0.01$).

There was no main effect of photoperiod on attack number ($F_{1,40}=1.41$, $p=0.24$) nor was a significant interaction detected ($F_{2,40}=1.72$, $p=0.19$) (Fig 3.5A). There was, however, a main effect of treatment ($F_{2,40}=5.03$, $p=0.01$). OVX females housed in LP and treated with EB attacked significantly less than OVX females in either LP or SP given empty capsules ($p=0.04$) and sham ($p=0.03$) hamsters housed in LP. Surprisingly, of the SP-housed females, only SP-housed OVX females given empty capsules had significantly more attacks compared to LP-housed EB-treated OVX females. We calculated duration of high intensity aggression/attack number and found only a main effect of photoperiod ($F_{1,38}=5.43$, $p=0.025$). Overall, SP-housed females had greater durations per attack than LP-housed animals (Fig 3.5B). Specifically, SP-housed sham females had significantly higher attack durations compared to LP-housed sham and LP-housed OVX females ($p=0.01$ for both).

Following the aggressive encounter, there was no main effect of photoperiod ($F_{1,40}=0.152$, $p=0.70$), treatment ($F_{2,40}=0.028$, $p=0.97$), nor an interaction between photoperiod and treatment ($F_{2,40}=0.362$, $p=0.70$) in the circulating concentrations of DHEA (Fig 3.6A). There was however, a main effect of photoperiod ($F_{1,40}=7.11$, $p=0.01$) and treatment on DHEAS concentrations ($F_{2,40}=6.00$, $p=0.005$). The interaction between photoperiod and treatment approached, but did not reach, statistical significance ($F_{2,40}=2.75$, $p=0.076$). SP-housed sham females had significantly higher DHEAS concentrations following an aggressive encounter than all other groups ($p\leq 0.05$ for all comparisons) (Fig 3.6B). There were also main effects of photoperiod ($F_{1,39}=4.79$, $p=0.035$) and treatment ($F_{2,39}=3.587$, $p=0.037$) on cortisol concentrations, but not an interaction between photoperiod and treatment ($F_{2,39}=0.50$, $p=0.61$).

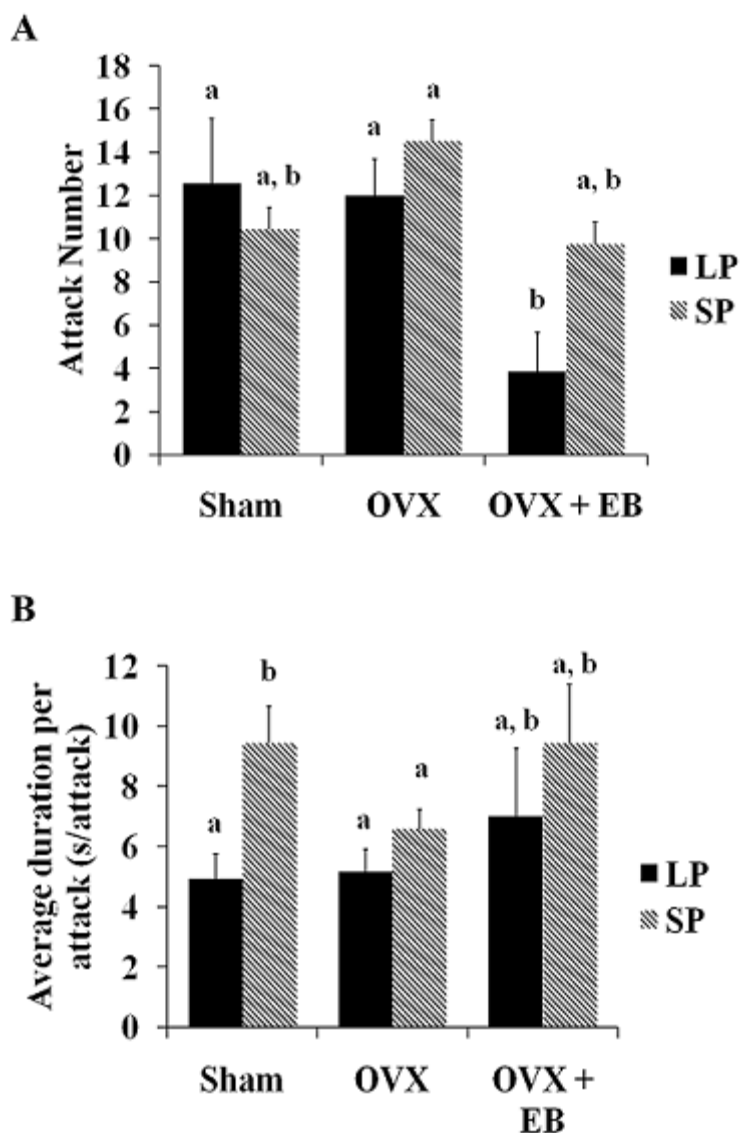

Figure 3.5: Effects of photoperiod and treatment on attack number and duration per attack. A.) A main effect of treatment, but not of photoperiod, was found on attack number ($p=0.011$). EB treatment in LP-housed females significantly reduced the number of attacks compared to the other LP-housed female groups. B.) Although there was not a significant photoperiod-dependent difference in the attack number of the sham groups, SP was associated with significantly longer durations per attack ($p=0.025$). SP-housed sham females exhibited significantly longer durations per attack compared to their LP-housed counterparts ($p=0.01$). These durations were also significantly higher in SP-housed sham females compared to OVX females in both photoperiods.

LP-housed EB-treated OVX animals had significantly higher circulating cortisol concentrations compared to all groups ($p \leq 0.05$) except LP-housed OVX females given empty capsules ($p > 0.05$) (Fig 3.6C).

Discussion

In the present study, female Syrian hamsters housed in SP conditions for 10 weeks were found to have significantly lower levels of circulating DHEA and significantly higher levels of DHEAS than females housed in LP. Previous studies in male Syrian hamsters also found that SP exposure significantly reduced DHEA levels compared to LP-exposed animals. It seems unlikely that the SP-induced reduction in DHEA concentrations is the result of the concomitant reduction in gonadal hormone concentrations since gonadectomy has little or no effect on circulating levels of DHEA (Pieper and Loboeki, 2000). The present study found no statistically significant changes in circulating levels of DHEA over the estrous cycle. However, DHEAS levels were significantly modulated over the estrous cycle with the greatest concentrations occurring on estrus. Previous studies in Syrian hamsters have found DHEA and DHEAS concentrations to peak in the hours preceding the onset of the dark phase, however in the present study no significant differences were observed in either DHEA or DHEAS levels during the three hours prior to lights-off. In summary, DHEA and DHEAS concentrations appear to be regulated by photoperiodic mechanisms in Syrian hamsters; however the existing data suggest that the changes in DHEA and DHEAS levels are not the result of photoperiodic induced changes in circulating gonadal hormones.

Previous studies in male Syrian hamsters have found that SP exposure significantly reduces circulating levels of cortisol and that SP exposure additionally dampens the 24 hr rhythm in cortisol (Ottenweller et al, 1987; Ronchi et al., 1998). The present study provides the first

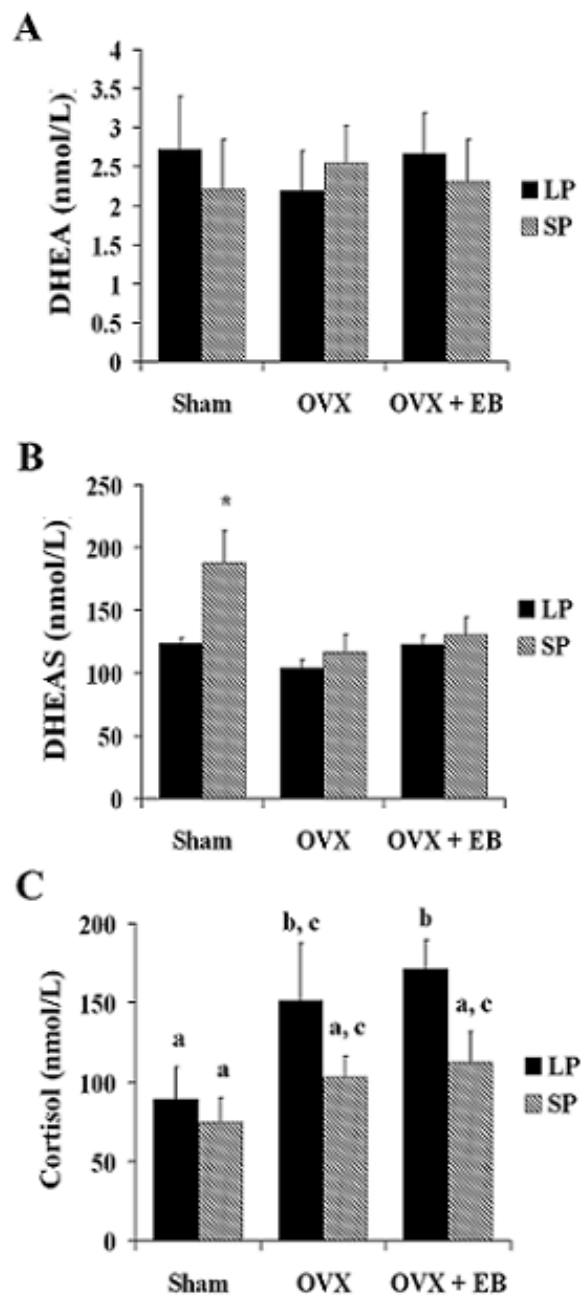

Figure 3.6: Adrenal hormone concentrations following an aggressive encounter. A.) There were no significant differences in DHEA concentrations between treatment groups or photoperiod groups after an aggressive encounter. B.) Main effects of photoperiod and treatment were detected on circulating DHEAS concentrations ($p \leq 0.01$ for both), but an interaction of the two was not detected ($p > 0.05$). The DHEAS concentrations of SP-housed sham females were significantly higher compared to all other groups. C.) Sham females showed significant differences in cortisol concentrations as a function of photoperiod and treatment ($p \leq 0.05$). In the case of LP-housed sham females, these concentrations were significantly lower than the other LP-housed groups.

data on the effects of SP exposure on the circulating levels of cortisol in female Syrian hamsters. Although, there was no main effect of photoperiod on cortisol concentrations there was a significant interaction between photoperiod and time suggesting that SP exposure reduces cortisol concentrations and dampens the rhythm of cortisol. Differences in basal concentrations of circulating adrenal hormones may indicate a change in HPA activity due to SP exposure. The association between observed photoperiod-dependent changes in DHEA and cortisol, along with the elevations in aggressive intensity displayed by SP-housed females, support the idea that adrenal hormones may impact aggressive behavior. However, a caveat of the present study is that baseline concentrations were not compared before and after an aggressive encounter. We suspect that increases in adrenal hormones would be observed in response to an aggressive encounter, but similar to a study done in mice (Pyter et al., 2007), the cortisol concentrations of SP-housed females would return to baseline more quickly than those housed in LP.

In the present study, the effects of photoperiod and estradiol on aggressiveness was evaluated by examining multiple measures of aggression including the latency to attack, the number of attacks, the duration of aggression as well as the intensity of aggression. The intensity of aggression in SP-housed females could be quite high. In fact, several of the behavioral tests of SP-housed females had to be terminated due to their intensity and the concern for injury. As a result, comparison of the total duration of aggression did not always represent a true reflection of the observed intensity of aggression. To address this issue, we quantified the duration of high intensity and low intensity aggression (see Table 3.1) and reported it as an absolute value or as a percentage of the total duration of aggression. This approach revealed that SP-housed females displayed significantly more high intensity aggression such as biting and roll fighting than hamsters housed in LP. One measure of aggression where no differences were found between

LP- and SP-housed hamsters was the number of attacks. However, the absence of differences in the number of attacks between photoperiod groups may have been due to the early termination of some of the behavioral tests in SP-housed hamsters. As a result, we also calculated the intensity of these encounters by determining the duration of high intensity aggression per attack. The duration of roll fighting/attack was significantly longer in SP-housed females compared to those housed in LP. In summary, exposure to SP was found to result in the display of high levels of aggression regardless of the endocrine state of the animal or the measure used to quantify aggression.

In the present study, estradiol administration to OVX females housed in LP significantly increased the latency to attack, and reduced the duration of aggression, the duration of high intensity aggression, the percentage of high intensity aggression and the mean duration of high intensity aggression/attack compared to OVX females housed in SP and given estradiol. No significant differences were observed in any measure of aggression between the LP- or SP-housed OVX hamsters given empty Silastic capsules and the SP-housed OVX hamsters given estradiol for four weeks. In contrast, estradiol administered for four weeks reduced aggression in OVX Siberian hamsters whether they were housed in LP or SP (Scotti et al., 2007).

Interestingly, estradiol may have more potent effects on high intensity aggression than on low intensity aggression. Estradiol significantly reduced the duration of high intensity aggression when measured as an absolute value or when measured as a percentage of the total duration of aggression but had no significant effects on low intensity aggression. There was also the suggestion that lower levels of estradiol might also reduce at least some measures of aggression in LP. The amount of high intensity aggression measured as a percentage of the total duration of aggression and the duration of high intensity aggression/attack number was significantly reduced

in intact sham OVX females who were tested on diestrus compared to females housed in SP. Taken together, these data suggest that SP exposure reduces or eliminates the ability of estradiol to reduce aggression.

The present data are also consistent with previous studies that demonstrated that SP exposure reduces the ability of progesterone to decrease aggression (Elliott and Nunez, 1992). In the present study, high levels of aggression were consistently observed in the SP-housed sham females even though progesterone levels have been reported to be substantially increased as a result of SP exposure (Bridges & Goldman, 1975; Jorgenson & Schwartz, 1980). Thus, aggression appears to occur consistently in SP even when Syrian hamsters are exposed to estradiol or progesterone, suggesting that SP turns off the ability of ovarian hormones to reduce aggression. Therefore, the data of the present study support the hypothesis that SP-housed females are more aggressive than LP-housed females because SP renders females insensitive to the aggression-reducing effects of ovarian hormones.

In previous studies the effects of estradiol on aggression in LP-housed females have been less consistent than observed in the present study. It seems likely that differences in methodology across these studies may have contributed to the inconsistency in the results. These differences include the form and duration of estradiol administration, how aggression was measured, the gender, size and hormonal state of the opponent and the testing apparatus (e.g. home cage versus neutral arena). Since one of the goals of the present study was to determine whether estradiol could reduce aggression in SP-housed females, we administered estradiol continuously in a Silastic capsule for an extended interval, i.e. four weeks. Many of the other studies examined the effects of estradiol on aggression in LP when it was administered for shorter durations. In addition, circulating levels of estradiol were measured in the present study.

The amount of estradiol administered to OVX females mimicked the levels of estradiol seen during the peak of the estrous cycle. The sham OVX group housed in LP were tested on diestrus and found to have substantially less estradiol than the OVX animals administered estradiol and substantially more estradiol than the OVX group. Another substantial difference between the present study and previous work is the way that aggression was measured. Some of the previous studies used discrete measures of aggression (e.g., latency to attack), while others used composite measures (e.g. the duration of aggressive behaviors). The present study employed both discrete and composite measures and also measured the intensity of aggression. In general, these different measures of aggression tended to be similar across treatment groups. However, unlike the other measures of aggression, few between-group differences were observed in either measure of low intensity aggression.

A previous study by Fleming et al. (1988) found that one of the most prominent differences in agonistic behavior between females housed in LP versus SP was in the ratio of offensive behaviors to defensive behaviors. SP-housed females had significantly higher ratios of offensive behaviors to defensive behaviors. However, in the present study the amount of defensive behavior was quite variable and no significant differences were observed between groups. The differences in these results may be due to differences in experimental design. For example, the use of the resident-intruder testing paradigm in the present study might have reduced the duration of defensive behaviors compared to Fleming et al. (1988) that used a neutral testing area. One of the goals of the present study was to analyze the components of aggression utilizing a method to differentiate high and low intensity behaviors. Traditionally, a total duration of aggression is used to determine differences between groups. The differences in total testing times, however, prompted us to analyze percentages of observed behaviors as well as the

average duration per attack. The calculation of these measures and the statistical differences between them more accurately reflected the interactions observed during the aggressive encounters.

Following the behavioral tests which occurred 2-3 hours after the onset of the dark phase, blood was sampled for measurements of DHEA, DHEAS and cortisol. DHEA concentrations did not differ significantly in any treatment group or as a result of photoperiod. However, DHEAS was significantly higher in SP-housed sham females compared to all other treatment groups. The absence of a significant effect of photoperiod on DHEA and DHEAS concentrations across groups was not surprising since the data from experiment 1 suggest that there are not dramatic differences between photoperiods at this time of day. There appears to be little relationship between the concentrations of DHEA and DHEAS and the various measures of aggression. As a result, these data provide little support for the possibility that aggressive behavior alters the levels of these hormones or that the hormones are involved in the activation or inhibition of aggression.

In experiment 1, cortisol concentrations were found to be significantly lower in SP-housed females compared to LP-housed females 2-3 hours after lights-off. A similar trend was observed in the cortisol concentrations following agonistic encounters. Again there was no clear relationship between the circulating levels of cortisol and the various measures of aggression, thus suggesting that aggressive behavior does not alter the levels of these hormones or that cortisol is responsible for the activation or inhibition of aggression. The inability of estradiol to affect aggression in SP, however, supports the idea that SP-induced increases in aggressive behaviors are independent of gonadal steroid hormones. The observation that DHEA concentrations are higher in LP-housed females compared to SP-housed females is in contrast to

what has been shown in male Syrian hamsters (Caldwell et al., 2008). In addition, the reduced concentrations of cortisol in SP indicate that HPA activity may change overall as a function of photoperiod in female Syrian hamsters. Future studies may focus on how these changes in HPA functioning impact the expression of photoperiod-dependent aggressive behaviors.

Acknowledgements

This work was supported by NIH Grant MH62641 and NSF IBN 9876754 awarded to H.E.A. This work was presented at the 2008 meeting of the Society for Neuroscience (Washington, D.C.).

This chapter was included in the publication: Gutzler, S.J., Karom, M., Erwin, W.D., Albers, H.E. Photoperiodic regulation of adrenal hormone secretion and aggression in female Syrian hamsters. In revision. *Horm Behav*.

CHAPTER 4: GENERAL DISCUSSION

This series of experiments addressed the phenomenon of seasonal aggression in female hamsters through analysis of photoperiodic regulation of hormones, the brain, and behavior. The seasonal utility of this behavior is relative to the reproductive status of the individual. For example, during the summer months, animals are reproductively active and females exhibit a four-day estrous cycle. While sexual receptivity occurs once every four days, the three days preceding this behavior are associated with high levels of aggression in the presence of a conspecific (Floody and Pfaff, 1977). Thus, the hormonal transition from a non-receptive state to a sexually receptive state tightly correlates to the amount of aggression observed. In a social context, the hormonal status of an individual is also coupled to the display of dominance behaviors, such as flank marking (Harmon et al., 2002). During the winter, or non-breeding season, the anestrus state of the animal is associated with consistently high levels of aggressive behavior (Elliott and Nunez, 1992; Fleming et al., 1988).

To better understand female aggressive behavior, we used the photoperiod model to naturally mimic seasonal changes in hormones and the brain. The duration of light exposure as a function of day length signals behavioral and physiological changes in photoperiod-responsive species such as Syrian hamsters. The chapters contained in this dissertation aimed to explain the effects of female cyclicity and photoperiod on the brain, specifically with regard to the vasopressin system. Additionally, we sought to determine whether secretion of circulating adrenal androgens is photoperiod-responsive and whether there are photoperiod-dependent differences in these hormones following an aggressive encounter. Finally, we explored whether the presence of estradiol can alter the expression of components of aggressive behavior, including its intensity. The relative contributions of the previous chapters to the understanding

of female aggression are discussed in the following sections, in addition to the relationship of these findings to existing ideas.

Vasopressin and aggression

Vasopressin has long been believed to play a role in regulation of complex social behaviors. To our knowledge, the idea that the effects of AVP are sex-specific has not been thoroughly investigated. The convention among vertebrate research is that vasopressin and its non-mammalian homologue arginine-vasotocin (AVT) stimulate aggressive behavior. This convention is supported by many studies in fishes (Santangelo and Bass, 2006), rats (Beiderbeck et al., 2007), hamsters (Ferris et al., 1997; Delville et al., 1996). To extend the idea that AVP and aggression are positively associated, dominant status has also been consistently correlated with AVP (Hattori and Wilczynski, 2009; Cooper et al., 2005; Harmon et al., 2002). These and other studies support the idea that the *social context and hormonal status* under which the role of AVP in social behavior is being tested are critical to the interpretation of the behavioral results.

To investigate the role of vasopressin in female aggression (Chapter 2), we measured estrous cycle-dependent changes in V1aR in the brain regions associated with aggression. The first experiment in Chapter 2 outlines V1aR binding densities observed in the brains of animals sacrificed throughout the cycle. Interestingly, binding densities were not uniform throughout brain regions in a cycle-dependent fashion. For example, in the intermediate portion of the lateral septum, V1aR binding densities were significantly higher on the day of estrus compared to diestrus 1, however, this relationship is reversed in the anterior portion of the MPOA. One reason for this may be the cycle-dependent regulation of steroid hormone receptors in these regions. For example, the large increase in estradiol late on the day of proestrus is associated with the induction of progesterone receptors in areas critical for sexual behavior (Olster and

Blaustein, 1989; McGinnis et al., 1981; Blaustein and Feder, 1979). Estradiol has also been shown to increase rates of AVP transcription due to an estrogen response element on the promoter region of the AVP gene (Shapiro et al., 2000). Thus, the decreased amounts of V1aR binding observed in a region such as the MPOA on the day of estrus may be the result of down-regulation in response to increased availability of AVP or its release.

To further investigate the hypothesis that V1aR binding densities are dependent upon gonadal steroid secretion, we measured these densities following housing in short photoperiod conditions. Surprisingly, in all of the subregions of interest, we found increased V1aR binding densities. Taken together with a study from our laboratory (Caldwell and Albers, 2004), these findings suggest that within an anatomical area, there exist subregions that are independently subject to differential regulation of neuropeptide receptors. Furthermore, V1aR binding densities in female Syrian hamsters do not appear to be linearly related to circulating gonadal steroid concentrations.

To determine the behavioral implications of manipulating V1a receptors, a series of microinjection studies was documented in Chapter 2. We administered four different doses of a V1aR antagonist into the anterior hypothalamus of intact female hamsters on the first day of diestrus. Surprisingly, a U-shaped response curve was detected with the intermediate doses associated with an *increase* in measures of aggressive behavior. In a follow-up study, we further compared the dosage associated with the greatest increase in aggression to injections of vehicle and found, again, that blocking V1aR was associated with an increase in aggressive measures. Conversely, the studies we performed to test whether AVP administration decreased aggression did not elicit a dose-response effect of the treatment.

Our final undertaking in the main part of Chapter 2 was to determine whether response to either treatment with AVP or a V1aR antagonist was photoperiod-dependent. We again confirmed a reliable increase in aggression due to administration of the V1aR antagonist. AVP, again, did not affect aggressive measures significantly compared to saline. One additional finding, however, is that AVP treatment was associated with increased frequency of submission.

It is clear through this series of studies that AVP does not stimulate aggression in female hamsters. It rather, may produce the opposite effect by increasing the probability an animal will not aggress, and rather submit. We took an “outside of the box” approach by re-interpreting our results from a sexual behavior standpoint. In reference to the binding studies, if decreased V1aR binding densities on the day of receptivity are a result of increased AVP availability or release, then we asked: why would that be? We hypothesized that AVP may somehow aid in the expression of sexual receptivity. To test this, we administered a V1aR antagonist on the day of estrus to determine if we could disrupt the lordosis response and, instead elicit aggressive behavior. In the supplemental portion of Chapter 2, we conclude that the action of V1aR binding is not necessary for lordosis to occur, nor is blockade of these receptors sufficient to inhibit lordosis.

In sum, it appears a sex difference in the role of AVP in aggressive behavior exists in the Syrian hamster species. The effects of AVP are not photoperiod-dependent which leads us to a series of questions regarding the regulation of seasonal aggression in females that we addressed in Chapter 3.

Photoperiod-dependent changes in adrenal androgen secretion

Initially, we hypothesized that V1aR densities changed in response to gonadal steroids and thus, photoperiod-dependent differences existed and provided the framework for seasonal

regulation of aggression. While the differential binding densities we have measured throughout the brain areas implicated in aggression suggest that AVP contributes to the modulation of this behavior, it appears to do so in a gonadal steroid-independent manner. In photoperiod-responsive species, the adrenal glands play a role in seasonal aggression as adrenalectomy reduces the induction of aggression by melatonin (Demas et al., 2004; Paterson and Vickers, 1981). The information on photoperiodic regulation of adrenal hormone secretion, however, is limited and virtually non-existent with regard to females.

In Chapter 3, we examined photoperiod-dependent alterations in basal adrenal hormone secretion. Following at least ten weeks of housing in long or short photoperiod conditions, DHEA was increased in those animals housed in LP whereas DHEAS concentrations were greater in the SP-housed group. Several possible explanations exist for these differences. For example, the adrenal cortex secretes both hormones and thus, SP-housed animals may simply produce more DHEAS in response to the increased duration of melatonin secretion. Another possible reason for these differences is the rate of conversion of DHEA to DHEAS may be greater in SP-housed animals. Finally, each hormone can also be converted to estradiol and testosterone. Activity and availability of the enzymes responsible for these conversions is a determining factor in how much circulating hormone remains in the system (for review, Soma et al., 2008).

We also measured circulating cortisol across time in both LP- and SP-housed animals. Cortisol is released from the adrenal glands in a diurnal rhythm (Albers et al., 1985), therefore, its secretion is affected by many factors including the sleep-wake cycle, metabolic processes, and mobilization of glucose in response to exercise. Additionally, cortisol is indicative of increased HPA activity due to response to a physical, social or psychological stress across species (Roelofs

et al., 2009; Wommack and Delville, 2003; Castro and Matt, 1997; Hennig et al, 1993; Sumpter et al., 1986). In Chapter 3, we first compared basal concentrations from animals sacrificed at timepoints beginning at the onset of the dark phase (the active phase) and up to four hours into this portion of the cycle. At two and three hours after the onset of the dark phase, LP-housed animals possessed significantly higher cortisol concentrations compared to SP-housed animals. In fact, SP animals did not show significant fluctuations at timepoints following the first hour into the dark phase. This effect suggests there may be differences in stress reactivity between LP- and SP-exposed animals. A previous study in male white-footed mice demonstrated that in SP-housed animals, the corticosterone increase in response to restraint stress was significantly greater compared to LP-housed animals (Pyter et al., 2007). Additionally, SP-housed mice returned to their baseline concentrations more quickly than LP-housed mice. The idea that SP conditions are associated with more efficient stress responsiveness is also supported by work in Syrian hamsters (Ronchi et al., 1998). The sensitivity and efficiency of this system in SP may also explain some of the differential regulation of V1aR in areas that are populated with glucocorticoid receptors, thus leading to a synergistic seasonal effect on behavior.

Photoperiod-dependent changes in behavioral responsiveness to estradiol

In Chapter 3, to extend the findings of previous studies regarding the seasonal effects on female aggression, we tested whether estradiol affected aggression in a photoperiod-dependent manner. While the literature on this topic is not extensive, many investigators have tested the effectiveness of estradiol administration in SP-housed females on both sexual and aggressive behaviors as detailed in Chapter 3. More importantly, the study we performed is one of the first to address a.) the components of aggressive behavior in females , including an intensity analysis,

and b.) to test for aggressive behavior after an extended period of hormone administration (5 weeks).

Overall, we found that while the duration of aggressive interactions tend to be equivalent between photoperiod groups, the *intensity* of the interactions is typically higher in SP conditions. Additionally, as supported by many previous studies, SP-housed females are insensitive to the effects of estradiol on aggression (Elliott and Nunez, 1992; Badura et al., 1987). Finally, there does not appear to be a linear relationship between any adrenal hormone measured following the aggressive encounter and the components of aggression. Our studies, however, did not test differences in HPA responsiveness although we suspect that further inquiry into photoperiod-dependent changes in the activity of this axis will elucidate the major mechanism of seasonal aggression in female hamsters.

A proposed neuroendocrine model of female aggressive behavior

The results of the studies presented in this dissertation support the existence of a seasonally-dependent mechanism that regulates the role of vasopressin in female aggression. During the breeding season, when animals are reproductively active, increases in estradiol increase the transcription of the AVP gene (Shapiro et al., 2000) and in vitro studies suggest increased AVP release from the hypothalamus (Ghuman et al., 2006; Wang et al., 1995). In addition, V1aR mRNA expression is increased in response to estradiol in the POA (Kalamatianos et al., 2004). While our studies do not show a linear relationship between estrous cycle state and V1aR binding densities throughout each of the regions associated with aggression, differential regulation of these densities may be influenced by the fluctuations in gonadal and adrenal hormones as well as local availability of AVP.

The day prior to sexual receptivity, proestrus, is associated with the highest circulating concentrations of estradiol. Thus, estradiol-mediated increases in AVP gene transcription, release, and receptor mRNA expression suggest that AVP plays a role in supporting the onset of sexually receptive behavior. The ability of V1aR blockade, as demonstrated in Chapter 2, to facilitate significantly greater levels of aggression supports this hypothesis. It is important, however, to note that antagonism of V1aR on estrus is not sufficient to disrupt the lordosis response. AVP, therefore, may play a role as a modulator to inhibit the expression of aggressive behavior to promote sexually receptive behavior in the female (Fig 4.1).

It is well-established that information about day length is converted into a neural signal in the retinohypothalamic pathway and is sent to the pineal gland where the indole amine, melatonin, is secreted into circulation (for a review: Tamarkin et al., 1985; Yellon et al., 1982). The duration of melatonin secretion causes physiological alterations in the HPG and HPA axes which feedback into regions of the brain that control a variety of social behaviors, including sex and aggression. Behaviorally, it is well-established that the hormonal responsiveness of females housed in SP is decreased compared to LP-housed counterparts. In SP, administration of exogenous estradiol alone or in combination with progesterone is not sufficient to induce sexual receptivity or inhibit the onset of aggressive behaviors (Elliott and Nunez, 1992). This dissertation, however, contains the first characterization of components of female aggression and aggressive intensity in SP-housed animals (Chapter 3). Our findings support the idea that aggression in SP-housed female hamsters is independent of circulating estradiol (Fleming et al., 1988; Scotti et al., 2007). The SP-responsiveness to antagonism of V1aR, however, led us to investigate whether photoperiod-dependent changes exist in the secretion of adrenocortical hormones.

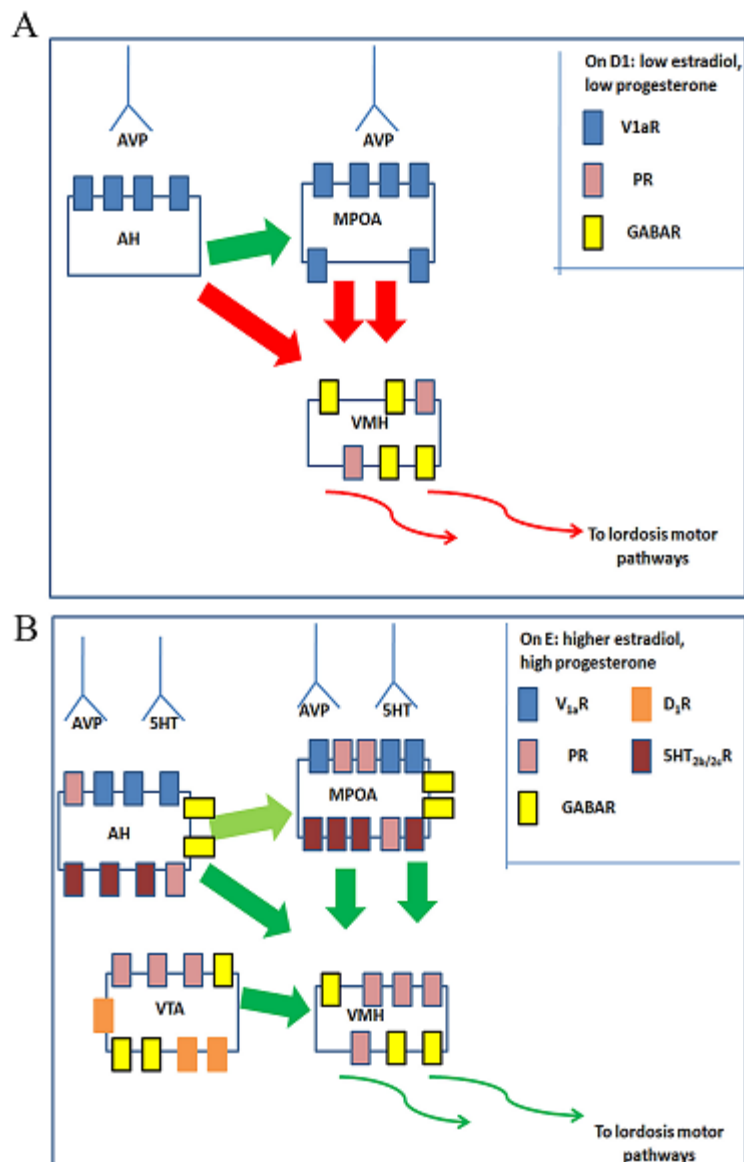

Figure 4.1: AVP modulates sexual and aggressive behavior as a function of hormonal fluctuations during the estrous cycle. A.) On diestrus 1, circulating estradiol and progesterone concentrations are low although V1aR binding densities in the MPOA are significantly higher on this day compared to the day of estrus. Excitation of the MPOA is maintained by inputs from the LS and BNST (not pictured) which serve to promote dominance behaviors and thus, inhibit VMH stimulation and sexual receptivity. B.) Following the surge in estradiol on proestrus, PR expression is significantly increased in the VMH. PR are also expressed in the VTA and MPOA where they act to stimulate and inhibit the areas, respectively, through modulation of the actions of other transmitters such as DA and GABA. Additionally, increased synthesis and release of AVP by ovarian hormones may act to maintain the expression of sexual behavior.

We confirm in Chapter 3 that the adrenal hormones DHEA and cortisol are decreased in SP-housed females while the sulfated form of DHEA, DHEAS, is increased. Interestingly, photoperiod-dependent differences in these hormone concentrations were not significantly different following an aggressive encounter. This indicates the possibility that HPA responsiveness is affected by photoperiod in female hamsters and supports previous work done in male rodents (Pyter et al., 2007; Ronchi et al., 1998). We propose from the findings of our studies that the effects of photoperiod, through the actions of melatonin, affect HPA activity at the levels of the hypothalamus and adrenal glands to feedback on production and release of AVP as well as expression of its receptors. We further propose that the effects of AVP on aggression are modulated through the peptide's interactions with GABA- and glutamate-containing neurons in the subregions implicated in aggressive behavior.

During the non-breeding season when estradiol concentrations are significantly decreased due to gonadal regression, V1aR binding densities are not decreased in linear response to these basal levels of hormone (Chapter 2). Instead, differential expression is again observed. Previous studies have shown AVP-i.r. does not change in response to photoperiod (Albers et al., 1991), thus the idea that local AVP availability regulates V1aR densities is not supported as a likely mechanism. Observed photoperiod-dependent regulation of V1aR, for example, may exist due to the necessity of performing breeding season-appropriate behaviors such as mate-seeking and copulatory behaviors and the energetic demands that go along with them. The impact of vasopressin action on HPA activity, therefore, may be regulated through the expression of V1aR. A study by Watters et al. (1996) identified decreased V1aR binding densities in the septum and BNST of rats following adrenalectomy (ADX) while ADX animals treated with dexamethasone showed binding densities similar to controls. Additionally, this study demonstrated increased

V1aR mRNA expression in these areas in ADX rats administered corticosterone compared to those given saline. Finally, the study also established the presence of glucocorticoid-response elements in the promoter region of the V1aR gene. This glucocorticoid-mediated regulation may provide a candidate feedback mechanism on V1aR through photoperiodic regulation of seasonal cortisol secretion and HPA responsiveness in hamsters.

Figure 4.2 illustrates a representation of the hypothesized feedback hormonal mechanisms that lead to increased intensity during aggressive encounters in female hamsters. The inability of exogenous vasopressin to affect aggression when administered into the AH suggests that its endogenous action at V1a and V1b receptors, along with its affinity for OXT receptors, may support the maintenance of a basal level of aggression and social behavior (Chapter 2). Thus, the role of AVP may be strongly dependent upon social context as well as hormonal status and may contribute to receptor expression as well as biosynthesis and release of neuropeptides.

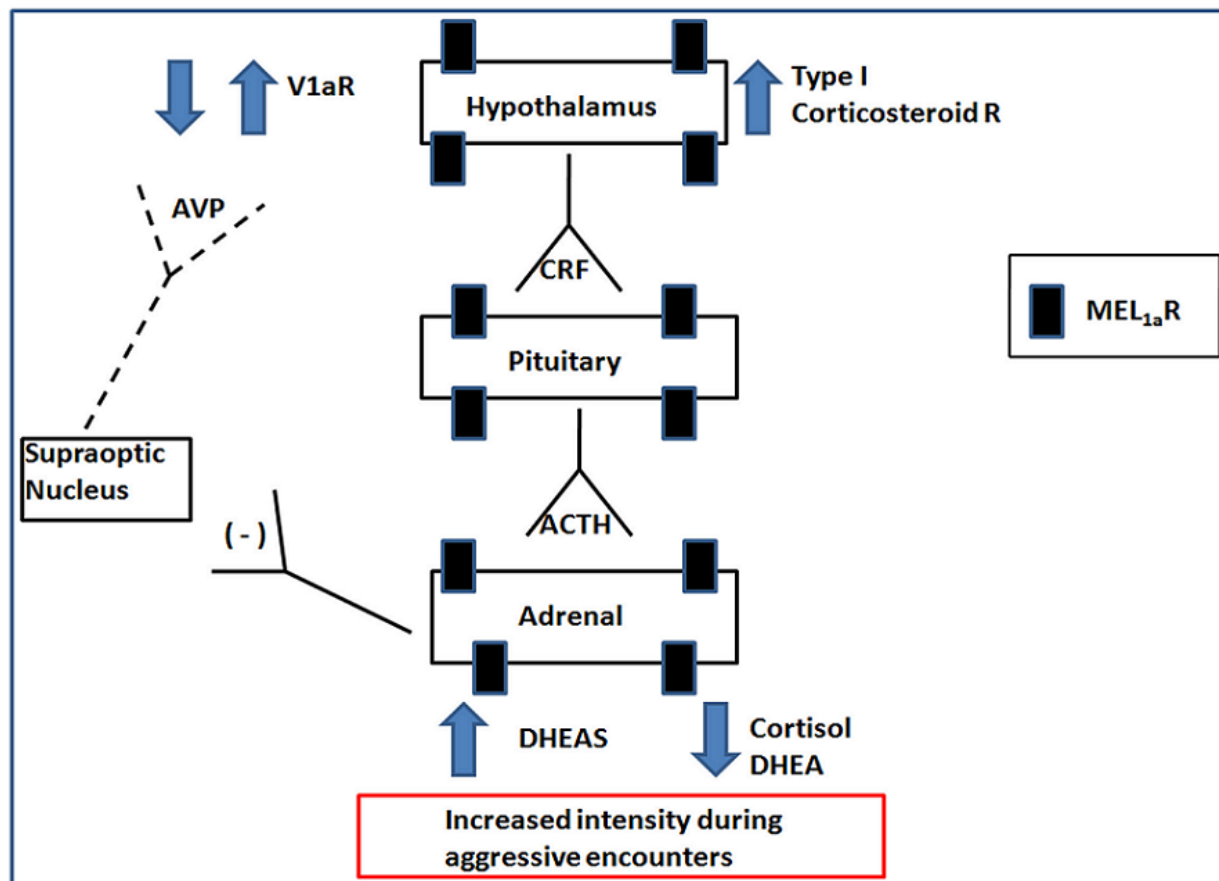

Figure 4.2: A proposed mechanism that regulates aggression in female hamsters during the non-breeding season. Increases in corticosteroid type I receptors occur as a result of SP exposure (Ronchi et al., 1998). This up-regulation has been proposed to contribute to the enhanced responsiveness of the HPA axis in SP-housed animals. Circulating concentrations of adrenocortical hormones are also regulated by photoperiod. We propose that SP-induced decreases in ACTH and cortisol concentrations contribute to decreases in AVP gene expression. This decreased availability of AVP may play a modulatory role at the level of the AH in the increases in aggressive intensity observed in SP females.

LITERATURE CITED

- Albers, H.E., Bamshad, M. (1998) Role of vasopressin and oxytocin in the control of social behavior in Syrian hamsters (*Mesocricetus auratus*). *Prog Brain Res.* **119**, 395-408.
- Albers, H.E., Cooper, T.T. (1995) Effects of testosterone on the behavioral response to arginine vasopressin microinjected into the central gray and septum. *Peptides.* **16**, 269-73.
- Albers, H.E., Dean, A., Karom, M.C., Smith, D., Huhman, K.L. (2006) Role of V1a vasopressin receptors in the control of aggression in Syrian hamsters. *Brain Res.* **1073-1074**, 425-430.
- Albers, H.E., Huhman, K.L., Meisel, R.L. (2002) Hormonal basis of social conflict and communication. In: Pfaff, D.W., Arnold, A.P., Etgen, A.M., Fahrback, S. E., Rubin, R. T. (Eds.), Hormones, Brain, and Behavior, vol 1. Academic Press, San Diego, pp. 393-433.
- Albers, H.E., Karom, M., Whitman, D.C. (1996) Ovarian hormones modulate the behavioral response of the medial preoptic anterior hypothalamus to arginine-vasopressin. *Peptides.* **17**, 1359-1363.
- Albers, H.E., Liou, S.Y., Ferris, C.F. (1988) Testosterone alters the behavioral response of the medial preoptic-anterior hypothalamus to microinjection of arginine-vasopressin in the hamster. *Brain Res.* **456**, 382-386.
- Albers, H.E., Pollock, J., Simmons, W.H., Ferris, C.F. (1986) A V1-like receptor mediates vasopressin-induced flank marking behavior in hamster hypothalamus. *J Neurosci.* **6**, 2085-9.
- Albers, H.E., Prishkolnik, J. (1992) Sex differences in odor-stimulated flank marking in the golden hamster (*Mesocricetus auratus*). *Horm Behav.* **26**, 229-39.
- Albers, H.E., Rawls, S. (1989) Coordination of hamster lordosis and flank marking behavior: role of arginine-vasopressin within the medial preoptic-anterior hypothalamus. *Brain Res. Bull.* **23**, 105-109.
- Albers, H.E., Rowland, C.M., Ferris, C.F. (1991) Arginine-vasopressin immunoreactivity is not altered by photoperiod or gonadal hormones in the Syrian hamsters (*Mesocricetus auratus*). *Brain Res.* **539**, 127-142.
- Albers, H.E., Yogev, L., Todd, R.B., Goldman, B.D. (1985) Adrenal corticoids in hamsters: role in circadian timing. *Am J Physiol.* **248**, R434-8.
- Amore, M., Menchetti, M., Tonti, C., Scarlatti, F., Lundgren, E., Esposito, W., Berardi, D. (2008) Predictors of violent behavior among acute psychiatric patients: clinical study. *Psychiatry Clin Neurosci.* **62**, 247-55.

- Auger, C.J., De Vries, G.J. (2002) Progesterone receptor immunoreactivity within steroid-responsive vasopressin-immunoreactive cells in the male and female rat brain. *J. Neuroendocrinol.* **14**, 561-7.
- Badura, L.L., Nunez, A.A. (1989) Photoperiodic modulation of sexual and aggressive behavior in female golden hamsters (*Mesocricetus auratus*): role of the pineal gland. *Horm Behav.* **23**, 27-42.
- Badura, L.L., Yant, W.R., Nunez, A.A. (1987) Photoperiodic modulation of steroid-induced lordosis in golden hamsters. *Physiol Behav.* **40**, 551-4.
- Bamshad, M., Cooper, T.T., Karom, M., Albers, H.E. (1996) Glutamate and vasopressin interact to control scent marking in Syrian hamsters (*Mesocricetus auratus*). *Brain Res* **731**, 213-216.
- Barberis, C., Mouillac, B., Durroux, T. (1998) Structural bases of vasopressin/oxytocin receptor function. *J Endocrinol* **156**, 223-229.
- Bartness, T.J., Powers, J.B., Hastings, M.H., Bittman, E.L., Goldman, B. D. (1993) The timed infusion paradigm for melatonin delivery: What has it taught us about the melatonin signal, its reception, and the photoperiodic control of seasonal responses? *J. Pineal Res.* **15**, 161-190.
- Beiderbeck, D.I., Neumann, I.D., Veenema, A.H. (2007) Differences in intermale aggression are accompanied by opposite vasopressin release patterns within the septum in rats bred for low and high anxiety. *Eur J Neurosci.* **26**, 3597-605
- Bester-Meredith, J.K., Marler, C.A. (2001) Vasopressin and aggression in cross-fostered California mice (*Peromyscus californicus*) and white-footed mice (*Peromyscus leucopus*). *Horm Behav.* **40**, 51-64.
- Bielsky, I.F., Hu, S.B., Szegda, K.L., Westphal, H., Young, L.J. (2004) Profound impairment in social recognition and reduction in anxiety-like behavior in vasopressin V1a receptor knockout mice. *Neuropsychopharmacology.* **29**, 483-93.
- Bielsky, I.F., Hu, S.B., Young, L.J. (2005) Sexual dimorphism in the vasopressin system: lack of an altered behavioral phenotype in female V1a receptor knockout mice. *Behav Brain Res.* **164**, 132-6.
- Birnbaumer, M. (2000) Vasopressin Receptors. *TEM* **11**, 406-410.
- Blanchard, R.J., Griebel, G., Farrokhi, C., Markham, C., Yang, M., Blanchard, D.C. (2005) AVP V1b selective antagonist SSR149415 blocks aggressive behaviors in hamsters. *Pharm Biochem Behav.* **80**, 189-194.

- Blanchard, R.J., Wall, P.M., Blanchard, D.C. (2003) Problems in the study of rodent aggression. *Horm Behav.* **44**, 161-170.
- Blanchard, D.C., Blanchard, R.J. (1988) Ethoexperimental approaches to the biology of emotion. *Ann Rev Psychol.* **39**, 43-68.
- Bleickardt, C.J., Mullins, D.E., Macsweeney, C.P., Werner, B.J., Pond, A.J., Guzzi, M.F., Martin, F.D., Varty, G.B., Hodgson, R.A. (2009) Characterization of the V1a antagonist, JNJ-17308616, in rodent models of anxiety-like behavior. *Psychopharmacology (Berl).* **202**, 711-718.
- Bridges, R.S., Goldman, B.D. (1975) Diurnal rhythms in gonadotropins and progesterone in lactating and photoperiod induced acyclic hamsters. *Biol. Reprod.* **13**, 617-622.
- Brodsky, H., Ames, D., Snowdon, J., Woodward, M., Kirwan, J., Clarnette, R., Lee, E., Lyons, B., Grossman, F. (2003) A randomized placebo-controlled trial of risperidone for the treatment of aggression, agitation, and psychosis of dementia. *J Clin Psychiatry.* **64**, 134-43.
- Caldwell, H.K., Albers, H.E. (2004) Photoperiodic regulation of vasopressin receptor binding in female Syrian hamsters. *Brain Res* **1002**, 136-141.
- Caldwell, H.K., Lee, H.J., Macbeth, A.H., Young, W.S. 3rd. (2008) Vasopressin: behavioral roles of an "original" neuropeptide. *Prog. Neurobiol.* **84**, 1-24.
- Caldwell, H.K., Smith, D. A., Albers, H.E., (2008) Photoperiodic mechanisms controlling scent marking: Interactions of vasopressin and gonadal steroids. *Eur. J. Neurosci.* **27**, 1189-1196.
- Caldwell, J.D., Clemens, L.G. (1986) Norepinephrine infusions into the medial preoptic area inhibit lordosis behavior. *Pharmacol Biochem Behav.* **24**, 1015-1023.
- Carter, C.S., Michael, S.J., Morris, A.H. (1973) Hormonal induction of female sexual behavior in male and female hamsters. *Horm. Behav.* **4**, 129-141.
- Castro, W.L., Matt, K.S. (1997) The importance of social condition in the hormonal and behavioral responses to an acute social stressor in the male Siberian dwarf hamster (*Phodopus sungorus*). *Horm Behav.* **32**, 209-216.
- Ciaccio, L.A., Lisk, R.D., Reuter, L.A. (1979) Prelordotic behavior in the hamster: A hormonally modulated transition from aggression to sexual receptivity. *J. Comp. Physiol. Psych.* **93**, 771-780.
- Connor DF, Steingard RJ, Anderson JJ, Melloni RH Jr. (2003) Gender differences in reactive and proactive aggression. *Child Psychiatry Hum Dev.* **33**, 279-94.

- Cooper, M.A., Karom, M., Huhman, K.L., Albers, H.E. (2005) Repeated agonistic encounters in hamsters modulate AVP V1a receptor binding. *Horm Behav.* **48**, 545-551.
- Dawson, B.L., McIntosh, W.D. (2006) Sexual strategies theory and Internet personal advertisements. *Cyberpsychol Behav.* **9**, 614-617
- Delville, Y., DeVries, G.J., Ferris, C.F. (2000) Neural connections of the anterior hypothalamus and agonistic behavior in golden hamsters. *Brain Behav. Evol.* **55**, 53-76.
- Delville, Y., Ferris, C.F. (1995) Sexual differences in vasopressin receptor binding within the ventrolateral hypothalamus in golden hamsters. *Brain Res* **681**, 91-96.
- Delville, Y., Mansour, K.M., Ferris, C.F. (1996) Testosterone facilitates aggression by modulating vasopressin receptors in the hypothalamus. *Physiol. Behav.* **60**, 25-29.
- Delville, Y., Koh, E.T., Ferris, C.F. (1994) Sexual differences in the magnocellular vasopressinergic system in golden hamsters. *Brain Res Bull.* **33**, 535-40.
- Demas, G.E., Polacek, K.M., Durazzo, A., Jasnow, A.M. (2004) Adrenal hormones mediate melatonin-induced increases in aggression in male Siberian hamsters (*Phodopus sungorus*). *Horm. Behav.* **46**, 582-591.
- De Vries, G.J., Panzica, G.C. (2006) Sexual differentiation of central vasopressin and vasotocin systems in vertebrates: Different mechanisms, similar endpoints. *Neuroscience.* **138**, 947-955.
- Donaldson, Z.R., Young, L.J. (2008) Oxytocin, vasopressin, and the neurogenetics of sociality. *Science.* **322**, 900-904.
- Eidson, L.N., Maras, P.M., Epperson, P., Petrulis, A. (2007) Female hamster preference for odors is not regulated by circulating gonadal hormones. *Physiol Behav* **91**, 134-141.
- Elliott, A.S., Nunez, A.A. (1992) Photoperiod modulates the effects of steroids on sociosexual behaviors of hamsters. *Physiol. Behav.* **51**, 1189-1193.
- Erskine, M.S., Denenberg, V.H., Goldman, B.D. (1978) Aggression in the lactating rat: effects of intruder age and test arena. *Behav Biol.* **23**, 52-66.
- Ertugrul, A., Meltzer, H.Y. (2003) Antipsychotic drugs in bipolar disorder. *Int J Neuropsychopharmacol.* **6**, 277-84
- Faruzzi, A.N., Solomon, M.B., Demas, G.E., Huhman, K.L. (2005) Gonadal hormones modulate the display of submissive behavior in socially defeated female Syrian hamsters. *Horm. Behav.* **47**, 569-575.

- Ferris, C.F. (2008) Functional magnetic resonance imaging and the neurobiology of vasopressin and oxytocin. *Prog Brain Res.* **170**, 305-320.
- Ferris, C.F., Melloni, R.H. Jr., Koppel, G., Perry, K.W., Fuller, R.W., Delville, Y. (1997) Vasopressin/Serotonin interactions in the anterior hypothalamus control aggressive behavior in golden hamsters. *J. Neurosci.* **17**, 4331-4340.
- Ferris, C.F., Potegal, M. (1988) Vasopressin receptor blockade in the anterior hypothalamus suppresses aggression in hamsters. *Physiol. Behav.* **44**, 235-239.
- Ferris, C.F., Pollock, J., Albers, H.E., Leeman, S.E. (1985) Inhibition of flank marking behavior in golden hamsters by microinjection of a vasopressin antagonist into the hypothalamus. *Neurosci Lett* **55**, 239-43.
- Ferris, C.F., Albers, H.E., Wesolowski, S.M., Goldman, B.D., Luman, S.E. (1984) Vasopressin injected into the hypothalamus triggers a stereotypic behavior in golden hamsters. *Science.* **224**, 521-523.
- Fleming, A.S., Phillips, A., Rydall, A., Levesque, L. (1988) Effects of photoperiod, the pineal gland, and the gonads on agonistic behavior in female golden hamsters (*Mesocricetus auratus*). *Physiol. Behav.* **44**, 227-234.
- Floody, O.R. (1983) Hormones and female aggression. In: Svare, B.B. (Ed.), Hormones and aggressive behavior. Plenum Press, New York, pp. 39-89.
- Floody, O.R., Pfaff, D.W. (1977) Aggressive behavior in female hamsters: the hormonal basis for fluctuations in female aggressiveness correlated with estrous state. *J. Comp. Physiol. Psychol.* **91**, 443-464.
- Fraile, I.G., McEwen, B.S., Pfaff, D.W. (1987) Progesterone inhibition of aggressive behaviors in hamsters. *Physiol. Behav.* **39**, 225-229.
- Frye, C.A. (2001) Inhibition of 5alpha-reductase enzyme or GABA(A) receptors in the VMH and the VTA attenuates progesterone-induced sexual behavior in rats and hamsters. *J Endocrinol Invest.* **24**, 399-407.
- Funabashi, T., Shinohara, K., Mitsushima, D., Kimura, F. (2000) Estrogen increases arginine-vasopressin V1a receptor mRNA in the preoptic area of young but not of middle-aged female rats. *Neurosci Lett.* **285**, 205-208.
- Garno, J.L., Gunawardane, N., Goldberg, J.F. (2008) Predictors of trait aggression in bipolar disorder. *Bipolar Disord.* **10**, 285-92.
- Garrett, J.W., Campbell, C.S. (1980) Changes in social behavior of the male golden hamster accompanying photoperiodic changes in reproduction. *Horm. Behav.* **14**, 303-319.

- Ghuman, S.P., Prabhakar, S., Smith, R.F., Dobson, H. (2006) Oestradiol stimulates the release of AVP and GnRH from the ewe hypothalamus in vitro. *Reprod Domest Anim.* **41**, 514-21.
- Goldman, B.D. (2001) Mammalian photoperiodic system: formal properties and neuroendocrine time mechanisms of photoperiodic time measurement. *J Biol Rhythms.* **16**, 283-301.
- Gutzler, S.J., Karom, M. Erwin, W.D., Albers, H.E. Photoperiod affects adrenal hormone production and intensity of aggression in female Syrian hamsters. In revision. *Horm Behav.*
- Hammock, E.A., Young, L.J. (2005) Microsatellite instability generates diversity in brain and sociobehavioral traits. *Science.* **308**, 1630-4.
- Harmon, A.C., Moore, T.O., Huhman, K.L., Albers, H.E. (2002) Social experience and social context alter the behavioral response to centrally administered oxytocin in female Syrian hamsters. *Neuroscience.* **109**, 767-772.
- Hattori, T., Wilczynski, W. (2009) Comparison of arginine vasotocin immunoreactivity differences in dominant and subordinate green anole lizards. *Physiol Behav.* **96**, 104-107.
- Hennessey, A.C., Huhman, K.L., Albers, H.E. (1994) Vasopressin and sex differences in hamster flank marking. *Physiol Behav.* **55**, 905-911.
- Hennig, J., Laschewski, U., Becker, H., Rammsayer, T., Netter, P. (1993) Immune cell and cortisol responses to physically and pharmacologically induced lowering of body core temperature. *Neuropsychobiology.* **28**, 82-6.
- Hodgson, R.A., Higgins, G.A., Guthrie, D.H., Lu, S.X., Pond, A.J., Mullins, D.E., Guzzi, M.F., Parker, E.M., Carty, G.B. (2007) Comparison of the V1b antagonist, SSR149415, and the CRF1 antagonist, CP-154,526, in rodent models of anxiety and depression. *Pharm Biochem Behav.* **86**, 431-440.
- Huhman, K.L., Albers, H.E. (1993) Estradiol increases the behavioral response to arginine vasopressin (AVP) in the medial preoptic-anterior hypothalamus. *Peptides.* **14**, 1049-1054.
- Hume, J.M., Wynne-Edwards, K.E. (2005) Castration reduces male testosterone, estradiol, and territorial aggression, but not paternal behavior in biparental dwarf hamsters (*Phodopus campbelli*). *Horm Behav.* **48**, 303-10.
- Jasnow, A.M., Huhman, K.L., Bartness, T.J., Demas, G.E. (2002) Short days and exogenous melatonin increase aggression of male Syrian hamsters (*Mesocricetus auratus*). *Horm. Behav.* **42**, 13-20.

- Jasnow, A.M., Huhman, K.L., Bartness, T.J., Demas, G.E. (2000) Short-day increases in aggression are inversely related to circulating testosterone concentrations in male Siberian hamsters (*Phodopus sungorus*). *Horm. Behav.* **38**, 102-110.
- Johansson, S.H., Jamora, C.W., Ruff, R.M., Pack, N.M. (2008) A biopsychosocial perspective of aggression in the context of traumatic brain injury. *Brain Inj.* **22**, 999-1006.
- Johnson, A.E., Barberis, C., Albers, H.E. (1995) Castration reduces vasopressin receptor binding in the hamster hypothalamus. *Brain Res.* **674**, 153-158.
- Johnston, R.E. (1977) The causation of two scent-marking behaviour patterns in female hamsters (*Mesocricetus auratus*). *Anim Behav.* **25**, 317-27
- Johnston, R.E., Kwan, M. (1974) Vaginal scent marking: effects on ultrasonic calling and attraction of male golden hamsters *Behav Neural Biol.* **42**, 158-168.
- Joppa, M.A., Meisel, R.L., Garber, M.A. (1995) c-Fos expression in female hamster brain following sexual and aggressive behaviors. *Neuroscience* **68**, 783-792.
- Jorgenson, K.L., Schwartz, N.B. (1985) Shifts in gonadotropin and steroid levels that precede anestrus in female golden hamsters exposed to a short photoperiod. *Biol. Reprod.* **32**, 611-618.
- Kalamatianos, T., Kallo, I., Goubillon, M.L., Coen, C.W. (2004) Cellular expression of V1a vasopressin receptor mRNA in the female rat preoptic area: effects of oestrogen. *J Neuroendocrinol.* **16**, 525-533.
- Kollack-Walker, S., Newman, S.W. (1995) Mating and agonistic behavior produce different patterns of fos immunolabeling in the male Syrian hamster brain. *Neuroscience.* **66**, 721-736.
- Leng, G., Meddle, S.L., Douglas, A.J. (2008) Oxytocin and the maternal brain. *Curr Opin Pharmacol.* **8**, 731-4.
- Leska, A., Dusza, L. (2007) Seasonal changes in the hypothalamo-pituitary-gonadal axis in birds. *Reprod. Biol.* **7**, 99-126.
- Lisk, R.D., Nachtigall, M.J. (1988) Estrogen regulation of agonistic and proceptive responses in the golden hamster. *Horm. Behav.* **22**, 35-48.
- Lopez-Duran, N.L., Olson, S.L., Hajal, N.J., Felt, B.T., Vazquez, D.M. (2009) Hypothalamic pituitary adrenal axis functioning in reactive and proactive aggression in children. *J Abnorm Child Psychol.* **37**, 169-82.
- Luine, V.N., Wu, V., Hoffman, C.S., Renner, K.J. (1999) GABAergic regulation of lordosis: influence of gonadal hormones on turnover of GABA and interaction of GABA with 5HT. *Neuroendocrinology.* **69**, 438-45.

- Maccoby, E.E., Jacklin, C.N. (1974) The Psychology of Sex Differences. Stanford University Press; Stanford, CA.
- Malone, R.P., Waheed, A. (2009) The role of antipsychotics in the management of behavioural symptoms in children and adolescents with autism. *Drugs*. **69**, 535-48.
- Malsbury, C.W., Pfaff, D.W., Malsbury, A.M. (1980) Suppression of sexual receptivity in the female hamster: neuroanatomical projections from preoptic and anterior hypothalamic electrode sites. *Brain Res*. **181**, 267-84.
- Mangels, R.A., Powers, J.B., Blaustein, J.D. (1998) Effect of photoperiod on neural estrogen receptor and progesterin receptor immunoreactivity in female Syrian hamsters. *Brain Res*. **796**, 63-74.
- Mayer, A.D., Rosenblatt, J.S. (1987) Hormonal factors influence the onset of maternal aggression in laboratory rats. *Horm Behav*. **21**, 253-67.
- McCarthy, M.M., Ball, G.F. (2008) The neuroendocrine control of sex specific behavior in vertebrates: lessons from mammals and birds. *Curr Top Dev Biol*. **83**, 213-48.
- McGinnis, M.Y., Krey, L.C., MacLusky, N.J., McEwen, B.S. (1981) Steroid receptor levels in intact and ovariectomized estrogen-treated rats: an examination of quantitative, temporal and endocrine factors influencing the efficacy of an estradiol stimulus. *Neuroendocrinology*. **33**, 158-65.
- Meisel, R.L., Sterner, M.R. (1990) Progesterone inhibition of sexual behavior is accompanied by an activation of aggression in female Syrian hamsters. *Physiol. Behav*. **47**, 415-417.
- Meisel, R.L., Sterner, M.R., Diekman, M.A. (1988) Differential hormonal control of aggression and sexual behavior in female Syrian hamsters. *Horm. Behav*. **22**, 453-466.
- Miczek, K.A., Fish, E.W., de Bold, J.F., de Almeida, R.M.M. (2002) Social and neural determinants of aggressive behavior: pharmacotherapeutic targets at serotonin, dopamine, and γ -aminobutyric acid systems. *Psychopharmacology*. **163**, 434-458.
- Morin, L.P., Wood, R.I. (2001) A Stereotaxic Atlas of the Golden Hamster Brain. Academic Press; San Diego, CA.
- Moyer, K.E. (1976) The Psychobiology of Aggression. Harper & Rowe; New York, NY
- Nelson, R.J., Badura, L.L., Goldman, B.D. (1990) Mechanisms of seasonal cycles of behavior. *Ann. Rev. Psychol*. **41**, 81-108.
- Nephew, B.C., Bridges, R. S. (2008) Central actions of arginine-vasopressin and a V1a receptor antagonist on maternal aggression, maternal behavior, and grooming in lactating rats. *Pharm. Biochem. Behav*. **91**, 77-83.

- Nicolas, L.B., Pinoteau, W., Papot, S., Routier, S., Guillaumet, G., Mortaud, S. (2001) Aggressive behavior induced by the steroid sulfatase inhibitor COUMATE and by DHEAS in CBA/H mice. *Brain Res.* **922**, 216-222.
- Olster, D.H., Blaustein, J.D. (1989) Development of progesterone-facilitated lordosis in female guinea pigs: relationship to neural estrogen and progestin receptors. *Brain Res.* **484**, 168-76.
- Orsini, M.W. (1961) The external vaginal phenomena characterizing the stages of the estrous cycle, pregnancy, pseudopregnancy, lactation, and the anestrus hamster, *Mesocricetus auratus* waterhouse. *Proc of the Animal Care Panel.* **11**, 193-206.
- Ottenweller, J.E., Tapp, W.N., Pitman, D.L., Natelson, B.H. (1987) Adrenal, thyroid, and testicular hormone rhythms in male golden hamsters on long and short days. *Am. J. Physiol.* **253**, R321-R328.
- Paterson, A.T., Vickers, C. (1981) Melatonin and the adrenal cortex: Relationship to territorial aggression in mice. *Physiol Behav.* **27**, 983-987.
- Payne, A.P., Swanson, H.H., 1972. The effect of sex hormones on the aggressive behavior of the female golden hamsters (*Mesocricetus auratus waterhouse*). *Anim. Behav.* **20**, 782-787.
- Payne, A.P., Swanson, H.H. (1971) Hormonal control of aggressive dominance in the female hamster. *Physiol Behav.* **6**, 355-357.
- Payne, A.P., Swanson, H.H. (1970) Agonistic behaviour between pairs of hamsters of the same and opposite sex in a neutral observation area. *Behaviour.* **36**, 260-269.
- Peters, P.J., Bronson, F.H., Whitsett, J.M. (1972) Neonatal castration and intermale aggression in mice. *Physiol Behav.* **8**, 265-8
- Pieper, D.R., Lobocki, C.A. (2000) Characterization of serum dehydroepiandrosterone secretion in golden hamsters. *Proc. Soc. Exp. Biol. Med.* **224**, 278-284.
- Potegal, M., Ferris, C.F. (1990) Intraspecific aggression in male hamsters is inhibited by intrahypothalamic vasopressin-receptor antagonist. *Agg. Behav.* **15**, 311-320.
- Potegal, M., Blau, A.D., Black, M., Glusman, M. (1980) Effects of castration of male golden hamsters on their aggression toward a restrained target. *Behav Neural Biol.* **2**, 315-30.
- Pyter, L.M., Adelson, J. D., Nelson, R.J. (2007) Short days increase hypothalamic-pituitary-adrenal axis responsiveness. *Endocrinology.* **148**, 3402-3409.
- Roelofs, K., van Peer, J., Berretty, E., Jong, P., Spinhoven, P., Elzinga, B.M. (2009) Hypothalamus-pituitary-adrenal axis hyperresponsiveness is associated with increased social avoidance behavior in social phobia. *Biol Psychiatry.* **65**, 336-43.

- Ronchi, E., Spencer, R.L., Krey, L.C., McEwen, B.S. (1998) Effects of photoperiod on brain corticosteroid receptors and the stress response in the golden hamster (*Mesocricetus auratus*). *Brain Res.* **780**, 348-351.
- Santangelo, N., Bass, A.H. (2006) New insights into neuropeptide modulation of aggression: field studies of arginine vasotocin in a territorial tropical damselfish. *Proc Biol Sci.* **273**, 3085-3092.
- Scotti, M.A., Place, N. J., Demas, G.E. (2007) Short-day increases in aggression are independent of circulating gonadal steroids in female Siberian hamsters (*Phodopus sungorus*). *Horm. Behav.* **52**, 183-190.
- Seegal, R.F., Goldman, B.D. (1975) Effects of photoperiod on cyclicity and serum gonadotropins in the Syrian hamster. *Biol. Reprod.* **12**, 223-31.
- Serradeil-Le Gal, C., Wagnon, J. 3rd, Tonnerre, B., Roux, R., Garcia, G., Griebel, G., Aulombard, A. (2005). An overview of SSR149415, a selective nonpeptide vasopressin V(1b) receptor antagonist for the treatment of stress-related disorders. *CNS Drug Rev.* **11**, 53-68.
- Shapiro, R. A., Xu, C., Dorsa, D.M. (2000) Differential transcriptional regulation of rat vasopressin gene expression by estrogen receptor α and β . *Endocrinology.* **141**, 4056-4064.
- Simon, N.G., Guillon, C., Fabio, K., Heindel, N.D., Lu, S.F., Miller, M., Ferris, C.F., Brownstein, M.J., Garripa, C., Koppel, G.A. (2008) Vasopressin antagonists as anxiolytics and antidepressants: recent developments. *Recent Pat CNS Drug Discov.* **3**, 77-93.
- Soma, K.K., Scotti, M.A., Newman, A.E.M., Charlier, T.M., Demas, G.E. (2008) Novel mechanisms for neuroendocrine regulation of aggression. *Front Neuroendocrinol.* **29**, 476-489.
- Soma, K.K., Sullivan, K.A., Tramontin, A.D., Saldanha, C.J., Schlinger, B.A., Wingfield, J.C., (2000) Acute and chronic effects of an aromatase inhibitor on territorial aggression in breeding and nonbreeding male song sparrows. *J. Comp. Physiol. A.* **186**, 759-769.
- Soma, K.K., Wingfield, J.C., 2001. Dehydroepiandrosterone in songbird plasma: Seasonal regulation and relationship to territorial aggression. *Gen. Comp. Endocrinol.* **123**, 144-155.
- Sumpter, J.P., Dye, H.M., Benfey, T.J. (1986) The effects of stress on plasma ACTH, alpha MSH, and cortisol levels in salmonid fishes. *Gen Comp Endocrinol.* **62**, 377-85.

- Takahashi, L.K., Lisk, R.D. (1985) Diencephalic sites of progesterone action for inhibiting aggression and facilitating sexual receptivity in estrogen-primed golden hamsters. *Endocrinology*. **116**, 2392-2399.
- Takahashi, L.K., Lisk, R.D. (1983) Organization and expression of agonistic and socio-sexual behavior in golden hamsters over the estrous cycle and after ovariectomy. *Physiol. Behav.* **31**, 447-482.
- Tamarkin, L., Baird, C.J., Almeida, O.F. (1985) Melatonin: a coordinating signal for mammalian reproduction? *Science*. **227**, 714-20.
- Trainor, B.C., Lin, S., Finy, M.S., Rowland, M.R., Nelson, R.J. (2007) Photoperiod reverses the effects of estrogens on male aggression via genomic and nongenomic pathways. *Proc Natl Acad Sci USA*. **104**, 9840-5.
- Turek, F.W., Elliott, J., Alvis, J., Menaker, M. (1975) Effects of prolonged exposure to nonstimulatory photoperiods on the activity of the neuroendocrine-testicular axis of golden hamsters. *Biol. Reprod.* **13**, 475-481.
- Vandenbergh, J.G. (1971) The effects of gonadal hormones on the aggressive behavior of adult golden hamsters (*Mesocricetus auratus*). *Anim. Behav.* **19**, 589-594.
- Veenema, A.H., Neumann, I.D. (2008) Maternal separation enhances offensive play-fighting, basal corticosterone and hypothalamic vasopressin mRNA expression in juvenile male rats. *Psychoneuroendocrinology*.
- Veenema, A.H., Blume, A., Niederle, D., Buwalda, B., Neumann, I.D. (2006) Effects of early life stress on adult male aggression and hypothalamic vasopressin and serotonin. *Eur J Neurosci*. **24**, 1711-1720.
- Wang, H., Ward, A.R., Morris, J.F. (1995) Oestradiol acutely stimulates exocytosis of oxytocin and vasopressin from dendrites and somata of hypothalamic magnocellular neurons. *Neuroscience*. **68**, 1179-1188.
- Watters, J.J., Wilkinson, C.W., Dorsa, D.M. (1996) Glucocorticoid regulation of vasopressin V1a receptors in rat forebrain. *Brain Res Mol Brain Res*. **38**, 276-84.
- Weinbrenner, A., Peus, V., Inta, D., Englisch, S., Zink, M. (2009) Risperidone-associated increase in triglyceride levels. *Am J Psychiatry* **166**, 113-114.
- Wersinger SR, Caldwell HK, Christiansen M, Young WS 3rd. (2007) Disruption of the vasopressin 1b receptor gene impairs the attack component of aggressive behavior in mice. *Genes Brain Behav.* **6**, 653-60.

- Wersinger, S.R., Ginns, E.I., O'Carroll, A.-M., Lolait, S.J., Young 3rd, W.S. (2002) Vasopressin V1b receptor knockout reduces aggressive behavior in male mice. *Mol Psychiatry*. **7**, 975-984.
- Wommack, J.C., Delville, Y. (2003) Repeated social stress and the development of agonistic behavior: individual differences in coping responses in male golden hamsters. *Physiol Behav*. **80**, 303-308.
- Yellon, S.M., Tamarkin, L., Pratt, B.L., Goldman, B.D. (1982) Pineal melatonin in the Djungarian hamster: photoperiodic regulation of a circadian rhythm. *Endocrinology*. **111**, 488-92.
- Young, L.J., Wang, Z., Cooper, T.T., Albers, H.E. (2000) Vasopressin (V1a) receptor binding, mRNA expression and transcriptional regulation by androgen in the Syrian hamster brain. *J Neuroendocrinol*. **12**, 1179-1185.

APPENDIX: CURRICULUM VITAE

Stephanie J. Gutzler

4000 Dunwoody Park, Apt. #1319 ♦ Atlanta, GA 30338
Phone: 404-606-1099 ♦ E-Mail: stephanie.gutzler@gmail.com

EDUCATION AND EXPERIENCE

DEGREE: Doctor of Philosophy

SPECIALIZATION: Neurobiology and Behavior

ADVISOR: H. Elliott Albers, Ph.D.

INSTITUTION: Georgia State University, Atlanta, Ga (2003-2009)

DEGREE: Bachelor of Science

SPECIALIZATION: Biological Science (Magna Cum Laude)

ADVISOR: Mac Given, Ph.D.

INSTITUTION: Neumann College, Aston, Pa (1999-2003)

DEGREE: Bachelor of Science

SPECIALIZATION: Psychology (Magna Cum Laude)

ADVISOR: R. Kurt Wallen, Ph.D.

INSTITUTION: Neumann College, Aston, Pa (1999-2003)

FELLOWSHIPS AND AWARDS

Center for Behavioral Neuroscience Scholar, Georgia State University (2003-2009)

Biology Department Award, Excellence in Student Leadership, Georgia State University (2006)

Psychology Department Award, Outstanding Senior Student, Neumann College (2003)

Summer Undergraduate Research Experience (SURE) Fellowship, Emory University (2002)

PROFESSIONAL ORGANIZATIONS

Society for Neuroscience

Society for Behavioral Neuroendocrinology

PROFESSIONAL EMPLOYMENT AND SERVICE

Center for Behavioral Neuroscience Brain Awareness Educator (2003-2009)

Atlanta Humane Society Volunteer (2009)

President, Biology Graduate Student Association (2005-2007)

South East Nerve Net Conference (SENN) Local Organizing Committee (2006)

BRAIN Program Mentor (2005)

Brains Rule! Expo Volunteer (2004-2005)

Co-chair, Neurobiology Graduate Student Association (2004-2005)

GRADUATE TEACHING EXPERIENCE

Graduate Teaching Assistant (2007-2008)

Human Anatomy, Biology 1110

Head Graduate Teaching Assistant (2008)

Human Anatomy, Biology 1110

PEER-REVIEWED PRIMARY RESEARCH PUBLICATIONS

1. **Gutzler, S.J.**, Karom, M., Erwin, W.D., Albers, H.E. Photoperiodic regulation of adrenal hormone secretion and aggression in female Syrian hamsters (*In revision, Hormones and Behavior*)
2. **Gutzler, S.J.**, Karom, M., Caldwell, H.K., Albers, H.E. Differential regulation of V1a receptor binding densities throughout subregions of the limbic system in response to estrous cycle and photoperiod. (*in preparation*)
3. **Gutzler, S.J.**, Karom, M., Erwin, W.D., Albers, H.E. Antagonism of V1a receptors in the anterior hypothalamus of female Syrian hamsters increases aggression, but not in a photoperiod-dependent manner. (*in preparation*)

ABSTRACT/POSTER PRESENTATIONS

1. **Gutzler, S.J.**, Karom, M., Albers, H.E. Aggression and photoperiod-dependent changes in adrenal cortisol and DHEA-S in female Syrian hamsters. Society for Neuroscience; Washington, D.C., 2008.
2. **Gutzler S.J.**, Karom, M., Albers, H.E. A vasopressin (V1a) receptor antagonist stimulates aggression in female Syrian hamsters, but not during behavioral estrus. Society for Neuroscience; San Diego, CA 2007.
3. **Gutzler, S.J.**, Karom, M., Albers, H.E. Differential regulation of vasopressin receptor binding in limbic structures in female Syrian hamsters. Society for Behavioral Neuroendocrinology, Monterey, CA, 2007.
4. **Gutzler, S.J.**, Karom, M., Albers, H.E. V1a receptor binding is associated with hormonal changes over the course of the estrous cycle in female Syrian hamsters. Society for Neuroscience, Washington D.C., 2005.
5. **Gutzler, S.J.**, Karom, M., Albers, H.E. Microinjection of AVP into the anterior hypothalamus and aggression on D1 in female Syrian hamsters. Society for Behavioral Neuroendocrinology; Austin, TX, 2005.
6. Karom, M., **Gutzler, S.J.**, Albers, H.E. Induction of flank marking in Syrian hamsters. Society for Behavioral Neuroendocrinology; Austin, TX, 2005.
7. **Gutzler, S.J.**, Karom, M., Albers, H.E. Microinjection of a selective V1a receptor antagonist in the anterior hypothalamus increases aggressive behavior of female Syrian hamsters. Society for Neuroscience; San Diego, CA, 2004.
8. Karom, M., Caldwell, H.K., **Gutzler, S.J.**, Albers, H.E. V1a receptors in the medial preoptic anterior hypothalamus (MPOA-AH) mediate the effects of AVP on flank marking in hamsters housed in long photoperiods (LP) and short photoperiods (SP). Society for Neuroscience; San Diego, CA, 2004.

SEMINAR PRESENTATIONS

1. **Gutzler, S.J.**, Karom, M., Albers, H.E. Let there be light!: The neuroendocrinology of female aggression. Neuroscience Institute Brown Bag Lunch (NIBBL); Georgia State University, 2008.
2. **Gutzler, S.J.**. Darwin Redefined: Has modern society reversed our evolutionary goals? Southeastern Pennsylvania Consortium for Higher Education (SEPCHE) Honors Conference; Cabrini College Radnor, PA. 2003.
3. **Gutzler, S.J.** Relationship of self-monitoring and self-awareness to alcohol consumption in college-age students. Southeastern Pennsylvania Consortium for Higher Education (SEPCHE) Honors Conference; Neumann College Aston, PA. 2001.