

Wind Power Forecasting: State-of-the-Art 2009

Decision and Information Sciences Division

About Argonne National Laboratory

Argonne is a U.S. Department of Energy laboratory managed by UChicago Argonne, LLC under contract DE-AC02-06CH11357. The Laboratory's main facility is outside Chicago, at 9700 South Cass Avenue, Argonne, Illinois 60439. For information about Argonne and its pioneering science and technology programs, see www.anl.gov.

Availability of This Report

This report is available, at no cost, at <http://www.osti.gov/bridge>. It is also available on paper to the U.S. Department of Energy and its contractors, for a processing fee, from:

U.S. Department of Energy
Office of Scientific and Technical Information
P.O. Box 62
Oak Ridge, TN 37831-0062
phone (865) 576-8401
fax (865) 576-5728
reports@adonis.osti.gov

Disclaimer

This report was prepared as an account of work sponsored by an agency of the United States Government. Neither the United States Government nor any agency thereof, nor UChicago Argonne, LLC, nor any of their employees or officers, makes any warranty, express or implied, or assumes any legal liability or responsibility for the accuracy, completeness, or usefulness of any information, apparatus, product, or process disclosed, or represents that its use would not infringe privately owned rights. Reference herein to any specific commercial product, process, or service by trade name, trademark, manufacturer, or otherwise, does not necessarily constitute or imply its endorsement, recommendation, or favoring by the United States Government or any agency thereof. The views and opinions of document authors expressed herein do not necessarily state or reflect those of the United States Government or any agency thereof, Argonne National Laboratory, or UChicago Argonne, LLC.

Wind Power Forecasting: State-of-the-Art 2009

by

C. Monteiro¹, R. Bessa¹, V. Miranda¹, A. Botterud², J. Wang², and G. Conzelmann²

¹Institute for Systems and Computer Engineering of Porto (INESC Porto)

²Decision and Information Sciences Division, Argonne National Laboratory, Argonne, Illinois

November 6, 2009

CONTENTS

ACKNOWLEDGMENTS	ix
LIST OF ABBREVIATIONS.....	xi
1 INTRODUCTION	1
2 NUMERICAL WEATHER PREDICTIONS	5
2.1 Numerical Weather Prediction Models.....	5
2.1.1 Global Models and Medium-Range Forecasts.....	6
2.1.2 Regional/Mesoscale Models	9
2.2 Performance of NWP	13
2.2.1 Evolution of Model Scores	13
2.2.2 Evaluation of Errors in High-Resolution Models	14
2.2.3 Critical Processes for Wind Forecast.....	15
2.3 Operational Aspects of Regional NWP	17
2.3.1 Computational Requirements.....	17
2.3.2 Cycle of Operations	18
2.4 Synthesis of Global and Regional NWP Models.....	18
3 DEFINITION OF WPF.....	21
3.1 Definitions.....	21
3.2 Time Horizons	21
3.3 Reference Models	22
3.4 Very Short-term Forecasting.....	23
3.5 WPF with Numerical Weather Prediction	24
3.5.1 Physical Approach	25
3.5.2 Statistical Approach.....	27
3.5.3 The Combined Approach.....	29
3.5.4 Regional Forecasting (Upscaling).....	30
3.6 Evaluation of Forecasts.....	34
3.6.1 Error Decomposition of Wind Speed Forecasts.....	34
3.6.2 Performance Evaluation of WPF	35
3.7 Synthesis of WPF Definitions.....	40
4 LITERATURE OVERVIEW OF THE WPF APPROACHES	45
4.1 Research WPF Methods and Techniques	45
4.1.1 Very-Short-Term Forecasting	45
4.1.2 Short-Term Forecasting using NWP.....	49
4.1.3 Regional Forecasting	58

4.2	Operational and Commercial WPF Systems.....	62
4.2.1	European WPF	62
4.2.2	U.S. WPF	79
4.3	WPF Systems Benchmarking Results.....	85
4.4	Synthesis of the Literature Overview	88
5	UNCERTAINTY IN WPF.....	99
5.1	Uncertainty Representation and Communication	99
5.1.1	Probabilistic Forecasts	99
5.1.2	Risk Indices or Skill Forecasting	102
5.1.3	Scenarios of Wind Power Generation.....	103
5.2	Uncertainty Estimation	105
5.2.1	Approaches Based on NWP Point Forecasts	106
5.2.2	Approaches Based on Power Output Point Forecasts.....	107
5.2.3	Approaches Based on NWP Ensembles	110
5.3	Evaluation of Probabilistic Forecasts.....	114
5.3.1	Reliability.....	114
5.3.2	Sharpness and Resolution	116
5.3.3	Unique Skill Score	117
5.4	Synthesis about Uncertainty in WPF	118
6	REQUIREMENTS AND PRE-REQUISITES FOR WPF MODELS	121
6.1	General Requirements of the Forecasting Tool	121
6.1.1	Selecting the Model	121
6.1.2	General System Requirements.....	122
6.1.3	Source of Information and Input Data	124
6.1.4	Output Data.....	127
6.1.5	Time Frame.....	128
6.1.6	Computational Methods and Methodology Requirements	129
6.1.7	Functionalities of the WPF	130
6.1.8	GUI Requirements	131
6.1.9	User Documentation Requirements	132
6.2	Forecast Evaluation and Benchmark	132
7	POWER SYSTEM OPERATIONS AND WIND POWER FORECASTING.....	135
7.1	Power System and Electricity Market Operations.....	135
7.1.1	Market Operations Timeline.....	135
7.1.2	Reserve Requirements	136
7.1.3	Day-Ahead Operations.....	137
7.1.4	Real-Time Operations.....	138
7.2	Wind Power Forecasting in System Operations	138
7.2.1	Current Status.....	138
7.2.2	Areas for Improvement.....	139

7.3	Wind Power and Forecasting in U.S. Markets — Overview Table.....	142
8	WIND POWER AND THE UNIT COMMITMENT PROBLEM.....	147
8.1	Definition of UC.....	147
8.2	Integration of Wind Power into Unit Commitment.....	149
8.2.1	Wind Integration Studies.....	150
8.2.2	Reserve Requirement for Wind Power.....	151
8.2.3	Novel Unit Commitment Algorithms.....	152
8.2.4	Role of Storage in Wind Integration.....	155
8.3	Summary and Future UC Work.....	155
9	UNIT COMMITMENT FORMULATIONS WITH WIND POWER UNCERTAINTY	157
9.1	Nomenclature.....	157
9.2	General Formulation of the UC Problem.....	158
9.2.1	Traditional Deterministic Formulation.....	158
9.2.2	Stochastic Formulation with Wind Uncertainty.....	159
9.2.3	Deterministic Formulation with Wind Uncertainty.....	161
9.2.4	Market-Based Stochastic Formulation.....	161
9.3	Detailed Representation of the Stochastic UC with Wind Uncertainty.....	162
9.3.1	Objective Function.....	162
9.3.2	Thermal Constraints.....	163
9.4	Current Status and Future Work on UC Formulations.....	165
10	CONCLUDING REMARKS.....	167
	REFERENCES.....	169

FIGURES

2-1	Wind Turbine Power Curve.....	15
3-1	Very-Short-Term Forecasting Structure.....	24
3-2	Physical Approach Structure.....	25
3-3	Main Steps of the Physical Approach.....	26
3-4	Main Steps of the Statistical Approach.....	28
3-5	Statistical Approach Structure.....	28
3-6	Main Steps of the Combined Approach.....	30
3-7	Direct Upscaling Method.....	31
3-8	Cascaded Method for m Reference Wind Farms.....	32
3-9	Cluster Method for n Clusters/Subregions.....	33
3-10	Different Approaches for WPF.....	43
5-1	Quantile Forecasts.....	100
5-2	Interval Forecasts.....	101
5-3	Scenarios of Wind Generation.....	104

5-4	Uncertainty Estimation Based on NWP Point Forecasts.....	106
5-5	Uncertainty Estimation Based on Power Output Point Forecasts	108
5-6	Uncertainty Estimation using Ensembles and the Filtering Approach.....	111
5-7	Uncertainty Estimation Using Ensembles and the Dimension Reduction Approach	112
5-8	Uncertainty Estimation Using Ensembles and the Direct Approach.....	113
7-1	Market Operations Timeline for Midwest ISO.....	135
7-2	Typical Categories of Operating Reserves	136
7-3	Role of Wind Power Forecasting in Power System Operations.....	140
8-1	Generalized SCUC Formulation.....	148
8-2	Stochastic SCUC Formulation	156

TABLES

2-1	NWP Global Models	19
2-2	NWP Regional Models.....	20
3-1	WPF Time Horizons.....	41
3-2	WPF Performance Evaluation	42
3-3	Regional Forecast Approaches	44
4-1	Research Models for Very-Short-Term WPF	89
4-2	Statistical and Computational Methods for Short-Term WPF	89
4-3	Main Conclusions of Short-Term WPF.....	90
4-4	Main Conclusions of Regional Forecasting.....	91
4-5	Overview of Operational and Commercial WPF Systems	92
5-1	Different Types of Uncertainty Representation.....	119
5-2	Different Approaches for Uncertainty Estimation.....	120
6-1	Various Wind Power Forecasting Applications	123
6-2	Input Data Needed to Carry Out Forecasts — Wind Turbine Detail Level	125
6-3	Input Data Needed to Carry Out Forecasts — Wind Farm Detail Level	125
6-4	Input Data Needed to Carry Out Regional Forecasts	126
6-5	Static Data for WPFs	126
6-6	Metadata for WPFs.....	127
7-1	Overview of Market Operation and Wind Power Forecasting in Five U.S. Electricity Markets.....	143

ACKNOWLEDGMENTS

This report has been prepared by Argonne National Laboratory in collaboration with INESC Porto, Portugal. The INESC Porto team acknowledges the assistance of Hrvoje Keko, Luís Seca, J. Peças Lopes, and Manuel Matos in the preparation of this report.

The authors acknowledge the U.S. Department of Energy, Office of Energy Efficiency & Renewable Energy through its Wind and Hydropower Technologies Program for funding the research presented in this report under contract DE-AC02-06CH11357.

Argonne National Laboratory, November 6, 2009.

This page is intentionally blank.

LIST OF ABBREVIATIONS

UNITS OF MEASURE

GHz	gigahertz
GW	gigawatts
hPa	hectopascal(s)
hr	hour(s)
km	kilometer(s)
m	meter(s)
min.	minute(s)
m/s	meters/second
MW	megawatts
S	second(s)

ACRONYMS

3-D	three dimensional
AC	Alternating Current
ACE	Area Control Error
AEC	Adaptive Exponential Combination
AESO	Alberta Electric System Operator
AGC	Automatic Generation Control
ANFIS	Adaptive Neural Fuzzy Inference System
ANN	Artificial Neural Network
AR	Autoregressive
ARIMA	Autoregressive Integrated Moving Average
ARMA	Autoregressive Moving Average
ARMINES	Association pour la Recherche et le Développement des Méthodes et Processus Industriels
ARPS	Advanced Region Prediction System
ARX	Autoregressive with Exogenous Input
ARXM	Autoregressive with Exogenous Input and Multi-timescale Parameter
AVN	Aviation Model
AWPPS	Wind Power Prediction System
BCD	Bayesian Clustering by Dynamics
BIAS	an estimate of the systematic error

ca.	circa
CAISO	California Independent System Operator
cdf	cumulative distribution function
CEC	California Energy Commission
CENER	National Renewable Energy Centre (Spain)
CFD	Computational Fluid Dynamics
CGUL	Geophysical Centre of the University of Lisbon
CHP	Combined Heat and Power
CIEMAT	Research Center for Energy, Environment, and Technology (Spain)
DA	Day-Ahead
DC	Direct Current
DC-OPF	Direct current - Optimal Power Flow
DHT	Discrete Hilbert Transform
DMI	Danish Meteorological Institute
DOE	U.S. Department of Energy
DRPE	Decoupled Recursive Prediction Error
DTU	Technical University of Denmark
DWD	Deutscher Wetterdienst (German Weather Service)
DWM	Diagnostic Wind Model
ECMWF	European Center for Medium-range Weather Forecasting
ED	Economic Dispatch
EEM	Empresa de Electricidade da Madeira
EMS	Energy Management System
EMSYS	Energy & Meteo Systems GmbH
EPRI	Electric Power Research Institute
EPSO	Evolutionary Particle Swarm Optimization
ERCOT	Electric Reliability Council of Texas
ESB	Electricity Supply Board (Ireland)
EU	European Union
EWEA	European Wind Energy Association
FIR-NN	finite-impulse response neural network
FIS	Fuzzy Inference System
FLC	fuzzy logic clustering
GARCH	generalized autoregressive conditional heteroskedasticity
GEM-LAM	Global Environmental Multiscale Limited Area Model
GENCO	Generation Company
GFS	NCEP Global Forecast System
GIMEX	Green Island Mesoscale Experiment
GMDH	Group Method of Data Handling
GME	German Global Meteorological Model
GMT	Greenwich Mean Time
GRADS	Grid Analysis and Display System

GRPE	Global Recursive Prediction Error
GUI	Graphical User Interface
HA	Hour Ahead
HIRLAM	High-resolution Limited Area Model (a NWP forecast system)
HIRPOM	HIRlam POver prediction Model
IASA	Institute of Accelerating Systems and Applications (Greece)
IFS	ECMWF Integrated Forecast System
IGCM	Intermediate General Circulation Model
IIR-MLP	Infinite Impulse Response Multilayer Perceptron
IMM	Institute for Informatics and Mathematical Modelling (Denmark)
INM	Instituto Nacional de Meteorología (Spanish Meteorological Institute)
ISSET	Institut für Solare Energieversorgungstechnik (Germany)
ISO	Independent System Operator
JMA	Japan Meteorological Agency
KDE	Kernel Density Estimation
KLIMM	KLImaModell Mainz
LAF-MLN	Local Activation Feedback MultiLayer Network
LAM	Limited Area Model
LLJ	Low Level Jet
LM	LokalModell
LMP	Locational Marginal Price
LRC	Long-Range Correlation
LS	least square
MAE	Mean Absolute Error
MCC	Maximum Correntropy Criterion
MEE	Minimum Error Entropy
MIBEL	Mercado Iberico de Electricidad (Iberian Electricity Market)
MIFS	Mutual Information-based Feature Selection
MILP	Mixed-Integer Linear Programming
MISO	Midwest Independent System Operator
MLP	Multilayer Perceptron
MM5	Fifth-generation mesoscale model
MOS	Model Output Statistics
MPI	Message Passing Interface
MRI	Meteo-Risk Index
MRTU	Market Redesign and Technology Update
MSAR	Markov-Switching AutoRegressive
MSE	Mean Square Error
MSEPS	Multi-Scheme Ensemble Prediction System

NAM	North American Mesoscale model
NBIAS	Normalized Bias
NCAR	National Center of Atmospheric Research (USA)
NCEP	National Centre for Environmental Prediction (USA)
NCL	NCAR Command Language
NERC	North American Electric Reliability Corporation
NMAE	Normalized Mean Absolute Error
NN	Neural Network
NNAM	Neural Network Assembling Model
NOAA	National Oceanic and Atmospheric Association (USA)
NPRI	Normalized Prediction Risk Index
NRMSE	Normalized Root Mean Square Error
NSDE	Normalized Standard Deviation of Errors
NWP	Numerical Weather Prediction
NYISO	New York Independent System Operator
OL	On-line
PCA	Principal Component Analysis
pdf	probability density function/probability distribution function
PIRP	Participant Intermittent Resource Program
PJM	Pennsylvania-Jersey-Maryland Interconnection
pmf	probability mass function
PPA	Power Purchase Agreements
PPC	Public Power Corporation of Greece
PROMES	“PROnóstico a MESoescala,” i.e., Mesoscale Prognosis
PSO	Particle Swarm Optimization
QRF	Quantile Regression Forests
RAC	Reliability Assessment Commitment
RAMS	Regional Atmospheric Modeling System
RBF	Radial Basis Function
REC	Renewable Energy Certificate
REE	Red Eléctrica de España (Spanish system operator)
RIX	Ruggedness Index
RLS	Recursive Least Square
RMSE	Root Mean Square Error
RNN	Recurrent Neural Network
RPC	Regressive Power Curve
RPE	Recursive Prediction Error
RPS	Renewable Portfolio Standard
RT	Real-Time
RTO	Regional Transmission Organization
RUC	Rapid Update Cycle

SARIMA	Seasonal Auto-Regression Integrated Moving Average
SCADA	Supervisory Control and Data Acquisition
SCED	Security-Constrained Economic Dispatch
SCUC	Security-Constrained Unit Commitment
SDE	Standard Deviation of the Errors
SDM	Statistical Downloading Method
SETAR	Self-Exciting Threshold Autoregressive
SO	System Operator
SOWIE	Simulation Model for the Operational Forecast of the Wind Energy Production in Europe
STAR	Smooth Transition Autoregressive
SVM	Support Vector Machine
TLS	Total Least Square
TSO	Transmission System Operator
UC	Unit Commitment
UTC	Coordinated Universal Time
W2P	Wind-to-power model
WAsP	Wind Atlas Analysis and Application Program
WEFS	Wind Energy Forecasting System
WEPROG	Weather & Wind Energy Prognosis
WF	Wind Farm
WFPC	Wind Farm Power Curve
WILMAR	Wind Power Integration in Liberalised Electricity Markets
WMEP	Wissenschaftliches Mess-und Evaluierungs Programm (German monitoring program)
WMO	World Meteorological Organization
WPF	Wind Power Forecast
WPMS	Wind Power Management System
WPPT	Wind Power Prediction Tool
WRF	Weather Research and Forecasting Model
WT	Wind Turbine

This page is intentionally blank.

1 INTRODUCTION

Many countries and regions are introducing policies aimed at reducing the environmental footprint from the energy sector and increasing the use of renewable energy. In the United States, a number of initiatives have been taken at the state level, from renewable portfolio standards (RPSs) and renewable energy certificates (RECs) [1], to regional greenhouse gas emission control schemes [2]. Within the U.S. Federal government, new energy and environmental policies and goals are also being crafted, and these are likely to increase the use of renewable energy substantially. The European Union is pursuing implementation of its ambitious 20/20/20 targets, which aim (by 2020) to reduce greenhouse gas emissions by 20% (as compared to 1990), increase the amount of renewable energy to 20% of the energy supply, and reduce the overall energy consumption by 20% through energy efficiency [3].

With the current focus on energy and the environment, efficient integration of renewable energy into the electric power system is becoming increasingly important. In a recent report, the U.S. Department of Energy (DOE) describes a model-based scenario, in which wind energy provides 20% of the U.S. electricity demand in 2030 [4]. The report discusses a set of technical and economic challenges that have to be overcome for this scenario to unfold. In Europe, several countries already have a high penetration of wind power (i.e., in the range of 7 to 20% of electricity consumption in countries such as Germany, Spain, Portugal, and Denmark). The rapid growth in installed wind power capacity is expected to continue in the United States as well as in Europe [4],[5],[6],[7],[8].

A large-scale introduction of wind power causes a number of challenges for electricity market and power system operators who will have to deal with the variability and uncertainty in wind power generation when making their scheduling and dispatch decisions. Wind power forecasting (WPF) is frequently identified as an important tool to address the variability and uncertainty in wind power and to more efficiently operate power systems with large wind power penetrations [4],[5],[9],[10]. Moreover, in a market environment, the wind power contribution to the generation portfolio becomes important in determining the daily and hourly prices, as variations in the estimated wind power will influence the clearing prices for both energy and operating reserves.

With the increasing penetration of wind power, WPF is quickly becoming an important topic for the electric power industry. System operators (SOs), generating companies (GENCOs), and regulators all support efforts to develop better, more reliable and accurate forecasting models. Wind farm owners and operators also benefit from better wind power prediction to support competitive participation in electricity markets against more stable and dispatchable energy sources [11]. In general, WPF can be used for a number of purposes, such as: generation and transmission maintenance planning, determination of operating reserve requirements, unit commitment, economic dispatch, energy storage optimization (e.g., pumped hydro storage), and energy trading.

The objective of this report is to review and analyze state-of-the-art WPF models and their application to power systems operations. We first give a detailed description of the

methodologies underlying state-of-the-art WPF models. We then look at how WPF can be integrated into power system operations, with specific focus on the unit commitment problem. The report includes:

- A review of Numerical Weather Prediction systems (meteorological systems for weather predictions) and a description of how their characteristics (spatial and temporal resolution) may affect the performance of the WPF models;
- A general presentation of WPF approaches;
- A detailed literature overview of various theoretical WPF approaches. A description of some exemplary mathematical models is also provided;
- A review of commercial and operational WPF tools;
- A review of existing benchmarking results and an overview of the main conclusions;
- A review of approaches on estimating uncertainty, as well as on uncertainty representation;
- Synthesis of end-user requirements for forecasting tools, including input/output data, user interfaces, etc.;
- A review of how wind power is currently handled in power system and electricity market operations, with focus on the electricity markets in the United States;
- A review of current and proposed approaches for including WPF into the centralized unit commitment problem;
- A set of alternative proposals for representing wind power and its uncertainty in unit commitment formulations; and
- Recommendations for how to improve WPF and its use in power system operations.

The review presented in this report builds partly on experiences with WPF in Europe, where research on WPF methods has been carried out over a long period of time. For instance, in 1993 ARMINES (Association pour la Recherche et le Développement des Méthodes et Processus Industriels) and Rutherford Appleton Laboratory developed a model for short-term wind power forecasting. Since then, several projects co-funded by the European Commission and other national projects have been developed. Some examples are: MORE-CARE [12],

ANEMOS [13], POW'WOW,¹ WILMAR,² and ANEMOS.plus³. WPF has also received increasing attention within the United States over the last few years, following the rapid increase in installed wind power capacity. A number of U.S. companies and research institutions are currently contributing to the development of better WPF tools.

Presently, the aim both in the United States and Europe is to improve the WPF systems' performance and to achieve a better integration of WPF in operational management tools. The reviews, assessments, and recommendations in this report can contribute to these efforts. Improved WPF can, in turn, facilitate a more efficient and larger introduction of wind power and other renewable energy sources in the electric power system.

¹ <http://powwow.risoe.dk/>.

² <http://www.wilmar.risoe.dk/index.htm>.

³ <http://anemosplus.cma.fr/>.

This page is intentionally blank.

2 NUMERICAL WEATHER PREDICTIONS

2.1 NUMERICAL WEATHER PREDICTION MODELS

Numerical Weather Prediction (NWP) models have been in place since 1950 after the pioneering work of *Charney, Fjortoft, and von Neumann* [14], who used a highly filtered, low-resolution version of the dynamical equations. Early NWP models relied on quasi-geostrophic theories in order to establish consistent low-resolution models, which, by design, lacked many relevant physical processes that were impossible to include either because of insufficient knowledge or computer resources. Quasi-geostrophic models were dominant in the 1950s and 1960s, when they were used mostly for hemispheric short-range forecasts (i.e., up to 3 days ahead) and for process studies.

Those early NWP models focused on synoptic-scale processes, namely on the evolution of mid-latitude weather systems, characterized by horizontal scales on the order of hundreds of kilometers, time scales on the order of numbers of days, and deep tropospheric structures. Verification of the forecasts was mainly done, and, to a certain extent, still is, as a function of the quality of mid-tropospheric fields (e.g., the 500- hectopascal [hPa] geopotential) or by an analysis of the evolution of the main weather systems (e.g., mid-latitude, near-surface storm trajectories). Because these models neglected many external forcing processes, such as the evolution of surface temperature and many important atmospheric processes (namely, radiation and phase transitions), they had limited predictive capabilities. On the other hand, those models already included some hints of what would constitute a modern meteorological model: a data assimilation system to define the model's initial state, a discretized system of equations written in spherical coordinates, and an implicit representation of surface topography - a so-called sigma-coordinate approach after *Phillips* (1957) [15], which was a pioneering representation of subgrid-scale turbulence initially developed at the U.S. Weather Bureau by *J. Smagorinsky* (1958) [16].

As early as 1955, *Charney* [17] advocated the use of a more accurate set of equations, the so-called “primitive equations.” This set was a version of the equations of the atmospheric dynamics with a major built-in approximation: the vertical momentum equation was replaced by the hydrostatic condition. The use of the word “primitive” to characterize the set of equations implies that it was considered, at the time, that nonhydrostatic processes had little meteorological relevance. Primitive equation models were widely used in the 1960s by the scientific community, despite having fully entered the weather forecast business only by the late 1970s.

During the 1970s, as the primitive equations set became mainstream, atmospheric models became global, and a number of relevant processes were progressively added to those models. Maybe as a tribute to the history of model development, an NWP model is usually characterized as a set of three main components: the “dynamical” core, dealing with the basic set of equations of the adiabatic inviscid flow; the “physics” pack, which includes a variable number of equations representing processes such as radiation, phase transitions, convection, or turbulence; and the data assimilation code.

The global primitive equation models still constitute the core of the weather forecast process. In the last three decades, those models evolved significantly towards higher resolution, more accurate physically based parameterizations, and better data assimilation systems, keeping pace with scientific advancements, progress in the observation systems (namely, with the new remote sensing platforms), and computer technology. At the same time, the forecast range was extended to more than one week, and new statistical techniques were incorporated into the forecast process to deal with data and model uncertainty.

In spite of the continuous progress in weather forecast, there is a clear understanding that there are limits to the predictability of atmospheric flow. Working on results from NWP and from simpler nonlinear models, *Lorenz* (1963, 1969) [18],[19], the founding father of the theory of chaos, found that very small differences in the initial state tend to grow in time, leading to qualitatively different forecasts in a couple of weeks. Because there is a limit to the accuracy of the initial state, this means that, even with a perfect model, there is an upper range limit to the usefulness of forecasts.

Weather forecast is a mixed initial and boundary value problem. In a global model, the initial three-dimensional (3-D) atmospheric state, generally referred to as the “analysis,” is computed from observations. However, as observations are sparse and have errors, the NWP data assimilation codes evolved into very sophisticated data processors that try to obtain the “best” possible estimate of the initial state from a diverse set of possibly conflicting observations, including from radiosondes, surface stations, aircraft, satellites, etc.

Models also need boundary conditions, defining the evolution of model variables in the limits of the domain. In the case of global models, boundary conditions are needed at the surface (ocean and land) and at the top of the domain for the full time range of the forecast. In the case of limited area models, time-evolving boundary conditions are also needed at the lateral boundaries.

Because the land surface properties experience a very strong diurnal cycle, all meteorological models include a specific model to compute the evolution of the topsoil properties (namely temperature and water). Usually, however, NWP models do not yet include an ocean model, and the sea surface temperature is generally prescribed from climatology. Some models are beginning to include a representation of inland water bodies, which may have significant diurnal cycles. While seasonal snow is computed by the land surface models, “permanent” land ice and ocean-floating ice are generally prescribed from climatology. Because of their relevance for climate modeling, research is ongoing on each of these processes.

2.1.1 Global Models and Medium-Range Forecasts

Global NWP models are the core of weather forecasting as they carry out most of the data assimilation process and produce the initial and boundary conditions used by limited area models. In recent years, those NWP models also became the main source of climatology data through the release of global 3-D gridded re-analyses by the National Center for Environmental Prediction (NCEP) (*Kalnay et al.*) [20] and the European Centre for Medium-Range Weather Forecasts (ECMWF) (*Uppala et al.*) [21]. Re-analyses datasets consist of the result of the NWP

data assimilation system produced by a fixed model, while the operational analyses are produced by different model versions because the models are frequently updated. Because of that, it is generally accepted that the re-analyses are the best available 3-D view of the Earth's atmosphere.

2.1.1.1 Data Assimilation for Model Initialization and Validation

Every atmospheric model requires some kind of data assimilation to establish its initial state. In modern global models, data assimilation constitutes one of the main assets of the model, as errors in the initial state are generally recognized as the major source of model uncertainty. Considering the huge amount of data available for assimilation, including data from radiosondes, surface stations, commercial aircraft, and multiple satellite platforms, it is only feasible to run the data assimilation processes in major meteorological centers, with privileged access to the World Meteorological Organization (WMO) data distribution channels and resources to deal with the data flow in real time.

Old NWP systems used simple data assimilation algorithms, which interpolated observations to the model grid, while imposing some filters and constraints on the balance between the different fields, designed to reduce the noise in the initial state. Modern data assimilation codes — for example, 3D-VAR and 4D-VAR methods (*Lewis and Derber* [22], *Le Dimet and Talagrand* [23], *Courtier et al.* [24]) — use a variational approach to optimize the initial state, often assimilating observations along a time window. This approach is highly appropriate for the modern remote sensing observations, which are not only global but are also frequently updated (e.g., up to every 15 minutes for geosynchronous imagery). Constraints imposed by modern data assimilation systems incorporate the physical balances included in the model equations, since the variational method uses the model forecasts as a first guess for the initial state.

The radiosonde network has been, for many decades, the backbone of atmospheric monitoring, providing the only direct observations of the atmosphere's 3-D state. Together with a much denser network of surface stations, they constitute the synoptic network, making worldwide synchronous observations at prescribed times. However, the synoptic network is very heterogeneous in space, with large areas virtually unobserved over the oceans and in less affluent countries. Because of this circumstance, the relevance of nonsynoptic data in the data assimilation process has grown steadily, mainly through the assimilation of more satellite observations, which became the main source of data. While most of these data products are large scale (i.e., they are being assimilated in the initialization process of global models), there are still many potential data sources for smaller-scale models, including radar images, lightning retrievals, etc., that may be soon relevant for regional NWP.

2.1.1.2 Model Formulation

Most global NWP models, with the notable exception of the UK Met Office model, use the spectral discretization method on the sphere, representing the atmospheric fields as a sum of spherical harmonics. The number of terms retained in that sum defines the order of truncation,

which is directly related to the model's spatial resolution, as was mentioned before in relation to the NCEP and ECMWF models. However, because many of the model's processes are computed in the physical and not in the spectral domain, the model computes forward and backward, transforming every time step.

Most global models use a pressure-based vertical coordinate in a terrain-following sigma system following *Phillips (1957)* [15], thus enabling a simple and accurate implementation of the surface boundary condition for the wind vector. The use of pressure to define the vertical coordinate simplifies the thermodynamic calculations and has a strong tradition in meteorological modeling. The approximation comes naturally in hydrostatic (primitive equation) models, but it is also feasible in nonhydrostatic codes (*Rõðm et al.* [25], *Skamarock et al.* [26]).

Global, primitive equation models integrate prognostic equations for the horizontal wind components, for surface pressure, for one thermodynamic variable (temperature or potential temperature), and at least for water vapor, besides also integrating other water reservoirs (e.g., cloud water, ice, etc.) on occasion. Other variables are computed from diagnostic relations. The vertical velocity, for example, which cannot be directly predicted in a hydrostatic model, may be computed by the integration of the continuity equation.

Models differ substantially in the numerical methods used. The (nonlinear) advection terms in the different prognostic equations are not adequate for computation in the spectral domain, and they are solved in the physical space, where the models may use different finite difference schemes or a semi-lagrangian approach. As horizontal advection is often the dynamical process that puts a limit to the model time step and is always a dominant process in the atmosphere, this component of the model code may have a strong impact on its overall performance.

2.1.1.3 Physical Packages

The physical pack of a global model includes the representation of a number of processes that are not explicitly represented by the prognostic equations because of the model resolution. At the same time, it includes the computation of some "source" terms in the prognostic equations. The contents of the model "physics" may vary substantially, and some research models may include different alternatives for each process.

Processes considered for parameterization in global models include: (subgrid-scale) turbulence; convection, often composed of shallow and deep convection schemes; clouds and precipitation; radiation; and gravity wave drag. Turbulence and shallow convection schemes represent boundary layer processes, with a strong impact on the low-level flow. However, when present, the other processes may also lead to important changes in that flow. The surface model, which is technically an independent coupled model, also has important impacts in low-level variables.

Generally, global models treat the different parameterizations of the model "physics" as unidimensional problems along the vertical resolution, without explicit interactions between

neighboring columns. This approach is justified by the extreme asymmetry between the vertical and horizontal resolutions in global models and significantly reduces the computational cost. In high-resolution mesoscale models, the approach may be questionable.

2.1.1.4 Standards of Operation

Global NWP models are operated twice or four times each day by a small number of large weather services, including NCEP, ECMWF, the U.S. Navy, and a few large national weather services, such as the ones in the UK, Germany, France, Japan, Brazil, and Russia. The main forecasts start at 00 and 12 UTC (Universal Time Coordinated, or GMT), corresponding to the world radiosonde launching — the only 3-D direct observation of the atmospheric state. Extra forecasts start at 06 and 18 UTC. The NCEP 10-day forecast is freely available for download and is widely used by small weather services, universities, and meteorology groups around the world. In the last several decades, ECMWF and NCEP have been setting the standard for medium-range forecasts, technically defined as forecasts in the range of 3 to 10 days. Both centers use a global spectral model with triangular truncature. Currently, the NCEP Global Forecast System (GFS) model (*Kanamitsu* 1989 [27]) is a T362L64 model, corresponding to a horizontal resolution of about 35 kilometers (km), with 64 unequally spaced vertical levels. The ECMWF Integrated Forecast System (IFS) (*Simmons et al.* 1989 [28]) runs at T799L91, corresponding to about 25 km of horizontal resolution, with 91 unequally spaced vertical levels. Both NCEP and ECMWF run parallel to the higher-resolution global model, an ensemble of about 50 lower-resolution (e.g., T159L61, with around 100 km of horizontal resolution) simulations with perturbed initial conditions and, in the case of ECMWF, with perturbed physics (*Molteni et al.* 1996 [29]). These ensembles are used to assess the predictability of the atmospheric system and have been successfully used to assign an objective degree of uncertainty to individual forecasts.

2.1.2 Regional/Mesoscale Models

Limited area models were initially developed for research of mesoscale atmospheric processes (i.e., processes with horizontal scales between 1 and a few hundred kilometers). This scale is relevant for many local weather phenomena, from sea breezes to mountain flows and thunderstorms. Some of these models are limited-area versions of global primitive equation models, sharing many of their characteristics, while others were specifically developed for high-resolution studies.

In the United States, NCEP used until recently the hydrostatic ETA model (*Mesinger et al.* 1988 [30]; *Black* 1994 [31]), at a horizontal resolution of about 10 km. In Europe, the HIRLAM model (*Källén* 1996 [32]) and ALADIN (*Bubnova et al.* 1995 [33]), also primitive equation models, are still in operational use by different meteorological services at comparable resolutions.

A number of other models, initially developed for research by different university groups, have turned into viable weather forecast models since global forecasts became widely available

in real time. These models include the MM5 model (*Anthes and Warner* 1978 [34]; *Dudhia* 1993 [35]; *Grell and Stauffer* 1994 [36]), initially developed at Pennsylvania State University and later adopted by the National Center of Atmospheric Research (NCAR) as a community model and made freely available for download. Consequently, MM5 rapidly turned into the most widely used, limited-area forecast model, being run by many small weather services and university groups worldwide. The relative simplicity of operation of MM5 in the Linux operating system — particularly the fact that the offered files include all that is needed to set up a forecast domain anywhere in the world — have turned MM5 into a popular choice for small research and operation groups.

In recent years, the MM5 development process has stopped, and NCAR, together with NCEP and many of the more relevant American-based atmospheric groups, launched a new limited-area model, the Weather Research and Forecasting Model (WRF), also freely available for download. WRF (*Skamarock et al.* 2005 [26]) is a new-generation, mesoscale model that was specifically designed for the new computing platforms, taking recent and current meteorological research into account, while carrying many of the products that were part of MM5. WRF has two basic versions (NCAR and NCEP “flavors”) and it includes many option switches that provide access to optional parameterizations and numerical schemes.

Other mesoscale models with a wide user base include: the Regional Atmospheric Modeling System (RAMS) model (*Pielke et al.* 1992 [37]), the U.S. Navy model COAMPS (*Hodur* 1993 [38]), the Météo-France research model MesoNH (*Lafore et al.* 1998 [39]), and the new European model, AROME. All these models share a feature with MM5 and WRF, namely, the fact that they use a nonhydrostatic equation set. Moreover, despite the fact that they have many differences in the details of their “physics” and numerics, they have achieved excellent results in the simulation of mesoscale flows. Some of those models (e.g., WRF and MesoNH) have also been successfully used for microscale simulations as Large Eddy Simulation Models, at horizontal resolutions of 100 meters or smaller.

2.1.2.1 Regional Forecasts as Mixed Boundary/Initial Condition Problem

Unlike global models, limited-area models cannot work on their own. They always need to be forced by boundary conditions at the limits of their domains, which can only be given by observations (in hindcast mode) or by global forecasts (in forecast mode). The model’s initial state must also be specified, either from interpolated observations or from an interpolation from the instantaneous field of a global model.

Most limited-area models include a simplified data assimilation code that performs the interpolation of the initial-state fields given to the model grid. The models may also assimilate time series of point observations by using simple “nudge” techniques. Some models, namely MM5 and WRF, even include optional sophisticated data assimilation methods, akin to 4D-VAR techniques with adjoint models. However, those components are still mostly used for research. *Crook and Sun* (2004) [40] used a model developed by *Sun et al.* (1991) [41] to test the capabilities of very short time forecasts (i.e., of up to 1 hr) of low-level wind with a sophisticated 4D-VAR data assimilation system in a case study of the Sydney 2000 Forecast Demonstration

Project. It included a 10-min. analysis, in hindcast mode, made with a special surface mesonet, two Doppler radars, and a boundary layer profile. *Crook and Sun* concluded that there was a possibility of improvement over persistence in case studies with strong gust fronts, but, on the other hand, results were less promising for a slow-moving, sea-breeze front. It is important to highlight, however, that the atmospheric model employed a dry boundary layer structure, which is not representative of what one would expect in a regional NWP.

2.1.2.2 General Formulation of Regional NWP Models

All limited-area NWP models use terrain-following coordinates, mostly in a pressure-based system, although there are models that use scaled geometric height (e.g., MesoNH). Most of the models are grid point models that use a variety of finite difference schemes, although some older hydrostatic models use spectral codes (e.g., HIRLAM) borrowed from global NWPs. Most regional NWP models use nested grids, with a lower-resolution grid covering the full domain and successive higher-resolution grids covering smaller and smaller fractions of that domain. Nested grids allow for very high resolution in a small domain, with a progressive transition at intermediate resolutions until the low resolution of the global NWP is met at the boundaries. This design is very efficient for studying mesoscale flows. The interaction between nested grids may be one-way (with the large scales forcing the small scales) or two-way. Because the time step scales linearly with resolution, most of the computing effort is generally associated with the computation of the inner (higher-resolution) grid.

Some regional NWPs have many optional switches, thus allowing somewhat different models to be set up for each resolution.

2.1.2.3 Domain, Resolution, and Range of Regional NWP Models' Standards of Operation

Domain and resolution of regional NWPs is largely controlled by computer resources. Some of the codes (e.g., MM5, WRF) may even run globally. Hydrostatic NWPs have been designed for horizontal resolutions around 10 km, although they may be used for slightly higher resolutions (e.g., 5 km). On the other hand, nonhydrostatic NWPs should be used for even higher resolutions. Technically, the hydrostatic approximation requires the aspect ratio of the studied atmospheric process to be small (i.e., that its horizontal scale is much larger than its vertical scale), a condition not generally fulfilled by mesoscale flows, notably by convective systems or by many internal waves.

While the dynamic core of nonhydrostatic NWPs is applicable to all mesoscale flows and, in some cases, even to the larger-scale microscale processes, most physical parameterizations have been designed for horizontal scales above a few kilometers, and thus they may be invalid at a higher resolution. As a result, 1-km simulations of unstable boundary layer flow may be challenging because even state-of-the-art models may respond to strong (but realistic) surface heating with spurious grid-scale convection, because of the insufficient response of their subgrid-scale turbulence scheme at that resolution. The same model may

achieve excellent results at 5 km and then at 250 m, with poor performance at intermediate resolutions.

At subkilometric resolutions, some parameterizations (e.g., radiation, cloud microphysics) may require expensive 3-D computations not generally available. However, for at least some processes, such as topographically forced flows, the models seem to respond well at those high resolutions (*Zhong and Fast* 2003) [42].

A number of studies have looked at the value of high resolution in weather forecasts for different applications. *Doyle et al.* [43] and *Doyle and Shapiro* [44],[45] used the COAMPS model to simulate severe winds in topographically complex regions in coastal California and Norway. They concluded that in order to achieve a good representation of downslope windstorms and other topographic effects, horizontal resolutions around 3–5 km were necessary. *Cairns and Corey* (2003) [46] found similar results in windstorm simulations in the mountains of Western Nevada, obtaining good results in 3-km-resolution MM5 simulations in conditions that were poorly forecasted by NCEP’s operational (lower-resolution and hydrostatic) ETA model. On the other hand, *Colle et al.* (2003) [47] concluded, on the basis of two years of continuous forecasts with the operational ETA and MM5 with a 36-km grid covering the eastern two-thirds of the United States and nested grids down to 4 km in the East coast (around southern New England), for improved results at 12 km (the intermediate MM5 grid) but little impact of a further increase in resolution. Nevertheless, an increase in resolution did not cause a significant impact. However, as will be discussed later, the use of higher-resolution grids requires changes in the data evaluation process, and, in fact, many new results indicate that an increased resolution can lead to some benefits.

2.1.2.4 Some Issues in Regional Modeling

The prospects of mesoscale weather forecasts, and indeed of all high-resolution forecasts, were considered unpromising for some time, as a consequence of the idea that smaller scales are generally associated with reduced predictability. Furthermore, the initialization of a high-resolution model seemed to require unrealistically dense observation networks. While both arguments have merit, practical results have generally exceeded those expectations, and model resolution has been evolving essentially as fast as computer resources have allowed, registering net gains in model scores.

The reason why mesoscale forecasts have exceeded expectations may be related to the fact that some mesoscale circulations are somewhat strictly controlled by “external factors” and are not strongly affected by predictability issues. One example is orographic flow, largely controlled by terrain geometry, a permanent and potentially very well represented constraint. A large number of case studies by different authors, reviewed by *Mass et al.* [48], looked at mesoscale model performance in the forecast of significant weather events (precipitation and wind, mainly), concluding in favor of high-resolution simulations in the representation of many aspects of local weather. However, those studies also indicated that traditional scores of high-resolution simulations may be poor, even when an expert assessment indicates that there has been an improvement in the quality of the simulation.

Zhong and Fast [42] looked at high-resolution simulations of thermally driven valley circulations, which were observed in a field campaign in the Salt Lake Valley by comparing three mesoscale models — MM5, RAMS, and ETA — with some simulations at resolutions below 1 km. Overall, results indicated that while the two higher-resolution models, MM5 and RAMS, tended to achieve better results, their errors had many similarities with those registered in ETA, in spite of their differences in design and developing histories. Indeed, their errors could be consistently attributed to common inaccuracies in the physical parameterizations of the long wave radiation and turbulent mixing, leading to a low troposphere cold bias and wrong boundary layer depths. *Hanna and Yang* [49] presented another model intercomparison experiment, using the MM5, RAMS, COAMPS, and OMEGA (*Bacon et al.* 2000) [50]. The aim was to carry out a set of 72-hr forecasts in different locations with a focus on model evaluation for atmospheric dispersion studies. That study concluded that there were systematic problems in the representation of subgrid-scale surface properties and in boundary layer turbulent fluxes, which led to large biases in boundary layer height and in low-level wind fields. They found results to depend on the vertical resolution model, registering better results when the vertical grid had a level at the anemometer height of 10 m. The previously mentioned study of *Colle et al.* [47] also found systematic errors in low-level temperature with impacts on (thermally driven) breeze circulations.

In a very recent paper, *Storm et al.* (2009) [51] studied the performance of the WRF model in the forecast of low-level jets (LLJs) in the U.S. plains, a common nighttime feature of the atmospheric flow that may lead to increased mean winds in the low troposphere, somewhere between 100 and 1,000 m and occasionally within reach of wind turbines. This study also found mixing results on NWP performance, with hints of a good representation of the essential features of the jets, indicating that the important driving processes are indeed considered by the model. However, there were some errors in the vertical location of the jet and in its intensity, probably due to the known inaccuracies of boundary parameterization in stable conditions. For all WRF configurations, *Storm et al.* found out that there is a tendency to underestimate the wind speed maximum and overestimate its vertical location, a result that could be caused by excessive vertical mixing, a feature that is common to NWP models. These results are consistent with the tendency of the models assessed by *Hanna and Yang* [49] to smooth out sharp low-level inversions in the nocturnal boundary layer. *Storm et al.* concluded that there is room for improvement in these parameterizations. LLJs may be an important source of wind energy (*Sisterson and Frenzen* 1978) [52] in some areas, namely on the U.S. plains (*Mitchell et al.* 1995) [53] and on the Californian coast (*Burk and Thompson* 1996) [54].

2.2 PERFORMANCE OF NWP

2.2.1 Evolution of Model Scores

The performance of global NWPs has been traditionally evaluated in 500 hPa geopotential fields, representing balanced (geostrophic) wind in the mid troposphere. Anomaly correlations of those fields have increased steadily from the late 1970s, when primitive equations of global NWP 10-day forecasts started operationally with less than 60% correlation, going up to

about 88% correlation in a 5-day-ahead forecast made with the IFS model by ECMWF [55]. There were some similar trends with slightly lower scores observed in other global models, namely by the NCEP's GFS model (with about 83% of anomaly correlation for a 5-day forecast in the period 2002–2007; data from *Kanamitsu* [27]). The previous data indicates that with today's average 5-day forecast, there is a net gain of more than 2 days in forecast predictability when compared to the 1980s' average 3-day forecast. Moreover, today's average 7-day forecast (70% anomaly correlation) is much better than a 5-day forecast from the 1980s (below 60%).

In the same period, a convergence between the Southern and Northern Hemispheres was observed, which corresponds not only to a steady increase of the relevance of satellite data in the initialization of NWP, but also to large improvements in their data assimilation systems.

2.2.2 Evaluation of Errors in High-Resolution Models

Traditional model evaluation scores (mean absolute error, root mean square error, bias, correlation) use point error statistics in order to compare observed time series in a meteorological station with contemporary time series model grid data interpolated to the same spatial location. When a model simulates a particular weather event, there are always errors, not only in its intensity, but also in its trajectory or timing. The latter errors are often called phase errors. As high-resolution models simulate sharper events, in both space and time, phase errors are more penalized in terms of point statistics, leading to what has been called a “double penalty” (*Hoffman et al.* [56]).

Different authors have tried to set up alternative scoring systems in order to improve the analysis of the new high-resolution models. *Case et al.* (2004) [57] developed a technique for the verification of high-resolution forecasts of sea-breezes with the RAMS model (*Pielke et al.*) [37] by using a Contour Map Error to identify sea-breeze transition times and to perform an objective comparison of the observed and simulated mean post-sea-breeze wind vectors. *Rife et al.* [58] studied the low-level wind forecasts during the 2002 Salt Lake City Winter Olympics from four models — ETA, Rapid Update Cycle-2 (RUC-2), GFS, and MM5, the latter with resolutions down to 1.33 km. Overall, they found that the high-resolution models did not lead to better point error statistics, although they did produce quite realistic-looking flows, unlike those present in lower resolution models. *Rife et al.* [59] returned to the same problem, proposing a new methodology that looks at the statistics of “wind events,” which are defined as changes in the wind vector at a given grid point above a threshold. *Mass et al.* [48] reviewed two continuous years of high-resolution MM5 forecasts in the northwest United States and stressed the fact that verification statistics are very much user-dependent: some users are very interested in the forecast of specific events, for instance, winds above a given threshold, or of time-integrated statistics, such as daily accumulated precipitation or daily mean histograms of wind speed. On the other hand, some users are more interested in detailed time series.

Motivated by the need for accurate, low-level wind fields for dispersion studies, *Hanna and Yang* [49] analyzed four mesoscale models in different regions and obtained grid point errors in forecasts of around 2.5 m/s in wind speed and on the order of 60° in wind direction. This error

level was not very different among the several models and was considered to be high for the proposed application.

Grimit and Mass [60] looked at 6-month MM5 forecasts in the northwestern United States driven by an ensemble of boundary conditions from different forecast centers, using completely different global models and data assimilation codes. They found significant correlations (above 0.6) between forecast spread, an estimate of the forecast uncertainty given by the ensemble, and forecast error in wind direction. In the case of very high and very low spreads, that correlation would increase to 0.8, thus indicating that mesoscale ensembles can be helpful when used in wind forecasts. However, they also found out the least-promising result, which was that the ensemble mean did not make better comparisons with observations when compared to any individual ensemble member.

2.2.3 Critical Processes for Wind Forecast

Wind forecasts for wind energy applications rely mostly on wind speed and direction at 50 to 100 m from ground level, at the top of the atmosphere surface layer, and only marginally on the forecast of air density. Because of the transfer functions of available generators (power curve depicted in FIGURE 2-1), the conversion of available wind power (which is proportional to the cube of the wind's speed) into actual power varies nonlinearly, with zero output below a minimum speed threshold (around 3 m/s), a rapid output in growth until the machine attains its nominal power (around 15 m/s), and a constant output above that level until the cut-off speed is attained (around 25 m/s).

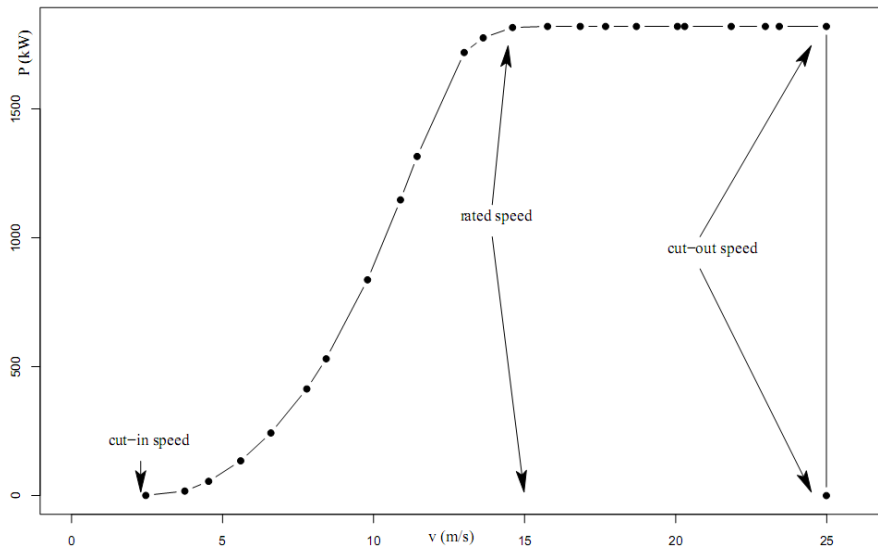

FIGURE 2-1 Wind Turbine Power Curve

Because generators in a given wind park may interact with each other, not only through their perturbed wakes but also because of local topographic speed-up or speed-down effects, the transfer functions of a park may vary significantly with wind direction. On the other hand, because the generators require a significant amount of time to align themselves with the prevailing wind, especially when they have to unwind after attaining maximum rotation in one direction, wind power is also a function of wind direction variability. Furthermore, the operation of wind generators will also be badly affected by small-scale turbulence.

Because of the nonlinearity of the transfer function, errors in wind speed forecast are penalized heterogeneously, when one thinks in terms of actual power. Errors at very low speeds are irrelevant since the output is always zero. On the other hand, errors in the flat region of the power curve (between 12 and 25 m/s) are also irrelevant as the output is constant, unless one has to consider changes in wind direction or in the intensity of turbulence. Errors at low-to-moderate speeds (3–12m/s) are highly penalized, as a small error in speed leads to a large error in power. Finally, the worst errors are obtained near the cut-off speed (around 25 m/s), when the system shifts abruptly from maximum output to zero output (or vice-versa).

Surface-layer wind speed and wind direction are directly affected by topographic effects at different scales, which makes wind forecast resolution highly relevant. Topographic forcing, however, depends qualitatively on atmospheric stability (*Smith et al.* [61]). Surface-layer profiles, for a given large-scale forcing, depend on surface characteristics, namely its rugosity and static stability. Thus, low-level wind forecasts may be expected to be affected by boundary layer parameterizations in an NWP model. On the other hand, low-level wind may be forced by heterogeneities in the surface temperature resulting from significant gradients in surface properties leading to breeze effects, which points to the relevance of the land-surface model. *Hong* [62] used GIMEX (Green Island Mesoscale Experiment) data in order to evaluate the performance of high-resolution (5-km) MM5 simulations over Taiwan. The author found out that the model tended to produce sea-breezes that were too strong, and with biased direction, because of a consistent warm bias over the island. Large root mean square errors (RMSEs) for wind direction (67°) and wind speed (2.5 m/s) were found. The fact that those errors were characterized by strong diurnal cycles indicates that they are related to errors in the heating/cooling cycle of the surface (i.e., on the model surface thermodynamics). These results are clearly consistent with those of *Zhong and Fast* [42], mentioned earlier, which attributed low-level wind errors to inaccuracies in long wave forcing and boundary-layer turbulent mixing. *Kotroni and Lagouvardos* (2004) [63] also found model errors dominated by low-level temperature biases in 8- and 2-km resolution forecasts in the urban area of Athens (Greece), with strong diurnal cycles in the model errors.

Hanna and Yang [49] argue that some of the errors found in mesoscale NWPs were caused by unrepresented subgrid-scale surface properties, which makes them difficult to overcome. However, new land surface models (e.g., *Viterbo and Beljaars* [64]) developed for global models include subgrid-scale surface effects, an approach that can be extended to higher-resolution models.

2.3 OPERATIONAL ASPECTS OF REGIONAL NWP

Global NWP forecasts are bound to be used only by large meteorological services and international organizations, as they need real-time access to proprietary WMO data and satellite products and huge state-of-the-art data assimilation systems. Assuming that at least one of those global forecasts is publicly available, as is the case today with the NCEP GFS model, regional forecasts can be run autonomously by small groups, tailoring the model parameters to their specific needs.

Ready-made and complete NWP systems are widely available, including the older MM5 and RAMS models and the new WRF model. Other models may be obtained for research through an agreement with their owners. All these models will require real-time access to a global NWP forecast in order to define initial and boundary conditions, as well as some pre-processing to generate the model runtime domain and choose some optional parameters. A small group of professionals with sufficient knowledge of meteorology, by using the corresponding computing literacy, is capable of setting up such a system in just a few weeks.

2.3.1 Computational Requirements

Computational requirements depend mostly on the domain size and resolution of the inner grid. For example, the MM5 model runtime for a 72-hr forecast at the University of Lisbon on a dual Quad core Xeon central processing unit (CPU) at 2.7 gigahertz (GHz) is 2.5 hr, for an inner domain of $=88 \times 91 \times 73$ grid points and at the resolution of 6 km and 31 vertical levels. For the same grid, the WRF model (version 3.0.1) may run in only 75 min. by using an “adaptive” time step, a technique that allows the model to run with larger time steps in appropriate meteorological conditions. For this setup, both the MM5 and WRF use three nested domains, with a larger domain at a 54-km resolution and an intermediate domain at 9 km, all with comparable grid sizes. However, the cost of the inner grid is the dominant term in the total computing time.

Generally, computing time increases linearly with the number of levels. At the same time, it increases with the number of horizontal grid points and is inversely proportional to the time step, which, in turn, is proportional to the horizontal grid spacing. By increasing the number of computing cores, it is possible to reduce computer time or to increase the domain sizes. However, that increase is generally sublinear: for the previous hardware and setup, doubling the number of cores will reduce computing times by about one-third.

All modern NWPs include the Message Passing Interface (MPI) standard, which makes it possible for the code to run parallel in a number of cores/CPU's. Some codes may also include OPEN-MP directives, being able to use both parallel technologies at the same time. The performance of the code in different computing topologies depends, however, not only on the code itself and on domain sizes but also on hardware details, namely, on inter-machine communication speeds, cache sizes, etc.

Finally, it should be mentioned that NWP models, especially those developed in research environments (as is the case with MM5 and WRF), always have a number of optional switches to select different numerical or physical approaches. Those selections may have significant impact in the model performance both in terms of computing and in the results themselves. Some understanding of the meteorological research literature is required in order to use a certain model properly.

2.3.2 Cycle of Operations

The operation of a regional NWP starts with the preparation of the domain files, namely, with a selection of the different nested grids to use and the processing of the different terrain data (e.g., topography, soil parameters, vegetation, land-sea masks) that are required. This step is only performed once for a given domain. In forecast time, it is necessary to download, up to four times a day, the latest global forecasts and launch the simulation. The global forecast will include a global analysis, incorporating available meteorological data from different sources, and a low-resolution global forecast, typically with 50- to 100-km horizontal grid sizes, which will define the lateral boundary conditions for the regional forecast. If extra local data are available, some regional NWPs may assimilate it as a correction to the analysis. At this point, the regional forecast may be launched.

If the regional NWP uses two-way grid nesting, forecasts for the different grids will be parallel computed and will be available at the same time. If the inner grid uses one-way grid nesting, it is possible to use the intermediate grid results while the inner grid is computed. It is easy to perform different domains at the same time with a large number of computer nodes, thus significantly decreasing total computing time.

A regional NWP forecast is completed with some post-processing to prepare automatic graphics, tables, and reports. Software for these operations is generally provided by the NWP model support team, including the old Grid Analysis and Display System (GRADS) and the new NCAR Command Language (NCL) software (from NCAR).

2.4 SYNTHESIS OF GLOBAL AND REGIONAL NWP MODELS

TABLE 2-1 provides an overview of the most relevant NWP global models, whereas TABLE 2-2 provides an overview of the most relevant NWP regional models.

TABLE 2-1 NWP Global Models

Global Model	Developed by
Global Forecast System (GFS) <i>(http://www.emc.ncep.noaa.gov/modelinfo/)</i>	National Oceanic and Atmospheric Administration (NOAA) (U.S.A.)
The Navy Operational Global Atmospheric Prediction System (NOGAPS)	United States Navy (USN) (U.S.A.)
Global Environmental Multiscale Model (GEM) <i>(http://collaboration.cmc.ec.gc.ca/science/rpn/gef_html_public/index.html)</i>	Recherche en Prévision Numérique (RPN), Meteorological Research Branch (MRB), and the Canadian Meteorological Centre (CMC)
Integrated Forecast System (IFS) <i>(http://www.ecmwf.int/research/)</i>	European Centre for Medium-Range Weather Forecasts (based in England)
Unified Model (UM) <i>(http://www.metoffice.gov.uk/science/creating/daysahead/nwp/um.html)</i>	UK Met Office
German Global Meteorological Model (GME)	Deutscher Wetterdienst (DWD), the German Weather Service
ARPEGE	French Weather Service, Météo-France
Intermediate General Circulation Model (IGCM) <i>(http://www.met.rdg.ac.uk/~mike/dyn_models/igcm/)</i>	University of Reading, Department of Meteorology (England)

TABLE 2-2 NWP Regional Models

Regional Model	Developed by
Weather Research and Forecasting Model (WRF) (http://www.wrf-model.org/index.php)	A partnership that includes the NOAA, NCAR, and more than 150 other organizations and universities
Regional Atmospheric Modeling System (RAMS) (http://rams.atmos.colostate.edu/)	Colorado State University
Fifth Generation Penn State/NCAR Mesoscale Model (MM5) (http://www.mmm.ucar.edu/mm5/)	Mesoscale Prediction Group in the Mesoscale and Microscale Meteorology Division, NCAR
Advanced Region Prediction System (ARPS) (http://www.caps.ou.edu/ARPS/)	University of Oklahoma
High Resolution Limited Area Model (HIRLAM) (http://hirlam.org/)	International HIRLAM programme
Global Environmental Multiscale Limited Area Model (GEM-LAM)	Meteorological Service of Canada (MSC)
Limited Area, dynamical Adaptation, International Development (ALADIN) (http://www.cnrm.meteo.fr/aladin/)	16 national meteorological services
COSMO	Consortium for Small-Scale Modeling (Germany, Switzerland, Italy, Poland, and Greece)
Skiron/Eta (http://forecast.uoa.gr/forecastnew.php)	Institute of Accelerating Systems and Applications - University of Athens (IASA)
Méso-NH (http://mesonh.aero.obs-mip.fr/mesonh/)	Laboratoire d'Aérodynamique (UMR 5560 UPS/CNRS) and CNRM-GAME (URA 1357 CNRS/Météo-France)
Rapid Update Cycle (RUC) (http://ruc.noaa.gov/)	NOAA (U.S.A)

3 DEFINITION OF WPF

3.1 DEFINITIONS

The forecasted wind generation made at time instant, t , for a look-ahead time, $t+k$, is the average power, $p_{t+k|t}$, the wind farm is expected to generate during the considered period of time (e.g., 1 hr) if it would operate under an equivalent constant wind. Forecasts are made for a time horizon, T , indicating the total length of the forecast period (e.g., 72 hr ahead) in the future. The time resolution of the forecasts is denoted by the time step k . The length of the time step (number of minutes) is related to the length of the horizon. Usually, for horizons on the order of 24 to 72 hr, the time step is hourly. In this case, intra-time step (e.g., intra-hourly) variations of power and their impact are not considered. This convention also comes from the fact that NWPs of wind speed, which are often used as input as explained below, are given as constant values for the considered step-ahead. For instance, a forecast of 1.5 megawatts (MW) for the look-ahead time, $t+8$, corresponds to the average generation over 1 hour. Practically, the value for the measured power, p_{t+k} , is derived from averaging higher-resolution measurements (e.g., 15 min.), which can be instantaneous power values or integrated energy values, depending on the acquisition system.

It is important to stress that $\hat{p}_{t+k|t}$ is called point forecast (or spot forecast), because it is only a single value. Other types of forecasts are currently being made. The probabilistic forecasts generate a probability distribution forecasted to every look-ahead time. They can be represented through density or percentile forecasts, which will be discussed in Chapter 5.

3.2 TIME HORIZONS

A forecasting system is characterized by its time horizon, which is the future time period for which the wind generation will be predicted (e.g., the next day). In other power system forecasting problems, such as load forecasting, the forecasting system is characterized according to its time horizon — very short term, short term, medium term, or long term.

In the WPF problem, time frontiers that separate the different time horizons are not unanimously defined because several authors have proposed different frontiers for each time horizon category. Generally, the WPF can be separated into three categories:

- *Very short term.* The time horizon range is a few hours, but there is no unanimity for the number of hours. A limit value of 4 hr for this time horizon is proposed in [11], and in [65], the value is 9 hr. The application of this time horizon WPF for the wind farm owner depends on the market rules; for example, these forecasts can be useful for trading in intraday markets. For the SO, the usefulness of these forecasts is related to the ancillary services management of the power system, as well as for UC and ED.

- *Short term.* The time horizon ranges from the very-short-term limit up to 48 or 72 hr. Much of the work is only with time horizons of 48 hr and sometimes only for 36 hr. This time horizon is mainly interesting for trading in the day-ahead market. For example, in the Iberian Electricity Market (MIBEL⁴) (daily market), the electric energy sale bids for the next day must be presented before 10:00 a.m., and, therefore, a 38-hr time horizon covers the entire following day. In other countries, the period for presenting offers is different (e.g., in the United States, it ranges from 5:00 am to 12:00 noon), so the number of hours in the time horizon can also diverge. These forecasts can also be used for maintenance scheduling, particularly when the time horizon is 72 hr.
- *Medium term.* The time horizon ranges from the short-term limit to a limit of 7 days. As the time horizon increases, so do the forecast errors. These forecasts can be used as inputs in the UC of the conventional generation (e.g., coal units), as well as in the maintenance planning of the conventional plants. At the same time, when using these forecasts as inputs, it is possible to plan the maintenance scheduling of power system lines and wind farms. This time horizon (between 3 to 7 days) can only be forecasted in operational mode by using NWP solely from large centers, such as the European Center for Medium Range Weather Forecasting (ECMWF) or the National Centre for Environmental Prediction (NCEP).

Presently, due to the economic value of forecasting, most of the commercial and research forecast systems are used for time horizons ranging from 36 to 72 hr ahead.

3.3 REFERENCE MODELS

Persistence wind or power forecasting assumes that the wind (speed and direction) or power at a certain future time will be the same as it is when the forecast is made, which can be formulated as $\hat{p}_{t+k|t} = p_t$.

At an operational level, one has to use the most recently available measurements of wind speed or power as they are provided by the supervisory control and data acquisition (SCADA) system. Persistence is obviously a very simple method and is mentioned here since it is used as a reference to evaluate the performance of advanced methods. An advanced method is worth implementing if it outperforms persistence. Wind, however, is somehow persistent in nature. Persistence is a difficult method to beat, especially on the short-term (1–6 hr).

In [65], a new reference model for WPF is described. The proposed reference model combines the persistence and the mean, where the weight is a function of the correlation between p_t and p_{t+k} . The relationship can be formulated as:

⁴ http://www.omip.pt/precos_volumes.php?id=103.

$$\hat{p}_{t+k|t} = a_k \cdot p_t + (1 - a_k)\bar{p},$$

where p_t is the last measure of the wind generation, \bar{p} is the estimated mean of the generation given by $\bar{p} = \frac{1}{N} \sum_{t=1}^N p_t$, and a_k is the correlation coefficient between p_t and p_{t+k} . The main disadvantage of this method is that the a_k coefficients have to be estimated or fixed by using some considerations or assumptions. The authors stated that if the forecast time horizon is greater than 3 hr, then the new reference model should be used instead of persistence.

3.4 VERY SHORT-TERM FORECASTING

The very short-term forecasting approach consists of statistical models based on the time series approach, such as the Kalman Filters, Auto-Regressive Moving Average (ARMA), Auto-Regressive with Exogenous Input (ARX), and Box-Jenkins forecasting methods. These types of models only take as inputs past values from the forecasted variable (e.g., wind speed, wind generation). At the same time, they can also use other explanatory variables (e.g., wind direction, temperature), which can improve the forecast error. Since these methods are merely based on past production data, they only outperform the persistence model (reference model) for forecast horizons of between 3 and 6 hr. The maximum improvement over the persistence for this short time horizon is in the range of 15% to 20% [67]. For time horizons greater than 3–6 hr, NWP should be used as inputs.

From the statistical point of view, these models can be called univariate/multivariate models. The univariate model only considers past values of wind power generation p .

The univariate model can be expressed as $\hat{p}_{t+k|t} = f(p_t, p_{t-1}, \dots, p_{t-n}) + e_t$, where e_t is white noise and f is a generic function that can be linear or nonlinear. The multivariate models not only use past values of that variable, but also past or present values of other variables. These past values (e.g., on-site meteorological data, active generation) are measured by the wind farm's SCADA system. The multivariate model can be expressed as $\hat{p}_{t+k|t} = f(p_t, p_{t-1}, \dots, p_{t-n}, x_t, x_{t-1}, x_{t-2}, \dots, x_{t-n}) + e_t$, which is a function of past values of p and a set of past values of the explanatory variables x . The structure of the model for very short-term forecasting is depicted in FIGURE 3-1.

Two possible forecasting schemes can be used to forecast a complete time horizon (also known as a multi-look-ahead forecast). One scheme consists of training, for each look-ahead time, a model to forecast the corresponding load-ahead instant. This implies that 48 models are trained for 48 look-ahead instants. Another scheme includes training one model only and using it in an iterative approach. This approach involves feeding the first look-ahead forecast back to replace the lagged value used as input in order to produce the next look-ahead forecast, and the process is repeated until the last time instant is reached. The advantage with this last solution is that it is only necessary to train one model. However, the cumulative error from one time step to the other increases the global forecast error.

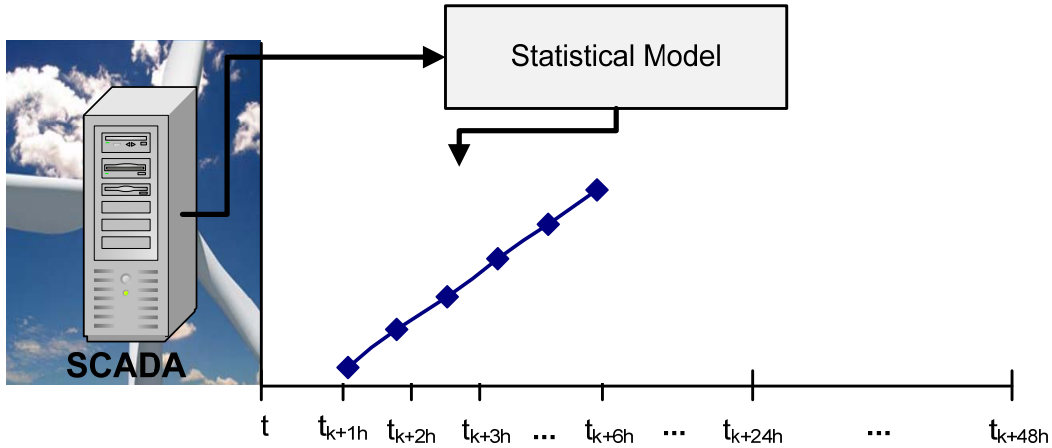

FIGURE 3-1 Very-Short-Term Forecasting Structure (adapted from [67])

The alternative to using these models depends on the purpose of the forecasts, and so a trade-off between NWP costs and the utility of the forecast should be measured. As an example, if the WPFs are inputs to a unit commitment or dispatch algorithm for horizons ranging from 10 min. to 1 hr, the use of very-short forecasts is enough and no additional costs with NWP are necessary.

3.5 WPF WITH NUMERICAL WEATHER PREDICTION

The current majority of short-term WPF approaches require meteorological predictions as inputs to forecast for horizons ranging from 6 to 72 hr. The main feature that distinguishes the approaches has to do with the way predictions of meteorological variables are converted to predictions of wind power generation through the power curve.

The advanced forecasting methods are generally divided into two main groups. The first group is called the physical approach, and it focuses on the description of the wind flow around and inside the wind farm, in addition to using the manufacturer's power curve in order to propose an estimation of the wind power output. The second group is called the statistical approach, and it consists of emulating the relation between meteorological predictions, historical measurements, and generation output through statistical models whose parameters have to be estimated from data without taking any physical phenomena into account. There are some WPF systems that combine the two approaches in order to join the advantages of both approaches and thus improve the forecasts.

The state-of-the art of these models can be found in numerous publications, such as [67]–[72].

3.5.1 Physical Approach

The NWP forecasts are provided by the global model to several nodes of grid covering an area. For a more detailed characterization of the weather variables in the wind farm, an extrapolation of the forecasts is needed. The physical approach in [73] and [74] consists of several submodels, which altogether deliver the translation from the wind forecast at a certain grid point and model level, to power forecast at the considered site and at turbine hub height. Every submodel contains the mathematical description of the physical processes relevant to the translation.

The two main steps are downscaling and conversion to power, as depicted in FIGURE 3-2 and FIGURE 3-3.

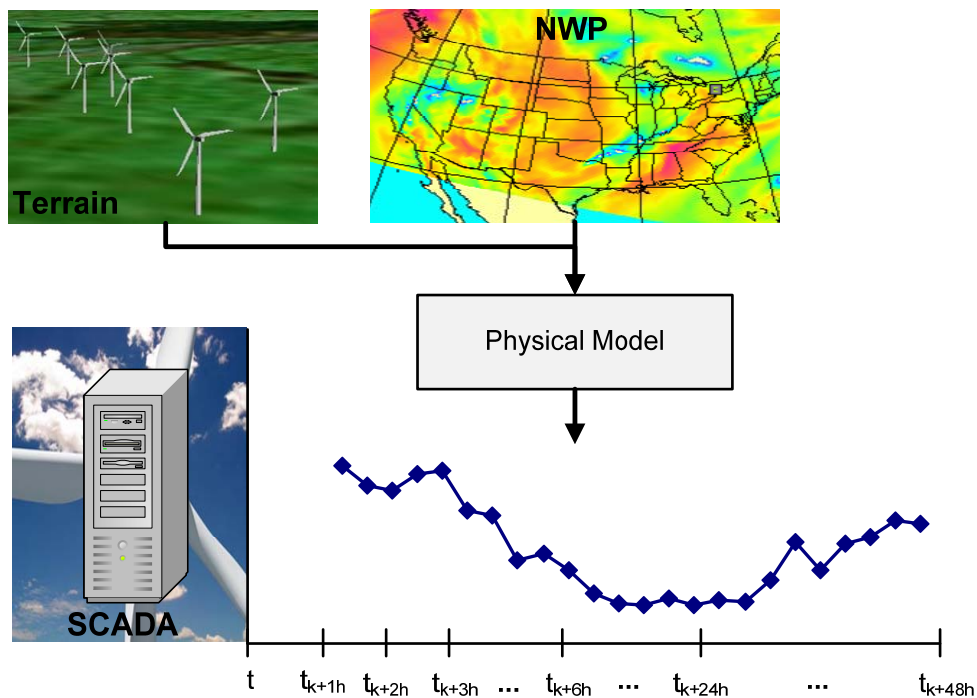

FIGURE 3-2 Physical Approach Structure (adapted from [67])

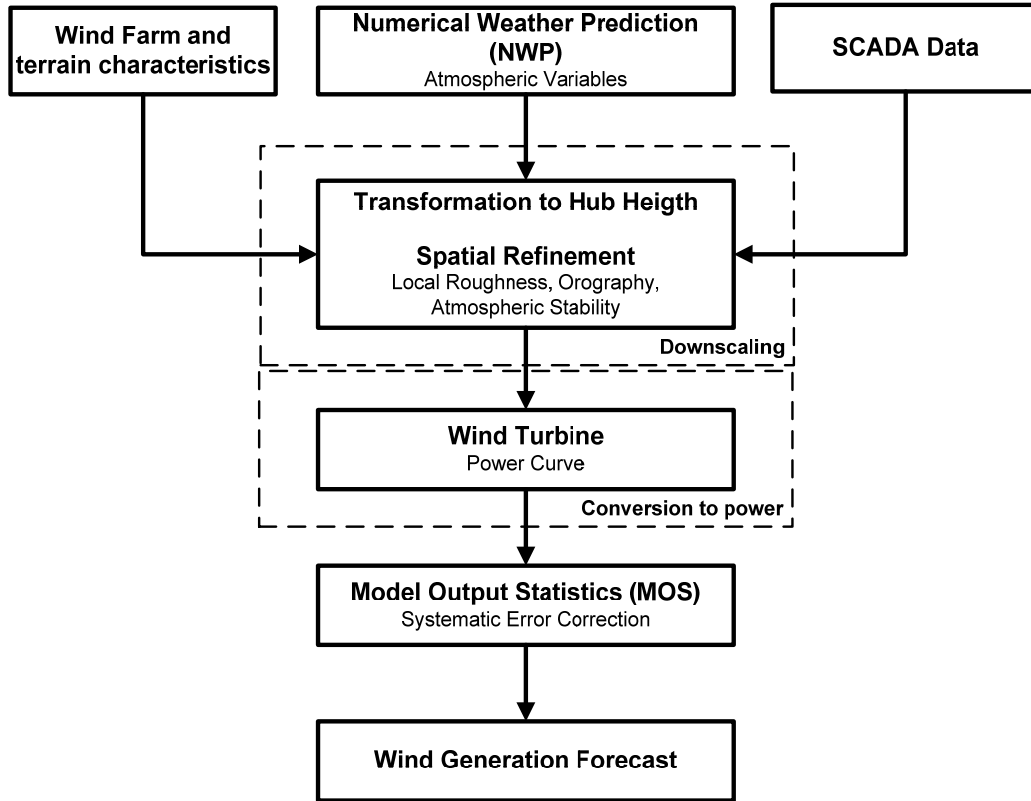

FIGURE 3-3 Main Steps of the Physical Approach

The downscaling step scales the wind speed and direction to the turbine hub's height. The first step of the downscaling consists of finding the best-performing NWP level (often the wind speed at 10 m or at one of the lowest models or pressure levels). The main idea is to refine the NWPs by using physical considerations about the terrain, such as the roughness, orography, and obstacles, and by modeling the local wind profile, possibly taking atmospheric stability into account. The two main alternatives to do so are as follows:

- a) Combine the modeling of the wind profile (with a logarithmic assumption) and the geostrophic drag law⁵ in order to obtain surface winds [73];
- b) Use a CFD (Computational Fluid Dynamics) code that enables an accurate computation of the wind field that the farm will see, considering a full description of the terrain [75]. After this step, a prediction of the *local wind* regime is available.

⁵ $G = \frac{u_*}{k} \sqrt{\left[\ln \left(\frac{u_*}{f z_0} \right) - A \right]^2 + B^2}$, where G is the geostrophic wind, u_* is the friction velocity, k is the Von Kármán constant, f is the Coriolis parameter, and z_0 is the aerodynamic roughness length.

The required input for the downscaling step is a detailed description of the wind farm area, such as wind farm layout, roughness, orography, and other descriptors.

The conversion-to-power step consists of converting the wind speed to power by using a power curve. The use of the manufacturers' power curve is the easiest approach, although newer research from a number of groups has shown that it is advantageous to estimate the power curve from the forecasted wind speed and direction and measured power [76].

In order to account for systematic forecasting errors that may be attributable to the NWP model or to their modeling approach, physical modelers often incorporate Model Output Statistics (MOS) [77] for post-processing power predictions. For an NWP model, statistical relations between model-forecast variables and observed weather variables are either used for correction of model-forecast variables or for the prediction of variables not explicitly forecast by the model. They have often taken the form of multilinear regression equations derived by screening potential model-forecast variables as predictors. The method produces forecasts of weather variables that, to some extent, account for the random and systematic errors in the numerical weather prediction model. The main disadvantage with this model is that it needs measured data (on-line or off-line), as well as data of good quality.

3.5.2 Statistical Approach

An alternative approach, which only consists of one step (direct transformation of the input variables into wind generation), is the statistical approach (depicted in FIGURE 3-4). The only performed step is a statistical block. As depicted in FIGURE 3-5, this block is able to combine inputs such as NWP's of the speed, direction, temperature, etc., of various model levels, together with on-line measurements, such as wind power, speed, direction, and others. With these models, a direct estimation of regional wind power from the input parameters is possible in a single step.

The statistical block can include one or several statistical linear and nonlinear models of different types. Some examples are the so-called "black-box" models, which include most of the artificial-intelligence-based models, such as Neural Networks (NNs) and Support Vector Machines (SVMs). Other types of models are the "grey-box" models, which learn from experience (from a dataset) and for which prior knowledge (such as diurnal variations) can be injected. There are also models that can be expressed analytically, such as the Kernel regression.

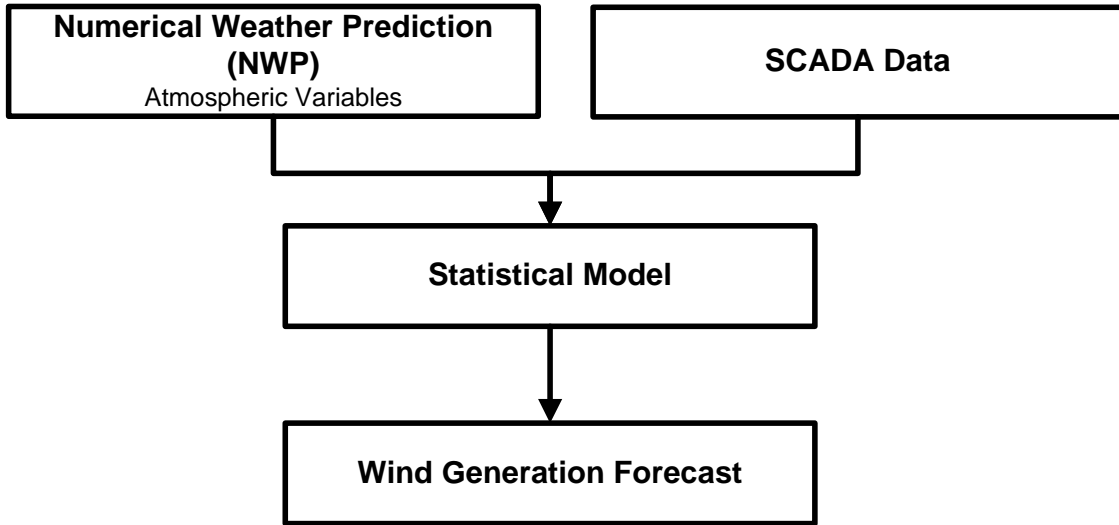

FIGURE 3-4 Main Steps of the Statistical Approach

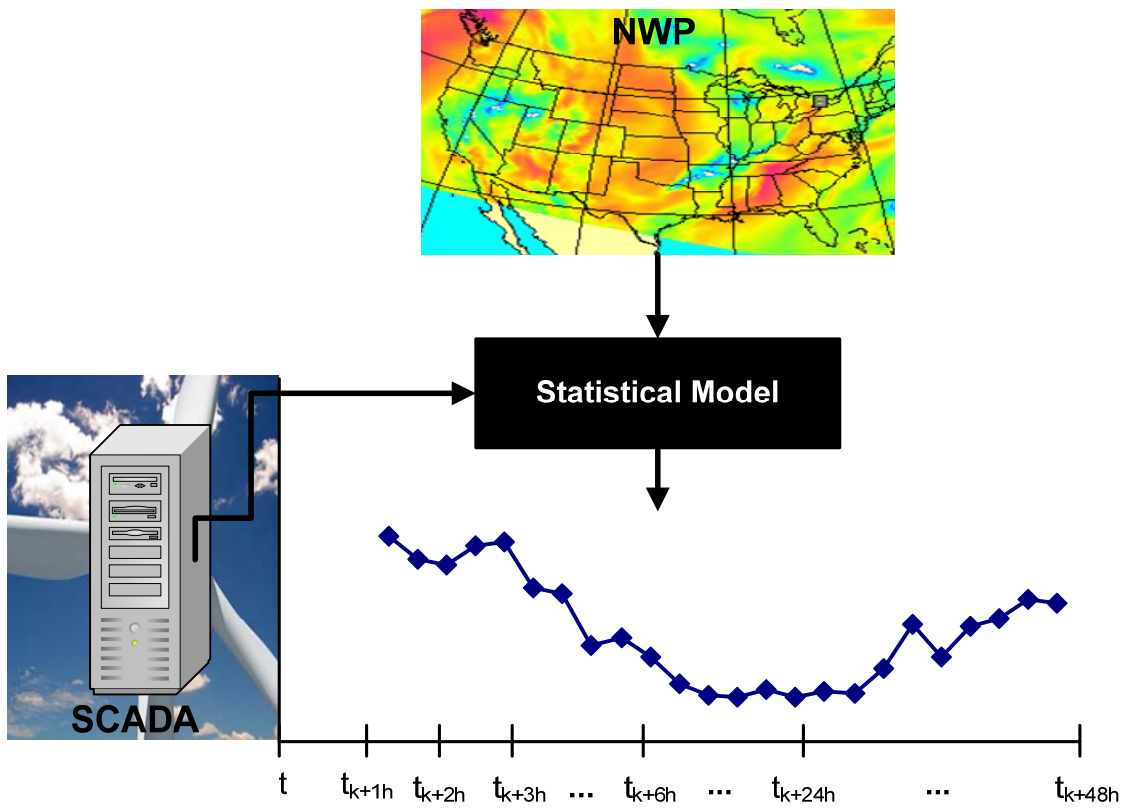

FIGURE 3-5 Statistical Approach Structure (adapted from [67])

This extrapolation of NWP forecast to power will be referred to in this document as a “wind to power (W2P)” model.

The statistical model can be expressed as:

$$\hat{p}_{t+k|t} = f(p_t, p_{t-1}, \dots, p_{t-n}, x_t, x_{t-1}, x_{t-2}, \dots, x_{t-n}, \hat{x}_{t+1|t}, \dots, \hat{x}_{t+k|t}) + e_t ,$$

which is a function of past values of p and a set of past values and forecasts of the explanatory variables x .

Statistical models are usually set up by an autoregressive part (see Section 3.4), which is used to seize the persistent behavior of the wind, and by a “meteorological” part, which consists of the nonlinear transformation of NWP forecasts. The autoregressive part enables significantly enhanced forecast accuracy for horizons up to 6–10 hr ahead (e.g., generally, in this period, the sole use of NWP forecasts may not be sufficient to outperform persistence).

Today, the main developments of statistical approaches to wind power prediction focus on the use of multiple meteorological forecasts (ensembles) as a combination of input and forecast. At the same time, these developments also focus on the optimal use of spatially distributed measurement data for the correction of prediction errors (phase errors) or for the issuing of warnings on potentially large uncertainty.

3.5.3 The Combined Approach

Recent developments in WPF systems are related to the integration of the two paired approaches, the physical and mathematical models [69]. The hybrid model benefits from the high accuracy of the time series models in short-time horizons and also from the high levels of accuracy of the physical models for horizons between 6 and 72 hours. The physical model also allows the spatial resolution of the NWP forecasts to increase, taking the terrain characteristics into account, as well as forecasting without SCADA measures. Two types of combinations can be used for the hybrid physical-statistical approach: (i) a combination of physical and statistical approaches (e.g., Zephyr model [78]); and (ii) a combination of models for the short-term (0 to 6 hr) and for the medium-term (0 to 48 hr) (e.g., UMPREDICTION project [79]).

A different approach is the combination of alternative statistical models. One example of that is the Spanish Sipleólico [80].

The combination is achieved through the use of the horizon as a criterion after the model that best suits each horizon is identified off-line or by a selection process based on the recent performance of each individual model. The structure of the combining approach is depicted in FIGURE 3-6.

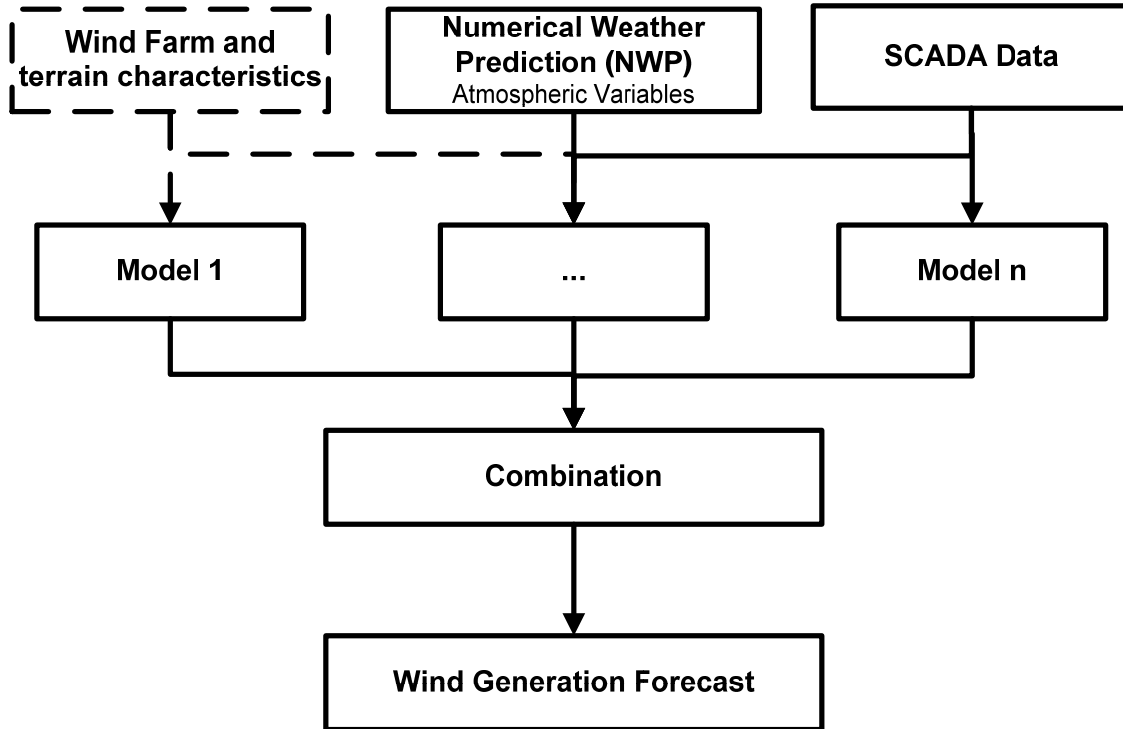

FIGURE 3-6 Main Steps of the Combined Approach

3.5.4 Regional Forecasting (Upscaling)

If one wants to forecast the wind generation of a region or a country, the first choice is to forecast the output of each wind farm and then add these predictions. This option can be called “brute force” because forecasting the output of each single wind farm in a region/country can be very expensive and even prohibitive, as far as data management and computer effort (particularly for the statistical approach) are concerned. Also, the data measured by the SCADA (e.g., wind generation, wind speed) of all the wind farms, as well descriptions of the wind farms (rated power, the power curve of the turbines, etc.), can be of low quality and sometimes even missing. For instance, the on-line information measured by the SCADA systems in some countries is not available because it is only mandatory to install the system in large wind farms. Moreover, it is not possible for an SO to have NWP predictions for all wind farms under its control area because that involves high computational effort and costs.

To overcome this problem, upscaling approaches have been developed to forecast regional/national wind generation from a sample of reference wind farms. Furthermore, the aggregation of wind farms appears to reduce the forecast error as a result of spatial smoothing effects [81]–[83].

The intention with upscaling is to extrapolate the total wind-generated power from predictions carried out for a number of representative (or reference) wind farms, for which NWPs and/or on-line measurements are made accessible by the forecasting system.

3.5.4.1 Direct Upscaling

Direct upscaling is a simple approach that links the production and NWP data available for one or more reference wind farms to the regional generation, as depicted in FIGURE 3-7. The upscaling model is designed and trained to provide forecasts for the regional wind power directly by using input from these reference wind farms. Thus, it requires the availability of detailed data on the total generation in order to estimate the model parameters. This approach is essentially based on statistical modeling. The main difficulty with this approach is that the function has to be updated if new wind farms are added to the system.

3.5.4.2 Cascaded Approach

The cascaded approach is the one that is mainly used today for upscaling. It considers two forecasting stages: first, the generation of the reference wind farms is estimated, and then the sum is extrapolated to the total regional/national generation, as depicted in FIGURE 3-8.

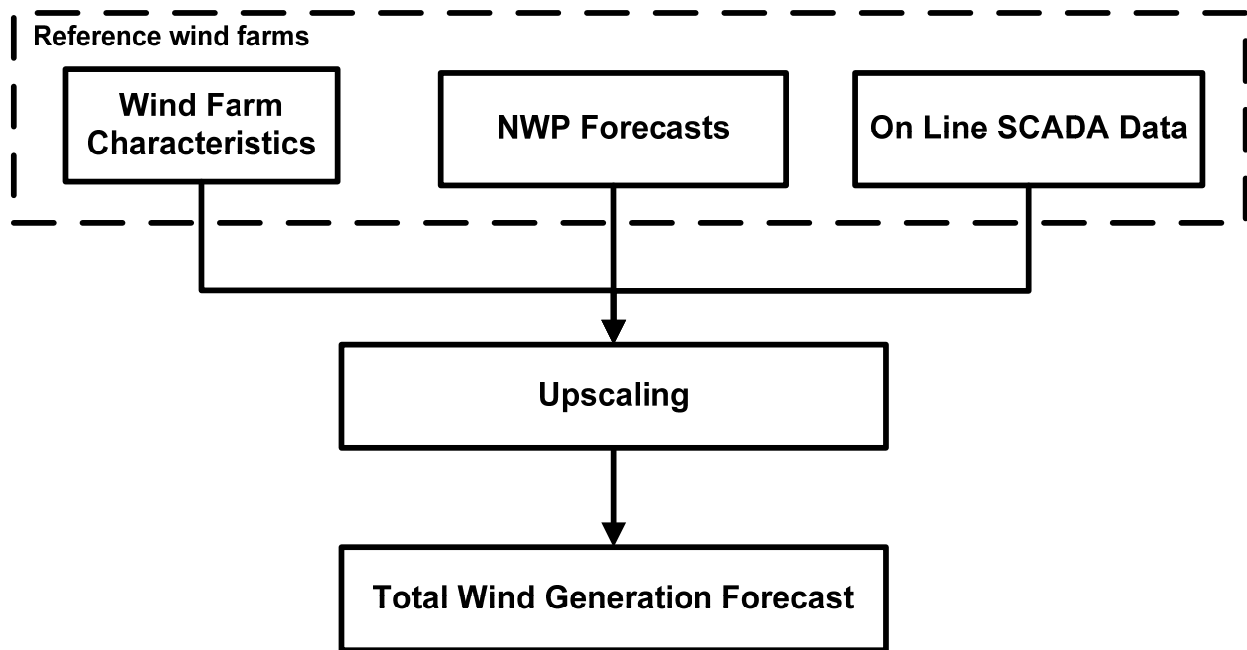

FIGURE 3-7 Direct Upscaling Method

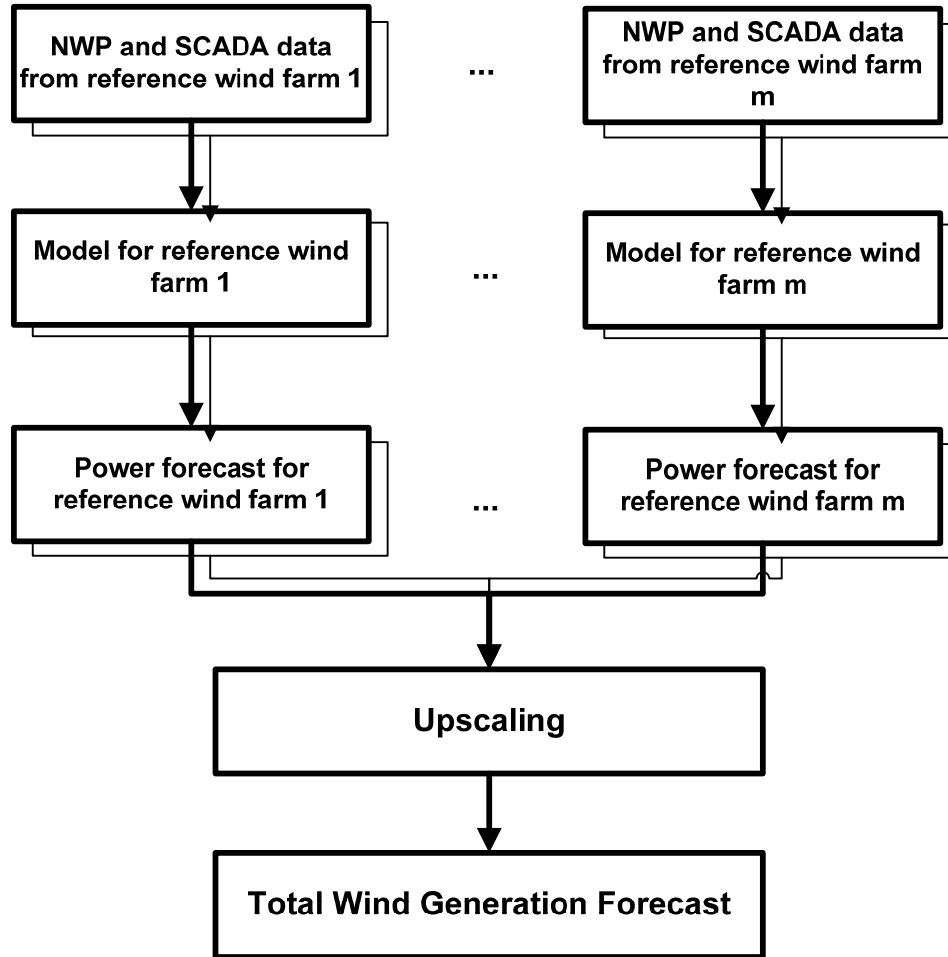

FIGURE 3-8 Cascaded Method for m Reference Wind Farms

3.5.4.3 Cluster or Subregions Approach

This approach is based on aggregating wind farms into clusters that contain neighboring wind farms or wind farms belonging to the same subregion. A model is developed for each cluster or subregion based on input (from NWP and/or SCADA) from the reference wind farms in that cluster/subregion. Finally, the sum of the clusters' generation forecasts provides the total forecast for the region. The structure of the approach is depicted in FIGURE 3-9.

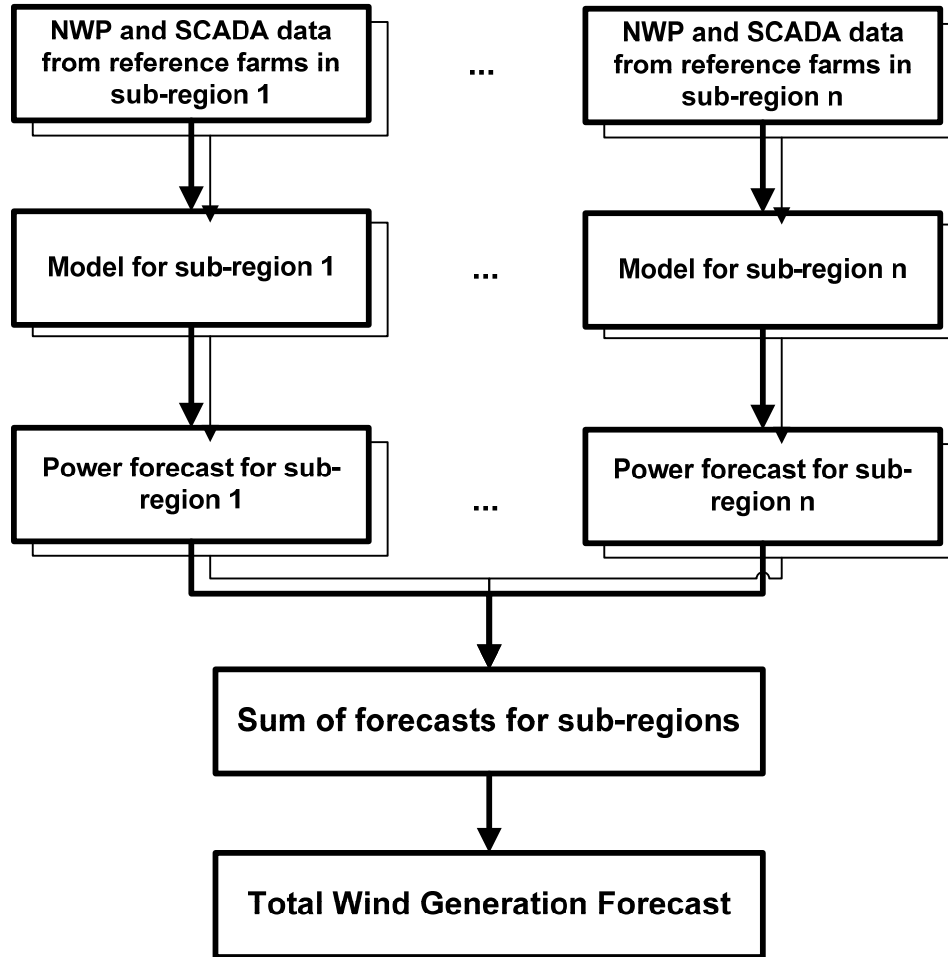

FIGURE 3-9 Cluster Method for n Clusters/Subregions

Another possible approach consists of combining the methodologies mentioned above. For example, in [84], a **combined approach** is developed based on the cascaded and the subregion configurations.

3.5.4.4 On-line (OL) Persistence for Upscaling Models

As stated above, persistence is a simple method according to which “the wind production in the future will be the same as the production now.” It is typically used to evaluate the performance of advanced models. Indeed, investing in the implementation of an advanced approach on-line is only worthwhile if the model is capable of beating persistence.

As far as upscaling is concerned, it is a common practice to consider equivalently that persistence means that: “the total wind production in the future will be the same as the total wind production now.” It is evident that, based on this definition, persistence cannot be an on-line model if data for all wind farms are not available on-line. In this case, it is only worth investing

in implementing an advanced model on-line if the model is capable of beating a persistence-like method based on on-line data. Such a method, defined as OL-Persistence, can be the sum of the production of the representative wind farms with SCADA, scaled to the total wind power (using nominal power). OL-Persistence can be defined as [83]:

$$\hat{P}_{t+k}^{reg} = \left(\frac{\sum_{i=1}^n P_i^{norm}}{\sum_{j=1}^r P_j^{norm}} \right) \cdot \sum_{j=1}^r P_j^{wf}(t),$$

where \hat{P}_{t+k}^{reg} is the regional power forecast for look-ahead k , P_i^{norm} is the nominal power of the i^{th} wind farm in the region, P_j^{wf} is the measured power of the j^{th} wind farm at time t , n is the total number of wind farms in the region, and r refers to the reference wind farms.

3.6 EVALUATION OF FORECASTS

WPFs are characterized by an inherent uncertainty, which means that no available wind power prediction can ever be exact. Therefore, it is essential that wind power forecasts are properly evaluated, not only to assess the performance of the chosen approaches adequately, but also to obtain a deeper understanding of what characterizes the prediction uncertainty.

Evaluation of the quality of forecasting methods is conducted by comparing wind power predictions made at a certain time directly with the actual corresponding observations. Hence, the quality of a given forecasting method is assessed through analysis of the deviation between the prediction and the truth (or the actual). The actions of determining and quantifying the quality of forecasting methods in terms of their statistical performance imply that there will be an evaluation of a long series of predictions, so that enough data are analyzed.

In this section, a framework for evaluating the accuracy of WPF methods is presented. Adapted from [85] and [86], it consists of an evaluation protocol to measure and grade their accuracy [85]. There is particular focus on the most relevant criteria that are considered for wind power predictions. In addition, several evaluation measures are presented in order to provide a comprehensive framework for the verification of WPFs. These measures will enable users to evaluate and compare different approaches for wind power forecasting and provide them with insight into uncertainty characteristics.

3.6.1 Error Decomposition of Wind Speed Forecasts

As far as wind speed forecasts are concerned, v_{pred} and v_{meas} are the forecasted and the measured wind speeds, respectively. The difference or deviation between v_{pred} and v_{meas} , which is called the forecast error, e , will be provided by:

$$e = v_{pred} - v_{meas}$$

The root mean square error between the two corresponding time series, $rmse$, will be calculated as the square root of the squared error value:

$$rmse = \sqrt{e^2}$$

The *rmse* can be decomposed into three different parts, according to the origin of the forecast errors [87]:

$$rmse^2 = bias^2 + sde^2 = bias^2 + sdbias^2 + disp^2,$$

where:

$$bias = \bar{e},$$

$$sde = \sigma(e),$$

$$sdbias = \sigma(v_{pred}) - \sigma(v_{meas}),$$

$$disp = \sqrt{2\sigma(v_{pred})\sigma(v_{meas})(1 - r_{p,m})},$$

with $r_{p,m}$ being the cross-correlation coefficient between the two time series and $\sigma(v_{pred})$ and $\sigma(v_{meas})$ their respective standard deviations.

The bias translates the difference between the mean values of the predictions and the measures series. The standard deviation of the errors expresses the variance around the mean of the errors, with two different components: (1) the *sdbias*, which consists of the difference between the standard deviations of v_{pred} and v_{meas} , translating the contributions of errors generated by incorrectly predicted variability, and (2) the dispersion, *disp*, involving the cross-correlation coefficient weighted with the standard deviations of both time series. The dispersion expresses the contribution of phase errors to the *rmse*, reflecting global characteristics of the wind-speed forecasting system.

3.6.2 Performance Evaluation of WPF

Evaluating a set of forecasts implies that related observations are available. Despite the fact that most modern wind farms are equipped with SCADA systems, there may be intervals of time during which data may not have been available. On the other hand, even if data is fully available, there is still the possibility that its quality is poor. In the latter case, tuning and verifying the forecast cannot be carried out successfully, since evaluating forecasts with figures that do not correspond to the actual makes drawing relevant conclusions less likely. The analyst must therefore decide how to deal with the available dataset by considering its overall quality.

Evaluating forecasts implies considering several available criteria that need to be adequately applied and combined in order to support drawing relevant conclusions.

3.6.2.1 Training and Test Dataset

A useful forecasting method should be capable of providing adequate predictions on new and independent test data. This capability is usually known as generalization, and its importance in assessing the quality of forecasting methods is crucial because it translates the ability of the

method to predict under different circumstances. Therefore, it is very important to evaluate the error measures on data that have not been used to build the prediction model or to tune the method's parameters.

In order to achieve this, the data are usually divided into two different sets, according to their time characteristics: (1) the training dataset, and (2) the testing dataset. The training dataset is used to build the model, taking into consideration the validation of decisions and/or rules on the model's structure. However, since the training dataset does not provide adequate estimates for the prediction errors, it is necessary to use new and independent data — the test dataset. Thus, prediction models should be developed and tuned by using the training data and disregarding the test data, while the error measures should be based on the test data only. However, the test data set can be used for self-adaptive training during the test phase.

3.6.2.2 Standard Error Measures

As far as wind power forecasting is concerned, the prediction error observed at a given time $t+k$ for a prediction made at time origin t , $e_{t+k|t}$, is defined as the difference between the value of wind power that is effectively measured at $t+k$, P_{t+k} , and the value of wind power at $t+k$ that was originally predicted at t , $\hat{P}_{t+k|t}$:

$$e_{t+k|t} = P_{t+k} - \hat{P}_{t+k|t} ,$$

where:

$e_{t+k|t}$ is the error corresponding to time $t+k$ for the prediction made at time t ,

P_{t+k} is the measured power at time $t+k$,

$\hat{P}_{t+k|t}$ is the power forecast for time $t+k$ made at time t .

It is often convenient to use the normalized prediction error e , which can be obtained by dividing the prediction error by the installed capacity, as follows:

$$e_{t+k|t} = \frac{e_{t+k|t}}{P_{inst}} = \frac{1}{P_{inst}} [P_{t+k} - \hat{P}_{t+k|t}] ,$$

where P_{inst} is the wind farm installed capacity. The usefulness of normalizing prediction errors creates the possibility of obtaining results that can be compared from one wind farm to another, regardless of their rated capacity. This produces results that do not depend on wind farm sizes.

Any prediction error can be decomposed into two components: a systematic error and a random error. Ideally, in a perfect model, the systematic error should be equal to zero, while the random part should be a sequence of independent random errors that can be modeled using a zero mean Gaussian distribution. For practical purposes, however, consecutive forecasting errors are often correlated and may not be normally distributed.

Using specific error measures, it is possible to assess the quality of forecasting methods. One example is the bias, $BIAS_k$, which corresponds to an estimate of the systematic error that is provided by the mean error over the whole evaluation period, as described by:

$$BIAS_k = \bar{e}_k = \frac{1}{N} \sum_{t=1}^N e_{t+k|t},$$

where N is the number of prediction errors used for method evaluation. The bias is computed for each look-ahead time k of the considered time horizon.

When calculated over the whole test set, the bias value provides an indication of whether the method tends to overestimate or underestimate the forecasted variable. Furthermore, if the bias is calculated for various data subsets with different weather conditions, it enables the detection of conditions for which the method produces predictions that are significantly above the underestimated value. This leads to the identification of a tendency.

However, it is very unlikely that a forecasting method with a zero bias will provide perfect predictions, since the bias cancels out as a result of positive and negative error values throughout the test dataset. A common error measure to identify the contribution of both positive and negative errors to a forecasting method's lack of accuracy is the Mean Square Error (MSE), which consists of the average of the squared errors over the test set:

$$MSE_k = \bar{e}_k = \frac{1}{N-p} \sum_{t=1}^N e_{t+k|t}^2,$$

where p is the number of estimated parameters using the considered data. For the test data, $p = 0$.

Besides the MSE, there are two other basic criteria to illustrate a model's performance: the Mean Absolute Error (MAE) and the Root Mean Square Error, or RMSE. The MAE is:

$$MAE_k = \frac{1}{N} \sum_{t=1}^N |e_{t+k|t}|$$

Both systematic and random errors contribute to the MAE value. The RMSE corresponds to the square root of the MSE:

$$RMSE_k = \sqrt{MSE_k} = \sqrt{\frac{\sum_{t=1}^N e_{t+k|t}^2}{N-p}}$$

Similar to the MAE, both systematic and random errors affect the RMSE criterion. Since the RMSE is expressed in the same units as the predicted variable, the information it conveys is easier to interpret than the information imparted by the MSE.

The MAE and RMSE, divided by the installed capacity or the average production of the wind farm, are called NMAE (Normalized Mean Absolute Error) and NRMSE (Normalized Root Mean Square Error).

The choice between MAE and RMSE as a main evaluation criterion for the evaluation of wind power forecasts depends on the end-users' sensitivity to the errors, which is represented by a loss function. The use of RMSE implies that a quadratic loss function should be considered, while using the MAE requires the use of a linear function. If a certain method was trained to produce minimum MSE forecasts, then using RMSE will be suitable in its evaluation. However, whenever the loss function representing the sensitivity of forecast users is not clearly defined, it will be preferable to also report MAE.

An alternative to the use of RMSE is to consider the Standard Deviation of the Errors (SDE):

$$SDE_k = \sqrt{\frac{\sum_{t=1}^N [e_{t+k|t} - \bar{e}_k]^2}{N - (p + 1)}}$$

Since the SDE criterion is an estimate for the standard deviation of the error distribution, only the random error contributes to the SDE criterion.

Because the values of the BIAS and of the MAE are associated with the first-order momentum of prediction error distributions, they are directly related to the produced power. In contrast, the values of RMSE and SDE are connected to the second-order momentum of prediction error distributions, thus being connected to the variance of the prediction error. It should be highlighted that RMSE and SDE do not have a direct interpretation, and they are highly affected by large prediction errors. This circumstance causes the RMSE criterion to be more sensitive to the presence of erroneous data when compared to the MAE criterion. Therefore, if there is doubt about the quality of the evaluation set, the MAE should be preferred as a main evaluation criterion since it presents greater robustness when confronted with large prediction errors. By taking this approach, one can avoid concluding that a certain prediction method would have poor accuracy when, in reality, the observed high RMSE values would be the result of the poor quality of the measured data.

3.6.2.3 Comparison of the Accuracy of Different Forecasting Methods

When comparing and evaluating several forecasting methods, the fact that a method can work best with a certain criterion but not with an alternative criterion must be taken into account. The performance of wind power forecasting methods depends not only on the variance of the

prediction error, but also on the evaluation period: some methods may perform better for low wind power availability, thus being surpassed by rival approaches when evaluated only under low wind power production periods. It is therefore necessary to include a wide variety of error measures when judging the accuracy of a forecasting method.

To compare the level of performance of various methods, it might be interesting to quantify the gain resulting from the preference for a certain approach instead of for the reference ones. This gain, defined as the improvement relative to the considered reference method and sometimes referred to as the “skill score,” corresponds to the prediction error reduction that is achieved by using the advanced method for a given error measure and being defined as:

$$Imp_{EC}^{ref}(k) = \frac{EvC_k^{ref} - EvC_k}{EvC_k^{ref}},$$

where EvC is the considered evaluation criterion, which can either be MAE, RMSE, SDE, or their equivalent normalized versions. EvC_k^{ref} denotes its value for the reference forecasting method, while EvC_k corresponds to the value of the advanced forecast being evaluated. The improvement is often expressed as a percentage improvement against the reference approach. Positive values of improvement denote that advanced approaches are better than the reference method (in terms of the chosen criterion), while negative values of improvement denote that advanced approaches are worse than the reference method.

A different way to compare several forecasting methods consists of computing the coefficient of determination, R^2 , for each look-ahead time:

$$R_k^2 = \frac{MSE_k^0 - MSE_k}{MSE_k^0},$$

where MSE^0 is the Mean Squared Error for the moving average model. The coefficient of determination translates a model’s ability to explain the variance of the data — varying between 0 (useless predictions) and 1 (perfect predictions). It is important to highlight that, as far as wind power predictions are concerned, the R^2 criterion is essentially designed for model selection using the training set. When used for large forecasting time horizons, the resulting R^2 value will be negative because the asymptotic variance of prediction errors doubles the variance of the global mean prediction. Thus, while the R^2 criterion can be considered for the comparison of the performance of several forecasting methods, its use as a main tool for performance evaluations should be avoided as it might yield misleading results.

One possibility for the definition of the R^2 value is to establish it by correlating the measured and the predicted power. In order to avoid a definition that leads to $R^2 = 1$, it is necessary to include both the systematic and random parts of prediction errors where these components are embedded in the MSE values. Whenever the R^2 criterion is used, it will be highly important to describe exactly how it is calculated.

3.6.2.4 Typical Forecasting Errors

The performance of the WPF systems is strongly related to several characteristics. Therefore, to evaluate the level of performance, the following characteristics must be taken into account:

- Terrain complexity: expressed by the ruggedness index (RIX), which reflects the slope of the terrain around the wind farm;
- Size of the wind farm: installed power, number of wind turbines, wind turbine layout;
- Geographic location: offshore, onshore, near shore;
- Quality of data: NWP forecast error, SCADA measurement error;
- Type of NWPs: mesoscale model, microscale model; spatial resolution;
- Type of model: physical, statistical, hybrid; and
- Site climatology conditions.

Also, the forecast error depends on the error measure involved for comparison. The most common error descriptors are the NRMSE and the NMAE.

Typical model results for single wind forecasting (based on the results presented in [88] and [89]) are as follows:

- The NMAE is around 6–9% and NRMSE is around 10–13% of the installed capacity for the first 6 hr, rising to 13–16% and 18–22% for 48 hr ahead, respectively.
- Typical results for regional forecasting are on the order of an NMAE of around 6–10% and an NRMSE of around 8–12% of the installed capacity for 24 hr ahead, rising to 11–14% and 14–17% for 48 hr ahead, respectively.

3.7 SYNTHESIS OF WPF DEFINITIONS

Time horizon: indicates the total length of the forecasting period (e.g., 72 hr ahead) into the future, with a specified time resolution.

Time step: the time resolution of the forecasts is denoted by the time step. Usually, for horizons in the order of 24 to 72 hr, the time step is hourly.

P_{t-k} : measured power derived from averaging higher-resolution measurements (e.g., 15 min.), which can be instantaneous values or energy, depending on the acquisition system.

$\hat{P}_{t+k|t}$: forecasted wind generation made at time instant t for a look ahead time $t+k$. It is the average power $P_{t+k|t}$ that the wind farm is expected to generate during the considered period of time (e.g., one hour), if operating under an equivalent constant wind.

Point or spot forecast: single value of the forecasted wind power generation.

Probabilistic forecasts: probability distribution of the forecasted wind power generation for every look-ahead time.

Reference models: a simple method used as a reference to evaluate the performance of advanced methods. An advanced method is worth implementing if it outperforms the reference model.

Persistence: this reference model assumes that the wind or power will be, at some future time, the same as it is when the forecast is made.

TABLE 3-1 provides an overview of the time horizon classifications and the potential application of each category in the operation and planning of power systems from the system operator’s perspective, as well as the usefulness for the generation companies.

TABLE 3-1 WPF Time Horizons

Time Horizons	GENCOs	SO
Very Short-term (up to 9 hrs)	Intraday market Real-time market	Ancillary services management Unit commitment Economic dispatch Congestion management
Short-term (up to 72 hrs)	Day-ahead market Maintenance planning of wind farms Wind farm and storage device coordination	Maintenance planning of network lines Congestion management Day-ahead reserve setting Unit commitment and economic dispatch
Medium-term (up to 7 days)	Maintenance planning of wind farms Maintenance planning of conventional generation	Maintenance planning of network lines

TABLE 3-2 summarizes the measures for the performance evaluation of point forecasts provided by a WPF system or method.

TABLE 3-2 WPF Performance Evaluation

Measures	
Normalized Mean Absolute Error (NMAE)	$NMAE_k = \frac{1}{P_{inst}} \cdot \frac{1}{N} \cdot \sum_{t=1}^N e_{t+k t} $
Normalized Root Mean Square Error (NRMSE)	$NRMSE_k = \frac{1}{P_{inst}} \cdot \sqrt{\frac{\sum_{t=1}^N e_{t+k t}^2}{N}}$
Normalized Bias (NBIAS)	$BIAS_k = \frac{1}{P_{inst}} \cdot \frac{1}{N} \cdot \sum_{t=1}^N e_{t+k t}$
Normalized Standard Deviation of the Errors (NSDE)	$NSDE_k = \frac{1}{P_{inst}} \cdot \sqrt{\frac{\sum_{t=1}^N [e_{t+k t} - \bar{e}_k]^2}{N}}$
Improvement over a reference method	$Imp_{EC}^{ref}(k) = \frac{EvC_k^{ref} - EvC_k}{EvC_k^{ref}}$

Notation: (i) the forecast error observed at a given time $t+k$ for a prediction made at time origin t is defined as $e_{t+k|t} = P_{t+k} - \hat{P}_{t+k|t}$; and (ii) N is the number of data used for the model's evaluation; P_{inst} is the installed capacity of the wind farm; EvC : is the evaluation criterion; EvC_k^{ref} denotes its value for the reference forecasting method, while EvC_k indicates the value of the advanced method.

FIGURE 3-10 depicts the different approaches for WPF.

Regional/upscaling forecast: the main idea is to extrapolate the total wind power generation from forecasts carried out for a number of representative (or reference) wind farms.

TABLE 3-3 reports the four approaches in regional (upscaling) forecast.

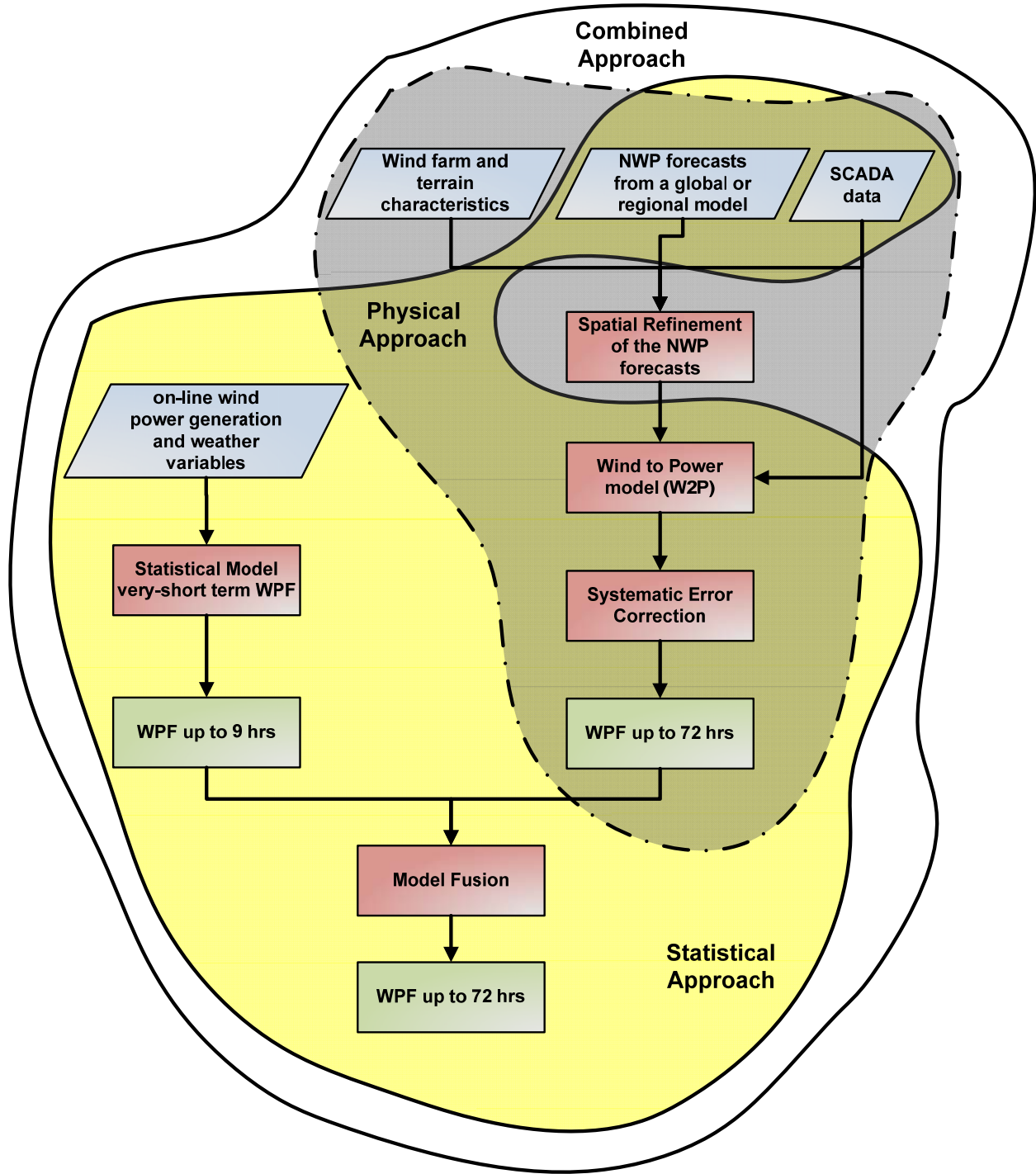

FIGURE 3-10 Different Approaches for WPF

TABLE 3-3 Regional Forecast Approaches

Approaches	Description
Direct	This approach links the generation and NWP data available from one or more reference wind farms to the regional generation.
Cascaded	This approach is divided into two stages: (i) the power of the reference wind farms is forecasted; and (ii) the sum is extrapolated to the total regional/national generation.
Cluster or subregions	This approach is divided into three stages: (i) the wind farms are aggregated into clusters; (ii) a model is developed for each cluster; and (iii) the sum of the clusters' generation forecasts provides the total generation for the region.
Combined	This approach is a combination of the aforementioned approaches.

4 LITERATURE OVERVIEW OF THE WPF APPROACHES

This section provides an overview of the past and current techniques in WPF. In the literature, there are some extensive survey documents in WPF, and some can be found in [67]–[72]. Some of the references and works described in the previous publications concerning the state-of-the-art are revisited in this section. However, recent developments in the subject area are also presented.

In addition to a survey of forecasting techniques, the commercial models are also reviewed, and their main characteristics are described.

4.1 RESEARCH WPF METHODS AND TECHNIQUES

4.1.1 Very-Short-Term Forecasting

4.1.1.1 Wind Speed Forecasting Using Statistical Methods

This approach has to do with wind speed forecasting only. However, this wind speed forecast is often converted to power through an empirical or manufacturer's power curve.

The first wind forecasting model, specifically used in wind generation forecasting, is presented in [90]. A Kalman filter [91] that uses the last six measured values as inputs is proposed to forecast wind speed for the following minutes. The results are good when compared with the persistence for time horizons below 10 min. of averaged data. The improvement was poorer in longer averages and was nonexistent for 1-hr averages. Also, in [92], a Kalman filter is used to control a variable speed wind turbine.

For models based on the Box-Jenkins methodology, the general Autoregressive Integrated Moving Average (ARIMA) approach [93] was the first to be employed on wind speed forecasting. For example, *Contaxis et al.* [94] employed an autoregressive (AR) model (more precisely an AR[3]) to forecast the wind speed for time horizons ranging between 30 min. and 5 hr and used the values to control an isolated hybrid diesel/wind system and short-term operation scheduling; *Kamal et al.* [95] used an ARIMA model to forecast the wind speed and estimate confidence intervals; *Schlink et al.* [96] employed these models to forecast the wind speed for the next 10 minutes in an airport; *Poggi et al.* [97] used an autoregressive model for each month in order to forecast the wind speed for the following 3 hr; *Torres et al.* [98] used five Auto-Regressive Moving Average (ARMA) models to forecast the hourly average wind speed for a time horizon of 10 hr in five different locations with different topographic characteristics. With this model, over nine years it was possible to achieve a 20% error reduction as compared to persistence; *Tantareanu* [99] found that ARMA models can perform up to 30% better than persistence for 3 to 10 steps ahead in 4-s averages of 2.5-Hz sampled data.

Kavasseri et al. [100] presented the fractional-ARIMA (f-ARIMA) model to forecast the wind speed day-ahead and two-days-ahead. The forecasted wind speed is converted to wind power by using a manufacturer's power curve. Following the results presented in [101], the authors suggest a modified ARIMA model (f-ARIMA) to deal with long-range correlations (LRCs). An LRC process is characterized by a slow decay of the autocorrelation function. The f-ARIMA model allows the differencing parameter to assume fractionally continuous values in the interval $[-0.5;0.5]$, and therefore the differencing parameter can represent LRC.

El-Fouly et al. [102] presents a new technique to forecast wind speed for the upcoming hour based on the Grey predictor model [103]. The wind speed is then converted to wind power by a manufacturer's power curve. The registered improvement in comparison to persistence is in the range of 12% for the wind generation forecast.

Alternative forecast methods are based on artificial intelligence techniques, namely neural networks (NNs), support vector machines (SVMs), or fuzzy inference systems (FISs). *Alexiadis et al.* [104] proposed a model based on an NN to forecast the wind speed for the Syros island (in Greece) using historical wind data from the island and from other neighboring islands as input variables. The results show an improvement of 32% over persistence in the forecast error for a 1-hr horizon; the same method was employed in [105] for a different location in Greece, and the improvement over persistence was 27% for a 2-hr time horizon.

Sfetsos evaluates different models in [106]: a persistence model, ARIMA models, NN, and neuro-fuzzy systems. The model with the best results was the NN, leading to a 20–40% average improvement when compared to the persistence. In more recent work, *Sfetsos* [107] uses two models based on NN to forecast the wind speed for a time horizon of one hour. The first model uses the last known values of the hourly wind speed as inputs, and the results are only 3% better than those registered for persistence models. The second model uses the wind speed time series with 10-min. intervals as inputs, in addition to using the NN output iteratively to forecast the subsequent 60 min. The improvement of the second model over persistence is 10%.

Cadenas and Rivera [108] tested four NN configurations to hourly wind speed forecast. The model with best performance was the simple one, an NN with two layers and three neurons.

Damousis and Dokopoulos [109] and *Damousis et al.* [110] present a *Takagi-Sugeno* FIS [111] that is based on wind measures of the target location and on the wind speed forecasts of neighboring locations for a time horizon of between 30 and 240 min. A genetic algorithm is used in order to optimize the FIS parameters. The improvement over persistence ranges between 9.5% and 28.4%, depending on the time horizon (it increases with the time horizon).

Maqsood et al. [112] present the idea of using more than one model to forecast three meteorological variables (including wind speed) for a 24-hr-ahead interval. Four different types of NNs [113] are considered: the multilayer perceptron (MLP), the recurrent neural network of Elman, the radial basis function (RBF), and the Hopfield neural networks. An NN of each type was trained for each season of the year. The best result was the one obtained with the RBF neural network, but accuracy increases when all of the models are combined (i.e., into an ensemble of models).

Abdel-Aal et al. [114] demonstrated the application of abductive networks based on the group method of data handling (GMDH) [115] to forecast the mean hourly wind speed. The authors demonstrated that the main advantage of the abductive networks over the NN is the fast convergence during training and automatic selection of both input variables and model structure. The model achieved an improvement of 8.2% compared to persistence in a 1-hr-ahead forecast. The model was also used to forecast the wind speed for 6 and 24 hr ahead, achieving an improvement over persistence of 14.6% and 13.7%, respectively.

Potter [116] presents an Adaptive Neural Fuzzy Inference System (ANFIS) [117] to forecast the wind speed for a 2.5-min. time horizon. The input data is the measured wind speed, which is then adjusted through splines that considerably decrease the forecast error relative to persistence.

Ramírez-Rosado and Fernández-Jiménez [118] and [119] presented a three-phase model: (i) the Fourier transform of the last 24 values of mean wind speed is computed; (ii) 23 fuzzy inference systems (Takagi-Sugeno) forecast the coefficients of the Fourier transform for the following hour; and (iii) the mean wind speed is forecasted for the following hour based on the forecasted coefficients of the Fourier transform.

A different approach consists of forecasts in the frequency domain. Two works regarding wind speed forecasting use Discrete Hilbert Transform (DHT) can be found in [120] and [121].

4.1.1.2 Wind Power Forecasting

Another possibility for very short-term forecasting is to forecast wind generation directly, without a previous step in which the wind speed is forecasted.

Kariniotakis et al. [122] and [123] tested various forecasting methods for the Greek island of Crete: adaptive linear models, adaptive fuzzy logic models, and wavelet-based models. Adaptive-fuzzy-logic-based models were installed for on-line operation in the context of the Joule II project CARE.

Ramírez-Rosado and Fernández-Jiménez [124] employed fuzzy time series to forecast the wind generation for a time horizon of 24 hr. Fuzzy time series were coupled with fuzzy linguistic information about wind, such as “strong wind” (e.g., given by an expert), which allowed the forecasting method to register an improvement of 14.3% over persistence. The same authors [125] presented a model based on grouping historical data by using a subtractive clustering method [126]. For each group, a linear regression model is employed to forecast wind generation. The forecasted value is the weighted mean of all values obtained by each group’s regression model. The time horizon is 6 hr, and the improvement over persistence in this horizon was around 14%.

Frías et al. [127] developed a model with an intention to participate in the Spanish intra-daily energy markets. The model was based on ANFIS and uses online generation data of wind farms jointly with forecasts for the daily market. The model focuses on short forecasting

horizons of up to 10 hr ahead. In order to find the best ANFIS architecture, a heuristic method that combines quantity and type of membership functions of the input variables was used, optimizing operative time through a selection of training samples.

The California Independent System Operator (CAISO) prototype forecasting algorithm for short-term forecasting is described in [128]. A modified ARIMA model is used to compute the 2.5-hr ahead forecasted growth/decline factor. The model coefficients are adapted on-line, and a bias self-compensation scheme was included in the model with the introduction of an additional term into the modified ARIMA model. The model presents good results in the first two hours, where the MAE is below 3% and 8% respectively of the maximal observed generation. The authors stressed the need to include NWP and unit status information into the model. Nevertheless, *Milligan et al.* [129] carried on research to understand to what extent time-series analysis can improve simple persistence forecasts, as well their usefulness in hour-ahead markets. The ARMA models for both wind speed and wind power output are tested with different parameters. The authors concluded that the capacity of ARMA forecast models differed when applied to different time periods. The authors suggest the possibility of using an ensemble of models instead of a single model.

The use of an AR model in WPF was analyzed by *Duran et al.* in [130]. The authors carried out several tests to select the AR order. Consequently, the authors stated that the order does not depend on the training period. Rather, the optimal order depends on the wind farm (e.g., terrain complexity) and the time horizon of the forecast. The best model found by the authors was an AR of order 11. However, from our experience with Portuguese wind farms, this order is very high, and it is even hard to find AR with an order above 2 in the WPF literature. The improvement over persistence in three wind farms ranges between 3% and 17%. The standard deviation of the error is also lower in the AR when compared with persistence. The results obtained for the independent and aggregated wind farms (the sum of the three independent wind farms) have shown that the aggregation reduces uncertainty and forecast error. For instance, for a time horizon of 6 hr, the aggregation leads to a 23.1% improvement.

Costa et al. [131] tested a purely and fuzzy autoregressive, as well as an MLP NN, in order to forecast for 10 steps ahead with 10-min. time steps. The only inputs were measured time series. The models were tested in three wind farms located in Spain. The neural network reached the best overall performance.

Kusiak et al. in [132] tested five different data-mining models [133] [134] to forecast the wind power: SVM, MLP NN, the M5P tree algorithm, the Reduced Error Pruning tree, and the bagging tree. The SVM and MLP NN performed particularly well. The SVM provided accurate forecasts from 10 min. up to 1 hr, while the MLP NN is accurate in forecasts of up to 4 hr.

Onshore generation yields smoothing power fluctuations because the wind farms are usually spread over a large area [82]. This smoothing effect in the offshore generation is uncommon because the wind turbines are concentrated in a single location and, therefore, the power fluctuations can reach significant levels. The modeling of the offshore fluctuations is currently a challenge in WPF. A discussion of these aspects is available in [135].

Pinson et al. [136] reported the use of statistical regime-switching models for situations with successive periods of fluctuations with large and lower magnitude. Three types of models are discussed and presented by the authors: the self-exciting threshold autoregressive (SETAR), the smooth transition autoregressive (STAR), and the Markov-switching autoregressive (MSAR). The performance of the models was evaluated on a one-step-ahead forecast (10 and 15 min.) in two Danish wind farms and afterwards compared with the ARMA linear model. In all test cases, the MSAR models significantly outperformed the other models. There is also a gain in applying the SETAR and STAR models instead of ARMA, although it is not significant. The authors concluded that the MSAR captures the influence of some complex meteorological variables on the power fluctuations. They also demonstrate that the regime sequence leading successive periods with different behaviors is very complex and cannot be considered as a simple function of the wind generation level.

Pinson et al. [137] and *Pinson and Madsen* [138] improved the previously described MSAR model. A time-variant estimation of the model coefficients is described, as well as a regularization term that enables the reduction of the variability of the model coefficients' estimates. In addition, predictive densities are provided by a combination of conditional densities in each regime. Their quantiles can then be computed by numerical integration methods.

4.1.2 Short-Term Forecasting Using NWP

4.1.2.1 Statistical and Computational Intelligence Techniques Applied to WPF

In the literature, several techniques were studied, and their performance was evaluated in the context of the WPF problem. The aim was not to build a “complete” WPF model but to evaluate the forecast capability of those techniques. Generally, these techniques are used to convert the NWP forecasts to wind power—the so-called “wind-to-power (W2P)” model.

Fugon et al. [139] presented a survey on the performance of different data-mining models in WPF. Two versions of linear regression were examined: one is a simple regression model used as reference, and the other consists of combining the input variables to create extra variables. The analyzed nonlinear models were NN, SVM [140], regression trees with bagging, and random forests for regression [141]. The performance of each model was assessed in three wind farms located in France for a time horizon of 60 hr. All models outperformed persistence, and a global superiority of the nonlinear models was verified in the three wind farms. However, the performance of the linear models is reasonably good when compared with the persistence model. The nonlinear model with best results was the random forests model. The random forests are a combination of tree predictors, where each tree depends on the values of a random vector independently sampled with the same distribution for all trees in the forest. The excellent performance of this model means that, as found in other papers mentioned previously, using multiple models for WPF may decrease the forecast error.

Negnevitsky et al. [142] and [143] addressed the combined use of neural networks and fuzzy logic in WPF. This is a hybrid approach called Adaptive Neural Fuzzy System (ANFIS).

Although this model has only been applied for very short-term forecasting, and although the authors only present results for this case, it can be applied for time horizons of between 24 and 72 hr.

Jursa [144] compares different techniques for wind power forecasts, such as a classical MLP NN, mixture of experts [145], SVM, and nearest neighbor search with a Particle Swarm Optimization (PSO) algorithm for feature selection of the input of several locations in a spread area [146]. The author additionally combines different models by averaging the model outputs. The results for 10 wind farms located in Germany were compared, and NWP data were available for each wind farm. The best model was the ensemble with three different models (i.e., mixture of experts, nearest neighbor, and SVM), with a 15% improvement over an NN. Using all the models in the ensemble, however, is not always the best solution. In fact, the ensemble with all four models in some wind farms has registered a lower improvement when compared with the three-model ensemble. The best individual model was the mixture-of-experts model, which achieved an 8.8% improvement over the NN. The results of the SVM are always better when compared with the neural network results. The nearest-neighbor model was better than the NN in some wind farms. However, in others, the NN performed better. The results showed the advantages of combining several models for day-ahead forecasts. The intention with this research was to improve the commercial model Wind Power Management System (WPMS) developed by the Institut für Solare Energieversorgungstechnik (ISET).

Kusiak et al. [147] tested five data-mining models to produce forecasts for very short-term horizons (1 to 12 hr ahead) and short-/long-term horizons (3 to 84 hr ahead) by using NWP forecasts from the Rapid Update Cycle (RUC) model and the North American Mesoscale (NAM) model, respectively. Two different forecast methodologies have been compared and analyzed: (i) a direct forecast method, in which the power generation is forecasted directly from the weather forecasting data; and (ii) an integrated method, in which the wind speed is forecasted with the weather data, and then the power is forecasted with the predicted wind speed with a k -nearest neighbor algorithm. The authors used a boosting tree algorithm [148] for selecting the most relevant NWP data points surrounding the wind farm. Moreover, even after feature selection, a principal component analysis (PCA) analysis is applied to reduce the input dimensionality.

The five data-mining models were: SVM, MLP NN, RBF NN, regression trees, and random forests. The MLP NN outperforms the other four models in both very-short and short-/long-term forecasts. The direct approach outperformed the integrated approach also for both very-short and short-/long-term.

The authors stressed the strong dependence between the WPF model accuracy and the NWP model accuracy.

Jursa and Rohrig [149] presented an approach for one-hour-ahead forecasts (we believe that this approach can be applied to day-ahead forecasts without major modifications) based on the application of optimization algorithms for feature selection and models parameter optimization. In order to forecast for a single wind farm, the authors used measured wind power data of several other wind farms (30 wind farms), as well as the NWP data of the corresponding

forecast points closest to the location of the wind farms. The two main contributions of the paper are: (i) a method that uses the spatial and temporal information from a wide area in order to improve a single wind farm forecast; and (ii) use of PSO and differential evolution [150] for the automatic selection of the input variables and model parameters. The two used forecast models were an NN and a nearest-neighbor search. The authors concluded that the wind power forecast error can be reduced with the use of optimization algorithms for feature selection and parameter setting. With this approach, it is possible to reduce forecast error for most wind farms, in comparison to the manually set NN model. For example, the mean improvement in the forecast error in comparison to the persistence of the best model approach (i.e., NN automated specified using PSO) was 9.6%, while the percentage was 6.8% with the manually specified NN. In combining the NN and the nearest-neighbor approaches, there was a 10.75% improvement.

Duran et al. [130] studied the ARX models for very-short-term and short-term forecasting with NWP and on-line generation data as inputs. They noticed that the improvement obtained in short time horizons (i.e., of 6 hr) was smaller as a result of the increasing relevance of the past output power when compared with the NWP for this time horizon. On the other hand, when the time horizon is 24 hr ahead, the past output power loses importance, and the NWP gains more relevance. When compared with the AR, the improvement of the ARX is about 14% for 24 hr and about 26% when compared with the persistence.

Barbounis and Theocharis [151] and [152] employed locally recurrent neural networks to forecast wind speed and power 72 hr ahead, based on meteorological information. Three types of local recurrent neural networks were studied: (i) the infinite impulse response multilayer perceptron (IIR-MLP); (ii) the local activation feedback multilayer network (LAF-MLN); and (iii) the diagonal recurrent neural network (RNN). Two new and efficient learning algorithms are presented: a global and a decoupled approach of the recursive prediction error (RPE) algorithm to train the neural network on-line (i.e., by updating weights and bias on-line). In the global RPE (GRPE), all weights are simultaneously updated. Moreover, to cope with the increased computational complexity of the GRPE, a local version of the algorithm, called a decoupled RPE (DRPE), was developed. The DRPE consists of dividing the global optimization problem into a set of manageable subproblems at the neuron level. In so doing, it is possible to reduce the computational and storage requirements considerably, while preserving high accuracy qualities of the GRPE at the same time. The three recurrent networks were compared to two static models, a finite-impulse response NN (FIR-NN) and a conventional static-MLP network. The performance of the proposed models was tested on a wind farm located in the Greek island of Crete, and the NWPs were provided by the regional forecast SKIRON for four points that were 30 km away from the wind farm. The results showed that the recurrent networks performed better when compared to the static models in all look-ahead times. The FIR-NN outperformed the static MLP by 11.82% and 12.7% in terms of mean absolute error. The recurrent models also achieved an average improvement of 50% (for look-ahead times longer than 20 hr) over persistence. Similar results are valid for the wind speed forecast. Because of the richness of the network architecture, IIR-MLP presented the best performance when compared with the other two. The main contributions of this paper are the new on-line training neural networks and algorithms.

These new training algorithms provide the ability to cope with changes in the wind farm behavior and operation, as well as low computational effort. *Bessa et al.* [153] reported the use of the back-propagation algorithm to directly train a neural network on-line. The methodology is as follows: (i) train a neural network by using a batch back-propagation approach with the available historical data; (ii) in the on-line mode, the NN makes predictions for time sample $t+k$ at the time stamp t ; and (iii) when the measured value is known, past k time then stamps the neural network forecasts again for time stamp t , and the forecast error that took place in t (on the new measured value) is computed and back-propagated through the network (weights and bias are updated) only once. This methodology makes it possible to deal adequately with data streams in the presence of concept drift or concept changes, which occur in the behavior of the wind. At the same time, these concept changes are also the result of the practical operations of wind farms, being caused by variations in the available generating capacity either because of maintenance or failure or simply because of capacity additions. The results from two wind farms located in Portugal have shown that there was an improvement with the use of on-line neural network training, not only in normal operation, but also in the event of a concept change.

It is well known that the wind speed vs. power curve of a wind turbine is highly nonlinear. The transformation of wind speed into wind power changes the statistical properties of the errors. This result has been shown, for instance, in [154] for six sites in Germany, where error distributions from wind power prediction models were skewed right and had a positive excess of kurtosis. This means that they were asymmetrical; they presented a higher frequency of errors to the left of the mean and were flatter than the Gaussian distribution. The authors stated the following:

“The relative standard deviation of the measured power output is by a factor 1.8–2.6 larger than the relative standard deviation, of the time series of the wind speed measurement. This factor was caused by the power curve and can be regarded as the effective nonlinearity factor that describes the scaling of variations in the wind speed due to the local slope of the power curve... .”

The same shape of error distribution can be found in [155],[156].

When observing the literature, it is possible to understand that, one way or another, models depend on a training process and usually adopt the Minimum Square Error (MSE) as a quality criterion. The applicability of MSE to train a mapper (any model mapping an input-output relation, such as neural networks, fuzzy inference systems, time series or other, with parameters to be learned) is only optimal if the probability distribution function (pdf) of the prediction errors is Gaussian [113]. Minimizing the square error is equivalent to minimizing the variance of the error distribution. Using this criterion, the higher moments (e.g., skewness, kurtosis) are not captured. However, they contain information that should be passed on to the parameters (weights) of the neural network instead of remaining in the error distribution.

The presence of non-Gaussian distributions has encouraged further research for new techniques to train mappers. In WPF, having a good mapper, means that it is possible to provide better estimates of the W2P model. To deal with this problem, alternative cost functions have been developed.

Pinson et al. [157] and [158] described two approaches for the local polynomial regression. The first work showed that the application of the recursive least squares in order to estimate the coefficients may lead to inaccurate results, especially in WPF where there is a significant amount of noise and a high number of outliers. An adaptive asymmetrical (yet convex) M-type estimator (inspired by the M-estimator described by Huber [159]) was proposed to deal with non-Gaussian errors. A local M-type estimator was proposed to account for the weighting in local polynomial regression. An innovative characteristic of this robust estimation is that, instead of defining a threshold value to reject outliers, a proportion of suspicious residuals is a model parameter. Another innovative contribution has to do with the time-varying coefficients, which allow the model to cope with the nonstationary process. The model was tested on datasets that included wind speed measurements at the level of a wind farm, as well as simulated wind speed and power data. The simulation results have shown that using the M-estimator and the local robustification is quite advantageous.

The second work describes an approach to compute the local linear coefficients that are orthogonally fitted by minimizing a weighted Total Least Squares (TLS). The main core of the approach has to do with the local minimization of the Euclidian distance between observations and the estimated nonparametric regression function. The robustification of the method follows the M-type estimation described above for local polynomial regression. Furthermore, an adaptive estimation of the coefficients was introduced to deal with the non-stationary process. This method was evaluated on semi-artificial data and the real wind speed data was passed through a modeled power curve in order to obtain noise free power data. Then, both wind speed and power data were corrupted in order to generate realistic datasets of wind speed forecasts and the corresponding power measurements. The comparison of the proposed method and the least square (LS) model showed a significant improvement. For instance, the value of the NMAE compared against noise-free data is 2.46% for the LS, 1.08% for the orthogonal fitting, and 0.97% for the robust orthogonal fitting. Moreover, a comparison of the final W2P conversion process obtained with the LS and robust TLS indicated that the true W2P conversion process became closer to the TLS method.

A different cost function consists of minimizing the information content of the error distribution instead of minimizing its variance (MSE). Entropy is a measure of information content and the incorporation of entropy as a cornerstone concept in mapper training has been the object of Information Theoretic Learning (ITL) [160],[161].

Miranda et al. [162] and *Bessa et al.* [163], in a first application devoted to wind power forecast, used an Evolutionary Particle Swarm Optimization (EPSO) algorithm to carry out an off-line optimization of the weights of a Takagi-Sugeno FIS, which is worked as a W2P model. In that paper, a comparison was established between a Takagi-Sugeno FIS trained by MSE and one trained by minimizing Renyi's quadratic entropy [161] of the error distribution — and the results have shown that a higher frequency of errors close to zero was produced by the entropy-based model.

In another paper, *Bessa et al.* [164] engaged in evaluating the performance of neural networks that were trained in off-line mode by comparing the MSE criterion with three

ITL-inspired criteria. The conclusion that was drawn from the analysis of two real cases of Portuguese wind farms, a 21.6 MW farm (12 units of 1.8 MW each) and a 16.2 MW farm (17 units of 0.6 MW and 3 units of 2 MW), was unmistakable: in off-line training, entropy, as a performance criterion, leads to better predictions (in terms of frequent errors close to zero and insensitivity to outliers), as opposed to the adoption of MSE as a training criterion. The error distribution of the MSE and two ITL-inspired criteria, Minimum Error Entropy (MEE) and Maximum Correntropy Criteria (MCC), were tested on the two Portuguese wind farms.

It was possible to obtain a narrower *pdf* (probability distribution function) with MEE and MCC criteria than with MSE. In fact, if the error *pdfs* were Gaussian, the MSE criterion would perform as well as an entropy-based criterion, but that was not the case.

Therefore, according to the theory, it was possible to design a mapper that would produce a predictor with a higher frequency of errors close to zero, a characteristic that is associated with the smaller entropy of the *pdf*. Generally, this is desirable.

Bessa et al. [153] presented practical results supporting two ideas: (i) criteria based on entropy (i.e., the measure of information content) of the distribution of prediction error are more suitable than the traditional MSE criterion in order to train accurate wind power prediction models; and (ii) the entropy-based criteria can be formatted into on-line adaptive models that perform better than off-line trained models when using feed-forward NN. The test was performed for two wind farms located in Portugal, and the results have shown that: (i) the NMAE of the ITL criteria is below the one obtained with the MSE criterion; and (ii) the advantages of using an on-line training are higher. Furthermore, in uncertainty forecasting, the non-Gaussian shape of error distribution was also addressed. More details regarding the modeling and estimation of uncertainty will be provided in Chapter 5.

Salcedo-Sanz et al. [165] presented a hybridization of the MM5 model with a neural network that tackles the final statistical downscaling process to obtain the wind speed forecast for each wind turbine of a wind farm. The MM5 model performs a physical downscaling of the data from the global model to obtain a wind speed forecast for a small area grid. In the second downscaling process (statistical), an NN takes as inputs the following variables: wind speed forecasted of two grid points surrounding the wind farm, wind direction in one of the points, temperature in one of the points, and two solar cycle equations. The output of the NN is the forecasted wind speed for each wind turbine.

4.1.2.2 Prototype WPF Systems

In the literature, it is possible to find several descriptions of forecasting system prototypes. Some of the models are currently being put into operation, while others are only a result of research projects, and they are expected to be commercialized in the near future. Unlike the techniques described in Section 4.1.2.1, the structure of these WPF systems comprises several statistical/physical methods with different objectives.

Jørgensen et al. [166] described an approach, which is called HIRPOM (HIRlam POver prediction Model), where the power prediction module was integrated within the NWP itself. The main conclusions are reported in Giebel et al.'s *State of the Art* [67], where it is stated:

“*Moehrlen* has looked at the resolution needed for successful application of NWP forecasting. In a study with the Danish HIRLAM model (High-resolution Limited Area Model) for one site in Ireland [167] she points out the reasons why NWP models are delivering inadequate accuracy of surface wind speeds. Amongst other things, these reasons were: so far, no customers required the accuracy of surface winds to be increased since the accuracy of the existing ones was good enough. The topography resolution is not good enough to be taken into account, for instance, for tunnel effects in valleys. Accurate predictions require high resolution and a large covered area. However, achieving both is too expensive - only few NWP models are capable of distinguishing between land and sea and adjust the resolution accordingly. In order to improve the state of things, she calculated the power directly in the NWP model. The advantage with this approach is that ‘major physical properties like direction dependent roughness, actual density, and stratification of the atmospheric boundary layer can be used in the calculations.’ In different runs with horizontal model resolutions of 30 km, 15 km, 5 km and 1.4 km for two months in January 2001, the most common statistical accuracy measures (MAE, RMSE, correlation etc.) only improved slightly with higher resolution. However, peak wind speeds were closer to the measured values for the high resolution forecasts. For the higher resolution forecasts, the best model layers were the ones closer to the ground, as opposed to coarser models. As far as errors are concerned, she points out that phase errors (the timing of the frontal system) have a much larger influence on the error scores (and possible payments) than on level errors. As a possible solution, she proposes the use of free-standing turbine data as inputs for the NWP, thereby increasing the observational meteorological network.”

The development of a wind power forecast system for IBERDROLA is reported in [168]. Preliminary results of a forecast system up to 48 hr ahead using NWP predictions from RAMS are presented. Once the NWPs are available, the wind speed is converted to wind power. Some methods were studied to compute the power curve of the wind farm using only wind speed or wind direction: (i) using bins similar to the standard procedure for wind turbine performance testing (International Standard IEC 61400-12); (ii) using a trend line that relates power and wind speed; (iii) relating the free-flow wind speed and the wind speed measured by the anemometer, and then using the correlation between wind speed and generation; and (iv) computing the power generated by each wind turbine using the wind speed and direction measured in the meteorological tower.

Ramírez-Rosado et al. [169] describe a model that comprises a set of forecast models, covering the whole range of considered forecast horizons. There are specific models for very-short-term forecasts and specialized forecast models for the following day. The set of best models is chosen according to the horizon and the moment when these forecasts are made. Three models were selected for each forecast horizon so that their outputs were the inputs of a fuzzy inference system that provided the forecasted value as a nonlinear combination of the outputs of the three selected models. There were nine FISs, one for each forecast horizon. A Kalman filter

was used to improve the performance of the global forecast system on the very-short-term period. The aim was to reduce the bias in the forecasted value for the mean wind speed provided by the NWP model. The model was tested in a wind farm located in the north of Portugal, in a complex mountainous region, and for several time intervals of wind farm power generation (daily market and intra-daily market) applications. The magnitude of the obtained forecast errors is very satisfactory when compared with the state-of-the-art. As expected, for the intra-daily market session, the error was lower than the error verified in the daily market session. The improvement in the RMSE over persistence ranged from a minimum of 7% for the first hour to a maximum of 65%, with a mean value of 48%.

Pinson and Kariniotakis [170] presented a wind forecasting model that uses on-line SCADA measurements and NWP. The prediction system uses fuzzy-neural networks to forecast for very-short-term (1–10 hr) and short-term (1–48 hr) time horizons. A simulated annealing algorithm controls the learning process, and cross-validation is applied to terminate learning. This type of model is used in the ARMINES (Association pour la Recherche et le Développement des Méthodes et Processus Industriels) Wind Power Prediction System (AWPPS). The main contribution of the paper, in addition to the method for estimating prediction intervals and risk indices, is the fact that it replaces the classic trial-and-error approach in which several candidate configurations are tested by a constrained, nonlinear simplex optimization algorithm. The simplex algorithm selects the relevant information (wind speed, direction, etc.) for the model, where the decision variables represent the number of fuzzy sets for a specific type of input data.

Yamaguchi et al. [171] described a model that takes as inputs NWP data from the Japan Meteorological Agency (JMA) and the SCADA data from wind farms. The forecasts provided by the JMA are downscaled to the horizontal resolution of 1 km by the mesoscale model, Regional Atmospheric Modeling System (or RAMS). Then, based on the wind farm power curve estimated on the historical values of forecasted wind speed and measured power, forecasted wind speed is converted to power. The model that was used to produce the wind power forecast is based on the ARX method, where the final predicted power is a combination of the estimated power curve and the measured power of the wind farms. The first main contribution of this paper is an improvement on the ARX method [93]. The new model introduces a new parameter to model the operational contingencies of the wind farm. The new statistical model is called ARXM (autoregressive with exogenous input and multi-timescale parameter). The other main contribution is a transfer coefficient method. This transfer function is a ratio between the wind speed of the mesoscale model and the wind speed of the JMA model. While mesoscale simulation requires 3–4 hr with the parallel computer (requiring eight CPUs), the proposed transfer coefficient method only takes a few seconds with one computer. The accuracy of the forecast is almost the same. However, this result must be confirmed in different terrain types and weather conditions.

Sideratos and Hatzargyriou [172] described a statistical WPF system that uses artificial intelligence and fuzzy logic techniques. The main contribution of this paper is the combination of the RBF NN with the fuzzy logic model in order to optimize the use of the NWP predictions. The overall forecasting methodology can be divided into three main blocks: (i) the preliminary wind power prediction; (ii) a model that provides a quality index of the numerical weather

predictions; and (iii) a final wind forecast model. The first model provides the initial predictions of power and comprises a self-organized map [173] that separates the wind speed forecast into three classes according to magnitude (low, medium, and high), as well as three RBF NNs that forecast the wind generation. The second model consists of a fuzzy logic model and two RBF NNs. One RBF NN receives the values of forecasted wind speed as inputs, while the other receives the forecasted direction and the prediction hour. The difference between the output of these two RBF NNs and the previous models is that they provide information on the “poor” NWP. The fuzzy logic model identifies the “poor” NWP, and the model estimates the quality of the NWP when the differences take high values and the wind direction is outside the expected limits. The third model comprises three RBF NNs, which provide the final forecast for each of the three wind classes. The performance of the methodology when compared with the current state-of-the-art models is close to the best models and sometimes overcomes their performance for the 48-hr time horizon. The results presented in the paper were carried out for an offshore wind farm, which makes forecasting more difficult.

A similar design was proposed by *Fan et al.* [174]. The authors describe and test a two-stage hybrid method with Bayesian Clustering by Dynamics (BCD) [175] and SVM. The BCD is first used to identify the switching or piece-wise stationary dynamics for the input data and to partition the dataset into several subsets. Then, groups of SVMs are used to fit the wind speed and wind generation data by taking advantage of all past data and similar dynamic information. The authors posit three main advantages of the model:

- (1) It is capable of dealing with the nonstationary time series because the BCD is capable of integrating prior and current evidences. However, the SVMs are not trained in an on-line mode and every new arrived measure is therefore not used to update the model.
- (2) It fits the data very well because multiple models are used.
- (3) It is robust because it uses different types of input data, and therefore, it can be applied to different wind farms without significant modifications.

The model was tested for a time horizon of 48 hr in a 74 MW wind farm located in southwest Oklahoma. Comparisons with the persistence demonstrate that the model is quite efficient in the sense that it can achieve a 40% improvement.

Costa et al. [176] presented results from a hybrid statistical/physical approach. The aim was to combine purely time-series-based models for very-short-term forecasting with a physical model with good performance between 9 and 72 hr. In order to do so, they tracked the intersection point between both error curves (best intersection point tracking). Three statistical models were studied to provide forecasts up to 10 hr ahead: autoregressive models, fuzzy-logic-based models, and NNs. The model that performed best was the fuzzy model. Three different structures of the physical models were studied, all using NWP predictions. The main differences between them were the stability regime and the inputs of the power curve model. Two models were based on non-neutral stability and the other was based on neutral stability. Two of the models were based on the conversion of wind speed to power at the site of an anemometrical

reference mast (forecast of wind farm power output), while the other was based on the individual conversion at the site of a wind turbine (forecast for each wind turbine). The physical model with best performance was the one using neutral stability and the conversion of wind speed to power at the site of an anemometrical reference.

The authors found out that the combination employed by the b.i. tracking improves the forecast in the medium time horizon (3–9 hr). The statistical models were used for the very short-term (1–3 hr), and the physical model was used for long horizons (9–36 hr).

In [177] and [178], the results of the Danish PSO-project, “Intelligent wind power prediction systems,” are reported. During the project, further improvements and automation tools for short-term WPF were studied. These tools have proved to be an interesting alternative to the operational forecasting tools that are currently being used. The systems used for the research were the WPPT (Wind Power Prediction Tool) [179] and Prediktor [180]. The major advantages reported in this project have to do with performance, robustness to external disturbances, and simplifications in the setup of such systems. Methods for the automatic selection of tuning parameters were developed. With these methods, the system is able to self-calibrate and self-tune. For instance, the authors considered how it is possible over time to tune forgotten factors and bandwidths of nonparametric estimators with the prediction performance.

An M-type robust estimator for the local polynomial regression approach was developed. This method was formulated in an adaptive and recursive version, which makes it possible for the methodology to be less sensitive to failures in the measurement equipment.

Statistical methods need to learn from sets of historical data about NWP forecasts and wind generation. However, for new wind farms, the historical data sometimes are not available or are reduced as far as size is concerned. This circumstance has an influence on the forecast error of the initial estimates until the effect of the initial estimates has vanished. The authors studied the improvement in the initial performance by supplying a “theoretical” wind farm power curve calculated with Wind Atlas Analysis and Application Program (WAsP). The authors also tried to understand whether stability measures and mesoscale modeling can further improve on the physical model.

Another method that was studied to improve performance involved combining several meteorological forecasts [181]. The authors showed that a simple optimal and self-calibrating procedure for the combination of a few forecasts can easily improve the forecast error. The results for the Klim wind farm in Denmark have shown a 15% improvement with an overall level of 9% in NRMSE, when compared to the combination of DMI (Danish Meteorological Institute)-DWD (Deutscher Wetterdienst)-NCEP with a very good DMI-HIRLAM forecast.

4.1.3 Regional Forecasting

In this section, the research results regarding the impact of the aggregation of wind farms are presented, as well as the selection of reference wind farms and its impact on regional WPF

forecast error. In Section 4.2, which discusses operational and regional models, there are some more details about the upscaling approaches of each WPF system.

As far as regional forecasting (or upscaling) is concerned, several publications studied the effects of the number and location of reference wind farms on the expected power output of a whole region, as well as its error. It is well reported in the literature that by aggregating several wind farms over a wide area, weakly correlated forecast errors cancel out due to statistical effects. Therefore, these statistical smoothing effects decrease the forecasting errors of a region, when compared to a single wind farm [81].

Focken et al. [82] studied the impact of two parameters in the magnitude of the regional forecast error, namely, the spatial extension of the region and the number of wind farms it contains, together with their distribution. They presented results in which the ratio between the standard deviation of the ensemble and the single wind farm decreases when the region size increases for different time horizons. This reduction is not as noticeable as the one in larger time horizons. The ratio decreases, as does the function of the number of sites in the region. However, it reaches a saturation level at which the reduction of error no longer depends on the number of sites. For instance, in a region of 370 km, less than 50 sites are enough to achieve a 0.63 ratio. The saturation level decreases with the increasing size of the region, mainly because of the exponential decay of the cross-correlation of forecast errors. The main conclusion is that the magnitude of the forecast error strongly depends on the size of the region: the larger the region, the larger the error reduction.

Moreover, the results have shown that for regions with a sufficient number of equally spread wind farms, it is possible to estimate the regional smooth effect of the wind power forecast error just by taking the size of the analyzed region into account. The authors also stressed that the aggregation of wind farms cannot mitigate single events, such as storm front or phase errors, because the weather patterns have a coherent structure that normally extends over several hundred kilometers. Therefore, the correlation between the forecast errors is higher in this case.

Lang et al. [182] showed that, with a combination of increased wind farm dispersion and an increased number of wind farms, the wind power forecast error is reduced, as well as the average load factor of the wind farm. The forecast errors increase with increasing load factor as a result of increasingly atypical weather events and higher average wind speeds.

Gastón et al. [183] evaluated the impact of wind farm aggregations in forecast errors. The error obtained for an aggregation is lower when compared with the one obtained in a single forecast. The authors realized that there is a limit to the reduction of errors with wind farm aggregation. In fact, groups of more than three wind farms do lead to a significant reduction of the errors. The best error reduction was obtained for three wind farms located in different regions.

Pinson et al. [83] achieved a reduction of between 25–30% of the forecast error level, when compared to the one obtained for a single wind farm. They also concluded that the advanced models based on fuzzy NN for time horizons greater than 15 hr end up benefiting more

from the smoothing effect than from persistence or OL-persistence. However, for a time horizon of between 1 and 5 hr, persistence is the only model that benefits from smoothing effects. Therefore, in regional forecasting, it is hard to beat persistence in this kind of time horizon.

Siebert and Kariniotakis [184] evaluated the impact of input selection (the number of reference wind farms) on the accuracy of regional forecasting. In a first phase, the authors tested all possible $2^n - 1$ combinations of n reference wind farms. The individual wind farms' forecasts were linearly combined in order to provide the regional forecast. The results showed that the increasing number of wind farms initially reduces the error. However, after adding a certain number of wind farms, the error started to increase. The authors explain this pattern by stating that "the additional information provided by an extra farm is outweighed by the additional noise it adds to the model's input." Three reference wind farms' selection algorithms were proposed by the authors: (i) k-means clustering algorithm [185], in which the wind farm nearest to the centroid is the reference wind farm (the distance measures are the Euclidian distance and the correlation between NWP); (ii) MIFS (mutual information-based feature selection) [186]; and (iii) the "greedy" forward selection algorithm to determine the best reference wind farm combination. The main contribution of the paper is that it stresses the importance of the selection of wind farms in regional forecasting. Although none of the three proposed methods generated optimal results, the application of these methods led to better results than the results verified in a random selection. Another relevant contribution of the paper is a new forecasting model, the RPC (regressive power curve). When compared with other state-of-the-art models, the RPC showed similar performance. However, the model has another advantage in the sense that it does not require significant computational effort.

An extension of this work and further improvements in regional forecasting can be found in the PhD dissertation of *Nils Siebert* [89]. The aim of the work was to present guidelines for modelers who wish to implement regional forecasting methods. The author showed that there is no significant performance difference between the modeling approaches presented in Section 3.5.4. The author's opinion is that "...when designing such a tool, the modeler should keep in mind the requirements of the end-user, the constraints of the specific regional forecasting problem and limit, as much as possible, the complexity and the dimensionality of the base model combinations... ."

According to the author, only a few well-selected explanatory variables are necessary in regional forecasting. For instance, the higher level of noise of the NWP prediction limits the number of variables used in the model. The author concluded by stating that only a few (between 5 and 8) NWP predictions are enough. The relation between single wind farm generation and regional generation is strongly linear. The feature selection problem was addressed, as it had already been addressed in his previous work. He compared the mutual information measure and MIFS approaches with two new ones — the clustering heuristics and a wrapper method — stressing their advantages and drawbacks.

The author also identified the need to build adaptive regional forecasting models in order to deal with the nonstationary process.

Yamaguchi et al. [187] studied how regional forecast errors can be sensitive to the number and location of reference wind farms. The extrapolation of the regional forecast from the reference wind farm forecasts is based on:

$$P_{region}(t) = \left(1 + \frac{P_{rate}^{free}}{P_{rate}^{ref}}\right) \cdot \hat{P}^{ref}(t) ,$$

where P_{rate}^{free} is the installed power of nonreference wind farms, P_{rate}^{ref} is the installed power of reference wind farms, and \hat{P}^{ref} is the wind power forecast of reference wind farms.

The authors found that the prediction error decreases with the increasing number of reference wind farms. The reference value is obtained through the sum of all wind farms when the capacity of reference wind farms is close to 50% of the total capacity. They also concluded that the forecast error depends on the location of reference wind farms and that an upscaling based on subregion shows good performance when the normalized capacities of reference wind farms in each subregion are almost the same. The authors proposed a new cross-correlation function, which shows good performance when compared with the conventional function.

Barbero et al. [188] presented a different regional forecast approach. The authors compared the performance of the MLP NN combined with PCA and the SVM for wide-area WPFs. Instead of using reference wind farms, the aggregated output comes from 84 “nodes,” which are grid points that correspond to the generation of several wind farms. The authors concluded that SVM may offer a better performance with training times that are much smaller than those of an MLP and principal component combination. Unfortunately, no comparison was made with an approach that uses a specific number of reference wind farms.

Bremen et al. [189] proposed a hybrid physical-statistical approach based on PCA, which is a mathematical procedure that transforms a number of possibly correlated variables into a smaller number of uncorrelated variables that are called principal components. The authors demonstrated that the spatial decomposition of wind power generation can be performed with PCA in order to extract the pattern of variability. At the same time, the principal components can be linked with typical weather situations. In this approach, maps with forecasted square wind speeds and multiplied by the normalized spatial distribution of wind power capacity in subregions are computed. In the case of Germany, these maps are given in a grid of 306 subregions. First, PCAs are performed with historical data of the predicted wind maps, and then the principal components are computed. The six first-principal components are then used in a multivariate linear regression, together with the total production, and the coefficients are computed. The forecasts are obtained by using the wind speed forecasts from ECMWF to build the forecasted maps, which are then projected on the first six dimensions determined by the PCA on the historical data. The projected values are then fed to the multivariate model in order to obtain the final regional forecast.

The performance of the approach is similar to the scale of the current state-of-the-art methods. The day-ahead NRMSE is 4.4% of the rated power.

4.2 OPERATIONAL AND COMMERCIAL WPF SYSTEMS

4.2.1 European WPF

4.2.1.1 Prediktor

Landberg [180] developed a physical WPF system in Risø National Laboratory (Denmark), named Prediktor⁶, which is based in part on the experience gathered during the development of the European Wind Atlas [190]. The system's main objective is to use the wind speed and direction from a NWP, transform these variables to the local site, and finally use the power curve, including the wake effects. A statistical MOS module is also used before the transformation to the local wind or before the transformation to power. The MOS module can also be used at the end of the model chain in order to change the power.

The model includes four main components (similar to Figure 3-3 in Section 3.5.1): (i) wind speed and direction data from an NWP model; (ii) correction for height; (iii) correction for local effects (roughness and orography); and (iv) wind power curve modeling, including wake effects.

The HIRLAM model is used to forecast weather variables. These NWPs are modified by using the geostrophic drag law and the logarithmic wind profile to produce an estimate of the surface wind speed and direction. Then, these modified variables are corrected for local effects by using the WASP model from Risø [191]. WASP modifies the local wind field for the effects of obstacles (houses, wind breaks, etc.) and of surface roughness and orography [73].

The Risø PARK model [192] is then applied to simulate the wake and array effects on each individual wind turbine. This model leads to an increasing wind farm efficiency and then identifies the reduction of the wind turbine output caused by the wakes of other wind turbines. The power output of the wind farm is based on the calculated array efficiency for each wind direction sector. Moreover, local corrections are applied to the local wind speed and direction and to the estimated power generation. For this, historical wind resource and wind power generation data are used in order to tune the model.

To correct the effects that are not accounted for by the physical models, a two-configuration MOS module is applied. First, MOS corrections in the form of simple linear functions (simple scaling) are applied to local wind speed forecasts since there were no off-set corrections on the local refinement. In the second MOS, corrections for any other biases in the power output forecasts are applied. The model was tested at Electricity Supply Board (ESB) in Ireland [193] and in Iowa [194]. There, the use of MOS was essential for predictions of the U.S. National Weather Service's Nested Grid Model. This result was partly attributable to the

⁶ <http://www.prediktor.dk/>.

fact that the resolution of the Nested Grid Model was ca. 170 km, and no local WAsP analysis of the site was available.

No upscaling algorithm was reported.

Prediktor was tested in California [195],[196]. The tests were directed by the Electric Power Research Institute (EPRI) and funded by the California Energy Commission. The model delivered forecasts for two large wind farm areas: 900 turbines generating 90 MW in Altamont Pass and 111 turbines generating 66.6 MW in San Geronio Pass. Prediktor achieved a mean annual MAE of 14.2% and 22.3% at the Altamont and San Geronio plants, respectively, for a period of one year.

4.2.1.2 Previento

A physical model that uses NWP predictions as inputs was developed at the University of Oldenburg, and is currently being distributed by Energy & Meteo Systems GmbH (EMSYS). Its name is Previento⁷ [197],[198], and it has been operating on German onshore sites for several years. It is based on the same principle as Prediktor regarding the refining of NWP predictions of wind speed and direction. It uses the DWD's Lokalmodell (LM) as the NWP model up to 48 hr.

Mönnich [198] found that the most important sub-model currently being used is the model for atmospheric stability. The sub-models for orography and roughness were not always able to improve the results. The use of MOS was deemed very useful. However, because the NWP model changed frequently, the use of a recursive technique was recommended. It had a large influence on the power curve, and the theoretical power curve provided by the manufacturer and the power curve found with the data could be rather different. Indeed, even the power curve estimated from the data of different years could show strong differences. The latter might be the result of a complete overhaul of the turbine. It was determined that the largest influence on the error came from the NWP model itself.

For very-short-term forecasting, the model used an NN, which takes on-line wind generation measurements as inputs. Previento also provides information on the uncertainty of wind power and speed forecast depending on weather conditions [199]. The uncertainty is modeled by the fact that the wind power uncertainty is proportional to the slope of the power curve and to the accuracy of the underlying wind speed forecast. The lower and upper limits of the confidence level change with weather conditions. The distribution of wind speed uncertainty is represented by a Gaussian distribution. On the other hand, the wind generation uncertainty is strongly non-Gaussian, and the uncertainty is provided at a predefined level of confidence, which is usually 70% so that it is possible to approximate the traditional standard deviation interval of Gaussian distributions. The upscaling algorithm is based on the correlation between the representative wind farm generations and the total production computed in past measurements. For instance, the algorithm uses 50 representative sites to produce a regional prediction in area

⁷ <http://energymeteo.de/gb/leistung/>.

diameters of up to 1,000 km. The power forecast NRMSE for the entire country (Germany) is about 6% of the installed capacity.

Moreover, uncertainty for a region is calculated from the uncertainty of each subregion, taking the spatial correlation of the forecast error of all subregions into consideration.

4.2.1.3 LocalPred and RegioPred

LocalPred and RegioPred [200] are two tools developed by CENER, the Spanish National Renewable Energy Center, in collaboration with the Spanish Research Center for Energy, Environment, and Technology (CIEMAT). The models have been operating since 2002 and running on-line since June 2003 at different wind farms in Spain.

The RegioPred is a regional forecast model that is based on the single wind farm prediction model LocalPred. The regional forecast can be carried out by adding each single wind farm forecast or selected reference wind farms using cluster analysis.

The LocalPred model was specifically developed to forecast for complex terrain wind farms. It involves an adaptive optimization of the NWP input, time series modeling, mesoscale modeling with MM5, and power curve modeling [201]. The MM5 model forecasts all relevant meteorological variables for 72 hours with a spatial resolution of 1 km² around the wind farm. Because of spatial resolution, this improvement is more significant in complex terrain.

A CFD was coupled with MM5 in order to include smaller-scale modeling (smaller than 1 km²). This model takes the MM5 forecasts, the topography, and roughness as inputs in order to modify the MM5 forecast, and it increases the spatial resolution up to meters [202]. An MOS is used to account for the systematic errors of the NWP predictions. This model is based on fuzzy logic with a self-tuning algorithm. After the MOS correction, an improved NWP is produced. The NWP forecasts are transformed into power by a W2P statistical model for each wind direction and air density. It is possible to use different W2P methods based on several situations related to the available measurements made at the wind farm. In [203] and [76], a comparison of five different methods based on statistical tools is presented: (i) global power curve referred to meteorological mast; (ii) global power curve referred to nacelle anemometers; (iii) cluster power curves referred to nacelle anemometers; (iv) turbine power curves referred to nacelle anemometers; and (v) fuzzy logic power curves.

For very-short-term forecasts (i.e., up to 10 hours ahead), the system uses autoregressive techniques. Two linear ARMA models are used: one for the wind speed data and the other for the generation data. Both of them are first-order autoregressive models.

CENER also developed a technique for combining different forecasts that is able to improve the performance of the individual forecasts for a single wind farm [181].

4.2.1.4 The WPPT System

The Wind Power Prediction Tool (WPPT)⁸ has been developed by the Institute for Informatics and Mathematical Modelling (IMM) of the Technical University of Denmark (DTU). WPPT [179] is a forecasting system that is capable of forecasting for a single wind farm, for a group of wind farms, or for a wide region (e.g., the western part of Denmark).

The model forecast for a whole area is carried out with on-line data covering only reference wind farms in the area. The approach consists of dividing the area into sub-areas, each of which is represented by a wind farm. The wind farm forecasts of each wind farm are upscaled to cover the whole generation in the sub-area. Then, each sub-area's forecasts are combined to perform the forecast for the entire area. The model can successfully forecast for time horizons of up to 48 hr, depending on the forecast time horizon of the NWP model. The resolution is typically 30 min.

The inputs of the WPF system are the NWP predictions for the region and reference wind farms and the on-line measurements of the generation (updated every 5 min.–1 hr), as well as measurements of the climate variables at the reference wind farms' locations (optional). The rated power and operation times of the reference and nonreference wind farms, as well as the aggregated energy readings from all wind turbines in the area (updated with a delay of 3 to 5 weeks), are also inputs.

A two-branch approach is used to forecast for a whole region. In the first branch, forecasts for the reference wind farms in sub-area i are carried out with on-line measurements and NWP; then, the forecasts for reference wind farms in sub-area i are summed up and upscaled to compute the total generation in sub-area i , and the total generation of the whole area is obtained by summing up the generation of each sub-area. In the second branch, a forecast for each sub-area i is computed directly with off-line measurements of the total sub-area generation and NWP for the area, and the total generation of the whole area is obtained by summing up the generation of each sub-area. The final generation total is a weighted average of the forecasts that are the results of the two branches [204].

A central part of this system is the fact that it provides statistical models for short-term predictions of the wind power production in wind farms or areas. Conditional parametric models are used [205]. These models describe the relation between the meteorological variables (wind speed and direction) and the measured generation in wind farms and areas. These functions are called direction-dependent power curve models. Four different models are employed by the two branches to forecast the wind power:

- **A wind farm model** that uses wind-direction-dependent power curves in the conversion of NWP predictions to power. The output of the first branch models is adjusted by a model that takes autocorrelation and diurnal variations into consideration;

⁸ http://www.enfor.eu/wind_power_prediction_tool_wppt.php.

- **An upscaling model** in which the generation in a sub-area is obtained through the multiplication of the sum of the sub-area reference wind farm forecasts using an upscaling function that is related with NWP for the area;
- **An area model** that transforms NWP predictions and off-line measures for the area with an approach that is similar to the wind farm model approach; and
- **A total model** that combines the predictions of the two branches by a time-dependent weighted average, using RMSE as weighting criterion.

Since the wind generation is a nonstationary process, a time-adaptive and recursive estimation method is applied. Because of the time adaptivity of the estimation, the forecasting system is capable of adapting to changes, such as changes in the surrounding vegetation or in the NWP models. The old information is disregarded as new information becomes available, by down-weighting the older information with a forgetting factor [205]. The parameters are recursively estimated by using recursive least squares.

The output of the WPPT also includes uncertainty estimation for the whole time horizon. Forecasted quantiles of the generation probability distribution are estimated by using three methods: adaptive variance estimation, ensemble based quantiles [206], and quantile regression [207].

The model is currently operating in Eltra/Energinet.dk (SO for the western part of Denmark), Elsam (combined heat and power (CHP) and wind farm owner in the western part of Denmark), Elkraft (SO for the eastern part of Denmark), and E2 (CHP and wind farm owner in the eastern part of Denmark).

In [208], the first tentative evaluation of one full year of WPPT operation in Australia at Hydro Tasmania is reported. The wind resource at the Woolnorth Bluff Point wind farm (64.75 MW) is very inconsistent, and therefore, it presents large errors with the persistence model. In fact, the WPPT brought a significant improvement over persistence: after 36 hr, the NRMSE of persistence is between 10% and as high as 48%, while the NRMSE of WPPT is between 9 and 27%.

The Hydro Tasmania energy traders expressed their interest in forecasting sudden changes in wind power output, such as turbine shut-down due to high wind speeds or variations in wind resources. Therefore, the performance of WPPT during sudden changes in the wind output was assessed. The results in the changes detected over one year showed that the information contained in the change in wind direction was more useful than the change in wind speed. The NWP and WPPT did not forecast large, sudden changes very well; therefore, further improvements were identified for WPPT.

The system was also tested in Ireland and at the NUON Energy Sourcing in Holland [209].

4.2.1.5 Zephyr

The WPPT and Prediktor approaches have been combined and extended, and the result was the Zephyr [210]. The objective with this approach is to merge the advantages of both systems. In this model, each wind farm has a forecast model assigned according to the available data. For instance, if the only types of knowledge available about the wind farm are the number, type, and location of wind turbines, then a simplified Prediktor model is used with only NWP as the input. However, if all the data (including on-line data) of the wind farm are available, then the statistical models of WPPT are used.

The most recent research work on this system includes stability parameters and mesoscale modeling [211] and ensemble forecasting [206].

4.2.1.6 Casandra Forecasting System

The Casandra wind power forecast system⁹ [212] includes the use of a mathematical mesoscale model within its operational chain, instead of simply retrieving the corresponding data from an external source. This wind power forecast system has been developed within the CASANDRA project, with the collaboration of Gamesa Energía, Barlovento Recursos Naturales, and the MOMAC group of the University of Castilla-La Mancha.

The Global Forecast System, or GFS, provides the predicted fields that are necessary to establish the initial boundary conditions of the limited area model. The PROMES (a Spanish acronym for “PROnóstico a MESoescala,” i.e., Mesoscale Prognosis) is a mesoscale meteorological model that has been developed by members of the MOMAC research group. It consists of a primitive equation model that is hydrostatic and fully compressible and uses vertical coordinates as terrain-following sigma coordinates and a Lambert formal projection for the Cartesian horizontal coordinates. The prognostic variables are potential temperature, surface pressure, horizontal wind components, specific humidity, cloud cover, and rainwater. The PROMES also includes detailed physical parameterizations of radiation, turbulent vertical exchange in the planetary boundary layer, exchanges between soil-vegetation and atmosphere and soil-water content, and temperature.

The statistical downloading method (SDM) not only enables the correction of systematic errors in the mesoscale model predictions, but also facilitates the collection of information related to the horizontal resolution's subgrid process. It uses a technique based on MOS.

The wind farm model provides an equivalent wind farm power curve, obtained by multivariate regression based on wind farm data and on MOS-predicted variables supplied by the SDM. Orographic effects and wake energy losses are considered. When operating, the wind farm model receives the meteorological prediction from SDM and on-line wind farm data, which are

⁹ <http://www.casandraenergy.com/>.

used to compute the wind power farm production value. The Casandra wind power prediction system provides an hourly wind total power production forecast for the considered wind farm, within certain confidence levels. Once the necessary global model forecast is available, the whole power prediction system runs in about 3 hr, including the PROMES forecast.

The Casandra wind power prediction system was tested from September 2002 to February 2003 for two different wind farms: one located in the northwestern corner of the Iberian Peninsula, with a total rated power of 24.4 MW; the other was located in the region of Aragon, with a total rated power of 17.5 MW. The test forecasting time horizon ranged between 24–48 hr ahead.

As far as the first wind farm is concerned, the observed hourly speed values obtained with PROMES presented an R^2 value of 0.81, with high wind speed values being underestimated by the model. The subsequent improvement of raw forecasts with SDM led to $R^2 = 0.87$. For the second wind farm, the raw predicted values from PROMES showed a larger deviation from the effectively observed wind speed, particularly for high wind speed values. The resulting R^2 value was 0.69. Again, with the MOS method (SDM module), it was possible to correct these values, thus leading to $R^2 = 0.83$.

As far as the magnitude of the errors observed in the first wind farm is concerned, most of the predicted values showed errors below 10% of the wind farm rated power. In the second wind farm, the results obtained were similar, although prediction errors were slightly larger. In both cases, the largest error values occurred for intermediate power values, a result that corresponds to the interval in which there is greater amplification of wind speed errors because of the nonlinear nature of the wind turbines' power curves, whereas the smallest errors were found for values near the wind farm's rated power.

4.2.1.7 The ARMINES Wind Power Prediction System

The AWPPS¹⁰ wind forecasting system of ARMINES integrates:

- **Short-term models:** based on the statistical time-series approach, which is capable of efficiently predicting wind power for horizons of up to 10 hours ahead.
- **Longer-term models:** based on fuzzy neural networks that are capable of predicting the output of a wind farm up to 72 hours ahead. These models receive on-line SCADA data and numerical weather predictions as inputs [213].

¹⁰ <http://www-cenerg.cma.fr/prediction/>.

- **Combined forecasts:** produced from the intelligent weighting of short- and long-term forecasts. The aim is to achieve an optimal performance over the whole forecast horizon.
- **Upscaling prediction model:** based on dynamic fuzzy neural networks, and it comprises the cascaded and cluster approaches with representative wind farm models (described in Section 3.5.4) [83]. The criterion for selecting reference wind farms is the correlation with total generation. There is a 50% of improvement with respect to OL-persistence.
- **Uncertainty estimation:** the estimation of confidence intervals is based on the adapted resampling approach. Moreover, an approach is implemented for the on-line assessment of prediction uncertainty by using appropriate prediction risk indices based on the weather stability [214].

The AWPPS prediction system is integrated in the MORE-CARE EMS software. It was installed for on-line operations in the power systems of Crete and Madeira [215]. A stand-alone application of the wind forecasting module was also configured for on-line operation in Ireland [216]. An evaluation of this application is presented in [217].

In Ireland, it was shown that using a power curve derived from HIRLAM wind and measured power can improve the forecast RMSE by nearly 20% in comparison to the manufacturer's power curve [216].

Currently, the MORE-CARE system [218] is installed in Crete, managed by the Public Power Corporation of Greece (PPC), and provides wind power forecasts for all wind farms for a horizon of 48 hr ahead. These forecasts are based on NWP provided by the SKIRON system, which was developed at the University of Athens and which is managed by its Institute of Accelerating Systems and Applications (IASA).

On-line data are provided by the SCADA system of the island. In Portugal, the MORE-CARE system is managed by EEM (Empresa de Electricidade da Madeira) and provides forecasts for the production of wind farms on the island of Madeira. The prediction modules provide short-term forecasts up to 8 hr ahead using on-line SCADA data as input.

4.2.1.8 The WPMS System

Since 2000, ISET (Institut für Solare Energieversorgungstechnik) has been working operatively with short-term forecasting by using the DWD model and neural networks. It was one of the results of the German federal monitoring program, WMEP (Wissenschaftliches Mess- und Evaluierungs Programm) [219], during which the growth of wind energy in Germany was monitored in detail. Their first customer was E.On, a company that initially lacked an overview of current wind power production and, therefore, required a good nowcasting tool [220].

Then, their model was called Advanced Wind Power Prediction Tool, AWPT. *Ernst and Rohrig* [221] reported developments of ISET's Wind Power Management System, WPMS¹¹ in Norrköping. The WPMS carries out the following operations: (i) current wind power generation (on-line monitoring) for control zone and subregions — the current power is calculated for all wind farms using the measurements of just a few wind farms; and (ii) day-ahead and short-term wind power forecasts for single wind farms, control areas, and subregions.

The WPMS is currently being used by the four German SOs (E.ON Netz, Vattenfall Europe Transmission, EnBW Transportnetze AG, and RWE Transportnetz Strom), as well as by the SO of Austria and Italy since 2007 [222]. For instance, the WPMS is used to forecast wind power production for 361.23 MW of wind power capacity in Austria.

Their input model is the Lokalmmodell of the DWD, which they then feed into an NN. To improve the LM, they transform the predicted wind for the location of wind farms by using the numerical mesoscale atmospheric model, KLIMM (KLimaModell Mainz). The LM is run twice daily with a horizontal resolution of 7 km, forecasting up to 48 hr ahead with 15-min. time resolutions. The upscaling approach is reported in [223]. First, individual wind farm forecasts are computed and then aggregated and upscaled by a transformation model. The way the regional forecasts are computed is not clear. However, it seems that the NN also provides for an area power curve.

In the case of E.On Netz, this model upscales the wind forecast from 50 representative wind farms (1,850 MW) to the total production of the entire control zone. The selection of the representative wind farm sites is based on the modeler's experience. Currently, the model's accuracy is 5–7% NRMSE of installed power for a regional forecast (e.g., all of Germany) for a day ahead and 2–3% NRMSE of installed power for a regional forecast for 2 hr ahead [222].

Ernst et al. [224] reported new research and developments in the WPMS. Research was carried out on several artificial intelligence models and their results were compared. The results are reported in the work of *Jursa* [144], which was discussed in Section 4.1.2.

Cali et al. [225] reported another line of research, which is the multi-model approach. The authors tested two methods for the multi-model approach: (i) a multi-NWP that combines the forecast of three different NWP models from different providers (different global and regional models); and (ii) a multi-scheme ensemble prediction system (MSEPS¹²) that uses forecasts of different members of the ensemble, typically from one provider.

In the multi-NWP method, the three NWP forecasts are used as inputs of the NN. Therefore, there were three different wind power forecasts, and a combination of the three was achieved after an average was calculated. This simple combination improves the forecast accuracy quite significantly when compared to the results of the individual models. The NRMSE

¹¹ http://www.iset.uni-kassel.de/pls/w3isetdad/www_iset_new.main_page?p_name=7261001&p_lang=eng.

¹² <http://www.mseps.net/>.

of the combined model for Germany is 4.7% of the rated power, while for the single model, the value is ranging between 5.8% and 6.1% of the rated power.

The multi-scheme ensemble consists of including and combining, in the WPMS, several members of the MSEPS operated by WEPROG (Weather & Wind Energy Prognosis¹³). The MSEPS system consists of 75 ensemble members based on NWP models with perturbations in the initial conditions and fast physical processes. It provides information about the physical uncertainty of the weather for the following three days. The evaluation is performed in three different configurations: (i) by conducting training for each of the 75 single members of the MSEPS model using NNs; (ii) by averaging the forecasted wind power of several ensemble members; and (iii) by using a two-step model using an NN for the optimized combination of several members' forecasted power. The results showed that this method is better than a single NWP approach. For instance, the NRMSE for a wind farm using a single NWP is about 13% of the installed capacity. With the multi-scheme approach and averaging the weather data prior to their use in the NN, the error is around 11.1% of installed capacity. The results of the simple averaging and two-step neural network are better than the results achieved by the single member and by the single NWP. The NRMSE of a two-step neural network model is around 10.5% of installed capacity.

4.2.1.9 WEPROG MSEPS

The WEPROG MSEPS [226] was the result of research started by Moehrlen and Joergensen in 2001. They studied the forecasting quality of an operational NWP model as Moehrlen carried out a Ph.D. dissertation on WPF at the University College Cork and Joergensen was responsible for the operational weather prediction system at the DMI. They considered 13 three-month experiments and several one-year experiments to carry out multiple analyses on multiple models and multiple resolutions of the NWP models. The results indicated that multiple forecasts of moderate resolutions would be better than the ones achieved by a single forecast of the extreme spatial resolution. Moreover, the uncertainty of the forecast quality becomes an important issue. Therefore, in order to quantify the uncertainty of a forecast, it is necessary to have an ensemble of forecasts. More details about these experiments can be found in *Moehrlen* [65].

These research results were the starting point of the WEPROG forecasting system. Between 2003 and 2004, an operational scheme was developed, and the system has been commercialized since 2005.

The forecast system consists of two main models: a weather prediction system running every 6 hours and a power prediction system that uses on-line and historical SCADA measurements. In the weather prediction system, a multi-scheme ensemble prediction technique is used. Different physical parameterizations (or schemes) are used to vary the formulation of the fast meteorological processes in NWP models. Each member's scheme differs in the formulation

¹³ <http://www.weprog.com/>.

of the most relevant fast meteorological processes to wind power. The MSEPS is a limited-area NWP model that produces 75 different forecasts for each model run. This process predicts uncertainty, thus improving forecast accuracy. The forecast of wind power uncertainty in this model is related to the nonlinearity of wind turbine power curves and, at the same time, it is also based on weather uncertainty. Therefore, part of the uncertainty is proportional to the spread in the ensemble.

In the power prediction system, a training step is performed in order to establish a relation between forecast weather data (e.g., wind speed, direction, temperature, surface fluxes, turbulent kinetic energy) and historical power generation data. A W2P model is computed for each ensemble member by using direction-dependent models to parameterize the obstacles and wake effects as each member has its own error statistics. The way in which the regional forecasts in MSEPS are computed is not clear.

After training a forecasting system with historical generation data, forecasts can be made for the wind farm or region.

In [227], the impact on the forecast error of six different methods for W2P conversion is assessed. The method with the more significant improvement in accuracy was based on direction dependence and the weighting of individual ensemble members, according to their overall statistics. The authors in this paper presented results that contradict the WPF community. In fact, they stated "... that the mesoscale weather error from the NWP model is a significant element of the error, but not necessarily the dominant one."

According to [228], MSEPS is currently operational in predicting more than 30% of the world's wind power. Moreover, the system is running in a quasi-operational manner for 60% of world's wind power, for which the forecasts are made for 48 hr ahead with a 1-hr time resolution. Their main customers are Energinet.dk (Denmark), RWE (a German SO), ESB National Grid (Ireland), and NEMMCO (Australia) [229].

In [182] and [226], an ensemble prediction model is used to forecast the aggregated production of Ireland, Germany, and western Denmark. For instance, the NMAE for a single wind farm in a complex terrain in Ireland is around 11% of the nominal capacity, while the percentage for the aggregated generation is around 6%.

4.2.1.10 Sipleólico

The strong wind energy growth in Spain led Red Eléctrica de España (the Spanish SO) to have the Sipleólico tool developed by the University Carlos III of Madrid [230]. The tool is based on Spanish HIRLAM forecasts and takes into account the hourly SCADA data from 80% of all Spanish wind turbines [230]. These inputs are then used in several adaptive statistical models that produce a final forecast using an adaptive combination of the alternative predictions [80]. The two main features of the WPF system are: (i) the adaptability to changes in the operation of the wind farms or in the NWP prediction model; and (ii) easy and fast adaptability

for different wind farms; that is, no pre-calibration is required. The system forecasts up to 36 hr ahead in an hourly time-step.

The model was built to deal with different levels of available data. For instance, on-line wind farm data may not be available. Therefore, it should be possible to carry out forecasts taking only the characteristics of the wind plant and the NWP forecasts into consideration. Moreover, when no off-line wind farm generation data are available, the forecast is made by using both the NWP predictions and the manufacturer's power curve.

Nine different models are used from two different groups. The models of the first group are dynamic linear models in which the W2P conversion is made with polynomials of different degrees, from linear to cubic. The models of the second group are nonparametric models based on local polynomials similar to the ones used in WPPT. Some models only take measurements as inputs (e.g., AR models) and, therefore, they are suitable for very-short-term forecasting. Others (e.g., ARX models) use forecasts of wind speed and direction provided by HIRLAM as inputs as well. Thus, different models will be estimated for each look-ahead time.

The model parameters are recursively estimated with a Recursive Least Square (RLS) algorithm or a Kalman Filter. For the RLS algorithm, a new approach is used to determine an adaptive forgetting factor on the basis of the link between the influence of a new observation, using Cook's distance as a measure and the probability that the parameters have changed.

The results of 18 models are then used in a forecast combination, in which the error term is based on an exponentially weighted, mean-squared prediction error with a forgetting factor matching to a 24-hr memory. *Sanchez* [231] reported a procedure for an adaptive combination of forecasts called Adaptive Exponential Combinations (AECs), where the aim is to always use the best individual model (predictor) in a time-varying environment. The method is based on a two-step combination, aiming to take advantage of different approaches of forecast combination. In the first step, several combination methods are used, the AEC being one of them. In the second step, the AEC method is used to combine the alternative combinations of the first phase.

Sanchez et al. [230] stated that the main drawback for error forecasting is the low spatial resolution of the HIRLAM model, which does not take local topography into account. This drawback may complicate forecasting efforts in Spain as many wind farms are located in complex terrain. The author identified a model for further development that introduces local corrections to the NWP.

The recent research on this model is related to the estimation of uncertainty. *Sanchez* [232] reported the first attempts to develop an uncertainty estimation module for the tool. The presentation described a procedure for the on-line estimation of the density function of wind power predictions. The procedure is based on the on-line (using adaptive algorithms) estimation of a set of conditioned moments of the prediction distribution. Once the conditioned models are estimated, a parametric density distribution is adjusted by using a flexible family of distributions (e.g., beta distributions). The model is still in its research phase.

Sipreólico is currently operating at the Red Eléctrica de España (REE) control center, and it manages 11,556 MW (9,247 MW measured) of wind energy in the Spanish Peninsular System.

4.2.1.11 GH Forecaster

The GH Forecaster is a forecast system that is used to forecast wind farm power outputs using multi-parameter statistical regression techniques. It has been developed by Garrad Hassan and Partners Ltd,¹⁴ and its commercial operation in Europe has proved to be successful, especially for wind farms in complex terrains [233].

The model uses multi-parameter statistical regression routines to transform global NWP's with appropriate geographical resolution and site data (provided by SCADA systems and/or site measurements) into site-specific models [234].

The development of site-specific models aims at creating meteorological forecasts for a certain predefined reference point (e.g., site meteorological mast). Although the GH Forecaster uses adaptive multilinear regression techniques, the site-specific models can be any user-defined transformation between the NWP and the site. The regression models can also contain various sub-models based on specific atmospheric conditions, which are defined by identifying the wind speed and direction values to which the input NWP data belong. Then, the corresponding site statistic model is selected.

It was found that the forecasting accuracy is higher when wind characteristics are forecasted at a reference point and when the operational characteristics of the wind farm are used to convert wind forecasts into wind farm output forecasts. Thus, the meteorological forecasts at the reference point are transformed into power output forecasts with site-specific models. The power model requires the following variables to be forecasted as input data: wind speed, wind direction, air temperature, and air pressure. The model can be trained to produce site-specific forecasts of any observed quantity. Similarly, any predictable quantity can be used as its input. In order to allow the meteorological model to be both autoregressive and adaptive, it is necessary for the feedback data from the site to be available. The statistical regressions have any variable that can be forecasted as input. Nevertheless, the variable's relationship to the output quantity must be linear. However, quantities that affect the input/output relationship in a nonlinear manner can be accommodated with the use of a specific atmospheric-condition, sub-model approach.

The GH Forecaster was tested at Hare Hill wind farm, which is located 4 km southeast of New Cumnock, Scotland, with a total generating capacity of 13 MW. Tests were performed for predictions with 1-, 12-, and 24-hr-ahead forecasting time horizons.

In terms of wind speed, observed hourly values presented a correlation coefficient R^2 of 0.70. After adaptive regression using site-specific models, R^2 was increased to 0.87. For 12-hr

¹⁴ <http://www.garradhassan.com/services/ghforecaster/>.

forecast horizons, feedback from the site led to a lower improvement for the model, with the correlation coefficient after adaptive regression being $R^2 = 0.66$. The GH Forecaster's overall improvement (i.e., the increase in accuracy over persistence) was up to 54% at 24 hr ahead. Low wind speed improvements reached 70%, while high-speed improvements went up to 65%.

As far as the accuracy of wind power forecasts is concerned, for 12-hr-ahead forecasting horizons, the increase in accuracy was higher at the low end of rated power (0–20%) than the overall improvement: 63% and 46%, respectively. Although the GH Forecaster's power models can introduce significant errors in the predications, those errors can be reduced to an MAE of 2% of the rated power. The percentage of forecasting errors within 15% of the wind farms' rated capacity is above 60%, even for forecasting time horizons as large as 40 hr.

4.2.1.12 SOWIE

The forecasting system, Simulation Model for the Operational Forecast of the Wind Energy Production in Europe (SOWIE), was developed by Eurowind GmbH.¹⁵

No scientific details or publications about the model are available. The model was only reported in a state-of-the-art in wind power forecast in Germany [235]. The forecasting system is a physical model that provides wind power forecasts four times a day for a time horizon that can extend up to 120 hr ahead. The model uses the NWP's of HIRLAM and GFS as inputs. High-resolution, three-dimensional wind and temperature forecasts, together with a database of all German wind energy turbines, are the inputs of the system for wind power calculation. HIRLAM is working with a grid resolution of 20 km.

According to the Eurowind Web site, the system seems capable of forecasting the WPF uncertainty (represented by an interval of confidence). However, no details are given about the estimation of uncertainty. Ensemble forecasts are also used (in this case, the three-dimensional flow dynamic of wind and temperature forecasts of several numeric forecast models are being consulted).

The system can also be used for all of Europe. A database with information about all wind energy turbines in Europe is currently being used.

4.2.1.13 EPREV

A group of Portuguese wind farm promoters who own the majority of installed capacity asked a consortium of universities and research institutes to develop a forecasting tool. The result was the EPREV project. The project consisted of a WPF system that forecasts wind speed and active power forecasting up to 72 hr ahead with a 30-min. time resolution. The research partners involved in the project were INESC Porto (Institute for Systems and Computer Engineering of

¹⁵ <http://www.eurowind-gmbh.de/english/Leistungen/prognose.php>.

Porto), INEGI (Institute of Mechanical Engineering and Industrial Management), and CEsa (Centre for Wind Energy and Atmospheric Flows).

The WPF system carries out forecasts for individual wind turbines and for wind farms. This system uses a cascade of models, starting in the mesoscale with a resolution that extends up to 2 km. The outputs of the mesoscale models are corrected and statistically adapted to the fine scale conditions. Two models and different boundary conditions are run in three nested domains (54x54, 18x18, and 6x6 km). The advantage of using a 2x2 km resolution was also tested. Three forecast models were tested with three global models (provided by ECMWF, NCEP, and Météo-France) and two mesoscale models (MM5 and ALADIN) in two spatial resolutions (6x6 and 2x2 km). Currently, the work is more focused on the MM5 model. These NWP forecasts were performed in the calculus cluster of the Geophysical Centre of the University of Lisbon (CGUL).

A set of 365 simulations to 72 hr (based on the 00-hr GMT) were obtained with MM5 in order to test some combinations with the available atmospheric models by using boundary conditions supplied by NCEP and ECMWF [236]. The conclusion was that at this 6- to 30-hr timescale, both simulations were remarkably coherent with each other.

The statistical models are fed with recent information from the wind farms after a learning process that uses historical information of their operation. Three different types of statistical models are employed [236]: (i) W2P model, (ii) Auto Regressive (AR), and (iii) Neural Network Assembling Model (NNAM).

The W2P model converts the meteorological forecasts into the power that will be generated by the wind turbine or by the wind farm. In addition to modeling the characteristic power curve of each wind turbine or wind farm, this model establishes a correspondence between wind speed and power, as well as a correction in the production of the wind turbine or farm because of the errors associated with weather forecasts.

Several approaches for the W2P model were tested: instance-based learning (degree 0, 1, and 2 functions), polynomial function (third-degree function), least squares, adjustment to a sigmoid function, and MLP NN. New approaches will be tested in the future to improve the model's performance. The W2P can be applied to each wind turbine or to the wind farm. On the basis of the results obtained in one of the test cases, the approach by wind turbine — with the predictions for each wind turbine using MLP NNs — was found to be the best [236]. A filter was also used in order to identify the On/Off plans of each wind turbine for the single wind turbine forecasts. This information is highly important to the model's functional mode because it allows the available wind turbines to be identified. Thus, it is possible to define the wind farm production factor.

An AR model of first order is used for very short-term forecasting. This model presents better results within the first six hours of the time horizon since it is a dynamic model that only depends on the on-line measurements of the wind farm's production.

The fusion of the AR and W2P models is rather complex because the precise moment at which one model is worse than the other is unknown. It is also impossible to control the

problems arising in the input information for which the fusion is applied to the entire forecasting horizon. The adopted approach was an MLP NN that takes as inputs the forecasts of the models that are meant to be combined, as well the corresponding errors in the last four iterations.

The estimation of WPF uncertainty is based on an error prediction model. The aim is to predict the ratio between the on-line measured power and the forecasted power, which effectively represents the error itself. The construction of the model consists of a quantile regression from 25%, 50%, and 75% quartiles.

In [236], we can find the results obtained for a wind farm located in Portugal with a moderated level of complexity. There was a 66% average improvement over persistence for the 72-hr time horizon, in comparison with the persistence forecast model.

In addition to the statistical model, the Wind Farm Power Curve (WFPC) or Matrix models that are based on the computational simulation of atmospheric flow in the wind farm were used to estimate wind characteristics at the points at which the turbines are installed. The WFPC was used to produce aliases of wind farm power series that were capable of training statistical models. However, the WFPC can also be used to forecast the wind farms' output after the corresponding wind forecast.

In a first approximation, one of the most widely spread models in the wind resource assessment, WAsP, was used to build the WFPC. Since this is a model that uses linearized versions of the fundamental equations (among other simplifications), WAsP has several limitations. However, it is possible to perform either by crossing all the recorded data from the metering stations, or by the analysis of the terrain's complexity. The WFPCs are also generated by using the CFD model, VENTOS[®] [237] (a code developed at the University of Porto), in which the fluid-flow equations are solved in their original nonlinear form.

Rodrigues et al. [238] reported results of the use of VENTOS[®] in two Portuguese wind farms. The system was used for the local refinement of wind speed forecasts provided by MM5. The wind speed was converted to power output by using a real power curve.

4.2.1.14 AleaWind

AleaWind is a forecasting system developed by Aleasoft¹⁶, which is a Spanish company with connections to the Polytechnic University of Catalonia. The model is capable of providing national, regional, or single wind farm forecasts for a horizon ranging from 24 to 48 hr. The model uses NWP data, wind speed, and direction as inputs, as well as on-line and off-line wind farm generation.

The forecasting system is based on AleaSoft's exclusive forecasting model — the AleaModel. The forecasting model is an NN with a SARIMA (Seasonal Auto-Regression

¹⁶ http://www.aleasoft.com/index_energy_forecasting.html.

Integrated Moving Average) structure. The model parameters are estimated on-line. Therefore, an off-line test is not required, which allows the model to continuously respond to changes in the system. Thus, there is no need for occasional training.

Details on the upscaling model are not available.

4.2.1.15 Scirocco

Scirocco is a physical and statistical WPF system developed by Aeolis Forecasting Services.¹⁷ The model takes as inputs NWP from several different NWP models, such as the HIRLAM, ECMWF, NCEP, and MM5 models.

The wind power forecast is an output of a model chain with consecutive steps from physical and statistical procedures. Some of the steps involve the application of known physics and mathematics procedures. The model chain has three different adjustment schemes. The first model is an MOS, which is placed after the weather prediction model. The WPF error is computed to adjust the systematic errors of the NWP. The second model computes the local wind from the resulting adjusted weather parameters on the surrounding grid points by using a combined adjustment scheme for local orography and local roughness. The third model is also an MOS that is used to cope with turbine and farm characteristics.

There is no need to train these three models because the system is capable of adapting to local geographical circumstances and wind farm characteristics by itself during the first months of operation. The difference between the forecasted and the actual wind power production defines an error that will be fed back into the model chain and used to adjust all the parameters in the adjustment schemes that have contributed to the error.

The wind speed is converted to power by means of the manufacturer's power curve and wind farm dimensions.

The forecast horizon depends on the NWP that is used. For instance, with ECMWF it is possible to generate a forecast up to 10 days ahead. However, the accuracy of the forecast will be lower after three days. If HIRLAM is used, then the forecast horizon will range between 15 min. and 45 hr ahead.

An upscaling procedure based on the installed power and hourly wind power output data can also be employed to carry out forecasts for an entire region. Therefore, the upscaling method of the tool is simply a linear relation between reference wind farms and regional power.

¹⁷ <http://www.windknowhow.com/site/english/home/1>.

4.2.1.16 MeteoLógica

MeteoLógica¹⁸ is a Spanish company that provides various services, such as long-term (10-day) speed forecasting for maintenance planning, wind resource evaluation on specific sites, and short-term WPF for wind farms.

MeteoLógica prediction services use NWP data from ECMWF, which are then downscaled by an advanced statistical downscaling system that uses local meteorological measurements. No details are available on this downscaling model.

4.2.2 U.S. WPF

In this section, we describe six forecasting models developed by forecasting providers in the United States. A discussion on the benefits of centralized forecasting and how system operators in North America are currently performing WPF can be found in [239]. We provide a more thorough discussion of these topics in Chapter 7.

4.2.2.1 eWind

eWind is a U.S. model developed by AWS Truewind, Inc.^{19,20} [240]. The model takes the following as inputs: grid point output from regional-scale and global-scale NWP models; measurement data from several meteorological sensors; high-resolution geophysical data (terrain height, roughness, etc.); and meteorological and power generation data from the wind farms. The forecast horizon is 48 hr.

Instead of using a once-and-for-all parameterization for the local effects, as the Risø approach does with WAsP, eWind runs the ForeWind numerical weather model as a mesoscale model using boundary conditions from a regional weather model. This way, more physical processes are captured, and the prediction can be tailored better to the local site. In the initial configuration of the eWind system, AWS used the Mesoscale Atmospheric Simulation System model [241]. Additional higher-resolution NWP models (of 1- to 5-km grid cell sizes) are used today: ForeWind, MM5, WRF, COAMPS, workstation-ETA, and OMEGA. Typically, several models are also used with different initializations to create an ensemble of high-resolution NWP predictions.

The outputs from the ensemble, along with the sensor and wind farm meteorological data, are introduced into a database. The data in the database are used to train statistical models so that they produce forecasts at the meteorological tower sites and correct systematic errors. The following statistical tools are used: screening multiple linear regressions (SMLRs), NNs, SVM,

¹⁸ http://www.meteologica.com/meteologica/sectores_en.htm.

¹⁹ <http://www.meteosimtruewind.com/>.

²⁰ <http://www.awstruewind.com/>.

fuzzy logic clustering (FLC), and PCA. FLC and PCA are used for the stratification of the training samples for SMLRs, NNs, and SVM. Using different statistical models, as well as different configurations of these models and training samples, it is possible to produce an ensemble of forecasts from the statistical models. This ensemble of forecasts is then transformed into a single probabilistic or deterministic forecast variable by using another statistical model named “ensemble compositing model.” The ensemble composition model is a neural network trained on historical forecast performance data that weights each forecast according to its recent performance.

The next step is to transform the meteorological forecasts into wind power. For that, a model named “statistical plant output model” is used. The output of this model is a deterministic and probabilistic power generation forecast for each hour. Two possible configurations can be employed: one is a basic relation between the average wind speed at the hub height anemometers and the corresponding power generation, while the other is a neural network with wind speed, direction, wind speed variability, and atmospheric stability. The final step is a quality control check on the forecast data.

In [241], a 50% improvement in RMSE over persistence is reported for a 12- to 36-hr range for five wind towers in Pennsylvania. eWind and Prediktor were tested in California in [195] and [196]. In Altamont, the monthly MAE for next-day forecasts ranged from a 2.4% low to a 22.9% high, registering a 14.1% annual average. The corresponding range in San Geronimo was from 10.4% to 22.7%, with a 16.6% annual average. The error registered with Prediktor in Altamont was comparable to the one registered with eWind. However, in San Geronimo, Prediktor’s error was 34% larger.

Recently, in [242], typical ranges of forecast performance for individual North American wind farms and the factors that cause an impact on performance were presented. The mean absolute error for the following hour typically ranged between 4% and 6% of the nominal capacity, while MAE ranged between 14% and 22% for the following day. A study about the improvement in forecast performance associated with the dispersive growth of wind power production was carried out for the New York State Independent System Operator (NYISO) [242]. In this study, a total of 3,300 MW of wind-generation capacity was added to the system over a period of 10 years. The wind conditions of the year 2002 were used to estimate day-ahead forecast errors for each of the projected wind plants, as well as day-ahead forecast errors for aggregated power production of all wind farms. The results showed an average 15% NMAE for wind farms. In the first year of the period, the MAE of the aggregated forecast was around 12%. In 2005, the NMAE rose to just over 14%. Therefore, the impact of the aggregation effect was substantially reduced between 2004 and 2005. In fact, this decrease was the result of adding a 300 MW wind plant to the system from 2004 to 2005, which led to a reduction of the system’s geographic diversity because the error was dominated by the 300 MW wind farm’s errors. After 2007, the NMAE of the aggregated forecasts will continue to decrease gradually — reaching a rate near 10% in 2013 — as more wind plants are added in the western and central parts of the state.

In [242], AWS Truewind identified the following research and development initiatives:
(i) a focus on very-short-term forecasting (by exploring new remote sensing technology to

obtain 3-D data, time-lagged 3-D spatial correlations, and rapid NWP update cycles); (ii) ramp forecasting (the optimal extraction of ramp event information from NWP data and the effective communication of ramp forecast information) [243]; (iii) optimal ways to identify systematic NWP errors; and (iv) best ways to display forecast information for each type of user application.

4.2.2.2 Visionpoint

Visionpoint is a U.S. model developed by WindLogics, Inc.²¹ The model uses an ensemble of the Rapid Update Cycle (RUC), the North American Model (NAM) and the Global Forecast System (GFS). Statistical analyses are applied to these NWP models in order to select and weigh the most applicable forecast data. In addition, the meteorological data from met towers are used to validate wind forecasts and provide on-line data to the mesoscale model.

The forecasting system uses SVMs to perform the conversion between wind speed and wind power generation. The SVM is retrained every month to incorporate new generation and weather data. The typical forecast error is an NMAE of 5% to 12% for hour-ahead forecasts and 12% to 20% for day-ahead forecasts.

Xcel Energy Northern States Power (NSP)²² and WindLogics have been leading a project to define, design, develop, and demonstrate a complete WPF system that will be used by Xcel system operators. The results of the project can be found in [244]. When the forecasting system was developed, the Xcel energy wind generation portfolio consisted of 81 wind farms with a total of 652 MW of installed power. The inputs to the forecasting system are 10-min. average wind power data from 17 interconnected power nodes, 12 on-site or near-site meteorological towers, and National Weather Service surface-observing stations.

Wind power forecasts are updated every six hours, providing hourly forecasts for a time horizon of up to 84 hr for each node, as well as for the global system. Moreover, hour-ahead forecasts of up to 12 hr can also be provided. The hour-ahead model is an ensemble of the trained NCEP RUC model and the NCEP NAM. This forecast is updated on an hourly basis, providing 10-min. step power generation for the following 3 hr, as well as hourly generation values of up to 9 to 12 hr.

The NMAE for aggregate forecasts ranges between 10% and 14% of nominal capacity for next-day hourly forecasts; between 14% and 20% for the second and third days; and between 5% and 7% for the following 2 to 3 hr.

²¹ <http://www.windlogics.com/>.

²² <http://www.xcelenergy.com/>.

4.2.2.3 PowerSight

PowerSight is a WPF system developed by the 3TIER Environmental Forecast Group²³ in cooperation with the University of Washington. They are currently providing operational forecasts for more than 6,000 MW of installed wind energy in the United States. The forecast system can be divided into two modules: (1) a day- and week-ahead forecast system; and (2) an hour-ahead forecast system [245],[246]. The first forecast system provides hourly forecasts for 168 hr (7 days) and 84 hours ahead. The best of six different configurations of NWP models (WRF or MM5) is chosen to forecast weather variables four times a day, with a 5-km spatial resolution. The bias of the NWP predictions is corrected with an MOS, and then the wind speed is converted into power using a power curve. The wind power forecast uncertainty is estimated by using quantile regression or conditional on power curve location. The input data to this model is global weather data from the NCEP GFS model, as well as regional weather and high-resolution surface data. The typical accuracy of the day-ahead model is an NMAE of between 11% and 14% of installed capacity, an NRMSE of between 15% and 20%, and an improvement of 40% to 60% when compared with persistence.

According to [247], a weather forecast ensemble is employed by using a series of NWP simulations, each obtained from different initial conditions or NWP models. A Bayesian model is used to compute the skill of each ensemble member and then to provide a weighted-ensemble mean forecast.

The short-term forecasting system provides hourly forecasts for a time horizon of up to 10 hr, with a 5-, 10-, or 15-min. update frequency. In addition to SCADA measurements of the wind farm, the system also uses historical day-ahead forecasts and weather variables of other sites. In [248], the authors support the position that the use of geographically dispersed meteorological off-site observations, possibly combined with mesoscale NWP forecasts, can lead to significant improvements in very-short-term forecasts. In addition, in [248], the authors compare several machine-learning algorithms (NNs, conditional NNs, SVMs) with linear regression for very-short-term forecasting. Conditional NNs provided better forecasts than linear regression or NNs every month in their study. Generally, the NRMSE error improvement over persistence is between 5% and 25%. MAE is between 6% and 9% of installed capacity, while NRMSE is between 7% and 11%.

Three major areas of improvement were identified in [247]: (1) day-ahead ramp forecasting; (2) intra-hour forecasting; and (3) hour-head ramp forecasting.

²³ <http://www.3tiergroup.com/>.

4.2.2.4 Precise Stream

Precise Stream is a WPF physical system developed by Precise Wind.²⁴ The forecasting system provides forecasts for single wind turbines, single wind farms, and for groups of wind farms.

The forecasting methodology is based on meso-microscale atmospheric models (CFD techniques). The main feature of this method is its ability to capture a full, 17 km vertical model depth and hundreds of km in the horizontal direction. This approach requires large computational effort; therefore, an approach based on parallel computational resources is used. The model uses three grids with different horizontal resolutions to define a large area around the site. At a 1-km level of resolution in the innermost domain, the model is capable of resolving fine features, including topographic features, vegetation, etc. This characteristic can be very advantageous for wind farms located in very complex terrains [249].

Two post-processing methods for correcting systematic errors are employed: (i) corrections based on site measurements of wind speed; and (ii) corrections based on site measurements of wind power.

As opposed to some statistical models that require at least one year of SCADA data, this model requires only 3 months' worth of data. The training method is a post-processing step that does not require any appreciable CPU time. The power production forecast methodology is based on a simulation of hourly average wind speed to determine rated power from the manufacturer's power curves for individual turbines. In addition, a loss factor for each wind turbine is applied to the rated power based on the simulated wind speed. Then, an adjustment based on 10 min. of observed power data is employed to reduce any systematic error associated with loss factors. Uncertainty estimation is also provided in the form of maximum and minimum wind-generation values that vary according to current and forecasted weather conditions. For instance, for stable weather conditions the error range is narrower.

The forecast system has several possible time horizons: (i) days-ahead forecasts (of 48 to 72 hr); (ii) next-day forecasts (of 24 hr); (iii) hours-ahead forecasts (from 4 to 6 hr); (iv) 1-hr ahead forecasts; and (v) within-hour forecasts.

Generally, the NMAE is between 2.5% to 5.5% for 6-hr-ahead forecasts, between 6% and 9.5% for 12 hr ahead, and between 10% and 17% for next-day forecasts [250].

²⁴ <http://www.precisionwind.com/>.

4.2.2.5 WEFS

The WEFS (Wind Energy Forecasting System) for WPF is a hybrid physical-statistical model developed by AMI Environmental Inc.²⁵ The forecasting system consists of the following models: (i) a mesoscale model; (ii) a diagnostic wind model (a small-scale model); (iii) an adaptive statistical model; and (iv) users' access to the forecasts [251].

The mesoscale models used by WEFS are the MM5 and WRF, which use outputs from a global NWP model for their initial conditions. In the current configuration, the outputs either come from the regional-scale ETA model, or from the global Aviation Model (AVN).

In order to account for the local topography and microscale effects, the NWP predictions of MM5 or WRF are coupled with a Diagnostic Wind Model (DWM) developed by AMI. The DWM model can derive mass-consistent, three-dimensional wind fields that include treatment for localized flow phenomena, such as terrain channeling, thermal drainage, and overland/overwater transition. A refined resolution of 100 m or less is frequently used in the DWM simulations. In order to improve the forecasts of very-short-term horizons (e.g., one hour ahead), the DWM model can also use on-site wind measurements as inputs.

An adaptive statistical model is used to account for the systematic errors. For each forecast, the statistical models compute simple linear regression equations by using the last measurements of wind, power, and temperature. The model is dynamic and adaptive because the recent forecast errors are used to adapt the regression coefficients. This model has an advantage over the classical MOS as it does not require long sampling times and extensive monitoring of data. Forecasts of wind speed, direction, temperature, and energy generation are provided to the end user.

The accuracy of the model was evaluated for one year for a 75 MW wind farm named Southwest Mesa, located on top of a mesa near McCamey, Texas, about 75 miles south of Odessa. The study's results showed that, for a time horizon that went up to 48 hr, WEFS was the best of three methods [252]. The annual mean absolute error of wind speed was 30% of the mean annual wind speed, while the percentage for wind generation was 48.4%. The improvement over persistence was 26.1% for wind speed and 28.3% for wind generation.

4.2.2.6 WSI WindCast

WindCast is a WPF system developed by WSI Corp.²⁶ Scientific details on the forecasting model are not available. The model produces hourly wind speed and power forecasts for single wind farms up to 7 days ahead. The forecasts can be updated seven times a day.

²⁵ <http://www.amiace.com>.

²⁶ <http://www.wsi.com/>.

4.3 WPF SYSTEMS BENCHMARKING RESULTS

Two benchmarking exercises of WPF systems were recently published. One is the four-year, European ANEMOS Project (launched in 2002) [253]. During the exercise, there was an evaluation of 11 forecasting models (e.g., AWPPS, LocalPred, Prediktor, Previento, Sipreólico, WPPT) from nine different institutes in six test-case wind farms with different types of climatology and terrain. The other benchmarking study was launched by the Asociación Empresarial Eólica (AEE) - Spanish Wind Energy Association) [254]. Seven wind farms located in Spain were chosen for this exercise as they represent different types of terrain. Eight companies (Meteológica, Meteotemp, CENER, Casandra, Garrad Hassan, Meteosim/AWS Truewind, Aleasoft, Aeolis) provided forecasts for these wind farms for a period of 13 months. Throughout this forecasting exercise, it was possible to compare different global NWP (ECMWF, GFS, INM) models.

The case studies of ANEMOS examined wind farms located in different terrains [255]: two onshore, two near shore, and one offshore. One of the Spanish wind farms is in a complex terrain, the second and the third are situated in semi-complex terrains, while the last three are all located in simple terrains. Different climate conditions in the northern and western parts of Europe are represented in these wind farms. However, the Mediterranean, central, and southern areas of Europe are not represented.

The main conclusions of the ANEMOS benchmarking project were as follows [253]-[256]:

- a) The spatial resolution of the NWP forecasts was highly important for WPF, especially in complex terrain wind farms;
- b) The use of Kalman filters is valuable for the removal of NWP systematic errors of (post-processing) wind speed forecasts [257];
- c) The performance of the models is strongly related to the wind farms' terrain complexity. The average value of the NMAE ranged between 10% (flat terrain) to 21% (highly complex terrain);
- d) The forecasts in complex terrain are less accurate. For instance, the Alaiz test case (located in Spain) is the one with higher-complexity terrain, registering an NMAE of between 20% and 35% for different models, with a 24-hr time horizon;
- e) The forecast errors were more dispersed in complex terrain. The lowest dispersion corresponds to the offshore wind farm (Tuno). The difference between the best and worst prediction was about 0.6%, and the highest dispersion was 11.5% in Alaiz;
- f) The offshore wind farms showed similar performance results as in the case of the flat terrain wind farms;

- g) No model was capable of overcoming the others in every look-ahead time or test case;
- h) The statistical models proved to be the most consistent, registering a slight improvement over physical models in the more complex terrain types. At the same time, models that use power measurements as inputs presented a best accuracy level in very-short-term forecasting; and
- i) The combination of different forecasts (either from different NWP models or different WPF models) can improve the forecast accuracy [231].

The main conclusions of the AEE benchmarking exercise were as follows [254]:

- a) The wind power forecast error is highly dependent on the wind speed forecast error since the effect of the NWP global model was considerable;
- b) The wind power forecast errors vary with the level of power. In moments of higher power generation, the forecasts presented fewer errors;
- c) The limit for the MAE normalized by the monthly mean power seemed to be 25% for day-ahead forecasts. It is said to be hard to improve this percentage with the currently available data and techniques;
- d) Apparently, the terrain type does not affect the forecast quality, which is contrary to the results obtained with ANEMOS;
- e) The forecast error is reduced by the aggregation of wind farms; and
- f) The statistical models that use NWP as inputs proved to be capable of providing precise forecasts.

The ISO in Alberta, Canada, (AESO) has promoted a forecasting pilot project in 12 wind farms and five regions during a period of one year [258]. The purpose of this project was to figure out which were the most effective WPF approaches for Alberta’s distinctive weather patterns and complex terrain. The project tested three different WPF providers with different models: AWS Truewind (eWind), EMSYS (Previento), and WEPROG (MSEPS).

The results of Previento during the forecasting pilot project in Alberta are reported in [259]. The wind farms in Alberta proved to be very challenging from a forecaster’s perspective, as the regime is quite extreme, and wind conditions can change rapidly, leading almost to a “binary” operation of the wind turbines. Several solutions were used to overcome these difficulties:

- a) Use of different NWP prediction models as inputs for the WPF system;

- b) Optimal combination of these several NWP models, taking different weather patterns and seasonal effects into consideration. In order to do so, weather conditions were automatically classified;
- c) Site-specific and direction-dependent power curves based on the wind farm's off-line generation data;
- d) Self-tuned models for very-short-term forecasting (e.g., 10 hr ahead);
- e) Improvement of the quality and accessibility of the wind farms' on-line and off-line power output data; and
- f) Use of information on turbines' historical and real-time availability.

The ramp event forecasting problem was addressed by EMSYS in this project.

According to WEPROG, the main challenge has to do with meteorology [260]. The quality of the wind power forecasts was significantly affected by the lack of quality in weather forecasts. The results showed that it is possible to improve the forecast by increasing the spatial resolution of the model. Therefore, the results in a 6 km resolution led to an improvement in predictability. The main findings of the WEPROG testing exercise are reported in [260]:

- a) The initial conditions are an important issue for the quality of the forecast;
- b) The lateral boundary conditions need to be provided by a high-resolution model (smaller than 22 km) because all verification scores of 45- to 60-km resolution simulations indicate a higher amount of forecasting errors;
- c) The 6-km ensemble does not require advanced statistical training. This result is attributable to the fact that it can produce wind natively, with a much higher accuracy when compared to the lower-resolution models;
- d) Only the 6-km ensemble produced the same structures of the wind field;
- e) The 6-km ensemble was capable of producing long narrow patterns parallel to the mountains of cut-off wind speeds in the southwest region;
- f) All tested error measures improved with the 6-km ensemble;
- g) Statistical processing suppresses the model signal in extreme events. The effect is strong in Alberta because there are considerable phase errors in the training;
- h) Ensembles with a larger amount of members provide the best statistical measures on the likelihood of sudden generator stops at extreme conditions;

- i) The ensemble spread is an important measure for the uncertainty of amplitude and steep ramp phase. The correlation between spread and actual error increases with spatial resolution and does not decrease with an increased forecast horizon; and
- j) Extreme static stability has caused systematic forecast errors with nearly all model formulations because of incorrect vertical mixing.

A Wind Generation Pool (WGP) concept was proposed based on the ensemble forecasts. The aim was to enable a 50% wind-generation penetration without jeopardizing system security [260].

AWS Truewind achieved an error magnitude (NMAE and NRMSE) for Alberta that was higher (20% to 30%) than the one achieved for many wind farms in California or Texas. It was stated that:

“the most significant factor is that the forecasting of near-surface winds in the typical weather regimes that affect the Alberta wind generation regions is more difficult than forecasting the near-surface winds in the typical weather regimes in other North American locations” [261].

Four weather regimes were identified as being strongly linked with forecasting errors: (i) changes in the strength of the cross-mountain flow at the mountain-top level; (ii) the onset and termination of shallow cold-air masses; (iii) cold-air surges; and (iv) nocturnal cooling. Further research should be oriented to study these four weather regimes. For instance, it was stated that:

“...the error characteristics of the NWP models were quite different in the shallow cold air regime (SCA) and the non-SCA regimes. A rerun of the forecasts using a modified forecast system configuration that more explicitly accounted for this characteristic, resulted in a 10% to 15% improvement in AWST’s overall NMAE... .”

Moreover, the importance of having high-quality historical and real-time power output and meteorological data on the wind farms was also stressed. The location and number of the meteorological towers is also important.

All the forecast providers recommend a centralized approach to forecasting. This approach is reported as the most efficient and economical approach in the sense that it can provide uniform and accurate forecasts.

4.4 SYNTHESIS OF THE LITERATURE OVERVIEW

The tables presented below summarize the literature overview provided in this chapter. TABLE 4-1 reports the state-of-the-art techniques used in very-short-term WPF. TABLE 4-2 reports the state-of-the-art techniques used in short-term WPF. TABLE 4-3 and TABLE 4-4 summarize the main conclusions of short-term and regional WPF. Finally, TABLE 4-5 provides an overview of all the commercial and operational WPF systems and their main features.

TABLE 4-1 Research Models for Very-Short-Term WPF

Wind Speed Forecasting	Wind Power Forecasting
Kalman Filter [90], [92]	Fuzzy Time Series [124], [131]
Grey Predictor [102]	Self-exciting Threshold Autoregressive [136]–[138]
Takagi-Sugeno [109], [110], [118], [119]	Smooth Transition Autoregressive [136]–[138]
Discrete Hilbert Transform [120], [121]	Markov-switching Autoregressive [136]–[138]
Abductive Networks (GMDH) [114]	Adaptive Fuzzy Logic Models [122], [123]
	Adaptive Linear Models [122], [123]
	ARIMA time series models [94]–[100], [106], [128]–[130]
	Neural Networks [104]–[108], [112], [131]
	Adaptive Neural Fuzzy Inference System [106], [116], [127]

TABLE 4-2 Statistical and Computational Methods for Short-Term WPF

Methods
Neural Networks [139], [144], [147], [153], [164], [165]
Support Vector Machines [139], [144], [147]
Regression Trees with Bagging [139]
Random Forests [139], [147]
Adaptive Neural Fuzzy System [142], [143]
Mixture of Experts [144]
Nearest Neighbor Search [144]
Autoregressive with Exogenous Input (ARX) [130]
Locally Recurrent Neural Networks [151], [152]
Local Polynomial Regression [157]
Takagi-Sugeno FIS [162]
Fuzzy Neural Networks [170]
Autoregressive with Exogenous Input and Multi-timescale Parameter (ARXM) [171]
Bayesian Clustering by Dynamics (BCD) [174]

TABLE 4-3 Main Conclusions of Short-Term WPF

Main Conclusions
Combining several statistical models for day-ahead forecasts serves to decrease the forecast error [139], [144].
Spatial and temporal information from a wide area improves a single wind farm forecast [149].
WPF error can be reduced by using optimization algorithms for feature selection and parameters setting [149].
A transfer coefficient method is proposed in [171] to downscale NWP forecasts, which only takes a few seconds with one computer.
Sideratos and Hatzigiorgiou [172] and Fan et al. [174] reported the importance of dividing the dataset into several subsets and fitting a model to each subset.
The authors of [181] showed that combining several NWP forecasts can easily improve the forecast error.
The main trend in learning algorithms is to be adaptive in order to deal with data streams and nonstationary processes.
Non-Gaussian error distributions have motivated research for new cost functions (e.g., error entropy minimization) [153].
Improvements in the initial performance can be achieved by supplying a “theoretical” wind farm power curve calculated with WASP, particularly for new wind farms [177].
Stability measures and mesoscale modeling can further improve the physical models [177].
The use of Kalman filters to remove systematic errors of NWP wind speed forecasts is valuable [257].
The performance of the models is strongly related to the terrain complexity of the wind farm [253].

TABLE 4-4 Main Conclusions of Regional Forecasting

Main Conclusions

In aggregating several wind farms over a wide area, weakly correlated forecast errors cancel out because of statistical smoothing effects [81].

The magnitude of the forecast error strongly depends on the size of the region — the larger the region, the larger the error reduction [82].

Forecasting errors increase with increasing load factor as a result of increasingly atypical weather events and higher average wind speeds [182].

Siebert et al. [184] showed that the increasing number of wind farms initially reduces the error. However, after adding a specific number of wind farms, the error started to increase again. The additional information provided by an extra farm is outweighed by the additional noise that is added to the model's input.

Siebert et al. [184] stressed the importance of reference wind farms selection.

The forecast error depends on the location of reference wind farms. An upscaling based on subregion shows good performance when the normalized capacities of reference wind farms in each subregion are almost the same.

Gastón et al. [183] identified that there is a limit to the reduction of errors by wind farm aggregation. In fact, groups of more than three wind farms do not necessarily result in a significant reduction of the errors.

Pinson et al. [83] concluded that the advanced models for time horizons of up to 15 hours gain more from the smoothing effect than persistence. For a time horizon between 1 and 5 hours, persistence is the only model that benefits from smoothing effects.

There is no significant difference in performance between the modeling approaches (direct, cascade, etc.) [89].

Only few and well-selected explanatory variables are necessary for regional forecast [89].

Siebert [89] found that the relation between single wind farm generation and regional generation is strongly linear.

Siebert [89] identified the need to build adaptive regional forecasting models to deal with the nonstationary process.

TABLE 4-5 Overview of Operational and Commercial WPF Systems

Model	Developer, Country	Approach	Key Features
Prediktor	Risø, Denmark	Physical	Provides local refinement of the NWP forecasts; has wind power curve modeling, including wake effects.
Previento	University Oldenburg/EMSYS, Germany	Hybrid	Uses approach similar to Prediktor, but with regional forecasting and uncertainty estimation.
LocalPred/ RegioPred	CENER, Spain	Hybrid	Regional forecasting; developed especially for complex terrain (microscale modeling); very-short-term forecasting with ARMA models.
WPPT	IMM.DTU/ENFOR, Denmark	Statistical	It provides point and uncertainty forecasts for a single wind farm, for a group of wind farms, or for a wide region; has a time-adaptive process to cope with a nonstationary process; takes autocorrelation and diurnal variations into account.
Zephyr	Risø and IMM.DTU, Denmark	Hybrid	A combination of WPPT and Prediktor models in which each wind farm is assigned a forecast model according to the available data.
Cassandra	University of Castilla-La Mancha/Gamesa, Spain	Physical	Statistical downloading method that corrects systematic errors on the mesoscale forecasts; employs multivariate regression to estimate wind farm power curve; features automatic update of power curves.

TABLE 4-5 (Cont.)

Model	Developer, Country	Approach	Key Features
AWPPS	ARMINES, France	Statistical	Very-short-term models based on the statistical time-series approach, in which short-term models are based on fuzzy neural networks; combines forecasts by an intelligent weighting of very-short and short-term forecasts; its upscaling prediction model is based on dynamic fuzzy neural networks, and uses cascaded and cluster approaches with reference wind farms; includes uncertainty estimation of confidence intervals; performs assessment of prediction risk indices based on weather stability.
WPMS	ISSET, Germany	Statistical	It calculates the current power for all wind farms by using the measurements of only a few wind farms (on-line monitoring); provides day-ahead and short-term wind power forecasts for single wind farms, control areas, and subregions; a multi-NWP that combines the forecasts of three different NWP models from different providers or MSEPS that use forecasts of different members of the ensemble.
WEPROG	WEPROG, Germany	Hybrid	Two main models: a weather prediction system running every 6 hr and a power prediction system that uses on- and off-line SCADA measurements. In the first model, a multi-scheme ensemble prediction limited-area NWP model produces 75 different forecasts (ensembles), which forecast uncertainty and improve forecast accuracy.

TABLE 4-5 (Cont.)

Model	Developer, Country	Approach	Key Features
Sipreólico	University Carlos III of Madrid, Spain	Statistical	The model was built to deal with different levels of available data; several adaptive statistical models are used in order to produce a final forecast by using an adaptive combination of the alternative predictions; the two main features are: (i) its adaptability to changes in the operation of the wind farms or in the NWP prediction model; and (ii) easy and fast adaptability for different wind farms; no pre-calibration required.
GH Forecaster	Garrard Hassan, UK	Statistical	Uses multi-parameter statistical regression routines to transform global NWP with appropriate geographical resolution and site data (provided by SCADA systems and/or site measurements) into site-specific models; the site-specific models can be any user-defined transformation between NWP and the site.
SOWIE	Eurowind GmbH, Germany	Physical	Uses high-resolution, 3-D wind and temperature forecasts as inputs, together with a database of all German wind energy turbines; provides uncertainty estimation and regional forecasting.
EPREV	INESC Porto/INEGI/CEsA/CGUL, Portugal	Statistical	Combines autoregressive models for very-short-term forecasting, with NNs for short-term forecasting; each wind turbine is modeled individually, thus enabling the identification of the availability of each wind turbine; the system provides uncertainty forecasts.

TABLE 4-5 (Cont.)

Model	Developer, Country	Approach	Key Features
AleaWind	AleaSoft, Spain	Statistical	The model is capable of providing national, regional, or single wind farm forecasts; it is based on the exclusive AleaSoft forecasting model; the parameters of an NN with a SARIMA structure are estimated on-line.
Scirocco	Aeolis Forecasting Services, Netherlands	Hybrid	The wind power forecast is an output of a model chain with consecutive steps from physical and statistical procedures; the system adapts itself to local geographical circumstances and wind farm characteristics during the first months of operation.
MeteoLógica	MeteoLógica, Spain	Physical	The NWP forecasts are downscaled by an advanced statistical downscaling system that uses local meteorological measurements.
eWind	AWS Truewind Inc., USA	Hybrid	Runs the ForeWind NWP as a mesoscale model using boundary conditions from a regional weather model; several models are used with different initializations in order to create an ensemble of high resolution NWP prediction; the output from the ensemble, along with the meteorological data, are used to train statistical models to produce forecasts at the meteorological tower sites and correct systematic errors; an “ensemble compositing model” transforms the ensemble of forecasts into a single probabilistic or deterministic forecast ; the model provides uncertainty forecast.

TABLE 4-5 (Cont.)

Model	Developer, Country	Approach	Key Features
Visionpoint	WindLogics Inc., USA	Statistical	Uses SVM to convert wind speed to generation and is retrained every month in order to include new generation and weather data; it uses an ensemble of the Rapid Update Cycle (RUC), North American Model (NAM), and the Global Forecast System (GFS).
PowerSight	3TIER, USA	Statistical	It provides hourly forecasts for 7 days and 84 hours ahead; the best of six different configurations of NWP models (WRF or MM5) is chosen to forecast the weather variables; the power forecast uncertainty is estimated using quantile regression or conditional on power curve location; a weather forecast ensemble is employed by using a series of NWP simulations, each obtained from different initial conditions or NWP models; the system provides hourly forecasts for a time horizon up to 10 hours where historical day-ahead forecasts and weather variables of other sites are used.
Precise Stream	Precision Wind, USA	Physical	Is based in meso-microscale atmospheric models (CFD techniques). The main feature is the ability to capture a full 17 km of vertical model depth and hundreds of kilometers of resolution in the horizontal direction. The model uses three grids with different horizontal resolutions to define a large area around the site. The training method is a post-processing step that requires only 3 months' worth of data. Uncertainty estimation is also

TABLE 4-5 (Cont.)

Model	Developer, Country	Approach	Key Features
			provided in the form of maximum and minimum wind generation values that vary according to current and forecasted weather conditions.
WEFS	AMI Environmental Inc., USA	Hybrid	In order to account for the local topography and microscale effects, the NWP predictions of MM5 or WRF are coupled with a Diagnostic Wind Model developed by AMI; an adaptive statistical model is used to account for the systematic errors without requiring long sampling times and extensive monitoring of data.
WindCast	WSI, USA	–	Provides hourly wind speed and power forecasts for single wind farms up to 7 days. The forecasts can be updated 7 times a day.

This page is intentionally blank.

5 UNCERTAINTY IN WPF

5.1 UNCERTAINTY REPRESENTATION AND COMMUNICATION

Short-term forecasting tools that are currently widely in use provide single-valued point (or spot) forecasts. The main drawback of point forecasts is that no information is provided on the dispersion of observations around the predicted value. It might be interesting to find, for instance, a wind power level that is, with high probability, not exceeded. Nevertheless, additional information on the uncertainty associated with future wind power predictions is required.

Recent research efforts have focused on associating uncertainty estimates with point forecasts, taking into account the form of probabilistic forecasts, risk indices, or scenarios of short-term wind power generation.

5.1.1 Probabilistic Forecasts

The prediction from most regression models (e.g., neural networks) provide point forecasts that are an estimate of the wind power's conditional mean, which only measures the "center" of the conditional distribution of the wind power. A more complete characterization of the conditional distribution is provided by probabilistic forecasts.

Probabilistic forecasting consists of estimating the future uncertainty of wind power that can be expressed as a probability measure. There are several models for estimation of probabilistic predictions, and studies concentrate both on the characterization of the sources of uncertainty, and on the development of methods for on-line uncertainty estimation [262],[263].

The forecasted power output from wind farms is described by using random variables, which may be expressed by many forms:

- a) Probability mass function (*pmf*);
- b) Moments of distributions (e.g., mean, variance, skewness, kurtosis);
- c) A set of quantiles and interval forecasts; and
- d) Probability density functions (*pdfs*) or cumulative distribution functions (*cdfs*).

Of all of the above, the *pdf* functions are generic and can be deduced to all of the other forms. The use of each uncertainty representations is case dependent. For instance, when faced with a decision-making problem, if one is interested in a parametric representation of the uncertainty, then one should use the moments of the distribution. In general, one cannot talk about better and worst uncertainty representation, only on more or less adequate representations.

The most commonly used form for representing probabilistic forecasts is through quantiles [264]. As an example, let f_{t+k} be the *pdf* of P_{t+k} (wind power for look-ahead time $t+k$) and let F_{t+k} be the consequent cumulative distribution function (cdf). Provided that F_{t+k} is a monotone increasing function, the quantile q_{t+k}^α with proportion $\alpha \in [0,1]$ of the random variable P_{t+k} is uniquely defined as the value x , such that $\text{prob}(P_{t+k} < x) = \alpha$, or in another form is defined as $q_{t+k}^\alpha = F_{t+k}^{-1}(\alpha)$. A quantile forecast $\hat{q}_{t+k|t}^\alpha$ with nominal proportion α is an estimate of q_{t+k}^α produced at time step t for look-ahead time $t+k$.

As is known in statistics, the quantiles are points taken at regular intervals from the *cdf* of the random variable (*r.v.*). Therefore, a single quantile forecast does not contain enough information. In fact, all of the information about the *r.v.* P_{t+k} for the entire time horizon is required. The *cdf* of the wind generation at look-ahead time $t+k$ is represented by a set of m forecasted quantiles with the chosen nominal proportions spread α :

$$\hat{F}_{t+k|t} = \{\hat{q}_{t+k|t}^\alpha | 0 \leq \alpha_1 \leq \dots \leq \alpha_i \leq \dots \leq \alpha_m \leq 1\}.$$

FIGURE 5-1 shows two forecasted quantiles with nominal proportions equal to 20% and 80%. The two quantiles form a confidence interval with probability 60%.

Note that no assumption is made about the shape of the target distributions. Any probabilistic distributions can be summarized by an adequate number of its quantiles.

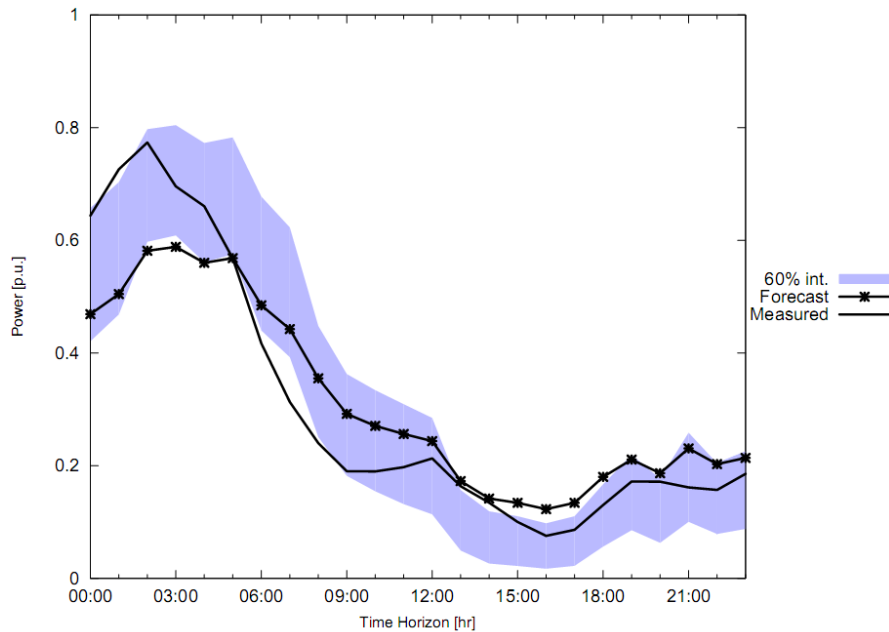

FIGURE 5-1 Quantile Forecasts

This set of quantiles represents the discrete *cdf* of the forecasted wind generation random variable. The forecasted wind generation can also be represented through its probability mass function (*pmf*). The *pmf* can be approximated by assigning the mid-point between two consecutive quantiles to the area between the two percentiles (probability) [265]. The probability is constant between quantiles.

Quantiles can also be used to build intervals that provide a range of possible values within which the observed value is expected to lie with a certain probability (nominal coverage rate, $1-\beta$). These are what are usually called interval forecasts [88], as depicted in FIGURE 5-2. The interval forecast is defined by its lower and upper bounds, which are two forecasted quantiles, as well as by the center of the interval (e.g., median, mean). The common representation is to center the intervals on the median. Thus, the probabilities are symmetric around the median. However, the distances are not symmetric. For instance, if the first quantile is 500 MW with $\alpha=35\%$, and the second is 1,800 MW with $\alpha=65\%$ around a median of 800 MW, the corresponding interval is [500, 1,800], with a coverage rate of 30% (15% for each side) and an amplitude of 1,300 MW (300 for one side and 1,000 for the other).

Since the error distribution in WPF is skewed and heavy-tailed, the forecasted distribution of wind power output might also be asymmetric. Therefore, is not usual to center the intervals on the mean or on the point forecasts because, in asymmetrical distributions, the mean and the median may be very different. In this situation, the point forecast may not lie inside an interval with low coverage rate.

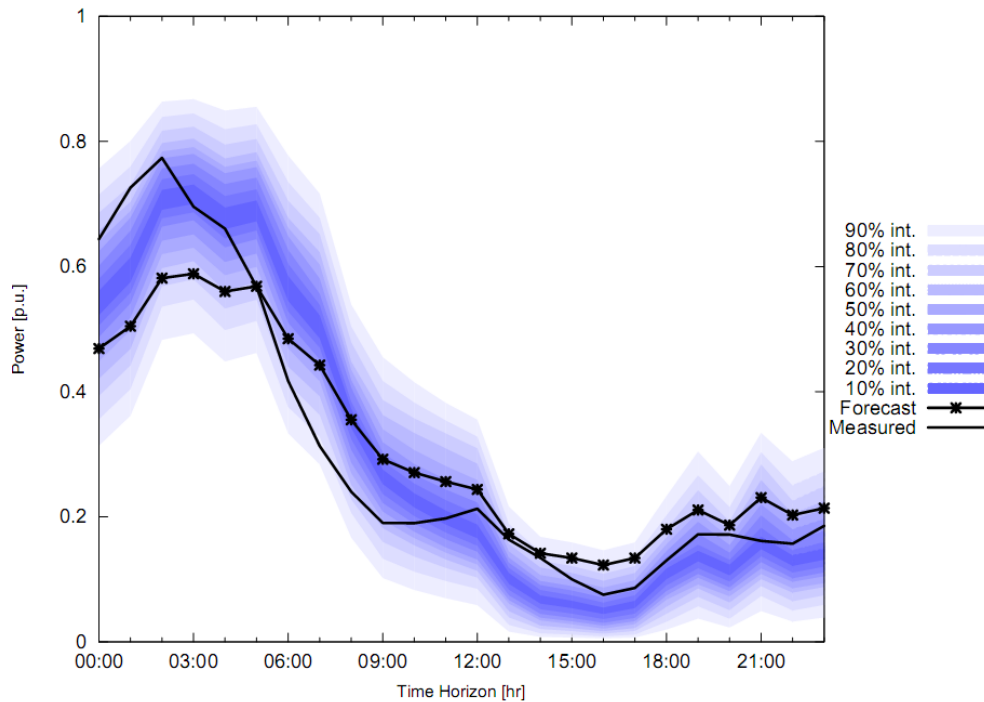

FIGURE 5-2 Interval Forecasts

The uncertainty can also be represented by the full *pdf* or forecasted density, as presented by *Juban et al.* [266]. As such, this *pdf* function can be used, thus providing complete information about the uncertainty, or in the form of quantiles or point forecasts (e.g., weighted mean value). The *pdf* can also be provided by a parametric function (e.g., *beta pdf*) associated with different power class bins, as presented by *Bludszuweit et al.* [267].

From the *pdf* function, it is possible to compute the moments of the forecasted distribution.

5.1.2 Risk Indices or Skill Forecasting

The uncertainty estimation in wind power forecasting is a complex subject that depends on several factors (e.g., meteorological conditions, the spatial smoothing effect of wind farms, level of predicted power). One source of error is related to how it is impossible to produce perfect NWP forecasts when weather stability is low. An unstable atmospheric situation may lead to a large error in wind speed forecasting, and thus the wind power forecasts will be poor. On the other hand, more accurate forecasts are expected during stable periods. This behavior does not depend on the forecasting method that is used. In addition to the forecasted uncertainty (e.g., a set of quantiles) and point forecast, it is possible to access risk indices that provide important information on the expected level of forecast accuracy (i.e., the predictability of the atmosphere situation).

Two risk indices (or skill forecasts) were proposed in the literature: (i) the Meteo-Risk Index (MRI), which reflects the spread of the available NWP ensemble at a given time [268]; and (ii) the Normalized Prediction Risk Index (NPRI), which reflects the spread of an ensemble of wind power forecasts for a single look-ahead time or over a forecast period [269]. These risk indices are not directly related to a forecasting method.

The forecast risk index consists of a single numerical value (or qualitative value) that provides an *a priori* warning on the expected level of prediction error. The risk index may be more easily understood by operators and forecast users as compared to probabilistic forecasts, and, at the same time, the index can also be related with information on the potential magnitude of prediction errors. From these risk indices, it is possible to understand how accurate or not the wind power forecast error is expected to be. However, in decision-making problems, risk indices will always need wind power forecasted uncertainty or point forecasts. Nevertheless, the risk indices can be used to broaden or narrow forecasted intervals. For instance, if the MRI is low, the model is expected to be accurate. Therefore, it will be acceptable for the forecast to present small uncertainty intervals.

The MRI uses NWP ensembles of two types: (i) those obtained by the perturbation of the initial conditions of the NWP model or by different NWP models; and (ii) lagged forecasts obtained from different initial conditions, yet with an unperturbed model. These forecasts are for the same look-ahead times, but they are made at different time instants. The ensemble spread is measured by a two-norm to calculate the distance between two forecasts.

The NPRI are derived from the NWP ensemble forecasts converted to wind power by a W2P model, such as the one described and evaluated in [206]. This risk index measures the spread of the wind power ensemble over a certain time period or for each look-ahead time. The spread is computed with a weighted standard deviation of the ensemble members. The weights are interpreted as each ensemble member's ability to provide information on predictability.

Pinson et al. [269] established a relation between several equally populated classes of NPRI values (5 classes) and distributions of energy imbalance. The authors showed that for different types of wind power ensembles, the NPRI could provide useful information on the expected level of forecast uncertainty.

These risk indices were implemented in the AWPPS forecasting system and estimated on-line.

5.1.3 Scenarios of Wind Power Generation

The probabilistic forecasts are produced for each look-ahead time independently. Therefore, they do not provide information on the development of the forecast uncertainty through the forecasted time series. The interdependence between the forecasted uncertainty over the time horizon is a valuable piece of information in time-dependent decision-making problems, such as in wind farm and pumped storage coordination or unit commitment.

Pinson et al. [270] presented a method for the generation of wind power scenarios (as depicted in FIGURE 5-3) that has to do with forecasted density/cumulative probability functions for the time horizon. At the same time, this method also provides information on the development of the prediction errors through the set of look-ahead times. The method is based on the conversion of the set of random variables composing probabilistic forecast series into a multivariate Gaussian random variable. The temporal interdependence structure is represented by the covariance matrix, which is recursively estimated because of nonstationary characteristics. Monte Carlo simulation is used for the generation of equiprobable scenarios.

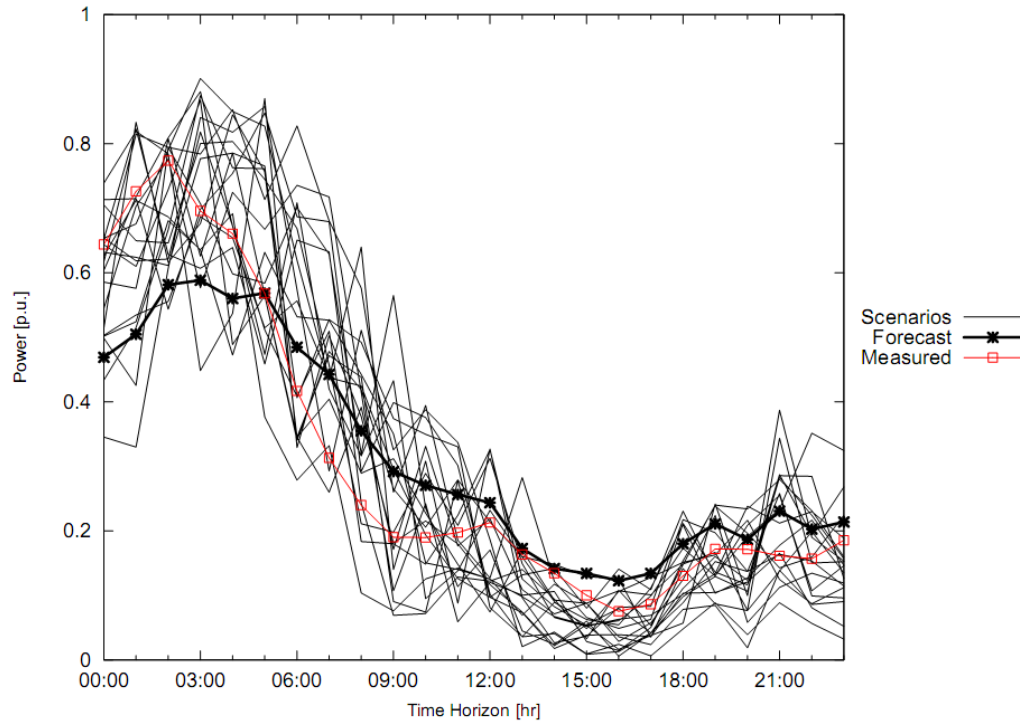

FIGURE 5-3 Scenarios of Wind Generation (20 scenarios)

Pinson et al. [271] used these scenarios for the dynamic assessment of the necessary storage capacity for each delivery period of the electricity market. However, to use these scenarios in some decision-making problems, it is necessary to compute the required number of scenarios to perform precise calculations or characterizations of risk indices.

This method was extended to incorporate the spatial [272] and spatial-temporal [273] interdependence of forecast uncertainty. These scenarios are useful for the congestion management problem, probabilistic power flow, or coordination of cluster of wind farms with storage devices.

Vlasova et al. [274] demonstrated and analyzed, for western Denmark, the influence that a forecast error made at a given location (space and time) can have on forecast errors in other locations (in time and space). Instead of scenarios that account for these dependencies, the authors proposed nonlinear models that capture the interdependence structure of wind power forecast errors. The main contribution of the paper, and indeed an important outcome, is the demonstration that there actually is a spatial and temporal interdependence structure in wind power forecast errors. The main conclusions derived by the authors for western Denmark are as follows:

- a) There is a significant cross-correlation between forecasting errors of near locations, with a few hours lag;

- b) The cross-correlation is conditioned by the prevailing weather situation characterized by wind speed and direction; and
- c) The influence of wind direction is clear and plays a crucial role. The influence of wind speed is smaller: the higher the wind speed level, the stronger the influence of more remote sites. For low wind speed levels, the influence has a local origin (showing an autoregressive pattern).

The influence of wind direction was modeled by state-of-the-art, regime-switching approaches. The wind speed influence was captured by conditional parametric models.

This approach was able to explain up to 54% of error variations of 1-hr-ahead wind power forecasts.

5.2 UNCERTAINTY ESTIMATION

Classical approaches to estimate uncertainty rely on a parametric representation or on a global evaluation criterion that only assesses the overall forecast error. For example, a standard deviation of forecast errors over several runs is used to provide full information on the forecast uncertainty; the forecast error variance can also be estimated. This provides an overview of constant uncertainty for the entire time horizon. However, because of the dynamic nature of weather conditions, it seems appropriate to develop a situation-dependent assessment of the forecast error.

Pinson [88] analyzed the performance of several WPF models in different locations. The author showed that the wind power uncertainty increases with the look-ahead time, and the level of uncertainty is 2 or 3 times higher for medium-range power values than for low and high values. Error distributions are highly skewed and peaked in the more extreme parts of the power curve.

Different factors influence the wind power forecast uncertainty: (i) NWP forecasts partially contribute to the forecasting error, as reported in [154] and [65]; (ii) the nonlinearity of the power curve, and therefore the different W2P models, may lead to significant differences between WPF systems; and (iii) the type of terrain (flat, complex, offshore, etc.) affects the forecasting error.

The wind power forecast uncertainty can be estimated with three different inputs: (i) NWP point forecasts; (ii) power-output point forecasts obtained by subjecting the NWP point forecast to a W2P model; and (iii) an ensemble of NWP forecasts.

5.2.1 Approaches Based on NWP Point Forecasts

The approaches described in this section (depicted in FIGURE 5-4) consist of either using the NWP forecast error as input for the uncertainty estimation method or computing the wind power uncertainty directly from the forecast of the NWP points.



FIGURE 5-4 Uncertainty Estimation Based on NWP Point Forecasts

A method that converts wind prediction errors into power output uncertainty relying on the derivative of the power curve is proposed by *Lange* in [154] and [275]. The conditional probability density functions are presented, and first the wind speed is considered to be an influential variable. The author found that the *pdf* of the measured wind speeds conditioned on the predicted wind speed were Gaussian, in the range of wind speeds that are relevant for wind energy applications.

In order to estimate the power forecast uncertainty, it is necessary to take the following points into account: (i) the predictability of the weather situation must be assessed/classified; and (ii) the uncertainty of the wind power output must be computed.

For the first step, the author focuses on the relation between the actual weather situations, classified by a suitable set of meteorological variables, and the corresponding prediction error of the NWP. The most important advantage with this approach is that the occurrence of the error forecasts can be easier understood in terms of meteorological phenomena. The forecast error is further analyzed quantitatively and related to different meteorological situations. An automatic classification scheme based on the weather variables was implemented. Furthermore, PCA was used to reduce the data to the most relevant patterns. Then, typical uncertainty forecasts of wind speed can be assigned for each meteorological condition.

In the second step, the author analyzes the non-Gaussian characteristics of wind power production, taking the nonlinear characteristics of the wind power curve into account. To map the wind speed to power intervals, a local derivative of the power curve is used, confirming that small errors in wind speed prediction are being amplified by local power curve derivatives. The output power uncertainty is provided by the product between the wind speed uncertainty and the local derivative of the power curve at the point of the forecasted wind speed.

This work proves that the accuracy of the wind speed prediction of the NWP depends on the prevailing weather conditions and that this effect can be quantitatively described. In particular, it was possible to confirm that dynamic low-pressure situations are on average related to a significantly larger forecast error, when compared to rather stationary high-pressure situations.

This uncertainty estimation method is the same used by the WPF system, Previento.

Bremnes [264] used a local quantile regression to compute quantiles of wind power generation. In quantile regression [276] applied to WPF, the aim is to forecast the wind power generation quantiles based on information about explanatory variables x (e.g., NWP forecasts). For wind power, the dependence may not be described by a simple polynomial. However, when close to a given x , the dependence must be simple enough so that it is possible to apply quantile regression to data points close to x . Local quantile regression allows data points close to x to cause more impact than those further away by weighting the data points accordingly. Local quantile regression estimates one quantile at a time, and the operation is repeated if several quantiles are interesting. However, quantiles may cross and constitute invalid distributions. Thus, it is necessary to impose constraints on quantiles.

Bremnes [277] presents a comparison of three statistical approaches: (i) local quantile regression; (ii) local Gaussian modeling; and (iii) the *Nadaraya-Watson* estimator [278].

Local Gaussian distribution is fully characterized by the mean and the variance. Therefore, the mean and variance of Gaussians are calculated from a linear combination of the known variables (predictors). The Gaussian assumption is rarely appropriate for forecasting power production, and a transformation of the measurements is usually applied through logistic, *probit*, or *arcsin* transformation. The *Nadaraya-Watson* estimator for conditional cumulative distribution functions provides estimates of a *cdf* at a set of given thresholds. Taking the threshold for energy production into consideration, the probability of production is directly provided either by an indicator variable (1 if true, 0 otherwise) or by a known *cdf*.

The conclusions of the work do not show strong preference for any of the statistical methods mentioned above. At the same time, the results indicate that the local Gaussian approach is not capable of producing bimodal distributions, besides having registered slightly worse results than the other approaches. The main advantage of the *Nadaraya-Watson* estimator is that it is simple and easy to implement.

5.2.2 Approaches Based on Power Output Point Forecasts

The approaches described in this section consist of forecast uncertainty based on the WPF errors, as depicted in FIGURE 5-5. However, these approaches can also use NWP point forecasts. The uncertainty estimation model is placed after the model that produces wind power forecasts.

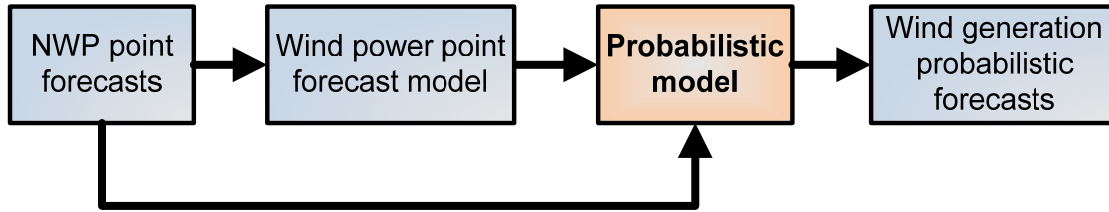

FIGURE 5-5 Uncertainty Estimation Based on Power Output Point Forecasts

One of the approaches used to provide situation-dependent uncertainty assessments separates the WPF errors into classes on the basis of explanatory variables of the forecasting problem. Then, standard deviation (or other moments) of prediction errors can be computed for these predefined classes. One example of this method is presented by *Bludszuweit et al.* [267]. The authors presented a method that consists of dividing the forecast into 50 power classes or bins and modeling the distribution of measured power within each forecast bin with the Beta *pdf*. It is possible to obtain the forecast error *pdf* when the power *pdf* associated to each bin is provided. It was found that the Beta distribution provides reasonably accurate results. However, it leads to an underestimation of the occurrence of the largest errors.

The main drawback with this approach is deciding on the number of classes and their width, as well as the discontinuities that are caused by the shifts from one class to another.

Pinson [88] uses the fuzzy inference model to determine the distributions of forecast errors associated with power output forecast. Each forecast's contribution to the total probability distribution is weighted. The weights are obtained by fuzzy inference. *Pinson* then applies adapted resampling. Generally, resampling is a process that uses the information from individual samples to draw alternative scenarios. *Pinson* applies adapted resampling to generate alternative scenarios of power production, and this way, it is possible to change the weights obtained by fuzzy inference. The quantiles of combined probability distribution are then calculated. The method is considered to be adaptive because the weights of each error sample are time dependent. Taking uncertainty into consideration, the contribution of *Pinson's* thesis is related to development of an on-line method that focuses on prediction of (nonstationary, nonlinear, and bounded) time-series based on "dressing" the point forecasts with weights obtained with the resampling. Another advantage of *Pinson's* uncertainty estimation is its independence on the point forecast model.

Nielsen et al. [207] presented a linear quantile regression with the base functions formulated as cubic B-splines relying on several explanatory variables in order to obtain the 25% and 75% quantiles of the forecast errors. The authors modeled each quantile as a sum of the nonlinear smooth functions of NWP forecasts and the forecasted wind power generation. Spline bases are used to approximate each of the smooth functions as a linear combination of base functions.

Several explanatory variables were tested in the proposed model. As expected, the forecast wind power output is the variable with larger impact on the model. The authors

concluded that the effect of the forecast time horizon was small, and the dependence on the air density seemed to be negligible. The authors also tested the inclusion of the MRI in the model (described in Section 5.1.2) estimated with lagged forecasts. The MRI seems to have only a slight impact on the model, and its effect is comparable to the time horizon effect.

The authors reported some problems with this method. Since several variables and spline bases are being used, may be causing some quantiles to cross. In order to estimate each quantile, it is necessary to use a separate model, and therefore quantile crossing may also occur. To solve this problem, their recommendation is that one should: "...start with the median (50% quantile) and find solutions to successive lower and higher quantiles under the restriction that the quantile does not cross." They also stated that another solution is to estimate the full distribution or, in other words, estimate the *pdf* instead of a set of quantiles. The authors argue against using local regression methods with a large number of explanatory variables because the model becomes less local as the number of variables increases. This uncertainty estimation approach was implemented in the Danish WPPT/Zephyr.

Møller [279] and *Møller et al.* [280] described the combination of the simplex method and an updating procedure for a time adaptive quantile regression combined with spline basis function. The simplex algorithm is used to solve a linear programming problem in which the knowledge about the solution at time t is used to compute the quantiles at time $t+1$. Assuming that the optimal solution at time step t was found, then, with the newly arrived information, the simplex algorithm iterates to the optimal solution of time step $t+1$. For instance, if wind power forecast data arrive every 15 min., then it is possible to update the solution when a new observation becomes available. This method allows the computational effort to be reduced and the computation speed to be increased.

The results are promising. *Møller* also proposes a method to avoid quantile crossing, stating that calculating several quantiles together becomes computationally expensive.

Juban et al. [266] present two nonparametric methods to forecast wind power uncertainty. The first method computes the complete wind power *pdf* instead of computing quantiles. The method is based on kernel density estimation (KDE) to compute the future conditional *pdf* of the wind generation for look-ahead $t+k$, taking the information available at time step t into consideration. The KDE computes smooth density estimation from data samples by placing, in each sample point, a function that represents its contribution to the density. The *pdf* is obtained after all these contributions are summed up. Because KDE gives unbounded densities, the resulting *pdf* is further corrected for boundaries, and a smoothing factor is applied.

The main advantage of the *pdf* estimation is its ability to identify multi-modal *pdfs* with various local maximums.

The second method, called quantile regression forests (QRFs) [281], is adapted from Random Forests [141], which relies on classification and regression trees. QRFs are a generalization of random forests, and thus they provide a nonparametric way of estimating conditional quantiles for high-dimensional predictor variables.

The paper [266] also had other contributions, such as the input selection for the problem of estimating uncertainty. The authors tested a methodology developed by *Bonnlander* [282] that is based on high-dimensional mutual information. The authors derived the following conclusions from 16 potential input variables: (i) wind speed and direction are the core relevant variables, with information content around 45% and 15%, respectively; (ii) the temperature at level 850 hPa has comprehensible information below 10%; (iii) all other variables do not depend on wind power generation; (iv) the levels closest to the wind turbine height (50 m) have slightly more information than the other levels (10 m); and (v) the information content decreases as the time horizon increases.

Juban et al. [262] compared KDE, QRFs, linear quantile regression (used as a reference), and B-spline quantile regression. The first stage of the comparison process was carried out by using point NWP forecasts. Then, the selected models used ensemble NWPs as input. The results for three French wind farms showed that all three models have similar performance levels and improve over the reference model. The authors also performed a deterministic comparison, computing the NMAE of the point forecast from the probabilistic model. All methods presented a significant improvement over persistence, and their performances were similar as well.

5.2.3 Approaches Based on NWP Ensembles

This section includes approaches that use NWP ensembles as inputs. The basic idea of the ensembles is that the inherent properties of the NWP can be used to assess the “predictability” of the forecast situations. There are two main approaches to obtain ensembles of NWP forecasts: using (i) different runs of the NWP systems (different initial conditions or numerical representations of the atmosphere [stochastic physics] are used in each run); and (ii) outputs of different NWP forecast models or different forecasts made at different times.

It is important to highlight that the ensemble members generated with the first approach are supposed to be statistically indistinguishable and equiprobable. On the other hand, the ensembles produced by the second approach should provide different statistical properties.

Generally, studies confirm that NWP ensembles cannot be used directly for probabilistic estimation because they do not possess good probabilistic properties. It is thus necessary to perform a calibration step to obtain such properties.

Juban et al. [262], in their survey about uncertainty estimation approaches, reported three different classes of methods to obtain probabilistic forecasts from NWP ensembles: (i) filtering approach; (ii) dimension reduction approach; and (iii) direct approach. Moreover, hybrid methods comprising ideas from more than one class of methods can also be found in the literature. In the filtering approach (FIGURE 5-6), wind NWP ensembles are converted into power ensembles when each ensemble member passes through a point forecasting W2P model. Either a single W2P model is applied to all the NWP ensemble members, or a different W2P model is applied to each NWP ensemble member. When multi-model NWP ensembles are used, a different W2P model is generally used for each member because the members have different statistical properties. Then, several approaches can be used to combine the power ensembles.

One example is the procedure presented by *Nielsen et al.* [181], already mentioned in Section 4.1.2.2. This multi-model ensemble approach is the one used by the WEPROG WPF system, as described in Section 4.2.1.9.

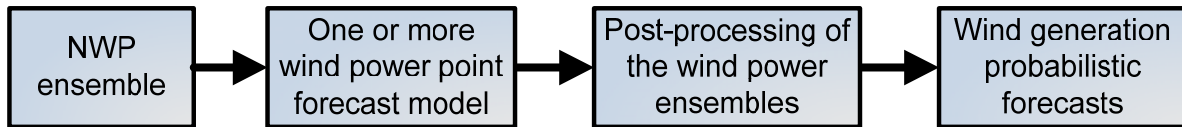

FIGURE 5-6 Uncertainty Estimation using Ensembles and the Filtering Approach

Juban et al. [262] stressed that this approach leads to an underestimation of the global uncertainty because it does not reflect the model uncertainty. In fact, it only reflects input uncertainty. With this approach, only the NWP forecast error is taken into account. The uncertainty associated with the power curve, however, is not taken into account.

Moreover, it is also necessary to calibrate the power output ensembles. Some authors use post-processing methods to convert uncalibrated power ensembles into probabilistic forecasts. This approach can be found in *Nielsen et al.* [206].

In this work, forecasts of nominal quantiles are derived from the power ensemble forecasts for every horizon and forecast. The data are then grouped so that the frequencies in ensemble forecasts are compared with the corresponding nominal quantiles. Two dependencies are observed in the work: a smooth dependence of the frequency on the nominal probability, and a fluctuating dependence of the actual frequency on the horizon. The dependence of the nominal probability is modeled as a cubic spline. The coefficients of the spline are estimated nonparametrically as smooth functions of the time horizon.

Logit-transformation is used to restrict the forecasted probabilities to unit intervals. Finally, an estimation is performed by using local regression with a fixed bandwidth and a tricube weight function. The authors show that it is possible to obtain reliable forecasts, stressing, however, that the model needs to be regularly calibrated. Therefore, the authors suggest the use of adaptive (e.g., automatically recalibrating) models.

Taylor et al. [283] present a generalized autoregressive conditional heteroskedasticity (GARCH) modeling approach using both Gaussian and empirical distributions to derive uncertainty. GARCH models have been used to determine the conditional variance. GARCH components make it possible for variance to evolve in an autoregressive manner over time. A seasonal dependence was used by applying a seasonal version of ARMA-GARCH, and seasonality was modeled as a quadratic function. The authors use a unique power curve model to filter 50 ECMWF ensemble members. The square root of the wind speed ensemble forecasts is used for calibration. Both the level and the spread are rescaled because the authors' analysis revealed a bias in the mean and in the variance of ensemble members. Kernel density estimation is applied in order to smooth the histogram of calibrated ensemble members. Finally, kernel

smoothing and the calibration are jointly estimated with the use of a maximum likelihood approach. While the work reveals the need for calibration techniques, it also considers that ensembles are more accurate than point forecasts.

Nielsen et al. [284] and *Giebel et al.* [285] present the results of three years of extensive research on wind power prediction using ensemble forecasting. The conclusions confirm that NWP are the main sources of errors in power predictions. Transformations of the calculated power are needed to force the power curve estimate to span the full range of possible levels of power production. The authors used a logarithmic transformation and considered that the estimation of a power curve does not depend on the time horizon. The authors stress in particular the need to adjust the ensemble percentiles to percentiles of the observed distribution because of the fact that the ensemble spread itself is not probabilistically correct. ECMWF and NCEP ensemble performance have been compared, and ECMWF ensembles have shown slightly better results, although the difference is small.

In [286], *Pinson and Madsen* present a technique for probabilistic forecasting of wind power production based on kernel dressing. The kernels are dressed with equal weights. However, if multiple-model ensembles are to be used, the authors propose dressing the kernels with different weights. The NWP are perceived as the main source of errors. However, the authors claim that a specific method for offshore wind power forecasting might be necessary, taking the effect of wakes into account, as well as wind speed and direction. In the work, *Pinson and Madsen* use a mean-variance model for kernel parameters, stating that there should be further developments in the area of adaptive weighted decomposition of the overall skill.

Möhrle [65] compares deterministic forecasts with various horizontal resolutions to ensemble forecasts with multi-model ensemble prediction systems. *Möhrle* claims that increasing horizontal resolutions does not reduce forecasting errors and that an ensemble-based approach may be a better choice. *Möhrle* uses a simplified power conversion module and identifies the main sources of prediction errors, in addition to presenting an ensemble-based method to reduce these errors based on a 50-member MSEPS.

The dimension reduction approach (FIGURE 5-7) consists of reducing the input dimensionality and then feeding the reduced inputs to a probabilistic prediction model. An example of dimension reduction is presented in [287], where *von Bremen* uses a principle component regression algorithm on two ensemble forecast models (ECMWF and HIRLAM). An NN is later used to calculate the power output and to model an MOS. *von Bremen* shows that the combination of the two models outperforms each of the single models. In [288], *von Bremen et al.* also applied the PCA algorithm to ECMWF ensembles' forecasts.

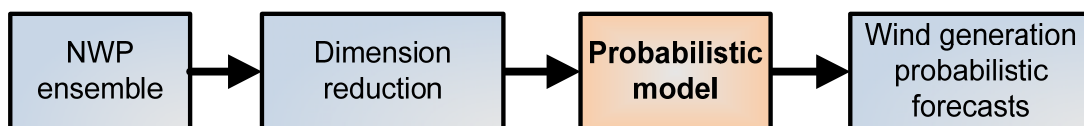

FIGURE 5-7 Uncertainty Estimation Using Ensembles and the Dimension Reduction Approach

If the probabilistic model is a quantile regression, *Bremnes* [264] suggests the following approach for the occasions when NWP ensembles are used as inputs:

“...first sort the ensemble members with respect to wind speed and then use the ensemble member that corresponds to the quantile of interest as predictor. For example, if 100 ensemble members are available and sorted in an increasing order, then, say, the 25th ensemble member could be used in predicting the 25 percentile of power production.”

The direct approach (FIGURE 5-8) consists of feeding the wind ensemble NWP directly to a probabilistic model. The main problem with this approach is the *curse of dimensionality*. With a high number of variables, the model’s complexity (number of parameters) increases. Therefore, several strategies have been proposed to overcome this problem, such as regularization techniques, random input selection (stemming from random forests), or dimension reduction.



FIGURE 5-8 Uncertainty Estimation Using Ensembles and the Direct Approach

Besides presenting a comprehensive overview of point and ensemble-based methods, *Juban et al.* in [262] present an evaluation of these methods on three French wind farms using ensemble NWP forecasts as inputs. The direct and the reduction approach were tested by the authors using KDE and QRFs as probabilistic models. The following inputs were used to feed the probabilistic forecasting models for dimension reduction: (i) mean and variance; and (ii) median and median absolute deviation. Two approaches were used for the direct approach in order to avoid the *curse of dimensionality*: (i) a KDE implementation that has the same parameter values for all ensemble members as the input ensemble members are statistically indistinguishable; and (ii) a QRF with a random input selection step.

The two probabilistic models with the different configurations were compared in two ways: (i) a deterministic evaluation with point forecasts obtained from the probabilistic forecasts; and (ii) a probabilistic forecast that used the indices to be described in Chapter 5. The main conclusions were: (i) the proposition that, even though NWP are a main source of error in WPF, using ensembles leads to relatively small improvements in most cases when compared to NWP point forecasts; (ii) similar improvement could be achieved if the ensemble mean was used instead of all ensemble members; and (iii) the results of the different models and confirmation were similar.

Hybrid approaches use techniques from more than one class of techniques. *Gneiting et al.* [289] present a technique that is used to model the predicted distribution as a Gaussian, where

the mean is computed directly as a linear combination of ensemble members, and the variance is computed by using a dimension-reduction approach. Because the Gaussian is used, this approach is unable to produce multi-modal distribution. Therefore, the authors stated that an ensemble smoothing technique should be used.

5.3 EVALUATION OF PROBABILISTIC FORECASTS

Evaluating classic point forecasts basically consists of assessing the deviation or discrepancy between the forecasted and the real value, as presented in Section 2.2. Evaluating probabilistic forecasts is, however, more difficult. In fact, an individual probabilistic forecast cannot be deemed as incorrect. The following example illustrates this statement: a probabilistic forecast states that the expected power generation for a given horizon is between 1 and 1.6 MW with 50% probability, and the actual outcome becomes 0.9 MW. The probabilistic forecast only covers 50% of the cases — and it is not possible to tell whether or not this particular case belongs to the cases missed by the prediction intervals.

Therefore, a specific framework to evaluate wind power probabilistic forecasts should be devised. *Pinson et al.* [290],[291] presented one evaluation approach. The evaluation set consists of a series of quantile forecasts for unique or varying nominal proportions and observations (measured values). The presented classification can be unconditional, but because several variables might influence the quality of intervals, the evaluation can also become conditional in order to reveal the influence of such variables.

There are several frameworks for interval forecast evaluation in the econometric forecasting community [292],[293] that are based on testing the hypothesis of correct conditional coverage of prediction intervals. Such a framework has been introduced to test the one-step-ahead prediction intervals. This is equivalent to testing the correct unconditional coverage of the intervals and their independence.

However, in wind power forecasting one has to consider multi-step-ahead predictions where there is a correlation among forecasting errors. This correlation is mainly the result of inertia in meteorological prediction uncertainty. If the wind power prediction method features an autoregressive part, it will also contribute to the correlation of errors for successive look-ahead times. Hence, using the methods that rely on the assumption of independence is not a good choice for the evaluation of wind power predictions — the correlation inflates the uncertainty of the estimate coverage of actual intervals.

5.3.1 Reliability

An obvious requirement for probabilistic forecasts is that the nominal probabilities — or nominal proportions of quantile forecasts — are indeed respected in practice. Obviously, this cannot be assessed on a single evaluation, so an evaluation set should have a significant size. Forecasted probabilities should asymptotically approach the observed probabilities. In other words, in an infinite series of interval forecasts, empirical coverage should equal the

pre-assigned probability exactly. This property is commonly referred to as reliability [294] or calibration.

In statistics, the difference between empirical and nominal probabilities is considered the bias of the probabilistic forecasting method. Therefore, being unbiased, reliability translates to the probability forecasts. Bias values are usually calculated for each quantile nominal proportion. However, care must be taken when evaluating reliability: it is not advisable to average the bias over the quantiles. Quantiles below 50% might, for instance, lead to an overestimation, and quantiles above 50% might lead to an underestimation, while the average bias of such prediction would be close to 0. Therefore, for example, simply checking the nominal coverage of intervals for interval forecasts is not sufficient, and it is necessary to verify that both quantiles defining the interval are not biased.

To evaluate quantile forecasts, it is necessary to define the indicator variable. An indicator variable for a quantile forecast $\hat{q}_{t+k|t}^\alpha$ is:

$$\xi_{t,k}^\alpha = \begin{cases} 1 & \text{if } p_{t+k} \leq \hat{q}_{t+k|t}^\alpha \\ 0 & \text{otherwise} \end{cases}.$$

The indicator variable refers to the actual outcome of p_{t+k} at time $t+k$ — that is, whether the quantile covers the actual outcome (“hit”) or not (“miss”).

Obviously, the aforementioned method can also be applied to the evaluation of intervals of probabilistic distribution. The intervals are defined by quantiles: a central prediction interval, with a nominal coverage rate $1-\beta$, estimated at time t for lead time $t+k$ is bounded with $\beta/2$ and $1-\beta/2$ quantiles of the predictive distribution:

$$\hat{I}_{t+k|t}^{(\beta)} \equiv \left[\hat{q}_{t+k|t}^{(\beta/2)}, \hat{q}_{t+k|t}^{(1-\beta/2)} \right].$$

Therefore, if the method is applied directly to prediction intervals, it is necessary to check whether the value of p_{t+k} lies inside the boundaries and is included in the prediction interval.

Furthermore, these indicators are defined as follows:

$$n_{k,1}^\alpha = \#\{\xi_{t,k}^\alpha = 1\} = \sum_{t=1}^N \xi_{t,k}^\alpha$$

$$n_{k,0}^\alpha = \#\{\xi_{t,k}^\alpha = 0\} = N - n_{k,1}^\alpha,$$

that is, as sums of hits and misses, respectively, for a given horizon k over N realizations.

A common way of checking reliability is to compare the empirical to the nominal coverage by using the indicators mentioned above, that is:

$$\hat{a}_k^\alpha \equiv E[\xi_{t,k}^\alpha] = \frac{1}{N} \sum_{t=1}^N \xi_{t,k}^\alpha .$$

This way, the estimation \hat{a}_k^α of the actual coverage \hat{a}_k^α for a given horizon k is obtained, using the test set of N realizations. This approach is often used to create reliability diagrams. Reliability diagrams allow the calibration of several quantiles (or intervals) to be summarized, giving, at the same time, an overview of whether a particular method systematically underestimates or overestimates uncertainty.

5.3.2 Sharpness and Resolution

Besides providing reliability requirements, probabilistic predictions should also provide users with situation-dependent assessments of uncertainty prediction. Therefore, the size of predictions should vary according to external conditions. In the case of wind power prediction, an intuitive requirement is that prediction intervals do not have the same size when the wind speed is zero, such as is the case when it is near to cut-off speed.

The sharpness of probabilistic forecasts is defined in meteorological literature as the ability that the forecasts have of deviating from climatological mean probabilities, where resolution [295] represents the ability to provide different conditional probability distributions, depending on the level of the predictand. It is important to highlight that if the probabilistic forecast has perfect reliability, the common viewpoint in meteorological literature is that resolution and sharpness are equivalent.

The evaluation of reliability and sharpness presented in [291] derives from a more statistical point of view, focusing on the shape of predictive distributions. In this case, resolution is considered to be the ability to provide a probabilistic forecast conditional to forecast conditions. For weather-related processes, such as wind-generation, in addition to the level of the predictand, some other explanatory variable (e.g., wind direction) may also have an influence on prediction uncertainty. Sharpness is then perceived as the property of concentrating the probabilistic information about the future outcome. This definition is the result of reliable predictive distributions with null width, corresponding to perfect point predictions.

Let $\delta_{t+k|t}^{(\beta)} = \hat{q}_{t+k|t}^{(1-\beta/2)} - \hat{q}_{t+k|t}^{(\beta/2)}$ be the size of central interval forecast with nominal coverage rate $1-\beta$ estimated at time t for lead time $t+k$. A measure of sharpness could then be provided as an average size of intervals:

$$\bar{\delta}_k^{(\beta)} = \frac{1}{N} \sum_{t=1}^N \delta_{t,k}^{(\beta)} .$$

Having a set of quantile forecasts in pairs, it is possible to summarize sharpness with diagrams, with $\bar{\delta}_k^{(\beta)}$ being the function of nominal interval size. This measure was used by *Bremnes* [264] and *Nielsen et al.* [296].

Resolution is the ability to provide a situation-dependent assessment. Therefore, if two approaches have similar sharpness, then a higher resolution translates a higher quality of related interval forecasts. Even though verifying this property is not directly possible, variation in interval size can be related to it. Because of the strong nonlinearity and heteroskedasticity of wind-generation processes, forecast uncertainty is highly variable, and thus it is expected that interval sizes also vary greatly. Therefore, taking a given horizon and nominal coverage rates into account, an approach that has higher standard deviation of interval sizes has a better resolution.

A nuance of difference between sharpness and resolution is provided here. Sharpness is related to the average size of prediction intervals, whereas resolution is measured with the variability of their size. Visualizing these two indices is equivalent to visualizing reliability: mean and variance diagrams can be presented, where resolution and sharpness are presented as functions of nominal coverage rate.

Juban et al. [262] reached an important conclusion:

“The results obtained through the different approaches revealed that a trade-off has to be accepted between reliability and sharpness...improving the reliability will generally degrade the sharpness and vice-versa.”

5.3.3 Unique Skill Score

A unique skill score is often demanded in order to provide the entire amount of information about a given method's performance. This means that a scoring rule exists that associates a single numerical value to a predictive distribution. Even if sharpness and resolution are intuitive properties, they can only be exploited in a diagnostic manner. A proper scoring rule allows the prediction method to be evaluated.

$$Sc(\hat{f}', \hat{f}) = \int Sc(\hat{f}'(p), p) \hat{f}(p) dp$$

is the score under \hat{f} when the predictive distribution is \hat{f}' . In other words, the abovementioned value is the prediction score when the predicted distribution is \hat{f}' , and the materialized probability density function is \hat{f} . Therefore, a scoring rule is proper if:

$$Sc(\hat{f}', \hat{f}) \leq Sc(\hat{f}, \hat{f}) \quad \forall \hat{f}', \hat{f} .$$

A scoring rule is *strictly* proper if the equation above holds with equality exclusively:

$$\hat{f}' = \hat{f} .$$

The scoring rule should reflect the forecaster's judgment. In other words, with a proper scoring rule, a higher score value means that the probabilistic forecast has a higher skill level.

Scoring rules of the following form:

$$Sc(\hat{f}', p) = \sum_{i=1}^m [\alpha_i s_i(\hat{q}^{(\beta_i)}) + (s_i(p) - s_i(\hat{q}^{(\beta_i)}))] \xi^{(\beta_i)} + h(p) ,$$

where $\xi^{(\beta_i)}$ is the indicator variable for quantile with proportion β_i , s_i are non-decreasing functions, and h is arbitrary, are proper for evaluating a set of quantiles. This is a positively rewarding score in which a higher score means that the skill level is higher. Additionally, the aforementioned score is a generalization of several scoring schemes available in the literature.

An important observation is that it is only possible to compare competing prediction approaches if a proper skill score is used. While scoring rules encompass all the aspects of probabilistic forecast evaluation, deeper analysis is still needed to observe the contributions provided by reliability and sharpness. A single numeric value given by a unique score cannot distinguish the contributions that reliability or sharpness/resolution can bring to the skill level, that is, a score according to the aforementioned equation cannot be decomposed, and its contributions of reliability or sharpness cannot be analyzed.

5.4 SYNTHESIS ABOUT UNCERTAINTY IN WPF

Probabilistic forecast [88]: Probabilistic forecasting consists of estimating the future uncertainty of wind power that can be expressed as a probability measure. A more complete characterization of the conditional distribution is provided by probabilistic forecasts.

Risk indices [269]: Risk indices provide information about the expected level of forecast accuracy. They reflect the spread of an ensemble of wind power forecasts for a single look-ahead time or over a forecast period.

Scenarios of generation [270]: Scenarios contain information about the forecasted density/cumulative probability functions for the time horizon, and provide information about the development of the prediction errors through the set of look-ahead times and the spatial distribution.

TABLE 5-1 summarizes the different types of uncertainty representation in WPF.

TABLE 5-1 Different Types of Uncertainty Representation

Uncertainty Representation	
Probabilistic	Quantiles
	Interval Forecasts
	Probability Mass Function
	Probability Density Function
Risk Indices	Meteo Risk Index
	Prediction Risk Index
	Scenarios with temporal dependency
Scenarios of Generation	Scenarios with spatial/temporal dependency

TABLE 5-2 summarizes the different approaches to estimate WPF uncertainty.

TABLE 5-2 Different Approaches for Uncertainty Estimation

Approaches	Description
<pre> graph LR A[NWP point forecasts] --> B[Probabilistic model] B --> C[Wind generation probabilistic forecasts] </pre>	<p>In the <i>NWP point forecast approach</i>, either the NWP forecast error is used as input or the wind power uncertainty is directly computed from the NWP points forecast (e.g., local quantile regression), presented by <i>Bremnes</i> [264].</p>
<pre> graph LR A[NWP point forecasts] --> B[Wind power point forecast model] B --> C[Probabilistic model] C --> D[Wind generation probabilistic forecasts] C --> B </pre>	<p>The <i>power output point approach</i> consists of forecasting uncertainty based on the WPF errors and NWP point forecasts. The probabilistic model is placed after the model that produces wind power forecasts (e.g., adapted resampling), presented by <i>Pinson</i> [88].</p>
<pre> graph LR A[NWP ensemble] --> B[One or more wind power point forecast model] B --> C[Post-processing of the wind power ensembles] C --> D[Wind generation probabilistic forecasts] </pre>	<p>In the <i>filtering approach</i>, wind NWP ensembles are converted into power ensembles, in which each ensemble member uses a single or different point forecasting model. It is also necessary to calibrate the power output ensembles with post-processing methods. This approach can be found in <i>Nielsen et al.</i> [206].</p>
<pre> graph LR A[NWP ensemble] --> B[Dimension reduction] B --> C[Probabilistic model] C --> D[Wind generation probabilistic forecasts] </pre>	<p>The <i>dimension reduction approach</i> consists of reducing the input dimensionality and then feeding the reduced inputs to a probabilistic model (e.g., PCA algorithm), used by <i>Bremen et al.</i> in [288]. The dimension can also be reduced to the ensemble mean and variance.</p>
<pre> graph LR A[NWP ensemble] --> B[Probabilistic model] B --> C[Wind generation probabilistic forecasts] </pre>	<p>The <i>direct approach</i> consists of feeding the wind ensemble NWP directly into a probabilistic model; for example, <i>Juban et al.</i> in [262] described a quantile regression forest with a random input selection step.</p>

6 REQUIREMENTS AND PRE-REQUISITES FOR WPF MODELS

In general, the requirements and pre-requisites for WPF are similar and independent of the site-specific characteristics. While the specifications and recommendations in this chapter are based mainly on experience from Europe, their application can be extended to U.S. sites. Although the same general recommendations apply, the models must always be parameterized and tuned to the site-specific characteristics. The specific characteristics of the WPF models are related with the user requirements and with the specific data availability for each application case. These issues will be addressed in detail in this chapter.

6.1 GENERAL REQUIREMENTS OF THE FORECASTING TOOL

6.1.1 Selecting the Model

The requirements of WPF tools are conditioned by type of model and classified by the inputs used. Forecasting tools with denser time-frame resolution, shorter refreshing times, and extended look-ahead times generally have higher costs and require more data and more computational resources. Thus, selecting a minimum level of complexity required for the forecast use is advisable.

While detailed requirements for WPF and the usage of WPF in operation and decision-making depend on the end-user, uncertainty generally plays an important part in information obtained by WPF. Forecasts quantifying uncertain information can be more efficiently integrated in decision support and risk management processes.

The basic classification of wind prediction end-use specifics and requirements is related to the details of a particular power market. However, a generic representation of entities interested in wind power forecasting can be stated. Some of the possible WPF end-users are:

- Independent power producers — generation companies (wind power plant operators),
- Wind farm owners,
- System operators (ISOs/RTOs/TSOs),
- Market operators, and
- Regulators.

The WPF models could be classified as those using:

- Only SCADA data (S): applicable only for very-short-term applications, with a time horizon less than 6 hr. These models do not include NWP forecasts.
- NWP regional models refreshed with SCADA data (R NWP/S): applicable for short-term forecasting problems with typical horizons of between 3 and 24 hr.
- NWP regional models without refreshment of SCADA data (R NWP): applicable for short-term forecasting problems with typical horizons of between 12 and 72 hr. For these models, the SCADA information is not useful, and consequently, the complexity of integrating this information could be avoided.
- NWP global models (G NWP): applicable for medium-term forecasting problems with typical horizons of between 72 and 168 hr. These global models are less accurate; however, they are the only ones capable of producing forecasts for these horizons.

The type of model must be selected according to the application. TABLE 6-1 shows the several uses of forecasts and the time frame model characterization. The use of WPF among system operators in the United States is further discussed in Chapter 7.

6.1.2 General System Requirements

The system could be a desktop forecasting tool to be installed in the user's platform, or it could be a forecasting service. Some utility users that need more complete output forecasts need to integrate the forecast results in their modules (e.g., integrating uncertainty forecast in UC or ED).

Some users need to receive and concentrate a lot of confidential information (e.g., market data or SO management). In these cases, the users need the forecasting tool in their platform. However, this arrangement implies the existence of a professional forecasting structure that is expensive and difficult to maintain and update. For these cases, the forecasting tool platform should be compatible with all platforms on which the client platform is capable of running, as well as with the user database technologies and interfaces with the related SCADAs.

Another consideration has to do with the decision about whether to use a centralized or decentralized forecasting system. A centralized system has some advantages: it is more cost effective and has the ability to be more consistent and efficient in the use of source information. The decentralized wind forecasting system is justifiable when several actors are involved and when the confidentiality of information and the distribution of forecasting costs are needed. The centralized system, when using the same data detail, could achieve better accuracy than the decentralized system. However, some centralized systems, because of the complexity and

volume of data, use less detailed information on local specific characteristics and therefore do not reach the maximum possible levels of accuracy for the forecasting system.

TABLE 6-1 Various Wind Power Forecasting Applications

Time Horizons ^a	GENCOs	ISO/RTO/TSO
S models (H up to 6 hr) (S – 10 min.) (R 10 to 60 min.)	Intraday market (1hr)	Ancillary services management (10 min.)
	Real-time market (1hr)	Unit commitment (up to 3 hr)
	Ancillary services management (10 min.)	Economic dispatch (up to 3 hr) Congestion management (up to 3 hr)
R NWP/S models (H up to 72 hr) (S – 30 min.) (R 30 to 60 min.)	Intraday market (3 hr to 24 hr)	Unit commitment (3 hr to 12 hr)
	Wind farm and storage devices coordination (3 hr to 72hr)	Economic dispatch (1 hr to 12 hr) Congestion management (1 hr to 12 hr)
	Maintenance planning of wind farms (3 hr to 12 hr)	
R NWP models (H up to 72 hr) (S – 60 min.) (R 12 hr)	Day-ahead market (>12 hr)	Maintenance planning of network lines (12 hr to 72 hr)
	Maintenance planning of wind farms (12 to 72 hr)	Congestion management (12 hr to 72 hr)
		Day-ahead reserve setting (12 hr to 72 hr) Unit commitment and economic dispatch (12 hr to 72 hr)
G NWP models (up to 7 days) (H up to 7 days) (S – 60 min.) (R 24 hr)	Maintenance planning of wind farms (72 hr to 168 hr)	Maintenance planning of network lines (72 hr to 168 hr)
	Maintenance planning of conventional generation (72 hr to 168 hr)	

^a H – Horizon (hr); S – Time Step (min.); R – Refreshment (hr).

6.1.3 Source of Information and Input Data

Input data to a WPF tool require information from distinct sources. The set of information could differ for different types of users. This difference in requirements is related to the time frame of forecast, as well as to the trade-off between the value of forecast and the cost of data. The sources of data could be the following:

Historical data: data gathered from SCADA systems, NWP services, or any information provided by wind farm operators (WF operators) or obtained by a simulation of power production based on real historical meteorological time series.

On-line SCADA data: real-time data gathered from on-line generation measurements (updated every 5 min.–1 hr) and from climate variable measurements carried out at the meteorological stations. These data are available from wind farm owners (Wind Farm SCADA) and from utilities (Utility SCADA). These data, available on-line, can also be used as historical data for training and tuning models. On-line information could be artificially generated from past information with the use of persistence models, not only for power generation, but also for turbine and wind farm availability.

Forecast data: some forecasting models use forecasting outputs from other sources. NWP services are often used as inputs and are generally essential for wind power forecasting. Power forecasts from other sources could also be a useful input for some models. Region-level models, which are used by market and system operators, could incorporate forecasts from wind farm owners or from other utilities. For the first forecasting hours, the persistence from current power production and the availability of wind power plants also provide relevant information, which is extended from past observed data.

Persistence data: a reference forecast (Ref. forecast) for some reference wind farm could also provide useful information for benchmark processes.

The models with highly detailed information use wind turbine detail data (TABLE 6-2). These models could integrate detailed information associated with the terrain, as well as with the physical and operational features of the wind turbine. These models have the potential to be more accurate because they use more information. However, the greatest advantage is the fact that with these models, it is possible to directly model the availability of the wind turbines and other operational characteristics.

TABLE 6-2 Input Data Needed to Carry Out Forecasts — Wind Turbine Detail Level

Data	Historical	On-line	Forecast	Source
Wind Speed	Useful	Useful		SCADA
Wind Direction	Essential		Essential	NWP services
	Useful	Useful		Meteorological station
Temperature	Useful	Useful		Meteorological station
Pressure	Important		Important	NWP services
Humidity				
Power Production	Essential	Important		WF SCADA
Turbine Availability	Essential	Important		WF SCADA
	Important		Essential	WF Operator

TABLE 6-3 shows input data needed for WPF at the wind farm level.

TABLE 6-3 Input Data Needed to Carry Out Forecasts — Wind Farm Detail Level

Data	Historical	On-line	Forecast	Source
Wind Speed	Useful	Useful		SCADA
Wind Direction	Essential		Essential	NWP services
	Important	Important		Meteorological station
Temperature	Useful	Useful		Meteorological station
Pressure	Useful		Useful	NWP services
Humidity				
Power Production	Essential	Important		WF SCADA
	Important	Important		Utility SCADA
			Useful	Reference forecast
Turbine Availability	Essential	Essential		WF SCADA
	Essential		Essential	WF Operator

TABLE 6-4 highlights input data needed to generate regional forecasts.

TABLE 6-4 Input Data Needed to Carry Out Regional Forecasts

Data	Historical	On-line	Forecast	Source
Wind Speed Wind Direction	Essential		Essential	NWP services
Temperature Pressure Humidity	Useful	Useful		NWP services
Power Production	Essential		Essential	WF forecasts
	Important		Important	Utility forecast
	Essential	Important		Utility SCADA
			Useful	Reference forecast
Wind Farm Availability	Essential	Essential		Utility SCADA
			Essential	WF Operator

Static data: also essential elements in creating the structures and training the forecasting models (TABLE 6-5). While these data are usually static, sometimes there are changes that must be communicated to the forecasting service provider so that it is possible to reformulate and retrain the WPF models.

TABLE 6-5 Static Data for WPFs

Level of Detail	Level of Detail		
	Wind Turbine	Wind Farm	Regional
Terrain Modeling Data	Essential	Essential	Useful
Terrain Roughness, Information about Obstacles	Useful	Useful	
Wind Farm Capacities		Essential	Important
Wind Farm Layout	Essential	Essential	
Power Curve Information	Useful	Useful	Useful
Wind Turbine Location	Essential	Useful	
Wind Turbine Characteristics	Essential	Essential	
Location and Characteristics of Meteorological Station	Important	Important	
Wind Farm Locations	Essential	Essential	Useful

Metadata: this data, including communication protocol and interface data definitions, are also important pieces of information that must be agreed upon between WPF providers and users (TABLE 6-6).

TABLE 6-6 Metadata for WPFs

Level of Detail	Level of Detail		
	Wind Turbine	Wind Farm	Regional
Database Format, Database Access Rights	Essential	Essential	Essential
Import and Export Formats	Essential	Essential	Essential
SCADA Formats	Essential	Essential	Important

6.1.4 Output Data

The outputs of forecast services could be as follows:

- **Meteorological forecasts** (e.g., wind speed, wind direction, temperature pressure humidity) could be useful for wind farm operators, although it is generally considered secondary information.
- **Point power forecast** is the main output of WPF services. Generally, the output is only the active power forecast. The output forecast is an average value for the defined time step. The power forecast service could be distinguished by time frame: horizon, refreshment rate, and time step.
- **Uncertainty forecast** is another important output. In most applications, the uncertainty output is more important than the point forecast without uncertainty estimation. The uncertainty output could be modeled as probability distribution parameters, confidence intervals, quantile intervals, or even scenario simulations.
- **Ramp forecast** could be very important for generation scheduling and system operation. Ramp forecasts provide information about time variation on wind power productions, as well as on slope and timing of the variation.

- **Extreme wind event forecast** is also an interesting output that forecasts the impacts of storm fronts or the steep ramps of power production caused by fast variations in wind speed or by wind speed in the cut-off region of the power curve.

The geographical resolution of the forecast is associated with the type and aggregation of equipment. Higher-resolution models are associated with the representation of more detailed equipment (e.g., wind turbine), thus including more information in the forecast model and providing more accurate forecasts. A lower resolution could be obtained by aggregating high-resolution forecasts or by using simplified models that use less detailed information as input. In both situations, upscaling decreases the error of the forecast. Aggregating high-resolution forecasts, on the other hand, provides more accurate forecast results. The several geographical resolution approaches could be set for:

- **Wind turbine power production** is useful for wind farm operators. By aggregating wind turbine forecasts, it is possible to obtain more accurate forecasts because the forecast structure integrates additional detailed information about the wind turbines' production features. On the other hand, this wind turbine (WT) forecasting approach is very intensive on a computational basis as it requires a large amount of data.
- **Wind farm power production** forecasts the output of the wind farm, aggregating the output information of several WT production levels and the availability of WTs, as well as the wind farm's losses and internal levels of consumption.
- **Wind farm clusters power production** provides a forecast for a cluster of neighboring wind farms. The aggregation of wind farms may make the forecasting process easier, requiring only information from some reference wind farms.
- **Regional power production** has a lower resolution level when compared to a wind farms cluster detail level. Hence, detailed information on wind farm production levels may not be needed. Results could be produced at a regional or even at a national level.

6.1.5 Time Frame

As far as the time frame is concerned, there are three characteristics that should be addressed:

- **The time horizon** is limited by the length of the NWP. The time horizon can be characterized as very-short-term (0 to 6 hr), short-term (0 to 72 hr) or medium-term (0 to 7 days) time horizons. These three time horizons require different sources of data and have different levels of resolution and accuracy.

Very-short-term predictions generally only use information from SCADA, while short-term could also integrate NWP data. Medium-term predictions additionally make use of data from global NWP models. It should be pointed out that longer horizon approaches can integrate shorter horizon predictions as information sources, thus becoming more accurate and complete.

- **The time step** defines the sampling density of the forecasting series. For short-term predictions, the time step could be of 10 to 15 min., depending on the time step adopted in the SCADA system. For medium and long-term predictions, the time step is 1 hr, which is the resolution of the NWP. It is possible to achieve higher-resolution times with an interpolation. However, this strategy does not add more information or accuracy to the forecast.
- **The refreshment of the forecast** is possible and recommended when new information is received. Updating information from SCADA is particularly useful in the first three hours. On the other hand, updating NWP and WT availability is useful at all times. Typically, SCADA measurements can be refreshed every 10 min., while NWP can be refreshed every 6 or 12 hr. The refreshment implies the existence of overlapping forecasts. Although generally more recent forecasts are also more accurate, the first hours of NWP are not necessarily the most accurate since the forecast ability is optimized for the medium term (6 to 48 hr ahead). In addition, this lack of accuracy is also attributable to the fact an estimate of initial conditions is used as input to the meteorological models, as opposed to a real snapshot of the initial state of the meteorological system.

6.1.6 Computational Methods and Methodology Requirements

The forecasting tool should implement state-of-the-art techniques in order to produce outputs that consist of state-of-the-art levels of accuracy.

The WPF tool should have some redundancy that can be achieved by integrating alternative prediction techniques, even simple ones such as persistence. The use of ensemble forecasting is a good option for ensembles of NWPs or even for the ensemble of final WPF models. However, the ensembles of models and information have additional costs that must be taken into consideration.

The forecasting system must integrate NWP information for forecasts with a time horizon of more than 3 hr. The forecasting performance of the NWP must be monitored frequently in order to detect changes in the forecasting environment that are not known by the knowledge base of the W2P models. Some changes that could occur in the NWP environment include:

- Changes in spatial resolution,
- Changes in the physical model parameterization, and
- Changes in the data used.

There could also be changes in the characteristics of the wind farm that could affect the W2P performance. When changes are detected, the W2P models must be retrained in order to adjust the knowledge base. On-line training methodologies that automatically mitigate these problems are recommended.

It is useful to consider several variables from the NWP system. However, wind speed and wind direction are the most important.

The availability of on-line measurements is useful because it allows prediction models to use this information as inputs and thus improve their accuracy in the very short term. This on-line information can come from the wind farm SCADA, utility SCADA, or meteorological stations scattered in the region.

6.1.7 Functionalities of the WPF

The WPF can have different kinds of useful functionalities, depending on the type of applications. However, some general functionalities are recommended:

- **Data preprocessing:** automatic modules to process data inputs (e.g., detecting availability or down-rating capacity).
- **Training functionalities:** modules that facilitate the selection of training, validation, and test datasets, as well as the selection of the training parameterization and models.
- **Performance monitoring:** functions that facilitate the comparison between historical predictions and current output data. The intention is to track the performance of the WPF.
- **Ability to insert new wind farms:** new wind farms require a different approach to build the W2P knowledge base. WPF should be capable of training the knowledge base on the basis of simulation data.
- **Definition of upscaling structures:** the aggregation of several wind farms could be carried out with several structures of cluster aggregation.
- **Multi-model functionality:** several models could be created and combined in order to provide parallel forecasting for the same wind farm or cluster.
- **Uncertainty modeling:** models that provide measures of uncertainty in addition to the point forecast. It can include probabilistic modeling, scenario modeling, and risk indexes.
- **W2P curve visualization:** useful for visually detecting unadapted W2P models or simply for visualizing the wind farm response.

6.1.8 GUI Requirements

A WPF system should include a graphical user interface (GUI) that meets the following requirements by providing:

- Web-based user interfaces
- Output display features that should:
 - Be intuitive and user friendly;
 - Allow the forecast data to be exported to files (e.g., *.csv, *.txt);
 - Display information clearly so that it is easy to read/understand the point forecasts for a configurable time horizon;
 - Provide the option to display/not display the probabilistic forecasts for a configurable time horizon and the possibility of choosing the quantile proportions;
 - Provide captions containing clear information about each displayed forecast;
 - Make it possible to choose dates;
 - Make it possible to display a rolling measure of forecast accuracy represented by statistical measures for point forecasts, as well as by reliability and sharpness for probabilistic forecasts;
 - Make it possible to display historical point and probabilistic forecasts;
 - Make it possible to see the forecast for each wind farm on a list (that could be a map), as well as to display the upscaling forecast for a selected region;
 - Make it possible to display the NWP forecasts (wind speed and temperature); and
 - Display the main characteristics of the wind farms: geographical region, installed capacity, maximum export capacity, available capacity, power curve, wind farm SCADA data, and availability;
- An option of outputting detailed reports in PDF format
- A dedicated environment to add and edit wind farms

- A dedicated environment to test the forecast models
- The Configuration panel that should:
 - Enable the configuration of point and probabilistic forecast parameters,
 - Enable the configuration of the output display,
 - Provide help and clear information for each option,
 - Allow the configurations to be restored to defaults, and
 - Include input and output file paths or communications.

6.1.9 User Documentation Requirements

The following documentation should be provided:

- **User guide:** The manual should include all relevant information on forecasts. The WPF system and set-up configurations should be according to the user preferences.
- **Methods guide:** The manual should include a survey of the methods available in the WPF system, as well as the outputs produced by each module. A mathematical description of each method may also be available in this manual.
- **Installation guide:** The manual should include all relevant information on the installation of the WPF system and on its integration with existing systems.
- **Maintenance operation and control guide:** The manual should include details on how to ensure a reliable operation and which precautions should be taken.

6.2 FORECAST EVALUATION AND BENCHMARK

The performance of the WPF systems is strongly related to several characteristics. Therefore, to evaluate the level of performance, the following characteristics must be taken into account:

- **Terrain complexity:** expressed by the RIX index, which reflects the slope of the terrain around the wind farm;

- Size of the wind farm: installed power, number of wind turbines, and wind turbine layout;
- Geographic location: offshore, onshore, or near shore;
- Quality of data: NWP forecast error, SCADA measurement error;
- Type of numerical weather predictions: mesoscale model, microscale model, spatial resolution;
- Type of the model: physical, statistical, hybrid;
- Site climatology conditions.

The selection of wind farms for model benchmarking must be made in a way that will make it possible to cover a wide range of the characteristics mentioned above. For model benchmarking, the following procedures must be employed:

- A common database for every WPF system (the same inputs), which includes wind and power measurements, as well as NWPs and information about each wind farm (digital terrain maps with elevation and roughness, wind farm layout, wind turbine power curves).
- A common forecast horizon for all test cases (must be selected because the models may have different forecast horizons).
- A training period for each test case for training the statistical models.
- A common time for forecast calculations (e.g., 8:00 a.m.).
- An independent testing period for each test case (at least one year). This test period must include different wind farm operation conditions, as well as different climatology conditions.
- A forecast error evaluation protocol for a standardized performance evaluation. Two approaches should be used for the evaluation protocol: (i) a measure-oriented approach where several statistical error measures, such as NMAE and NBIAS, are used (as described in Section 3.6 and in [85]); and (ii) a distribution-oriented approach that focuses on the analysis of the joint distributions of predictions and observations (as described in [88]).
- A reference WPF system that can be used for benchmarking with the new models instead of a naïve model (e.g., persistence).
- Probabilistic forecasts, which should be evaluated by using two measures: reliability and sharpness (as described in Section 5.3 and in [291]).

As previously stated in Section 4.3, the forecast error strongly depends on several factors. For instance, the average value of the NMAE ranged from between 10% for flat terrains to 21% for highly complex terrains. Therefore, it would be preferable to avoid comparing the models' performance with reference error values. The correct approach is to compare the models with a benchmark of WPF systems applied to the same location.

7 POWER SYSTEM OPERATIONS AND WIND POWER FORECASTING

In this chapter, we first outline the main steps typically involved in the short-term operation of power systems and electricity markets. We then discuss how wind power forecasting is currently used in operations, and how to improve the use of forecasts in different parts of the operational procedures. Our discussion is based on the operation of independent system operator/regional transmission organization (ISO/RTO) markets in the United States, where different regions of the country have seen a considerable degree of convergence in their electricity market design over the last several years. A table summarizing market operation and the current state of wind power forecasting for the Midwest ISO (MISO), New York ISO (NYISO), Pennsylvania-Jersey-Maryland Interconnection (PJM), Electric Reliability Council of Texas (ERCOT), and California ISO (CAISO) is provided at the end of the chapter in TABLE 7-1.

7.1 POWER SYSTEM AND ELECTRICITY MARKET OPERATIONS

7.1.1 Market Operations Timeline

A typical timeline for the operation of the market is shown in FIGURE 7-1. The procedures and timeline are based on the current rules in the MISO market. However, other markets are operated in a similar way, as summarized in TABLE 7-1. The main steps in the market operations, including determination of reserve requirements, day-ahead (DA) operations, and real-time (RT) operations, are discussed below. In the next section, we discuss how wind power forecasting can be used in the different parts of market operations.

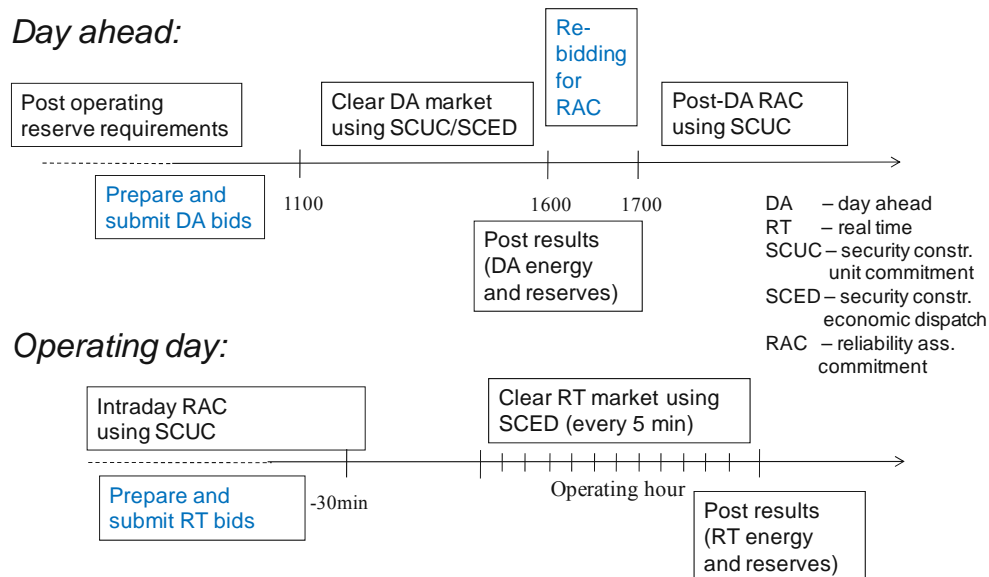

FIGURE 7-1 Market Operations Timeline for Midwest ISO

7.1.2 Reserve Requirements

It is necessary to maintain a certain amount of operating reserves in order to run the power system in a reliable and secure manner. The operating reserves are typically categorized into several types depending on how quickly they can respond to changes in the system (FIGURE 7-2). The regulating reserve responds immediately to generation adjustment needs in the system and is usually provided by generating units with automatic generation control (AGC) responding to frequency deviations in the network. The contingency reserves need to be able to respond within 10 min. and are used to respond to contingencies that may occur, such as forced outages of generators or transmission lines. The contingency reserve can be split into spinning and supplemental (non-spinning) reserves. It is common in U.S. markets that both generation and demand resources can provide operating reserves.

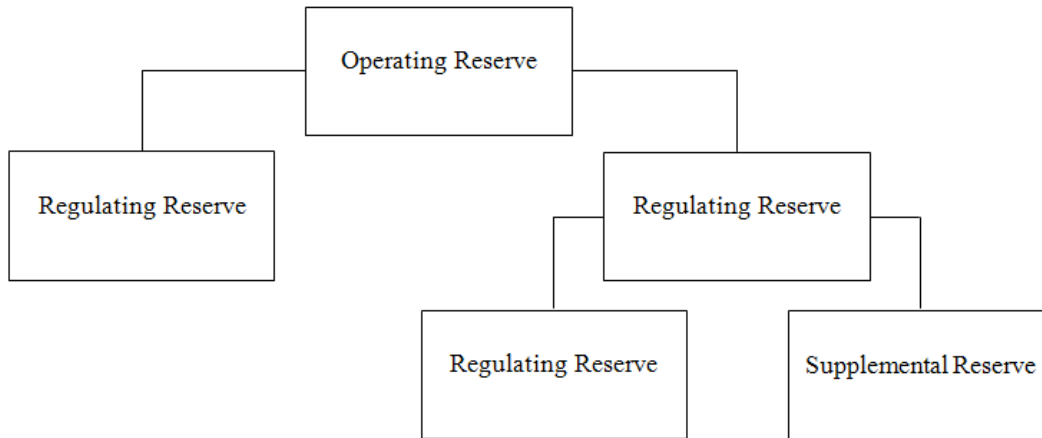

FIGURE 7-2 Typical Categories of Operating Reserves

The requirements for operating reserves in U.S. power systems are based on standards determined by the North American Electric Reliability Corporation (NERC) [297]. The ISOs/RTOs are required to maintain sufficient regulation to meet NERC’s criterion for area control error (ACE). The ACE is a measure for the deviation between scheduled and realized exchange from a balancing authority area and is defined as “the instantaneous difference between net actual and scheduled interchange, taking into account the effects of Frequency Bias including correction for meter error” [297]. The requirement for contingency reserves is usually based on the N-1 rule, that is, sufficient contingency reserve must be held to cover “the loss of generating capacity due to forced outages of generation or transmission equipment that would result from the most severe single contingency” [297]. In addition, at least half of the contingency reserve must be spinning. These are the minimum requirements set by NERC. However, regional variations exist, and some ISOs/RTOs use more stringent requirements for their operating reserves. In systems with large and congested networks, it is also common to specify regional reserve requirements, in addition to the system-wide criteria. It is also

interesting to note that some markets have introduced use of a demand curve for different types of operating reserves rather than following the traditional fixed requirements. As an example, MISO determines the number of reserve zones and their boundaries on a quarterly basis. A stepwise demand curve for operating reserves is in place for each individual zone, in addition to the system-wide demand curve for operating reserves [298].

Operating reserve requirements may be updated to accommodate changes in the system conditions. The update frequency varies between different markets (seasonal, monthly, and daily updating). However, the requirements for the next operating day must at least be posted before the operation of the DA market starts.

7.1.3 Day-Ahead Operations

At the DA stage, market participants (from the demand and supply side) must submit their bids to the ISO/RTO by a certain deadline. The actual bidding deadline varies between different markets, as shown in TABLE 7-1. The bids of the market participants must reflect how much energy and operating reserves they can provide. Information on unit commitment constraints (ramping rates, start-up costs/times, minimum down-time, etc., for generating units) is also provided to the ISO/RTO.

The clearing of the DA market for energy and reserves is a two-stage procedure. First, a security-constrained unit commitment (SCUC) is run to commit resources in the DA market. The objective of the SCUC is to minimize the operating costs while meeting the total demand bid into the market and also the unit commitment constraints (start-up time, minimum up/down time, ramp rates, etc.). Hence, the optimization problem includes integer variables. Mixed integer linear programming, or MILP, is typically used to solve the resulting large-scale SCUC problem. The unit commitment problem is discussed in greater detail in Chapter 8. The next step in the market clearing is to run a security-constrained economic dispatch (SCED) algorithm, which is based on the commitment schedule from the SCUC. The SCED is formulated as a linear programming routine, and locational marginal prices (LMPs) are calculated from the energy balance constraints in each of the transmission nodes. It is important to note that the LMPs cannot be derived from the SCUC optimization because it is a mixed integer problem. Transmission constraints are also sometimes simplified or omitted from the SCUC formulation in order to be able to solve the complex problem in reasonable time. In contrast, the transmission constraints are always included in the SCED formulation, although usually with a simplified linear representation (e.g., DC-OPF).

In most U.S. markets, the SCUC/SCED procedure co-optimizes energy and operating reserves (TABLE 7-1). The output from the DA market clearing therefore includes schedules for both energy and operating reserves. In addition, LMPs are derived for each transmission node, and market clearing prices are also calculated for each category of operating reserves. The prices are used in the financial settlement of the DA market. Note that currently, most intermittent resources are typically not bidding into the DA market but are being handled as price-takers in the RT market.

After the clearing of the DA market and before the start of the operating day, the ISO/RTO usually performs a revised commitment with focus on reliability. The post-DA reliability assessment commitment (RAC) is also performed with SCUC. However, the demand bids that are used to clear the DA market are now replaced with the forecasted load for the next day. In addition, the status of generating units may have changed as a result of forced outages. The ISO/RTO may therefore decide to change the commitment schedule from the DA market clearing on the basis of the results from the RAC. Rules are typically in place to make sure that committed generating resources recover all of their operating costs. This arrangement may sometimes require side-payments in addition to the regular payments based on the market clearing prices to enable recovery of no-load costs, start-up costs, etc.

7.1.4 Real-Time Operations

During the operating day, the RAC is repeated as needed in order to adjust the commitment to accommodate changes in the operating conditions (forced outages, deviations from forecasted loads, etc.). At the same time, market participants can bid their remaining resources into the RT market. The deadline for submitting bids to the RT market varies quite widely between different markets (TABLE 7-1).²⁷ During the operating hour, the ISO/RTO uses SCED to dispatch the system. At the same time, RT prices for energy (LMPs) and operating reserves are calculated. The frequency of the RT dispatch is now 5 min. in most ISO/RTO markets (TABLE 7-1). The variations in load that are not taken care of by the 5-min. dispatch signals are handled through regulation reserves and AGC. Therefore, if wind power adds more variability and uncertainty in the very short term (i.e., within each dispatch interval), it may become necessary to increase the amount of regulation reserves in the system.

Conventional power generation sources are typically penalized if they deviate from their RT dispatch signals. However, so far renewable generation such as wind power has not been given dispatch signals from the ISO/RTO. Wind power has therefore typically been exempt from RT deviation penalties [299], and the majority of the wind power generation is settled at the RT price in the ISO/RTO market clearing.²⁸ However, this may change as the ISOs/RTOs are working on improving the integration of wind power into their operating procedures for the DA and RT markets.

7.2 WIND POWER FORECASTING IN SYSTEM OPERATIONS

Next, we discuss to what extent wind power forecasts are currently used in electricity market operations and identify important areas of improvement. A brief summary of the current status and development of wind power forecasting among selected U.S. ISOs/RTOs is provided at the end of this chapter in TABLE 7-1.

27 Some ISO/RTOs, like NYISO and CAISO, also have a formal hour-ahead market.

28 Note that the power from most new wind power projects is typically sold on long-term power purchase agreements (PPAs). This arrangement hedges the wind farm owner from fluctuations in DA and RT prices.

7.2.1 Current Status

There is a relatively short history of wind power forecasting among ISOs/RTOs in the United States. CAISO was the first ISO/RTO to start using WPF for system operation when it introduced forecasting as part of its Participant Intermittent Resource Program (PIRP) in 2004 [300]. MISO, NYISO, and ERCOT all introduced centralized wind power forecasting in 2008, whereas PJM is implementing its forecasting system in 2009.

Wind power forecasting is used for different purposes, as summarized in TABLE 7-1. The planning horizon ranges from several days ahead to RT operations. In the course of this review, we found areas of application ranging from transmission outage planning, transmission security, and peak load analysis to reliability unit commitment, hour-ahead market bidding, and real-time commitment and dispatch. The wind power forecasts are used as input to some of the procedures for system and market operations outlined in Section 7.1. However, the ISOs/RTOs have limited experience in this area so far and are continuously working on improving and automating the use of wind power forecasting in DA and RT operations.

A common problem is obtaining sufficient real-time weather and wind power generation data that is of good quality. This input is important for improving the wind power forecast quality. Some ISOs/RTOs are therefore introducing mandatory data reporting requirements for wind power producers, with penalties for noncompliance.

7.2.2 Areas for Improvement

The need for wind power forecasting in power system operations is obviously dependent on the amount of wind power capacity in the system. However, given the rapid increase in wind power generation in many areas of the United States, it is quickly becoming important for ISOs/RTOs to efficiently utilize the information provided by advanced wind power forecasting models. The need to revise current operating procedures and integrate wind power forecasting into system operation has also been emphasized by NERC's Integration of Variable Generation Task Force in a recent report [5].

In general, wind power forecasting can potentially provide important information to several of the main procedures involved in power system operations (FIGURE 7-3). Some important areas for improving the use of wind power forecasting in power system operations are briefly discussed below, with a focus on operating reserve requirements, unit commitment, and dispatch methodologies.

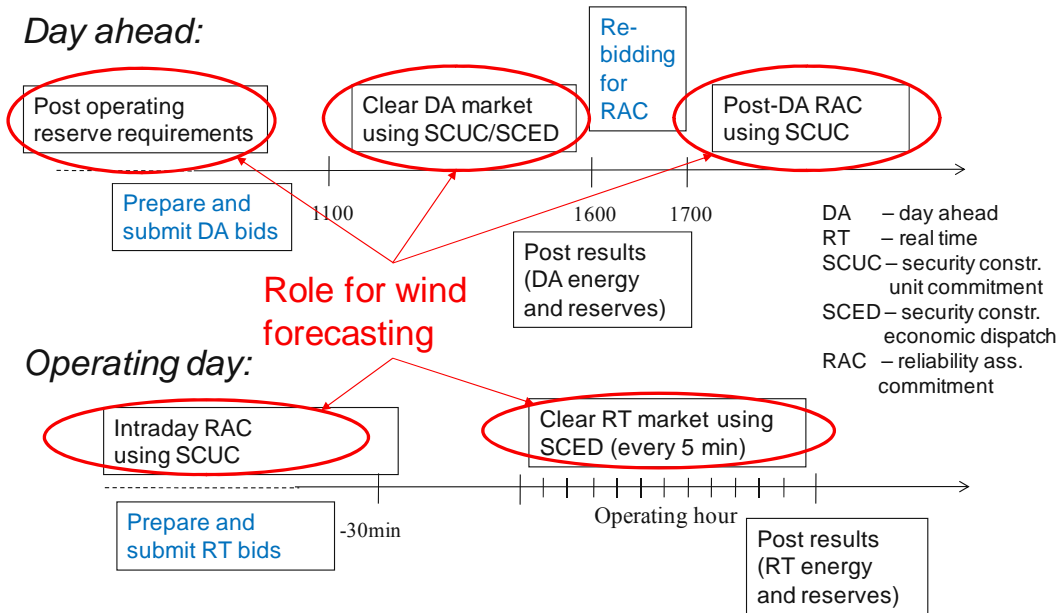

FIGURE 7-3 Role of Wind Power Forecasting in Power System Operations

7.2.2.1 Operating Reserves

The additional uncertainty and variability caused by an increasing penetration of wind power generation raise the question of whether current requirements for operating reserves are adequate.

The need for regulation reserve may increase because of the short-term variations in wind power generation, which may influence the ability to control the ACE. Nevertheless, the short frequency of RT dispatch in most ISO/RTO markets (5 min.) limits the magnitude of variations that must be handled through regulation services and AGC. An increase in contingency reserves may also be necessary to counter large-scale wind power down-ramping events.

Ongoing research is addressing the optimal determination of reserve requirements under high penetration of wind power, as further discussed in the next chapter (Section 8.2.2). Because wind power forecasting models now are able to produce probabilistic estimates for the wind power generation, the uncertainty information from the forecast could potentially be used in determining the operating reserves requirements. Consequently, the operating reserve requirement could depend on the forecasted level and uncertainty in wind power generation for the next day. This method would require that operating reserve requirements are determined more frequently and closer to real time than what is typically the case today.

Among ISOs/RTOs in the United States, it is interesting to note that ERCOT is already considering wind power penetration and forecasting uncertainty in its determination of requirements for regulation and non-spinning reserves [301],[302]. ERCOT is currently the ISO/RTO with the highest share of wind power in its footprint (TABLE 7-1), and this

circumstance may explain why it is the first to introduce changes in its reserve requirements to accommodate wind power generation.

7.2.2.2 Unit Commitment

UC decisions are obviously of major importance for the reliability and cost efficiency of power system operations. The generation from wind power plants and the information in wind power forecasts should therefore be efficiently integrated into the UC problem, both at the day-ahead stage and in the reliability commitment adjustments that take place closer to real time. Traditionally, UC is formulated as a deterministic optimization problem. However, the additional uncertainty from wind power generation makes considering alternative formulations relevant.

Several different approaches have been proposed in the recent literature to address uncertainty in wind power generation in the unit commitment problem (e.g., *Bart et al.* 2006 [303]; *Bouffard and Galiana* 2008 [304]; *Wang et al.* 2008 [305]; *Ruiz et al.* 2009 [306]; *Tuohy et al.* 2009 [307]). Preliminary results indicate that stochastic UC models can play an important role in reducing costs while maintaining system security under increased uncertainty and variability. However, more research is needed into developing and testing stochastic models for UC. At the same, there is a need to improve understanding about how wind power forecasting errors (e.g., magnitude and phase errors) are likely to influence reliability and cost in the power system but under the traditional deterministic UC formulation and with stochastic alternatives. In addition, it is important to consider the close interaction between operating reserve requirements and unit commitment policy. A more comprehensive discussion of the influence of wind power on the UC problem is provided in Chapter 8.

So far, it appears that the U.S. ISOs/RTOs are focusing on how to integrate the information in wind power forecasts into the reliability commitment, which takes after the clearing of the day-ahead market. The RAC is obviously important to address reliability, and the reliability commitment will also influence RT prices. However, it is also important to integrate the information in wind power forecasts into the DA market clearing. Wind power will have an increasing impact on the marginal cost of electricity generation, and this impact should be properly reflected in the DA market clearing, where most of the energy is settled. Ideally, the forecast information should be reflected in the DA bids from wind power producers. However, given that only a small share of the wind power generation typically participates in the DA market, it may be necessary for the ISO/RTO to use information from its own centralized forecasting system as input to the DA market clearing. However, it is not clear how this step can be implemented without distorting market prices and incentives. In the long run, it is hoped we will see that more wind power producers participate in the DA market and have the incentives to bid according to their best forecasting information.

An important challenge is how to consider the uncertainty information in the wind power forecast in the DA operating procedures. An interesting approach is taken by ERCOT, which is currently using an 80% exceedance forecast for wind power generation as input to their DA resource planning procedures [302]. However, ERCOT does not currently have a DA market, so the DA planning is geared more toward reliability than economics.

7.2.2.3 Real-time Operations and Wind Power Control

Efficiently integrating wind power into RT dispatch is also important. Short-term wind power forecasts, which have relatively low uncertainty, should be taken into account in the ISOs/RTOs' RT SCED. At the same time, with increasing market penetration of wind sources, it is important that the ISO/RTO be able to control the generation from wind power plants and enforce curtailment of wind power generation in situations where this limit is needed, either from an economic or reliability perspective. Modern wind power plants include a number of features that make them appear similar to conventional dispatchable power plants, including reactive power contribution, voltage regulation, disturbance ride-through, grid frequency response, smoothing wind ramps, and controlled start-up/shut-down. It will be increasingly important that system operators take advantage of these features in RT dispatch and operations.

The U.S. ISOs/RTOs are working on integrating wind power forecasts into their dispatch procedures. CAISO is already requiring wind power plants participating in PIRP to bid into their hour-ahead market according to a short-term wind power forecast. Rules are also in place to limit the deviation charges for wind power, which are based on monthly net deviations and monthly average prices [308]. An interesting development currently is taking place in NYISO, which is introducing new rules to incorporate wind power in their SCED [309],[310]. With the new rules, wind power plants will be required to bid into the RT market as flexible units. During unconstrained hours, wind power plants can operate freely. However, in constrained situations, wind power plants will be directed to reduce output when the clearing price at their locations falls below their economic bid. Penalties will be introduced for exceeding the dispatch instructions. The new procedure will ensure that the economic preferences of the wind power producers are reflected in the SCED and that wind curtailment can be performed more efficiently. It will also contribute to a more efficient overall dispatch and reduce the need for using out-of-market actions to maintain system reliability. PJM is in the process of introducing similar rules for dispatch of wind power, along with its new wind power forecasting system [311]. Other ISOs/RTOs may be persuaded to consider similar measures to improve the handling of wind power resources in the RT dispatch.

7.3 WIND POWER AND FORECASTING IN U.S. MARKETS — OVERVIEW TABLE

TABLE 7-1 provides an overview of electricity market operations and the current status of wind power forecasting in five ISO/RTO markets — MISO, NYISO, PJM, ERCOT, CAISO — in the United States.

TABLE 7-1 Overview of Market Operation and Wind Power Forecasting in Five U.S. Electricity Markets

	MISO	NYISO	PJM	ERCOT	CAISO
Peak load	109,157 MW (7/31, 2006)	33,939 MW (8/2, 2006)	144,644 MW (8/2, 2006)	62,339 MW (8/17, 2006)	50,270 MW (7/24, 2006)
Installed capacity	Ca. 127,000 MW	Ca. 39,000 MW	Ca. 163,000 MW	Ca. 71,000 MW	Ca. 58,000 MW (including imports)
Wind capacity (at end of 2008)	Ca. 4,000 MW	Ca. 1,275 MW	Ca. 2,050 MW	Ca. 8,000 MW	Ca. 2,500 MW
Pricing and congestion management	LMP	LMP	LMP	Zonal (LMP to be introduced)	LMP
Reserve requirements	<ul style="list-style-type: none"> – Based on NERC standards. – Demand curve for reserves. – Zonal reserve requirements. – Demand can participate in all markets. – Requirements updated daily. – Published 2 days ahead. – Wind not directly considered. 	<ul style="list-style-type: none"> – Based on NERC standards. – Demand curve for reserves. – Zonal reserve requirements (3 zones). – Demand can participate in all markets. – Requirements updated monthly. – Wind not directly considered. 	<ul style="list-style-type: none"> – Based on NERC standards. – Regulation: 1% of peak load (hrs. 5–24), 1% of valley load (hrs. 0–5). – Zonal reserve requirements. – Demand can participate in all markets. – Wind not directly considered. 	<ul style="list-style-type: none"> – Using own requirements, similar to NERC. – System-wide requirements. – Updated monthly. – Wind and forecast error considered for regulation and non-spinning. 	<ul style="list-style-type: none"> – Based on Western Electricity Coordinating Council criteria and NERC standards. – Regional requirements enforced (up to 8 regions). – Published 2 days ahead. – Wind not directly considered.
DA ^a market	Energy + regulation, spinning, supplemental reserves co-optimized	Energy + regulation, spinning, supplemental reserves co-optimized	Energy + supplemental reserves co-optimized	No energy but regulation, spinning, supplemental, replacement reserves	Energy + regulation, spinning, supplemental reserves co-optimized
RT ^a market	Energy + regulation, spinning, supplemental reserves co-optimized	Energy + regulation, spinning, supplemental reserves co-optimized	Energy + regulation, spinning reserves co-optimized	Energy balancing market	Energy + regulation, spinning, supplemental reserves co-optimized

TABLE 7-1 (Cont.)

	MISO	NYISO	PJM	ERCOT	CAISO
Market timeline	<p>DA offers due: 11:00 a.m.</p> <p>DA results: 4:00 p.m.</p> <p>Re-bidding due: 5:00 p.m.</p> <p>RT offers due: OH^a – 30 min.</p>	<p>DA offers due: 5:00 a.m.</p> <p>DA results: 11:00 a.m.</p> <p>RT offers due: OH – 75 min.</p>	<p>DA offers due: 12:00 noon</p> <p>DA results: 4:00 p.m.</p> <p>RT offers due: 6:00 p.m. (DA)</p>	<p>DA bids due (reserves): 1:00 p.m./ 4:00 p.m.</p> <p>DA results (reserves): 1.30 p.m./ 6:00 pm</p> <p>RT offers due: OH – 60 min.</p>	<p>DA offers: 10:00 a.m.</p> <p>DA results: 1:00 p.m.</p> <p>RT offers: OH – 75 min.</p>
RT dispatch frequency	5 min.	5 min.	5 min.	15 min.	5 min.
Centralized unit commitment procedure	Yes. SCUC used DA, post-DA, and intra-day, as needed.	Yes. SCUC used DA and 75 min. before RT (results 45 min. before RT).	Yes. SCUC used DA, reliability UC, post-DA, and intra-day, as needed.	No. Will be introduced with nodal market.	Yes. SCUC used DA, HA, ^a and for RT operations.
Wind forecasting	<p>In operation since 2008:</p> <ul style="list-style-type: none"> – 90+ nodes included. – Transmission outage coordination. – Wind impact tool for ramp event impact on flowgates. – Transmission security and peak load analysis. – Input to reliability UC. 	<p>In operation since 2008:</p> <ul style="list-style-type: none"> – DA forecast twice daily (4:00 a.m., 4:00 p.m.). – RT forecast every 15 min. – Reliability pass of DA SCUC. – Real-time commitment and dispatch. – Wind plants required to provide meteorological data to NYISO. 	<p>Forecasting system is being introduced in 2009:</p> <ul style="list-style-type: none"> – Four types of forecasts (short, medium, long, ramp). – Each wind farm required to provide information from one meteorological tower. 	<p>In operation since 2008:</p> <ul style="list-style-type: none"> – Updated hourly. – 80% exceedance forecast used for DA planning. 	<p>Introduced in 2004:</p> <ul style="list-style-type: none"> – Next hour, next day, extended. – Part of PIRP. – Used in HA market, as PIRP participants must bid forecast. – Wind plants required to provide meteorological data to ISO.

TABLE 7-1 (Cont.)

	MISO	NYISO	PJM	ERCOT	CAISO
Wind forecasting developments	<ul style="list-style-type: none"> – Automated procedure for use in system operations. – Required participant provision of DA forecasts. 	<ul style="list-style-type: none"> – Wind plants required to bid into RT markets (DA optional). – Bids included in RT dispatch to improve efficiency. – Penalties for exceeding base points. – Ramping alert system. – More/better data from plants. – Evaluating needs for operating reserves. 	<p>Planned use:</p> <ul style="list-style-type: none"> – Reliability assessment (DA and RT). – Unit commitment (DA and RT). – Ancillary services (regulation, contingency). – Rules for wind power plant bidding, dispatch, and control being introduced. 	<ul style="list-style-type: none"> – To be fully integrated in DA and RT operations in new nodal design to be introduced at the end of 2010. 	<ul style="list-style-type: none"> – Improving data quality. – Improving forecast quality. – Integrate forecast into new MRTU market design, including DA operations.
Imbalance settlements for wind power	Most wind settled at RT price. No deviation penalties.	No penalties for deviation from schedule in RT (3,300 MW exempt from penalties).	Wind usually settled at RT price.	Settled at real-time zonal energy price. No deviation penalties.	Deviations netted over month at average price. No deviation penalty (PIRP).
Sources	[298], [299], [312]	[309], [310], [313], [314], [315]	[299], [311], [316], [317]	[299], [301], [302], [318], [319]	[299], [300], [308], [320], [321]

^a DA: day-ahead, HA: hour-ahead, MRTU: Market Redesign and Technology Update, RT: real-time, OH: operating hour.

This page is intentionally blank.

8 WIND POWER AND THE UNIT COMMITMENT PROBLEM

The Obama Administration has put renewed emphasis on renewable generation. Broad use of renewable generation is crucial to realizing national energy independence and addressing climate change. A report published by DOE last year described a scenario in which 20% of the United States electricity consumption would come from wind energy by 2030 [322]. High penetration of renewable generation such as wind has posed great challenges to power system operators in grid management and generation scheduling. The inherent intermittency and variability of renewable resources such as wind require that current industry practices, such as unit commitment (UC) and dispatch, be altered to accommodate large amounts of renewable generation, as discussed in Chapter 7. While extensive research exists on how to formulate and improve the general UC algorithm, the unit commitment research that considers uncertain wind power is limited. The survey conducted here focuses in particular on how wind forecasting can be incorporated into the unit commitment and economic dispatch (ED) problem.

The review is organized as follows: Section 8.1 gives a general definition of unit commitment and dispatch. Section 8.2 reviews the current research in integrating wind into the UC and ED algorithms. A summary of the chapter and future work are described in Section 8.3.

8.1 DEFINITION OF UC

The unit commitment problem is the centerpiece of market clearing in many electricity markets in the United States, as discussed in Chapter 7. In those markets, generation companies send their bids (i.e., generation quantities and prices) to the ISO. The associated information on unit constraints is also provided to the ISO. Then, the ISO runs a security-constrained unit commitment (SCUC) to clear the market and send dispatch signals to those units.²⁹ The objective of the SCUC is to obtain a unit commitment schedule at minimum production cost without compromising the system security [323]. The constraints in SCUC typically include load balance, reserve requirements, ramp rate limits, minimum up and down time limits, and network constraints. Because some types of units, such as coal and nuclear, need some time to start up and shut down, the SCUC is normally carried out in the day-ahead market to clear the market. Closer to real time, the SCUC is run mainly for reliability assessment purposes. In comparison, the security-constrained economic dispatch, or SCED, only schedules the on-line units without changing their commitment (on/off) statuses.

SCUC and SCED are defined by MISO as follows [324]:

SCUC: “A computer program that uses an algorithm over a multi-hour time horizon that minimizes the offered Start-Up and production costs, while respecting the physical operating characteristics of each selected Resource and Transmission System constraint.”

²⁹ The SCUC can also be used by a utility in the traditional scheduling regime, in which the generation bids are replaced by the production costs.

SCED: “An algorithm performed by a computer that simultaneously clears Bids and Offers, including Self-Schedules and Dispatchable Physical Bilateral Transaction Schedules, submitted to: (i) supply to, and purchase Energy from, the Day-Ahead Energy Market; and (ii) determine Dispatch Instructions for the Real-Time Energy Market.”

A typical market operation timeline is shown in Figure 7-1 in Chapter 7. It can be seen that both SCUC and SCED are executed to clear the day-ahead market, while SCUC is run in the real-time market and post-DA period on an as-needed basis for reliability assessment. Compared to SCUC, SCED is run more frequently in the RT market, usually every 5 min. in the U.S. ISO/RTO markets (TABLE 7-1).

A generalized SCUC formulation is shown in Figure 8-1:

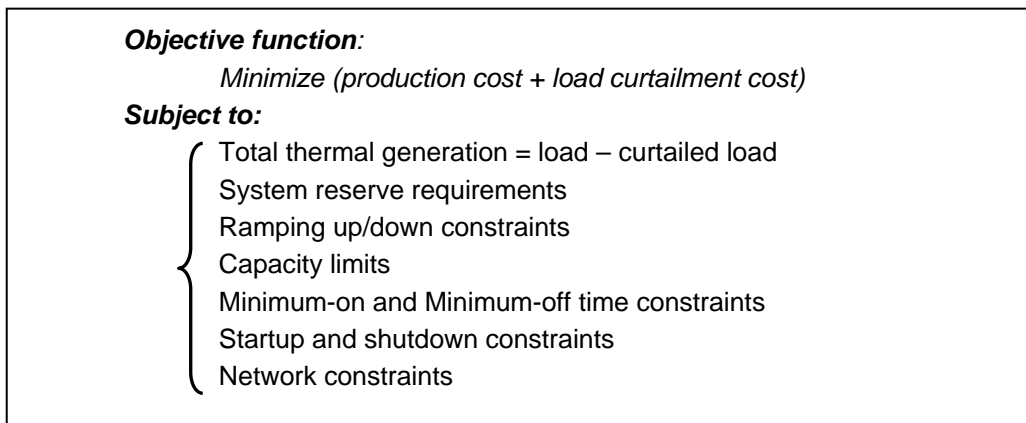

FIGURE 8-1 Generalized SCUC Formulation

The objective function in Figure 8-1 is composed of fuel costs for producing electric power, startup and shutdown costs of individual units over the scheduling horizon, and load curtailment cost. The hourly UC constraints include the system power balance constraints, system reserve requirements, unit ramping up/down limits, unit minimum-on and minimum-off time limits, unit generation limits, and network constraints, which could be alternating current (AC)- or direct current (DC)-based. A detailed mathematical formulation is provided in Chapter 9. Because of the unique requirements and scheduling focus in the individual market, there are different variants of the SCUC formulation. In some cases, contingencies are included in the SCUC formatulion. Some constraints in the above formulation can also be extended to include more details. For instance, the system reserve requirements are categorized into zonal regulation, spinning, and supplemental reserve requirements in the MISO reserve market. On the basis of their response time to the system component outages and deviation in load balancing, various resources from both generation and demand sides can bid to participate in the reserve market. By linearizing the nonlinear constraints, such as production cost function and start-up cost function, the above formulation can be transformed into a mixed-integer linear programming problem. There are optimization techniques available to solve this type of problem. Such techniques include Lagrangian relaxation, computational intelligence, and MILP, among

which MILP has been broadly adopted by the industry because of its efficiency and accuracy. We list below several representative modeling approaches that are the major references to our modeling formulation in the next chapter.

Carrion and Arroyo [325] proposed a computationally efficient mixed-integer linear formulation for the thermal unit commitment problem. The algorithm is an improvement over an earlier paper by *Arroyo and Conejo* [326]. Only one integer variable is used to formulate ramping up/down constraints and minimum-on and minimum-off time constraints. With fewer binary variables and constraints, the computational performance is greatly improved. The formulated problem is then solved by calling on commercially available solvers, such as CPLEX [327]. Intensive testing is performed to justify the efficiency of the proposal algorithm. The data is provided by *Kazarlis et al.* [328]. The formulation does not model transmission lines and other types of units, such as hydro.

Fu et al. [329] provide a complete formulation of AC-constrained SCUC formulation. The approach applies Benders decomposition to separate the unit commitment problem and network security check problems. The master unit commitment problem is solved by Lagrangian relaxation and dynamic programming, while the network security check subproblem examines whether obtained power flow converges. A six-bus system and an IEEE 118-bus system are used to exhibit the effectiveness of the proposed algorithm.

8.2 INTEGRATION OF WIND POWER INTO UNIT COMMITMENT

High penetration of wind power has tremendous impact on unit commitment. Unlike other conventional and controllable generation sources, wind power is unpredictable and intermittent. The *uncertainty* and *variability* of wind power require the current SCUC and SCED algorithms to be revised.

The impact of large amounts of wind has complicated implications to SCUC and SCED. First of all, wind forecasting errors bring great uncertainty to the system operations, since the real-time wind power output may be very different from what is forecasted. The reliability of the system may be hampered in case of unforeseen decreases in wind power because the available ramping capability of on-line units in the system may not be sufficient to accommodate this change. Also, a large upward ramp in wind power may not be favorable in a system in which sufficient downward reserves from other resources are not present. In this case, wind power may have to be curtailed, which leads to a waste of available resources. The same rationale applies to the wind power supply surplus that may happen at night, when wind is usually the strongest but the system load is low. In this case, wind generation may also have to be spilled to maintain normal operation of other slow-start units, such as coal and nuclear, because of the physical and economic constraints of those units. Second, variability is also an issue to generation scheduling. Since wind power is normally assumed to have an operating cost of zero in the SCUC formulation, the system operator tries to utilize wind power as much as possible, with the objective of minimizing the supply cost to meet the system load. The system operator has to adjust its other generation sources to address the variability of wind power. Because wind power may vary to a great extent, the non-wind generation resources have to be skillfully scheduled

accordingly through unit commitment and dispatch. Even though wind power might be forecasted perfectly, variability is still an important issue to be taken into consideration when the other resources are being scheduled.

A typical market operations timeline based on the market operations in MISO was presented in Chapter 7 (Figure 7-1). As discussed in Chapter 7, the role of wind power forecasting exists in multiple aspects of the system operation, from the DA SCUC scheduling to the real-time SCED. Wind power needs to be taken into consideration in system reserve procurement, load balancing, and network constraints in the unit commitment formulation. In turn, physical constraints of other non-wind units, such as ramping up/down constraints, minimum-on and minimum-off time constraints, etc., are also influenced, which leads to the question of how to change the overall unit commitment and dispatch algorithms to accommodate wind power. Consequently, areas to consider for improving unit commitment and dispatch to integrate wind power have been proposed to address the uncertainty and variability of wind power. Some researchers focus on revising the current SCUC formulation. Others aim at novel UC methods. A limited review of current research appears below. The review is structured into several sections, depending on how it relates to UC and wind integration.

8.2.1 Wind Integration Studies

Ahlstrom et al. [330] discussed one recent wind integration study performed by Xcel Energy and analyzed the results. The authors also investigated issues related to integrating wind forecasting into the control room, the integration of EMS with wind forecasting, and the role of wind forecasting in the real-time power system prediction. It is pointed out that the current mixed integer programming techniques can be used with success to solve the large unit commitment problems without the use of complex decomposition methods.

Smith et al. [331] describe the current status of integrating wind energy into the electric power system. The paper reviews the history of wind technology development, today's commercial wind energy, and grid connection issues with wind. The authors point out that:

“[t]he value of good wind forecasting has been clearly demonstrated to reduce unit commitment costs in the day-ahead time frame. There is also evidence that faster markets (e.g., 10 mins rather than 1 hr) can reduce wind integration costs.”

The importance of wind forecasting is also emphasized. Updates on wind power integration in the United States and Europe are provided.

Smith et al. [332] also published an earlier review of the utility wind integration and operating impact in 2007. That paper reviews the wind integration studies across the United States. Wind-plant interconnection, wind plant integration operating impacts, transmission planning and market operation, and future research directions are presented.

8.2.2 Reserve Requirement for Wind Power

The paper by *Söder* [333] was one of the first papers to analyze the reserve requirement in a power system with significant amounts of wind generation. Wind speed forecast uncertainties, system load forecast uncertainties, ramp rates of thermal units, and spinning reserves are considered. The method concentrates on the instantaneous, fast, and slow reserve margins in each hour. The reserve margins are predefined to be uniform for all the hours. As the paper was published many years ago (in 1993), the most recent advances in wind power forecasting and market development are not reflected.

Dany [334] presented another study on reserve procurements in an interconnected power system. The reserves considered include the primary, secondary, and long-term reserve. Unit commitment is used to dispatch the generators with the predicted load and wind power production. The main results from the multiple runs of the unit commitment problem are the distribution and standard deviation of the area control error. By comparing the system without wind power and the system with gradually increased wind power penetration, the reserve requirements can be calculated.

A new approach to quantify reserve demand in systems with significant installed wind capacity is presented by *Doherty and O'Malley* in [335]. Generator outages and load and wind forecasting errors are taken into consideration when determining the required amount of system reserves. A reliability target is defined before calculating the reserve requirement for the system. The Irish system is used to test the proposed method. The study finds that the amount of reserve must be increased if the wind power capacity increases in the system. However, setting a universal optimal reliability target will be difficult because of the different characteristics of a specific system. Also, pre-defining a reliability target for all the periods may be economically suboptimal considering the cost and benefit associated with reserves. *Holtinen* [336] also presented an approach for setting reserve requirements of a power system, taking wind power forecasts and uncertainties into account.

Ortega-Vazquez and Kirschen [337] proposed a method to calculate the optimal amount of spinning reserve requirements, which is determined by the generator outages, load forecasting errors, and wind forecasting errors. A Monte Carlo simulation is used instead of traditional deterministic methods to obtain the amount of spinning reserves. The method is based on the cost/benefit analysis method proposed in the authors' previous companion paper (*Ortega-Vazquez and Kirschen* [338]). The optimal reserve requirements are set at a level at which the marginal cost of providing the reserves is equal to the marginal benefit of providing an additional MW of reserve. The objective of the optimization is to minimize the expected total cost of reserves. The authors conclude that an increased wind power penetration does not necessarily require larger amounts of spinning reserve. This conclusion can not be generalized to other systems because it depends heavily on the assumptions of the study and the underlying model used in the study. Also, the specific generation portfolio and load profile, which are highly system dependent, are critical for this kind of assessment.

Matos and Bessa [265] described a new reserve management tool that is intended to support the SO in the on-line definition of operating reserve needs for the daily and intraday

markets. Decision strategies, such as setting an acceptable risk level or finding a compromise between economic issues and the risk of loss of load, are explored in the paper.

8.2.3 Novel Unit Commitment Algorithms

Barth et al. [339] presented the early stage of the Wind Power Integration in Liberalised Electricity Markets (WILMAR) model [340]. WILMAR was originally developed for the Nordic system to evaluate the change in system costs attributable to wind power integration and uncertainty and to analyze potential integration measures. In the paper, a day-ahead unit commitment schedule is assumed to be known. Based on the updated information of wind power output, a re-dispatch is carried out for each rolling planning period in the entire scheduling time horizon. During the re-dispatch, the output of generation units is adjusted as the regulation service. However, the early versions of the model proposed in the paper do not constitute a unit commitment model. The unit commitment statuses are taken as the given conditions, not the model output. More recently, a more comprehensive UC algorithm based on MILP has been introduced in WILMAR. The model now considers typical UC constraints, such as start-up time, minimum-up and -down time, and ramping rates. However, the model is still mainly a planning tool and is not currently used for system operations. The later development of the WILMAR model was discussed in *Tuohy et al.* [341].

Tuohy et al. [341] extended their previous studies in [342] and [343] to examine the effects of stochastic wind and load on the unit commitment and dispatch of power systems with high levels of wind power by using the WILMAR model. By comparing the impact of stochastic unit commitment on unit operation, performance of schedules, and costs, the study finds that the stochastic optimization is able to reduce the cost on the order of 0.25% and produce better-performing schedules than the traditional deterministic approach. The frequency of unit commitment (i.e., how often the unit commitment is run in the market) is also tested, which is based on the assumption that more updated wind forecasting results can be provided during the time of market operations, thereby reducing the errors in wind forecasting. Three frequencies are tested (i.e., every 1, 3, or 6 hr). The study concludes that mid-merit and peaking units and interconnection are impacted the most when uncertainty of wind is considered because the variability of wind power output needs the ramping capability provided by those flexible units and those in other areas connected to the system. The paper provides further insight by testing the Irish system.

However, the authors acknowledged in the paper that a generalized conclusion (i.e., that increasing the rolling planning frequency will lead to a better scheduling solution) cannot be reached because of the modeling limitation that the first stage of the scenario tree is assumed to have a perfect forecast and the length of the first stage depends on the rolling horizon. Another limitation of the model is that it does not consider the transmission constraints. Transmission congestion is particularly important for some markets in the United States. Limited transmission capacities restrict transmitting wind power from the often remote locations of wind turbines to load centers. The model used is in essence a planning model; as such, it builds on the assumptions needed for the hours-ahead or day-ahead system scheduling. The analysis compares

only the scheduling alternatives at the scheduling stage. The effectiveness of the methods should be further examined by using the operational results in the real-time market.

Denny and O'Malley [344] conducted a detailed analysis of the costs/benefits of grid-integrated wind. The authors discussed such costs as the wind development costs, network reinforcement costs, cycling costs of conventional units, and additional reserves costs. The capacity benefit, emissions benefit, and fuel savings benefit are calculated as well. The authors found that “increased interconnection, high CO₂ prices and a flexible plant mix are particularly beneficial for wind generation.” A unit commitment model in the PLEXOS [345] environment is used to calculate the cost and benefit.

Ummels et al. [346] analyzed the impacts of wind power on thermal generation unit commitment and dispatch. A rolling commitment method is used to schedule the thermal units. The common constraints (i.e., ramping constraints and minimum-on and minimum-off time constraints) are considered. The wind power forecasting errors are captured by an autoregressive moving average (ARMA) process. The method is applied to the Dutch power system. It is shown that in a large power system with a significant share of combined heat and power (CHP) units, the wind forecasting does not necessarily provide benefit for unit commitment and dispatch. This conclusion, which is contrary to the common assumption of the value of wind power forecasting, is attributable to the specifics of the analyzed system. The heat demand constraints on the CHP units in the system result in a high power reserve level, which help address the variability of wind power.

Bouffard and Galiana [347] proposed a stochastic unit commitment model to integrate significant wind power generation while maintaining the security of the system. The wind uncertainty is modeled by a scenario tree provided that the wind forecasting error is subject to a normal distribution. The reserve requirements are determined by simulating the wind power realization in the scenarios rather than being pre-defined. The wind curtailment and load shedding are also allowed in the scenarios. A simple hypothetical power system is used to test the proposed method. The authors acknowledged in the paper that the problem might become intractable because its dimensionality becomes huge when multiple scenarios are considered.

Wang et al. [348] presented an SCUC algorithm that takes into account the intermittency and variability of wind power generation. The uncertainty in wind power output is captured in a number of scenarios. The wind power output in each scenario representing one possible realization in real time differs from another. To reduce the computational efforts, the original large-scale, mixed-integer problem is decomposed to a master problem and many subproblems by Bender's decomposition technique. Scenario reduction and variance reduction methods are applied to generate the scenarios and increase the accuracy of the Monte Carlo simulation. The unit commitment problem is solved in the master problem with the forecasted wind power generation. Next, possible scenarios are simulated for representing the wind power variability. The initial dispatch is checked in the subproblem, and generation re-dispatch is considered for satisfying the hourly volatility of wind power in the simulated scenarios. If the re-dispatch fails to mitigate violations, Benders cuts are created and added to the master problem to revise the commitment solution. The iterative process between the commitment problem and the feasibility check subproblem will continue until the simulated wind power scenarios can be accommodated

by re-dispatch. Numerical simulations indicate the effectiveness of the proposed SCUC algorithm for managing the security of power system operation by taking into account the intermittency and variability of wind power generation. The algorithm is designed in a conservative way in that it does not allow for load curtailment in any scenario, and the objective is to accommodate the difference in wind power output between the real-time and the forecasted by re-dispatching on-line generators while preserving the reserves for other possible contingencies in the system. The method can be improved by better modeling of wind forecasting errors and allowing wind spillage and load curtailment and by using reserves to address the uncertainty in wind.

Methaprayoon et al. [349] proposed a method to integrate artificial neural network (ANN)-based wind power forecasting into unit commitment by considering the forecasting uncertainty. A concept called WindGen at Risk, which is similar to Value at Risk in financial risk management, is used to describe the wind forecasting errors. Then, WindGen at Risk is used as the representation of wind forecasting uncertainty and is applied to the unit commitment problem. The unit commitment is run to obtain the system dispatch results with a certain confidence level of the wind power forecast. The majority of the paper focuses on applying ANN to generate wind forecasts, with limited discussion on improvement of the unit commitment algorithm for such an integration need.

Delarue and D'haeseleer [350] described a method to compute the value of forecasting (for load, wind power, etc.) in electricity generation. For this purpose, the authors developed an adaptive unit commitment (UC) strategy, where a new hourly forecast is made for a fixed number of hours, and the UC scheme is adapted. The UC problems are solved through a Mixed-Integer Linear Programming (MILP) approach. The paper focuses mainly on the effects and the results of having limited and inaccurate forecasts.

Makarov et al. [351] analyzed the operational impacts of wind generation on the California power systems. Hour-ahead and 5-min.-ahead load wind generation forecasts are used for regulation and load-following models. The objective of such a model is to enable CAISO to adjust real-time dispatch to accommodate high penetration of wind in the CASIO system. Load forecast errors and wind generation forecast errors are modeled by using a statistical approach. The additional capacity, ramping, and ramping duration requirements that CAISO will face with wind in the future are assessed. While a detailed discussion is presented in the paper, the authors do not conduct any statistical tests on the proposed approach.

Ruiz et al. [352] proposed a stochastic formulation to manage uncertainty in the unit commitment problem. The stochastic alternative to the traditional deterministic approach can capture sources of uncertainty and define the system reserve requirement in the scenarios. Both generation and load uncertainties are considered. Monte Carlo simulation is used to evaluate the impact of the proposed policy on the real-time system operations. The authors concluded that this alternative is better than the traditional approach both in terms of economics and reliability metrics. In a related paper [353], the authors consider uncertainty and variability in wind power in the UC problem by using the same stochastic framework. In test simulations of the Public Service Company system in Colorado, they find that the stochastic approach offers improvements compared to the traditional deterministic UC formulation. However, more

research is clearly needed to evaluate the benefits and challenges of using a stochastic approach to UC and system operations.

8.2.4 Role of Storage in Wind Integration

Castronuovo and Lopes [354] presented a model to optimize the operation of a wind-hydro power plant. An hourly optimization algorithm is used first to determine the optimum daily operational strategy, assuming wind power is constant during each period. Monte Carlo simulation is used to represent the errors in wind power forecasting. The statistics on the benefits and wind and hydro power generation can be obtained, which will be used as the proposed operation strategy for the next hours.

Brown et al. [355] presented an economic analysis of inclusion of pumped storage in a small island system with abundant renewable energy resources. The objective of the optimization is to find the optimal pumped storage capacity level required to address the stochastic nature of load and uncertain renewable production. The problem is formulated as a linear problem which does not result in a unit commitment solution.

Garcia-Gonzalez et al. [356] proposed a stochastic joint optimization model for a generation company to bid wind power into the electricity market. The variability and uncertainty of wind power are accommodated by pumped-storage units owned by the same company. The problem is formulated as a two-stage stochastic programming problem. Market prices and wind generation are considered as the random variables. By using this model, the energy imbalance resulting from uncertain wind power can be managed effectively. The joint optimization is compared with the uncoordinated one, which shows the merits of joint operation of wind and pumped-storage units.

Other studies related to storage devices and WPF can be found, for example, in [357], [358], and [359].

8.3 SUMMARY AND FUTURE UC WORK

Integration of wind power has a broad impact on power system operations, ranging from short-term system operations to the long-term planning. The traditional deterministic unit commitment and dispatch algorithms currently used in power system operations cannot capture the uncertainty and variability from wind. The review above illustrates the current research efforts in revising reserve procurement, innovative unit commitment algorithms, wind integration studies, and the role of storage in wind integration.

In [339]–[343], [347], and [352], the stochastic unit commitment is repeatedly discussed, which shows a promising generation scheduling alternative to the deterministic one. The general idea behind the stochastic formulation is to use scenarios to model uncertainty in wind power output. A generalized stochastic unit commitment formulation is shown in Figure 8-2.

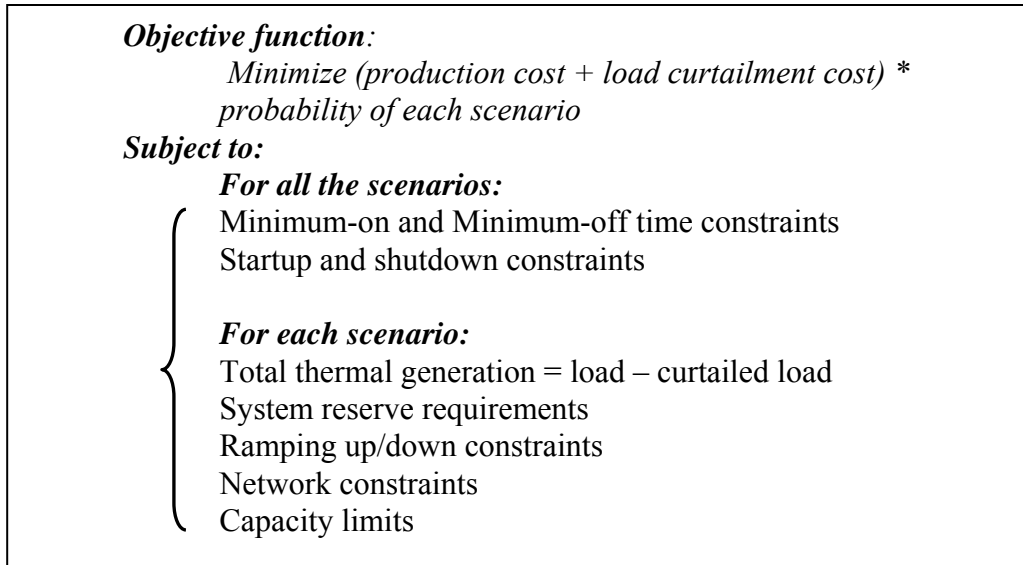

FIGURE 8-2 Stochastic SCUC Formulation

In comparison with Figure 8-1, the objective is to minimize the expected cost to supply the load. Because of the nonanticipatory constraints, the minimum-on and minimum-off time constraints and capacity limits are enforced for all the scenarios to obtain a single unit commitment solution. In each scenario, other constraints (such as load balance, ramping up/down, and capacity limits) have to be satisfied.

Obviously, scenario generation is a key to accurately represent the uncertainty and errors in wind power forecasting. A majority of the research so far assumes that the wind power forecasting errors are subject to a normal distribution. However, as discussed in the wind power forecasting chapter of this report, those errors do not follow a normal distribution. Another important aspect of stochastic unit commitment with wind is how an operational policy in terms of reserve requirement can be defined. These issues will be investigated further in this project.

9 UNIT COMMITMENT FORMULATIONS WITH WIND POWER UNCERTAINTY

As part of this project, we propose and analyze novel power system operations methods that can address the uncertainty and variability brought about by wind power, while seeking to maintain the stability and reliability of the system. The new methods may eventually be used by system operators in their control rooms to manage the grid. The methods can also be applied in planning studies to assess the impact of high penetration of wind sources on the power system.

In this chapter, we first present four different general formulations of the UC problem. We then present a stochastic UC formulation in more detail. The mathematical formulations follow [325], which proposes a mathematically efficient formulation of the UC problem. Our aim is to solve the problem as a mixed integer linear programming problem, along the lines of what is done in the paper. However, as compared to [325], we will introduce wind power plants and wind power forecasts. Particular attention is paid to the uncertainty representation of the wind power generation forecast. In addition, we introduce energy not served and its assumed cost, and demand side bidding in some of the formulations.

9.1 NOMENCLATURE

	<i>Description</i>	<i>Unit</i>
<i>Indices</i>		
i	Index for wind unit, $i = 1..I$	
j	Index for thermal unit, $j = 1..J$	
k	Index for time period, $k = 1..24$	
l	Index for generation block, thermal units, $l = 1..L$	
s	Index for scenario, $s = 1..S$	
<i>Constants</i>		
$D(k)$	Load or demand, period k	MW
$R(k)$	Operating reserve requirement, period k	MW
C_{ens}	Cost of energy not served	\$/MWh
A_j	Operating cost at min load, thermal unit j	\$
$MC_{l,j}$	Marginal cost (or bid), block l , thermal unit j	
\overline{PT}_j	Capacity, thermal unit j	MW
\underline{PT}_j	Minimum output, thermal unit j	MW
$\overline{\Delta}_{l,j}$	Capacity, block l , thermal unit j	MW
CC_j	Cold start cost, thermal unit j	\$
HC_j	Hot start cost, thermal unit j	\$
DC_j	Shut-down cost, thermal unit j	\$
T_j^{cold}	Time for cold start cost (in addition to min downtime), thermal unit j	hours
T_j^{up}	Minimum up-time, thermal unit j	hours

$T_j^{up,0}$	Minimum up-time, initial time step, thermal unit j	hours
T_j^{dn}	Minimum down-time, thermal unit j	hours
$T_j^{dn,0}$	Minimum down-time, initial time step, thermal unit j	hours
SU_j	Start-up ramp limit, thermal unit j	MW/h
SD_j	Shut-down ramp limit, thermal unit j	MW/h
RU_j	Ramp up limit, thermal unit j	MW/h
RD_j	Ramp down limit, thermal unit j	MW/h
$W_i(k)$	Actual max wind generation, wind unit i , period k	MW
$PW_i^{f,s}(k)$	Forecasted max generation, wind unit i , period k , scenario s	MW
$prob_s$	Probability of occurrence, wind scenario s	
<i>Variables</i>		
$c_j^p(k)$	Production cost, thermal unit j , period k	\$
$c_j^u(k)$	Start-up cost, thermal unit j , period k	\$
$c_j^d(k)$	Shut-down cost, thermal unit j , period k	\$
$pt_j(k)$	Generation, thermal unit j , period k	MW
$\delta_{l,j}(k)$	Generation, block l , thermal unit j , period k	MW
$\overline{pt}_j(k)$	Maximum feasible generation, thermal unit j , period k	MW
$\pi_j(k)$	Feasible dispatch region, thermal unit j , period k	
Δ_j	Permissible deviation from expected generation, thermal unit j , period k	
$v_j(k)$	Binary on/off variable, thermal unit j , period k	
$pw_i^s(k)$	Generation, wind unit i , period k , scenario s	MW
$cw_i^s(k)$	Curtailed wind generation, wind unit i , period k , scenario s	
$ens(k)$	Energy not served, period k	MW
$sw(k)$	Short-run social surplus, period k	\$

9.2 GENERAL FORMULATION OF THE UC PROBLEM

We first give a general high-level formulation of the UC problem, with four different formulations representing different assumptions about uncertainty and market operation. A more detailed MILP formulation (including the UC constraints) is provided in the next section.

9.2.1 Traditional Deterministic Formulation

The traditional approach is to formulate the UC problem as a deterministic optimization problem, where the objective is to minimize the sum of production cost, start-up cost, and shut-down cost for thermal units, taking into account load constraints, reserve constraints, and also the UC constraints for the thermal units to ensure that they stay within their feasible region of generation. This approach can be expressed as shown in equations (1)–(4):

$$\text{Min} \sum_{k=1}^K \sum_{j=1}^J [c_j^p(k) + c_j^u(k) + c_j^d(k)] \quad (1)$$

s.t.

$$\sum_{i=1}^I W_i(k) + \sum_{j=1}^J pt_j(k) = D(k) \quad , \quad \forall k \quad (2)$$

$$\sum_{j=1}^J [\overline{pt}_j(k) - pt_j(k)] \geq R(k) \quad , \quad \forall k \quad (3)$$

$$p_j(k) \in \pi_j(k) \quad , \quad \forall j, \forall k \quad (4)$$

In the formulation above, (2) represents the energy balance; (3) represents the spinning reserve requirement, which is assumed to be provided by the thermal units; and (4) is a general expression stating that the thermal generation at any time must stay within its UC constraints. The mathematical formulation is explained further in the next section.

Of note is that in the energy balance in (2), wind generation is represented with its actual generation. The UC problem is usually solved at the day-ahead stage. Hence, in reality the actual wind generation will be uncertain and can be represented by a wind power generation forecast, assuming that the system operator has access to this information. Of course, there is also uncertainty in the load for the next day, but for the sake of simplicity, we will limit our focus to uncertainty in wind power generation only in this analysis.

The operating reserve requirement is assumed to be deterministic in (3) and could, for instance, be equal to a percentage of the hourly load or be dimensioned according to the size of the largest generator in the power system (i.e., the traditional N-1 criterion). The purpose of the operating reserve is to take care of unforeseen events, such as generator outages and deviations between expected and realized load.

9.2.2 Stochastic Formulation with Wind Uncertainty

In this formulation, we introduce probabilities for the wind power generation forecasting scenarios, as shown in (5)–(10). In addition, we include in the formulation the possibility that energy is not served. This event would happen in scenarios where the sum of available wind and thermal power generation is not sufficient to meet the load, as shown in (6). However, unserved energy has a cost, which is usually high, and this cost is now taken into account in the objective function, as shown in (5). The objective now becomes to minimize the sum of expected production costs, the expected cost of unserved energy, and start-up/shut-down costs. It is of note that the start-up and shut-down costs are independent of wind scenario. This situation emerges because we assume that the commitment of thermal units has to be fixed at the day-ahead stage. This is a strong assumption that we may consider relaxing, at least for flexible peaking plants

with short start-up times and costs. In general, the frequency of unit commitment is one potential area for further analysis.

$$\text{Min} \sum_{s=1}^S \text{prob}_s \times \left\{ \sum_{k=1}^K \sum_{j=1}^J c_j^{p,s}(k) + \sum_{k=1}^K C_{ens} \times \text{ens}^s(k) \right\} + \sum_{k=1}^K \sum_{j=1}^J [c_j^u(k) + c_j^d(k)] \quad (5)$$

s.t.

$$\sum_{i=1}^I \text{pw}_i^s(k) + \sum_{j=1}^J \text{pt}_j^s(k) = D(k) - \text{ens}^s(k) \quad , \quad \forall k, \forall s \quad (6)$$

$$\sum_{j=1}^J [\overline{\text{pt}}_j^s(k) - \text{pt}_j^s(k)] \geq R(k) \quad , \quad \forall k, \forall s \quad (7)$$

$$\text{pw}_i^s(k) + \text{cw}_i^s(k) = \text{PW}_i^{f,s}(k) \quad , \quad \forall i, \forall s, \forall k \quad (8)$$

$$\text{pt}_j^s(k) \in \pi_j^s(k) \quad , \quad \forall j, \forall k, \forall s \quad (9)$$

In contrast to the commitment decisions, the dispatch of the thermal plants and the amount of energy not served may now vary with wind scenario, as indicated by the index s . The thermal generation therefore becomes a function of the scenario for wind power generation, as seen in (6). Hence, the reserve requirements and UC constraints must be met in all wind scenarios, as shown in (7) and (9). Another change in this formulation is that we introduce the possibility of wind power curtailment, as shown in (8), assuming that the market operators curtails wind generation in periods of surplus wind generation. The wind curtailment also depends on the wind scenario. In sum, this formulation increases the number of constraints substantially compared to the deterministic formulation. However, the introduction of energy not served and wind curtailment should make it easier for the MILP solver to find a feasible solution, since more flexibility is being introduced in the formulation.

The formulation above still contains a reserve requirement. Because the only uncertainty we consider in this formulation is from wind generation, it may be argued that the need for reserves is already taken care of since we include a representative set of wind power outcomes in the scenarios and also the cost of unserved energy in the objective function. Sensitivity analysis could be carried out to analyze the effect of changing the reserve requirement, along the lines of what was done by *Ruiz et al.* in [353]. At the same time, varying the cost of unserved energy would also be an interesting scenario analysis.

In its simplest version, the formulation above would consider only one scenario for forecasted wind generation. In that case, we would again have a deterministic formulation similar to the one found in (1)–(4). The only difference is that we include the possibility of unserved energy and wind curtailment. The selected scenario could be the expected wind power generation, or it could also represent a certain percentile in the forecasting distribution. The choice of representative scenario would depend on how conservatively the system operator wants to operate the system. When using multiple scenarios, the challenge is to come up with a representative set of wind power scenarios, capturing both the magnitude and phase errors of the wind power forecast.

9.2.3 Deterministic Formulation with Wind Uncertainty

The formulation in (10)–(14) is based on *Wang et al.* [348]. The objective is here to minimize the operating cost for the expected wind generation (scenario s^*), which could be represented by the expected value of the wind power forecast. However, demand, operating reserves, and UC constraints all have to be met for all scenarios, as shown in (11)–(13). An additional constraint is introduced in (14) to ensure that scenario dispatches remain within a feasible range from the dispatch in the expected wind scenario. In *Wang et al.* [348], this problem is solved by using Bender’s decomposition, where cuts are added iteratively when infeasible deviations are detected until a feasible solution is found.

$$\text{Min} \sum_{k=1}^K \sum_{j=1}^J [c_j^{p,s^*}(k) + c_j^u(k) + c_j^d(k)] \quad (10)$$

s.t.

$$\sum_{i=1}^I PW_i^{f,s}(k) + \sum_{j=1}^J pt_j^s(k) = D(k) \quad , \quad \forall k, \forall s \quad (11)$$

$$\sum_{j=1}^J [\bar{pt}_j^s(k) - pt_j^s(k)] \geq R(k) \quad , \quad \forall k, \forall s \quad (12)$$

$$p_j^s(k) \in \pi_j(k) \quad , \quad \forall j, \forall k, \forall s \quad (13)$$

$$|pt_j^s(k) - pt_j^{s^*}(k)| \leq \Delta_j \quad , \quad \forall j, \forall k, \forall s \quad (14)$$

Of note is that, compared to the stochastic formulation above, this set-up does not allow for energy not served. Hence, demand has to be served in all scenarios. At the same time, there is a fixed reserve requirement that also has to be met, and there is no wind curtailment. Hence, this formulation represents a relatively conservative operating strategy. The MILP solver may run into problems finding feasible solutions. One alternative would be to introduce the possibility of energy not served in the energy balance and the cost of energy not served in the objective function, similar to the approach in the formulation above. In addition, we could introduce wind curtailment. Adding this component would make the optimization problem less constrained, and it should therefore be easier for the solver to find a solution.

9.2.4 Market-Based Stochastic Formulation

In this formulation, we try to mimic more closely the operation of real-world electricity markets by introducing demand-side bidding in the UC problem. Compared to the formulation in (5)–(9), the objective is now to maximize short-run social surplus that is net of start-up/shut-down costs, as opposed to minimizing cost. The social surplus is a function of the aggregate thermal supply curve, the wind generation, and the demand. The demand is now assumed to be represented with an aggregate demand curve instead of a fixed load (the demand curve must be stepwise linear in order to have a linear formulation). Energy not served is therefore not explicitly represented in (16), but rather modeled as an implicit voluntary reduction in demand.

In this formulation, the market clearing price would be equal to the shadow price of (16). The price is therefore determined, either by the cost of the marginal thermal unit or by the willingness to pay for the marginal demand. It is of note that, with multiple scenarios, there will be multiple realizations of constraint (16). The market price should be the sum of the dual variables of (16) in all the realizations. Equations (17) and (18) remain unchanged. The possibility of wind curtailment is represented in (19), again assuming that the market operators curtail wind generation in periods of surplus wind generation. A market clearing formulation with demand response and wind curtailment, which is somewhat similar to the one below, is presented in *Bouffard and Galiana* [347].

$$\text{Max} \sum_{s=1}^S \text{prob}_s \times \sum_{k=1}^K \sum_{j=1}^J \text{sw}^s(k) - \sum_{k=1}^K \sum_{j=1}^J [c_j^u(k) + c_j^d(k)] \quad (15)$$

s.t.

$$\sum_{i=1}^I \text{pw}_i^s(k) - \sum_{i=1}^I \text{cw}_i^s(k) + \sum_{j=1}^J \text{pt}_j^s(k) = D(k) \quad , \quad \forall k, \forall s \quad (16)$$

$$\sum_{j=1}^J [\bar{\text{pt}}_j^s(k) - \text{pt}_j^s(k)] \geq R(k) \quad , \quad \forall k, \forall s \quad (17)$$

$$\text{p}_j^s(k) \in \pi_j(k) \quad , \quad \forall j, \forall k, \forall s \quad (18)$$

$$\text{pw}_i^s(k) + \text{cw}_i^s(k) = \text{PW}_i^{f,s}(k) \quad , \quad \forall i, \forall s, \forall k \quad (19)$$

9.3 DETAILED REPRESENTATION OF THE STOCHASTIC UC WITH WIND UNCERTAINTY

The problem for the stochastic UC formulation in Section 9.2.2 above is described in detail here. The UC constraints follow *Carrion and Arroyo* [325] equations (5)–(26). However, we make adjustments in the formulation based on the introduction of wind power and wind power forecasting uncertainty. The full formulation will include equations (5)–(8) in Section 9.2.2, along with the detailed equations presented in this section.

9.3.1 Objective Function

We assume that each thermal unit is offered into the market as a stepwise price-quantity offer function and that the offers can be derived by linearizing a standard quadratic production cost function. Hence, we can express the operating cost for one thermal unit with the equations in (20)–(23). The coefficients for the generator blocks can easily be derived from a quadratic production cost function, as explained in [325]. Alternatively, the costs of each block could also reflect strategic bidding from the generators, by introducing strategy multipliers to manipulate the original cost and quantity. Of note is that in this formulation, it is assumed that the system operator includes the thermal generators' operating cost at minimum load (A_j) in the objective function in (21), and also considers the minimum generation level in (22).

$$c_j^{p,s}(k) = A_j v_j(k) + \sum_{l=1}^L MC_{l,j}(k) \cdot \delta_{l,j}^s(k) \quad , \quad \forall j, \forall k, \forall s \quad (20)$$

$$pt_j^s(k) = \underline{P}_j \cdot v_j(k) + \sum_{l=1}^L \delta_{l,j}^s(k) \quad , \quad \forall j, \forall k, \forall s \quad (21)$$

$$\delta_{l,j}^s(k) \leq \bar{\Delta}_{l,j} \quad , \quad \forall l, \forall j, \forall k, \forall s \quad (22)$$

$$\delta_{l,j}^s(k) \geq 0 \quad , \quad \forall l, \forall j, \forall k, \forall s \quad (23)$$

The second part of the objective function is the start-up cost. This part is modeled by assuming that there is a cold start-up cost and a warm start-up cost, depending on the length of time that the unit is down. This treatment is a simplification compared to the formulation in [325], which assumes multiple steps on the start-up cost function. The mathematical formulation is shown in (24)–(26).

$$c_j^u(k) \geq CC_j \cdot \left[v_j(k) - \sum_{n=1}^N v_j(k-n) \right] \quad , \quad \forall j, \forall k \quad (24)$$

$$c_j^u(k) \geq HC_j \cdot [v_j(k) - v_j(k-1)] \quad , \quad \forall j, \forall k \quad (25)$$

$$c_j^u(k) \geq 0, \quad \forall j, \forall k \quad (26)$$

$$\text{where } N = T_j^{dn} + T_j^{cold}$$

Finally, the last part of the objective function is the shut-down cost, which can be expressed in (27)–(28). It is important to note that the equations for the generation cost are repeated for each wind scenario, s . This approach is used because the thermal dispatch varies between the scenarios. In contrast, the start-up and shut-down costs are functions of the binary commitment variables (and not the dispatch) and are therefore the same for all the wind scenarios.

$$c_j^d(k) \geq DC_j [v_j(k-1) - v_j(k)] \quad , \quad \forall j, \forall k \quad (27)$$

$$c_j^d(k) \geq 0, \quad \forall j, \forall k \quad (28)$$

9.3.2 Thermal Constraints

The constraints for the operation of the thermal units must be included as well. These are outlined below and include:

- 1) Generation limits,
- 2) Ramping-up limits,

- 3) Ramping-down limits,
- 4) Minimum-up time, and
- 5) Minimum-down time.

Again, we follow the MILP implementation of [325], equations (16)–(26). The upper and lower generation limits for the thermal plants are shown in (29) and (30), respectively. Limitations on start-up and ramp-up rates are imposed by (31), shut-down ramp rates imposed by (32), and ramp-down limits are imposed by (33).

$$\underline{PT}_j \cdot v_j(k) \leq p_j^s(k) \leq \overline{pt}_j^s(k) \quad , \quad \forall j, \forall k, \forall s \quad (29)$$

$$0 \leq \overline{pt}_j^s(k) \leq \overline{PT}_j \cdot v_j(k) \quad , \quad \forall j, \forall k, \forall s \quad (30)$$

$$\overline{pt}_j^s(k) \leq pt_j^s(k-1) + RU_j \cdot v_j(k-1) + SU_j \cdot [v_j(k) - v_j(k-1)] + \overline{PT}_j \cdot [1 - v_j(k)] \quad , \quad \forall j, \forall k, \forall s \quad (31)$$

$$\overline{pt}_j^s(k) \leq \overline{PT}_j \cdot v_j(k+1) + SD_j \cdot [v_j(k) - v_j(k+1)] \quad , \quad \forall j, \forall k \quad (32)$$

$$= 1.23, \forall s$$

$$pt_j^s(k-1) - pt_j^s(k) \leq RD_j \cdot v_j(k) + SD_j \cdot [v_j(k-1) - v_j(k)] + \overline{PT}_j \cdot [1 - v_j(k-1)] \quad , \quad \forall j, \forall k, \forall s \quad (33)$$

Of note is that the availability of spinning reserves is equal to the difference between the maximum potential generation and the actual generation, i.e. $\overline{pt}_j^s(k) - pt_j^s$. Hence, the reserve requirement in (7) takes into account the ramping constraints imposed by (29)–(33). The reserve requirement is maintained for each individual wind scenario.

The final constraints to include are the minimum-up and -down time constraints. Minimum-up times are represented by (34)–(36), which represent the initial status, the intermediate time periods, and the final time steps of the planning period, respectively. The minimum-down time constraints are represented analogously by (37)–(39).

$$T_j^{up,0} \sum_{k=1} [1 - v_j(k)] = 0 \quad , \quad \forall j \quad (34)$$

$$\sum_{n=k}^{k+T_j^{up}-1} v_j(n) \geq T_j^{up} \cdot [v_j(k) - v_j(k-1)] \quad , \quad \forall j, \forall k \quad (35)$$

$$= T_j^{up,0} + 1, \dots, T - T_j^{up} + 1$$

$$\sum_{n=k}^T \{v_j(n) - [v_j(k) - v_j(k-1)]\} \geq 0, \quad \forall j, \forall k = T - T_j^{up} + 2, \dots, T \quad (36)$$

$$\sum_{k=1}^{T_j^{dn,0}} v_j(k) = 0, \quad \forall j \quad (37)$$

$$\sum_{n=k}^{k+T_j^{dn}-1} [1 - v_j(n)] \geq T_j^{dn} \cdot [v_j(k-1) - v_j(k)], \quad (38)$$

$$\forall j, \forall k = T_j^{dn,0} + 1, \dots, T - T_j^{dn} + 1$$

$$\sum_{n=k}^T \{1 - v_j(n) - [v_j(k-1) - v_j(k)]\} \geq 0, \quad \forall j, \forall k = T - T_j^{dn} + 2, \dots, T \quad (39)$$

Note that the equations for generation and ramping limits (i.e., equations (29)–(33) — must be included for all wind scenarios, because thermal dispatch depends on the wind generation. The minimum-up and -down time constraints in (34)–(39) are functions of commitment only and do not vary with wind scenario.

9.4 CURRENT STATUS AND FUTURE WORK ON UC FORMULATIONS

We are currently working on implementing and testing the formulation of the UC problem presented in Section 9.3. Initial results are presented in *Wang et al.* [360]. We will also attempt to implement alternative UC formulations, like the ones outlined in this chapter. Our objective is to assess how stochastic formulations of the UC problem can help system operators handle the increased variability and uncertainty caused by wind power by making use of the information in stochastic wind power forecasts.

This page is intentionally blank.

10 CONCLUDING REMARKS

With the rapid increase in wind power generation in the United States, WPF will play an increasingly important role in the operations of electric power systems and electricity markets. In this report, we have reviewed the current state of WPF models. The report includes an overview of the theoretical methodologies underlying the physical and statistical modeling approaches used in state-of-the-art WPF systems. We pay specific attention to how the uncertainty in the forecasted wind power can be estimated and presented. A review of existing commercial and operational WPF tools is also provided, along with an overview of existing benchmarking studies of WPF models. Furthermore, we present a review of the use of WPF in the operations of electricity markets in the United States. We also discuss how WPF can be efficiently integrated into power system operations, focusing on the unit commitment problem with wind power uncertainty.

WPF can provide important input to decision-making processes for different participants in the electricity market, including system operators, GENCOs, wind power plant owners/operators, market analysts, and traders. When introducing WPF into the operational procedures of these market participants, it is obviously important to tune the forecasting model to their individual needs. The local geographical and meteorological conditions must be considered when customizing a WPF tool. Furthermore, the role and objectives of the company should ideally be reflected in the criteria used in the iterative training of the statistical models as well as in the assessment of forecasting errors. At the same time, the forecasting results must be prepared and communicated in a format that facilitates effective use in the relevant decision-making processes.

In this report, we have focused on the application of WPF among system operators. An improvement in the overall forecasting accuracy is of course desirable for these forecasting users. Of specific concern is the ability to forecast wind power ramping events, as these potentially may have severe impact on the operations of the power system. In addition, for system operators it is particularly important that the WPF tool can give reliable estimates of the forecast uncertainty. Several ISOs/RTOs in the United States are currently working on implementing WPF as an integral part of their system and market operations. There is clearly a need for better integration of WPF into different parts of the operations, from determination of operating reserve requirements to unit commitment and dispatch decisions.

In the continuation of our project, we will build on the findings in this report to develop and test improved methodologies for WPF and its use in the electric power industry. On the forecasting side, we will systematically compare different forecasting methodologies, paying particular attention to how innovations in computational intelligence can contribute to improve the quality of WPF models. In the applications area, we will continue our work on analyzing how WPF and wind power uncertainty can be efficiently included in the system operator's unit commitment and dispatch problems and in the determination of operating reserves. In addition, we will address how wind power operators can make use of WPF in their operations, bidding, and hedging decisions.

This page is intentionally blank.

REFERENCES

- [1] R. Wiser and G. Barbose, “Renewables Portfolio Standards in the United States: A Status Report with Data Through 2007,” Lawrence Berkeley National Laboratory, Report LBNL 154-E, April 2008. Available at: <http://eetd.lbl.gov/ea/ems/reports/lbnl-154e.pdf>.
- [2] “Overview of RGGI CO₂ Budget Trading Program,” Regional Greenhouse Gas Initiative (RGGI), October 2007. Available at: <http://www.rggi.org/home>.
- [3] European Union (EU), “Climate change: Commission welcomes final adoption of Europe's climate and energy package,” Press Release, EU, Dec. 17, 2008. Available at: <http://europa.eu/rapid/pressReleasesAction.do?reference=IP/08/1998>.
- [4] U.S. Department of Energy (DOE), “20% Wind Energy by 2030: Increasing Wind Energy’s Contribution to U.S. Electricity Supply,” DOE Office of Energy Efficiency and Renewable Energy Report, July 2008. Available at: http://www1.eere.energy.gov/windandhydro/wind_2030.html.
- [5] NERC (North American Electric Reliability Corporation), “Accommodating High Levels of Variable Generation,” Special Report, April 2009. Available at: http://www.nerc.com/news_pr.php?npr=283.
- [6] “Wind Power Targets for Europe: 75,000 MW by 2010,” European Wind Energy Association, Oct. 2003.
- [7] “Making 180 GW a reality by 2020,” The European Wind Energy Association Position Paper, Oct. 2007.
- [8] “Pure Power: Wind Energy Scenarios up to 2030,” The European Wind Energy Association, March 2008.
- [9] Mark L. Ahlstrom and Robert M. Zavadil, “The Role of Wind Forecasting in Grid Operations & Reliability,” in *Proceedings of IEEE/PES Transmission and Distribution Conference & Exhibition: Asia and Pacific*, China, pp. 1–5, 2005.
- [10] Ana Estanqueiro, Rui Castro, Pedro Flores, João Ricardo, Medeiros Pinto, Reis Rodrigues, and J. Peças Lopes, “How to prepare a power system for 15% wind energy penetration: the Portuguese case study,” *Wind Energy*, vol. 11, no. 1, pp. 75–84, 2008.
- [11] J. Usaola, O. Ravelo, G. González, F. Soto, M.C. Dávila, and B. Díaz-Guerra, “Benefits for Wind Energy in Electricity Markets from Using Short Term Wind Power Prediction Tools; a Simulation Study,” *Wind Engineering*, vol. 28, no. 1, pp. 119–127, 2004.

- [12] MORE-CARE, “More Advanced Control Advice for Secure Operation of Isolated Power Systems with Increased Renewable Energy Penetration and Storage,” EU Project ERK5-CT1999-00019.
- [13] G. Kariniotakis, et al., “ANEMOS: Development of a Next Generation Wind Power Forecasting System for the Large-Scale Integration of Onshore & Offshore Wind Farms,” in *Proceedings of the European Wind Energy Conference & Exhibition EWEC 2003*, Madrid, Spain, June 16–19, 2003.
- [14] J. Charney, R. Fjortoft, and J. von Neumann, “Numerical integration of the barotropic vorticity equation,” *Tellus*, vol. 2, pp. 237–254, 1950.
- [15] N.A. Phillips, “A coordinate system having some special advantages for numerical forecasting,” *J. Meteor.*, vol. 14, pp. 184–185, 1957.
- [16] J. Smagorinsky, “On the numerical integration of the primitive equations of motion for baroclinic flow in a closed region,” *Monthly Weather Review*, 86, pp. 457–466, 1958.
- [17] J. Charney, “The use of the primitive equations of motion in numerical prediction,” *Tellus*, vol. 7, pp. 22–26, 1955.
- [18] E.N. Lorenz, “Deterministic nonperiodic flow,” *Journal of Atmospheric Sciences*, vol. 20, pp. 131–140, 1963.
- [19] E.N. Lorenz, “The predictability of a flow which possesses many scales of motion,” *Tellus*, vol. 21, pp. 289–307, 1969.
- [20] E. Kalnay, et al., “The NCEP/NCAR 40-Year Reanalysis Project,” Bulletin of the American Meteorological Society, 1996.
- [21] S.M. Uppala, et al., “The ERA-40 re-analysis,” *Quarterly Journal of the Royal Meteorological Society*, vol. 131, pp. 2961–3012, 2005.
- [22] J.M. Lewis and J.C. Derber, “The use of adjoint equations to solve a variational adjustment problem with advective constraints,” *Tellus*, vol. 37A, pp. 309–322, 1985.
- [23] F.-X. Le Dimet and O. Talagrand, “Variational algorithms for analysis and assimilation of meteorological observations: Theoretical aspects,” *Tellus*, vol. 38A, pp. 97–110, 1986.
- [24] P. Courtier, J.-N. Thepaut, and A. Hollingsworth, “A strategy for operational implementation of 4D-Var using an incremental approach,” *Quarterly Journal of the Royal Meteorological Society*, vol. 120, pp. 1367–1388, 1994.
- [25] R. Rødm, P.M.A. Miranda, and A.J. Thorpe, “Filtered non-hydrostatic models in pressure-related coordinates,” *Quarterly Journal of the Royal Meteorological Society*, vol. 127, pp. 1277–1292, 2001.

- [26] W.C. Skamarock, J.B. Klemp, J. Dudhia, D.O. Gill, D.M. Barker, W. Wang, and J.G. Powers, “A Description of the Advanced Research WRF Version 2,” NCAR/TN–468, 2005.
- [27] M. Kanamitsu, “Description of the NMC global data assimilation and forecast system,” *Weather and Forecasting*, vol. 4, pp. 335–342, 1989.
- [28] A.J. Simmons, D.M. Burridge, M. Jarraud, C. Girard, and W. Wergen, “The ECMWF medium-range prediction models: development of the numerical formulations and the impact of increased resolution,” *Meteorology and Atmospheric Physics*, vol. 40, pp. 28–60, 1989.
- [29] F. Molteni, R. Buizza, T.N. Palmer, and T. Petroliaqis, “The ECMWF Ensemble Prediction System: Methodology and Validation,” *Quarterly Journal of the Royal Meteorological Society*, vol. 122, pp. 73–119, 1996.
- [30] F. Mesinger, Z.I. Janjić, S. Ničković, D. Gavrilov, and D.G. Deaven, “The step-mountain coordinate: Model description and performance for cases of Alpine lee cyclogenesis and for a case of an Appalachian redevelopment,” *Monthly Weather Review*, vol. 116, pp. 1493–1518, 1988.
- [31] T.L. Black, “The new NMC mesoscale Eta Model: Description and forecast examples,” *Weather Forecasting*, vol. 9, pp. 265–278, 1994.
- [32] E. Källén, “HIRLAM documentation manual. System 2.5,” Technical report, HIRLAM, 178 p. + 55 p. Appendix. Available from SMHI, S-60176 Norrköping, Sweden, 1996.
- [33] R. Bubnova, G. Hello, P. Bénard, and J.-F. Geleyn, “Integration of the fully-elastic equations cast in the hydrostatic pressure terrain-following coordinate in the framework of the ARPEGE/ALADIN NWP system,” *Monthly Weather Review*, vol. 123, pp. 515–535, 1995.
- [34] R.A. Anthes and T.T. Warner, “Development of hydrodynamic models suitable for air pollution and other mesometeorological studies,” *Monthly Weather Review*, vol. 106, pp. 1045–1078, 1978.
- [35] J. Dudhia, “A nonhydrostatic version of the Penn State–NCAR Mesoscale Model: Validation tests and simulation of an Atlantic cyclone and cold front,” *Monthly Weather Review*, vol. 121, pp. 1493–1513, 1993.
- [36] J. Dudhia Grell and D.R. Stauffer, “A description of the fifth-generation Penn System/NCAR Mesoscale Model (MM5),” NCAR Tech. Note NCAR/TN-39811A, 107 pp., 1994.
- [37] R.A. Pielke, et al., “A comprehensive meteorological modeling system—RAMS,” *Metrological Atmospheric Physics*, vol. 49, pp. 69–91, 1992.

- [38] R.M. Hodur, "Development and testing of the Coupled Ocean Atmosphere Mesoscale Prediction System (COAMPS)," NRL/ MR/7533-93-7213, Naval Research Laboratory, 84 pp., 1993.
- [39] J.-P. Lafore, et al., "The Meso-NH atmospheric simulation system. Part 1: Adiabatic formulation and control simulations," *Annales Geophysicae*, vol. 16, pp. 90–109, 1998.
- [40] N.A. Crook and J. Sun, "Analysis and Forecasting of the Low-Level Wind during the Sydney 2000 Forecast Demonstration Project," *Weather and Forecasting*, vol. 19, pp. 167, 2004.
- [41] J. Sun, D.W. Flicker, and D.K. Lilly, "Recovery of three-dimensional wind and temperature fields from single-Doppler radar data," *Journal Atmospheric Sciences*, vol. 48, pp. 876–890, 1991.
- [42] S. Zhong and J. Fast, "An Evaluation of the MM5, RAMS, and Meso-Eta Models at Subkilometer Resolution Using VTMX Field Campaign Data in the Salt Lake Valley," *Monthly Weather Review*, vol. 131, pp. 1301–1322, 2003.
- [43] J.D. Doyle, M.A. Shapiro, and R.M. Hodur, "A multiscale simulation of a topographically induced downslope windstorm over Norway using the Navy's COAMPS model," in *Preprints of the Seventh Conf. on Mountain Meteorology*, Breckenridge, Colo., Amer. Meteor. Soc., pp. 184–188, 1995.
- [44] J.D. Doyle and M.A. Shapiro, "Mesoscale characteristics of a topographically modulated frontal zone over Norway," in *Preprints of the Seventh Conf. on Mesoscale Processes*, Reading, United Kingdom, Amer. Meteor. Soc., pp. 319–321, 1996.
- [45] J.D. Doyle and M.A. Shapiro, "Numerical simulations of severe coastal orographic winds," in *Preprints of the Conf. on Coastal Oceanic and Atmospheric Prediction*, Atlanta, Georgia, Amer. Meteor. Soc., pp. 173–180, 1996.
- [46] M.M. Cairns and J. Corey, "Mesoscale Model Simulations of High-Wind Events in the Complex Terrain of Western Nevada," *Weather Forecasting*, vol. 18, pp. 249–263, 2003.
- [47] B.A. Colle, J.B. Olson, and J.S. Tongue, "Multiseason Verification of the MM5. Part I: Comparison with the Eta Model over the Central and Eastern United States and Impact of MM5 Resolution," *Weather Forecasting*, vol. 18, pp. 431–457, 2003.
- [48] C.F. Mass, D. Ovens, K. Westrick, and B.A. Colle, "Does Increasing Horizontal Resolution Produce More Skillful Forecasts?," *Bull. Amer. Meteor. Soc.*, vol. 83, pp. 407–430, 2002.
- [49] S.R. Hanna and R. Yang, "Evaluations of Mesoscale Models' Simulations of Near-Surface Winds, Temperature Gradients, and Mixing Depths," *Journal of Applied Meteorology*, vol. 40, pp. 1095–1104, 2001.

- [50] D.P. Bacon, et al., “A dynamically adapting weather and dispersion model: The Operational Multiscale Environmental Model with Grid Adaptivity (OMEGA),” *Monthly Weather Review*, vol. 128, pp. 2044–2076, 2000.
- [51] B. Storm, J. Dudhia, S. Basu, A. Swift, and I. Giammanco, “Evaluation of the Weather Research and Forecasting model on forecasting low-level jets: implications for wind energy,” *Wind Energy*, vol. 12, pp. 81–90, 2008.
- [52] D.L. Sisterson and P. Frenzen, “Nocturnal boundary-layer wind maxima and the problem of wind power assessment,” *Environmental Science and Technology*, vol. 12, pp. 218–221, 1978.
- [53] M.J. Mitchell, R.W. Arritt, and K. Labas, “A climatology of the warm season great plains low-level jet using wind profiler observations,” *Weather and Forecasting*, vol. 10, pp. 576–591, 1995.
- [54] S.D. Burk and W.T. Thompson, “The summertime low-level jet and marine boundary layer structure along the California Coast,” *Monthly Weather Review*, vol. 124, pp. 668–686, 1996.
- [55] T. Palmer, “30 Years of NWP at ECMWF,” presentation from European Center for Medium-Range Weather Forecasting (ECMWF), 2008.
- [56] R.N. Hoffman, Z. Liu, J.-F. Louis, and C. Grasotti, “Distortion representation of forecast errors,” *Monthly Weather Review*, 1995.
- [57] J.L. Case, J. Manobianco, J.E. Lane, C.D. Immer, and F.J. Merceret, “An Objective Technique for Verifying Sea Breezes in High-Resolution Numerical Weather Prediction Models,” *Weather Forecasting*, vol. 19, pp. 690–705, 2004.
- [58] D.L. Rife, C.A. Davis, Y. Liu, and T.T. Warner, “Predictability of Low-Level Winds by Mesoscale Meteorological Models,” *Monthly Weather Review*, vol. 132, pp. 2553–2569, 2004.
- [59] D.L. Rife, C.A. Davis, and J.C. Knievel, “Temporal Changes in Wind as Objects for Evaluating Mesoscale Numerical Weather Prediction,” submitted to *Weather and Forecasting*, 2008.
- [60] E.P. Gritmit and C.F. Mass, “Initial Results of a Mesoscale Short-Range Ensemble Forecasting System over the Pacific Northwest,” *Weather Forecasting*, vol. 17, pp. 192–205, 2002.
- [61] R. Smith, et al., “Local and remote effects of mountains on weather: Research needs and opportunities,” *Bull. Amer. Meteor. Soc.*, vol. 78, pp. 877–892, 1997.
- [62] J.S. Hong, “Evaluation of the High-Resolution Model Forecasts over the Taiwan Area during GIMEX,” *Weather Forecasting*, vol. 18, pp. 836–846, 2003.

- [63] V. Kotroni and K. Lagouvardos, “Evaluation of MM5 High-Resolution Real-Time Forecasts over the Urban Area of Athens, Greece,” *Journal of Applied Meteorology*, vol. 3, pp. 1666–1678, 2004.
- [64] P. Viterbo and A.C.M. Beljaars, “An improved land surface parametrization scheme in the ECMWF model and its validation,” *Journal of Climate*, vol. 8, pp. 2716–2748, 1995.
- [65] C. Moerhlen, “Uncertainty in wind energy forecasting,” Ph.D. dissertation, University College Cork, Ireland, May 2004.
- [66] T. Nielsen, A. Joensen, H. Madsen, L. Landberg, and G. Giebel, “A new reference for Wind Power Forecasting,” *Wind Energy*, vol. 1, pp. 29–34, 1999.
- [67] Gregor Giebel, G. Kariniotakis, and R. Brownsword, “State of the Art on Short-term Wind Power Prediction,” ANEMOS Deliverable Report D1.1, 2003.
- [68] Gregor Giebel, G. Kariniotakis, and R. Brownsword, “The State-of-the-Art in Short-Term Prediction of Wind Power – From a Danish Perspective,” in *Proceedings of the 4th International Workshop on Large-Scale Integration of Wind Power and Trans-mission Networks for Offshore Wind farms*, Billund, Denmark, Oct. 20–21, 2003.
- [69] A. Costa, A. Crespo, J. Navarro, G. Lizcano, H. Madsen, and E. Feitosa, “A review on the young history of the wind power short-term prediction,” *Renewable and Sustainable Energy*, vol. 12, pp. 1725–1744, 2008.
- [70] Yuan-Kang Wu and Jing-Shan Hong, “A literature review of wind forecasting technology in the world,” in *Proceedings of IEEE Power Tech Conference*, pp. 504–509, Lausanne, Switzerland, July 1–5, 2007.
- [71] Lars Landberg, Gregor Giebel, Henrik Aalborg Nielsen, Torben Nielsen, and Henrik Madsen, “Short-term Prediction – An Overview,” *Wind Energy*, vol. 6, no. 3, pp. 273–280, 2003.
- [72] M. Leia, L. Shiyana, J. Chuanwen, L. Honglinga, and Z. Yana, “A review on the forecasting of wind speed and generated power,” *Renewable and Sustainable Energy Reviews*, vol. 13, pp. 915–920, May 2009.
- [73] L. Landberg, “Short-term prediction of the power production from wind farms,” *Journal of Wind Engineering and Industrial Aerodynamics*, vol. 80, pp. 207–220, 1998.
- [74] Matthias Lange and Ulrich Focken, *Physical Approach to Short-Term Wind Power Prediction*, Berlin: Springer, 15 Dec. 2005.
- [75] M. Magnusson and L. Wern, “Wind energy predictions using CFD and HIRLAM forecast” in *Proceeding of the European Wind Energy Conference EWEC’01*, Copenhagen, Denmark, pp. 861–863, June 2001.

- [76] D. Cabezon, I. Marti, M.J. San Isidro, and I. Perez, “Comparison of Methods for Power Curve Modelling,” in *Proceedings of the Global WindPower 2004 Conference*, Chicago, Illinois, United States, March 28–31, 2004.
- [77] H.R. Glahn and D.A. Lowry, “The use of Model Output Statistics (MOS) in objective weather forecasting,” *Journal of Applied Meteorology*, vol. 11, pp. 1202–1211, 1972.
- [78] T.S. Nielsen, H. Madsen, H.Aa. Nielsen, L. Landberg, and G. Giebel, “Zephyr – The Prediction Models,” in *Proceedings of the European Wind Energy Conference EWEC’01*, pp. 868–871, Copenhagen, Denmark, July 2–6, 2001.
- [79] A. Costa, A. Crespo, E. Feitosa, J. Navarro, P. Jiménez, and E. García, “Mathematical and Physical Wind Power Forecasting Models: A Proposal for the UMPREDICTION Project,” in *Proceedings of the second joint action symposium on wind forecasting techniques*, Lyngby, Denmark, International Energy Agency (IEA), 2004.
- [80] Ismael Sanchez, “Short-term prediction of wind energy production,” *International Journal of Forecasting*, vol. 22, no. 1, pp. 43–56, 2006.
- [81] U. Focken, M. Lange, and H.-P. Waldl, “Reduction of Wind Power Production Error by Spatial Smoothing Effects,” in *Proceedings of the European Wind Energy Conference EWEC’01*, pp. 822–825, Copenhagen, Denmark, June 2–6, 2001.
- [82] U. Focken, M. Lange, K. Mönnich, H.-P. Waldl, H.G. Beyer, and A. Luig, “Short-term prediction of the aggregated power output of wind farms – a statistical analysis of the reduction of the prediction error by spatial smoothing effects,” *Journal of Wind Engineering and Industrial Aerodynamics*, vol. 90, no. 3, pp. 139–249, March 2002.
- [83] P. Pinson, N. Siebert, and G. Kariniotakis, “Forecasting of Regional Wind Generation by a Dynamic Fuzzy-Neural Networks Based Upscaling Approach,” in *Proceedings of the European Wind Energy Conference EWEC’03*, Madrid, Spain, June 16–19, 2003.
- [84] T.S. Nielsen, L. Landberg, and G. Giebel, “Prediction of Regional Wind Power,” in *Proceedings of the 2002 Global Windpower Conference*, Paris, France, April 2–5, 2002.
- [85] H. Madsen, “A Protocol for Standardizing the Performance Evaluation of Short-Term Wind Power Prediction Models,” Project ANEMOS, Deliverable 2.3, March 2004.
- [86] H. Madsen, P. Pinson, G. Kariniotakis, Henrik Aa. Nielsen, and Torben S. Nielsen, “Standardizing the performance evaluation of short-term wind prediction models,” *Wind Engineering*, vol. 29, no. 6, pp. 475–489, Dec. 2005.
- [87] D. Hou, E. Kalnay, and K. Droegemeier, “Objective Verification of the SAMEX’98 Ensemble Forecasts,” *Monthly Weather Review*, vol. 129, no. 1, pp. 73–91, Jan. 2001.
- [88] P. Pinson, “Estimation of the uncertainty in wind power forecasting,” PhD. dissertation, Ecole des Mines de Paris, Paris, France, 2006.

- [89] N. Siebert, “Development of methods for regional Wind Power Forecasting,” Ph.D. dissertation, CEP – Centre Energétique et Procédés, ENSMP, 2008.
- [90] E.A. Bossanyi, “Short-Term Wind Prediction Using Kalman Filters,” *Wind Engineering*, vol. 9, no. 1, pp. 1–8, 1985.
- [91] R.E. Kalman, “A new approach to linear filtering and prediction problems,” *Journal of Basic Engineering*, vol. 82, no. 1, pp. 35–45, 1960.
- [92] H. Vihriälä, P. Ridanpää, R. Perälä, and L. Söderlund, “Control of a variable speed wind turbine with feedforward of aerodynamic torque,” in *Proceedings of the European Wind Energy Conference EWECC’99*, pp. 881–884, Nice, France, March 1–5, 1999.
- [93] G.E. Box and G. Jenkins, *Time Series Analysis, Forecasting and Control*, Holden Day, 1976.
- [94] G.C. Contaxis and J. Kabouris, “Short term scheduling in a wind/diesel autonomous energy system,” *IEEE Transactions on Power Systems*, vol. 6, no. 3, pp. 1161–1167, 1991.
- [95] L. Kamal and Y.Z. Jafri, “Time series models to simulate and forecast hourly average wind speed in Quetta,” *Solar Energy*, vol. 61, no. 1, pp. 23–32, 1997.
- [96] U. Schlink and G. Tetzlaff, “Wind speed forecasting from 1 to 30 minutes,” *Theoretical and Applied Climatology*, vol. 60, pp. 191–198, 1998.
- [97] P. Poggi, M. Muselli, G. Notton, C. Cristofì, and A. Louche, “Forecasting and simulating wind speed in Corsica by using an autoregressive model,” *Energy Conversion and Management*, vol. 44, no. 20, pp. 3177–3196, 2003.
- [98] J.L. Torres, A. García, M. de Blas, and A. de Francisco, “Forecast of hourly averages wind speed with ARMA models in Navarre,” *Solar Energy*, vol. 79, no. 1, pp. 65–77, 2005.
- [99] C. Tantareanu, “Wind prediction in short-term: a first step for a better wind turbine control,” *Nordvestjysk Folkecenter for Vedvarende Energi*, October 1992.
- [100] R.G. Kavasseri and K. Seetharaman, “Day-ahead wind speed forecasting using f-ARIMA models,” *Renewable Energy*, vol. 34, no. 5, pp. 1388–1393, May 2009.
- [101] R.G. Kavasseri and R. Nagarajan, “Evidence of crossover phenomena in wind speed data,” *IEEE Transactions on Circuits and Systems*, vol. 51, no. 11, pp. 2255–2262, Nov. 2004.
- [102] T.H.M. El-Fouly, E.F. El-Saadany, and M.M.A. Salama, “Grey Predictor for Wind Energy Conversion Systems Output Power Prediction,” *IEEE Transactions on Power System*, vol. 21, no. 3, pp. 1450–1452, 2006.

- [103] J.L. Deng, "Introduction to grey system theory," *Journal of Grey System*, vol. 1, no. 1, pp. 1–24, 1989.
- [104] M.C. Alexiadis, P.S. Dokopoulos, H.S. Sahsamanoglou, and I.M. Manousaridis, "Short-term forecasting of wind speed and related electric power," *Solar Energy*, vol. 63, no. 1, pp. 61–68, 1998.
- [105] M.C. Alexiadis, P.S. Dokopoulos, and H.S. Sahsamanoglou, "Wind speed and power forecasting based on spatial correlation models," *IEEE Transactions on Energy Conversion*, vol. 14, no. 3, pp. 836–837, 1999.
- [106] A. Sfetsos, "A comparison of various forecasting techniques applied to mean hourly wind speed time series," *Renewable Energy*, vol. 21, no. 1, pp. 23–35, 2000.
- [107] A. Sfetsos, "A novel approach for the forecasting of mean hourly wind speed time series," *Renewable Energy*, vol. 27, no. 2, pp. 163–174, 2002.
- [108] E. Cadenas and W. Rivera, "Short term wind speed forecasting in La Venta, Oaxaca, México, using artificial neural networks," *Renewable Energy*, vol. 34, no. 1, pp. 274–278, Jan. 2009.
- [109] I.G. Damousis and P. Dokopoulos, "A fuzzy model expert system for the forecasting of wind speed and power generation in wind farms," in *Proceedings of the IEEE International Conference on Power Industry Computer Applications PICA 01*, pp. 63–69, 2001.
- [110] I.G. Damousis, M.C. Alexiadis, J.B. Theocharis, and P. Dokopoulos, "A fuzzy model for wind speed prediction and power generation in wind farms using spatial correlation," *IEEE Transactions on Energy Conversion*, vol. 19, no. 2, pp. 352–361, 2004.
- [111] T. Takagi and M. Sugeno, "Fuzzy identification of systems and its application to modeling and control," *IEEE Transactions on Systems, Man, and Cybernetics*, vol. 15, pp. 116–132, 1985.
- [112] I. Maqsood, M. Khan, G. Huang, and R. Abdalla, "Application of soft computing models to hourly weather analysis in southern Saskatchewan, Canada," *Engineering Applications of Artificial Intelligence*, vol. 18, no. 1, pp. 115–125, 2005.
- [113] Christopher M. Bishop, *Neural Networks for Pattern Recognition*, Oxford and New York: Oxford University Press, 1995.
- [114] R.E. Abdel-Aal, M.A. Elhadidy, and S.M. Shaahid, "Modeling and forecasting the mean hourly wind speed time series using GMDH-based abductive networks," *Renewable Energy*, vol. 34, no. 7, pp. 1686–1699, July 2009.
- [115] A.G. Ivakhnenko, "Polynomial theory of complex systems," *IEEE Transactions on Systems, Man and Cybernetics*, SMC-1(4), pp. 364–378, 1971.

- [116] C.W. Potter and M. Negnevistky, “Very short-term wind forecasting for Tasmanian power generation,” *IEEE Transactions on Power Systems*, vol. 21, no. 2, pp. 965–972, 2006.
- [117] J.-S.R. Jang, “ANFIS: Adaptive Network-based Fuzzy Inference Systems,” *IEEE Transactions on Systems, Man, and Cybernetics*, vol. 23, pp. 665–685, 1993.
- [118] I.J. Ramírez-Rosado and L.A. Fernández-Jiménez, “A new model for short-term wind electric power forecasting,” in *Proceedings of International Conference on Modeling, Identification, and Control*, Innsbruck, Austria, pp. 66–69, 2001.
- [119] I.J. Ramírez-Rosado and L.A. Fernández-Jiménez, “An advanced model for short-term forecasting of mean wind speed and wind electric power,” *Control and Intelligent Systems*, vol. 31, no. 1, pp. 21–26, 2004.
- [120] S. Alpay, L. Bilir, S. Ozdemir, and B. Ozerdem, “Wind speed time series characterization by Hilbert transform,” *International Journal of Energy Research*, vol. 30, pp. 359–364, 2006.
- [121] Zuojin Zhua and Hongxing Yang, “Discrete Hilbert transformation and its application to estimate the wind speed in Hong Kong,” *Journal of Wind Engineering and Industrial Aerodynamics*, vol. 90, pp. 9–18, 2002.
- [122] G. Kariniotakis, E. Nogaret, and G. Stavrakakis, “Advanced Short-Term Forecasting of Wind Power Production,” in *Proceedings of the European Wind Energy Conference EWEC’97*, Dublin, Ireland, pp. 751–754, October 1997.
- [123] G. Kariniotakis, E. Nogaret, A.G. Dutton, J.A. Halliday, and A. Androutsos, “Evaluation of Advanced Wind Power and Load Forecasting Methods for the Optimal Management of Isolated Power Systems,” in *Proceedings of the European Wind Energy Conference EWEC’99*, pp. 1082–1085, Nice, France, March 1–5, 1999.
- [124] I.J. Ramírez-Rosado and L.A. Fernández-Jiménez, “Next-day wind farm electric energy generation forecasting using fuzzy time-series,” in *Proceedings International Conference on Modeling, Identification and Control*, Innsbruck, Austria, pp. 237–240, 2003.
- [125] I.J. Ramírez-Rosado and L.A. Fernández-Jiménez, “A new electric power forecasting model for wind farms,” in *Proceedings International Conference on Modeling, Identification, and Control*, Grindelwald, Switzerland, pp. 398–401, 2004.
- [126] S. Chiu, “Fuzzy model identification based on cluster estimation,” *Journal of Intelligent and Fuzzy Systems*, vol. 2, pp. 267–78, 1994.
- [127] Laura Frías, Martín Gastón, and Ignacio Martí, “A new model for wind energy forecasting focused in the intra-daily markets,” Poster Session of the European Wind Energy Conference EWEC’07, Milan, Italy, 2007.

- [128] Y.V. Makarov, D.L. Hawkins, E. Leuze, and J. Vidov, “California ISO Wind Generation Forecasting Service Design and Experience,” in *Proceedings of the 2002 AWEA Windpower Conference*, Portland, Oregon, June 2–5, 2002.
- [129] M. Milligan, M.N. Schwartz, and Y. Wan, “Statistical Wind Power Forecasting for U.S. Wind Farms,” in *Proceedings of the 17th Conference on Probability and Statistics in the Atmospheric Sciences/2004 American Meteorological Society Annual Meeting*, Seattle, Washington, Jan. 11–15, 2004.
- [130] Mario J. Duran, Daniel Cros, and Jesus Riquelme, “Short-Term Wind Power Forecast Based on ARX Models,” *Journal of Energy Engineering*, vol. 133, no. 3, pp. 172–180, Sept. 2007.
- [131] A. Costa, A. Crespo, and E. Migoya, “First results from a prediction project,” in *Proceedings of the European Wind Energy Conference EWEC’03*, Madrid, Spain, 2003.
- [132] A. Kusiak, H.-Y. Zheng, and Z. Song, “Short-Term Prediction of Wind Farm Power: A Data-Mining Approach,” *IEEE Transactions on Energy Conversion*, vol. 24, no. 1, pp. 125–136, 2009.
- [133] E. Frank, Y. Wang, S. Ingis, G. Holmes, and I.H. Witten, “Using model trees for classification,” *Machine Learning*, vol. 32, pp. 63–76, 1998.
- [134] I.H. Witten and E. Frank, *Data Mining: Practical Machine Learning Tools and Techniques*, 2nd ed., San Francisco, CA: Morgan Kaufmann, 525 pp., 2005.
- [135] P.E. Sørensen, N.A. Cutululis, A. Viguera-Rodriguez, L.E. Jensen, J. Hjerrild, M.H. Donovan, and H. Madsen, “Power fluctuations from large wind farms,” *IEEE Transactions on Power Systems*, vol. 22, pp. 958–965, 2007.
- [136] P. Pinson, L.E.A. Christensen, H. Madsen, P. Sørensen, M.H. Donovan, and L.E. Jensen, “Regime-switching modelling of the fluctuations of offshore wind generation,” *Journal of Wind Engineering & Industrial Aerodynamics*, vol. 96, no. 12, pp. 2327–2347, 2008.
- [137] P. Pinson, H. Madsen, P.E. Sorensen, and N.A. Cutululis, “Adaptive modelling of offshore wind power fluctuations,” in *Proceedings of Nordic Wind Power Conference*, Roskilde, Denmark, 2007.
- [138] P. Pinson and H. Madsen, “Adaptive modeling and forecasting of wind power fluctuations with Markov-switching autoregressive models,” *International Journal of Forecasting* (submitted), 2009.
- [139] Lionel Fugon, Jérémie Juban, and G. Kariniotakis, “Data mining for Wind Power Forecasting,” in *Proceedings of the European Wind Energy Conference EWEC’08*, Brussels, Belgium, April 2008.
- [140] V.N. Vapnik, *The Nature of Statistical Learning Theory*, New York: Springer, 1999.

- [141] Leo Breiman, “Random Forests,” Technical report of the Statistics Department, University of California, Jan. 2001.
- [142] M. Negnevitsky, S. Santoso, and N. Hatziaargyriou, “Data mining and analysis techniques in wind power system applications: abridged,” in *Proceedings of the IEEE Power Engineering Society General Meeting*, 2006.
- [143] M. Negnevitsky, P. Johnson, and S. Santoso, “Short-term Wind Power Forecasting using hybrid intelligent systems,” in *Proceedings of the IEEE Power Engineering Society General Meeting*, pp.1–4, June 24–28, 2007.
- [144] R. Jursa, “Wind power prediction with different artificial intelligence models,” in *Proceedings of the European Wind Energy Conference EWEC’07*, Milan, Italy, May 2007.
- [145] A.S. Weigand, M. Mangeas, and A.N. Srivastava, “Nonlinear gated experts for time series: discovering regimes and avoiding overfitting,” *International Journal of Neural Systems*, vol. 6, pp. 373–399, 1995.
- [146] R. Jursa, “Variable selection for wind power prediction using particle swarm optimization,” in *Proceedings of the 9th Annual Conference on Genetic and Evolutionary Computation*, pp. 2059–2065, London, England, U.K., 2007.
- [147] A. Kusiak, H.-Y. Zheng, and Z. Song, “Wind Farm Power Prediction: A Data-Mining Approach,” *Wind Energy*, vol. 12, no. 3, pp. 275–293, 2009.
- [148] J.H. Friedman, “Stochastic gradient boosting,” *Comput. Statist. Data Anal.*, vol. 38, pp. 367–378, 2002.
- [149] René Jursa and Kurt Rohrig, “Short-term Wind Power Forecasting using evolutionary algorithms for the automated specification of artificial intelligence models,” *International Journal of Forecasting*, vol. 24, pp. 694–709, 2008.
- [150] R. Storn and K. Price, “Differential Evolution – A Simple and Efficient Heuristic for Global Optimization over Continuous Spaces,” *Journal of Global Optimization*, vol. 11, pp. 341–359, 1997.
- [151] T.G. Barbounis and J.B. Theocharis, “Long-term wind speed and power forecasting using local recurrent neural network models,” *IEEE Transactions on Energy Conversion*, vol. 21, no. 1, pp. 273–284, 2006.
- [152] T.G. Barbounis and J.B. Theocharis, “Locally recurrent neural networks for long-term wind speed and power prediction,” *Neurocomputing*, vol. 69, pp. 466–496, 2006.
- [153] R. Bessa, V. Miranda, and J. Gama, “Entropy and Correntropy against Minimum Square Error in Off-Line and On-Line 3-day ahead Wind Power Forecasting,” *IEEE Transactions on Power Systems* (paper in revision), 2009.

- [154] M. Lange, “On the uncertainty of wind power predictions – Analysis of the forecast accuracy and statistical distribution of errors,” *Transactions of the ASME, Journal of Solar Energy Engineering*, vol. 2, no. 127, pp. 177–194, May 2005.
- [155] H. Bludszuweit, J.A. Dominguez-Navarro, and A. Llombart, “Statistical Analysis of Wind Power Forecast Error,” *IEEE Transactions on Power Systems*, vol. 23, no. 3, pp. 983–991, Aug. 2008.
- [156] A. Fabbri, T. Gomezsanroman, J. Rivierabbad, and V.H. Mendezquezada, “Assessment of the Cost Associated With Wind Generation Prediction Errors in a Liberalized Electricity Market,” *IEEE Transactions on Power Systems*, vol. 20, no. 3, pp. 1440–1446, Aug. 2005.
- [157] P. Pinson, Henrik Aa. Nielsen, and H. Madsen, “Robust Estimation of Time-varying Coefficient Functions - Application to the Modeling of Wind Power Production,” Technical Report of the Project Intelligent Wind Power Prediction Systems, DTU, Lyngby, Denmark, March 2007.
- [158] P. Pinson, H.A. Nielsen, H. Madsen, and T. S. Nielsen, “Local linear regression with adaptive orthogonal fitting for the wind power application,” *Statistics and Computing*, vol. 18, no.1, pp. 59–71, 2008.
- [159] P.J. Huber, *Robust Statistics*, New York: Wiley, 1981.
- [160] J.C. Principe and Dongxin Xu, “Introduction to information theoretic learning,” in *Proceedings of the International Joint Conference on Neural Networks (IJCNN'99)*, pp. 1783–1787, Washington, DC, United States, July 10–16, 1999.
- [161] D. Erdogmus “Information Theoretic Learning: Renyi’s Entropy and Its Applications to Adaptive System Training,” Ph.D. dissertation, University of Florida, 2002.
- [162] V. Miranda, C. Cerqueira, and C. Monteiro, “Training a FIS with EPSO under an Entropy Criterion for Wind Power prediction,” in *Proceedings of International Conference on Probabilistic Methods Applied to Power Systems, PMAPS 2006*, Stockholm, Sweden, June 11–15, 2006.
- [163] R. Bessa, V. Miranda, and J. Gama, “Improvement in Wind Power Forecasting Based on Information Entropy-Related Concepts,” in *Proceedings of IEEE Power & Energy Society 2008 General Meeting*, Pittsburgh, Pennsylvania, USA, July, 2008.
- [164] R. Bessa, V. Miranda, and J. Gama, “Wind Power Forecasting with Entropy-Based Criteria Algorithms,” in *Proceedings of International Conference on Probabilistic Methods Applied to Power Systems, PMAPS 2008*, Puerto Rico, May 2008.

- [165] S. Salcedo-Sanza, A.M. Pérez-Bellidoa, E.G. Ortiz-Garcíaa, A. Portilla-Figuerasa, L. Prietob, and Daniel Paredesc, “Hybridizing the fifth generation mesoscale model with artificial neural networks for short-term wind speed prediction,” *Renewable Energy*, vol. 34, no. 6, pp. 1451–1457, June 2009.
- [166] J. Jørgensen, C. Moehrlen, B.Ó Gallagher, K. Sattler, and E. McKeogh, “HIRPOM: Description of an operational numerical wind power prediction model for large scale integration of on- and offshore wind power in Denmark,” poster session on the Global Windpower Conference and Exhibition, Paris, France, April 2–5, 2002.
- [167] C. Moehrlen, “On the Benefits of and Approaches to Wind Energy Forecasting,” invited speaker at the Irish Wind Energy Association Annual Conference: Towards 500MW, 2001.
- [168] T. Lozano, P. Orellana, E. Navarro, A. Abascal, and E. Piernagorda, “Prediction and planning of wind energy production,” in *Proceedings of the European Wind Energy Conference EWEC’03*, Madrid, Spain, 2003.
- [169] Ignacio J. Ramirez-Rosado, L.A. Fernandez-Jimenez, C. Monteiro, J.N. Sousa, and R. Bessa, “Comparison of two new short-term wind-power forecasting systems,” *Renewable Energy*, accepted November 16, 2008 (also available online).
- [170] P. Pinson and G. Kariniotakis, “Wind Power Forecasting using fuzzy neural networks enhanced with on-line prediction risk assessment,” in *Proceedings of the IEEE Power Tech Conference*, Bologna, vol. 2, pp. 23–26, June 2003.
- [171] A. Yamaguchi, T. Ishihara, K. Sakai, T. Ogawa, and Y. Fujino, “A Physical-Statistical Approach for the Regional Wind Power Forecasting,” in *Proceedings of the European Wind Energy Conference EWEC’07*, Milan, Italy, 2007.
- [172] George Sideratos and Nikos D. Hatziargyriou, “An Advanced Statistical Method for Wind Power Forecasting,” *IEEE Transactions on Power Systems*, vol. 22, no. 1, February 2007.
- [173] T. Kohonen, “Self-Organizing Maps,” *Springer Series in Information Sciences*, vol. 30, Berlin, Heidelberg, New York: Springer, 1995, 1997, 2001.
- [174] Shu Fan, James R. Liao, Ryuichi Yokoyama, and Luonan Chen, “Forecasting the Wind Generation Using A Two-stage Hybrid Network Based on Meteorological Information,” *Information and Communication Engineering*, Osaka Sangyo University, 2006.
- [175] M. Ramoni, P. Sebastiani, and P. Cohen, “Bayesian Clustering by Dynamics,” *Machine Learning*, vol. 47, pp. 91–121, 2002.

- [176] A. Costa, A. Crespo, J. Navarro, A. Palomares, and H. Madsen, “Modelling the Integration of Mathematical and Physical Models for Short-term Wind Power Forecasting,” in *Proceedings of the European Wind Energy Conference EWEC’06*, Athens, Greece, 2006.
- [177] H.A. Nielsen, P. Pinson, L.E. Christiansen, T.S. Nielsen, H. Madsen, J. Badger, G. Giebel, and H.F. Ravn, “Improvement and Automation of Tools for Short-term Wind Power Forecasting,” in *Proceedings of the European Wind Energy Conference EWEC’07*, Milan, Italy 2007.
- [178] H.A. Nielsen, P. Pinson, T.S. Nielsen, L.E. Christiansen, H. Madsen, G. Giebel, J. Badger, X.G. Larsen, H. Ravn, J. Tøfting, and L. Voulund, “Intelligent wind power prediction systems – final report,” Informatics and Mathematical Modelling, Technical University of Denmark, DTU, 2007.
- [179] H. Madsen, H.A. Nielsen, and T.S. Nielsen, “A tool for predicting the wind power production of off-shore wind plants,” in *Proceedings of the Copenhagen Offshore Wind Conference & Exhibition*, Danish Wind Industry Association, Copenhagen, Denmark, 2005.
- [180] L. Landberg, “Short-term Prediction of Local Wind Conditions,” Ph.D. dissertation, Risø National Laboratory, Roskilde, Denmark, 1994.
- [181] H.A. Nielsen, T.S. Nielsen, H. Madsen, M.J.S.I. Pindado, and I. Marti, “Optimal Combination of Wind Power Forecasts,” *Wind Energy*, vol. 10, no. 5, pp. 471–482, July 19, 2007.
- [182] S. Lang, J. Möhrlein, J. Jørgensen, B.O. Gallachóir, and E. McKeogh, “Application of a Multi-Scheme Ensemble Prediction System for Wind Power Forecasting in Ireland and Comparison with Validation Results from Denmark and Germany,” in *Proceedings of the European Wind Energy Conference EWEC’06*, Athens, Greece, 2006.
- [183] Martín Gastón, Laura Frías, and Ignacio Martí, “Exploring the limits of wind farm grouping for prediction error compensation,” in *Proceedings of the European Wind Energy Conference EWEC’06*, Athens, Greece, 2006.
- [184] N. Siebert and G. Kariniotakis, “Reference wind farm selection for regional wind power prediction models,” in *Proceedings of the European Wind Energy Conference EWEC’06*, Athens, Greece, 2006.
- [185] J.P. Marques de Sá, *Pattern Recognition: Concepts, Methods and Applications*, Berlin: Springer Verlag, 2001.
- [186] R. Battiti, “Using Mutual Information for Selecting Features in Supervised Neural Net Learning,” *IEEE Transactions on Neural Networks*, vol. 5, no. 3, July 1994.

- [187] A. Yamaguchi, T. Ishihara, K. Sakai, T. Ogawa, and Y. Fujino, “An upscaling approach for the regional Wind Power Forecasting,” in *Proceedings of the European Wind Energy Conference EWEC’07*, Milan, 2007.
- [188] Álvaro Barbero, Jorge López, and José R. Dorransoro, “Kernel methods for wide area Wind Power Forecasting,” in *Proceedings of the European Wind Energy Conference EWEC 08*, Brussels, Belgium, 2008.
- [189] L. von Bremen, N. Saleck, and D. Heinemann, “Enhanced regional forecasting considering single wind farm distribution for upscaling,” *Journal of Physics: Conference Series*, vol. 75, Aug. 2007.
- [190] I. Troen and E.L. Petersen, “European Wind Atlas,” published for the EU Commission DGXII by Risø National Laboratory, Denmark, 1998.
- [191] N.G. Mortensen, L. Landberg, I. Troen, and E.L. Petersen, “Wind Atlas Analysis and Application program (WASP), Users Guide,” Risø National Laboratory, Roskilde, Denmark, 1993.
- [192] P. Sanderhoff, “PARK – User’s Guide. A PC-program for calculation of wind turbine park performance,” Risø National Laboratory, Roskilde, Denmark, 1993.
- [193] R. Watson, L. Landberg, R. Costello, D. McCoy, and P. O’Donnell, “Evaluation of the Prediktor Wind Power Forecasting System in Ireland,” in *Proceedings of the European Wind Energy Conference EWEC’01*, pp. 703–706, Copenhagen, Denmark, June 2–6, 2001.
- [194] G. Giebel, L. Landberg, K. Mönnich, and H. P. Waldl, “Relative Performance of different Numerical Weather Prediction Models for Short-Term Prediction of Wind Energy,” in *Proceedings of the European Wind Energy Conference EWEC’99*, pp. 1078–1081, Nice, France, March 1–5, 1999.
- [195] “California Wind Energy Forecasting System Development and Testing, Phase 1: Initial Testing,” EPRI Final Report, January 2003.
- [196] “California Wind Energy Forecasting System Development and Testing, Phase 2: 12-Month Testing and Evaluation,” EPRI Final Report, 2003.
- [197] U. Focken, M. Lange, and H.P. Waldl, “Previento - A Wind Power Prediction System with an Innovative Upscaling Algorithm,” in *Proceedings of the European Wind Energy Conference EWEC’01*, Copenhagen, Denmark, pp. 826–829, June 2–6, 2001.
- [198] K. Mönnich, “Vorhersage der Leistungsabgabe netzeinspeisender Windkraftanlagen zur Unterstützung der Kraftwerkseinsatzplanung,” Ph.D. dissertation, Carl von Ossietzky Universität Oldenburg, 2000.
- [199] M. Lange, U. Focken, and D. Heinemann, “Previento – Regional Wind Power Prediction with Risk Control,” in *Proceedings of the World Wind Energy Conference*, Berlin, 2002.

- [200] Ignácio Martí, “Wind Forecasting Activities,” in *Proceedings of the First IEA Joint Action Symposium on Wind Forecasting Techniques*, published by FOI Swedish Defence Research Agency, Norrköping, Sweden, pp. 11–20, Dec. 2002.
- [201] I. Marti, D. Cabezón, J. Villanueva, M.J. San Isidro, Y. Loureiro, E. Cantero, and J. Sanz, “LocalPred and RegioPred. Advanced tools for wind energy prediction in complex terrain,” in *Proceedings of the European Wind Energy Conference EWEC’03*, Madrid, Spain, June 16–19, 2003.
- [202] J. Villanueva and I. Martí, “Improving wind resource assessment and wind forecast by using a CFD model developed in CENER,” in *Proceedings of the Conference: The Science of Making Torque from Wind*, Delft, The Netherlands, April 19–21, 2004.
- [203] I. Marti, J.J. San Isidro, D. Cabezón, Y. Loureiro, J. Villanueva, E. Cantero, and I. Pérez, “Wind Power Prediction in Complex Terrain: From the Synoptic Scale to the Local Scale,” in *Proceedings of the Conference: The Science of making Torque from Wind*, Delft, The Netherlands, April 19–21, 2004.
- [204] T.S. Nielsen, L. Landberg, and G. Giebel, “Prediction of Regional Wind Power,” poster presentation at the Global Windpower Conference, Paris, France, April 2–5, 2002.
- [205] H.Aa. Nielsen, T.S. Nielsen, A.K. Joensen, H. Madsen, and J. Holst, “Tracking time-varying coefficient-functions,” *Int. J. of Adapt. Control and Signal Processing*, vol. 14, no. 8, pp. 813–828, 2000.
- [206] H.A. Nielsen, T.S. Nielsen, H. Madsen, G. Giebel, J. Badger, L. Landberg, K. Sattler, L. Voulund, and J. Tofting, “From wind ensembles to probabilistic information about future wind power production – results from an actual application,” in *Proceedings of the International Conference on Probabilistic Methods Applied to Power Systems, PMAPS 2006*, pp.1–8, June 11–15, 2006.
- [207] H.A. Nielsen, H. Madsen, and T. S. Nielsen, “Using quantile regression to extend an existing Wind Power Forecasting system with probabilistic forecasts,” *Wind Energy*, vol. 9, nos. 1–2, pp. 95–108, 2006.
- [208] Nicholas Cutler, Kieran Jacka, T. S. Nielsen, and Merlinde Kay, “The First Australian Installation of the Wind Power Prediction Tool,” in *Proceedings of the Global Wind Energy Conference*, Adelaide, Australia, Sept. 18–21, 2006.
- [209] Frank Hochmuth, “Wind & Imbalance Management,” Wind Workshop Delf, NUON Energy Sourcing, Oct. 25, 2006.
- [210] G. Giebel, L. Landberg, T.S. Nielsen, and H. Madsen, “The Zephyr Project – The Next Generation Prediction System,” poster presentation at the Global Windpower Conference and Exhibition, Paris, France, April 2–5, 2002.

- [211] J. Badger, G. Giebel, X.G. Larsen, T.S. Nielsen, H.A. Nielsen, H. Madsen, and J. Tøfting, “Report on the use of stability parameters and mesoscale modelling in short-term prediction,” Technical Report, Risø National Laboratory, DTU, June 2007.
- [212] M.A. Gaertner, C. Gallardo, C. Tejada, N. Martínez, S. Calabria, N. Martínez, and B. Fernández, “The Casandra project: results of wind power 72-hr range daily operational forecasting in Spain,” in *Proceedings of the European Wind Energy Conference EWEC’03*, Madrid, Spain, July 16–19, 2003.
- [213] G. Kariniotakis and D. Mayer, “An Advanced On-Line Wind Resource Prediction System for the Optimal Management of Wind Farms,” in *Proceedings of the 3rd MED POWER Conference 2002*, Athens, Greece, November 4–6, 2002.
- [214] P. Pinson and G. Kariniotakis, “On-line Assessment of Prediction Risk for Wind Power Production Forecasts,” in *Proceedings of the European Wind Energy Conference EWEC’03*, Madrid, Spain, June 16–19, 2003.
- [215] G. Kariniotakis, D. Mayer, J.A. Halliday, A.G. Dutton, A.D. Irving, R.A. Brownsword, P.S. Dokopoulos, and M.C. Alexiadis, “Load, Wind, and Hydro Power Forecasting Functions of the More-Care EMS System,” in *Proceedings of the 3rd MED POWER Conference 2002*, Athens, Greece, Nov. 4–6, 2002.
- [216] R. Costello, D. McCoy, P. O’Donnell, A.G. Dutton, and G. Kariniotakis, “Potential Benefits of Wind Forecasting and the Application of More-Care in Ireland,” in *Proceedings of the 3rd MED POWER Conference 2002*, Athens, Greece, Nov. 4–6, 2002.
- [217] G. Kariniotakis and P. Pinson, “Evaluation of the More-Care Wind Power Prediction Platform. Performance of the Fuzzy Logic Based Models,” in *Proceedings of the European Wind Energy Conference EWEC’03*, Madrid, Spain, June 16–19, 2003.
- [218] G.C. Hatzigiorgiou, M. Matos, J.A. Pecos Lopes, G. Kariniotakis, D. Mayer, J. Halliday, G. Dutton, P. Dokopoulos, A. Bakirtzis, J. Stefanakis, A. Gigantidou, P. O’Donnell, D. McCoy, M.J. Fernandes, J.M.S. Cotrim, and A.P. Figueira, “MORE CARE Advice for Secure Operation of Isolated Power Systems with Increased Renewable Energy Penetration & Storage,” in *Proceedings of the European Wind Energy Conference EWEC’01*, pp. 1142–1145, Copenhagen, Denmark, June 2–6, 2001.
- [219] M. Durstewitz, C. Ensslin, B. Hahn, and M. Hoppe-Kilpper, “Annual Evaluation of the Scientific Measurement and Evaluation Programme (WMEP),” Kassel, Germany, 2001.
- [220] B. Ernst, K. Rohrig, H. Regber, and P. Schorn, “Managing 3000 MW Wind Power in a Transmission System Operation Center,” in *Proceedings of the European Wind Energy Conference EWEC’01*, pp. 890–893, Copenhagen, Denmark, June 2–6, 2001.

- [221] B. Ernst and K. Rohrig, “Online-Monitoring and Prediction of Wind Power in German Transmission System Operation Centres,” in *Proceedings of the First IEA Joint Action Symposium on Wind Forecasting Techniques*, pp. 125–145, Norrköping, Sweden, Dec. 2002. Published by FOI Swedish Defence Research Agency.
- [222] B. Lange, “Experiences from the Development of Wind Power Forecasts for Six European TSOs,” presentation at the Second Workshop on Best Practice in the Use of Short-term Forecasting of Wind Power, Madrid, Spain, May 2008.
- [223] K. Rohrig, B. Ernst, M. Hoppe-Kilpper, and F. Schlögl, “Online-monitoring and prediction of wind power in German transmission system operation centres,” in *Proceedings WVEC 2003 – WorldWind Energy Conference*, Cape Town, South Africa, November 2003.
- [224] B. Ernst, B. Oakleaf, M.L. Ahlstrom, M. Lange, C. Moehrlen, B. Lange, U. Focken, and K. Rohrig, “Predicting the wind,” *IEEE Power & Energy Magazine*, pp. 78–88, November/December, 2007.
- [225] Ue. Cali, B. Lange, J. Dobschinski, M.Kurt, C. Moehrlen, and B. Ernst, “Artificial neural network based Wind Power Forecasting using a multi-model approach,” presented at the 7th International Workshop on Large Scale Integration of Wind Power and on Transmission Networks for Offshore Wind Farms, Madrid, Spain, May 26–27, 2008.
- [226] S. Lang, J. Möhrle, J. Jørgensen, B.O. Gallachóir, and E. McKeogh, “Aggregate forecasting of wind generation on the Irish grid using a multi-scheme ensemble prediction system,” in *Proceedings, Renewable Energy in Maritime Island Climates, 2nd Conference*, Dublin, Ireland, April 2006.
- [227] S. Lang, J. Möhrle, J. Jørgensen, B.O. Gallachóir, and E. McKeogh, “Forecasting Total Wind Power Generation on the Republic of Ireland Grid with a Multi-Scheme Ensemble Prediction System,” in *Proceedings of the Global Windpower Conference 2006*, Adelaide, Australia, September 16–21, 2006.
- [228] “Operations & Reliability – Solution Overview,” Technical Report of the Wind Power Forecasting Pilot Project, Part A: The Forecast, April 16, 2007.
- [229] N. Cutler, M. Kay, H. Outhred, and I. MacGill, “High-Risk Scenarios for Wind Power Forecasting in Australia,” in *Proceedings of the European Wind Energy Conference EWEC’07*, Milan, Italy, May 7–10, 2007.
- [230] I. Sánchez, J. Usaola, O. Ravelo, C. Velasco, J. Domínguez, M.G. Lobo, G. González, and F. Soto, “SIPREÓLICO – A Wind Power Prediction System Based on Flexible Combination of Dynamic Models. Application to the Spanish Power System,” poster presentation at the World Wind Energy Conference, Berlin, Germany, June 2002.

- [231] I. Sánchez, “Adaptive combination of forecast with application to wind energy forecast,” in *Proceedings of International Conference on Probabilistic Methods Applied to Power Systems, PMAPS 2006*, June 11–15, 2006.
- [232] I. Sánchez, “Adaptive density estimation of wind power predictions,” in *Proceedings of the International Symposium on Forecasting ISF2008* (oral presentation), Nice, France, July 2008.
- [233] J. Parkes and A. Tindal, “Forecasting short term wind farm production in complex terrain,” in *Proceedings of the European Wind Energy Conference EWEC’04*, London, U.K., Nov. 2004.
- [234] G. Gow, “Forecasting Short-Term Wind Farm Production,” Technical Report, Garrad Hassan and Partners Ltd., Bristol, U.K., 2003.
- [235] M. Lange and U. Focken, “State-of-the-art in wind power prediction in Germany and international developments,” in *Proceedings of the Second Workshop of International Feed-In Cooperation*, Berlin, Dec. 2005.
- [236] A. Rodrigues, J.A. Peças Lopes, P. Miranda, L. Palma, C. Monteiro, R. Bessa, J. Sousa, C. Rodrigues, and J. Matos, “EPREV – A Wind Power Forecasting Tool for Portugal,” in *Proceedings of the European Wind Energy Conference EWEC’07*, Milan, Italy, 2007.
- [237] J.C. Lopes da Costa, F.A. Castro, L. Palma, and P. Stuart, “Computer Simulation of Atmospheric Flows Over Real Forests for Wind Energy Resource Evaluation,” *Journal of Wind Engineering and Industrial Aerodynamics*, vol. 94, pp. 603–620, 2006.
- [238] C. Rodrigues, J. Matos, A. Rodrigues, F.A. Castro, P. Miranda, and L. Palma, “Short-term forecasting of a wind farm output using CFD,” in *Proceedings of the European Wind Energy Conference EWEC’08*, Brussels, Belgium, 2008.
- [239] Independent Electricity System Operator (IESO) of Ontario, “Centralized Renewable Forecasting,” Feb. 4, 2009.
- [240] B. Bailey, M.C. Brower, and J. Zack, “Short-Term Wind Forecasting,” in *Proceedings of the European Wind Energy Conference EWEC’99*, pp. 1062–1065, Nice, France, March 1–5, 1999.
- [241] J.W. Zack, M.C. Brower, and B.H. Bailey, “Validating of the Forewind Model in Wind Forecasting Applications,” Talk on the EUWEC Special Topic Conference Wind Power for the 21st Century, Kassel, Germany, Sept. 25–27, 2000.
- [242] J.W. Zack, “An overview of AWS Truewind’s approach and experience in providing wind power production forecasting services to utilities and balancing authorities in North America,” presented at the International Wind Forecasting Workshop Portland, Oregon, July 24–25 2008.

- [243] J.W. Zack, “Optimization of wind power production forecast performance during critical periods for grid management,” poster presentation at the AWEA Windpower Conference, Los Angeles, Calif., June 3–6, 2007.
- [244] Renewable Energy Research and Development Project – Final Report, Oct. 6, 2008.
- [245] Pascal Storck, “Wind Energy Forecasting: The State of the Art & Future Possibilities,” presentation at UWIG Fall Technical Workshop Wind Integration: Focus on the Value of Wind Forecasting, Sacramento, California, Nov. 7–9, 2005.
- [246] Kristen Larson, “State-of-the Art in Wind Forecasting,” presentation at Putting Wind on the Wires – Arizona Wind Power Forum Friday, Phoenix, Arizona, Nov. 7, 2008.
- [247] Eric Gruit and Cameron Potter, “State-of-the-Art Wind Energy Forecasting (and the Future of Forecasting),” presentation at International Wind Forecasting Workshop, July 24–25, 2008.
- [248] Kristin A. Larson and Kenneth Westrick, “Short-term wind forecasting using off-site observations,” *Wind Energy*, vol. 9, no. 9, pp. 55–62, 2006.
- [249] Precision Wind, Precise Stream – Inside the Precision Wind Forecast Service, brochure available at the Wind Power 2009 Exhibition, 2009.
- [250] Robert Kelly, “New modeling techniques: from wind assessment and forecasting to wind resource management,” presentation in the Bonneville Power Administration & California ISO’s International Wind Forecast Techniques and Methodologies Workshop, Portland, Oregon, July 2008.
- [251] E. McCarthy, R. Nierenberg, L. Landberg, J. Zack, and K. Tran, “Texas Wind Energy Forecasting System Development and Testing. Phase 1: Initial Testing,” Technical Report, December 2003.
- [252] E. McCarthy, R. Nierenberg, L. Landberg, J. Zack, and K. Tran, “Texas Wind Energy Forecasting System Development and Testing. Phase 2: 12-Month Testing,” Technical Report, August 2004.
- [253] G. Kariniotakis, et al., “Next Generation Short-term Forecasting of Wind Power – Overview of the ANEMOS Project,” in *Proceedings of the European Wind Energy Conference EWEC’06*, Athens, Greece, 2006.
- [254] Alberto Ceña, et al., “Advancing in Manageability,” AEE Wind Power 2006, pp. 81–87, Madrid, Spain, 2006.
- [255] G. Kariniotakis, I. Marti, et al., “What Performance Can Be Expected by Short-term Wind Power Prediction Models Depending on Site Characteristics?,” in *Proceedings of the European Wind Energy Conference EWEC’04*, London, U.K., Nov. 22–25, 2004.

- [256] I. Marti, et al., “Evaluation of Advanced Wind Power Forecasting Models – The Results of the ANEMOS Project,” in *Proceedings of the European Wind Energy Conference EWEC’06*, Athens, Greece, 2006.
- [257] P. Louka, G. Galanis, N. Siebert, G. Kariniotakis, P. Katsafados, G. Kallos, and I. Pytharoulis, “Improvements in wind speed forecasts for wind power prediction purposes using Kalman filtering,” *Journal of Wind Engineering and Industrial Aerodynamics*, vol. 96, no. 12, pp. 2348–2362, Dec. 2008.
- [258] “Wind Power Forecasting Pilot Project – Industry Work Group Report,” Technical Report, Aug. 6, 2008.
- [259] Ulrich Focken and Matthias Lange, “Final Report – Wind Power Forecasting Pilot Project in Alberta, Canada,” Oldenburg, May 26, 2008.
- [260] Jess U. Jørgensen and Corinna Moehrlen, “AESO Wind Power Forecasting Pilot Project – Final Project Report,” Technical Report, May 2008.
- [261] AWS Truewind’s Final Report for the Alberta Forecasting Pilot Project, Technical Report, June 25, 2008.
- [262] J. Juban, L. Fugon, and G. Kariniotakis, “Uncertainty Estimation of Wind Power Forecasts,” in *Proceedings of the European Wind Energy Conference EWEC’08*, Brussels, Belgium, March 31–April 3, 2008.
- [263] P. Pinson, H. Aa. Nielsen, H. Madsen, M. Lange, and G. Kariniotakis, “Methods for the estimation of the uncertainty of wind power forecasts,” ANEMOS project deliverable report D3.1b, Informatics and Mathematical Modelling, Technical University of Denmark, March 2007.
- [264] John B. Bremnes, “Probabilistic wind power forecasts using local quantile regression,” *Wind Energy*, vol. 7, no. 1, pp. 47–54, 2004.
- [265] M.A. Matos and R. Bessa, “Operating Reserve Adequacy Evaluation using Uncertainties of Wind Power Forecast,” in *Proceedings of the IEEE PowerTech Conference*, Bucharest, Romania, June 28–July 2, 2009.
- [266] J. Juban, L. Fugon, and G. Kariniotakis “Probabilistic short-term wind power forecasting based on kernel density estimators,” in *Proceedings of the European Wind Energy Conference EWEC’07*, Milan, Italy, 2007.
- [267] H. Bludszuweit, J.A. Dominguez-Navarro, and A. Llombart, “Statistical Analysis of Wind Power Forecast Error,” *IEEE Transactions on Power Systems*, vol. 23, no. 3, pp. 983–991, Aug. 2008.
- [268] P. Pinson and G. Kariniotakis, “On-line assessment of prediction risk for wind power production forecasts,” *Wind Energy*, vol. 7, no. 2, pp. 119–132, 2004.

- [269] P. Pinson, H.Aa. Nielsen, H. Madsen, and G. Kariniotakis, “Skill forecasting from ensemble predictions of wind power,” *Applied Energy*, vol. 86, nos. 7–8, pp. 1326–1334, July–August 2009.
- [270] P. Pinson, G. Papaefthymiou, B. Klockl, H.Aa. Nielsen, and H. Madsen, “From probabilistic forecasts to statistical scenarios of short-term wind power production,” *Wind Energy*, vol. 12, no. 1, pp. 51–62, 2009.
- [271] P. Pinson, G. Papaefthymiou, B. Klockl, and J. Verboomen, “Dynamic sizing of energy storage for hedging wind power forecast uncertainty,” in *Proceedings of the IEEE Power Engineering Society General Meeting 2009*, Calgary, Canada, July 26–30, 2009.
- [272] G. Papaefthymiou and P. Pinson, “Modeling of spatial dependence in wind power forecast uncertainty,” in International Conference on Probabilistic Methods Applied to Power Systems, PMAPS 2008 (invited oral presentation), Puerto Rico, May 2008.
- [273] P. Pinson and G. Papaefthymiou, “Spatio-temporal scenario forecasts of wind generation” (working paper), 2009.
- [274] J. Vlasova, P. Pinson, E. Kotwa, H.Aa. Nielsen, and H. Madsen, “Spatio-temporal analysis and modeling of wind power forecast errors,” *Wind Energy*, 2008 (submitted).
- [275] M. Lange, “Analysis of the uncertainty of wind power predictions,” Ph.D. dissertation, Carl von Ossietzky Oldenburg University, 2003.
- [276] R. Koenker and G. Bassett, “Regression quantiles,” *Econometrica*, vol. 46, pp. 33–49, 1978.
- [277] John B. Bremnes, “A comparison of a few statistical models for making quantile wind power forecasts,” *Wind Energy*, vol. 9, no. 1-2, pp. 3–11, 2006.
- [278] P. Hall, R.C. Wolff, and Q. Yao, “Methods for estimating a conditional distribution function,” *Journal of the American Statistical Association*, vol. 94, pp. 154–163, 1999.
- [279] Jan Kloppenborg Møller, “Modeling of Uncertainty in Wind Energy Forecast,” Master thesis, Technical University Denmark, Oct. 2006.
- [280] Jan Kloppenborg Møller, H.A. Nielsen, and H. Madsen, “Time-adaptive quantile regression,” *Computational Statistics & Data Analysis*, vol. 52, no. 3, pp. 1292–1303, Jan. 2008.
- [281] Nicolai Meinshausen, “Quantile Regression Forests,” *Journal of Machine Learning Research*, vol. 7, pp. 983–999, June 2006.
- [282] B. Bonnländer, “Nonparametric selection of input variables for connectionist learning,” PhD dissertation, University of Colorado Department of Computer Science, 1996.

- [283] J. Taylor, P. McSharry, and R. Buizza, “Wind power density forecasting using wind ensemble predictions and time series models,” *IEEE Transactions on Energy Conversion*, 2008, (in press).
- [284] H.A. Nielsen, H. Madsen, T.S. Nielsen, J. Badger, G. Giebel, L. Landberg, K. Sattler, and H. Feddersen, “Wind Power Ensemble Forecasting Using Wind Speed and Direction Ensembles from ECMWF or NCEP,” Denmark Project PSO, Technical Report, 2005.
- [285] G. Giebel, J. Badger, L. Landberg, H.A. Nielsen, T.S. Nielsen, H. Madsen, K. Sattler, H. Feddersen, H. Vedel, J. Tøfting, L. Kruse, and L. Voulund, “Wind Power Prediction using Ensembles,” Technical Report, Risø National Laboratory, Roskilde, Denmark, Sept. 2005.
- [286] P. Pinson and H. Madsen, “Ensemble-Based Probabilistic Forecasting at Horns Rev,” *Wind Energy, Special Issue on Off-shore Wind Energy*, vol. 12, no. 2, pp. 137–155, Nov. 2008.
- [287] L. von Bremen, “Combination of Deterministic and Probabilistic Meteorological Models to Enhance Wind Farm Power Forecasts,” *Journal of Physics: Conference Series*, vol. 75, 2007.
- [288] L. von Bremen, R. Hagedorn, and T. Peroliagis, “Towards probabilistic wind power forecasting based on ensemble prediction techniques,” presentation at the 7th European Meteorological Society Annual Meeting, October 2007.
- [289] T. Gneiting, A.E. Raftery, A.H. Westveld, and T. Goldman, “Calibrated probabilistic forecasting using ensemble model output statistics and minimum CRPS estimation,” *Monthly Weather Review*, vol. 133, pp. 1098–1118, 2004.
- [290] P. Pinson, G. Kariniotakis, H. A. Nielsen, T. S. Nielsen and H. Madsen, “Properties of Quantile and Interval Forecasts of Wind Generation and their Evaluation,” in *Proceedings of the European Wind Energy Conference EWEC’06*, Athens, Greece, 2006.
- [291] P. Pinson, H.A. Nielsen, J.K. Moller, H. Madsen, and G. Kariniotakis, “Nonparametric probabilistic forecasts of wind power: required properties and evaluation,” *Wind Energy*, vol. 10, no. 6, pp. 497–516, Nov. 2007.
- [292] F. Kenneth, “Chi-squared tests of interval and density forecasts, and the Bank of England’s fan charts,” *International Journal of Forecasting*, vol. 19, no. 2, pp. 165–175, 2003.
- [293] Michael P. Clements, *Evaluating Econometric Forecasts of Economic and Financial Values*, New York: Palgrave Macmillan, 2005.
- [294] F. Atger, “The Skill of Ensemble Prediction Systems,” *Monthly Weather Review*, vol. 127, no. 9, Sept. 1999.

- [295] D.B. Stephenson, “Glossary” in *Forecast Verification: A Practitioner’s Guide in Atmospheric Science*, I. Jolliffe, D.B. Stephenson, New York: Wiley & Sons, pp. 203–213, 2003.
- [296] H.Aa. Nielsen, T.S. Nielsen, H. Madsen, J. Badger, G. Giebel, L. Landberg, K. Sattler, and H. Feddersen, “Wind power ensemble forecasting,” in *Proceedings of the 2004 Global Windpower Conference*, Chicago, Illinois, March 2004.
- [297] NERC (North American Electric Reliability Corporation), “Reliability Standards for the Bulk Electric System of North America,” April 2009. Available at: <http://www.nerc.com/page.php?cid=2|20>.
- [298] MISO (Midwest ISO), “Business Practices Manual: Energy and Operating Reserve Markets,” Jan. 2009. Available at: <http://www.midwestmarket.org/publish>.
- [299] E. DeMeo, K. Porter, and C. Smith, “Wind Power and Electricity Markets,” Utility Wind Integration Group, Sept. 2007. Available at: <http://www.uwig.org/windinmarketstableSep07.pdf>.
- [300] J. Blatchford, “Wind Energy Forecasting 101,” Presentation to PJM conference, May 15–16, 2008.
- [301] ERCOT, “ERCOT Methodologies for Determining Ancillary Service Requirements,” ERCOT, February 2009. Available at: <http://www.ercot.com/mktinfo/services/>.
- [302] D. Maggio, “Integrating Wind Forecasting into Market Operation – ERCOT,” Presentation Wind Forecasting Workshop, Utility Wind Integration Group (UWIG), Phoenix, Arizona, Feb. 2009.
- [303] R. Bart, H. Brand, P. Meibom, and C. Weber, “A Stochastic Unit-commitment Model for the Evaluation of the Impacts of Integration of Large Amounts of Intermittent Wind Power,” *Proceedings 9th Int. Conf. on Probabilistic Methods Applied to Power Systems*, Stockholm, Sweden, June 2006.
- [304] F. Bouffard, F.D. Galiana, “Stochastic Security for Operations Planning With Significant Wind Power Generation,” *IEEE Transactions on Power Systems*, vol. 23, no. 2, pp. 306–316, 2008.
- [305] J. Wang, M. Shahidehpour, and Z. Li, “Security-Constrained Unit Commitment with Volatile Wind Power Generation,” *IEEE Transactions on Power Systems*, vol. 23, no. 3, pp. 1319–1327.
- [306] P.A. Ruiz, C.R. Philbrick, and P.W. Sauer, “Wind Power Day-Ahead Uncertainty Management through Stochastic Unit Commitment Policies,” *Proceedings IEEE PES Power Systems Conference and Exhibition*, March 2009.

- [307] A. Tuohy, P. Meibom, E. Denny, and M. O'Malley, "Unit Commitment for Systems With Significant Wind Penetration," *IEEE Transactions on Power Systems*, vol. 24, no. 2, pp. 592–601.
- [308] C. Loutan and D. Hawkins, "Integration of Renewable Resources: Transmission and Operating Issues and Recommendations for Integrating Renewable Resources on the California ISO-controlled Grid," Report California ISO, Nov. 2007.
- [309] R. Gonzales, R. Mukerji, M. Swider, D. Allen, R. Pike, D. Edelson, E. Nelson, and J. Adams, "Integration of Wind into System Dispatch," New York ISO White Paper, Oct. 2008. Available at: http://www.nyiso.com/public/webdocs/documents/white_papers/wind_management_whitepaper_11202008.pdf.
- [310] M. Swider, "Integrating Wind Forecasting and Bids into Market Operations," Presentation Wind Forecasting Workshop, Utility Wind Integration Group (UWIG), Phoenix, Arizona, Feb. 2009.
- [311] PJM, "Wind Generation Operational Considerations," PJM presentation, May 2009. Available at: <http://www.pjm.com/~media/committees-groups/working-groups/irwg/20090527/20090527-item-03d-wind-dispatching-training.ashx>.
- [312] M. McMullen, "Integrating Wind Forecasting into Market Operation," Presentation Wind Forecasting Workshop, Utility Wind Integration Group (UWIG), Phoenix, Arizona, Feb. 2009.
- [313] NYISO, "Market Participants User's Guide," New York ISO, Nov. 2008. Available at: <http://www.nyiso.com/public/documents/guides/index.jsp>.
- [314] NYISO, "Ancillary Services Manual," New York ISO, Sept. 2008. Available at: <http://www.nyiso.com/public/webdocs/documents/manuals/operations/ancserv.pdf>.
- [315] D. Edelson, "Wind Forecasting at the NYISO," presentation at the Wind Forecasting Workshop, Utility Wind Integration Group (UWIG), St. Paul, Minnesota, Feb. 2008.
- [316] S. Patil, "Wind Power Forecasting Process Development," presentation at the Spring Technical Workshop and Annual Meeting, Utility Wind Integration Group (UWIG), Philadelphia, Pennsylvania, Apr. 2009.
- [317] PJM, "PJM Manual 11: Scheduling Operations," PJM, Jan. 2009. Available at: <http://www.pjm.com/documents/manuals.aspx>.
- [318] ERCOT, "ERCOT Wholesale Market Operations: Module 2," ERCOT Presentation, January 2009. Available at: http://www.ercot.com/services/training/Wholesale_Basics.

- [319] ERCOT, “ERCOT Operating Guides. Section 2: System Operation. ERCOT Control Area Authority Operation,” ERCOT, March 1, 2009. Available at: <http://www.ercot.com/mktrules/guides/operating/>.
- [320] CAISO, “Business Practice Manual for Market Operations,” California ISO, March 23, 2009. Available at: <http://www.caiso.com/17ba/17baa8bc1ce20.html>.
- [321] Y.V. Makarov, C. Loutan, J. Ma, P. de Mello, “Operational Impacts of Wind Generation on California Power Systems,” *IEEE Transactions on Power Systems*, vol. 24, no. 2, pp. 1039–1050, 2009.
- [322] DOE, “20% Wind Energy by 2030: Increasing Wind Energy’s Contribution to U.S. Electricity Supply,” U.S. Department of Energy, Office of Energy Efficiency and Renewable Energy Report, July 2008. Available at: http://www1.eere.energy.gov/windandhydro/wind_2030.html.
- [323] M. Shahidehpour, H. Yamin, and Z. Li, *Market operations in electric power systems*, John Wiley and Sons, March 2002.
- [324] MISO (Midwest ISO), “Market concepts study guide”, December 2005.
- [325] M. Carrion and J.M. Arroyo, “A computationally efficient mixed-integer linear formulation for the thermal unit commitment problem,” *IEEE Transactions on Power Systems*, vol. 21, no. 3, pp. 1371–1378, 2006.
- [326] J.M. Arroyo and A.J. Conejo, “Optimal response of a thermal unit to an electricity spot market,” *IEEE Transactions on Power Systems*, vol. 15, no. 3, pp. 1098–1104, 2000.
- [327] The ILOG CPLEX Website, 2006. Available at: <http://www.ilog.com/products/cplex/>.
- [328] S.A. Kazarlis, A.G. Bakirtzis, and V. Petridis, “A genetic algorithm solution to the unit commitment problem,” *IEEE Transactions on Power Systems*, vol. 11, no. 1, pp. 83–92, 1996.
- [329] Y. Fu, M. Shahidehpour, and Z. Li, “Security-constrained unit commitment with AC constraints,” *IEEE Transactions on Power Systems*, Vol. 20, no. 3, pp. 1538–1550, 2005.
- [330] M. Ahlstrom, L. Jones, R. Zavadil, and W. Grant, “The future of wind forecasting and utility operations,” *IEEE Power and Energy Magazine*, vol. 3, no.6, pp. 57–64, 2005.
- [331] J. Smith, R. Thresher, R. Zavadil, E. DeMeo, R. Piwko, B. Ernst, and T. Ackermann, “A mighty wind,” *Power and Energy Magazine*, vol. 7, no. 2, pp. 41–51, 2009.
- [332] J.C. Smith, M.R. Milligan, E.A. DeMeo, and B. Parsons, “Utility Wind Integration and Operating Impact State of the Art,” *IEEE Transactions on Power Systems*, vol. 22, no. 3, pp. 900–908, 2007.

- [333] L. Söder, “Reserve margin planning in a wind-hydro-thermal power system,” *IEEE Transactions on Power Systems*, vol. 8, no. 2, pp. 564–571, 1993.
- [334] G. Dany, “Power reserve in interconnected systems with high wind power production,” in *2001 IEEE Porto Power Tech Proceedings*, vol. 4, pp. 6, Sept. 10–13, 2001.
- [335] R. Doherty and M. O’Malley, “A new approach to quantify reserve demand in systems with significant installed wind capacity,” *IEEE Transactions on Power Systems*, vol. 20, no. 2, pp. 587–595, 2005.
- [336] H. Holttinen, “Impact of hourly wind power variations on the system operation in the Nordic countries,” *Wind Energy*, vol. 8, no. 2, pp. 197–218, 2004.
- [337] M.A. Ortega-Vazquez and D.S. Kirschen, “Estimating the Spinning Reserve Requirements in Systems With Significant Wind Power Generation Penetration,” *IEEE Transactions on Power Systems*, vol. 24, no. 1, pp. 114–124, 2009.
- [338] M.A. Ortega-Vazquez and D.S. Kirschen, “Optimizing the spinning reserve requirements using a cost/benefit analysis,” *IEEE Transactions on Power Systems*, vol. 22, no. 1, pp. 24–33, 2007.
- [339] R. Barth, H. Brand, P. Meibom, and C. Weber, “A stochastic unit commitment model for the evaluation of the impacts of the integration of large amounts of wind power,” in *Proceedings 9th Int. Conf. Probabilistic Methods Applied to Power Systems*, Stockholm, Sweden, 2006.
- [340] Wind Power Integration in Liberalised Electricity Markets (Wilmar) Project. Available at: <http://www.wilmar.risoe.dk>.
- [341] A. Tuohy, P. Meibom, E. Denny, and M. O’Malley, “Unit Commitment for Systems With Significant Wind Penetration,” *IEEE Transactions on Power Systems*, vol. 24, no. 2, pp. 592–601, 2009.
- [342] A. Tuohy, E. Denny, and M. O’Malley, “Rolling Unit Commitment for Systems with Significant Installed Wind Capacity,” *2007 IEEE Lausanne Power Tech*, pp. 1380–1385, July 1–5, 2007.
- [343] A. Tuohy, P. Meibom, and M. O. Malley, “Benefits of stochastic scheduling for power systems with significant installed wind power,” in *Proceedings 10th Int. Conf. Probabilistic Methods Applied to Power Systems (PMAPS)*, Mayagüez, Puerto Rico, 2008.
- [344] E. Denny and M. O’Malley, “Quantifying the total net benefits of grid integrated wind,” *IEEE Transactions on Power Systems*, vol. 22, no. 2, pp. 605–615, 2007.
- [345] Drayton Analytics, *PLEXOS for Power Systems – Electricity Market Simulation*. Available at: <http://www.draytonanalytics.com>.

- [346] B.C. Ummels, M. Gibescu, E. Pelgrum, W.L. Kling, and A.J. Brand, "Impacts of Wind Power on Thermal Generation Unit Commitment and Dispatch," *IEEE Transactions on Energy Conversion*, vol. 22, no. 1, pp. 44–51, 2007.
- [347] F. Bouffard and F. Galiana, "Stochastic security for operations planning with significant wind power generation," *IEEE Transactions on Power Systems*, vol. 23, no. 2, pp. 306–316, 2008.
- [348] J. Wang, M. Shahidehpour, and Z. Li, "Security-constrained unit commitment with volatile wind power generation," *IEEE Transactions on Power Systems*, vol. 23, no. 3, Aug. 2008.
- [349] K. Methaprayoon, C. Yingvivatanapong, Wei-Jen Lee; and J.R. Liao, "An Integration of ANN Wind Power Estimation Into Unit Commitment Considering the Forecasting Uncertainty," *IEEE Transactions on Industry Applications*, vol. 43, no. 6, pp. 1441–1448, 2007.
- [350] E. Delarue and W. D'haeseleer, "Adaptive mixed-integer programming unit commitment strategy for determining the value of forecasting," *Applied Energy*, vol. 85, no. 4, pp. 171–181, 2008.
- [351] Y.V. Makarov, C. Loutan, J. Ma, and P. de Mello, "Operational Impacts of Wind Generation on California Power Systems," *IEEE Transactions on Power Systems*, vol. 24, no. 2, pp. 1039–1050, 2009.
- [352] P.A. Ruiz, C.R. Philbrick, E. Zak, K.W. Cheung, and P.W. Sauer, "Uncertainty Management in the Unit Commitment Problem," *IEEE Transactions on Power Systems*, vol. 24, no.2, pp. 642–651, 2009.
- [353] P.A. Ruiz, C.R. Philbrick, and P.W. Sauer, "Wind Power Day-Ahead Uncertainty Management through Stochastic Unit Commitment Policies," *Proceedings Power Systems Conference and Exhibition*, Seattle, Washington, March 2009.
- [354] E.D. Castronuovo and J.A.P. Lopes, "On the optimization of the daily operation of a wind-hydro power plant," *IEEE Transactions on Power Systems*, vol. 19, no. 3, pp. 1599–1606, 2004.
- [355] P.D. Brown, J.A. Peas Lopes, and M.A. Matos, "Optimization of Pumped Storage Capacity in an Isolated Power System with Large Renewable Penetration," *IEEE Transactions on Power Systems*, vol. 23, no. 2, pp. 523–531, 2008.
- [356] J. Garcia-Gonzalez, R.M.R. de la Muela, L.M. Santos, and A.M. Gonzalez, "Stochastic Joint Optimization of Wind Generation and Pumped-Storage Units in an Electricity Market," *IEEE Transactions on Power Systems*, vol. 23, no. 2, pp. 460–468, 2008.
- [357] M.B. Blarke and H. Lund, "The effectiveness of storage and relocation options in renewable energy systems," *Renewable Energy*, vol. 33, no. 7, pp. 1499–1507, July 2008.

- [358] M. Korpaas, A.T. Holen, and R. Hildrum “Operation and sizing of energy storage for wind power plants in a market system,” *Int. Journal of Electrical Power and Energy Systems*, vol. 25, pp. 599–606, 2003.
- [359] L.M. Costa, F. Bourry, and G. Kariniotakis, “Stochastic Optimization Techniques for the Optimal Combination of Wind Power Generation and Energy Storage in a Market Environment,” poster presentation in *Proceedings of the European Wind Energy Conference EWEC’08*, Brussels, Belgium, March 31–April 3, 2008.
- [360] J. Wang, A. Botterud, G. Conzelmann, V. Miranda, C. Monteiro, G. Sheble, “Impact of Wind Power Forecasting on Unit Commitment and Dispatch,” 8th Int. Workshop on Wind: Large-Scale Integration of Wind Power into Power Systems, Bremen, Germany, October 2009.



Decision and Information Sciences Division

Argonne National Laboratory
9700 South Cass Avenue, Bldg. 900
Argonne, IL 60439-4867

www.anl.gov



Argonne National Laboratory is a U.S. Department of Energy
laboratory managed by UChicago Argonne, LLC