

BEAM FIELDS IN AN INTEGRATED CAVITY, COUPLER AND WINDOW CONFIGURATION *

Stephen Weathersby, Alexander Novokhatski
(SLAC National Accelerator Laboratory, Menlo Park, California)

Abstract

In a multi-bunch high current storage ring, beam generated fields couple strongly into the RF cavity coupler structure when beam arrival times are in resonance with cavity fields. In this study the integrated effect of beam fields over several thousand RF periods is simulated for the complete cavity, coupler, window and waveguide system of the PEP-II B-factory storage ring collider. We show that the beam generated fields at frequencies corresponding to several bunch spacings for this case gives rise to high field strength near the ceramic window which could limit the performance of future high current storage rings such as PEP-X or Super B-factories.

INTRODUCTION

The SLAC PEP-II asymmetric B-factory storage ring collider nominally collides 1700 bunches of 3.0 A of 3 GeV positrons on 2.0 A of 9 GeV electrons consisting of a low energy positron storage ring (LER) situated above a high energy electron storage ring (HER). The rings intersect at an interaction point (IP) within the BaBar detector sustaining a luminosity of $1.2 \times 10^{34} \text{cm}^{-2}\text{s}^{-1}$ at the $\Upsilon(4S)$ resonance.

Energy lost from synchrotron radiation and wake fields is replenished to the beam with high power RF supplied to cavities. Klystrons generate the 1 MW high power 476 MHz CW RF which is transported through WR2100 waveguides into the cavities through a 1.8 cm thick 24.8 cm diameter ceramic window. The window holds the ultra-high vacuum pressure required in the cavity from the near atmosphere pressure of the waveguide while transmitting 500 kW of RF power[1, 2]. The coupler geometry places the window at a half wavelength away from a detuned short position of the cavity field to minimize reflected power at the window position[1, 2]. This works well for reflected energy at harmonics of the main generator RF frequency. For high current storage ring B-factories and light sources, higher order modes (HOMs) excited by the beam constitute a significant portion of the cavity fields. The effect of such fields on the complete cavity/coupler/window/waveguide system is examined in this study. Fields produced by the beam in the cavity enter the waveguide through the cavity coupler and excite modes with fields near the window.

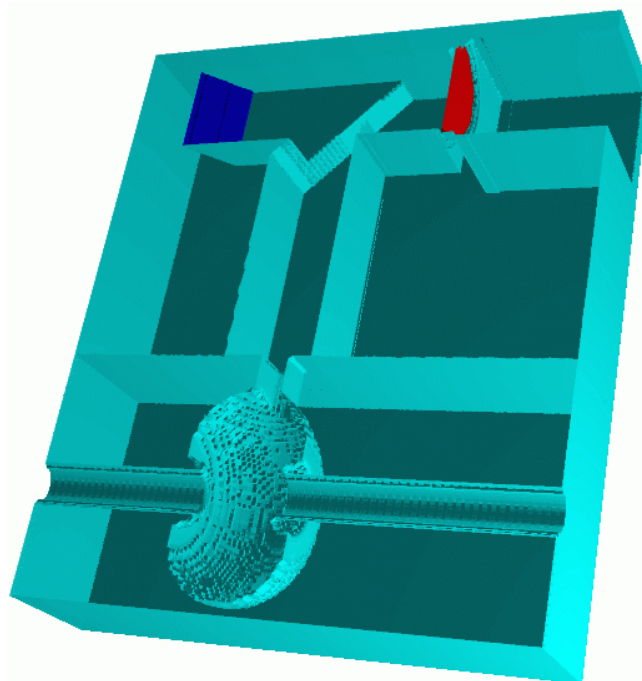

Figure 1: Model of PEP-II cavity/coupler/window/waveguide system.

RF SYSTEM MODEL

Figure 1 shows a cut plane through the full 3d model of the PEP-II cavity/coupler/window/waveguide RF system. A section of 1.5 meter long beam pipe is surrounded by a cavity which is connected through a small coupling iris into a rectangular volume which acts as a quarter-wave transformer. This volume intercepts a second rectangular volume, which functions as a filter, in which there exists a dielectric ceramic window (red) of relative permittivity $\epsilon_r=9$ and HOM absorbing ceramic tiles (blue) [6] with a relative permittivity of $\epsilon_r=30$ and conductivity $\sigma = 0.918 \text{ohm}^{-1}\text{m}^{-1}$. The model does not include the higher order mode dampers and detuning structures attached to the cavity. The WR2100 waveguide cutoff frequency for the TE₁₀ mode is 280 MHz. The beam pipe diameter is 9.5 cm with a cutoff frequency of 1.8 GHz.

RF SYSTEM EIGENMODES

The resonant modes in the cavity/coupler/window/waveguide RF system are identified in two ways. One is by performing an eigenmode deter-

* Work supported by Department of Energy Contract DE-AC02-76SF00515

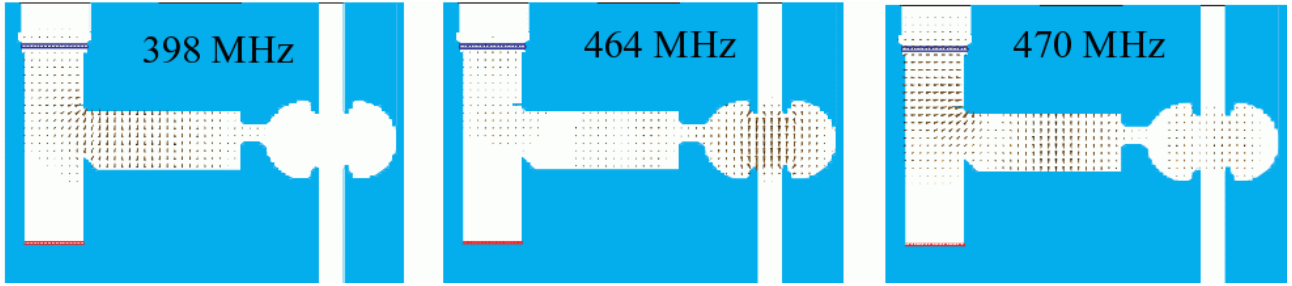

Figure 2: Eigenmode electric field distributions for the complete cavity-coupler-window-waveguide system from a MAFIA[4] calculation. Note the window is blue while the HOM absorbing tile is red in this figure.

mination with waveguide and beam ports shorted. The second is a scattering parameter simulation in which the waveguide port is excited with a matched broadband TE₁₀ waveguide mode to determine a reflected and transmitted power spectrum. The cavity resonant frequency found from these calculations is used to set the bunch spacing in resonance with the cavity for a time domain simulation.

Frequency domain solvers GdfidL[3] and MAFIA[4] both find the three eigenmodes shown in figure 2. The mode at 470 MHz exhibits substantial field near the window and in the cavity. The 464 MHz mode is the cavity accelerating mode.

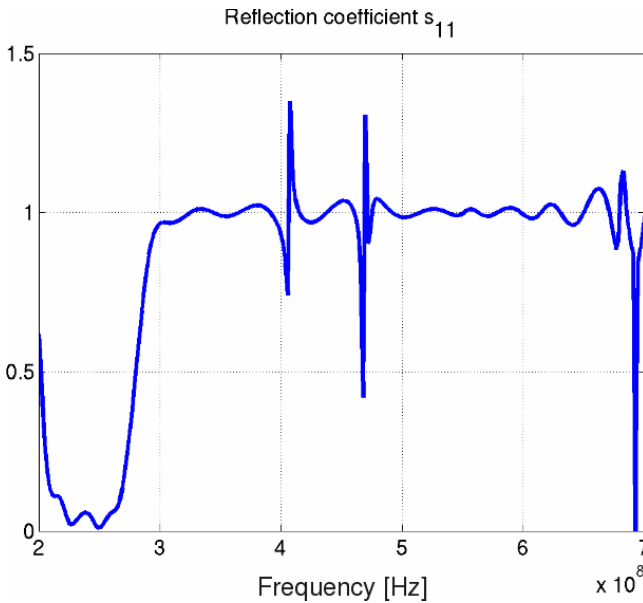

Figure 3: Reflection coefficient of the cavity/coupler/window/waveguide system at the waveguide port for a TE₁₀ waveguide mode showing resonances indicated near 400 MHz and 470 MHz.

Figures 3 and 4 show the reflection coefficient s_{11} and phase of the system from a Gaussian frequency domain WR2100 TE₁₀ waveguide excitation applied at the waveguide port as computed with GdfidL. This response is consistent with MAFIA results for the same geometry. The reflection coefficient indicates resonances near 400 and 470

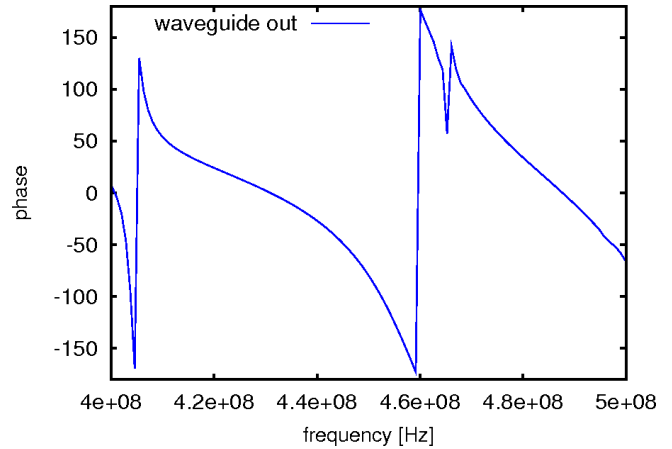

Figure 4: Reflection phase of the cavity/coupler/window/waveguide system at the waveguide port for a TE₁₀ waveguide mode showing resonances indicated near 400 MHz and 470 MHz.

MHz. They correspond to eigenmodes of the system found from GdfidL and MAFIA and indicate that these modes are not an artifact of boundary conditions imposed in the eigenmode determination.

TIME DOMAIN SIMULATIONS

To simulate nominal operating conditions, one thousand bunches are introduced into the beam pipe at a time interval resonant with the 464 MHz cavity resonance using the GdfidL time domain solver, with bunch spacing at every two 464 MHz RF buckets. Unlike normal operating conditions, no generator RF is applied at the waveguide port, which is simulated with perfectly matched layers (PML)[5] to absorb with negligible reflection any outgoing fields. The beam pipe boundaries are similarly treated with PMLs. The beam is the only source of fields in this simulation. Fields are solved for the entire cavity/coupler/window/waveguide system.

As shown in figure 5, the integrated electric field distribution after 1000 bunches shows a superposition of the main cavity mode and another mode with a similar field distribution to the 470 MHz mode with fields near the win-

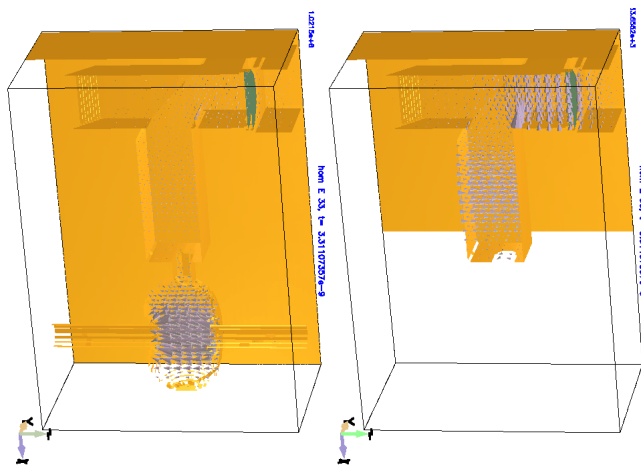

Figure 5: Electric fields after 1000 bunches determined from GdfidL. Left figure exhibits buildup of cavity fields in relation to coupler and waveguide. Right figure is same distribution auto-scaled to coupler and waveguide fields. The coupler waveguide field distribution has geometry similar to the 470 MHz mode of figure 2.

down. Fields naturally build up in the cavity, but also in the coupler, waveguide and window areas. The waveguide and window fields exhibit the geometry of the 470 MHz mode of figure 2 which has substantial field near the window. Figure 6 plots the maximum electric field strength at

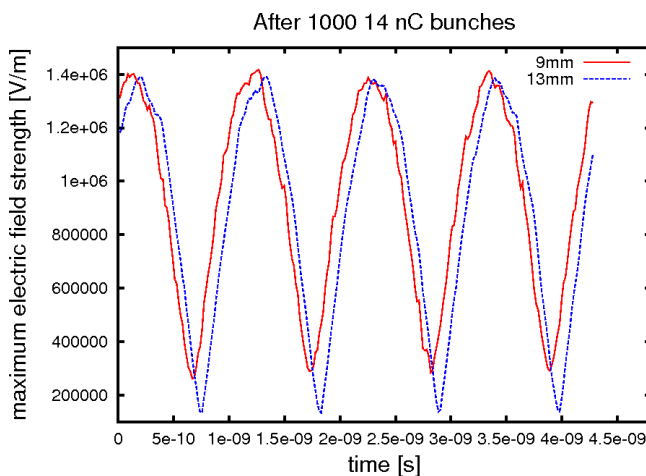

Figure 6: Maximum electric field as a function of time near the window after 1000 14 nC 9 mm and 13 mm bunches as calculated by GdfidL.

the location of the window as a function of time after passage of 1000 bunches of 14 nC bunch charge with bunch lengths 9 and 13 mm. The average field is higher for the shorter 9 mm bunch. A maximum electric field strength of 1.4 MV/m is generated by the beam near the window for both cases, which corresponds to nearly half of the copper breakdown voltage taken to be 30 kV/cm. The field distribution near the window is shown in figure 7 indicating large fields at both the center of the ceramic window and

locations near the window/waveguide interface.

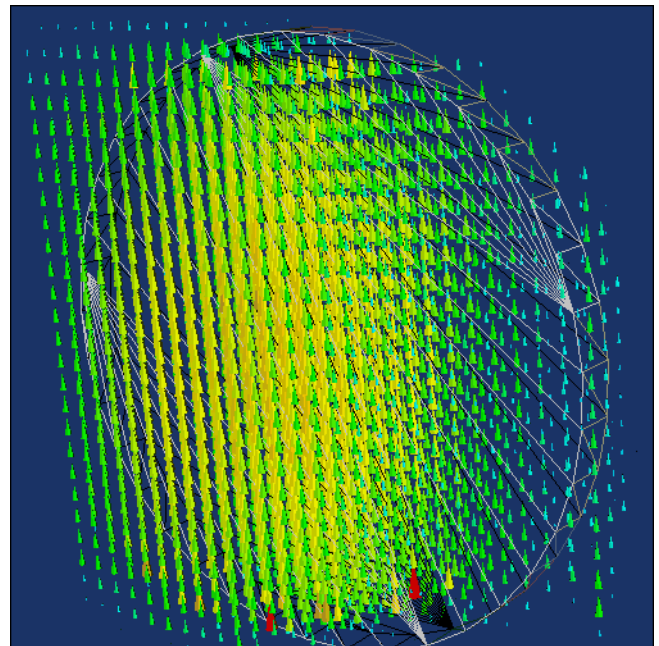

Figure 7: Snapshot of electric field distribution near the window after 1000 bunches looking from the waveguide vacuum side.

CONCLUSIONS

For high current storage ring B-factories and light sources, beam generated fields can compromise the performance of an RF system. Characterizing this effect requires modeling a complete cavity/coupler/window/waveguide RF system. In addition to the accelerating 464 MHz cavity mode, eigenmode and scattering parameter analysis performed on a model of the PEP-II cavity/coupler/window/waveguide RF system has found a 470 MHz mode with significant electric fields near the window. This mode is excited by the beam and produces a maximum electric field strength of 1.4 MV/m near the window after 1000 14 nC bunches at a two RF bucket spacing of the cavity resonance frequency. The average maximum electric field strength near the window increases with a shorter bunch.

REFERENCES

- [1] High power RF window and coupler development for the PEP-II B factory. M. Neubauer, K. Fant, J. Hodgson, J. Judkins, H. Schwarz, (SLAC), R.A. Rimmer, (LBL, Berkeley). SLAC-PUB-6897, SLAC-PUB-95-6897, LBL-37250, May 1995. 3pp.
- [2] An Asymmetric B factory based on PEP: Conceptual design report. SLAC-0372, SLAC-R-372, Feb 1991. 496pp.
- [3] <http://www.gdfidl.de>
- [4] The MAFIA collaboration "User Guide", CST GmbH, Darmstadt, Germany.

- [5] J. Berenger (1994). "A perfectly matched layer for the absorption of electromagnetic waves". *Journal of Computational Physics* 114: 185–200.
- [6] Coupling Network Simulation for the PEP-II RF Cavity. C.-K. Ng, K. Ko, N. Kroll, and R. Rimmer, SLAC-PUB-6565, LBL-35808, June 1994.