

MANAGED BY UT-BATTELLE FOR
THE DEPARTMENT OF ENERGY

Assessment of Dose to the Nursing Infant from Radionuclides in Breast Milk

August 2008

Prepared by
**R. W. Leggett
K. F. Eckerman**

**Oak Ridge National Laboratory
Oak Ridge, Tennessee 37831**

DOCUMENT AVAILABILITY

Reports produced after January 1, 1996, are generally available free via the U.S. Department of Energy (DOE) Information Bridge:

Web site: <http://www.osti.gov/bridge>

Reports produced before January 1, 1996, may be purchased by members of the public from the following source:

National Technical Information Service
5285 Port Royal Road
Springfield, VA 22161
Telephone: 703-605-6000 (1-800-553-6847)
TDD: 703-487-4639
Fax: 703-605-6900
E-mail: info@ntis.fedworld.gov
Web site: <http://www.ntis.gov/support/ordernowabout.htm>

Reports are available to DOE employees, DOE contractors, Energy Technology Data Exchange (ETDE) representatives, and International Nuclear Information System (INIS) representatives from the following source:

Office of Scientific and Technical Information
P.O. Box 62
Oak Ridge, TN 37831
Telephone: 865-576-8401
Fax: 865-576-5728
E-mail: reports@adonis.osti.gov
Web site: <http://www.osti.gov/contact.html>

This report was prepared as an account of work sponsored by an agency of the United States Government. Neither the United States government nor any agency thereof, nor any of their employees, makes any warranty, express or implied, or assumes any legal liability or responsibility for the accuracy, completeness, or usefulness of any information, apparatus, product, or process disclosed, or represents that its use would not infringe privately owned rights. Reference herein to any specific commercial product, process, or service by trade name, trademark, manufacturer, or otherwise, does not necessarily constitute or imply its endorsement, recommendation, or favoring by the United States Government or any agency thereof. The views and opinions of authors expressed herein do not necessarily state or reflect those of the United States Government or any agency thereof.

The work described in this report was performed at Oak Ridge National Laboratory for the Centers for Disease Control, Radiation Studies Branch, through a subcontract with Oak Ridge Associated Universities. The Project Number is NFE-07-00632.

Assessment of Dose to the Nursing Infant from Radionuclides in Breast Milk

Authors:

R. W. Leggett

K. F. Eckerman

Oak Ridge National Laboratory

Oak Ridge, Tennessee 37831

Date Published: August 2008

Published by

OAK RIDGE NATIONAL LABORATORY

Oak Ridge, Tennessee 37831

Managed by UT-Battelle, LLC, for the

U. S. DEPARTMENT OF ENERGY

under contract DE-AC05-00OR227

CONTENTS

LIST OF TABLES	v
LIST OF FIGURES	vii
ABSTRACT	ix
1.0. INTRODUCTION	1
2.0. METHODS	3
2.1. Starting point: Methods of ICRP Publication 95	3
2.2. Changes made here in assumptions and models of ICRP Publication 95.....	7
3.0. BIOKINETIC MODELS USED IN THE PRESENT SOFTWARE PACKAGE	9
3.1. Respiratory model.....	9
3.2. Gastrointestinal model	9
3.3. Systemic models	9
3.3.1. Cobalt.....	9
3.3.2. Strontium.....	11
3.3.3. Cesium	12
3.3.4. Iridium.....	12
3.3.5. Plutonium.....	13
3.3.6. Americium	13
3.3.7. Californium.....	14
4.0. USER GUIDE TO THE SOFTWARE PACKAGE	15
4.1. Basic information about the package.....	15
4.2. Illustrative applications of the package.....	16
APPENDIX A. BIOKINETIC MODEL FOR COBALT IN THE ADULT HUMAN	34
APPENDIX B. BIOKINETIC MODEL FOR STRONTIUM IN THE ADULT HUMAN ..	37
APPENDIX C. BIOKINETIC MODEL FOR CESIUM IN THE ADULT HUMAN	40
APPENDIX D. BIOKINETIC MODEL FOR IRIDIUM IN THE ADULT HUMAN	44
D.1. Summary of the database	44
D.2. Systemic model for iridium.....	47
APPENDIX E. BIOKINETIC MODEL FOR PLUTONIUM IN THE ADULT HUMAN ..	52
APPENDIX F. BIOKINETIC MODEL FOR AMERICIUM IN THE ADULT HUMAN...	55

CONTENTS (Continued)

APPENDIX G. BIOKINETIC MODEL FOR CALIFORNIUM IN THE ADULT
HUMAN 57
G.1. Summary of the database 57
 G.1.1. Fate of inhaled californium 57
 G.1.2. Uptake from the gastrointestinal tract 57
 G.1.3. Systemic biokinetics 58
G.2. Systemic biokinetic model for californium 60

LIST OF TABLES

Table A-1. Transfer coefficients in the systemic biokinetic model for cobalt in the adult....	35
Table B-1. Transfer coefficients in the systemic model for strontium in the adult	38
Table C-1. Transfer coefficients for the adult male in the systemic biokinetic model for cesium	41
Table C-2. Transfer coefficients for the reference young adult female, pregnant young adult female, and lactating young adult female in the systemic biokinetic model for cesium.....	42
Table D-1. Cumulative activities of iridium isotopes in the whole body based on retention curves derived by Furchner et al. (1971)	46
Table D-2. Transfer coefficients in the systemic biokinetic model for iridium in the adult..	49
Table E-1. Transfer coefficients in the systemic biokinetic model for plutonium in the adult.....	53
Table F-1. Transfer coefficients in the systemic biokinetic model for americium in the adult.....	55
Table G-1. Species differences in the early distribution of ^{252}Cf injected as citrate	59

LIST OF FIGURES

Figure 1. Representative structure of the non-recycling biokinetic models used in current ICRP documents.....	5
Figure 2. Illustration of modified non-recycling models used in ICRP Publication 95 to address time-dependent transfer of radionuclides to breast milk.....	5
Figure 3. Schematic of the ICRP's generic model structure for a large class of bone-seeking radionuclides as an illustration of recycling biokinetic models	7
Figure A-1. Structure of the systemic model for cobalt in the adult human.....	34
Figure B-1. ICRP's generic model structure for calcium-like elements.....	37
Figure C-1. Structure of a recently published model of the systemic biokinetics of cesium in the human body.....	40
Figure D-1. Whole-body retention of ^{192}Ir in laboratory animals following intravenous or intraperitoneal injection of $\text{Na}_2^{192}\text{IrCl}_6$	46
Figure D-2. Generic model structure for bone-surface-seeking radionuclides.....	48
Figure D-3. Comparison of model predictions of whole-body retention of iridium with observations for dogs	50
Figure E-1. Structure of the systemic model for Pu used in this report.....	52
Figure G-1. Observed patterns of urinary excretion of ^{252}Cf following acute inhalation.....	58
Figure G-2. Comparison of predictions of urinary californium based on the systemic biokinetic model for californium given in ICRP Publication 68 and Publication 78 and a proposed model, assuming intravenous injection of californium at time zero	61

ABSTRACT

A computer software package was developed to predict tissue doses to an infant due to intake of radionuclides in breast milk based on bioassay measurements and exposure data for the mother. The package is intended mainly to aid in decisions regarding the safety of breast feeding by a mother who has been acutely exposed to a radionuclide during lactation or pregnancy, but it may be applied to previous intakes during the mother's adult life. The package includes biokinetic and dosimetric information needed to address intake of Co-60, Sr-90, Cs-134, Cs-137, Ir-192, Pu-238, Pu-239, Am-241, or Cf-252 by the mother. It has been designed so that the library of biokinetic and dosimetric files can be expanded to address a more comprehensive set of radionuclides without modifying the basic computational module. The methods and models build on the approach used in Publication 95 of the International Commission on Radiological Protection (ICRP 2004), "Doses to Infants from Ingestion of Radionuclides in Mothers' Milk". The software package allows input of case-specific information or judgments such as chemical form or particle size of an inhaled aerosol. The package is expected to be more suitable than ICRP Publication 95 for dose assessment for real events or realistic planning scenarios in which measurements of the mother's excretion or body burden are available.

1.0. INTRODUCTION

The purpose of this project is to provide a computer software package that predicts tissue doses to an infant due to intake of radionuclides in breast milk based on bioassay measurements and exposure data for the mother. The software package is intended mainly to aid in decisions regarding the safety of breast feeding by a mother who has been acutely exposed to a radionuclide during lactation, but it may be applied to any previous acute or chronic exposure during the mother's adult life. This report serves as a user's guide to the software and provides background information on each of the biokinetic models included in this initial version of the package.

The software package builds on the general methods and assumptions used in ICRP Publication 95, "Doses to Infants from Ingestion of Radionuclides in Mothers' Milk" (ICRP 2004). That document addresses selected radioisotopes of 35 elements and provides dose coefficients for the nursing infant due to intakes of individual radionuclides in maternal milk. A dose coefficient represents a tissue dose or effective dose (Sv) to the newborn infant from unit intake (Bq) of a radionuclide by the mother. Coefficients are provided in ICRP Publication 95 for each of a set of exposure scenarios describing acute or chronic intake of a radionuclide by the mother at specified times before or during pregnancy or lactation.

The present package addresses nine radionuclides of concern because of their availability, relatively high dose per unit intake, and potential for malicious use such as in radiological dispersal devices: Co-60, Sr-90, Cs-134, Cs-137, Ir-192, Pu-238, Pu-239, Am-241, and Cf-252. The package has been designed so that the library of biokinetic and dosimetric files can be expanded to address a more comprehensive set of radionuclides without modifying the basic computational module.

While ICRP Publication 95 provides dose coefficients only for specific exposure scenarios, the present package can be used to derive dose estimates to the nursing infant based on bioassay measurements for the mother and any user-specified exposure situation. Except for Sr-90 and Am-241, the biokinetic models included in this initial version of the software package are updates of ICRP models. In contrast to some of the biokinetic models used in Publication 95, all of the models used here depict realistic pathways of transfer of material from tissues to blood to mammary glands. Two of the radionuclides addressed in this initial version of the software package, Ir-192 and Cf-252, are not addressed in Publication 95.

The software package is designed for use on a personal computer (PC) and consists of three main modules: a computational module driven by a user interface, a library of biokinetic files, and a library of dose coefficients. The library of biokinetic files includes the ICRP's current generic models for the respiratory and gastrointestinal tracts, plus systemic biokinetic models for selected elements. The library of dosimetric data consists of dose coefficients for the infant for selected isotopes of those elements. The biokinetic model for the respiratory tract includes different sets of parameter values needed to

address likely forms of a radionuclide such as relatively soluble, moderately soluble, or relatively insoluble particulate forms.

In response to screen prompts the user supplies case-specific information including the radionuclide, mode of intake by the mother, time and pattern of exposure to the mother, start and end times of breast feeding, available information or assumptions concerning the form of the radionuclide taken into the body such as solubility and particle size, and the results of any external measurements or excretion measurements for the mother. The computational module uses the case-specific information to select appropriate biokinetic files and calculates cumulative intake of the radionuclide in breast milk by the infant. The calculated intake by the infant is used together with dose coefficients for the infant, read from the dosimetric library, to estimate committed dose to the infant.

The main body of the report is divided into three sections. Section 2 describes the general approach for estimating transfer of radionuclides from the environment to breast milk, starting with a summary of the methods of ICRP Publication 95 and ending with a summary of modifications to those methods made for this project. Section 3 summarizes the biokinetic models for cobalt, strontium, cesium, iridium, plutonium, americium, and californium used in this report and the sources of information or assumptions used to derive transfer rates from the mother's body to breast milk. Section 4 is a user's guide to the software package developed to project doses to the nursing infant due to transfer of radionuclides from the mother to the infant in breast milk.

Appendices A-G provide specific information on the structures and parameter values of the systemic biokinetic models for cobalt, strontium, cesium, iridium, plutonium, americium, and californium, respectively, used in this report. In cases where the systemic models have not yet been published in the open literature, the appendices also include summaries of the data sets and assumptions used to develop these models.

2.0. METHODS

2.1. Starting point: Methods of ICRP Publication 95

This subsection describes the methods and assumptions of ICRP Publication 95, which are used as a starting point for the present approach. The following subsection describes ways in which the present approach differs from Publication 95.

ICRP Publication 95 addresses selected isotopes of 35 elements. These include 31 elements for which age-dependent biokinetic models are provided in previous ICRP documents on doses to the public from environmental exposures (ICRP 1989, 1993, 1995a, 1995b, 1996, 2001): hydrogen, carbon, sulfur, calcium, iron, cobalt, nickel, zinc, selenium, strontium, zirconium, niobium, molybdenum, technetium, ruthenium, silver, antimony, tellurium, iodine, cesium, barium, cerium, lead, polonium, radium, thorium, uranium, neptunium, plutonium, americium, and curium. Publication 95 also addresses radioisotopes of four additional elements not considered in previous ICRP documents on age-dependent dosimetry: sodium, magnesium, phosphorus and potassium.

The biokinetic models applied to the mother in ICRP Publication 95 generally are extensions of models used by the ICRP in previous publications to address direct intake of forms of radionuclides commonly encountered in the environment or work place. It is assumed that breast-feeding continues for 6 months from birth, with milk intake by the infant increasing from zero to 800 ml d⁻¹ over the first week and remaining at this level. Ingestion dose coefficients previously developed by the ICRP for the 3 month-old infant are applied to the total period of milk consumption by the infant.

The acute intake times considered in ICRP Publication 95 are 6 months prior to conception; at 5 weeks, 15 weeks, or 35 weeks of pregnancy; and at one week, 10 weeks, or 20 weeks after birth. Chronic exposures throughout pregnancy or lactation are also addressed.

For most radionuclides the gastrointestinal uptake values (f_1 values) for the mother used in ICRP Publication 95 are those given in ICRP documents on exposure to members of the public (ICRP 1989, 1993, 1995a, 1995b, 1996, 2001) or occupational intakes (ICRP 1994a). Consideration is also given in Publication 95 to the choice of appropriate f_1 values for the periods of pregnancy and lactation, in which gastrointestinal uptake of some elements may increase.

The values used for the fractional absorption of radionuclides ingested by infants in breast milk are those applied to infants in previous ICRP documents (ICRP 1989, 1993, 1995a, 1995b, 1996, 2001). These f_1 values for infants take account of human and animal data indicating that fractional absorption of many elements is substantially greater in infants than in adults.

The ICRP's human respiratory tract model (ICRP Publication 66, 1994b) is applied in ICRP Publication 95, with parameter values for deposition of inhaled radionuclides

appropriate for the adult female. Default values of parameters describing the rates of uptake of activity from the respiratory tract are adopted for different particulate forms of radionuclides according to whether dissolution and absorption are considered to be fast (Type F), moderate (Type M) or slow (Type S). The assumed particle size distributions for particulate forms used in ICRP Publication 95 are default values used by the ICRP, i.e., an Activity Median Aerodynamic Diameter (AMAD) of 1 μm for environmental intakes and 5 μm for occupational intakes. Gas or vapor forms of some radionuclides are also addressed.

The ICRP's biokinetic models for the systemic distribution and retention of radionuclides are extended in ICRP Publication 95 to include transfer of activity to compartments called breast and milk, where

- breast refers to the pool of milk still in the mother's breast, and
- milk refers to breast milk after ingestion by the nursing baby.

The names "breast" and "milk" have the same meanings in the present report.

The biokinetic models used in ICRP Publication 95 may be divided into two categories: recycling models and non-recycling models.

The systemic biokinetic models traditionally used by the ICRP and still applied to many radionuclides in current ICRP documents are non-recycling models. A non-recycling model is not intended to depict actual paths of movement of a radionuclide in the body but is simply a mathematically convenient representation of the estimated inventories of the radionuclide in its major repositories as a function of time after its initial entry into blood. As illustrated in Figure 1, a non-recycling model includes a transfer compartment representing blood, one or more compartments representing systemic tissues (two tissue compartments are shown in the figure), two excretion pathways (urinary bladder contents or large intestine contents), and two excretion compartments (urine and feces). The model depicts one-directional movement from the transfer compartment to tissues to excretion pathways and subsequent loss in excreta. Some non-recycling models also depict prompt excretion of part of the absorbed activity, represented as direct movement from the transfer compartment to excretion pathways (dashed arrows in Figure 1).

To adapt a non-recycling biokinetic model to depict time-dependent transfer of activity to breast milk, a second transfer compartment is added in ICRP Publication 95 to receive activity released from tissues (Figure 2). Transfer to breast milk from both transfer compartments is assumed. The rate of transfer of an element from each of these transfer compartments to breast milk is set to reproduce its quantitative transfer to breast milk as indicated by available environmental or experimental data. The time-course of transfer of a radionuclide from the mother to breast milk is assumed to parallel the time-course of transfer to excretion pathways. That is, the rate of entry of the radionuclide into excretion pathways is assumed to reflect the rate of entry of the radionuclide into blood, due either to absorption or to return from tissues to blood, and hence the availability of the radionuclide for transfer into milk.

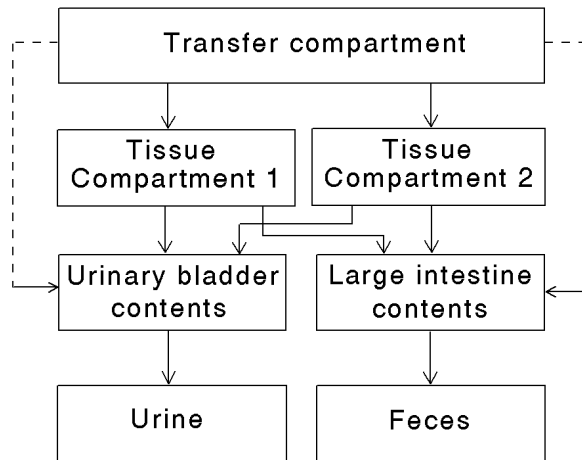

Figure 1. Representative structure of the non-recycling biokinetic models used in current ICRP documents. The number of tissue compartments varies from element to element. The dashed arrows represent prompt excretion, assumed in some but not all non-recycling models.

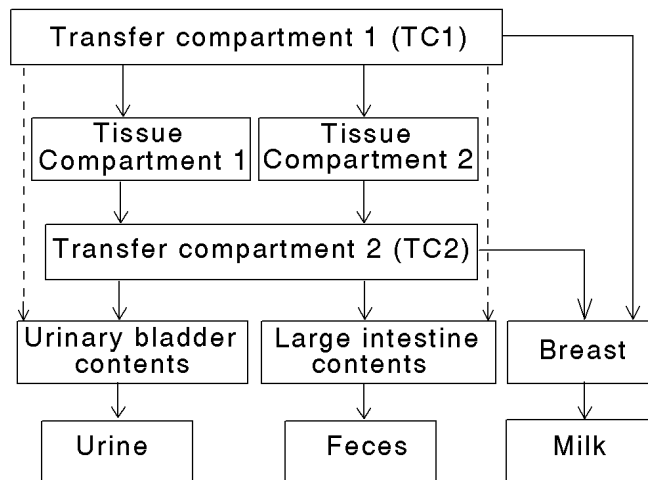

Figure 2. Illustration of modified non-recycling models used in ICRP Publication 95 to address time-dependent transfer of radionuclides to breast milk (compare with Figure 1).

Many of the systemic models adopted by the ICRP in recent years are recycling models that include some degree of physiological realism. As illustrated in Figure 3, such models depict exchange of activity between blood and tissues and transfer from blood to excretion pathways. The structure of recycling models is readily extended to the case of the nursing mother by addition of a breast compartment representing the pool of milk within the mother's breast, a milk compartment representing breast milk that has been ingested by the baby, and arrows depicting feeds from the mother's blood to breast to milk. Depending on the nature of available information on transfer of an element from the environment or the mother's body to breast milk, use of a physiologically realistic model may facilitate derivation of transfer rates to breast milk and provide increased accuracy with regard to time dependence of transfer to breast milk.

For both recycling and non-recycling models, the rate of transfer of an element from blood to the breast compartment is set to reproduce its quantitative transfer to breast milk as indicated by available environmental or experimental data. In many cases the best available information consists of reported relations between an element in the mother's diet and the mother's breast milk, in which case the assumed transfer rate from blood to the breast compartment depends on the gastrointestinal absorption fraction (f_1 value) applied. For example, if the f_1 value underestimates true fractional absorption to blood, then the transfer rate from blood to breast would have to overestimate the true transfer rate to reproduce an observed quantitative relationship between the concentration of a radionuclide in diet and its concentration in breast milk.

For some elements the rate of transfer from blood (or from blood plasma, if plasma is depicted separately in the model) to milk can be estimated in terms of reported concentration ratios for milk and blood (or blood plasma). In such cases, use of a recycling model has advantages with regard to setting transfer rates to milk and predicting time-dependent transfer of a radionuclide from the mother's body to breast milk, due to the more realistic representation of circulating activity in recycling models than in non-recycling models. For example, if the amount of milk produced per day is taken to be 800 ml and the blood plasma volume of the adult female is taken to be 2400 ml, the rate of transfer from blood plasma to milk would be given by $800/2400$ times the milk-to-plasma concentration ratio. A concentration ratio of 0.1, say, corresponds to a milk transfer rate of $0.1 \times 800/2400 \text{ d}^{-1} = 0.033 \text{ d}^{-1}$. In the systemic model the transfer from blood plasma to milk (i.e., transfer from blood plasma to the infant in ingested milk) would be represented as two serial transfers that give an overall rate of transfer from blood plasma to milk of 0.033 d^{-1} , i.e., a derived transfer rate from blood plasma to the breast compartment followed by a typical or reference rate of emptying of the breast compartment in milk.

For both recycling and non-recycling models, the amount of milk transferred through the breast compartment to milk each day is assumed to be 12 times the average content of that compartment. The conceptual model is that the breast milk pool increases linearly with time between feedings and is completely emptied at each feeding, so that the amount of milk transferred in each of the six daily feedings is twice the average content. For computational convenience, emptying of the breast compartment is represented as a first-

order process with transfer coefficient 12 d^{-1} . All emptied milk is assumed to be ingested by the nursing infant.

For several elements addressed in ICRP Publication 95, the authors of could not find sufficient element-specific information to derive a specific rate of transfer from the mother's diet or blood to milk. In all such cases the elements were judged to have relatively low transfer to milk on the basis of the limited available element-specific data or information on more frequently studied chemical or physiological analogues of the element. For each of these elements, total transfer to milk (i.e. without radioactive decay) was assumed to account for 5% of the amount absorbed to maternal blood following acute ingestion by the mother at one week after birth. This was considered a reasonably cautious approach for radiological protection purposes.

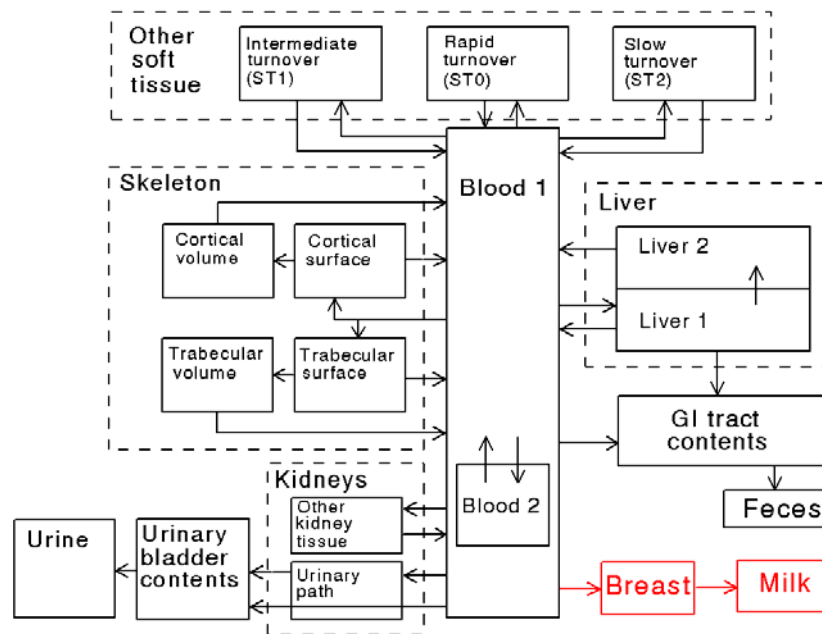

Figure 3. Schematic of the ICRP's generic model structure for a large class of bone-seeking radionuclides (ICRP, 1993) as an illustration of recycling biokinetic models. For such models, addition of breast and milk compartments is straightforward.

2.2. Changes made here in assumptions and models of ICRP Publication 95

The approach used in the present software package is the same as that applied in ICRP Publication 95, with the following exceptions.

- In Publication 95, daily ingestion of breast milk by the infant is assumed to be 800 ml except during the first week of life, when there is assumed to be a “ramping up” from 0 ml d^{-1} at birth to 800 ml d^{-1} at 1 wk. In the present software

package, daily ingestion of milk by the infant is assumed to be 800 ml from birth to the end of the nursing period.

- In Publication 95 the nursing period is assumed to be from birth to age 6 mo (182 d). The present software package allows the user to assign the length of the nursing period, although it is recommended that the period be shorter than one year because the dose coefficients applied in the package are those for an infant.
- In contrast to Publication 95, only recycling systemic biokinetic models are used in the present software package. The systemic models for cobalt, cesium, and plutonium used here are updates of the models for these elements used in ICRP Publication 95. These updated models were developed by the authors of the present report and are expected to replace current ICRP models in upcoming ICRP reports. The models applied here to iridium and californium (neither of which was addressed in ICRP Publication 95) are also updates of current ICRP models and are also expected to be used by the ICRP in upcoming reports.
- Much lower transfer of Co-60 to breast milk is depicted here than in ICRP Publication 95, because the assumptions regarding transfer of cobalt to milk made in Publication 95 seem much more cautious than is warranted by the data. For the other radionuclides considered here, the total transfer from diet to breast milk over a nursing period of 6 mo is reasonably similar to that predicted by models of ICRP Publication 95.

3.0. BIOKINETIC MODELS USED IN THE PRESENT SOFTWARE PACKAGE

3.1. Respiratory model

As in ICRP Publication 95, the ICRP's human respiratory tract model (ICRP Publication 66, 1994b) is applied to radionuclides inhaled by the mother, using the ICRP's parameter values for deposition of inhaled radionuclides in an adult female. Default absorption types are applied, i.e., those for fast (Type F), moderate (Type M) or slow (Type S) absorption of inhaled material to blood. The assumed particle size distributions for particulate forms are default values used by the ICRP, i.e., an Activity Median Aerodynamic Diameter (AMAD) of 1 μm for environmental intakes and 5 μm for occupational intakes.

3.2. Gastrointestinal model

As in ICRP Publication 95, the gastrointestinal transit model of ICRP Publication 30 (1979) is applied. An ICRP task group has recently developed an updated Human Alimentary Tract Model (HATM) (ICRP Publication 100, 2006) that may be implemented in a later version of this software. Application of the HATM would have no effect on estimates of transfer of radionuclides to milk but for some radionuclides could result in slightly lower estimates of dose per unit intake by the nursing infant.

The gastrointestinal uptake values for the mother applied here are those given in ICRP documents on exposure to members of the public (ICRP 1989, 1993, 1995a, 1995b, 1996, 2001) or occupational intakes (ICRP 1994a). The values used for the fractional absorption of radionuclides ingested by infants in breast milk are those applied to infants in previous ICRP documents (ICRP 1989, 1993, 1995a, 1995b, 1996, 2001).

3.3. Systemic models

3.3.1. Cobalt

The systemic biokinetic model for cobalt used in ICRP Publication 95 is a non-recycling model introduced in ICRP Publication 30 (1979) and modified slightly in ICRP Publication 67 (1993). An updated model was published recently (Leggett, 2008). Although cobalt is not regarded as a bone-seeking radionuclide, the updated model is constructed within the ICRP's generic model structure for bone-surface-seeking radionuclides (Figure 3) because this structure includes all of the compartments and pathways considered important for cobalt. This updated model, modified by addition of a breast compartment and milk compartment, is used in the present report to describe the biokinetics of systemic cobalt in the mother.

In ICRP Publication 95, transfer rates describing fractional transfer of cobalt from diet to breast milk were based on the following information (see Publication 95 for original

references). Several modern studies of cobalt in diets of Western populations indicate daily intake of about 10 (7-14) μg of cobalt by a young adult female. A central estimate of the concentration of cobalt in breast milk based on reported values is $0.5 \mu\text{g l}^{-1}$ (range, $0.2\text{-}3 \mu\text{g l}^{-1}$). The gastrointestinal (GI) uptake fraction (f_1 value) for cobalt recommended in ICRP Publication 67 (1993) for adult members of the public is 0.1. Based on this uptake fraction and a dietary intake of $10 \mu\text{g d}^{-1}$, daily absorption of cobalt to blood of a young adult female is estimated as $1.0 \mu\text{g d}^{-1}$. A cobalt concentration of $0.5 \mu\text{g l}^{-1}$ in milk corresponds to daily intake by an infant of $0.4 \mu\text{g d}^{-1}$ (in 800 ml milk). The implied transfer factor from diet to milk (concentration in breast milk in $\mu\text{g kg}^{-1}$ divided by daily dietary intake by the mother in μg) is $0.5 \mu\text{g kg}^{-1} / 10 \mu\text{g d}^{-1} = 0.05 \text{ d kg}^{-1}$. To achieve a transfer factor of 0.05 d kg^{-1} , 40% of outflow from blood (i.e., from the transfer compartments of the non-recycling cobalt used in ICRP Publication 95) was assumed in ICRP Publication 95 to deposit in the breast compartment.

The transfer coefficient from blood to breast derived for cobalt in Publication 95 depends strongly on the f_1 value applied. The f_1 value 0.1 applied in that document is a central estimate for adults based on variable absorption data for cobalt, derived mainly for adult male subjects. Absorption of cobalt appears to be strongly influenced by iron requirements and may be substantially higher on average in adult females than in adult males.

Application of the ICRP's f_1 value 0.1 for cobalt results in a predicted maximal transfer to milk of 40% of cobalt reaching the mother's blood. This is the highest transfer of any of the elements considered in Publication 95 and seems artificially high in view of the high competitive clearance rate of cobalt to urine. If the f_1 value of 0.1 applied to cobalt is substantially lower than the true value, then the assumed rate of transfer of cobalt from blood to the breast compartment is a substantial overestimate of the true transfer rate. While errors in the f_1 value and rate of transfer from blood to the breast compartment tend to cancel one another in dose calculations for ingested Co-60, they would not cancel in calculations for inhaled Co-60 because most of the activity reaching blood would be due to absorption from the respiratory tract.

Cobalt is chemically and physiologically related to iron. In cows administered both iron and cobalt isotopes, about 1.1% of intravenously injected iron and 3.3% of intravenously injected cobalt were transferred to milk. The iron model of Publication 95 is consistent with these results for cows, but the cobalt model of Publication 95 predicts an order of magnitude higher transfer of cobalt to milk than observed in cows.

In the present model the transfer coefficient from the mother's blood to milk is set so that maximal transfer to milk is 10% of cobalt absorbed to blood during lactation. This is higher than observed in cows but lower than estimated in ICRP Publication 95 (40%). The precise percentage of absorbed cobalt that transfers to breast milk varies to some extent with the assumed gastrointestinal absorption fraction due to assumed recycling of cobalt from liver to small intestine contents (biliary secretion) back to blood (absorption). The transfer rate from blood to milk was set to attain 10% transfer of absorbed cobalt to

milk if the gastrointestinal uptake fraction is set at the ICRP's default value for adults of 0.1.

3.3.2. Strontium

The systemic biokinetic model for the mother applied to strontium in ICRP Publication 95 is also used in the present report. This is a recycling model developed by Leggett (1992a) and first used by the ICRP in Publication 67 (ICRP, 1993). The model structure and parameter values are given in Appendix B. The reader is referred to Leggett (1992a) or ICRP Publication 67 for a discussion of the basis for the model.

For application in ICRP Publication 95 and in the present report, the model has been adapted to include transfers from blood plasma to breast and from breast to milk. The transfer rates from blood to breast to milk applied in Publication 95 are also applied here.

The systemic biokinetic model for calcium applied in ICRP Publication 95 is taken from ICRP Publication 71 (1995b) and is qualitatively similar to the ICRP's systemic model for strontium. Strontium is a chemical and physiological analogue of calcium but has somewhat different biokinetics from calcium due to discrimination between these elements by biological membranes and hydroxyapatite crystals of bone. In ICRP Publication 95 the assumed rate of transfer of strontium from blood to milk was based largely on comparison of strontium and calcium because there is relatively good information on transfer of calcium to human milk and on discrimination between strontium and calcium by the body. The rate of transfer of strontium from blood to breast was taken to be 0.72 d^{-1} , determined as 0.4 times the rate estimated for calcium from detailed data for that element. The fraction 0.4 is a central estimate of reported discrimination ratios Sr/Ca by different membranes in the body.

Application of the models for calcium and strontium used in Publication 95 to chronic ingestion throughout lactation gives a ratio of Sr/Ca in milk to Sr/Ca in diet of 0.25, compared with values of 0.09-0.16 determined in various studies on human subjects (e.g., data on environmental ^{89}Sr and ^{90}Sr in from fallout) and laboratory animals. It was pointed out in Publication 95 that this discrepancy between model predictions and reported Sr/Ca discrimination factors from mother's diet to breast milk can be explained on the basis of the ICRP's f_1 values for calcium and strontium in the adult. The ICRP's f_1 value for both elements is 0.3 and thus does not take into account discrimination between these elements by the gut. Current plans by the ICRP are to revise f_1 values for strontium and calcium in adults to 0.25 and 0.4, respectively, for use in upcoming documents on occupational exposure to radionuclides. If these f_1 values are used, application of the systemic models for calcium and strontium used in ICRP Publication 95 to chronic ingestion throughout lactation gives a ratio of Sr/Ca in milk to Sr/Ca in diet of 0.16, which is within the range of values (0.09-0.16) reported for human subjects and laboratory animals. Model predictions were also found to be reasonably consistent with the rate of transfer of stable strontium from diet to milk based on measurements of stable strontium in diet and in human breast milk of the same subjects.

3.3.3. Cesium

The biokinetic model for the mother applied in ICRP Publication 95 is an adaptation of the non-recycling model for cesium applied to the mother in ICRP Publication 88, “Doses to the Embryo and Fetus from Intakes of Radionuclides by the Mother” (ICRP, 2001). The Cs model of ICRP Publication 88 takes into account that Cs retention typically is shorter in adult females than in adult males and is further decreased in the pregnant female. In ICRP Publication 88, it is assumed that Cs is removed from blood with a half-time of 0.25 d and is distributed uniformly throughout all body tissues. Two components of retention in tissues are depicted: 10% is removed with a half-time of 2 days and 90% with a half-time of 75 days before conception and after birth, and 50 days during pregnancy. These same assumptions are made in ICRP Publication 95, but the model of Publication 95 includes an additional transfer compartment to receive Cs returning to the circulation from tissues, as illustrated in Figure 2.

An updated model of the systemic biokinetics of cesium in the adult male was published recently (Leggett et al., 2003). A simplified version of that model is used in the present report as a starting place for modeling the biokinetics of cesium in the adult female. The simplified version of the model for males is described in Appendix C, along with modifications of parameter values for application to non-pregnant, non-lactating young adult females, pregnant young adult females, and lactating young adult females. The changes in parameter values reflect lower residence times of cesium in adult females than adult males, a reduced portion of total-body cesium in the relatively smaller mass of skeletal muscle in adult females, an increased rate of transfer from plasma to the urinary bladder content during pregnancy, and substantial transfer of cesium from blood plasma to the mammary glands during lactation.

Following ICRP Publication 95, the rate of transfer of cesium from blood plasma to the breast compartment is set for consistency with a transfer factor from diet to milk of 0.3 d L^{-1} . This transfer factor is based on the following considerations.

- Reported central values for transfer factors derived from comparisons of ^{137}Cs in diet and breast milk are in the range $0.16\text{-}0.37 \text{ d kg}^{-1}$ with an overall rounded mean of 0.3 d kg^{-1} (for milk, $1 \text{ d kg}^{-1} \sim 1 \text{ d L}^{-1}$).
- The transfer coefficient 0.3 d L^{-1} is consistent with reported concentration ratios A:B, where A = ^{137}Cs in the mother's body and B = ^{137}Cs in her milk.
- The transfer coefficient 0.3 d L^{-1} is consistent with the estimate that secretion of ^{137}Cs in milk accounted for 16% of the total rate of loss of ^{137}Cs from the body in a nursing mother contaminated with ^{137}Cs in the Goiania accident in 1987 before giving birth.

3.3.4. Iridium

Iridium was not addressed in ICRP Publication 95. The ICRP's current systemic biokinetic model for iridium is a non-recycling model introduced in ICRP Publication 30 (1981). A recycling model for iridium developed for use in the present report (Leggett, 2007b) is described in Appendix D. The model is constructed within the ICRP's generic

model structure for bone-surface seeking elements (Figure 3). Parameter values are based primarily on experimental data for various animal species, including monkeys and dogs, but biokinetic data for the chemically similar element ruthenium including some data for human subjects are also considered.

No specific information was found concerning transfer of iridium from diet to breast milk or from the mother's body to breast milk. Judging from data for its chemical analogue ruthenium, transfer of iridium to milk presumably is at most a few percent of the amount reaching blood. A default approach for assigning transfer rates from the mother's blood to the breast compartment was applied in ICRP Publication 95 to elements with apparently low but imprecisely determined levels of transfer to milk. That is, total transfer to milk (i.e. without radioactive decay) was assumed to account for 5% of the amount absorbed to maternal blood following acute ingestion by the mother one week after birth. This default approach was applied in ICRP Publication 95 to ruthenium and is applied in the present report to iridium. The rate of transfer of iridium from the mother's blood to the breast compartment derived from this default approach, based on the systemic model described in Appendix D, is 1.14 d^{-1} .

3.3.5. Plutonium

In ICRP Publication 95, the biokinetic model for the reference adult given in Publication 67 (ICRP, 1993) was adapted to include transfers from blood plasma to breast to milk and applied to the mother. The model used in the present report (Leggett et al., 2005) is an update of the model of ICRP Publication 67. This updated model is also adapted to include transfers from blood plasma to breast to milk and applied to the mother. The structure and parameter values of the updated model are given in Appendix E. The reader is referred to the paper by Leggett et al. (2005) for a discussion of the basis of the updated model.

Following the approach in Publication 95, the rate of transfer of plutonium from the mother's blood to the breast compartment was calculated on the basis of a milk to blood plasma concentration ratio of 0.1. This value is based on reported milk to plasma ratios determined in farm animals, on transfer coefficients from diet to milk in farm animals, and on accumulation of americium in milk of lactating rats receiving plutonium by intravenous injection (ICRP, 2004). The derived transfer rate from blood to breast is 0.033 d^{-1} . The maximum transfer of plutonium to milk was calculated as 5.0% of plutonium reaching blood.

3.3.6. Americium

As in ICRP Publication 95, the systemic model for americium in the adult introduced in ICRP Publication 67 (1993) is applied to the mother after adaptation to include transfers from blood to breast and from breast to milk. The model is constructed within the generic framework for bone-surface seeking models, as shown in Figure 3. Parameter values are given in Appendix F. The reader is referred to Leggett (1992b) or ICRP Publication 67 (1993) for a description of the basis for the model.

Following the approach in Publication 95, the rate of transfer of americium from the mother's blood to the breast compartment was calculated on the basis of a milk to blood plasma concentration ratio of 3. This is a cautiously high value based on reported milk to plasma ratios determined in farm animals and accumulation of americium in milk of lactating rats receiving americium by intravenous injection. The derived transfer rate from blood to breast is 0.99 d^{-1} . The maximum transfer of americium to milk was calculated as 5.0% of americium reaching blood.

3.3.7. Californium

Californium was not addressed in ICRP Publication 95. The ICRP's current systemic biokinetic model for californium is a non-recycling model introduced in ICRP Publication 30, Part 1 (1979). A physiologically based recycling model for californium is now available (Leggett, 2001) and is applied in the present report. This updated model was constructed within the ICRP's generic model structure for bone-surface seeking elements (Figure 3). Parameter values are listed in Appendix G.

A paper describing the basis for the model for californium used in this report was published in an issue of a journal dedicated to the proceedings of a topical symposium (Leggett, 2001). Because the journal has limited circulation, the basis for the model is discussed at length in Appendix G.

Due to lack of direct information, transfer of californium from the mother's blood to breast milk is assumed to be the same as for americium, which bears a reasonably close physiological resemblance to californium (Leggett, 2001). That is, the rate of transfer of californium from the mother's blood to the breast compartment is set so that the maximum transfer of californium to milk over the first 6 mo after birth is 5.0% of californium reaching blood. The derived rate of transfer from blood to breast based on this assumption is 0.541 d^{-1} .

4.0. USER GUIDE TO THE SOFTWARE PACKAGE

4.1. Basic information about the package

A computer software package called NIDMAT was developed to predict tissue doses to an infant due to intake of radionuclides in breast milk, based on intake of the radionuclide by the mother as estimated from urinary, fecal, or *in vivo* measurements. The software package is designed for use on a personal computer (PC) and consists of three main modules:

- a computational module driven by a user interface,
- a library of biokinetic files, and
- a library of dose coefficients.

The library of biokinetic files includes the ICRP's current generic models for the respiratory and gastrointestinal tracts, plus systemic biokinetic models for selected elements.

The NIDMAT libraries currently contain biokinetic and dosimetric files needed to estimate doses to the infant due to the mother's intake of any of the following radionuclides: Co-60, Sr-90, Cs-134, Cs-137, Ir-192, Pu-238, Pu-239, Am-241, or Cf-252. The library of biokinetic and dosimetric files can be expanded to address a more comprehensive set of radionuclides without modifying the basic computational module.

The software allows consideration of different biokinetics of the radionuclides in mother's body prior to pregnancy, during pregnancy, and during lactation. Intakes in any of these periods can result in activity being transferred to the nursing infant. Information for most elements is insufficient to develop different sets of parameter values specific to each of these three periods. Among the radionuclides considered in this project, parameter values specific to pregnancy and lactation are provided only for Cs-134 and Cs-137.

The user may address acute or chronic intake by ingestion, inhalation or injection (representing a puncture wound or a medical exposure, for example). Intake rates are given in units of becquerels per day (Bq d^{-1}). The intake rate during the period of chronic intake may be at a constant rate, a declining exponential rate, or a piece-wise constant rate (a histogram).

NIDMAT requests the following input data from the user: date of birth of the infant (pregnancy is assumed to have occurred 38 weeks earlier), starting and ending dates of breast feeding, the date of acute intake or the duration of chronic intake, and the radionuclide. For inhalation intakes the user can select the activity aerodynamic diameter (AMAD) and the absorption type (F, M, or S) of the ICRP Human Respiratory Tract Model (ICRP 1994a). Models of the systemic behavior of these radionuclides are provided, as discussed in the previous sections. Finally, the bioassay information is requested. Measurements of urinary or fecal excretion or *in vivo* measurements of retained activity in the lung (in the case of inhalation intakes) or whole body can be analyzed.

Note of caution: At present the software performs only limited checks of the user's input. Thus nonsensical input might be processed. No attempt is made to process bioassay measurement values reported as zero or "less than". Future development of the software may address these issues.

A conventional Windows installation procedure¹ is provided to install NIDMAT and its data files. The procedure creates a main folder on the hard drive with the default name ORNL_CDC, creates additional folders within the main folder, and places a NIDMAT icon on the desktop. Although the installation procedure allows the user to install the software in any selected main folder, it is recommended that the default folder ORNL_CDC be used. In any case, NIDMAT's data libraries and its input and output folders must reside in folders located within the main folder, and the names of these folders should not be changed. The two folders of most importance to users are named "input" and "output". The folder "output" contains the files generated during the calculations. The folder "input" is discussed below.

NIDMAT is a 32-bit console application compiled with PowerBASIC™ Console Compiler². NIDMAT solves the system of differential equations describing the behavior of the radionuclide in the body using an elementary approximation technique developed and refined by ORNL's dosimetry team (Leggett et al., 1993). A plot of the solution is generated using the DPlot Jr³ module.

4.2. Illustrative applications of the package

The user can provide the input data for the analysis either in an interactive manner or by creating an input file with extension "INP" in the "input" folder. When NIDMAT is invoked a menu of the input files found in the "input" folder will appear. **To enter the data in an interactive manner rather than by reading an "INP" file, click the "cancel" button on the menu.** An input file can be created using any ANSI editor; e.g., Notepad. The file can be created by editing the template (file template.txt) found in the input folder. The template file is shown below.

¹ NIDMAT install package created using Inno Setup compiler available from <http://www.innosetup.com>.

² PowerBASIC, Inc.; 1978 Tamiami Trail S. #200; Venice, FL 34293. See <http://www.powerbasic.com/> for further information.

³ DPlot Jr is available from HydeSoft Computing, Inc., 110 Roseland Drive, Vicksburg, MS 39180 and can be downloaded from the website www.dplot.com/index.htm.

File template.txt :

This file can be used as a template when creating an input file to be saved in the input folder. After the template is edited it should then be saved with an appropriate name with the extension INP. DO NOT SAVE THE EDITED FILE WITHOUT CHANGING THE NAME. A backup copy can be found in the root folder.

Lines marked with "<-- Delimiter ..." and "<-- Data Delimiter..." should not be changed. The text appearing on the input lines to the left of ":" should not be modified as these are key phrases; however, the whole input line can be deleted if it is not needed. The information to the right of the colon on these lines is the input. Where appropriate, alternative input is noted. No blank lines should appear in the input file following the start of the input.

```
Start Input:                                <-- Delimiter for start of input data
Nuclide:                                   Co-60                               ' See note 1 below
Intake Mode:                               Inhalation                          ' Other modes - 'Ingestion' and 'Injection'
Type & AMAD:                               M 1.0                              ' Only if the intake mode is 'Inhalation'
Exposure Mode:                             Chronic                             ' Other exposure mode - 'Acute'
Intake Pattern:                             Exponential                          ' See note 2 below
Half-time:                                 1924.9                              ' See note 3 below
Start of Chronic Intake:                   01/01/2006                          ' See note 4 below
End of Chronic Intake:                     07/01/2008                          ' See note 5 below
Infant's Birth:                            01/01/2007
Start of Breast Feeding:                   01/01/2007
End of Breast Feeding:                     07/01/2008
Bioassay:                                  Urine                                ' Other - 'Fecal', 'Lung', or "Whole Body'
Start Bioassay Data:                       <-- Data Delimiter start of bioassay data
XX/XX/XXXX YY                             ' Date and measurement (Bq)
""                                           ""
End Bioassay Data:                         <-- Data Delimiter for end of bioassay data
End of Input Data                           <-- Delimiter for input data (end of file)
Notes:
1) Nuclides include Co-60, Sr-90, Cs-134, Cs-137, Ir-192, Pu-238, Pu-239,
   Am-241, and Cf-252
2) Other intake patterns are 'Constant' and 'Histogram'.
3) Omit this line if the intake pattern is not 'Exponential'.
4) Omit line if exposure mode is "Acute" and insert the line
Date of Acute Intake:   XX/XX/XXXX
5) Omit line if exposure mode is "Acute". Also omit line iff intake pattern is
   'Histogram' and insert the following lines defining the pattern
Histogram Definition:   <-- Delimiter for start of histogram
XX/XX/XXXX 1.0         '
XX/XX/XXXX 1.0
End of Histogram:      <-- Delimiter for end of histogram
```

Sample 1.

This example involves interactive input of the case data rather than creation of an input file in the folder “input”.

Consider an acute inhalation exposure of a nursing mother to ¹³⁷Cs, occurring on 01/09/2007. The inhaled material is assumed to be soluble (Type F) with an activity median aerodynamic diameter (AMAD) of 1 µm. The infant was born on 10/01/2006. Nursing began at birth and is projected to end on 09/30/2007. *In vivo* measurements on 01/10/2007 and 01/20/2007 indicated total-body retention of 67 and 46 kBq, respectively. Input files for the examples are available in the input folder. The discussion below illustrates the NIDMAT’s interactive prompts; i.e., the cancel button was pressed on the first menu. NIDMAT thus requests a name for the case. The name “sample_1” is used, as indicated below:

```
NIDMAT
NIDMAT : Nursing Infant Dose Based on Maternal Bioassay Data
Authors: K.F. Eckerman & R.W. Leggett
Oak Ridge National Laboratory
Oak Ridge, TN 37831-6480

Input to be obtain in an interactive manner.
Enter name of output file <root name> for this case --> sample_1

The following output files will be created:
SAMPLE_1.LOG - ODE describing the biokinetics of the case.
SAMPLE_1.ACT - activity as function of time in maternal organs.
SAMPLE_1.EUD - maternal bioassay and infant cummulative intake.
SAMPLE_1.HRT - infant equivalent/effective dose.
SAMPLE_1.OUT - summary of bioassay interpretation.

Files are written in the folder C:\ORNL_CDC2\OUTPUT.

Press any key to continue...
```

As shown on the screen, five files will be written to the output folder. The files are identified by the selected root name (sample_1) and the extension LOG, ACT, EUD, HRT, or OUT. The user is then requested to press any key to continue defining the case.

Information for the case is then requested. The user is asked to enter the date of the infant's birth and the dates of the start and end of breast feeding and select the type of exposure, acute or chronic. In this example acute exposure is selected. The user is asked to enter the date of acute exposure. The radionuclide ¹³⁷Cs and the exposure mode are then selected from a menu (not shown below).

```
NIDMAT
NIDMAT : Nursing Infant Dose Based on Maternal Bioassay Data
Authors: K.F. Eckerman & R.W. Leggett
Oak Ridge National Laboratory
Oak Ridge, TN 37831-6480

Date of infant's birth (mm/dd/yyyy): 10/01/2006
Start of breast feeding (mm/dd/yyyy); blank default to birth: 10/01/2006
End of breast feeding (mm/dd/yyyy): 09/30/2007
Exposure - (a)cute or (c)hronic intake: (l|a|c)? a
Date of acute exposure (mm/dd/yyyy): 01/09/2007
Maternal Exposure: Acute Intake
Radionuclide: Cs-137 T1/2 (d) = 10957.5
Enter AMAD (0.001 <= AMAD <= 10.0 um) --> 1.0
```

After 1.0 is entered for the AMAD, the next screen requests the identity of the bioassay procedure and the measured activity values. These values must be entered in SI activity units (Bq). As indicated above, the measured values in this case are *in vivo* measurements of activity in the total body. The user is asked to enter the dates of measurement and the measured values.

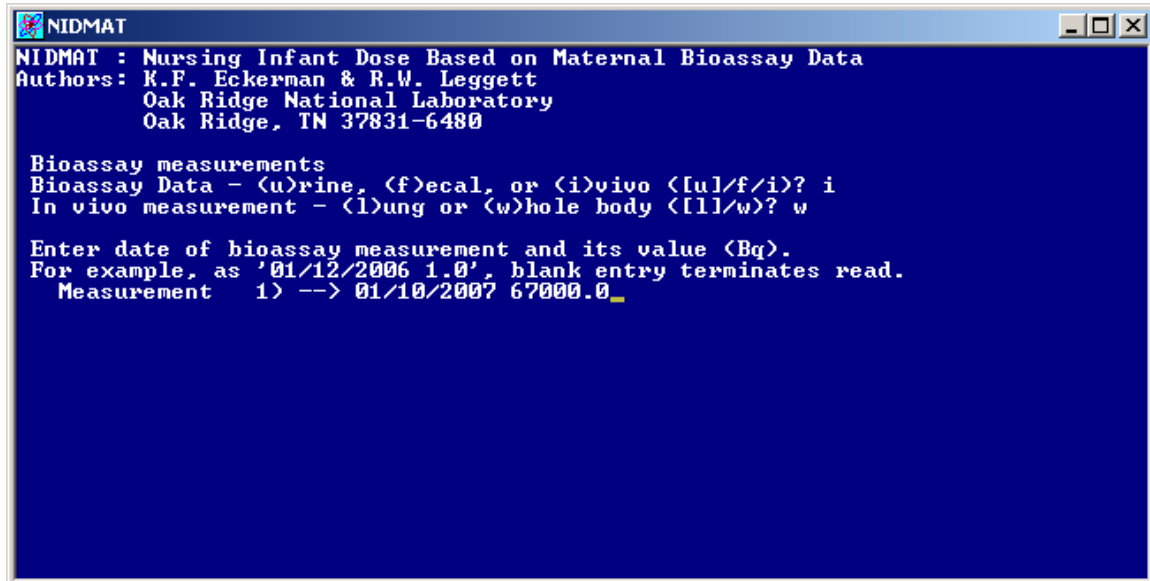

```
NIDMAT
NIDMAT : Nursing Infant Dose Based on Maternal Bioassay Data
Authors: K.F. Eckerman & R.W. Leggett
         Oak Ridge National Laboratory
         Oak Ridge, TN 37831-6480

Bioassay measurements
Bioassay Data - (u)rine, (f)ecal, or (i)vivo (l|f|i)? i
In vivo measurement - (l)ung or (w)hole body (l|w)? w

Enter date of bioassay measurement and its value (Bq).
For example, as '01/12/2006 1.0', blank entry terminates read.
Measurement  1) --> 01/10/2007 67000.0_
```

Input of the bioassay measurements is terminated by a blank entry, that is, by pressing <Enter> in response to the prompt for the next measurement. The calculations are then made by NIDMAT, and the following screen appears:

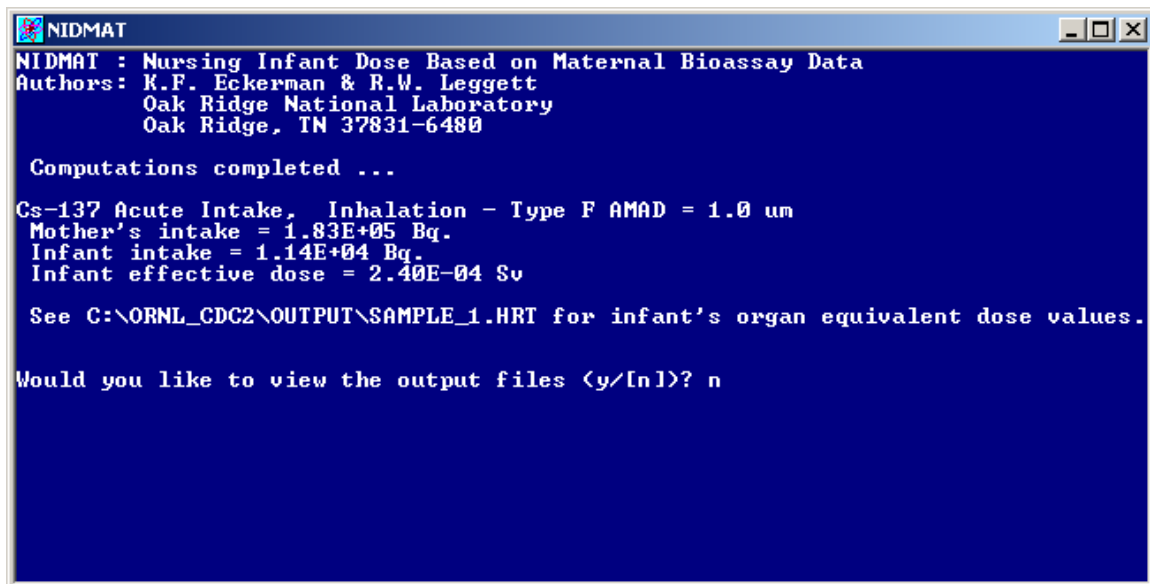

```
NIDMAT
NIDMAT : Nursing Infant Dose Based on Maternal Bioassay Data
Authors: K.F. Eckerman & R.W. Leggett
         Oak Ridge National Laboratory
         Oak Ridge, TN 37831-6480

Computations completed ...

Cs-137 Acute Intake, Inhalation - Type F AMAD = 1.0 um
Mother's intake = 1.83E+05 Bq.
Infant intake = 1.14E+04 Bq.
Infant effective dose = 2.40E-04 Sv

See C:\ORNL_CDC2\OUTPUT\SAMPLE_1.HRT for infant's organ equivalent dose values.

Would you like to view the output files (y/In)? n
```

The above screen indicates that the calculations have been completed. The mother's intake of ^{137}Cs is about 180 kBq, and the projected intake of the nursing infant is 11 kBq. The infant's intake represents a committed effective dose of 240 μSv (24 mrem). As indicated, a file of the organ dose values for this case exists in the output folder. A plot of the projected and observed whole body retention is also displayed. The user can manipulate the plot display; see the help menu for details.

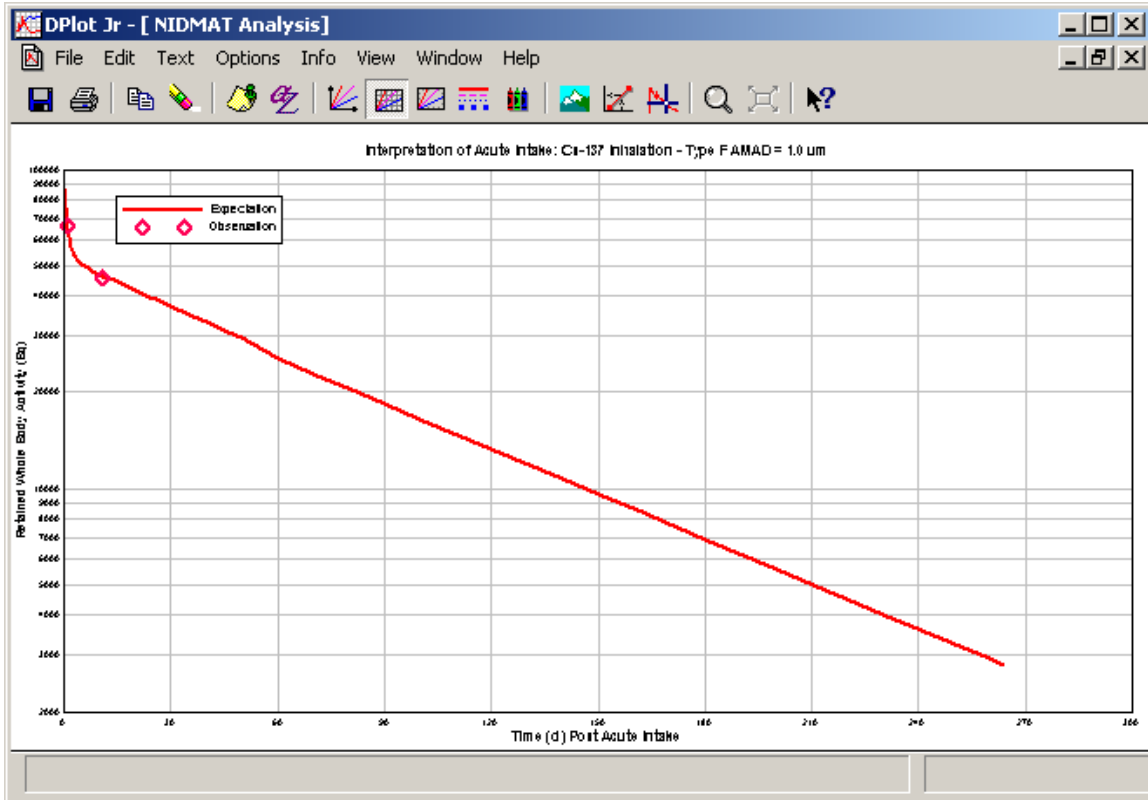

The user can view the five files documenting this case by either responding to the request to view the files or using an ASCII editor or Notepad to view the files in the output folder. It is particularly important that the user examine the validity of the input data. These data appear in each output file, but it might be easiest to examine them in the file with the extension OUT. The five output files for this case are described and listed below.

SAMPLE_1.OUT

This "OUT" file summarizes input and output data. The "OUT" file for this case is listed below.

Summary data file for NIDMAT calculations run on Jul 31, 2007 at 10:32.

	Calendar	Julian
Infant's Birth:	10/01/2006	2454010
Pregnancy - 38 wk:	01/08/2006	2453744
Start of Breast Feeding:	10/01/2006	2454010
End of Breast Feeding:	09/30/2007	2454374

Acute Intake 01/09/2007 2454110

Exposure Mode: Acute Intake
Nuclide: Cs-137 T1/2 (d) = 10957.5
Intake mode: Inhalation - Type F AMAD = 1.0 um
Acute exposure post birth (d): 100
Acute exposure post start of breast feeding (d): 100
Duration of breast feeding (d): 364
Whole Body Retention Measurements
 Calendar Julian Measurement (Bq)
 01/10/2007 2454111 6.700E+04
 01/20/2007 2454121 4.600E+04

Bioassay information
Date Measurement Response
01/10/2007 6.700E+04 3.615E-01
01/20/2007 4.600E+04 2.546E-01

Estimated Intakes (Bq):
 Mother - 1.83E+05
 Infant - 1.14E+04

Infant Effective Dose = 2.40E-04 Sv
See C:\ORNL_CDC2\OUTPUT\SAMPLE_1.HRT for infant's organ dose values.

SAMPLE_1.LOG

The LOG file lists the kinetic model (the differential equations) describing the intake (in this case the lung model) and the models describing the behavior of systemic activity. The file begins with a summary of the input information for the case and then lists the transfer coefficients between the donor and receiver compartments. This information is assembled from the data files in the DAT\BIO and DAST\MIS folders. At the end of the file the nonzero initial conditions on the system of equations are listed – in this case the fractional deposition in the lung of the female for an aerosol characterized by an AMAD of 1 µm. This information only appears in the case of acute intakes. The “LOG” file for this case is listed below.

Log file for NIDMAT calculations run on Jul 31, 2007 at 10:32.

	Calendar	Julian
Infant's Birth:	10/01/2006	2454010
Pregnancy - 38 wk:	01/08/2006	2453744
Start of Breast Feeding:	10/01/2006	2454010
End of Breast Feeding:	09/30/2007	2454374
Acute Intake	01/09/2007	2454110

Exposure Mode: Acute Intake
Nuclide: Cs-137 T1/2 (d) = 10957.5
Intake mode: Inhalation - Type F AMAD = 1.0 um
Acute exposure post birth (d): 100
Acute exposure post start of breast feeding (d): 100
Duration of breast feeding (d): 364
Whole Body Retention Measurements
 Calendar Julian Measurement (Bq)
 01/10/2007 2454111 6.700E+04
 01/20/2007 2454121 4.600E+04

ODE describing biokinetics of current case:

Donor	Receiver		- Transfer Coefficients (/d) -		
			Normal	Pregnant	Lactating
AI_1	(1) -> Blood	(17)	1.000E+02	1.000E+02	1.000E+02
AI_2	(2) -> bbe-gel	(4)	1.000E-03	1.000E-03	1.000E-03

AI_2	(2)	-> Blood	(17)	1.000E+02	1.000E+02	1.000E+02
AI_3	(3)	-> bbe-gel	(4)	1.000E-04	1.000E-04	1.000E-04
AI_3	(3)	-> LN-Th	(13)	2.000E-05	2.000E-05	2.000E-05
AI_3	(3)	-> Blood	(17)	1.000E+02	1.000E+02	1.000E+02
bbe-gel	(4)	-> BBi-gel	(7)	2.000E+00	2.000E+00	2.000E+00
bbe-gel	(4)	-> Blood	(17)	1.000E+02	1.000E+02	1.000E+02
bbe-sol	(5)	-> BBi-gel	(7)	3.000E-02	3.000E-02	3.000E-02
bbe-sol	(5)	-> Blood	(17)	1.000E+02	1.000E+02	1.000E+02
bbe-seq	(6)	-> LN-Th	(13)	1.000E-02	1.000E-02	1.000E-02
bbe-seq	(6)	-> Blood	(17)	1.000E+02	1.000E+02	1.000E+02
BBi-gel	(7)	-> ET2-sur	(10)	1.000E+01	1.000E+01	1.000E+01
BBi-gel	(7)	-> Blood	(17)	1.000E+02	1.000E+02	1.000E+02
BBi-sol	(8)	-> ET2-sur	(10)	3.000E-02	3.000E-02	3.000E-02
BBi-sol	(8)	-> Blood	(17)	1.000E+02	1.000E+02	1.000E+02
BBi-seq	(9)	-> LN-Th	(13)	1.000E-02	1.000E-02	1.000E-02
BBi-seq	(9)	-> Blood	(17)	1.000E+02	1.000E+02	1.000E+02
ET2-sur	(10)	-> St-Cont	(15)	1.000E+02	1.000E+02	1.000E+02
ET2-sur	(10)	-> Blood	(17)	1.000E+02	1.000E+02	1.000E+02
ET1-sur	(11)	-> Excreta	(35)	1.000E+00	1.000E+00	1.000E+00
ET2-seq	(12)	-> LN-ET	(14)	1.000E-03	1.000E-03	1.000E-03
ET2-seq	(12)	-> Blood	(17)	1.000E+02	1.000E+02	1.000E+02
LN-Th	(13)	-> Blood	(17)	1.000E+02	1.000E+02	1.000E+02
LN-ET	(14)	-> Blood	(17)	1.000E+02	1.000E+02	1.000E+02
St-Cont	(15)	-> SI-Cont	(16)	2.400E+01	2.400E+01	2.400E+01
SI-Cont	(16)	-> Blood	(17)	5.940E+02	5.940E+02	5.940E+02
SI-Cont	(16)	-> ULI-Cont	(18)	6.000E+00	6.000E+00	6.000E+00
Blood	(17)	-> St-Cont	(15)	4.906E+00	4.906E+00	4.906E+00
Blood	(17)	-> SI-Cont	(16)	1.775E+00	1.775E+00	1.775E+00
Blood	(17)	-> ULI-Cont	(18)	4.384E-01	4.384E-01	4.384E-01
Blood	(17)	-> Muscle	(20)	2.102E+01	2.102E+01	2.102E+01
Blood	(17)	-> Liver	(21)	2.037E+01	2.037E+01	2.037E+01
Blood	(17)	-> Kidneys	(22)	7.005E+01	7.005E+01	7.005E+01
Blood	(17)	-> R-Marrow	(23)	5.531E+00	5.531E+00	5.531E+00
Blood	(17)	-> T-Bone-S	(24)	9.218E-01	9.218E-01	9.218E-01
Blood	(17)	-> C-Bone-S	(25)	9.218E-01	9.218E-01	9.218E-01
Blood	(17)	-> T-Bone-V	(26)	9.218E-01	9.218E-01	9.218E-01
Blood	(17)	-> C-Bone-V	(27)	9.218E-01	9.218E-01	9.218E-01
Blood	(17)	-> Blood_1	(28)	1.879E+00	1.879E+00	1.879E+00
Blood	(17)	-> Other_1	(29)	2.348E+01	2.348E+01	2.348E+01
Blood	(17)	-> Other_2	(30)	3.685E-03	3.685E-03	3.685E-03
Blood	(17)	-> Other_3	(31)	8.204E+01	8.204E+01	8.204E+01
Blood	(17)	-> Breast	(33)	0.000E+00	0.000E+00	1.000E+00
ULI-Cont	(18)	-> LLI-Cont	(19)	1.800E+00	1.800E+00	1.800E+00
LLI-Cont	(19)	-> Feces	(36)	1.000E+00	1.000E+00	1.000E+00
Muscle	(20)	-> Blood	(17)	7.510E-02	7.510E-02	7.510E-02
Liver	(21)	-> SI-Cont	(16)	9.757E-02	9.757E-02	9.757E-02
Liver	(21)	-> Blood	(17)	1.854E+00	1.854E+00	1.854E+00
Kidneys	(22)	-> Blood	(17)	3.188E+01	3.188E+01	3.188E+01
Kidneys	(22)	-> UB-Cont	(32)	1.600E+00	2.000E+00	1.600E+00
R-Marrow	(23)	-> Blood	(17)	7.060E-01	7.060E-01	7.060E-01
T-Bone-S	(24)	-> Blood	(17)	1.280E-01	1.280E-01	1.280E-01
C-Bone-S	(25)	-> Blood	(17)	1.280E-01	1.280E-01	1.280E-01
T-Bone-V	(26)	-> Blood	(17)	1.280E-01	1.280E-01	1.280E-01
C-Bone-V	(27)	-> Blood	(17)	1.280E-01	1.280E-01	1.280E-01
Blood_1	(28)	-> Blood	(17)	2.570E-01	2.570E-01	2.570E-01
Other_1	(29)	-> Blood	(17)	7.436E-01	7.436E-01	7.436E-01
Other_1	(29)	-> Excreta	(35)	2.450E-03	2.450E-03	2.450E-03
Other_2	(30)	-> Blood	(17)	1.410E-03	1.410E-03	1.410E-03
Other_3	(31)	-> Blood	(17)	6.164E+00	6.164E+00	6.164E+00
UB-Cont	(32)	-> Urine	(37)	1.200E+01	1.200E+01	1.200E+01
Breast	(33)	-> Milk	(34)	0.000E+00	0.000E+00	1.200E+01

Number of biokinetic compartments = 37

Total number of transfers = 63

Nonzero Initial Conditions on Acute Intake

AI_1	3.170E-02
AI_2	6.340E-02
AI_3	1.057E-02
bbe-gel	1.030E-02
bbe-sol	1.012E-02
bbe-seq	1.440E-04

```

BBi-gel      5.850E-03
BBi-sol      5.453E-03
BBi-seq      7.968E-05
ET2-sur      1.921E-01
ET1-sur      1.513E-01
ET2-seq      9.610E-05

```

System solved in 777.34 ms

SAMPLE_1.ACT

This file contains information on the activity residing in maternal tissues as a function of time. This is a large file; the listing below has been compressed in the horizontal direction (number of columns). The file begins with a listing of summary information on the case followed by the activity in the various regions (so-called source regions in dosimetric schema) and in excreta. The activity values are for a unit activity inhaled at time zero. Date and time information are given in the first two columns of the listing. The activity present in mother's milk is shown in the column headed 'Breast' and the cumulative activity transferred to the infant appears in the column headed 'Milk'. It is assumed that all milk produced is consumed by the infant. The data under columns 'Excreta', 'Feces', and 'Urine' are the cumulative activity transferred to outside the body. The 'Total' column represents the total activity retained in the mother's tissues. The entry in the 'Milk' column at 12/31/2007, day 356, of 6.3888E-02 indicates that about 6% of the activity inhaled by the mother is transferred to the nursing infant. The "ACT" file for this case is listed below.

Compartment activity data file for NIDMAT calculations run on Jul 31, 2007 at 10:32.

```

                Calendar   Julian
Infant's Birth: 10/01/2006  2454010
Pregnancy - 38 wk: 01/08/2006  2453744
Start of Breast Feeding: 10/01/2006  2454010
End of Breast Feeding: 09/30/2007  2454374
Acute Intake     01/09/2007  2454110

```

```

Exposure Mode: Acute Intake
Nuclide: Cs-137 T1/2 (d) = 10957.5
Intake mode: Inhalation - Type F AMAD = 1.0 um
Acute exposure post birth (d): 100
Acute exposure post start of breast feeding (d): 100
Duration of breast feeding (d): 364

```

Date	Time(d)	Breast	Milk	Excreta	Feces	Urine	Total
01/09/2007	0.00000E+00	0.00000E+00	0.00000E+00	0.00000E+00	0.00000E+00	0.00000E+00	4.8111E-01
01/10/2007	1.00000E+00	1.9394E-04	5.1803E-03	9.5801E-02	1.0188E-03	1.7108E-02	3.6146E-01
01/11/2007	2.00000E+00	1.2671E-04	6.9714E-03	1.3115E-01	2.5974E-03	2.3191E-02	3.1366E-01
01/12/2007	3.00000E+00	1.0161E-04	8.3259E-03	1.4424E-01	3.8356E-03	2.7758E-02	2.9407E-01
01/13/2007	4.00000E+00	8.6485E-05	9.4475E-03	1.4911E-01	4.7496E-03	3.1534E-02	2.8378E-01
01/14/2007	5.00000E+00	7.6243E-05	1.0420E-02	1.5096E-01	5.4548E-03	3.4803E-02	2.7725E-01
01/15/2007	6.00000E+00	6.8961E-05	1.1288E-02	1.5169E-01	6.0313E-03	3.7721E-02	2.7234E-01
01/16/2007	7.00000E+00	6.3648E-05	1.2081E-02	1.5200E-01	6.5260E-03	4.0386E-02	2.6821E-01
01/17/2007	8.00000E+00	5.9695E-05	1.2819E-02	1.5215E-01	6.9661E-03	4.2865E-02	2.6449E-01
01/18/2007	9.00000E+00	5.6696E-05	1.3516E-02	1.5224E-01	7.3683E-03	4.5204E-02	2.6103E-01
01/19/2007	1.00000E+01	5.4374E-05	1.4181E-02	1.5231E-01	7.7431E-03	4.7436E-02	2.5774E-01
01/20/2007	1.10000E+01	5.2533E-05	1.4821E-02	1.5237E-01	8.0976E-03	4.9585E-02	2.5458E-01
01/23/2007	1.40000E+01	4.8733E-05	1.6635E-02	1.5252E-01	9.0802E-03	5.5673E-02	2.4560E-01
01/25/2007	1.60000E+01	4.6978E-05	1.7780E-02	1.5261E-01	9.6911E-03	5.9518E-02	2.3993E-01
01/27/2007	1.80000E+01	4.5532E-05	1.8888E-02	1.5269E-01	1.0278E-02	6.3235E-02	2.3444E-01
01/29/2007	2.00000E+01	4.4269E-05	1.9963E-02	1.5278E-01	1.0846E-02	6.6844E-02	2.2911E-01
01/31/2007	2.20000E+01	4.3120E-05	2.1009E-02	1.5286E-01	1.1398E-02	7.0356E-02	2.2392E-01
02/02/2007	2.40000E+01	4.2050E-05	2.2028E-02	1.5294E-01	1.1935E-02	7.3779E-02	2.1886E-01
02/04/2007	2.60000E+01	4.1035E-05	2.3022E-02	1.5302E-01	1.2458E-02	7.7118E-02	2.1393E-01

```

02/08/2007 3.00000E+01 3.9129E-05 2.4939E-02 1.5317E-01 1.3467E-02 8.3560E-02 2.0441E-01
02/13/2007 3.50000E+01 3.6917E-05 2.7211E-02 1.5335E-01 1.4663E-02 9.1199E-02 1.9312E-01
02/18/2007 4.00000E+01 3.4853E-05 2.9355E-02 1.5352E-01 1.5792E-02 9.8408E-02 1.8246E-01
02/23/2007 4.50000E+01 3.2917E-05 3.1378E-02 1.5368E-01 1.6858E-02 1.0522E-01 1.7240E-01
02/28/2007 5.00000E+01 3.1093E-05 3.3287E-02 1.5383E-01 1.7864E-02 1.1165E-01 1.6290E-01
03/10/2007 6.00000E+01 2.6720E-05 3.6497E-02 1.5408E-01 1.9569E-02 1.2247E-01 1.4011E-01
03/20/2007 7.00000E+01 2.4099E-05 3.9522E-02 1.5432E-01 2.1165E-02 1.3268E-01 1.2568E-01
03/30/2007 8.00000E+01 2.1625E-05 4.2237E-02 1.5453E-01 2.2600E-02 1.4186E-01 1.1274E-01
04/09/2007 9.00000E+01 1.9397E-05 4.4668E-02 1.5473E-01 2.3888E-02 1.5010E-01 1.0113E-01
04/19/2007 1.00000E+02 1.7397E-05 4.6844E-02 1.5490E-01 2.5044E-02 1.5748E-01 9.0725E-02
05/09/2007 1.20000E+02 1.3994E-05 5.0534E-02 1.5519E-01 2.7009E-02 1.7005E-01 7.3016E-02
05/29/2007 1.40000E+02 1.1257E-05 5.3486E-02 1.5543E-01 2.8591E-02 1.8016E-01 5.8771E-02
06/08/2007 1.50000E+02 1.0096E-05 5.4732E-02 1.5553E-01 2.9261E-02 1.8444E-01 5.2731E-02
06/18/2007 1.60000E+02 9.0548E-06 5.5845E-02 1.5562E-01 2.9862E-02 1.8829E-01 4.7313E-02
07/08/2007 1.80000E+02 7.2839E-06 5.7725E-02 1.5577E-01 3.0885E-02 1.9483E-01 3.8095E-02
07/28/2007 2.00000E+02 5.8595E-06 5.9222E-02 1.5589E-01 3.1708E-02 2.0009E-01 3.0680E-02
08/27/2007 2.30000E+02 4.2280E-06 6.0908E-02 1.5603E-01 3.2651E-02 2.0612E-01 2.2186E-02
09/26/2007 2.60000E+02 3.0510E-06 6.2090E-02 1.5613E-01 3.3332E-02 2.1047E-01 1.6056E-02
09/30/2007 2.64000E+02 2.9212E-06 6.2217E-02 1.5615E-01 3.3407E-02 2.1095E-01 1.5379E-02

```

SAMPLE_1. EUD

This file is a tabulation of the maternal excretion and retention data and the cumulative activity transferred to the infant. This tabulation is derived from the ACT file. The definition of the column headings are as follows:

- E_u(t) is the urinary excretion coefficients (Bq d⁻¹ in urine per Bq intake)
- E_f(t) is the fecal excretion coefficients (Bq d⁻¹ in urine per Bq intake)
- R_lng(t) is activity retained in lung (Bq in lung per Bq intake)
- R_milk(t) is activity retained in breast milk (Bq in maternal breast milk per Bq intake)
- I_inf(t) is cumulative activity transferred to infant via nursing (Bq per Bq intake)
- R_tb(t) is activity retained in mother's tissues (Bq in whole body per Bq intake).

The committed dose to the infant is assumed to be directly proportional to the cumulative intake. For example, if breast feeding were terminated on 04/19/2007, day 100, the cumulative intake by the infant would be 4.47×10^{-2} and the equivalent and effective dose would be 4.47×10^{-2} divided by 6.39×10^{-2} or 70% of the values derived in the present case. The "EUD" file for this case is listed below.

The committed dose to the infant is directly proportional to the cumulative intake. Thus, for example, if breast feeding were terminated on 04/19/2007, day 100, the cumulative intake by the infant would be 4.47×10^{-2} and the equivalent and effective dose would be 4.68×10^{-2} divided by 6.22×10^{-2} or 75% of the total value.

Bioassay data file for NIDMAT calculations run on Jul 31, 2007 at 10:32.

	Calendar	Julian
Infant's Birth:	10/01/2006	2454010
Pregnancy - 38 wk:	01/08/2006	2453744
Start of Breast Feeding:	10/01/2006	2454010
End of Breast Feeding:	09/30/2007	2454374
Acute Intake	01/09/2007	2454110

Exposure Mode: Acute Intake
 Nuclide: Cs-137 T1/2 (d) = 10957.5
 Intake mode: Inhalation - Type F AMAD = 1.0 um

Acute exposure post birth (d): 100
 Acute exposure post start of breast feeding (d): 100
 Duration of breast feeding (d): 364

Date	Time(d)	E_u(t)	E_f(t)	R_lng(t)	R_milk(t)	I_inf(t)	R_tb(t)
01/09/2007	0.00000E+00	0.00000E+00	0.00000E+00	1.3762E-01	0.0000E+00	0.0000E+00	4.8111E-01
01/10/2007	1.00000E+00	7.9562E-03	1.6142E-03	0.0000E+00	1.9394E-04	5.1803E-03	3.6146E-01
01/11/2007	2.00000E+00	5.1331E-03	1.4335E-03	0.0000E+00	1.2671E-04	6.9714E-03	3.1366E-01
01/12/2007	3.00000E+00	4.1056E-03	1.0558E-03	0.0000E+00	1.0161E-04	8.3259E-03	2.9407E-01
01/13/2007	4.00000E+00	3.4897E-03	7.9275E-04	0.0000E+00	8.6485E-05	9.4475E-03	2.8378E-01
01/14/2007	5.00000E+00	3.0737E-03	6.3074E-04	0.0000E+00	7.6243E-05	1.0420E-02	2.7725E-01
01/15/2007	6.00000E+00	2.7783E-03	5.2980E-04	0.0000E+00	6.8961E-05	1.1288E-02	2.7234E-01
01/16/2007	7.00000E+00	2.5628E-03	4.6399E-04	0.0000E+00	6.3648E-05	1.2081E-02	2.6821E-01
01/17/2007	8.00000E+00	2.4026E-03	4.1902E-04	0.0000E+00	5.9695E-05	1.2819E-02	2.6449E-01
01/18/2007	9.00000E+00	2.2812E-03	3.8708E-04	0.0000E+00	5.6696E-05	1.3516E-02	2.6103E-01
01/19/2007	1.00000E+01	2.1872E-03	3.6366E-04	0.0000E+00	5.4374E-05	1.4181E-02	2.5774E-01
01/20/2007	1.10000E+01	2.1127E-03	3.4601E-04	0.0000E+00	5.2533E-05	1.4821E-02	2.5458E-01
01/23/2007	1.40000E+01	1.9592E-03	3.1268E-04	0.0000E+00	4.8733E-05	1.6635E-02	2.4560E-01
01/25/2007	1.60000E+01	1.8885E-03	2.9897E-04	0.0000E+00	4.6978E-05	1.7780E-02	2.3993E-01
01/27/2007	1.80000E+01	1.8303E-03	2.8844E-04	0.0000E+00	4.5532E-05	1.8888E-02	2.3444E-01
01/29/2007	2.00000E+01	1.7794E-03	2.7971E-04	0.0000E+00	4.4269E-05	1.9963E-02	2.2911E-01
01/31/2007	2.20000E+01	1.7332E-03	2.7203E-04	0.0000E+00	4.3120E-05	2.1009E-02	2.2392E-01
02/02/2007	2.40000E+01	1.6901E-03	2.6503E-04	0.0000E+00	4.2050E-05	2.2028E-02	2.1886E-01
02/04/2007	2.60000E+01	1.6493E-03	2.5848E-04	0.0000E+00	4.1035E-05	2.3022E-02	2.1393E-01
02/08/2007	3.00000E+01	1.5727E-03	2.4632E-04	0.0000E+00	3.9129E-05	2.4939E-02	2.0441E-01
02/13/2007	3.50000E+01	1.4838E-03	2.3231E-04	0.0000E+00	3.6917E-05	2.7211E-02	1.9312E-01
02/18/2007	4.00000E+01	1.4009E-03	2.1929E-04	0.0000E+00	3.4853E-05	2.9355E-02	1.8246E-01
02/23/2007	4.50000E+01	1.3230E-03	2.0708E-04	0.0000E+00	3.2917E-05	3.1378E-02	1.7240E-01
02/28/2007	5.00000E+01	1.2497E-03	1.9560E-04	0.0000E+00	3.1093E-05	3.3287E-02	1.6290E-01
03/10/2007	6.00000E+01	1.0739E-03	1.6735E-04	0.0000E+00	2.6720E-05	3.6497E-02	1.4011E-01
03/20/2007	7.00000E+01	9.6857E-04	1.5145E-04	0.0000E+00	2.4099E-05	3.9522E-02	1.2568E-01
03/30/2007	8.00000E+01	8.6917E-04	1.3594E-04	0.0000E+00	2.1625E-05	4.2237E-02	1.1274E-01
04/09/2007	9.00000E+01	7.7961E-04	1.2194E-04	0.0000E+00	1.9397E-05	4.4668E-02	1.0113E-01
04/19/2007	1.00000E+02	6.9923E-04	1.0937E-04	0.0000E+00	1.7397E-05	4.6844E-02	9.0725E-02
05/09/2007	1.20000E+02	5.6245E-04	8.7972E-05	0.0000E+00	1.3994E-05	5.0534E-02	7.3016E-02
05/29/2007	1.40000E+02	4.5243E-04	7.0764E-05	0.0000E+00	1.1257E-05	5.3486E-02	5.8771E-02
06/08/2007	1.50000E+02	4.0577E-04	6.3467E-05	0.0000E+00	1.0096E-05	5.4732E-02	5.2731E-02
06/18/2007	1.60000E+02	3.6393E-04	5.6922E-05	0.0000E+00	9.0548E-06	5.5845E-02	4.7313E-02
07/08/2007	1.80000E+02	2.9276E-04	4.5789E-05	0.0000E+00	7.2839E-06	5.7725E-02	3.8095E-02
07/28/2007	2.00000E+02	2.3551E-04	3.6835E-05	0.0000E+00	5.8595E-06	5.9222E-02	3.0680E-02
08/27/2007	2.30000E+02	1.6993E-04	2.6578E-05	0.0000E+00	4.2280E-06	6.0908E-02	2.2186E-02
09/26/2007	2.60000E+02	1.2263E-04	1.9180E-05	0.0000E+00	3.0510E-06	6.2090E-02	1.6056E-02
09/30/2007	2.64000E+02	1.1741E-04	1.8363E-05	0.0000E+00	2.9212E-06	6.2217E-02	1.5379E-02

	Calendar	Julian
Infant's Birth:	10/01/2006	2454010
Pregnancy - 38 wk:	01/08/2006	2453744
Start of Breast Feeding:	10/01/2006	2454010
End of Breast Feeding:	12/31/2007	2454466
Acute Intake	01/09/2007	2454110

SAMPLE_1_HRT

This file tabulates the committed equivalent and effective dose to the nursing infant for activity ingested in breast milk. The file begins with the summary information as in the other files (not fully shown below) followed by a table of the committed organ doses and effective dose. The committed dose values are derived using the dose coefficients tabulated in the ICRP CD. The "HRT" file for this case is listed below.

Nuclide: Cs-137 T1/2 (d) = 10957.5
Intake mode: Inhalation - Type F AMAD = 1.0 um
Acute exposure post birth (d): 100
Acute exposure post start of breast feeding (d): 100
Duration of breast feeding (d): 364

Infant dose (Sv):
Infant intake = 1.14E+04 Bq

Organ	H (Sv)
Adrenals	2.17E-04
Bladder	2.28E-04
Bone	2.17E-04
Brain	2.05E-04
Breast	1.83E-04
Esophagus	2.05E-04
St	2.51E-04
SI	2.28E-04
ULI	3.31E-04
LLI	5.59E-04
Colon	4.34E-04
Kidneys	2.17E-04
Liver	2.17E-04
Muscle	2.05E-04
Ovaries	2.28E-04
Pancreas	2.17E-04
Red	1.94E-04
ET	2.17E-04
Lungs	2.05E-04
Skin	1.83E-04
Spleen	2.17E-04
Testes	2.05E-04
Thymus	2.05E-04
Thyroid	2.17E-04
Uterus	2.17E-04
Remainder	2.05E-04
Effective	2.40E-04

Sample 2.

In this example the user creates an input file (SAMPLE_2.INP) in the folder “input” rather than entering the case data interactively.

An environmental contamination is assumed to result in chronic inhalation of ^{60}Co by the mother. The period of maternal intake is from 01/01/2006 through the expected termination of nursing. The infant is born on 01/10/2007. Nursing begins at birth and ends on 10/01/2007. The ^{60}Co is assumed to be moderately soluble (Type M) with an AMAD of 1 μm . The chronic intake pattern is represented by an exponentially declining intake. The half-time of the decline in intake is taken to be the physical half-life of ^{60}Co , representing the situation that intake is declining due to decay of ^{60}Co in the mother’s environment. Extensive bioassay measurements (urinary excretion data) are available for different times including the nursing period. The measurements are as follows:

Urinary Excretion Measurements

Date	Measurement (Bq)
03/01/2006	122.0
04/01/2006	135.0
06/01/2006	150.0
08/01/2006	160.0
10/01/2006	167.0
12/01/2006	170.0
02/01/2007	72.0
03/01/2007	57.0
04/01/2007	46.0
06/01/2007	32.0

A listing of the input file for this case, Sample_2.INP. is given below.

This is sample 2 input file - Sample_2.INP

An environmental contamination of Co-60 results to the future mother, chronic inhalation beginning on 01/01/2006 - the infant is born on 01/10/2007. Nursing began at birth and ended on 10/01/2007. The Co-60 is assumed to be of Type M with an AMAD of 1 μ m. The chronic intake pattern is represented by an exponentially declining intake with the half-time corresponding to the physical half-life of Co-60. Extensive bioassay measurements (urinary excretion) are available including after nursing had ended.

```

Start Input:                                <-- Delimiter for start of input input data
Nuclide:                                    Co-60
Intake Mode:                                Inhalation
Type & AMAD:                                M 1.0
Exposure Mode:                              Chronic
Intake Pattern:                             Exponential
Half-time:                                  1924.9
Start of Chronic Intake:                    01/01/2006
End of Chronic Intake:                      10/01/2007
Infant's Birth:                             01/10/2007
Start of Breast Feeding:                   01/10/2007
End of Breast Feeding:                     10/01/2007
Bioassay:                                    Urine
Start Bioassay Data:                        <-- Data Delimiter for start of bioassay data
03/01/2006 122.0
04/01/2006 135.0
06/01/2006 150.0
08/01/2006 160.0
10/01/2006 167.0
12/01/2006 170.0
02/01/2007 72.0
03/01/2007 57.0
04/01/2007 46.0
06/01/2007 32.0
End Bioassay Data:                          <-- Data Delimiter for end of bioassay data
End of Input Data                           <-- Delimiter for input data (end of file)

```

The results of the analysis are shown below.

```

NIDMAT
NIDMAT : Nursing Infant Dose Based on Maternal Bioassay Data
Authors: K.F. Eckerman & R.W. Leggett
Oak Ridge National Laboratory
Oak Ridge, TN 37831-6480

Computations completed ...

Co-60 Chronic Intake Exponential, Inhalation - Type M AMAD = 1 um
Mother's intake = 1.12E+06 Bq.
Infant intake = 1.53E+03 Bq.
Infant effective dose = 8.28E-05 Sv

See C:\ORNL_CDC2\OUTPUT\SAMPLE_2.HRT for infant's organ equivalent dose values.

Would you like to view the output files (y/[n])? n

```

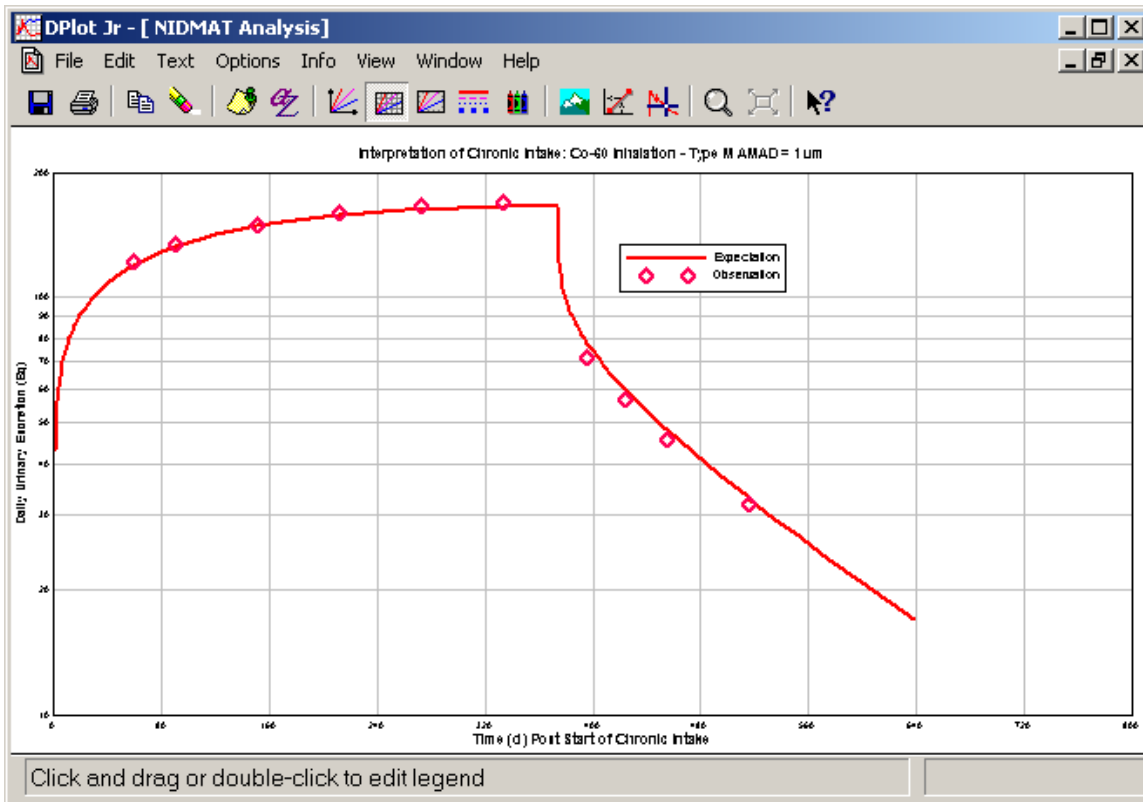

Sample 3.

In this example the user creates an input file (SAMPLE_3.INP) in the folder “input” rather than entering the case data interactively.

A female worker is chronically exposed to ^{239}Pu over a two year period, 2005 and 2006. No bioassay data are available for the work period. The infant is born one month after the end of employment. The infant is breast feed from birth (02/01/2000) to 07/01/2007. Three measurements of ^{239}Pu urinary excretion of 1.1, 1.0, and 1.1 Bq are obtained on 07/10/2007, 07/15/2007, and 07/30/2007, respectively.

A listing of the input file for this case, Sample_2.INP. is given below.

```
This is sample 3 input file - Sample_3.INP
A worker was potentially exposed (chronic) to Pu-239 over a two year period
(2005 and 2006), but no bioassay data are available for this period. The infant
is born one month after end of employment and was breast feed from birth
(02/01/2007) to 07/01/2007. Three measurements of Pu-239 urinary excretion of
1.1, 1.0, and 1.1 Bq were obtained on 07/10/2007, 07/15/2007, and 07/30/2007.
Start Input:                                <-- Delimiter for start of input input data
Nuclide:                                    Pu-239
Intake Mode:                                Inhalation
Type & AMAD:                                S 5.0
Exposure Mode:                              Chronic
Intake Pattern:                              Constant
Start of Chronic Intake: 01/01/2005
End of Chronic Intake: 12/31/2006
Infant's Birth: 02/01/2007
Start of Breast Feeding: 02/01/2007
End of Breast Feeding: 07/01/2007
Bioassay: Urine
Start Bioassay Data:                        <-- Data Delimiter for start of bioassay data
07/10/2007 1.10
07/15/2007 1.00
07/30/2007 1.10
End Bioassay Data:                          <-- Data Delimiter for end of bioassay data
End of Input Data                           <-- Delimiter for input data (end of file)
```

The results of the analysis are shown below.

```

NIDMAT
NIDMAT : Nursing Infant Dose Based on Maternal Bioassay Data
Authors: K.F. Eckerman & R.W. Leggett
Oak Ridge National Laboratory
Oak Ridge, TN 37831-6480

Computations completed ...

Pu-239 Chronic Intake Constant, Inhalation - Type S AMAD = 5 um
Mother's intake = 5.86E+06 Bq.
Infant intake = 2.00E+02 Bq.
Infant effective dose = 8.42E-04 Sv

See C:\ORNL_CDC\OUTPUT\SAMPLE_3.HRT for infant's organ equivalent dose values.

Would you like to view the output files <y/[n]? n

```

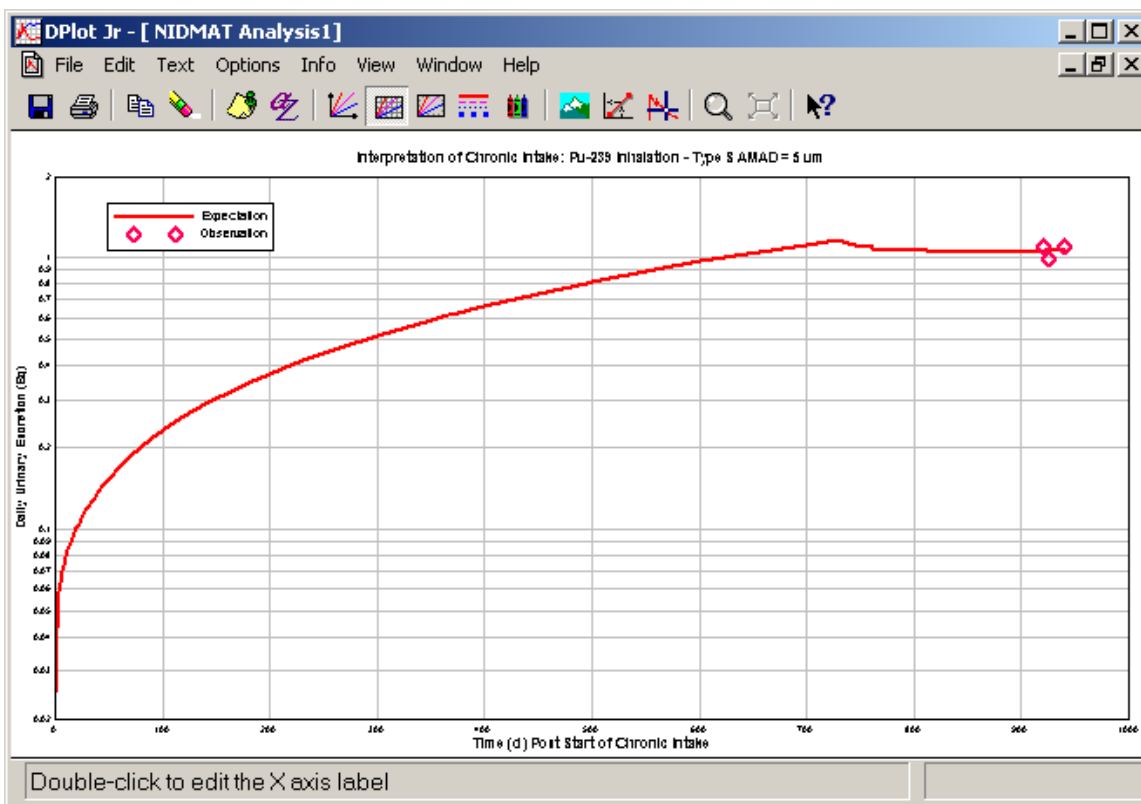

Future Development of Software

The present version of the software addresses a select set of radionuclides, has limited checking of the user's input, and other assorted limitations. These limitations could be addressed in future development efforts to ensure the software is responsive to the analyst's needs.

REFERENCES TO THE MAIN TEXT

- ICRP (1979). Limits for intakes of radionuclides by workers. ICRP Publication 30, Part 1. Oxford: Pergamon Press.
- ICRP (1980). International Commission on Radiological Protection. Limits for intakes by workers. ICRP Publication 30, Part 2. Oxford: Pergamon Press.
- ICRP (1989). International Commission on Radiological Protection. Age-dependent doses to members of the public from intake of radionuclides, Part 1, ICRP Pub. 56. Oxford: Pergamon Press.
- ICRP (1993). International Commission on Radiological Protection. Age-dependent doses to members of the public from intake of radionuclides: Part 2. ICRP Publication 67. Oxford: Pergamon Press.
- ICRP (1994a). International Commission on Radiological Protection. Dose coefficients for intakes of radionuclides by workers, ICRP Publication 68. Oxford: Pergamon Press.
- ICRP (1994b). International Commission on Radiological Protection. Human respiratory tract model for radiological protection, ICRP Publication 66. Oxford: Pergamon Press.
- ICRP (1995a). International Commission on Radiological Protection. Age-dependent doses to members of the public from intake of radionuclides, Part 3, ICRP Pub. 69. Oxford: Pergamon Press.
- ICRP (1995b). International Commission on Radiological Protection. Age-dependent doses to members of the public from intake of radionuclides, Part 4, ICRP Pub. 71. Oxford: Pergamon Press.
- ICRP (1996). International Commission on Radiological Protection. Age-dependent doses to members of the public from intake of radionuclides: Part 5. Compilations of ingestion and inhalation dose coefficients. ICRP Publication 72. Oxford: Pergamon Press.
- ICRP (2001). International Commission on Radiological Protection.. Doses to the embryo and fetus from intakes of radionuclides by the mother. ICRP Pub. 88. Oxford: Pergamon Press.
- ICRP (2004). International Commission on Radiological Protection. Doses to infants from ingestion of radionuclides in mothers' milk. ICRP Pub. 95. Oxford: Pergamon Press.
- Leggett, R. W. (1992). A generic age-specific biokinetic model for calcium-like elements, *Radiat. Prot. Dosim.* 41:183-198.

Leggett, R. W. (2001). Consistent biokinetic models for the actinide elements. *Rad. Prot. Env.* 24:616-622.

Leggett, R. W. (1992). A retention-excretion model for americium in humans. *Health Phys.* 62:288-310.

Leggett, R. W.; Williams, L. R.; Melo, D. R.; Lipsztein, J. L. (2003). A physiologically based biokinetic model for cesium in the human body. *Sci. Total Environ.* 317:235-255.

Leggett, R. W.; Eckerman, K. F.; Khokhryakov, V. F.; Suslova, K. G.; Krahenbuhl, M. C.; Miller, S. C. (2005). Mayak worker study: An improved biokinetic model for reconstructing doses from internally deposited plutonium. *Radiat. Res.* 164:111-122.

Leggett, R. W. (2008). The biokinetics of inorganic cobalt in the human body. *Science of the Total Environment* 389:259-269.

Leggett, R. W. (2007b). The biokinetics of iridium in the body. To be submitted for publication.

APPENDIX A: BIOKINETIC MODEL FOR COBALT IN THE ADULT HUMAN

A recently published systemic biokinetic model for inorganic cobalt is used in this report (Leggett, 2008). The model depicts recycling of cobalt between blood and four systemic tissues: liver, kidneys, skeleton, and other (Figure A-1). The model structure is patterned after a model developed earlier for the alkaline earth elements (Leggett, 1992; ICRP, 1993). Although cobalt is not physiologically related to the alkaline earths, this structure provides a convenient framework in which to model the biokinetics of cobalt for radiation protection purposes.

First-order kinetics is assumed. Parameter values (Table A-1) are expressed as transfer coefficients, i.e., as fractional transfers per day from donor to receptor compartments. These transfer coefficients were based as far as feasible on data from controlled human studies involving administration of inorganic forms of cobalt.

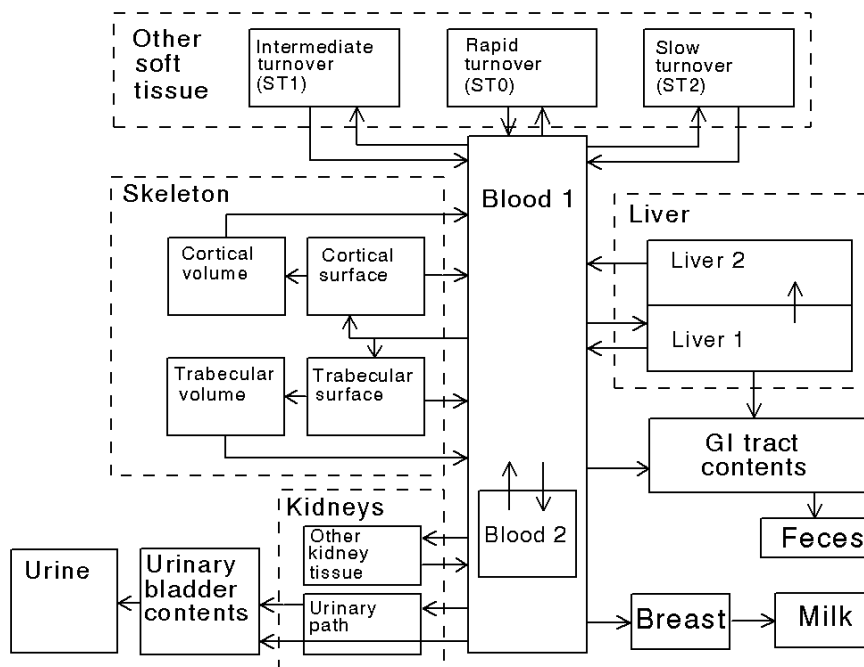

Figure A-1. Structure of the systemic model for cobalt in the adult human. The breast and milk compartments were not part of the original model but were added for application to the lactating mother.

Table A-1. Transfer coefficients (d^{-1}) in the systemic biokinetic model for cobalt in the adult.^a

Blood 1 to Liver 1	7.0000E+01
Blood 1 to Urinary bladder contents	6.0000E+01
Blood 1 to Right colon contents	4.0000E+00
Blood 1 to ST0	1.8000E+01
Blood 1 to ST1	1.0000E+01
Blood 1 to ST2	4.0000E+00
Blood 1 to Cortical bone surf	6.0000E+00
Blood 1 to Trabecular bone surf	6.0000E+00
Blood 1 to Kidneys 1	9.0000E+00
Blood 1 to Kidneys 2	1.0000E+00
Blood 1 to Blood 2	1.2000E+01
Blood 2 to Blood 1	6.9315E-01
Liver 1 to SI cont	9.2420E-02
Liver 1 to Blood 1	3.4658E-01
Liver 1 to Liver 2	2.3105E-02
Liver 2 to Blood 1	1.9000E-03
ST0 to Blood 1	9.9021E-02
ST1 to Blood 1	1.3863E-02
ST2 to Blood 1	9.5000E-04
Cortical bone surf to Blood 1	8.4168E-02
Cortical bone surf to Cortical bone vol	1.4853E-02
Trabecular bone surf to Blood 1	8.4168E-02
Trabecular bone surf to Trabecular bone vol	1.4853E-02
Cortical bone vol to Blood 1	8.2100E-05
Trabecular bone vol to Blood 1	4.9300E-04
Kidneys 1 to Urinary bladder contents	4.6210E-01
Kidneys 2 to Blood 1	1.9000E-03
Blood 1 to Breast ^b	1.0250E+01
Breast to Milk ^b	1.2000E+01

^asurf = surface, vol = volume, SI = small intestine, Kidneys 1 = Urinary path, Kidneys 2 = Other kidney tissue

^bBasis for transfer coefficient discussed in main text.

REFERENCES TO APPENDIX A

ICRP (1993). International Commission on Radiological Protection. Age-dependent doses to members of the public from intake of radionuclides: Part 2. ICRP Publication 67. Oxford: Pergamon Press.

Leggett, R. W. (1992). A generic age-specific biokinetic model for calcium-like elements, *Radiat. Prot. Dosim.* 41:183-198.

Leggett, R. W. (2008). The biokinetics of inorganic cobalt in the human body. *Science of the Total Environment* 389:259-269.

APPENDIX B: BIOKINETIC MODEL FOR STRONTIUM IN THE ADULT HUMAN

The systemic biokinetic model for strontium applied in this report to the mother is the ICRP's current model for strontium in adults (ICRP, 1993). The basis for the model is discussed in a paper by Leggett (1992) and in ICRP Publication 67 (1993) and will not be repeated here.

The structure of the systemic model for strontium is shown in Figure B-1. This is the ICRP's generic structure for radionuclides that follow the movement of calcium in the skeleton. Parameter values are given in Table B-1.

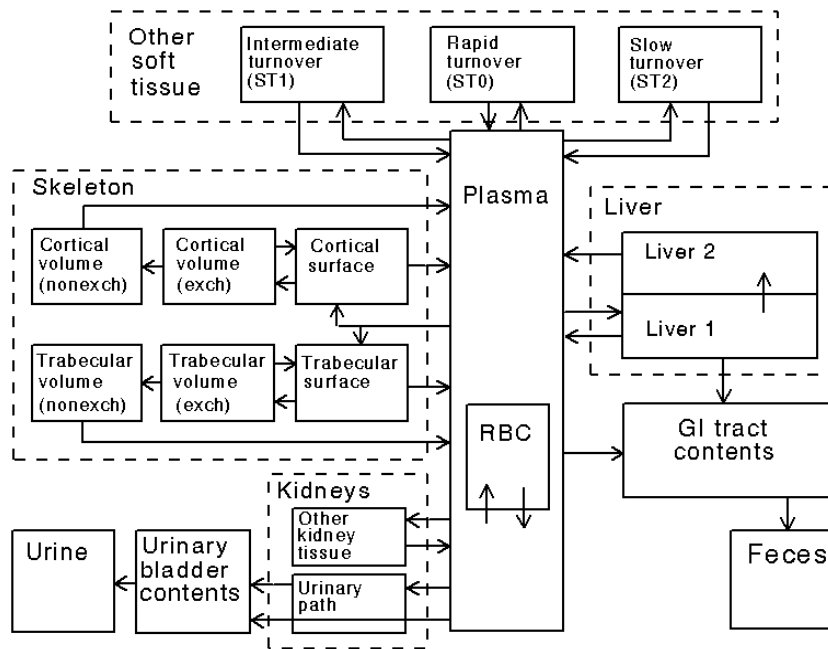

Figure B-1. ICRP's generic model structure for calcium-like elements, introduced in ICRP Publication 67 (1993) where it is applied to strontium. Liver and kidneys are not considered explicitly in the model for strontium but are included in "other soft tissues". Also, red blood cells (RBC) are not addressed in the strontium model. The breast and milk compartments were not part of the original model but were added for application to the lactating mother.

Table B-1. Transfer coefficients (d^{-1}) in the systemic model for strontium in the adult (ICRP, 1993).^a

Plasma to urinary bladder contents	1.7250E-01
Plasma to upper large intestine contents	5.2500E-01
Plasma to trab bone surface	2.0800E+00
Plasma to cort bone surface	1.6700E+00
Plasma to ST0	7.5000E+00
Plasma to ST1	1.5000E+00
Plasma to ST2	3.0000E-03
Trabecular bone surface to plasma	5.7800E-01
Trabecular bone surface to exch volume	1.1600E-01
Cortical bone surface to plasma	5.7800E-01
Cortical bone surface to exch volume	1.1600E-01
ST0 to Plasma	2.5000E+00
ST1 to Plasma	1.1600E-01
ST2 to Plasma	3.8000E-04
Exch trabecular bone volume to surface	4.3000E-03
Exch to nonexch trabecular bone volume	4.3000E-03
Exch cortical bone volume to surface	4.3000E-03
Exch to nonexch cortical bone volume	4.3000E-03
Nonexch cortical bone volume to plasma	8.2190E-05
Nonexch trabecular bone volume to plasma	4.9320E-04
Plasma to Breast ^b	0.7200E+00
Breast to Milk ^b	1.2000E+01

^aexch = exchangeable, nonexch = nonexchangeable

^bTransfer to breast and milk not addressed in ICRP Publication 67. Basis for these two transfer coefficient discussed in main text.

REFERENCES TO APPENDIX B

ICRP (1993). International Commission on Radiological Protection. Age-dependent doses to members of the public from intake of radionuclides: Part 2. ICRP Publication 67. Oxford: Pergamon Press.

Leggett, R. W. (1992). A generic age-specific biokinetic model for calcium-like elements, *Radiat. Prot. Dosim.* 41:183-198.

APPENDIX C: BIOKINETIC MODEL FOR CESIUM IN THE ADULT HUMAN

A detailed physiologically based systemic biokinetic model for cesium was developed recently (Leggett et al., 2003). The model structure (Figure C-1) is based on directions of flow of cardiac output in the human body. Parameter values provided in the published paper, including those describing the distribution of output (percentages next to arrows in Figure C-1), are for a reference adult male.

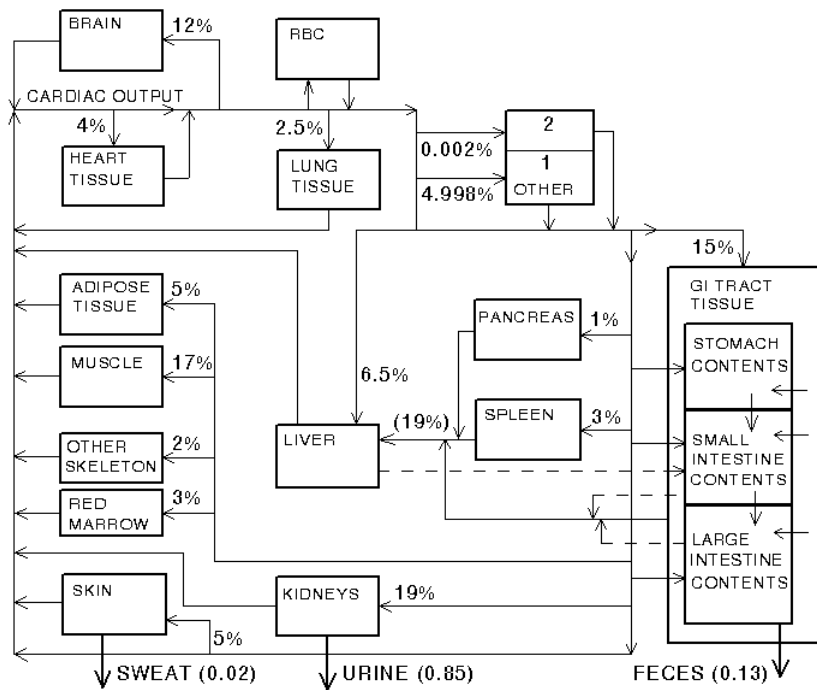

Figure C-1. Structure of a recently published model of the systemic biokinetics of cesium in the human body (Leggett et al., 2003). Solid arrows represent plasma flow and broken arrows represent flow not involving plasma. Percentages indicate distribution of cardiac output. Numbers beside SWEAT, URINE, and FECES are fractions of cumulative excretion. A simplified version of this model framework is used in this report.

A simplified version of the model indicated in Figure C-1 has been developed for use in a report of the U.S. National Council on Radiation Protection and Measurements (NCRP) on treatment of persons contaminated with radionuclides (NCRP, to appear). The structure of the simplified model resembles the structure shown in Figure 3 of the main text. In the simplified version: (1) the compartment in Figure C-1 labeled “Other skeleton” is divided into four pools, trabecular bone surface, trabecular bone volume, cortical bone surface, and cortical bone volume, and each of these pools is assumed to receive one-fourth of the transfer from plasma to “Other skeleton”; (2) the compartment identified in the figure as Other 1 is expanded to include adipose tissue, skin, and brain;

and (3) spleen, pancreas, and tissues of the heart, lung, and gastrointestinal tract are combined into one compartment identified as Other 3. The simplified model predicts virtually the same urinary and fecal excretion rates and dose estimates to radiosensitive tissues as the original model and is easier to implement than the original model. For these reasons the simplified model is used in the present report.

Parameter values for the adult male are listed in Table C-1. Modifications of these parameter values were made for application to non-pregnant, pregnant, or lactating young adult females (Table C-2). The changes in parameter values reflect lower residence times of cesium in adult females than adult males, a reduced portion of total-body cesium in the relatively smaller mass of skeletal muscle in adult females, an increased rate of transfer from plasma to the urinary bladder content during pregnancy, and substantial transfer of cesium from blood plasma to the mammary glands during lactation.

Table C-1. Transfer coefficients (d^{-1}) for the adult male in the systemic biokinetic model for cesium

Path ^a		Transfer coefficients (d^{-1}) for reference adult male
From	To	
Plasma	Liver	1.9515E+01
Plasma	Kidneys	6.7108E+01
Plasma	Muscle	3.0022E+01
Plasma	Stomach Contents	4.7E+00
Plasma	SI Contents	1.7E+00
Plasma	ULI Contents	4.2E-01
Plasma	Red Marrow	5.298E+00
Plasma	Trab Bone Surf	8.83E-01
Plasma	Cort Bone Surf	8.83E-01
Plasma	Trab Bone Vol	8.83E-01
Plasma	Cort Bone Vol	8.83E-01
Plasma	RBC	1.8E+00
Plasma	Other 1	2.2495E+01
Plasma	Other 2	3.53E-03
Plasma	Other 3	7.8587E+01
Liver	Plasma	1.8539E+00
Liver	SI Contents	9.7575E-02
Kidneys	UB Contents	1.6E+00
Kidneys	Plasma	3.1876E+01
Muscle	Plasma	7.51E-02
Red Marrow	Plasma	7.06E-01
Trab Bone Surf	Plasma	1.28E-01
Cort Bone Surf	Plasma	1.28E-01
Trab Bone Vol	Plasma	1.28E-01
Cort Bone Vol	Plasma	1.28E-01
Other 1	Plasma	7.436E-01
Other 1	Sweat	2.45E-03
Other 2	Plasma	1.41E-03
Other 3	Plasma	6.1637E+00
RBC	Plasma	2.57E-01

^aSI = small intestine, ULI = upper large intestine, trab = trabecular, cort = cortical, surf = surface, vol = volume, RBC = red blood cells, UB = urinary bladder

Table C-2. Transfer coefficients (d^{-1}) for the reference young adult female, pregnant young adult female, and lactating young adult female in the systemic biokinetic model for cesium

Path ^a		Reference young	During	During
From	To	adult female	pregnancy	lactation
Plasma	Liver	2.04E+01	2.04E+01	2.04E+01
Plasma	Kidneys	7.01E+01	7.01E+01	7.01E+01
Plasma	Muscle	2.10E+01	2.10E+01	2.10E+01
Plasma	Stomach Contents	4.91E+00	4.91E+00	4.91E+00
Plasma	SI Contents	1.77E+00	1.77E+00	1.77E+00
Plasma	ULI Contents	4.38E-01	4.38E-01	4.38E-01
Plasma	Red Marrow	5.53E+00	5.53E+00	5.53E+00
Plasma	Trab Bone Surf	9.22E-01	9.22E-01	9.22E-01
Plasma	Cort Bone Surf	9.22E-01	9.22E-01	9.22E-01
Plasma	Trab Bone Vol	9.22E-01	9.22E-01	9.22E-01
Plasma	Cort Bone Vol	9.22E-01	9.22E-01	9.22E-01
Plasma	RBC	1.88E+00	1.88E+00	1.88E+00
Plasma	Other 1	2.35E+01	2.35E+01	2.35E+01
Plasma	Other 2	3.69E-03	3.69E-03	3.69E-03
Plasma	Other 3	8.20E+01	8.20E+01	8.20E+01
Liver	Plasma	1.85E+00	1.85E+00	1.85E+00
Liver	SI Contents	9.76E-02	9.76E-02	9.76E-02
Kidneys	UB Contents	1.60E+00	2.80E+00	1.60E+00
Kidneys	Plasma	3.19E+01	3.19E+01	3.19E+01
Muscle	Plasma	7.51E-02	7.51E-02	7.51E-02
Red Marrow	Plasma	7.06E-01	7.06E-01	7.06E-01
Trab Bone Surf	Plasma	1.28E-01	1.28E-01	1.28E-01
Cort Bone Surf	Plasma	1.28E-01	1.28E-01	1.28E-01
Trab Bone Vol	Plasma	1.28E-01	1.28E-01	1.28E-01
Cort Bone Vol	Plasma	1.28E-01	1.28E-01	1.28E-01
Other 1	Plasma	7.44E-01	7.44E-01	7.44E-01
Other 1	Sweat	2.45E-03	2.45E-03	2.45E-03
Other 2	Plasma	1.41E-03	1.41E-03	1.41E-03
Other 3	Plasma	6.16E+00	6.16E+00	6.16E+00
RBC	Plasma	2.57E-01	2.57E-01	2.57E-01

^aSI = small intestine, ULI = upper large intestine, trab = trabecular, cort = cortical, surf = surface, vol = volume, RBC = red blood cells, UB = urinary bladder

REFERENCES TO APPENDIX C

Leggett, R. W.; Williams, L. R.; Melo, D. R.; Lipsztein, J. L. (2003). A physiologically based biokinetic model for cesium in the human body. *Science of the Total Environment* 317:235-255.

NCRP (to appear). *Handbook for Managing Persons Contaminated with Radionuclides*. U.S. National Council on Radiation Protection and Measurements. Bethesda, MD.

APPENDIX D: BIOKINETIC MODEL FOR IRIDIUM IN THE ADULT HUMAN

The basis for the systemic model for iridium used in this report will be described in detail because the model has not been published in the open literature.

D.1. Summary of the database

In two workers who accidentally inhaled submicron-sized particles of ^{192}Ir metal, approximately 90% of the deposited activity was removed from the lungs during the first 33 h (Cool et al., 1979; Brodsky and Wald, 2004). From days 4 to 6 post exposure, the remaining lung burden decreased at ~6.6% per day for one subject and ~2.5% per day for the other. A biological removal half-time from the lungs to feces on the order of 1000 d was found for a small portion of the inhaled activity. Urine samples indicated little absorption of ^{192}Ir to blood.

A worker received a contaminated acid burn while mixing ^{192}Ir chloride in a nitric acid solution with toluene in an effort to label the toluene with ^{192}Ir (Kelsey and Mettler, 2001). The activity in the solution was ~740 MBq, up to 30% of which was from the contaminant ^{194}Ir . The mixture exploded, and some of the solution deposited on the worker's face and hair. Skin contamination was reduced by about a factor of five over the next few hours, to an estimated 7 MBq, by gentle cleaning with water. Urine samples taken at 2, 3.5, 6.5, 14, and 23 h after the accident showed 115, 425, 103, 27.4, and 8.5 Bq/ml, respectively. Integration of these values yields an estimated total urinary excretion of approximately 1.3×10^5 Bq during the first 24 h after the accident.

Casarett et al. (1960) studied the biokinetics of acutely inhaled metallic ^{192}Ir in rats. The count median diameter of the particles was 0.07 μm with a geometric standard deviation of about 1.5. Several rats were sacrificed immediately after exposure for determination of deposition in the respiratory tract, and pairs of rats were sacrificed at 3 h after exposure and at 1, 3, 6, 9, 13, and 14 d after exposure. Excretion was measured in some animals up to 28 d. Mean deposition in the respiratory tract was ~58% of the inhaled activity. More than 95% of the deposition was in the upper respiratory tract. The half-time of the initial phase of clearance was 2-4 h, and the half-time of a second phase was ~24 h. Activity was found in the liver in two rats immediately after exposure and in one rat at 3 h after exposure, amounting to about 0.2-0.6% of the deposited amount. In other rats, no significant activity was found in the liver or other tissues excluding skin except for spleen in two rats (0.14% at time zero and 0.02% at 3 d) and bone in two rats (0.55% at time zero and 0.14% at 3 h). In skin, small but measurable activities were found throughout the 28-day study. Urinary and fecal excretion accounted for <4% and >96% of the deposited amount, respectively, over 28 days. The urinary excretion rate averaged over 48-hour periods was on the order of 1%/day for 0-2 d, 0.1%/day for 10-12 d, and 0.01%/day for 26-28 d.

Durbin et al. (1957, 1960) described the results of tracer studies with ^{190}Ir or ^{192}Ir in rats. Kidney, liver, and spleen were the main deposition sites, and excretion was mainly in urine. After intravenous injection 36% was excreted in urine in the first 4 h. At 1 d the liver, kidneys, bone, blood, and muscle of rats contained 19.3%, 4%, 3.1%, 6.4%, and 5.6% and excretion accounted for 43.5% of the administered amount. By 33 d, 45% was excreted in urine and 35% in feces, and about 12% remained in liver, skin, and muscle. Furchner et al. (1971) studied the systemic behavior of ^{192}Ir in mice, rats, monkeys, and dogs after oral administration, intravenous injection, or intraperitoneal injection of $\text{Na}_2^{192}\text{IrCl}_6$. Cumulative urinary excretion during the first two days after oral intake averaged 0.86% of the administered amount in mice, 2.02% in *Myristomys* rats, 0.96% in Sprague-Dawley rats, 1.34% in monkeys, and 3.54% in dogs. These results indicate that average fractional uptake by the gastrointestinal tract was higher than the value 0.01 applied to iridium in current ICRP documents. Whole-body retention over several months following intravenous or intraperitoneal injection was similar in dogs, mice, *Myristomys* rats, and Sprague-Dawley rats (Figure D-1). Monkeys showed lower excretion rates initially than dogs, mice, or rats but a faster drop in the body burden than the other species at times remote from injection (Figure D-1). Whole-body retention in all species could be described in terms of three components with average biological half-times on the order of a few hours, a week, and several months (120-375 d). On average the rapid phase of loss represented about 20% (9-27%) of the administered amount, compared with mean excretion of 43.5% in rats receiving ^{190}Ir or ^{192}Ir chloride by intravenous injection as reported by Durbin (1960). The long-term component represented at least 46% of the administered amount in all species. As illustrated in Table D-1, whole-body retention curves based on the different animal species and different modes of injection give fairly similar cumulative activities in the body for iridium isotopes with a range of half-lives. The distribution of activity was determined in rats over the first 120 d after intraperitoneal injection. The retention times in individual organs roughly paralleled that in the whole body. Highest concentrations were found in spleen, kidneys, and liver, in that order. The concentration in bone was a factor of 2-3 lower than that of liver but higher than the average concentration in the body. The liver, kidneys, and bone contained roughly 15%, 5%, 1-2%, and 10% of total-body content, respectively, during the observation period. The authors concluded from comparison with injection data of Durbin et al. (1957) for rats that the rate of loss of iridium from the body depends on the chemical form reaching blood.

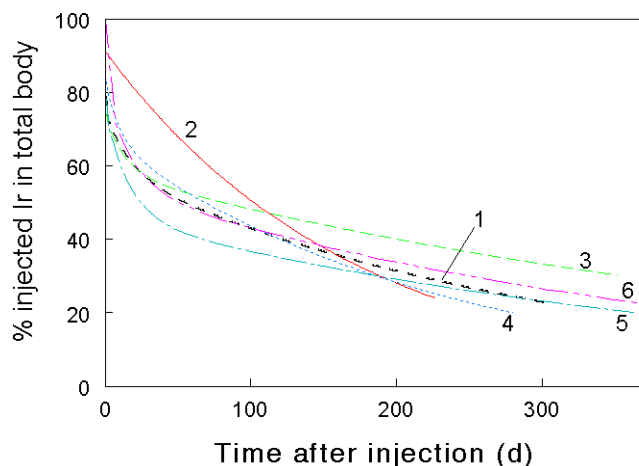

Figure D-1. Whole-body retention of ^{192}Ir in laboratory animals following intravenous (iv) or intraperitoneal (ip) injection of $\text{Na}_2^{192}\text{IrCl}_6$ (curve fits reported by Furchner et al. 1971). Curve 1 = dogs, iv injection, observation period 304 d; 2 = monkeys, iv, 227 d; 3 = mice, iv, 352 d; 4 = rats, iv, 280 d; 5 = mice, ip, 364 d; 6 = rats, ip, 371 d.

Table D-1. Cumulative activities of iridium isotopes in the whole body based on retention curves derived by Furchner et al. (1971). Values for a given isotope are normalized to the value for that isotope in dogs.

Isotope	Half-life	Dogs ^a	Monkeys ^a	Mice ^a	Rats ^a	Mice ^b	Rats ^b
Ir-190	11.78 d	1.0	1.3	1.0	1.1	0.8	1.0
Ir-192	73.827 d	1.0	1.2	1.1	1.0	0.7	1.0
Ir-192n	241 y	1.0	0.8	1.7	0.8	0.6	1.2
Ir-194	19.28 h	1.0	1.1	1.0	1.0	1.0	1.1
Ir194m	171 d	1.0	1.1	1.2	1.0	0.7	1.1

^aintravenous injection

^bintraperitoneal injection

Ando et al. (1989) determined the distribution of ^{192}Ir in rats at 3, 24, and 48 h after intravenous injection of $\text{H}_2^{192}\text{IrCl}_6$. Cumulative urinary excretion at 3 h represented 79.8% of injected ^{192}Ir . At all three observation times the highest concentration was found in the kidneys, followed by liver. In contrast to findings of Durbin et al. (1957) and Furchner et al. (1971), the concentration of iridium in the spleen was an order of magnitude lower than that of kidney and a factor of 3-4 lower than that of liver.

Hirunuma et al. (1997) studied uptake, retention, and excretion of 17 trace elements including iridium in Wistar rats over the first 6 d after oral intake of radioisotopes of these elements in a hydrochloric acid solution. Iridium was found in liver, kidney, and intestinal tissue, with the kidneys generally showing the highest concentration. Iridium was not detectable by the multi-tracer technique in brain, skeletal muscle, bone, spleen,

testes, or blood. On Day 3 the liver, kidneys, and intestines contained about 0.35%, 0.26%, and 0.13%, respectively, of the administered iridium. On Day 6 these three organs contained about 0.11%, 0.13%, and 0.04%, respectively, of the administered iridium. Over the 6-day study about 90% of the administered iridium was excreted in feces and 7.7% was excreted in urine, indicating that most of the absorbed iridium was excreted during the short study period.

D.2. Systemic model for iridium

Biokinetic data for iridium summarized above indicate that whole-body retention is not predictable on the basis of body size and does not vary greatly from one species to another. Three phases of excretion of absorbed or intravenously injected iridium are indicated: a rapid phase of loss, primarily in urine, with a half-time of a few hours; an intermediate phase of loss with a half-time on the order of 1-2 wk; and a slow phase of loss with a half-time of several months. The fraction of uptake associated with each of these phases is variable and depends on the form of iridium reaching blood. For example, the fraction associated with the rapid phase of loss in urine has varied from <0.1 to 0.8 or more. The rate of loss from individual tissues roughly parallels that in the whole body. Concentrations of iridium in the kidneys and liver are much higher than those in most other tissues. Elevated uptake of iridium by the spleen is indicated by some data, but findings are inconsistent. Data on rats indicate that the liver contains roughly 15-20% of the systemic content during the first few months after input to blood. Kidneys and bone have contained somewhat less than the liver in most studies.

The systemic model for iridium is constructed within the ICRP's generic model structure for bone-surface seeking elements (Figure D-2). Although iridium does not show heavy deposition in bone and its sites of retention in bone are not known, this is a convenient framework in which to describe the typical biokinetics of iridium as indicated by animal studies. The generic framework is modified slightly for application to iridium in that cortical and trabecular bone surface is each divided into two compartments representing relatively short-term and relatively long-term retention.

Parameter values for iridium are given in Table D-2. To produce a reasonably cautious model from the limited information on iridium, data of Furchner et al. (1971) for animals administered $\text{Na}_2^{192}\text{IrCl}_6$ by different modes were relied on heavily because the rate of loss from the body appears to be slower for this form than for other forms used in experimental studies. Whole-body retention data of Furchner et al. for dogs were used as a guide for model parameters because the dog is the largest animal studied and its whole-body retention was typical of the species addressed.

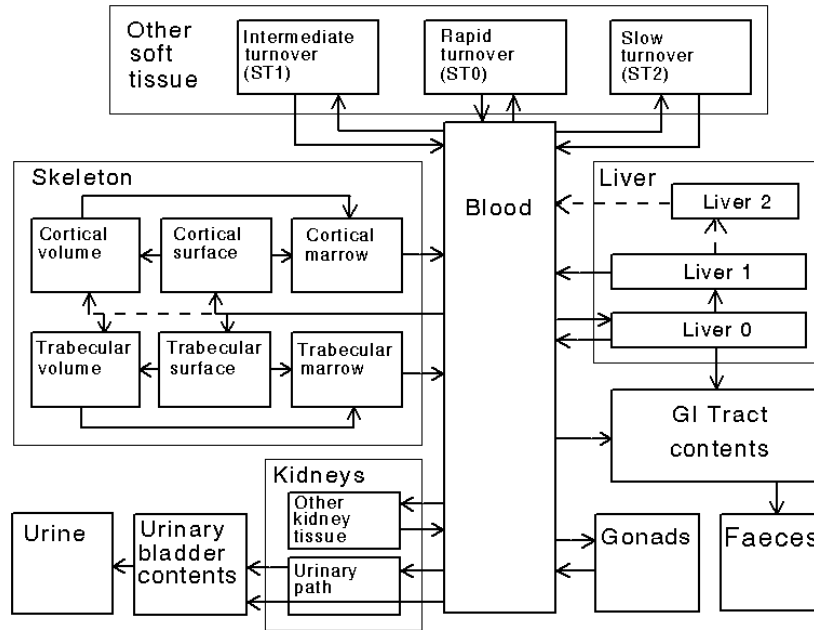

Figure D-2. Generic model structure for bone-surface-seeking radionuclides. Not all compartments were applied to iridium. Blood was divided into two compartments. Cortical surface and Trabecular surface were each divided into two compartments representing relatively fast and relatively slow removal from bone surface to blood.

In the model urinary excretion is assumed to arise from transfer of activity from blood into the urinary bladder contents and transfer from blood to the kidneys (Urinary path) and subsequent release to the urinary bladder contents over a period of days. Faecal excretion is assumed to arise in part from biliary secretion into Small intestine contents from a liver compartment (Liver 1) and in part from secretion from Blood 1 into Small intestine contents; these two sources are assumed to contribute equally to endogenous faecal excretion of ruthenium, in the absence of specific data on relative contributions of these sources.

Deposition fractions and removal half-times for compartments are set to reproduce different phases of loss of iridium from the total body observed in laboratory animals. The rapid phase of loss is represented by transfer from Blood 1 to Urinary bladder contents and Small intestine contents. The intermediate phase of loss is represented by a removal half-time of 5 d for part of the activity entering Liver and Kidneys and 10 d for part of the activity leaving Bone or Other (remaining tissues). Long-term losses are represented by a half-time of 100 d for half of the activity entering Liver, Kidneys, Bone, or Other. Because much of the activity lost from tissues reenters Blood 1 and much of that entering Blood 1 returns to tissues, net retention in the body is longer than these half-times might suggest.

Due to limited information on the behavior of iridium in blood, the rate of disappearance of iridium from blood is modeled on the basis of human data for the chemically related element ruthenium (Veronese et al., 2003). Blood is divided into two compartments

called Blood 1 and Blood 2. Iridium entering blood is assigned to Blood 1, which is a rapid-turnover pool. Blood 2 is a more slowly exchanging pool that contains the preponderance of activity in blood except for a short period soon after acute uptake of iridium. Activity leaves Blood 1 at the rate 50 d^{-1} , corresponding to a half-time of ~20 min, with 7% of outflow going to Blood 2 and the remaining 93% divided among tissue compartments, urinary bladder contents, and gastrointestinal contents. Activity moves from Blood 2 back to Blood 1 with a half-time of 1 d.

Table D-2. Transfer coefficients (d^{-1}) in the systemic biokinetic model for iridium in the adult.^a

Blood to Small intestine contents	3.0000E+00
Blood to Urinary bladder contents	8.0000E+00
Blood to Liver_0	7.5000E+00
Blood to Kidneys_1	2.0000E+00
Blood to Kidneys_2	1.0000E+00
Blood to Blood_1	3.5000E+00
Blood to Other_0	1.0000E+01
Blood to Other_1	1.0000E+01
Blood to Cortical bone surf	1.2500E+00
Blood to Trabecular bone surf	1.2500E+00
Blood to Cortical bone vol	1.2500E+00
Blood to Trabecular bone vol	1.2500E+00
Blood_1 to Blood	6.9315E-01
Liver_0 to Blood	4.1589E-02
Liver_0 to Small intestine contents	2.7726E-02
Liver_0 to Liver_1	6.9315E-02
Liver_1 to Blood	6.9315E-03
Kidneys_1 to Urinary bladder contents	1.3863E-01
Kidneys_2 to Blood	6.9315E-03
Other_0 to Blood	6.9315E-02
Other_1 to Blood	6.9315E-03
C_Bone-S to Blood	6.9315E-02
T_Bone-S to Blood	6.9315E-02
C_Bone-V to Blood	6.9315E-03
T_Bone-V to Blood	6.9315E-03
Blood to Breast ^b	1.1400E+00
Breast to Milk ^b	1.2000E+01

^asurf = surface, vol = volume, SI = small intestine, Kidneys_1 = Urinary path, Kidneys_2 = Other kidney tissue

^bBasis for transfer coefficient discussed in main text.

In addition to the 7% of outflow from Blood 1 assigned to Blood 2, outflow from Blood 1 is assumed to be distributed as follows: 15% to Liver, 6% to Kidneys, 10% to Bone, 16% to the Urinary bladder contents, 6% to Small intestine contents, and 40% to Other. Activity entering Liver is assigned to the rapid-turnover liver compartment called Liver 1. Two-thirds of the activity entering Kidneys (4% of outflow from Blood 1) is assigned to Urinary path and one-third (2%) to Other kidney tissue; thus, a total of 16% +

4% = 20% of activity leaving Blood 1 enters the urinary excretion pathways. Activity depositing in Bone is assigned to Bone Surface and is divided equally among four compartments, called Cortical surface 1, Cortical surface 2, Trabecular surface 1, and Trabecular surface 2. Activity entering Other is divided equally between compartments called ST0 and ST1 representing relatively fast turnover and relatively slow turnover, respectively.

Activity transfers from Liver 1 with a half-time of 5 d, with 20% going to the Small intestine contents (biliary secretion), 50% to Liver 2, and 30% to Blood 1. Activity transfers from Liver 2 to Blood 1 with a half-time of 100 d. Activity transfers from Urinary path to Urinary bladder contents with a half-time of 5 d and from Other kidney tissues to Blood 1 with a half-time of 100 d. Activity in soft-tissue compartments ST0 and ST1 returns to Blood 1 with half-times of 10 d and 100 d, respectively. Activity transfers from the bone compartments Cortical surface 1, Trabecular surface 1, Cortical surface 2, and Trabecular surface 2 with half-times of 10 d, 10 d, 100 d, and 100 d, respectively.

As illustrated in Figure D-3, the model closely reproduces whole-body retention of iridium as determined in dogs after intravenous injection with ^{192}Ir (Furchner et al., 1971).

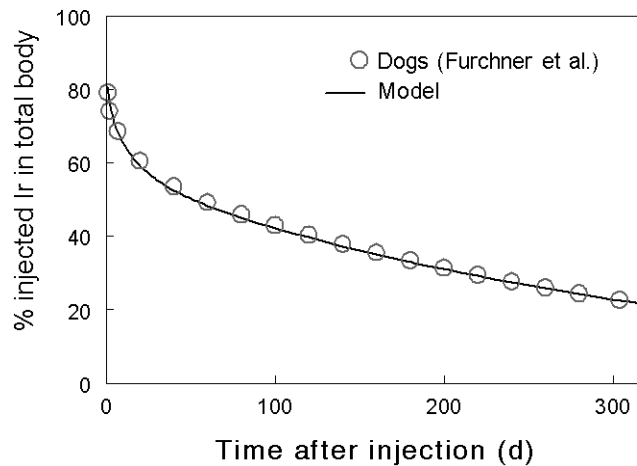

Figure D-3. Comparison of model predictions of whole-body retention of iridium with observations for dogs. Data points derived from whole-body retention curve reported by Furchner et al. (1971) for dogs intravenously injected with $\text{Na}_2^{192}\text{IrCl}_6$.

REFERENCES TO APPENDIX D

Ando, A.; Ando, I.; Hiraki, T.; Hisada, K. (1989). Relation between the location of elements in the periodic table and various organ-uptake rates. *Nucl. Med. Biol.* 16: 57-69.

Brodsky, A.; Wald, N. (2004). Experiences with early emergency response and rules of thumb. In: Brodsky, A.; Johnson, R.H., Jr., Goans, R. E., editors. *Public protection from nuclear, chemical, and biological terrorism. Health Physics Society 2004 Summer School. Madison, Wisconsin: Medical Physics Publishing; 2004; Chapter 20, pp. 335-371.*

Casarett, L. J.; Bless, S.; Katz, R.; Scott, J. K. (1960). Retention and fate of iridium-192 in rats following inhalation. *J. Amer. Ind. Hyg. Assoc.* 21:414-418.

Cool, D. A.; Cool, W. S.; Brodsky, A.; Eadie, G. G. (1979). Estimation of long-term biological elimination of insoluble ^{192}Ir from the human lung. *Health Phys.* 36:629-632.

Durbin, P. W. (1960). Metabolic characteristics within a chemical family. *Health Phys.* 2:225-238.

Durbin, P. W.; Scott, K. G.; Hamilton, J. G. (1957). Distribution of radioisotopes of some heavy metals in the rat. *University of California (Berkeley) Publ. Pharmacol.* 3:1-34.

Furchner, J. E.; Richmond, C. R.; Drake, G. A. (1971). Comparative metabolism of radionuclides in mammals—V. Retention of ^{192}Ir in the mouse, rat, monkey and dog. *Health Phys.* 20:375-382.

Hirunuma, R.; Endo, K.; Yanaga, M.; Enomoto, S.; Ambe, S.; Tanaka, A.; Tozawa, M.; Ambe, F. (1997). The use of a multitracer technique for the studies of the uptake and retention of trace elements in rats. *Appl. Radiat. Isot.* 48:727-733.

ICRP (1980). International Commission on Radiological Protection. Limits for intakes by workers. ICRP Publication 30, Part 2(Pergamon Press, Oxford).

Kelsey, C. A.; Mettler, Jr., F. A. (2001). Iridium-192 acid skin burn in Albuquerque, New Mexico, U.S.A. Chapter 29 in: Gusev, I. A.; Guskova, A. K.; Mettler, Jr., F. A., *Medical management of radiation accidents, 2nd edition; New York: CRC Press; 2001; pp. 421-423.*

Veronese, I.; Cantone, M. C.; Giussani, A.; Maggioni, T.; Birattari, C.; Bonardi, M.; Groppi, F.; Garlaschelli, L.; Werner, E.; Roth, P.; Hoellriegl, V.; Louvat, P.; Felgenhauer, N.; Zilker, Th. (2003). Stable tracer investigations in humans for assessing the biokinetics of ruthenium and zirconium radionuclides. *Rad. Prot. Dosim.* 105: 209–212.

APPENDIX E: BIOKINETIC MODEL FOR PLUTONIUM IN THE ADULT HUMAN

The systemic biokinetic model for plutonium applied in this report to the mother is an update of the ICRP's current model (ICRP, 1993) for plutonium in adults. The basis for the updated model is described in a publication by Leggett et al. (2005). The model structure and parameter values are given below. The updated model has been adopted by a task group of the ICRP for use in upcoming documents on occupational intake of radionuclides.

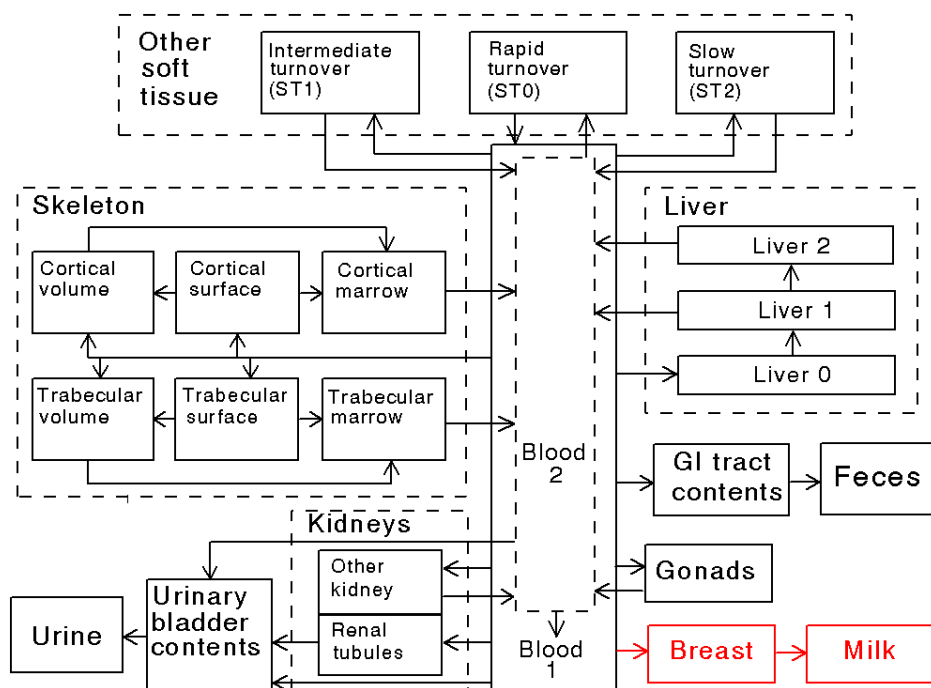

Figure E-1. Structure of the systemic model for Pu used in this report (Leggett, 2003; Leggett et al., 2005). The compartments representing breast and milk are not part of the original model but were included for use in this project.

Table E-1. Transfer coefficients (d^{-1}) in the systemic biokinetic model for plutonium in the adult. Initial input to blood through absorption or injection is assumed to distribute rapidly between Blood 1 (70%) and ST0 (30%).

Source	Destination	Transfer coefficient (d^{-1})
Blood 1	Liver 0	4.6200×10^{-1}
Blood 1	Cortical surface	8.7780×10^{-2}
Blood 1	Cortical volume	4.6200×10^{-3}
Blood 1	Trabecular surface	1.2474×10^{-1}
Blood 1	Trabecular volume	1.3860×10^{-2}
Blood 1	Urinary bladder contents	1.5400×10^{-2}
Blood 1	Renal tubules	7.7000×10^{-3}
Blood 1	Other kidney	3.8500×10^{-4}
Blood 1	Upper large intestine contents	1.1550×10^{-2}
Blood 1	Testes	2.6950×10^{-4}
Blood 1	Ovaries	0.8470×10^{-4}
Blood 1	ST1	1.8511×10^{-2}
Blood 1	ST2	2.3100×10^{-2}
ST0	Blood 1	9.9000×10^{-2}
Blood 2	Urinary bladder contents	3.5000×10^0
Blood 2	Blood 1	6.7550×10^1
Blood 2	ST0	2.8950×10^1
Renal tubules	Urinary bladder contents	1.7329×10^{-2}
Other kidney	Blood 2	1.2660×10^{-4}
ST1	Blood 2	1.3860×10^{-3}
ST2	Blood 2	1.2660×10^{-4}
Liver 0	Small intestine contents	9.2420×10^{-4}
Liver 0	Liver 1	4.5286×10^{-2}
Liver 1	Blood 2	1.5200×10^{-3}
Liver 1	Liver 2	3.8000×10^{-4}
Liver 2	Blood 2	1.2660×10^{-4}
Testes	Blood 2	3.8000×10^{-4}
Ovaries	Blood 2	3.8000×10^{-4}
Cortical surface	Cortical marrow	8.2100×10^{-5}
Cortical surface	Cortical volume	2.0500×10^{-5}
Cortical volume	Cortical marrow	8.2100×10^{-5}
Trabecular surface	Trabecular marrow	4.9300×10^{-4}
Trabecular surface	Trabecular volume	1.2300×10^{-4}
Trabecular volume	Trabecular marrow	4.9300×10^{-4}
Cortical marrow	Blood 2	7.6000×10^{-3}
Trabecular marrow	Blood 2	7.6000×10^{-3}
Blood 1 ^a	Breast	3.6000×10^{-2}
Breast ^a	Milk	1.2000×10^1

^aBasis for transfer coefficient discussed in main text.

REFERENCES TO APPENDIX E

ICRP (1993). International Commission on Radiological Protection. Age-dependent doses to members of the public from intake of radionuclides: Part 2. ICRP Publication 67. Oxford: Pergamon Press.

Leggett, R. W., Eckerman, K. F., Khokhryakov, V. F., Suslova, K. G., Krahenbuhl, M. P. and Miller, S. C. (2005). Mayak worker study: An improved biokinetic model for reconstructing doses from internally deposited plutonium. *Radiat. Res.* 164:111-122.

**APPENDIX F: BIOKINETIC MODEL FOR
AMERICIUM IN THE ADULT HUMAN**

The systemic biokinetic model for americium applied in this report to the mother is the ICRP's current model for americium in adults (ICRP, 1993). The basis for the model is described in a paper by Leggett (1992) and in ICRP Publication 67 (1993). The model structure is the ICRP's generic structure for bone-surface-seeking radionuclides, shown in Figure 3 of the main text. Parameter values are given in Table F-1.

Table F-1. Transfer coefficients (d^{-1}) in the systemic biokinetic model for americium in the adult.

Source	Destination	Transfer coefficient (d^{-1})
Blood	Liver 1	11.645
Blood	ST0	10.0
Blood	ST1	1.67
Blood	ST2	0.466
Blood	Cortical surfaces	3.49
Blood	Trabecular surfaces	3.49
Blood	Kidneys 1	0.466
Blood	ULI Content	0.303
Blood	Kidneys 2	0.116
Blood	Testes	0.0082
Blood	Ovaries	0.0026
Blood	Urinary bladder contents	1.63
Liver 1	Blood	0.00185
Liver 0	SI Content	0.000049
ST0	Blood	1.386
ST1	Blood	0.0139
ST2	Blood	0.000019
Cortical marrow	Blood	0.00760
Cortical surface	Cortical marrow	0.0000821
Cortical surface	Cortical volume	0.0000411
Cortical volume	Cortical marrow	0.0000821
Red marrow	Blood	0.00760
Trabecular surfaces	Red marrow	0.000493
Trabecular surface	Trabecular volume	0.000247
Trabecular volume	Red marrow	0.000493
Kidneys 1	Urinary bladder contents	0.099
Kidneys 2	Blood	0.00139
Testes	Blood	0.00019
Ovaries	Blood	0.00019
Blood ^a	Breast	0.99
Breast ^a	Milk	12.0

^aTransfer to breast and milk not addressed in ICRP Publication 67. Basis for these two transfer coefficient discussed in main text of this report.

REFERENCES TO APPENDIX F

ICRP (1993). International Commission on Radiological Protection. Age-dependent doses to members of the public from intake of radionuclides: Part 2. ICRP Publication 67 (Pergamon Press, Oxford).

Leggett, R. W. (1992). A retention-excretion model for americium in humans, Health Physics 62:288-310; 1992.

APPENDIX G: BIOKINETIC MODEL FOR CALIFORNIUM IN THE ADULT HUMAN

A paper describing the basis for the model for californium used in this report was published in an issue of a journal dedicated to the proceedings of a topical symposium (Leggett, 2001). Because the journal has limited circulation, the basis for the model is discussed in this appendix.

G.1. Summary of the database

G.1.1. Fate of inhaled californium

A case of accidental inhalation of a mixture of ^{249}Cf and its parent, ^{249}Bk , by a chemist was studied by external measurements and excretion analysis over the first year after intake (Rundo and Sedlet, 1973). The inhaled material was ignited before intake and was presumably highly insoluble. Except for an initially rapid clearance via feces, the urinary and fecal excretion rate of both radionuclides increased with time for 2-3 months after intake and then declined. This pattern differs from the monotonically decreasing rates of transfer from lungs to blood and excretion in urine and feces depicted in models of the ICRP(1994a, 2002).

In another case, a chemist and an analyst inhaled airborne ^{252}Cf while attempting to reprocess a medical source (Poda and Hall, 1975). Approximately $1\ \mu\text{g}\ ^{252}\text{Cf}_2\text{O}_3$ was released when the end plug of the inner capsule was sheared during the removal of the outer capsule. Both persons left the work area when an alpha air monitor sounded shortly after the accident. An initial survey indicated contamination in the nostrils and on the clothing of the analyst (Subject 1), but no contamination was detected on the chemist (Subject 2). Both persons were treated with chelates. A rapid renal excretion of Cf was observed for the first 24-hour period in each subject but may have been strongly affected by DTPA treatment. Total urinary excretion of ^{252}Cf during the first month by the chemist was 1-2 orders of magnitude lower than that for the analyst. Urinary excretion patterns for the two subjects are shown in Figure G-1, where excretion has been normalized to the percentage of the first day's excretion for the respective individual.

G.1.2. Uptake from the gastrointestinal tract

Gastrointestinal absorption of californium has been measured in rats administered $^{252}\text{Cf}(\text{NO}_3)_3$ intragastrically (ICRP, 1979). Absorption is in the range 0.01-0.1%, depending on the method of estimation. The ICRP assumes absorption of 0.05% of ingested californium in an adult, which is consistent with values determined for plutonium, americium, and curium in human subjects as well as with the limited animal data for californium (ICRP, 1993, 1994b).

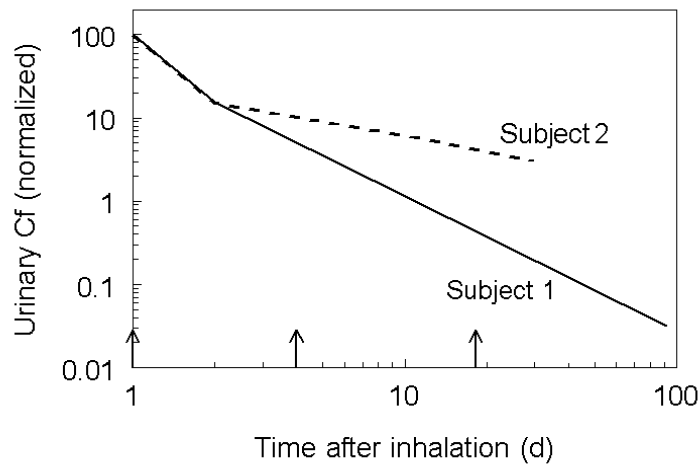

Figure G-1. Observed patterns of urinary excretion of ^{252}Cf following acute inhalation. DTPA administered on Days 1, 4, and 18 (arrows). Data normalized to individual's Day 1 excretion (percent).

G.1.3. Systemic biokinetics

The ICRP's current systemic biokinetic model for californium was introduced in ICRP Publication 30 (1979) and extended to a bioassay model in Publication 68 (1994). The model does not have a physiologically meaningful structure but depicts one-directional movement of activity from blood to tissues to excretion pathways. It is assumed that californium leaves blood with a half-time of 0.25 d, with 65% depositing in the skeleton, 25% in the liver, 0.011% in ovaries, and 0.035% in testes. The rest (9.954%) is promptly excreted. The removal half-time is 50 y for skeleton, 30 y for liver, and infinite for gonads. Activity lost by prompt excretion or through biological removal from tissues is equally divided between the urinary bladder contents for removal in urine and the upper large intestine contents for removal in feces.

Biokinetic studies of californium in laboratory animals indicate that its behavior is qualitatively similar to that of other transuranium elements. Among the frequently studied transuranics, americium appears to be its closest physiological analogue. The microscopic distribution of californium in soft tissues of beagles 1-3 wk after intravenous injection of a citrate solution was found to be similar to that of americium (Taylor et al., 1972). The gross distribution of californium in the skeleton, expressed as the percentage of skeletal californium in a given bone, is similar to that of americium (Lloyd et al., 1972). The microscopic distribution of californium in the skeleton is also similar to that of americium in rats, with heaviest deposits on the trabeculae of the primary spongiosa and on epiphyseal and metaphyseal trabeculae (Durbin 1973).

The biokinetics of californium has been studied in mice, rats, Chinese and Syrian hamsters, and beagles (Parker et al., 1962; Mewhinney et al., 1971, 1972; Lloyd et al.,

1972, 1976; Smith, 1972; Atherton and Lloyd, 1972; Bruenger et al., 1972; Stevens and Bruenger, 1972; Taylor et al., 1972; Durbin, 1973; Graham et al., 1978). Species differences have been observed. For example, Mewhinney et al. (1972) found significant differences in the behavior of ^{252}Cf in rats and Chinese hamsters over 64 d following intraperitoneal injection of the citrate complex, including lower uptake of activity by the liver and kidneys and higher uptake by the skeleton in rats and much faster removal from the liver in rats (Table G-1). The behavior of californium in beagles receiving ^{249}Cf or ^{252}Cf by intravenous injection (Lloyd et al., 1972) was broadly similar to that in the hamster with regard to uptake and retention in major repositories. The fecal to urinary excretion ratio was much higher in rats than in dogs, probably due to a higher rate of biliary secretion of californium.

Table G-1. Species differences in the early distribution of ^{252}Cf injected as citrate (Mewhinney et al., 1972; Lloyd et al., 1972; Durbin, 1973).

Tissue or excreta	% injected activity at 7-8 d		
	Hamster	Rat	Dog
Kidney	2.9	1.2	0.9
Liver	25.6	3.5	19.2
Skeleton	25.3	65.7	44.1
Whole body	66.3	69.3	78.3
Urine	--	7.8	15.1
Feces	--	11.0	6.9

Measurements on rats and mice indicate a biological half-time for the whole body on the order of 2 y (400-1000 d). This reflects primarily skeletal retention on these animals because the removal half-time from the liver is short and other soft tissues do not retain much californium. In dogs or hamsters, whole-body retention of californium reflects tenacious retention of in both the liver and skeleton. For the beagle, half-times of 8.5 y and 4.2 y have been estimated for the whole body and liver, respectively.

Observed species differences in the retention time of californium in the liver is consistent with a pattern seen for other transuranic elements. That is, certain mammalian species show rapid removal of transuranics from the liver, while others show extremely slow removal. For example, rats, tree shrews, macaque monkeys, and baboons show rapid loss of plutonium from the liver, with half-times of 4-200 d, while another set of adult animals with an overlapping range of body weights, including hamsters, dogs, pigs, and humans, show tenacious retention of plutonium in the liver, with half-times measured in years or decades (Taylor, 1984).

In the skeleton, californium appears to be deposited most heavily about the trabeculae of the primary spongiosa and on epiphyseal and metaphyseal trabeculae. In soft tissues of dogs, relatively high concentrations are found in the hepatic cells of the liver, the glomeruli of the kidney, the interfollicular region of the thyroid, the cartilaginous tissues of the lung, and in the smaller arterioles of most organs. Intense but scattered "hot spots"

were found in the renal papillae and the submucosa of the bronchioles. Except for deposition in hepatic cells, most of the deposition sites in soft tissues were extracellular, associated with connective tissue.

The beagle is expected to be a reasonable laboratory model for the biokinetics of californium in humans due to qualitative similarities in the biokinetics of other transuranics (plutonium, americium, and curium) in dogs and humans, particularly for the liver and skeleton. In extrapolating biokinetic data for californium from beagles to humans, species differences in rates of apparently pertinent physiological processes must be taken into account. For example, the residence time of californium in bone may be substantially greater in adult humans than in adult beagles due to a slower rate of bone turnover in humans.

There is no direct information on the variability of dose in the population from exposure to ^{252}Cf . On the basis of animal data for transuranium elements, it is expected that gastrointestinal absorption of ^{252}Cf would be elevated in infants, and that the deposition ratio skeleton:liver would be greater during growth than after maturity.

G.2. Systemic biokinetic model for californium

The ICRP's current systemic biokinetic model for californium was introduced in ICRP Publication 30 (1979) and extended to a bioassay model in Publication 68 (1994b). The model does not have a physiologically meaningful structure but depicts one-directional movement of activity from blood to tissues to excretion pathways. It is assumed that californium leaves blood with a half-time of 0.25 d, with 65% depositing in the skeleton, 25% in the liver, 0.011% in ovaries, and 0.035% in testes. The rest (9.954%) is promptly excreted. The removal half-time is 50 y for skeleton, 30 y for liver, and infinite for gonads. Activity lost by prompt excretion or through biological removal from tissues is equally divided between the urinary bladder contents for removal in urine and the upper large intestine contents for removal in feces.

The ICRP's model described above is not physiologically meaningful and does not fully reflect available information on the biokinetics of californium. A more detailed model based on current data for californium has been proposed (Leggett, 2001). The ICRP's generic model for bone-surface-seeking radionuclides is applied (see Figure 3 of main text). Parameter values are based on the relatively detailed information on californium biokinetics in laboratory animals, particularly dogs, and the comparative biological behavior of californium and americium. The rationale is that there is relatively good information on the behavior of americium in human subjects and comparative data on americium and californium in animals. It seems reasonable to use the ICRP's model for americium as a starting point for modeling the biokinetics of californium and adjust the parameter values for americium as indicated by comparative data on americium and californium in beagles.

The following adjustments to the ICRP's systemic biokinetic model for americium were made (Leggett, 2001): the removal half-time from blood is 1 h, compared with 30 min for americium; deposition in liver plus skeleton is 70% (i.e., 70% of activity leaving the circulation), compared with 80% for americium; the division between liver and skeleton is 20%-50%, compared with 50%-30% for americium; deposition in urinary bladder contents is 11%, compared with 7% for americium; deposition in the contents of the GI tract is 6%, compared with 1.3% for americium; deposition in the urinary path (Kidneys 1) is 2% and in other kidney tissues (Kidneys 2) is 1%, compared with 2% and 0.5%, respectively, for americium; the removal half-time from Kidneys 2 to blood is 5 y, compared with 500 d for americium; the removal half-time from the intermediate-term soft-tissue compartment to blood is 100 d, compared with 50 d for americium. Otherwise, the biokinetics of californium is assumed to be the same as that of americium.

The proposed model for californium was applied to estimate the rate of urinary excretion of californium and dose per unit intake of californium isotopes. Predicted urinary excretion rates following introduction of californium to blood are compared in Figure G-2 with predictions of the current ICRP model. Predictions of the ICRP model are 1-2 orders of magnitude lower than those of the proposed model from a few days to a few weeks after uptake of californium to blood.

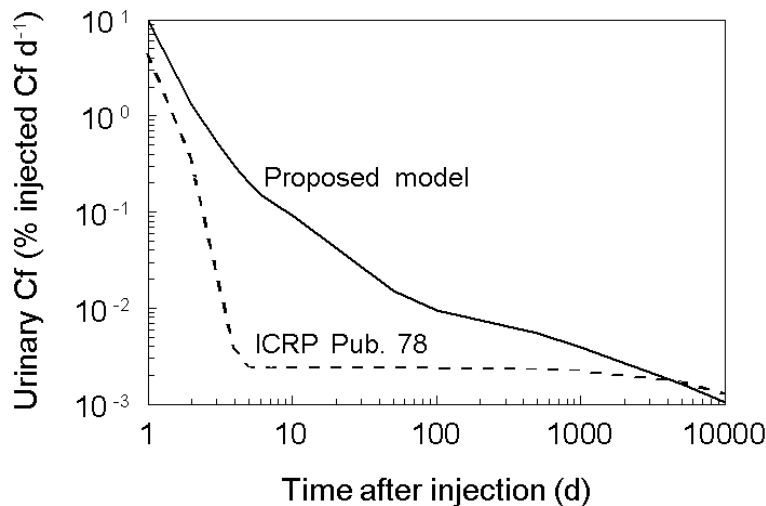

Figure G-2. Comparison of predictions of urinary californium based on the systemic biokinetic model for californium given in ICRP Publication 68 (1994b) and Publication 78 (1997) and a proposed model (Leggett, 2001), assuming intravenous injection of californium at time zero.

REFERENCES TO APPENDIX G

- Atherton, D. R.; Lloyd, R. D. (1972). The distribution and retention of ^{249}Cf in beagle soft tissue. *Health Phys.* 22:675-677.
- Bruenger, F. W.; Atherton, D. R.; Stevens, W. (1972). Intracellular distribution of ^{249}Cf in canine liver. *Health Phys.* 22:685-689.
- Durbin, P. W. (1973). Metabolism and Biological Effects of the Transuranium Elements. In: Uranium, Plutonium and Transplutonic Elements. Eds. H. C. Hodge, J. N. Stannard and J. B. Hursh. *Handbook of Experimental Pharmacology.* (Berlin, Springer-Verlag), 739-896.
- Graham, B. W.; Ziemer, P. L.; Landolt, R. R.; Shaw, S. M. (1978). The metabolism of $^{252}\text{CfCl}_3$ in the rat and the effect of in vivo DTPA chelation therapy. *Health Phys.* 34:635-641.
- ICRP (1979). International Commission on Radiological Protection. Limits for intakes by workers. ICRP Publication 30, Part 1. Oxford: Pergamon Press.
- ICRP (1993). International Commission on Radiological Protection. Age-dependent doses to members of the public from intake of radionuclides: Part 2. ICRP Publication 67 (Pergamon Press, Oxford).
- ICRP (1994a). International Commission on Radiological Protection. Human respiratory tract model for radiological protection, ICRP Publication 66 (Pergamon Press, Oxford).
- ICRP (1994b). International Commission on Radiological Protection (ICRP). Dose coefficients for intakes of radionuclides by workers. ICRP Publication 68. (Pergamon Press, Oxford).
- ICRP (2002). International Commission on Radiological Protection. Supporting guidance 3. Guide for the practical application of the ICRP Human Respiratory Tract Model (Pergamon Press, Oxford).
- Leggett, R. W.; Eckerman, K. F.; Williams, L. R. (1993). An elementary method for implementing complex biokinetic models. *Health Phys.* 64: 260-278.
- Leggett, R. W. (2001). Consistent biokinetic models for the actinide elements. *Rad. Prot. Env.* 24:616-622.
- Lloyd, R. D.; Mays, C. W.; McFarland, S. S.; Atherton, D.R.; Williams, J. L. (1976). Californium studies in beagles. *Radiat. Res.* 65:462-473.

Lloyd, R. D.; Mays, C. W.; Taylor, G. N.; Williams, J. L. (1972). Californium excretion and retention by beagles injected with ^{249}Cf or ^{252}Cf . *Health Phys.* 22:667-673.

Mewhinney, J. A.; Brooks, A. L.; McClellan, R. O. (1972). Comparison of the retention and distribution of injected ^{252}Cf in rats and chinese hamsters. *Health Phys.* 22:695-700.

Mewhinney, J. A.; Ziemer, P. L.; Landolt, R. R. (1971). Retention and distribution of injected californium-252 in the rat. *Health Phys.* 21:860-862.

Parker, H. G.; de Low-Beer, A.; Isaac, E. L. (1962). Comparison of retention and organ distribution of Am-241 and Cf-252 in mice: The effect of in vivo DTPA chelation. *Health Phys.* 8:679-684.

Poda, G. A.; Hall, R. M. (1975). Two californium-252 inhalation cases. *Health Phys.* 29:407-409.

Rundo, J.; Sedlet, J. (1973). Retention and elimination of berkelium-249-californium-249 following acute accidental inhalation. In: Proceedings of the 3rd International Congress of the International Radiation Protection Association. Washington, D.C. September 9-14, 1973. IRPA CONF-730907-P1.

Smith, V. H. (1972). Therapeutic removal of internally deposited transuranium elements. *Health Phys.* 22:765-778.

Stevens, W.; Bruenger, F. W. (1972). Interaction of ^{249}Cf and ^{252}Cf with constituents of dog and human blood. *Health Phys.* 22:679-683.

Taylor, D. M. (1984). The Retention of Plutonium and Americium in Liver: An Interspecies Comparison. In: Radiation - Risk - Protection, Compacts Volume I, ed. by A. Kaul, R. Neider, J. Pensko, F.-E. Stieve, H. Brunner. 6th International Congress Organized by the Fachverband für Strahlenschutz e.v. Berlin (West) May 7-12, 1984, IRPA, 431-434.

Taylor, G. N.; Jee, W. S. S.; Mays, C. W.; Dell, R. B.; Williams, J. L.; Shabetari, L. (1972). Microscopic distribution of californium-249 and berkelium-249 in the soft tissues of beagles. *Health Phys.* 22:691-693.