

BEAM DIAGNOSTIC BY OUTSIDE BEAM CHAMBER FIELDS*

A. Novokhatski[#], S. Heifets, SLAC National Accelerator Laboratory, Stanford University, Menlo Park, California, 94025, U.S.A.

A. Aleksandrov, Oak Ridge National Laboratory, Spallation Neutron Source, Oak Ridge, Tennessee, 37830. U.S.A.

Abstract

Fields induced by a beam and penetrated outside the beam pipe can be used for a beam diagnostic. Wires placed in longitudinal slots in the outside wall of the beam pipe can work as a beam pickup. This has very small beam-coupling impedance and avoids complications of having a feed-through. The signal can be reasonably high at low frequencies. We calculate the beam-coupling impedance due to a long longitudinal slot in the resistive wall and the signal induced in a wire placed in such a slot and shielded by a thin screen from the beam. We present a field waveform at the outer side of a beam pipe, obtained as a result of calculations and measurements. Such kind of diagnostic can be used in storage rings, synchrotron light sources, and free electron lasers, like LINAC coherent light source.

FIELDS OUTSIDE THE BEAM PIPE

Computation

The electro-magnetic (EM) field induced by a beam outside of a thin beam pipe may be quite noticeable. The analytical solution for electromagnetic fields in a round beam pipe in the frequency domain can be found elsewhere [1]. The field waveform can be determined by numerically solving the wave equations in the time domain [2]. As a numerical example, Fig. 1 shows the time profile of the field induced by a bunch on the inner side (pancake thin red line) and on the outer side (blue line) of a stainless steel tube.

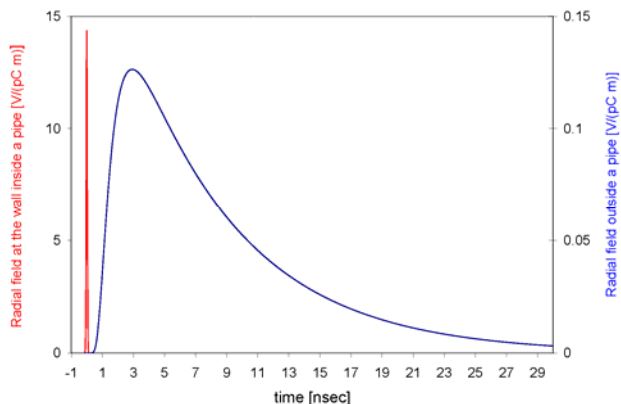

Figure 1: The radial component of the E-field on the inner

*Work supported by DoE contracts: DE--AC03--76SF00515 and DE-AC05-96OR22464

[#]novo@slac.stanford.edu

(red line) and outer (blue line) sides of a beam pipe. Scales for the fields are on the left and right plot side. The bunch length is 10 mm, the tube radius is 5 mm, and the wall thickness is 0.1 mm. One can see that the field amplitude outside of the pipe decreases by only a factor of 100.

Another example is given in Fig. 2 for an aluminium chamber with a radius of 2.5 mm and with a tube thickness of 0.5 mm (parameters of the LCLS [3], round chamber). The signal outside of the pipe in this case may reach amplitude of 35 V/m for a 1 nC bunch.

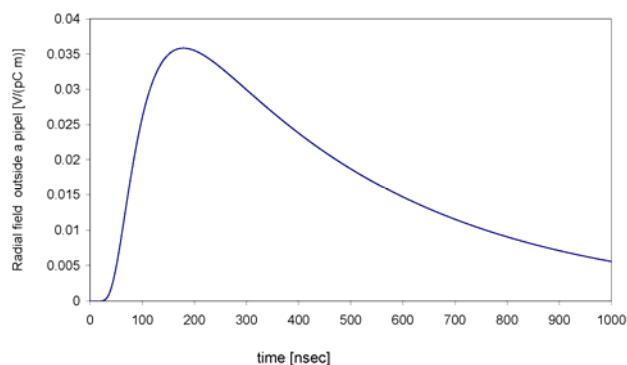

Figure 2: Field outside of the Al 0.5 mm round beam pipe.

In both examples, the main contribution to the signal is given by the low frequencies modes, which can penetrate through the wall. Such frequencies for short bunches are much lower than the width of the bunch spectrum. Therefore, the signal is practically independent on the bunch length what simplifies the design of the measuring electronics. Another common feature of both results is the time delay between the signals on the inner and outer sides defined by the diffusion time of the magnetic field through the wall (about 3 ns in Fig. 1 and 200 ns in Fig. 2.)

Measurements

The field outside of the beam pipe can be detected and used to build a beam position monitor (BPM) without any feed-through thereby preserving the smooth beam pipe wall seen by the beam. An idea of a BPM based on the detection of the electro-magnetic fields behind a thin foil was suggested long ago [4]. Based on this approach, a low impedance BPM was proposed and tested by one of the authors (A.A.) for the VEPP-5 collider, a B-factory

project planned to be built in Novosibirsk [5]. To prove the feasibility of the approach an experimental model was built. Schematic view of the experimental set-up is shown in Fig. 3.

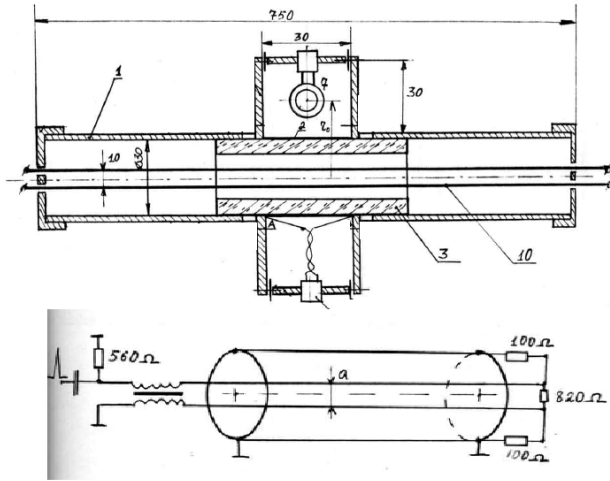

Figure 3: Schematic view of the experimental set-up and electrical diagram of the transmission line. 1- aluminium pipe, 2 – 50 micron stainless steel foil, 3 - Plexiglas foil support, 7 - measuring coil, 10 – two-wire transmission line.

The experimental signal measured outside of the beam pipe with the 15 mm inner radius [5] is shown in Fig. 4. At that time, the full solution for electro-magnetic fields was not obtained but simple estimates were used to derive the signal amplitude and duration. Dipole mode of the beam electro-magnetic field was simulated by a short pulse propagating in a two-wire transmission line. The transmission line was inserted into an aluminium pipe with central part of the pipe replaced with a 50-micron thick stainless steel foil. Magnetic field penetrating through the foil was measured using 12 turns coil with 2×2 cm cross-section. Oscilloscope snapshot of the current pulse in the transmission line and the signal measured by the coil are shown in Fig. 4 (a) and (b), respectively. Measured signal amplitude and duration were in good agreement with expected values

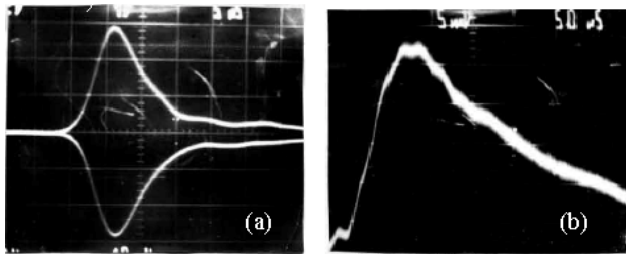

Figure 4: a) Left pane: the signal from the transmission line terminating resistors, 5 ns/div horizontal scale, and 20V/div vertical scale. (b) Right pane: the signal from the measuring coil, 50 ns/div horizontal scale, and 20 mV/div vertical scales.

Such kind of a BPM may be used in free-electron lasers like LCLS where the wall thickness can be as small

as 0.5 mm [3]. In general, a BPM can be made as a loop of wire set into a thin longitudinal groove (or several grooves) in the outer side of the beam-pipe wall, as shown in Fig. 5.

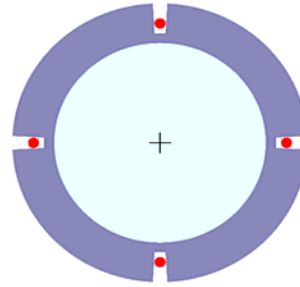

Figure 5: Sketch of the BPM design. Red circles show longitudinal wires located in the grooves.

ELECTROMAGNETIC FIELDS IN A BEAM PIPE WITH A SLOT

Let us consider the case when a particle is moving in a round resistive beam pipe along the z -axes with the offset r_0 . The radius of a beam pipe is a . The thickness of the resistive material (with conductivity σ) between inner part of a pipe and a thin slot is Δ , so radial position of a slot is $r + \Delta$. Angular slot width is α . For a round beam pipe the only direction breaking azimuthal symmetry is the direction to the slot. We assume below that $\varphi = 0$ corresponds to this direction and refer to the plane of a slot as the horizontal plane. Assuming dependence on time in the form $e^{i\omega t}$ we represent the field as a set of azimuthal harmonics. One can notice that, for a beam pipe with a slot, there are azimuthal harmonics with $m > 0$ even for a beam with a zero offset. Such harmonics have the same magnitude at all symmetrically placed slots and we are not interested in such harmonics if the goal is to build a beam position monitor detecting the difference of the signals on the opposite wires. The signal in this case is given by the harmonics due to the non-zero beam offset. We can expect that such azimuthal harmonics b_n^\pm get smaller for larger n . This is certainly the case when there are no slots. In this case, if the beam has a zero offset $r_0 = 0$ there is only the $n = 0$ harmonics and with a small r_0 the harmonics $b_n^\pm \propto (r_0/a)^n$. For narrow slots such a hierarchy still exists although non-zero harmonics may be present even for the zero offset case. This allows us to use a perturbation technique taking into account only the lowest azimuthal harmonics and neglecting the coupling between higher order azimuthal harmonics. However, if the goal is to build a pickup, the following results can be used as an estimate to obtain the order of the signal. All details of calculations can be found in reference [6], we present

here a final result. Azimuthal magnetic components inside a slot is

$$B_m^\mp(r) = \frac{1+i}{\kappa(1+\kappa)} \frac{e^{ik_w[a+\Delta+\kappa(r-a-\Delta)]}}{\sqrt{\pi k_w r}} \times \{\pm is(m) \times (\kappa-1)[-i-k_w(r-a-\Delta)]\alpha_0^\pm e^{-im\pi/2} \mp 2\kappa\alpha_m^\pm\}$$

$$k_w^2 = i \frac{4\pi\sigma}{\omega} \left(\frac{\omega}{c}\right)^2$$

$$s(n) = \frac{\sin(n\alpha/2)}{n\alpha/2} \quad \kappa = \sqrt{1 - \frac{\alpha}{2\pi}}$$

The radial dependence of the m=1 harmonics within the wall at frequency of 1 MHz is illustrated in Fig. 6 for three values of the screen thickness $\Delta=0.01, 0.2$ and 0.5 cm. Slot has an angle of 0.04 in a stainless steel beam pipe of radius of 5 cm. At this frequency skin depth is 0.042 cm. Beam offset is one micron.

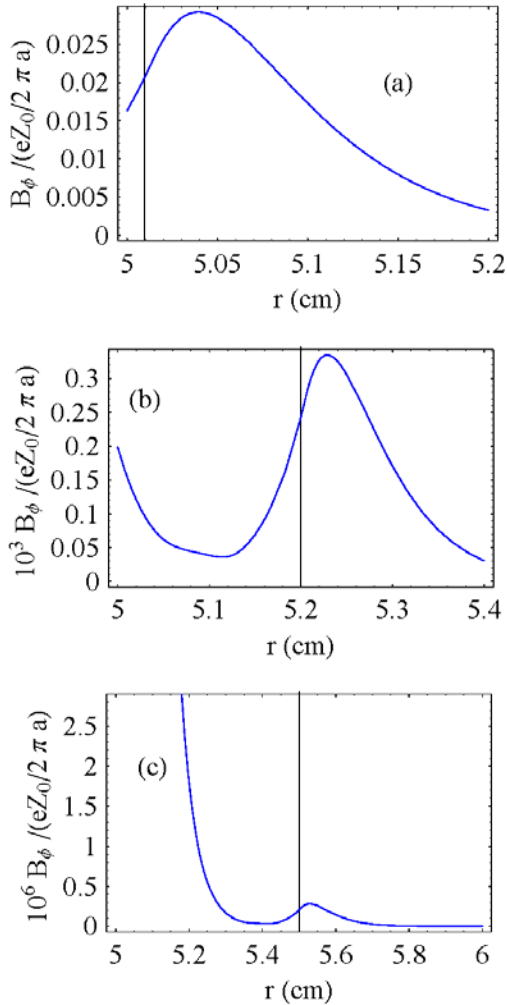

Figure 6: Radial dependence of the m=1 harmonics within the wall for (a) $\Delta=0.01$ cm, (b) $\Delta=0.2$ cm, and (c) $\Delta=0.5$ cm. The vertical line corresponds to the radius of $a+\Delta$. The radial behaviour shows the resonance character

caused by reflection from the slot. The spectral density of the voltage induces in the wire contour calculated by integrating the magnetic flux due to m=1 harmonics excited by a single particle is shown in Fig. 7. Wire length is 10 cm.

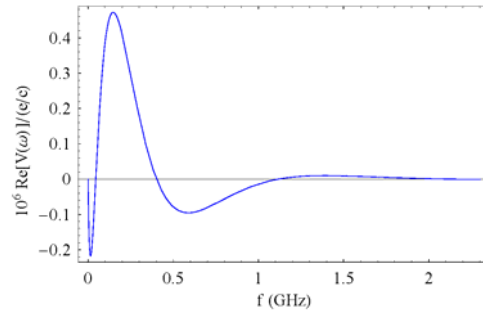

Figure 7: Spectral density of the voltage induced by a dipole harmonics of a single particle for wire length of $L=10$ cm.

The signal from a bunch is obtained by summing up contributions of all particles. For a Gaussian bunch with the rms length σ_b replacing the sum by the convolution with the spectrum density of the bunch, Result of integration for m=1 mode is shown in Fig. 8 for wire length of 10 cm and beam pipe radius of 5 cm.

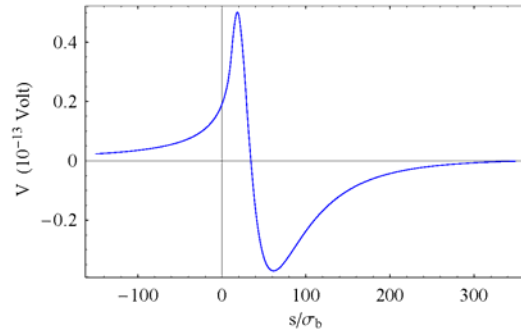

Figure 8: Voltage induced in the wire loop by the dipole harmonics of the azimuthal magnetic field of a single beam particle for $\Delta=0.01$ cm.

REFERENCES

- [1] B. Zotter, S. Kheifets, Impedances and Wakes in High-Energy Particle Accelerators, World Scientific, 1998
- [2] A. Novokhatski, Computer 2-d algorithm for resistive wake field calculations, to be published.
- [3] Linac Coherent Light Source Conceptual Design Report, SLAC-R-593, SLAC (2002).
- [4] A.A. Michailichenko, PTE (Pribery and Technika of Experiments, in Russian), N 2, 1984, p. 149.
- [5] A. V. Aleksandrov, Diplom Thesis, Institute of Nuclear Physics, Novosibirsk, 1989.
- [6] A. Novokhatski, S. Heifets, A. Alexandrov, "Simple low-frequency beam pickup", Physical Review Special Topics Accelerators and Beams, V 11, 114401 (2008).