



BNL- 81636-2008-CP

***Integrated Global Orbit Feedback with
Slow and Fast Correctors***

Igor Pinayev

*Presented at the 11th European Particle Accelerator Conference (EPAC '08)
Genoa, Italy
June 23-27, 2008*

July 2008

National Synchrotron Light Source II

Brookhaven National Laboratory

P.O. Box 5000
Upton, NY 11973-5000
www.bnl.gov

Notice: This manuscript has been authored by employees of Brookhaven Science Associates, LLC under Contract No. DE-AC02-98CH10886 with the U.S. Department of Energy. The publisher by accepting the manuscript for publication acknowledges that the United States Government retains a non-exclusive, paid-up, irrevocable, world-wide license to publish or reproduce the published form of this manuscript, or allow others to do so, for United States Government purposes.

This preprint is intended for publication in a journal or proceedings. Since changes may be made before publication, it may not be cited or reproduced without the author's permission.

DISCLAIMER

This report was prepared as an account of work sponsored by an agency of the United States Government. Neither the United States Government nor any agency thereof, nor any of their employees, nor any of their contractors, subcontractors, or their employees, makes any warranty, express or implied, or assumes any legal liability or responsibility for the accuracy, completeness, or any third party's use or the results of such use of any information, apparatus, product, or process disclosed, or represents that its use would not infringe privately owned rights. Reference herein to any specific commercial product, process, or service by trade name, trademark, manufacturer, or otherwise, does not necessarily constitute or imply its endorsement, recommendation, or favoring by the United States Government or any agency thereof or its contractors or subcontractors. The views and opinions of authors expressed herein do not necessarily state or reflect those of the United States Government or any agency thereof.

INTEGRATED GLOBAL ORBIT FEEDBACK WITH SLOW AND FAST CORRECTORS*

I. Pinayev[#], BNL, Upton, NY 11793, U.S.A.

Abstract

The NSLS-II Light Source, which is planned to be built at Brookhaven National Laboratory, will provide users with ultra-bright synchrotron radiation sources and is designed for horizontal beam emittances <1 nm. Full utilization of the very small emittances and beam sizes requires sub-micron orbit stability in the storage ring. This can be provided by means of a wide bandwidth orbit feedback system. Traditional approach is to utilize a uniform set of fast correctors or use two separate systems with strong slow and weaker fast correctors. In the latter case two systems need to communicate to suppress transients associated with different update rates of corrector settings. In this paper we consider an integrated system with two types of correctors. Its main feature is that setpoints of slow correctors are updated with the same rate as fast correctors; however the bandwidth is limited in order to stay in linear regime. Possible architectures and technical solutions as well as achievable performance are discussed.

INTRODUCTION

General layout of the combined fast and slow feedback is shown in Figure 1. Characteristics of BPMs can differ (RF and photon BPMs) as well as trims. The storage ring defines the lattice functions and electron beam serves as a summing junction. We consider here a dynamic system in which sampling rate far exceeds the characteristic frequencies in opposite to the static system where sampling and DAC update rates are less than characteristic frequencies. The latter system measures and corrects the orbit after all transients end. In many facilities static system is referred as slow thus creating confusion.

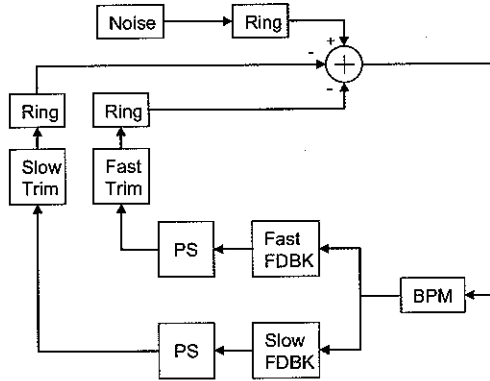

Figure 1: Simplified layout of combined fast and slow orbit feedbacks.

*Work supported by the U.S. Department of Energy with Contract No. DE-AC02-98CH10886
[#]pinayev@bnl.gov

External factor excites orbit error measured by a beam position monitor, which has unity gain and time response of 0.75 milliseconds (corresponding to 2 kHz bandwidth). The internal delay of Libera Brilliance BPM processor $\tau_{\text{delay}}=350 \mu\text{s}$ is defined by a built-in DSP notch filter, which suppresses switching noise [1]. In the model slightly larger delay was used (360 μs) to account for data transfer and computational overhead. We considered power supplies with 10 kHz small signal frequency response and unity gain. The trims also have unity gain but different response times: $\tau_{\text{slow}}=0.03 \text{ s}$ and $\tau_{\text{fast}}=0.002 \text{ s}$. The response time is mostly defined by a vacuum chamber and eddy currents.

DEVELOPING SISO MODEL

For simplicity we will develop a single input/single output (SISO) model. The model will have single BPM and two channels of orbit feedback and can be used for preliminary study of system behavior in the time domain. The gain-phase characteristics of open loop in each channel are corrected with a conventional zero-pole compensator, which has transfer function

$$H_{\text{comp}} = \frac{1 + s / 2\pi f_{\text{zero}}}{1 + s / 2\pi f_{\text{pole}}} \quad (1)$$

The transfer functions in the frequency domain for BPM, power supplies, and trim are defined by corresponding time constant

$$H = \frac{1}{1 + s\tau} \quad (2)$$

The transfer function of the whole system can be found by using simple arithmetic functions

$$H_{\text{fdbk}} = (H_{\text{strim}}H_{\text{slow}} + H_{\text{ftrim}}H_{\text{fast}})H_{\text{PS}}H_{\text{BPM}} \quad (3)$$

And suppression of the beam motion induced by the noise is

$$A(s) = \frac{1}{1 + H_{\text{fdbk}}} \quad (4)$$

By proper choice of the gains, cut-off frequencies, and the filters parameters one can provide for desired noise suppression and stable feedback loop with sufficient phase and gain margins of the combined system.

Feedback with slow correctors

In the channel with slow correctors the error signal is amplified by an integrator with time constant τ_i . The transfer function of compensated error amplifier is shown in Eq. 5.

$$H_{slow} = \frac{1}{s\tau_i} \frac{1 + s/2\pi f_{zero}}{1 + s/2\pi f_{pole}} \quad (5)$$

The integration time was chosen equal to 4.5 milliseconds. The zero frequency was 5.3 Hz and pole was located at 150 Hz. Such parameters provides stable loop for separate operation of slow channel.

Feedback with fast correctors

For the fast feedback transfer function was defined by gain $G_f=30$, its cut-off frequency $F_{ff}=2.5$ Hz and zero-pole compensation filter with frequencies $F_{fzero}=70$ Hz and $F_{fpole}=1300$ Hz. The transfer function is described by Eq. 6.

$$H_{fast} = \frac{G_f}{1 + s/2\pi F_{ff}} \frac{1 + s/2\pi f_{zero}}{1 + s/2\pi f_{pole}} \quad (6)$$

The compensation filter stabilizes the feedback with only fast channel as well as expands the bandwidth beyond 100 Hz. The Bode diagram, found with Control Toolbox in MATLAB, is shown in Fig. 2.

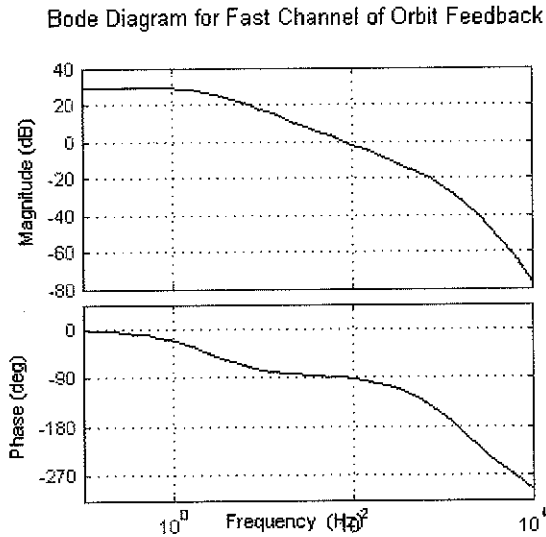

Figure 2: Bode diagram of fast channel of orbit feedback system.

Integrated system

The transfer function of the integrated system can be found as sum of transfer functions for slow and fast channels. Its Bode diagram is shown in Fig. 3.

Bode Diagram for Integrated Orbit Feedback

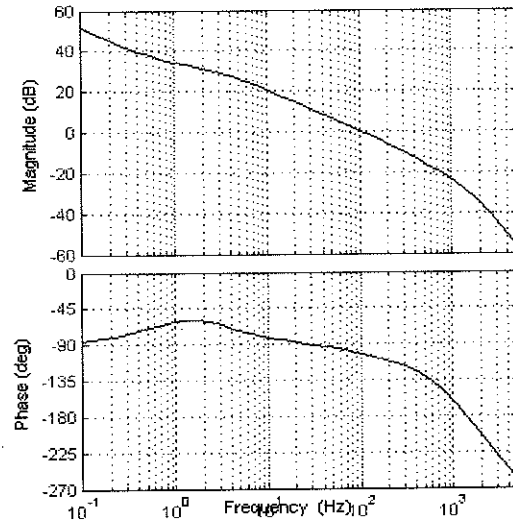

Figure 3: Bode diagram of integrated orbit feedback.

The integrated feedback is stable with closed loop and provides 72° phase margin and 29 dB gain margin. The noise suppression provided by feedback system is shown in Fig. 4.

Noise Suppression by Two-channel Orbit Feedback

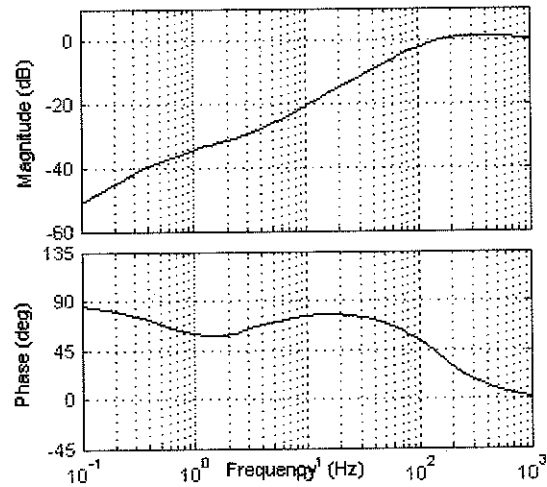

Figure 4: Calculated noise suppression by the integrated feedback. Noise is suppressed with frequencies up to 140 Hz.

MODELING SYSTEM WITH LATENCY

As it was mention before there is a substantial processing delay, which can affect the stability and parameters of the feedback system. The transfer function of the delay can be found from Eq. 7.

$$H_{delay}(s) = \exp(-s\tau_{delay}) \quad (7)$$

Another important issue is discrete timing in the system. To account for both factors we developed MATLAB Simulink model of the orbit feedback. The model has continuous time models of power supply, trims and the beam, while the BPM and “amplifier” with compensating filter are discrete time units. The delay was introduced between beam position and BPM processor. The results of modeling are shown in Fig. 5 and 6.

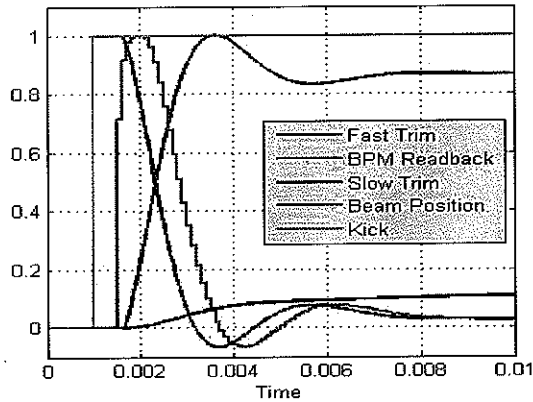

Figure 5: Response of the integrated orbit feedback system to the step.

The integrated system provides fast response to the external factor and orbit deviation is almost gone in 8 milliseconds.

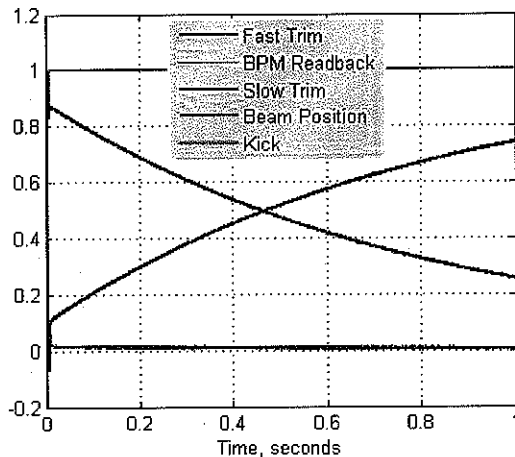

Figure 6: Response of the integrated orbit feedback system to the step with longer time scale. The strength of the fast trim is gradually decreasing while slow trim picks up the correction.

In order to evaluate the suppression of the noise input was excited with sine wave with different frequencies

(instead of step function) and amplitude of oscillations was observed. The results of modeling are shown in Fig. 7. The results are comparable with continuous time system without delay.

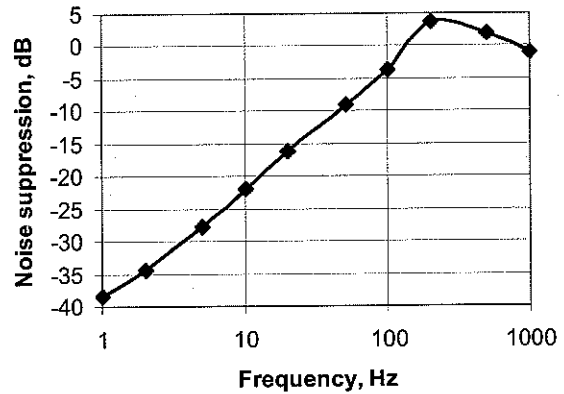

Figure 7: Suppression of noise by the integrated orbit feedback with delay and discrete time processing.

POSSIBLE REALIZATIONS

The described approach is rather flexible. It can be applied for an orbit feedback with the strong slow correctors and the weak fast correctors. In such case integrator in the slow channel is needed to prevent saturation of the weak trims by transferring correction to the slow trims. Another possibility is to use a high pass filter in the fast channel. Modeling showed good results with such approach as well.

If the fast trims have sufficient strength it is also possible to utilize them in the slow channel. In this case the orbit drifts will be suppressed better due to more frequent spatial distribution of correctors. The summing can be done either with two DACs (two inputs are required for power supply) or in the digital processor (the fast trim in this case will have two virtual channels).

CONCLUSION

The modeling showed the feasibility of building of the integrated orbit feedback with fast and slow trims. The orbit feedback utilizes full speed of fast channel and full strength of slow trims. Digital realization allows easy tuning of the system parameters.

REFERENCE

- [1] Libera Brilliance User Manual.