



Lawrence Berkeley Laboratory

UNIVERSITY OF CALIFORNIA

APPLIED SCIENCE DIVISION

**Novel Regenerated Solvent Extraction Processes
for the Recovery of Carboxylic Acids or Ammonia
from Aqueous Solutions
Part II. Recovery of Ammonia from Sour Waters**

L.J. Poole* and C.J. King

(*Ph.D. Thesis)

March 1990

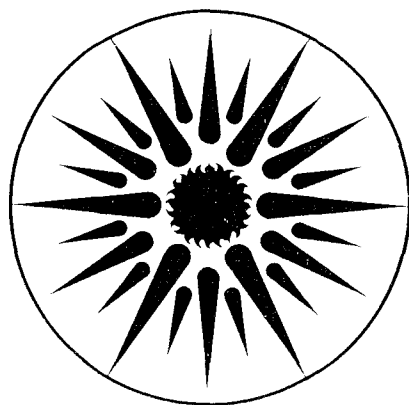

**APPLIED SCIENCE
DIVISION**

APPLIED SCIENCE DIVISION
LAWRENCE BERKELEY LABORATORY
UNIVERSITY OF CALIFORNIA
BERKELEY, CALIFORNIA 94720

NOVEL REGENERATED SOLVENT EXTRACTION PROCESSES
FOR THE RECOVERY OF CARBOXYLIC ACIDS OR AMMONIA
FROM AQUEOUS SOLUTIONS

PART II. RECOVERY OF AMMONIA FROM SOUR WATERS

Loree Joanne Poole* and C. Judson King

(*Ph.D. Thesis)

Lawrence Berkeley Laboratory
University of California
Berkeley, California 94720

March 1990

This work has been funded by the Fossil Energy Division of the U.S. Department of Energy, through the Morgantown Energy Technology Center, under Contract No. DE-ACO3-76SF00098.

NOVEL REGENERATED SOLVENT EXTRACTION PROCESSES
FOR THE RECOVERY OF CARBOXYLIC ACIDS OR AMMONIA
FROM AQUEOUS SOLUTIONS

by

Loree J. Poole

ABSTRACT

Two novel regenerated solvent extraction processes are examined. The first process has the potential to reduce the energy costs inherent in the recovery of low-volatility carboxylic acids from dilute aqueous solutions. The second process has the potential for reducing the energy costs required for separate recovery of ammonia and acid gases (e.g. CO₂ and H₂S) from industrial sour waters.

The recovery of carboxylic acids from dilute aqueous solution can be achieved by extraction with tertiary amines. An approach for regeneration and product recovery from such extracts is to back-extract the carboxylic acid with a water-soluble, volatile tertiary amine, such as trimethylamine. The resulting trimethylammonium carboxylate solution can be concentrated and thermally decomposed, yielding the product acid and the volatile amine for recycle.

Experimental work was performed with lactic acid, succinic acid, and fumaric acid. Equilibrium data show near-stoichiometric recovery of the carboxylic acids from an organic solution of Alamine 336 into aqueous solutions of trimethylamine. For fumaric and succinic acids, partial

evaporation of the aqueous back extract decomposes the carboxylate and yields the acid product in crystalline form. The decomposition of aqueous solutions of trimethylammonium lactates was not carried out to completion, due to the high water solubility of lactic acid and the tendency of the acid to self-associate.

The separate recovery of ammonia and acid gases from sour waters can be achieved by combining steam-stripping of the acid gases with simultaneous removal of ammonia by extraction with a liquid cation exchanger. The use of di-2,4,4-trimethylpentyl phosphinic acid as the liquid cation exchanger is explored in this work.

Batch extraction experiments were carried out to measure the equilibrium distribution ratio of ammonia between an aqueous buffer solution and an organic solution of the phosphinic acid (0.2N) in Norpar 12. The concentration-based distribution ratios increase from 0.11 to 0.46 as the aqueous phase pH increases from 7.18 to 8.15. Regeneration of the organic extractant solution was carried out by stripping at elevated temperatures to remove the ammonia, with 99% recovery of the ammonia being obtained at 125°C.

TABLE OF CONTENTS

	page
Abstract	
Table of Contents	i
List of Tables	v
List of Figures	vii
Preface	ix

Part II. Recovery of Ammonia from Sour Waters

CHAPTER 7. INTRODUCTION

7.1 Sources of Sour Waters	1
7.1.1 Coal Gasification Condensate Waters	
7.1.2 Coal Liquefaction Wastewaters	
7.1.3 Sour Waters from Oil Shale Retorting	
7.1.4 Sour Waters from Petroleum Refining	
7.1.5 Sour Waters from Coking Operations in the Iron and Steel Industry	
7.2 Treatment of Sour Waters	7
7.2.1 Organics Removal	
7.2.2 Steam Stripping of $\text{NH}_3\text{-CO}_2\text{-H}_2\text{S}$ Wastewaters	
7.2.3 Isolation of Ammonia from Acid Gases	
7.2.3.1 Phosam-W	
7.2.3.2 Chemie Linde Lurgi (CLL) and Waste Water Treating (WWT) Processes	
7.2.3.3 Combined Stripping/Liquid Membrane Extraction Process	
7.2.3.4 Combined Stripping/Extraction Process	
7.3 Identification of an Alternative Liquid Cation Exchanger to be used in the Combined Stripping/Extraction Process	25

TABLE OF CONTENTS (continued)

	page
CHAPTER 8. IDENTIFICATION OF A THERMALLY STABLE LIQUID CATION EXCHANGER FOR AMMONIA	
8.1 Liquid Cation Exchangers	30
8.2 Desired Characteristics	31
8.3 Carboxylic Acids	32
8.4 Sulfonic Acids	34
8.5 Organophosphorus Acids	35
8.5.1 Organophosphoric Acids	
8.5.2 Organophosphonic Acids	
8.5.3 Organophosphinic Acids	
CHAPTER 9. EXPERIMENTAL PROCEDURES AND EQUIPMENT	
9.1 Reagents Used	43
9.2 Equipment	45
9.3 Pretreatment of Cyanex 272	46
9.3.1 Washing of Cyanex 272 with Basic Solution	
9.3.2 Gas Chromatographic Analysis of the Extractant Solution	
9.3.3 Isolation of the Phosphinic Acid	
9.4 Extraction Experiments	50
9.5 Thermal Regeneration Experiments	53
9.6 Thermal Stability Tests	58
9.6.1 Heating of the Extractant	
9.6.2 Aqueous Solubility Measurements	
9.6.3 Extraction Characteristics	

TABLE OF CONTENTS (continued)

	page
 CHAPTER 10. RESULTS OF THE AMMONIA EXTRACTION EXPERIMENTS	
10.1 Modeling of Extraction of Ammonia by a Liquid Cation Exchanger	63
10.2 Experimental Results with As-Received Cyanex 272	68
10.3 Experimental Results with Washed Cyanex 272 and with the Purified Phosphinic Acid	74
10.4 Third Phase Formation	77
 CHAPTER 11. RESULTS OF THE THERMAL REGENERATION EXPERIMENTS AND OF THE THERMAL STABILITY TESTS	
11.1 Thermal Regeneration Experiments	79
11.2 Thermal Stability Tests	84
11.2.1 Aqueous Solubility Losses	
11.2.2 Extraction Characteristics	
11.3 Discussion	93
 CHAPTER 12. PROCESS DESIGN CONSIDERATIONS	
12.1 Combined Stripping/Extraction Process	97
12.1.1 Extraction of Ammonia with Cyanex 272	
12.1.2 Combined Stripping/Extraction	
12.1.3 Thermal Regeneration of the Solvent	
12.2 Process Costs	108
12.2.1 Steam Required for Acid-Gas Stripper	
12.2.2 Cost of Aqueous Solubility Losses of the Extractant	
12.2.3 Steam Required for Solvent Regeneration Column	
12.2.4 Additional Process Operating Costs	
12.3 Summary and Conclusions	122

TABLE OF CONTENTS (continued)

	page
APPENDIX A. EXPERIMENTAL DATA	
A.1 Ammonia Extraction Experiments	126
A.2 Thermal Regeneration of Loaded Cyanex 272 Solutions . . .	132
APPENDIX B. NOMENCLATURE.	135

LIST OF TABLES

Table	page
7-1 Characteristics of Sour Waters from Solid-Fuel Conversions	8
7-2 Dilute Solution Henry's Constants	10
7-3 Sour Water Stripper Simulation Conditions	13
7-4 Percent Removal as a Function of Steam-to-Feed Ratio	13
8-1 Comparison of Liquid Cation Exchangers as Extractants for Ammonia	33
8-2 Some Organophosphorus Acid Extractants	36
8-3 Comparison of Cyanex 272 to D2EHPA	39
9-1 Source and Description of Chemicals Used	44
11-1 Aqueous Phase Phosphorus Losses: As-Received Cyanex 272	88
11-2 Aqueous Phase Phosphorus Losses: Washed Cyanex 272	90
12-1 Ammonia Distribution Ratios for Extraction with As-Received Cyanex 272 in Norpar 12	100
12-2 Major Operating Costs of Sour Water Treatment Processes	109
12-3 Partial Pressure of CO ₂ versus pH Aqueous CO ₂ Concentration = 0.3M	112
12-4 Aqueous Solubility of Di-2,4,4-trimethylpentyl Phosphinic Acid	117
12-5 Operating Cost Estimates	121

LIST OF TABLES (continued)

Table	page
A-1 Extraction at 25°C with As-Received Cyanex 272	126
A-2 Extraction at 25°C with Washed Cyanex 272	128
A-3 Extraction at 25°C with the Purified Phosphinic Acid	129
A-4 Extraction at 25°C with Washed, Previously Heated Cyanex 272	130
A-5 Removal of Ammonia from Loaded Extractant Solution at 125°C .	132
A-6 Removal of Ammonia from Loaded Extractant Solution at 120°C .	134

LIST OF FIGURES

Figure	page
7-1 Ratio of Unionized Species to Total Dissolved Species	10
7-2 The Phosam-W Process	16
7-3 The CLL Process	18
7-4 The Chevron WWT Process	18
7-5 Combined Stripping/Liquid Membrane Extraction Process	21
7-6 Combined Stripping/Extraction Process	23
9-1 Apparatus for Thermal Regeneration Experiments	55
10-1 Extraction of Ammonia at 25°C with As-Received Cyanex 272	69
10-2 Extraction of Ammonia at 25°C with D2EHPA	69
10-3 Extraction of Ammonia at 25°C with As-Received Cyanex 272 Comparison with Theoretical Curve for K_r equal to 2.5×10^{-8}	72
10-4 Extraction of Ammonia at 25°C with As-Received Cyanex 272 Comparison with Theoretical Curves	72
10-5 Comparison of Extraction Data with As-Received Cyanex 272 to the data of Inoue et al.	73
10-6 Extraction of Ammonia at 25°C with Washed Cyanex 272 and with the Purified Phosphinic Acid	75
11-1 Removal of Ammonia from Loaded Extractant Solution Comparison of Cyanex 272 and D2EHPA.	80
11-2 Removal of Ammonia from Loaded Extractant Solution at 120°C	83
11-3 Composition of As-Received Cyanex 272	85
11-4 Comparison of the Extraction Characteristics of Washed Cyanex 272 before and after Heating	92
11-5 Predicted Effect of the Thermal Decomposition of Cyanex 272 on a Plot of K_c versus the pH of the Aqueous Raffinate	94
12-1 Combined Stripping/Extraction Process	98

LIST OF FIGURES (continued)

Figure	page
12-2 Removal of CO ₂ from Aqueous Solution Comparison of Stripping with Extraction/Stripping	104
12-3 Equilibrium Curve for Ammonia at 125°C Organic Phase: 0.48N As-Received Cyanex 272 in Norpar 12 .	107

PREFACE

The research presented in this dissertation is a study of two novel regenerated solvent extraction processes. The feasibility of each process is explored through experimental work designed to simulate process steps.

In the first process, carboxylic acids of low volatility are recovered from dilute aqueous solution by extraction with tertiary amines. The organic extract is then regenerated by back-extraction of the acid into aqueous amine solution, followed by thermal decomposition of the alkylammonium carboxylates. The principal applications are for the recovery of organic acids from fermentation broths and waste streams. This process is examined in Chapters 1 through 6.

In the second process, ammonia is recovered from aqueous buffer solutions in the pH range 7.5-9.5 by extraction with an organic liquid cation exchanger. The organic extract is then regenerated by stripping at elevated temperature to remove the ammonia. The principal application is for the treatment of industrial sour waters. This process is examined in Chapters 7 through 12.

PART II. RECOVERY OF AMMONIA FROM SOUR WATERS

CHAPTER 7. INTRODUCTION

Sour waters are industrial wastewaters that contain ammonia and acid gases (e.g., carbon dioxide and hydrogen sulfide). In treating these wastewaters, it is desirable to recover the ammonia separately from the acid gases. Ammonia, in either the anhydrous or aqueous form, can be sold for chemical or fertilizer purposes; while an acid gas stream of carbon dioxide and hydrogen sulfide can be used as a feed to a sulfur recovery unit or a sulfuric acid plant.

A sour water treatment process designed to achieve separate recovery of the ammonia and acid gases has been developed by Mackenzie and King (1,2). This process combines steam-stripping of carbon dioxide and hydrogen sulfide with simultaneous removal of ammonia by extraction with a liquid cation exchanger, thereby potentially giving reduced energy consumption. The cation exchanger is regenerated thermally. The goal of this work is to improve that process through the identification of a liquid cation exchanger that is more thermally stable, less water soluble, and/or weaker in acidity than the di-alkyl phosphoric acid used by Mackenzie.

7.1 Sources of Sour Waters

Wastewaters containing ammonia (NH_3) and acid gases are generated during coal gasification and other energy producing processes such as coal liquefaction, oil-shale retorting, and petroleum refining. They are also

generated during coking operations in the iron and steel industry. Although the composition of the sour waters varies among the different processes, the most common acid gases are carbon dioxide (CO_2) and hydrogen sulfide (H_2S). The simultaneous presence of dissolved ammonia and acid gases stabilizes the pH of sour waters at values typically between 7.5 and 9.5.

7.1.1 Coal Gasification Condensate Waters

Coal gasification involves pyrolysis and partial oxidation of coal to form a gaseous fuel of low-molecular weight hydrocarbons, primarily methane. The coal is fed to a gasifier where air, oxygen, and/or steam is added to provide heat through partial combustion.

The temperatures at which coal gasifiers operate range between 815°C and 1925°C . Sulfur- and nitrogen-containing compounds are present in coal in varying amounts. Operation of a gasifier at the lower end of the temperature range favors the reaction of nitrogen with hydrogen to form ammonia and the reaction of sulfur with hydrogen to form hydrogen sulfide. Operation at the higher end of the temperature range favors the reaction of nitrogen with oxygen to form nitrous oxide and nitrogen dioxide. (3)

After the gaseous product stream leaves the gasifier, steam not consumed in the gasifier is recovered as condensate water in a cooling step. Condensate water produced during low-temperature coal gasification processes contains absorbed ammonia, carbon dioxide, and hydrogen sulfide. The composition of coal gasification condensate waters has been studied

extensively by Mohr and King (4,5) and Senetar (6).

The product gas stream may pass through several gas cleaning units, such as scrubbers. Scrubbers in which water is used to remove solid particles and oils are another source of sour waters (7).

At the present time, only one large-scale coal gasification plant is operating in the United States to produce fuel gas. The Great Plains Coal Gasification Plant located in North Dakota produces 150 million cu. ft./day (8) of synthetic natural gas from coal using a low-temperature coal gasification process.

7.1.2 Coal Liquefaction Wastewaters

The main difference in the chemical compositions of coal and petroleum is in the ratio of hydrogen to carbon atoms (H/C ratio). In coal conversion processes, the aim is to increase the H/C ratio of coal (approx. 0.7) to that of petroleum (greater than 1.2). In coal gasification this is accomplished by the reaction of steam with carbon, carbon monoxide, and carbon dioxide to form gaseous hydrocarbons. In direct coal liquefaction processes, liquid hydrocarbons are formed by the addition of hydrogen to liquefied coal (9) in any of several ways.

The majority of direct coal liquefaction processes involve mixing powdered or crushed coal with coal-derived liquid. This slurry is heated to 400 to 500°C. Decomposition of the coal occurs through the reaction of

hydrogen with carbon to form liquid hydrocarbons. The hydrogen is added as a gaseous stream and/or is supplied by hydrogen-donor compounds present in the coal derived-liquid. (9,10) Much of the sulfur and nitrogen present in the original coal is hydrogenated to form hydrogen sulfide and ammonia (11).

Wastewater from a direct coal liquefaction process consists of water formed in the liquefier, water present in the feed coal, and water that is added to the process to prevent the deposition of ammonium salts. This water has been in contact with the liquefied coal and contains organic compounds, ammonia, and hydrogen sulfide. (12)

7.1.3 Sour Waters from Oil Shale Retorting

Oil can be produced from oil-shale by an above-ground retorting process or by an in-situ process. The above-ground process presents the problem of disposal of spent shale and also involves large capital investments and high operating costs. The production of oil by in-situ retorting is less costly; however, it produces much larger quantities of wastewater, often in volumes equal to and sometimes in excess of the volume of oil produced. (13,14,15)

In in-situ oil-shale retorting, wells are drilled into the underground formation. Void spaces are created by fracturing. Propane is then injected into central wells. The propane is burned until ignition of the shale formation occurs. Air is then supplied to maintain the combustion. The

kerogen and bitumen present in the shale decompose and oil, residual carbon, hydrocarbon gases, water, and other combustion products are formed. The oil, gases, and water flow outwards along induced fractures to the collection wells. The water contains ammonia and hydrogen sulfide produced by the reaction of nitrogen- and sulfur-containing compounds present in the shale. (13)

7.1.4 Sour Waters from Petroleum Refining

Sour waters are a by-product of a number of different processes used in petroleum refining. Crude oil contains varying amounts of sulfur and nitrogen. One process designed to remove these compounds is catalytic hydrofining in which reaction to NH_3 and H_2S is promoted at high temperatures and pressures in the presence of hydrogenation catalysts. These reactions also take place to a certain degree during other refining processes such as thermal and catalytic cracking, reforming, and hydrocracking. The NH_3 and H_2S are removed from the gaseous effluents of these processes by scrubbing with water, thereby producing sour waters. (16,17)

In petroleum refining, steam is used as a stripping medium in distillation and as a diluent during cracking operations in order to reduce the hydrocarbon partial pressure. When this steam is recovered in condensed form it generally contains H_2S and NH_3 . The NH_3 is present due to either the presence of nitrogen-containing compounds in the oil or injection of NH_3 into fractionator overhead systems to neutralize the H_2S

and thereby prevent corrosion of equipment by acidic aqueous solutions. (17)

The processes used to upgrade oil derived from oil-shale and tar sands are similar to those used to refine oil derived from petroleum. Sour waters are therefore by-products of these upgrading plants as well. (16,18)

7.1.5 Sour Waters from Coking Operations in the Iron and Steel Industry

There are three main steps in the production of steel from its raw materials, coal and iron ore. The first step is the "coking" process in which coal is converted to coke, or pure carbon. In the second step the coke is combined with iron ore and limestone in a blast furnace to form pig iron. The third step involves purification of the pig iron plus the addition of alloying substances to produce steel of the desired properties. (19,20).

In the coking step, coal is heated in the absence of air at temperatures from 1600 to 2300°F for approximately 16 to 20 hours. During this heating, organic compounds present in the coal are released as gases and withdrawn through exhaust pipes. These gases include ammonia, hydrogen cyanide, and phenol (20). Water vapor is also released from the coal when it is heated (21).

The gas stream leaving the coke ovens is usually processed to recover chemicals for in-plant use. Typically, the gas stream is cooled and contacted with water to dissolve the organic compounds, which are then separated in condensation columns, scrubbers and decanters (20). In

general, not all of the organic compounds are recovered from the water. The waste water leaving these processing steps contains substantial amounts of phenolic compounds, ammonia, and cyanide (20).

7.2 Treatment of Sour Waters

Typical ranges of concentrations of NH_3 , CO_2 , and H_2S in wastewaters from solid-fuel conversion processes are shown in Table 7-1. Sour waters from petroleum refining contain lower concentrations of CO_2 and higher concentrations of H_2S (7), while sour waters from coking operations usually contain hydrogen cyanide (20,21), rather than H_2S . Also shown are the limits for effluent release to the environment. In most cases, a certain proportion of the water would be recycled within the industrial plant; the maximum concentrations allowable in the treated water would then depend on the recycle use.

7.2.1 Organics Removal

Sour waters contain some dissolved organic compounds. The types and concentrations of organic compounds vary depending on the source of the sour water. Sour waters from petroleum refining have low concentrations of organics (7), while coal gasification condensate waters can contain 1 wt. % organic compounds (6). The organic compounds can be removed from the sour water by a solvent extraction step.

Table 7-1.
Characteristics of Sour Waters
from Solid-Fuel Conversions

	Typical Concentrations in Sour Waters (ppm)	Maximum Concentrations for Effluent Release (ppm)
Ammonia	1,000-30,000	1-15
Sulfide	20-30,000	0.1-10
Carbonate (as CaCO ₃)	1,500-25,000	---
pH	7.5-9.5	6-8.5

Source: King et al. (22)

The organic compounds present in low-temperature coal gasification condensate waters are primarily phenolic compounds (6). An industrial process that is used to remove these compounds is the Phenosolvan process in which either diisopropyl ether or butyl acetate is used as the extractant (23). A competitive process is one licensed by the Chem-Pro Corporation in which methyl isobutyl ketone is used as the extractant (6). The use of extractants with high boiling points has been examined by Bell (24) and MacGlashan et al. (25,26).

In this work, we are focusing on the treatment of sour waters after the organic compounds have been removed.

7.2.2 Steam Stripping of NH_3 - CO_2 - H_2S Wastewaters

Because of the vapor/liquid equilibrium characteristics of the sour water system, simple steam stripping of sour waters can not be used if separate streams of high purity ammonia and acid gases are to be produced. For dilute aqueous solutions, the partial pressure of a component above the solution is equal to the product of the Henry's constant for the component and the concentration of the component in unionized form. Table 7-2 gives the values of the Henry's constants at 100°C for NH_3 , CO_2 , and H_2S . Figure 7-1 shows the ratios of unionized (volatile) species to the total dissolved species for NH_3 , CO_2 , and H_2S .

During steam stripping of a sour water, initially CO_2 and H_2S will be removed from solution due to their higher values of Henry's constant;

Table 7-2.
Dilute Solution Henry's Constants

Species	Henry's Constant at 100°C (kg H ₂ O-atm/gmol)
NH ₃	0.23
CO ₂	94.5
H ₂ S	28.5

Source: Edwards et al. (27)

Figure 7-1.
Ratio of Unionized Species to Total Dissolved Species

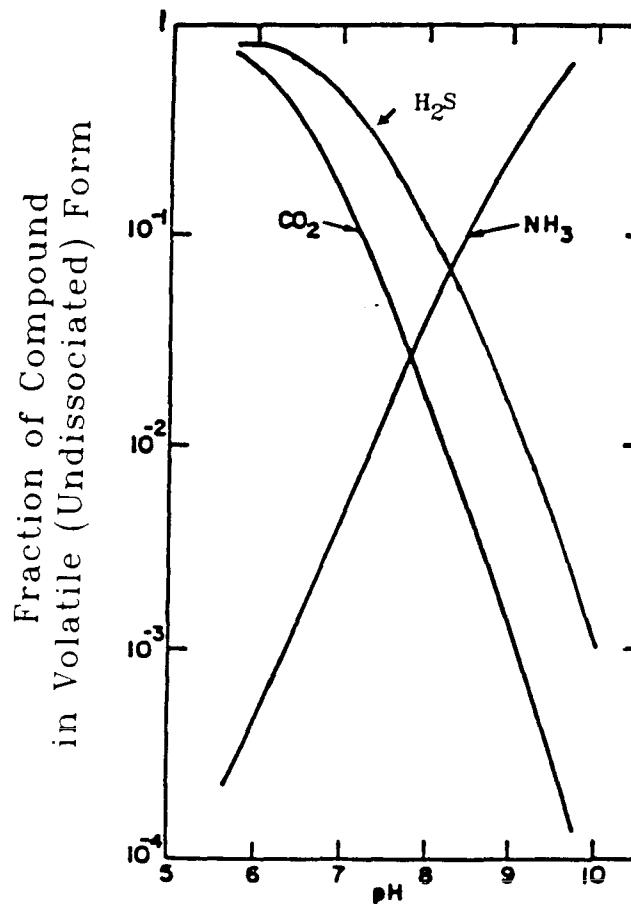

Source: Mackenzie (2) and Cahn et al. (28)

however, as the acid gases are removed, the pH of the water increases, decreasing the volatility of the acid gases and increasing that of NH_3 until a point is reached where the NH_3 is stripped along with the acid gases. When this point is reached, the remaining aqueous solution contains nearly all of the NH_3 ; however, it also contains a substantial amount of H_2S (29).

Steam-stripping of sour waters can be used to remove the ammonia and acid gases as a single product stream. However, since the presence of ammonia (a weak base) suppresses the volatility of the acid gases and likewise the presence of the dissolved acid gases suppresses the volatility of ammonia, there is a high energy cost required to remove all three compounds from solution. Energy requirements range from 0.08 to 0.2 lb steam/lb of feed water for columns operated at about 25 psia and temperatures greater than 100°C . Stripping columns containing 15 to 20 actual trays with tray efficiencies between 35 and 65% are required. (30,31)

The vapor-liquid equilibrium of waters containing NH_3 , CO_2 , and H_2S was studied by Van Krevelen et al. (32). More recently, the vapor-liquid equilibrium of waters containing these compounds as well as other compounds commonly found in industrial sour waters has been modeled. Edwards et al. (27) examined aqueous solutions containing hydrogen cyanide and sulfur dioxide as well as NH_3 , CO_2 , and H_2S , while Pawlikowski et al. (33) expanded on this work to include phenol, lower hydrocarbons, and dissolved hydrogen, nitrogen, carbon monoxide, carbonyl sulfide and argon.

Procedures for designing sour water strippers are available in the literature. Beychok (17) presents a tray-to-tray calculational procedure utilizing charts of partial pressure data. Verhoff and Choi (7) have developed a simplified computer-aided design procedure that "...ignores the energy balance which should be included for accurate plate-to-plate stripper design". Design procedures developed by Seufert et al. (31), Melin et al. (34), and Pawlikowski (35) consist of more rigorous calculations.

The multi-stage distillation computer program, DELTAS, developed by Pawlikowski (35) and revised by Harvey (36) models the distillation of sour waters using stage-to-stage calculations involving simultaneous solution of mass and energy balance equations, chemical and phase equilibrium equations, and electroneutrality equations. DELTAS can be used to model sour water strippers by setting the reflux ratio and boil-up flow rate equal to zero and by using two feed streams; a sour water stream at the top of the column and a steam feed at the bottom of the column.

Sour water stripper simulations were carried out using DELTAS. The sour water feed conditions and steam flow rate were initially set at the values used by Verhoff and Choi (7) and are given in Table 7-3. The steam flow rate was then varied to observe the effect on the percent removal of the contaminants. Table 7-4 gives the values of percent removal of NH_3 , CO_2 , H_2S , and phenol versus steam-to-feed ratio (S/F) and compares the values obtained at a ratio of 1.0 lb steam/gal feed to those obtained by Verhoff and Choi. The large difference between the percent removal of phenol predicted by Verhoff and Choi and that predicted using DELTAS is a

Table 7-3.
Sour Water Stripper Simulation Conditions

Number of Ideal Trays: 4

Feed Conditions

Feed Temperature: 93.6°C

Feed Composition: NH₃ = 2655 ppm
 CO₂ = 5100 ppm
 H₂S = 349.5 ppm
 phenol = 3120 ppm

Steam Conditions: saturated steam
 at 100°C

Stripper Pressure: 0.94 atm.

Table 7-4.
Percent Removal as a Function of Steam-to-Feed Ratio

	S/F (lb steam/gal feed)	% Removal			
		NH ₃	CO ₂	H ₂ S	phenol
Verhoff and Choi (7):	1	91.0	99.8	95.7	71.8

DELTA:	1	93.9	100	98.6	59.3
	0.90	92.0	100	97.7	54.8
	0.75	87.6	99.9	95.4	47.6
	0.60	80.3	99.8	91.3	40.1
	0.50	73.2	99.6	87.4	35.0
	0.45	68.8	99.4	85.1	32.5

result of the more rigorous correlations used in DELTAS to describe the thermodynamic and chemical equilibrium characteristics of phenol.

As shown in Table 7-4, S/F of 0.8 lb steam/gal feed, or greater, is required for effective removal of ammonia. This corresponds to boil-up of 10% or more of the feed. A boil-up ratio closer to 15% is needed for a sufficiently high degree of removal of NH_3 . These results illustrate the need for improved sour water treatment process configurations which lessen energy consumption.

7.2.3 Isolation of Ammonia from Acid Gases

Sour water treatment processes that achieve the goal of separate recovery of ammonia and acid gases have been developed. Three industrial processes are: the Phosam-W process; the Chemie-Linde Lurgi (CLL) process; and an analogue to the CLL process, the Waste Water Treating (WWT) process. Other processes that have not as yet been used in industry are the extripping process proposed by Cahn et al. (28) and the combined stripping/extraction process proposed by Mackenzie and King (1).

7.2.3.1 Phosam-W

The Phosam-W process was developed by U.S. Steel Corporation to treat sour waters from fossil fuel conversion processes and oil upgrading plants. It is used to treat dephenolized condensate water at the Great Plains Coal Gasification Plant in North Dakota (37). In the Phosam-W

process, shown in Figure 7-2, the sour water enters the bottom of a superstill. The acid gases and ammonia are steam stripped out of solution using steam produced in the reboiler. Some make-up steam may be required. (38) The gas stream containing NH_3 , CO_2 , and H_2S rises into the Phosam absorber section of the superstill where ammonia is removed by absorption into an ammonium phosphate solution. The acid gases are sent to a sulfur recovery unit. (39)

The ammonium phosphate solution leaving the superstill contains a ratio of ammonia to phosphoric acid equal to 1.7 to 2.0. This rich solution is fed to a stripper in which the absorbed ammonia is removed until the ammonia to phosphoric acid ratio is in the range of 1.2 to 1.4. This lean solution is recycled back to the superstill. The $\text{NH}_3/\text{H}_2\text{O}$ stream leaving the top of the stripper is fed to a fractionator to yield an anhydrous liquid ammonia product. (37,39)

In the traditional treatment of sour waters from coke plants, ammonia was removed from a coke-oven gas stream by absorption into a solution of ammonium sulfate containing excess sulfuric acid. This process produces an ammonium sulfate product which can be used as fertilizer. However, this traditional process consumes 3 tons of sulfuric acid for every ton of ammonia removed. Since the cost of sulfuric acid is greater than the price that can be obtained for ammonium sulfate, this recovery process is no longer considered to be economical. (37)

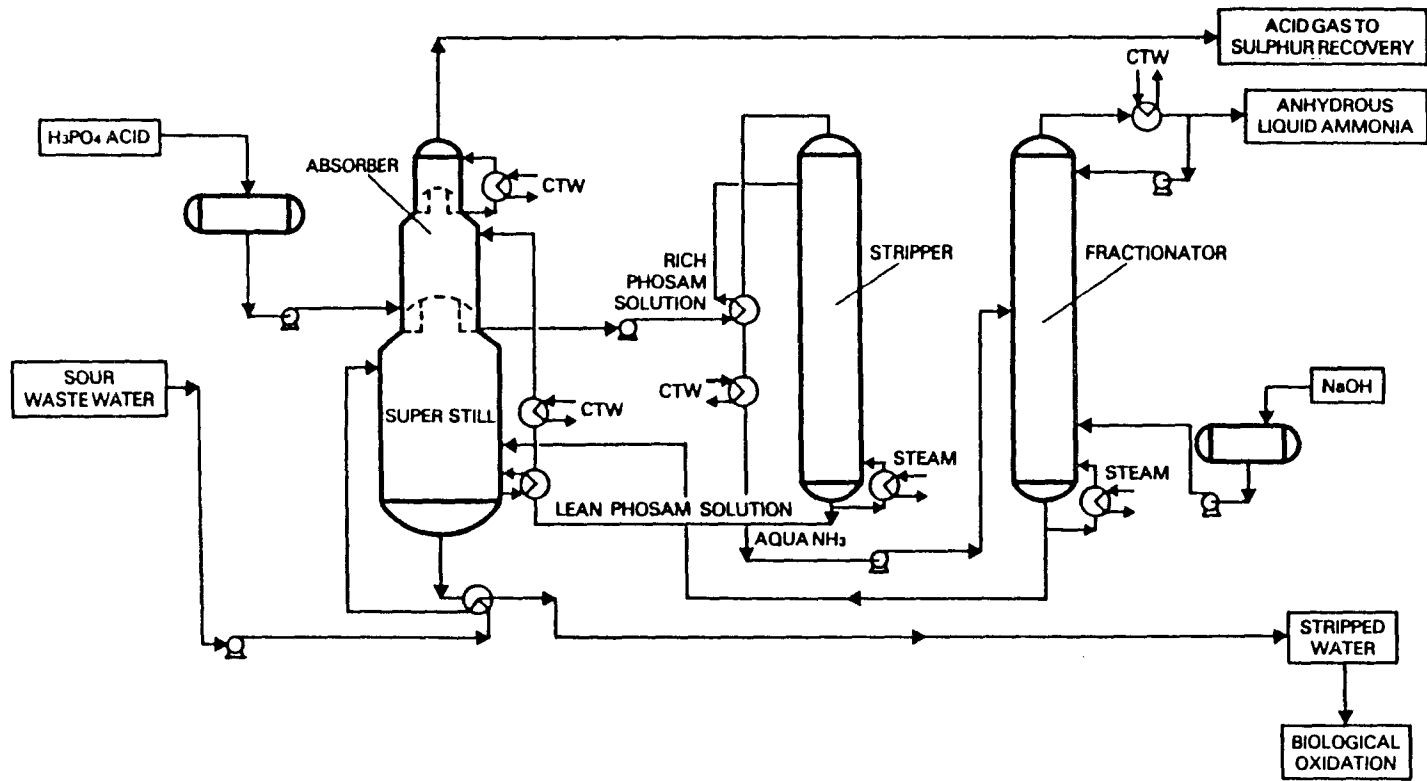

Figure 7-2.
The Phosam-W Process
 (from Eriksson and Prior [39])

7.2.3.2 Chemie Linde Lurgi (CLL) and Waste Water Treating (WWT)

Processes

The CLL process was developed by Chemie Linz AG and LURGI for use in coal upgrading plants. The process is shown in Figure 7-3, as described by Wohler (23). The sour water (gas condensate) is combined with a recycle stream of aqueous ammonium carbonate and fed to a deacidifier column. In the deacidifier column, the acid gases are stripped with steam. The ammonia that is stripped along with the acid gases is then removed from the vapor phase by absorption into a cold water stream.

The bottoms product of the deacidifier is sent to the top of the total stripper. In the total stripper, the ammonia and residual acid gases are removed from solution. The overhead product of the total stripper is fed to a CO₂ scrubber in which the acid gases are removed from the vapor phase by washing with water. Part of the overhead product from the total stripper is condensed in the bottom of the CO₂ scrubber and used as reflux for the total stripper. Near the bottom of the CO₂ column, a stream is removed and sent to an NH₃ stripper to remove excess ammonia. The bottom product of the NH₃ stripper is an aqueous ammonium carbonate stream which is recycled to the acidifier.

The gas stream leaving the top of the CO₂ scrubber is compressed and fed to a distillation column. In the distillation column, ammonia is separated from volatile organic compounds. The ammonia leaving the top of the column is compressed to yield a liquid product.

Figure 7-3.
The CLL Process
(from Wohler [23])

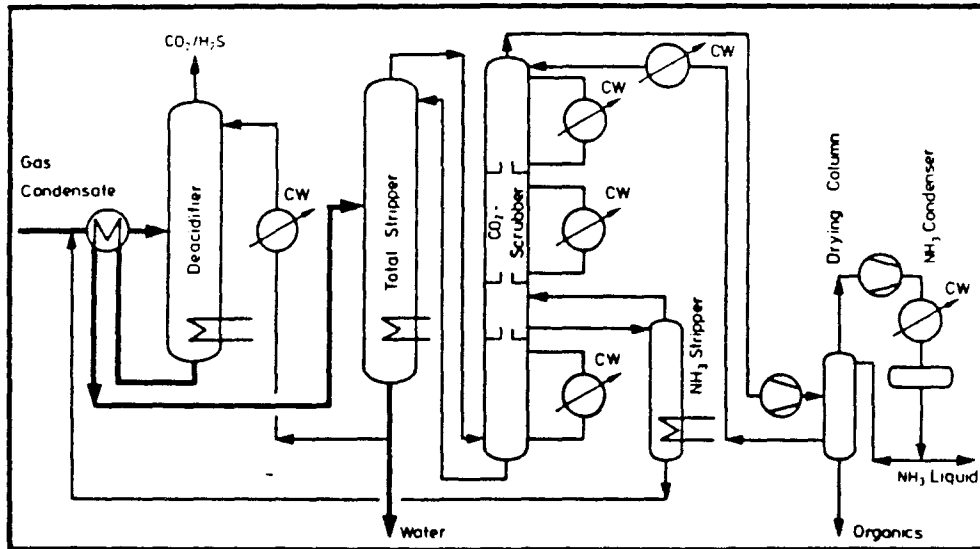
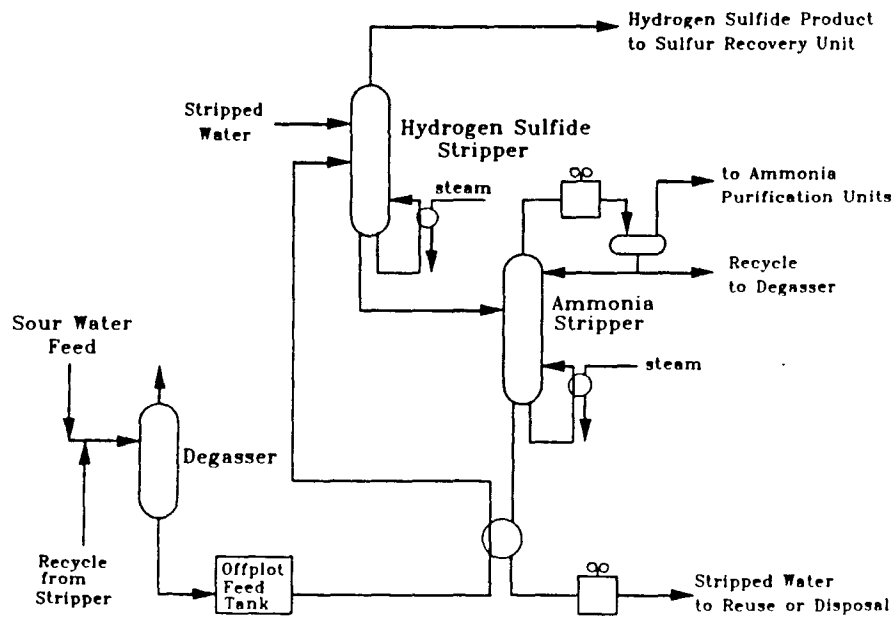

Figure 7-4.
The Chevron WWT Process
(from Leonard et al. [18])



The WWT process was developed by Chevron to treat the sour water generated in petroleum refineries as well as other oil upgrading plants. The process, as shown in Figure 7-4, is similar to the CLL process in that the ammonia is removed from the acid gas stream by washing with water. The acid gases (here, primarily H_2S) are removed in one steam stripper, and the ammonia is removed in a second stripper. After the ammonia leaves the top of the second stripper, it must be scrubbed to remove residual hydrogen sulfide. Typical steam requirements for this process are in the range of 0.27 to 0.44 lb steam/lb feed water. (18)

7.2.3.3 Combined Stripping/Liquid Membrane Extraction Process

A sour water treatment process proposed by Cahn et al. (28) combines steam stripping of acid gases with simultaneous liquid membrane extraction of ammonia. This process is termed "extripping". The simultaneous extraction of ammonia keeps the pH of the water low, favoring the stripping of the acid gases. Cahn et al. also suggest that the treatment of aqueous solutions of weak acids and weak bases can be accomplished by the combination of two other simultaneous separation processes and list distillation, extraction, precipitation, ion exchange, and adsorption as other possibilities.

In the extripping process, the liquid membrane system consists of an water-in-oil emulsion in which the internal phase is an acidic aqueous solution. The unionized forms of H_2S and NH_3 permeate through the oil

layer. The driving force for permeation is the difference in the activity of the unionized species between the outer sour water phase and the inner aqueous phase.

The driving force for ammonia is kept high as a result of two factors: (1) the activity of the free ammonia in the external aqueous phase is kept high due to the simultaneous removal of acid gas (here, H_2S); and (2) the activity of unionized ammonia in the internal aqueous phase is kept low due to the reaction of ammonia with the internal acid solution to form the ammonium ion. Because the hydrogen sulfide remains in molecular form in the internal aqueous phase, the driving force for permeation of H_2S rapidly approaches zero.

If a relatively weak acid (e.g., succinic acid) is used in the internal aqueous phase, it may be possible to regenerate the extract solution, allowing recycle of the aqueous acid solution. In one suggested configuration (40), shown in Figure 7-5, the sour water stream is mixed with the emulsion and fed to the top of a steam stripper. The internal phase of the emulsion initially consists of a 30 wt.% aqueous solution of the monoammonium salt of succinic acid. The acid gases are stripped from the sour water and the NH_3 is extracted into the internal aqueous phase where it reacts to form the diammonium salt of succinic acid.

The treated sour water is separated from the emulsion in a settler. The emulsion is sent to a regeneration tower where ammonia is removed by steam stripping, converting the di-ammonium salt back to the mono-

Figure 7-5.
Combined Stripping/Liquid Membrane Extraction Process
(from Li and Cahn [40])

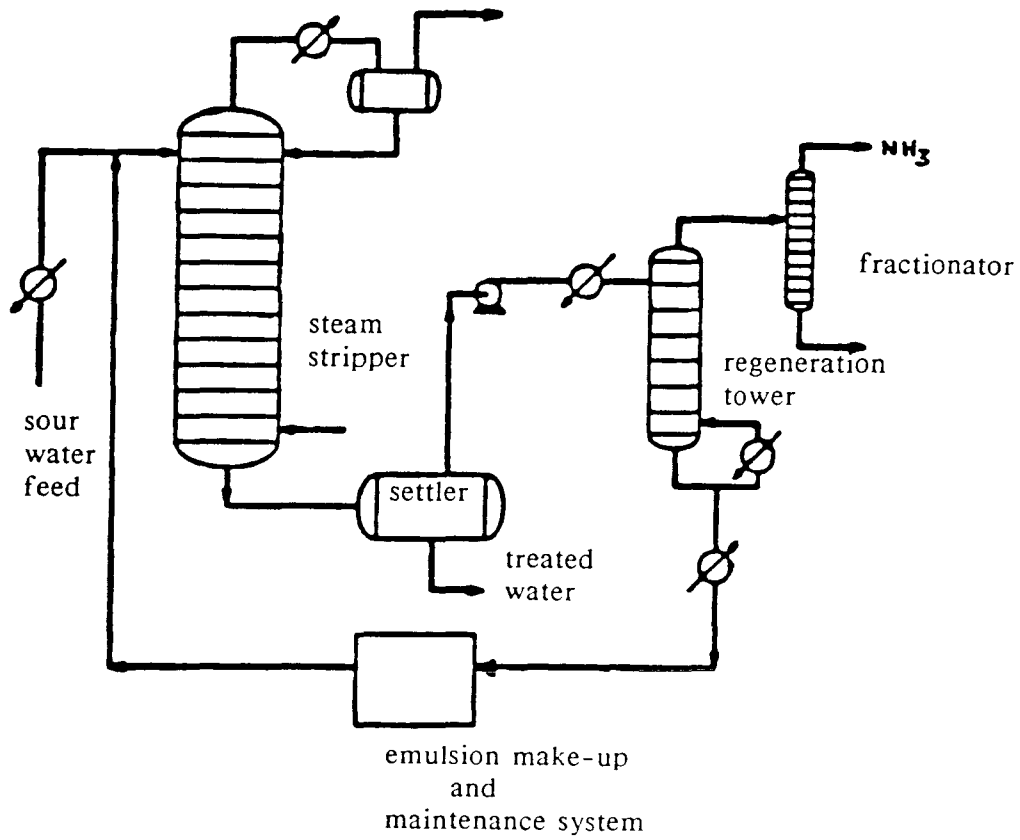

ammonium salt. (No discussion was given by Li and Cahn [40] of possible amide formation upon heating.) The regenerated emulsion solution is sent to an emulsion make-up and maintenance system. This system may include an emulsifier needed to repair emulsion broken in the regeneration tower. The stream leaving the top of the regeneration tower is sent to a fractionator to yield anhydrous ammonia.

A successful industrial implementation of the extripping process must overcome several problems. For example, a means must be found to prevent leakage of the internal aqueous solution into the sour water. Technology for breaking and reforming emulsions is another need.

7.2.3.4 Combined Stripping/Extraction Process

In the combined stripping/extraction process (1,2), as shown in Figure 7-6, the wastewater enters the top of a conventional stripping column. As the water flows downward, acid gases are stripped and the pH of the water is raised. The liquid is removed at various points in the column and passes through extractors where liquid/liquid extraction of ammonia by an organic cation-exchanging extractant takes place. This extraction of ammonia is favored at high pH as will be seen in Chapter 10.

As NH_3 is extracted, the pH of the aqueous solution is lowered and the aqueous stream is returned to the acid-gas stripping column. "The net effect is the stripping of the acid gases at a low pH, which enhances their volatility and lowers steam requirements for their removal (2)." The sour

Figure 7-6.
Combined Stripping/Extraction Process
(from Mackenzie [2])

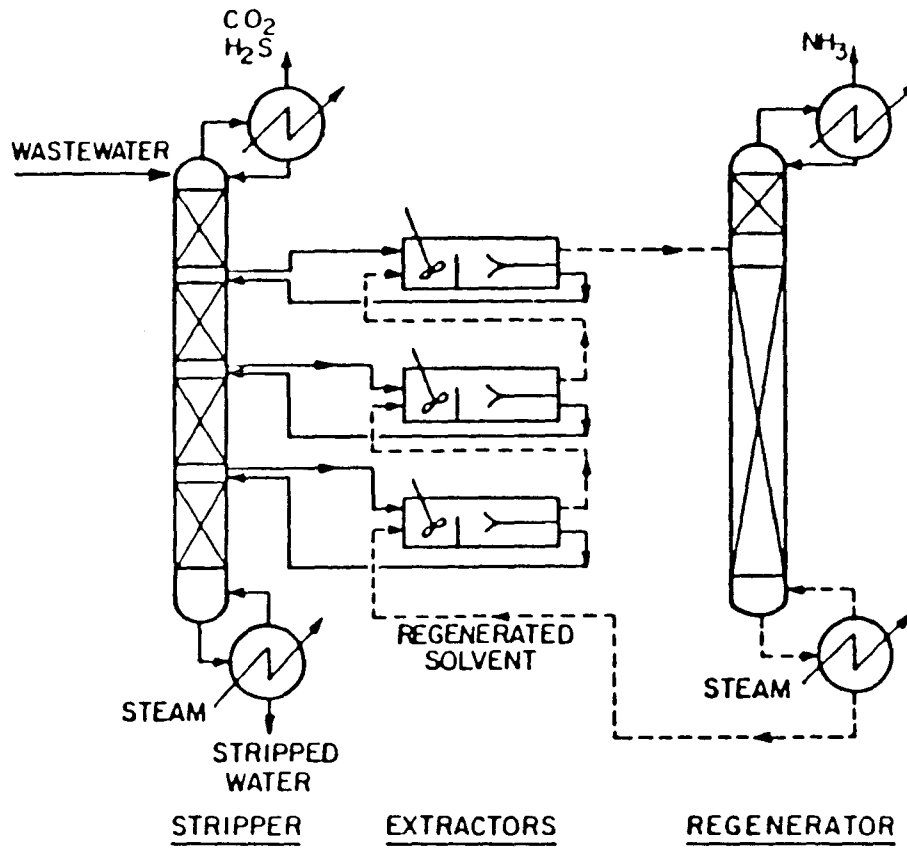

water treatment process should be most effective for treating waters in which the ratio of acid gases to ammonia is such that ammonia is the least volatile compound, which is usually the case with industrial sour waters (2).

The organic extractant solution is thermally regenerated to liberate ammonia and recover the liquid cation exchanger. The liquid cation exchanger used in Mackenzie's work was di-2-ethyl hexyl phosphoric acid (D2EHPA). Experimental work carried out by Mackenzie (1,2) demonstrated that the simultaneous extraction of ammonia enhanced the removal of CO₂ by stripping and enabled the separate recovery of the two compounds.

An overall cost analysis of the combined extraction/stripping process was performed by Mackenzie (2) and the estimated cost of the process per thousand gallons of wastewater was compared to that of the Phosam-W process. The combined extraction/stripping process was found to be less economical due to the amount of energy required to recover the ammonia thermally from the liquid cation exchanger and thus regenerate the extractant, D2EHPA, and also due to the cost of replacing the D2EHPA that would be lost to the aqueous phase during ammonia extraction. From the results of a process analysis, Mackenzie determined that in order for the combined extraction/stripping process to be economically feasible, a liquid cation exchanger is needed that is more thermally stable, less water soluble, and/or weaker in acidity than D2EHPA.

7.3 Identification of an Alternative Liquid Cation Exchanger to be used in the Combined Stripping/Extraction Process

In this work, the feasibility of using a di-alkyl phosphinic acid as the liquid cation exchanger for ammonia is explored. The ability of the phosphinic acid to extract ammonia from a buffer solution of the appropriate pH range and the thermal regenerability of the ammonia/acid ion pair were the most important factors for investigation. The phosphinic acid used was Cyanex 272 (di-2,4,4-trimethylpentyl phosphinic acid) obtained from American Cyanamid Company. The criteria used in selecting Cyanex 272 as the liquid cation exchanger are reviewed in Chapter 8.

The results of experiments in which Cyanex 272 was used to extract NH_3 from a buffer solution are discussed in Chapter 10. In Chapter 11, the results of experiments in which the organic phase containing the extracted ammonia was heated to drive off the NH_3 and regenerate the extractant are discussed, as well as the results of experiments conducted to test the thermal stability of Cyanex 272. The experimental procedures and analytical methods used are described in Chapter 9.

The process as a whole is examined in Chapter 12. The economic viability of the combined stripping/extraction process using Cyanex 272 as the liquid cation exchanger is assessed and compared to that of the Phosam-W and WWT processes.

REFERENCES

1. Mackenzie, P.D. and King, C.J., "Combined Solvent Extraction and Stripping for Removal and Isolation of Ammonia from Sour Waters", Ind. Eng. Chem. Process Des. Dev., Vol. 24, No. 4, 1192-1200 (1985).
2. Mackenzie, P.D., "Simultaneous Stripping and Solvent Extraction for the Recovery of Ammonia and Acid Gases from Wastewaters", Ph.D. Dissertation, Department of Chemical Engineering, University of California, Berkeley (1984). LBL-17740.
3. Probst, R.F. and Hicks, R.E., Synthetic Fuels, McGraw Hill, New York (1982).
4. Mohr, D.H., Jr., and King, C.J., "Identification of Polar Organic Compounds in Coal-Gasification Condensate Water by Gas Chromatography-Mass Spectrometry Analysis of High-Performance Liquid Chromatography Fractions", Environ. Sci. & Technol., 19(10), 929-935 (1985).
5. Mohr, D.H., Jr., "Identification and Separation of the Organic Compounds in Coal-Gasification Condensate Waters", Ph.D. Dissertation, Department of Chemical Engineering, University of California, Berkeley (1983). LBL-15869.
6. Senetar, J.J., "Characterization and Treatment of Coal-Gasification Condensate Waters", Ph.D. Dissertation, Department of Chemical Engineering, University of California, Berkeley (1986).
7. Verhoff, F.H. and Choi, M.K., "Sour Water Stripping of Coal Gasification Waste Water", Department of Chemical Engineering, West Virginia University, Morgantown (1979). METC/CR-79/23.
8. "In Fact: Great Plains Project Starts on the Road to Profitability", Chem. Eng. Prog., 7 (September, 1989).
9. Berkowitz, N., An Introduction to Coal Technology, Academic Press (1979).
10. Neavel, R.C., "Exxon Donor Solvent Liquefaction Process", New Coal Chemistry, Royal Society, London (1981).
11. Cotter, J.E., Shih, C.C., St. John, B., "Initial Effort on a Pollution Control Guidance Document; Direct Liquefaction", Symposium Proceedings: Environmental Aspects of Fuel Conversion Technology, V (September 1980, St. Louis, MO), U.S. EPA, Office of Research and Development (January, 1981). EPA-600/9-81-006.

12. Drummond, C.J. and Noceti, R.P., "The Treatment of Coal Liquefaction Process Wastewaters", Processing Needs and Methodology for Contaminated Water Streams from Synfuels Processes, King, C.J., Lynn, S., and Mohr, D.H., Jr., Eds., U.S. Dept. of Energy, Environmental Control Technology Division (November, 1981). DOE/METC-83-61.
13. Murphy, C.L., "Hot Gas Stripping of Ammonia and Carbon Dioxide from Simulated and Actual In Situ Retort Waters", Ph.D. Dissertation, Department of Chemical Engineering, Colorado School of Mines (c1979).
14. Wen, C.S. and Yen, T.F., "Purification and Recovery of Economic Materials from Oil Shale Retort Water by an Electrolytic Treatment Process", Proceedings, 2nd Pacific Chemical Engineering Conference, PACHEC-77, Denver, CO, American Institute of Chemical Engineers (August, 1977).
15. Farrier, D.S., Poulson, R.E., Skinner, Q.D., Adams, J.C., and Bower, J., "Acquisition, Processing and Storage for Environmental Research of Aqueous Effluents Derived from In Situ Oil Shale Processing", Proceedings, 2nd Pacific Chemical Engineering Conference, PACHEC-77, Denver, CO, American Institute of Chemical Engineers (August, 1977).
16. Farrell, T.R., "Selective Removal and Recovery of Ammonia and Hydrogen Sulfide", U.S. Patent No. 4,414,103 (Nov. 8, 1983).
17. Beychok, M.R., Aqueous Wastes from Petroleum and Petrochemical Plants, John Wiley & Sons, London (1967).
18. Leonard, J.P., Haritatos, N.J., and Law, D.V., "Treating Acid and Sour Gas: Waste Water Treating Process", Chem. Eng. Prog., 57-60 (October, 1984).
19. United Nations/Economic Commission for Europe, Low-Waste and Non-Waste Technology in the Iron and Steel Industry, New York (1981). ECE/STEEL/32.
20. Cannon, J.S., Environmental Steel, Pollution in the Iron and Steel Industry, Halloran, J.M., Ed., The Council on Economic Priorities (1973).
21. United Nations/Economic Commission for Europe, Problems of Air and Water Pollution Arising in the Iron and Steel Industry, New York (1970). ST/ECE/STEEL/32.
22. King, C.J., Lynn, S., and Mohr, D.H., Jr., Processing Needs and Methodology for Contaminated Water Streams from Synfuels Processes, U.S. Dept. of Energy, Environmental Control Technology Division (November, 1981). DOE/METC-83-61.
23. Wohler, F., "Removal and Recovery of Phenol and Ammonia from Gas Liquor", CHEMSA, Vol. 5, No. 2, 71-73 (1979).

24. Bell, N.E., "Solvent Extraction of Phenolics from Water", M.S. Thesis, Department of Chemical Engineering, University of California, Berkeley (1980).
25. MacGlashan, J.D., Bixby, J.L., and King, C.J., "Separation of Phenols from Dilute Aqueous Solution by Use of Tri-n-octyl Phosphine Oxide as Extractant", Solvent Extraction and Ion Exchange, 3(1&2), 1-25 (1985).
26. MacGlashan, J.D., "Extraction of Phenols from Water with Tri-Octyl Phosphine Oxide", M.S. Thesis, Department of Chemical Engineering, University of California, Berkeley (1982).
27. Edwards, T.J., Maurer, G., Newman, J., and Prausnitz, J.M., "Vapor-Liquid Equilibria in Multicomponent Aqueous Solutions of Volatile Weak Electrolytes", AIChE Journal, Vol. 24, No. 6, 966-976 (November, 1978).
28. Cahn, R.P., Li, N.N., and Minday, R.M., "Removal of Ammonium Sulfide from Wastewater by Liquid Membrane Process", Environ. Sci. & Technol., Vol. 12, No. 9, 1051-1056 (September, 1978).
29. Hill, J.D., "Stripping of Process Condensates from Solid Fuel Conversion", M.S. Thesis, Department of Chemical Engineering, University of California, Berkeley (1980). LBL-11031.
30. Darton, R.C., van Grinsven, P.F.A., and Simon, M.M., "Development in Steam Stripping of Sour Water", The Chemical Engineer, No. 339, 923-927 (December, 1978).
31. Seufert, F.B., Hicks, R.E., Wei, I.W., and Goldstein, D.J., "Conceptual Designs for Water Treatment in Demonstration Plants", U.S. Dept. of Energy (March, 1979). FE-2635-TI.
32. Van Krevelen, D.W., Hoftijzer, P.J., and Huntjens, F.J., "Composition and Vapour Pressures of Aqueous Solutions of Ammonia, Carbon Dioxide and Hydrogen Sulphide", Rec. Trav. Chim., Vol. 68, 191-216 (1949).
33. Pawlikowski, E.M., Newman, J., and Prausnitz, J.M., "Vapor-Liquid Equilibrium Calculations for Aqueous Mixtures of Volatile, Weak Electrolytes and other Gases for Coal-Gasification Processes", Chemical Engineering Thermodynamics, Newman, S.A., Ed., Ann Arbor Science Publishers, Chapter 27, 323-337 (1982).
34. Melin, G.A., Niedzwiecki, J.L., and Goldstein, A.M., "Optimum Design of Sour Water Strippers", Chem. Eng. Prog., 78-82 (June, 1975).
35. Pawlikowski, E.M., "Vapor-Liquid Equilibria for Volatile, Weak Electrolytes in Aqueous Solutions", Ph.D. Dissertation, Department of Chemical Engineering, University of California, Berkeley (1981).
36. Harvey, A., Department of Chemical Engineering, University of California, Berkeley, personal communication (1987).

37. Rice, R.D., and Busa, J.V., "Treating Acid & Sour Gas: Recovering NH_3 by the PHOSAM-W Process", Chem. Eng. Prog., 61-63 (October, 1984).
38. Water Purification Associates, "Water Conservation and Pollution Control in Coal Conversion Processes", U.S. EPA (June, 1977). EPA-600/7-77-065.
39. Eriksson, S., and Prior, M., "Treatment of Liquid Effluents from Coal Gasification Plants", Economic Assessment Service (March, 1979). EAS B2/79.
40. Li, N.N. and Cahn, R.P., "Process for Removing the Salt of a Weak Acid and a Weak Base from Solution", U.S. Patent No. 4,029,744 (June 14, 1977).

CHAPTER 8. IDENTIFICATION OF A THERMALLY STABLE LIQUID CATION EXCHANGER FOR AMMONIA

This chapter discusses the criteria used in selecting an appropriate liquid cation exchanger for use in the proposed sour water treatment process. Various classes of organic acids are examined with respect to the desired characteristics of the liquid cation exchanger. Di-alkyl phosphinic acids possess the desired characteristics, with di-2,4,4-trimethylpentyl phosphinic acid being suitable for exploratory use in the combined stripping/extraction process.

8.1 Liquid Cation Exchangers

The ammonia recovery method examined in this work involves extraction of ammonia from sour waters into an organic solution of a liquid cation exchanger followed by thermal regeneration of the organic solution to recover the ammonia and regenerate the extractant. Sour waters are buffered at a pH value ranging from 7.5 to 9.5. In this pH range, a certain proportion of the ammonia will be present in the ammonium ion form. Liquid cation exchangers are compounds that are capable of extracting cations from aqueous solution by an ion-exchanging mechanism. Liquid cation exchangers include carboxylic acids, sulfonic acids, and organophosphorus acids.

One factor (other factors are discussed in Chapter 10) affecting the extraction characteristics of an organic acid for a particular cation is the

pK_a of the acid. In general, the order of pK_a increase (corresponding to acid strength decrease) is as follows: sulfonic acids/organophosphorus acids/carboxylic acids (1). Within each category of acid type, there is a range of possible pK_a values, depending on the chemical structure of the acid. Mackenzie (2,3) and Tunick et al. (4) both found that, in general, ammonia extractability increases with the acid strength of the extractant.

8.2 Desired Characteristics

The combined stripping/extraction process as proposed by Mackenzie (2,3) and discussed in Chapter 7, Section 2.3.4, requires a liquid cation exchanger with specific properties which will now be described. A liquid cation exchanger is needed that can effectively extract ammonia with a reasonable solvent to water ratio (i.e., between 0.1 and 1). The extractant should also have low solubility in water. The liquid cation exchanger must form an ion pair with the ammonium ion, and it must be possible to decompose the ion pair thermally to yield ammonia. The cation exchanger must be thermally stable at the temperature required to carry out this regeneration. In order for the sour water treatment process to be economical, the liquid cation exchanger should be commercially available and relatively inexpensive.

Most commercially available liquid cation exchangers have high viscosity and thus are generally used in diluted form. The properties of the extractant/diluent mixture should be chosen to yield good phase separation between the organic and aqueous phases.

8.3 Carboxylic Acids

Mackenzie (2,3) examined the extraction capacity of neodecanoic and decanoic acid for ammonia. Table 8-1 shows the distribution ratio for ammonia (ratio of ammonia concentration in the organic phase to ammonia concentration in the aqueous phase, where here the concentrations are on a molar basis), K_c , for systems in which a carboxylic acid (either neodecanoic acid or decanoic acid) is used as the extractant. Also shown are results for the system in which di-2-ethylhexyl phosphoric acid (D2EHPA) is used as the extractant. The organic phase consisted of the extractant in a diluent mixture of 50% (v/v) decanol in toluene. The initial aqueous ammonia solution consisted of an ammonium bicarbonate solution containing 0.58M ammonia. An organic to aqueous (S/W) phase ratio of 5 was used.

The K_c values for the two carboxylic acids are too low for effective extraction of ammonia. Carboxylic acids of greater acidic strength should result in higher K_c values. The length of the carbon chain has only a slight effect on the pK_a of an aliphatic mono-carboxylic acid (1); for low pK_a values, one needs to turn to substituted carboxylic acids or di-carboxylic acids. α -Halo carboxylic acids have been used as extractants for metal ions from aqueous solution (5,6).

Substituted carboxylic acids tend to be chemically reactive. For example, α -halo carboxylic acids can react with ammonia to form α -amino acids through a reaction in which the ammonia molecule replaces the

**Table 8-1. Comparison of Liquid Cation Exchangers
as Extractants for Ammonia**

Diluent: 50% (v/v) Decanol in Toluene
S/W (v/v) = 5
(from Mackenzie [2])

<u>Extractant</u>	<u>Concentration of Extractant (mol/l)</u>	<u>pK_a of Extractant</u>	<u>K_c^a</u>
neodecanoic acid	0.27	7.1 ^b	0.034
decanoic acid	0.27	6.3 ^c	0.12
D2EHPA	0.21	3.6 ^d	6.1

^a at 25°C

^b in 50% (v/v) 2-propanol, at 25°C, from ref. 8

^c in 50% (v/v) 2-propanol, at 20°C, from ref. 5

^d in 75% (v/v) 2-propanol, at 25°C, from ref. 9

halogen atom (7). In addition, carboxylic acids can react with ammonia to form amides, as was discussed in Chapter 2. For these reasons, carboxylic acids were not considered for use as extractants for ammonia.

8.4 Sulfonic Acids

Dinonylnaphthylene sulfonic acid (DNNSA) is a commercially available liquid cation exchanger that is used as an extractant for metals from aqueous solution (10). Mackenzie (2,3) found DNNSA to be a strong extractant for ammonia; however, the ionic bond that formed between the acid and the ammonium ion could not be broken by heating. Mackenzie (2) also determined that "...ammonia cannot be stripped from a DNNSA-containing solvent without massive thermal decomposition of the extractant." Therefore, DNNSA is not suitable for use in the combined stripping/extraction process.

In general, sulfonic acids are strong acids, comparable to sulfuric acid (11). The experimental results of Mackenzie (3) indicate that DNNSA has a pK_a value less than 1. In the sour water treatment process, the need for good extraction of ammonia combined with the need for thermal regenerability of the ion pair leads to the requirement for a cation exchanger with a pK_a value within a certain range. The pK_a needs to be low enough that the ion pair is formed at a pH which is only slightly less than the pH of the sour water. At the same time, the pK_a needs to be high enough to allow thermal regeneration of the liquid cation exchanger. As seen in the previous section, the pK_a values of aliphatic carboxylic acids

are too high for good extraction of ammonia from waters of the pH range of sour waters. DNNSA, on the other hand, is too strong an acid (the pK_a value is too low) in that the bond formed between ammonia and the acid can not be broken by heating. Organophosphorus acids have pK_a values intermediate between those of aliphatic carboxylic acids and sulfonic acids.

8.5 Organophosphorus Acids

The three main classes of organophosphorus acids commonly used as extractants are: phosphoric acids, phosphonic acids, and phosphinic acids (10). Table 8-2 shows the structures of some of these compounds, where the R groups are alkyl groups. The R groups on a dialkyl acid can have either the same or different structures. In general, the order of pK_a increase is as follows: alkylphosphoric acids/alkylphosphonic acid esters and alkylphosphonic acids/alkylphosphinic acids (12).

Organophosphoric and organophosphonic acids are used as extractants for lanthanides (13) and for the separation of lanthanides and actinides (14). The ability of a phosphonic acid ester to extract molybdenum from acidic solution was examined by Sato et al. (15).

8.5.1 Organophosphoric Acids

Mackenzie (2,3) carried out studies using di-2-ethylhexyl phosphoric acid (D2EHPA) and di-octylphenyl phosphoric acid (OPAP) as extractants for ammonia. Compared to OPAP, D2EHPA gave lower aqueous solubility losses;

Table 8-2. Some Organophosphorus Acid Extractants
(from Ritcey and Ashbrook [10])

<u>ACID</u>	<u>STRUCTURE</u>
dialkylphosphoric acid	$\begin{array}{c} \text{RO} \quad \text{O} \\ \quad \quad // \\ \quad \quad \text{P} \\ \quad \quad \backslash \\ \text{RO} \quad \text{OH} \end{array}$
monoalkylphosphoric acid	$\begin{array}{c} \text{RO} \quad \text{O} \\ \quad \quad // \\ \quad \quad \text{P} \\ \quad \quad \backslash \\ \text{HO} \quad \text{OH} \end{array}$
alkylphosphonic acid ester (or alkyl alkylphosphonic acid)	$\begin{array}{c} \text{R} \quad \text{O} \\ \quad \quad // \\ \quad \quad \text{P} \\ \quad \quad \backslash \\ \text{RO} \quad \text{OH} \end{array}$
alkylphosphonic acid	$\begin{array}{c} \text{R} \quad \text{O} \\ \quad \quad // \\ \quad \quad \text{P} \\ \quad \quad \backslash \\ \text{HO} \quad \text{OH} \end{array}$
dialkylphosphinic acid	$\begin{array}{c} \text{R} \quad \text{O} \\ \quad \quad // \\ \quad \quad \text{P} \\ \quad \quad \backslash \\ \text{R} \quad \text{OH} \end{array}$
monoalkylphosphinic acid	$\begin{array}{c} \text{R} \quad \text{O} \\ \quad \quad // \\ \quad \quad \text{P} \\ \quad \quad \backslash \\ \text{H} \quad \text{OH} \end{array}$

however, the cost of replacing D2EHPA lost to the aqueous phase during the extraction was found to be significant compared to the overall cost of the combined stripping/extraction process. In addition, the ionic bond that formed between D2EHPA and the ammonium ion was strong enough that there would be a significant energy cost required to regenerate the extractant thermally and recover the ammonia in product form. Thermal decomposition of the acid occurred above about 150°C. The problems encountered during the regeneration step would most likely occur with other organophosphoric acids as well. The pK_a values of alkylphosphoric acids are somewhat too low for facile thermal regeneration of the extractant.

8.5.2 Organophosphonic Acids

The thermal stability of organophosphonic acid esters is not expected to be greater than that of organophosphoric acids since the phosphonic acid esters contain a RO-P bond which is the type of bond that breaks during the thermal decomposition of D2EHPA (3) as well as during the thermal decomposition of orthophosphate esters (16). Alkylphosphonic acids do not contain this RO-P bond; however, these compounds tend to be surfactants, and their use would most likely result in poor phase separation.

8.5.3 Organophosphinic Acids

Organophosphinic acids contain no RO-P bonds, and thus are potentially thermally more stable than organophosphoric acids. Depending

on the structure of the R groups, these compounds are also less water soluble than organophosphoric acids due to the lack of the RO-P linkages. In general, organophosphinic acids are weaker acids than organophosphoric acids, which should facilitate the thermal regeneration of the extractant.

Alkylphosphinic acids have been studied by Peppard et al. (17,18) as extractants for metals from aqueous solution. A comparison was made by Alexandratos and Quillen (19) of the metal ion complexing ability of ion-exchange resins containing phosphinic acid functional groups with that of resins containing sulfonic acid functional groups. Di-2,4,4-trimethylpentyl phosphinic acid can be used to separate cobalt from nickel in sulfate solution (10,12) and was examined by Inoue et al. (20) as an extractant for ammonia from aqueous ammonium nitrate/ammonia solution.

Di-2,4,4-trimethylpentyl phosphinic acid was chosen as a potential liquid cation exchanger for use in the combined stripping/extraction process. The commercial product, Cyanex 272, is manufactured by Cyanamid. Table 8-3 compares Cyanex 272 to D2EHPA, the extractant used by Mackenzie (2,3).

Cyanex 272 consists of 85 wt.% of the active ingredient, as well as approximately 10 wt.% of the corresponding tertiary phosphine oxide and less than 0.5 wt.% of the corresponding phosphonic acid in a Varsol (Exxon) diluent (9). Tertiary phosphine oxides are known to have high thermal stability, their decomposition temperature being "...several hundred degrees higher than that of amine oxides" (21), and therefore the thermal stability

Table 8-3.
Comparison of Cyanex 272 to D2EHPA

	CYANEX 272	D2EHPA
ACTIVE INGREDIENT:	Dialkyl Phosphinic Acid	Dialkyl Phosphoric Acid
	$\begin{array}{c} \text{R} \quad \text{O} \\ \diagdown \quad // \\ \text{P} \\ \diagup \quad \backslash \\ \text{R} \quad \text{OH} \end{array}$	$\begin{array}{c} \text{RO} \quad \text{O} \\ \diagdown \quad // \\ \text{P} \\ \diagup \quad \backslash \\ \text{RO} \quad \text{OH} \end{array}$
	$\text{R} = \text{CH}_3 - \underset{\text{CH}_3}{\overset{\text{CH}_3}{\text{C}}} - \text{CH}_2 - \underset{\text{CH}_3}{\text{CH}} - \text{CH}_2$	$\text{R} = \text{CH}_3\text{CH}_2\text{CH}_2\text{CH}_2 - \underset{\text{CH}_3}{\overset{\text{CH}_3}{\text{CH}}} - \text{CH}_2$
pK _a ¹ :	5.9	3.6
THERMAL STABILITY:	Higher than D2EHPA?	Decomposes excessively at temperatures above about 150°C
COST:	\$20/lb for quantities ² less than 2 metric tons \$12.5/lb for 10-20 metric tons \$10/lb for more than 20 metric tons	\$4.5/lb for quantities ³ less than 0.6 metric tons \$2.8/lb for 0.6-9 metric tons \$2.65/lb for more than 9 metric tons

1. in 75% 2-propanol, from ref. 9

2. American Cyanamid Company, 1989

3. Albright and Wilson, Americas, 1989

of the phosphinic acid should be the limiting factor in determining the range of possible temperatures at which thermal regeneration of the loaded extractant can be conducted.

REFERENCES

1. Blumberg, R., Liquid-Liquid Extraction, Academic Press, Harcourt Brace Jovanovich, New York (1988).
2. Mackenzie, P.D. and King, C.J., "Combined Solvent Extraction and Stripping for Removal and Isolation of Ammonia from Sour Waters", Ind. Eng. Chem. Process Des. Dev., Vol. 24, No. 4, 1192-1200 (1985).
3. Mackenzie, P.D., "Simultaneous Stripping and Solvent Extraction for the Recovery of Ammonia and Acid Gases from Wastewaters", Ph.D. Dissertation, Department of Chemical Engineering, University of California, Berkeley (1984). LBL-17740.
4. Tunick, A.A., Koff, F.W., and Sifniades, S., "Hydroxylamine Purification via Liquid-Liquid Extraction", U.S. Patent No. 4,166,842 (Sept. 4, 1979).
5. Preston, J.S., "Solvent Extraction of Nickel and Cobalt by Mixtures of Carboxylic Acids and Non-Chelating Oximes", Hydrometallurgy, 11, 105-124 (1983).
6. Blumberg, R., and Melzer, P., "Recovery of Common Metals by a Solvent Process", Trans. Intern. Mineral Dressing Congr. 1964, Part 3: Chemical Processing, 139-145 (1965).
7. Streitweiser Jr., A., and Heathcock, C.H., Introduction to Organic Chemistry, Macmillan, New York (1976).
8. Ashbrook, A.W., "The Extraction of Metals from Ammonium Sulphate Solution Using a Carboxylic Acid-I. Cobalt", J. Inorg. Nucl. Chem., Vol. 34, 1721-1737 (1972).
9. Robertson, A., Cyanamid Canada Inc., Niagara Falls, Ontario, personal communication (1985).
10. Ritcey, G.M. and Ashbrook, A.W., Process Metallurgy I, Solvent Extraction, Principles and Applications to Process Metallurgy, Elsevier Science Publishing Company Inc., New York, Part 1, Chapter 3, 87-171 (1984).
11. Shultz, A., "Sulfonic Acids", in Kirk-Othmer Encyclopedia of Chemical Technology, 3rd ed., Vol. 22, 45-63 (1983).
12. Danesi, P.R., Reichley-Yinger, L., Mason, G., Kaplan, L., Horwitz, E.P., and Diamond, H., "Selectivity-Structure Trends in the Extraction of Co(II) and Ni(II) by Dialkyl Phosphoric, Alkyl Alkylphosphonic, and Dialkylphosphinic Acids", Solvent Extraction and Ion Exchange, 3(4), 435-452 (1985).

13. Kolarik, Z., Drazanova, S., and Chotivka, V., "Acidic Organophosphorus Extractants-XII, Effect of the Extractant Structure on the Extraction of Lanthanides(III)", J. Inorg. Nucl. Chem., Vol. 33, 1125-1133 (1971).
14. Ferraro, J.R., Peppard, D.F., and Mason, G.W., "Physical Studies of Organophosphorus Acids of the Type (RO)PO(OH)₂ and (R)PO(OH)₂", J. Inorg. Nucl. Chem., Vol. 27, 2055-2063 (1965).
15. Sato, Y., Valenzuela, F., Tsuneyuki, T., Kondo, K., and Nakashio, F., "Extraction Equilibrium of Molybdenum(VI) with 2-Ethylhexyl Phosphonic Acid Mono-2-Ethylhexyl Ester", Journal of Chemical Engineering of Japan, Vol. 20, No. 3, 317-321 (1987).
16. Gamrath, H.R., Hatton, R.E., and Weesner, W.E., "Chemical and Physical Properties of Alkyl Aryl Phosphates", Ind. Eng. Chem., Vol. 46, No. 1, 208-212 (1954).
17. Peppard, D.F., Mason, G.W., and Andrejasich, C., "Two Mono-Octyl Phosphinic Acids, (R)(H)PO(OH), as Extractants for Metallic Cations. Selected M(II), M(III) and M(IV) Tracer Studies", J. Inorg. Nucl. Chem., Vol. 28, 2347-2359 (1966).
18. Peppard, D.F., Mason, G.W., and Lewey, S., "Di n-Octyl Phosphinic Acid as a Selective Extractant for Metallic Cations. Selected M(III) and M(VI) Tracer Studies", J. Inorg. Nucl. Chem., Vol. 27, 2065-2073 (1965).
19. Alexandratos, S.D., and Quillen, D.R., "Mechanism of Polymer-Based Separations. I. Comparison of Phosphinic Acid with Sulfonic Acid Ion Exchange Resins", Solvent Extraction and Ion Exchange, 7(3), 511-525 (1989).
20. Inoue, K., Nakayama, D., and Watanabe, Y., "Extraction Equilibria of Ammonia with Acidic Organophosphorus Compounds", Hydrometallurgy, 16, 41-53 (1986).
21. "Phosphine Chemicals: The Chemistry", American Cyanamid Company, Specialty Products Department, Wayne, New Jersey (1980).

CHAPTER 9. EXPERIMENTAL PROCEDURES AND EQUIPMENT

To test the feasibility of using Cyanex 272 as the liquid cation exchanger for ammonia in the combined stripping/extraction process, the following experiments were conducted:

1. extraction experiments in which Cyanex 272 in an organic diluent is used to extract ammonia from an aqueous buffer solution;
2. thermal regeneration experiments in which the loaded organic phase is heated to recover the ammonia and regenerate the extractant; and
3. thermal stability tests to determine whether the regeneration can be carried out without thermal decomposition of the liquid cation-exchanger.

This chapter describes the experimental procedures and analytical methods used in these experiments.

9.1 Reagents Used

The reagents used and their sources are given in Table 9-1. The liquid cation exchanger (the phosphinic acid) was used both in the as-received (85 wt.%) form and in purified forms. All other reagents were used as received.

**Table 9-1.
Source and Description of Chemicals Used**

<u>Compound</u>	<u>Supplier</u>	<u>Description</u>
Cyanex 272	American Cyanamid Company	85 wt.% di-2,4,4- trimethylpentyl phosphinic acid
Norpar 12	King Industries and Exxon Company, U.S.A.	straight-chain C ₁₀ -C ₁₃ hydrocarbons
n-Undecane	The Humphrey Chemical Company	99% purity
Toluene	Mallinckrodt	reagent grade
Cyclohexane	Mallinckrodt	reagent grade
Acetone	Fisher-Scientific	reagent grade
Diethyl ether	Fisher-Scientific	reagent grade
N-Methyl-N- (<i>tert</i> -butyldimethylsilyl) trifluoroacetamide (MTBSTFA)	Pierce Chemical Company	98.7% purity
Acetonitrile	Pierce Chemical Company	water-free silylation grade solvent
Silyl-8	Pierce Chemical Company	GC column conditioner

9.2 Equipment

Gas chromatography (GC) analysis was carried out using a Varian model 3700 chromatograph with an FID detector and a Hewlett-Packard 3390A integrator. Samples (1 μ l) were injected into a GC column packed with 5% silicone OV-17 on acid-washed, DMCS-treated, 80/100 mesh Chromosorb W (Alltech Associates). The column was 5 ft. stainless steel tubing with an outer diameter of 1/8 in. A glass injector port was used. The injector temperature was 300°C. The column temperature was held at 120°C for 2 minutes and then increased to 240°C at a rate of 5°C/min. Nitrogen was used as the carrier gas. Before each series of runs, the column was conditioned by the injection of 11 μ l of Silyl-8 at a column temperature of 175°C and an injector temperature of 270°C.

All aqueous solutions were prepared with distilled water that had been passed through a Milli-Q water purification system (Millipore Corp.). Aqueous phase pH values were determined using an Orion 701A pH meter equipped with an Orion semimicro Ross pH electrode. Flasks containing two-phase extraction systems were placed in a shaker bath -- either a Fisher Scientific, Versa-Bath S or a Lab-Line, Orbit Water Bath Shaker. Centrifugation was carried out in either a Sorvall, Superspeed centrifuge (model RC-2) or a Damon centrifuge (model IEC HN-SII).

Aqueous phase ammonia concentrations were determined using an Orion ammonia electrode, model 95-10. Calibration curves were generated using 0.0001M, 0.001M, 0.01M, and 0.1M NH_4Cl standard solutions. To adjust the

solution pH to the operating range of the electrode (pH 11 to 14), 1 ml of 10M NaOH was added to each 100 ml of sample or standard immediately before measurement. The ammonia electrode is a gas-sensing electrode designed to measure ammonia concentrations in aqueous solutions. Raising the pH of the solution to the operating range converts the ammonia present in solution to the unionized (volatile) form, the form sensed by the electrode.

9.3 Pretreatment of Cyanex 272

Cyanex 272 consists of 85 wt.% di-2,4,4-trimethylpentyl phosphinic acid (the active ingredient), approximately 10 wt.% of the corresponding tertiary phosphine oxide and less than 0.5 wt.% of the corresponding phosphonic acid (1). The phosphonic acid impurity has a high water solubility and should be removed from the extractant before the extractant is used in the sour water treatment process. The tertiary phosphine oxide is a Lewis base and could serve to solvate the phosphinic acid, thereby lowering its extraction capacity for ammonia. To test this possibility, some extraction data were taken using the purified phosphinic acid and compared to those taken using Cyanex 272.

9.3.1 Washing of Cyanex 272 with Basic Solution

The phosphonic acid impurity present in Cyanex 272 has a first pK_a value of 3 and a second pK_a value between 9 and 10 (1), while the pK_a of the phosphinic acid is equal to 5.9 (all pK_a values were determined in a

mixture of 25% (v/v) water and 75% 2-propanol). The aqueous solubility of acidic extractants has been found to increase with increasing pH, a sharp rise in solubility occurring above the pK_a of the acid (2,3). Successive washings of Cyanex 272 with basic aqueous solution serves to separate the phosphonic acid from the phosphinic acid due to their differences in acid strength.

As-received Cyanex 272 was contacted with 0.05M NH_4HCO_3 in a separatory funnel. An organic-to-aqueous phase ratio of 2/3 was used. The two phases were mixed by shaking and then allowed to settle for 30 minutes. The aqueous phase was withdrawn from the bottom of the separatory funnel and discarded. The organic phase was placed in a centrifuge bottle (Thomas Scientific) and centrifuged at 6500 rpm for 30 minutes to remove entrained water.

The organic phase was then contacted with fresh 0.05M NH_4HCO_3 solution and the steps outlined above were repeated. After each wash, the concentrations of the two acids in the organic phase were measured by GC analysis as described below. After 7 washes, 85% removal of the phosphonic acid impurity was achieved. During the washing process, approximately 10% of the phosphinic acid was lost to the aqueous phase.

During the washing process, ammonia is extracted into the organic phase. After the Cyanex 272 was washed 7 times with 0.05N NH_4HCO_3 , the extractant solution was washed with an equal volume of approximately 5N HCl to remove the extracted ammonia and convert the phosphinic acid back

to the unionized form. As will be seen in Chapter 10, at low aqueous phase pH, ammonia will partition completely into the aqueous phase.

The concentration of phosphinic acid remaining in the extractant solution was confirmed by titration. A 1.5 ml sample of the extractant solution was dissolved in 150 ml of 75% (v/v) 2-propanol and titrated with 0.025N NaOH in 75% (v/v) 2-propanol.

9.3.2 Gas Chromatographic Analysis of the Extractant Solution

Before a sample of the organic phase could be analyzed by GC, the sample was washed with an acid wash to remove any extracted ammonia. The organic extractant solution was then reacted with a silylation reagent to increase the volatility of the phosphorus compounds.

A 5 ml sample of the organic phase was contacted with 5 ml of approximately 5N HCl in a centrifuge tube. The two phases were mixed by stirring with a magnetic stir bar. The two phase system was then centrifuged for 30 minutes at 2000 rpm to separate the phases. Then a 100 μ l sample of the organic phase was added to 100 μ l of acetonitrile and 100 μ l of the silylation reagent, N-Methyl-N-(*tert*-butyldimethylsilyl)-trifluoroacetamide, or MTBSTFA. The resulting solution was stirred for 20 minutes in a 60°C water bath to allow the silylation reactions to occur. Then a 1 μ l sample of the solution was analyzed by GC.

9.3.3 Isolation of the Phosphinic Acid

The phosphinic acid can be separated from the tri-alkyl phosphine oxide present in Cyanex 272 by use of a CuSO_4 purification procedure described in detail by Partridge and Jensen (4). The first two steps of this procedure involved contacting Cyanex 272 in toluene or in cyclohexane with an aqueous CuSO_4 solution and then adding a saturated solution of NaOH to the combined phases. These two steps cause the formation of the sodium salt of the phosphinic acid, which, once formed, extracts the copper from the aqueous phase. The copper replaces the sodium and a copper/phosphinic acid salt is formed.

The organic phase is then separated from the aqueous phase. The subsequent addition of acetone to the organic phase results in precipitation of the copper/phosphinic acid salt. The salt is removed by filtration, and then dissolved in diethyl ether. The resulting organic phase is washed with HCl to convert the phosphinic acid to the free acid form. The diethyl ether is then removed by evaporation.

The CuSO_4 purification procedure was developed by Partridge and Jensen (4) to purify di-2-ethylhexyl phosphoric acid from the commercially available extractant, DEHPA or D2EHPA. When this procedure is used to isolate the di-alkyl phosphinic acid present in Cyanex 272, a low yield of the purified acid is obtained. In this work, only a 17% yield was achieved; in work done by other investigators (5), a 30% yield was obtained.

Upon addition of the NaOH to the 2-phase system, a third phase forms which is most likely a high-pH aqueous emulsion of the tri-alkyl phosphine oxide. This emulsion contains a certain amount of the phosphinic acid. This amount of acid is therefore not carried through the purification procedure. The loss of the phosphinic acid to the emulsion explains the low yield of the purified phosphinic acid achieved using this CuSO_4 purification procedure.

Because the CuSO_4 purification procedure was time-consuming and gave a low yield, we asked American Cyanamid Company to provide a sample of purified phosphinic acid. We obtained from American Cyanamid Company a phosphinic acid extractant solution containing less than 0.5 wt.% of the tertiary phosphine oxide. This purified phosphinic acid was obtained by American Cyanamid Company during the synthesis procedure. The precursor of the phosphinic acid (a dialkyl phosphine) and the precursor of the tertiary phosphine oxide (a trialkyl phosphine) are separated by distillation.

9.4 Extraction Experiments

Extraction experiments were conducted to measure the capability of Cyanex 272 to extract ammonia from aqueous solution. The extraction experiments were conducted at 25°C. The organic extractant solution consisted of either the as-received Cyanex 272, the washed Cyanex 272, or the purified phosphinic acid, in an inert diluent -- either Norpar 12 or undecane. In each case, the initial organic phase contained 0.2N di-2,4,4-

trimethylpentyl phosphinic acid. (The total acidity of the extractant solution containing as-received Cyanex 272 is slightly greater than 0.2N due to the presence of the phosphonic acid impurity.)

The initial aqueous ammonia solution consisted of 0.48M NaOH, 0.36M NaHCO₃, and between 0.13M and 0.15M NH₃ added as (NH₄)₂CO₃. The pH of this solution was approximately equal to 10.5. The distribution of ammonia between this aqueous phase and the organic extractant phase was measured as a function of the aqueous raffinate pH. Different raffinate pH values were obtained by varying the initial pH of the aqueous phase through addition of small amounts of 12.1N HCl (between 0 and 4 ml of HCl were added to 40 ml aqueous ammonia solutions).

The two phases were contacted in a separatory funnel. Organic-to-aqueous phase ratios of either 1 or 4/3 were used. The phases were mixed by shaking and then the two phase system was transferred to an Erlenmeyer flask and placed in a shaker bath (set at approximately 55 rpm) overnight to allow the phases to settle.

Upon removal of the flasks from the shaker bath, the phases were separated by removal of each phase by pipet. The pH of the aqueous phase (the aqueous raffinate) was measured. A 10 ml sample of the aqueous phase was placed in a 40 ml centrifuge tube and centrifuged for 30 minutes at 2000 rpm to remove any entrained organic solution. After centrifugation, any visible organic material that had separated from the aqueous solution was removed by pipet and discarded. The ammonia concentration of the

aqueous raffinate was then measured using the ammonia electrode. As discussed earlier, the ammonia electrode was calibrated for ammonia concentrations between 0.0001 and 0.1M; for samples in which the ammonia concentration was greater than 0.1M, the sample was diluted with water (5 ml of sample was mixed with 25 ml of water) before a measurement was made.

The amount of ammonia extracted into the organic phase was determined by measuring the ammonia concentration of a HCl extract of the organic phase. A 5 ml sample of the organic phase was contacted with 5 ml of approximately 5N HCl in a centrifuge tube. The two phases were mixed by stirring with a magnetic stir bar. The two phase system was then centrifuged for 30 minutes at 2000 rpm to separate the phases. The ammonia-depleted organic phase was then removed by pipet and discarded.

A 1 ml sample of the HCl extract was mixed with 100 ml of water and then the ammonia concentration of the mixture was measured using the ammonia electrode. The dilution of the HCl extract was necessary in order to increase the pH of the sample. Without this dilution, an excessive amount of 10M NaOH would have to be added to the sample to raise the solution pH to the operating range of the ammonia electrode.

The values of the distribution ratio for ammonia, K_c , were calculated as:

$$K_c = \frac{\text{NH}_3 \text{ concentration, organic phase (mol/l)}}{\text{NH}_3 \text{ concentration, aqueous raffinate (mol/l)}} \quad (9-1)$$

and plotted as a function of aqueous raffinate pH. During the extraction experiments, third-phase formation occurred for aqueous pH values above about 8.5. The K_c value was then determined by measurements of the ammonia concentrations in the top and bottom phases.

The distribution ratio of ammonia into the diluent itself -- Norpar 12 or undecane -- was also measured. The aqueous phase consisted of the buffer solution used above. Primarily the unionized form of NH_3 will distribute into an aliphatic hydrocarbon solvent; therefore, HCl was not added to the aqueous phase so that the maximum possible distribution of ammonia between this buffer solution and the diluent could be determined. The procedure outlined in the preceding paragraphs was used to measure the distribution ratio.

9.5 Thermal Regeneration Experiments

Experiments were conducted to determine the ease of ammonia recovery from a loaded organic extract by combined heating and nitrogen stripping of the loaded organic solution. A loaded organic extract was prepared by contacting a solution of as-received Cyanex 272 in Norpar 12 (concentrations of either 0.2N or 0.48N phosphinic acid were used) with an equal volume of aqueous ammonium bicarbonate in a separatory funnel. The 2 phases were mixed by shaking, and the two phase system was then left in the separatory funnel overnight to allow the phases to settle.

A 50% loading of the organic phase was obtained, where

$$\text{loading} = \frac{\text{moles NH}_3 \text{ in the organic phase}}{\text{moles phosphinic acid}} \quad (9-2)$$

by using the K_c values obtained in the extraction experiments described in the previous section to predict the required ammonia concentration in the initial aqueous phase. Organic extractant solutions containing 0.2N phosphinic acid were contacted with 0.5N NH_4HCO_3 ; organic extractant solutions containing 0.48N phosphinic acid were contacted with 0.7N NH_4HCO_3 . To confirm that the desired loading had been obtained, the concentrations of ammonia in the loaded organic phase and in the aqueous raffinate were measured using the procedure outlined in the previous section.

The loaded solvent was then heated and stripped with nitrogen to remove the ammonia and regenerate the extractant solution. The apparatus used in these experiments is shown in Figure 9-1.

The loaded solvent (either 80 ml or 100 ml) was placed in a 250 ml 3-neck flask in an oil bath heated to either 120°C or 125°C. The oil bath was heated to the desired temperature using a combination hot plate/magnetic stirrer (Corning, PC-101) and maintained at that temperature by use of a 250 watt blade heater connected to a temperature controller (Hallikainen Model 1140). The oil bath was stirred with a magnetic stir bar.

Figure 9-1.
Apparatus for Thermal Regeneration Experiments

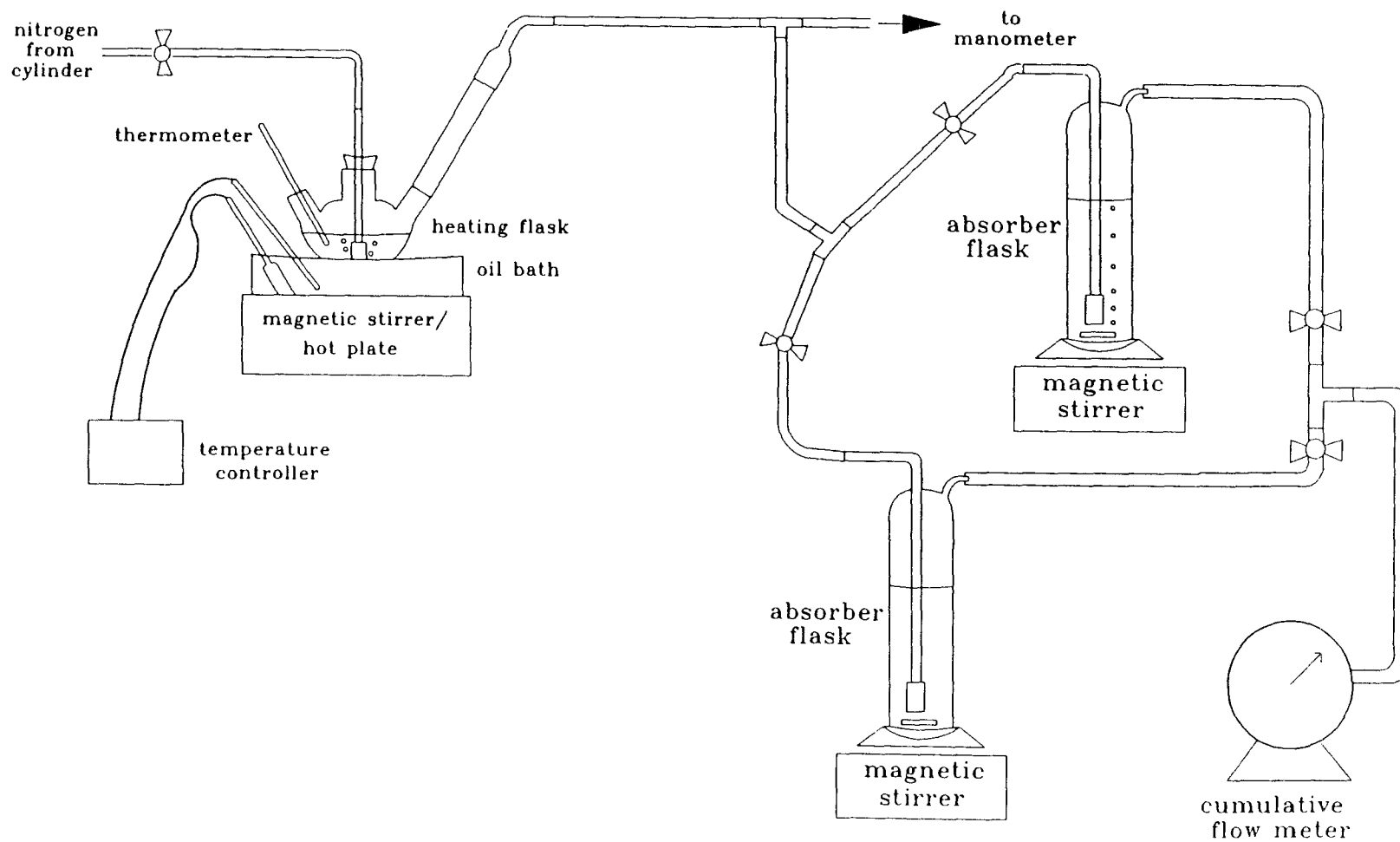

A sparger was used to bubble nitrogen through the solvent. The nitrogen then passed through one of two flasks containing dilute sulfuric acid, which served to absorb NH_3 from the gas stream. The nitrogen leaving the absorber flask then passed through a cumulative flow meter (wet-test gas meter, American Meter Company). Nitrogen flow rates of approximately $0.013\text{--}0.014\text{ ft}^3/\text{min}$ was used.

At the beginning of an experimental run, each absorber flask was filled with 400 ml of H_2SO_4 concentrated enough to neutralize 10% of the NH_3 initially present in the loaded organic solution. Methyl red was added to the solution to serve as an indicator. When 10% of the ammonia had been absorbed, the solution changed in color from red to clear. At this point, a reading was taken of the cumulative nitrogen flow (total amount of nitrogen passed through the loaded solvent) and the nitrogen stream was diverted to the other absorber flask. The contents of the first flask were stored and the flask was refilled with sulfuric acid. This process was repeated throughout the experimental run.

The amount of ammonia collected in each 400 ml volume of absorber solution was confirmed by use of the ammonia electrode. The amount of ammonia remaining in the organic solution at the end of an experimental run was determined by using the ammonia electrode to measure the ammonia concentration of a HCl extract of the organic solution.

A preliminary regeneration run was conducted using 200 ml volumes of absorber solution; however, it was found that the residence time of the

nitrogen stream in the 200 ml absorber solutions was not long enough to allow all of the NH_3 to be removed from the gas stream. During this run, 17% of the NH_3 removed from the organic solution was not recovered in the absorber solutions. The subsequent regeneration runs were conducted using 400 ml volumes of absorber solution resulting in an absorber solution head of 7.5 inches. During these runs, only 7% of the NH_3 driven off from the loaded organic solution was not recovered.

The data taken of moles of NH_3 collected versus moles of N_2 passed through the organic extractant solution were used to calculate the partial pressure of NH_3 above the solvent as a function of the concentration of NH_3 remaining in solution. The ammonia partial pressure values were calculated as:

$$P_{\text{NH}_3} = \frac{\text{moles NH}_3}{\text{moles NH}_3 + \text{moles N}_2} \times P_{\text{total}} \quad (9-3)$$

where P_{total} is the total pressure of the system as measured with a mercury manometer.

In order to test whether these partial pressure values approach equilibrium values, two regeneration runs were conducted at 125°C with ammonia-loaded organic extract solutions containing a phosphinic acid concentration of 0.48M in Norpar 12. In the first regeneration run, 100 ml of loaded solvent were heated and nitrogen-stripped. In the second regeneration run, 200 ml of solvent were used. The larger volume of solvent was used to allow a longer residence time of the nitrogen in the

organic solvent solution thereby allowing more time for mass transfer of the NH_3 into the gas stream (200 ml resulted in a 2 inch head of liquid; 100 ml in a 1 inch head). The data from the two runs were to be compared to see whether the longer contact time resulted in higher values of ammonia partial pressure.

In both runs, the solvent was placed in a 250 ml heating flask. During the second regeneration run, the nitrogen bubbling through the solution caused the liquid to splash into the necks of the flask. This liquid wet the connection between the neck of the flask and the thermometer adapter, thereby causing a leak in the system. This leak occurred after approximately 30% of the ammonia had been recovered from the loaded solvent, with the result that only 2 data points were obtained from this experimental run. These 2 data points did agree with the data from the regeneration run conducted with 100 ml of loaded solvent.

9.6 Thermal Stability Tests

The thermal stability of as-received and washed Cyanex 272 was examined by comparing properties of extractant solutions that had previously been heated to properties of extractant solutions that had not been heated. The properties that were compared were the aqueous solubility losses and the extraction characteristics of the liquid cation exchanger. The expected effects of thermal decomposition of the extractant on these properties are discussed in Chapter 11.

9.6.1 Heating of the Extractant

Samples of Cyanex 272 (either washed or as-received) were placed in Erlenmeyer flasks sealed with teflon stoppers. Holes of 0.02 inch diameter were bored through the stoppers to allow gas phase samples to be collected with a gas-tight syringe. (This sampling was not done.) The flasks were placed in an oil bath heated to the desired temperature (either 110°C, 125°C, 150°C, or 190°C) and held at that temperature for 5 hours. The extractant samples were stirred with magnetic stir bars during the heating process.

After 5 hours, the flasks were removed from the oil bath and allowed to cool to room temperature. The aqueous solubility and the extraction characteristics of these previously heated extractant solutions were then examined at 25°C. In testing the extraction characteristics, the Cyanex 272 was used in diluted form; however, only the extractant (Cyanex 272) and not the diluent (Norpar 12) had been previously heated.

9.6.2 Aqueous Solubility Measurements

The water solubility of the extractant was measured. Distilled water that had been passed through a Milli-Q water purification system (Millipore Corp.) was used. This treated water had a pH of 5.7 due to equilibration with atmospheric carbon dioxide. Cyanex 272 (either washed or as-received) was contacted with water in a centrifuge tube using an organic-to-aqueous phase ratio of either 2.5 or 1. The two phases were mixed by

stirring with a magnetic stir bar.

The two phase system was centrifuged at 2000 rpm for 30 minutes to allow the phases to settle. The organic phase was then removed by pipet and discarded. The aqueous phase was transferred to a fresh centrifuge tube and centrifuged again at 2000 rpm for 30 minutes. After this second centrifugation, the amount of extractant that had been transferred to the aqueous phase was determined by means of a measurement of the phosphorus concentration in the aqueous phase.

The phosphorus concentration measurement was conducted by V. Tashinian of the Microanalytical Laboratory, College of Chemistry, at the University of California, Berkeley. The analytical procedure involved sulfuric and nitric acid digestion followed by precipitation and subsequent weighing of a molybdenum/phosphate salt. It is described in detail by Pregl and Grant (6).

The aqueous solubility losses of the extractant to an aqueous ammonium bicarbonate solution were also measured. An organic phase of either as-received or washed Cyanex 272 in Norpar 12 (with a concentration of 0.2N phosphinic acid) was contacted with 0.5N NH_4HCO_3 using an organic-to-aqueous phase ratio of either 4 or 1. Depending on the volumes of extractant solution being tested, the phases were either contacted in a centrifuge tube as above or, for large volumes (200 ml of organic solution), were contacted in a separatory funnel. In either case, the aqueous raffinate was centrifuged twice as described above.

The amount of extractant transferred into the aqueous phase was determined by a phosphorus concentration measurement. A blank run was performed in which Norpar 12 was contacted with 0.5N NH_4HCO_3 using an organic-to-aqueous phase ratio of 4, and the resulting phosphorus concentration in the aqueous phase was measured.

9.6.3 Extraction Characteristics

The extraction characteristics of the liquid cation exchanger were examined before and after heating by determining the distribution ratio of ammonia versus the pH of the aqueous raffinate. These plots were determined experimentally as described in Section 4 of this chapter.

REFERENCES

1. Robertson, A., Cyanamid Canada Inc., Niagara Falls, Ontario, personal communication (1985).
2. Ashbrook, A.W., "The Extraction of Metals from Ammonium Sulphate Solution Using a Carboxylic Acid-I. Cobalt", J. Inorg. Nucl. Chem., Vol. 34, 1721-1737 (1972).
3. Mackenzie, P.D., "Simultaneous Stripping and Solvent Extraction for the Recovery of Ammonia and Acid Gases from Wastewaters", Ph.D. Dissertation, Department of Chemical Engineering, University of California, Berkeley (1984). LBL-17740.
4. Partridge, J.A., and Jensen, R.C., "Purification of Di-(2-Ethylhexyl) Phosphoric Acid by Precipitation of Copper(II) Di-(2-Ethylhexyl)Phosphate", J. Inorg. Nucl. Chem., Vol. 31, 2587-2589 (1969).
5. Reichley-Yinger, L., Argonne National Laboratory, Argonne, Illinois, personal communication (1985).
6. Pregl, F., and Grant, J., Quantitative Organic Microanalysis, The Blakiston Company, Philadelphia, Pennsylvania, 140-146 (1951).

CHAPTER 10. RESULTS OF THE AMMONIA EXTRACTION EXPERIMENTS

This chapter discusses the experimental results for the extraction of ammonia from aqueous buffer solution into organic solutions of di-2,4,4-trimethylpentyl phosphinic acid. The initial organic solution consisted of the extractant and the diluent. The extractant was either as-received Cyanex 272, washed Cyanex 272, or the purified di-alkyl phosphinic acid. The diluent was either Norpar 12 or undecane. The aqueous phase was composed of sodium hydroxide, sodium bicarbonate, and ammonium carbonate. During the extraction experiments, the concentration of extractant in the initial organic phase was held constant while the pH of the aqueous phase was varied. Cyanex 272 was found to be a good extractant for ammonia from aqueous solutions of pH value ranging from 7.5 to 9.5.

10.1 Modeling of Extraction of Ammonia by a Liquid Cation Exchanger

The extraction of ammonia from aqueous solution by a liquid cation exchanger can be expressed by the following equation:

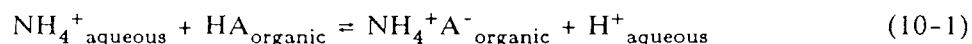

where HA is the liquid cation exchanger (the organic acid), and NH_4^+ is the ammonium ion. Ammonia is extracted into the organic phase by ion-pair formation with the liquid cation exchanger. This equation assumes that there is no dimerization of the liquid cation exchanger in the organic phase and that there is no complexation of the ion pair with additional acid

molecules or with the diluent (1). The equation also ignores possible polymerization of the ion pair in the organic phase (1).

The equilibrium constant, K_r , for the above reaction can be expressed as:

$$K_r = \frac{[\text{NH}_4^+\text{A}^-] (\text{H}^+)}{[\text{HA}] (\text{NH}_4^+)} \quad (10-2)$$

where the brackets denote concentrations in the organic phase and the parentheses denote concentrations in the aqueous phase. The value of K_r depends on the particular liquid cation exchanger and organic diluent being used. The distribution of ammonia into the organic phase as a result of this reaction can be expressed in terms of a distribution ratio, K_1 , equal to:

$$K_1 = \frac{[\text{NH}_4^+\text{A}^-]}{(\text{NH}_3) + (\text{NH}_4^+)} \quad (10-3)$$

where the ammonia extracted into the organic phase is in the ion-pair form.

Equations 10-2 and 10-3 can be combined to give the following expression for K_1 :

$$K_1 = K_r \frac{[\text{HA}]}{(\text{H}^+)} \alpha \quad (10-4)$$

where α is the fraction of aqueous ammonia in the ammonium ion form and

is equal to:

$$\alpha = \frac{(\text{NH}_4^+)}{(\text{NH}_3) + (\text{NH}_4^+)} = \frac{1}{1 + \frac{K_w}{K_b(\text{H}^+)}} \quad (10-5)$$

where K_w is the ionization constant of water (10^{-14} at 25°C [2]) and K_b is the dissociation constant of aqueous ammonia which is equal to:

$$K_b = \frac{(\text{OH}^-) (\text{NH}_4^+)}{(\text{NH}_3)} \quad (10-5a)$$

The quantity K_w/K_b is equal to K_a , where K_a is the ionization constant of the ammonium ion and is equal to:

$$K_a = \frac{(\text{H}^+) (\text{NH}_3)}{(\text{NH}_4^+)} \quad (10-5b)$$

At low pH values, α is approximately equal to 1 and:

$$K_1 = K_r \frac{[\text{HA}]}{(\text{H}^+)}, \quad \text{low pH} \quad (10-6)$$

At pH values much greater than the $\text{p}K_a$ of the ammonium ion (9.25 at 25°C [2]), α is approximated as:

$$\alpha = \frac{K_b(\text{H}^+)}{K_w}, \quad \text{high pH} \quad (10-7)$$

and then K_1 can be approximated as:

$$K_1 = K_r \frac{K_b [HA]}{K_w} = K_r \frac{[HA]}{K_a}, \quad \text{high pH} \quad (10-8)$$

As shown by Equations 10-6 and 10-8, provided [HA] remains relatively constant; i.e., the liquid cation exchanger is present in substantial excess of that required to extract all of the ammonia present in the system, K_1 will increase with increasing aqueous phase pH and level off at a constant value at high pH. However, at high pH values, an apparent decrease in K_1 may occur due to increased aqueous solubility losses of the liquid cation exchanger or of the ion pair, or due to competition from another cation (3).

The above equations describe extraction of ammonia by the liquid cation exchanger. The type of diluent used can affect the degree of extraction achievable with a given liquid cation exchanger by providing a more or less favorable environment for the ion pair. The effect of the diluent on this extraction is accounted for in the above equations in the value of K_r . A detailed discussion of diluent effects on extraction by liquid cation exchangers is given by Mackenzie (4).

The diluents used in this work are aliphatic hydrocarbon solvents. The physical partitioning of unionized ammonia into such solvents can be described as (5):

$$D = \frac{[NH_3]}{(NH_3)} \quad (10-9)$$

The relation between the ammonia present in the organic phase due to physical partitioning and the total ammonia in the aqueous phase is as follows:

$$K_2 = \frac{[\text{NH}_3]}{(\text{NH}_3) + (\text{NH}_4^+)} = \frac{D}{1 + \frac{(\text{H}^+)}{K_a}} \quad (10-10)$$

As can be seen in Equation 10-10, the physical partitioning of unionized ammonia into an hydrocarbon solvent will increase with increasing aqueous phase pH.

Equations 10-4 and 10-10 can be combined to give the overall distribution ratio for ammonia, K_c , equal to the ratio of the total concentration of ammonia (both ionized and unionized) in the organic phase to the total concentration of ammonia in the aqueous phase:

$$K_c = K_r \frac{[\text{HA}]}{(\text{H}^+)} \alpha + \Phi \frac{D}{1 + \frac{(\text{H}^+)}{K_a}} \quad (10-11)$$

where Φ is the volume fraction of diluent in the organic phase. There was relatively low partitioning of unionized ammonia into the diluents used in this work. At the highest aqueous phase pH used in the experimental work, the quantity defined in Equation 10-10 was equal to 0.01 for Norpar 12 and 0.009 for undecane. Therefore Equations 10-4, 10-6, and 10-8 should adequately describe the partitioning of ammonia, in all forms.

If other cations (other than NH_4^+ and H^+) are present in the initial aqueous phase, there will be competition between the cations for the liquid cation exchanger. The equations describing extraction of a monovalent cation such as Na^+ are analogous to Equations 10-1, 10-2, and 10-4 and are as follows:

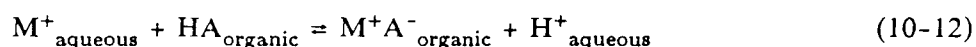

$$K_r^* = \frac{[\text{M}^+\text{A}^-] (\text{H}^+)}{[\text{HA}] (\text{M}^+)} \quad (10-13)$$

where M^+ is the monovalent cation and K_r^* is the equilibrium constant for the reaction given in Equation 10-12. The distribution ratio of the monovalent cation, K_{c,M^+} , is then equal to:

$$K_{c,M^+} = \frac{[\text{M}^+\text{A}^-]}{(\text{M}^+)} = K_r^* \frac{[\text{HA}]}{(\text{H}^+)} \quad (10-14)$$

The value of K_r^* depends on the cation being extracted and on the particular liquid cation exchanger and organic diluent being used. Therefore, at a given pH, one cation will have a higher value of K_{c,M^+} than another cation, and thus separation of cations can be achieved (1).

10.2 Experimental Results with As-Received Cyanex 272

Figure 10-1 shows the experimental data for the extraction of ammonia at 25°C from aqueous buffer solution into a solution of as-received Cyanex

Figure 10-1. Extraction of Ammonia at 25°C with As-Received Cyanex 272

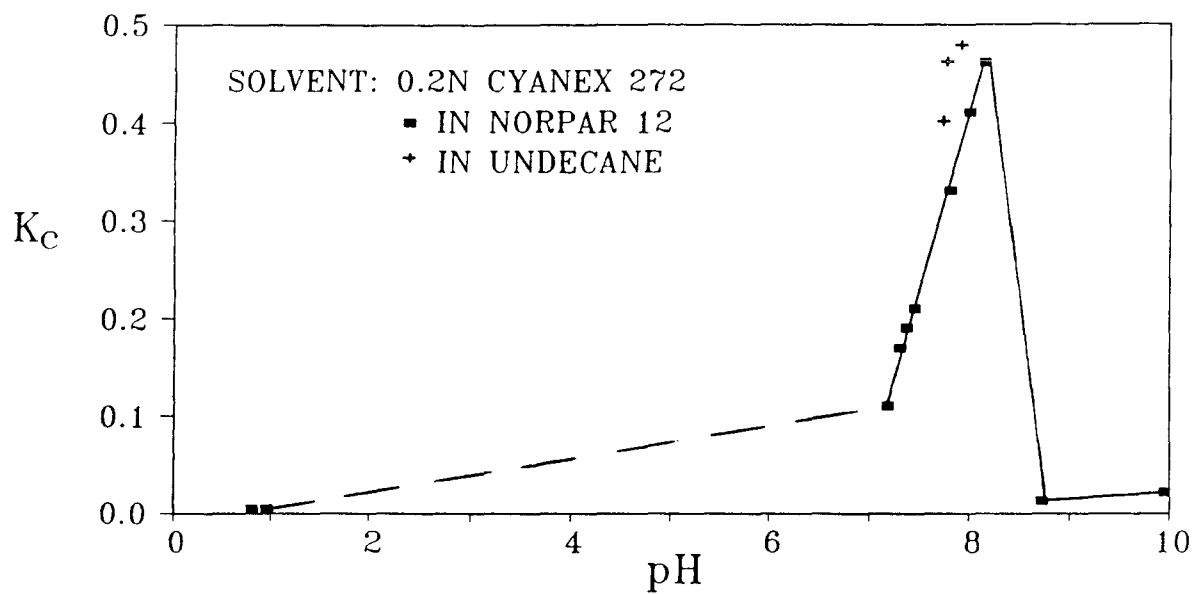
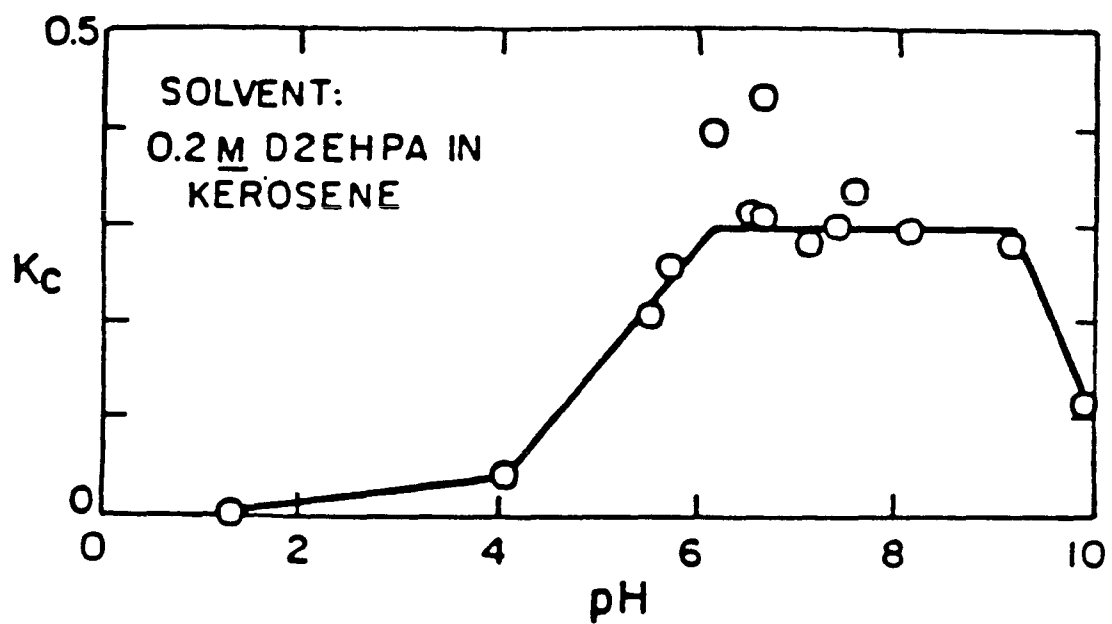
Figure 10-2. Extraction of Ammonia at 25°C with D2EHPA
(from Mackenzie [4])

272 in either Norpar 12 or undecane. The concentration of di-2,4,4-trimethylpentyl phosphinic acid in the initial organic phase was 0.2N. (The total acidity of the solution is approximately equal to 0.204N due to the presence of the phosphonic acid impurity.) The distribution ratio of ammonia (in terms of mol/l divided by mol/l) is plotted versus the pH of the aqueous raffinate. At high pH values -- approaching the pK_a of the ammonium ion (9.25 at 25°C [2]) -- the concentration of ammonia that is in the ammonium ion form decreases and as discussed in the previous section, the K_c values should approach a constant value. The experimental results show a decrease in the K_c values at high pH due to two factors -- the preferential extraction of sodium ions at high pH, and the loss of ammonium ions to a third phase. As discussed in Chapter 9, Section 4, third phase formation occurred for aqueous pH values above about 8.5.

The location at which there is a sharp rise in K_c values with increasing pH is a function of the pK_a of the liquid cation exchanger. The rise in K_c values shows the increasing preference of the organic acid for the ammonium ion over the hydrogen ion. Figure 10-2 shows the data of Mackenzie (4) for the extraction of ammonia at 25°C from aqueous buffer solution into an organic solution of 0.2N di-2-ethylhexyl phosphoric acid (D2EHPA) in kerosene. (The aqueous buffer solution used in this work is the same as that used by Mackenzie.) D2EHPA is a stronger acid than the phosphinic acid used in this work and thus has a lower pK_a value; the pK_a of D2EHPA is 3.6 while the pK_a of the phosphinic acid is 5.9 (6). When D2EHPA is used as the extractant, the sharp rise in K_c values should therefore occur at a pH that is 2.3 units lower (the difference in the pK_a

values). Comparing the curves shown in Figures 10-1 and 10-2, the sharp rise in K_c values occurs for D2EHPA at a pH that is about 2.5 units lower than for Cyanex 272.

Sour waters have pH values ranging from 7.5 to 9.5. The data for Cyanex 272 show that it is a good extractant for ammonia from aqueous solutions of that pH range. It should be more readily regenerable than D2EHPA because the rise in K_c values occurs at a higher pH for Cyanex 272 than for D2EHPA.

Figures 10-3 and 10-4 show theoretical curves of K_1 versus pH for varying values of K_r (see Equation 10-4). The experimental data from Figure 10-1 are also shown. A K_r value of 2.5×10^{-8} gives a good fit to the experimental data.

In Figure 10-5, the middle pH range of data obtained with as-received Cyanex 272 in Norpar 12 is given in the form of a plot of the logarithm (base 10) of the total ammonia concentration in the organic phase ($\log C_{\text{NH}_3, \text{org}}$) versus the raffinate pH, and these data are compared to the data of Inoue et al. (7). Inoue and his coworkers used Cyanex 272 in toluene to extract ammonia from ammonium nitrate solutions and observed a rise in the concentration of extracted ammonia with increasing pH followed by a leveling off at pH values near the $\text{p}K_a$ of the ammonium ion (9.25). This leveling off occurred because the only competing cation present in the aqueous ammonium nitrate solution was the hydrogen ion.

Figure 10-3. Extraction of Ammonia at 25°C with As-Received Cyanex 272
Comparison with Theoretical Curve for K_r equal to 2.5×10^{-8}

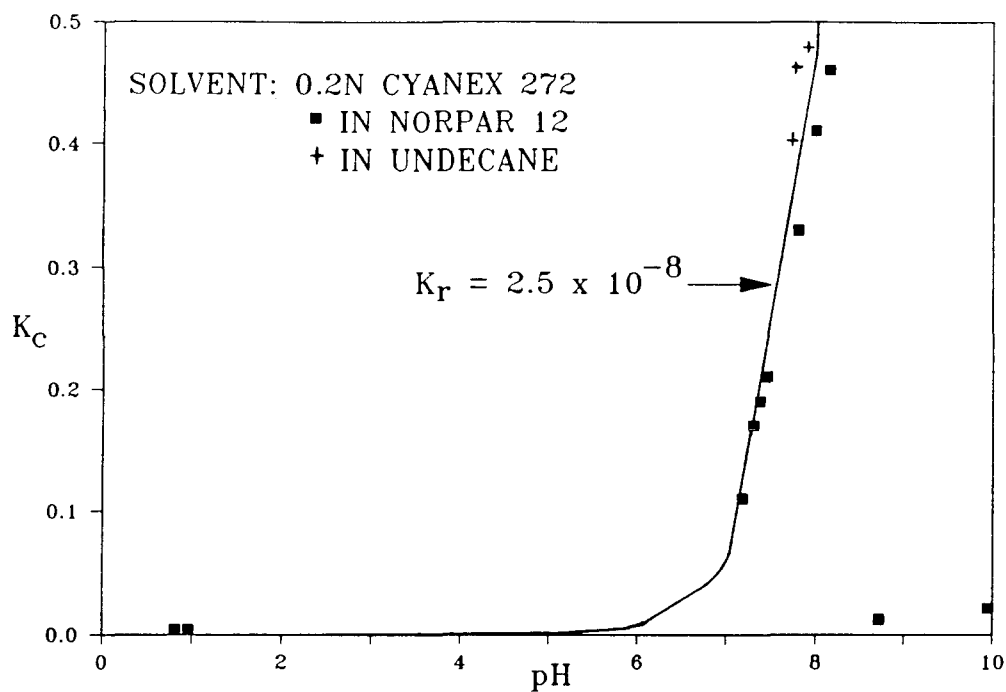

Figure 10-4. Extraction of Ammonia at 25°C with As-Received Cyanex 272
Comparison with Theoretical Curves

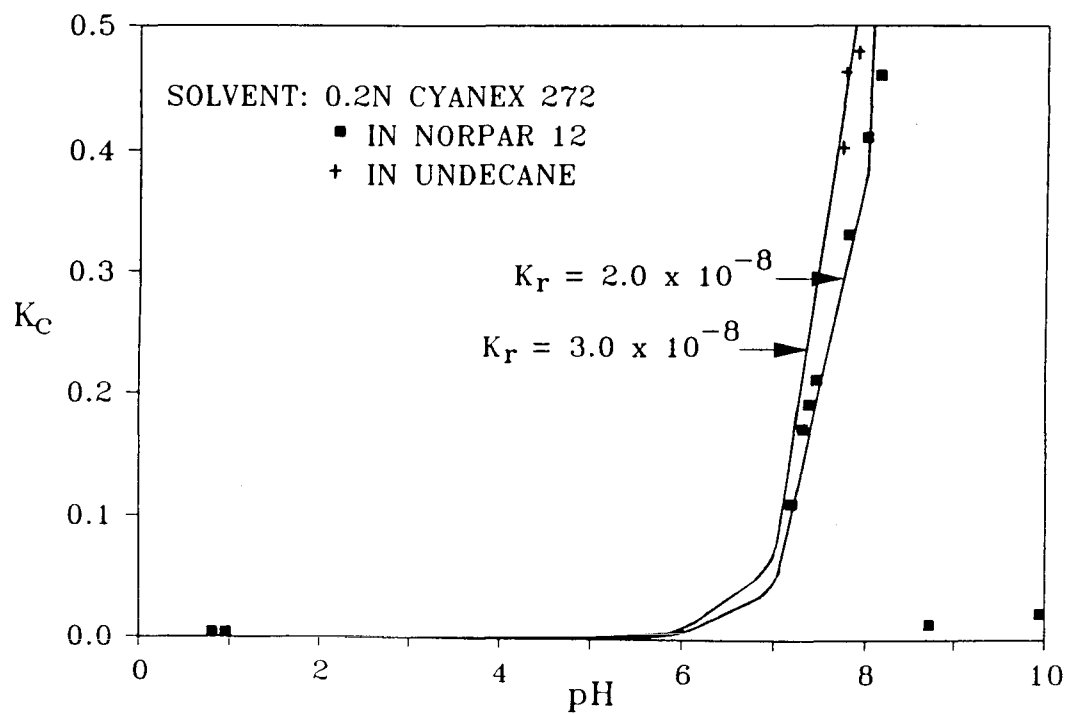
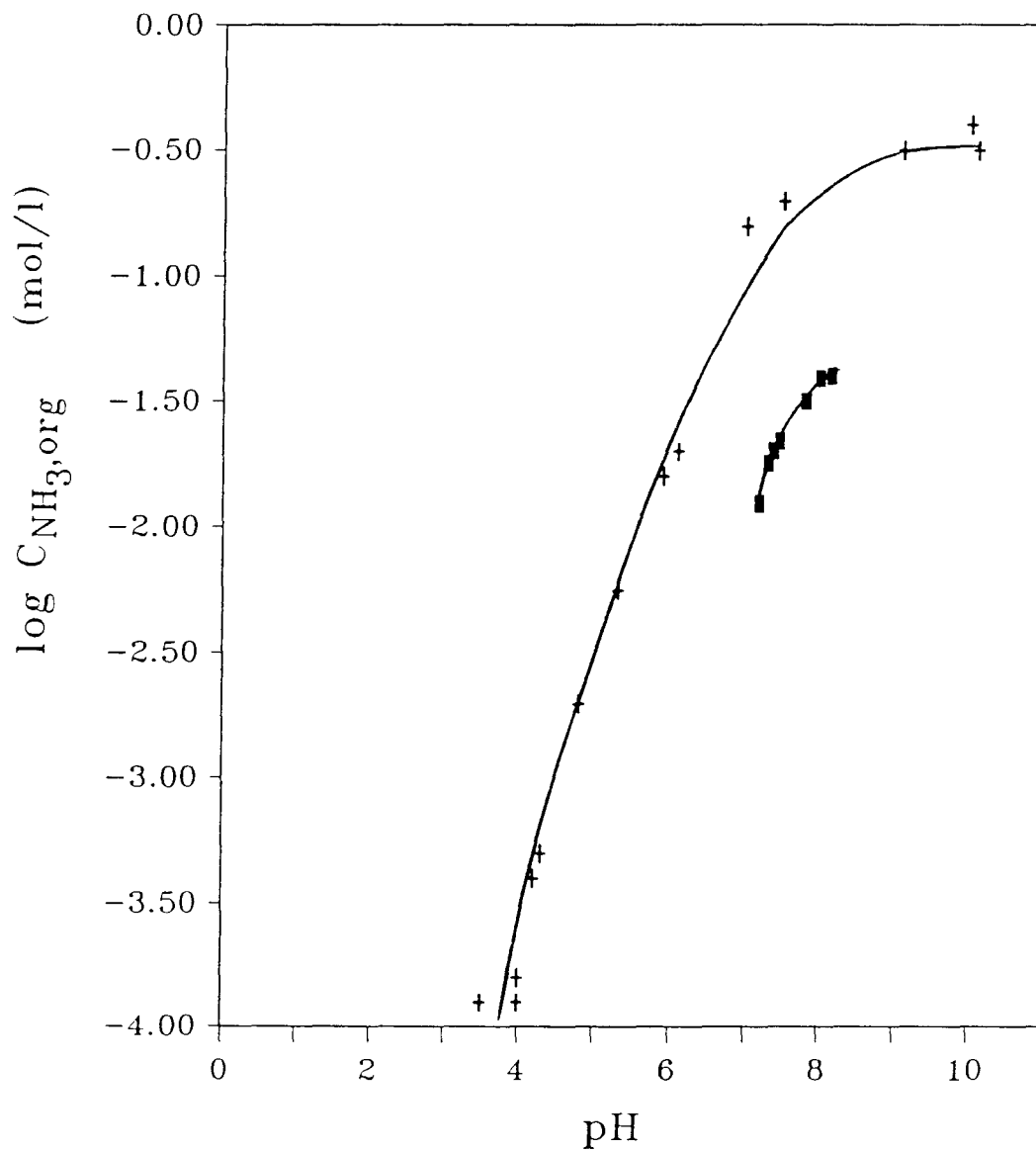

Figure 10-5. Comparison of Extraction Data with As-Received Cyanex 272 to the Data of Inoue et al. (7)



■ Solvent: 0.2N Cyanex 272 in Norpar 12
(data involving competition with sodium
are not shown)

+ Solvent: 0.34N Cyanex 272 in Toluene
(from Inoue et al. [7])

When these two sets of data are compared, at a given value of pH, the value obtained by Inoue et al. (7) for the concentration of ammonia in the organic phase is higher than the value from the present work. (The K_c values obtained by Inoue et al. are approximately 1.12 times higher.) This is expected because of the greater concentration of Cyanex 272 used by Inoue et al. (0.34N vs. 0.2N) and the greater polarizability of the diluent that was used.

10.3 Experimental Results with Washed Cyanex 272 and with the Purified Phosphinic Acid

Figure 10-6 shows the experimental data for the extraction of ammonia at 25°C from aqueous buffer solution into solutions of either washed Cyanex 272 or the purified phosphinic acid in Norpar 12. In either case, the initial organic phase contained 0.2N di-2,4,4-trimethylpentyl phosphinic acid. The distribution ratio of ammonia (mol/l divided by mol/l) is plotted versus the pH of the aqueous raffinate.

As discussed in Chapter 9, Section 3.1, Cyanex 272 was washed with basic solution to remove the highly water soluble phosphonic acid impurity. This impurity composes less than 0.5 wt.% of the as-received Cyanex 272, and as can be seen by comparing Figures 10-6 and 10-1, the removal of the impurity does not seem to affect the ammonia extraction capability of the extractant mixture.

The purified phosphinic acid used in the extraction experiments was

Figure 10-6. Extraction of Ammonia at 25°C with Washed Cyanex 272 and with the Purified Phosphinic Acid

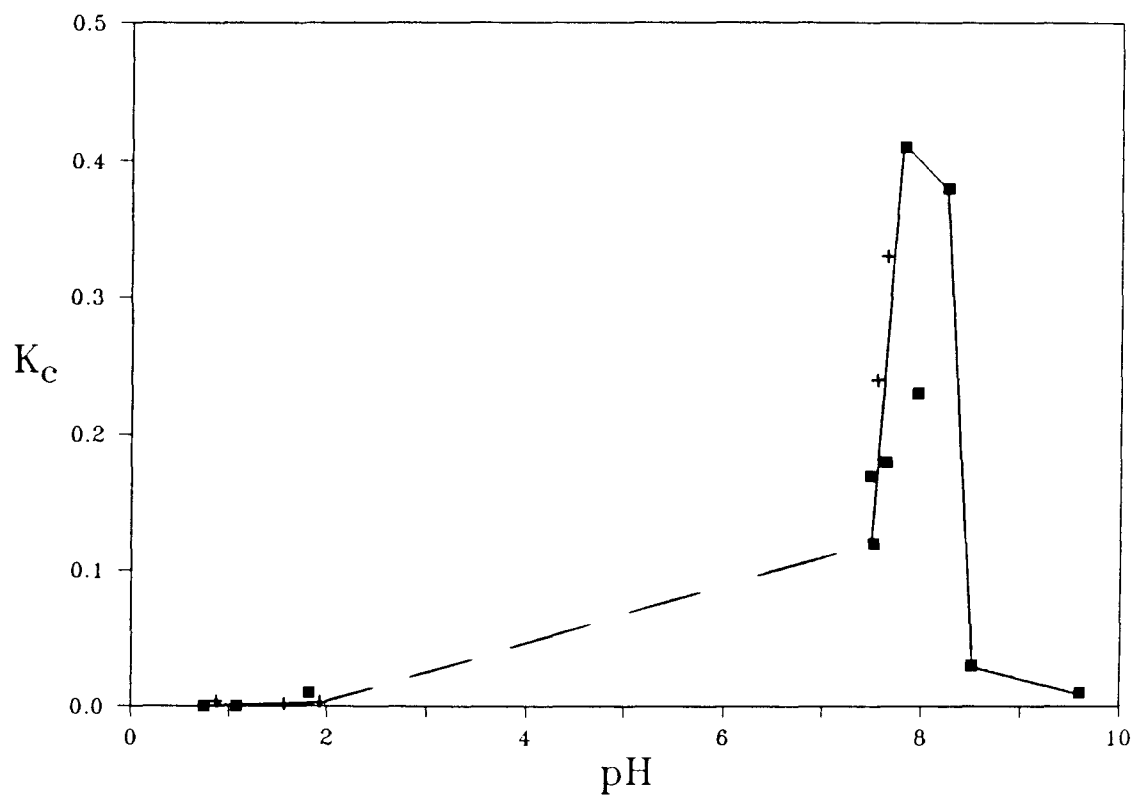

■ Solvent: 0.2N Washed Cyanex 272
in Norpar 12

+ Solvent: 0.2N di-2,4,4-trimethylpentyl
phosphinic acid in Norpar 12

obtained using the CuSO_4 purification procedure discussed in Chapter 9. During the extraction experiments conducted with the purified phosphinic acid in Norpar 12, there was an increased solubility of some component(s) of the organic phase into the aqueous phase. This became apparent during the measurement of the ammonia concentration in the aqueous raffinate. The membrane of the ammonia electrode is gas-permeable and hydrophobic. Water does not wet the membrane and does not penetrate the holes of the membrane. If an organic compound is present in the solution being measured by the electrode, the organic substance will penetrate the membrane, resulting in leakage of the internal filling solution of the electrode. Problems with leakage occurred during the measurement of these aqueous raffinate samples. Leakage did not occur when measuring ammonia concentrations of aqueous raffinates from the runs conducted with as-received Cyanex 272 or washed Cyanex 272.

The as-received Cyanex 272 contains approximately 10 wt.% tri-(2,4,4-trimethylpentyl) phosphine oxide, while the washed Cyanex 272 contains approximately 11 wt.% of this tertiary phosphine oxide. The tertiary phosphine oxide is a Lewis base and could serve to solvate the phosphinic acid, thereby lowering its extraction capacity for ammonia. However, at the same time the solvation of both the phosphinic acid and the ammonia/phosphinic acid ion pair by the phosphine oxide could serve to reduce aqueous solubility losses of the extractant. The distribution ratio of ammonia into a solution of the as-received or washed Cyanex 272 is high enough that the removal of the phosphine oxide in an attempt to further increase the distribution ratio is not necessary.

10.4 Third Phase Formation

The problem of third phase formation at aqueous raffinate pH values of 8.5 and above needs further study. When third phase formation occurred, between 15 and 30% (by moles) of the ammonia present in the system was lost to this third phase. The formation of the third phase could be due to a high-pH aqueous emulsion of the sodium cation and the tertiary phosphine oxide (8) present in Cyanex 272. The aqueous buffer solutions used in the experimental work contained a high concentration of sodium (0.84N). Such high concentrations of sodium would not be present in most sour waters.

REFERENCES

1. Ritcey, G.M., and Ashbrook, A.W., Process Metallurgy 1, Solvent Extraction: Principles and Applications to Process Metallurgy, Part 1, Elsevier Science Publishing Company Inc., New York (1984).
2. CRC Handbook of Chemistry and Physics, 65th ed., CRC Press, Inc., Boca Raton, Florida (1984).
3. Rice, N.M., "Recent Developments and Potential Uses for Carboxylic Acid Extractants - A Review, Hydrometallurgy, Vol. 3, No. 2, 111-133 (1978).
4. Mackenzie, P.D., "Simultaneous Stripping and Solvent Extraction for the Recovery of Ammonia and Acid Gases from Wastewaters", Ph.D. Dissertation, Department of Chemical Engineering, University of California, Berkeley (1984). LBL-17740.
5. Sekine, T., Hishikura, H., and Kusakabe, S., "Liquid-Liquid Partition Behavior of Ammonia and Ammonium Ion between Hexane Containing Trioctylphosphine Oxide and Aqueous Perchlorate Solutions", Bunseki Kagaku (Japan Analyst), Vol. 31, E157-E162 (1982).
6. Robertson, A., Cyanamid Canada Inc., Niagara Falls, Ontario, personal communication (1985).
7. Inoue, K., Nakayama, D., and Watanabe, Y., "Extraction Equilibria of Ammonia with Acidic Organophosphorus Compounds", Hydrometallurgy, 16, 41-53 (1986).
8. Mohr, D.H., "Identification and Separation of the Organic Compounds in Coal Gasification Condensate Waters", Ph.D. Dissertation, Department of Chemical Engineering, University of California, Berkeley (1983). LBL-15869.

CHAPTER 11. RESULTS OF THE THERMAL REGENERATION EXPERIMENTS AND OF THE THERMAL STABILITY TESTS

This chapter discusses the results of thermal regeneration experiments in which ammonia is driven off from an organic extractant solution of as-received Cyanex 272 in Norpar 12. At a temperature of 125°C, 99% removal of ammonia was achieved. The thermal stabilities of both as-received and washed Cyanex 272 were tested. Both forms of the extractant appear to be thermally stable to at least 150°C; however, further work needs to be done in this area.

11.1 Thermal Regeneration Experiments

In the proposed sour water treatment process as shown in Figure 7-6, ammonia is to be removed from the loaded organic phase by steam stripping at elevated temperature. The regenerated solvent is to be recycled within the process. Experiments were conducted to test the feasibility of this process step. The apparatus used in these thermal regeneration experiments was discussed in Chapter 9, Section 5. In the experimental runs, ammonia was removed from a loaded organic extract by nitrogen stripping at either 120°C or 125°C.

Figure 11-1 shows the experimental data from a thermal regeneration run in which 100 ml of loaded extractant solution initially consisting of 0.23N NH_3 and 0.48N as-received Cyanex 272 (i.e., 0.48N di-2,4,4-trimethylpentyl phosphinic acid) in Norpar 12 was nitrogen stripped at

Figure 11-1. Removal of Ammonia from Loaded Extractant Solution
Comparison of Cyanex 272 and D2EHPA

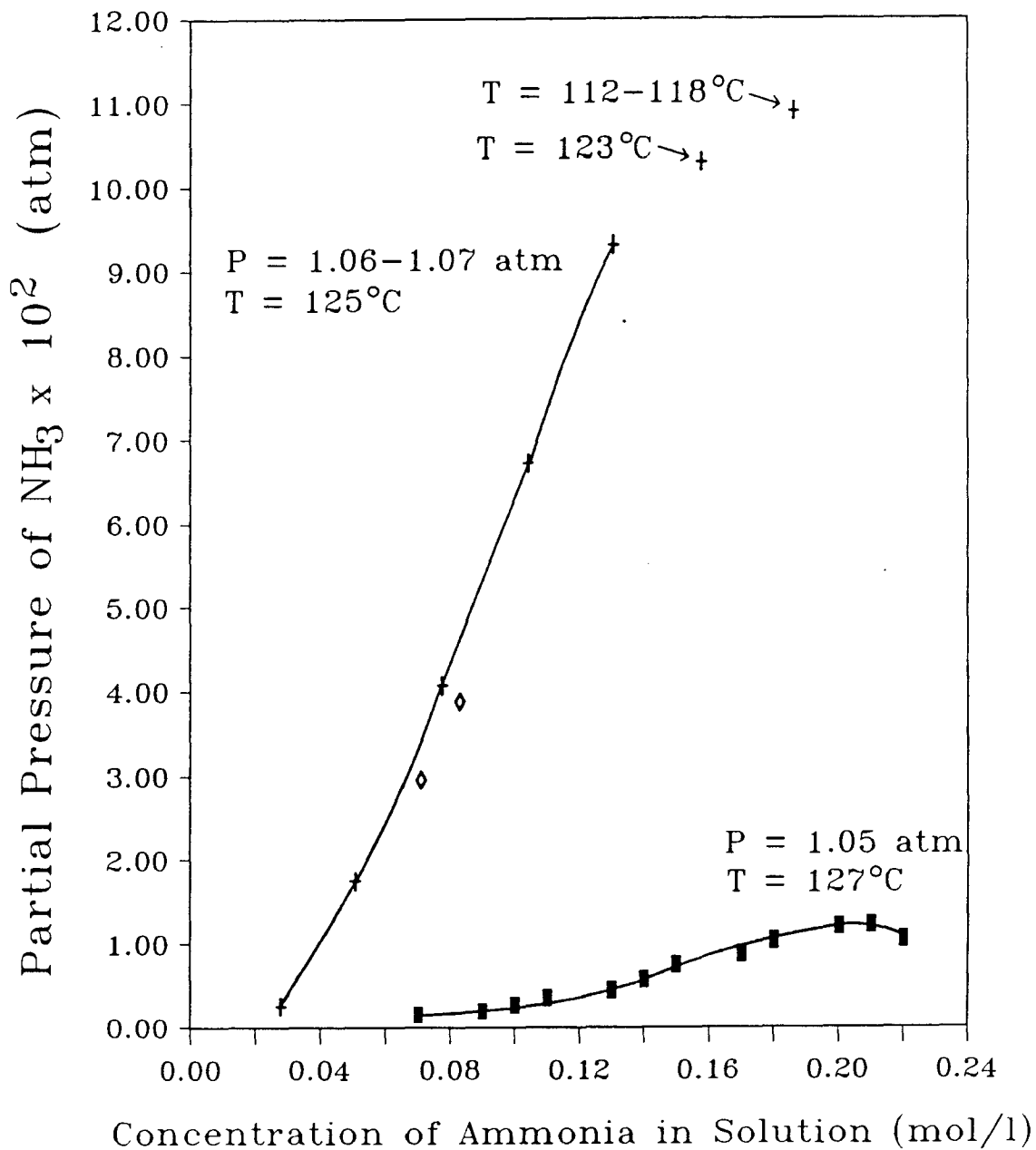

+ Solvent = 0.48N Cyanex 272 in Norpar 12
(100 ml)

◇ Solvent = 0.48N Cyanex 272 in Norpar 12
(200 ml)

■ Solvent = 0.48N D2EHPA in Norpar 12

125°C to remove the ammonia. The partial pressure of ammonia above the solution is plotted as a function of the concentration of ammonia remaining in solution, as determined by a mass balance. (The data points for the two highest partial pressure values were taken while the solution was being heated to 125°C.) During this regeneration run, 99% of the ammonia was removed from solution, leaving a regenerated extractant solution containing only 0.0016N NH_3 (as determined by analysis, and confirmed by a mass balance).

Also shown are two data points from a similar run in which 200 ml of the loaded extractant solution was nitrogen stripped at 125°C. As discussed in Chapter 9, Section 5, this second run was conducted to test whether the partial pressure values from the first run approach equilibrium values. The two data points from this second run agree with the data from the first run.

The data for Cyanex 272 obtained at 125°C are compared in Figure 11-1 to those of Mackenzie (1,2) for the partial pressure of ammonia above a solution of ammonia in a mixture of di-2-ethylhexyl phosphoric acid (D2EHPA) and Norpar 12 at 127°C. At a given concentration of ammonia in solution, the partial pressure above the Cyanex 272 solution is more than 20 times larger than that above the D2EHPA solution. This is in line with the lesser acidity of Cyanex 272 (pK_a equal to 5.9, versus 3.6 for D2EHPA; both pK_a values were measured in a mixture of 25% by volume water and 75% 2-propanol [3]). These results demonstrate that a loaded solution of Cyanex 272 will be more readily regenerated than a loaded solution of D2EHPA.

Figure 11-2 shows the results from a thermal regeneration run conducted at 120°C in which the initial organic solution (80 ml) consisted of 0.1N NH₃ and 0.2N as-received Cyanex 272 in Norpar 12. During this regeneration run, 94% of the ammonia was removed from solution.

The release of ammonia from the loaded organic solution may be modeled using the following equation:

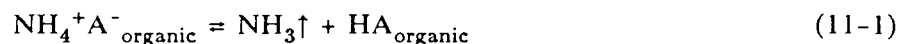

where NH₄⁺A⁻ is the ammonia/phosphinic acid ion pair and HA is the unionized phosphinic acid. This equation has the same limitations as Equation 10-1; it assumes no dimerization of the liquid cation exchanger, no polymerization of the ion pair, and no complexation of the ion pair with additional acid molecules.

The equilibrium constant for this reaction, K, can be defined as follows:

$$K(T) = \frac{P_{\text{NH}_3} [\text{HA}]}{[\text{NH}_4^+\text{A}^-]} \quad (11-2)$$

where P_{NH₃} is the partial pressure of ammonia above the solution, the parentheses denote concentrations in the organic phase, and K is a function of temperature, T. Using the experimental data (values of P_{NH₃}, [HA], and [NH₄⁺A⁻]) for Cyanex 272, values of K were calculated. The mean value of K was calculated to be 0.13 atm with a standard deviation of 0.02 atm at

Figure 11-2. Removal of Ammonia from Loaded Extractant Solution at 120°C

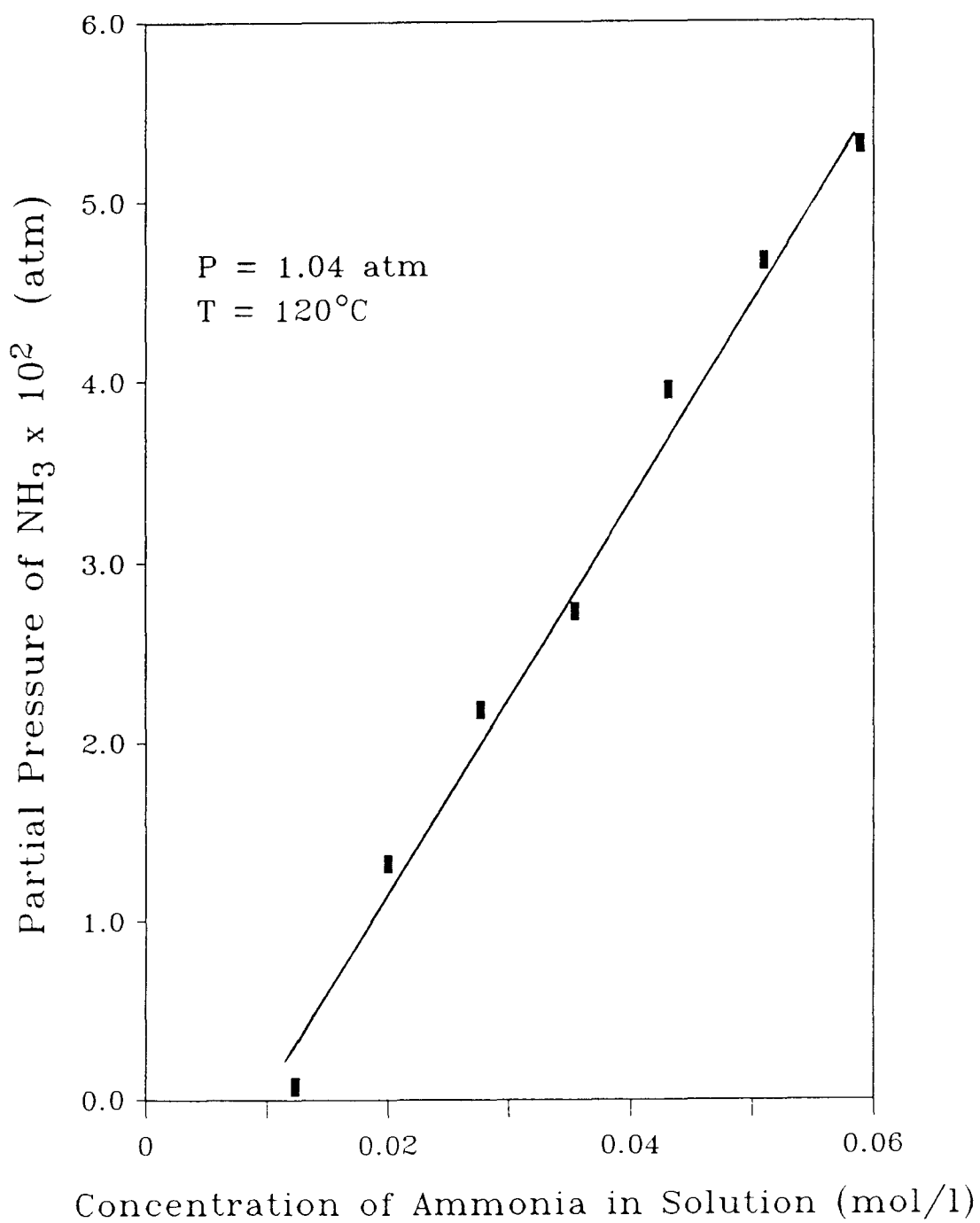

120°C, and 0.20 atm with a standard deviation of 0.06 atm at 125°C. The accuracy of these values is uncertain due to the small number of experimental data points taken at each temperature.

During the regeneration run at 125°C, the value of [HA] increased from 0.25M to approximately 0.48M; during the regeneration run at 120°C, the value of [HA] increased from 0.1M to approximately 0.19M. The partial pressure data obtained at 120°C and 125°C above a solution of ammonia, as-received Cyanex 272, and Norpar 12 can be compared at a given value of $[\text{NH}_4^+\text{A}^-]$. Rearranging Equation 11-2 gives the following equation for the partial pressure of ammonia:

$$P_{\text{NH}_3} = \frac{K(T) [\text{NH}_4^+\text{A}^-]}{[\text{HA}]} \quad (11-3)$$

The value of K is lower at 120°C than at 125°C; however, at a given value of $[\text{NH}_4^+\text{A}^-]$, the partial pressure value at 120°C is higher than the partial pressure value at 125°C due to the smaller value of [HA] throughout the 120°C regeneration run.

11.2 Thermal Stability Tests

Cyanex 272 consists of 85 wt.% di-2,4,4-trimethylpentyl phosphinic acid (the active component), approximately 10 wt.% of the corresponding tertiary phosphine oxide, and less than 0.5 wt.% of the corresponding phosphonic acid (3). The structures of these compounds are shown in Figure 11-3. As discussed in Chapter 8, Section 5.3, tertiary phosphine oxides are known to

Figure 11-3. Composition of As-Received Cyanex 272

Dialkylphosphinic acid	Alkylphosphonic acid	Tertiary Phosphine Oxide
85 wt.%	< 0.5 wt.%	10 wt.%

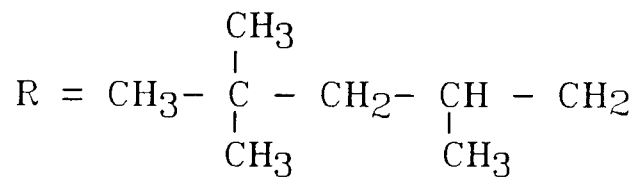
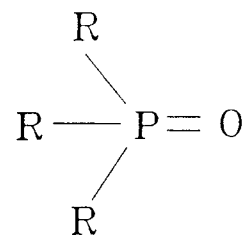
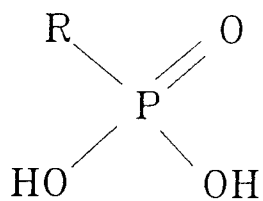
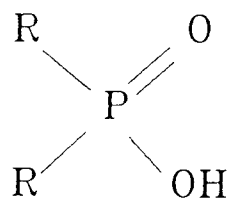

have high thermal stability. The thermal stability of the phosphinic acid was explored in this work. Most of the thermal stability tests were conducted with washed Cyanex 272 (see Chapter 9, Section 3.1) so that the presence of the phosphonic acid and its possible thermal degradation products would not interfere with the results of the thermal stability tests.

The thermal stability tests that were conducted were based on the assumption that if thermal decomposition of the di-alkyl phosphinic acid were to occur, it would most likely occur through the cleavage of the R-P bond. If this cleavage occurred, the results could be:

1. the production of volatile hydrocarbons; i.e, isooctane and/or diisobutylene;
2. increased extractant losses to the aqueous phase due to the production of a more polar phosphorus-containing compound; and
3. changes in the extraction characteristics of the liquid cation exchanger.

The thermal stability of the phosphinic acid was examined by comparing properties of extractant solutions that had previously been heated to properties of extractant solutions that had not been heated. The properties that were compared were the aqueous solubility losses and the extraction characteristics of the liquid cation exchanger. Gas chromatographic analysis of vapor phase samples could be used to monitor for possible volatile hydrocarbon production during the heating of an extractant sample; however, this analysis was not done.

11.2.1 Aqueous Solubility Losses

The water solubility of the phosphinic acid was determined by measuring extractant losses to distilled water, while the aqueous solubility of the ammonium/phosphinate ion pair was determined by measuring extractant losses to aqueous ammonium bicarbonate solution. If significant thermal decomposition of the phosphinic acid had occurred during heating, there would be a noticeable increase in the extractant losses. The extractant losses were determined by measuring the phosphorus concentration in the aqueous phase.

Table 11-1 shows the results of measurements for as-received Cyanex 272. Three sets of measurements were taken at 25°C: the first with Cyanex 272 that had never been heated; the second with Cyanex 272 that had previously been heated at 110°C for 5 hours; and the third with Cyanex 272 that had previously been heated at 190°C for 5 hours. A blank run was carried out in which 200 ml of Norpar 12 was contacted with 50 ml 0.5N NH_4HCO_3 . The resulting phosphorus concentration in the aqueous phase was 0.004 mg/ml.

The aqueous phase phosphorus concentrations are larger for the extractant that had previously been heated than for the extractant that had not been heated, possibly indicating thermal decomposition of the phosphinic acid. However, the as-received Cyanex 272 contains a phosphonic acid impurity which could also undergo thermal decomposition, resulting in

Table 11-1. Aqueous Phase Phosphorus Losses: As-Received Cyanex 272

1. Phosphorus Losses to Water

Organic Phase: 25 ml As-Received Cyanex 272

(contains 0.115 g phosphonic acid, equivalent to 0.0183 g P
and 19.55 g phosphinic acid, equivalent to 2.083 g P)Aqueous Phase: 10 ml H₂O

Previous heating of extractant:	25°C	110°C (5 hrs.)	190°C (5 hrs.)
<u>Extractant Losses</u>			
(mg P/ml)	0.04-0.05	0.08-0.10	0.25-0.30
(mg P)	0.4-0.5	0.8-1.0	2.5-3.0
(% of 0.0183 g)	2.5%	4.9%	15%

2. Phosphorus Losses to NH₄HCO₃ SolutionOrganic Phase: 200 ml 0.2N As-Received Cyanex 272
in Norpar 12(contains 0.068 g phosphonic acid, equivalent to 0.0108 g P
and 11.57 g phosphinic acid, equivalent to 1.233 g P)Aqueous Phase: 50 ml 0.5N NH₄HCO₃

Previous heating of extractant:	25°C	110°C (5 hrs.)	190°C (5 hrs.)
<u>Extractant Losses</u>			
(mg P/ml)	0.63-0.64	0.70	0.97-0.98
(mg P)	31-32	35	48-49

increased aqueous phase phosphorus concentrations. The amount of phosphorus lost to water in each of the three cases could be accounted for by the phosphonic acid alone; however, the increase (17 mg) in the amount of phosphorus lost to aqueous ammonium bicarbonate is too large to be accounted for solely by the phosphonic acid.

Additional aqueous phase phosphorus measurements were taken with washed Cyanex 272 (Cyanex 272 from which the phosphonic acid impurity had been removed) so that the presence of the phosphonic acid and its potential thermal degradation products would not interfere with the results of this thermal stability test. The results of these additional phosphorus measurements are shown in Table 11-2. Three sets of measurements were taken at 25°C: the first with washed Cyanex 272 that had never been heated; the second with washed Cyanex 272 that had previously been heated at 125°C for 5 hours; and the third with washed Cyanex 272 that had previously been heated at 150°C for 5 hours.

The aqueous phase phosphorus concentrations are significantly larger for the extractant that had previously been heated than for the extractant that had not been heated, with the extractant that had been heated to 150°C yielding higher values than the extractant that had been heated to 125°C. This increase in aqueous phase phosphorus concentrations possibly indicates some thermal degradation of the phosphonic acid. The largest phosphorus concentrations correspond to a loss of 3 or 4 wt.% of the extractant.

Table 11-2. Aqueous Phase Phosphorus Losses: Washed Cyanex 272

1. Phosphorus Losses to Water

Organic Phase: 15 ml Washed Cyanex 272
 (contains 10.6 g phosphinic acid,
 equivalent to 1.13 g P)

Aqueous Phase: 15 ml H₂O

Previous heating of extractant:	25 °C	125 °C (5 hrs.)	150 °C (5 hrs.)
<u>Extractant Losses</u>			
(mg P/ml)	0.01	0.08	0.21
(wt.% of total extractant)	0.01%	0.1%	0.3%

2. Phosphorus Losses to NH₄HCO₃ Solution

Organic Phase: 15 ml 0.2N Washed Cyanex 272
 in Norpar 12
 (contains 0.869 g phosphinic acid,
 equivalent to 92.9 mg P)

Aqueous Phase: 15 ml 0.5N NH₄HCO₃

Previous heating of extractant:	25 °C	125 °C (5 hrs.)	150 °C (5 hrs.)
<u>Extractant Losses</u>			
(mg P/ml)	0.12	0.17	0.23
(wt.% of total extractant)	2%	3%	4%

11.2.2 Extraction Characteristics

The phosphorus-containing compound -- either a monoalkylphosphinic acid or an alkylphosphonic acid -- that would result from the cleavage of the R-P bond would be more strongly acidic (have a lower pK_a value) than di-2,4,4-trimethylpentyl phosphinic acid (3). As discussed in Chapter 10, a plot of the distribution ratio of ammonia (K_c) versus the pH of the aqueous raffinate can be used to examine the extraction characteristics of the liquid cation exchanger. In such a plot, the location of the sharp rise in K_c values is a function of the pK_a of the liquid cation exchanger. If extensive thermal degradation of the phosphinic acid were to occur, this degradation should result in a shift in the location of the sharp rise in K_c values.

Figure 11-4 shows three plots of the distribution ratio of ammonia at 25°C versus aqueous raffinate pH. Ammonia was extracted from aqueous buffer solution into 0.2N washed Cyanex 272 in Norpar 12. The aqueous phase was composed of sodium hydroxide, sodium bicarbonate, and ammonium carbonate. The data in the first plot were determined using washed Cyanex 272 that had not been heated; the data in the second plot were determined using washed Cyanex 272 that had previously been heated at 125°C for 5 hours; and the data in the third plot were determined using washed Cyanex 272 that had previously been heated at 150°C for 5 hours.

The two plots of data for extractant that had previously been heated do not show a shift in the location of the rise in K_c values. However, if only a small percentage of the extractant is thermally decomposed upon

Figure 11-4. Comparison of the Extraction Characteristics of Washed Cyanex 272 before and after Heating

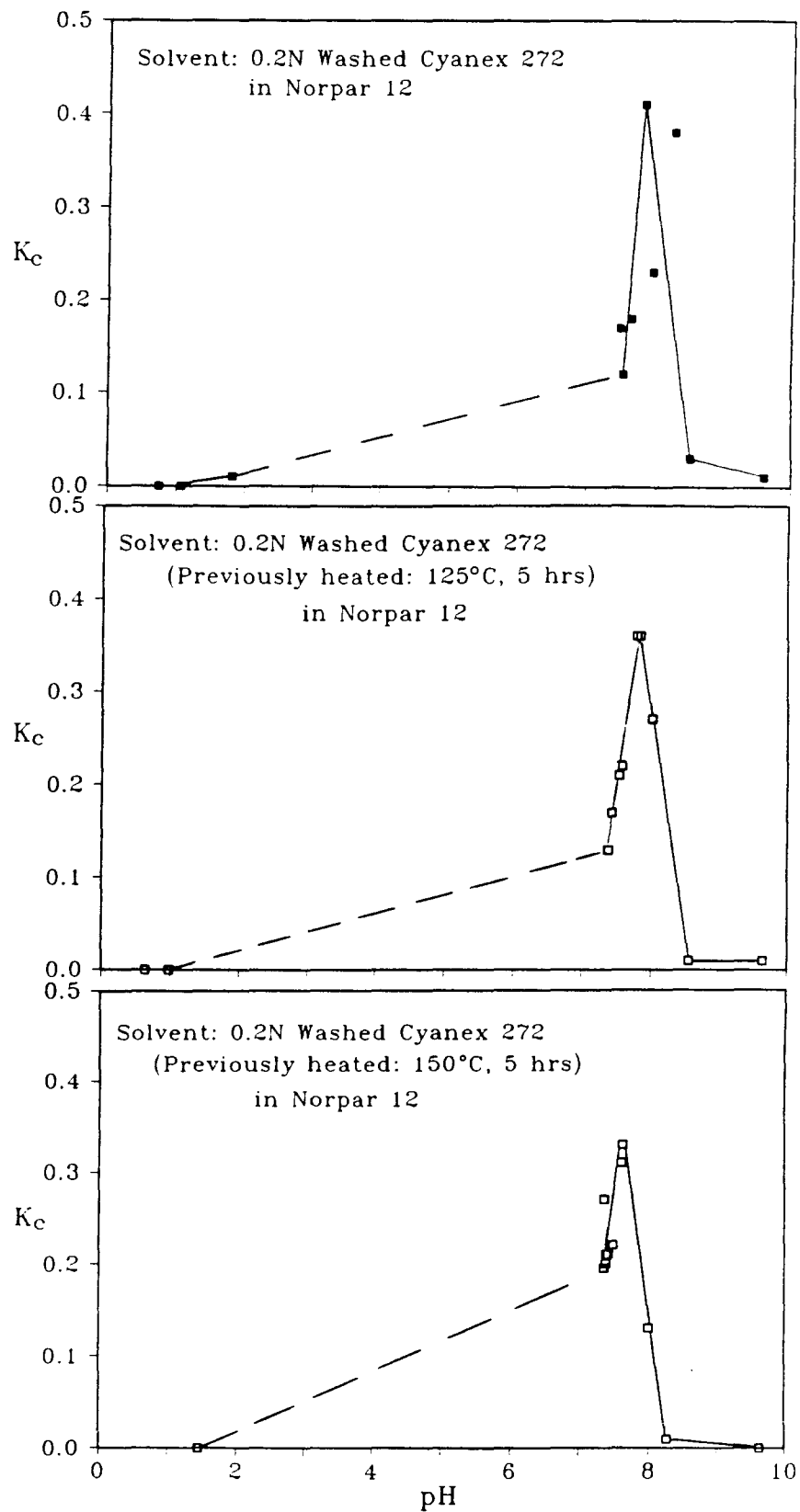

heating, the result would appear on the plot as a superposition of two extraction curves -- one curve that is characteristic of the phosphinic acid and one curve that is characteristic of the decomposition product. This superposition would show as a 'shoulder' on the plot, as illustrated in Figure 11-5. Experimental data are needed in the pH 5-7 range in order to determine whether or not this effect has occurred.

11.3 Discussion

The aqueous solubility data indicate slight (up to 1 wt.%) thermal decomposition of the phosphinic acid due to heating at 125°C for 5 hours. The data show slightly greater (up to 2 wt.%) thermal decomposition of the phosphinic acid due to heating at 150°C for 5 hours. The extraction data do not show evidence of thermal decomposition; however, these data are incomplete. Extraction data are needed in the aqueous phase pH 5-7 range. In addition, the 'shoulder' resulting from 1 or 2 wt.% decomposition of the phosphinic acid would probably not be discernible.

The results of the thermal regeneration experiments show that complete removal of ammonia from an organic solution of Cyanex 272 in Norpar 12 can be achieved by nitrogen stripping at 125°C and that a good degree of removal (94%) of the ammonia can be achieved at 120°C. Therefore, it is not necessary that the phosphinic acid be thermally stable to as high as 150°C. In order for the phosphinic acid to be a suitable extractant for use in the proposed sour water treatment process, it needs to be thermally stable at the temperature at which the thermal regeneration is carried out.

Figure 11-5. Predicted Effect of the Thermal Decomposition of Cyanex 272 on a Plot of K_c versus the pH of the Aqueous Raffinate

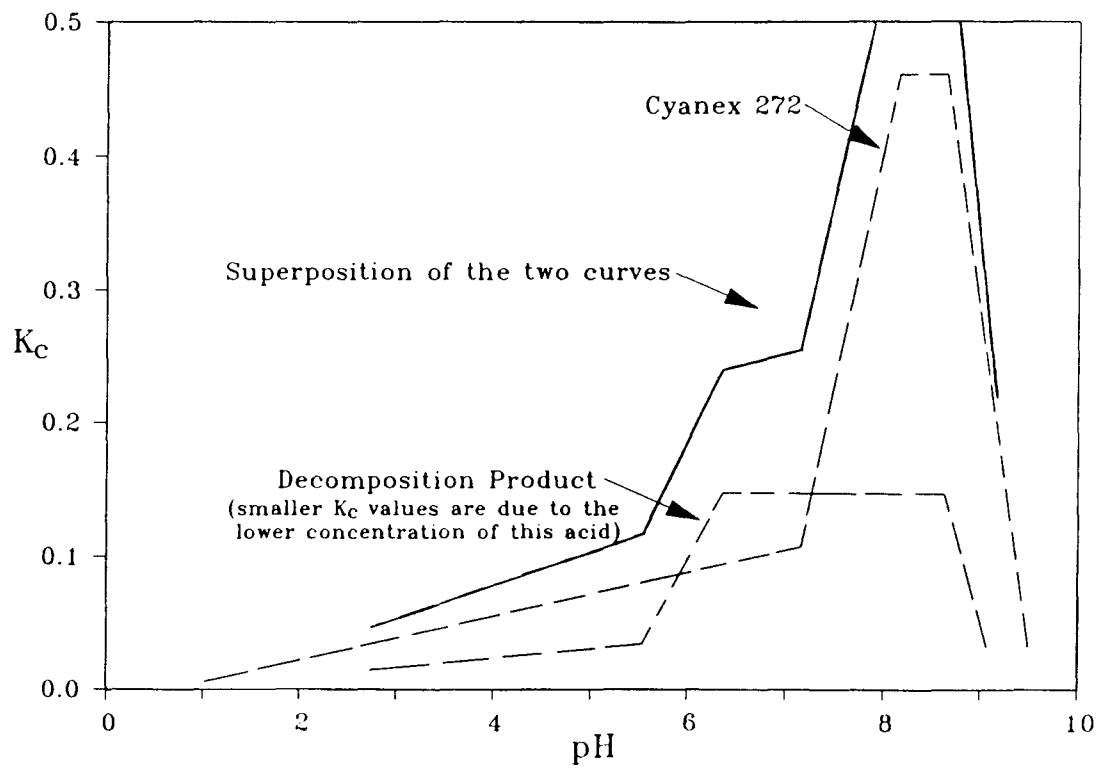

A series of successive thermal regeneration experiments could be used to study the thermal stability of di-2,4,4-trimethylpentyl phosphinic acid further. These experiments would involve loading the organic phase with ammonia, then nitrogen stripping at elevated temperature to remove the ammonia, followed by loading the regenerated extractant again with ammonia, and then again nitrogen stripping at elevated temperature. If thermal decomposition of the phosphinic acid occurs during the first thermal regeneration run, then during the second regeneration run the partial pressure of ammonia above the solution at a given concentration of ammonia in solution will be lower, due to the presence of the more strongly acidic decomposition product. (However, 1 or 2 wt.% decomposition of the phosphinic acid would probably not be great enough to cause a discernible change in the partial pressure of ammonia.) The successive thermal regeneration runs could be carried out at various temperatures ranging from 110°C to 135°C. The results of these experiments would define a safe operating range of temperatures at which thermal regeneration of the loaded extractant solution could be carried out without thermal decomposition of the phosphinic acid.

REFERENCES

1. Mackenzie, P.D., and King, C.J., "Combined Solvent Extraction and Stripping for Removal and Isolation of Ammonia from Sour Waters", Ind. Eng. Chem. Process Des. Dev., Vol. 24, No. 4, 1192-1200 (1985).
2. Mackenzie, P.D., "Simultaneous Stripping and Solvent Extraction for the Recovery of Ammonia and Acid Gases from Wastewaters", Ph.D. Dissertation, Department of Chemical Engineering, University of California, Berkeley (1984). LBL-17740.
3. Robertson, A., Cyanamid Canada Inc., Niagara Falls, Ontario, personal communication (1985).

CHAPTER 12. PROCESS DESIGN CONSIDERATIONS

This chapter examines the use of Cyanex 272 as the liquid cation exchanger for extraction of ammonia in the proposed sour water treatment process. The implications of the experimental results reported in previous chapters are discussed. Each step of the process is first examined separately, and then the economic viability of the combined stripping/extraction process is assessed in comparison with the Waste Water Treating (WWT) and the Phosam-W processes.

12.1 Combined Stripping/Extraction Process

The overall design of the sour water treatment process developed by Mackenzie and King (1,2) was discussed in Chapter 7, Section 2.3.4. The process flow diagram is repeated in Figure 12-1.

12.1.1 Extraction of Ammonia with Cyanex 272

As was shown in Chapter 10, Cyanex 272 is a good extractant for ammonia from aqueous solutions of the typical pH range of sour waters, i.e., 7.5-9.5. The distribution ratios for ammonia obtained using 0.2N as-received Cyanex 272 in Norpar 12 increase from 0.11 to 0.46 as the aqueous phase pH increases from 7.18 to 8.15. The values of the distribution ratio are comparable to those of Mackenzie (2) obtained with 0.2N di-2-ethylhexyl phosphoric acid (D2EHPA) in kerosene. The distribution ratios remain high over a wider pH range (pH 6-10 versus pH 8-10 for Cyanex 272) when

Figure 12-1. Combined Stripping/Extraction Process
(from Mackenzie [2])

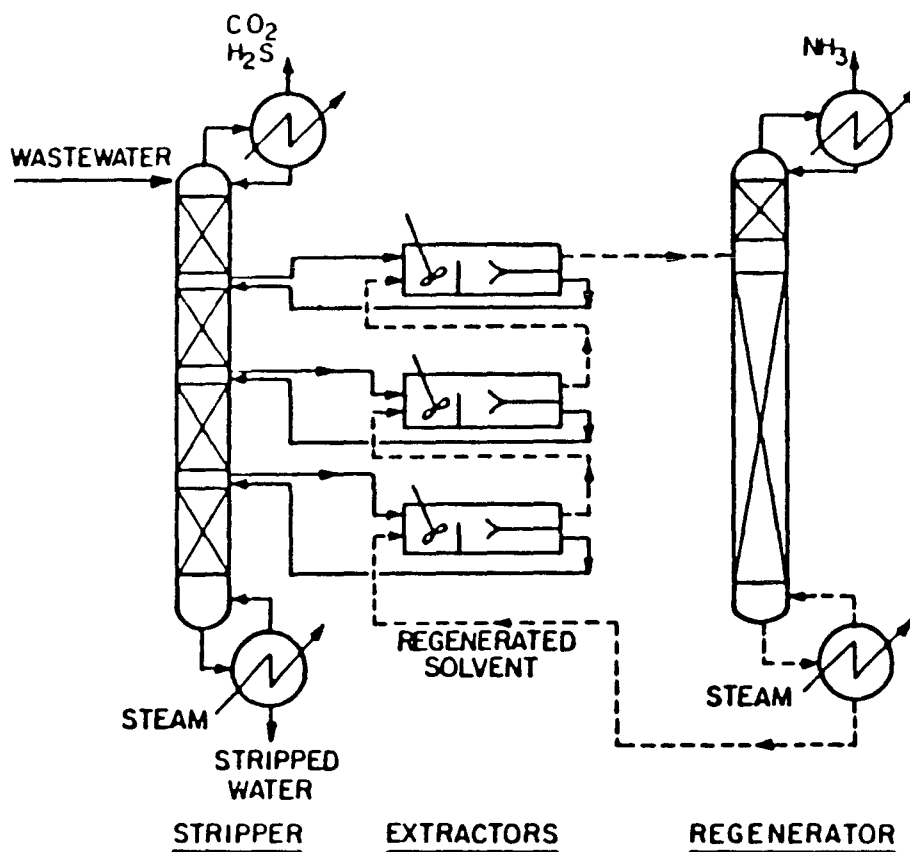

D2EHPA is used as the extractant, due to the greater acidic strength of D2EHPA; however, due to its weaker acidity, Cyanex 272 is more readily regenerable than D2EHPA, as was shown in Figure 11-1.

For a given liquid cation exchanger and at a given aqueous phase pH, the value of the distribution ratio for ammonia (K_c) will depend on the concentration of the uncomplexed liquid cation exchanger and on the organic diluent used. This relationship was shown in Equation 10-11, where the type of diluent affects the values of K_r and D . Distribution ratios were measured during the preparation of loaded organic solutions for later use in the thermal regeneration experiments. In Table 12-1, the distribution ratio measured during the preparation of a loaded organic solution of 0.48N as-received Cyanex 272 in Norpar 12 is compared to the distribution ratio obtained with 0.2N as-received Cyanex 272 in Norpar 12, at the same aqueous pH. The distribution ratio is higher at higher concentrations of the uncomplexed organic acid, in rough proportion to the concentration of the acid.

The diluents used in this work (Norpar 12 and undecane) are relatively inert diluents in that the distribution ratio into the pure diluent is low (0.01 for Norpar 12 and 0.009 for undecane at a pH of approximately 10) because the components of the diluent lack functional groups to interact with the complex. In the work of Mackenzie and King (1,2) with D2EHPA as the liquid cation exchanger, K_c was found to increase when alcohols, phenols, or carboxylic acids with sterically unhindered -OH groups were added to the organic solvent mixture. These modifiers tend to solvate the

**Table 12-1. Ammonia Distribution Ratios
for Extraction with As-Received Cyanex 272 in Norpar 12**

Organic Phase	Concentration of Uncomplexed Phosphinic Acid (mol/l)	Aqueous pH	K_c (M/M)
0.48N as-received Cyanex 272 in Norpar 12	0.25	7.7	0.48
0.2N as-received Cyanex 272 in Norpar 12	0.165	7.7	0.30

ammonium/organic acid ion pair. However, the presence of these modifiers results in less facile thermal regeneration of the loaded solvent, i.e., lower values of ammonia partial pressure at a given temperature and ammonia concentration.

Assuming a 1-1 interaction of the ammonium ion with the phosphinic acid (the active component of Cyanex 272), the maximum molar concentration of ammonia achievable in the organic phase would be equal to the concentration of the liquid cation exchanger. However, ammonia could be present in the organic phase at concentrations in excess of that of Cyanex 272 due to the solubility of unionized ammonia in the diluent. In the work of Inoue et al. (3) in which ammonia was extracted from 1M aqueous ammonium nitrate into solutions of Cyanex 272 in toluene, at high aqueous pH values the molar concentration of ammonia in the organic phase was found to approach the concentration of Cyanex 272.

During the extraction process, a certain amount of water is coextracted with the ammonia. In this work, the concentration of water in the loaded organic solutions was not measured. Inoue et al. (3) found that ammonia-saturated (1 mole of ammonia per mole of phosphinic acid) organic solutions of Cyanex 272 in toluene contained 5 moles of water for every mole of ammonia. In contrast, an ammonia-saturated organic solution of D2EHPA in toluene contains greater than 11 moles of water per mole of ammonia (2).

Before use in the sour water treatment process, Cyanex 272 should

probably be treated to remove the phosphonic acid impurity. The phosphonic acid is more water soluble than the phosphinic acid and its presence in the extractant mixture would result in higher concentrations of phosphorus-containing compounds in the treated water. As was shown in Figure 10-6, the removal of the phosphonic acid impurity does not affect the extraction characteristics of Cyanex 272 for ammonia.

In the sour water treatment process (Figure 12-1), the organic stream would pass back and forth between the extractors and the ammonia stripper. The distribution ratio of ammonia between the two phases in the extractors depends on the pH of the aqueous phase. As the aqueous stream passes through the acid-gas stripper, the pH will increase due to the removal of CO_2 and H_2S . The degree of removal of the acid gases will depend on the pH and the steam to water ratio (V_g/W) in the acid-gas stripper. As the aqueous stream passes through an extraction stage, the degree of removal of ammonia depends on both the aqueous pH and the water to solvent flow ratio (W/S). The removal of ammonia will lower the aqueous pH. A thorough design of the combined stripping/extraction process would require combining a model for the acid-gas stripper (such as DELTAS [4,5], described in Chapter 7, Section 2.2) with a model for the extraction process.

12.1.2 Combined Stripping/Extraction

Experimental work carried out by Mackenzie (1,2) demonstrated that the simultaneous extraction of ammonia from aqueous ammonium bicarbonate

enhanced the removal of CO_2 by stripping and enabled the separate recovery of the two compounds. In one combined stripping/extraction experiment, an aqueous solution initially containing 0.56M NH_3 and 0.6M CO_2 was added to a heating flask containing 0.2M D2EHPA in Norpar 12. The W/S was 0.2 and the two phases were mixed throughout the experimental run with a magnetic stirrer. The two-phase system was stripped with nitrogen.

Figure 12-2 shows a plot of the fraction of CO_2 left in solution as a function of the volume of nitrogen passed through the solution. Less than 0.5% of the NH_3 initially present in the aqueous phase was stripped along with the CO_2 . The data are compared to an experimental run in which an aqueous ammonium bicarbonate solution with no organic phase present was stripped with nitrogen. In that experiment, 20% of the NH_3 was stripped along with the CO_2 .

The extraction of ammonia by the solvent serves to lower the pH, thereby increasing the volatility of the CO_2 . The presence of the solvent also serves to lower the volatility of the NH_3 , due to the resultant lower concentration of NH_3 in the aqueous phase and the lower aqueous pH.

12.1.3 Thermal Regeneration of the Solvent

The ammonia can be removed from the loaded organic solution by stripping at elevated temperatures. If a relatively volatile diluent is used, the stripping medium could be generated by vaporization of a portion of the

Figure 12-2. Removal of CO_2 from Aqueous Solution
 Comparison of Stripping with Extraction/Stripping
 (from Mackenzie [2])

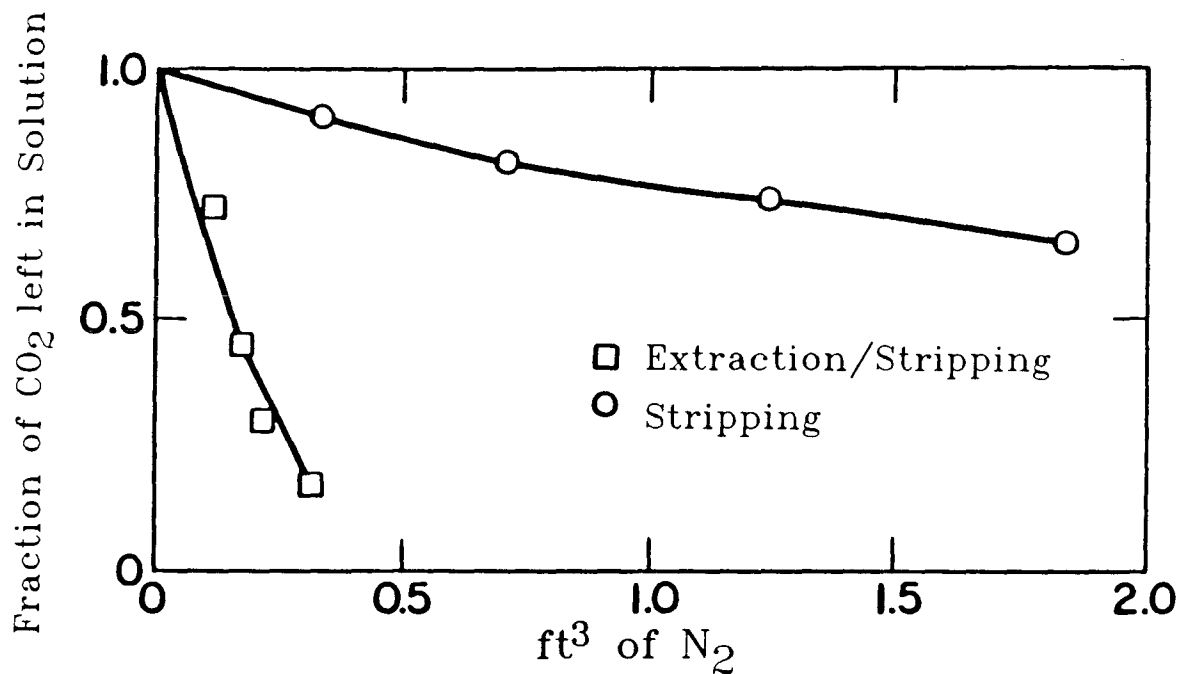

STRIPPING: Initial Aqueous Phase = 50 ml of 0.6M CO_2 , 0.56M NH_3

EXTRACTION/STRIPPING: Initial Aqueous Phase = same as above
 Organic Phase = 0.2N D2EHPA in Norpar 12
 S/W (v/v) = 5

diluent in the reboiler of the regeneration tower. The overhead vapor stream exiting the regeneration tower would consist of NH_3 , the diluent, and water that had been coextracted into the organic phase. This vapor stream could be condensed to form two phases -- an aqueous ammonia solution and an organic diluent phase. The diluent phase could be refluxed to the regeneration column. The aqueous ammonia solution could be sent to a distillation column for separation into purified ammonia and water.

The diluents used in this work have relatively high boiling points; the boiling point of undecane is 194-196°C (6) and the initial boiling point of Norpar 12 is 188°C (7). (The initial boiling point of the Varsol diluent composing approximately 5 wt.% of as-received Cyanex 272 is approximately 155°C [7].) If vaporized diluent is to be used as the stripping medium, a lower-boiling diluent such as toluene (b.p. 110.6°C [8]) or octane (b.p. 125.6°C [8]) should be used.

At a given operating temperature and pressure, the degree of removal of ammonia that occurs in the regeneration column will depend on the vapor (the stripping medium) to liquid flow ratio (V_r/S) and on the number of equilibrium stages in the column. For the stripping of dilute solutions in conventional countercurrent stripping columns, the most economic design is one in which the product of V_r/S and the slope of the equilibrium line (m) is in the range 1.2-2.0 (9). The product mV_r/S is typically set equal to 1.4 (9). The equilibrium curve will tend to deviate from linearity at high concentrations (i.e., molar ratio of NH_3 to phosphinic acid approaching unity); therefore, if a concentrated solution is to be stripped, the value of

m will vary with column height. The minimum value of m should then be used to determine V_r/S .

Figure 12-3 shows the equilibrium line at 125°C for ammonia partitioning between a vapor phase and an organic phase of 0.48N as-received Cyanex 272 in Norpar 12. (These data -- previously given in Figure 11-1 -- are from the thermal regeneration run at 125°C with 100 ml of solvent, and are here taken to correspond to equilibrium conditions.) The vertical axis is the mole fraction of ammonia in the vapor phase and the horizontal axis is the concentration (mol/l) of ammonia in the organic phase. In this case, there is a slight curvature to the experimental data; however, the equilibrium curve can be approximated by a line of slope equal to 0.84. If mV_r/S is set equal to 1.4, then V_r/S is equal to 1.7 (moles vapor/liter solvent).

The equilibrium curve is a function of temperature, extractant concentration, and diluent composition. As discussed in Chapter 11, Section 3, the operating temperature for the regeneration column should be below that at which significant thermal decomposition of the phosphinic acid occurs. Thermal degradation of the phosphinic acid would result in an increase in the energy required to regenerate the loaded extractant (due to the presence of the more strongly acidic decomposition product) and an increase in the aqueous solubility losses of the extractant.

Figure 12-3. Equilibrium Curve for Ammonia at 125°C
Organic Phase: 0.48N as-received Cyanex 272 in Norpar 12

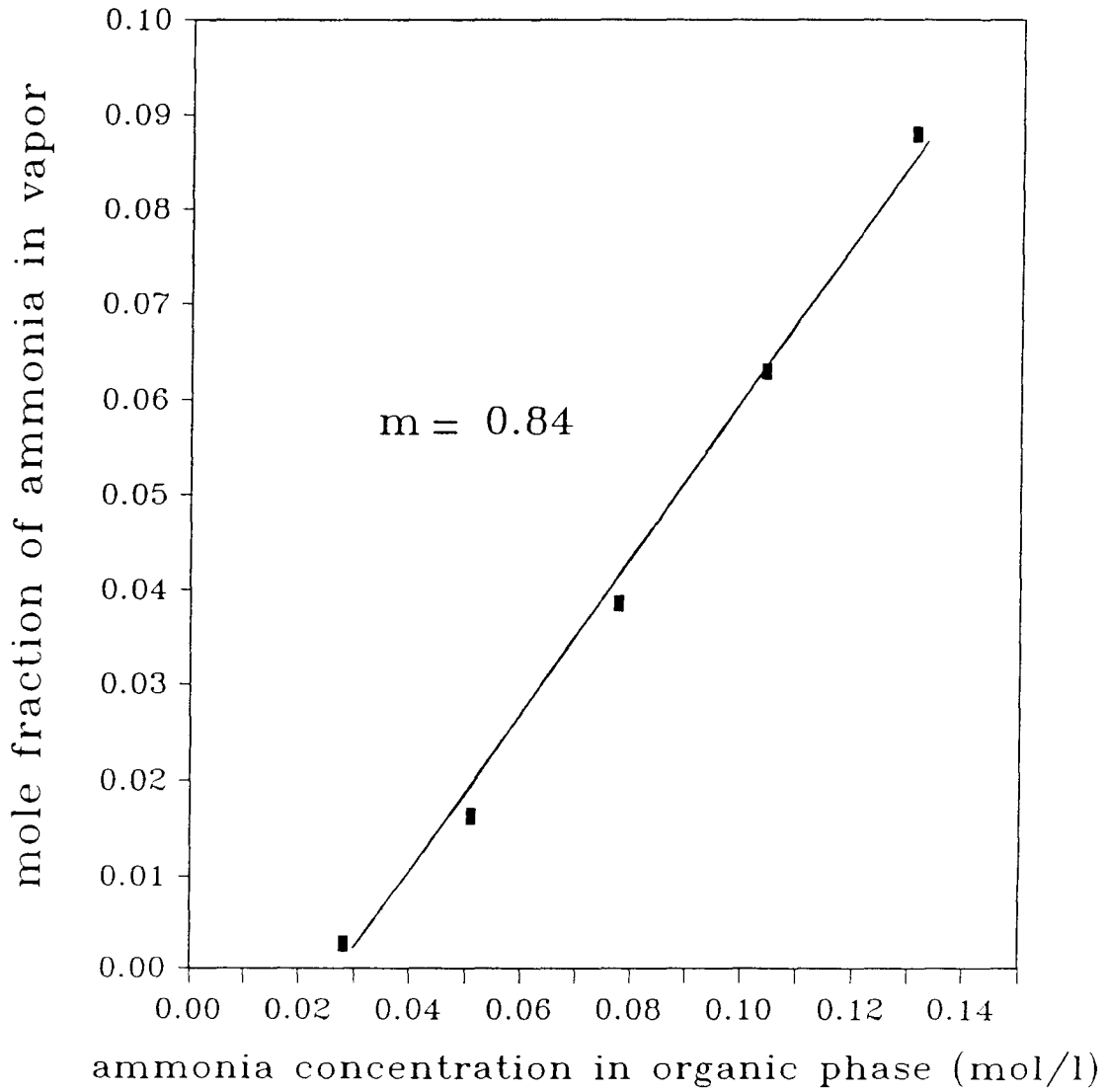

12.2 Process Costs

The goal of this work is to improve the sour water treatment process developed by Mackenzie and King (1,2) through the identification of an alternative liquid cation exchanger. Mackenzie determined that in order for the combined stripping/extraction process to be economically feasible, the liquid cation exchanger must be more stable thermally, less water soluble, and/or weaker in acidity than D2EHPA. Table 12-2 gives a summary of the major operating costs of the sour water treatment process with D2EHPA as the extractant for a sour water feed containing 0.6M NH_3 and approximately 0.3M CO_2 . Mackenzie (2) calculated a total operating cost of \$15.40/1000 gallons of water; this cost includes the energy requirement for an ammonia fractionation column, but does not include other operating costs such as labor, maintenance and insurance.

The dominant operating cost is that required to replace the extractant that is lost to the aqueous phase. Mackenzie (2) estimated that D2EHPA would have a solubility in the treated sour water of 550 ppm. This value is based on the results of extraction experiments intended to simulate a countercurrent extraction column. Two batch extraction experiments were performed. In the first extraction, a solvent phase was contacted with an aqueous NH_4HCO_3 solution. In the second extraction, the ammonia-depleted raffinate from the previous extraction was contacted with fresh organic solvent. The D2EHPA present in the aqueous phase after these two extraction steps was then determined by means of a phosphorus measurement.

Table 12-2. Major Operating Costs of Sour Water Treatment Processes

	COST (\$/1000 gal water)
COMBINED STRIPPING/EXTRACTION ^a	
Sour Water Feed = 0.6M NH ₃ , 0.3M CO ₂ Solvent = 0.25N D2EHPA in inert diluent ^b S/W (v/v) = 4.9	
Steam Requirement for Acid-Gas Stripper: 0.04 lb steam/lb water @ \$2/1000 lb	0.67
D2EHPA Solubility Losses: 550 ppm @ \$2.65 ^c /lb	12.00
Steam Requirement for Solvent Regenerator: 0.14 lb steam/lb water @ \$2/1000 lb	2.30
Steam Requirement for Ammonia Fractionator: 0.025 lb steam/lb water @ \$2/1000 lb	0.42
Total:	15.40
WASTE WATER TREATING	
Sour Water Feed ^d : 0.65M NH ₃ , 0.65M H ₂ S	
Total Steam Requirement for NH ₃ Stripper and for H ₂ S Stripper ^d : 3.7 lb steam/gal water @ \$2/1000 lb (0.44 lb steam/lb water)	7.40
PHOSAM-W	
Sour Water Feed ^e : 1M NH ₃ , 0.75M CO ₂ , 0.003M H ₂ S	
Total Steam Requirements ^e : 0.29 lb steam/lb water @ \$2/1000 lb	4.80
Chemical Makeup ^e : H ₃ PO ₄ (\$26.5 ^f /100 lbs 75%)	0.07
NaOH (\$265 ^f /ton 50% soln)	0.37
Total:	5.24

^afrom ref. 2

^btoluene for K_c and solubility data, Norpar 12 for regeneration data

^c1989 price, Albright and Wilson, Americas

^dfrom ref. 10, ^efrom ref. 11, ^ffrom ref.13

Also given in Table 12-2 are the operating costs of the Chevron WWT process (10) and Phosam-W process (11,12) for comparison with the costs calculated by Mackenzie and shown in the same table for the combined stripping/extraction process. The references cited considered different compositions for the feed water than that postulated by Mackenzie, but the compositions are similar enough to enable a meaningful comparison. Utilities costs have been converted to a common basis.

The Chevron WWT process was described in Chapter 7, Section 2.3.2. A major operating cost of this process is the steam required for the ammonia stripper and the hydrogen sulfide stripper. For a sour water feed containing approximately 0.65M NH_3 and 0.65M H_2S , 3.7 lb of 150 psig steam are required per gallon of water (10). If the steam cost (\$2/1000 lb) used by Mackenzie (2) is assumed, this steam requirement corresponds to a cost of \$7.4/1000 gallons of water.

The Phosam-W process was described in Chapter 7, Section 2.3.1. Steam requirements represent a major operating cost (11); steam is required for the superstill, the stripper, and the ammonia fractionator. For a sour water feed containing 1M NH_3 , 0.75 M CO_2 , and 0.003M H_2S , the total steam requirement is about 0.29 lb steam/lb water (11) corresponding to a cost of \$4.8/1000 gallons of water. The 1979 cost of chemical makeup (75% phosphoric acid - \$17/100 lbs, 50% aqueous sodium hydroxide - \$150/ton) was \$0.25/1000 gallons of water (11). Converting to 1990 prices (13), the chemical makeup cost would be about \$0.44/1000 gallons.

With D2EHPA as the liquid cation exchanger, the operating costs of the combined stripping/extraction process exceed those of the WWT and Phosam-W processes. The effect on process costs of the use of Cyanex 272 instead of D2EHPA will now be discussed.

12.2.1 Steam Required for Acid-Gas Stripper

As the sour water passes through an extraction stage, the pH will be lowered due to the removal of ammonia. A decrease in the pH of the sour water will increase the partial pressures of the acid gases. The steam requirement for the acid-gas stripper is inversely proportional to the partial pressures of the acid gases.

Table 12-3 shows the partial pressure of CO_2 at 100°C (a likely operating temperature for the acid-gas stripper) above an aqueous solution containing 0.3M CO_2 , as a function of pH (2). For each pH value, the associated molar ratio of CO_2 to NH_3 in solution is given, assuming no other acids or bases are present (2). A decrease in pH from 8.1 to 6.5 increases the partial pressure of CO_2 by a factor of 2; a decrease in pH from 8.1 to 5.5 increases the partial pressure of CO_2 by a factor of 4.

The pH of the sour water on a given stage of the stripping column will depend on the values of V_g/W and W/S . Referring to Figure 10-1, the pH of the sour water leaving an extraction stage is not likely to fall below 6.5 if Cyanex 272 is the extractant, particularly at the dilute end (the

Table 12-3. Partial Pressure of CO₂ versus pH
Aqueous CO₂ Concentration = 0.3M
(from Mackenzie [2], calculated using computer program: "TIDES"[5])

pH (25°C)	CO ₂ /NH ₃ (molar ratio)	P _{CO₂} at 100°C (atm)
5.5	7.1	29.5
6.5	1.5	14.1
8.1	0.9	6.6
9.1	0.5	2.0

bottom) of the stripper. With D2EHPA as the extractant, an exit pH of 5.5 is possible (see Figure 10-2).

The steam requirement for removing both NH_3 and CO_2 from solution in a conventional acid-gas stripper is about 0.15 lb steam/lb water (11). (Energy requirements range from 0.08 to 0.2 lb steam/lb water for stripping columns operated at about 25 psia and temperatures greater than 100°C [11,14].) The steam requirement given in Table 12-2 for the acid-gas stripper in the combined stripping/extraction process was calculated by dividing this value by 4 -- the factor by which the partial pressure of CO_2 will be increased if D2EHPA is the extractant (2). This is a conservative estimate as the steam requirement for effective removal of CO_2 in a conventional acid-gas stripper is less than 0.15 lb steam/lb water.

With Cyanex 272 as the extractant for ammonia, the corresponding estimate for the steam requirement of the acid-gas stripper would be 0.07 lb steam/lb water, as the partial pressure of CO_2 is expected to increase by only a factor of 2 in comparison with the conventional case. If the steam cost (\$2/1000 lb) used by Mackenzie (2) is assumed, this steam requirement corresponds to a cost of \$1.17/1000 gallons of water.

12.2.2 Cost of Aqueous Solubility Losses of the Extractant

The aqueous solubility of acidic extractants has been found to increase with increasing pH, a sharp rise in solubility occurring above the pK_a of the acid (2,15). The distribution of an organic acid between the organic

solvent and aqueous phases can be represented by:

$$[HA] = (HA) = (H^+) + (A^-) \quad (12-1)$$

where HA is the organic acid, the brackets denote concentrations in the organic phase, the parentheses denote concentrations in the aqueous phase, and the acid dissociates in the aqueous phase (2). The equilibrium constant for this reaction can be expressed as:

$$K_d = \frac{a_{H^+} (A^-) \gamma_{A^-,a}}{[HA] \gamma_{HA,o}} \quad (12-2)$$

where a_{H^+} is the aqueous-phase hydrogen ion activity, $\gamma_{A^-,a}$ is the activity coefficient of the ionized acid in the aqueous phase, and $\gamma_{HA,o}$ is the activity coefficient of the acid in the organic phase. The type of diluent used will affect the value of $\gamma_{HA,o}$.

The total concentration of acid in the aqueous phase, P, can be written as:

$$P = (A^-) + (HA) + (NH_4^+A^-) \quad (12-3)$$

where $NH_4^+A^-$ is the ammonia/acid ion pair. If the pH of the aqueous phase is significantly higher than the pK_a of the acid, then (HA) is small compared to (A^-) . If it is further assumed that the ion pair will be almost completely dissociated due to the high dielectric constant of water, then the quantity $(NH_4^+A^-)$ will be negligible, and

$$P = (A^-), \quad \text{high pH} \quad (12-4)$$

Substituting Equation 12-4 in Equation 12-2, gives the following equation for the aqueous phase concentration of the acid:

$$P = \frac{K_d [HA] \gamma_{HA,o}}{a_{H^+} \gamma_{A^-,a}}, \quad \text{high pH} \quad (12-5)$$

The extraction of ammonia from aqueous solution by an organic acid was described by Equation 10-1. The equilibrium constant for this reaction expressed in terms of activities (rather than concentrations, as in Equation 10-2) is:

$$K_r = \frac{[NH_4^+ A^-] \gamma_{NH_4+A^-,o} a_{H^+}}{[HA] \gamma_{HA,o} (NH_4^+) \gamma_{NH_4^+,a}} \quad (12-6)$$

where the subscripts o and a denote the organic and aqueous phases, respectively. Combining Equations 12-6 and 12-5 gives the following equation for P :

$$P = \frac{K_d [NH_4^+ A^-] \gamma_{NH_4+A^-,o}}{K_r (NH_4^+) \gamma_{NH_4^+,a} \gamma_{A^-,a}} \quad (12-7)$$

Again, for a given organic acid extractant, the type of diluent used will affect the values of K_d , K_r , and the organic-phase activity coefficients. The values of the aqueous-phase activity coefficients will be affected by the salt concentration of the aqueous phase.

From Equations 12-5 and 12-7, it can be seen that the aqueous solubility losses of the extractant will be affected by the aqueous phase pH,

the organic-phase concentration of the extractant, the ratio of the concentration of extracted ammonia to the concentration of ammonium ion in the aqueous phase, the type of diluent used, and the salt concentration of the aqueous phase. A diluent that serves to solvate the organic acid will decrease $\gamma_{HA,o}$, thereby decreasing extractant losses; a diluent that interacts with the ion pair will decrease $\gamma_{NH_4+A^-,o}$, again lowering extractant losses. High aqueous-phase salt concentrations have been found to lower solubility losses due to the resultant increase in $\gamma_{A^-,a}$ (15-17).

Table 12-4 shows aqueous solubility losses of di-2,4,4-trimethylpentyl phosphinic acid (the active component of Cyanex 272) resulting from the contact of undiluted Cyanex 272 with an aqueous solution. Also shown is the aqueous-phase phosphorus concentration (previously reported in Table 11-2) resulting from the contacting of 0.2N washed Cyanex 272 in Norpar 12 with an equal volume of 0.5N NH_4HCO_3 . This phosphorus concentration corresponds to 1130 $\mu\text{g/ml}$ phosphinic acid at an aqueous pH of 7.7.

If, as in the previous section, the pH of the sour water leaving an extraction stage is assumed to be 6.5, the extractant solubility losses that would occur if 0.2N washed Cyanex 272 in Norpar 12 were used as the extractant in the sour water treatment process can be estimated using Equation 12-5 to be 71 ppm (1130 ppm times the ratio of the antilogs of the pH values). This is a rough estimate, as more experimental data are needed to confirm the relationship expressed in Equation 12-5.

This value for the aqueous solubility of the extractant (71 ppm) can

**Table 12-4. Aqueous Solubility
of Di-2,4,4-trimethylpentyl Phosphinic Acid**

Solubility in distilled H ₂ O	at pH 2.6:	16 $\mu\text{g/ml}$
	at pH 3.7:	38 $\mu\text{g/ml}$

Source: American Cyanamid Company, ref. 17

Experimental Results at 25°C:

	Resultant Concentrations in Aqueous Phase	
	Phosphorus (mg/ml)	Phosphinic Acid ($\mu\text{g/ml}$)
	-----	-----
Organic Phase: washed Cyanex 272 - 15 ml (2.44N phosphinic acid)		
Aqueous Phase: distilled H ₂ O - 15 ml pH = 5.7	0.01	94
Organic Phase: 0.2N washed Cyanex 272 in Norpar 12 - 15 ml (0.2N phosphinic acid)		
Aqueous Phase: 0.5N NH ₄ HCO ₃ - 15 ml pH = 7.7	0.12	1130

not be compared directly to the value (550 ppm) in Table 12-2, as that value corresponds to a higher concentration of extractant (0.25N) in a different diluent (toluene). The solubility loss corresponding to 0.25N Cyanex 272 should be higher than that for a concentration of 0.2N; however, the use of toluene rather than Norpar 12 as the diluent would lower solubility losses due to the higher polarizability of toluene.

An aqueous solubility loss of 71 ppm of the phosphinic acid corresponds to 0.59 lb of phosphinic acid per 1000 gal of sour water. At a replacement cost of \$10/lb (18) for Cyanex 272 (which consists of 85 wt.% phosphinic acid) the cost of the solubility losses would be \$6.9/1000 gallons of water.

Table 11-2 showed the increase in extractant solubility losses that resulted after heating the extractant at either 125°C or 150°C for 5 hours. The extractant that had been heated at 125°C showed a 1% increase in the amount (in terms of weight) of extractant lost to the aqueous phase which would correspond to an additional cost of \$0.07/1000 gallons of water. The extractant that had been heated at 150°C showed a 2% increase in the amount (in terms of weight) of extractant lost to the aqueous phase which would correspond to an additional cost of \$0.14/1000 gallons of water.

12.2.3 Steam Required for Solvent Regeneration Column

The steam requirement for the solvent regeneration column is inversely proportional to the partial pressure of ammonia above the solution. The

experimental data given in Figure 11-1 show that at a given concentration of ammonia in solution, the partial pressure of ammonia above a solution of 0.48N as-received Cyanex 272 in Norpar 12 is more than 20 times larger than that above a solution of 0.48N D2EHPA in Norpar 12. Therefore substantially less energy will be required to recover ammonia from loaded Cyanex 272 solution than from a solution of D2EHPA.

The steam requirement (0.14 lb steam/lb sour water feed) given in Table 12-2, includes the energy necessary to vaporize the coextracted water (0.059 lb steam/lb sour water feed) present in the loaded D2EHPA solvent at a concentration of 1.1M -- 6 times that of the ammonia (0.18M). In this work, the water concentrations of loaded organic solutions of Cyanex 272 were not measured. However, the experimental results of Inoue et al. (3), which were discussed in Section 1.1 of this chapter, indicate that the concentrations of coextracted water would be lower for a solution of Cyanex 272 than for D2EHPA.

If the energy required to remove the ammonia from the loaded Cyanex 272 solution is assumed to be 1/20 that required for the loaded D2EHPA solution, and the amount of coextracted water is assumed to be present at a concentration 3 times that of the ammonia, then an estimate of the steam requirement for the solvent regeneration column would be 0.03 lb steam/lb of sour water. At a steam cost of \$2/1000 lb, this steam requirement corresponds to a cost of \$0.50/1000 gallons of sour water.

12.2.4 Additional Process Operating Costs

The operating cost estimates for the combined stripping/extraction process with Cyanex 272 as the extractant are given in Table 12-5. The energy cost for the ammonia fractionation column is also given. The steam requirement for the fractionation of aqueous ammonia into ammonia and water is about 0.3 lb steam/lb aqueous ammonia (11). This corresponds to a steam requirement of 0.013 lb steam/lb sour water feed.

Mackenzie (1,2) found that K_c values decrease with increasing temperature, therefore the solvent extraction part of the process would most likely operate at a lower temperature than the acid-gas stripper, which would operate at about 100°C. There would be an additional operating cost involved in heating and cooling the aqueous stream as it passes between the acid-gas stripper and the extraction stages. Heat exchangers can be used to effect heat transfer between exiting and entering aqueous streams; however, some additional steam and cooling water would most likely be required.

There would also be an operating cost involved in heating the loaded solvent stream to the temperature of the solvent regeneration column. Again, heat exchange between the solvent stream entering the column and the solvent stream exiting the column can be used to reduce this steam cost.

Table 12-5. Operating Cost Estimates

	COST (\$/1000 gal water)
COMBINED STRIPPING/EXTRACTION PROCESS	
Sour Water Feed = 0.6M NH ₃ , 0.3M CO ₂	
Solvent = 0.25N washed Cyanex 272 in inert diluent	
S/W (v/v) = 4.9	
Steam Requirement for Acid-Gas Stripper:	
0.07 lb steam/lb water @ \$2/1000 lb	1.17
Solubility Losses of the phosphinic acid:	
71 ppm @ \$10 ^a /lb for Cyanex 272 (85 wt.% phosphinic acid)	6.90
Steam Requirement for Solvent Regenerator:	
0.03 lb steam/lb water @ \$2/1000 lb	0.50
Steam Requirement for Ammonia Fractionator:	
0.013 lb steam/lb water @ \$2/1000 lb	0.21
Total:	8.78

^a1989 price, American Cyanamid Company

12.3 Summary and Conclusions

An alternative liquid cation exchanger, Cyanex 272, has been proposed for use in the combined stripping/extraction process developed by Mackenzie and King (1,2). The feasibility of the use of Cyanex 272 in this sour water treatment process has been explored through experimental work designed to simulate the process steps in which the liquid cation exchanger is used. Cyanex 272 has been found to be a good extractant for ammonia from aqueous solutions of the pH range typical of sour waters; i.e., 7.5-9.5. Thermal regeneration experiments have shown that ammonia can be recovered from a loaded organic solution of Cyanex 272 by stripping at elevated temperatures, with 99% recovery of the ammonia being obtained at 125°C.

The thermal stability of di-2,4,4-trimethylpentyl phosphinic acid (the active component of Cyanex 272) was examined up to a temperature of 150°C. Preliminary results indicate that 2 wt.% of the acid decomposes as a result of heating at 150°C for 5 hours, while 1 wt.% of the acid decomposes as a result of heating at 125°C for 5 hours.

The sum of the major operating costs of the combined stripping/extraction process using Cyanex 272 as the liquid cation exchanger is comparable to those of two industrial sour water treatment processes, the WWT process and the Phosam-W process, allowing for the fact that there is substantial uncertainty in the cost of replacing lost dissolved extractant. The combined stripping/extraction process serves to substantially lower the

energy cost for the removal of ammonia and acid gases from sour water; however, there is a high cost involved in replacing the extractant that is lost to the aqueous phase. An additional process step to recover this extractant could serve to reduce the overall cost of the process. This process step could involve passing the treated water stream through a packed column containing a polymeric sorbent, regenerated by leaching with an appropriate organic solvent. This recovery of the dissolved extractant from the treated water stream would most likely be necessary before discharge of the water to the environment.

REFERENCES

1. Mackenzie, P.D. and King, C.J., "Combined Solvent Extraction and Stripping for Removal and Isolation of Ammonia from Sour Waters", Ind. Eng. Chem. Process Des. Dev., Vol. 24, No. 4, 1192-1200 (1985).
2. Mackenzie, P.D., "Simultaneous Stripping and Solvent Extraction for the Recovery of Ammonia and Acid Gases from Wastewaters", Ph.D. Dissertation, Department of Chemical Engineering, University of California, Berkeley (1984). LBL-17740.
3. Inoue, K., Nakayama, D., and Watanabe, Y., "Extraction Equilibria of Ammonia with Acidic Organophosphorus Compounds", Hydrometallurgy, 16, 41-53 (1986).
4. Pawlikowski, E.M., Newman, J., and Prausnitz, J.M., "Vapor-Liquid Equilibrium Calculations for Aqueous Mixtures of Volatile, Weak Electrolytes and other Gases for Coal-Gasification Processes", Chemical Engineering Thermodynamics, Newman, S.A., Ed., Ann Arbor Science Publishers, Chapter 27, 323-337 (1982).
5. Pawlikowski, E.M., "Vapor-Liquid Equilibria for Volatile, Weak Electrolytes in Aqueous Solutions", Ph.D. Dissertation, Department of Chemical Engineering, University of California, Berkeley (1981).
6. "n-Undecane", The Humphrey Chemical Company, North Haven, Connecticut (1980).
7. Industrial Solvents Handbook, 3rd ed., Flick, E.W., Ed., Noyes Data Corporation (1985).
8. The Merck Index, 10th ed., Windholz, M., Ed., Merck & Co., Inc., Rahway, New Jersey (1983).
9. King, C.J., Separation Processes, 2nd ed., McGraw-Hill, Inc. (1980).
10. Leonard, J.P., Haritatos, N.J., and Law, D.V., "Treating Acid and Sour Gas: Waste Water Treating Process", Chem. Eng. Prog., 57-60 (October, 1984).
11. Seufert, F.B., Hicks, R.E., Wei, I.W., and Goldstein, D.J., "Conceptual Designs for Water Treatment in Demonstration Plants", U.S. Dept. of Energy (March, 1979). FE-2635-TI.
12. Eriksson, S., and Prior, M., "Treatment of Liquid Effluents from Coal Gasification Plants", Economic Assessment Service (March, 1979). EAS B2/79.
13. "Chemical Prices", Chemical Marketing Reporter, p. 32-34 (January 8, 1990).

14. Darton, R.C., van Grinsven, P.F.A., and Simon, M.M., "Development in Steam Stripping of Sour Water", The Chemical Engineer, No. 339, 923-927 (December, 1978).
15. Ashbrook, A.W., "The Extraction of Metals from Ammonium Sulphate Solution Using a Carboxylic Acid-I. Cobalt", J. Inorg. Nucl. Chem., Vol. 34, 1721-1737 (1972).
16. Grinstead, R.R., and Davis, J.C., "Extraction by Phase Separation with Mixed Ionic Solvents. Recovery of Magnesium Chloride from Sea Water Concentrates", Ind. Eng. Chem. Prod. Res. Dev., Vol. 9, No. 1, 66-72 (1970).
17. "Cyanex 272 Extractant", American Cyanamid Company, Industrial Products Division, Phosphine Chemicals, Wayne, New Jersey (1985).
18. American Cyanamid Company, personal communication (1989).

APPENDIX A. EXPERIMENTAL DATA

A.1 Ammonia Extraction Experiments

This section gives the experimental results for the extraction of ammonia from aqueous buffer solution into organic solutions of di-2,4,4-trimethylpentyl phosphinic acid.

Table A-1. Extraction at 25°C with As-Received Cyanex 272

Initial Organic Phase: 0.2N Cyanex 272 in Norpar 12

Initial Aqueous Phase: 0.48M NaOH, 0.36M NaHCO₃, and 0.13M NH₃
 added as (NH₄)₂CO₃
 pH of aqueous phase was varied by the addition
 of small amounts of 12.1N HCl

Organic to Aqueous Phase Ratio: 1/1 (v/v)

Final Aqueous pH	Third Phase?	NH ₃ in Final Aqueous Phase (M)	NH ₃ in Final Organic Phase (M)
8.00		0.0943	0.0388
7.30		0.107	0.0179
7.18		0.110	0.0123
0.81		0.112	0.000454
8.15		0.0848	0.0394
9.95	yes	0.112	0.00239
8.72	yes	0.0868	0.00103
7.37		0.105	0.0199
0.96		0.115	0.000462
7.45		0.105	0.0221
7.80		0.0963	0.0319

Table A-1. (continued)

Initial Organic Phase: 0.2N Cyanex 272 in undecane

Initial Aqueous Phase: 0.48M NaOH, 0.36M NaHCO₃, and 0.125M NH₃
 added as (NH₄)₂CO₃
 pH of aqueous phase was varied by the addition
 of small amounts of 12.1N HCl

Organic to Aqueous Phase Ratio: 4/3 (v/v)

Final Aqueous pH	Third Phase?	NH ₃ in Final Aqueous Phase (M)
7.73		0.081
7.77		0.077
7.91		0.076

Table A-2. Extraction at 25°C with Washed Cyanex 272

Initial Organic Phase: 0.2N Washed Cyanex 272 in Norpar 12

Initial Aqueous Phase: 0.48M NaOH, 0.36M NaHCO₃, and 0.15M NH₃
 added as (NH₄)₂CO₃
 pH of aqueous phase was varied by the addition
 of small amounts of 12.1N HCl

Organic to Aqueous Phase Ratio: 1/1 (v/v)

Final Aqueous pH	Third Phase?	NH ₃ in Final Aqueous Phase (M)	NH ₃ in Final Organic Phase (M)
7.95		0.112	0.0259
7.48		0.118	0.0201
7.52		0.124	0.0147
1.08		0.130	0.000561
7.64		0.119	0.0217
0.75		0.128	0.000591
1.82		0.133	0.00129
9.60	yes	0.102	0.00103
8.51	yes	0.0884	0.00231
8.25		0.0978	0.0375
7.81		0.0939	0.0381

Table A-3. Extraction at 25°C with the Purified Phosphinic Acid

Initial Organic Phase: 0.2N di-2,4,4-trimethylpentyl phosphinic acid
in Norpar 12

Initial Aqueous Phase: 0.48M NaOH, 0.36M NaHCO₃, and 0.13M NH₃
added as (NH₄)₂CO₃
pH of aqueous phase was varied by the addition
of small amounts of 12.1N HCl

Organic to Aqueous Phase Ratio: 4/3 (v/v)

Final Aqueous pH	Third Phase?	NH ₃ in Final Aqueous Phase (M)	NH ₃ in Final Organic Phase (M)
7.64		0.0864	0.0283
7.54		0.102	0.0248
1.56		0.114	0.000273
0.87		0.125	0.000475
1.93		0.128	0.000384

**Table A-4. Extraction at 25°C with Washed,
Previously Heated Cyanex 272**

Initial Organic Phase: 0.2N Washed Cyanex 272 (Previously Heated at 125°C for 5 hours) in Norpar 12

Initial Aqueous Phase: 0.48M NaOH, 0.36M NaHCO₃, and 0.15M NH₃ added as (NH₄)₂CO₃
pH of aqueous phase was varied by the addition of small amounts of 12.1N HCl

Organic to Aqueous Phase Ratio: 1/1 (v/v)

Final Aqueous pH	Third Phase?	NH ₃ in Final Aqueous Phase (M)	NH ₃ in Final Organic Phase (M)
9.64	yes	0.108	0.000811
0.98		0.125	0.000409
0.64		0.126	0.000340
7.43		0.106	0.0180
7.38		0.111	0.0145
8.55	yes	0.0902	0.000844
8.01		0.0962	0.0263
7.84		0.0944	0.0343
7.79		0.0921	0.0329
7.53		0.0983	0.0209
7.58		0.0979	0.0215

Table A-4. (continued)

Initial Organic Phase: 0.2N Washed Cyanex 272 (Previously Heated at 150°C for 5 hours) in Norpar 12

Initial Aqueous Phase: 0.48M NaOH, 0.36M NaHCO₃, and 0.15M NH₃ added as (NH₄)₂CO₃
pH of aqueous phase was varied by the addition of small amounts of 12.1N HCl

Organic to Aqueous Phase Ratio: 1/1 (v/v)

Final Aqueous pH	Third Phase?	NH ₃ in Final Aqueous Phase (M)	NH ₃ in Final Organic Phase (M)
9.63	yes	0.120	0.000469
8.26	yes	0.101	0.000872
8.00		0.100	0.0133
7.62		0.110	0.0365
7.61		0.111	0.0344
7.49		0.115	0.0253
7.42		0.117	0.02405
7.36		0.118	0.0230
7.39		0.116	0.0249
7.39		0.111	0.0227
1.45		0.122	0.000543
7.36		0.0978	0.0260

A.2 Thermal Regeneration of Loaded Cyanex 272 Solutions

This section gives the experimental results of thermal regeneration experiments in which ammonia is driven off from an organic extractant solution of as-received Cyanex 272 in Norpar 12.

Table A-5. Removal of Ammonia from Loaded Extractant Solution at 125°C

Initial Organic Solution: 100 ml of 0.23N NH₃ and 0.48N Cyanex 272 in Norpar 12

Pressure of System: 1.06-1.07 atm

Flowrate of Nitrogen: 0.013-0.014 ft³/min

Cumulative Flow of N ₂ (ft ³)	Δ N ₂ (moles)	NH ₃ absorbed (mmoles)	Avg. Conc. of NH ₃ in organic solution (M)	P _{NH₃} x 10 ² (atm)
0			0.23	
0.095	0.118	2.92	0.22	2.59 ¹
0.12	0.0254	2.91	0.19	10.9 ²
0.14	0.0260	2.78	0.16	10.3 ³
0.16	0.0274	2.64	0.13	9.32
0.19	0.0395	2.66	0.10	6.73
0.24	0.0667	2.67	0.078	4.08
0.37	0.160	2.66	0.051	1.75
0.98	0.746	1.92	0.028	0.272

¹Temperature of system: 55°C-105°C

²Temperature of system: 112°C-118°C

³Temperature of system: 123°C

final concentration of ammonia in organic solvent: 0.0016M

Table A-5. (continued)

Initial Organic Solution: 200 ml of 0.1N NH_3 and 0.48N Cyanex 272
in Norpar 12

Pressure of System: 1.06-1.07 atm

Flowrate of Nitrogen: 0.013-0.014 ft^3/min

Cumulative Flow of N_2 (l)	ΔN_2 (moles)	NH_3 absorbed (mmoles)	Avg. Conc. of NH_3 in organic solution (M)	$P_{\text{NH}_3} \times 10^2$ (atm)
0			0.1	
4.47	0.197	2.33	0.094	1.25 ¹
5.86	0.0607	2.31	0.083	3.89
7.63	0.0784	2.23	0.071	2.96

¹Temperature of System: 115°C

final concentration of ammonia in organic solvent: 0.001M

Table A-6. Removal of Ammonia from Loaded Extractant Solution at 120°C

Initial Organic Solution: 80 ml of 0.1N NH_3 and 0.2N Cyanex 272 in Norpar 12

Pressure of System: 1.04 atm

Flowrate of Nitrogen: 0.013-0.014 ft^3/min

Cumulative Flow of N_2 (l)	ΔN_2 (moles)	NH_3 absorbed (mmoles)	Avg. Conc. of NH_3 in organic solution (M)	$P_{\text{NH}_3} \times 10^2$ (atm)
0			0.1	
0.28	0.0121	0.680	0.0958	5.53
0.555	0.0119	0.640	0.0589	5.31
0.865	0.0134	0.632	0.0510	4.67
1.23	0.0157	0.616	0.0431	3.95
1.76	0.0230	0.624	0.0354	2.73
2.42	0.0288	0.608	0.0277	2.18
3.54	0.0481	0.624	0.0200	1.32
5.52	0.0860	0.608	0.0123	0.74

final concentration of ammonia in organic solvent: 0.006M

APPENDIX B. NOMENCLATURE

Chapter 8

K_c distribution ratio of ammonia, (mol/L)/(mol/L)

Chapter 10

HA liquid cation exchanger (organic acid)

[] organic-phase concentration

() aqueous-phase concentration

K_b dissociation constant of aqueous ammonia

K_w ionization constant of water

K_a ionization constant of the ammonium ion

K_c distribution ratio of ammonia, (mol/L)/(mol/L)

D partition ratio of ammonia, (mol/L)/(mol/L)

Φ volume fraction of diluent in the organic phase

M^+ monovalent cation

K_{c,M^+} distribution ratio of monovalent cation

Chapter 11

K equilibrium constant for the reaction: $NH_4^+A^- = NH_3\uparrow + HA$, atm

P_{NH_3} partial pressure of ammonia, atm

Chapter 12

W/S	water to solvent flow ratio
V_s	steam flowrate
W	water flowrate
V_r	vapor flowrate
m	slope of equilibrium curve
HA	liquid cation exchanger (organic acid)
P	total concentration of acid in the aqueous phase
[]	organic-phase concentration
()	aqueous-phase concentration